



# HOW THE ARMY RUNS

*A Senior Leader Reference Handbook*

2011–2012



*U.S. Army War College, Carlisle, PA 17013*

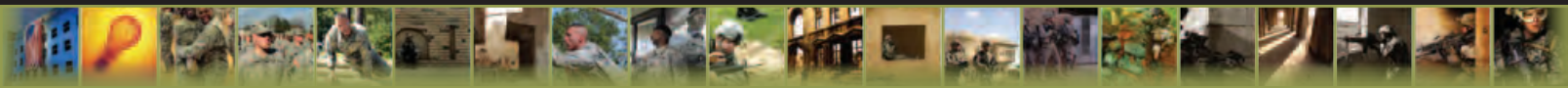

## Report Documentation Page

*Form Approved*  
*OMB No. 0704-0188*

Public reporting burden for the collection of information is estimated to average 1 hour per response, including the time for reviewing instructions, searching existing data sources, gathering and maintaining the data needed, and completing and reviewing the collection of information. Send comments regarding this burden estimate or any other aspect of this collection of information, including suggestions for reducing this burden, to Washington Headquarters Services, Directorate for Information Operations and Reports, 1215 Jefferson Davis Highway, Suite 1204, Arlington VA 22202-4302. Respondents should be aware that notwithstanding any other provision of law, no person shall be subject to a penalty for failing to comply with a collection of information if it does not display a currently valid OMB control number.

1. REPORT DATE <b>2011</b>	2. REPORT TYPE	3. DATES COVERED <b>00-00-2011 to 00-00-2011</b>	
4. TITLE AND SUBTITLE <b>How the Army Runs: A Senior Leader Reference Handbook, 2011-2012.</b>		5a. CONTRACT NUMBER	
		5b. GRANT NUMBER	
		5c. PROGRAM ELEMENT NUMBER	
6. AUTHOR(S)		5d. PROJECT NUMBER	
		5e. TASK NUMBER	
		5f. WORK UNIT NUMBER	
7. PERFORMING ORGANIZATION NAME(S) AND ADDRESS(ES) <b>U.S. Army War College, Carlisle Barracks, PA, 17013</b>		8. PERFORMING ORGANIZATION REPORT NUMBER	
9. SPONSORING/MONITORING AGENCY NAME(S) AND ADDRESS(ES)		10. SPONSOR/MONITOR'S ACRONYM(S)	
		11. SPONSOR/MONITOR'S REPORT NUMBER(S)	
12. DISTRIBUTION/AVAILABILITY STATEMENT <b>Approved for public release; distribution unlimited</b>			
13. SUPPLEMENTARY NOTES			
14. ABSTRACT			
15. SUBJECT TERMS			
16. SECURITY CLASSIFICATION OF:			17. LIMITATION OF ABSTRACT
a. REPORT <b>unclassified</b>	b. ABSTRACT <b>unclassified</b>	c. THIS PAGE <b>unclassified</b>	<b>Same as Report (SAR)</b>
			18. NUMBER OF PAGES <b>650</b>
			19a. NAME OF RESPONSIBLE PERSON

**Disclaimer: The systems, processes and views described in this book reflect the judgments and interpretations of authors and editors and do not necessarily represent the official policies or positions of the Department of the Army (DA), the Department of Defense (DOD), or the U.S. Government. The text is a synthesis and interpretation of existing and developing Army and Joint systems, processes and procedures as currently practiced and is intended only for instructional purposes within the U.S. Army War College and as an informal desk reference for its graduates and other interested organizations and project officers.**



DEPARTMENT OF THE ARMY  
UNITED STATES ARMY WAR COLLEGE AND CARLISLE BARRACKS  
CARLISLE, PENNSYLVANIA 17013-5210

REPLY TO  
ATTENTION OF

Office of the Commandant

The U.S. Army War College (USAWC) is proud to present the 28th Edition of *How the Army Runs: A Senior Leader Reference Handbook, 2011-2012*. Publication of this text at this time, when the Army has been at war for almost a decade, has almost completed restructuring of its operating force, and is addressing the structure of the generating force, as well as completing formidable base closure and restationing actions, gives credence to the enduring truth that in order to be successful the Army must sustain and improve itself while it is fully committed to the Nation's bidding. The systems and processes documented and explained in this work are designed to do just that.

This edition is being released electronically on both fixed media (CD) and on the USAWC Internet site at: <http://www.carlisle.army.mil/usawc/dclm/htar2012.htm>. It will also be published in hard copy. The CD includes the ability to link to our Internet site where changes will be posted between complete updates.

This text was prepared under the direction of the faculty of the Department of Command, Leadership, and Management. It is intended to be used in an academic environment during the study of the systems and processes used to develop and sustain trained and ready combat forces to be used by the Combatant Commanders. It has also found great utility as a reference for those who actually use and "run" the organizations, systems, and processes described.

Every effort has been made to ensure that the text accurately describes the systems and processes as they are. While there is no intent to advocate either the reform of the described systems or their continuance, the text does provide a foundation of knowledge for those who are charged with developing potential reforms.

We look forward to your comments regarding the value of the text to you and to your organization.

Sincerely,

A handwritten signature in black ink, appearing to read "Gregg F. Martin".

Gregg F. Martin  
Major General, U.S. Army  
Commandant

Enclosure

## PREFACE

This text is designed to explain and synthesize the functioning and relationships of numerous Defense, Joint, and Army organizations, systems, and processes involved in the development and sustainment of trained and ready forces for the Combatant Commanders.

It is designed to be used by the faculty and students at the U.S. Army War College (as well as other training and educational institutions) as they improve their knowledge and understanding of "How the Army Runs." We are proud of the value that senior commanders and staffs have placed in this text over the years and are pleased to continue to provide this reference.

The text is revised every two years as we strive to capture the most up-to-date information available. This involves the synthesis of a wide array of published and unpublished references from a variety of sources. Necessarily, there is a point in time at which updates must stop.

This volume contains our best description of the systems, processes, and organizations as of March 2011; however, we caution the reader that there may be some inaccuracies as the system or process may have evolved from the description in the text.

We encourage all readers to contribute to its continued development and improvement. Please send your recommendations for changes, improvements, and additions to the Department of Command, Leadership, and Management, U.S. Army War College, Carlisle, Pennsylvania 17013-5240, ATTN: Editor, "How the Army Runs."

To the maximum extent possible these changes will be posted to our Internet site pending the next complete update. The text can also be accessed over the Internet at <http://www.carlisle.army.mil/usawc/dclm/htar2012.htm>.

Request the text contained on this web site not be quoted, extracted for publication, or otherwise copied or distributed without prior coordination with the Department of Command, Leadership, and Management of the U.S. Army War College. (You may contact us at commercial telephone number 717-245-4794.)

The U.S. Army War College also extends its appreciation to the staff and faculty of the Army Force Management School and other contributing organizations for their efforts in the publication of this text.



Harold W. Lord  
Colonel, U.S. Army Retired  
Editor, "How the Army Runs"

## U.S. ARMY WAR COLLEGE FACULTY EDITORS

CHAPTER	TITLE	EDITOR	PHONE # 717-245- DSN 242- 4797	Email Address -@us.army.mil
1	Introduction	Dr Richard Meinhart	4797	Richard.Meinhart
2	Integration of the Army Organizational Life Cycle	Prof Ed Filiberti	3715	Edward.Filiberti
3	Army Structure-The Army as an Organization	Prof Ed Filiberti	3715	Edward.Filiberti
4	The Relationship of Joint and Army Force Planning	Dr Richard Meinhart	4797	Richard.Meinhart
5	Army Force Development	Prof Ed Filiberti	3715	Edward.Filiberti
6	Planning for Mobilization and Deployment	CAPT Doug Waters	4465	Doug.Waters1
7	Reserve Components	COL Oliver Norrell	4514	Oliver.Norrell
8	Force Readiness	CAPT Jim Heffernan	4814	Jim.Heffernan
9	Army Planning, Programming, Budgeting, and Execution System	Prof. Harold Lord	4802	Harold.Lord
10	Resource Management	Prof. Harold Lord	4802	Harold.Lord
11	Material System Research, Development, and Acquisition Management	COL Lou Yuengert	4790	Louis.G.Yuengert
12	Materiel System-Logistics Policy and Procedure	COL Rhonda Urey	3435	Rhonda.Urey
13	Military Human Resource Management	COL Patricia O'Keefe	4793	Patricia.L.Keefe
14	Civilian Personnel Management	DR Sara Morgan	3922	Sara.Morgan
15	Army Training	COL Julie Manta	4791	Julie.Manta
16	Army Knowledge Management	Dr. Jeff Groh	3587	Jeffrey.Groh
17	Installation Command Management	COL Charles Allen	3460	Charles.Allen
18	Army Health Services Support System	COL Steve Rumbaugh	4785	Steven.Rumbaugh
19	Management of Legal Affairs	COL Ken Lassus	3514	Kenneth.Lassus
20	Civil Functions of the Department of the Army	COL Mike Chesney	4808	Michael-Chesney
21	Public Affairs	CH(COL) Dave Reese	4471	Dave.Reese
22	Military Assistance to Civil Authorities	COL Mike Chesney	4808	Michael-Chesney

*Note: If you can not contact a chapter editor, please contact the volume editor Prof Harold Lord*

## Authors/Writers

**Army Force Management School "How the Army Runs"  
Program Manager: Bill J. Laster, COL (Ret)  
Administrator: Thomas A. Story, CW5 (Ret)**

CHAPTER	TITLE	Author/Writer
1	Introduction	Tom Story, CW5 (Ret)
2	Integration of the Army Organizational Life Cycle	David Retherford LTC (RET)
3	Army Structure-The Army as an Organization	Tom Story, CW5 (Ret)
4	The Relationship of Joint and Army Force Planning	Tim Keating, COL (Ret)
5	Army Force Development	Bob Keenan, LTC (Ret); David Retherford, LTC (Ret); James Camp, LTC (RET) Warren Greer, LTC (Ret)
6	Planning for Mobilization and Deployment	John Walsh, COL (Ret)
7	Reserve Components	John Walsh, COL (Ret)
8	Force Readiness	Richard Ledbetter, COL (Ret)
9	Army Planning, Programming, Budgeting, and Execution System	Colin Halvorson, LTC (Ret)
10	Resource Management	John Walsh, COL (Ret)
11	Material System Research, Development, and Acquisition Management	Bob Keenan, LTC (Ret)
12	Materiel System-Logistics Policy and Procedure	Jon Marker, LTC (Ret); Tom Polmateer, LTC (Ret)
13	Military Human Resource Management	Jeff Christianson, COL (Ret); Tom Washburn, LTC (Ret)
14	Civilian Personnel Management	Dr. Nate Ainspan
15	Army Training	Harry Crumling, LTC (Ret)
16	Army Knowledge Management	Joe Albert, MAJ (Ret)
17	Installation Command Management	Jim Waters LTC (Ret)
18	Army Health Services Support System	Leif Johnson, COL (Ret)
19	Management of Legal Affairs	Ron Smith, COL (Ret)
20	Civil Functions of the Department of the Army	Dr. George E. Dickey
21	Public Affairs	Ms. Cathy Ferguson
22	Military Assistance to Civil Authorities	Mark Eshelman, COL (Ret)

The AFMS acknowledges and expresses our appreciation to the HQDA staff and Army agencies who contributed to the update of the Army War College Senior Leader Handbook 2011-2012 version of "How the Army Runs".

**Contents** (Listed by paragraph and page number)

**Chapter 1**  
**Introduction, page 1**

*Section I*

*Fulfilling the Intent of the Congress, page 1*  
Changing How We Manage Change • 1-1, *page 1*  
Managing The Army • 1-2, *page 2*

*Section II*

*Army Focus, page 2*  
Background • 1-3, *page 2*  
Army Posture Statement • 1-4, *page 3*  
The Army Campaign Plan 2011 • 1-5, *page 3*  
Accelerate Change and Future Needs • 1-6, *page 3*  
Transformation • 1-7, *page 4*

*Section III*

*Purpose, Scope, and Objectives of this Text, page 4*  
Purpose • 1-8, *page 4*  
Scope and Objectives • 1-9, *page 5*

*Section IV*

*Text Organization and Relevance, page 5*  
Text Organization • 1-10, *page 5*  
Relevance • 1-11, *page 5*

**Chapter 2**  
**The Army Organizational Life Cycle, page 7**

*Section I*

*Introduction, page 7*  
Chapter content • 2-1, *page 7*  
The Army Organizational Life Cycle Model (AOLCM) • 2-2, *page 7*

*Section II*

*Force management, page 10*  
The Army War College Model • 2-3, *page 10*  
Force management terms. • 2-4, *page 10*

*Section III*

*Coordination of force integration actions, page 12*  
Information exchange as a key element of force integration • 2-5, *page 12*  
The team approach to force integration • 2-6, *page 12*

*Section IV*

*Changing how we manage change, page 14*  
Alterations to force management • 2-7, *page 14*  
Basic Force Management Tools • 2-8, *page 16*

*Section V*

*Summary and references, page 16*  
Summary • 2-9, *page 16*  
References • 2-10, *page 17*

**Chapter 3**  
**Army Organizational Structure, page 19**

*Section I*

*Introduction, page 19*



## How the Army Runs

Chapter content • 3-1, *page 19*  
The Army organizational system • 3-2, *page 19*

### *Section II*

*The production subsystem, page 21*  
Statutory requirements • 3-3, *page 21*  
Production of needed resources • 3-4, *page 21*

### *Section III*

*The combat subsystem, page 24*  
Products of the combat subsystem • 3-5, *page 24*  
The Army in the field • 3-6, *page 24*

### *Section IV*

*The integrating subsystem, page 25*  
Tasks of the integrating subsystem • 3-7, *page 25*  
Differentiation and integration • 3-8, *page 25*

### *Section V*

*Summary and references, page 29*  
Summary • 3-9, *page 29*  
References • 3-10, *page 30*

## **Chapter 4**

### **The Relationship of Joint and Army Planning, page 31**

#### *Section I*

*Introduction, page 31*  
Chapter Content • 4-1, *page 31*  
Secretary of Defense • 4-2, *page 31*  
Other DOD Strategic Guidance • 4-3, *page 31*  
Chairman of the Joint Chiefs of Staff • 4-4, *page 31*  
Joint Strategic Planning System • 4-5, *page 32*  
JSPS Overview • 4-6, *page 32*  
Army Participation in joint planning and resourcing processes • 4-7, *page 33*

#### *Section II*

*Joint Strategic Planning System, page 33*  
JSPS • 4-8, *page 33*  
Chairman's Assessments • 4-9, *page 35*  
Chairman's Advice • 4-10, *page 35*  
Chairman's Direction • 4-11, *page 36*  
The Joint Requirements Oversight Council (JROC) • 4-12, *page 36*  
Capabilities Based Assessments • 4-13, *page 39*

#### *Section III*

*Planning and Resourcing, page 40*  
DOD planning, programming, budgeting system, and execution process (PPBE) • 4-14, *page 40*  
The Army Planning System • 4-15, *page 40*

#### *Section IV*

*The Joint Operations Planning, page 40*  
Joint Operations, Planning and Execution System (JOPES) • 4-16, *page 40*  
Combatant Commands • 4-17, *page 41*  
Relationship of the CJCS to Combatant Commands • 4-18, *page 42*

#### *Section V*

*Summary and References, page 43*  
Summary • 4-19, *page 43*  
References • 4-20, *page 43*

## **Chapter 5** **Army Force Development, page 45**

### *Section I*

*Introduction, page 45*

Force development overview • 5-1, *page 45*

Force development process summary • 5-2, *page 45*

### *Section II*

*Phase I—Develop capability requirements, page 46*

Joint capabilities integration and development system (JCIDS) • 5-3, *page 46*

Army implementation of JCIDS overview • 5-4, *page 46*

Standing integrated capabilities development teams (ICDTs) • 5-5, *page 47*

Concept development and experimentation (CD&E) • 5-6, *page 47*

Capabilities-based assessment (CBA) process • 5-7, *page 51*

### *Section III*

*Phase II—Design organizations, page 56*

Organization design • 5-8, *page 56*

The organization design process • 5-9, *page 56*

### *Section IV*

*Phase III—Develop organizational models, page 57*

TOE and BOIP development • 5-10, *page 57*

TOE description • 5-11, *page 57*

The TOE system • 5-12, *page 58*

TOE review and approval • 5-13, *page 59*

Basis-of-issue plan (BOIP) • 5-14, *page 59*

### *Section V*

*Phase IV—Determine organizational authorizations, page 60*

Determining organizational authorizations • 5-15, *page 60*

Total Army Analysis (TAA) • 5-16, *page 60*

The TAA process • 5-17, *page 61*

TAA Phase I—Requirements determination • 5-18, *page 62*

TAA Phase II—Resource determination • 5-19, *page 65*

Army Structure (ARSTRUC) Memorandum • 5-20, *page 66*

The product of TAA • 5-21, *page 66*

### *Section VI*

*Phase V—Document organizational authorizations, page 67*

Documentation components overview • 5-22, *page 67*

Structure and manpower allocation system (SAMAS) • 5-23, *page 67*

The Army authorization documents system (TAADS) • 5-24, *page 68*

The force documentation process. • 5-25, *page 69*

Structure and composition system (SACS) • 5-26, *page 69*

Force management system (FMS). • 5-27, *page 71*

Global Force Management Data Initiative (GFM DI) • 5-28, *page 71*

References • 5-29, *page 72*

## **Chapter 6** **Planning For Mobilization And Deployment, page 73**

### *Section I*

*Introduction, page 73*

Chapter content • 6-1, *page 73*

Chapter organization • 6-2, *page 73*

### *Section II*

*Planning system description, deliberate contingency planning, and crisis action planning, page 73*

The planning system • 6-3, *page 73*

Deliberate contingency planning • 6-4, *page 78*

Crisis action (time sensitive) planning (CAP) • 6-5, *page 82*

Relationship to deliberate contingency planning • 6-6, *page 82*

## How the Army Runs

Crisis action planning phases • 6–7, *page 82*

Background • 6–8, *page 85*

### *Section III*

*Army mobilization, page 89*

Framework for mobilization planning • 6–9, *page 89*

AMOPES overview • 6–10, *page 89*

Mobilization planning responsibilities • 6–11, *page 90*

Department of the Army mobilization processing system (DAMPS) • 6–12, *page 98*

### *Section IV*

*Industrial preparedness, page 98*

The need for industrial preparedness • 6–13, *page 98*

DOD industrial base preparedness objectives • 6–14, *page 98*

DOD-level industrial preparedness management • 6–15, *page 99*

The defense priorities and allocations system (DPAS) • 6–16, *page 99*

The national defense stockpile (NDS) • 6–17, *page 99*

DOD key facilities list (KFL) • 6–18, *page 100*

Army industrial preparedness program • 6–19, *page 100*

### *Section V*

*Summary and references, page 100*

Summary • 6–20, *page 100*

References • 6–21, *page 100*

## **Chapter 7**

**Reserve Components, page 103**

### *Section I*

*Introduction, page 103*

Chapter content • 7–1, *page 103*

Reserve Components • 7–2, *page 103*

### *Section II*

*The Army National Guard, page 103*

An American tradition • 7–3, *page 103*

National Defense Act of 1916 • 7–4, *page 103*

World War I • 7–5, *page 104*

World War II • 7–6, *page 104*

Korean War • 7–7, *page 104*

Vietnam War • 7–8, *page 104*

Desert Shield/Desert Storm • 7–9, *page 104*

Post 9/11 • 7–10, *page 104*

Current force • 7–11, *page 105*

### *Section III*

*The Army Reserve, page 105*

Evolution of the Army Reserve • 7–12, *page 105*

Current Army Reserve • 7–13, *page 105*

### *Section IV*

*Title 10 U.S. Code, page 106*

United States Code (USC) • 7–14, *page 106*

Title 10 and Title 32 • 7–15, *page 106*

### *Section V*

*Reserve service, page 106*

The categories • 7–16, *page 106*

The Ready Reserve • 7–17, *page 107*

Standby Reserve (Army Reserve only) • 7–18, *page 108*

Retired Reserve (Army Reserve only) • 7–19, *page 109*

### *Section VI*

*Reserve component management, page 109*

Structure • 7-20, *page 109*  
Congress • 7-21, *page 109*  
Office of the Secretary of Defense (OSD) • 7-22, *page 109*  
Office of the Chairman, Joint Chiefs of Staff (CJCS) • 7-23, *page 110*  
Headquarters, DA • 7-24, *page 110*  
The National Guard Bureau (NGB) • 7-25, *page 111*  
Office of the Chief, Army Reserve (OCAR) • 7-26, *page 114*  
Army Commands • 7-27, *page 115*  
State Adjutants General (National Guard) • 7-28, *page 116*

#### *Section VII*

*Training, page 116*  
Goals • 7-29, *page 116*  
Challenges • 7-30, *page 117*  
Unit Training Assemblies (UTAs) • 7-31, *page 117*  
Collective tasks • 7-32, *page 117*

#### *Section VIII*

*Equipment, page 117*  
Policy • 7-33, *page 117*  
National Guard and Reserve Equipment Appropriation (NGREA) • 7-34, *page 118*  
Withdrawal • 7-35, *page 118*

#### *Section IX*

*Readiness/Mobilization Assistance, page 118*  
Background • 7-36, *page 118*  
Training Support Organizations • 7-37, *page 118*  
Force Management/Force Generation • 7-38, *page 119*  
Overseas Deployment Training (ODT) • 7-39, *page 119*  
Full time support (FTS) • 7-40, *page 119*  
The Army School System (TASS) • 7-41, *page 120*

#### *Section X*

*Reserve Component Pay, Benefits, and Entitlements, page 121*  
Individual status • 7-42, *page 121*  
Benefits • 7-43, *page 121*  
Retirement • 7-44, *page 121*  
Uniform Code of Military Justice (UCMJ) • 7-45, *page 121*

#### *Section XI*

*Reserve Component Transformation Campaign Plan, page 121*  
Army Reserve transformation • 7-46, *page 121*  
Army Reserve Expeditionary Force • 7-47, *page 122*  
Multiple Component Units (MCU) • 7-48, *page 122*

#### *Section XII*

*Summary and References, page 122*  
Summary • 7-49, *page 122*  
References • 7-50, *page 122*

### **Chapter 8**

**Force Readiness, page 123**

#### *Section I*

*Introduction, page 123*  
Maintaining readiness • 8-1, *page 123*  
Chapter content • 8-2, *page 123*

#### *Section II*

*Managing Army readiness, page 124*  
Definitions of readiness • 8-3, *page 124*  
Factors affecting force readiness • 8-4, *page 124*  
Cost of force readiness. • 8-5, *page 124*

## How the Army Runs

### Section III

*Department of Defense Readiness Reporting System (DRRS), page 125*

DRRS Overview • 8–6, *page 125*

Chairman’s Readiness System (CRS). • 8–7, *page 125*

The Joint Combat Capabilities Assessment Process (Figure 8–4) • 8–8, *page 127*

JFRR Metrics • 8–9, *page 128*

JFRR Deficiencies. • 8–10, *page 129*

JFRR Readiness Assessment (RA) Levels. • 8–11, *page 129*

CRS Outputs • 8–12, *page 130*

Senior Readiness Oversight Council (SROC) • 8–13, *page 131*

Assessing future readiness • 8–14, *page 131*

### Section IV

*Department of Defense Readiness Reporting System Army (DRRS–A), page 131*

DRRS–A overview • 8–15, *page 131*

NetUSR purpose • 8–16, *page 132*

NetUSR relationship to joint readiness • 8–17, *page 132*

NetUSR procedures • 8–18, *page 132*

Use of DRRS–A data at HQDA • 8–19, *page 136*

### Section V

*Summary and references, page 137*

Summary • 8–20, *page 137*

References • 8–21, *page 137*

## Chapter 9

### **ARMY PLANNING, PROGRAMMING, BUDGETING, AND EXECUTION PROCESS, page 139**

#### Section I

*Introduction, page 139*

Chapter content • 9–1, *page 139*

PPBS-a dynamic system • 9–2, *page 139*

#### Section II

*System Responsibilities, page 141*

Secretarial oversight • 9–3, *page 141*

System management • 9–4, *page 141*

Planning phase • 9–5, *page 141*

Integrated programming-budgeting phase • 9–6, *page 149*

Execution phase • 9–7, *page 150*

#### Section III

*Responsibilities for PPBE–Related Operational Tasks, page 151*

HQDA principal officials • 9–8, *page 151*

Army commanders • 9–9, *page 154*

Staff managers and sponsors for congressional appropriations • 9–10, *page 154*

#### Section IV

*DOD PPBE Process Description, page 155*

Purpose • 9–11, *page 155*

The Future Years Defense Program (FYDP) • 9–12, *page 155*

Key participants • 9–13, *page 156*

Department of Defense Decision Bodies • 9–14, *page 157*

Intelligence Program Review Group • 9–15, *page 158*

Defense Acquisition Board and Joint Requirements Oversight Council • 9–16, *page 158*

#### Section V

*Army PPBE, page 159*

Army’s primary resource management system • 9–17, *page 159*

PPBE concept • 9–18, *page 159*

PPBE objectives • 9–19, *page 159*

Control of planning, programming, and budgeting documents • 9–20, *page 160*

*Section VI*

*Recording Resources, page 160*

The MDEP: what it is and how it is used • 9–21, *page 160*

Program and budget years covered by the MDEP • 9–22, *page 161*

Extent that manpower and dollars can be redistributed in the MDEP • 9–23, *page 162*

How flexibility affects the MDEP • 9–24, *page 162*

Resource recording structures • 9–25, *page 163*

Automated support • 9–26, *page 163*

*Section VII*

*Army PPBE Deliberative Forums, page 163*

Army Resources Board • 9–27, *page 163*

Senior Review Group • 9–28, *page 164*

Planning Program Budget Committee • 9–29, *page 164*

PPBC Council of Colonels • 9–30, *page 164*

Emerging Fora • 9–31, *page 165*

Program Evaluation Groups • 9–32, *page 165*

A principal PPBE-related committee • 9–33, *page 167*

*Section VIII*

*Process and Structure, page 167*

System process • 9–34, *page 167*

System structure • 9–35, *page 167*

*Section IX*

*DoD PPBE Planning Phase, page 170*

NSC guidance • 9–36, *page 170*

Planning by OSD and the Joint Staff • 9–37, *page 170*

Joint Strategic Planning System • 9–38, *page 170*

OSD Planning Process • 9–39, *page 170*

*Section X*

*PPBE Planning, page 170*

Army Long Range Force Planning • 9–40, *page 170*

The Army Plan • 9–41, *page 171*

Army Strategy • 9–42, *page 171*

Army Planning Priorities Guidance • 9–43, *page 171*

Army Program Guidance Memorandum • 9–44, *page 171*

Army Campaign Plan • 9–45, *page 171*

Required Capability determination • 9–46, *page 172*

Army Modernization Strategy • 9–47, *page 172*

Army Research, Development, and Acquisition Plan • 9–48, *page 172*

Force Development and Total Army Analysis • 9–49, *page 173*

*Section XI*

*Operational Planning Link to the DOD PPBE, page 173*

Operational planning • 9–50, *page 173*

Missions and tasks • 9–51, *page 173*

*Section XII*

*Integrated Programming-Budgeting Phase, page 173*

Army programming and budgeting • 9–52, *page 173*

Guidance • 9–53, *page 173*

Resource framework • 9–54, *page 174*

POM preparation • 9–55, *page 174*

Program and budget correlation • 9–56, *page 178*

BES preparation • 9–57, *page 178*

OSD program and budget review • 9–58, *page 178*

President's Budget • 9–59, *page 180*

Justification • 9–60, *page 180*

*Section XIII*

*Budget Execution Phase, page 180*

Management and accounting • 9–61, *page 180*

## How the Army Runs

Financial management • 9–62, *page 180*  
Revised approved program for RDT&E • 9–63, *page 182*  
Program Budget Accounting System • 9–64, *page 182*  
Obligation and outlay plans • 9–65, *page 183*  
Financing unbudgeted requirements • 9–66, *page 183*  
Oversight of non-appropriated funds • 9–67, *page 183*

### *Section XIV*

*Program Performance and Review, page 183*  
Program implementation • 9–68, *page 183*  
Performance Assessment • 9–69, *page 183*  
Review of selected acquisition systems • 9–70, *page 184*  
Joint Reconciliation Program • 9–71, *page 184*

### *Section XV*

*SUMMARY AND References, page 184*  
PPBE concept • 9–72, *page 184*  
System products and process • 9–73, *page 184*  
References • 9–74, *page 184*

## **Chapter 10**

### **Resource Management, page 185**

#### *Section I*

*Introduction, page 185*  
The need for resource management • 10–1, *page 185*  
Resource management—a definition • 10–2, *page 185*  
Resource management terms • 10–3, *page 185*  
Key players in Army resource management • 10–4, *page 186*  
A framework to help study resource management • 10–5, *page 188*

#### *Section II*

*Acquire Resources, page 189*  
Getting the fiscal resources for the Army to use • 10–6, *page 189*  
Treasury warrants • 10–7, *page 189*

#### *Section III*

*Allocate Resources to the Field, page 190*  
Fund distribution and control • 10–8, *page 190*  
Fund Authorization Document (FAD) • 10–9, *page 191*  
Fund allowance system • 10–10, *page 191*  
Delegation of funding authority • 10–11, *page 191*  
Special classified programs • 10–12, *page 191*  
Secretary of the Army Representation Funds • 10–13, *page 191*

#### *Section IV*

*Account for the Use of the Resources, page 192*  
Legally using the resources to accomplish the mission • 10–14, *page 192*  
Availability of appropriations for obligations • 10–15, *page 192*  
Properly obligating the resources • 10–16, *page 193*  
The Anti-deficiency Act (ADA) • 10–17, *page 193*  
Accounting for the obligation • 10–18, *page 193*  
The Army management structure (AMS) • 10–19, *page 194*  
Year end certification of accounts • 10–20, *page 195*

#### *Section V*

*Analyze the Use of Resources, page 195*  
1981 - A change in responsibilities • 10–21, *page 195*  
Execution reviews • 10–22, *page 195*  
HQDA Quarterly Reviews • 10–23, *page 195*  
Shifting resources • 10–24, *page 195*  
Analyzing the “accounting books”- Joint Reconciliation Program • 10–25, *page 196*

*Section VI**Improving Management and Business Practices in the Army, page 196*Efforts to improve Army management • 10–26, *page 196*Federal Manager's Financial Integrity Act (FMFIA) of 1982 • 10–27, *page 196*Chief Financial Officers (CFO) Act of 1990 • 10–28, *page 196*Government Management Reform Act (GMRA) of 1994 • 10–29, *page 197*Government Performance and Results Act (GPRA) of 1993. • 10–30, *page 197*Federal Financial Management Improvement Act (FFMIA) of 1996 • 10–31, *page 198*Management controls • 10–32, *page 198*Improving business practices • 10–33, *page 198*Cost management (CM) • 10–34, *page 199*Cost modeling • 10–35, *page 199*Planning • 10–36, *page 199*Building an ABC model • 10–37, *page 200*Using the ABC model • 10–38, *page 200*Cost commitment and review • 10–39, *page 201*General Fund Enterprise Business System (GFEBS) • 10–40, *page 202*Cost benefit analysis (CBA) • 10–41, *page 203*Links to principles • 10–42, *page 204*Summary • 10–43, *page 204**Section VII**Non-Appropriated Funds, page 204*Non-appropriated funds definitions. • 10–44, *page 204*NAFI management. • 10–45, *page 205*Fiduciary responsibility for NAF (10 United States Code Section 2783) • 10–46, *page 205*Management of MWR and NAF • 10–47, *page 205*HQDA oversight of non-appropriated funds • 10–48, *page 205**Section VIII**Summary and References, page 206*Summary • 10–49, *page 206*References • 10–50, *page 206***Chapter 11****Matériel System Research, Development, and Acquisition Management, page 207***Section I**Introduction, page 207*

Department of Defense (DOD) and U.S. Army Capabilities Development and System Acquisition Management

• 11–1, *page 207*System focus • 11–2, *page 207**Section II**Capabilities Integration and Development, page 207*Policy • 11–3, *page 207*Joint capabilities integration and development system (JCIDS) • 11–4, *page 207*DOD science and technology (S&T) • 11–5, *page 207*Defense science and technology strategy • 11–6, *page 208*Army science and technology (S&T) • 11–7, *page 208*Army technology transition strategy • 11–8, *page 210*Trades in a joint, resource constrained environment • 11–9, *page 212*TRADOC Capabilities Needs Analysis (CNA)/Soldier Outcomes Analysis (WFO) • 11–10, *page 213**Section III**Matériel Capabilities Documents (MCDs), page 213*Generating and documenting capabilities-based matériel requirements • 11–11, *page 213*MCD performance characteristics, KPPs, and KSAs. • 11–12, *page 214**Section IV**Matériel Requirements Approval, page 215*Army requirements approval • 11–13, *page 216*Cost-benefit analysis (C-BA) • 11–14, *page 216*Army Requirements Oversight Council (AROC) • 11–15, *page 216*



## How the Army Runs

Army requirements approval process • 11–16, *page 217*  
Joint requirements approval process • 11–17, *page 218*  
Capability portfolio reviews (CPRs) • 11–18, *page 221*

### Section V

*Materiel Systems Acquisition, page 221*  
DOD system acquisition policy • 11–19, *page 221*  
Materiel systems acquisition management • 11–20, *page 222*  
Acquisition strategies and program plans • 11–21, *page 223*  
Environmental considerations • 11–22, *page 224*  
Risk assessments and management • 11–23, *page 224*

### Section VI

*DOD Acquisition Organization and Management, page 224*  
DOD System Acquisition Management • 11–24, *page 224*  
Organizational linkage • 11–25, *page 224*  
Defense Advanced Research Projects Agency (DARPA) • 11–26, *page 225*  
Defense Acquisition University (DAU) • 11–27, *page 225*  
Defense Systems Management College (DSMC) • 11–28, *page 225*

### Section VII

*Army Acquisition Organization and Management, page 226*  
Army Research, Development, and Acquisition (RDA) goals • 11–29, *page 226*  
Army Acquisition Executive (AAE) • 11–30, *page 226*  
The program executive officer (PEO) • 11–31, *page 228*  
The program/project/product manager (PM) • 11–32, *page 230*  
PEO resource control • 11–33, *page 230*  
Acquisition career management • 11–34, *page 230*  
Headquarters, Department of the Army (HQDA) • 11–35, *page 231*  
Army Commands (Major) • 11–36, *page 235*  
Other DA agencies • 11–37, *page 238*

### Section VIII

*Acquisition Activities, Phases and Milestones, page 239*  
Pre-systems acquisition activity • 11–38, *page 239*  
Materiel development decision (MDD) review • 11–39, *page 239*  
Materiel solution analysis (MSA) phase • 11–40, *page 240*  
Milestone (MS) A • 11–41, *page 240*  
Technology development (TD) phase • 11–42, *page 240*  
Systems acquisition activity • 11–43, *page 241*  
Milestone (MS) B • 11–44, *page 241*  
Engineering and manufacturing development (EMD) phase • 11–45, *page 242*  
Entrance criteria • 11–46, *page 242*  
Integrated system design work effort • 11–47, *page 242*  
post-critical design review (CDR) assessment • 11–48, *page 243*  
system capability and manufacturing process demonstration work effort • 11–49, *page 243*  
Production and deployment (P&D) phase • 11–50, *page 243*  
Entrance criteria • 11–51, *page 243*  
Milestone (MS) C • 11–52, *page 244*  
Low-rate initial production (LRIP) work effort • 11–53, *page 244*  
Full-rate production (FRP) decision review • 11–54, *page 244*  
Full-rate production and deployment work effort • 11–55, *page 244*  
Sustainment activity/operations and support (O&S) phase • 11–56, *page 245*  
Life-cycle sustainment work effort • 11–57, *page 245*  
Disposal work effort • 11–58, *page 245*  
Additional considerations • 11–59, *page 245*

### Section IX

*Accelerated Capabilities and Materiel Developments, page 245*  
Joint urgent operational needs statements (JUONS)/Joint rapid acquisition cell (JRAC)/DOD immediate Soldier needs (IWN) • 11–60, *page 246*  
Joint improvised explosive devices defeat organization (JIEDDO) • 11–61, *page 246*  
Operational needs statement (ONSs)/Army requirements and resourcing board (AR2B) process • 11–62, *page 246*  
Rapid equipping force (REF) • 11–63, *page 248*  
Capability packages (CPs) • 11–64, *page 249*

Capability development for rapid transition (CDRT)/Army immediate Soldier needs (IWN) • 11–65, *page 250*  
 Directed requirement • 11–66, *page 251*  
 Rapid acquisition authority • 11–67, *page 251*

#### *Section X*

*Acquisition Oversight and Review*, *page 252*  
 Integrated product teams (IPTs) • 11–68, *page 252*  
 The Defense Acquisition Board (DAB) • 11–69, *page 253*  
 The DOD Information Technology Acquisition Board (ITAB) • 11–70, *page 253*  
 The Army Systems Acquisitions Review Council (ASARC) • 11–71, *page 253*  
 In-process review (IPR) • 11–72, *page 254*  
 Configuration Steering Board (CSB) • 11–73, *page 254*

#### *Section XI*

*Acquisition Documentation*, *page 254*  
 Materiel capabilities documents (MCDs) • 11–74, *page 254*  
 Other service requirements • 11–75, *page 254*  
 Catalog of approved requirements documents (CARDS) • 11–76, *page 255*  
 Program review documentation and program plans • 11–77, *page 255*  
 Typical waivers and reports • 11–78, *page 257*  
 Other documentation • 11–79, *page 258*

#### *Section XII*

*Testing and Evaluation (T&E)*, *page 258*  
 T&E strategy • 11–80, *page 258*  
 Developmental testing (DT) and operational testing (OT) • 11–81, *page 259*

#### *Section XIII*

*Integrated Logistics Support (ILS)*, *page 259*  
 ILS overview and management • 11–82, *page 259*  
 Total package fielding (TPF) process • 11–83, *page 260*

#### *Section XIV*

*Manpower and Personnel Integration (MANPRINT) Program*, *page 261*  
 Seven MANPRINT domains • 11–84, *page 262*  
 MANPRINT objectives and concept • 11–85, *page 262*

#### *Section XV*

*Training Development*, *page 263*  
 Training development (TD) overview • 11–86, *page 264*  
 System training plan (STRAP) • 11–87, *page 264*  
 Army modernization training (AMT) • 11–88, *page 264*  
 Training requirements analysis system (TRAS) • 11–89, *page 264*  
 Training aids, devices, simulators, and simulations (TADSS) • 11–90, *page 264*

#### *Section XVI*

*Acquisition Resource Management*, *page 265*  
 Appropriations • 11–91, *page 265*  
 Program and budget process • 11–92, *page 265*  
 RDTE appropriation activities • 11–93, *page 266*  
 Procurement appropriations • 11–94, *page 266*  
 Military construction (MILCON) appropriation • 11–95, *page 267*  
 Operations and maintenance appropriation (OMA) • 11–96, *page 267*  
 Research, development, and acquisition plan (RDA Plan) • 11–97, *page 267*  
 Program stability • 11–98, *page 268*

#### *Section XVII*

*Summary and References*, *page 268*  
 Summary • 11–99, *page 268*  
 References • 11–100, *page 268*

## **Chapter 12** **Logistics**, *page 271*

## How the Army Runs

### Section I

*Introduction, page 271*

Chapter content • 12–1, *page 271*

Key definitions and concepts • 12–2, *page 271*

Army logistics • 12–3, *page 274*

### Section II

*National Logistics Organization: ASA (ALT); Army G–4; and AMC, page 275*

Assistant Secretary of the Army for Acquisition, Logistics and Technology, ASA (ALT). • 12–4, *page 275*

Deputy for Acquisition Policy and Logistics DASA (APL). • 12–5, *page 276*

Missions, Organization and Functions of the Army G–4 • 12–6, *page 276*

AMC Mission: Title X and Executive Agent Responsibilities. • 12–7, *page 293*

Maintaining the Force-Army Force Generation (ARFORGEN). • 12–8, *page 295*

Theater Sustainment. • 12–9, *page 299*

Supporting Acquisition. • 12–10, *page 302*

AMC: Changing to Satisfy Future Requirements. • 12–11, *page 303*

### Section III

*National logistics organization: other, page 305*

Other Logistics-related organizations • 12–12, *page 305*

Defense Logistics-related organizations • 12–13, *page 307*

### Section IV

*Standard Systems, page 308*

Defense standard systems. • 12–14, *page 308*

Department of the Army standard systems • 12–15, *page 309*

### Section V

*Funding, page 312*

Appropriations • 12–16, *page 312*

Army Working Capital Fund (AWCF) • 12–17, *page 313*

### Section VI

*Security, page 314*

Security Assistance Responsibilities (SA) • 12–18, *page 314*

Co-production • 12–19, *page 315*

### Section VII

*Summary, references, annexes, websites, & professional reading list, page 315*

Summary • 12–20, *page 315*

Selected official military references • 12–21, *page 315*

## Chapter 13

**Military Human Resource Management, page 319**

### Section I

*Introduction, page 319*

Military human resource management (MHRM) • 13–1, *page 319*

Personnel transformation (PT) • 13–2, *page 319*

Military HR life cycle functions • 13–3, *page 320*

Human resources (HR) leadership • 13–4, *page 320*

Key military human resource (HR) publications • 13–5, *page 321*

Military occupational classification and structure system (MOCS) • 13–6, *page 321*

Key terms and interrelated documents and systems at the heart of the human resources (HR) process • 13–7, *page 321*

### Section II

*The structure function, page 322*

Military manpower management • 13–8, *page 322*

Manpower management at HQDA • 13–9, *page 323*

Personnel management authorization document (PMAD) and Updated Authorizations Document (UAD) • 13–10, *page 324*

Notional force (NOF) system • 13–11, *page 324*

Military force alignment • 13–12, *page 324*

### *Section III*

*The acquisition function, page 325*

Enlisted procurement • 13–13, *page 325*

Warrant officer (WO) Procurement • 13–14, *page 326*

Commissioned officer procurement • 13–15, *page 326*

### *Section IV*

*The compensation function, page 327*

Compensation overview • 13–16, *page 327*

Manning Program Evaluation Group (PEG) • 13–17, *page 328*

### *Section V*

*The distribution function, page 329*

Enlisted distribution and assignment • 13–18, *page 329*

Officer distribution and assignment • 13–19, *page 333*

### *Section VI*

*The development function, page 335*

Enlisted development • 13–20, *page 335*

Enlisted personnel management system (EPMS) • 13–21, *page 335*

Enlisted evaluation system (EES) • 13–22, *page 335*

The NCO leader self-development career model • 13–23, *page 335*

Enlisted promotions • 13–24, *page 336*

Command sergeants major program • 13–25, *page 336*

Total army retention program • 13–26, *page 336*

Qualitative management program (QMP) • 13–27, *page 337*

Warrant officer development • 13–28, *page 337*

Warrant officer management act (WOMA) • 13–29, *page 337*

Warrant officer education system (WOES) • 13–30, *page 338*

Warrant officer promotions • 13–31, *page 339*

Warrant officer retention programs • 13–32, *page 340*

Officer development • 13–33, *page 340*

Officer personnel management system (OPMS) • 13–34, *page 340*

Fundamentals of officer management • 13–35, *page 342*

Functional categories • 13–36, *page 342*

Functional category assignment • 13–37, *page 342*

Centralized selection for command and key billet positions • 13–38, *page 343*

Army acquisition corps (AAC) • 13–39, *page 343*

Officer evaluation system • 13–40, *page 344*

Officer evaluation reporting system • 13–41, *page 344*

Officer promotions • 13–42, *page 345*

Officer quality management • 13–43, *page 345*

Officer strength management • 13–44, *page 345*

Defense Officer Personnel Management Act (DOPMA) • 13–45, *page 346*

DOD Reorganization Act of 1986 (“Goldwater-Nichols”) • 13–46, *page 346*

### *Section VII*

*The sustainment function, page 346*

Sustainment function overview • 13–47, *page 346*

Army continuing education system (ACES) • 13–48, *page 346*

Equal opportunity program • 13–49, *page 347*

The army casualty system • 13–50, *page 347*

### *Section VIII*

*The transition function, page 348*

Transition function overview • 13–51, *page 348*

The Army Career and Alumni Program (ACAP) • 13–52, *page 348*

Army retirement services program • 13–53, *page 348*

Separation • 13–54, *page 348*

Enlisted separation • 13–55, *page 348*

Enlisted non-disability retirement system • 13–56, *page 349*

Officer non-disability retirement system • 13–57, *page 349*

## How the Army Runs

Physical disability separation • 13–58, *page 349*

### *Section IX*

*Summary and references, page 349*

Summary • 13–59, *page 349*

References • 13–60, *page 350*

## **Chapter 14**

**Civilian Human Resource Management, page 351**

### *Section I*

*Introduction, page 351*

Chapter content • 14–1, *page 351*

Categories of civilian personnel • 14–2, *page 352*

Army workforce mix • 14–3, *page 353*

Decentralized management • 14–4, *page 353*

### *Section II*

*Organization of civilian personnel management, page 354*

Merit System Principles • 14–5, *page 354*

U.S. Office of Personnel Management (OPM) • 14–6, *page 355*

Other agencies with federal government-wide authority • 14–7, *page 355*

Department of Defense (DOD) • 14–8, *page 356*

Assistant Secretary of the Army for Manpower and Reserve Affairs (ASA (M&RA)) • 14–9, *page 356*

Other Army organizations with civilian personnel responsibilities • 14–10, *page 357*

### *Section III*

*CHR Service Delivery, page 357*

Civilian Personnel Advisory Centers (CPACs) • 14–11, *page 357*

Automation tools • 14–12, *page 357*

### *Section IV*

*Personnel management at installation/activity level, page 358*

Personnel management responsibility and authority. • 14–13, *page 358*

Commander responsibilities • 14–14, *page 358*

Supervisor responsibilities • 14–15, *page 358*

Position classification and pay • 14–16, *page 359*

Recruitment, Selection, and Assignment • 14–17, *page 360*

Evaluation of employee performance and administration of awards/incentives programs • 14–18, *page 360*

Training and development of employees • 14–19, *page 361*

Workers Compensation Program • 14–20, *page 362*

Communication, discipline, and labor-management relations. • 14–21, *page 363*

### *Section V*

*Equal Employment Opportunity (EEO) in the Army, page 364*

Equal Employment Opportunity laws and regulatory requirements • 14–22, *page 364*

The Equal Employment Opportunity complaints program and process • 14–23, *page 365*

### *Section VI*

*Executive and Senior Professional (ESP) Personnel, page 366*

ESP Structure and Composition • 14–24, *page 366*

Qualifications of Senior Executive Service (SES) Members • 14–25, *page 367*

### *Section VII*

*Defense Civilian Intelligence Personnel System, page 368*

Structure and composition of the Defense Intelligence Personnel System (DCIPS) • 14–26, *page 368*

Relationship of DCIPS to the Army civilian personnel program • 14–27, *page 368*

Civilian Expeditionary Workforce (CEW) • 14–28, *page 368*

### *Section VIII*

*Army personnel transformation, page 369*

Current and transforming CHR administration • 14–29, *page 369*

Transforming CHR Administration • 14–30, *page 369*

Hiring Reforms • 14–31, page 369

*Section IX*

*Summary and references, page 369*

Summary • 14–32, page 369

References • 14–33, page 370

**Chapter 15**

**Army Training, page 373**

*Section I*

*Introduction - Army Training Strategy, page 373*

The Army Training Strategy • 15–1, page 373

Chapter organization • 15–2, page 373

*Section II*

*Army Training Overview, page 373*

Army Training • 15–3, page 373

Combined Arms Training Strategy (CATS) • 15–4, page 376

The Future of Army training • 15–5, page 377

*Section III*

*The Policy, Requirements, and Resourcing Process, page 379*

General • 15–6, page 379

Organization • 15–7, page 379

Requirements and resourcing • 15–8, page 380

Development of the Army individual training requirements • 15–9, page 380

*Section IV*

*Training and Doctrine Command (TRADOC) Organization and Training Development Systems., page 382*

Training in institutions-general • 15–10, page 382

Education and Training Automation • 15–11, page 386

*Section V*

*The Army School System (TASS), page 387*

Overview of The Army School System (TASS) • 15–12, page 387

The Army Training System (TATS) • 15–13, page 387

Enlisted initial military training/Initial Entry Training (IET) • 15–14, page 387

Noncommissioned officer (NCO) training • 15–15, page 388

Non-Commissioned Officer Education System (NCOES) • 15–16, page 389

Officer education system (OES) • 15–17, page 389

Civilian education system (CES) • 15–18, page 394

Self-development training • 15–19, page 395

Mobilization training base • 15–20, page 395

*Section VI*

*Training in units, page 396*

General • 15–21, page 396

Organization for training in units • 15–22, page 397

Training of Soldiers and leaders in units (FM 7–0 Training Units and Developing Leaders for Full Spectrum Operations February 2011) • 15–23, page 397

Soldier training publications (STP) • 15–24, page 397

Collective training • 15–25, page 398

Composite Risk Management (CRM) • 15–26, page 398

Mission Training Plans (MTPs) and drills • 15–27, page 399

Combat Training Center (CTC) Program • 15–28, page 399

Unit training management • 15–29, page 400

Army modernization training (AMT) • 15–30, page 401

The Security Assistance Training Program (SATP) • 15–31, page 402

*Section VII*

*The Training Support System, page 402*

Training Support System (TSS) • 15–32, page 402

Training Support System Management • 15–33, page 403

## How the Army Runs

Simulation Training Technologies • 15–34, *page 403*

### *Section VIII*

*Summary and References, page 407*

Summary • 15–35, *page 407*

References • 15–36, *page 407*

Training websites with links • 15–37, *page 408*

## **Chapter 16**

**Army Knowledge Management and Information Technology, *page 409***

### *Section I*

*Introduction, page 409*

Information Management Transformation • 16–1, *page 409*

Information Management Transformation Implementation • 16–2, *page 409*

AKM Transformation Strategy • 16–3, *page 411*

### *Section II*

*CIO/G–6 Roles and Responsibilities, page 411*

Office of the CIO/G–6 • 16–4, *page 411*

CCA Implementation • 16–5, *page 412*

Army IT Governance • 16–6, *page 413*

C4/IT Investment Strategy • 16–7, *page 414*

### *Section III*

*Army Enterprise Management, page 414*

Army Enterprise Management • 16–8, *page 414*

Army Data Management • 16–9, *page 414*

Enterprise Services • 16–10, *page 415*

Enterprise Architecture • 16–11, *page 415*

Information Assurance (IA) • 16–12, *page 416*

### *Section IV*

*CIO/G–6 Organization, page 416*

Chief Integration Office • 16–13, *page 416*

Information Resource Integration (IRI) • 16–14, *page 416*

Governance, Acquisition, and Chief Knowledge Office (GA&CKO) • 16–15, *page 417*

Architecture, Operations, Networks and Space, • 16–16, *page 417*

Cyber Directorate • 16–17, *page 418*

### *Section V*

*Other Strategic Partnerships with the Army CIO/G–6, page 418*

Program Executive Office Enterprise Information Systems (PEO EIS) • 16–18, *page 418*

AKM Transformation Strategy • 16–19, *page 419*

Cultural Changes • 16–20, *page 419*

AKM Implementation • 16–21, *page 419*

### *Section VI*

*Summary and References, page 420*

Summary • 16–22, *page 420*

References • 16–23, *page 420*

## **Chapter 17**

**Installation Command and Management, *page 421***

### *Section I*

*Introduction, page 421*

Chapter content • 17–1, *page 421*

The Army's installation environment • 17–2, *page 421*

ACSIM mission and functions • 17–3, *page 422*

### *Section II*

*Installation Management Command (IMCOM) organization, page 423*

General • 17-4, *page 423*  
 HQ & Regions • 17-5, *page 423*  
 Installation management organization • 17-6, *page 424*

*Section III*

*Key installation management positions, page 424*  
 IMCOM Garrisons • 17-7, *page 424*  
 Garrison Commander. • 17-8, *page 425*

*Section IV*

*Installation management professional development, page 425*  
 Additional skill identifier (ASI) 6Y (Installation Management) • 17-9, *page 425*  
 Garrison pre-command course (GPC) • 17-10, *page 426*  
 General officer installation commander's course (GOIC) • 17-11, *page 426*  
 Garrison Command Sergeants Major course (GCSMC) • 17-12, *page 426*

*Section V*

*Garrison Staff Organization, page 426*  
 US Army Garrison (USAG) Standard Garrison Organization • 17-13, *page 426*  
 Installation management personnel designations • 17-14, *page 427*

*Section VI*

*Installation management strategy, page 427*  
 Army Campaign Plan (ACP) - Transformation • 17-15, *page 427*  
 Installation Management Campaign Plan • 17-16, *page 428*  
 IMCOM Commanders Intent. • 17-17, *page 428*

*Section VII*

*Major installation management initiatives and programs, page 428*  
 Strategic communications • 17-18, *page 428*  
 Doctrine • 17-19, *page 429*  
 Privatization and outsourcing • 17-20, *page 429*  
 Competitive sourcing • 17-21, *page 429*  
 Environmental cleanup strategy • 17-22, *page 430*  
 Hazardous Material Management System (HMMS) • 17-23, *page 431*  
 Toxics management program • 17-24, *page 431*  
 Army Environmental Management Systems and Sustainability Planning • 17-25, *page 431*  
 Recycling • 17-26, *page 432*  
 Army's energy and water management program • 17-27, *page 432*  
 Energy Savings Performance Contracts (ESPC) • 17-28, *page 433*  
 Army environmental restoration program • 17-29, *page 433*  
 Army conservation program. • 17-30, *page 434*  
 Military construction army (MCA) program • 17-31, *page 434*  
 Army facility reduction program • 17-32, *page 434*  
 Revitalization of housing • 17-33, *page 435*  
 Army Stationing and Installation Plan (ASIP) • 17-34, *page 436*  
 Real Property Planning and Analysis System (RPLANS). • 17-35, *page 436*  
 Installation Geospatial Information & Services (IGI&S) • 17-36, *page 436*  
 Installation Status Report (ISR) • 17-37, *page 437*  
 Base realignment and closure (BRAC) • 17-38, *page 437*  
 Managing installations to standards • 17-39, *page 438*  
 Institutional Adaptation. • 17-40, *page 439*  
 IMCOM Transformation • 17-41, *page 440*  
 Business Transformation • 17-42, *page 441*  
 Army communities of excellence (ACOE) • 17-43, *page 441*

*Section VIII*

*Summary and references, page 442*  
 Summary • 17-44, *page 442*  
 References • 17-45, *page 442*

**Chapter 18**  
**The Army Health Service Support System, page 443**



## How the Army Runs

### Section I

*Introduction, page 443*

The revolution in military medicine • 18–1, *page 443*

Scope of the AMEDD • 18–2, *page 443*

Army health system support • 18–3, *page 443*

Medical support to the transforming Army. • 18–4, *page 444*

### Section II

*AMEDD mission and support to commanders, page 444*

Mission of the Army Medical Department • 18–5, *page 444*

AMEDD support to commanders • 18–6, *page 445*

### Section III

*The Army Health System, page 445*

Key elements • 18–7, *page 445*

Staff relationships and responsibilities • 18–8, *page 445*

### Section IV

*Command and management, page 446*

AMEDD Organization • 18–9, *page 446*

U.S. Army Medical Command (USAMEDCOM) • 18–10, *page 447*

U. S. Army Medical Research and Materiel Command (USAMRMC) • 18–11, *page 447*

U.S. Army Dental Command • 18–12, *page 448*

U.S. Army veterinary service • 18–13, *page 448*

U.S. Army Public Health Command (Provisional) • 18–14, *page 448*

U.S. Army Medical Department Center and School • 18–15, *page 449*

Warrior Transition Command • 18–16, *page 449*

Regional Medical Commands (RMCs) • 18–17, *page 449*

AMEDD role in sustainment units • 18–18, *page 450*

Staff surgeons • 18–19, *page 451*

Health service logistics • 18–20, *page 451*

Secretary of the Army's executive agent representative for DoD executive agencies (DOD EA) • 18–21, *page 452*

### Section V

*Summary and references, page 453*

Summary • 18–22, *page 453*

References • 18–23, *page 453*

## Chapter 19

### Management Of Legal Affairs, *page 455*

#### Section I

*Introduction, page 455*

Law and the commander • 19–1, *page 455*

Office of the Staff Judge Advocate (OSJA) • 19–2, *page 455*

Staff Judge Advocate • 19–3, *page 455*

#### Section II

*Administrative and civil law, legal assistance, claims, page 455*

The Army as an administrative agency • 19–4, *page 455*

Corrective administrative personnel actions • 19–5, *page 455*

Improper relationships • 19–6, *page 456*

Standards of conduct • 19–7, *page 456*

Legal basis of command • 19–8, *page 457*

Environmental law • 19–9, *page 458*

Federal labor relations and the role of the labor counselor • 19–10, *page 459*

Legal assistance • 19–11, *page 460*

Claims • 19–12, *page 460*

Command authority and judicial review of military activities • 19–13, *page 461*

#### Section III

*Military Justice, page 461*

Background • 19–14, *page 461*

Providing military justice legal services • 19–15, *page 462*

Active Army jurisdiction • 19–16, *page 462*  
Jurisdiction over reservists • 19–17, *page 462*  
The commander's role • 19–18, *page 462*  
Options available to the commander • 19–19, *page 463*  
19–20. Unlawful command influence • 19–20, *page 465*

*Section IV*

*International and Operational Law, page 466*

International law • 19–21, *page 466*  
Operational law (OPLAW) • 19–22, *page 466*  
U.S. Forces stationed overseas under a Status of Forces Agreement (SOFA) • 19–23, *page 466*  
Deployment for conventional combat missions • 19–24, *page 467*  
Security assistance missions • 19–25, *page 469*  
Deployment for overseas exercises • 19–26, *page 470*  
Smaller-scale contingencies (SSC) • 19–27, *page 471*

*Section V*

*Contract and Fiscal Law, page 472*

Overview • 19–28, *page 472*  
Contract legal review • 19–29, *page 472*  
Fiscal law • 19–30, *page 473*

*Section VI*

*Summary and references, page 474*

Summary • 19–31, *page 474*  
References • 19–32, *page 474*

**Chapter 20**

**Civil Functions of the Department of The Army, page 477**

*Section I*

*Introduction, page 477*

Civil functions defined • 20–1, *page 477*  
Authorization, congressional oversight and funding • 20–2, *page 477*  
Relationship to warfighting competencies • 20–3, *page 477*  
Leadership and organization • 20–4, *page 477*

*Section II*

*Civil works program, page 479*

Civil works program activities • 20–5, *page 479*  
Research and development (R&D) • 20–6, *page 484*

*Section III*

*Support to other government agencies, page 484*

Overview of support to other government agencies • 20–7, *page 484*  
Value of support activities • 20–8, *page 484*

*Section IV*

*Engineer Overseas Activities, page 485*

Overview of engineer overseas activities • 20–9, *page 485*  
Foreign military sales (FMS) • 20–10, *page 485*  
Partnership for peace • 20–11, *page 485*  
Support for U.S. agencies • 20–12, *page 486*

*Section V*

*Support To Unified Combatant Commanders, page 486*

Benefits to warfighting capabilities • 20–13, *page 486*  
Overview of support to unified combatant commanders • 20–14, *page 486*  
Examples of support to unified combatant commanders • 20–15, *page 486*

*Section VI*

*Summary and References, page 487*

Summary • 20–16, *page 487*

## How the Army Runs

References • 20–17, *page 487*

### Chapter 21

**Public Affairs**, *page 489*

#### *Section I*

*Introduction, page 489*

Chapter content • 21–1, *page 489*

Specialized and specific terms used in public affairs • 21–2, *page 489*

#### *Section II*

*Public affairs principles, page 490*

Public affairs strategic goals • 21–3, *page 490*

Public affairs vision • 21–4, *page 490*

#### *Section III*

*Public affairs doctrine and processes, page 490*

The Constitution and First Amendment • 21–5, *page 490*

Freedom of Information Act • 21–6, *page 491*

Privacy Act • 21–7, *page 491*

DOD principles of information • 21–8, *page 491*

Guidelines for coverage of DOD combat operations • 21–9, *page 491*

Operational security • 21–10, *page 492*

Core processes • 21–11, *page 492*

#### *Section IV*

*Army public affairs organizations, page 493*

The Office of the Chief of Public Affairs (OCPA), Department of the Army • 21–12, *page 493*

ACOM, ASCC, DRU and installation public affairs • 21–13, *page 493*

Organic public affairs sections • 21–14, *page 494*

Theater Army Public Affairs Section • 21–15, *page 494*

Corps and Theater Army Area Command (TAACOM) PA Sections • 21–16, *page 494*

Division and Corps Support Command (COSCOM) Public Affairs Sections • 21–17, *page 494*

U.S. Army Reserve and Army National Guard component public affairs • 21–18, *page 494*

Public Affairs Operations Center (PAOC) • 21–19, *page 494*

Mobile Public Affairs Detachment (MPAD) • 21–20, *page 494*

Broadcast Operations Detachment (BOD) • 21–21, *page 495*

Public Affairs Detachment (PAD) • 21–22, *page 495*

#### *Section V*

*Joint and combined public affairs organizations, page 495*

Assistant Secretary of Defense (Public Affairs) (ASD(PA)) • 21–23, *page 495*

Joint Information Bureau (JIB) • 21–24, *page 495*

Combined Information Bureau (CIB) • 21–25, *page 495*

Pentagon correspondents • 21–26, *page 495*

DOD National Media Pool • 21–27, *page 495*

Joint combat camera • 21–28, *page 496*

#### *Section VI*

*Information mediums, page 496*

News media • 21–29, *page 496*

Television • 21–30, *page 496*

Television “news magazines” • 21–31, *page 496*

Radio • 21–32, *page 496*

Print • 21–33, *page 496*

Motion picture industry support • 21–34, *page 496*

Internet • 21–35, *page 497*

#### *Section VII*

*Summary and references, page 497*

Summary • 21–36, *page 497*

References • 21–37, *page 497*

## **Chapter 22** **Defense Support of Civil Authorities, page 499**

### *Section I*

*Introduction, page 499*

DSCA Overview • 22-1, *page 499*

Constitutional and Policy Basis for DSCA • 22-2, *page 499*

Historic Context for Domestic Military Support • 22-3, *page 499*

DOD Role in Homeland Security (HS) Today • 22-4, *page 500*

DSCA Principles • 22-5, *page 500*

DSCA Mission Sets • 22-6, *page 501*

### *Section II*

*Domestic Emergency Management Environment, page 501*

National Incident Management • 22-7, *page 501*

Local Response • 22-8, *page 504*

State Support • 22-9, *page 505*

### *Section III*

*Federal Role in the National Response Process, page 505*

Primary Federal Departments and Agencies • 22-10, *page 505*

Federal Structure for NRF Response & Recovery • 22-11, *page 506*

Emergency Support Function (ESF) - 3 (Public Works and Engineering) • 22-12, *page 507*

Department of Defense DSCA Structure • 22-13, *page 508*

### *Section IV*

*Defense support process, page 509*

Planning Considerations • 22-14, *page 510*

DSCA Request and Approval Process • 22-15, *page 510*

Immediate response • 22-16, *page 511*

Emergency Authority • 22-17, *page 511*

Media Considerations • 22-18, *page 512*

### *Section V*

*DSCA Mission Category: Disasters and Declared Emergencies, page 512*

DoD NRF Response Process • 22-19, *page 512*

Improving DoD Incident Response: • 22-20, *page 513*

Unique CBRNE Response Considerations: • 22-21, *page 513*

### *Section VI*

*DSCA Mission Category: Restore Public Health and Services and Civil Order, page 514*

Support to Law Enforcement: • 22-22, *page 514*

Other types of Public Health and Services DSCA: • 22-23, *page 516*

### *Section VII*

*DSCA Mission Categories: Special Events & Planned Periodic Support, page 517*

DSCA Mission Category: Special Events • 22-24, *page 517*

DSCA Mission Category: Periodic Planned Support • 22-25, *page 517*

### *Section VIII*

*Summary and references, page 517*

Summary • 22-26, *page 517*

References • 22-27, *page 518*

## **Table List**

Table 8-1: Joint Capability Areas, *page 129*

Table 8-2: RA Levels Definitions, *page 130*

Table 9-1: Program Evaluation Groups, *page 141*

Table 9-2: Managers for manpower and force structure issues, *page 143*

Table 9-3: Budget activity management structure for operation and maintenance appropriations, *page 143*

Table 9-4: Budget activity management structure for operation and maintenance appropriations-Army manpower only activity structure, *page 144*

## How the Army Runs

- Table 9-5: Budget activity management structure for operation and maintenance appropriation-Base operations support (BOS), *page 145*
- Table 9-6: Budget activity management structure for operation and maintenance appropriations-Sustainment, Restoration, and Modernization (SRM), *page 146*
- Table 9-7: Budget activity management structure for operation and maintenance appropriations-Army National Guard, *page 147*
- Table 9-8: Budget activity management structure for operations and maintenance appropriations-U.S. Army Reserve, *page 147*
- Table 9-9: Army appropriations-managers for functional requirements and program and performance, *page 148*
- Table 9-11: FYDP Programs and Subprograms with Army Proponents, *page 156*
- Table 9-12: Composition of Army PPBE deliberative forums, *page 164*
- Table 9-13: Topics covered in POM/BES 12-16, *page 177*
- Table 10-1: Translating an accounting code, *page 194*
- Table 11-1: Below Threshold Reprogramming Levels, *page 266*
- Table 12-1: Focus of national and theater logistics, *page 273*
- Table 12-2: UMMIPS Time Standards, *page 308*
- Table 13-1: Warrant Officer Promotion Goals, *page 340*
- Table 13-2: Career Progression Pattern, *page 345*
- Table 14-1: Executive Service Personnel, *page 367*
- Table 14-2: Executives Organizationally, *page 367*
- Table 15-1: SAT Phase Functions Requirements, *page 385*
- Table 15-2: Enlisted Training Program, *page 388*
- Table 19-1: Court Martial maximum punishments, *page 464*
- Table 20-1: Construction support for non-DoD Agencies, *page 484*
- Table 22-1: Federal Response Plan Emergency Support Functions, *page 507*

## Figure List

- Figure 2-1: The Army Organizational Life Cycle Model, *page 8*
- Figure 2-3: ARFORGEN Force Pools, *page 15*
- Figure 2-4: Rotational Model, *page 16*
- Figure 3-1: HQDA Reorganization Structure, *page 26*
- Figure 3-2: Differentiation of Army Hierarchical Functions and Tasks, *page 28*
- Figure 4-1: Joint Strategic Planning System, *page 32*
- Figure 4-2: Execution of Joint Strategic Planning System, *page 34*
- Figure 4-3: JROC Functional Areas, *page 38*
- Figure 4-4: Functional Capabilities Board, *page 39*
- Figure 4-5: Combatant Commands, *page 41*
- Figure 5-1: Force development process, *page 46*
- Figure 5-2: Army concept framework (ACF), *page 49*
- Figure 5-3: Capabilities-based assessment (CBA) process, *page 52*
- Figure 5-4: Solutions documents, *page 55*
- Figure 5-5: Force design update (FDU), *page 57*
- Figure 5-6: Modernization over time (Resource Driven), *page 59*
- Figure 5-7: Total Army Analysis 2014 - 2018, *page 62*
- Figure 5-8: Force structure components (COMPO), *page 66*
- Figure 5-9: SACS/Force builder process, *page 70*
- Figure 6-1: Joint strategic planning system, *page 74*
- Figure 6-2: Joint operation planning and execution system (JOPES)., *page 75*
- Figure 6-3: Functional process major inputs and output, *page 78*
- Figure 6-4: JOPES relational functions, *page 78*
- Figure 6-5: JOPES deliberate contingency planning, *page 81*
- Figure 6-6: Deliberate contingency planning process, *page 81*
- Figure 6-7: JOPES crisis action planning, *page 82*
- Figure 6-8: Crisis action planning process, *page 85*
- Figure 6-9: Transforming Operational Planning., *page 86*
- Figure 6-10: In-Progress Review (IPR) during plan development, *page 87*
- Figure 6-11: APEX integrates several processes that influence planning, *page 88*
- Figure 6-12: Army mobilization planning, *page 89*
- Figure 6-13: AMOPES Subsystems, *page 92*
- Figure 6-14: Reserve categories and mobilization, *page 94*
- Figure 6-15: Stages of mobilization, *page 97*
- Figure 6-16: Operational and mobilization continuum, *page 97*
- Figure 6-17: Mobilization and Execution Process, *page 98*
- Figure 7-1: Reserve Service Categories, *page 107*
- Figure 7-2: Army Reserve Command Relationship, *page 111*

- Figure 7-3: NGB management structure, *page 113*  
 Figure 7-4: Army National Guard Directorate, NGB, *page 113*  
 Figure 7-5: Office of the Chief, Army Reserve, *page 115*  
 Figure 8-1: Restoring Balance, *page 123*  
 Figure 8-2: The Cost of Force Readiness, *page 125*  
 Figure 8-3: Chairman's Readiness System, *page 126*  
 Figure 8-4: The Components of the JCCA Process, *page 128*  
 Figure 8-5: JFRR Readiness Assessment Definitions, *page 129*  
 Figure 8-6: CRS Output Flow, *page 131*  
 Figure 8-7: Commander's Unit Status Report Measured Areas, *page 133*  
 Figure 8-8: Army Unit Status Reporting Channels, *page 134*  
 Figure 8-9: Commander's Unit Status Report C-Levels, *page 135*  
 Figure 8-10: Commander's Unit Status Report A-Levels, *page 136*  
 Figure 9-1: Program Integrators, *page 153*  
 Figure 9-2: Resources in the FYDP reflecting the FY12 budget, *page 156*  
 Figure 9-3: FY structure of resources in an MDEP reflecting the FY 12 budget, *page 161*  
 Figure 9-4: FY structure of resources in an MDEP reflecting the FY 12-16 POM, *page 162*  
 Figure 9-5: FY structure of resources in an MDEP reflecting in the FY 12 budget, *page 162*  
 Figure 9-6: Program Evaluation Groups, *page 166*  
 Figure 9-8A: PPBE framework and acronyms, *page 168*  
 Figure 9-8B: PPBE framework acronyms, *page 169*  
 Figure 9-9: Army Resource Framework, *page 174*  
 Figure 9-10: Representative Timeline for POM/BES build, *page 176*  
 Figure 9-11: Program versus budget perspective, *page 178*  
 Figure 9-12: Representative timeline for program and budget review, *page 179*  
 Figure 10-1: Office of the Assistant Secretary of the Army (Financial Management and Comptroller), *page 188*  
 Figure 10-2: Resource Management's "4-A's", *page 189*  
 Figure 10-3: Fund Distribution Process, *page 190*  
 Figure 10-4: Cycle of Commitment and Review, *page 202*  
 Figure 10-5: GFEBS Deployment Schedule, *page 203*  
 Figure 10-6: Cost Benefit Analysis, *page 204*  
 Figure 11-1: Army S&T Oversight, *page 210*  
 Figure 11-2: Technology Readiness Levels (TRLs), *page 211*  
 Figure 11-3A: Acquisition categories (ACATS), *page 219*  
 Figure 11-3B: Acquisition categories (ACATS)-continued, *page 219*  
 Figure 11-4: Defense Acquisition System, *page 222*  
 Figure 11-5: Organizational linkage for Army materiel acquisition, *page 225*  
 Figure 11-6: Army acquisition executive (AAE), *page 227*  
 Figure 11-7: DOD Acquisition authority chain, *page 229*  
 Figure 11-8: Army Requirements And Resourcing Board (AR2B), *page 247*  
 Figure 11-9: Rapid Equipping Force (REF), *page 249*  
 Figure 11-10: Acquisition strategy, *page 256*  
 Figure 11-11: Total package fielding concept, *page 261*  
 Figure 12-1: Strategic Lines of Operation and Communication, *page 274*  
 Figure 12-2: Army G-4 Organization, *page 277*  
 Figure 12-3: U.S. Army Materiel Command, *page 294*  
 Figure 12-4: ARFORGEN, *page 295*  
 Figure 12-5: Responsible Reset Task Force (R2TF), *page 298*  
 Figure 12-6: Single Manager for Conventional Ammunition, *page 299*  
 Figure 12-7: Army Sustainment Command, *page 300*  
 Figure 12-8: SALE Architecture and Component ERP Systems, *page 309*  
 Figure 12-9: Army Working Capital Fund, *page 313*  
 Figure 13-1: Strength Relationships, *page 324*  
 Figure 13-2: Enlisted Procurement, *page 325*  
 Figure 13-3: Manning Programs, *page 328*  
 Figure 13-4: Manning Priorities and Standards, *page 330*  
 Figure 13-5: Enlisted Automation Management System, *page 331*  
 Figure 13-6: Officer Distribution, *page 334*  
 Figure 13-7: Warrant Officer Training and Education, *page 339*  
 Figure 13-8: Functionally Aligned OPMS Design, *page 342*  
 Figure 13-9: Centralized Selection List Categories, *page 343*  
 Figure 14-1: Civilians Supporting the Army in FY 10, *page 352*  
 Figure 14-2: Differences between the military and civilian systems, *page 353*  
 Figure 14-3: Civilian Career Program Strength as of 31 Dec 2010, *page 362*  
 Figure 15-1: Army Force Generation, *page 374*  
 Figure 15-2: Army Leader Development Model, *page 376*

Figure 15-3: Structure Manning Decision Review (SMDR), *page 381*  
Figure 15-4: Systems Approach to Training (SAT), *page 385*  
Figure 15-5: Warrant Officer Education System, *page 391*  
Figure 15-6: Officer Education System, *page 393*  
Figure 15-7: Civilian Education System, *page 394*  
Figure 18-1: The Army medical department, *page 447*  
Figure 18-2: Regional boundaries for medical and dental commanders, *page 450*  
Figure 18-3: Army Medical Logistics Enterprise, *page 452*  
Figure 20-1: USACE division and districts with Civil Works missions, *page 485*  
Figure 22-1: Tiered disaster/emergency response, *page 502*  
Figure 22-2: The National Response Plan (Under the Stafford Act), *page 503*  
Figure 22-3: The National Response Plan (Non-Stafford Act Situations), *page 504*  
Figure 22-4: Initial Request for DOD Assistance, *page 511*  
Figure 22-5: Civil disturbance support mission command, *page 515*

## **Glossary**

---

# Chapter 1

## Introduction

One of the first actions undertaken by the Continental Congress on 14 June 1775 was to direct General George Washington to muster troops for a Continental Army and this was done even before they began considering a Declaration of Independence. The American Army's core mission has changed very little in over 235 years. Today the Army comprises a standing force of troops and equipment ready at all times to defend the United States from attack and to protect our National security. The Army National Guard of today is the provincial militias the Continental Congress ordered General Washington to muster. They belong to the states but are called on by the federal government to supplement the active Army to meet threats to our security. The Army Reserve provides further support in times of need. The Army National Guard and Army Reserve are called the reserve component of the U.S. Army. In support of the war on terrorism, the reserve component has played an important role in the security of the Nation, with over 86,000 Soldiers forward deployed in Iraq, Afghanistan and 18 other countries. Today, the active Army and its reserve component make up a seamless force committed to fighting the war on terrorism and with the same mission: to defend the United States from attack and to protect her security. "It is the intent of Congress to provide an Army that is capable, in conjunction with the other Armed Forces, of preserving the peace and security, and providing for the defense of the United States,... supporting the national policies,... implementing national objectives and overcoming any nations responsible for aggressive acts that imperil the peace and security of the United States. [The Army] shall be organized, trained, and equipped primarily for prompt and sustained combat incident to operations on land. It is responsible for the preparation of land forces necessary for the effective prosecution of war except as otherwise assigned and, in accordance with integrated joint mobilization plans, for the expansion of the peacetime components of the Army to meet the needs of war." Title 10, United States Code, Section 3062 a and b.

### Section I

#### Fulfilling the Intent of the Congress

##### 1-1. Changing How We Manage Change

"[t]he Army must continually adapt to changing conditions and evolving threats to our security. An essential part of that adaptation is the development of new ideas to address future challenges." Quote when General Martin E. Dempsey was Commanding General, U.S. Army Training and Doctrine Command

a. Fulfilling the intent of Congress and the requirements of Section 3062 of Title 10 United States Code are formidable tasks. The Army is a dynamic organization that must constantly change to adapt to changing threats and challenges to the Nation's security and the assignment of new missions to fully execute the range of responsibilities identified in the National Security, Defense, and Military Strategies. The Army must be capable of accomplishing the full range of missions ranging from domestic disaster relief and homeland security (HLS) through major combat operations and stability and reconstruction operations across the full spectrum of conflict. This requires the continual adaptation and development across the Army's Doctrine, Organization, Training, Materiel, Leadership and Training, Personnel and Facilities (DOTMLPF) domains.

b. Today, the Nation remains engaged in an era of persistent conflict, a period of protracted confrontation against adversaries willing to use any and all means at their disposal to achieve their political and ideological ends. The wars that we are fighting in this new era are unlike any other in American history; wars in which military forces operating among the people will decide the outcome. The United States Army, with its singular ability to achieve decisive effects on land, is at the forefront of this struggle, not only in Iraq and Afghanistan, but throughout the world. In addition to meeting the demands of persistent conflict, the Army is undergoing its largest, most comprehensive transformation since World War II. We are continuing through our transition to a modular force, capable of deploying, fighting and winning anywhere in the world. At the same time, we are continuously developing breakthrough technologies and capabilities that will help us win current and future conflicts.

c. Changing large organizations with well-developed cultures embedded in established bureaucracies can be incredibly difficult. Functioning complex organizational systems and embedded processes can tend to resist change or cause change to become more evolutionary in nature. The Army's systems and processes outlined in this text are no exception. The Army has the internal challenge to ensure these processes are both flexible and adaptable to facilitate and not impede change as the Army incorporates flexible and adaptive processes to reduce unnecessary bureaucracy, inspire creativity and rapidly incorporate technological, cognitive, and organizational innovations. By describing these systems with this text, the authors do not intend to advocate their continued use nor indirectly resist their modification or wholesale reform. Instead, this text is intended to be a reference for educating our leaders so that they may make informed decisions on how these organizations, systems, and processes work to provide a basis of knowledge. This knowledge allows leaders to determine how systems and processes can be used or changed to better serve our Soldiers and our nation. This text should provide a basis of understanding that empowers continued change and the eventual transformation in *How the Army Runs*.



## How the Army Runs

### 1–2. Managing The Army

*a.* The Army as an organization performs a myriad of functions within the framework of well-defined systems and processes to effect the changes that enable it to accomplish the full range of missions. Some of the many complex functions that the Army must address when managing change include the following: recruiting and accessing military and civilian manpower; providing individual and unit training and education; developing war fighting doctrine and requirements; designing and organizing units and activities; equipping and sustaining fielded units; mobilizing and demobilizing Reserve Component units; stationing and supporting units; and deploying and redeploying forces.

*b.* The Army's institutionalized systems and processes address those just described and many other functions. Systems such as the civilian and military personnel management systems, strategic planning, and the Army Health Services System, and processes such as the Planning, Programming, Budgeting, and Execution (PPBE), combat development, force development, force integration, and materiel acquisition, are some examples of the systems and processes covered in this text's following chapters. The Army's capability to transform, fully execute its statutory obligations, and effectively accomplish the complex missions assigned to its activities and organizations depends upon how well the functions that are performed by any one of these systems or processes are integrated with the functions performed by each of the other systems and processes.

*c.* Stated another way, the successful integration of new doctrine, organizations, and equipment into the Army and the subsequent sustainment of the force in a trained and ready posture requires the synchronization of many Army systems and processes. This needs to occur at many levels of leadership and management to perform the functions that are vital to enabling the Army to not only fully execute its current responsibilities, while also preparing for the future with significant challenges.

*d.* There is no better or continuing example of why and how the Army must change to adapt to changing threats and missions, or of the complexities of effecting change, than the Army's ongoing transformation effort. While the Army has changed throughout its history, a transformation focus that began in 1999 and continues today through the full fielding of the Stryker Brigades, the modularity brigade reorganizations being implemented across the Army, the Army's modernization program, integrating technology spinouts from acquisition programs, and the transition of the Reserve Component to an operational reserve are especially dynamic. This transformation effort also includes a host of other activities that range from transforming business practices within an enterprise management framework to integrating technologies to rapidly acquiring materiel to enhancing force protection and improving readiness.

## Section II Army Focus

### 1–3. Background

*a.* In response to the strategic environment briefly discussed above, the Army has tremendous challenges. The clarity of these challenges is evident in the 2011 Army Posture Statement letter from the Secretary and Chief of Staff of the Army. "Our Nation has been at war for almost a decade, the longest period of continuous combat ever for our all-volunteer force. During that time our Army-Active, Guard, Reserve and Civilians-has met every challenge. We have successfully ended combat operations in Iraq, while simultaneously conducting one of the largest retrogrades in our Nation's history. We have surged Soldiers into Afghanistan, to support a strategy to address an adaptive enemy. We have also nearly completed the transformation of our operational force and are now addressing the Army's generating force. Additionally, the Army has provided lifesaving humanitarian assistance to those affected by natural disasters in Pakistan and Haiti and supported homeland defense and civil authorities in border screening and the Gulf of Mexico oil clean up.

*b.* In almost a decade of sustained combat, more than 1.1 million Soldiers have deployed to combat, impacting not only the Soldiers, but their families as well. Additionally, 30,000 Civilians have deployed into harm's way. Over 4,000 Soldiers have sacrificed their lives leaving over 25,000 surviving family members. More than 28,000 have been wounded, 7,500 of whom require long term care. Despite this sacrifice the Army remains strong because of the courage, commitment and resilience of our people and the bond of trust that exists between its members."

*c.* The Army challenge is in providing the right forces with the right capabilities to meet a variety of challenges. The Army recruits, organizes, trains, and equips Soldiers who operate as members of Joint, interagency, intergovernmental, and multi-national teams in an integrated manner. The Army also provides logistics, communications, transportation, and other support to enable our Joint and interagency partners to accomplish their missions, as well as support civil authorities in times of national emergencies. Responding to the strategic environment and the national security, defense, and military strategies that flows from these strategic documents, the Army continues to build and sustain an expeditionary and campaign quality force that is capable of deploying rapidly into any operational environment, conducting operations with modular forces anywhere in the world, and sustaining operations as long as necessary to accomplish the mission.

*d.* To fulfill the requirements of today's missions, including the defense of the homeland and support to civil authorities, the Army FY 2012 base budget requests is to fund military pay, benefits and associated personnel costs for 1.1 million Soldiers: 547,000 active, 358,200 Army National Guard, and 205,000 Army Reserve. Additionally, requests from the Overseas Contingency Operations (OCO) funds the pay and allowances for an average mobilization level of

50,100 reserve component personnel and special pays for all deployed Soldiers. While the numbers of soldiers deployed are down from the 251,000 in 2008, 229,940 of our Soldiers are deployed or forward-stationed in nearly 80 countries overseas. Additionally, more than 250,000 Army Civilians are performing a variety of missions vital to America's national defense. Many of them are forward deployed in support of our Soldiers.

#### 1-4. Army Posture Statement

The Secretary of the Army (SA) and Army Chief of Staff (CSA) submit an annual Posture Statement of the United States Army to the Committees and Subcommittees of the United States Senate and House of Representatives. This is done in preparation for subsequent hearings on the Army budget. The annual Army Posture Statement (APS) is an unclassified summary of Army roles, missions, accomplishments, plans and programs. Designed to reinforce the Secretary and Chief of Staff of the Army posture and budget testimony before Congress, the APS serves a broad audience as a basic reference on the state of the Army. The information provided in the addendum to the Army Posture Statement satisfies information required by the National Defense Authorization Act for Fiscal Year 1994. The information is presented in the order and depth as required by the act.

a. The 2011 Army Posture Statement Introduction states: "In the coming years, our top priorities will be to maintain our combat edge while we reconstitute the force for other missions and build resilience in our people. The Army has made significant progress in restoring balance through the four imperatives we identified in 2007- sustain, prepare, reset, and transform. We are on track to achieve a sustainable deployment tempo for our forces and restore balance to the Army beginning in FY 12. We successfully completed combat operations in Iraq, transitioning from Operation Iraqi Freedom to Operation New Dawn while executing one of the largest wartime retrogrades in the Nation's history. Operation New Dawn marks the beginning of a new mission for our Army while demonstrating our ongoing commitment to the government and people of Iraq. Concurrently, we surged Soldiers to Afghanistan in support of a new strategic direction in this vital theater. Even with all we have done, there is still much work to do." There are various subjects covered in the APS Addenda that are related to specific issues such as Reserve Component Readiness, a topic required by the National Defense Authorization Act of 1994, or other subjects that need more detail such as Army Force Generation (ARFORGEN), Reset, Army Families, and Modernization to name a few. As such, the Army Posture Statement must be read by Army Soldiers and civilians to appreciate both the current challenges and future direction that the systems and processes described in this text must respond to.

b. In 2007 the Army identified four imperatives to restore balance which were *Sustain, Prepare, Reset, and Transform*. The progress on achieving the balance on all four imperatives is reported in the 2011 Army Posture Statement. As stated in the introduction letter to the 2011 Army Posture Statement, "In 2007, we described the Army as 'out of balance' and put in place a four year plan to restore balance to a point where we could meet the demands on our force at a tempo that was predictable and sustainable for this all-volunteer Army. We are in the final year of this effort, and we are beginning to see the positive effects of the progress we have made. The Army is in a much better position today than we were in 2007, and with the FY 12 budget request, we are posed to meet our goals".

#### 1-5. The Army Campaign Plan 2011

a. The Army Campaign Plan (ACP) approved and released by the Secretary of the Army on 4 Feb 2011 as Section IV of the - The Army Plan (TAP). It is the operational expression of the first three sections of the TAP. It directs those actions necessary to execute Army transformation, restore balance to the Army and perform Service Title 10 functions by providing guidance for development of the Army program and budget while integrating continuous evolution of capabilities over time with the Army's current strategic posture. The ACP manages this transformation in order to better balance current versus future requirements.

b. The Army Campaign Plan has been published since 2004 to coordinate and synchronize Army Transformation efforts to include the modular conversion and growth of 302 brigades, the relocation of Army formations all the way up to the Army Command level under Base Realignment and Closure (BRAC) and Global Defense Posture Realignment (GDPR), and the change to the cyclical readiness model of Army Force Generation (ARFORGEN), all while fighting two wars. This plan, because it is synchronized with other Defense and Army resource guidance and processes, looks out six years or more. It also includes various annexes to provide comprehensive direction to Army organizations, identify focus areas along with the lead organization and proponent, as well provide strategic guidance in such areas as aviation, lifecycle management, modernization, and force generation. Its comprehensive nature ensures that the Army synergistically and systematically plans and executes change.

#### 1-6. Accelerate Change and Future Needs

a. One of the responsibilities of senior leaders is to identify the strategic issues facing the organization and the questions that must be answered and actions taken to deal with these issues. Those issues are identified in the ACP and the key elements in the Army Campaign Plan 2011 are: (1) re-energizing generating force transformation, which is the focus of the Secretary of the Army; (2) operationalizing business transformation; (3) identifying and measuring progress and success of Army priorities and; (4) effectively and efficiently using resources to transform the Army in a fiscally constrained environment.

b. The most significant change with Army Campaign Plan 2011 is the update of the Army Campaign Plan Strategy

## How the Army Runs

Map, which provides the blueprint for the campaign plan. First, to support the Under Secretary of the Army's role as the Chief Management Officer of the Army in improving business practices, a campaign objective was added. Second, an assistant secretary of the Army was chosen to lead each campaign objective. In support of these leads, an Army Staff element was identified as a coordinator to provide the best military advice as was a core enterprise, whose members can provide subject matter expertise. Lastly, objectives were updated and refined to best support achieving the Army vision of "A Balanced Army for the 21st Century."

c. The Army Campaign Plan 2011 provides the plan to "build a balanced Army for the 21st century that is a versatile mix of tailorable and networked organizations, operating on a rotational cycle, to provide a sustained flow of trained and ready forces for full-spectrum operations and to hedge against unexpected contingencies - at a tempo that is predictable and sustainable for our all-volunteer force over the course of the next six to eight years.

d. A key value of this text is that the systems and processes identified within will help enable Army leaders and managers to implement these strategic choices. Future budgets and internal and external challenges will impact the pace of implementing these choices as well as making proper adjustments in how these choices are fully executed.

### 1-7. Transformation

a. The subject of transformation had been embedded in the first sections of this chapter in various ways. That is because transformation in some manner impacts or influences almost everything the Army does from personal, unit and joint perspectives. We are entering a critical phase of our transformation from a Cold War Army to a 21st Century Army; one that is an expeditionary, campaign capable, disciplined Warrior Team dominant across the spectrum of conflict. The past decade has seen the Army transform in many ways. Secretary White and General Shinseki provided an intellectual framework for our transformation. Secretary Harvey and General Schoomaker led the Operating Force transformation. Secretary Geren and General Casey have clearly articulated our need to adapt our institutions in order to cement the transformation of the Army of the 21<sup>st</sup> Century, Now both Secretary McHugh and General Casey are seeing transformation of the operational force nearing completion as 297 of the 302 Army brigades will have been converted from Cold War formations to more deployable, tailorable and versatile modular formations in 2011, leaving only a few to be completed in 2012.

b. As specified in an earlier 2009 Army Campaign Plan: The Army will continue to transform to improve the capabilities of Soldiers and the Joint Force to meet the challenges of the new security environment characterized by continuous full spectrum operations (Offense, Defense and Stability or Civil Support) in persistent conflict against complex, adaptive enemies at home or abroad. This, however, is not the end-state. Trends toward the future that are clearly visible today, though fraught with multiple unknowns, require that transformation must not merely continue; it must accelerate in the coming years. Army transformation improves the capabilities of Soldiers engaged in an era of persistent conflict against global terrorism and the conditions that give it life and sustenance, while preserving the All-Volunteer Force. Transformation, as established in Army concepts and capabilities, improves Army capabilities to meet Joint Force requirements to defend the Homeland, deter conflict in critical regions, respond promptly to small-scale contingencies, conduct stability operations and swiftly defeat any enemy in major combat operations. This, in turn, improves the Nation's military capability to deal with traditional, irregular, disruptive and catastrophic challenges on the horizon.

c. Army transformation integrates a broad range of concept-based initiatives and institutional processes across the doctrine, organization, training, materiel, leadership and education, personnel, and facilities, (DOTMLPF) domains to achieve the Army vision and execute its mission. This transformation is framed in terms of the broader defense transformation effort and addresses the needs of the Joint Force, as well as the needs of the Army.

## Section III

### Purpose, Scope, and Objectives of this Text

#### 1-8. Purpose

a. The purpose of this text is to provide a primer and ready reference to officers preparing to assume command and management positions at the senior and strategic levels of leadership. It explains the relationships of the systems and processes that produce both future change and contribute to daily mission accomplishment. It is these systems and processes that will be taxed to their fullest capabilities and capacities during the execution of the Army Campaign Plan.

b. While a principal use of this reference text is to support the Department of Command, Leadership, and Management's (DCLM) portion of the U.S. Army War College (USAWC) curriculum, there are additional objectives that serve broader purposes. These other objectives include its use by the following ways: by nonresident students in fulfilling the requirements of the Army War College's Distance Education Program; as a general reference for branch and service schools in the military education system; and as a primer for all who seek to better understand the Army's organization and functions, along with its systems and processes.

c. The major focus of the text is on the United States Army as specified by its title. However, this text also addresses how the Army interfaces with the Office of the Department of Defense, other Services, the Joint Chiefs of Staff (JCS) and the Combatant Commanders to better achieve joint interdependence. Hence, it describes other systems

and processes such as the Joint Strategic Planning System and the Planning, Programming, Budgeting and Execution process.

### 1–9. Scope and Objectives

*a.* This reference text supports the DCLM portion of the USAWC curriculum which focuses on strategic leadership, joint processes, defense enterprise management, and the development of landpower. Elihu Root founded the institution “not to promote war, but to preserve peace by intelligent and adequate preparation to repel aggression.” He charged the faculty with directing “the instruction and intellectual exercise of the Army, to acquire information, devise the plans, and study the subjects indicated, and to advise the Commander-in-Chief of all questions of plans, armament, transportation, and military preparation and movement.” Much of that original emphasis remains in the current USAWC mission, which includes preparing leaders to assume strategic leadership responsibilities and supporting the operational and institutional force.

*b.* The DCLM presents that portion of the curriculum that promotes a better understanding of the theory and practice of command, leadership, and management in the Department of Defense and the Department of the Army. This text is particularly used in the Course titled, Defense Enterprise Management, which includes methods of instruction with faculty presentations, lectures, and discussions with distinguished academicians and prominent practitioners, seminar group discussions, case studies, independent reading, and practical exercises.

*c.* From 1977 to 1997, the primary reference text published by DCLM was entitled Army Command, Management, and Leadership: Theory and Practice. Because of the growing volume of discussion and information in the category of theory as well as the many changes that have occurred in Army organizations and systems since the end of the Cold War, the single theory and practice volume was replaced in 1997. The theory has been incorporated into a Course text that changes yearly. The current version of *How the Army Runs*, which is published biannually, is an outgrowth of this division. This text addresses the operation and relationships of the systems and processes that enable the Army to fulfill its roles and accomplish its missions.

## Section IV

### Text Organization and Relevance

#### 1–10. Text Organization

*a.* This text is organized into 22 different chapters, which cover Army structure, systems and processes from broad as well as specific perspectives. For example, the Army structure is described from an organizational life cycle perspective before describing the various structural components. A separate chapter is devoted to the Reserve components.

*b.* Broad systems and processes that impact the Army overall are first described. When appropriate, these systems and processes are covered from Defense, Joint and Army perspectives to understand their interaction and synergy. This includes chapters that involve subjects such as: strategic planning, force development, mobilization and deployment, readiness, resources, and materiel system research, development and acquisition.

*c.* This text’s later chapters focus more on Army functional organizations, systems or processes. This includes chapters devoted to the following: logistics, military human resources, civilian personnel management, training, knowledge management, installations, health services, legal, civil functions and public affairs. Finally, the last chapter deals with the complex Defense and Army’s contributions to the subject of defense support of civil authorities.

#### 1–11. Relevance

*a.* This text helps one understand how to operate within strategic context and meet the critical challenges as addressed in the Army Posture Statement and other strategic documents. This text is about the systems and processes that will enable the Army to remain as effective in service to the Nation in the future as it has been in the past. The Army has an historic legacy from which to build upon and it is just as profound today as stated in the cover of the 2011 Army Posture Statement: “**AMERICA’S ARMY: THE STRENGTH OF THE NATION.**”

*b.* It is hoped that students and practitioners of the military art who use this text will more fully appreciate the truth in the words of General Harold K. Johnson, Chief of Staff Army 1964–1948 who said: “The Army is like a funnel. At the top you pour in doctrine, resources concepts, equipment, and facilities. And out at the bottom comes one lone soldier walking point.”

*c.* In his arrival message to the Soldiers, Civilians, and Families of the United States Army, Army Chief of Staff, General George W. Casey stated in the first sentence: “I am extremely proud to be taking charge of an organization that is rightly regarded as the best in the world.” He goes on to say: “Seldom in our history have Soldiers faced greater challenges. We serve at a time when the stakes for our Nation and way of life are high, and the demands on our force significant. We will continue to reflect the very best of our Nation by defeating the enemies of freedom and the proponents of terror, by defending our homeland, and by assisting our Nation to build a better future for coming generations.” When commenting on the achievements of the past year in the beginning of the 2011 Posture Statement, Secretary John M. McHugh stated: “Even as we applaud these achievements, we must be mindful that our nation and

## How the Army Runs

our Army are **at a strategic crossroads** marked by significant challenges.” Understanding and applying the organizations, systems, and processes described in this text are part of the way leaders will continue the legacy of those who have come before us to keep the Army as the best in the world. It is in support of the Army’s Soldiers around the world who are living the Warrior Ethos that this reference text is written. The closing sentence of the Introduction in the 2011 Posture Statement says this succinctly: **As the Strength of the Nation, the American Soldier is the centerpiece of everything we do.**

## Chapter 2

### The Army Organizational Life Cycle

In his Biennial Report of the Chief of Staff of the United States Army to the Secretary of War for the period July 1, 1939, to June 30, 1941, General George C. Marshall described the stark situation in which he found the Army as the war in Europe erupted and threatened to involve a neutral United States. President Roosevelt's emergency proclamation of September 8, 1939 had given the authority for the Active Army to expand from 210,000 to 227,000 men and to reorganize from the World War I square divisions to the new triangular divisions. However, General Marshall's problems could not be solved by a manpower increase of less than 10% and division reorganization. He also had major training deficiencies to correct. There was such a shortage in motor transportation that divisional training was impracticable. A lack of corps headquarters and experienced commanders and obsolete doctrine and organizations further degraded capabilities. Over half the undermanned Active Army divisions were horse-mounted and the horse was still the primary means of mounted movement. At the same time Congress had reduced the Army Air Corps request for replacements to World War I aircraft to only 57 planes. It was even worse in the National Guard organizations. General Marshall's solution to these massive problems was to reconstruct the Army systemically, by resourcing, structuring and integrating new equipment, personnel, and organizations while training. Ultimately, he improved the youth and vitality of the Army by discharging elderly and substandard soldiers. The U.S. Army's success in creating, deploying, and sustaining 89 divisions for the European Theater during World War II was largely due to General Marshall's genius for leadership and his skill at what, today, is known as force management.

#### Section I Introduction

##### 2-1. Chapter content

a. This chapter provides an overview of the systems and processes employed by the Army to manage change on a continuing basis. It reflects the fact, as General George C. Marshall understood all too well, that, in complex organizations, every action or problem affects every other function of the organization. Army management systems and processes dictate the entire life cycle of the Army, from the earliest stages of conceptual development to the final disposition of people, equipment, and facilities.

b. The Army manages change by utilizing a myriad of institutional processes as it performs its legal function as specified in Title 10, United States Code, Section 3062, to prepare forces "...organized, trained, and equipped primarily for prompt and sustained combat incident to operations on land. It is responsible for the preparation of land forces necessary for the effective prosecution of war except as otherwise assigned and, in accordance with integrated joint mobilization plans, for the expansion of the peacetime components of the Army to meet the needs of war."

c. This chapter looks holistically at the interconnected systems and processes used to develop and manage the Army. The chapter is an overview of 'How the Army Runs' and addresses systems that are necessary to the overall leadership and management of the Army, and that are integral to the force management processes. Subsequent chapters will expand upon the sub-elements presented here.

##### 2-2. The Army Organizational Life Cycle Model (AOLCM)

a. Managing change in any large, complex organization requires management of many interrelated processes. In the context of developing operational organizations with highly trained personnel, led by confident leaders, using technologically advanced equipment, and providing that capability when needed by the unified combatant commander (CCDR), the Army manages from an organizational lifecycle view. The Army Organizational Life-Cycle Model graphically captures the continuous cycle of developing, employing, maintaining, and eliminating organizations. The Army management approach recognizes the need to understand modernization and change as a complex adaptive system. *The Army Plan and The Army Modernization Strategy (AMS)* mandate the Army transformation and modernization efforts such as the Brigade Combat Team Modernization, modular force design, and AC/RC rebalancing to produce relevant and ready landpower that is strategically agile and expeditionary. The AOLCM provides a conceptual framework to both analyze and assess Army change efforts.

b. The AOLCM shown at Figure 2-1 reflects the stages that organizations and their personnel and equipment will experience at one time or another (and oftentimes concurrently) during their service in the Army. The functions performed in these stages develop, field, sustain, and modernize operational units and their supporting organizations; maintain their viability and effectiveness; and remove them or their assets (personnel and materiel) from the force as requirements change. Each individual asset (a soldier or civilian or materiel) required by a unit or activity will be found at some stage of the model beginning with the establishment of the need and entry into the Army to ultimate separation or disposal. The model details the critical stages through which an organizational resource will move, at some point, during its life span. Generally, the model depicts the life cycle of Army organizations from their development and their progression (clockwise around Figure 2-1) to separation. The dynamic of the model, displayed by the interconnecting

lines, illustrates that the Army leadership must resource and manage all of the functions simultaneously, since Army assets will be in each functional stage at any one time. Any change to a resource in a functional stage will affect resources in most if not all of the other functional stages. In other words, if you influence or change something in one functional node the response will impact the entire model affecting other nodes to some degree.

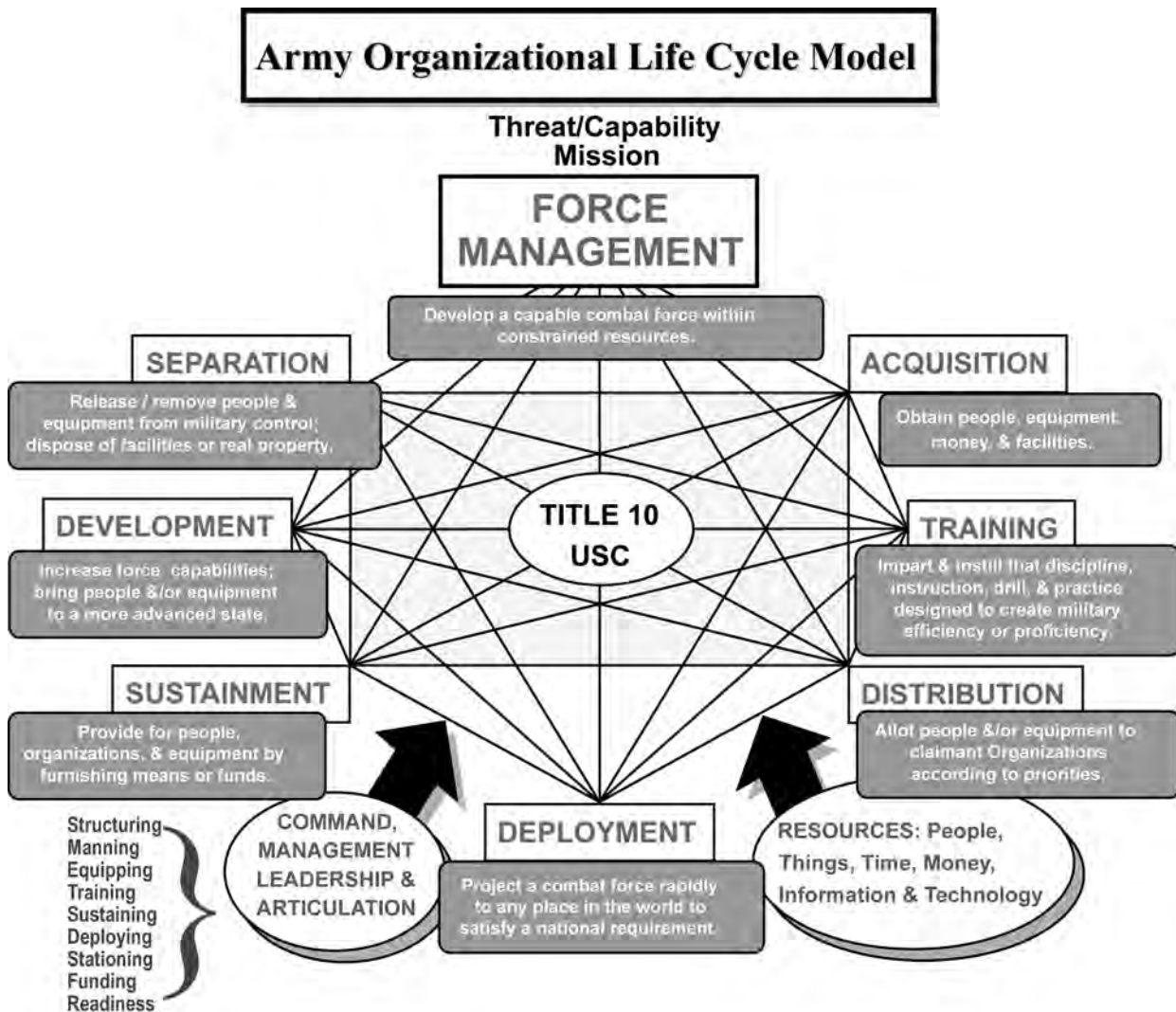

Figure 2-1. The Army Organizational Life Cycle Model

c. Life cycle functions are listed below.

(1) *Force Management*. As the first phase of the organizational life cycle model, force management becomes the key activity underlying all other functions. The process involves decision-making, and execution of activities encompassing conceptual development, capabilities requirements generation, force development, organizational development, force integration functions and resourcing. Force management results in the development of a capable operational force within constrained resources.

(2) *Acquisition*. After the Congress authorizes, and the DOD provides, the budget and the end strength (ES) (see para 13-7b) guidance, the Army must then acquire the people and materiel specified in the requirements and authorizations documents necessary to accomplish specified missions. From a materiel acquisition perspective, the acquisition function extends beyond the principal item being fielded and must consider other essential requirements such as the availability of associated support items of equipment and personnel (ASIOEP), technical publications, repair parts, trained personnel, and facilities. From a human resource (HR) (see Chapter 13 and 14) acquisition

perspective, the acquisition function must consider recruiting and accession missions in concert with the overall manpower management program and the influences of personnel life cycle functions.

(3) *Training.* The training function encompasses the processes for accomplishing the transition from civilian status to military life. In this context, the training function is somewhat different from what most Army leaders think of when discussing training. At this point in the life cycle, consider training from the aspect of initial entry training or the requirement to provide soldiers with initial new equipment training or familiarization training on new or displaced equipment. In other words, this aspect of the training cycle imparts new skills to the soldier or converts the civilian into a soldier. It most often results in award of a military occupational specialty (MOS) or additional skill identifier (ASI). The training function also includes the transition of U.S. Military Academy (USMA), Reserve Officer Training Corps (ROTC), and Officer Candidate School (OCS) graduates into officers through the Basic Officer Leadership Courses (BOLC). Traditional collective training and professional educational and leader development fall under the "development" phase of the Organizational Life Cycle Model.

(4) *Distribution.* Having produced or procured the resources necessary to form and sustain units they must be distributed according to established requirements, authorizations, and priorities. The distribution function includes the assignment of people from entry-level training to their initial unit and the delivery of new materiel from the wholesale level to the user. This activity is primarily managed and synchronized through the Army Force Generation (ARFORGEN) process that focuses equipment and personnel distribution during the reset phase. See paragraph 2-7b (3) below.

(5) *Deployment.* Once trained or prepared units, individuals, packages, or materiel become available to support worldwide operations. An individual soldier, civilian, unit, or item of equipment may be subject to some, if not all, of the mobilization, deployment, redeployment, demobilization, and reconfiguration processes of this function. Deployment represents both a planning and operational function involving agencies on the ARSTAF, other levels of DOD, and the civilian transportation structure. Like many of other AOLCM activities, unit deployments are managed on a cyclical basis with the ARFORGEN model.

(6) *Sustainment.* In peace or war the presence of people and materiel in units establishes a requirement for sustainment. People, skills, capability, and equipment must be maintained to the standard set for mission accomplishment by replacement, rotation, repair, and training operations. From a personnel perspective this function covers soldier reassignments throughout a career or obligation period, quality of life and well-being programs, as well as other aspects of the personnel systems influencing retention. Repair parts and maintenance provide the sustainment process for materiel. Training in units covering the process of sustaining common soldier skills that maintain unit or individual proficiency falls under this function as well. The manning priority level, the Dynamic Distribution System (DDS) (see para 13-19b), Dynamic Army Resource Priority List (DARPL), Basis of Issue Plan (BOIP), ten classes of supply, the authorized stockage lists (ASL), and prescribed load lists (PLL) illustrate some of the systems or techniques used to manage authorizations and priorities within the sustainment function.

(7) *Development.* The Army must constantly develop and improve. We develop individuals through civilian, enlisted, and officer education programs that include character and leader development modules. Education and training programs range from individual self-development, including graduate-level degree programs, to the entire range of branch and skill related institutional training culminating at either the senior service college for officers and civilians or Sergeants Major Academy for enlisted soldiers. Units develop through collective training processes that include individual training in units, home station training, and deployments for training. Examples are collective training tasks (CTT), leader training, live fire and maneuver training, external evaluations such as those under the Army Training and Evaluation Program (ARTEP), deployment exercises, and training rotations to the combat training centers (CTC).

(8) *Separation.* Finally, there comes a time when people and equipment separate from military control. People may separate voluntarily by not extending following completion of an obligated service period or by retiring. Involuntary separation may occur due to reduction in force (RIF) actions or qualitative reasons. The Army normally separates materiel through the Defense Reutilization and Marketing Office (DRMO) process or through foreign military sales (FMS) actions.

d. External influences affecting the functioning of the model. There are two categories of external influences that affect the model:

(1) The first category is the availability of resources. Resources include tangible objects in the form of funds, materiel, or personnel as well as intangible resources such as time, information, and technology.

(2) The second category is the influence of command, management, and leadership in planning, organizing, directing, controlling, and monitoring the multitude of inputs, decisions, and actions to ensure that functions at each stage of the model execute effectively and at the appropriate time. These command and management activities are synchronized within the ARFORGEN process to ensure the timely allocation of scarce resources and to maximize the availability of trained and ready Army forces to meet CCDR Army force requirements.



### Section II

#### Force management

##### 2-3. The Army War College Model

To aid in examining specific force management systems (FMS) (see Chapter 5) and their interactions, the U.S. Army War College has adopted the force management model shown in Figure 2-2 (see the end of this book). This model reflects a System-of-Systems approach (see para 11-9d), each of which provides an essential force management function and, more important, how these functions relate to each other.

*a.* In this network, strategic and senior leadership guidance, the processes for determining warfighting capabilities requirements, conducting research and development (R&D), and providing resources all provide input to the force development process. The resulting products of force development, in turn, provide the basis for the force integrating functions of acquiring and distributing materiel, as well as acquiring, training, and distributing personnel in the Army. This widely used model highlights key aspects and relationships of force management. The model shows the relationships of Army processes to each other and to the major DOD management processes. These processes drive and interact with Army processes. Each process displayed in the figure is examined in detail in other chapters of this text. These major DOD management processes are the:

- (1) Joint Strategic Planning System (JSPS) (see Chapter 4, Section II).
- (2) Joint Operations, Planning and Execution System (JOPES) (see Chapter 4, Section IV).
- (3) Planning, Programming, Budgeting and Execution (PPBE) Process (see Chapter 4, Section III and Chapter 9).
- (4) Materiel System Research, Development, and Acquisition Management process (see Chapter 11).

*b.* The underlying basis for this model is that force management, in its simplest context, is the management of change using many interrelated and complex processes. Although the model depicts the flow of processes in a somewhat linear, sequential manner, the complexities of managing change mandate that at any one time an initiative may be simultaneously in several of these processes at some level of maturity. As organizations develop, these processes may run sequentially, be compressed, run in parallel, or even run in reverse depending on the urgency, risk and senior leader guidance on the issue. History has shown, however, that eventually all of the steps must take place to produce a fully trained and equipped operational force at the right time and at the right place for the geographic Combatant Commanders (CCDR).

##### 2-4. Force management terms.

This section will explore the terms commonly used when describing the force management process. Force management has two major sub-components, Force Development and Force Integration:

*a. Force development.* Force development determines Army doctrinal, organizations, training, materiel, leadership and education, personnel, and facilities (DOTMLPF) capabilities requirements and translates them into plans and programs, within allocated resources, to accomplish Army missions and functions. A capability provides the means to accomplish a mission or task decisively. Capability comes from organizations comprised of well-trained people with superior equipment, led by competent leaders employing sound doctrine. The following paragraphs offer a condensed explanation of the force development process. (For more detail see Chapter 5).

- (1) *Generate capabilities requirements.*

*(a)* The force development process has its roots in the process of developing operational concepts to meet the future functional needs of the Joint force. The Joint Capabilities Integration and Development System (JCIDS) (see para 5-3) identifies the required operational capability in terms of personnel, equipment, and unit structure. This process begins with national-level guidance such as Quadrennial Defense Review (QDR); the National Security Strategy; the National Defense Strategy; the National Military Strategy; Defense Planning and Programming Guidance; guidance from the Army's senior leadership (The Army Plan [TAP] [see para 1-4d], which includes the Army Strategy, the Army Planning Priorities Guidance, the Army Programming Guidance Memorandum, and the Army Campaign Plan [ACP]); and operational requirements of the geographic Combatant Commanders. With this guidance, the military examines trends, patterns and projections to forecast the future joint operating environment (JOE). The military and the Army then develop a family of operational concepts expected to accomplish the strategic guidance and related operational objectives and prevail in that environment. These include development of the family of Joint Operations Concepts (JOpsC) such as the Capstone Concept for Joint Operations (CCJO), supporting Joint Concepts, and the family of concepts in the Army Concept Framework (ACF). The ACF includes the Army Capstone Concept, Army Operating Concept, and Army Functional Concepts. The U.S. Army Training and Doctrine Command (TRADOC) assesses the future concepts through a series of analyses, tests, experiments, and studies to gain insights for solutions across DOTMLPF domains for emerging functional needs. Through this analysis key capabilities are refined and documented as Force Operating Capabilities (FOCs).

*(b)* Using the Integrated Capabilities Development Team (ICDT) management technique, TRADOC pursues timely involvement of appropriate agencies/expertise to aggressively analyze and assess future operating capabilities requirements. The Director of TRADOC's Army Capabilities Integration Center (ARCIC) charters an ICDT to conduct Capability-based Assessments (CBA) that includes functional area analysis (FAA), functional needs analysis (FNA),

functional solution analysis (FSA), and the preparation of capability documents. This assessment process leads to the identification by the Commanding General (CG) TRADOC to HQDA of DOTMLPF change recommendations (non-materiel solutions) or a materiel capability need. If the capability requires a change in doctrine, training, or leadership and education TRADOC begins action to meet the requirement upon approval of HQDA Deputy Chief of Staff (DCS), G-3/5/7. For doctrinal changes, TRADOC prepares a program directive (PD) (normally approved by the CG, CAC) to define and document in detail the doctrinal requirement. If the analysis results in a need for change in soldier occupational specialty structure, then the recommendation goes forward to U.S. Army Human Resources Command (HRC) for Army wide coordination and approval (See Chapter 13). If the required capability needs a materiel solution, TRADOC conducts a more detailed Analysis of Materiel/non-materiel Approaches (AMA) and, if appropriate, prepares an Initial Capabilities Document (ICD) and forwards it to HQDA DCS, G-3/5/7 for approval of the capability requirement through the Army Requirements Oversight Council (AROC) validation/approval process. HQDA DCS, G-8 has responsibility for materiel solutions and DOTMLPF integration throughout the program life cycle. (For more detail on fulfilling materiel capabilities requirements see Chapter 11). If the solutions analysis determines a need for change in facilities, then the recommendation goes forward to the Assistant Chief of Staff for Installation Management (ACSIM) (see para 9-8b) for action (also see Chapter 17). If TRADOC determines the required capability needs an organizational solution, TRADOC prepares a Unit Reference Sheet (URS). TRADOC forwards the URS to HQDA for approval. The approved organizational solutions move to the next phase of force development.

(2) *Design organizations.* As the conceptual change in organizational structure becomes recognized and codified, the organizational design process captures the organizational personnel and equipment requirements. The combat development community develops the proposed organization, as well as its mission and functions, to meet the required mission capabilities. Organizational solutions to capabilities requirements are captured in a URS in sufficient detail to support Army force design initiatives, and related studies and analyses. After the design has been developed, laid out and analyzed by TRADOC, it moves forward to HQDA in the force design update (FDU) process. The FDU process is used to gain consensus within the Army on new organizations and changes to existing organizations. Once approved, this design will be further refined into an organizational model known as a table of organization and equipment (TOE) in the next phase (see para 5-9).

(3) *Develop organizational models.* Following approval of the URS during the FDU process, the U. S. Army Force Management Support Agency (USAFMSA) applies rules, standards, and guidance to the doctrinally correct design to produce the organizational model (TOE). The TOE is a requirements document, and defines a fully resourced and mission-capable organization (i.e.; assuming all personnel and equipment are available and resourced).

(4) *Determine organizational authorizations.* The HQDA approved TOE competes in the Total Army Analysis (TAA) process for resources. TAA develops requirements and authorizations defining the force structure the Army must build, raise, provision, sustain, maintain, train and resource. Through TAA, the Army provides the geographic CCDRs with the proper force structure to execute assigned tasks. In the first phase, the TAA determines the requirements (number and type) for all approved TOEs. In the second phase, the TAA process resources the requirements based upon Army leadership directives, written guidance, risk analyses, and the priorities of the Combatant Commanders. The resourcing phase of TAA also accounts for the materiel requirements. TAA takes into account force guidance and resource availability to produce a balanced and affordable force structure. It determines and/or verifies the affordability, supportability, and executability of the proposed organizational models. (see Chapter 5, Section V)

(5) *Document organizational authorizations.*

(a) After approval of the resourced force structure by the Army leadership, USAFMSA manages the process of documenting the decision(s). This process results in organizational authorizations documented as modification tables of organization and equipment (MTOE) or tables of distribution and allowance (TDA) (see Chapter 5, Section VI). The force development process culminates with the HQDA approval and documentation of personnel and equipment authorizations as Army organizations in the force structure. The resource-constrained decisions on the allocation of authorizations are recorded in The Army Authorization Document System (TAADS) (see para 5-24) and the Structure and Manpower Allocation System (SAMAS) (see para 5-23).

(b) The marriage of these two systems occurs in the Structure and Composition System (SACS). SACS produces the Army's time-phased demands for personnel and equipment over the current, budget and program years and is extended for a total of a ten-year period. Additionally, SACS builds a fully modernized Objective TOE (OTOE) position for all units. In this way, SACS shows current levels of modernization, levels achieved at the end of the Program Objective Memorandum (POM) (see para 5-26a and 9-54) period and a fully modernized Army (for planning purposes). SACS outputs combine information from Basis of Issue Plan (BOIP), TOE, SAMAS, TAADS and known force structure constraints not included in the previous files. Key outputs are the Personnel SACS (PERSACS) and the Logistics SACS (LOGSACS) (see Chapter 5).

(c) SACS provides the data that drives the force integration processes to acquire, train, and distribute personnel and acquire and distribute materiel to the right place at the right time. Upon completion of force development the management processes become integrating functions. These force integration functions take an approved force development program and incorporate it into the force.

b. *Force Integration.*

## How the Army Runs

(1) Effective force integration is a difficult and demanding process that involves coordinating many complex and unique procedures and data systems. Force integration is the synchronized, resource-constrained execution of approved force development plans and programs to achieve systematic management of change, including—

- (a) The introduction, incorporation, and sustainment of doctrine, organizations, and equipment into the Army.
- (b) Coordination and integration of operational and managerial systems collectively designed to improve the effectiveness and capability of the Army.
- (c) Knowledge and consideration of the potential implications of decisions and actions taken within the execution process.

(2) The scope of force integration includes the functions of structuring organizations, manning, equipping, training, sustaining, deploying, stationing, and funding the force during the introduction and incorporation of approved organizational or force structure changes. It also includes the function of minimizing adverse impacts on force readiness during the introduction and incorporation of change. Force integration synchronizes these functional activities to produce combat ready organizations. Force integration is the enabling process of force management. Force integration focuses Army management actions towards organizations to ensure the orderly incorporation and sustainment of structure, equipment, and doctrine in the Army. The objective of the effort is to assess the combined impact of Army functional systems on units and ensure the appropriate mix of resources (structure, people, equipment, dollars, facilities, and information) result in fully operational units.

### Section III

#### Coordination of force integration actions

##### 2–5. Information exchange as a key element of force integration

Coordination of all aspects of force integration requires the constant exchange of information. In the Army's battle to achieve effective force integration, there have been and continue to be initiatives that focus on improving the information flow within and between the multiple systems and processes of force integration. Throughout this text, readers will find detailed descriptions of systems and processes that exchange information and help coordinate force integration actions.

##### 2–6. The team approach to force integration

a. HQDA learned from the challenges of rapidly fielding the Stryker brigades, managing the modular conversions, and rebalancing the AC/RC the value of integrated process team (IPT) problem solving. Correspondingly, teams of stakeholders meet to discuss and seek solutions to implementation challenges of force management initiatives. These cross-functional working groups have been able to work the complex issues faced by the accelerating pace of change in a manner superior to the linear and sequential methods used in the past. HQDA continues to use the team approach for force management. The three key staff officers that chair the major integrating working groups are the requirements staff officer (RSO) assigned to the G–3/5/7, the synchronization staff officer (SSO) assigned to the G–8, and the DA system coordinator (DASC) assigned to the Assistant Secretary of the Army for Acquisition, Logistics and Technology (ASAALT). They work with other team members including the G–3/5/7 force integrator (FI) (see para 2–6c), the G–3/5/7 organization integrator (OI), the G–8 PA&E action officer, the document integrators (DI) (see para 2–6c), the personnel system staff officer (PERSSO) (see para 11–17f(1), command managers and resource integrators (RI). As required, representatives from Army Commands (ACOM), Army Service Component Commands (ASCC), Direct Reporting Units (DRU), Reserve Components and other functional area and special interest representatives are included in this function and in staffing force management issues.

b. The integrating team approach helps to ensure that every action is properly coordinated with representatives who have knowledge of the doctrine, design, structure, personnel, acquisition, equipping, resources, facilities, information management, and training activities that impact a unit. The G–3/5/7 RSO serves as the HQDA single point of contact and represents the HQDA position for DOTLMPF capabilities requirements. RSOs convene capabilities requirements teams to analyze, coordinate, refine, resolve critical comments, non-concurrences and develop recommendations for the capability. The SSO is the counterpart to the RSO for the G–8 and serves as the HQDA single point of contact for the integration and synchronization of approved capabilities requirements in order to achieve the Army Strategy, Army Campaign Plan (ACP) priorities and modernization strategy. The DASC is the primary acquisition staff officer at DA. The DASCs are responsible for the day-to-day support of their assigned programs and serve as the PMs' representatives and primary points of contact within the Pentagon. These staff action officers are responsible for preparing, handling, and coordinating actions in their areas of expertise. For more detail on duties and responsibilities of these staff members see Chapter 11.

c. Roles of other ARSTAF team members.

(1) *Force integrator.* The FI assigned to G–3/5/7 represent the interests of functionally dissimilar force-level organizations (e.g., the entire force structure from Modular Brigade through Theater Army). They are horizontal force-level integrators and work with brigades, regiments, divisions, and corps and Theater Armies. The FI:

- (a) Assesses ability of functional systems to support major organizations.

- (b) Recommends prioritization of resources.
  - (c) Assesses impacts of organizational change, at the appropriate force level, on readiness.
  - (d) Facilitates integration of units into major organizations.
  - (e) Evaluates and analyzes impact of incorporating personnel, facilities, equipment, doctrine, structure, and capability changes into major organizations.
  - (f) Ensures major units are represented in force integration and force planning processes (e.g., TAA, FDU, etc.).
  - (g) Assesses impacts of mid-range and long-range planning on major units including new doctrine, structure, manning, equipment, technology, facilities, stationing, strategic policy, and resource strategies.
  - (h) Links organization requirements to resource allocation.
- (2) *Organization integrator*. The OI are assigned to the G-3/5/7 Force Management Directorate and represent organizational interests of functionally similar organizations, e.g. Infantry, Armor, etc. These individuals are organized into teams for Maneuver, Maneuver Support, and Maneuver Sustainment. The OI serves as the vertical integrator, in their area of specialization. Additionally, they provide subject matter expertise to the RSO regarding requirements documentation that deal with these functionally similar organizations. The duties of the OI include, but are not limited to:
- (a) Analyze, coordinate, refine and develop recommendations on requirements.
  - (b) Ensures doctrinal linkage exists between organizational and current and emerging capabilities.
  - (c) Coordinate approval of TOE, BOIP and Concept Capabilities Plans.
  - (d) Participate in force management analysis reviews of all force management documentation.
  - (e) Develops and coordinates the HQDA position on proposed TAA process changes.
- (3) *Command manager (CM)*. Command managers (force structure) (CM [FS]) assigned to the G-3/5/7 represent the organizational interests of an ACOM/ASCC/DRU by managing its TDA units, and serves as the FI for the command's MTOE. The second focus of the CM is managing program budget guidance by ensuring that the manpower allocation for each ACOM/ASCC/DRU is accurately reflected in the SAMAS in compliance with Army leadership decisions and within manpower controls established by OSD. Duties, include:
- (a) Point of contact for command plans and concept plans (CONPLAN).
  - (b) Maintaining the documentation audit trail on all additions, deletions, and other changes to unit MTOEs and TDAs.
  - (c) Producing manpower resource guidance for ACOM/ASCC/DRU program budget guidance (PBG).
  - (d) Managing command FSAs.
  - (e) Providing analysis and assessment of resource alternatives for organizational actions under consideration.
  - (f) Documenting current and programmed personnel strength, applicable Joint RDA programs, and organization force structure.
  - (g) "Cross-walking" analysis of Army programming decisions with those of the DOD, OMB, and Congress.
- (4) *Document integrator*. The DI, are assigned to the U.S. Army Force Management Support Agency (USAFMSA), a DCS, G-3/5/7 field operating agency (FOA). The DI produces organizational requirement and authorization documents that implement approved Army force programs. Their duties include:
- (a) Document the unit mission and required capabilities by applying equipment utilization policies, manpower requirements criteria (MARC), standards of grade (SG), and BOIP to develop the proper mix of equipment and personnel for an efficient organizational structure.
  - (b) Develop MARC that serves as HQDA approved standards for determining the minimum mission essential wartime requirement (MMEWR) for staffing to accomplish maneuver support and maneuver sustainment functions in TOE and MTOE documents.
  - (c) Review proponent proposed or approved authorization documents to ensure compliance with manpower, personnel, and equipment policies and directives.
  - (d) Centrally build ACOM/ASCC/DRU authorization documents based on HQDA guidance, Command Plan, and input from the ACOM/ASCC/DRU.
- (5) *ACOMs, ASCCs, and DRUs*. Force management staffs at these echelons manage the planning and execution of the force integration mission through—
- (a) Document integration, including authorization document (MTOE and TDA) review, and database management.
  - (b) Systems integration, including, requirements and authorization document review, the Materiel Fielding Plan (MFP) process, New Equipment Training Plan (NETP) review, and facilities support annex review.
  - (c) Organization integration, including the organizational assessment process, review of requirement and authorization documents, and doctrine review.
  - (d) Force structure management, including TDA manpower management and end strength management.
  - (e) Force planning, including the TAA process, command plan process, force reduction planning and monitoring, and CONPLAN development.

## How the Army Runs

(6) *Corps, division, regiment, separate brigade, and installation.* Force management staffs at these levels continue to manage force integration through—

(a) Force structure management, including authorization document management, Unit Status Report (USR) (see para 8–17) monitoring, and force structure review and analysis.

(b) Systems integration, including action plan development, distribution plans reviews, and facilities review.

(c) Organization integration, including organizational assessments, force structure review and analysis, and authorization document review process.

### Section IV

#### Changing how we manage change

##### 2–7. Alterations to force management

a. The elements for managing change are themselves changing and this fundamentally alters force management. The processes that develop operational units often frustrate those who need the capabilities in the near term. Several factors contribute to this frustration. The pace of technological advances challenges our ability to envision future force capabilities and to properly plan for their development. The time required to change the primary long lead elements of the institution: such as doctrine, materiel, and organizations can appear excessive. Materiel changes may require up to 15 years for developing and fielding, organizational change may require 2–8 years, doctrine may require 2–4 years, and leader development and training follow changes in the other “drivers” by several years. For the future Army to benefit from the synergism of integrated doctrine, organizations, training, materiel, leader development, personnel and facilities, it must continue to work to shorten development and fielding times, and increase the ability to envision and conceive future warfighting capabilities. Because of these, current operational exigencies and many more factors, the Army senior leadership continues to implement policies and procedures to streamline existing force management processes and improve their effectiveness. Today, the ARSTAF continues to evolve to meet the demanding requirements of force management. Initiatives for improving the ARSTAF enable HQDA to streamline the requirements approval process, replace and combine several legacy automated force management support systems, and fielding equipment to brigades as integrated sets.

b. Force management changes at HQDA.

(1) *Support to current operations: Interim Policy on Capabilities Requests.* In response to exigent capability requirements generated by current operations, HQDA instituted streamlined processes and staffing procedures to rapidly procure and distribute materiel solutions to identified operational deficiencies. Operational Needs Statements (ONS) and Authorized/Pre-validated request procedures were developed and implemented in order to support deployed or deploying units’ accomplishment of their assigned missions. The Army Requirements and Resourcing Board (AR2B) process was developed for presenting critical operational needs to the Army’s senior leadership for rapid decision making (accelerated fielding solutions). The response to an ONS is based on an ARSTAF validation supported by TRADOC, AMC, and MATDEV reviews. The AR2B determines validity of the need, availability of technology, and source of resources to fill the requirement. If the need is determined to be critical, and can be resourced (at least for the present situation) a directed requirement may result. Additionally, the Army Capabilities Integration Center (ARCIC) has developed a process and supporting structure to accelerate capabilities development, such as those resulting from ONSs. Support to on-going and emerging operational urgent requirements will likely continue to drive changes in force management organizations, systems and processes.

(2) *The Modular Conversion of Army Force Structure.* To maximize force effectiveness, the Army is reorganizing to a modular, brigade-based force to achieve three primary goals: (1) Increase the number of available BCTs to meet operational commitments while maintaining combat effectiveness that is equal or better than that of previous divisional BCTs; (2) Create combat and support formations of common organizational designs that can be tailored to meet the varied demands of the regional Combatant Commanders- reducing joint planning and execution complexities; (3) Redesign organizations to perform as integral parts of the Joint Force-making them more effective across the range of military operations and enhancing their ability to contribute to joint, interagency, and multinational efforts. This modular conversion is a total Army effort affecting nearly every combat and support organization in the inventory. Most combat formations and headquarters have been completed; the current effort is mainly on converting and activating theater Army headquarters and Support Brigades. The restructuring of the force from Division-based to Brigade-based will likely impact many of the Army Force Management-specific organizations, systems and processes, and proponent and management relationships.

(3) *Implementation of the Army Force Generation Model (ARFORGEN).* The Army is currently faced with ongoing, continuous force deployments while simultaneously preparing for the full spectrum of other possible contingencies. As a response the Army is adapting from tiered readiness to cyclic readiness to meet both rotational and contingency operational requirements. Fundamentally, ARFORGEN is a cyclic training and readiness process that synchronizes strategic planning, prioritization and resourcing to generate trained and ready modular expeditionary forces tailored to Joint mission requirements. The RESET, Train/Ready and Available force pools provide the framework for the structured progression of increased unit readiness in ARFORGEN. The Army uses these force pools

in addition to mission requirements to prioritize resources over time and synchronize unit manning, equipping, resourcing, and training (See figure 2–3). Units transition through the force pools based on the unit commander's assessment or designated criteria, validated by the next-higher commander, and monitored by FORSCOM. The Army focuses units against future missions as early as possible in the ARFORGEN process and task organizes units in globally available force packages tailored to joint mission requirements. In RESET, units conduct recovery, reconstitution, equipment reset and recapitalization, receive and stabilize new personnel, reconnect with families, and conduct individual and institutional training. After RESET, all forces designated for a known operational mission will be placed under the operational control of the corresponding higher headquarters in a Deployment Expeditionary force (DEF) with a Latest Arrival Date (LAD). They will train on their Full Spectrum Operations Mission Essential Task List (FSOMETL) and later on their Assigned Mission Essential Task List (AMETL) as required. All other units will become part of the Contingency Expeditionary Force (CEF) and receive an available force pool date (AFPD), a mission focus, and may be projected as a surge force unit. Surge forces are those units that are in the Train/Ready force pool and are assigned to respond to emergent requirements or contingency missions. They provide operational depth. They are not part of a large organization that deploys at the same time. The CEF will train on their FSOMETL and prepare for full spectrum operations (See figure 2–4). As units reach their highest state of readiness, they will move into the Available pool. Designated forces will deploy in accordance with their programmed rotation and all others will be prepared for immediate deployment on any emerging contingency. Once a unit's deployment is over or after a unit spends a year in the Available pool without deploying, it returns to the RESET pool and the cycle is repeated. When combatant commanders require more forces than the Army has in the Available Pool, the Army can surge forces from the Train/Ready Pool at lower levels of preparedness. The expeditionary force consists of modular AC and RC brigade combat teams, multi-functional and functional support brigades, Echelons Above Brigade (EAB) maneuver, maneuver support, and sustainment units, and the appropriate operational headquarters necessary to provide the required capabilities to the Joint force. The implementation of the ARFORGEN process impacts nearly every institutional function as they adapt to achieve greater effectiveness and efficiency and accommodate the cyclic nature of the ARFORGEN process.

---

***ARFORGEN: The structured progression of readiness over time, to produce trained, ready, and cohesive units prepared for operational deployment in support of combatant commander and other Army requirements.***

## **ARFORGEN Force Pools**

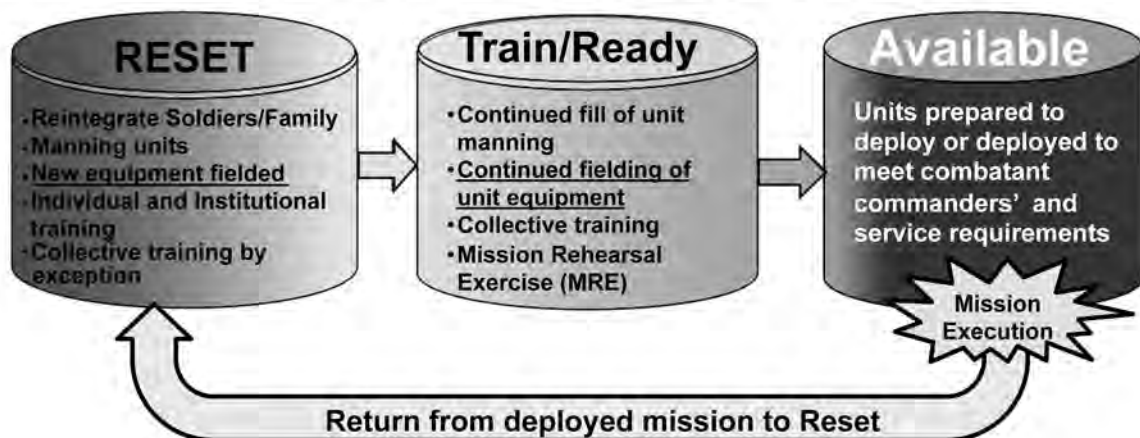

***ARFORGEN applies to Army globally available units.***

Figure 2–3. ARFORGEN Force Pools

---

**A versatile mix of tailorable and networked organizations, operating on a rotational cycle--**

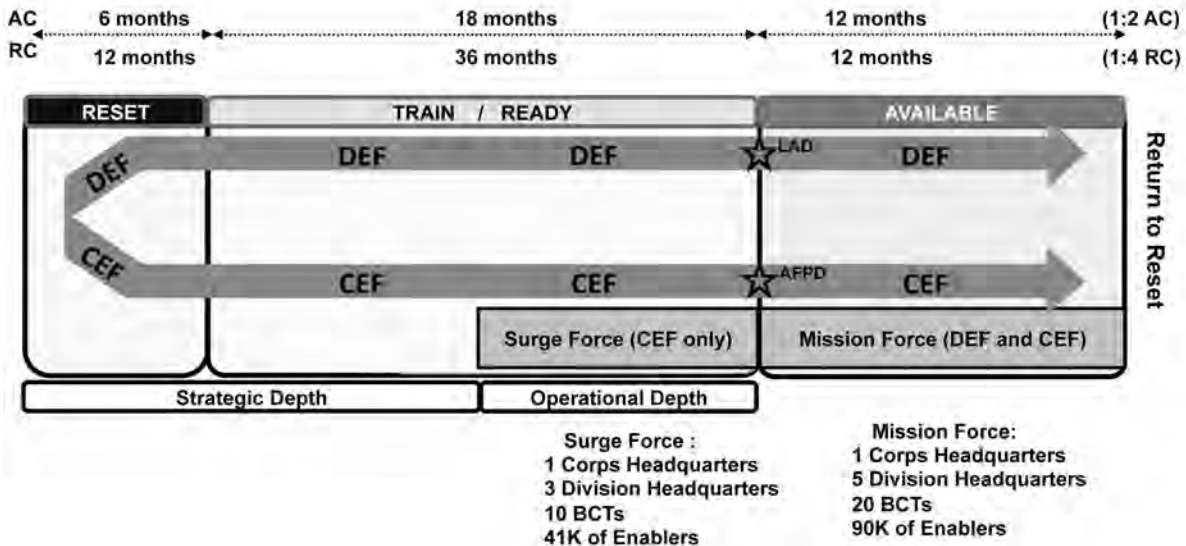

Figure 2-4. Rotational Model

**2-8. Basic Force Management Tools**

Force integration carries a significant manpower bill across the HQDA staff. The required activities for detailed and interactive coordination contribute to and drive manpower requirements. Across the staff, it takes people to participate in the management, synchronization and coordination activities and their collective knowledge to make force integration a viable function. These staff officers need access to the many different databases and models that provide information in order to efficiently accomplish their functions and responsibilities. Correspondingly, steps are underway to apply technology to help reduce the manpower costs of this process. These automation and information technology improvements are continuous and on-going.

a. The Army Flow Model (AFM), The Army Equipping Enterprise System (AE2S) developed by the Army Strategic and Advanced Computing Center, is a decision support system designed to provide the ARSTAF with an integrated, quick turnaround planning tool to assess actual or notional force structures and/or policies across the Army's major functional areas (force structure, personnel, logistics, installations, and budget). Part of AE2S is the Army Flow Model (AFM), which supplements the current functional models. These legacy functional models remain "stovepipe" systems and cannot easily conduct "What If" analyses in a timely manner. The AFM provides the capability to readily assess force structure or policy changes and examine the effects of these changes on unit fill levels and readiness both within and across functional areas. Users can access AFM through Army Knowledge Online (AKO) (see para 16-18).

b. USAFMSA has developed the Force Management System (FMS). This system replaces the four existing stovepipe automated support systems, Requirements Documentation System (RDS), TAADS, SAMAS and Force Builder. These legacy automated systems can only exchange data through manual file exchange. FMS is based upon a single integrated database providing access through an integrated set of user applications. The first phase of FMS (requirements documentation) is now operating with full implementation to take several years. No implementation timelines have been published. (For more detail see Chapter 5).

**Section V**

**Summary and references**

**2-9. Summary**

a. In modern, complex organizations there is a cause and effect relationship involving almost every process and

system. An appreciation of these interrelationships and knowledge of the individual systems that contribute to force management will in turn lead to an understanding of how the Army runs.

*b.* Changes within the Army and the processes used to implement those changes require a holistic application of cross-functional factors. To be successful, future senior Army leaders and managers must understand the nature of the interrelations of the systems and subsystems, as well as the key players and functions. Senior leaders who understand how these processes work and where leadership can influence these processes will be more effective. Experience shows us that successful senior leaders understand how the Army develops and sustains its part of our nation's military capability and use this knowledge to make informed decision on how to use or change the processes to improve that capability. The overviews of the Army Functional Life Cycle Model and the Army War College Model introduced in this chapter provide a basis for subsequent and more detailed examinations of the Army management systems and processes in subsequent chapters. Additional information can be found at the following web sites:

- (1) <http://www.carlisle.army.mil/>
- (2) <http://www.afms1.belvoir.army.mil>.
- (3) <https://fmsweb.army.mil/>

### **2-10. References**

- a.* Public Law 99-433, DOD Reorganization Act of 1986.
- b.* Public Law 103-62, Government Performance Results Act of 1993.
- c.* Title 10, United States Code.
- d.* HQDA, Army Campaign Plan 2009, 19 February 2009.
- e.* General Orders Number 3 (GO 3), Assignment of Functions and Responsibilities Within Headquarters, Department of the Army.
- f.* General Orders No. 2009-03 (GO 2009-03), Amendment to General Orders No. 2002-3, Assignment of Functions and Responsibilities within Headquarters, Department of the Army, 18 Mar 2009.
- g.* See also: *Army Force Management-A Selected Bibliography*. Compiled by Virginia C. Shope. U.S. Army War College Library. Carlisle Barracks, PA: August 2002. Available from <http://cbnet/orgs/library/bibs/frcmgt02.htm>.
- h.* HQDA, Army Regulation 525-29, Army Force Generation, 14 March 2011.h.



RESERVED

## Chapter 3

### Army Organizational Structure

The resolution of Congress on 2 June 1782 clearly illustrates the concepts of civil control of military forces and the primacy of the Congress in the determination of the Army's structure. That resolution resolved to discharge all remaining Continental Army troops from Federal service except 80 men. It further assigned the remaining men to "guard stores." It established the Army's force structure as:

#### Section I Introduction

##### 3-1. Chapter content

*a.* The United States Army is a strategic instrument of national policy that has served our country in peace and war for over two centuries. The Department of the Army is separately organized under the SECARMY (10 USC 3011). This chapter provides a discussion on how the Army is organized to perform its doctrinal tasks and how it responds to changes in its environment. *DA PAM 10-1, Organization of the United States Army*, General Orders Number 3, *Assignment of Functions and Responsibilities Within Headquarters, Department of the Army*, and AR 10-87, *Army Commands, Army Service Component Commands, and Direct Reporting Units*, provide the official description of Army organizations, as well as their roles, missions and functions. The Army web site at: <http://www.army.mil/info/organization/> provides links to the home pages of the Army Headquarters staff elements and the Army Commands (ACOM), Army Service Component Commands (ASCC), and Direct Reporting Units (DRU).

*b.* The understanding of how the Army operates as a system to carry out its Title 10 functions within the context of its organizational, operational and strategic environment provides the insights into how the Army efficiently allocates resources and effectively manages change to provide trained and ready forces to the combatant commanders for "prompt and sustained combat incident to operations on land." What follows is a discussion of the framework that describes the Army as an organization of headquarters, staffs, commands, and functional units. Additionally, this and other chapters will discuss major realignments within Army organizations, which have taken place over the past 18 months.

##### 3-2. The Army organizational system

*a. The Army as an open organizational system.*

(1) In terms of management theory, the Army can be considered an open organizational system with three distinct components: the production, combat, and integrating subsystems. Each of these components has tasks to accomplish, each operates in a given environment, and each requires and acquires resources. Because of the size and complexity of the Army and its tasks, its corresponding organizational structure must provide as much flexibility as possible (given resources and mission requirements) while also maintaining the mission command necessary to develop forces and marshal, deploy, employ those forces and sustain operations in support of our national strategy.

(2) The Army's organizational design has evolved over time and is continuously being adapted to ensure a "goodness of fit" between its overall structure and the conditions of the external environment. In essence, the Army exists as an "open system" and thus must be structured and re-structured in such a way as to allow the system to adapt to external factors in an appropriate manner. To facilitate adaptation, the Army organizational system is composed of a combination of decentralized functionally-focused subordinate organizations empowered to adapt and make decisions to effectively and efficiently support or execute mission requirements and a centralized hierarchy designed to establish policies to effect coordination and cooperation between the sub-organizations and ensure cross-functional integration and differentiation.

*b. Differentiation and integration.* Every complex and open organization that is functionally organized to allow for decentralized sub-optimization is also challenged with ensuring both the integration of its sub-organizational outputs and continued differentiation of those organizations as they in-turn adapt to the external environment. To manage integration and differentiation organizations need to continuously scan their environment, both internally and externally, in order to best determine—

- (1) The overall tasks and corresponding functional sub-tasks to be accomplished.
- (2) The resource constraints placed on the organization.
- (3) The extent of coordination that is needed within the organization in order to make effective and efficient decisions across all tasks and functional sub-tasks.
- (4) Whether accomplishment of new tasks or sub-tasks requires sufficiently unique skills, equipment, activities or management (requires creation of a new sub-organization) or should or could be subsumed under an existing functional sub-organization.
- (5) The most effective and efficient overall organizational design needed to accomplish those tasks and, most important, assure that the organization can rapidly adapt to future changes within and across the identified functional areas.

## How the Army Runs

(6) Differentiation. Organizations should be tailored in design to meet specific mission requirements and avoid unnecessary redundancy. For example, to demonstrate a forward presence in an area of vital interest to U.S. security, such as Europe, and to enhance relations with our allies, the Army has organized U.S. Army, Europe (USAREUR). Conversely, the U. S. Army Recruiting Command (USAREC), which is now part of Accessions Command under TRADOC, was established to deal with the soldier acquisition task. To accommodate these different demands, the Army's systemic organizational response must be different. USAREUR would be as ineffective recruiting in the continental United States (CONUS) as USAREC would be in dealing with the Army's mission in Europe.

(a) Task or functional specialization is both a dimension and a requirement of the structure of Army organizations. Such functions as personnel management, resource (funds and manpower) management, operations, intelligence and security, logistics, and research and development are found separately identified in both the management staffs and subordinate commands.

(b) A major result of task specialization is that organizations tend to be designed and structured to fit the requirements of their sub-environments. Depending on the demands of the environment, organizations in one functional specialty tend to be differentiated from organizations in other specialties in the following manner:

(c) Unique functionally-related mission focus.

(d) Orientation on time, i.e., a focus on short-term, mid-term, long-term results.

(e) Degree of formality of the structure of organizations, i.e., rules, job descriptions, chain of command, process or procedural adherence, etc.

(f) Interpersonal orientation-ways of dealing with people, i.e., very mission-oriented vs. a concern for relationships with others.

(7) Integration. The environments within which the Army competes require one primary output: mission-ready forces with a full range of operational capabilities. The Army is successful only to the extent that it produces such forces. The widely diverse operational environments also require a high degree of differentiation if the Army is to meet its full spectrum requirements. These two environmental demands-output and high differentiation-must be reconciled and the Army must integrate many elements to produce mission-ready forces. One should expect that the greater the degree of differentiation in an organization, the more difficult it is to get the necessary coordination and integration. There are three levels of complexity of the approaches to integrating diverse organizational activities ranging from the simple to the highly complex. The use of each depends on a wide range of situational factors.

(a) The simplest devices, which can be used to deal with more certain environments, are standard rules and procedures. Integration is achieved through adherence by the sub-organizations to specified procedures and active management is normally not necessarily required.

(b) Somewhat more complex is a plan, directive or order. Integration is achieved through formulated guidance that specifies for the overall mission each organization's roles, responsibilities and sub-tasks in time, space and purpose. Coordination and integration is achieved through the coherency of the planning concept and the sub-organization's compliance to both the letter and intent of the plan.

(c) Third, and the most complex, is the process of active management and directed integration leading to mutual adjustment in which iterative communication is required within the management hierarchy (or chain of command) and which could also entail the formation and use of cross-functional teams or individual integrators. A good example of the last process is the battalion task-force approach to integrating and maneuvering the combined arms team after contact with the enemy. A project management organization also exemplifies integration by mutual adjustment.

(d) Each of these devices is operating in any Army organization to some extent. Effective and complex organizations facing dynamic and diverse environments will use all of these integrative processes.

(8) The Army is organized into a managing headquarters with a permanent and enduring management construct constituting 8-levels of headquarters managing activity (see General Orders No. 00, Managing the Headquarters, Department of the Army) and four types of subordinate organizational headquarters and supporting activities: Army Commands (ACOM), Army Service Component Commands (ASCC), Direct Reporting Units (DRU), and Field Operating Agencies (FOAs).

(9) Army Command (ACOM): an Army force, designated by the Secretary of the Army, performing multiple Army Service Title 10 functions (3013b) across multiple disciplines. Command responsibilities are those established by the Secretary. There are three ACOMs: TRADOC, AMC and FORSCOM (FORSCOM also serves as an Army Service Component Command).

(10) Army Service Component Command (ASCC): an Army Force, designated by the Secretary of the Army, comprised primarily of operational organizations serving as the Army component for a combatant commander. If designated by the combatant command, serves as a Joint Forces Land Component Command (JFLCC) or a Joint Task Force (JTF). Command responsibilities are those established by the Secretary. Examples include U.S. Army Central (USARCENT), U.S. Army Pacific (USARPAC), and U.S. Army North (USARNORTH).

(11) Direct Reporting Unit (DRU): an Army organization comprised of one or more units with institutional or operational functions, designated by the Secretary of the Army, providing broad general support to the Army in a normally, single, unique discipline not otherwise available elsewhere in the Army. Direct Reporting Units report directly to a Headquarters, Department of the Army principal and/or Army Command and operate under the authorities

established by the Secretary of the Army. Examples include the U.S. Army Corps of Engineers (USACE), U.S. Army Medical Command (MEDCOM), and U.S. Army Criminal Investigation Command (USACIDC).

(12) Field Operating Agency (FOA): an agency under the supervision of Headquarters, Department of the Army, but not an Army Command, ASCC or DRU, which has the primary mission of executing policy. Examples include: the Center for Army Analysis is a FOA for the Army DCS, G-8; and the Army Human Resources Command (HRC) is a FOA of the DCS, G-1.

## Section II

### The production subsystem

#### 3-3. Statutory requirements

The Army's fundamental purpose is to fight and win the Nation's wars by establishing conditions for lasting peace through land force dominance. Laws further direct the Army to be organized and trained for prompt and sustained combat. Many other specific requirements are assigned by statute to the SECARMY and the ARSTAF. They include requirements to form organizations of men and women and machines "for the effective prosecution of war."

#### 3-4. Production of needed resources

The production subsystem is the cornerstone of the process. Its job is to secure from its resource environments the "raw materials" for its many production efforts: recruiting untrained people, searching for useable technology, and dealing with producers of outside goods and services. Its task, accomplished through its people and structure, is to convert the "raw materials" into the "intermediate goods" required by the combat system. To do this, the Army integrates doctrine, organizations, training, materiel, leadership and education, personnel and facilities (DOTMLPF) to produce the desired end state (see Chapter 5 for more details). Training centers and schools transform untrained people into tank crewmen, infantrymen, and mechanics. Schools convert ideas and knowledge into doctrine, tactics, techniques, and training methods for the use of the combat subsystem. Laboratories, arsenals, and procurement and test organizations convert technology and contractor effort into weapons systems and equipment for the combat subsystem. Other parts of the production subsystem provide such sustaining support to the whole organizational system as health care, commissary support, and other services. The production subsystem serves primarily to meet the needs of the combat subsystem.

##### *a. Training and Doctrine Command (TRADOC).*

(1) TRADOC is first of two major components of the production subsystem. TRADOC develops the Army's Soldier and Civilian leaders and designs, develops and integrates capabilities, concepts and doctrine in order to build a campaign-capable expeditionary Army in support of joint warfighting commanders through Army Force Generation (ARFORGEN). TRADOC recruits, trains and educates the Army's soldiers; develops leaders; supports training in units; develops doctrine; establishes standards; and builds the future Army. It is an Army Command (ACOM) consisting of HQ TRADOC, three Major Subordinate Commands (MSC), and eight special activities. All TRADOC centers and schools are aligned under an MSC, except the US Army War College and TRADOC Analysis Center (TRAC). The MSCs have direct authority over the centers and schools aligned under them and are the linkage with non-TRADOC schools. (See Chapter 15 for a more detailed description of TRADOC's training-oriented organizations.)

(2) TRADOC operates 32 schools and centers at 16 Army installations, and conducts more than 1600 courses, of which over 300 are language courses.

(3) The HQ TRADOC staff consists of a command group, personal staff, coordinating staff, and special staff, with the Army Capabilities and Integration Center (ARCIC) as a FOA in support of the TRADOC coordinating staff. Although established as a FOA, the ARCIC is an integral part of, and functions as an element of, the HQ TRADOC staff.

(4) The HQ TRADOC staff provides staff management, facilitates external coordination, and assists the Deputy Commanding General/ Chief of Staff (DCG/CofS) in the prioritization of resources. It ensures the coordination and integration of DOTMLPF initiatives and functions between external commands and organizations, and the TRADOC MSCs and special activities. The HQ TRADOC staff is the primary interface with external agencies (DOD, Headquarters, Department of the Army (HQDA), joint organizations, other Services, and other external agencies and organizations) to provide TRADOC positions and receive taskings and requests for support.

(5) TRADOC's MSCs are also functionally aligned:

(a) U.S. Army Accessions Command: provides integrated mission command of the recruiting and initial military training for the Army's officer, warrant officer, and enlisted forces. Designed to meet the human resource needs of the Army from first handshake to first unit of assignment, the command transforms volunteers into soldiers and leaders for the Army.

(b) U.S. Army Combined Arms Center: provides leadership and supervision for leader development and professional military and civilian education; institutional and collective training; functional training; training support; mission command; doctrine; lessons learned; and activities in specified directed areas that serve as a catalyst for change and that support developing relevant and ready expeditionary land formations with campaign qualities in support of the joint force commander.

## How the Army Runs

(c) U.S. Army Combined Arms Support Command: develops logistics leaders, doctrine, organizations, training, and materiel solutions to sustain a campaign quality Army with joint and expeditionary capabilities in war and peace.

b. *Army Materiel Command (AMC)*. The second major component of the production subsystem is AMC. AMC is the Army's premier provider of materiel readiness-technology, acquisition support, materiel development, logistics power projection, and sustainment-to the total force, across the spectrum of joint military operations. The command's complex missions range from development of sophisticated weapon systems and cutting-edge research, to maintenance and distribution of spare parts.

(1) AMC operates the research, development and engineering centers; Army Research Laboratory; depots; arsenals; ammunition plants; and other facilities; and maintains the Army's prepositioned stocks, both on land and afloat. The command is also the Department of Defense Executive Agent for the chemical weapons stockpile and for conventional ammunition.

(2) To develop, buy and maintain materiel for the Army, AMC works closely with Program Executive Officers, the Army Acquisition Executive, industry and academia, the other services, and other government agencies. AMC handles the majority of the Army's contracting including contracting services for deployed units and installation-level services, supplies and common-use information technology hardware and software.

(3) The command's main effort is to achieve the development, support, and sustainment of the future force in this decade. At the same time, AMC is key to supporting, sustaining and resetting the current force. Its maintenance depots and arsenals restore weapon systems needed as the Army makes its way to full transformation. The command's overhaul and modernization efforts are enhancing and upgrading major weapon systems-not just making them like new, but inserting technology to make them better and more reliable.

(4) AMC handles diverse missions that reach far beyond the Army. For example, AMC manages the multi-billion dollar business of selling Army equipment and services to friends and allies of the United States and negotiates and implements agreement for co-production of U.S. weapons systems by foreign nations. AMC also provides numerous acquisition and logistics services to the other components of the DOD and many other government agencies.

(5) Continuing support across the spectrum of operations plays a large role in maintaining combat readiness. Perhaps no other organization is faced with such a diversity and cross-functional panoply of activities. Consequently, AMC is almost continuously adjusting its organizations to adapt to the changing operational and strategic environments while ensuring both differentiation and integration of its subordinate organizations roles, responsibilities and functions.

(6) The MSCs include the Research Development and Engineering Command, concerned with R&D missions; the Army Sustainment Command (ASC) that functions to manage Army Prepositioned Stocks (APS), administers the Logistics Civil Augmentation and Logistics Assistance Programs, oversees the timely retrograde and of war materiel from the theater to Army Depots for reset, and supports through seven assigned deployable Army Field Support Brigades army operations in strategic locations around the world; Joint Munitions Command that provides the conventional ammunition life-cycle functions of logistics sustainment, readiness and acquisition support for all U.S. military services, other government agencies, and allied nations as directed; the U.S. Army Security Assistance Command (USASAC) which is concerned with security assistance programs to include foreign military sales (FMS); and the Army's Chemical Materials Agency (CMA) which safely stores and destroys the nation's aging chemical weapons and effectively recovers the nation's chemical warfare materiel. The AMC also coordinates directly with the Military Surface Deployment and Distribution Command (SDDC), concerned with ground transportation and port operations. The SDDC is under the combatant command (COCOM) of U.S. Transportation Command (USTRANSCOM) and serves as its ASCC.

(7) The four Life Cycle Management Commands LCMCs are commodity oriented and perform life-cycle management over the initial and follow-on procurement and materiel readiness functions for items and weapon systems in support of the Army in the field. As part of an effort to more closely integrate the Army's procurement priorities with maintenance and support needs, AMC realigned the service's far-flung acquisition, technology and logistics organizations into "life cycle management commands." The LCMC concept is designed to break up the traditional fiefdoms in the Army's bureaucracy and ensure that weapon systems get the appropriate funding from "cradle to grave." Previously, the Program Executive Officers (PEOs) had development and procurement responsibilities for weapon systems, while the AMC subordinate commanders were in charge of maintaining those systems. The new LCMC now integrate both functions under one command headquarters by commodity. See Chapter 12 for a more detailed description of AMC. AMC's log site is [www.amc.army.mil](http://www.amc.army.mil) and it is informative and current.

(8) AMC impacts or has a presence in 49 states and 127 countries with a workforce of over 67,000 military and civilian employees. The 2005 Base Realignment and Closure (BRAC) decision relocated the AMC headquarters from Fort Belvoir, VA to Redstone Arsenal, AL.

c. *Installation operations*. Key to the production subsystem is the growing central role of Army installations. The subparagraphs below provide a general discussion and background for installations operations with the detail of this function discussed in Chapter 17.

(1) The integration of installation organization and operations into the Army's overall organizational structure in the 1980's, both as a home station and training base, has proven to have a significant and positive effect on readiness. Installations are organized for and capable of training, mobilizing, deploying, sustaining, supporting, recovering, and

reconstituting assigned and mobilized operating forces. Additionally, activities on the installation receive installation support in accomplishing their missions. Examples of these are schools, hospitals, reserve component elements, and tactical headquarters and their subordinate units. However, the traditional boundary between tactical and sustaining base activities are disappearing as the installation power projection platforms assume an increasing role in the sustainment, support and the welfare of deploying operating forces as information technology (IT), rapid transportation and improved management techniques enables more consolidated installation activities and “reach-back” to the installations for deployed forces.

(2) In October, 2006 the Army reorganized its structure for managing installations with the activation of the Installation Management Command (IMCOM). The Army established IMCOM to improve its ability to provide critical support programs to Soldiers and their families while ensuring its installations are “flagships of readiness.” The IMCOM’s mission is to provide the Army the installation capabilities and services to support expeditionary operations in a time of persistent conflict, and to provide a quality of life for Soldiers and Families commensurate with their service.

(3) IMCOM transformed the Army’s installation management structure into an integrated command structure. As a Direct Reporting Unit, IMCOM is accountable to the Chief of Staff of the Army for effective garrison support of mission activities, and serves as the Army’s single authority and primary provider of base support services. Installations are power projection platforms. They provide a home to the force and are resourced as a productive work and training site. This evolution of the installation’s role in the army structure and its placement in the Army’s organization has established it as a critical production subsystem of the Army.

*d. Functional commands.*

(1) Not only is the installation operations task common to both the combat and production subsystems, but parts of the installation operations function have become recognizable “specialty” commands - and therefore part of the production subsystem - providing their goods and services usually to both the combat and production subsystems. For example, U. S. Army Medical Command (MEDCOM) (see Chapter 18) operates most Army medical activities in CONUS; and the U. S. Army Criminal Investigation Command (USACIDC) directs all criminal investigators.

(2) The principal reason for the establishment and continuation of functional commands is that the required degree of integration for their specialty activities differs substantially from those functions that are the responsibility of the installation commander. Each of the specialty functions is a goods or service provider that performs very different missions than those of the installation, whether it is force readiness or training. Mission performance does not require that telephone service, or commissary operations, or medical care delivery is totally integrated with facilities or maintenance so that unit readiness or training objectives can be met. The same is not true of functions like maintenance or personnel support, which more directly affect installation goal achievement.

(3) Further, the conceptual model would suggest that achieving greater performance on the delivery or performance of these functions could best be accomplished by improving the degree of corresponding organizational differentiation. The “functional” organizational model appears to do just that. The central control reinforces the commitment by the local agency to: high quality, efficient telephone service, and medical care, good commissary support, meeting recruiting objectives, carrying out engineer construction projects, by emphasizing the uniqueness of the function and providing associated specialty career paths for employees.

*e. HQDA support specialty commands.* Another secondary category of organizations within the producer subsystem is the group of service producing, special-purpose organizations reporting to HQDA. This category includes, among others, the U.S. Human Resources Command (USAHRC) (See Chapter 13). It has tasks that do not require field units to produce the service; therefore it does not fall into the functional command category. USAHRC’s services are used by the producer and combat subsystems, as well as HQDA. Because of its specialty tasks, such agencies are directly linked to the HQDA staff, yet they are not classified as extensions to the staff because their functions are operational, rather than policy. Most organizations operating in such manner are categorized as field operating agencies (FOAs) or Direct Reporting Units (DRUs).

(1) Listed below are the current HQDA FOAs under the staff principal they support:

(a) Assistant Secretary of the Army for Financial Management and Comptroller (ASA (FM&C)) - U.S. Army Finance Command (USAFINCOM)

(b) Assistant Secretary of the Army for Manpower & Reserve Affairs (ASAM&RA):

1. U.S. Army EEO and Civil Rights Office
2. U.S. Army Manpower Analysis Agency
3. Department of the Army Review Boards Agency
4. U.S. Army Environmental Policy Institute

(c) Office of the Auditor General (SAAG) - U.S. Army Audit Agency

(d) Office of the Chief of Public Affairs (OCPA) - U.S. Army Public Affairs Operations Group (APAOG)

(e) Office of the Assistant Secretary of the Army for Installations and Environment - U.S. Army Environmental Policy Institute (AEPI)

(f) Office of the Administrative Assistant to the Secretary of the Army:

1. U.S. Army Resources and Programs Agency (RPA)

## How the Army Runs

2. U.S. Army Headquarters Services (AHS)
3. U.S. Army Information Technology Agency (ITA)
4. U.S. Army Center of Military History (CMH)
  - (g) Office of the Inspector General (OTIG) - U.S. Army Inspector General Agency (USAIGA)
  - (h) Office of the Deputy Under Secretary of the Army - U.S. Army Test and Evaluation Office (TEO)
  - (i) Office of the Chief of Staff of the Army (OCSA) - U.S. Army Combat Readiness Center
  - (j) Office of the Army G-1:
    1. U.S. Army Human Resources Command (HRC)
    2. U.S. Army Civilian Human Resources Agency (CHRA)
    3. U.S. Civilian Personnel Operations Centers (total of 8 regional centers)
    4. U.S. Military Postal Service Agency (MPSA) (Army is the EA for USD (ATL))
  - (k) Office of the Army G-3/5/7:
    1. U.S. Army Command and Control Support Agency
    2. U.S. Army Asymmetric Warfare Group
    3. U.S. Army Rapid Equipping Force (REF)
    4. U.S. Army Biometric Defense Agency (BDA)
    5. U.S. Army Operations and Plans Support Group Agency
    6. U.S. Army Force Management Support Agency (USAFMSA)
  - (l) Office of the Army G-4 - U.S. Army Logistics Innovation Agency (LIA)
  - (m) Office of the Army G-8 - U.S. Center for Army Analysis (CAA)
  - (n) Office of the Assistant Chief of Staff for Installation Management (ACSIM) - U.S. Army Installation Support Management Activity (USAISMA)
    - (o) Office of the Judge Advocate General (OTJAG):
      1. U.S. Army Judge Advocate General's Legal Center and School
      2. U.S. Army Legal Services Agency
      3. U.S. Army Corrections Command
- (2) Listed below are the HQDA Direct Reporting Units:
  - (a) U.S. Army Network Enterprise Technology Command/9th Signal Command (Army) (NETCOM/9thSC(A))
  - (b) U.S. Army Medical Command (MEDCOM)
  - (c) U.S. Army Intelligence and Security Command (INSCOM)
  - (d) U.S. Army Criminal Investigation Command (USACIDC)
  - (e) U.S. Army Corps of Engineers (USACE)
  - (f) U.S. Army Military District of Washington (MDW)
  - (g) U.S. Army Test and Evaluation Command (ATEC)
  - (h) United States Military Academy (USMA)
  - (i) U.S. Army Reserve Command (USARC)
  - (j) U.S. Army Acquisition Support Center (USAASC)
  - (k) U.S. Army Installation Management Command (IMCOM)
- (3) For more information on Army organizations log on to: <http://www.army.mil/info/organization/>

### Section III

#### The combat subsystem

##### 3-5. Products of the combat subsystem

The combat subsystem's major task is to convert the Army's intermediate products, obtained from the production subsystem, into mission-ready forces, that is, into units and organizations. Each element of its structure welds together individual soldiers, equipment, and procedures and produces combat readiness. The combat subsystem engages in a process of continued interaction with its resource environment, primarily the production and the integrating subsystems. Its task environment includes the enemy threat(s), the unified combatant commands, allied forces with whom it must deal, and, especially in peacetime, the OSD and the Congress.

##### 3-6. The Army in the field

a. This category of the Army's organizational structure consists of three ACOMs including two of the commands previously addressed under the production subsystem and installation operations and nine ASCCs. The Army's designated ACOMs/ASCCs are the following:

- (1) Army Commands (ACOM):
  - (a) U.S. Army Forces Command (FORSCOM)
  - (b) U.S. Army Training and Doctrine Command (TRADOC)

- (c) U.S. Army Materiel Command (AMC)
- (2) Army Service Component Commands (ASCC):
  - (a) U.S. Army Central (USARCENT)
  - (b) U.S. Army North (USARNORTH)
  - (c) U.S. Army South (USARSO)
  - (d) U.S. Army Europe (USAREUR)
  - (e) U.S. Army Pacific (USARPAC)
  - (f) Eighth Army(EUSA)
  - (g) U.S. Army Special Operations Command (USASOC)
  - (h) Military Surface Deployment and Distribution Command (SDDC)
  - (i) U.S. Army Space and Missile Defense Command/Army Strategic Command (USASMD/ARSTRAT)

*b.* In some respects each command faces similar environments although they differ from each other in many ways. Several (FORSCOM, USAREUR, USARPAC, EUSA, USASOC, and USARSO) have the principal task of providing mission-ready land forces—the primary output of the Army. As a result, each has developed an organizational structure reflecting its environment.

## Section IV

### The integrating subsystem

#### 3–7. Tasks of the integrating subsystem

*a.* The integrating subsystem ties all of the subordinate subsystems together for the Army as a whole. Its tasks are to decide what is to be “produced” or accomplished by the whole system and to see to it that the system performs as expected. It also acts as the source of funds for the subsystems, obtaining them from DOD, Office of Management and Budget (OMB) (see chapter 10, sections II and III), and the Congress.

*b.* In any large organization, the headquarters has the major function to see to it that the overall mission and major tasks of the organization are accomplished. It is the most prominent integrating device in the organization. The challenge for the integrating subsystem is one of structuring the organization to accomplish the following tasks effectively:

- Determining the nature of current and future demands and requirements from the strategic and operational environments (e.g., from OSD, Congress, the public, other Services, the nature of the threat, etc.).
- Charting a course for the Army that can and will meet the projected demands/requirements.
- Securing the necessary resources (appropriations authority) for the Army.
- Allocating resources, responsibilities, objectives and performance requirements to the combat and production subsystems.
- Evaluating the performance of the subsystems’ organizations against the requirements.
- Bringing about change, whether evolutionary or revolutionary, in cases where performance does not meet present requirements, or the projected security needs of the nation.
- Transforming the Army to future force structure organizations in order to meet the National Security and National Military Strategies.

#### 3–8. Differentiation and integration

The exercise of these functions calls for both a high degree of differentiation within the headquarters and cross-functional integration. Each function must relate to a similar functional group in OSD, to some extent to interested committees in Congress, and to members of the same specialist community in the combat and production subsystems. Figure 3–1 reflects the current HQDA structure.



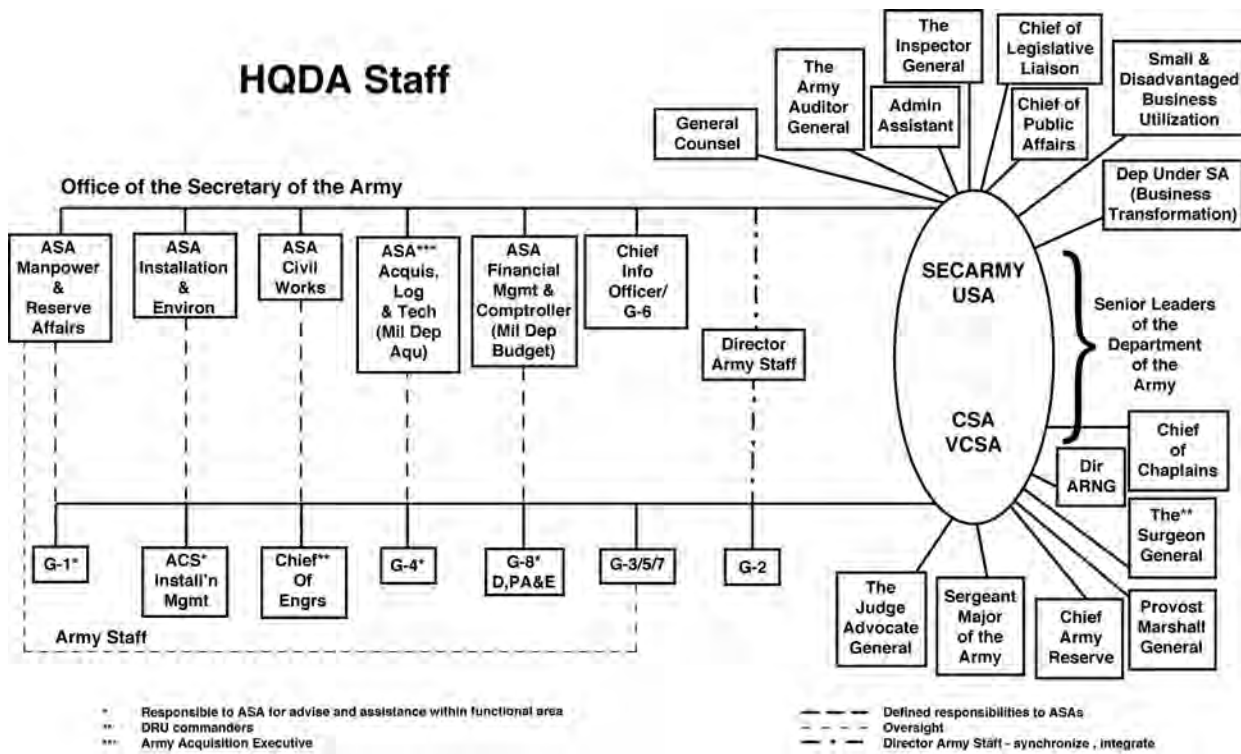

Figure 3-1. HQDA Reorganization Structure

a. Achieving differentiation.

(1) Differentiation is achieved through the assignment of functional responsibilities to the HQDA directorates and the HQDA special and personal staff sections. It is within the directorates that assigned tasks such as recruiting, planning, or budgeting are managed; goals are formulated; timing coordinated; and sub-organizational hierarchy and protocols established. The directorates possess knowledge and experience sufficient for most decisions that concern their task environments.

(2) It is important at HQDA that the requirements of the associated functional environments are communicated and analyzed. This includes both upward relationships-with OSD, OMB, and congressional committee staffers-and downward relationships with the subordinate organizations. The senior leadership of the Army has a large influence on goal-setting and performance evaluation for the whole functional or specialty community within the Army and a similar influence on getting the needed resources from OSD, OMB, and Congress.

b. Horizontal Differentiation in HQDA.

(1) Part of the past debate on HQDA reorganization was the belief that the structure of HQDA actually complicates the achievement of the required differentiation and performance. The criticism focused on the functional parts of the Army Secretariat and the ARSTAF directorates which seemed to perform duplicating activities or have overlapping responsibilities. The *Goldwater-Nichols DOD Reorganization Act of 1986* required the integration of the two staffs into a single HQDA comprised of a Secretariat focused on managing the business of the Army and the Chief of Staff and deputy chiefs of staff responsible for planning, developing, executing, reviewing, and analyzing Army programs. The policy/business management vice program development and execution differentiation does provide for a unified headquarters approach that limits sub-optimization while concurrently producing subordinate organizations with required differentiation, capable of being integrated into the roles, missions, and functions of the Army. Notwithstanding, the Army has continued to increase the integration of HQDA with the creation of the "Executive Office of the HQDA" and subsequently re-designated as "Senior Leaders of the Department of the Army" that increased administrative oversight by the Director of the Army Staff of both the Army Secretariat and the Army Staff and required closer staff relationships.

(2) To achieve greater differentiation in acquisition management, Congress directed and placed into law that the service acquisition executive functions be placed within the service secretariats. Correspondingly, the Secretary of the Army appointed the Assistant Secretary of the Army for Acquisition, Logistics and Technology as the Army Acquisition Executive (AAE) to centrally manage this function.

(3) As another example, the Army Contracting Command now centralizes the Army's previously decentralized installation and information technology (IT) (see Chapter 16) contracting processes into one system. It is responsible for all contracts over \$500K and tasked to eliminate redundant contracts, and leverages Army-wide requirements to achieve economies of scale. ACC supports Army Transformation efforts by aligning all base support contracting into a single organization that best supports installation management transformation. All of these initiatives use IT to leverage enterprise-wide buying capabilities. Additionally, ACC will act as the single coordinating element and form the base from which to deploy contingency-contracting and operational support to the war fighting commands. The Army Contracting Command and other contracting activities will also continue to support small business awards.

(4) Correspondingly, the Army differentiates functions and tasks vertically. Efficiency and effectiveness demands that organizations eliminate any level that does not perform essential and unique tasks or perform critical integrating functions. The Army executes unique Title 10 functions and tasks and produces value-added outputs at the strategic, operational and tactical levels. These levels are further divided into eight levels. Figure 3-2 depicts the eight hierarchical levels of differentiated functions and critical tasks.

		Functions	Critical Tasks		
<b>S T R A T E G I C</b>	Level VIII (SA & CSA)				
	<ul style="list-style-type: none"> <li>&gt; Sets the Direction of the whole Enterprise, and</li> <li>&gt; Assigns Major Areas of Accountability to Each Direct Subordinate</li> </ul>				
	Level VII (USA; VCSA; ASA; GEN)				
	<ul style="list-style-type: none"> <li>&gt; External Affairs</li> <li>&gt; Policy Application Governance</li> <li>&gt; Resourcing</li> <li>&gt; Continuous Alignment</li> </ul>		<ul style="list-style-type: none"> <li>&gt; Set Vision: Structure, Systems and Processes</li> <li>&gt; Define Mission Establish Values</li> <li>&gt; Create Culture</li> <li>&gt; Formulate Enterprise Projects Initiate Change</li> </ul>		
<b>O P E R A T I O N A L</b>	Level VI (PDASS; SES-4; LTG)				
	<ul style="list-style-type: none"> <li>&gt; Policy Formulation</li> <li>&gt; Strategy Development</li> <li>&gt; Program Analysis &amp; Integration</li> <li>&gt; Best Business Practices (Networking)</li> <li>&gt; (Command Direct Reporting Units)</li> </ul>		<ul style="list-style-type: none"> <li>&gt; Maintain Global Awareness (Political Environmental, Social, Technical, Informational)</li> <li>&gt; Manage Portfolios</li> <li>&gt; Allocate Resources</li> <li>&gt; Design: Structure, Systems, and Processes</li> </ul>		
	Level V (SES-5; MG)				
	<ul style="list-style-type: none"> <li>&gt; Strategy Implementation</li> <li>&gt; Identify Customer Needs</li> <li>&gt; Business Plan &amp; Program Development</li> <li>&gt; Implement Continuous Improvement</li> </ul>		<ul style="list-style-type: none"> <li>&gt; Manage Operational Unit(s)</li> <li>&gt; Manage Resources</li> <li>&gt; Integrate Cross-functions</li> <li>&gt; Create Supportive Climate Formulate Operational Unit Projects</li> </ul>		
<b>T A C T I C A L</b>	Level IV (SES-6; GS-15; BG(Colonels))				
	<ul style="list-style-type: none"> <li>&gt; Program Execution</li> <li>&gt; Meets Customer Needs</li> <li>&gt; Implements Continuous Improvement</li> <li>&gt; Manage Resources</li> </ul>		<ul style="list-style-type: none"> <li>&gt; Manage people, processes, activities, and resources to achieve goals &amp; objectives</li> <li>&gt; Integrate Functions</li> <li>&gt; Measure Customer Satisfaction</li> </ul>		
	Level III, II, and I				
	<ul style="list-style-type: none"> <li>&gt; Produce Direct Outputs</li> <li>&gt; Interact with Customers</li> <li>&gt; Manage to Budget</li> <li>&gt; Implement Continuous Improvements</li> </ul>		<ul style="list-style-type: none"> <li>&gt; Increase Productivity</li> <li>&gt; Measure Customer Satisfaction</li> <li>&gt; Eliminate waste</li> <li>&gt; Apply Lean Principles</li> <li>&gt; Ensure Quality</li> </ul>		
		Functions	Critical Tasks		

Figure 3–2. Differentiation of Army Hierarchical Functions and Tasks

(5) The top level (Level VIII) sets the direction for the total enterprise and assigns major areas of accountability to each of the Army's subordinate organizations. The other senior levels (Levels VII and VI) set the vision and mission of the major components of the Army and, therefore, involve work with long term horizons (15 years or more). These are the strategic levels in an organization. Fulfilling the Army vision of "relevant and ready Landpower in service to the Nation" and the mission "to provide necessary forces and capabilities ..." requires outputs (e.g., resource decisions, program development, change management, organizational alignment, etc.) by Level VII and Level VI leaders that impact the Nation's defense for the next 15 years and beyond.

(6) The operational levels (Level V and IV) have traditionally provided the leadership of Divisions and Brigades. The outputs of Level V and Level IV equal those of strategic business units found in large scale enterprises. These two levels transform the strategic vision of Level VII leaders into a 3 to 6 year framework within which organizations implement programs and devise and implement training plans to create the conditions for successful activities at the tactical levels.

(7) The lower levels (Levels III, II, I) produce the direct outputs (products and services) of the organization. Time horizons at these levels are much shorter - 1 year or less. Several product/service examples: the output of a depot is a recapped piece of equipment (product); the output of an Army Training and Document Command training center is a Soldier ready for warfighting; the output for the operational army are trained and ready combined-arms units; and the output of an Army installation daycare center is childcare (service).

(8) The left side of Figure 3-2 shows the nature of value adding functions undertaken at higher levels in a properly designed organization. The right column shows the critical tasks performed at each level in the organization. Finally, the right side of Figure 3-2 emphasizes the importance of an enterprise perspective. The tactical level produces direct outputs, i.e., the products and services consumed by the customer. The output of a service school is a trained and educated Soldier. The output of a small unit combat team is occupied and controlled territory. In a command situation, the direction of work flow and its outputs at operating commands are directed down to lower levels because this is where the organization's "production" of the direct outputs occurs.

(9) By contrast, in HQDA at Levels VI and VII the work fundamentally changes. Individuals doing their work at these levels produce outputs (services or products), but their outputs, and therefore their work, is directed to supporting a more senior Principal. The work at Level VI supports the outputs of Level VII. For example, the work of the Deputy Chief of Staff, G-4 supports the resourcing mission of the Assistant Secretary for Acquisition, Logistics, and Technology at Level VII. The outputs might be data analyses (services) or reports (products). The G-4 at Level VI may also prescribe tasks to Level V directorates that have been established to assist the Level VI Principal in carrying-out his or her work. The Level V output in this case might be drafts of specifications, directives, or programs.

#### *c. Achieving integration.*

(1) Integration is achieved in a formal series of meetings at the senior staff level within the Secretariat and ARSTAF. The heads of the staff agencies, the Deputy Chiefs of Staff themselves, have a principal integrating role, serving more as a corporate management committee, than as simply representatives of their own staff agencies. And there are also many task forces, working groups, and committees with membership drawn from throughout the ARSEC and ARSTAF, which also serve as important knowledge-based integrators.

(2) Integration is also the primary function of the Army's senior leadership: the SECARMY, Under Secretary, Chief of Staff, and VCSA. This group decides on management strategies: stability, modernization of equipment, allocation of scarce resources, and force structure issues. These strategies, enunciated in the yearly Posture Statement, are unifying, integrating statements of objectives that relate directly to the dominant overall issue...maintaining mission-ready forces.

## **Section V**

### **Summary and references**

#### **3-9. Summary**

*a.* The United States Army Posture Statement, available through the U.S. Army home page (<http://www.army.mil>), articulates the strategic role of the Army and the integration necessary to produce combat ready units. The document acknowledges that while fighting the ongoing Global War on Terrorism, the Army is concurrently transforming its organizational structure and doctrine.

*b.* This chapter presents a theoretical construct for the organizational design and structure of the Army and examines the two defining characteristics of functional differentiation and integration. The start point is our current National Security and Joint Military Strategies. Currently, the Joint Operations Concepts (JOpsC) family ([www.dtic.mil/futurejointwarfare](http://www.dtic.mil/futurejointwarfare)) provides the direction for change and The Army Strategy focuses that direction for the Army. The Army Campaign Plan maps the lines of operations the Army will pursue to manage the change effort as it continues its journey towards achieving required future capabilities. The remainder of this text will address the systems that actually plan and execute this continuous process of change and growth.

## How the Army Runs

### 3–10. References

- a.* Department of Defense Reorganization Act of 1986 (Goldwater-Nichols).
- b.* Joint Publication 1–02, DOD Dictionary of Military and Associated Terms.
- c.* Army Regulation 10–5, Headquarters, Department of the Army.
- d.* Army Regulation 10–87, Major Army Commands in the Continental United States.
- e.* Army Regulation 10–88, Field Operating Agencies, Office of the Chief of Staff.
- f.* General Orders Number 3 (GO 3), Assignment of Functions and Responsibilities Within Headquarters, Department of the Army.
- g.* General Orders Number 00 (GO 00), Managing the Headquarters, Department of the Army.
- h.* Amendment to GO 2002–03, Assignment of Functions and Responsibilities within Headquarters, Department of the Army.

## Chapter 4

### The Relationship of Joint and Army Planning

Joint matters, as identified in Title IV, Public Law 99-433, Goldwater-Nichols Department of Defense Reorganization Act of 1986, are defined as "... matters relating to the integrated employment of land, sea, and air forces including matters relating to:"

#### Section I Introduction

##### 4-1. Chapter Content

The 1986 Goldwater-Nichols Act profoundly changed the relationships among the Services and with the organizations of the Office of the Secretary of Defense (OSD), the Combatant Commands, and the Joint Chiefs of Staff (JCS). The Chairman and JCS were given additional responsibilities, the Combatant Commands were given greater authority and responsibilities to execute their missions, and Services and OSD realigned specific responsibilities and made organizational changes to include some that involved greater civilian oversight and control. This chapter addresses the processes used within the DOD, the JCS, the Combatant Commands and the Army to determine the joint capabilities and associated force levels required to meet the U.S. national security and military strategies and to fulfill Combatant Command requirements. These processes also determine the capabilities that need to be resourced by Services' programs within the Planning, Programming, Budgeting, and Execution Process (PPBE) and provide the basis for the DOD's Future Years Defense Program (FYDP). While the emphasis of this entire text is on the Army management systems, it is first necessary to understand the relationship of DOD, the JCS, and the Combatant Commands to the Army. Hence, this chapter provides more of a joint perspective to then better appreciate and apply information in other chapters in this text, and because the Army has significant input to the joint processes that supports the development of requirements, programs and budgets, as well as strategic planning.

##### 4-2. Secretary of Defense

The Secretary of Defense provides both formal and informal guidance to the services, Combatant Commands and Defense Agencies. The Secretary's formal guidance is provided in two broad strategy documents called the National Defense Strategy and the Quadrennial Defense Review (QDR). The defense strategy document, while not required under Title 10 USC, has become a capstone document for providing strategic guidance throughout the Department of Defense. Signed by the Secretary, the document is designed to take the national goals and objectives of the Nation delineated in the National Security Strategy signed by the President and turn them into Defense objectives and goals. The document has been used to guide the formulation of Quadrennial Defense Review required by the Congress other Department of Defense strategy documents, and informs the development of the National Military Strategy (NMS) signed by the Chairman of the Joint Chiefs of Staff. The NDS provides strategic guidance on campaign and contingency planning, force development, and intelligence. It addresses how the Armed Forces will fight and win the Nations Wars and work with partner nations to enhance security and avert conflict. The QDR, mentioned above, has been used to either identify ways to implement the NDS as occurred in 2006, or to identify a new defense strategy, as had been done in the 2010 QDR. Furthermore, the most recent QDR identified main elements of the Service's force structure, as well as a series of enhancements and initiatives in specific capability areas. Hence, the 2011 NMS's forward referenced the 2010 QDR when it identified that the NMS was focused on accomplishing this QDR's defense objectives.

##### 4-3. Other DOD Strategic Guidance

The Department of Defense changed the format for its guiding documents by merging thirteen (13) strategic-level planning documents into two (2) documents. The two (2) new documents are the Guidance for Employment of the Force (GEF) and the Defense Planning and Programming Guidance (DPPG). The GEF, as its name implies, provides guidance that identifies how the military forces should be used, and it impacts current operations and the current planning process. The DPPG provides planning and programming guidance by establishing the Department's priority missions, force sizing construct, force planning assumptions and key capabilities to size and shape the Joint Force. Unique to the GEF is the inclusion of Nuclear Weapons Planning Guidance.

##### 4-4. Chairman of the Joint Chiefs of Staff

The Chairman by Title 10 USC is the principal military advisor to the President and the Secretary of Defense, the National Security Council (NSC) and the Homeland Security Council (HSC). The Chairman is required under the law to: assist the President and Secretary of Defense in providing strategic direction; conduct strategic planning; advise on preparedness of the Armed Forces; advise on requirements, programs and budgets; develop joint doctrine. The Chairman was required by the Congress in 2004 to produce every even year a detailed report that reviewed the current National Military Strategy to include the strategic and military risks to execute that strategy, and during every odd year

## How the Army Runs

the Chairman was to produce an assessment of the strategic and military risks associated with executing the current NMS (discussed below).

### 4–5. Joint Strategic Planning System

The Joint Strategic Planning System (JSPS) was revised in December 2008 to provide an integrated assessment, advice, and direction system to better enable the Chairman to assess the strategic environment, provide comprehensive military advice and provide unified direction to the Armed Forces. JSPS is the means by which the Chairman can, in the larger cycle of strategic planning by the Department of Defense, provide the assessments, advice, and direction he is required to provide under Title 10 USC. Through JSPS, the Chairman can conduct the comprehensive assessments to provide the statutory advice to the President, Secretary of Defense, National Security Council, Homeland Security Council, and the Congress. JSPS provides the Chairman a formal planning system to assist the President and the Secretary of Defense with unified direction to the Armed Forces.



Figure 4–1. Joint Strategic Planning System

### 4–6. JSPS Overview

The three major components of JSPS address the Chairman's statutory responsibilities: Chairman's Assessment, Chairman's Advice, and the Chairman's Direction. A way to envision these three major components is in Figure 4–1 that comes from the Chairman's instruction. While these three major components and the associated products are more fully discussed later, a brief summary of them provides broad context to appreciate this strategic planning system and its integrated nature.

*a.* The Chairman conducts both deliberate and continuous assessments to understand the security environment. These assessments focus on such topics as global trends, challenges, readiness, risk, sufficiency, and joint military requirements. The main formal products as a result of this assess component are the Comprehensive Joint Assessment (CJA), the Joint Strategy Review (JSR) process. Furthermore, there are various insights associated from the Chairman's readiness system that are incorporated within these two formal products when appropriate.

*b.* The Chairman's Advice is a principal statutory requirement of the Chairman and is designed to provide independent military advice to the senior leadership to assist in their development of strategy, guidance, and policy.

The formal roles and areas associated with this advice include: Combatant Commander Spokesman, strategic direction, strategic planning, contingency planning, programming, budget, strategic environment and validate military requirements. In addition to the National Military Strategy, this advice includes formal documents such as the Chairman's Risk Assessment, Chairman's Program Recommendation, Chairman's Program Assessment and Joint Strategy Review Report.

c. The Chairman's Direction provides strategic direction on behalf of the President and Secretary of Defense to implement their guidance associated with the roles of strategic direction, strategic planning and developing doctrine. The two formal products associated with these roles are the National Military Strategy, which provides broad direction and identifies priorities to the Armed Forces to support the NSS and NDS strategies, and the Joint Strategic Capabilities Plan (JSCP), which provides guidance to Combatant Commanders, Service Chiefs, Combat Support Agency directors, Defense Agencies, DOD Field Activity directors, and the Chief, National Guard Bureau to accomplish task and missions based on near term capabilities. The JSCP implements planning guidance reflected in the GEF.

#### **4-7. Army Participation in joint planning and resourcing processes**

The Army participates fully in the strategic planning and resource processes. The ARSTAF supports the SECARMY and Chief of Staff of the Army (CSA) by participating in various ways in working groups associated with the Quadrennial Defense Review, which is a comprehensive defense review required by Congress with the beginning of each new administration. The ARSTAF supports the Chief of Staff of the Army (CSA), in his role as a member of the JCS, by performing analyses and providing inputs to the JSPS. The ARSTAF supports the VCSA, in the role as a member of the Joint Requirements Oversight Council (JROC) and Deputies Advisory Working Group (DAWG), by direct participation in the capabilities assessment process. The ARSTAF supports the SECARMY, as a member of the Defense Resources Board (DRB) and DAWG by participating in JSPS, QDR and JROC, and by performing additional analyses as required in support of the development of the Defense Planning and Programming Guidance. In essence, the Army Staff has developed parallel processes to provide the Army's perspective to these joint systems and processes both at the working and general officer levels. Most of the outcomes of these efforts that affect the Army are then codified in The Army Plan, specifically in Section IV, The Army's Campaign Plan.

a. Global Force Management (GFM) is designed to integrate force apportionment, assignment, and allocation methodologies in support of the National Defense Strategy and joint force availability requirements. It provides the comprehensive insights into the global availability of U.S. military forces and provides the senior decision makers a process to assess quickly and accurately the impact and risk of proposed changes in forces/capability assignment, apportionment, and allocation. GFM is designed to transform the previous reactive force management process into a more near real-time, proactive process.

b. As specified in Title 10 U.S. Code and as identified in the Unified Command Plan and the "Forces For" memorandum, forces are assigned to Combatant Commands. Forces are generally apportioned by the CJCS based on Guidance for Employment of the Force (GEF) provided by the Secretary of Defense and the President. Allocation of forces is the authority that resides with the Secretary of Defense and President. GFM integrates these two main responsibilities into a single overarching process. The two major elements are the Global Force Management Board and the Joint Force Providers. The GFM Board is chaired by the Director of the Joint Staff with advice from the other Joint Staff Directors and Services Operations Deputies. This Board provides overarching guidance for the process and reviews controversial recommendations to be presented to the Chairman and Secretary. The Army G-3, or a designate general officer from G3/5/7, represents the Army in making recommendations for final outcomes of this process that result in decisions by the SECDEF and the President as to force assignment, allocation, and apportionment. The Joint Force Providers (JFP) recommend solutions for request for forces (RFF) or request for capabilities (RFC) submitted by Combatant Commands. The JFP are responsible for recommending and developing risk assessments for conventional forces, special operating forces, mobility forces, and strategic and intelligence/surveillance/reconnaissance forces. The final outcome of GFM is the production of deployment orders and execution orders signed by the Secretary of Defense.

## **Section II**

### **Joint Strategic Planning System**

#### **4-8. JSPS**

a. The CJCS is charged with preparing strategic plans and with assisting the President and the Secretary of Defense in providing strategic direction to the Armed Forces. The JSPS and the Global Force Management Process, as prescribed by CJCS Instruction (CJCSI) 3100.01B and the Secretary of Defense's Global Force Management Implementation Guidance, provide the framework for strategic planning and formulating strategic direction of the Armed Forces. Joint strategic planning begins the process to create the forces and associated capabilities that are then allocated to Combatant Commands for their planning. Since the capabilities integration and development process is essential to many of the formal strategic planning products and processes, CJCSI 3170.01E, which covers this Joint Capabilities Integration and Development System (JCIDS), helps to validate and prioritize joint warfighting requirements. JCIDS is also a key supporting process for DOD acquisition and PPBE processes. A primary objective of the JCIDS and associated processes is to ensure the joint Soldier receives the capabilities required to successfully execute the missions



## How the Army Runs

assigned to them. The Capstone Concept for Joint Operations, Version 3.0 describes how the Joint Force will operate in an uncertain, complex, and changing future environment characterized by persistent conflict.

b. Within the Joint Staff, strategic planning is primarily the responsibility of the Strategic Plans and Policy Directorate, J-5, and capabilities and resources are primarily the focus of the Force Structure, Resources, and Assessment Directorate, J-8. They use input from the Joint Staff, OSD, other DOD and Defense Agencies, Combatant Commands, and the Services to assist in formulating policy, developing strategy, and providing force planning guidance. The Adaptive Planning Roadmap II and the review and approval of operations plans, which resides with the Operational Plans and Interoperability Directorate, J-7, and Operations Directorate, J-3. All of the above mentioned Joint Staff Directors are members of the Global Force Management Board. Furthermore, the J-1, J-4 and J-6 Directorates have responsibilities for providing direction to specific Functional Capability Boards. Hence, all elements of the Joint Staff work together to fully execute these processes in an integrated manner.

c. The JSPS constitutes a continuing process in which formal products on a specific cycle such as the Joint Strategic Capabilities Plan or other focused assessments or studies are produced as required to provide this formal direction. Some of these products provide direction while others provide formal advice or shape the informal advice from the Chairman. The CJCS uses this planning system to give him the formal ability to execute his Title 10 US Code responsibilities to conduct continuous strategic assessments, assess risk, provide statutory and personal advice to the President and Secretary of Defense, develop strategic plans, and provide strategic direction to the Armed Forces. Figure 4-2, which comes from the Chairman's instruction, provides a way to envision this strategic planning system's execution.

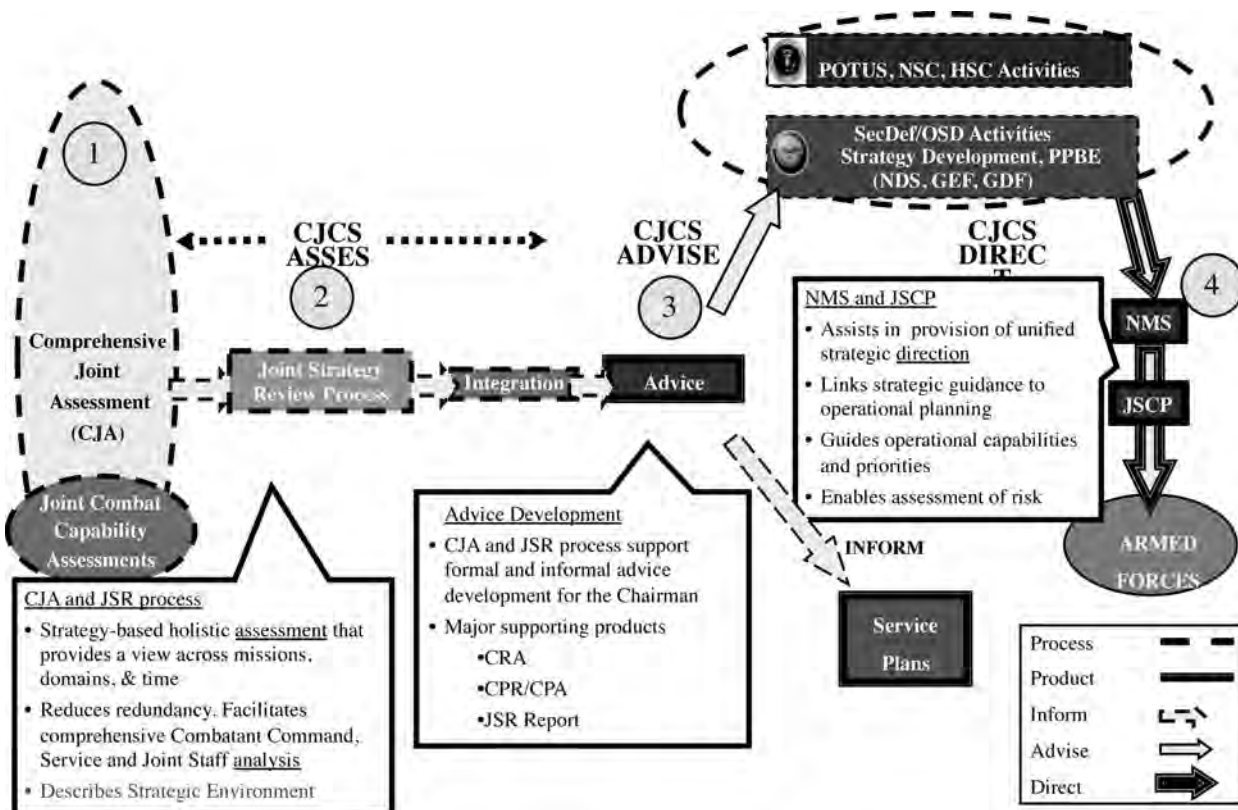

Figure 4-2. Execution of Joint Strategic Planning System

#### 4-9. Chairman's Assessments

The Chairman's Assessments are a major component of the JSPS process. These assessments consist of obtaining and analyzing data concerning: the nature of the strategic environment; U.S. and allies ability to operate and influence that environment; adversaries and potential enemies' ability to operate and influence that environment; the risk to the national strategies over the near, mid and far term.

*a.* The Comprehensive Joint Assessment (CJA) is a deliberate process intended to reduce redundancy and facilitate integrated comprehensive Combatant Command, Service and Joint Staff analysis. The CJA survey requests assessments from the Service Chiefs and Combatant Commanders relating to statutory and Unified Command Plan responsibilities in support of the NMS. CJA focuses on qualitative not quantitative inputs. Further the CJA draws on other assessment such as the Joint Combat Capability Assessment (JCCA), Defense Readiness Reporting System, and Service and Combatant Commander Assessments. The Chairman uses these assessment to formulate: military advice to the President and Secretary of Defense on strategic direction for the Armed Forces; identify the most important military issues; reconcile issues and requirements across Service and Combatant Commands; provide input to DOD processes; and Congressional reports.

*b.* As Combatant Command Campaign Plans are developed and approved as directed by the JSCP and the GEF, assessments of those plans will become a part of the CJA. Until the plans are fully developed, Campaign Assessments will be incorporated in the CJA survey.

*c.* The Joint Strategy Review (JSR) process provides an analytical framework that looks in depth at a variety of CJCS products to include: strategic documents; directives; instructions and memorandums. The JSR provides the synthesis of the CJA and the Joint Staff's functional estimates and processes. The components of the JSR process include: Joint Intelligence Estimate; Joint Strategic Assessment; Joint Strategy Review Report; Capability Gap Assessment; Joint Concept Development and Experimentation; Joint Logistics Estimate; Joint Personnel Estimate/Health Force Metrics; Chairman's Risk Assessment; Operational Availability Studies; Joint Combat Capability Assessment; Chairman's Readiness System; and Global Force Management.

#### 4-10. Chairman's Advice

A major statutory responsibility of the Chairman is to provide military and strategic advice to the President, Secretary of Defense, NSC and HSC. By providing formal advice the Chairman enhances his ability to assist the nation's leadership in developing Nation Security and Defense Strategies, and programs and budgets.

*a.* The Chairman's advice is developed using the information provided through the CJA and the analysis of the JSR process, as well as the various ways readiness is assessed. The readiness component is covered in another HTAR chapter.

*b.* The Chairman's formal advice provides National Security, Defense and Agency staffs with a framework and military baseline for strategic policy and guidance as well as direction for developing Joint Staff assessments and recommendations. The Chairman's advice assists the President, the Secretary of Defense, and their staffs in the formulation of the NSS, NDS, Program Budget Review, GEF, DPPG, QDR and Service strategies.

*c.* The Chairman's formal advice includes: Chairman's Program Recommendation (CPR); Chairman's Program Assessment (CPA); National Military Strategy (NMS); Chairman's Risk Assessment (CRA). Furthermore, the Chairman provides advice from various Chairmen's briefings, Council Membership and other Formal Correspondence and Guidance Statements.

(1) The CPR is developed under the leadership of the Joint Requirements Oversight Council (JROC) using the Functional Capabilities Board (FCB) process to provide the Chairman's personal programmatic advice to the Secretary of Defense. This advice is designed to influence the Secretary of Defense's DPPG.

(2) The CPA is developed under the leadership of the JROC using the Functional Capabilities Board process to shape the Chairman's personal advice and assessment of Service and Defense Agency POMS and Budget Estimate Submissions to the Secretary of Defense to influence the Program and Budget Review (PBR). This advice is used within various Pentagon meetings associated with translating the POMS into the final DOD budget submissions sent to Congress by the President.

(3) The NMS is primarily to transmit strategic direction to the Armed Forces. This document provides the Chairman's formal military advice on the global strategic environment, and the military's best approach to accomplishing the interests and goals identified in the NSS, NDS and QDR. The 2011 NMS identified the following four national military objectives: counter violent extremism; deter and defeat aggression; strengthen international and regional security; and shape the future force. (4)The requirement for the Chairman's Risk Assessment (CRA) is contained in Title 10, USC in those sections requiring the Chairman to assess the nature and magnitude of the strategic and military risk to missions called for under the NMS, and to confer with the Combatant Commanders, and Service Chiefs to provide that advice. This risk assessment is accomplished every year by the Chairman and is first transmitted to the Secretary of Defense. The Secretary of Defense is then required to transmit the report to Congress with the Secretary's

## How the Army Runs

comments, and if that risk with executing the NMS is determined significant, the Secretary shall include a plan for mitigating that risk.

(4) The Chairman's provides formal advice to Secretary of Defense; the President and other interagency leaders via the many venues associated with briefings and discussions in include advice to formal councils such as the National Security Council and Homeland Security Council.

### 4-11. Chairman's Direction

The Chairman assists the President and the Secretary of Defense in providing unified strategic direction to the Armed Forces. He assists them with their command functions and performs directive functions, which the law specifies, and includes: planning, joint doctrine, education, and training. The Chairman's formal direction is executed in the National Military Strategy (NMS) and the Joint Strategic Capability Plan (JSCP).

*a.* Formal strategic direction is generally executed annually but some documents are sequenced biennially. The components of JSPS are sequenced to best support the formulation of key strategic documents. The development of strategic direction begins with the issuance of Chairman's advice. The Chairman's advice informs the National Security Strategy and Defense Strategy developers and provides the military baseline for staff interaction and the development of critical work such as the NSS and QDR.

*b.* The production of the strategic direction by the Chairman is a collaborative effort requiring extensive coordination. The Chairman provides advice and recommendations to influence the NSS, NDS, DPPG, GEF, UCP, Quadrennial Role and Missions Reviews (QRM), and the QDR.

*c.* The NMS and the JSCP are the major direction documents signed by the Chairman and produced under the JSPS.

(1) The NMS sets priorities and focuses the efforts of the Armed Forces while providing the Chairman's advice on the security environment and necessary military capabilities to protect the Nation's interests. Based on the NSS and NDS, the NMS provides the guidance that Combatant Commanders use to employ the Joint Force to protect the Nation's interest, and the Service Chiefs use to develop capabilities that support the Joint Force.

(2) The NMS provides military objectives to Combatant Commanders and Service Chiefs, derived from the NSS and the NDS. The NMS provides military ways and means to achieve military objectives to achieve national objectives.

(3) The NMS provides the Chairman's advice on the strategic environment, the Implications of that environment, and the best way to accomplish the objectives of the NSS and NDS.

(4) The NMS state the Joint Force's resolve to defend the American people and the nation's vital interests, while achieving the national and defense objectives.

(5) The NMS forms the basis for the advice in the Chairman's Risk Assessment (odd years) and Bi-annual Review (even years) provided to the congress.

(6) The JSCP provides guidance to accomplish tasks and missions based on near term military capabilities to Combatant Commanders, Service Chiefs, Combat Support Agencies (CSA) directors, applicable Defense agency and DOD Field Activities directors, and the Chief, National Guard Bureau.

(7) The JSCP implements campaign, campaign support, contingency, and posture planning guidance from the GEF.

(8) The JSCP implements the objectives in the NSS and NDS through the resulting combatant command campaign and contingency plans.

(9) The JSCP provides a coherent framework for military planning advice from the President and the Secretary of Defense and follows, implements, and augments presidential and SecDef guidance provided in the GEF, UCP, and the Global Force Management Implementation Guidance.

(10) The JSCP provides: strategic planning direction; detail planning guidance, force apportionment guidance, assumptions and tasks; tasks the Combatant Commanders to prepare campaign, campaign support, contingency, and posture plans; establishes the synchronizing, supported and supporting relationships.

### 4-12. The Joint Requirements Oversight Council (JROC)

By statute the Chairman, Joint Chiefs of Staff is responsible to chair the Joint Requirements Oversight Council, and the functions of the JROC chairman may only be delegated to the Vice CJCS (VCJCS). Other members of the JROC are selected by the CJCS after consultation with the Secretary of Defense, who is in the grade of General and Admiral that are recommended by their military Departments. In addition, Combatant Commanders now have a standing invitation to attend JROC sessions in an advisory role. Historically, the JROC has consisted of the VCJCS, the Vice Chiefs of Staff of the Army and Air Force, Vice Chief of Naval Operations, and the Assistant Commandant of the Marine Corps. Since 1994, the CJCS expanded the authority of the JROC to assist in building senior military consensus across a range of issues across four broad functional areas. These functional areas are broadly identified under capabilities, assessments, joint integration, and resources (Figure 4-3). The Under Secretary of Defense (Comptroller), the Under Secretary of Defense Acquisition, Technology and Logistics (AT&L), and the Director of Cost Assessment and Performance Evaluation (CAPE) serve as advisors to the JROC within their authority and expertise. Furthermore, FCB participating organizations have a standing invitation to attend JROC-related meetings in an advisory role to the JROC

Chairman. The CJCSI that covers this organization's functions and membership is 5123.01E. This instruction identifies 15 specific responsibilities and 23 functions.

*a.* The JROC has continued to broaden its strategic focus to include providing top down guidance in defining military capabilities from a joint perspective and integrating this advice within the planning, programming and budgeting process. The JROC oversees the Joint Capabilities Integration and Development System (JCIDS) and provides advice on acquisition programs as specified in CJCSI 3170.01G and DOD 5000.01. Additionally, JROC activity has continued to focus on dialogue with Combatant Commanders on the full range of warfighting requirements and capabilities. Assessment teams perform the assessment of those requirements and capabilities or working groups are organized within the established Functional Capabilities Boards (FCBs). The domains of each of these Functional Capabilities Boards include the following joint capabilities areas: Battlespace Awareness; Force Application; Building Partnerships; Command and Control; Logistics; Protection; Net-Centric; and Force Support (See Figure 4-4). There is currently an action in the Joint Staff to combine the Command and Control and Net-Centric Functional Capability Boards. Finally, the JROC continues to maintain its direct integration in the PPBE process. Significant effort is involved in the production of two JSPS documents: the Chairman's Program Recommendations (CPR) and the Chairman's Program Assessment (CPA) that were discussed earlier in this chapter. By providing joint capabilities based assessments in the domains listed above, the JROC provides significant input into the development of the full range of Chairman's programmatic advice required by statute.

*b.* The JROC chartered the Joint Capabilities Board (JCB) to serve as an executive level advisory board to assist the JROC in fulfilling its many responsibilities. The JCB consists of the Director, J-8, and the appropriate Service-designated general/flag officer representatives. The JCB assists the JROC in overseeing the capabilities integration and development process and the capabilities assessment process. The JCB reviews capabilities based assessment insights, findings, recommendations, and provides both guidance and direction.

*c.* Functional Capabilities Boards (FCBs) serve as the points of entry for the JROC's actions related to the joint capabilities areas. Additionally, the FCBs, under the leadership of a Joint Staff or Functional Combatant Command flag officer or senior executive service civilian, serve as integrators of joint capability development and ensure that major programs are fully integrated into joint architectures from the outset. The JROC and its associated sub organizations continue to evolve in order to remain focused on strategic issues and concepts. As an example of this strategic focus and desire to directly influence future systems and capabilities, each of the organizations within the JROC process has become deeply involved in developing Operational Concepts and Operational Architectures, as well as developing strategic guidance to influence capabilities. The overall intent is to provide more upfront guidance to ensure capabilities and systems are "born joint" and the focus is on joint interdependency.

*d.* Along with the changes to the structures and establishment of these boards discussed above, advisory support to the JROC has also increased. For example, there are eight organizations within the Office of the Secretary of Defense and Milestone Decision Authorities such as Comptroller and Intelligence that now come to the capabilities meetings as part of the Functional Control Boards as well as provide advisory support the JROC. Further, there are certain defense and interagency organizations have a standing invitation to attend and provide senior level advisory participation at JROC related meetings on specific subjects, such as the NSA, DLA, DCMA, NSC, CIA, OMB, DHS and others. This evolution allows for a broader vetting and input of issues and capabilities before they get to the most senior level for decision.

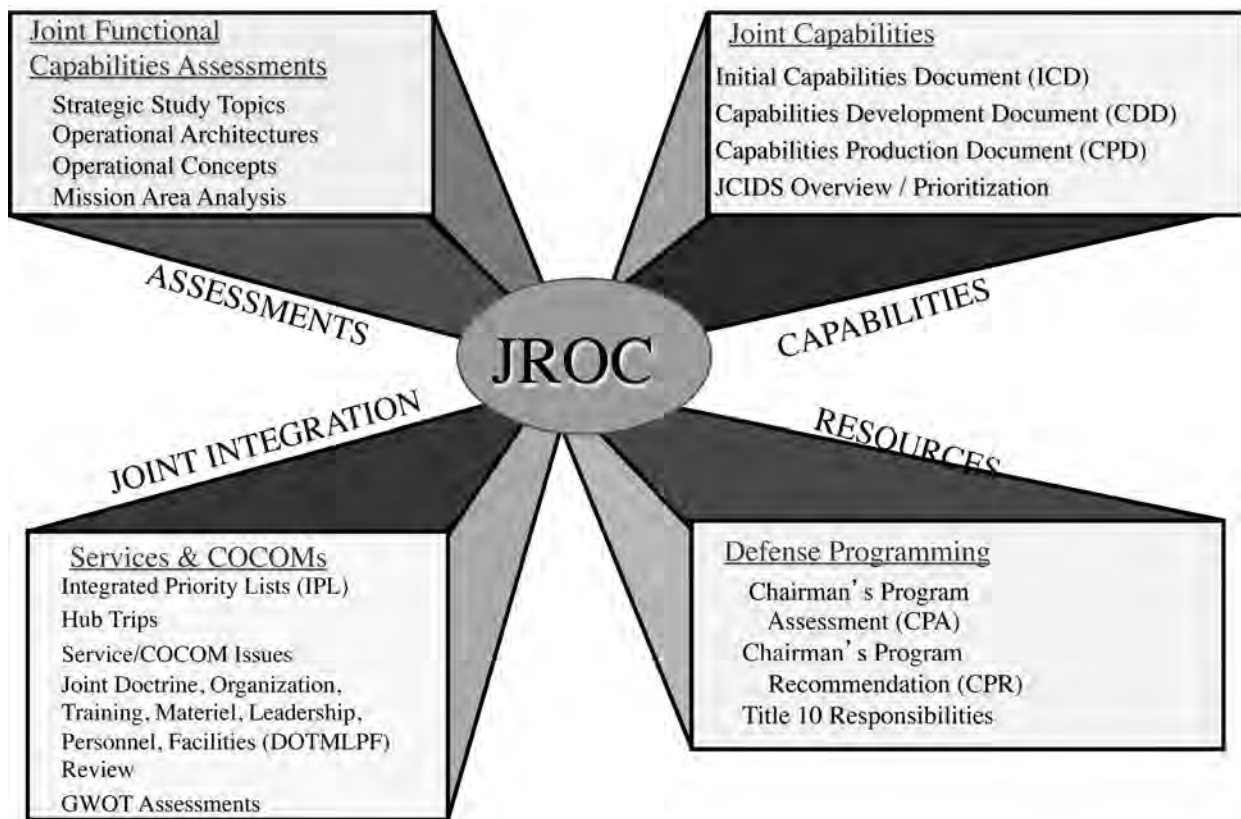
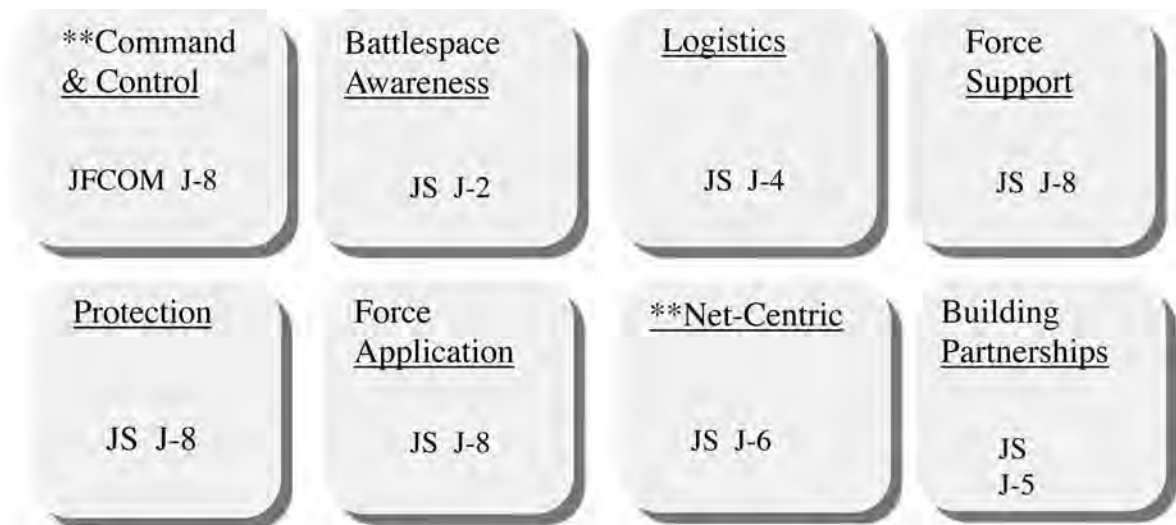

Figure 4-3. JROC Functional Areas



**FCB Membership: (O-6 level)**

Services	ASD NII/ DOD CIO	OSD(Comptroller)
Combatant Command Reps	D, CAPE	
OSD (AT&L)	DIA Rep (Threat)	
OSD (I)	ODNI/IRB	
USecAF (Space)	Other DoD Agencies as necessary	

\*\*Command and Control and Net-Centric Boards are to be combined into a single board in the future.

**Figure 4-4. Functional Capabilities Board**

**4-13. Capabilities Based Assessments**

Capabilities Assessment teams, under the supervision of a Functional Capability Board, examine key relationships and interactions among joint capabilities areas and identify opportunities for improving warfighting effectiveness. Much of this work is focused on identifying and resolving capability gaps with an integrated and joint force perspective. The teams consist of warfighting and functional area experts from the Joint Staff, Combatant Commands, Services, OSD, DOD agencies, and others as deemed necessary. Assessment issues are presented to the FCB for initial issue review, to the JCB for further issue development, and then to the JROC for final recommendation to the CJCS. Through this process, the JROC then is instrumental in helping the CJCS forge consensus and examine alternatives.

a. There are a series of documents that provide guidance for the defense capabilities development process. Within this capabilities process, the Capstone Concept for Joint Operations (CCJO) is the overarching concept that guides the development of the family of joint concepts and future capabilities. It broadly describes how the future joint forces are expected to operate across the range of military operations for an approximate period of time of 2016 to 2028. This document then provides broad guidance for the family of concepts called Joint Operating Concepts (JOCs) and Joint Integrating Concepts (JICs). The JOCs of which there are currently a total of seven describe broad joint operations such as deterrence and major combat operations to name two. There are currently sixteen Joint Integrating Concepts (JICs) that describe more narrowly focused operations or functions such as Joint Command and Control, Strategic Communications, and Joint Urban Operations. The number and type of concepts is being evaluated as this is being written, so there may be future changes in this family of concepts framework.

b. Guidance in the above documents is used by the capabilities assessments that are part of the Joint Capabilities Integration and Development System (JCIDS) briefly described earlier. The CJCSI that describes this detailed process and the documents produced this process is 3170.01G. The documents produced by the JCIDS process that support the materiel and non-materiel solutions are as follows: Joint Capabilities Document (JCD), Initial Capabilities Document

## How the Army Runs

(ICD), Capabilities Development Document (CDD), Capabilities Production Document (CPD), and Joint DOTMLPF Change Recommendations (DCR).

### Section III

#### Planning and Resourcing

##### 4-14. DOD planning, programming, budgeting system, and execution process (PPBE)

The PPBE is a cyclic process containing four interrelated phases: planning, programming, budgeting and execution. The process provides for decision-making on future programs and permits prior decisions to be examined and analyzed from the viewpoint of the strategic environment and for the time period being addressed. Through the JSPS, the Chairman performs his statutory requirement to provide advice on requirements, programs and budgets. Formal advice is provided broadly in the NMS and more specifically in the CPR and CPA. These documents are designed to impact the planning, programming and budgeting phases of PPBE. Through JSPS, the Services and Combatant Command by their input to the Comprehensive Joint Assessment, and their input to the capabilities based assessment process, overseen by the JROC, assists the Chairman in providing formal advice to the PPBE process. The PPBE is covered in detail in another HTAR Chapter.

##### 4-15. The Army Planning System

The Army planning system is designed to meet the demands of JSPS, JROC/CA, GFM, JOPES, and PPBE. Through its interfacing with the JSPS and the JROC's capabilities based assessments processes and its input as a member on the various councils and boards, the Army provides its input to joint assessments and strategic planning documents, which present the advice and direction of the CJCS, in consultation with the other members of the JCS and the Combatant Command Commanders, to the Secretary of Defense and the President.

*a.* The Army PPBE initiates Army planning system. This planning system addresses the direction provided by defense policies and the military strategy for attainment of national security objectives and policies. It determines force requirements and objectives, and establishes guidance for the allocation of resources for the execution of Army roles and functions in support of national objectives. It provides the forum within which the Army conducts its planning to integrate CJCS guidance and provide Service assistance. The Army's PPBE planning phase supports the DOD PPBE process and the JSPS. It also provides guidance for the subsequent phases of the Army PPBE. Planning is defined as the continuing process by which the Army establishes and revises its goals or requirements and attainable objectives, chooses from among alternative courses of action, and determines and allocates its resources to achieve the chosen course of action. The value of comprehensive planning comes from providing an integrated decision structure for an organization as a whole.

*b.* Adequate planning requires a ways and means of making events happen to shape the future of an organization instead of adapting to a future that just unfolds. Planning is considering and assessing ideas that represent the resources of an organization without risking those resources. It is designed to reduce risk by simplifying and integrating as much information as possible upon which to make a decision. It includes the development of options.

*c.* The Army planning system includes strategic planning and force planning for both requirements and objectives. Strategic planning includes the development of national defense policy along with the ends, ways and means associated with the various parts of the NMS. Strategic planning provides direct support to the DOD PPBE and JSPS, while concurrently supporting the Army PPBE. These planning activities serve to guide the subsequent development of programs and budgets. Army planning includes the identification of the integrated and balanced military forces necessary to accomplish that strategy, and provision of a framework for effective management of DOD resources towards successful mission accomplishment consistent with national resource limitations.

### Section IV

#### The Joint Operations Planning

##### 4-16. Joint Operations, Planning and Execution System (JOPES)

The joint operation planning process is a coordinated joint staff procedure used by commanders to determine the best methods of accomplishing tasks and to direct the actions necessary to accomplish those tasks. Joint Operations, Planning, and Execution System (JOPES) is used to conduct joint planning. JOPES facilitates the building and maintenance of operation plans (OPLANs) and concept plans. It aids in the development of effective options and operations orders through adaptation of OPLANs or create plans in a no-plan scenario. JOPES provides policies and procedures to ensure effective management of planning operations across the spectrum of mobilization, deployment, employment, sustainment, and redeployment. As part of the Global Command and Control System, JOPES supports the deployment and transportation aspects of joint operation planning and execution. JOPES contains five basic planning functions: threat identification and assessment; strategy determination; course of action development; detailed planning; and implementation.

*a.* In 2008 the Secretary of Defense directed that be changed to the Adaptive Planning and Execution Process (APEX) by FY 2012. The changes were to incorporate accelerating joint planning, integrating contingency planning,

crises action planning, and execution processes and technology enabling plans to quickly and transparently moving to execution.

b. In accordance with directions in the DPPG FY 12–16, the Military Departments will move to complete the conversion of the JOPES process to the APEX process by FY2015.

**4–17. Combatant Commands**

Combatant Commands provide for the integrated effectiveness of U.S. military forces in combat operations and for the projection of U.S. military power in support of U.S. national policies. They are established by the President through the Secretary of Defense with the advice and assistance of the CJCS.

a. The Unified Command Plan (UCP) is the document signed by the President that establishes the roles, functions and mission for the Combatant Commands and it specifies their day to day responsibilities.

b. The chain of command extends from the President to the Secretary of Defense to the commanders of the Combatant Commands. Forces are assigned under the authority of the Secretary of Defense. A Combatant Command is assigned a broad continuing mission under a single commander and is composed of assigned components of two or more Services. Combatant Commands have full command of all forces assigned.

c. There are two types of Combatant Commands: geographic, which have responsibility for specific areas, and functional, which have responsibility for executing certain functions. There are six geographic and four existing functional Combatant Commands.

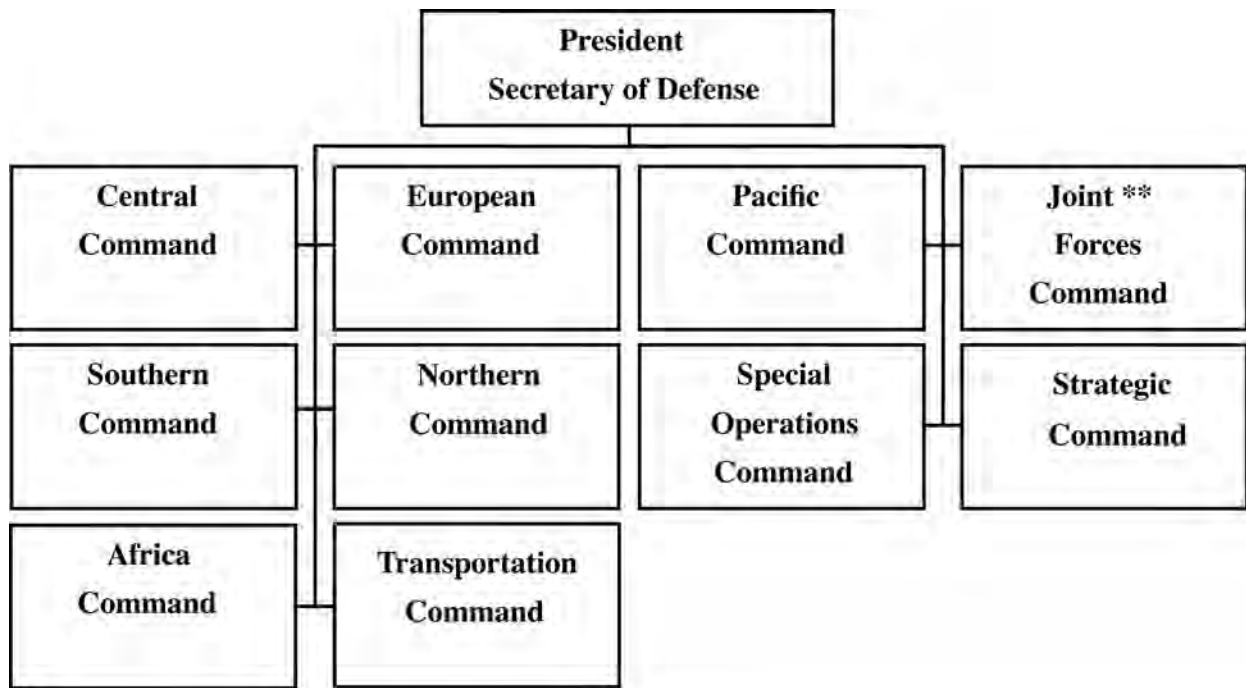

**\*\*Joint Forces Command scheduled to be disestablished.**

Figure 4–5. Combatant Commands

(1) U.S. Joint Forces Command (USJFCOM) is the primary joint force provider and will develop recommended global joint sourcing solutions for conventional forces and capabilities worldwide in coordination with the Services and Combatants. USJFCOM does not provide forces from SOCOM, TRANSCOM, or STRATCOM. USJFCOM is responsible for experimentation, joint training, interoperability and force provisioning. USJFCOM develops future concepts, tests these concepts through rigorous experimentation, educates joint leaders, trains joint forces, and makes recommendations on how the Army, Navy, Air Force and Marines can better integrate their warfighting capabilities. (USJFCOM has been approved for disestablishment. Currently the training function residing at USJFCOM will move under the J–7,



## How the Army Runs

Joint Staff. The decision to transfer the operational and command functions residing at USJFCOM have not yet been formalized or approved when this chapter was written.)

(2) U.S. Central Command's (USCENTCOM) area of responsibility includes 25 culturally and economically diverse nations located throughout the Horn of Africa, South and Central Asia, and Northern Red Sea regions, as well as the Arabian Peninsula. It includes the countries of Egypt, Iraq and Afghanistan.

(3) U.S. European Command (USEUCOM) is responsible for the U.S. contribution to North Atlantic Treaty Organization (NATO) and for commanding U.S. forces assigned to Europe. Its area of responsibility includes six countries that belonged to the former Soviet Union as well as portions of the Middle East. The Command USEUCOM is also Supreme Allied Commander, Europe (SACEUR), a major NATO commander, and as such is responsible for the defense of Allied Command Europe.

(4) U.S. Pacific Command (USPACOM) is responsible for defense of the United States from attacks through the Pacific Ocean, and for U.S. defense interests in the Pacific, Far East, South Asia, Southeast Asia, and the Indian Ocean.

(5) U.S. Special Operations Command (USSOCOM) is responsible to lead, plan, synchronize and as directed execute global operations against terrorist networks. USSOCOM trains, organizes, equips and deploys combat ready special operations forces to combatant commands. It executes and exercises COCOM of all CONUS-based special operations forces (SOF). Major units include: Army Special Forces, Rangers, special operations aviation, PSYOP, and CA units; Navy sea-air-land teams (SEALs) and special boat units; and Air Force special operations squadrons. USSOCOM is unique in that it is responsible for planning, programming, and budgeting for Major Force Program 11, Special Operations Forces.

(6) U.S. Southern Command (USSOUTHCOM) area of responsibility includes the landmass of Latin America south of Mexico; the waters adjacent to Central and South America; the Caribbean Sea, its 12 island nations and European territories; the Gulf of Mexico; and a portion of the Atlantic Ocean. It encompasses 32 countries (19 in Central and South America and 12 in the Caribbean) and covers about 15.6 million square miles.

(7) U.S. Transportation Command (USTRANSCOM) is responsible for providing global air, land, and sea transportation to deploy, employ, and sustain military forces to meet national security objectives in peace and war. Its component commands are the Air Mobility Command (AMC), the Military Sealift Command (MSC), and the Military Traffic Management Command (MTMC).

(8) U.S. Strategic Command (USSTRATCOM) is responsible to provide global deterrence capabilities and synchronize regional combating weapons of mass destruction plans. It enables decisive global kinetic and non-kinetic combat effects to include nuclear and information operations in support of US Joint Force Commander operations and provides: integrated surveillance and reconnaissance; space and global strike operations; integrated missile defense; cyber space security, and robust command and control.

(9) U.S. Northern Command's (USNORTHCOM) is responsible to conduct operations to deter, prevent, and defeat threats and aggression aimed at the United States; its territories and interests within the assigned area of responsibility; and as directed by the President or SecDef, provide defense support to civil authorities including consequence management operations. USNORTHCOM plans, organizes, and executes homeland defense and civil support missions, but has few permanently assigned forces. The command will be assigned forces whenever necessary to execute missions as ordered by the President and SecDef.

(10) U.S. Africa Command (AFRICOM): The guidance to establish AFRICOM was provided in February 2007 and the general area of operation will be African continent that was under the three Combatant Commands of EUCOM, CENTCOM and PACOM. Their mission, which was approved by the Secretary of Defense in May 2008, was defined as "in concert with other U.S. government agencies and international partners, conducts sustained security engagement through military-to-military programs, military-sponsored activities, and other military operations as directed to promote a stable and secure African environment in support of U.S. foreign policy."

### 4-18. Relationship of the CJCS to Combatant Commands

The US Code Title 10 specifies that the Secretary of Defense may assign to the CJCS responsibility for assisting him with his command responsibilities. In further identifying that subject to the Secretary, the CJCS can also serve as the spokesman for the Combatant Commands. In addition, the President may direct that communications between the Combatant Command Commanders and the President or Secretary be transmitted through the CJCS. This places the CJCS in a unique and pivotal position. However, this does not confer command authority on the CJCS, and does not alter the responsibilities of the Combatant Command Commanders. Subject to the direction of the President, a Combatant Command Commanders: performs duties under the authority, direction, and control of the President and Secretary; and responds directly to the President and Secretary for the preparedness of the command to carry out missions assigned to the command. These broad responsibilities of the Combatant Commands are also specified in US Code Title 10.

## Section V Summary and References

### 4–19. Summary

Joint strategic planning is conducted under the direction of the CJCS in consultation with the Services, Combatant Commands, and the Secretary of Defense.

*a.* The JSPS is oriented toward identifying and evaluating the threats facing the nation and looking at the ever changing strategic environment. It provides the basis for formulating the nation's military strategy and helps in defining resource needs in terms of capabilities, forces, and materiel. It accomplished this an overall integrated and comprehensive assess, advise and direct framework that has specific documents and processes.

*b.* The PPBE focuses resource allocation, making it more dollar and manpower oriented. The PPBE is concerned with the amount and direction of those resources necessary to provide the capabilities required to execute the planning guidance identified by the DPPG as well as the strategy outlined in the National Defense Strategy and guidance articulated in the QDR while considering risk.

*c.* The JSPS, JROC, and Capabilities Based Assessments process impact the PPBE starting with the planning phase by providing broad strategy advice contained the NMS, more specific advice in the CPR, and through the programming phase by assessing the Services and certain Defense Agency programs and budgets with the CPA.

*d.* The JSPS, based on the GEF, directs the development of strategic plans through the JSCP. The JSCP requires that plans be completed to accomplish tasked missions within available resources. The Combatant Commands are the organizations that develop the various JSCP directed plans. The JSCP is the JSPS document that starts the deliberate planning process while being a formal link between JSPS and JOPES.

*e.* The details of planning change constantly to include some parts of the systems and processes just examined. However, the overall process includes the following: identifying the capabilities required; assessing various threats to include asymmetric and hybrid threats; developing a military strategy; structuring forces and determining capabilities to support the strategy; providing resources for priority requirements; and planning for the deployment of those forces to meet contingencies. These responsibilities are essentially a requirement from year to year, with both a near, mid and long term focus depending on the operational and strategic challenges.

*f.* Capabilities' planning is not a precise activity, even though the resulting force levels to execute some of these capabilities are stated precisely in terms of brigades, air wings, carrier battle groups, and the like. There are many challenges involved in capabilities planning and the resultant analyses to determine force structure, as well as the risks inherent with a particular force level. All of this requires senior leader judgment integrating many different perspectives. Throughout all of these processes, the Army has developed internal processes and organizational structures, which will be covered in later chapters, to ensure the Army fully contributes to all these processes and the subsequent products.

### 4–20. References

- a.* National Security Strategy of the United States of America 2010 May 2010.
- b.* National Defense Strategy, June 2008.
- c.* National Military Strategy of the United States of America 2011, February 2011.
- d.* Quadrennial Defense Review 2010, February 2010.
- e.* Joint Publication 0–2, Unified Action Armed Forces (UNAAF).
- f.* Joint Publication 5–0, Doctrine for Planning Joint Operations.
- g.* CJCS Instruction 3100.01B, Joint Strategic Planning System, Dec 2008.
- h.* CJCS Instruction 3137.01D, The Functional Capabilities Board Process
- i.* CJCS Instruction 3170.01G, Joint Capabilities Integration and Development System.
- j.* CJCS Instruction 5123.01E, Charter of the Joint Requirements Oversight Council.
- k.* Army Regulation 1–1, Planning, Programming, Budgeting, and Execution System.
- l.* Joint Forces Staff College (JFSC) Pub 1, The Joint Staff Officer's Guide 2000.
- m.* Global Force Management Guidance Implementation Guidance 2010–20, Jan 2010.
- n.* Adaptive Planning Road Map II 2008, March 2008.

RESERVED

## Chapter 5

### Army Force Development

“Institutions, all institutions, just have a historical tendency to evolve slowly, if at all. That’s especially true when you don’t give them the construct and structure to make those changes.” Quote from Hon. John McHugh, Secretary of the Army October 25<sup>th</sup>, 2010, AUSA Keynote Remarks

#### Section I Introduction

##### 5–1. Force development overview

Force development starts with the operational capabilities desired of the Army as specified in national strategies and guidance such as the Quadrennial Defense Review (QDR), National Defense Strategy (NDS), Guidance for Employment of the Force (GEF), Defense Planning and Programming Guidance (DPPG), the National Military Strategy (NMS), and the Army Strategy as well as the needs of the Combatant Commanders (CCDRs). Strategic guidance identifies the range of military operations that the U.S. expects its military forces to perform, the effects they must achieve, the attributes those forces must possess, where they must operate, and generally what kind and what size of force is expected to execute those operations. Strategic guidance informs the development of the contemporary operational environment (COE) and future joint operational environments (JOE). These visualizations of the operational environment (OE) describe the composite of conditions, circumstances, and influences that affect commanders’ decisions on the employment of military capabilities. The JOE provides the framework for the development of more specific concepts that are intended to accomplish the strategic objectives and decisively prevail within the JOE. These concepts, in turn, provide a visualization of how joint and Army forces will operate 10–20 years in the future, describe the capabilities required to carry out the range of military operations against adversaries in the expected OE, and how a commander, using military art and science, might employ these capabilities to achieve desired effects and objectives. Concepts consist of future capability descriptions within a proposed projection of future military operations. Each concept describes the operational challenges, the components of potential solutions, and how those components work together to solve those challenges. The force development process then determines Army doctrinal, organizational, training, materiel, leadership and education, personnel, and facility (DOTMLPF) capabilities-based requirements and produces plans and programs that, when executed through force integration activities, brings together people and equipment and forms them into operational organizations with the desired capabilities for the combatant commanders. Force development uses a phased process to develop operational and organizational plans, and then combines them with technologies, materiel, manpower, and limited resources to eventually produce combat capability. The force development process interfaces and interacts with the Joint Strategic Planning System (JSPS), the materiel systems acquisition management process, the Joint Operations Planning and Execution System (JOPES) (see para 6–3) and the DOD Planning, Programming, Budgeting and Execution (PPBE) process.

##### 5–2. Force development process summary

*a.* This chapter explains the Army force development process (Figure 5–1). Force development initiates the organizational life cycle of the Army, and is the underlying basis for all other functions. It is a process that defines military capabilities, designs force structures to provide these capabilities, and produces plans and programs that, when executed through force integration activities, translate organizational concepts based on doctrine, technologies, materiel, manpower requirements, and limited resources into a trained and ready Army. The five-phased process includes:

- (1) Develop capabilities.
- (2) Design organizations.
- (3) Develop organizational models.
- (4) Determine organizational authorizations.
- (5) Document organizational authorizations.

*b.* The Army force management chart (Figure 2–2 at the end of this book) displays a schematic framework of the force development sub-processes as part of the force management process. The Army force management chart depicts how each process or system relates to others and contributes to the accomplishment of the overall process. The following sections will explain the phases of force development in detail.

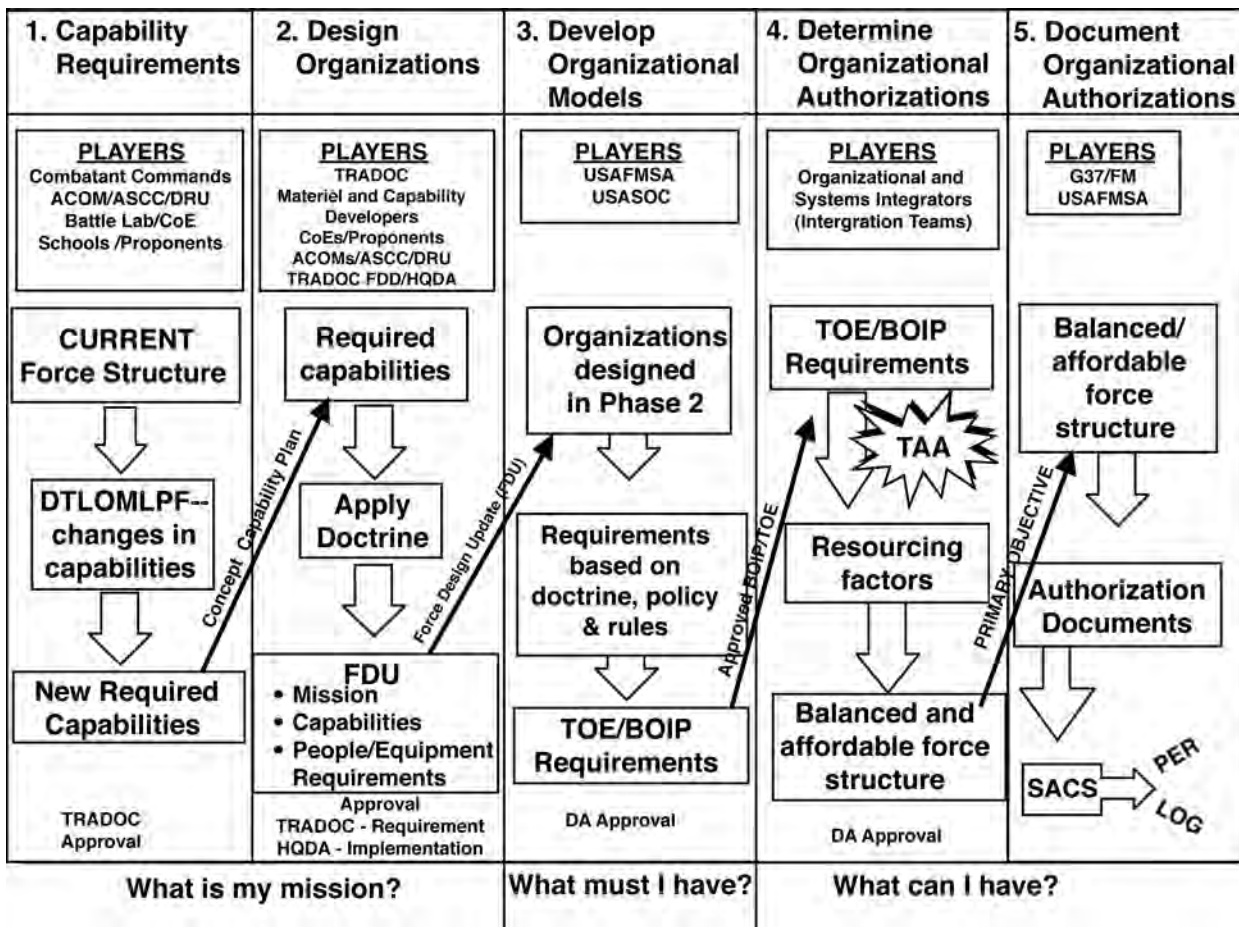

Figure 5-1. Force development process

**Section II**

**Phase I-Develop capability requirements**

**5-3. Joint capabilities integration and development system (JCIDS)**

a. The JCIDS, the Defense Acquisition Management System (DAS), and the Planning, Programming, Budgeting, and Execution (PPBE) process form the DOD’s three principal decision support processes for transforming the military forces to support the NDS. The procedures established in JCIDS support the Chairman, Joint Chiefs of Staff (CJCS) and the Joint Requirements Oversight Council (JROC) in advising the Secretary of Defense (SECDEF) in identifying, assessing, and prioritizing joint military capabilities-based requirements (needs).

b. JCIDS is a need driven joint capabilities-based requirements generation process. The objective is to develop a balanced and synchronized doctrine, organization, training, materiel, leadership and education, personnel, and facilities (DOTMLPF) solution approach proposal that is affordable, militarily useful, supportable by outside agencies, and based on mature technology that is demonstrated in a relevant operational or laboratory environment. JCIDS implements an integrated, collaborative process, based on top-level strategic direction, to guide development of new capabilities through changes in DOTMLPF. Change recommendations are developed and evaluated in consideration of how to optimize the joint force’s ability to operate as an integrated force. This integrated, collaborative approach requires a process that uses joint/services concepts and integrated architectures to identify prioritized high risk capability gaps and integrated joint DOTMLPF and policy approaches (materiel and non-materiel) to resolve those gaps. See para 5-6b below.

**5-4. Army implementation of JCIDS overview**

a. Capabilities-based requirements generation begins the Army force development process. Army CIDS develops an integrated set of Army DOTMLPF requirements that support national strategic guidance, The Army Plan (TAP) and

operational needs of the combatant commands. This process assesses future joint and Army warfighting concepts in the context of the future joint operating environment (JOE) to identify functional needs and solutions. The JOE describes the physical, demographic, political, economic, technological and military conditions in which the Army will operate during the next two decades.

*b.* The Army begins the JCIDS process with the development of an Army concept framework (ACF), Army capstone concept (ACC), Army operating concept (AOC), Army functional concepts (AFCs), and concepts directed by CG, TRADOC. These concepts provide a conceptual foundation for conducting capabilities based assessment (CBA) of the ability of our current force to meet the future operational challenges. Properly applied, Army CIDS produces an integrated set of DOTMLPF and policy solution approaches that collectively provide the required capabilities (RCs). As it is grounded in joint/Army concepts, the Army CIDS provides traceability of all Army system and non-system solutions back to overarching national strategic guidance.

*c.* The CBA identifies and documents capability gaps; determines the attributes of a capability or combination of capabilities that would resolve the gaps; and identifies non-materiel and/or materiel approaches for possible implementation. As a result, the concepts-centric Army CIDS process is a robust analysis of warfighting capabilities required to prevail in the future operational environment. This process helps ensure the Army considers the most effective joint force capabilities and the integration of those capabilities early in the process. Appropriate component, cross-component, and interagency expertise; S&T community initiatives; wargaming and experimentation results are considered in the development of DOTMLPF and policy solutions. See para 5–7.

*d.* Joint/Army CIDS documentation - initial capabilities document (ICD), capability development document (CDD), capability production document (CPD), and the DOTMLPF change recommendation (DCR) - provides the formal communication of DOTMLPF between the user and the acquisition, test and evaluation, and resource management communities. Capability documents are discussed in detail in chapter 11.

### **5–5. Standing integrated capabilities development teams (ICDTs)**

*a.* Standing ICDTs are a gathering of multi-disciplined personnel, formally chartered by the Director, TRADOC Army Capabilities Integration Center (ARCIC), to prioritize, integrate, and synchronize all DOTMLPF requirements within their assigned portfolio and those interdependent capabilities requiring integration across other TRADOC functional and/or organizational portfolios. A “portfolio” includes all solutions across the DOTMLPF within assigned Army warfighting functions (WFF) and organizations.

*b.* The Director ARCIC chartered six Center of Excellence (CoE) standing ICDTs to conduct a complete warfighting functional portfolio review on a biennial basis to support the Army Force Generation (ARFORGEN) process and products. Portfolio reviews include: conducting and/or updating the assigned WFF CBA that addresses the RCs delineated in the assigned AFC (and any other applicable concepts); identification, risk assessment, and prioritization of gaps in all DOTMLPF domains; and proposing mitigating solutions across DOTMLPF for those gaps considered to have unacceptable risk. These reviews are resource-informed, integration-focused, and outcome-based (RIO) and address the full scope of assigned warfighting functions and solutions to include an assessment of all approved programs of record (PORs) and fielded systems. The assigned CoE will also be responsible for conducting DOTMLPF assessments, integration and synchronization for their designated organizational structures (e.g., Fires Brigade).

*c.* The ICDT membership and participants vary, depending on the specific product; however, core membership always includes representation across the DOTMLPF domains. The ICDT charter identifies the membership, the participating organizations, and the expected deliverables. While industry and academia are not members of the ICDT, their input is a key to the process risks the Army may face and what it might cost.

*d.* The six WFF standing ICDTs are:

- (1) Fires WFF - U. S. Army Fires CoE, Fort Sill, OK.
- (2) Intelligence WFF - U. S. Army Intelligence CoE, Fort Huachuca, AZ.
- (3) Mission Command WFF - U. S. Army Combined Arms Center, Mission Command CoE, Fort Leavenworth, KS.
- (4) Movement and Maneuver WFF - U. S. Army Maneuver CoE, Fort Benning, GA.
- (5) Protection WFF - U. S. Army Maneuver Support CoE, Fort Leonard Wood, MO.
- (6) Sustainment WFF - U. S. Army Combined Arms Support Command CoE, Fort Lee, VA.

### **5–6. Concept development and experimentation (CD&E)**

CD&E is a campaign of learning supporting current and future force development through a two-path approach - concept development and prototyping. Concepts, developed and refined through wargames and experiments, are the basis for determining the capabilities required for the future force.

*a.* Concepts. Concepts are the centerpiece of the CD&E process. An operational concept is a generalized visualization of operations. It describes a problem to be solved, the components of the solution to that problem, and the interaction of those components in solving the problem.

(1) Concepts serve as the foundation for architecture development and for generating capabilities-based DOTMLPF solutions - doctrine (fundamental warfighting principles and tactics, techniques, procedures (TTPs)) development, organizational design changes, training initiatives, materiel solutions, leadership and education requirements, personnel

## How the Army Runs

solutions, and facilities renovation/design - through an evolutionary development process that results in enhanced capabilities at the unit level.

(2) Components of an operational concept include a description of the JOE and its associated range of operational challenges, a set of concepts that address the “how to” of countering and overcoming the challenges posed, and a corresponding set of RCs and initial force design principles needed to implement the concept.

*b. Joint/Army concept development.* Fundamental ideas about future concepts of military operations and their associated capabilities are documented in operational concepts. The translation of concepts into capabilities is an iterative process. To maximize their future utility, concepts are broadly based and encompass both the art and science of future warfighting, continually refined through wargaming, experimentation, assessment, and analysis.

(1) The family of joint operations concepts (JOpsC) consists of a capstone concept for joint operations (CCJO), and supporting joint operating concepts (JOCs) and joint integrating concepts (JICs). These concepts address the period from just beyond the Future Years Defense Program (FYDP) out to 20 years. The NSS, NDS, Unified Command Plan (UCP), Defense Planning and Programming Guidance (DPPG), and Quadrennial Defense Review (QDR) provide top-level strategic guidance for JOpsC development and are the impetus for deriving capabilities needed to shape the joint force.

*(a) Capstone concept for joint operations (CCJO).* The CCJO is the overarching concept of the JOpsC that guides the development of future joint capabilities. The purpose of the CCJO is to lead force development and employment primarily by providing a broad description of how the future joint force will operate. Service concepts and subordinate JOCs and JICs expand on the CCJO solution. The CCJO broadly describes how future joint forces are expected to operate across the range of military operations 8–20 years in the future in support of strategic objectives. The CCJO briefly describes the environment and military problem expected to exist in 8–20 years. It proposes a solution to meet challenges across the range of military operations and describes key characteristics of the future joint force. The CCJO concludes by presenting risks and implications associated with the concept. The CCJO is approved by the SECDEF and CJCS.

*(b) Joint operating concepts (JOCs).* A JOC applies the CCJO solution to describe how a future joint force commander, 8–20 years in the future, is expected to conduct operations within a military campaign, linking end states, objectives and effects. It identifies the broad capabilities considered essential for implementing the concept. JOCs provide the operational context for JIC development. There are currently six approved JOCs: Major Combat Operations, Homeland Defense and Civil Support, Deterrence Operations, Military Support to Stabilization Security, Transition, and Reconstruction Operations (SSTRO), Irregular Warfare, and Cooperative Security and Engagement. The JOCs are approved by the SECDEF and CJCS.

*(c) Joint integrating concepts (JICs).* A JIC is an operational-level description of how a joint force commander, 8–20 years in the future, will perform a specific operation or function derived from JOCs. JICs are narrowly scoped to identify, describe, and apply specific capabilities, decomposing them into the fundamental tasks, conditions, and standards required to conduct a JCIDS capabilities-based assessment (CBA). Additionally, a JIC contains an illustrative vignette to facilitate understanding of the concept. To date, 16 JICs have been developed and approved by the JROC (e.g., Global Strike; Joint Logistics Distribution; Joint Mission Command; Seabasing; Integrated Air and Missile Defense; Joint Undersea Superiority; and Joint Forcible Entry Operations).

(2) Army concept framework (ACF). The Army documents its fundamental ideas about future joint operations in the ACF, promulgated in TRADOC 525-series pamphlets. The ACF family of concepts consists of a capstone concept, an Army operating concept (AOC), Army functional concepts (AFCs), and concepts directed by CG, TRADOC. Concepts facilitate the visualization and communication of the Army’s key ideas on future operations. The ACF is at figure 5–2.

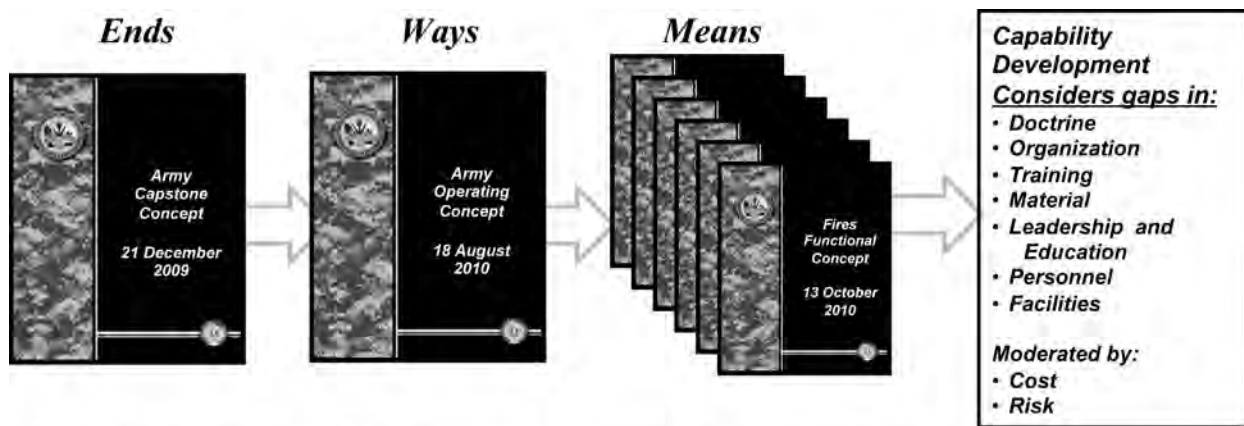

- **The Army determines its required capabilities starting with warfighting concepts**
- **Current concept work focused on 2016-2028; refined every two years**
- **The Army organizes its warfighting concepts through warfighting functions:**
  - **Mission Command**
  - **Intelligence**
  - **Movement and Maneuver**
  - **Fires**
  - **Protection**
  - **Sustainment**
- **Additional Army concepts address the Human Dimension, Learning, and Training**

Figure 5-2. Army concept framework (ACF)

(a) The Army Capstone Concept (ACC), Operational Adaptability: Operating under Conditions of Uncertainty and Complexity in an Era of Persistent Conflict, documented in TP 525-3-0, is a foundational document that provides a description of future armed conflict and how the Army will conduct future joint land operations. It provides a common framework to help Army leaders think about future war and to guide Army force development and modernization. The ACC describes the broad capabilities the Army will require in 2016-2028 to overcome a combination of adaptive enemies and challenging missions within complex operational environments across the spectrum of conflict in order to facilitate the achievement of national objectives. The purpose of the ACC is to articulate clear ideas to enlighten thinking about future conflict within an uncertain and complex environment. Within the ACF, this concept is the baseline of a campaign of experimentation and analysis which will test these ideas. The ACC is the unifying framework for developing the AOC, AFCs, and integrated architectures.

(b) The Army operating concept (AOC), documented in TP 525-3-1, provides a generalized visualization of operations across the range of military operations. The AOC describes the Army's contribution to national security within the context of joint operations. It focuses on the operational and tactical levels of war and explains how the Army, 6-18 years in the future, employs combined arms maneuver and wide area security as part of full-spectrum operations to accomplish military missions on land. By addressing these operations in a way that illustrates how the Army integrates its warfighting functions, the AOC provides a conceptual framework for the development of subordinate Army functional concepts. The functional concepts, in turn, contain more specific explanations of how Army forces operate within each warfighting function and outline their mutual dependencies. The AOC does not include the details required to initiate the JCIDS CBA.

(c) The Army functional concepts (AFCs) describe how the Army force will perform a particular military function across the full range of military operations 6-18 years in the future. AFCs support the capstone concept and the AOC, as well as joint concepts, and draw operational context from those documents. Organized along the lines of the classic functions of a military force, the 6 AFCs are Fires, Intelligence, Mission Command, Movement and Maneuver, Protection, and Sustainment. As an integrated suite of concepts, they describe the full range of land combat functions across the range of military operations. AFCs may include the details required to initiate the JCIDS CBA.

(d) Three additional concepts devoted to learning, training, and the human dimension round out the ACF. The Army learning concept describes the learning model required by the future Army to develop adaptive, thinking Soldiers and leaders. The Army training concept outlines the requirements and capabilities of the future force to generate and sustain trained and capable units. TP 525-3-7 outlines how the Army will develop the cognitive, physical, and social



## How the Army Runs

components of every Soldier to operate within the Army in full-spectrum operations. Collectively, the ACF defines the Army's vision of how it will operate in the future and provides the conceptual framework needed to determine the capabilities required across the Army to ensure future force effectiveness.

c. Concept of operations (CONOPS). A CONOPS is a verbal or graphic statement, in broad outline, of a commander's assumptions or intent in regard to an operation or series of operations. It is designed to give an overall picture of the operation and provides a useful visualization of how a future operation would be conducted. It is frequently embodied in campaign and/or operational plans; in the latter case, particularly when the plans cover a series of connected operations to be carried out simultaneously or in succession. When used in concept development, it is a tool to help describe how a particular operation is conducted in the future.

(1) For JOpsC and ACF families of concepts, CONOPS provide the overall understanding of an operation and the broad flow of tasks assigned to subordinate/supporting entities. It presents the joint force or land component commander's plan that maps capabilities to effects to accomplish the mission for a specific scenario 8 to 20 years into the future. CONOPS focus on describing the end-to-end streams of activities and how the commander might organize and employ forces to accomplish those activities.

(2) The following two types of CONOPS may be used in the JOpsC and ACF families' concept development process:

(a) Illustrative vignettes provide operational context to describe how a joint force commander might organize and employ forces 8 to 20 years into the future. These vignettes are used to clarify and increase understanding of the concepts.

(b) Defense planning scenarios (DPS) and Army scenarios (based on DPS) are written, 8 to 20 years into the future, in order to facilitate experimentation and CBA under JCIDS. These scenarios have classified CONOPS that provide a high level of specificity and defined parameters to aid in robust analysis of capabilities, and a comparison of alternate solutions.

(3) For near-term requirements, CONOPS have a different use. They are written to describe how a joint force and/or Army commander may organize and employ forces now through 7 years into the future in order to solve a current or emerging military problem. These CONOPS provide the operational context needed to examine and validate current capabilities and examine new and/or proposed capabilities required to solve a current or emerging problem. There is no strict format for a CONOPS used to support capabilities development, but it should cover the following areas at a minimum: the problem being addressed, the mission, the commander's intent, an operational overview, functions or effects to be carried out/achieved, and the roles and responsibilities of affected organizations.

d. Force operating capabilities (FOCs).

(1) The TRADOC ARCIC establishes required FOCs as the foundation upon which to base the JCIDS CBA process. These critical, force-level, measurable statements of operational RC frame how the Army will realize future force operations as stated in the approved capstone, operating and functional warfighting concepts. The FOCs help focus the Army's Science and Technology Master Plan (ASTMP) and warfighting concepts development and experimentation (CD&E) efforts. All warfighting capabilities-based requirements must have direct linkage through an FOC to an approved Army concept (capstone, operating, and functional) and the TAP. FOCs are listed biannually in TRADOC Pamphlet 525-66.

(2) TRADOC Pamphlet 525-66 also guides independent research & development (IR&D) efforts. By providing the private sector an unclassified, descriptive list of desired FOCs, the Army is able to tap into a wealth of information and new ideas on different means to achieve those capabilities. The Army encourages industry to share these ideas with the appropriate capability developer (CAPDEV) and training developer (TNGDEV) organizations.

e. Experimentation. Experimentation is the heart of joint/Army's capabilities integration and development system (CIDS). Experimentation explores warfighting concepts to identify joint and Army DOTMLPF change recommendations and capabilities needs. It provides insight and understanding of the concepts and capabilities that are possible given the maturity of specific technologies and capabilities that need additional research and development emphasis. The results of joint/Army experimentation help define the art of the possible and support the identification of DOTMLPF solutions to provide new capabilities. Progressive and iterative mixes of high fidelity live, virtual, constructive (LVC) and simulations using real Soldiers and units in relevant, tactically competitive scenarios provide joint/Army leaders with FOC insights. Warfighting experiments are conducted to gain an understanding about some aspect of future warfighting. Capability insights from warfighting experiments are "way points" used to plot the future course to the future force.

(1) The U.S. Army Experimentation Plan (AEP), Annex B of the 2010-2011, ARCIC Campaign Plan (ArCP), is the Army's directed plan supporting futures development. It integrates Army concept development and experimentation (CD&E) in a coherent service/joint context to ensure the Army provides combatant commanders (COCOMs) with sustained land capabilities that are an indispensable, decisive component of the joint force. Ultimately, the goal of CD&E is to reduce risk through learning, through innovation, and through pushing the limits of the possible. The AEP is a holistic effort that inductively and deductively examines the future, supporting both current and future force development. Simply put, the AEP is about what the Army must learn, when, and how. Army experimentation is hypothesis based - the overarching hypothesis is that the future force capabilities will provide the joint force

commander a means to rapid decision-making by providing a much broader range of decisive capabilities. The AEP is about validating that hypothesis.

(2) The Army CD&E strategy spans two mutually supporting, yet distinct paths—prototyping and concept development:

(a) The prototype path satisfies critical operational needs and tests compelling technology to shape the future and spirals forward feasible future force capabilities. Prototype experiments address current force annually defined Capability Needs Analysis (CNA) capability gap areas. At any point in time, the Army is a hybrid of new and existing capabilities. Prototyping also informs the future force and supports the Army Brigade Combat Team Modernization Program (ABCTMP) by prototyping ABCTMP spinout capabilities. Spinout capabilities support development and validation of DOTMLPF products for ABCTMP spinout systems, and assist with system-of-systems (SoS) and current force integration. “Spinout” is a term developed by OSD to describe the unique method in which the ABCTMP program provides mature ABCTMP capabilities/technologies to the current force while simultaneously maintaining focus on achieving threshold and objective capabilities for the Army’s future force.

(b) The concept development path develops a concepts-based, coherently joint future force using LVC experimentation to provide actionable recommendations to reduce future force development risk. The concept development path is focused by approved foundational operational themes which contain the key ideas of Army warfighting concepts.

f. In summary, a robust CD&E program can optimize return on investment while acknowledging that there are elements of the future that cannot be planned. Conducting a deliberate and coordinated CD&E program enables transformation by ensuring some resources are allocated to prototyping emerging concepts and capabilities which, in turn, enable robust and adaptive transformation.

### **5–7. Capabilities-based assessment (CBA) process**

The Army CIDS CBA is a structured, three-phased JCIDS process. The three major phases of the JCIDS directed CBA are the functional area analysis (FAA), the functional needs analysis (FNA), and the functional solution analysis (FSA) of non-materiel and materiel approaches. The product of CBA is a materiel or non-materiel approach, with DOTMLPF solutions. In the Army, the materiel approach is articulated in a functional area strategic framework delineating a modernization roadmap that satisfies the identified needs over the desired time-frame. These strategic frameworks produce timely input to the materiel acquisition and resourcing (PPBE) processes. The results of the CBA become the basis for the ICD and/or joint DCR (Figure 5–3). In this context, the CBA results are merely a tool. Currently, the Joint Staff (JS) has streamlined the CBA process and eliminated the terms FAA, FNA, and FSA, while retaining the CBA methodology. The Army is retaining these terms.

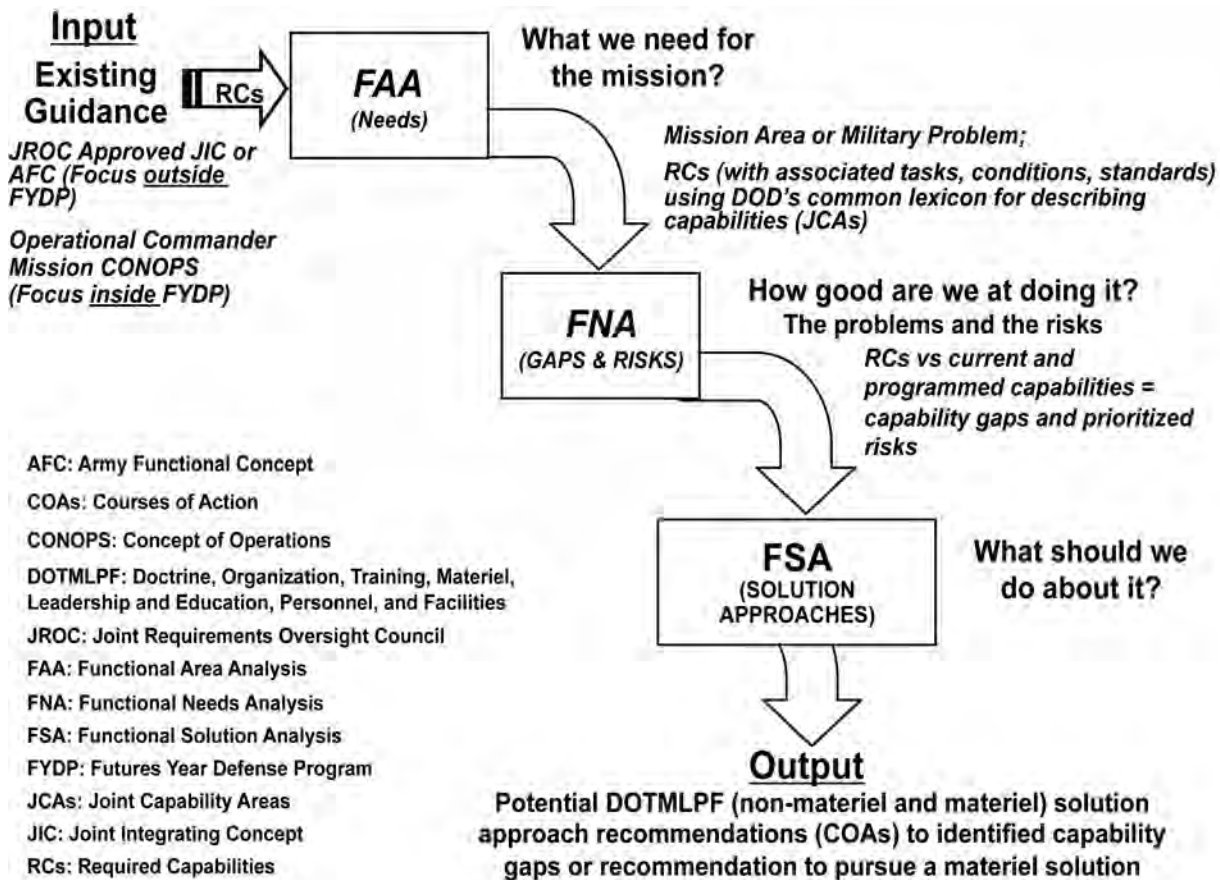

Figure 5-3. Capabilities-based assessment (CBA) process

a. Joint Operating Environment (JOE). The CBA process begins with an analysis of the JOE. This analysis describes the physical, demographic, political, economic, technological and military conditions in which the joint/Army force will operate during the next 25 years. The JOE results from an analysis of military and civilian documents, classified and unclassified, that describe future world conditions. Analyzed through the lens of professional military judgment (PMJ), the JOE serves as a basis for shaping future force operating capabilities (FOCs), previously discussed.

(1) The JOE is described in *The 2010 Joint Operating Environment (JOE)*, written by U.S. Joint Forces Command (USJFCOM), J-59, Joint Futures Group. This living document serves as the frame of reference for developing the concepts that provide a macro-level description of the future force's operational tasks and specific functional areas required in the JOE. Also, the JOE supports joint/service concept development and experimentation (CD&E) processes.

(2) The JOE reflects the analysis and assimilation of dozens of futures studies conducted by DOD, other government agencies, academia and industry, considered in relation to the *National Security Strategy (NSS)*, the *National Defense Strategy (NDS)*, and *Defense Planning and Programming Guidance (DPPG)*. Joint experimentation and exercise wargames and the Army transformation process further supplement the development and definition of the JOE. Ultimately, these studies provide the basis for detailing the Army's future force, and for its subsequent preparation for combat.

b. Functional Area Analysis (FAA). The FAA is the first analytical phase of the JCIDS-directed CBA. Strictly a capabilities-based task analysis, the FAA provides the framework to assess required capabilities (RCs) in the follow-on FNA.

(1) The input to the FAA is an approved joint integrating concept (JIC), Army functional concept (AFC) or CONOPS that describes how the force will operate, the timeframe and environment in which it must operate, its RCs (in terms of missions and effects), and its defining physical and operational characteristics. Any analysis begins with a problem statement, and the FAA must start with the military problem to be examined. From the examination of the problem statement, the FAA isolates the RCs documented in the concept, identifies those tasks that the force must perform, the conditions of task performance, and the required performance standards. The output is a list of RCs and

associated tasks and attributes. Mapped to each RC, the tasks, conditions, and standards are developed to the level required for analysis against which current and programmed capabilities will be evaluated in the follow-on FNA. Not all warfighting concepts will necessarily generate an FAA.

(2) The FAA is based on professional military knowledge of established doctrine and standards that are modified to account for the projected concept for future operations and organizations. The FAA employs operational analysis that is primarily qualitative in nature. The analysis must identify the tasks that must be performed to accomplish the mission or achieve effects, and the specific conditions (e.g., weather, terrain, threat) in which the tasks must be performed. Many of these conditions are described in the Universal Joint Task List (UJTL), but they must be adapted based upon PMJ of related operational experiences and the forecasted influence of the future environmental factors. The performance standards developed for required tasks are found in the Army Universal Task list (AUTL), UJTL, approved concepts, or may also be based on operational experience.

c. Functional Needs Analysis (FNA). The FNA is the second analytic phase in the CBA. It assesses the ability of current and programmed Army capabilities to accomplish the tasks identified in the FAA, in the manner prescribed by the concept, under the full range of operating conditions, and to the prescribed standards. The FNA will identify any gaps and overlaps in capabilities and the risk posed by those gaps. The FNA determines which tasks identified in the FAA cannot be performed, performed to standard, performed in some conditions, or performed in the manner that the concept requires using the current or programmed force; and which of these gaps in capability pose sufficient operational risk to constitute needs that require a solution. Capability needs are defined as those capability gaps determined to present unacceptable risk. Following the FNA, the Director, ARCIC will direct the CoE standing ICDT chair or proponent to proceed with an FSA for those needs considered critical to executing operations IAW the concept.

(1) The tasks, conditions, and standards identified in the FAA and a list of current and programmed capabilities are the inputs to the FNA. The initial output of the FNA is a list of all gaps in the capabilities required to execute a concept to standard. When these gaps are subjected to risk analysis, the final output is a list of prioritized gaps (needs) - capabilities for which solutions must be found or developed. Not all capability gaps will be identified as needs.

(2) In its simplest form, the FNA is a comparison of RCs to existing and programmed capabilities and the identification of the corresponding gaps. It must accurately and fairly assess current and programmed solutions' ability to provide RCs when employed in the manner and conditions called for by the AFC/CONOPS. The FNA includes supportability as an inherent part of defining the capability needs. Emphasis will be placed on defining capabilities by functional domain, describing common attributes desired of subordinate systems, family-of-systems (FoS), or system-of-systems (SoS) and non-materiel solutions. Required capabilities must address joint and coalition warfare applications. The issue of determining whether the risk posed by specific capability gaps rises to the level of need, and to decide the relative priority of competing needs is a leadership decision. The FNA must provide the Army's leadership with an understanding of the operational effect of each identified capability gap at levels ranging from the simplest functional or tactical task to tasks of potentially operational or strategic impact.

d. Functional Solution Analysis (FSA). The FSA is the third analytic phase in the CBA. It is an operationally based assessment of potential non-materiel doctrine, organization, training, leadership and education, personnel, and facilities (DOTmLPF) and policy, and/or materiel approaches to solving (or mitigating) one or more of the capability needs determined from the FNA. The FSA describes the ability of each identified approach to satisfy the need. The FNA high-risk capability gaps are inputs to the FSA. The outputs of the FSA are the potential materiel and/or non-materiel approaches to resolve the capability needs. The FSA is composed of two sub steps: ideas for non-materiel approaches (DOTmLPF analysis) and ideas for materiel approaches.

(1) Approaches proposed by an FSA must meet three criteria:

- they are strategically responsive and deliver approaches when and where they are needed;
- they are feasible with respect to policy, sustainment, personnel limitations, and technological risk;
- they are affordable — DOD could actually resource and implement the approaches within the timeframe required.

(2) Ideas for non-materiel approaches. Potential non-materiel solution approach recommendations are sometimes called DOTmLPF or DOT\_LPF. The first sub step in the FSA identifies whether a non-materiel (DOTmLPF) or integrated DOTMLPF and/or policy approach can address the capability gaps (needs) identified in the FNA. It first determines how the needed capability might be met by changes in DOTmLPF or existing materiel short of developing new systems. These include changes in quantity of existing materiel, improving existing materiel, adopting other services' materiel, or purchasing materiel from non U.S. sources. If the analysis determines that the capability can be partially or completely addressed by a purely DOTmLPF approach, a DOTMLPF change recommendation (DCR) is prepared and appropriate action is taken IAW the *JCIDS Manual*. If it is determined that DOTmLPF changes alone are inadequate and that product improvements to existing materiel, adoption of other service or interagency materiel, acquisition of foreign materiel, or a new materiel approach is required, the FSA process continues to sub step 2 below. Some capability proposals will involve combinations of DOTmLPF and policy changes and materiel changes. Also, these proposals continue through the FSA process at sub step 2.

(3) Ideas for materiel approaches. In sub step 2, materiel approaches (courses of action) are identified to provide the

## How the Army Runs

RCs. The collaborative nature of this effort is meant to develop potential solutions that are truly “born joint.” In other words, solutions that involve all services. The process brainstorms possible materiel approaches and always includes existing and future materiel programs that can be modified to meet the capability need. The DOTLPPF and policy implications of a materiel solution must always be considered throughout the process.

*e.* CBA recommendations. A CBA offers actionable recommendations for both non-materiel and materiel solution approaches.

(1) Potential non-materiel solution approach recommendations include the following:

- change policy
- change doctrine
- reorganize
- train and educate DOD personnel differently
- acquire commercial or non-developmental items
- acquire more quantities of existing items or commodities to include increases in manpower operational tempo, spare parts, and fuel supplies
- add or reassign personnel to mission areas
- move or realign facilities to support new mission areas

(2) Materiel initiatives tend to fall into three broad categories (listed in terms of fielding uncertainty from low to high):

- development and fielding of information systems (or similar technologies with high obsolescence rates) or evolution of the capabilities of existing information systems
- evolution of existing systems with significant capability improvement (this may include replacing an existing system with a newer more capable system, or simple recapitalization)
- breakout systems that differ significantly in form, function, operation, and capabilities from existing systems and offer significant improvement over current capabilities or transform how we accomplish the mission.

*f.* TRADOC ARCIC tasks a CoE standing ICDT or proponent to develop the initial DOTMLPPF capabilities document(s) - initial capabilities document (ICD) and/or joint DOTMLPPF change recommendation (DCR). When documented, TRADOC’s ARCIC submits DOTMLPPF solution sets to HQDA G-3/5/7 for ARSTAF validation and VCSA approval via the Army Requirements Oversight Council (AROC) validation and approval process (discussed later in chapter 11). Figure 5-4 illustrates some documents that might initiate resourcing for DOTMLPPF domains. This collection of possible solution approaches forms the strategic framework plan to reach the desired capability.

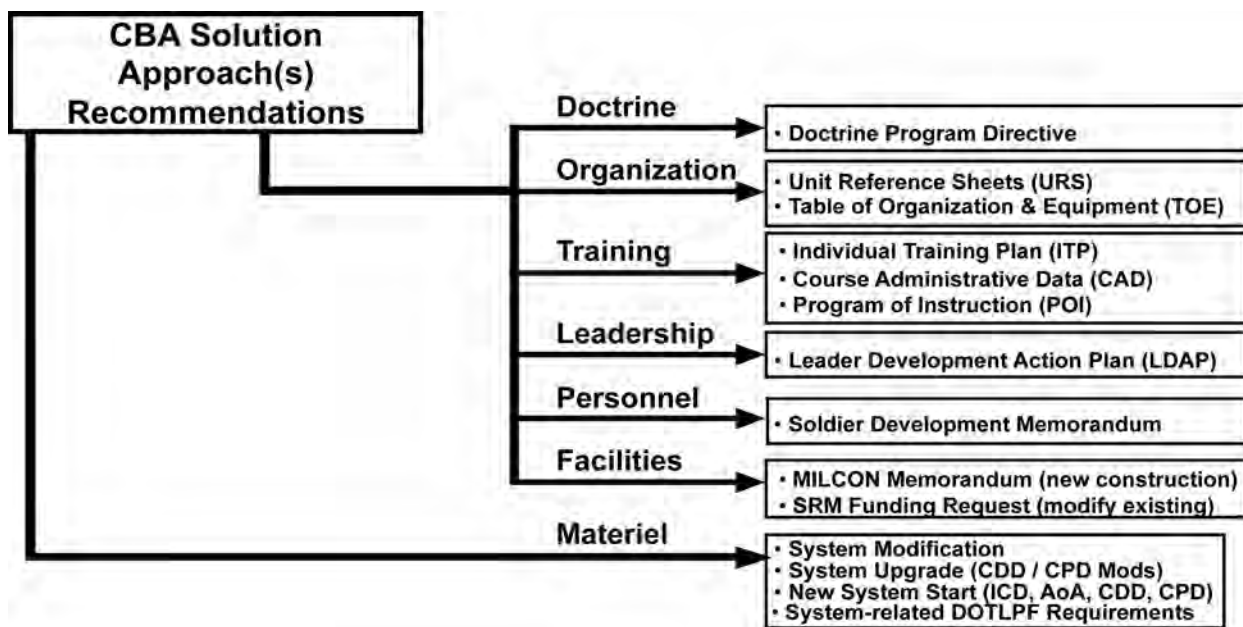

**AoA: Analysis of Alternatives**  
**CBA: Capabilities-based Assessment**  
**CDD: Capability Development Document**  
**CPD: Capability Production Document**  
**ICD: Initial Capabilities Document**  
**MILCON: Military Construction**  
**SRM: Sustainment, Restoration, and Modernization**

Figure 5-4. Solutions documents

g. Processes that may substitute for the CBA. DOD has several processes in place that can be used in lieu of a formal CBA. They are listed below:

(1) Joint Capability Technology Demonstration (JCTD). The military utility assessment (MUA), which is completed at the end of the JCTD, may be a suitable replacement for the required analysis used as the basis for ICD preparation. MUAs that do not contain the critical elements of information presented in the ICD (description of the capability gap(s); associated tasks, conditions and operational performance standards/metrics; and how the materiel and non-materiel approaches and analyses from the JCTD addressed these factors), will be augmented with a final demonstration report to qualify the results as equivalent to an ICD. The MUA/final demonstration report will be used to support the development and subsequent AROC and/or JROC approval of the CDD or CPD. A CDD or CPD, as appropriate, will be developed for the JCTD to transition into a DAS program of record (POR).

(2) Prototypes. Results of prototype projects (e.g., USJFCOM prototypes) and operationally validated quick reaction technology projects intended for direct transition to fielded capabilities may also be eligible for consideration as potential solution approaches. This consideration will be based on mission need validation and MUA processes as applied to JCTDs.

(3) Joint Improvised Explosive Device (IED) Defeat Organization (JIEDDO) Initiative Transition. The JIEDDO Transition Packet, which is completed after JIEDDO validates an initiative, may be the appropriate replacement for the required analysis used as the basis for ICD preparation. The Transition Packet will be used as the CDD/CPD equivalent document for subsequent AROC and/or JROC approval and transition to a POR.

(4) Joint Urgent Operational Needs Statement (JUONS) or service's urgent needs processes. Capabilities developed and fielded to support the resolution of an operational commander's urgent need can be transitioned into the JCIDS process. An urgent need validated by the Joint Staff J-8, or the service as appropriate, may be used to enter the JCIDS process without an ICD. The sponsor can enter the JCIDS and DAS processes at milestone B or C by initiating development of a CDD or CPD as appropriate. Capabilities fielded to resolve an urgent need which will continue to be required and sustained for the duration of an on-going operation do not require additional JCIDS documentation.

h. Overall, the capabilities-based Army CIDS process examines where we are, where we want to be, what risks we

## How the Army Runs

may face and what it might cost. The Army learned many lessons from the wars in Iraq and Afghanistan and accelerated processes used to develop the Stryker Brigade Combat Teams (SBCTs). These lessons have helped to shape the informed changes to how we generate current and future force structure requirements. Inserting an up-front and robust integrated analysis based on guidance from overarching joint and Army concepts, allows informed decisions earlier in the process, producing optimal DOTMLPF and policy solution proposals and making it easier to synchronize development and fielding. In addition, this process allows requirements to be traced back to national strategies, concepts and policies, thus helping to eliminate redundant capabilities within the Army and DOD.

### Section III

#### Phase II—Design organizations

##### 5–8. Organization design

Organizational requirements flowing from the functional solution analysis determine whether a new or modified organization is required on tomorrow's battlefield. Once identified, organizational requirements are documented through a series of connected and related organizational development processes: Unit Reference Sheet (URS) development; Force Design Update (FDU) process; Table of Organization and Equipment (TOE) development; basis-of-issue plan (BOIP) development, and Total Army Analysis (TAA). Every process may not always be required before organizational changes are made to the force structure. For instance, phase III, Development of Organizational Models, starts before the end of Phase II, Designing Organizations.

##### 5–9. The organization design process

*a.* Organizations have their beginnings in warfighting concepts and concept capability plans. They provide the conceptual basis for the proposed organization and address a unit's mission, functions, and required capabilities. The combat developers (CBTDEV) at TRADOC Centers of Excellence, the Army Medical Department Center and School (AMEDDC&S) (see Chapter 18), the U.S. Army Special Operations Command (USASOC), and the U.S. Army Space and Missile Defense Command (SMDC) develop new organizational designs or correct deficiencies in existing organizations. The Army Capabilities Integration Center (ARCIC) Director integrates and validates concepts developed for future force capabilities. These concepts normally address:

- (1) Missions, functions, capabilities, and limitations.
- (2) Mission command linkages.
- (3) Individual, collective, and leader training requirements.
- (4) Sustainment in field and garrison.
- (5) Doctrinal impacts.
- (6) Impacts on materiel programs.

*b.* The FDU is used to develop consensus within the Army on new organizations and changes to existing organizations and to obtain approval and implementation decisions (Figure 5–5). On a semi-annual basis, the FDU process addresses organizational solutions to desired capabilities and improvements to existing designs in which other doctrine, training, materiel, leader development, personnel or facilities solutions were insufficient. The FDU serves as the link between the development of the URS and the development of the TOE. During the FDU, the URS is staffed throughout the Army to include the Combatant Commanders and the Army's commands. HQDA then makes approval and implementation decisions. Force design issues will then go through a HQDA force integration functional analysis (FIFA). The FIFA reviews force structure issues and the impacts of force structure decisions.

*c.* During the FIFA, the ARSTAF analyzes the force to assess affordability, supportability, and sustainability. At the macro level, within the limits of personnel and budgetary constraints, the FIFA determines the ability for the force to be manned, trained, equipped, sustained, and stationed. The FIFA may provide alternatives based on prior initiatives, unalterable decisions from the Army leadership or program budget decisions (PBD). The FIFA can result in one of three recommendations.

- (1) HQDA can decide to implement the change and find resources.
- (2) Or HQDA can return it to the ARCIC for further analysis,
- (3) Or prioritize the issue for resourcing in the next TAA.

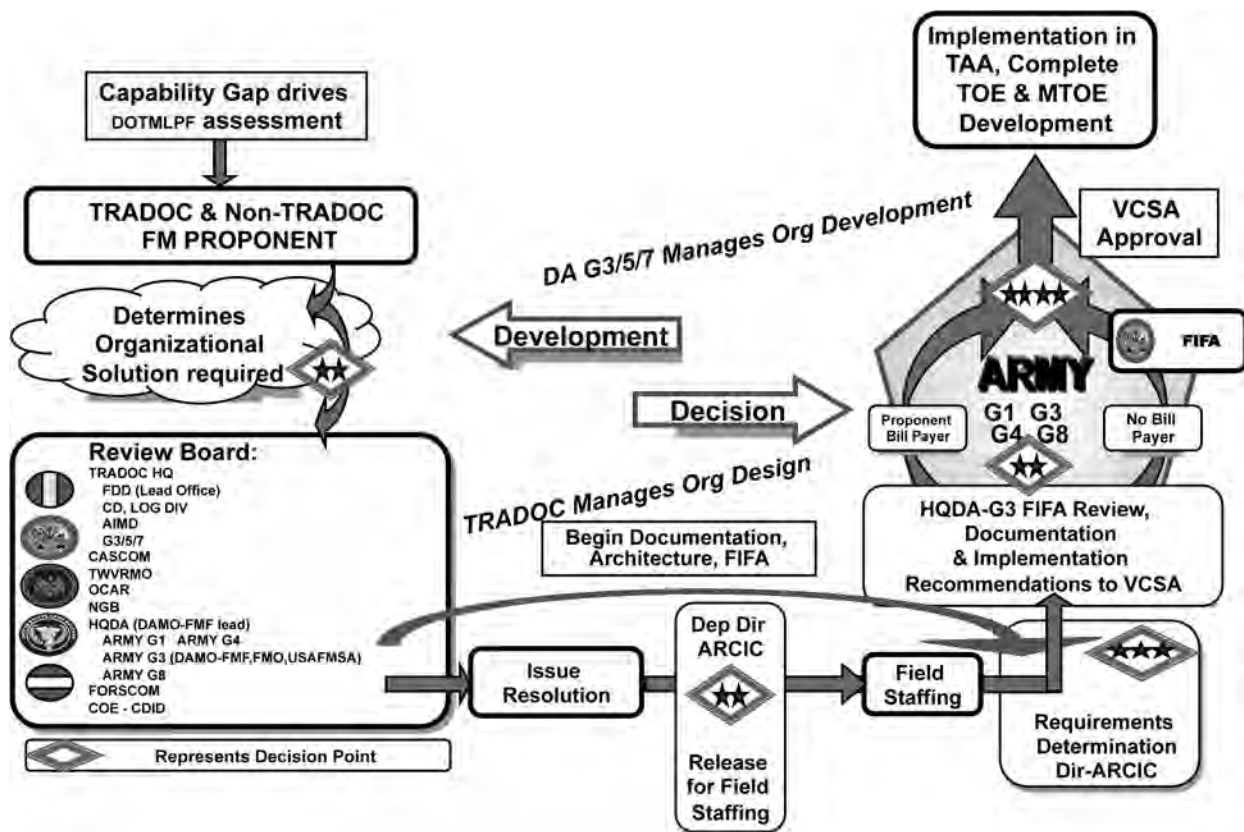

Figure 5-5. Force design update (FDU)

## Section IV

### Phase III—Develop organizational models

#### 5-10. TOE and BOIP development

a. Organizations in the process of being designed in the preceding phase become the start point for the next phase. Following the first level of approval of the URS during the FDU process, the design goes to U.S. Army Force Management Support Agency (USAFMSA) for documentation as a TOE. The USAFMSA and USASOC develop TOEs and BOIPs codifying the input from the URS basic design.

b. TOEs and BOIPs are developed using an Army-wide development system and database called the Force Management System (FMS). The Force Management System (FMS) is currently being implemented and should reach full operational capability in the next few years. FMS will eventually feature a relational database for both requirement and authorization documentation and other information management systems as well.

c. Although the organization design phase and organizational model development phase are depicted as separate processes, they are closely related and conducted very nearly concurrently. The proponent organization designers and the USAFMSA TOE developers work closely to ensure that the designs reflect requirements consistent with doctrine and policy and include all the elements necessary to provide an organization fully capable of accomplishing its doctrinal mission. The approved organization design should capture personnel and equipment requirements as accurately and completely as possible.

#### 5-11. TOE description

a. TOEs provide a standard method for documenting the organizational structure of the Army. A TOE prescribes the doctrinal mission, required structure, and mission essential wartime manpower and equipment requirements for several levels of organizational options for a particular type unit. These organizational options provide models for fielding a unit at full or reduced manpower authorizations if resource constraints so mandate. A TOE also specifies the capabilities (and limitations or dependencies) for the unit.

b. TOEs provide the basis for developing authorization documents and provide input for determining Army resource



## How the Army Runs

requirements for use by force managers. In addition, these unit models establish increments of capability for the Army to develop an effective, efficient, and combat-ready force structure.

*c.* The TOE is a collection of related records in the database. There are a variety of records to include narrative information, personnel requirements, equipment requirements, paragraph numbers and titles, and changes in the form of BOIP records to name a few. A TOE consists of base TOE (BTOE) records and related BOIP records,

*d.* Document developers construct a TOE in three levels of organization based on the manpower requirements necessary to achieve the following percentage levels: 100 percent (level 1) minimum mission essential wartime requirement (MMEWR), organization partially manned by personnel other than soldiers (level B) and cadre (level C). As TOE level 1 is the wartime requirement, it is what is reflected in the “required” column of the authorization document (MTOE) unless adjusted on the MTOE only to reflect available resources.

*e.* FDU decisions, branch proponent input, and Army commands’ issues, along with force design guidance developed during capabilities analyses, provide TOE developers with recommended TOE additions/modifications. Policy and doctrine provide the missions and probable areas of employment of a unit. Policy includes guidance, procedures, and standards, in the form of regulations, on how to develop TOEs. Policy published in Human Resources Command’s MOS Smartbook contains standards of grade (SG), duty titles, guidance for occupational identifiers (area of concentration [AOC], MOS, skill identifier, special qualification identifier (SQI), and ASIs used in the development of requirement documents and concept capability plans. Doctrine describes how each type of unit will perform its functions and details the mission and required capabilities.

*f.* TOE developers consider the unit mission and required capabilities when applying equipment utilization policies, Manpower Requirements Criteria (MARC), SG, and BOIPs to develop the proper mix of equipment and personnel for an efficient organizational structure. Resource guidance limits the development of draft TOEs, as they must use resources available in the inventory.

### 5–12. The TOE system

The Army uses a TOE system with personnel and equipment modernization over time that reflects how the Army actually conducts its organizational and force modernization business. The TOE system illustrates capability enhancements or increases to the productivity of an organizational model through the application of related doctrinally sound personnel and equipment changes in separately identifiable BOIPs. See Figure 5–6. TOE begins with a doctrinally sound BTOE and through the application of BOIPs building up to a fully modernized Objective TOE (OTOE). The TOE is the basis for force programming and becomes an authorization document (MTOE) upon HQDA approval of resources, specific unit designations, and Effective Date (EDATE) for the activation or reorganization. The TOE system consists of the following components.

*a. Base TOE.* The BTOE is an organizational model design based on doctrine and equipment currently available. It is the least modernized version of a type of organization and identifies mission-essential wartime requirements for personnel and equipment.

*b. Basis of issue plan.* A BOIP is a doctrinally sound grouping of related personnel and equipment changes that is applied to a BTOE to provide an enhanced capability, increased productivity, or modernization.

*c. Objective TOE.* The OTOE is a fully modernized; doctrinally sound organizational model design achieved by applying all DA-approved BOIPs. The OTOE sets the goal for planning and programming of the Army’s force structure and supporting acquisition systems.

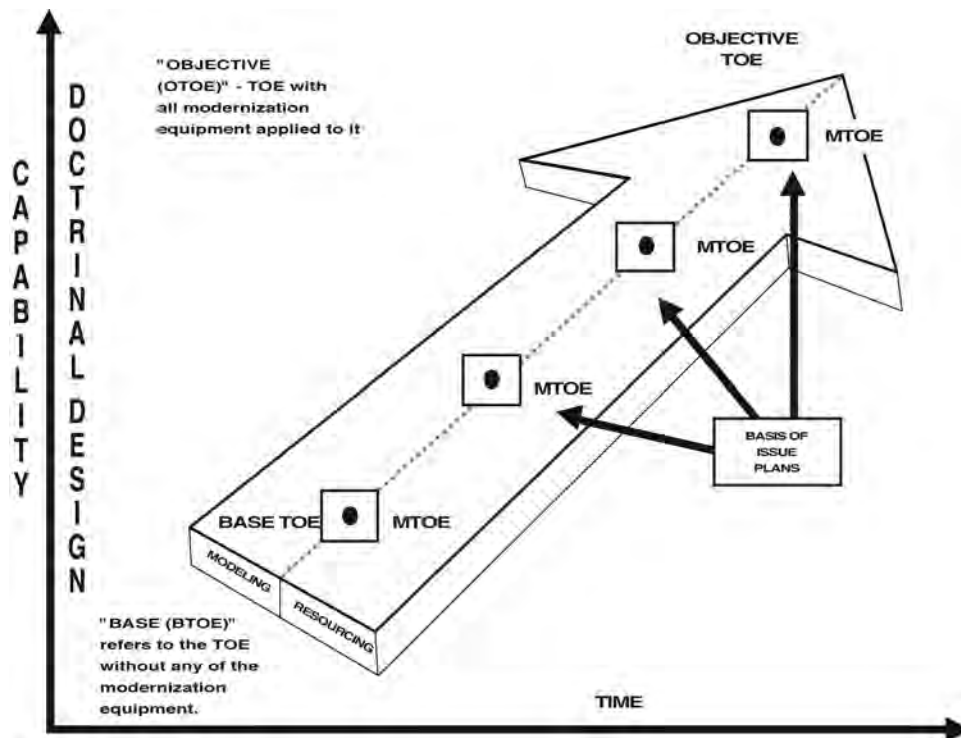

Figure 5-6. Modernization over time (Resource Driven)

### 5-13. TOE review and approval

- URSs form the basis for developing TOEs.
- A TOE in the revision, development, or staffing process and not yet DA approved is called a draft TOE (DTOE). DTOEs are reviewed by USAFMSA and coordinated with appropriate commands, agencies, and activities during an area-of-interest (AOI) review. After AOI review, USAFMSA makes final changes before the responsible G-37 (FMO) OI staffs the TOE HQDA-wide and presents the DTOE to Director, Force Management for approval. Following approval, the DTOE status is changed to "DA approved" in the FMS.
- A TOE becomes eligible for cyclic review every three years.

### 5-14. Basis-of-issue plan (BOIP)

- A BOIP specifies the planned placement of new or improved items of equipment and personnel in TOEs at 100 percent of wartime requirements. It reflects quantities of new equipment and Associated Support Items of Equipment and Personnel (ASIOEP), as well as equipment and personnel requirements that are being replaced or reduced. In addition to its use for TOE development/revision, HQDA uses it for logistics support and distribution planning for new and improved items entering the Army supply system. Materiel developers (MATDEV), Program Executive Officers (PEOs)/Program Managers (PMs), Army Materiel Command (AMC), and USASOC communities use it as input for concept studies, life cycle cost estimates, and trade-off analyses during the system development and demonstration phase of the system acquisition management process.
- A BOIP provides personnel and equipment changes required to introduce a new or modified item into Army organizations. The development of a BOIP can play an integral part in TOE development. A BOIP provides the data to place a new or substantially changed materiel item into organizations along with associated equipment and personnel to maintain and operate it as specified in the materiel capability document and the basis-of-issue feeder data (BOIPFD).
- BOIPFD, prepared by the MATDEV, contains a compilation of organizational, doctrinal, training, duty position, and personnel information that is incorporated into the BOIP. The information is used to determine the need to develop or revise military occupational specialties and to prepare plans for the personnel and training needed to operate and maintain the new or improved item. Human Resources Command (HRC) provides input to the BOIP through development of the Operator and Maintainer (O/M) decision. The BOIP process begins when the MATDEV receives an approved and resourced CDD. The project manager and/or MATDEV develop BOIPFD, and then obtain a developmental line item number (ZLIN) and Standard Study Number (SSN) from AMC.

## How the Army Runs

*d.* The BOIPFD goes to USAFMSA via the Logistic Integrated Warehouse where the information is reviewed for accuracy, continuity, and completeness before the formal development of the BOIP. During staffing, the training impacts associated with the BOIP equipment and the associated personnel requirements are developed. If the O/M decision includes an occupational identifier, the personnel proponent must prepare a proposal per AR 611-1 for submission to HRC to revise the military occupational classification and structure. USAFMSA requests TDA requirements for new or modified items from the Army's commands and TDA requirements are entered into the BOIP at unit level. Note that BOIPs are not developed for TDA-only equipment. When the BOIP is complete, it goes to DA for approval. The G-37 (FMO) organizational integration officer, in coordination with the G-8 synchronization staff officer is responsible for HQDA staffing and for presenting the BOIP to the Director, Force Management in the G-37 (FM) for approval.

*e.* There may be several iterations of the BOIP: an initial BOIP, developed during system development and demonstration, and amended BOIPs, which are based on updated information provided by the MATDEV as required. A BOIP may be amended at any time during system development and fielding, upon approval of HQDA, or when new or changed information becomes available.

## Section V

### Phase IV—Determine organizational authorizations

#### 5-15. Determining organizational authorizations

*a.* The fourth force development phase, determining organizational authorizations, provides the mix of organizations, resulting in a balanced, and affordable, force structure. Force structuring is an integral part of the OSD management systems, PPBE and the JSPS. It is the resource-sensitive process portrayed in the "Determine Authorizations" section of the Army Force Management Chart at Figure 2-2. It develops force structure in support of joint, strategic, and operational planning and Army planning, programming, and budgeting. Force structure development draws upon an understanding of the objectives, desired capabilities, and externally imposed constraints (e.g., dollars, total strength, roles, and missions). The Army has transitioned from a Division-based design to a modular design; TAA supported the transition, providing the correct number and types of units over the POM period.

*b.* The determination of the size and content of the Army force structure is an iterative, risk-benefit, trade-off analysis process, not all of which is exclusively within the purview of the Army. The national security strategies, NDS, NMS, QDR and DPPG constitute the major JCS/DOD directives and constraints imposed upon Army force structure. Overall, The Army Plan (TAP) captures Army-specific strategic and programmatic guidance.

*c.* TAP articulates the SECARMY and CSA translation of the JCS/DOD guidance to all Services into specific direction to the ARSTAF and commands for the development of the Army POM, and the initiation of the TAA process. The TAP is the principal Army guidance for development of the Army POM submission.

#### 5-16. Total Army Analysis (TAA)

*a.* TAA builds a POM Force which serves as the basis for building the POM submission. The TAA process and the POM Force identify the capabilities necessary to achieve the full spectrum of missions expected of the Army as outlined in the TAP. It takes us from the Army of today to the Army of the future. It requires a doctrinal basis and analysis, flowing from strategic guidance and joint force capability requirements. TAA has been compressed from a biennial process, initiated during even-numbered years, to an annual process. TAA determines the best mix of forces for each program year. It has Army wide participation and culminates in a Senior Leaders of the Department of the Army (SLDA) decision and approval.

*b.* The TAA principal products are the:

(1) Army's full range of demands for the Capabilities necessary to achieve the full spectrum of missions expected of the Army (unconstrained and all green suiter)

(2) Best mix of support forces (EAB support and sustainment) and identified risk

(3) Force resourced against requirements and budgetary constraints

(4) Army Structure (ARSTRUC) memorandum

(5) POM Force

*c.* TAA objectives are to:

(1) Develop, analyze, determine and justify a POM Force, aligned with the strategic guidance and TAP. The POM Force is projected to be raised, provisioned, sustained, and maintained within resources available during the FYDP.

(2) Provide analytical underpinnings for the POM Force for use in dialogue among Congress, OSD, Joint Staff, CCDRs, and the Army.

(3) Assess the impacts of planned and potential alternatives for materiel acquisition, the production base, and equipment distribution programs for the projected force structure.

(4) Assure continuity of demanded force structure within the PPBE process.

(5) Provide program basis for structuring organizational, materiel, and personnel requirements and projected authorizations.

### **5–17. The TAA process**

TAA supports the fourth force development phase by determining the mix of organizations that comprise a balanced and affordable force structure. There are typically two phases associated with TAA: Capability Demand Analysis (Requirements) and Resource Determination.

*a.* TAA is the resource sensitive process that integrates the decisions of the OSD, directives and initiatives of the Joint Staff, and Army Leadership into the PPBE process by building a force for the program years that can be used by programmers to build the Army budget.

*b.* TAA serves as the bridge between OSD/JS guidance and the Army's force structure planning and program building processes; balancing the Army's force structure demands (manpower and equipment) against available and planned resources. Decisions, as a result of the TAA process, will shape the future composition of the Army, are senior leadership-sensitive and made in the best interest of the Army. The Army's resourced force structure must support strategic guidance. Therefore, TAA develops a force that best meets guidance, within the defined scenarios, under the established resource constraints, and fulfills all the roles and missions within the parameters of congressional oversight and guidance.

*c.* Additionally, the TAA process is the means to transition force structure from the planning phase to the programming phase within the Army's PPBE process, assisting in determining, verifying and justifying Army capability demands, while assessing force capabilities. The process flows from internal Army actions, decisions and guidance (e.g., allocation rules, resource assumptions, warfighting capabilities, and infrastructure priorities), and from external inputs from the President, Secretary of Defense, CJCS, JS, OSD, and CCDR priorities (e.g., anticipated threats, scenarios, and assumptions). The Army develops the POM force to achieve an affordable force capable of best supporting national objectives and CCDR Army warfighting needs. This force supports the joint strategic planning conducted by the JS, CCDRs and the Services at the transition between planning and programming. The mix of capabilities that make up a balanced and affordable force structure must support Joint and Army planning, programming, and budgeting at the strategic, operational and tactical levels within manageable levels of risk.

*d.* The TAA process is focused on building an affordable balanced force for the program years. TAA is flexible and responsive to dynamic changes within those program years. Changes intended for the years preceding the program years can still be made using resources programmed in a previous TAA for the year of execution in question. The only limiting factor in the scope of pre-program year transformation is the availability and flexibility of resources in the year of execution budget.

*e.* Figure 5–7 depicts the sequence of activities in the TAA process. TAA is a two-phased analytical and subjective process consisting of Capability Demand Analysis (force guidance and quantitative analysis) and Resource Determination (qualitative analysis and leadership review).

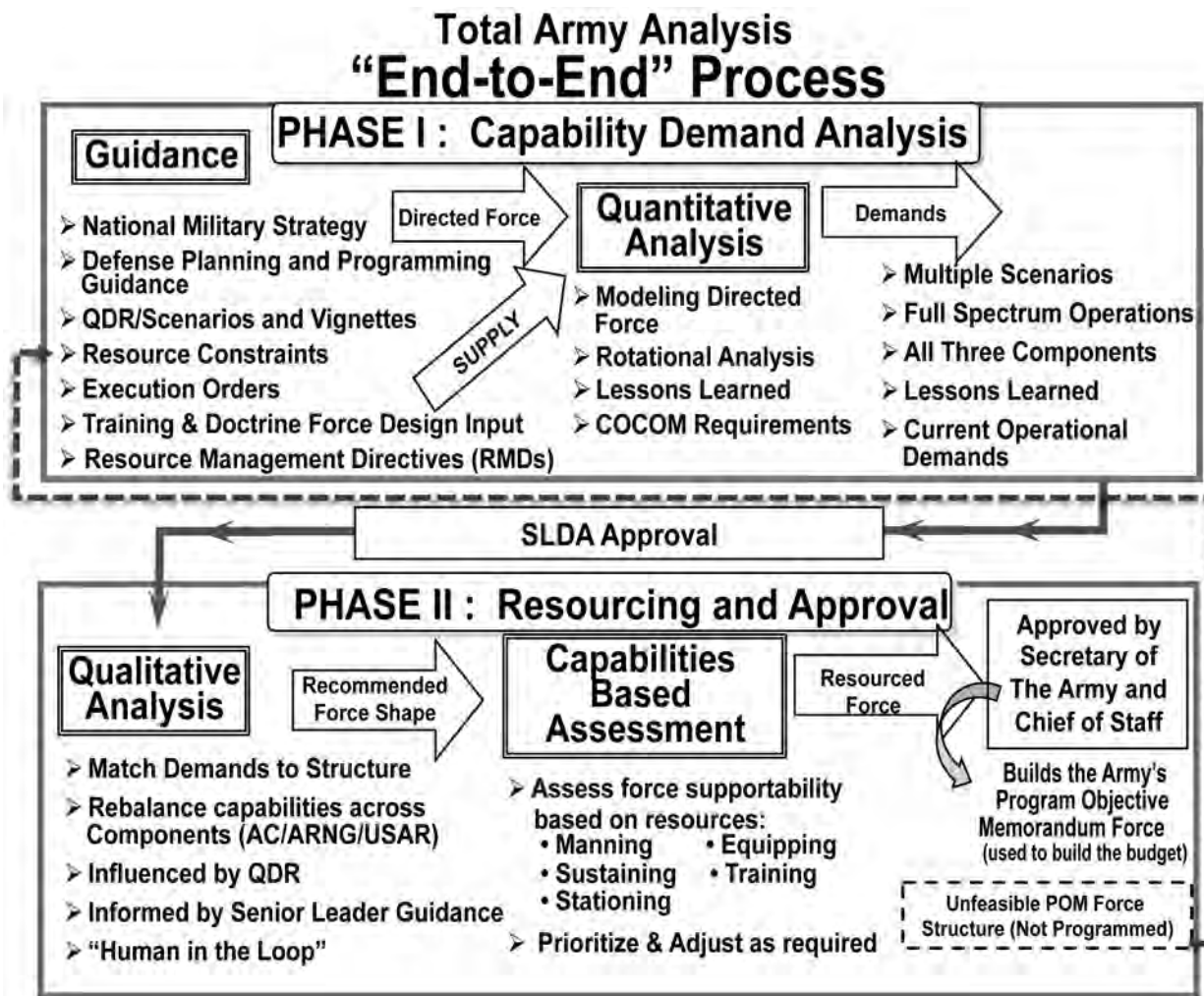

Figure 5-7. Total Army Analysis 2014 - 2018

#### 5-18. TAA Phase I-Requirements determination

TAA Phase I, the Capability Demand Analysis Phase, begins by leveraging OSD scenarios from Operational Availability (OA) series analytical work, the QDR and MSFD work to capture the Army’s directed force (maneuver, fires and effects) Operating Force (OF) requirements. The scenarios are modeled and analyzed to determine the unconstrained OF capability demand list necessary to accomplish the full spectrum of missions with “minimum risk.” Accurate planning, consumption and workload factors, threat data, and allocation rules ensure accurate computer developed demands. This unconstrained OF capability demand list will be used to help determine the best mix of forces for the Army within authorized end strength (shape); it is not intended to be used to determine the size of the Army. The unconstrained OF capability demand list will likely far exceed the capabilities resident within the authorized endstrength and the capabilities required to accomplish any one task (it is the worst case for each task to highlight all possible demands). During the Phase II, the Resourcing Phase, the determination must be made as to the level of acceptable “risk” that can be taken for each OF capability. These capability demands are based on Army leadership directives, written guidance, risk analysis, the Army Force Generation Model (ARFORGEN) and input from the Combatant Commander’s daily operational requirements (CCDOR). The purpose of TAA is to build a POM Force with which the PEGs can begin to craft their portion of the Army’s budget. The POM Force also will determine the Operating Force (OF) enabler support force structure and define the Generating Forces (GF) necessary to support and sustain the OF capabilities directed in strategic guidance. The determination of the composition of the Army force structure (shape) is an iterative, risk-benefit, trade-off analysis process. Capability Demand Analysis is made up of two separate events: force guidance and quantitative analysis.

a. *Force guidance.* Force guidance consists of data inputs and guidance from various sources.

(1) *Quadrennial Defense Review (QDR)*. QDR is a permanent requirement (every four years). The principal purposes of the QDR are to: develop strategic guidance for the DOD; lay out an agenda for developing needed future capabilities; forecast defense requirements 20 years into the future; and satisfy statutory requirements. The 2010 QDR, along with the Ballistic Missile Defense Review (BMDR) and the Nuclear Posture Review (NPR) serve as the basis for the development of the Defense Planning and Programming Guidance (DPPG).

(2) *Defense Planning and Programming Guidance (DPPG)*. The DPPG establishes the DOD force development, resource and programming priorities, and consolidates and integrates DOD force development planning and programming priorities. The DPPG is a fiscally informed policy and strategy document and a fiscally constrained programming guidance document.

(3) *The Army Plan (TAP)*. The TAP is the principal Army guidance for development of the Army POM submission. The SECARMY and CSA translate the DOD guidance into specific direction to the ARSTAF and commands for the development of the Army POM. The TAP provides the senior leadership's vision, identifies strategic vision and intent, translates vision into prioritized capabilities, links vision with capabilities and resources, and provides the synchronized road map of "how" to implement the TAP through the Army Campaign Plan (ACP). The TAP provides the OF constituting the start point for force structuring activities (shaping). DAMO-SSW and DAMO-FMF determine the specific identification, size, and composition of the OF in accordance with TAP force structure guidance.

*b. Data and guidance inputs.*

(1) *Homeland Defense (HD)*. NORTHCOM and USARPAC have the responsibility to develop and identify the missions, threats, areas of responsibility and Army force structure demands to accomplish HD/ *Homeland Defense (HD)*.

(2) *Analytic Agenda*. OSD provides the directed scenarios (one possible future) within the Analytic Agenda.

(a) Primarily focused on strategic analysis of future force capabilities (force effectiveness and sufficiency).

(b) DOD Components, to include the Army, participate in the development of products led by OSD (Policy) and the Joint Staff J8.

(c) Analytical Baselines (a package comprising a scenario, a concept of operations, and integrated data used by DOD Components as a foundation for strategic analyses).

(d) Studies (e.g., operational availability, force sufficiency).

(e) Integrated Security Campaigns (ISCs) - each ISC comprises multiple, simultaneous activities occurring over a multiyear timeframe to create one possible future; product includes Combatant Command foundational activities and scenarios, concepts of operations, and associated data for each of the major activities.

(f) Scenarios are developed for Joint/Combined warfighting at the theater level.

(g) Future force structure requirements will be generated through the QDR 2010 influenced strategy.

(h) OSD has executed several Operational Availability (OA) studies to determine mid-term warfighting scenarios or vignettes. Each OA study leverages previous efforts against the large pool of capability. Each OA study informs the Army's force planning construct.

(i) The OA studies provide the approved scenarios for DAMO-SSW and DAMO-FMF to select from for the TAA modeling.

(3) *Force sizing construct*. Guidance from OSD and the Army leadership include the force sizing guidance. The current guidance includes "persistent conflict" and ARFORGEN rotational requirements.

(4) *Foundational Activities*.

(a) Develop force requirements for COCOM activities to prevent and deter over time.

(b) Other challenges - to develop force requirements in support of a range of multiple, simultaneous operations at home & abroad (e.g., Stabilization, COIN, defeat regional aggressors(s), support to civil authorities in the U.S.).

(5) *Parameters, planning and consumption factors and assumptions*.

(a) HQDA DCS G-4, TRADOC, U.S. Army Combined Arms Support Command (CASCOM), the theater commands and other elements of the HQDA staff (G-1, G-3/5/7, G-4, G-6 and G-8) provide specific guidance, accurate and detailed consumption factors, planning factors, doctrinal requirements, unit allocation rules, network requirements, weapons and munitions data and deployment assumptions. The Center for Army Analysis (CAA) uses the parameters, factors, and assumptions to conduct the series of modeling and simulations (M&S) iterations that are analyzed to develop and define the total capability demands for logistical support necessary to sustain the combat force(s) in Homeland Defense, Army support to other Services (ASOS), Foundational Activities, each Major Combat Operation (MCO), and the GF.

(b) The parameters, factors, and assumptions contain theater-specific information concerning logistics and personnel planning, consumption and workload factors, host-nation support (HNS) offsets and other planning factors crucial to theater force development. A critical step in force guidance development is the update and revision of the planning and consumption factors and assumptions.

(6) *Allocation rules*. Another critical step during the force guidance development is the review and updating of support-force allocation rules used by the CAA during the modeling process (quantitative analysis).

(a) These allocation rules, developed by TRADOC and the functional area proponents, represent a quantitative

## How the Army Runs

statement of doctrine for each type of unit (maneuver, fires, effects, support and sustainment). An allocation rule is a machine-readable statement of a unit's capability, mission and/or doctrinal employment. Allocation rules are normally an arithmetic statement that incorporates the appropriate planning factors. They are adjusted as necessary to incorporate theater-specific planning factors. There are three basic types of rules:

- Direct input (manual) rules are stand-alone capability demands in a theater. This generally is the maneuver force (e.g., Brigade Combat Teams (BCT))
  - Existence rules tie a capability demand for one unit to another. Allocation of units based on the existence of other units, or a function of a theater's physical or organizational structure (e.g., for one large general purpose port: one each Harborcraft Company, one each Military Police Company, etc)
  - Workload Mission Command rules tie capability demands to the existence of doctrinally assigned functional subordinate units (e.g., 0.199 each per Headquarters, POL Supply Company)
- Workload rules that tie capability demands to a measurable logistical workload or administrative services in proportion to the volume of those services. (e.g., one each DS Maintenance Company per 375 daily man-hours of automotive maintenance or one each POL Supply Company per 2200 tons of bulk POL consumed per day)
- Workload rules that tie capability demands to a measurable logistical workload or administrative services in proportion to the volume of those services. (e.g., one each DS Maintenance Company per 375 daily man-hours of automotive maintenance or one each POL Supply Company per 2200 tons of bulk POL consumed per day)

(b) The allocation rules need modification whenever unit TOEs, scenario assumptions, logistical support plans, or doctrinal employment concepts change.

(c) Council of Colonel (CoC) and General Officer (GO) level reviews ensure all allocation rules are appropriate and approved for use in the current scenarios.

(7) *CoC and GO-level reviews are decision*. forums where all the parameters, constraints, data inputs and guidance are identified and approved for inclusion in the current TAA cycle and CAA models.

(a) The term "GO-level" includes assigned Senior Executive Service (SES) personnel.

(b) The CoC reviews and recommends approval of all data inputs and required forces developed by CAA modeling.

(c) The GO-level review ensures all data input and guidance is appropriate and approved for use in the current scenario(s). It specifically addresses those issues that were unresolved at the CoC review.

c. *Quantitative analysis*. Warfighting requirements are determined in this phase. CAA, through computer modeling and analysis, generates the scenario generated requirements (OF only) for types of units needed to ensure success of the BCTs, support brigades and headquarters commands directed in the different scenarios. CAA accomplishes the modeling through a series of analytical efforts and associated computer simulations. CAA uses the apportioned force provided in the OSD and Army guidance for employment in the Major Combat Operations (MCO) scenarios.

(1) *Operating Force (OF)*. The OF is those forces whose primary missions are to participate in combat and the integral supporting elements thereof. (JP 1-02):

(a) The TAP provides the number and type of BCTs.

(b) The CAA computer models and analysis generate resources (units or classes of supply) needed in each illustrative scenario. Based on the illustrative scenario, allocation rules and the capability demands generated for units or classes of supply, CAA modeling and analysis develops the unconstrained (minimum risk) demand for enablers to ensure success of the deployed BCTs in the warfight.

(2) *Generating Force (GF)*. Army organizations whose primary mission is to generate and sustain the OF capabilities for employment by joint force commanders. As a consequence of its performance of functions specified, and implied by law, the GF also possesses operationally useful capabilities for employment by, or in direct support of, joint force commanders (FM 1-01).

d. *Review and approval*. Phase I (Capability Demand Analysis) is complete after the CoC/GO-level reviews of the CAA modeling and analysis.

(1) The CoC/GO-level forums "review and approve" the warfighting capability demands portrayed by FORGE as a fully structured and resourced force.

(2) Additionally, the CoC/GO-level forums review and reach agreement on the force structure demands supporting HD, Army Support to Other Services and Foundational Activities and the appropriate level of inclusion of contractor support, use of strategic partners, joint capabilities, and other risk mitigation variables to appropriately scope the capability demands within endstrength ensuring a focus on shaping the Army and not on sizing the Army. The GO-level review recommends approval of the capability demands to the Senior Leaders of the Department of the Army (SLDA).

(3) The SLDA reviews and approves the capability demands generated through the computer models and analysis recognized within the required force structure. The SLDA review and approval is the transition to Phase II of TAA (Resource Determination).

(4) After the SLDA reviews and approves the capability demands, DAMO-FMF makes a comparison of data files

(MATCH report) between the SLDA approved capability demands and the current program force from the most recent force review point (usually the Master Force (MFORCE)) (see para 5–22f). The MATCH (not an acronym) report identifies the difference between the capability demands and the programmed force in order to determine the projected unit deficits (COMPO 4) for future programming discussions and issue formulation. The MATCH report and required force files are analyzed in preparation for the Resource Determination phase.

### 5–19. TAA Phase II—Resource determination

Resource determination consists of two separate activities: qualitative analysis and leadership review. The qualitative analysis is the most emotional facet of the TAA process because the analysis results in the distribution of scarce resources, impacting every aspect of the Army. Therefore, this phase requires extensive preparation by participants to ensure all force structure tradeoffs are accurately assessed and the best warfighting force structure is developed.

*a.* Qualitative analysis. Qualitative analysis is conducted to develop the initial POM force, within total strength guidance, for use in the development of the POM. A series of resourcing forums, analyses, panel reviews, and conferences consider and validate the FORGE model generated capability demands and the analysis of those demands. The qualitative analysis begins in the Capability Demand Analysis Phase as risk mitigation measures are applied but prior to the resourcing panels. The qualitative analysis will continue until the POM Force is approved by the SLDA.

*b.* The resourcing conference is held in two separate sessions: Organizational Integrator (OI) Panels and Resourcing CoC.

(1) *OI Panels.*

*(a)* HQDA action officers and their counterparts enter an intense round of preparations for the resourcing panels. Since the quantitative analysis only determined capability demands for doctrinally correct, fully resourced maneuver, fires, effects, support and sustainment units deployed into the theater(s) of operations, the determination of a need for additional non-deploying units and the allocation of resourced units to components (Active Army, Army Reserve (AR), Army National Guard (ARNG)) must all be accomplished during the OI Panels. HQDA bases force structuring options on an understanding of the objectives to be achieved, the desired capabilities and the constraints. The primary differences among various options are the extent to which risk, constraints and time are addressed. It is through the OI Panels that the “Art” of Force Management is applied to the “Science” introduced during Capability Demand Analysis modeling.

*(b)* The Resourcing CoC provides the opportunity for the ARSTAF, commands, proponent representatives and staff support agencies to provide input, propose changes, and to surface issues related to the OI Panel recommendations. The issues focus on COMPO and center on resolving risk mitigation issues, while balancing priorities. The active/reserve component (AC/RC) balance and total-strength concerns are key recommendation outputs of this CoC. It allows Army Service Component Commanders (ASCC) to verify theater specific capability demands are satisfied by Army force structure assigned/apportioned to their commands to meet current CCDR OPLAN/CONPLAN warfighting requirements and CCDOR. The Resourcing CoC is typically a multi-day event chaired by the HQDA, G–3/7, Director of Force Management (DFM).

*(c)* The resourcing conference focuses on identifying and developing potential solutions for the wide range of issues brought to TAA. The Organizational Integrators (OI) and Force Integrators (FI) are key individuals in this forum. The OIs and FIs have the responsibility to pull together the sometimes diverse guidance and opinions developed during the conference, add insight from a branch perspective, and establish whether the changes in the building blocks for the design case were in fact the best course of action. The OIs pull all the relevant information together for presentation to the CoC. During these presentations, the OI reviews each standard requirements code (SRC) that falls under his/her area of responsibility, and presents recommendations on how to solve the various issues.

*(d)* The resourcing conference CoC integrates Generating Force issues and requirements, and reviews and resolves issues based upon sound military judgment and experience. The CoC forwards their recommendations and any unresolved issues to the resourcing GOSC.

(2) *Resourcing General Officer Steering Committee (GOSC).* The GOSC has evolved into a series of GO resourcing forums at the two- and three-star level. The GO forums review and approve the decisions of the resourcing CoC, and address remaining unresolved issues.

(3) *Force Feasibility Review (FFR).* The ARSTAF further analyzes the force, initially approved by the GO resourcing conferences, via the FFR. The FFR process uses the results of the TAA resourcing conference as input, conducting a review and adjusting the POM force to assure it is affordable and supportable. At the macro level, within the limits of personnel and budgetary constraints, the FFR determines if the POM force can be manned, trained, equipped, sustained and stationed. The FFR process identifies problems with the POM force and provides alternatives, based on prior TAA initiatives, unalterable decisions from the Army leadership, or Program Budget Decisions (PBD), to the GOSC for determining the most capable force within existing or projected constraints. The FFR process is the vehicle to analyze force structure options developed during the TAA process. Additionally, with the TAA/POM process on an annual schedule, the PEGs conduct the FFR each year while building the POM. Their feedback is injected back into the next OI Panel and Resourcing CoC

(4) *Resourcing General Officer Steering Committee (GOSC).* The qualitative phase culminates with the Resourcing



## How the Army Runs

GOSC. The GOSC reviews/approves the decisions of the Resourcing CoC and addresses remaining unresolved issues. The Resourcing GOSC approves the force that is forwarded to the SLDA for review and final approval.

(5) *Leadership review.* After the Resourcing conference sequential GO Resourcing reviews meet to resolve any contentious or outstanding issues. The Secretary of the Army, Undersecretary of the Army, CSA and VCSA attend the SLDA meetings. The SEC ARMY reviews and approves the POM force

### 5-20. Army Structure (ARSTRUC) Memorandum

The ARSTRUC memorandum provides a historical record of Army's Senior Leadership final decisions made during the TAA process as well as changes made as part of the out-of-cycle process since the last ARSTRUC; the ARSTRUC describes the POM Force. The ARSTRUC memorandum, produced by Army G-37 (Force Management), is directive in nature, providing the commands results at the SRC level of detail. The ARSTRUC memorandum directs the commands to make appropriate adjustments to their force structure at the unit identification code (UIC) level of detail during the next command plan. Commands record changes during the Command Plan process in SAMAS, the official database of record for the Army. SAMAS, along with the BOIP and TOE files, provides the basis for Army authorization documentations (MTOE and TDA).

### 5-21. The product of TAA

a. The resourced TAA force (POM Force) represents the force structure for POM development, capturing all components (Active, Reserve, Host Nation [HN]) and type (MTOE, TDA) capability demands through the end of the POM years. The POM Force meets the projected mission requirements with appropriate risk within anticipated end strength and equipment level. The final output should result in an executable POM Force. The Army forwards the POM Force to OSD with a recommendation for approval. All approved units are entered into the Structure and Manpower Allocation System (SAMAS) and documented in The Army Authorization Documents System (TAADS) to create the POM Force. TAA is the acknowledged and proven mechanism for explaining and defending Army force structure for budget submission.

b. The product of the TAA and POM processes is the approved force structure for the Army, which has been divided for resource management purposes into components: the Active Component (AC) (COMPO 1), the ARNG (COMPO 2), and the AR (COMPO 3). Three other components - direct host-nation support (COMPO 7), indirect host-nation support (COMPO 8), and logistics civil augmentation (COMPO 9) - comprise force structure offsets. Host-nation support agreements guarantee the COMPO 7 and 8 resources. COMPO 9 is an augmentation, not an offset and represents the contracts for additional support and services to be provided by domestic and foreign firms augmenting existing force structure (Figure 5-8).



Figure 5-8. Force structure components (COMPO)

---

## Section VI

### Phase V—Document organizational authorizations

#### 5–22. Documentation components overview

*a.* The fifth and final phase of force development, the documenting of unit authorizations, can be viewed as the integration of organizational model development and organizational authorization determination. Battlefield requirements for specific military capabilities drive the development of organizational models. The results of this process are TOEs for organizations staffed and equipped to provide increments of the required capabilities. TOEs specify Army requirements. Determining organizational authorizations, on the other hand, is a force structure process that documents resources (people, equipment, dollars and facilities) for each unit in the Army.

*b.* Because the Army is a complex array of people, each with one or more of a variety of skills, and many millions of items of equipment, there must be an organized system for documenting what is required and how much is authorized. More importantly, as the Army moves forward with transformation, modularity, equipment modernization, application of new doctrines, and the development of resulting organizations, the Army must have a way of keeping track of changes that are made so that they may be managed efficiently and with a minimum of turbulence. The following paragraphs will discuss the systems the Army utilizes to perform this function.

*c.* Each unit in the Army has a The Army Authorization Document System (TAADS) document identifying its mission, structure, personnel and equipment requirements and authorizations. These documents are essential at each level of command for the Army to function. A unit uses its authorization document as authority to requisition personnel and equipment and as a basis for readiness evaluation. Authorization documents are used to manage personnel and materiel procurement, force planning, programming, budgeting, training, and distribution. Additionally, authorization documents are used at various levels of command for inspections, surveys, special projects, and studies.

#### 5–23. Structure and manpower allocation system (SAMAS)

*a.* SAMAS is the force development automated database that records, maintains and distributes force structure information for all 7500+ units in the Army. SAMAS is the Army’s “database of record” for all force structure actions. It maintains information for all COMPOs.

*b.* The primary inputs to SAMAS are the “operating” forces (BCTs, divisions, corps, ASCCs, ACRs and Special Forces groups) directed by the Army Leadership. “Operating” forces are developed during TAA to support the combat force structure; “generating” forces are derived during TAA and refined through the Force Management Review (FMR) and Command Plan processes.

*c.* SAMAS has two primary views. One is the Force Structure (FS) File (commonly referred to as the “force file”), which reflects the approved (programmed and documented) force structure position for each unit in the Army. The force file produces the Army’s MFORCE. The second file is the Program and Budget Guidance (PBG) File (commonly referred to as the “budget file”). The budget file produces the manpower addendum to the PBG.

*d.* The force file is updated and maintained by the Force Structure Command Managers and Organizational Integrators at HQDA G–37/FM (DAMO–FM). The force file displays the force structure position for every unit in the Army at UIC level of detail. There are approximately 46 total data items for each unit, displayed over time (previous, current and future programmed and approved actions). These data items include UIC, Troop Program Sequence Number (TPSN), unit number and regimental designation, unit description, SRC, EDATE, Army Management Structure Code (AMSCO), MDEP, required and authorized strength levels (manpower spaces), MTOE and TDA number, location code, station name, phase and action codes, and Dynamic Army Resource Priority List (DARPL) number. SAMAS drives the development of authorization documents (captured in TAADS), which contains the MTOEs and TDAs at paragraph, line, MOS and grade, line item number (LIN), Equipment Readiness Code (ERC) and quantity level of detail.

*e.* The budget file is maintained by the PBG Command Managers. The budget file contains military and civilian manpower data and represents the manpower for which budget authority is available. The budget file also feeds other HQDA data systems, most notably the HQDA Program Analysis and Evaluation (PA&E) Program Optimization and Budget Evaluation (PROBE) database, which captures the Army’s POM and Budget submissions. It also feeds civilian data to the Assistant SECARMY (Financial Management and Comptroller) (ASA [FM&C]) Civilian Manpower Integrated Costing System (CMICS) where civilian costing is performed for all PPBE process events. Primary inputs to the budget file come from the annual command plan submissions of the Army commands, concept plans, PBD, Budget Change Proposals, Program Change Proposals, and POM decisions. The primary output of the budget file is the manpower addendum to the PBG.

*f.* SAMAS is updated and “locked” annually, usually in the June timeframe, at the end of the documentation cycle. This locked position is called the Army’s Master Force (MFORCE) and reflects the CSA-approved current, budgeted and programmed force structure of the Army. As such, it is the authoritative record of the total force over time.

### 5–24. The Army authorization documents system (TAADS)

a. Authorization documents. Every Army unit and Army components of other agencies must have an authorization document to reflect an organizational structure that can be supported in terms of manpower and equipment. Authorization documents detail a unit's approved structure and resources, and serve as the basis and authority for requisitioning of personnel and equipment. There are two types of authorization documents in the Army:

(1) *Modification Table of Organization and Equipment (MTOE)*. The MTOE is a modified version of a HQDA approved TOE prescribing the unit organization, personnel, and equipment necessary to perform a mission in a specific geographical or operational environment. It reflects the organizational option selected from the TOE as directed by the Army command and HQDA. It also reflects the level of modernization directed by the Army command and HQDA. At unit level, the MTOE is the base document for:

- Requesting personnel and equipment.
- Distributing personnel and equipment resources.
- Unit status reporting.
- Reporting supply and maintenance status.

(2) *TDA*. The TDA prescribes the organizational structure for a unit having a mission for which a TOE does not exist. TDAs are unique in that they are typically developed based on the type and level of workloads associated with the unit's mission. Units with similar missions, like U.S. Army garrisons, may be organized similarly but may have a substantially different mix and number of personnel and equipment authorizations due to differences in the population and composition of the post they support. All TDA documents are built at HQDA (USAFMSA). This allows for standardization of unit design for units with like-type missions provide the ability to conduct supportability analyses and compliance reviews, and enhance the capability to plan and evaluate changes. There are four specialized types of TDAs.

(a) *Mobilization TDA (MOBTDA)*. The MOBTDA records the mission, organizational structure, and personnel and equipment requirements and authorizations for an Army unit to perform assigned missions upon mobilization. It reflects the unit's mobilization plan by identifying functions to be increased, decreased, established, or discontinued.

(b) *Augmentation TDA (AUGTDA)*. The AUGTDA provides the functional support required for the MTOE unit to execute functions beyond the capabilities for which the MTOE was designed and are unique to that particular unit. AUGTDA may include military and/or civilian personnel and/or military or commercial equipment allowances required and authorized to augment or supplement an MTOE unit. An example is the augmentation of the 11th ACR at the National Training Center (NTC), Fort Irwin, CA with equipment authorizations for their "visually modified" (VIS-MOD) opposing forces (OPFOR) equipment.

(c) *Full Time Support TDA (FTSTDA)*. The FTSTDA documents military (AC and AGR) and Federal Civil Service positions required and authorized to provide full-time support to RC MTOE and TDA units.

(d) *Joint Table of Authorization/Joint Table of Distribution (JTA/JTD)*. JTAs and JTDs are documents that authorize equipment and personnel for joint activities supported by two or more services. Examples of this would be the Army component for the CCDR's staff or for the Joint Staff.

b. The development and documentation of authorization documents is supported by TAADS. TAADS is a HQDA automated system that contains all unit authorization documents, maintains personnel and equipment data for individual units and the entire Army force structure, standardizes authorization documents for similar parent units, and interfaces with other DA automated systems, e.g. SAMAS, LOGSACS, and PERSACS. TAADS documents can now be accessed on line at: <http://fmsweb.army.mil>. This web site instructs users on how to obtain access to the FMSWeb tools.

c. The authorization document data maintained in TAADS are organizational structure, personnel, and equipment requirements and authorizations. The basic procedures for documentation are the same for MTOE and TDA units; that is, all unit personnel and equipment requirements and authorizations are written in the same detail. However, the basis for developing the two documents differs.

(1) MTOEs are derived by adjusting/modifying TOEs to meet specific operational requirements at affordable modernization and manning levels. A unit will be organized under the proper level of its TOE to the greatest extent consistent with the mission and the availability of manpower spaces and equipment.

(a) Personnel authorizations are derived from SAMAS, FDUs, TOE design and leadership decisions.

(b) Equipment authorizations are derived from the Army Modernization Strategy (AMS), fielding time lines and distribution plans.

(2) TDAs are developed to attain essential manning, the most efficient use of personnel, and the most effective operational capability within the manpower spaces prescribed in the command force structure. Manpower surveys, manpower requirements models, FMR generating force directives and change requests through concept plans, are used to structure TDA manpower.

d. The HQDA annual Command Plan process reviews and approves all authorization documents (MTOEs and TDAs) to ensure compatibility among the unit's mission, capabilities, organization, authorized level of organization

(ALO), and the allocation of resources. Approved MTOEs and TDAs are documented in TAADS and the SAMAS MFORCE.

### **5–25. The force documentation process.**

*a.* The MTOE force structure authorization documentation process begins with documentation guidance released by HQDA G–37/FM at the start of the documentation window. The HQDA guidance establishes the focus (“target”) of the documentation window and directs documentation of specific units and actions. USAFMSA builds draft MTOEs based on the documentation guidance and forwards these documents to HQDA and the Army commands for subject matter expert (SME) and command review before being incorporated into the Command Plan process.

*b.* The TDA force structure authorization documentation process closely resembles the MTOE documentation process. USAFMSA initiates the process with the receipt of HQDA guidance and builds the appropriate draft TDAs to reflect current guidance. The TDAs will be staffed with the Army commands and appropriate ARSTAF office/agency SMEs before being incorporated into the Command Plan process.

*c.* Detailed integration and documentation of the force centers on the “Command Plan process,” a yearlong process running from the approved June MFORCE until the next June’s approved MFORCE. The Army uses this process to update and create MTOE and TDA documents up to two years out. These documents officially record decisions on missions, organizational structure, and requirements and authorizations for personnel and equipment. The command plan process also updates programmed decisions for the out years in SAMAS. The command plan is used to make adjustments between spaces programmed in SAMAS and the proposed draft authorization documents for that cycle. The command plan is also used by HQDA and the Army commands to comply with FMR directed force structure actions and to document approved concept plans and other HQDA directed actions.

*d.* The Reconciliation Process. At the close of each documentation window, the “SAMAS–TAADS compare” is run. The “SAMAS–TAADS compare” or Automated Update Transaction System (AUTS) reconciles the forces programmed in SAMAS with the authorization documents submitted for approval in TAADS at the UIC level of detail. Those TAADS documents that match SAMAS programming at UIC, SRC, EDATE, MDEP, AMSCO, and requirements and authorizations strength level of detail (officer/warrant officer, enlisted, civilian), are approved and forwarded to the Army commands for distribution to the appropriate units. The approved SAMAS database and the approved TAADS documents provide the basis for updating a number of other data bases and systems, including:

(1) The HQDA DCS, G–1/Army Human Resources Command (AHRC) Personnel Management Authorization Document (PMAD).

(2) The Structure and Composition System (SACS)-personnel and logistics.

(3) HQDA DCS, G–37/TR-(Training) (DAMO–TR) Battalion Level Training Model (BLTM) and the Training Resource Model (TRM) for developing operating tempo (OPTEMPO) funding.

(4) ASA (FM&C) Army Budget Office (ABO) for civilian costing through the CMICS model and budget estimate submission (BES) preparation.

(5) HQDA G–8 PA&E for POM preparation.

*e.* Organization Change Concept Plans.

(1) A Concept Plan is a detailed proposal by an Army command/Agency to create or change one or more units when the level of change reaches a specified threshold. The purpose of a Concept Plan is to ensure that appropriate resources are used to support Army objectives, priorities, and missions. AR 71–32 addresses Concept Plans, provides guidance, and formats for submission.

(2) To warrant creating a new organization or changing an existing one, Concept Plans must demonstrate a valid need for change, or demonstrate significant improvement to be realized, in order to warrant creating a new, or reorganizing an existing, organization.

(3) The HQDA approval process for Concept Plans includes an evaluation of the missions, functions, organization, workload data, and required operational capability of the organization affected and the proposed manpower and equipment requirements. The outcome of a successful submission and approval of a proposed concept plan is the establishment of the organizational/unit personnel and equipment requirements and positioning the organization/unit to compete for resourcing against the Army’s priorities.

### **5–26. Structure and composition system (SACS)**

*a.* The SACS produces the Army’s time-phased demands for personnel and equipment over the current, budget and program years. These demands are then extended for a total of a ten-year period. Additionally, SACS defaults to FY 2050 and builds a fully modernized OTOE position for all units. In this way, SACS shows current levels of modernization, levels achieved at the end of the POM, and a fully modernized Army (for planning purposes).

*b.* Operated and maintained by USAFMSA, SACS is produced by merging data from a number of management information systems and databases addressing force structure, personnel, manpower, and dollar resource constraints. Specifically, SACS combines information from BOIP, TOE, SAMAS, TAADS and Equipping the Force (EQ4). SACS products are the Personnel SACS (PERSACS) and the Logistical SACS (LOGSACS). Both PERSACS and LOGSACS

## How the Army Runs

are at the UIC/EDATE and MOS/grade (GRD)/ LIN/ ERC/quantity (QTY) level of detail for requirements and authorization for MTOE and TDA units. The SACS process is shown in figure 5-9.

(1) PERSACS combines data from the SAMAS, TAADS, and TOE systems to state military personnel requirements and authorizations by grade, branch, and MOS/AOC for each unit in the force for the 10 years of the SACS. This data supports planning for personnel recruiting, training, promoting, validating requisitions, and distribution. LOGSACS combines data from the SAMAS, TAADS, TOE, BOIP, and EQ4 to state equipment requirements and authorizations by LIN and ERC for each unit in the force for the current, budget, and POM years extended for a total of ten years. Authorized/required quantities of currently documented equipment are determined for each unit from its authorization document in TAADS for the first two years of the SACS run. Data for the POM period and beyond is derived from the unit TOE model and data on unit equipment for new developmental items that are undocumented, but planned for inclusion at a later date, are applied through application of the applicable BOIP file. A summary of all unit requirements for a particular LIN, as computed by LOGSACS, is the initial issue quantity (IIQ) of that LIN. The Army Acquisition Objective (AAO) is computed by taking the IIQ input and adding requirements for Army war reserves, operational projects, war reserve stocks for allies and operational readiness float (ORF)/ repair cycle float (RCF).

(2) LOGSACS and PERSACS, while products of SACS, are themselves inputs to other processes. The Total Army Equipment Distribution Program (TAEDP), for example, uses equipment requirements and authorizations from LOGSACS to plan equipment distribution. The PMAD, used by DCS, G-1 and AHRC provides personnel requirements and authorizations, and is updated by TAADS.

c. USAFMSA typically produces SACS twice a year, once when the force locks (the MFORCE) or at a Force Review Point.

d. SACS output products (PERSACS and LOGSACS) are published after the AUTS process at the end of the command plan cycle. The reconciled MFORCE is the key force structure input to initiate the SACS cycle. See Figure 5-9.

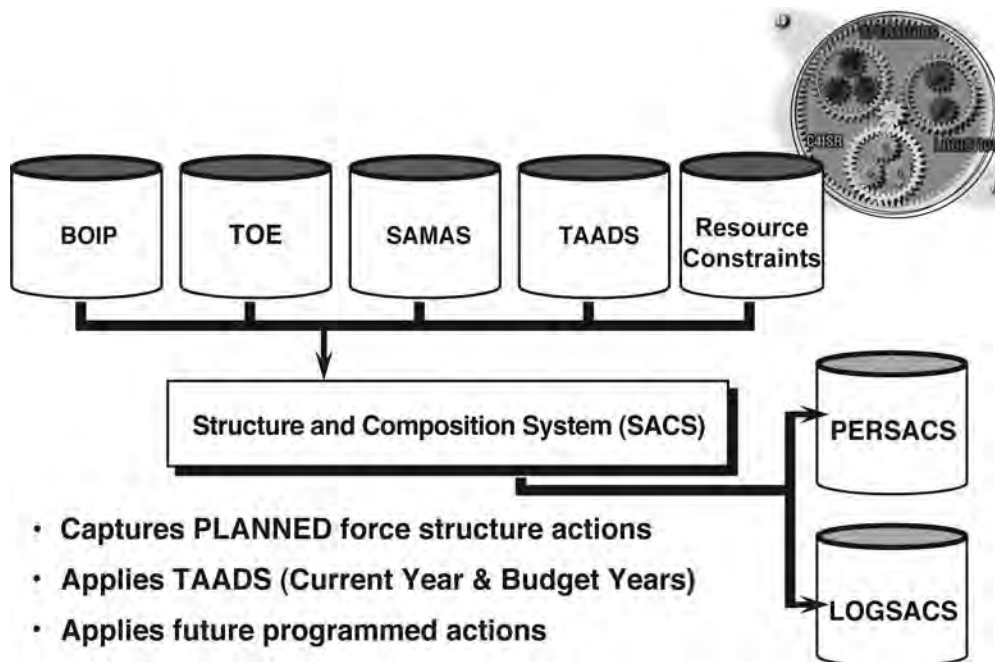

Figure 5-9. SACS/Force builder process

### 5-27. Force management system (FMS).

*a.* The increased complexity of the Army, together with the frequency and scope of changes, has made the task of coordinating the various systems and databases that direct, control or document the force increasingly difficult. To meet these challenges, HQDA G-37/FM, is developing the FMS under the management/oversight of PEO-Enterprise Information Systems (EIS). FMS will be an overarching automation system that will ultimately replace the existing systems for developing, documenting, accounting, and managing organizational requirements and authorizations. FMS will become the Army's single database for requirements and authorizations information. FMS will provide capability to plan tactical unit conversions to new concepts and doctrine. It will also support other Army databases such as HQDA DCS G-1, G-4, G-8, and ASA-MRA with baseline and out-year force structure modernization authorization data. This integrated system will replace the four legacy systems, which evolved in the 1970s-80s. The FMS is critical to Force Management mission support including total Army force structure management and manpower allocation; development of organizational models (both operating and generating forces); providing analytical support in determining organization authorizations; and documenting organization authorizations across the Army both now and in support of future personnel and logistics planning efforts.

*b.* FMS is designed to effectively manage manpower, personnel, equipment, readiness, and force structure decisions and databases. Specifically, FMS has or will integrate the capabilities of, and then replace, the following automated systems:

- (1) Requirements Documentation System (RDS)
- (2) TAADS
- (3) SAMAS

*c.* The principal advantages that FMS will bring to the Army's force management process include:

- (1) A single, integrated, hierarchical unit structure across all Force Management processes with a single, common, integrated database system.
- (2) An automated change management system utilizing integrated product dependencies enabling automatic pushing of approved changes to higher order products (NOFC, BOIP, Requirements, Authorizations, Structure).
- (3) A single, integrated unit document combining TOE, MTOE, AUGTDA and other currently disparate document components.
- (4) The ability to create TDA organizational templates, e.g. requirement documents, to enable the development of doctrinal standards for the Army Generating Force.
- (5) A rule engine capable of storing and applying force management rules against new data condition sets in order to provide more consistent and efficient force management documentation processes.
- (6) An Army Organizational Server to provide tailorable web services for FMS data consumers consistent with the Global Force Management directives utilizing Enterprise Identifiers.

*d.* FMS brings to the Force Management community interactive tools, use of direct database access, web access technologies, supporting on-line transactions and on-line analysis. These capabilities will be available for daily use by all portions of the Force Management community. Initial operating capability of FMS was achieved in August 2006.

### 5-28. Global Force Management Data Initiative (GFM DI)

*a.* Synopsis: Global Force Management (GFM) establishes a transparent and universal process to manage, assess, and display the worldwide disposition of US Forces. This includes the availability, readiness, and capability information required to assess risks associated with proposed allocation, assignment, and apportionment options. The Army Organization Server (AOS) is the Army's authoritative data source (ADS) for providing Army administrative default force structure prescribed by GFMDI. The Force Management System (FMS) is the system of record the Army will use to maintain the AOS data.

*b.* Strategic Vision: The basic premise of GFM is that force structure is the common element between all systems within the Department of Defense (DOD). Force structure acts as a common reference point that will allow computers to integrate and manipulate data. GFM is the foundation upon which force structure information will be captured, and used, to associate and aggregate information from the Soldier and business domains in order to form a coherent, integrated global picture.

(1) A key enabler for GFM is the GFM Data Initiative (GFM DI), which organizes force structure data in a hierarchical way for integration across DOD. The GFM DI defines how the Services electronically document organizational structures across the DOD enterprise and establishes a standard structure for the organization information needed. The GFM Organization Servers provide the means of implementing that plan through identification of force structure data sources by Component, creation and maintenance of that information in a standard format and, most important, a single authoritative data source (ADS) for the dissemination of that information across the DOD enterprise.

(2) The Army Organization Server is the Army's ADS for Global Force Management data. This data is developed and maintained in the Army's Force Management System (FMS). Army G3 has oversight, with G3 FM-USAFMSA

## How the Army Runs

managing the completion of loading the Organizational Server with the Force Structure data, G3-FMP overseeing the Hierarchical interconnections and G3 SS managing the connectivity to downstream readiness, personnel and equipment systems. The Force Management System consumes legacy force management systems and links to applicable funding, personnel, and equipment systems to ensure its validity as the Army's authoritative data source.

c. Mission: In support of the Department of Defense Global Force Management initiative, the Army has developed net-centric web-based classified and unclassified organizational servers that are interoperable with the DOD organizational servers and that fulfill the requirements of the DOD Global Force Management Data Initiative. The Army has demonstrated GFM-DI capability and anticipates full operational capability in the next few months.

### 5-29. References

- a. CJCSI 3170.01G, Joint Capabilities Integration and Development System (JCIDS), 1 March 2009 with supporting JCIDS Manual, February 2009.
- b. CJCSI 3470.01, Rapid Validation and Resourcing of Joint Urgent Operational Needs (JUONS) in the Year of Execution, 9 July 2007.
- c. CJCSI 6212.01E, Interoperability and Supportability of National Security Systems, and Information Technology Systems, 15 Dec 2008.
- d. CJCS Manual 3010.02B, Joint Operations Concepts Development Process (JOPSC-DP), 27 January 2006.
- e. JCS J-8 Force Structure, Resources, and Assessments Directorate, Capabilities-Based Assessment (CBA) Users Guide, December 2006.
- f. Deputy Secretary of Defense Memorandum, *Meeting Immediate Warfighting Needs (IWNs)*, 15 November 2004.
- g. Department of the Army, Amendment to GO 2002-03: Assignment of Functions and Responsibilities within Headquarters, Department of the Army, 18 Mar 2009.
- h. General Orders #4, Redesignation of the United States Army Training and Doctrine Command Futures Center as the Army Capabilities Integration Center, 10 February 2006.
- i. TRADOC Regulation 71-20), Concept Development, Experimentation, and Requirements Determination, 5 March 2009.
- j. HQ TRADOC, *TRADOC Campaign Plan*, 31 March 2006.
- k. TRADOC Pamphlet 525-3-0, The Army in Joint Operations, Version 3.0, 15 January 2009.
- l. TRADOC Pamphlet 525-66 *Force Operating Capabilities*, 7 March 2008.
- m. HQ TRADOC, TRADOC Campaign Plan, 31 March 2006.
- n. HQ TRADOC, 2009 Army Capabilities Integration Center (ARCIC) Campaign Plan (ArCP), 1 October 2008.
- o. TRADOC Army Capabilities Integration Center (ARCIC), Capabilities-Based Assessment Guide, 28 January 2008.
- p. U.S. Joint Forces Command (USJFCOM), The 2008 Joint Operating Environment (JOE), 25 November 2008.

## Chapter 6

### Planning For Mobilization And Deployment

“The Reserve components provide operational capabilities and strategic depth to meet the nation’s defense requirements across the full spectrum of conflict. While these roles are not new, the degree to which the military services have relied upon the National Guard and Reserve to support operational missions has changed.... the Reserve components have been used in different ways and at unprecedented levels, most significantly after September 11, 2001, and the onset of the global war on terrorism. The demands of the persistent conflicts of the past seven years have been high—beyond the ability of the Active component to meet alone. The Reserve components have been relied on heavily to fill operational requirements—comprising close to 40 percent of forces in theater at the height of the mobilization. The role of the Reserves in the total force changed fundamentally. Today, the Department of Defense is asking much more of its Guard and Reserve members. Being in the Reserves is no longer about deploying once in a career, or maybe not at all. Today’s reservist might deploy three or four times over the course of a career. This is a different type of commitment, based on different expectations—for members, their families, and employers. The military services are asking for more time from their reserve members—for more training and more frequent deployments.” Department of Defense White Paper “Managing the Reserve Components as an Operational Force”, October 2008, Office of the Assistant Secretary of Defense for Reserve Affairs.

#### Section I

##### Introduction

#### 6–1. Chapter content

As of December 28, 2010 the more than 793,000 Army Reserve Component soldiers mobilized since September 11, 2001 [Contingency Tracking System (CTS)) Daily Processing Files produced by the Defense Manpower Data Center] dramatically expresses today’s Army mobilization and deployment requirements. Our Army is evaluating its ability to rapidly deploy decisive force throughout the world. In view of today’s complex global environment, the Army must remain prepared, trained and ready to deploy operationally. It must have the capability to expand rapidly through mobilization to meet its regional and territorial responsibilities. The Army force structure must be designed to allow force projection with maximum combat power and support units to sustain that power. The AC and RC must provide both capabilities without the lengthy preparation periods that have been characteristic of the past. The need for deploying a substantial number of RC units overseas in the initial stages of a conflict underscores the importance placed on the Army force structure. The deterrent value of mobilization resides not only in the AC and RC, but in the preparedness to convert civilian manpower and industrial production rapidly into military power, individual replacements, and supplies. The capability of the United States to expand the active force rapidly and efficiently through mobilization is essential to deter potential enemies. Such a capability assures our allies of U.S. resolve. Fundamental to achieving such a capability is the coordination of mobilization planning with the planned deployments for war that require mobilization.

#### 6–2. Chapter organization

This chapter covers mobilization and deployment planning systems. Although the focus is on joint planning systems, the participation of the Army in these systems is explained in some detail. Also discussed are the DOD objectives for improving industrial preparedness in the United States and the Army industrial preparedness program. The discussion of mobilization and deployment is presented in five sections:

- Planning System Description, Deliberate Contingency Planning, and Crisis Action Planning.
- Adaptive Planning and the Adaptive Planning Execution System (APEX).
- Army Mobilization.
- Industrial Preparedness.
- Summary and References.

#### Section II

##### Planning system description, deliberate contingency planning, and crisis action planning

#### 6–3. The planning system

Joint operational planning encompasses planning for the full range of activities required for conducting joint operations and includes mobilization, deployment, and employment planning. Joint operational planning is conducted within the framework of the Joint Strategic Planning System (JSPS) (discussed in chapter 4) and the Joint Operation Planning and Execution System (JOPES). These systems are related to each other and to the DOD PPBE process (discussed in chapter 9). Army operational planning to implement joint operational planning tasks is conducted within the framework of the Army Mobilization and Operations Planning and Execution System (AMOPES). Other service systems, similar



## How the Army Runs

to AMOPES, include the Navy Capabilities and Mobilization Plan (NCMP), the Marine Corps Capabilities Plan (MCP) and Marine Corps Mobilization Management Plan (MPLAN), the Air Force War and Mobilization Plan (WMP), the Coast Guard Capabilities Plan (CG CAP) and Coast Guard Logistic Support and Capabilities Plan (CG LSCLP).

a. *JSPS*. The JSPS is a flexible and interactive process, and is the primary formal means by which the CJCS, in coordination with the other members of the JCS and Combatant Commanders, carries out statutory responsibilities and discharges strategic planning responsibilities. The JSPS is the mechanism for translating national security policy, resource planning guidance, and Combatant Commanders requirements into strategic guidance, force structure objectives, and operations planning guidance (Figure 6-1). The link with JOPES is through the Joint Strategic Planning System (JSPS) which provides short-term operational planning guidance to the military Services and Combatant Commands.



b. *Joint Strategic Capabilities Plan (JSCP)*. The JSCP, as the link to JOPES, provides guidance to the Combatant Commanders and the Chiefs of the Services to accomplish tasks and missions utilizing the current capabilities. It also apportions resources to Combatant Commanders based on military capabilities resulting from completed program and budget actions. Additionally, the JSCP provides a solid framework for capabilities-based military advice provided to the President and the SecDef.

c. *JOPES*. JOPES provides a single, interoperable planning and execution process. It also provides for orderly and coordinated problem solving and decision-making supported by mission command networks and systems. Thus, it is the joint command and control system for operation planning and execution covering the full spectrum of potential threats identified through the national security planning process. JOPES provides the means to respond to emerging crisis situations or transition to war through rapid, coordinated planning and execution. It also addresses mobilization, deployment, employment, and sustainment mission areas. JOPES is designed to support commanders and planners at national, theater, and supporting levels. The goals of JOPES are to—

- (1) Support the development of OPLANs, CONPLANs, functional plans, campaign plans, and the development of operation orders (OPORD) within time-constrained crisis situations.
- (2) Permit theater commanders to start, stop, or redirect military operations effectively and rapidly.
- (3) Support peacetime, crisis, and wartime planning and execution.
- (4) Integrate mobilization, deployment, employment, and sustainment activities.
- (5) Standardize policies and procedures that will be similar, in peacetime (including exercises) and crisis situations.
- (6) Support the rapid evaluation of military options and develop courses of action in single or multi-theater scenarios.

(7) Exploit information technology (IT) and communications technology advances. Specifically, utilization of the capabilities of the Global Command and Control System (GCCS) and communications assets such as the Defense Data Network (DDN).

(8) Expedite the development of military estimates of situations.

(9) Ensure the dissemination and presentation of timely, accurate, and properly aggregated information.

(10) Allow planners to identify resource shortfalls (personnel, transportation, materiel, forces, medical, and civil engineering services).

(11) Secure information from unauthorized access, data manipulation, and data retrieval. System hardware must be tempest (an unclassified term referring to technical investigations for compromising emanations from electrically operated information processing equipment) qualified and must be security certifiable for top secret sensitive compartmented information (SCI).

*d. Systems relationship.* JOPES is the principal system for translating and implementing policy decisions of the National Security Council (NSC) System (NSCS) and the JSPS into plans and orders for operations in support of national security policy. It also provides a means of identifying risks in executing currently assigned missions employing currently available resources. AMOPES is the Army's mobilization interface with JOPES. It is applicable to Army components of combatant commands, the ACOMs, and other supporting commands and agencies.

*e. JOPES overview.* JOPES is the integrated joint conventional command and control system used to support all military operation monitoring, planning, and execution (including theater-level nuclear and chemical plans) activities. JOPES incorporates policies, procedures, personnel, and facilities by interfacing with IT systems, reporting systems, and the underlying GCCS. JOPES provides IT support to senior-level decision makers and their staffs with enhanced capabilities to plan and conduct joint / combined military operations. JOPES procedures and IT systems are the mechanisms for submitting movement requirements to USTRANSCOM.

*f. Joint Planning and Execution Community (JPEC).* JOPES provides support to and is used by decision makers and their staffs at all levels of the national structure for joint planning and execution. This structure is defined as the President, the SecDef, and the JPEC. Membership includes, but is not limited to the following:

(1) *National level.* CJCS; Service Chiefs; Joint Staff; Services.

(2) *Theater level.* Supported commands (including Service component commands, sub-combatant commands, and joint task forces (JTF)).

(3) *Supporting organizational level.* Supporting commands (including Service component commands and supporting Combatant Commands); Defense agencies; Non-DOD departments and agencies; Allied commands and agencies.

*g. JOPES planning and execution methodology.* JOPES supports the joint planning and execution process used during peacetime operations, exercises, military operations in a peacetime or permissive environment, and war. JOPES procedures provide for various levels of decision-making in contingency and crisis action planning environments. The five operational functions of JOPES (Figure 6-2) govern both contingency and crisis action planning processes. Together with the two JOPES supporting functions (simulation and analysis; and monitoring), they form the JOPES methodology.



Figure 6-2. Joint operation planning and execution system (JOPES).

## How the Army Runs

### *h. JOPES procedural principles.*

(1) Single set of IT procedures. JOPES embodies a single set of IT procedures that, combined with administrative policies and procedures, govern all aspects of conventional military operation planning and execution (including theater-level nuclear and chemical plans). This single networked system ensures that all users of joint military planning and execution use the same vocabulary, procedures, and joint IT support, thus facilitating the transition from training to planning, then to effective military operations.

(2) Use of existing or programmed capabilities and resources. JOPES planning is capabilities based. Military planners use the forces and resources specified for regional or global planning in the JSCP and CJCS orders, Service capabilities documents, and approved OPLANs or orders. Using the forces and resources apportioned for planning, the Combatant Commanders select those forces they intend to employ within their plans to complete the assigned tasks.

(3) Shortfall identification and risk analysis. JOPES contains specific procedures for the supported command to identify shortfalls between the planned requirement and the identified capability at various points in the planning process. The supported command then attempts to resolve shortfalls, conducts risk analysis if the shortfalls are not resolved, and redefines the Combatant Command's Strategic Concept if the resultant risk is too great.

(4) Plans maintenance. Completed and approved plans will be maintained and updated as changes occur. A new plan is required only when the threat, tasks, forces assigned, resources available, or concept of operations change to the extent the supported Combatant Commander and the CJCS deem it necessary to develop a new plan. Otherwise, commanders and their staffs concentrate on keeping existing plans and orders up to date and executable. Currently, the SecDef requires Combatant Commanders to brief their major OPLANs and CONPLANs every six months during the planning revision process.

*i. JOPES policies, procedures, and guidance.* Procedures, guidance, and descriptions of IT system support and reporting structure necessary to conduct joint operation planning and execution are contained in four Chairman of the Joint Chiefs of Staff Manuals (CJCSM):

(1) CJCSM 3122.01A, Joint Operation Planning and Execution System (JOPES) Volume I (Planning Policies and Procedures), provides policy, guidance, and procedures for the development, coordination, dissemination, review, approval, and implementation of joint OPLANs and OPORDs.

(2) CJCSM 3122.03C, Joint Operation Planning and Execution System Volume II, Planning Formats, prescribes standard formats and minimum content for OPLANs, concept summaries, annexes, appendixes, tabs, and exhibits. It is functionally oriented and provides directional, procedural, and planning guidance keyed to certain plan annexes.

(3) CJCSM 3122.02C, Joint Operation Planning and Execution System Volume III, Crisis Action Time-Phased Force and Deployment Data Development and Deployment Execution, prescribes standard formats and minimum content for crisis action planning (CAP) procedures, orders, letters, reports, and the CAP checklists.

(4) CJCSM 3150.16D, Joint Operation Planning and Execution System Reporting Structure (JOPESREP), prescribes reporting procedures, reporting channels, and timelines necessary to conduct joint operation planning.

*j. JOPES functions.* JOPES consists of seven interrelated functions that provide a framework for joint military planning and execution. Figure 6–2 depicts the five operational functions and two supporting functions. The five operational functions are sequentially related, proceeding in a logical order from identification of a threat, to determination of strategy that counters the threat, to course of action development, to detailed planning, and finally, to actual implementation of military operations. The supporting functions, on the other hand, relate to all of the operational functions and have an impact on each JOPES operational function. Figure 6–3 displays the operational functions and identifies the major inputs and outputs of each operational function.

(1) *Threat identification and assessment.* This function addresses procedures for continuous monitoring of the international political and military environment so threats to national security can be detected and analyzed, alerting decision makers, and determining and defining threat capabilities and intentions. Through detailed planning and the development of courses of action at the operational level and monitoring and adjusting operations during execution, this function provides information for strategic planning and resource allocation at the national level. All organizational levels are supported by this function during crisis action planning and execution.

(2) *Strategy determination.* Using this function, the President, SecDef, CJCS, and JS formulate suitable and feasible military direction to counter the threats and to develop courses of action. It involves formulating political-military assessments, developing and evaluating military strategy and clearly defining political and military objectives or end state, apportioning forces and other resources, formulating concepts and military options, and developing planning guidance leading to the preparation of courses of action, OPLANs, and OPORDs. This process begins with an analysis

of existing strategy guidance in light of the intelligence estimate and ends with issuance of either the JSCP in peacetime or a CJCS warning or planning order during crisis action planning situations.

(3) *Course of action development.* In course of action development during peacetime, the supported command develops the Combatant Commander's Strategic Concept based on JS and Service planning guidance and resource apportionment provided in the JSCP and Service documents. In crisis situations, the supported command develops courses of action based on CJCS planning guidance and resource allocation from approved OPLANs and CJCS warning or alert orders. Using this JOPES function coupled with the simulation and analysis JOPES support function, force sustainment and transportation feasibility are analyzed. The Services, through Service component commands and supporting commands provide supportability estimates of the Combatant Commanders Strategic Concept or courses of action to the supported command. Products from course of action development include the Combatant Commanders Strategic Concept; CJCS-approved Concept of Operations; the Commander's Estimate, including courses of action; supportability estimates; and, time permitting, an integrated time-phased database of notional combat, combat support (CS), and combat service support (CSS) force requirements with an estimate of required sustainment.<sup>1</sup>

(4) *Detailed planning.* This function is used in developing a CONPLAN, OPLAN, or OPORD with supporting annexes and in determining preliminary movement feasibility. This function provides detailed force lists and required sustainment. This includes a fully integrated schedule of deployment, employment and mobilization activities, determination of support requirements, including medical, civil engineering, air refueling, host nation support and transportation needs, all based on the CJCS-approved concept of operations or course of action. Detailed planning begins with CJCS guidance in the form of an approval for further planning in a peacetime environment and a CJCS Alert or Planning Order in a crisis action-planning situation and ends with a CJCS-approved OPLAN or President/SecDef-approved OPORD.

(5) *Implementation.* This function provides decision makers the tools to monitor, analyze, and control events during the conduct of military operations. It encompasses the execution of military operations and provides procedures to issue OPORDs; conduct mobilization, deployment, employment, and sustainment activities; and adjust operations where required. The ability to monitor and compare actual events with scheduled events is crucial to assessing mission accomplishment; controlling, directing, re-planning, redirecting, or terminating operations; and conducting redeployment. Planning is a cyclic process that continues throughout implementation. Implementation begins with the CJCS execute order and usually ends with some type of re-planning effort such as redeployment or redirection of operations.

(6) *Supporting functions.* Two supporting functions identified in Figure 6-2, monitoring and simulation and analysis, complement the operational functions to complete the conceptual framework of JOPES.

(a) *Monitoring.* This supporting function supports each of the other JOPES functions by obtaining current, accurate information concerning the status of friendly, enemy, and neutral forces and resources to accomplish mission tasks. Examples of information processed are objective accomplishment; consumption data; and the status of deployment, procurement, mobilization, forces, and facilities.

(b) *Simulation and analysis.* This supporting function offers various automated techniques that enhance each of the other JOPES functions. Examples of simulation and analysis applications, when feasible, are force-on-force assessments (suitability); generation of force requirements; comparison of requirements to capabilities, such as consumption data; closure profiles (feasibility); and generation of mobilization and sustainment requirements based on need.

k. *JOPES planning process.* Joint operation planning and execution is a continuous, iterative process. It begins in response to perceived and identified threats to U.S. security interests; continues through military flexible deterrent option (FDO) and course of action selection, OPLAN, and operation order development and implementation; and ends when the requirement for the plan is canceled, the operation is terminated, or the crisis is satisfactorily resolved. Figure 6-4 shows the JOPES operational functions aligned with the contingency and crisis action planning process.

---

<sup>1</sup> Note: FM 3-0, Operations, dated February 2008 rescinded the terms combat arms, combat support, and combat service support. Unit types and functions are described instead by one of the following appropriate war fighting functions: Move and Maneuver, Intelligence, Fires, Sustainment, Command and Control, and Protection. Use of the former naming convention combat, combat support, and combat service support is continued in this chapter because of familiarity of use until more definitive guidance is published on the correlation to the war fighting functions.

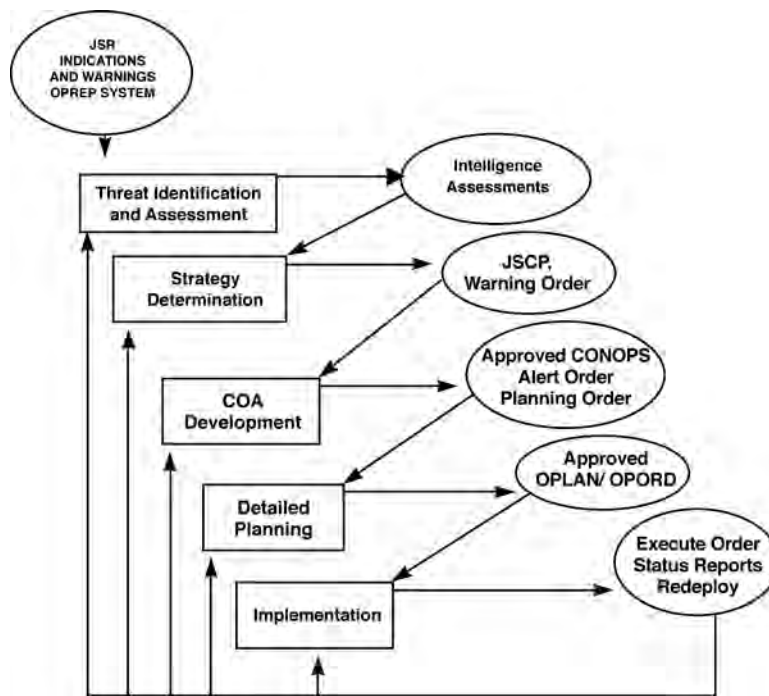

Figure 6-3. Functional process major inputs and output

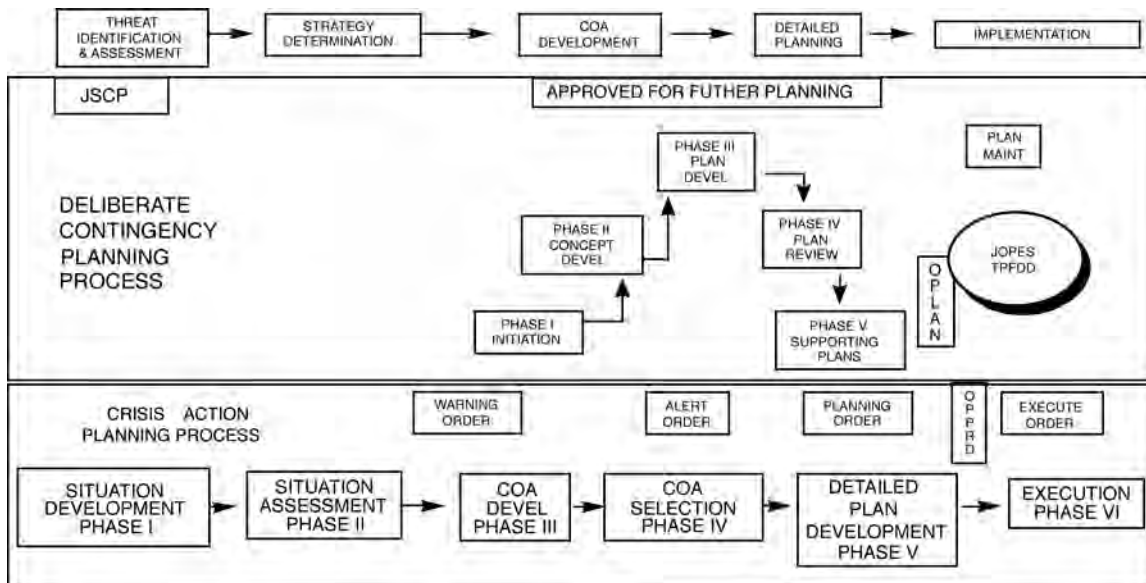

Figure 6-4. JOPES relational functions

**6-4. Deliberate contingency planning**

a. *Applicability of JOPES.* This section describes the applicability of JOPES to contingency planning, describes the contingency planning process for OPLANs, outlines responsibilities and recommended time requirements for the planning cycle, and provides guidance for resolving conflicts. JOPES applies to all OPLANs except for the Single Integrated Operation Plan (SIOP) that is prepared with inputs from the Combatant Commanders in response to CJCS requirements. OPLANs are prepared in complete format or in CONPLAN format. Theater engagement plans and campaign plans are also a vital portion of the contingency planning process. All are described below:

(1) *Operation plans (OPLAN).* An OPLAN is a complete and detailed plan for the conduct of joint military operations. Prepared by the Combatant Commander, it includes a full description of the concept of operations and all

annexes applicable to the plan. It identifies the specific forces, functional support, and resources required to execute the plan and provide closure estimates for their movement into the theater. An OPLAN can be quickly developed into an OPORD. OPLANs are normally prepared when the contingency is critical to national security and requires detailed prior planning or when detailed planning will contribute to deterrence by demonstrating readiness through planning. In some cases detailed planning is required to support alliance or combined planning. OPLANs also facilitate the transition to war and, through the development of supporting plans; establish the feasibility of the plan's concept of operations. OPLANs usually discuss the Combatant Commanders desired end state and include as a phase or sequel the transition to post hostility operations.

(2) *Concept plans (CONPLANs)*. A CONPLAN is an OPLAN with or without time-phased force and deployment data (TPFDD) in an abbreviated format that would require considerable expansion or alteration to convert it into an OPLAN or OPORD. A CONPLAN contains the Combatant Commanders strategic concept and those annexes and appendixes deemed necessary by the Combatant Commander to complete planning. CONPLANs with TPFDD require more detailed planning for the phased deployment of forces. Supporting plans are prepared as tasked by the supported Combatant Commander in support of their contingency plans. As a rule, detailed support requirements are not calculated and TPFDD files are not prepared.

(3) *Functional plans*. The Combatant Commanders develop plans involving the conduct of military operations in a peacetime or permissive environment. Examples include plans for disaster relief, peacekeeping, nation assistance, logistics, communications, surveillance, and protection of U.S. citizens, nuclear weapon recovery and evacuation, and continuity of operations. Requirements for these plans should be satisfied by command publications. An example is the United States USAREUR Reconstitution Plan. Unless specifically directed, no requirement exists to submit these plans to the JS for review and CJCS approval, but information copies will be submitted to the JS, J-7, for internal JS distribution. Although the planning procedures and formats prescribed in JOPES, Volume II, are not mandatory for such plans, they may be useful.

*b. Campaign planning*. Campaign planning is the process whereby Combatant Commanders and subordinate JTF commanders translate national and theater strategy into operational concepts through the development of campaign plans. Campaign planning may begin prior to or during contingency planning when the actual threat, national guidance and resources become evident, but is not completed until the Combatant Commander and CJCS provide recommended courses of action to the President and SecDef and they select the course of action during crisis action planning. Campaign planning is normally conducted when contemplated military operations exceed the scope of a single major joint operation.

*c. Deliberate contingency planning process for OPLANs.*

(1) Conducted primarily during peacetime, contingency planning is designed as a cyclic process that involves the entire JPEC in a coordinated effort to develop and refine plans to be used in wartime. In its basic form, contingency planning has five formal phases (Figure 6-5). These phases produce a family of plans (the supported commander's plan, supporting plans, and plans designed for concurrent execution).

(2) Forces and sustainment requirements are developed by the supported commander, tasked by OSD and resourced by the Services, supporting commanders, and Defense agencies. The resourced forces and sustainment requirements requiring common-user lift are time-phased by the supported Combatant Command and scheduled for movement by USTRANSCOM. The supported commander prepares the various annexes that provide detailed guidance to supported command components and subordinate commanders. The supported commander is authorized to task supporting commands and DOD agencies to participate in the planning process to include submitting supporting plans, as required. The supported command may also request JS assistance in gaining planning support from agencies outside the DOD. Supporting commands and agencies should be informed of support requirements as early as possible in the planning process. OPLANs must be thoroughly coordinated. The format and content for an OPLAN are prescribed in CJCSM 3122.03C, JOPES, Volume II.

*d. Deliberate contingency planning process for CONPLANs.* The planning process for CONPLANs is the same as for OPLANs, except that the CONPLAN process normally omits the resource detail developed in the Plan Development Phase. The format and content for a CONPLAN are prescribed in CJCSM 3122.03C, JOPES, Volume II.

*e. Planning cycle responsibilities and time requirements.* JOPES uses a planning cycle that begins when the JS, in the name of the CJCS, publishes the JSCP and planning schedules and terminates at the end of the period to which the JSCP applies. The JS also reviews OPLANs, CONPLANs, and FUNCPLANs prepared by the Combatant Commands in accordance with provisions of Enclosures C and D, CJCSM 3122.03C. The JSCP provides guidance, assigns tasks, apportions major combat forces, and specifies items of materiel and lift assets available for planning. Following publication of the JSCP, the JS, in coordination with the Combatant Commands, will produce an initial planning schedule for the development of the OPLANs and concept summaries tasked in the JSCP. The initial planning schedule will be disseminated by message and will set forth established OPLAN submission and, if required, plan refinement conference dates. All Combatant Commanders' plans will be forwarded to the JS for CJCS and SecDef review and approval. CJCS and SecDef review and approval is also required for selected Tier 3 CONPLANs, Consequence Mgt, and anti-terrorism plans. Tier 4 FUNCPLANs Peacekeeping Operations (PKO), Noncombatant Evacuation Operations (NEO), etc) are reviewed and approved at the Combatant Command level. Upon receipt and after analysis of JSCP tasking and planning guidance, supported commanders develop new OPLANs, request permission to cancel approved

## How the Army Runs

plans no longer meeting JSCP requirements, or revise existing plans to conform to current JSCP and CJCS tasking. Canceled plans must be retained on file for a two-year period. Upon expiration of the two-year period, the record copy of the OPLAN (less TPFDD file) or CONPLAN specified as the permanent record will be retired to the applicable Federal records center. Records so retired will be marked with appropriate instructions to ensure their protection against improper release in accordance with CJCSI 5714.01C, Policy for the Release of Joint Information. If the requirement for an existing OPLAN is not changed by the JSCP taskings, the supported commander should review the plan to determine whether it is still sufficient and can still pass the tests of acceptability, feasibility, adequacy, and consistency with joint doctrine. If the plan still sufficiently passes these tests, the taskings may be satisfied by a message to the CJCS stating that the plan has been reviewed, analyzed, and can still meet the JSCP taskings. If the CJCS review results in concurrence, a CJCS message or memorandum will approve the plan for the appropriate JSCP period.

*f. Conflicting guidance.* Combatant Commanders who are also commanders of combined commands or who conduct coordinated planning on a bilateral or combined basis will report to the CJCS any conflicts between the guidance contained in JOPES and directives received from international authorities or provisions of any plan established by international agreement. The Chairman, U.S. Section, Canada-United States Military Cooperation Committee, will report to the CJCS any conflicts between plans developed by the committee and the guidance in JOPES. In all cases, the provisions in JOPES will have precedence pending resolution of the conflict.

*g. Deliberate contingency planning procedures.* Procedures for contingency planning are designed to assist the planning community in the timely, efficient development of OPLANs and to provide a consistent framework for the planning process. The contingency planning process phases and procedures are as shown in Figure 6-5 and 6-6. A detailed discussion of the requirements of each phase follows:

(1) *Phase I—Initiation.* Initiation is the phase in which planning tasks are assigned, resources available for planning are identified, and the groundwork is laid for planning.

(a) *Task assignment.* In the JSCP, the CJCS tasks the Combatant Commanders to develop OPLANs and concept summaries. When a message or other directive issues such taskings, they will normally be incorporated into the next edition of the JSCP. The extent of Combatant Commanders' planning is not limited by JSCP taskings. Each Combatant Commander has broad responsibilities assigned in the Unified Command Plan (UCP) and Joint Pub 0-2, Unified Action Armed Forces (UNAAF) July 10, 2001 and may prepare whatever plans are necessary to discharge those responsibilities. The Combatant Commander may decide to prepare an OPLAN not required by the JSCP that would task forces not apportioned to the affected theater. However, the Combatant Commander will submit the requirements for the plan to the CJCS for approval before preparing the plan.

(b) *Resources.* The JS and the Services identify resources and provide guidance to the supported commander. The JSCP, other JSPS documents, joint doctrine, and Service planning documents provide the following:

- Strategic intelligence and guidance.
- Service doctrine and guidance.
- Resources available for planning.
- Priorities for accomplishing tasks.

(c) *Review of previous operations.* The Joint Center for Lessons Learned (JCLL), as well as the Joint Utilization Lessons Learned System (JULLS) database, should be queried early in the planning process and periodically thereafter to obtain specific practical lessons in all areas of planning and execution based on actual operation and exercise occurrences. A regular review of this information during plan development can alert planners to known pitfalls and highlight successful and innovative ideas.

(2) *Phase II—Concept development.* Concept development is the phase in which all factors that can significantly affect mission accomplishment are collected and analyzed, the mission statement is deduced, subordinate tasks are derived, courses of action are developed and analyzed, the best course of action determined, and the Combatant Commander's Strategic Concept developed and documented.

(3) *Phase III—Plan development.*

(a) Plan development is the phase in which the basic OPLAN, CONPLAN and supporting annexes are prepared. Upon receipt of the approved concept of operations, the supported commander prepares the OPLAN or CONPLAN in the format prescribed in CJCSM 3122.03C, JOPES Volume II, and submits it to the CJCS for formal review and approval.

(b) During this phase, the supported commander publishes guidance in a memorandum of instruction (MOI); the force list is structured; non-unit-related materiel, non-unit-related personnel, noncombatant evacuation order and medical evacuees, enemy prisoners of war (EPW), retrograde cargo, and transportation requirements are determined; the nuclear, civil engineering, and medical support planning is conducted; the TPFDD file is developed; shortfalls are identified; transportation feasibility is determined; and all the elements of the plan are documented for TPFDD refinement and preparation of the plan for submission to the CJCS for review and approval.

(c) At the beginning of the Plan Development Phase, the supported commander publishes a letter of instruction (LOI). The purpose of the LOI is to provide specific guidance to the Combatant Commander's service component

commanders and supporting commands and agencies on how to develop the plan. The LOI should be coordinated with affected organizations (e.g. USTRANSCOM or Defense Logistics Agency (DLA) (see para 12–10)) prior to publication to ensure that the planning guidance is current. The LOI should contain the supported commander’s classification and Operational Security (OPSEC) (see para 21–10) planning guidance.

(4) *Phase IV–Plan review.* In this phase, all elements of the OPLAN, CONPLAN, and Concept Summary are assessed and validated. The JS, in coordination with the Services and appropriate Defense agencies, reviews OPLANs, CONPLANs, and Concept Summaries in accordance with the procedures in CJCSM 3122.01A JOPES Volume 1.

(5) *Phase V–Supporting plans.* In this final phase, all required supporting plans are completed, documented, and validated. Supporting plans, when required by the supported commander, will be submitted by the supporting command or agency to the supported commander within 60 days after CJCS approval. Information in the supported plan need not be repeated in the supporting plan unless it is so directed by the supported commander. In the absence of JS instructions to the contrary, the supported commander will review and approve supporting plans.

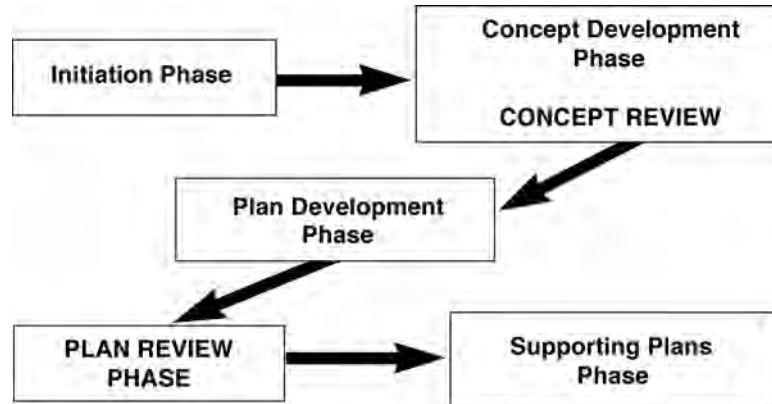

Figure 6-5. JOPES deliberate contingency planning

Figure 6–5. JOPES deliberate contingency planning

Deliberate Contingency Planning	
PHASE I	<b>INITIATION</b> - Combatant Cdr Receives Planning Task From CJCS - Major Forces Available For Planning
PHASE II	<b>CONCEPT DEVELOPMENT</b> - Mission Statement is Deduced - Subordinate Tasks Are Derived - Combatant Cdr Strategic Concepts Are Developed The Product: A Concept of Operations
PHASE III	<b>PLAN DEVELOPMENT</b> - Forces Selected and Time Phased - Support Requirements Computed - Strategic Deployments Simulated / Analyed - Shortfalls Identified and Resolved - Operation Plan Completed The Product: A Complete Plan
PHASE IV	<b>PLAN REVIEW</b> - OPLAN / CONPLAN Reviewed & Approved By CJCS - Combatant Cdr Revises Plan / Based on Review Comments The Product: An Approved Plan
PHASE V	<b>SUPPORTING PLANS</b> - Supporting Plans Prepared

Figure 6-6. Deliberate contingency planning process

Figure 6–6. Deliberate contingency planning process



### 6-5. Crisis action (time sensitive) planning (CAP)

a. This paragraph and paragraphs 6-6 and 6-7 describe how the basic planning process is adapted and employed to plan and execute joint operations in crisis situations. Crisis is defined within the context of joint operation planning and execution as an incident or situation involving a threat to the United States, its territories, citizens, military forces, and possessions or vital interests that develops rapidly and creates a condition of such diplomatic, economic, political, or military importance that commitment of U.S. military forces and resources is contemplated to achieve national objectives.

b. An adequate and feasible military response to a crisis demands a flexible adaptation of the basic planning process that emphasizes the time available, rapid and effective communications and the use of previously accomplished contingency planning whenever possible. In time-sensitive situations, the JPEC follows formally established CAP procedures to adjust and implement previously prepared contingency plans or to develop and execute OPODs where no useful contingency plan exists for the evolving crisis. CAP procedures provide for the rapid and effective exchange of information and analysis, the timely preparation of military courses of action for consideration by the President and SecDef, and the prompt transmission of their decisions to supported commanders (Figure 6-7). The CJCS or Combatant Commander may adjust the CAP cycle based on the urgency of the situation for issuing the Warning Order or Planning Order. Only the President and SecDef may issue the Alert Order and the Execute Order based on their approval of course(s) of action.

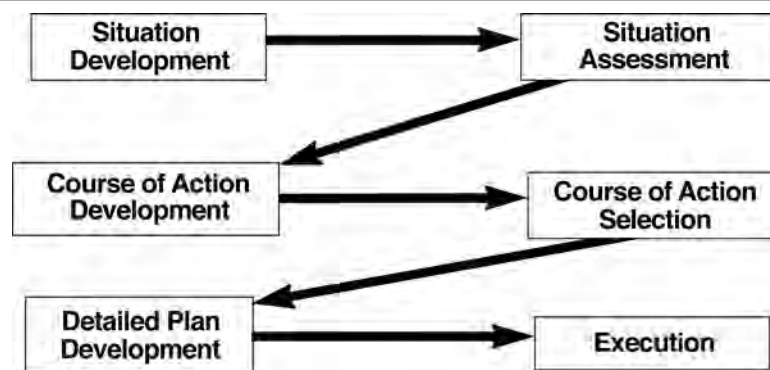

Figure 6-7. JOPES crisis action planning

### 6-6. Relationship to deliberate contingency planning

CAP procedures provide for the transition from peacetime operations to military operations in a peacetime or permissive environment or war. Contingency planning supports crisis action planning (CAP) by anticipating potential crises and operations and developing contingency plans, which facilitates the rapid development and selection of a course of action and execution planning during crises. Contingency planning prepares for a hypothetical crisis based on the best available intelligence and using forces and resources projected to be available for the period during which the plan will be in effect. It relies heavily on assumptions regarding the political and military circumstances that will exist when the plan is implemented. These ambiguities make it improbable that any contingency plan will be usable without modification as a given crisis unfolds. Every crisis situation cannot be anticipated. However, the detailed analysis and coordination accomplished during the time available for contingency planning can expedite effective decision-making and execution planning as assumptions and projections are replaced with facts and actual conditions. CAP procedures provide the means to respond to any crisis within a constrained time frame. CAP routinely includes the consideration and exploitation of deliberate contingency planning.

### 6-7. Crisis action planning phases

a. *Planning sequence.* Because crises are fluid and involve dynamic events, planning procedures must be flexible. The activities of the JPEC are keyed to the time available and the significance of the crisis. Planning procedures describe a logical sequence of events beginning with the recognition of a crisis and progressing through the employment of U.S. military forces. Several points are identified in this sequence where key activities (or decisions) are required:

(1) *Phase I–Situation development.* An event with possible national security implications occurs, is recognized, and reported.

(2) *Phase II–Situation assessment.* The diplomatic, military, economic, and political implications of the crisis are

weighed and FDOs are developed. A decision is made on the possible requirement for a military force. Current strategy and applicable operations plans are reviewed.

(3) *Phase III—Course of action development.* Combatant Commands are tasked, or a Combatant Commander is tasked to develop and recommend courses of action, or the President and SecDef may develop their own course of action. The CJCS is the principle advisor to the President and SecDef for recommending a particular course of action.

(4) *Phase IV—Course of action selection.* The President and SecDef select the course of action.

(5) *Phase V—Execution planning.* A detailed operation order is prepared to support the selected course of action. The level of detail is proportional to the time available for planning. Combatant Commanders also develop branches or sequels to their OPORD as a result of the CAP process.

(6) *Phase VI—Execution.* The decision of the President and SecDef to deploy or employ U.S. Forces is implemented. CAP phases are further defined in the remaining paragraphs of this section. Through the inherent flexibility of CAP, the time spent in each phase depends on the nature of the crisis.

*b. Post-execution activities.* Post-execution requirements (including preparing detailed after-action reports, assessing results, developing lessons learned, declassifying material, releasing information, and preparing follow-on plan reviews) will be as directed by the CJCS.

*c. Operation plans.* In a crisis, existing OPLANs or CONPLANs are reviewed for applicability to the situation at hand. Using CAP procedures, applicable existing plans are expanded or modified to fit the situation. If no existing plan applies, CAP procedures are followed to build an OPORD.

*d. Joint planning and execution community responsibilities.* Many organizations are involved in planning during a crisis. The composition of the JPEC and roles of members are described below.

*e. Chairman of the Joint Chiefs of Staff (CJCS).* The CJCS is the principal military adviser to the President, the National Security Council (NSC), and the SecDef. The CJCS manages the planning process; provides advice, options, and recommendations to the President and SecDef; and conveys President and SecDef decisions to the Combatant Commanders. More specifically, the CJCS receives and analyzes reports, tasks commanders to prepare estimates and courses of action, reviews those estimates and courses of action, resolves conflicts and shortfalls or seeks resolution from the President and SecDef, and monitors the deployment and employment of forces. The CJCS and Combatant Commanders have the flexibility to modify particular portions of the process depending on the situation. The President and SecDef have the final responsibility and authority in a crisis. The President and SecDef approve a course of action and authorize the major actions to be taken, including the deployment, employment, or redeployment of forces. Authority to conduct military operations against a potential enemy, as delineated in the JSCP, rests solely with the President and SecDef, except as authorized under the applicable rules of engagement.

*f. Joint Chiefs of Staff.* The other members of the JCS are military advisers to the President, the NSC, and the SecDef. A member of the JCS (other than the Chairman) may submit to the Chairman advice or an opinion in disagreement with, or advice or an opinion in addition to, the advice presented by the Chairman to the President, the NSC, or the SecDef. Additionally, the members of the JCS, individually or collectively, in their capacity as military advisers provide advice to the President, the NSC, or the SecDef on a particular matter when requested. The VCJCS plays a critical role during the CAP process and frequently acts on behalf of the CJCS at key interagency Policy Coordinating Committee meetings. These meetings take place in a parallel manner to the Military CAP.

*g. Supported commander and service component commanders.* The supported commander, designated by the CJCS, has the primary responsibility for responding to a crisis. The supported commander is usually the commander of the unified command of the geographic area in which the crisis occurs. As soon as the supported commander becomes aware that a military response may be needed, course of action development begins and the supported commander provides an estimate of the situation to the CJCS. In developing courses of action, the supported commander will consult with and task the commanders of subordinate components, sub combatant commands, or JTFs. If time permits, the Service component commands will develop the Service aspects of the concept, determine force and resource requirements, and build TPFDD files to implement appropriate concepts. The Service component commands will also work within Service channels to identify CS and CSS forces, critical materiel, sustaining supplies, filler and replacement personnel, and RC asset availability. Throughout the crisis, the supported commander will ensure that continuous communications are maintained with the supporting commanders concerning present requirements and anticipated future actions that might affect or necessitate additional support. The supported or supporting Combatant Commander may request additional ADP support (e.g. GCCS terminals) through the JS during the CAP.

*h. Supporting commanders.* Supporting commanders are designated by the CJCS. Relationships between the supported and supporting commander will be in accordance with Joint Pub 0-2 (UNAAF). Supporting commanders determine their ability to support each of the proposed military courses of action and identify the actual units and associated movement data. Additionally, when supporting commanders provide lift assets in support of a course of action, they will provide deployment estimates and schedules for non-USTRANSCOM assets.

*i. Services.* The Services are responsible for mobilizing and calling up RC forces when authorized; providing units, individual fillers, and replacement personnel; and sustaining deployed forces.

*j. Commander, USTRANSCOM and components.* As a supporting commander, the Commander, USTRANSCOM is responsible for the transportation aspects of worldwide strategic mobility planning (contingency and crisis) and

## How the Army Runs

centralized wartime traffic management, including developing and operating the deployment elements of the crisis action planning and execution system; receiving, evaluating, and coordinating global strategic mobility requirements in support of the other Combatant Commands; optimizing the use of transportation capability; and validating service component TPFDD.

*k. Other supporting agencies.* Combat support agencies such as the Defense Intelligence Agency (DIA), Defense Information Systems Agency (DISA), DLA, National Geospatial-Intelligence Agency (NGA), National Security Agency (NSA); and other U.S. Government agencies, such as the Department of State (DOS), Central Intelligence Agency (CIA), Department of Transportation (DOT), U.S. Coast Guard (USCG), and the Federal Emergency Management Agency (FEMA) play important roles as part of the planning community in developing, evaluating, selecting, and executing military courses of action. These agencies provide information vital to decisions made by the President and SecDef and should be considered early in the planning process. Other agencies supply materiel, personnel, or other resources to support the military forces.

*l. The interagency process.* Concurrent to the military CAP process discussed in this section, there is an informal Interagency Process that takes place to ensure the other components of national power (Political, Economic and Informational) are integrated into a national crisis. The interagency group may contain many functional capabilities from throughout the executive branch. The purpose of the interagency process is to provide recommended courses of action to the President and lead agency Director (e.g. Secretary of State, Secretary of Homeland Security).

(1) The interagency planning group conducts Policy Coordination Committees (PCC) that develops policy options and positions for the President to use during a crisis. This group is non-standard in composition but usually consist of DOS, NSC, Department of Homeland Security, Department of Justice (DOJ), Department of Treasury (DOT), the FEMA and the DOD.

(2) Other agencies may be invited to PCC as directed by the lead agency.

(3) The President through the NSC normally directs the lead agency.

(4) The DOD usually sends a representative from OSD. OSD may also require that a representative from the JS be present at the PCC. An example of a proposed interagency crisis action planning process is shown in Figure 6–8. There is no formal doctrine developed for the Interagency CAP by the NSC; however, this figure closely resembles models used during previous national crises. Section III Adaptive Planning (AP) and the Adaptive Planning and Execution (APEX) System This section on AP and APEX, except for Figure 6–9, was taken from A Primer for: Guidance for Employment of the Force (GEF), Joint Strategic Capabilities Plan (JSCP), the Adaptive Planning and Execution (APEX) System, and Global Force Management (GFM) 24 March 2009 by Professor Patrick C. Sweeney, The United States Naval War College, Joint Military Operations Department. Professor Sweeney credits Robert M. Klein's, "Adaptive Planning: Not Your Great Grandfather's Schlieffen Plan," Joint Forces Quarterly 2 Qtr, 2007: 84–6; and the "Adaptive Planning Roadmap II" (March 2008) as his source for the information on Adaptive Planning and the Adaptive Planning and Execution system.

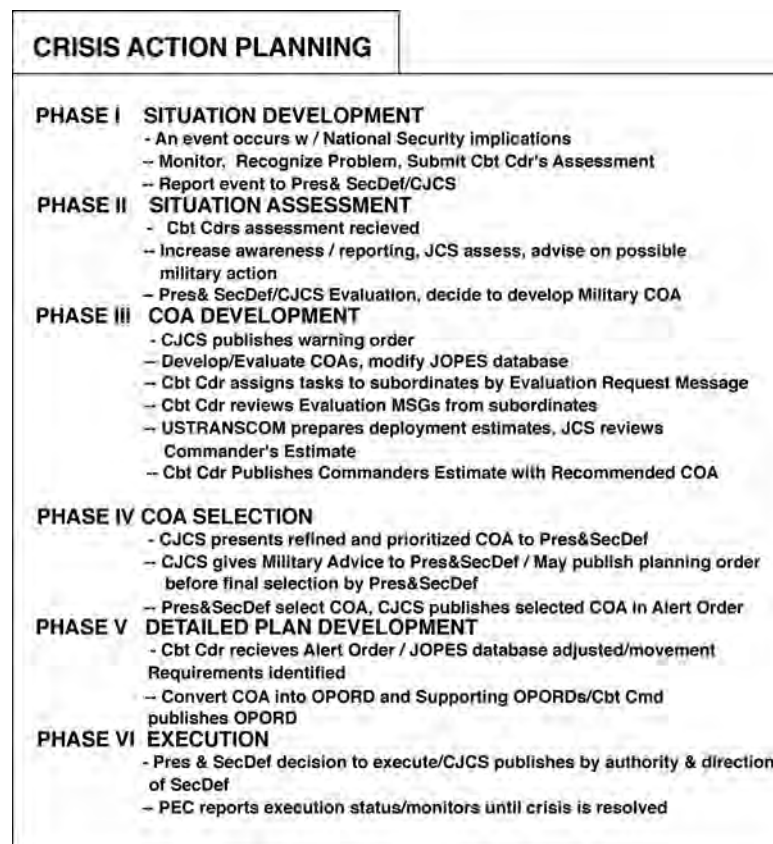

Figure 6–8. Crisis action planning process

## 6–8. Background

*a.* The demands of homeland and global operations warrant revisions to the current planning and execution paradigm. Rapidly changing circumstances and uncertainty define the security environment. The accelerated pace and complexity of military operations requires the President of the United States, SecDef, CJCS, and CCDRs have the ability to respond quickly to dynamic threats and challenges. The fluid and uncertain international situation requires a transformed planning and execution capability (see Figure 6–9), which quickly generates and/or updates detailed plans containing multiple options that can be readily adapted to the given circumstances and then rapidly transitioned to execution. DOD initiated this new approach to planning with the approval of the Adaptive Planning initiative outlined in the first Adaptive Planning (AP) Roadmap on 13 December, 2005. Since the approval of Adaptive Planning Roadmap I in December 2005, the AP initiative has made great strides merging contingency and crisis planning into a single end-to-end planning and execution, “living plans,” construct. AP will provide the foundation for a constellation of Joint and Combined Operations, and living plans designed and resourced to achieve National, Defense, and Military Strategy objectives in a manner that is both militarily and politically acceptable. By approving AP Roadmap II in March 2008, the Secretary of Defense directed the “expeditious transition” of the Joint Operation Planning and Execution System (JOPES) to the Adaptive Planning and Execution (APEX) system. The current “Implementation Stage” of the AP initiative will emphasize the melding of intelligence, logistics and interagency planning into a cohesive APEX system that delivers relevant, comprehensive, and feasible plans.

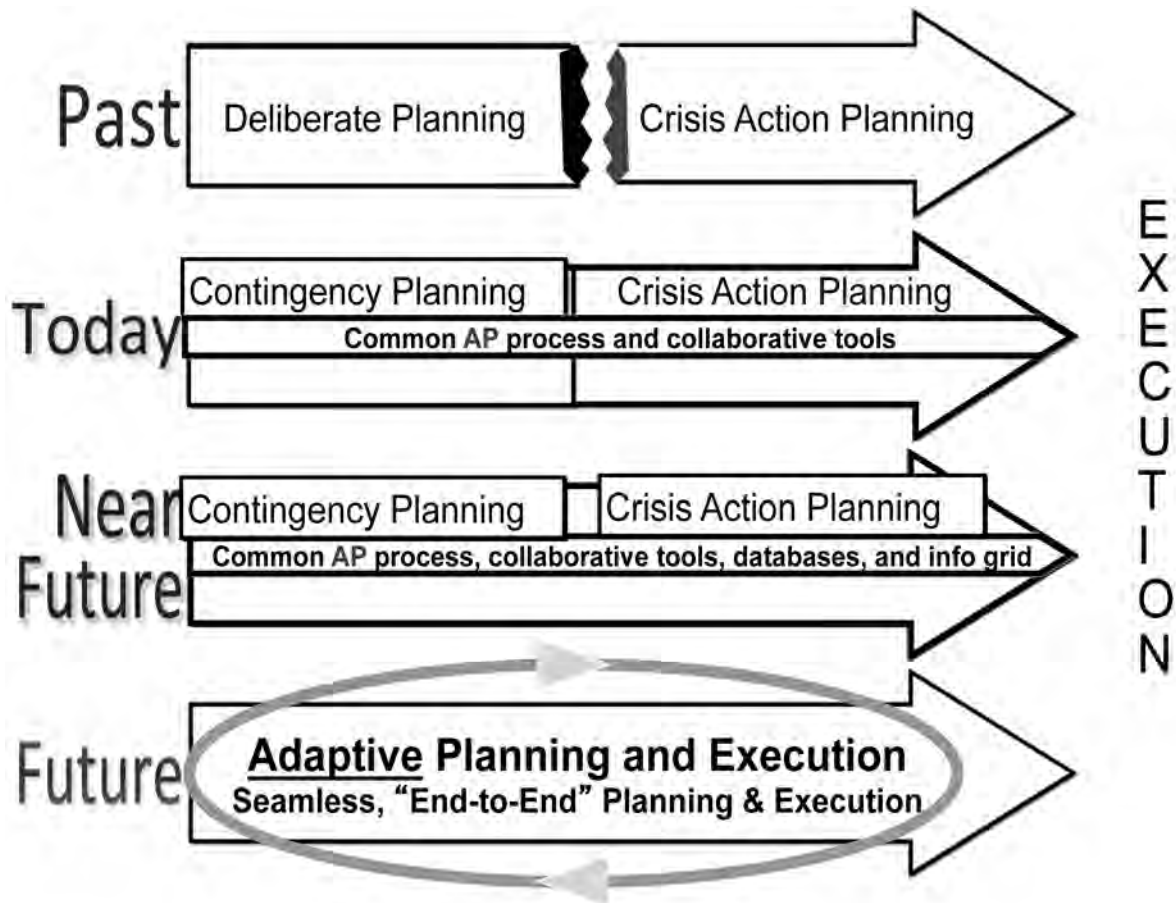

Figure 6-9. Transforming Operational Planning.

b. Adaptive Planning is the joint capability to create and revise plans rapidly and systematically, as circumstances require. It occurs in a networked, collaborative environment, requires the regular involvement of senior leaders, and results in plans containing a range of viable options that can be adapted to defeat or deter an adversary to achieve national objectives. At full maturity, AP will form the backbone of a joint adaptive system supporting the development and execution of plans, preserving the best characteristics of present-day contingency and crisis planning with a common process. AP allows combatant commanders to produce plans more quickly and adaptively and of higher quality. Rapid planning and greater efficiency are achieved through combining multiple stovepipe processes into one common AP process that includes:

- clear strategic guidance and iterative dialogue
- early integrated interagency and coalition planning
- integrated intelligence planning
- embedded options
- living plans
- parallel planning in a network-centric, collaborative environment.

c. The AP initiative has developed into a broader, overarching construct known as the Adaptive Planning and Execution (APEX) system. APEX is a system of joint policies, processes, procedures, and reporting structures supported by communications and information technology that is used by the Joint Planning and Execution Community to monitor, plan, and execute mobilization, deployment, employment, sustainment, redeployment, and demobilization activities associated with joint operations. APEX is the joint capability to create and revise and execute situational relevant plans rapidly and to a higher level of quality. APEX seeks to leverage:

- near-continuous collaboration
- frequent senior-subordinate consultation
- parallel multi-level and multi-functional planning
- expeditious plan reviews
- web-based data networking
- integrated or interoperable tools Portions of APEX are already in practice, such as the inclusion of In-Progress Reviews by CCDRs with the SecDef during the plan development process (see Figure 6–10.)

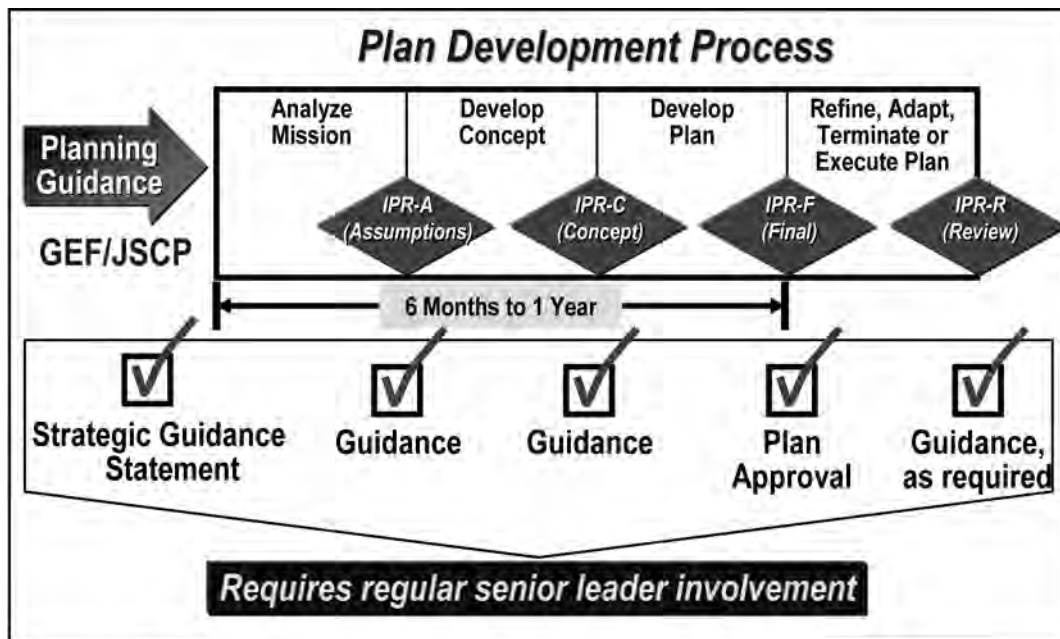

Figure 6-10. In-Progress Review (IPR) during plan development.

Figure 6–10. In-Progress Review (IPR) during plan development

d. APEX’s comprehensive end-to-end approach includes the streamlining of strategic guidance (GEF/JSCP) as the “up front” piece to planning as well as the “backend” plan assessment piece. Additionally, APEX integrates various department processes such as Global Force Management, Defense Readiness and Reporting System, Logistics, Transportation, and Intelligence, all necessary elements to inform CCDR “Living Plans” (see Figure 6–11).

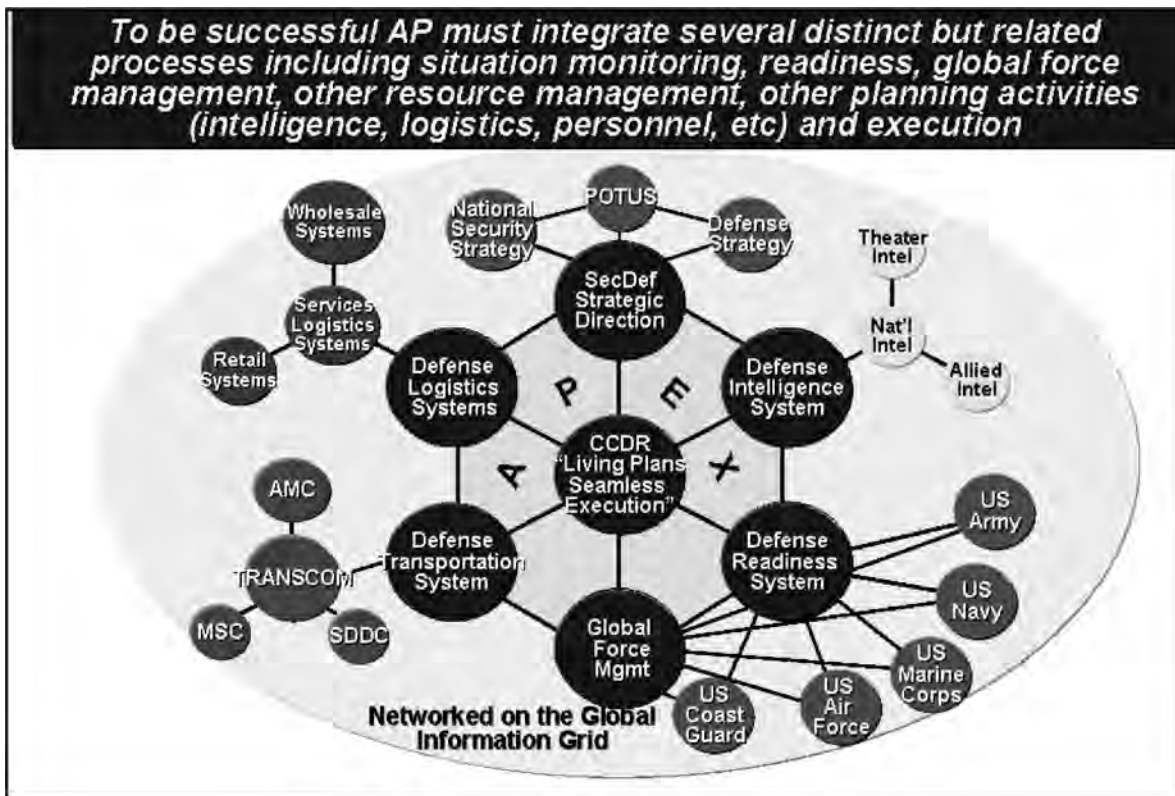

Figure 6-11. APEX integrates several processes that influence planning.

**Figure 6-11. APEX integrates several processes that influence planning**

e. Other initiative principles have been incorporated into the current Joint Publications and JOPES volumes. They consists of a multi-volume set of Chairman of the Joint Chiefs of Staff Manuals (CJCSM 3122 series) that specifies policies, procedures, and reporting structures supported by communications and computer systems for planning mobilization, deployment, employment, sustainment, redeployment and demobilization of joint forces and supporting technology. These CJCSMs will be retitled APEX volumes at their next update and rewritten to complete the transition from the legacy system to the Adaptive Planning and Execution system. At full implementation, the APEX system will provide a single planning process encompassing both contingency and crisis action planning through execution (called the APEX process) and will establish and facilitate through Doctrine Organization Training Material Leadership Personnel Facilities (DOTMLPF) actions a constellation of joint operations, military activities, and living plans integrated with living databases designed and resourced to achieve the objectives of the National Security, Defense and Military Strategies in a manner that is both militarily and politically acceptable. 6.10 Assumptions for Integration of Planning and Execution JP 5-0, Joint Operation Planning and CJCSM 3122.01A, Joint Operation Planning and Execution System (JOPES) Volume I, Planning Policies and Procedures, were revised in late 2006 to codify many of the changes to the existing processes brought about with the AP initiative and establish a framework for continued AP refinement and implementation. Future revisions of Joint and Service doctrine and the JOPES manuals will further incorporate AP vision and principles. This will assist in bringing the Department closer to the desired end state of a fully implemented and integrated APEX process. Assumptions used in developing the APEX process include:

- (1) Planning never stops until a plan / OPORD is rescinded and/or the operation is terminated.
- (2) Execution requires the comparable categories of information as planning, but with greater detail, refined fidelity and speed.
- (3) To achieve the essential unity of action in execution, early and continuous dialogue between DOD planners and those from other Depts. and Agencies is essential to successful planning and execution.
- (4) The speed of planning during execution for continuing and potential operations is critical.
- (5) Operations and intelligence officers, logisticians and planners will be closely integrated.
- (6) Information Technology (IT) will assist in collection of disparate data to form actionable information.

- (7) Where applicable, automated “flags” will assist in:
- (a) Plan update and maintenance to form “living plans.”
  - (b) Confirmation and/or replacement of planning assumptions with current intelligence and operational Mission, Enemy, Terrain and weather, Troops and support available–Time available, Civil Considerations (METT–TC) factors.

### Section III

#### Army mobilization

#### 6–9. Framework for mobilization planning

a. The DOD Master Mobilization Guide (MMG) provides the framework for mobilization planning within the DOD. The MMG provides a conceptual overview of the DOD mobilization planning process and its relationship to the development of military operations plans. It also provides a basis for making mobilization decisions within the DOD and managing the mobilization process to support military operations.

b. Army participation in joint operations planning and Army planning for mobilization must be integrated processes. Joint Pub 4–05, Joint Mobilization Planning, facilitates integration of these processes by identifying the responsibilities of the JS, Services, Combatant Commands, transportation component commands, and other agencies engaged in mobilization planning. The mobilization annex of the JSCP guides the Army and Combatant Commands in preparing mobilization plans.

c. AR 500–5, *Army Mobilization*, incorporates DOD and CJCS mobilization planning guidance in a single Army publication. It recognizes the close relationship between operations planning and mobilization planning. It provides the means, within the Army, to accomplish both in a coordinated manner.

d. The mobilization plans of ACOMs and agencies, together with those of HQDA, constitute the Army Mobilization Plan (Figure 6–12). AMOPES is the vehicle by which all components of the Army plan and execute actions to provide and expand Army forces and resources to meet the requirements of combatant commands. AMOPES serves as the Army supplement to the Joint Operation Planning and Execution System. It provides the interface between the Army’s plans to provide forces and resources and the combatant commander’s plans to deploy and use them. It also provides a standard set of guidelines for developing these plans and an integrated structure for the planning products.

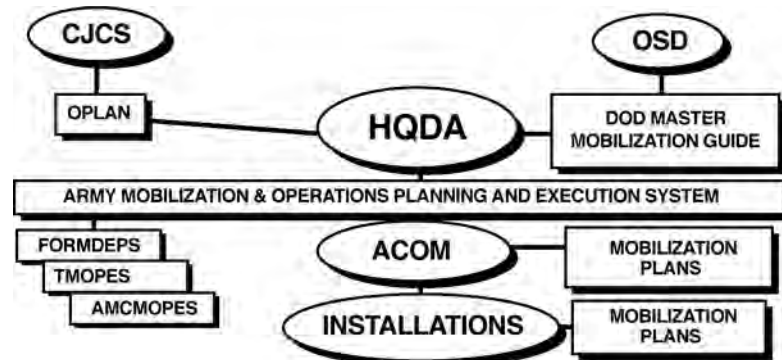

Figure 6–12. Army mobilization planning

#### 6–10. AMOPES overview

a. *AMOPES*. AMOPES ensures that the Army plans and executes actions necessary to provide the forces and resources to meet requirements of the Combatant Commander. It covers a wide range of general functions covering the full course of a military action, conflict, or war. These functions include training, exercises, mobilization, deployment, employment, and sustainment, expansion of forces beyond the approved force structure, redeployment, demobilization, and reconstruction of Army forces. The goal of AMOPES is to ensure that the Army can adequately support all future combat operations of the Combatant Command, as opposed to concentrating only on getting forces into the theater of operations. AMOPES is also adaptable for planning military operations in a peacetime or permissive environment. The system is not just a planning system but also an execution system. The use of OPLAN format, with functional annexes and appendices, emphasizes the operational nature of the system.

b. *Required mobilization plans*. Each of the following commands/activities will prepare mobilization plans, to include deployment, redeployment, demobilization, and reconstitution actions when appropriate. Mobilization plans of ACOMs, Army components of combatant commands and other Army elements as indicated by the DCS G–3/5/7



## How the Army Runs

HQDA are forwarded to HQDA for review prior to publication. Plans will be prepared in accordance with guidance contained in the AMOPES basic plan and the following annexes:

- ACOMs
- Army components of combatant commands
- Mobilization stations (Power Projection Platforms/Power Support Platforms) (PPP/PSP)
- Support installations (AR 5–9, Area Support Responsibilities)
- Staff support agencies and field operating agencies

*c. Mobilization files.* Mobilization files in place of plans will be maintained as directed by Commander, FORSCOM or the Commanders of EUSA, USAREUR, USASOC, or USARPAC. The latter commands will use FORSCOM guidance to develop mobilization files.

*d. The Army mobilization plan.* The Army mobilization plan is a collection of individually published mobilization plans of the ACOMs, Army components of combatant commands, and other designated Army elements. The Army mobilization plan currently consists of Volume I through Volume XIX. AR 500–5 further amplifies responsibility for each volume.

### 6–11. Mobilization planning responsibilities

*a. Deputy Chief of Staff G–3/5/7.* Army Staff organization responsible for developing Army mobilization and operations policy and guidance; developing priorities for mobilization of RC units; directing the call-up of RC units and preparing them for deployment; and establishing, publishing, and maintaining AMOPES. The AMOPES responsibilities include coordinating the structure and content of AMOPES with ARSTAF, ACOM, and other Army activities; tasking agencies and commands to prepare appropriate portions of AMOPES; reviewing agency and command mobilization plans; and ensuring AMOPES guidance, policies, and products satisfy applicable OSD and CJCS guidance and are updated biennially, as a minimum, but not later than 45 days after publication of the JSCP.

*b. Principal DA officials and Army Staff agencies.* Each agency is responsible for assisting the DCS G–3/5/7, HQDA, in developing and maintaining those portions of AMOPES pertaining to their respective areas of interest and for mobilization and operational planning activities within their respective functional areas. They disseminate additional guidance to staff support agencies and field operating agencies (FOA) on related matters in development of mobilization, deployment, redeployment, demobilization, reconstitution plans and other matters. They review and approve mobilization plans of their respective staff support agencies and FOA.

*c. ACOMs.* Each ACOM is responsible for assisting the DCS G–3/5/7, HQDA, in developing and maintaining those portions of the AMOPES pertaining to their respective mission areas. ACOMs are also responsible for mobilization and operations planning within their respective mission areas and for publishing a command mobilization plan as a volume of the Army Mobilization Plan. Such plans will be submitted to HQDA for review and approval prior to publication. ACOMs are also responsible for compliance with the guidance and procedures published in the AMOPES.

*d. Specific responsibilities.*

(1) FORSCOM is the DA executing agent for CONUS unit mobilization, deployment, redeployment, demobilization, and reconstitution planning and execution. FORSCOM also develops the FORSCOM Mobilization and Deployment Planning System (FORMDEPS) that standardizes policies and procedures for all Army mobilization efforts for CONUS based Army forces in support of approved military operations.

(2) USASOC and USARC are responsible for the alert notification of all RC special operations forces (RCSOF) units to include mobilization, validation, deployment, redeployment and demobilization for wartime or other assigned missions. USASOC provides follow-on personnel and equipment to sustain RCSOF units and individual replacements provided to the Combatant Commands.

(3) TRADOC acts as HQDA executive agent for CONUS Replacement Center (CRC) operations. TRADOC establishes and operates CRCs that receive and prepare individuals and replacement personnel for onward movement. TRADOC establishes procedures and ensures the training base infrastructure can be rapidly expanded to support contingency operations and that individual ready reserve (IRR) soldiers are properly assessed, trained and processed for onward movement in time of crisis. As part of the AMOPES, TRADOC develops and maintains the TRADOC Mobilization Operation Planning and Execution System (TMOPES).

(4) ACOMS and Army components of combatant commands support HQDA in developing and maintaining AMOPES, and assist FORSCOM units to ensure plans to mobilize, deploy, re-deploy, demobilize, and reconstitute are sound and workable. Memorandums of Understanding will be initiated with FORSCOM, where appropriate, for execution of Army Mobilization functions.

*e. Mobilization planning.* Mobilization, under the concept of graduated mobilization response, is a tool provided to the President and SecDef to respond in varying degrees to crises as they occur. It is the act of preparing for war or other emergencies through assembling and organizing national resources. It is also the process by which the armed forces are brought to a state of readiness for war or other national emergency. It can include ordering the RC to active duty, extension of terms of service, and other actions necessary to transition to a wartime posture. This section provides

an overview of the mobilization process within the framework of the AMOPES, the types of mobilization, and the interface with non-DOD agencies.

(1) *AMOPES major and functional subsystems.* The primary objective of the Army mobilization process is to mobilize, deploy, and sustain the theater force. The major subsystems involved are theater force units, military manpower, and materiel. Supporting these subsystems are a number of interrelated CONUS-based functionally oriented subsystems; principally PPP/PSP, the training base, the logistics structure, the medical structure, and transportation support. These subsystems are interrelated as shown in Figure 6–13 and described in more detail below.

(2) *Theater force.* The theater force consists of theater force units, military manpower (individuals), and materiel apportioned for deployment to the theater of operations. The objective of the theater force units subsystem is to ensure the orderly and timely availability of Army units at ports of embarkation (air and sea) for deployment as prescribed in war plans or as directed by the JS. It also may include new, or un-resourced, units that would be activated on order.

(a) Deployed or designated to support one or more OPLANs by the JSCP and Annex A of the AMOPES. When an emergency arises, the JS alerts CONUS-based active units through FORSCOM channels (through the PACOM Combatant Commander channels for Hawaii and Alaska-based units). Active Army units do not require mobilization; they are either forward positioned or pre-position (PREPO) units which deploy by air to link up with pre-positioned equipment. Units with organic equipment load their equipment and move either to an air or seaport of embarkation. PREPO units turn in equipment that will remain behind, load equipment to accompany troops, load equipment not authorized pre-positioning (NAP) and items that may be short in PREPO, and move to a designated airport of embarkation. PREPO shortages may be shipped by air and/or sea as required by the TPFDD. Units may be deployed from an ongoing smaller contingency operation location to a higher priority large contingency operation at the direction of the President or SecDef.

(b) Army National Guard. During peacetime, the preparation of Army National Guard units for mobilization is the responsibility of the State Governor. Guidance is issued to the Governor by HQDA through the Chief, National Guard Bureau (CNGB) (see Para 9–81), and by FORSCOM and USARPAC to the adjutants general of the States within their area of operation. The State Governor commands ARNG units until they are federalized. Once federalized, ARNG units become AC units under the appropriate ACOM.

(c) Army Reserve. During peacetime, the preparation of Army Reserve units for mobilization is the responsibility of the CG, FORSCOM through the United States Army Reserve Command (USARC); the Commander, USARPAC; and Commander, USAREUR for assigned Army Reserve units. Army Reserve units are usually apportioned to one or more OPLANs or designated to support the CONUS sustaining base. Selected later-deploying units may receive interim assignments to augment a particular element in the CONUS base. Human Resources Command, St. Louis (HRC St. Louis) is responsible for the management and continued training of the IRR and Retired Reserve. These groups provide the largest resource of pre-trained soldiers. HRC St. Louis executes its peacetime mission through direction of the Office of the Chief Army Reserve (OCAR) and, on order of the Deputy Chief of Staff, G–1, orders selected numbers of individuals to active duty.

(d) Unresourced and new units. FORSCOM prepares, in coordination with each supported Combatant Command, a proposed unit activation schedule for each major planning scenario identified in the JSCP. Changes emanating from the Combatant Commander's response to biennial JSCP guidance (TPFDD shortfall), TAA determinations of which units in the required force structure will be un-resourced, and structure changes reflected in Program Objective Memorandum (POM) development will all be considered in the development of the proposed unit activation schedule (UAS). The prioritized activations include additional support units required to sustain the current force. In preparing this activation schedule, close attention is given to recognized equipment availability constraints, particularly major weapon systems. The composition of the proposed UAS and the recommended priorities will be reviewed and approved by HQDA.

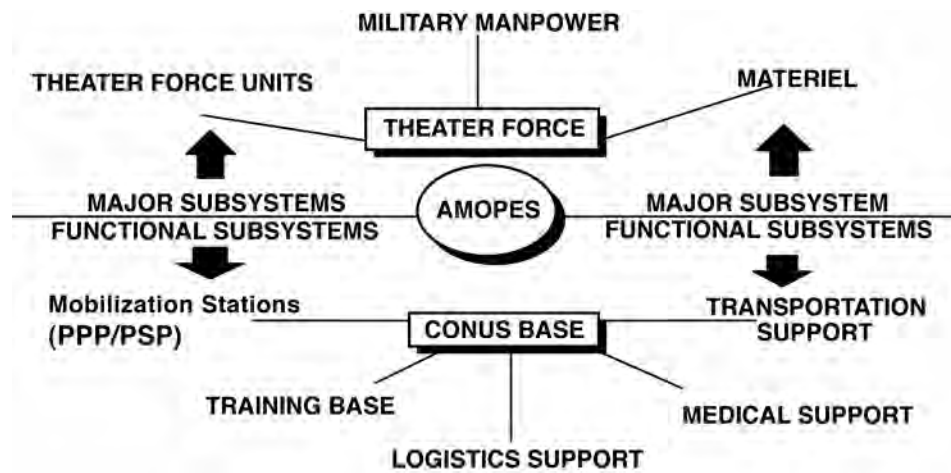

Figure 6-13. AMOPES Subsystems

(e) Military manpower. The objective of the military manpower subsystem is to ensure full and timely use of all available sources of individual military manpower to fill the requirements of theater force units for deployment, sustain the deployed force with trained replacements and provide mobilization augmentation for the CONUS sustaining base.

1. Prior service personnel are grouped generally by their training status. Pre-trained individual manpower (PIM) is a generic term for the following manpower categories: Individual Ready Reserve (IRR), Inactive National Guard (ING), Individual Mobilization Augmentee (IMA), Standby Reserve (SBR), and the Retired Reserve. Qualified individuals in these categories are the primary source of manpower to reinforce AC and RC units during the early phases of mobilization. Unskilled individuals, principally IRR members whose skills have eroded or who were transferred to the IRR in lieu of discharge prior to the completion of initial entry training, will be ordered to an appropriate training center to complete training. Each of these PIM categories is explained further in Chapter 7.

2. Non-prior service personnel include Selective Service inductees, delayed entry enlistees, and volunteer enlistees who, by law, require a minimum of 12 weeks training prior to deployment.

3. Selective Service inductees constitute the largest single source of post-mobilization manpower. Delayed entry personnel are active and reserve enlistees who are high school graduates or students awaiting graduation, and reserve unit members who have completed basic training and are awaiting advanced training.

4. Replacement centers, which process and equip non-unit-related individual replacements, will be established by the Training and Doctrine Command (TRADOC) at sites normally collocated with Army Training Centers. These CONUS replacement centers (CRC) are close to Air Force Air Mobility Command (AFAMC) designated airfields with strategic lift capability. In addition to final preparation of replacements for overseas movement, Preparation for Overseas Replacement (POR) CRCs will issue individual clothing, equipment, and weapons.

(f) Materiel. The objective of the materiel subsystem is to ensure the full and timely availability of adequate military materiel to fill the requirements of theater force units for deployment and to sustain the deployed force in accordance with requirements and priorities.

1. Sources of supplies and equipment include the organic equipment of deploying and non-deploying units, PREPO Unit Residual (left behind) Equipment (PURE) and that equipment scheduled for delivery through procurement and maintenance channels.

2. War reserve materiel stocks (WRMS) consist of military materiel acquired in peacetime to meet military requirements at the outbreak of war until the sustaining production base can be established. WRMS are acquired to meet the war reserve materiel requirement (WRMR) established in the Army guidance.

(g) Mobilization stations or Power Projection Platforms/Power Support Platforms (PPP/PSP). The objective of the mobilization stations subsystem, now called (PPP/PSP), is to ensure the orderly expansion of Army posts, camps, and stations and their ability to receive, house, supply, train, and deploy theater force units in a timely manner.

1. There are 15 designated PPP and 12 PSP. Mobilization stations develop mobilization TDAs (MOBTDA) based on guidance provided by their parent ACOM to enable mobilization stations to meet surge population and operational requirements. Deleting non-mission-essential services; extending the workweek; executing option clauses in existing contracts; and contracting for personnel and services accomplish expansion of mobilization services.

2. When mobilized units arrive at their designated mobilization stations command passes to the mobilization station commander. The commander is then responsible for correcting readiness deficiencies that restrict the deployment

readiness of the units. The mobilization station commander cross-levels personnel and equipment in accordance with established HQDA policies and priorities and FORSCOM/USARPAC instructions. The commander is responsible for unit training and deployment validation in accordance with HQDA policy as implemented by FORSCOM/USARPAC.

(h) Training base. The objective of the training base subsystem is to ensure the orderly and timely availability of trained manpower to mobilize for CONUS base support and theater force requirements.

1. TRADOC and HQDA are responsible for operating the component organizations that comprise the post-mobilization training base, induction centers, reception stations, training centers, and Service schools. HQDA (G-1) is the agent for DOD on all matters pertaining to the operation of the Military Entrance Processing Command (MEPCOM) and the military entrance processing stations (MEPS) (see para 13-13b(4)), also known as induction centers. MEPCOM, through the MEPS, is responsible for providing facilities for conducting physical and mental examinations and inducting qualified registrants into the armed forces.

2. The Army's capability to receive and process enlistees, inductees, and other accessions will be increased in the event of mobilization. The existing reception stations (all collocated with existing TRADOC training centers) will be expanded. Army Reserve training divisions/brigades will be mobilized to increase the capacity of TRADOC training centers and establish new training centers at selected FORSCOM installations. This is important, especially during any large contingency operation; however it seldom happens or is very limited during smaller contingency operations.

3. The capacity and capability of the Army Service Schools will also be expanded. The existing TRADOC Service School structure will be expanded. Selected United States Army Reserve Forces (USARF) schools will be mobilized to expand the capability of designated TRADOC Service Schools and to augment the U.S. Army Training Centers.

4. AMC provides extensive refresher and skill sustainment training for both Army National Guard and Army Reserve units and individuals during peacetime and specialized post-mobilization training in accordance with existing agreements.

(i) Logistics support system. The objective of the logistics support system is to provide logistical support to meet mobilization and deployment/employment requirements of the Army.

1. Supply, maintenance, services, and facilities capabilities must be expanded to deploy and sustain the force. Storage policies will be relaxed to permit open storage on improved and unimproved sites, public warehouses, and contractor facilities. The waiving of formal advertising and competitive bidding will expedite the ability to procure goods and services. Suppliers will accelerate deliveries by going to multi-shift production operations. A major objective of the supply system will be to expedite the availability of needed materiel for entry into the transportation subsystem and responsive delivery to the recipient. The Army will call on the existing (wartime) authority to utilize the national industrial base for preplanned production and buy, lease, or contract for goods and services from any available commercial source.

2. Upon mobilization, the Army maintenance structure has several immediate goals. It absorbs RC combat service support units, executes emergency civilian hiring procedures in accordance with mobilization TDAs, and implements already negotiated maintenance contracts and inter-service and Federal agency support agreements. Mission-essential items receive the highest priority of maintenance effort. First priority is for equipment items for deployed and/or deploying theater force units. Second priority is for equipment in excess of mobilization needs left behind by deploying units. Third priority is specific items identified and managed by HQDA.

3. It will be necessary to expand troop service support (food services, laundry, dry cleaning, bath, and mortuary) to accommodate the expanded mobilization station population. Service facilities at newly activated mobilization stations will be renovated utilizing available materiel, funds, and manpower. As required, support units will be tasked to provide mobilization stations with unit facilities and equipment until general support force units can assume these functions.

4. The Army production base is comprised of Army-controlled industrial activities and contractor facilities. The Army will coordinate expanded production requirements with the DLA on common use items. Included in these industrial activities are active and inactive ammunition plants, arsenals and proving grounds, missile plants, and other miscellaneous plants. These facilities are to be activated or expanded to provide maximum wartime production levels of materiel.

5. Expansion of the CONUS training and sustaining base facilities will be required at initial Presidential Reserve Call-Up (PRC) and will increase incrementally through partial and full mobilization as the mobilization surge passes through the mobilization stations and ports. Initially, expansion of capacity will be achieved from immediate cessation of nonessential activities; relaxation of space, environmental, and other constraining criteria; and the rehabilitation of facilities using available labor and the self-help effort of using units. New facilities construction will feature modern prefabrication technology to provide increased living, storage, and workspace needed early in the post-mobilization buildup period.

(j) Medical support. As dictated by crisis action, U.S. Army hospitals may initiate conversion to their planned mobilization configuration to accommodate the vastly increased military population and expected theater force casualties.

1. Health care services (inpatient and outpatient) may be limited to active duty military personnel with the exception that outpatient occupational health services will continue for civil service employees. If so, all nonmilitary inpatients

## How the Army Runs

will be discharged or transferred to civilian or other Federal hospitals as expeditiously as possible. TRICARE service centers and the local military medical treatment facility will assist eligible beneficiaries in completing administrative requirements for procuring health care from civilian sources.

2. With the approval of the Commander, Medical Command (MEDCOM), and the Office of the Surgeon General (OTSG) (see para 18–8 and 18–11) HQDA, inpatient services may be continued beyond M–Day to D–Day for family members and retirees (if M–Day and D–Day do not coincide). Medical center (MEDCEN) (see Chapter 18)/medical department activity (MEDDAC) (see Chapter 18) commanders may continue outpatient services for family members and retirees as resources permit.

(k) Transportation support. The objective of the transportation support subsystem is to move the entire force (units, individual replacements, and materiel) within CONUS, and to and from overseas commands. Overall responsibility for transportation support is vested in USTRANSCOM and its transportation component commands.

1. The Surface Deployment and Distribution Command (SDDC) coordinate intra-CONUS movements of mobilizing units and materiel in cooperation with installation transportation officers and various state and local agencies. Strategic transportation to and from overseas theaters is the responsibility of the Military Sealift Command (MSC) and the AFAMC, the other two component commands.

2. Management of the surface lines of communication is split among SDDC, MSC, and the theater commanders. SDDC is responsible for CONUS line-haul and common-user terminal operations. MSC is charged with ship contracting and scheduling. The theater commander manages intra-theater surface movements. The schedule for cargo movement and port operations must interface with the schedule for ships. Port throughput capacity, both in CONUS and in a theater of operations, is a major consideration and is often a limiting factor. Finally, surface transportation planning procedures must be flexible enough to allow planners to adjust to exigencies such as ship or port losses.

3. AFAMC is responsible for airlift operations. To meet response times postulated by the JSCP, planners must be able to develop and maintain flow plans that can be executed rapidly. This capability requires detailed planning among the users of common-user airlift assets. In addition, AFAMC requires 3–4 days to achieve a full-surge airlift capability. This time is required to marshal Active Air Force elements and to mobilize and position essential Air National Guard and Air Reserve units. Therefore, to develop realistic flow plans, planners must carefully balance airlift requirements with capabilities until a full surge capability can be achieved and maintained. A limiting factor to U.S. airlift capability is the availability of Strategic Air Command (SAC) tanker resources, which are periodically tasked to support other national-level operations. Planners must consider the potential availability of tanker resources when developing flow plans and must closely coordinate with other claimants for refueling aircraft.

4. USTRANSCOM coordinates and monitors time-sensitive planning and execution of force and re-supply movements for deployment of CONUS-based Army and Air Force combat forces. It also coordinates deployment planning with Navy and Marine Corps forces. (These deployments should not be confused with the normal rotation of units, ships, squadrons, etc. in peacetime.) USTRANSCOM assists the JS in resolving transportation shortfalls with supported and supporting commanders, military transportation agencies, and the Services.

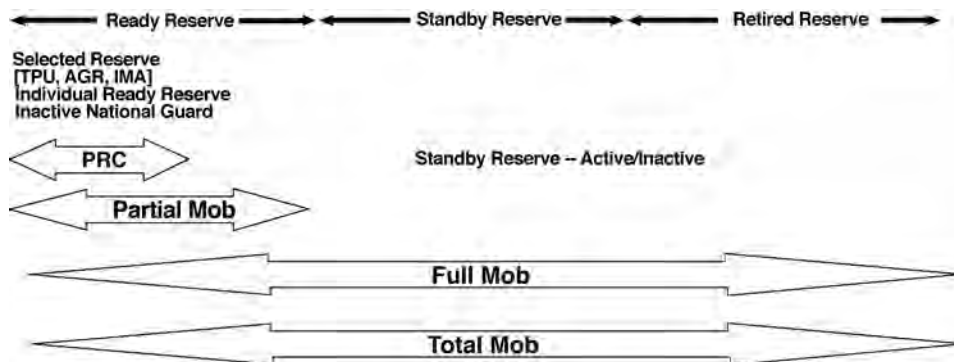

Figure 6–14. Reserve categories and mobilization

*f. Types of mobilization.* Generally, the magnitude of the emergency governs the type of mobilization. As authorized by law or congressional resolution and when directed by the President, DOD mobilizes all or part of the Reserve Components as shown in Figure 6–14. Concurrently, the DOD and other Federal agencies marshal national resources in order to sustain the mobilized force.

(1) *Selective mobilization.* For “domestic emergencies”, the President may order expansion of the active armed forces by activation of RC units and/or individual Reservists to deal with a situation where the armed forces may be required to protect life, federal property, or to prevent disruption of Federal activities. A selective mobilization would not be associated with a requirement for contingency plans involving external threats to the national security.

(2) *Presidential reserve call-up (PRC).* The President may augment the active forces by an involuntary call-up of units and individuals of the Selected Reserve or any member of the IRR designated as essential up to 200,000 persons from all Services for up to 365 days to meet an operational requirement. No more than 30,000 of the 200,000 may be members of the IRR. The President must notify Congress whenever this authority to call up the RC is exercised.

(3) *Partial mobilization.* In time of national emergency declared by the President or when otherwise authorized by law, an authority designated by the Secretary concerned may, without the consent of the persons concerned, order any unit, and any member not assigned to a unit organized to serve as a unit, in the Ready Reserve under the jurisdiction of that Secretary to active duty for not more than 24 consecutive months. Not more than 1,000,000 members of the Ready Reserve may be on active duty, without their consent, under partial mobilization at any one time.

(4) *Full mobilization.* In time of war or national emergency declared by the Congress, or when otherwise authorized by law, an authority designated by the Secretary concerned may, without the consent of the persons affected, order any unit, and any member not assigned to a unit organized to serve as a unit, of a RC under the jurisdiction of that Secretary to active duty for the duration of the war or emergency and for six months thereafter.

(5) *Total mobilization.* Total mobilization involves expansion of the active armed forces beyond the approved force structure by organizing and/or activating additional units to respond to requirements of the emergency. All national resources, to include production facilities, needed to sustain additional forces will also be mobilized. Congressional authorization is required for these actions.

*g. Mobilization Authority.*

(1) The authority to order mobilization resides with the President and the Congress as outlined in the stages of mobilization shown in Figure 6–15. An example of Reserve Component participation on the mobilization continuum is shown in Figure 6–16. The President, Congress, or both may declare a national emergency.

(2) The National Emergencies Act passed in 1976 provides that when the President declares a national emergency, the declaration or subsequent Executive order must specify the specific authorities being invoked. The President’s powers are limited to those invoked until the subsequent announcement of the invoking of additional specific authorities. Once the President declares a national emergency for a specific purpose, the national emergency will remain in effect for one year, unless sooner rescinded or extended. Under the Federal Administrative Procedure Act of 1946, all Executive orders must be published in the Federal Register.

(3) The SecDef, with the advice and recommendation of the CJCS and the Service Secretaries, recommends to the President and the Congress the mobilization authority required to support a given contingency, OPLAN, or national emergency. The SecDef directs mobilization of RC units and manpower through the military departments.

*h. Peacetime planning.* The Army plans and prepares for mobilization in peacetime. It participates in war planning to establish Army forces and the requirements for their augmentation. It programs and budgets resources and acts to man, equip, and train The Army and to prepare for its employment during a war or other national emergency. Planning is accomplished in accordance with the provisions of the JOPES and AMOPES. This peacetime planning essentially consists of war planning intended to develop the OPLANs for the conduct of operations (addressed earlier in the chapter and in Chapter 4) and mobilization planning.

*i. DOD mobilization planning process.* Mobilization planning, primarily a Service responsibility, is based on guidance from OSD and JCS. OSD guidance is included in the Defense Planning and Programming Guidance (DPPG) and Guidance for Employment of the Force (GEF) (see Chapter 4). JS guidance is contained in the JSCP (see Chapter 4). In addition, Joint Pub 4–05, Joint Mobilization Planning, assigns general responsibilities and procedures for mobilization. The JS coordinates the mobilization plans of the Services and ensures the interface of these plans with deployment.

*j. Mobilization planning in other Federal departments and agencies.* In addition to DOD, approximately 50 federal departments and agencies have emergency planning responsibilities. FEMA is the federal government coordinator of these emergency management activities in both peace and war.

(1) FEMA’s responsibilities include policy guidance and planning to ensure that government at all levels is able to cope with and recover from emergencies. FEMA assesses national civil mobilization capabilities and develops concepts, plans, and systems for management of national resources. It identifies actual and potential shortages in natural,

## How the Army Runs

industrial, economic, and other resources; develops plans to mitigate their national security impacts; and fosters programs to reduce our national vulnerability to such resource shortages.

(2) FEMA is the principal respondent to military requirements for civilian sector resources during mobilization. It coordinates the response of the civil agencies to defense needs, always cognizant that without the might of the Nation's industrial production, transportation networks, work force, financial institutions, energy, and natural resources, there could be no national security. Likewise, without food, clothing, housing, health care, and education, there would be no civilian population to support the defense of our way of life and our constitutional government. FEMA must, therefore, see to it that national resources are used to meet both the military and the essential civilian needs of the nation.

*k. Army mobilization planning.* Army mobilization planning provides the resources required to support various OPLANs. This includes mobilizing the units, manpower, and materiel required for immediate implementation of an OPLAN as well as the resources required to sustain the operation. AMOPES incorporates the guidance of the DPPG, GEF, JSCP, and Joint Pub 4-05 and specifies the planning process used to develop HQDA and ACOM mobilization plans. The FORSCOM Mobilization Plan, with its associated FORSCOM Mobilization and Deployment Planning System (FORMDEPS), details the time-phased flow of mobilizing RC units from home stations to their mobilization stations. The TRADOC Mobilization Operations Planning and Execution System (TMOPES) provide installations and training base augmentation units in the Army Reserve with guidance on training base expansion activities.

*l. Relationships of war planning and mobilization planning.* AMOPES provides the linkage between war planning under JOPES and mobilization planning as directed by DOD and the JS. AMOPES establishes the "who, what, where, why and how" of mobilization. It further prescribes the Army Crisis Action System for managing the execution of mobilization and OPLANs. The principal products of AMOPES are prepared executable plans, supporting information, and databases prepared and maintained for use during national crises. Mobilization plans incorporate the specific actions and responsibilities that must be accomplished both in peacetime and upon the order to mobilize. HQDA and ACOM mobilization plans that constitute the Army Mobilization Plans are based on guidance contained in AMOPES and other documents. Most mobilization plans are oriented toward full mobilization. For selected contingencies, however, the Army has developed partial mobilization plans.

*m. Peacetime preparation.* Preparation for mobilization proceeds concurrently with planning. The Army programs, budgets, and funds resources to overcome the shortfalls and limiting factors identified from a continuing analysis of the various operation plans. Concurrently, the Army trains units and individuals. Within its capabilities, it identifies and pre-assigns augmenting manpower and prepositions materiel to support those plans.

*n. Alert, mobilization, and deployment (Figure 6-17).*

(1) On receiving the order to mobilize, the Army begins a PRC, a partial mobilization or full mobilization, as directed by the SecDef, of RC units, pre-trained manpower, and materiel. A portion or all of the mobilizing force may augment an established theater force such as Europe, or may augment a force deployed in a contingency operation. Under the general supervision of HQDA FORSCOM, USAREUR, and USARPAC bring AC and RC units to combat-ready status and then deploy them by air and sea to the area(s) of operation according to the deployment plans.

(2) An initial pool of reserve materiel resources exists in war reserve stocks in CONUS and pre-positioned stocks in overseas areas. The initial resources sustain the deployed force until reinforcement and re-supply pipelines can be established or the emergency is resolved. AC units in place in the theater of operations are referred to as "forward-presence" units. Other AC units, most of them CONUS-based, are earmarked by FORSCOM war plans to support one or more requirements of the JSCP and AMOPES.

(3) When an emergency arises, units are alerted through FORSCOM, USAREUR, or USARPAC channels to deploy to the theater of operations in accordance with applicable OPLANs. RC units (ARNG and Army Reserve) are ordered to active duty by mobilization orders transmitted by HQDA through FORSCOM/ USARPAC command channels. Units may be apportioned to support one or more OPLANs or they may be apportioned to become part of the CONUS base.

*o. FORSCOM mobilization planning.*

(1) FORSCOM publishes the FORSCOM Mobilization and Deployment Planning System (FORMDEPS), FORSCOM Regulation 500-3, based on HQDA guidance contained in AMOPES. FORMDEPS contains planning directives and guidance to ACOM commanders, Continental U.S. Armies (CONUSA), major troop units, FORSCOM installation commanders, other ACOM installation commanders, State adjutants general (in consonance with NGB), and the major U.S. Army Reserve commands (MUSARCs). FORMDEPS also contains annexes on the various functional aspects of mobilization and updates the GCCS-A Mobilization Planning Line based on OPLAN TPFDD.

(2) FORSCOM coordinates with USASOC, TRADOC, MEDCOM, TRANSCOM, Surface Deployment and Distribution Command (SDDC), AMC, and NGB in preparing data. The GCCS-A Mobilization Planning Line includes scenario dependent data for RC deploying and redeploying MTOE and TDA units in the Army Status of Resources and Training System (ASORTS). The Mobilization Planning Line includes the following data (as applicable) for these units:

- Unit description, component, and home station.
- Power projection platform data.
- Unit mobilization data (notional).
- Ready-to-load dates.

- Deployment data for the applicable TPFDD(s).

*p. Mobilization flow.* Mobilization execution is decentralized to commands. FORSCOM, USARPAC, and USAREUR are the principal commands that command mobilizing RC units. Other commands (USASOC, TRADOC, MEDCOM, AMC, and SDDC) assume command of designated non-deploying units. Upon receiving the order to mobilize, most RC units move to one of 15 PPPs and 12 PSPs within the First Army area and the USARPAC area to train before deploying or augmenting the CONUS base. Cross leveling of equipment and personnel assets, required to make units mission-capable, takes place primarily at PPPs. AMC provides wholesale management for materiel. Human Resources Command (HRC) serves in a similar management role for personnel. Medical Command expands medical support services and facilities. The U.S. Army Corps of Engineers expands troop housing, training, industrial, and other facilities.

AUTHORITY LIMITS	<ul style="list-style-type: none"> <li>• EXPAND BEYOND THE APPROVED PEACETIME FORCE STRUCTURE</li> <li>• DURATION PLUS 6 MONTHS</li> <li>• DECLARATION OF WAR OR NATIONAL EMERGENCY DECLARED BY CONGRESS</li> <li>• INVOKE THE DEFENSE PRIORITIES AND ALLOCATIONS SYSTEM</li> </ul>				
	<ul style="list-style-type: none"> <li>• ALL EXISTING RESERVE COMPONENT FORCE STRUCTURE TO INCLUDE INACTIVE AND RETIRED</li> <li>• DURATION OF WAR OR NATIONAL EMERGENCY PLUS 6 MONTHS</li> <li>• DECLARATION OF WAR OR NATIONAL EMERGENCY DECLARED BY CONGRESS</li> </ul>			FULL MOBILIZATION	TOTAL MOBILIZATION
	<ul style="list-style-type: none"> <li>• 1 MILLION ALL SERVICES</li> <li>• 24 CONSECUTIVE MONTHS</li> <li>• DECLARATION OF NATIONAL EMERGENCY DECLARED BY THE PRESIDENT</li> </ul>				
	<ul style="list-style-type: none"> <li>• 200K ALL SERVICES</li> <li>• 365 DAYS W/ NO EXTENSION</li> <li>• PRESIDENTIAL EXECUTIVE ORDER</li> <li>• SELECTED RESERVE AND ESSENTIAL INDIVIDUAL READY RESERVE</li> </ul>		PARTIAL MOBILIZATION		
	*	PRESIDENTIAL RESERVE CALL-UP			
AUTHORITY TYPE	SELECTIVE MOBILIZATION				
CRISIS LEVEL	DOMESTIC EMERGENCY	SSC	1 OR 2 Major Contingency Operations	2 Plus Major Contingency Operations	GLOBAL WAR

\* PERSONNEL AND DURATION BASED UPON SITUATION

Figure 6-15. Stages of mobilization

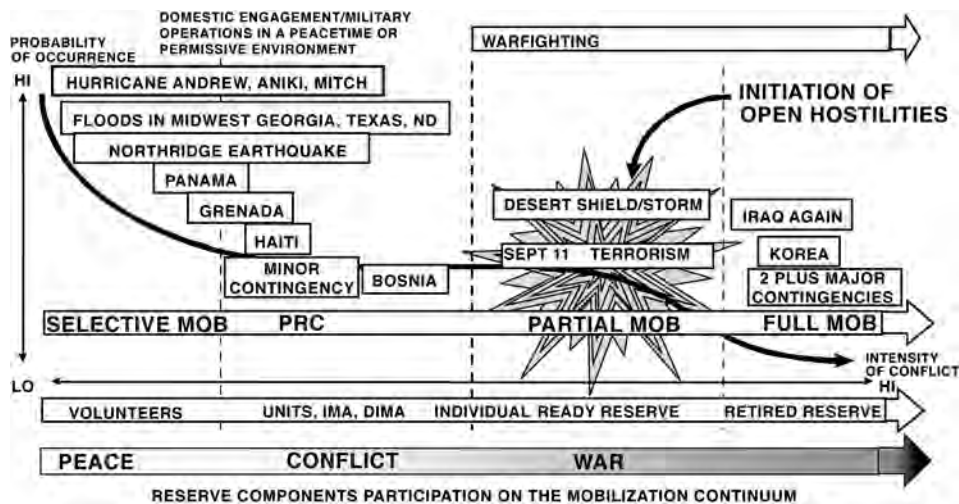

Figure 6-16. Operational and mobilization continuum



MOBILIZATION PHASE	PHASE 1 PRE-MOB	PHASE 2 ALERT	PHASE 3 HOME STATION	PHASE 4 Mobilization Station	PHASE 5 PORT OF EMBARKATION
PRIMARY ACTIVITY LOCATION	HOME STATION (ARMORY OR USAR CENTER)	HOME STATION (ARMORY OR USAR CENTER)	HOME STATION (ARMORY OR USAR CENTER)	Mobilization Station	AIR OR SEA PORT
ACTIVITY DURATION (DAYS)	AS TIME PERMITS	3 to 7 DAYS	3 DAYS	10 to 180 DAYS	1 to 2 DAYS
PRIMARY ACTIVITY	<ul style="list-style-type: none"> <li>• MOB PLANNING</li> <li>• TRAINING</li> <li>• SOLDIER READINESS PROCESSING</li> </ul>	<ul style="list-style-type: none"> <li>• UNIT RECALL</li> <li>• MOB ORDER PREP</li> <li>• PERSONNEL SCREENING</li> <li>• EQUIP. RECORDS CHECK</li> </ul>	<ul style="list-style-type: none"> <li>• CONTINUE SRP</li> <li>• INVENTORY EQUIP.</li> <li>• CROSS LEVEL PER./EQUIPMENT</li> <li>• LOAD FOR MVMT.</li> <li>• ADV. PARTY TO MS</li> </ul>	<ul style="list-style-type: none"> <li>• MOVE TO PPP</li> <li>• COMPLETE SRP</li> <li>• CONDUCT TNG</li> <li>• COMPLETE CROSS LEVEL</li> <li>• COMPLETE VALID.</li> <li>• LOAD FOR MVMT.</li> </ul>	<ul style="list-style-type: none"> <li>• MOVE TO POE</li> <li>• LOAD TRANSPORT.</li> <li>• DEPLOY</li> </ul>
OUTCOME	PLANNING	NOTIFICATION	PREPARATION	VALIDATION	DEPLOYMENT

Figure 6–17. Mobilization and Execution Process

**6–12. Department of the Army mobilization processing system (DAMPS)**

Subsequent to the attacks of September 11, 2001, the Army Operations Center initiated development of an automated mobilization process resulting in DAMPS. DAMPS is the current system used to mobilize units and individuals. DAMPS electronically processes and tracks mobilization request packets through all necessary approval levels and stages enabling the rapid issuance of mobilization orders and improving the Army’s ability to account for and track units and individuals throughout the mobilization process. DAMPS is an Army mobilization resource that is essential for the timely expansion and sustainment of military forces.

**Section IV**

**Industrial preparedness**

**6–13. The need for industrial preparedness**

In the post-Cold War era when global conflicts between nation states are unlikely, we must maintain a viable industrial base that can replenish expenditures of critical war materiel following regional conflicts or military operations in a peacetime or permissible environment in a timely manner. Most future conflicts will be “come as you are” actions. Although the industrial base may be called upon to sustain the deployed forces, more than likely it will be needed to expeditiously replace losses in order to be prepared for another contingency.

**6–14. DOD industrial base preparedness objectives**

a. OSD’s objectives for improving the preparedness of our nation’s industrial base to meet contingency requirements have changed radically in recent years. There are six objectives set forth in the DOD strategy:

- (1) Promote a strong, technologically advanced industrial base able to develop, produce, and support advanced military systems in a cost-effective manner.
- (2) Foster integration of the civilian and military industrial and technology base by: encouraging and using commercial technologies in military equipment to the maximum extent feasible; eliminating defense-unique specifications and standards wherever possible; and demonstrating a clear preference for commercial and other non-developmental items, as well as commercial buying and manufacturing practices, to the extent permitted by law.
- (3) Preserve only those unique defense-related skills, facilities, processes and technologies essential to execute the program, or that are highly likely to be essential beyond the program, and not likely to be reconstituted economically, or available from other non-domestic sources. This includes cost-effective investments in layaway/shutdown procedures for those assets deemed essential to support requirements; e.g., storage of blueprints, videotapes, data files, or other

documentation of the production processes/skills and, where necessary, storage of production equipment and tooling, etc.

(4) Maintain real growth in industrial preparedness planning (IPP) (see Para 6–19a) funding levels. Use the funding to support planning and to accomplish the first three objectives.

(5) Program industrial preparedness measures (IPM) (see Para 6–19e) to permit accelerated production of only those munitions, critical support items, and spares where this is a cost-effective alternative to maintaining full war reserve inventories.

(6) Reduce weapon system support costs without sacrificing readiness or wartime mission capability. Near-term actions are desired that will result in out year support cost reductions.

*b.* The DOD strategy that can be inferred from these objectives is relatively straightforward. To begin with, the focus is on producing advanced military systems cost-effectively. The next objective deals with utilizing commercial and dual-use technology by eliminating defense peculiar specifications and standards whenever possible. The next two deal with retention and enhancement of the industrial base. Retention will only be undertaken for those essential unique defense-related processes and technologies that cannot be economically replaced or for which a substitute is not available. Enhancement of the industrial base IPMs will only be employed to accelerate production of critical items when it is economically more advantageous than retention of assets.

### **6–15. DOD-level industrial preparedness management**

*a.* It is DOD policy to maintain a state of industrial preparedness by working with private industry to produce, maintain, and repair materiel that meets mobilization requirements. Where it is determined that required mobilization items cannot be provided by the private sector, then government-owned facilities and equipment are acquired and maintained to produce them.

*b.* Overall responsibility for managing the DOD Industrial Preparedness Program is vested in the Deputy Assistant Secretary of Defense for Industrial Policy (DASD (IP)). The Office of the DASD (IP) develops policy to ensure the rapid and coordinated production of materiel to meet mission requirements; provides a basis for planning, programming, and budgeting related to improving industrial base responsiveness; and it directs the industrial preparedness programs of the Services and the DLA. It develops procedures to guide the allocation of available industrial production capacity for contingencies to avoid conflicts or over commitment.

*c.* The DASD (IP) is responsible for advising the SecDef on the relative urgency of acquisition programs. The recommendations are presented as the DOD Master Urgency List (MUL) and provide the priority basis for assigning production resources. The DOD MUL includes only those programs that are designated as “DX” (use of the DX rating is limited to contracts and orders for programs approved by the President as of the highest national urgency and contracts and orders to which ratings may be applied or assigned as specified in Department of Defense Directive (DODD) 4400.1, Defense Production Act Programs). Essential support items are assigned to the same urgency category as their end items. Since the production of every item needed by the Services is prohibitively expensive, the key to a successful industrial preparedness program is the careful selection of critical materiel on which to apply scarce resources. The following paragraphs exemplify this management philosophy.

### **6–16. The defense priorities and allocations system (DPAS)**

*a.* This regulatory system (15 Code of Federal Regulations (CFR) 700), administered by the Department of Commerce (DOC), is used to ensure the timely availability of industrial resources to meet approved national defense and emergency preparedness program requirements and to provide an operating system to support rapid industrial response in a national emergency.

*b.* The authority for this regulatory system is found in Title I of the Defense Production Act (50 USC App. 2061, et seq.), which authorizes the President to require—

- (1) The priority performance of defense contracts and orders over all other contracts and orders.
- (2) The allocation of materials, services, and facilities necessary and appropriate to promote the national defense.

*c.* The DPAS establishes two levels of contract priority- “DX” (highest national urgency) and “DO” (critical to national defense). DX priority rated contracts and orders take precedence over DO priority rated contracts and orders; and DO rated contracts and orders take precedence over un-rated / commercial contracts and orders. The DPAS requires that—

- (1) Contractors and suppliers capable of their performance accept all priority rated contracts and orders.
- (2) Precedence is given to priority rated contracts and orders as necessary to achieve timely delivery.
- (3) Contractors extend the priority rating to contracts and orders placed with their vendors and suppliers.

*d.* Although the DPAS is self-executing, in the event of a problem involving acceptance, scheduling, production, or any situation that would interfere with timely delivery of a priority rated contract or order, Special Priorities Assistance may be requested. DOC may take “official action” under the DPAS to resolve the problem.

### **6–17. The national defense stockpile (NDS)**

The Federal Government has maintained a supply of strategic and critical materials designed to decrease our nation’s

## How the Army Runs

vulnerability to interruptions in the foreign supply of these materials in time of national emergency. Recently it was decided to dispose of the stockpile materials, retaining only a few of the most critical and essential to cover U.S. defense requirements for not less than three years of national emergency. [0]In April 2009, at the direction of Congress, DOD released a report on recommendations for the reconfiguration of the NDS. The report recommended a . . . “reshaped NDS, the Strategic Materials Security Management System (SMSP), (which) would continuously monitor global markets, establish supply chain commitments with producers/suppliers; monitor performance to ensure timely availability of materials, and store only limited amounts and types of materials”. The DOD through the Defense National Stockpile Center, a DLA organization, manages the stockpile.

### 6–18. DOD key facilities list (KFL)

KFL is a list of facilities of such importance that loss through sabotage, subversion, terrorism, or other hostile acts would seriously impair the national defense posture of the United States. FORSCOM uses the KFL in fulfilling its responsibility for CONUS land defense planning.

### 6–19. Army industrial preparedness program

The DOD-level management philosophy applies to the Army’s Industrial Preparedness Program as well. The Army depends on private industry as the foundation for production of military materiel. Therefore, when Army production facilities or depot-level maintenance do not exist, first consideration will be given to developing private industrial facilities that produce critically needed items. Management tools available include the following:

*a. Industrial preparedness planning (IPP).* Conducted to ensure that an adequate industrial base is established, maintained, and retained to be responsive to military materiel requirements in the event of an emergency. It involves the assessment of the capability of the industrial base to support peacetime and emergency operations, and planning with industry to ensure adequate procurement, production, and maintenance capabilities to meet support requirements.

*b. DA critical items list (DACIL).* Prepared by HQDA (Deputy Chief of Staff G–3/5/7), they provide biennially a priority list of items required to sustain war fighting for either an indefinite or surge contingency. They also provide stable mobilization requirements to support planning with industry. The DACIL are the basic documents from which IPP is conducted.

*c. Industrial preparedness planning list (IPPL).* Prepared by AMC from the DACIL, the IPPL consists of critical items having long lead-time components. Many of these components require special manufacturing skills or present other production challenges requiring detailed planning.

*d. Production base analysis (PBA).* PBA describes the status of the Army’s industrial readiness. It shows the base required for production and depot-level maintenance of IPPL items. Contingency production requirements are matched against the capacity of the industrial base and actions needed to improve industrial base readiness are identified.

*e. Industrial preparedness measures (IPMs).* These actions aid industry to overcome production deficiencies in the Army’s industrial base. IPMs are designed to shorten production lead-time, increase production or repair capacity, and reduce inspection time. IPMs for accelerated production will only be used when they are cost-effective alternatives to stockpiling.

## Section V

### Summary and references

#### 6–20. Summary

The utility of the Army to the Nation depends to a large extent on whether its forces can be rapidly and effectively mobilized, deployed, employed, and sustained. The process of planning for contingencies or for emergencies where Army forces are needed to accomplish specified tasks is a continuous, all-encompassing process. It incorporates all aspects of Army management including manpower procurement, training, materiel development, and fiscal assets and constraints. Central to the task of reinforcing active forces is the ability to mobilize RC assets and to deploy them with the least possible delay. Although the U.S. industrial base may be called upon to accelerate production to directly support the deployed forces, it will normally be utilized to repair and replace the damaged/destroyed equipment and munitions and other consumable expenditures following the conflict.

#### 6–21. References

- a.* DOD Directive 4400.01E, Defense Production Act Programs. October 12, 2001, Certified Current as of September 14, 2007.
- b.* Joint Pub 1, Doctrine for the Armed Forces of the United States, May 2, 2007 Change 1 March 20 2009.
- c.* Joint Publication 4–05, Joint Mobilization Planning, March 22, 2010.
- d.* Joint Publication 5–0, Joint Operation Planning, December 26, 2006.
- e.* Joint Publication 6–0, Joint Communications System, June 10, 2010.
- f.* CJCS Manual 3122.01A, Joint Operation Planning and Execution System (JOPES), Volume I, (Planning Policies and Procedures) September 29, 2006, Current as of July 2, 2010.

- g. CJCS Manual 3122.03C, Joint Operation Planning and Execution System (JOPES), Volume II, (Planning Formats), August 17, 2007).
- h. CJCS Manual 3122.02C, Joint Operation Planning and Execution System (JOPES), Volume III, (Crisis Action Time-Phased Force and Deployment Data Development and Deployment Execution), March 22, 2004, Current as of April 16, 2008.
- i. CJCS Manual 3150.16D, Joint Operation Planning and Execution System Reporting Structure (JOPESREP), December 1, 2008.
- j. CJCS Manual, 3500.03B, Joint Training Manual for the Armed Forces of the United States, August 31, 2007, Current as of August 15, 2008.
- k. CJCSI 3100.01B Joint Strategic Planning System, December 12, 2008.
- l. CJCSI 5714.01C, Policy for the Release of Joint Information August 28, 2006.
- m. Army Regulation 500–5, *Army Mobilization* July 6, 1996.
- n. Army Regulation 700–90, Army Industrial Base Process December 14, 2004.
- o. FORSCOM Regulation 55–1, *Unit Movement Planning* June 1, 2006.
- p. FORSCOM Regulation 500–3, FORSCOM Mobilization and Deployment Planning System (FORMDEPS), Vols. 1–5 (U) December 14, 2006.
- q. U.S. National Defense University, Joint Forces Staff College Publication 1, The Joint Staff Officer’s Guide 2000.
- r. U.S. Department of Commerce, Defense Priorities and Allocations System (DPAS) Regulation (2009 CFR Title 15 Chapter VII Part 700) r.

RESERVED

## Chapter 7

### Reserve Components

“... Greater use of the Reserves ... means higher resource requirements for time, for training, and for equipment. Effective management of the Guard and Reserve as an operational force requires changes in how Soldiers are recruited, trained, equipped, compensated, and resourced. Over the past decade and a half some changes in force management were made in support of the evolution of the Reserve components as an operational force. New management approaches evolved as the Department gained a better understanding of the demands of the new operational environment and the role played by the Guard and Army Reserve as part of an integrated total force. The Department is faced with a significant change in how the Reserve components are being used as part of the total force. *This change is not temporary; it is not business as usual. Rather, it reflects a fundamental shift from the past. As such, a new approach to management is needed—one that also reflects a new way of doing business for the future. Incremental changes at the margin will no longer be enough.*” Department of Defense White Paper “Managing the Reserve Components as an Operational Force”, October 2008, Office of the Assistant Secretary of Defense for Reserve Affairs.

#### Section I Introduction

##### 7–1. Chapter content

Traditionally, the Reserve Components (RC) provided the Army with the capacity to rapidly expand war fighting capability when the need arose. Over the last 17 years, the Army has relied more and more on the RC to meet demanding mission requirements in support of the National Military Strategy (NMS). In recent years, the Army has taken major steps to integrate the efforts of the Active Component (AC) and the RC, and today’s power-projection force can only accomplish its missions through such integrated efforts. This chapter addresses the role, organization, structure, and contributions of the RC of the Army.

##### 7–2. Reserve Components

The Reserve forces of the Army consist of two components: the Army National Guard (ARNG) and the Army Reserve (AR). The Army National Guard represents Component 2 and Army Reserve represents Component 3. The Reserve Components - the Army National Guard and Army Reserve - comprises nearly 51% of the Total Army’s military force<sup>1</sup> The ARNG is currently structured with eight combat divisions and 28 brigade combat teams (BCT). The ARNG has the only two RC Special Forces Groups which are part of USASOC. The Army Reserve is largely structured with CS and CSS units. These support units are absolutely essential for the Army’s operating force. For example, the Army Reserve provides the lion’s share of the Army’s medical, civil affairs, and psychological operations force capability.

#### Section II The Army National Guard

##### 7–3. An American tradition

Although inheriting the militia traditions of several European nations going back to the 1500s, the Army National Guard officially dates to 1636, when the Massachusetts Bay Colony organized its militia companies into regiments; these units are perpetuated today in the Massachusetts Army National Guard, and are the United States Army’s oldest units. Over two dozen ARNG units pre-date the United States itself. Militia units fought in every major conflict in North America during the colonial period, to include the French and Indian War, and some ARNG units trace their lineage back to militia organizations that fought on the side of the British during the French and Indian War and later against the British in the Revolutionary War. The term “National Guard” was first used in connection with the militia to honor the Marquis de Lafayette upon a state visit to the United States. While visiting New York City in 1824, the 2<sup>nd</sup> Battalion, 11<sup>th</sup> New York Artillery, part of the honor guard receiving Lafayette, named itself the “Battalion of National Guards” in tribute to Lafayette’s command of the *la Garde nationale*, the French militia established in 1789.

##### 7–4. National Defense Act of 1916

With the *National Defense Act of 1916 (NDA–1916)*, the term “National Guard” became the official name of the organized militia of the United States. The NDA–1916 also expanded the role of the National Guard in national defense. Though the Guard remained a State force, the act increased Federal oversight and assistance for training and equipment. NDA–1916 also increased the number of times a National Guard unit was brought together for training, called drills. An annual training camp was increased from five to fifteen days, and forty-eight four hour drill periods were mandated (the origin of today’s 48 UTAs and 15 day AT annual training requirement). Additionally, NDA–16 authorized National Guard units to perform fifteen consecutive days of paid annual training (AT), pay for the drill

<sup>1</sup> See FY 2011 President’s Budget Highlights, February 2010, p. 5, Assistant Secretary of the Army (Financial Management and Comptroller) <http://asafm.army.mil/Documents/OfficeDocuments/Budget/BudgetMaterials/FY11/pbhl.pdf>

## How the Army Runs

periods, and increased overall Federal funding. NDA–1916 also required National Guard units to be organized like regular Army units, established federal recognition processes for both units and commissioning officers in the Guard, established the dual oath to support and defend State and Federal constitutions, and gave the President authority to mobilize the National Guard in case of war or national emergency.

### 7–5. World War I

The National Guard has made significant contributions to the Army's combat power. The National Guard provided 17 of the 43 divisions for the American Expeditionary Force (AEF) in World War I. Soldiers of the 30th Division, from North Carolina, South Carolina, and Tennessee, received the highest number of Medals of Honor in the AEF. Following World War I, questions arose over the National Guard's status that was ultimately resolved in the *National Defense Act of 1933*, also referred to as the *National Guard Status Act*. This act made the National Guard a permanent part of the Army during peacetime as well as wartime. The National Guard in active state service is referred to as the National Guard of the several States. The National Guard in active Federal service is referred to as the National Guard of the United States. The National Guard of the United States is identical in personnel and units to the States' National Guard. This new component is part of the Army and can be ordered into Federal service by the President with or without a declaration of national emergency. At the same time, the Guard provides the nation a force for disaster relief, maintaining public peace, and when in a State status, it provides the governors a force for utilization during state and local emergencies.

### 7–6. World War II

The entire National Guard was mobilized in 1940 during the period of National Emergency declared by President Roosevelt before the United States entered WWII. Several units, including New Mexico's 200th Coast Artillery and two multi-State tank battalions, were diverted from their training mission and were ordered to the Philippines as part of a peacetime reinforcement of the newly created US Army Forces Far East. They soldiered on with their Regular Army and Filipino counterparts as prisoners of war after U.S. forces surrendered on the Bataan Peninsula and Corregidor. Eighteen National Guard divisions fought in World War II, equally divided between the European and Pacific theaters. The first U.S. Army division to deploy overseas, the 34th Infantry Division, was a National Guard division. National Guard divisions were also an instrumental part of General MacArthur's island hopping campaign in the Pacific theater. In the European theater, National Guard divisions participated in all major campaigns from North Africa, to Sicily and Italy, to the Normandy Invasion and the subsequent breakout, the race across France, the Battle of the Bulge, and the final campaign to conquer Germany. Following World War II, the twenty-nine pre-war observation squadrons of the National Guard were expanded into a force of eighty-four flying squadrons in what became a separate Air National Guard when the Air Force was established as a separate service in 1947.

### 7–7. Korean War

The Korean War caused a partial mobilization of the National Guard. A total of 138,600 ARNG Soldiers were mobilized, including eight infantry divisions and three regimental combat teams. Two of these divisions served as part of the Eighth Army in Korea, two divisions went to the Seventh Army in Europe, and four divisions remained in the U.S. to help constitute the Strategic Reserve. In addition, all ARNG air defense artillery units were mobilized for CONUS air defense. Experience with this ARNG ADA mobilization contributed directly to the post-war ARNG Air Defense Artillery Gun Program and its successor the Nike-Ajax/Hercules missile defense program.

### 7–8. Vietnam War

During the Vietnam War, the National Guard played a much smaller role than in the past. This was primarily due to a political decision not to mobilize the country's RC forces. After the Tet Offensive of January 1968, a small number of RC units mobilized, including 34 Guard units. Most were support units.

### 7–9. Desert Shield/Desert Storm

During Operation Desert Shield/Desert Storm, RC units were on active duty within days after the invasion of Kuwait. The majority of the Army's combat support (CS) and combat service support (CSS) units were in the RC<sup>2</sup>. The first ARNG units mobilized were transportation, quartermaster, and military police. Later, two ARNG field artillery brigades deployed to Southwest Asia, providing essential fire support capabilities. In total, 62,411 ARNG personnel were ordered to active Federal service, of which 37,848 deployed to Southwest Asia.

### 7–10. Post 9/11

In recent years, the role of the ARNG has expanded. Over the past decade, operations in Bosnia, Kosovo and Sinai

---

<sup>2</sup> Note: FM 3-0, Operations, dated February 2008 rescinded the terms combat arms, combat support, and combat service support. Unit types and functions are described instead by one of the following appropriate war fighting functions: Move and Maneuver, Intelligence, Fires, Sustainment, Command and Control, and Protection. Use of the former naming convention combat, combat support, and combat service support is continued in this chapter because of familiarity of use until more definitive guidance is published on the correlation to the war fighting functions.

have become ARNG missions. ARNG units have been transformed as a result of continuing AC/RC Rebalancing initiatives. Since 11 September 2001, 338,038 ARNG Soldiers have been mobilized to support the war on terrorism as of 28 December 2010.

### 7-11. Current force

The Reserve Component - Army National Guard and Army Reserve - comprises nearly 51% of the Total Army's military force<sup>3</sup>. The ARNG is currently structured with eight combat divisions and 28 brigade combat teams (BCT). The ARNG has the only two RC Special Forces Groups which are part of USASOC. The Army Reserve is largely structured with CS and CSS units. These support units are absolutely essential for the Army's operating force. For example, the Army Reserve provides the lion's share of the Army's medical, civil affairs, and psychological operations force capability.

## Section III The Army Reserve

### 7-12. Evolution of the Army Reserve

Although the Army Reserve has existed since 1908, the concept of non-state affiliated federal citizen-Soldiers serving this nation goes back much further, tracing back to the French and Indian War (1756-1763). During the War for Independence, General George Washington's Continental Line stood out as a non-state affiliated force that fought for the infant United States. Impressed by the citizen-Soldiers capabilities, General Washington, in 1783, was among the first to suggest that a "well-regulated" federal militia would eliminate the need for a large peacetime regular force, eventually leading to the formation of the Army Reserve. On April 23, 1908, the Army Reserve was founded as a permanent institution. In the beginning only officers of the medical corps were included, and the organization was known as the Medical Reserve Corps. In 1912, the Army Reserve expanded to include combat arms with the creation of the Officers Reserve Corps and the Enlisted Reserve Corps. They were later combined as the Organized Reserve. During World War II (1941-1945), the Army mobilized 26 Reserve (designated) infantry divisions and more than 200,000 AR Soldiers. Approximately one-fourth of all Army officers who served during World War II were AR Soldiers. The Korean War (1950-1953) saw more than 240,000 AR Soldiers called to active duty. While the Korean Conflict was still underway, Congress made significant changes in the structure and role of the AR, transforming the ORC into the *United States Army Reserve*. This new organization was divided into a Ready Reserve, Standby Reserve, and Retired Reserve. In 1967, Congress established the Office of the Chief, Army Reserve (OCAR) on the Army Staff to give Army Reserve Soldiers an official spokesman at the Department of the Army level. In 1973, Congress established the *Total Force Policy*, which focused the Army Reserve's role as the Army's strategic force used primarily in the event of large scale conventional war. In the 1990s, the AR began its transition to an integral component of the Army's operational force and solidified its role as a critical provider of Combat Support and Combat Service Support capabilities to the Total Army. After September 11, 2001, the AR quickly evolved into a robust operational, expeditionary force replete with streamlined deployable headquarters and Citizen-Soldiers who embodied an operational mindset and culture.

### 7-13. Current Army Reserve

*a. Without question, the AR will continue to provide essential strategic depth for the Total Army.* AR units provide integral surge enablers within the ARFORGEN cycle. AR generating forces, such as Initial Military Training (IMT) and Professional Military Education (PME) training divisions, greatly expand the training capacity of the Total Force. Additionally, the non-rotational Operational and Functional Commands (e.g. Engineer, Civil Affairs, and Theater Sustainment Commands) are available to provide the surge capability for contingencies.

*b. Forces Available.* Dedicated AR Soldiers provide essential skills and capabilities supporting the functions and missions of the Total Army. The growing demand of force requirements necessary to address the complex security environment of the coming decade will ensure that the AR is routinely called upon as the force of first choice for ready enablers. These AR enabler packages will be drawn from two distinct sets of available forces:

(1) The Army Reserve Operating Force. The AR is structured to provide Title 10 deployable enabler forces for Full-Spectrum Operations and steady-state Security Cooperation missions. The Operational Army Reserve will routinely provide forces in a cyclical manner to meet the Nation's military demands. Many civil affairs, medical, transportation, and information operations (including Military Information Support Operations) capabilities reside exclusively, or predominately, within the AR. Under ARFORGEN, our ability to mobilize trained AR units quickly and responsively is essential to meeting the operational requirements for our Nation's security.

(2) The Army Reserve Generating Force. AR units support force generation, with units that provide IMT, PME, and mobilization support, as well as sustainment of Army units and personnel (all components) for Full Spectrum Operations. Given its structure, geographic spread, and experience base, the AR is well suited for future Generating Force activities and missions. This capacity to augment the training base, mobilization stations, and institutional or

<sup>3</sup> See FY 2011 President's Budget Highlights, February 2010, p. 5, Assistant Secretary of the Army (Financial Management and Comptroller) <http://asafm.army.mil/Documents/OfficeDocuments/Budget/BudgetMaterials/FY11/pbhl.pdf>



## **How the Army Runs**

garrison activities is critical to the Army's ability to train, equip, and deliver combat forces worldwide. The Generating Force may also be used in an operational role to provide foreign military training abroad or assist with domestic disaster response.

### **Section IV**

#### **Title 10 U.S. Code**

##### **7-14. United States Code (USC)**

Title 10, U.S. Code, contains the general and permanent laws governing the Armed Forces. Various sections of Title 10 establish and govern the RC. Specific provisions of the Code pertaining to the Army and Air National Guard are contained in Title 32, U.S. Code.

##### **7-15. Title 10 and Title 32**

The role of the RC, as stated in section 10102, Title 10, USC is to provide trained units and qualified persons available for active duty in time of war, national emergency, or when national security requires. Title 32 further states that ARNG units shall be ordered to federal active duty and retained as long as necessary whenever Congress determines they are needed. Policy statements further define these basic roles. The RC role clearly has expanded from one of a strategic reserve for wartime augmentation to being both an operational force as well as part of the strategic reserve. The RC is an integral part of the Total Force. The Army cannot prosecute a major contingency without all of its components. An integrated Total Army is no longer just a concept; it is a guiding principle.

### **Section V**

#### **Reserve service**

##### **7-16. The categories**

There are three major categories of reserve service: the Ready Reserve, the Standby Reserve, and the Retired Reserve (Figure 7-1).

- 
- **Ready Reserve (ARNG/AR)**
    - **Selected Reserve**
      - **Troop Program Units (TPUs)**
      - **Active Guard Reserve (AGR)**
      - **Individual Mobilization Augmentees (IMA)**
    - **Individual Ready Reserve (IRR) (AR Only)**
    - **Inactive National Guard (ING) (ARNG Only)**
  - **Standby Reserve**
  - **Retired Reserve**

Figure 7–1. Reserve Service Categories

---

### 7–17. The Ready Reserve

The Ready Reserve has three subcategories:

*a. The Selected Reserve.*

(1) The Selected Reserve consists of ARNG and Army Reserve unit members, Active Guard Reserve (AGR) members, and Individual Mobilization Augmentees (IMAs) (Army Reserve only). Normally, members of ARNG and AR units attend forty-eight paid Unit Training Assemblies (UTA) annually, each of which is a minimum of four hours duration, and perform two weeks of Annual Training (AT) each year (AR: 14 days, ARNG: 15 days). Commanders may extend AT, with approval, up to 29 days. Members may also perform additional training assemblies (ATA) as part of unit training. During UTAs and ATs, members are in an Initial Military Training (IMT) and Professional Military Education (PME) and consisting of regularly scheduled UTA's, ATA's, periods of appropriate duty or equivalent training, and any special additional duties authorized for RC personnel by the Secretary concerned, and performed by them in connection with the prescribed activities of the organization in which they are assigned with or without (though creditable for retirement) pay. IDT does not include work or study associated with correspondence courses. During AT members are in an Active Duty for Training (ADT) status. ADT is a tour of active duty, which is used for training members of the RC to provide trained units and qualified persons to fill the needs of the Armed Forces in time of war or national emergency. The member is under orders that provide for their return to non-active status when the period of ADT is complete. In addition to AT, ADT includes special tours, school tours, and the Initial Entry Training performed by non-prior service enlistees.

(2) Officers, Noncommissioned Officers (NCO) (see Chapter 15), and members of high-priority units have increased AT and IDT requirements. RC units have conducted IDT in the form of Multiple Unit Training Assemblies (MUTAs), what is referred to as Battle Assembly (USAR) and weekend drill (ARNG) since the 1960s (a two-day weekend consists of four, four-hour UTAs and is referred to as a MUTA–4). The minimum peacetime training objective is that each unit attains proficiency at platoon level in combat arms units and company level in CS/CSS units.

(3) RC members are also eligible for Multiple Unit Training Assemblies (MUTAs), 10 USC § 115(b) empowers Congress to authorize the maximum number of RC members permitted on active duty or full-time National Guard duty at any given time to provide operational support. The code also sets time limitations for ADOS periods. ADOS replaced the term Multiple Unit Training Assemblies (MUTAs),

(4) Army Reserve Soldiers are acquired primarily through Army Reserve AGR recruiters working for the US Army Recruiting Command (USAREC), and with RC career counselors who move Soldiers from the AC to RC at transition points. ARNG Soldiers are acquired primarily by ARNG AGR recruiters working for State ARNG recruiting organizations and, like AR Soldiers, with the assistance of RC career counselors at transition points. Both ARNG and AR units have Military Technicians (Mil-Techs) who serve as federal civil service employees during the week and as members of the unit during training assemblies or periods of active duty. RC personnel serving on active duty in an AGR status and members of the AC attached directly to RC units provide full-time support.

(5) The Human Resources Command assigns officers from the Individual Ready Reserve (IRR) in coordination with the Regional Support Commands (RSC) and gaining Troop Program Units (TPU). The vast majority of officers are assigned to Army Reserve TPUs based on voluntary assignments.

(6) The allocation of Force Structure Allowance (FSA) above end strength created a situation where both the ARNG and USAR were over-structured. This caused authorized positions to go unfilled. To remedy this situation, the Army reduced the RC FSA below the authorized end strength thereby creating Trainees, Transients, Holdees and Students (TTHS) accounts (see para. 13–7). TTHS accounts are also referred to as “individuals” accounts (Note: The Army Reserve has eliminated its over-structure and has had an established TTHS account since FY05).

## How the Army Runs

(7) The Selected Reserve also includes the Army Reserve IMA Program (AR 140–145). These are positions documented on Army MOBTDAs that are available for immediate support. All IMA's (except General Officers) are funded to support 48 MUTA's and 12 days of Annual Training. IMAs are also assigned to DOD, FEMA, Selective Service, and other positions as validated by the HQDA G3.

### *b. Individual Ready Reserve (IRR) (Army Reserve only).*

(1) HRC exercises command and control over the IRR, the Standby Reserve, and the Retired Reserve. For strength accountability purposes, the IRR consists of pre-trained individual Soldiers assigned to various groups for control and administration. The IRR is available for mobilization in time of war or national emergency declared by Congress or the President and a portion of the IRR is available under Presidential Reserve Call-Up Authority (PRC). The control group's "AT" consists of non-unit Ready Reserve members with a training obligation, who may receive a mandatory assignment to a unit by the HRC Commander. The control group's "Reinforcement" consists of obligated members who do not have a mandatory training requirement and those non-obligated members interested in non-unit programs which provide retirement point credit. This includes AR, ARNG, and discharged AC Soldiers that have met their training requirement but have not completed their eight-year service obligation.

(2) The *Reserve Officer Personnel Management Act (ROPMA)* replaced the Officer Personnel Management System - Army Reserve (OPMS-AR) and defines the training requirements and opportunities for IRR and unit officers. The Enlisted Personnel Management System-Army Reserve (EPMS - AR) (see para 13–21) focuses on training and management of IRR enlisted members. The Army Reserve created the Individual Augmentation (IA) program, which serves as a single, unstructured holding account in the Army Reserve for the assignment of individual Soldiers. Assigning individuals to one account precludes the need to break or reduce parent unit readiness and streamlines the mobilization process. Soldiers assigned to the IA Program are volunteers (primarily Army Reserve Soldiers) who are readily and immediately available to meet individual mobilization requirements and contingency operational needs. The IA Program also allows qualified Soldiers to continue to serve, even though they do not reside near an Army Reserve unit. As of 30 September 2008, approximately 4,000 Army Reserve Soldiers were registered in the on-line volunteer database. Retention counselors' assist in providing IA volunteers by advising qualified Soldiers who transfer from either the Active Army, Army Reserve troop program units (TPU), or the Army National Guard to the IRR about the IA Program.

(3) The IRR constitutes the largest category of the pre-trained individual manpower. These personnel provide the majority of filler personnel required to bring both the AC and Selected Reserve units to their wartime required personnel strength in the event of mobilization and initial casualty replacement/fillers in fighting theaters. Currently, IRR strength is approximately 214,674 as of 30 September 2010.

### *c. Inactive National Guard (ING).*

(1) The ING provides a means for individuals to continue in a military status in the ARNG who are otherwise unable to participate in an active status. While in the ING, individuals retain their federal recognition and Reserve of the Army status as members of ARNG units. Subject to immediate involuntary mobilization with their assigned units in time of Federal or State emergency, personnel transferred to the ING normally are attached to their former ARNG units and are responsible to participate in an annual muster with their unit.

(2) Individuals assigned to the ING are included in the Ready Reserve strength of the Army. Each FY, ARNG units schedule an annual muster day assembly for their ING personnel that serves to:

- (a) Screen Soldiers for mobilization.
- (b) Inform Soldiers of unit training plans and objectives.
- (c) Conduct lay-down inspections of clothing and/or equipment.
- (d) Update personnel records
- (e) Determine requirements for immunization and physical examination.
- (f) Discuss transfer back to active status (especially with those individuals who possess a critical skill).

## **7–18. Standby Reserve (Army Reserve only)**

*a.* The Standby Reserve includes those Soldiers who have completed all active duty and reserve training requirements and have either requested reassignment to the Standby Reserve to maintain an affiliation with the military or who have been screened from RC unit or IRR roles for one of several cogent reasons. Key employees of the Federal Government (for example, members of Congress or the Federal judiciary), who cannot vacate their positions during mobilization without seriously impairing their parent agency's capability to function effectively, are examples of Standby Reservists. Other reasons for a Standby Reserve assignment include graduate study, temporary (one year or less) medical disqualification, or temporary extreme hardship. Standby Reservists may not be ordered to active duty except during a declared national emergency.

*b.* The Standby Reserve is composed of an active list and an inactive list. Those assigned in an active status are authorized to participate in Ready Reserve training at no expense to the Government. Such participation includes training to earn retirement points or to qualify for promotion. Individuals assigned in an inactive status are normally

not authorized to participate in Army Reserve training. As of 30 September 2010, the Standby Reserve consisted of 22,816 individuals.

### **7–19. Retired Reserve (Army Reserve only)**

*a.* Individuals who are eligible for and have requested transfer to the Retired Reserve are in this third category of the Ready Reserve. The Retired Reserve includes those individuals who are entitled to retiree pay from the Armed Forces because of prior military service or who have completed twenty or more qualifying years of service in the Reserve Component (ARNG or AR) and/or active service for which retirement benefits are not payable until age sixty. In addition, ARNG/AR officers and warrant officers who are drawing retired pay after completing twenty or more years of active Federal service are, by statute, members of the Retired Reserve. Regular Army enlisted personnel, retired after twenty, but less than thirty years of active service, are transferred to the Retired Reserve until they have completed thirty years of service.

*b.* Members of the Retired Reserve and those with less than twenty years of active service are not provided any form of training and are not available for military service except in time of war or a congressionally declared national emergency. However, Service Secretaries may recall retired personnel with twenty or more years of active service to active duty at any time in the interests of national defense.

## **Section VI**

### **Reserve component management**

#### **7–20. Structure**

All three Components of the Army are governed by Congress, and affected by recommendations of OSD and DA.

#### **7–21. Congress**

*a. Committees.* The House and Senate Armed Services Committees (HASC and SASC) establish end strength authorizations and other matters concerning the ARNG and AR. Certain areas such as pay and allowances and officer promotions are closely controlled. Establishing and approving the annual paid end strength authorizations is the most significant Congressional action. Each year, end strength ceilings are authorized to support appropriations for reserve pay and allowances. The Defense Subcommittees of both the House and Senate Appropriations Committees prepare the appropriation acts that allow funding.

*b. Uniform Services Employment and Reemployment Rights Act (USERRA).* This Congressional legislation is significant because it protects RC Soldiers' rights for employment and reemployment after military service or training. This act does not replace the *Service members Civil Relief Act (SCRA)*, but further codifies and clarifies 50 years of case law and court decisions. The USERRA entitles Reserve Soldiers to return to their civilian employment with the seniority, status, and pay they would have attained had they been continuously employed. Among other protections, it expands health care and employee benefit pension plan coverage.

#### **7–22. Office of the Secretary of Defense (OSD)**

*a. Assistant Secretary of Defense (Reserve Affairs) (ASD (RA)).* Overall responsibility for all RC issues at the OSD level is vested in the Office of the ASD (RA).

*b. Reserve Forces Policy Board (RFPB).* Also at the OSD level, the RFPB is, by statute, an independent adviser to the Secretary of Defense to provide advice and recommendations to the Secretary on strategies, policies, and practices designed to improve and enhance the capabilities, efficiency, and effectiveness of the reserve components (10 U.S.C. §10301). The RFPB consists of 20 members and includes a civilian chairman, two active or retired reserve officers or enlisted members from each of the three military departments (Army, Navy, and Air Force), one active or retired reserve officer or enlisted member of the Coast Guard, ten United States citizens appointed or designated by the Secretary of Defense that have significant knowledge of and experience in policy matters relevant to national security and reserve component matters, a general or flag reserve officer from the Army, Navy, Air Force, or Marine Corps to serve as military adviser to the chair, as military executive officer of the Board, and as supervisor of the operations and staff of the Board, and a senior enlisted member of a reserve component to serve as enlisted military adviser to the chair. The SecDef is formally associated with the RC community through the RFPB. The SecDef is required by statute to submit an annual report to the President and Congress prepared by the RFPB on any reserve component matter that the Reserve Forces Policy Board considers appropriate to include in the report.

*c. National Committee for Employer Support of the Guard and Reserve (ESGR).* This OSD-level committee, in operation since 1972, is dedicated to improvement of relations between civilian employers and local ARNG and Army Reserve units. The committee has successfully resolved many employer/employee misunderstandings arising from RC service. It operates on an informal basis with the goal of ensuring that individuals have the freedom to participate in training without employment obstacles or loss of earned vacations. In FY 1979, State chairmen were appointed to work with the national chairman. The use of State committees provides widespread support for the program.

### 7–23. Office of the Chairman, Joint Chiefs of Staff (CJCS)

The 1998 DOD Authorization Bill created two new two-star positions in the Office of the Joint Chiefs of Staff, the Assistant to the CJCS for National Guard Matters and the Assistant to the CJCS for Reserve Matters. They assist the CJCS in assuring that National Guard and Reserve Forces are fully integrated in the Joint arena and reach full potential in executing the NMS. As further outlined in Title 10 U.S.C. § 155, “*The Secretary of Defense, in consultation with the Chairman of the Joint Chiefs, shall develop appropriate policy guidance to ensure that, to the maximum extent practicable, the level of reserve component officer representation within the Joint Staff is commensurate with the significant role of the reserve components within the Total Force.*”

### 7–24. Headquarters, DA

The Office of the Chief, Army Reserve (OCAR) management structure is shown in Figure 7–5. Except for OCONUS units commanded by USAEUR and USARPAC, almost all Army Reserve TPU are commanded by the US Army Reserve Command (USARC) (Figure 7–2. Army Reserve Command Relationships). State Governors command their respective ARNG units unless they are in federal service.

*a. Assistant Secretary of the Army (Manpower and Reserve Affairs) (ASA (M&RA)).* Within HQDA, overall responsibility for RC is vested in the Office of the ASA (M&RA).

*b. Reserve Component Coordination Council (RCCC).* The RCCC, established in 1976, reviews progress on RC matters related to readiness improvement, examines problem areas and issues, coordinates the tasking of issues to the ARSTAF, and reviews staff efforts. The Council, chaired by the VCSA, includes selected general officers from the ARSTAF, Chief of the Army Reserve, Director of the Army National Guard, the FORSCOM Chief of Staff, and the Deputy ASA (M&RA).

*c. Army Reserve Forces Policy Committee (ARFPC).* The ARFPC reviews and comments to the SECARMY and the Chief of Staff, U.S. Army (CSA) on major policy matters directly affecting the RC and the mobilization preparedness of the Army. Membership of the committee, which is appointed by the SECARMY, consists of five AC general officers on duty with the ARSTAF, five ARNG general officers, and five AR general officers. There are also five alternate members appointed from the ARNG and five alternate members appointed from the AR. RC principal members are appointed for a three-year term and RC alternate members are appointed for a one-year term, and AC members are appointed for the duration of their assignment to the ARSTAF. The ASA (M&RA), ARNG, OCAR, U.S. Army TRADOC, and FORSCOM also provide liaison representatives. The Director of the ARSTAF serves as adviser to the committee. The committee chairman is selected from the RC members, and serves a two-year term. The *Goldwater-Nichols Department of Defense Reorganization Act of 1986* reassigned the committee from the Office of the CSA to the Office of the Secretary of the Army (OSA). The Chairman of the ARFPC now reports directly to the SECARMY. The act also modified the nomination procedures. The committee normally meets in March, June, September, and December.

# Army Reserve Transformed

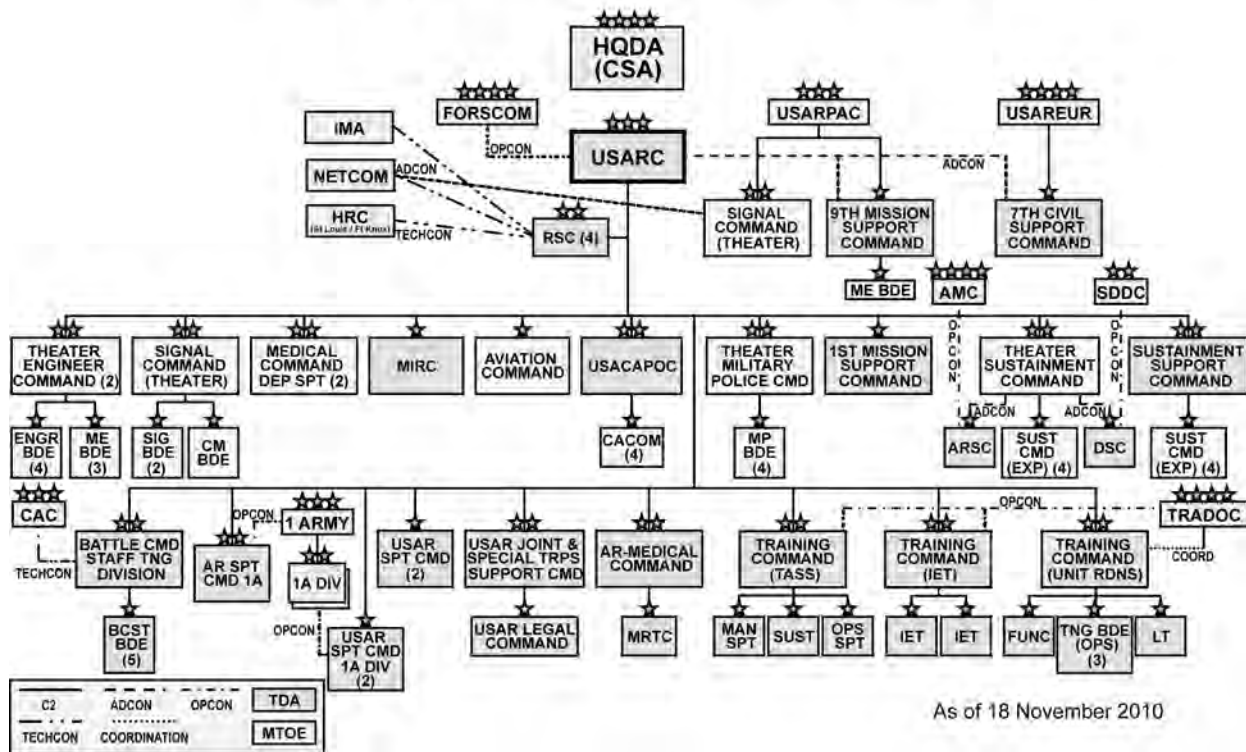

Figure 7-2. Army Reserve Command Relationship

## 7-25. The National Guard Bureau (NGB)

a. The NGB is a joint activity of the Department of Defense and the legally designated peacetime channel of communication between the Departments of the Army and Air Force and the States, Territories, and the District of Columbia as established by section 10501, Title 10, USC. The Chief of the National Guard Bureau (CNGB) is a principal advisor to the Secretary of Defense, through the Chairman of the Joint Chiefs of Staff, on matters involving non-federalized National Guard forces and on other matters as determined by the Secretary of Defense and the principal advisor to the Secretary of the Army and the Chief of Staff of the Army and to the Secretary of the Air Force and the Chief of Staff of the Air Force on matters relating to the National Guard, the Army National Guard of the United States and the Air National Guard of the United States. (10 U.S.C. §10502 as amended by the National Defense Authorization Act of 2008)

b. The CNGB works directly with the State Adjutants General (TAG) (Figure 7-3). Although the CNGB has no command authority in these dealings, cooperation is facilitated through control and coordination of funds, end strength, equipment, force structure programs, and by authority to develop and publish regulations pertaining to the ARNG when not federally mobilized. The CNGB is appointed to a four-year term by the President, with the advice and consent of the Senate. Appointment is made from officers of the Army National Guard of the United States or the Air National Guard of the United States who:

- (1) are recommended for such appointment by their respective Governors or, in the case of the District of Columbia, the commanding general of the District of Columbia National Guard;
- (2) are recommended for such appointment by the Secretary of the Army or the Secretary of the Air Force;
- (3) have had at least 10 years of federally recognized commissioned service in an active status in the National Guard;
- (4) are in a grade above the grade of brigadier general;
- (5) are determined by the Chairman of the Joint Chiefs of Staff, in accordance with criteria and as a result of a process established by the Chairman, to have significant joint duty experience;
- (6) are determined by the Secretary of Defense to have successfully completed such other assignments and

## How the Army Runs

experiences so as to possess a detailed understanding of the status and capabilities of National Guard forces and the missions of the National Guard Bureau as set forth in section 10503 of this title; (10 U.S.C.)

(7) have a level of operational experience in a position of significant responsibility, professional military education, and demonstrated expertise in national defense and homeland defense matters that are commensurate with the advisory role of the Chief of the National Guard Bureau;

(8) possess such other qualifications as the Secretary of Defense shall prescribe for purposes of this section. (10 U.S.C. §10502 as amended by the National Guard Empowerment Act of 2007).

(a) The CNGB may succeed himself. The grade authorized for this position is general.

(b) The functions of the NGB are delineated in 10 U.S.C. §10503 as amended by the National Guard Empowerment Act of 2007.

(c) The CNGB is the appropriation sponsor of six appropriations: three ARNG and three Air National Guard (pay and allowance, operations and maintenance, and construction). The CNGB delegates administration of the appropriations to the Directors of the Air National Guard and Army National Guard.

c. The Director of the Army National Guard (DARNG) is a federally recognized lieutenant general who directs resources to provide combat-ready units. In support of the Federal mission, the DARNG formulates the ARNG long-range plan, program, and budget for input to the ARSTAF. The DARNG administers the resources for force structure, personnel, facilities, training, and equipment, and serves as the principal advisor to CNGB on Army matters. The Army National Guard Directorate assists the DARNG in these efforts.

(1) The Army National Guard Directorate serves as the primary channel of communications between DA and the States, Territories, and the District of Columbia (Figure 7–3). The Director, Army National Guard serves as the head of the Army National Guard Directorate which functions as part of the ARSTAF. Its mission is to acquire, manage and distribute resources to meet the ARNG priorities and influence the development of policies in order to support the Combatant Commanders, Services, States, Territories, and the District of Columbia. The Army National Guard Directorate is structured along the following functional areas:

- (a) Personnel.
- (b) Operations, training, and readiness.
- (c) Force management.
- (d) Installations, logistics, and environment.
- (e) Aviation and safety.
- (f) Comptroller.
- (g) Information systems.
- (h) Missile Defense.
- (i) Operational support airlift.

(2) Figure 7–4 shows the organization of the ARNG Directorate. The ARNG Directorate is both a staff agency interacting with the Army Staff (ARSTAF), and an operating agency that supports the ARNG of the fifty-four States, Territories, and the District of Columbia. As part of the ARSTAF, the ARNG Directorate assists HQDA in identifying resource requirements and determining the allocation to ARNG units (including: funding, personnel, force structure, equipment, and supplies). To accomplish this, the ARNG Directorate coordinates with HQDA to ensure proposed policies are conducive and responsive to ARNG unique requirements. The ARNG Directorate assists the Chief, NGB and Director, ARNG in the execution and implementation of ARNG policies and programs, prepares detailed instructions for the execution of approved plans, and supervises execution of plans and instructions.

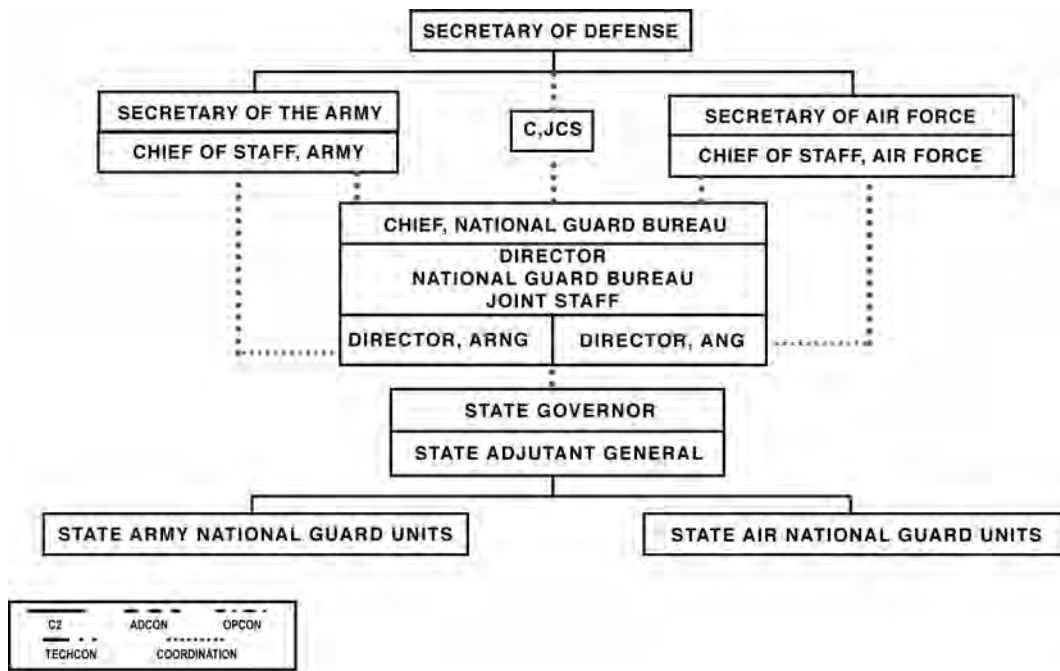

Figure 7-3. NGB management structure

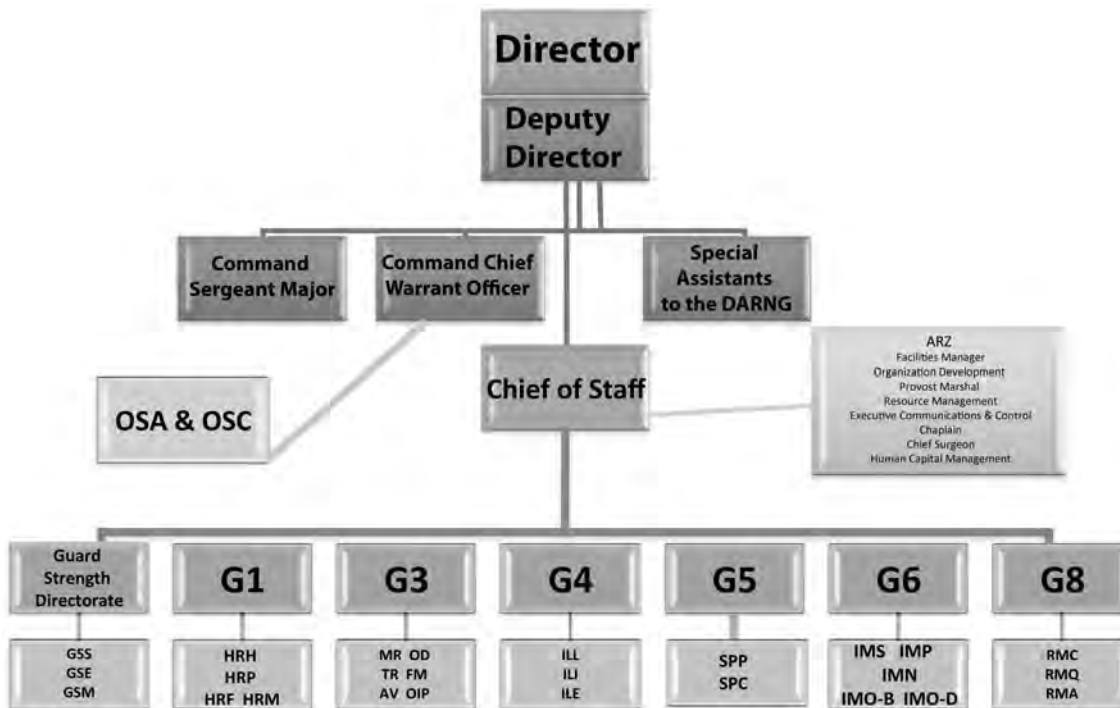

Figure 7-4. Army National Guard Directorate, NGB



### 7-26. Office of the Chief, Army Reserve (OCAR)

a. The OCAR provides direction for Army Reserve planning to accomplish the mission of providing trained units and individuals to support Army mobilization plans. The Chief, Army Reserve (CAR) is appointed by the President with the advice and consent of the Senate and holds office for four years. The CAR may succeed himself one time, and holds the rank of Lieutenant General, Army of the United States, for the duration of the appointment. The CAR also serves as CG, USARC. Figure 7-5 shows the organization of OCAR. The duties of the CAR:

- (1) Commander, USARC 2) Adviser to the CSA on Army Reserve matters.
- (2) Directly responsible to the CSA for matters pertaining to the development, readiness, and maintenance of the Army Reserve.
- (3) Responsible for implementation and execution of approved Army Reserve plans and programs.
- (4) Army Reserve representative in relations with governmental agencies and the public.
- (5) Adviser to ARSTAF agencies in formulating and developing DA policies affecting the Army Reserve.
- (6) Assists in development of Army Reserve mobilization policy and plans.
- (7) In coordination with other appropriate ARSTAF agencies, develops, recommends, establishes, and promulgates DA policy for Army Reserve training.
- (8) Appropriation sponsor for three Army Reserve appropriations (pay and allowances, operations and maintenance, and construction).
- (9) Member of DA and OSD committees as required.

b. In 2003, the Army Reserve Personnel Center was reorganized and re-designated as the Human Resources Command - St. Louis (HRC-STL). In 2010, Human Resources Command - St. Louis (HRC-STL) and HRC - Alexandria were consolidated and simultaneously moved to Ft Knox, KY and renamed HRC. HRC is a field operating agency of HQDA G-1. HRC has the mission of providing personnel life cycle management to all members of the Active, Inactive, and Retired Reserve. Critical responsibilities for HRC include:

- (1) Maintaining Official Military Personnel File using the Personnel Electronics Records Systems (PERMS).
- (2) Conducting officer and enlisted selection boards required by law and policy.
- (3) Managing officer and enlisted forces, including full-time support personnel (AGR Force).
- (4) Managing life cycle personnel systems to optimize utilization of HR assets.
- (5) Synchronizing personnel activities across the Army Reserve for peacetime, mobilization, and wartime.
- (6) Administering the branch and functional area proponent and training requirements.
- (7) HRC provides necessary services for maintaining individual morale and esprit de corps by administering to those individuals who are veterans or retirees. In this capacity, HRC- provides information to various government agencies that is used as a basis for obtaining veteran/retiree entitlements or benefits. HRC corrects records, replaces essential documents, verifies status and service, and accomplishes many other functions involving the individual military personnel record. In addition, HRC provides administrative support for many DOD programs involving records in its custody, as well as records of discharged personnel in the custody of the National Archives and Records Administration.

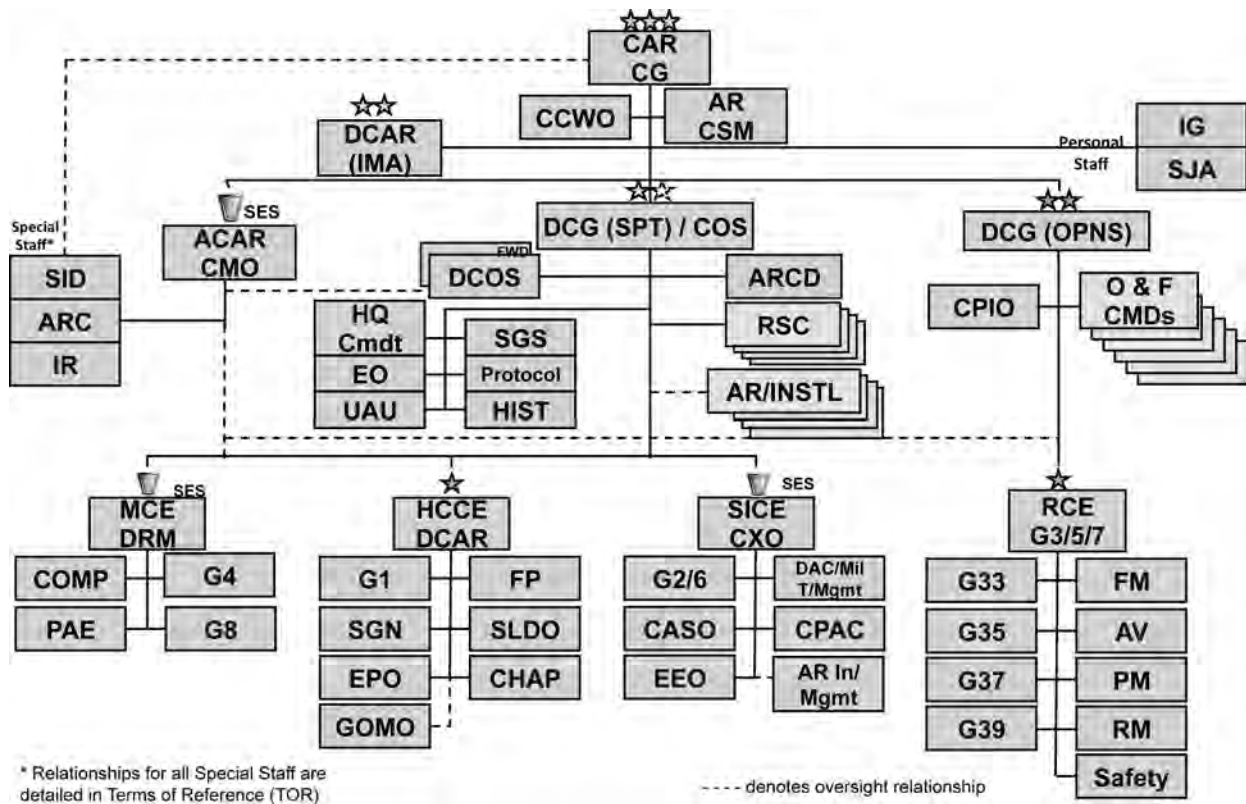

Figure 7-5. Office of the Chief, Army Reserve

## 7-27. Army Commands

### a. U.S. Army Forces Command (FORSCOM).

(1) The missions of the CG, FORSCOM, include command of all assigned Army Reserve TPUs in CONUS and evaluation and support of training of the ARNG. The CG is responsible for organizing, equipping, stationing, training, and maintaining the combat readiness of assigned units. The CG, FORSCOM also manages the RC advisory structure and exercises command of the Army Reserve units through the CG, USARC.

(2) The USARC, established as a major subordinate command of FORSCOM on 18 October 1991, became fully operational on 1 October 1992. Today the USARC is a direct reporting unit (DRU) to the Department of the Army and commands and controls all Army Reserve TPUs assigned to FORSCOM. The USARC commands and controls assigned units through Operational and Functional Commands. Operational and Functional Commands are deployable elements which command units of the same or similar functional capabilities. For instance, Army Reserve MEDCOM commands all Army Reserve medical units while the 11th Aviation Command commands all Army Reserve aviation assets regardless of the unit's geographic location. Operational and Functional Commands are fully deployable as headquarters, individual units, or both. (See Army Reserve web site at: <http://www.armyreserve.army.mil/arweb/organization/commandstructure/usarc/operational/>). Regional Support Commands (RSCs) provide base operations and administrative support to Army Reserve units within their geographic region. In fiscal year 2008 and 2009, four Regional Readiness Commands transformed to become Regional Support Commands (RSCs) with larger geographic responsibilities. In addition, the 9th Regional Readiness Command transformed into the 9th Mission Support Command, the 7th ARCOM transformed into Civil Support Command Europe, and the 65th Regional Readiness Command transformed into the 1st Mission Support Command. Unlike the RRCs of the legacy Army Reserve structure, Regional Support Commands do not have operational or command and control (C2) relationships with the units in their geographic areas. (see Army Reserve web site at: <http://www.armyreserve.army.mil/arweb/organization/commandstructure/usarc/support/default.htm>).

(3) The USARC also established four Mobilization Support Units (MSU) and reorganized port/terminal units, medical augmentation hospitals, movement control units, and replacement battalions/companies to provide the Army with a robust power-projection capability. These units, ready on the first day of any contingency, are essential to the

## How the Army Runs

successful deployment of AC heavy divisions. The MSUs are also used to backfill AC base operations activities vacated by deploying AC units. In addition, the MSUs provide peacetime support to their respective AC counterparts.

(4) AR units include such diverse organizations as CS and CSS units; training divisions with a mission to provide tri-component individual and collective unit training, simulation training, special courses, and Professional Military Education (PME) courses for AC, ARNG, and AR Soldiers; and, Army garrison units with a mobilization mission of staffing an installation;. The AR, in addition to maintaining units, has individuals in non-unit control groups as described in the section on the IRR [section 7–22b (1)]. In addition to the major Army Reserve organizations, there are almost 2,000 company/detachment-sized units.

*b. Training and Doctrine Command (TRADOC).* TRADOC is responsible for the Initial Entry Training for RC members. All non-prior service enlistees under the Reserve Enlistment Program of 1963 (REP–63) perform Initial Active Duty for Training (IADT). This includes basic training, Advanced Individual Training (AIT), and One Station Unit Training (OSUT) (see para 15–14) under AC auspices. An alternative method of conducting this training is the “split-option training” concept whereby an RC member may do BT during one year and AIT the following year.

### 7–28. State Adjutants General (National Guard)

*a.* Army National Guard units are located in each of the fifty States, the District of Columbia, Guam, Puerto Rico, and the Virgin Islands. In addition, Guam and American Samoa signed a Memorandum of Agreement in 2010 whereby American Samoans are able to serve in the Guam Army National Guard. Command of the ARNG, when not in active Federal service, is vested with the Governors of the States and Territories, who exercise command through their State Adjutants General (TAG). The TAG is either an Army or Air National Guard officer who is appointed by the Governor in all States and Territories except for Vermont, South Carolina, and the District of Columbia. The Vermont TAG is elected by the State legislature; the South Carolina TAG is determined by popular election; and the President appoints the Commanding General of the District of Columbia. The TAG is also a State official whose authority is recognized by Federal law. The authorized TAG grade is normally major general.

*b.* State TAGs and their management staffs (which include both State and Federal employees) manage Federal resources to build combat-ready units. Under the TAG, ARNG commanders lead their combat-ready units in training during peacetime.

*c.* A Joint Force Headquarters-State (JFHQ–State) is organized within each State. The JFHQ–State is responsible for the manning, equipping, and training of ARNG units during pre-mobilization. As directed by FORSCOM and First Army and as coordinated by NGB, the JFHQ is responsible for providing increased levels of support to federalized units and moving federalized units to the mobilization station or port of embarkation. The JFHQ–State is also capable of providing some installation support, family support, and mobilization support to other RC units within the State upon declaration of a national emergency. The JFHQ–State continues to provide support to non-federalized ARNG units within the State. Upon mobilization, the gaining numbered Army or COCOM assumes command and control of federalized ARNG units. If the JFHQ–State is federalized for a domestic Homeland Defense mission, it will fall under the command and control of the respective geographic COCOM.

*d.* The U.S Property and Fiscal Officer (USPFO) is an officer (Colonel) of the National Guard of the United States (Army or Air) ordered to active duty under the provisions of Title 10, USC, and assigned to the National Guard Bureau with duty in the State supporting the State TAG. The USPFO receives and accounts for all Federal funds and property and provides financial and logistical resources for the maintenance of Federal property provided to the state. The USPFO manages the Federal logistics support systems (Army and Air Force) for the State and, upon mobilization of a supported unit, provides the support necessary for the unit to transition to active duty status. Additionally, the USPFO functions as a Federal-contracting officer responsible for Federal procurement activities within the state. The USPFO is also responsible for certifying the accuracy of Federal payrolls.

*e.* Title 10, United States Code, Chapter 1803 “Facilities for Reserve Components”, provides for federal support of construction of ARNG facilities. This law permits construction of facilities on sites furnished by States at no cost to the Federal Government or on Federal property licensed to the State specifically for ARNG purposes. Funding for approved armory construction is normally 75 percent federal funds and 25 percent state funds with 100 percent federal support for other construction such as administrative, logistics support, and training facilities in direct support to sole federal functions. Operations and maintenance costs for these facilities are funded via cooperative agreements between the Federal Government and the State military departments. The Federal Government provides all funding for construction and maintenance of facilities for the Army Reserve.

## Section VII Training

### 7–29. Goals

The training goals of the ARNG and the AR are the same as the Regular Army. Plans to achieve objectives are accomplished during IDT, during UTAs, MUTAs, drills, or assembly periods and during an annual training (AT) periods. The same training standards apply to the RC that applies to the AC.

*a.* To meet current operational mission requirements, Reserve Component (RC) training is now based on the

ARFORGEN model, reducing post mobilization training requirements. To continue providing capabilities to support the Army in sustained joint and expeditionary operations and to provide predictability for Soldiers, families and employers, the Army Reserve implemented the Army Reserve Expeditionary Force (AREF) (see paragraph 7–49 Army Reserve Expeditionary Force). Beginning in 2005, ten like-structured deployable organizations called Army Rotational Expeditionary Packages (AREPs) were formed. Units in each AREP plan to mobilize for up to twelve months once every five years. Unit capabilities and readiness within an AREP are more formally validated as it approaches the employment window. The Army Reserve implemented the AREF in 10 phases. As the Army Reserve transforms, early AREP rotations and their timelines were condensed. As the concept is fully implemented, the rotations and their phases become more distinct and sequential.

b. The Army Reserve has sought innovative ways to continue contributing to the performance of training across the Army. To support combatant commanders, the Army Reserve created the Foreign Army Training Assistance Command (FA–TRAC), which conducts foreign army training. In OIF, the 98th Division deployed hundreds of Army Reserve Soldiers to train the newly operational Iraqi National Army.

c. The mission of FA–TRAC is to provide foreign armed forces with advice, training, and organizational practices in leadership, Soldier skills, and unit tactics. Army Reserve Soldiers assigned to FA–TRAC will deploy to the combatant command to live, train, and eat with the host-nation Soldiers. The FA–TRAC was built from the existing structure of a current Army Reserve division (institutional training). FA–TRAC will provide "plug and play" training teams to the combatant commander.

### **7–30. Challenges**

A key factor to understanding RC training challenges is comprehending the distinct differences between RC and AC training. Unlike AC units, which have MOS qualified Soldiers assigned to them by HRC, RC units usually recruit Soldiers from the local area. Whether initial entry or prior service, these Soldiers are assigned to the unit and then must attend MOS qualification training. Qualification training, sustainment training, additional duty training, and professional development education are often conducted in lieu of scheduled UTAs and AT, and in some cases require more than a year to complete. Even though these RC Soldiers are counted against the unit's assigned strength (pending full implementation of the TTHS program) they are generally not available to participate in collective training. Another training challenge is that RC Soldiers and units must meet the same standards as AC units in a fraction of the time. Non-Directed Mission Essential Task List (DMETL) training, Non-Core Mission Essential Task List (CMETL) training, and other events, such as Army physical fitness tests (APFT), weapons qualification, mandatory training, inventories, physicals, etc., have a greater impact because they take the same time as AC units within fewer available days.

### **7–31. Unit Training Assemblies (UTAs)**

ARNG and AR units, as elements of the Selected Reserve, are normally authorized forty-eight drill periods and a two-week (14–17 days) AT during the training year, which starts on 1 October and terminates on 30 September of the following year. The general trend is to consolidate UTAs during the year so that four UTA (sixteen hours minimum) are accomplished during a single weekend. This MUTA–4 configuration provides continuity for individual and crew training, qualification firing, field training, and refresher training. Training for mobilization, i.e. completing Phase I and II actions identified in FR 500–3–3, FORSCOM Mobilization and Deployment Planning System (FORMDEPS) Volume III Reserve Component Unit Commander's Handbook Annex E, Mobilization Checklist for Unit Commanders and Annex G, Required Documents Checklist, and the Soldier readiness program (SRP) (see para. 19–11b) checklist should be conducted during UTA.

### **7–32. Collective tasks**

AT is primarily directed toward collective pre-mobilization tasks. Individual training and weapons qualification are typically performed during IDT. Soldiers and units train to established pre-mobilization levels of proficiency. Combat maneuver units generally train to individual/crew/platoon levels of proficiency. CS/CSS units are generally required to train to company level proficiency.

## **Section VIII Equipment**

### **7–33. Policy**

The Army accepted risk over the years during the Cold War by not fully fielding force modernization equipment to authorized levels in its Reserve Components. This risk seemed prudent at the time. The Reserve Components were characterized as a "strategic reserve" and were not expected to immediately deploy in the event of a crisis. The global strategic environment has changed dramatically over the past two decades and, in order to meet the nation's national security demands today, the Reserve Components function as both an operational force and a strategic reserve. In their operational role the Reserve Components' deployment timeline has shortened considerably with the expectation that it will continue to move farther away from the Cold War paradigm of mobilize, train, deploy and move closer and closer

## How the Army Runs

to the Active Component model of train deploy. As a result, DA policy today distributes equipment to units in first-to-fight/ first-to-support sequence. Later deploying units are provided the minimum-essential equipment required for training and to achieve acceptable readiness levels. The component to which a unit belongs (Active or Reserve), with the exception of specified programs (for example, National Guard Reserve Equipment Appropriation (NGREA) formerly known, as Dedicated Procurement Program (DPP) is not a factor in equipment distribution. This policy ensures units employed first in time of crisis have the necessary equipment to accomplish the mission. Under this policy, the Army Reserve and the Army National Guard have received substantial amounts of modern equipment in recent years and are programmed to receive even more in the near future.

### **7–34. National Guard and Reserve Equipment Appropriation (NGREA)**

The NGREA is a special appropriation designated for the acquisition of equipment for the RC to improve readiness. Congress may further fence these funds for the purchase of specific items of equipment. NGREA funds complement the Service appropriations, which primarily fund force modernization, thereby improving training and readiness in the RC. Until the Army is able to support total Army modernization, the continued programming of NGREA funding will allow the Army Reserve and the Army National Guard to procure critical modernization equipment in order to improve survivability and interoperability.

### **7–35. Withdrawal**

Procedures are in place to ensure that new and/or serviceable equipment is not withdrawn from the RC without justification. Requests for withdrawal of NGREA appropriated equipment must be coordinated with the SecDef. Waiver of this provision during a crisis allows the SecDef to delegate that authority to the ASD(RA) after coordination with the chairman, JCS. Requests for the delegation of authority for all withdrawals or diversions will be forwarded through the ASD(RA), who will coordinate with the Assistant Secretary of Defense (Special Operations and Low Intensity Conflict), for Ready Reserve units falling under his oversight, prior to submission to either the Secretary or Deputy Secretary of Defense (DepSecDef). The Secretaries of the Military Departments will develop and submit projected replacement plans in accordance with published DOD directives, not later than 90 days from the date that the affected units are released from active duty under any provision of law. Replacement plans are also required within 90 days from the date of withdrawal, or diversion, for units not ordered to active duty, but from which equipment was withdrawn or diverted.

*a.* Department of the Army (DA) has directed the USAR to leave equipment in theater known as Theater Provided Equipment (TPE). The continued use of Army Reserve equipment as TPE to remain in theater to support other services and forces continues to degrade the ability of redeploying Army Reserve units to reset and prepare for future deployments. Today almost 76 percent of on-hand Army Reserve equipment is deployed, mobilizing, demobilizing or assigned as Theater Provided Equipment (TPE) in theater. This equipment supports some 40% of the units assigned to the USARC.

*b.* The Army Reserve continues to support subsequent OIF/OEF rotations and other requirements only through using the assets from its stateside-based institutional training structure. Much of the equipment returning from OIF/OEF has had its service life rapidly expended under combat conditions. This equipment will need to be replaced. The concept of a transformed, modular Army of “plug and play” units demands that all units, regardless of component, be equipped to the same levels and with compatible and interoperable systems. Current Army procurement planning in conjunction with congressionally directed procurement and the National Guard and Reserve Equipment Appropriations (NGREA) are keys to achieve this goal.

## **Section IX**

### **Readiness/Mobilization Assistance**

#### **7–36. Background**

In 1973, the Army leadership recognized the potential of many types of RC units for early deployment. Accordingly, the affiliation program was conceived to improve the mobilization and deployment readiness of selected RC units and provide added combat power earlier in the execution of contingency plans. As more structure and missions were added to the RC in the mid-to-late 1970s, the Army instituted several programs to facilitate achievement of higher training readiness levels for the RC. These included the AC/RC partnership program which aligned selected combat and Special Forces RC units with AC units, the counterpart program that aligned ARNG attack helicopter units with AC counterparts, and the Corps and Division Training Coordination Program (CORTRAIN) that associated AC/RC combat units with a CONUS corps for command post exercises. Together these programs provided resources and opportunities for RC unit leaders and Soldiers to work closely and share their experiences with their AC counterparts.

#### **7–37. Training Support Organizations**

In response to a lack of readiness and resources during ARNG deployments for the first Gulf War, Congress passed the ARNG Combat Readiness Reform Act of 1992 (Title XI of Public Law 102–484). The Act as amended required the Army to assign not less than 5000 active component personnel to RC units to provide training and readiness advice and

support. The Army developed five USAR-flagged Training Support Divisions aligned with First and Fifth Armies composed of Active, Guard and Reserve personnel to provide collective training support for RC units. Additionally, a portion of the 5000 personnel were embedded in RC units as full-time support personnel. The Army Transformation Campaign Plan realigned the First and Fifth Armies into two different mission areas. Effective July 2006, Fifth Army became ARNORTH, the Army Service Component Command (ASCC) providing support to United States Northern Command (NORTHCOM) for Homeland Defense and Civil Support missions. Effective October 2006, First Army assumed the mission for the entire continental United States of mobilizing, training, validating, and deploying RC units. First Army is organized with two divisions (First Army-East and First Army-West) which command Training Support Brigades (TSB), with associated ARNG and USAR elements, that provide exercise support, pre-mobilization training, and post-mobilization validation capability for RC units to ensure Army standards and doctrinal mission capabilities are achieved prior to deployment. The USAR provides additional support through two Regional Support Groups (East and West) with assigned training support structure to provide a capability to conduct quality training and exercise events. In response to the Army's requirement to mobilize units more efficiently in order to maximize Boots on Ground (BOG) time the Army Reserve activated two (third programmed for FY10) Combat Support Training Centers (CSTC) to conduct pre-mobilization training. The objective is to provide 1<sup>st</sup> Army with Army Reserve units that can be certified and deployed within 30 days of mobilization.

### **7-38. Force Management/Force Generation**

Several transformational programs such as Global Force Basing, capabilities based versus threat based planning, the shift from Army of Excellence designs to modular Force designs and the shift from using the RC as strategic reserve to an operational force impact the way the Army manages its forces and prepares them for sustained as well as surge operations. The Army developed the Army Force Generation Model (ARFORGEN) to manage these forces and develop increased readiness and mission capability through a cyclic process. Within ARFORGEN, the USAR employs a five year cycle of not more than one-year deployed boots on the ground (BOG) and four years dwell. In the model, most USAR MTOE units are spread equally across the 10 Army Reserve Expeditionary Packages (AREP) (see paragraph 7-52 Army Reserve Expeditionary Force) within the five year-group stacks. Some generating force units are held out of the rotational model: TDA training base expansion (TBE) and CONUS support base (CSB) units particularly. Theater aligned MTOE units, due to their unique capabilities and low density, are managed separately from the ARFORGEN model. Individuals accounts, such as trainee, transient, holdee and student (TTHS) accounts and individual mobilization augmentees (IMA) are also managed outside of the ARFORGEN model.

*a.* Through the use of this five-year rotation cycle, the Army Reserve Expeditionary Force (AREF) offers increased predictability to Army Reserve Soldiers, their families and employers. With this concept, the majority of Army Reserve units are assigned to one of the ten AREP. While units at one end of the five year spectrum are reconstituting after returning from a deployment units at the other end of the spectrum are prepared, trained and equipped to mobilize and deploy wherever needed.

*b.* In conjunction with the new AREF strategy, the Army Reserve is also implementing a new equipping strategy that is synchronized with the AREF. Resources are apportioned according to a unit's location in the cycle in order to obtain increasing levels of readiness and mission capability. As units progress through each year of the five-year cycle their state of readiness increases. Units ready to deploy, are at the highest level of readiness. Units reconstituting from a deployment are at the lowest level. In the year prior to deployment, units receive full complements of modernized equipment compatible with AC equipment. This influx of equipment allows Army Reserve units to train up on their go-to-war systems prior to mobilization and deployment. In this way, equipment is located where it is needed the most, with the units heading for deployment.

### **7-39. Overseas Deployment Training (ODT)**

Although ODT has been severely curtailed because of overseas contingency operations, the program is still ongoing. The ODT program provides RC units the opportunity to exercise their skills in a realistic environment with the added benefits of reducing AC OPTEMPO and providing needed operational support to Combatant Commanders. Within the ARFORGEN cycle, selected units from the "Ready" or "Available" pool may be designated to train in JCS exercises and in non-exercise mission training that enhances their awareness of mobilization/deployment processing. The ODT program has provided training opportunities to an increasing number of companies/battalions. ODT reduces mobilization and deployment timelines, enhances readiness, and promotes unit cohesion.

### **7-40. Full time support (FTS)**

*a.* The FTS program was directed by Congress to increase the readiness of ARNG and Army Reserve units. The majority of FTS personnel work in ARNG and Army Reserve units. The FTS staff performs all the day-to-day support functions for the unit to operate including personnel, administration, training, operations, maintenance, and supply which enables drilling reservists to use their limited training time (generally 39 days annually) to concentrate on their wartime tasks instead of sustainment functions.

*b.* The FTS program consists of AGR Soldiers, military technicians, DA civilians, and AC Soldiers. AGR Soldiers are traditional ARNG and AR Soldiers who are on active duty. Military Technicians and DA civilians are full-time

## How the Army Runs

civilian employees; Military Technicians have the distinction of also being RC Soldiers who must maintain their reserve status as a condition of employment. The AC assigns Soldiers to support RC units, and these Soldiers are considered part of the FTS program. 1) ARNG and Army Reserve technicians provide full-time, day-to-day assistance and support and act as the representative for their commanders during non-drill periods. Technicians ensure continuity in administration, supply, maintenance, and training and their services are critical to mobilization preparedness. 2) Both ARNG and Army Reserve technicians are Federal Civil Service employees. The Army Reserve technicians are governed by the provisions of the Civil Service System. ARNG technicians are governed by the same provisions except as modified by Public Law 90-486 (*National Guard Technician Act of 1968*) as well as Title 32, USC, Section 709, and regulations prescribed by the NGB. As a provision of employment in the Military Technician Program (Civil Service) technicians must also be members of the ARNG or Army Reserve. Many technicians are employed in the same unit to which they are assigned. 3) AGR Soldiers serve on active duty in support of the RC. Title 10, United States Code AGR personnel are available for worldwide assignment whereas Title 32 United States Code AGR personnel receive assignments within their state, territory, or the District of Columbia.

### 7-41. The Army School System (TASS)

a. The Army School System (TASS) ensures all Soldiers receive quality institutional training taught to a single standard throughout the Army. TASS is a composite school system made up of Army National Guard (ARNG), Army Reserve (USAR) and Active Army institutional training systems.

b. The TASS mission statement is to “enhance Army readiness through an efficient, fully-integrated, educational system that guarantees Soldiers of all components are trained to a single standard.” In order to meet this mission TASS must complete and sustain the integration of training and develop future concepts.

c. TASS decentralizes training allowing AC and RC Soldiers to attend NCOES, OES or complete MOS reclassification close to their duty station, thus reducing unit temporary duty costs, improving Soldier quality of life (less family separation), and fostering retention.

d. TASS conducts initial entry military training, MOS-T, officer, warrant officer (WO), and noncommissioned officer (NCO) training, as well as Department of the Army (DA) civilian education, functional training, and professional development training. Training is accomplished through both standard resident courses and distributed learning courses. TASS is the AC/RC integration vehicle for the Institutional Army which includes the TRADOC proponent schools, the United States Army Reserve Training Command, and the Army National Guard Regional Training Institutes.

e. The TASS initiative is a TRADOC program designed to leverage existing school resources. Army Reserve TASS units are functionally aligned and linked to appropriate training school proponents. Courseware and standards are the same throughout the system and students are chosen from all three components depending on the situation. During mobilization, the TASS school battalions have the mission to assist TRADOC in MOS-T training or refresher training for IRR Soldiers and recalled retiree personnel.

f. The Army Reserve 80th Training Command (TASS) provides MOS-T training and technical phases of NCOES for CS, CSS and health services education. The 80th Training Command (TASS) has subordinate divisions and brigades responsible for these subject areas. USAR TASS Brigades are functionally aligned under respective Training Divisions with responsibility for aligned USAR TASS Battalions. The TASS training battalions and Regional Training Site Maintenance (RTSMs) are proponent accredited schools responsible for functionally aligned instruction. RTSMs are functionally aligned with the Ordnance proponent Quality Assurance Office (QAO). High Tech RTSMs located in California and Pennsylvania are functionally aligned with the Signal proponent QAO.

g. The 84<sup>th</sup> Training Command (Leader Readiness) provides functional and leader development training for RC Soldiers and Civilians. The 84<sup>th</sup> Training Command has subordinate Training Divisions, Training Brigades, and three Non-commissioned Officer Academies (NCOAs) responsible for Intermediate Level Education (ILE) portions of the Officer Education system (OES) and the NCO Common Core and other NCO Training courses for the Non commissioned Officer Education System (NCOES).

h. The USAR Training Command also coordinates and manages TASS training requirements with Multifunctional Training Brigades (MFTB). MFTBs are TASS training institutions located outside the continental United States (OCONUS). The MFTBs present unique situations because of their lack of proximity to other training facilities. They offer Officer and Non-commissioned Officer Professional Development Courses and MOS-T to all components of the Army. USAR MFTBs are located in Germany, Hawaii and Puerto Rico.

i. The ARNG has faculty and support personnel executing the ARNG TASS mission in fifty-four States, Territories, and the District of Columbia. The ARNG mission is to conduct leadership, combat arms, and selected CS/CSS training. There are seven Army National Guard Leadership Training Brigades and all have an officer candidate school and an NCOA. The Combat Arms Training Brigades conduct training in the career management fields (CMF) of armor, field artillery, infantry, air defense artillery, and aviation. Additionally, in four of seven regions, the ARNG is responsible for the ordnance training battalion and provides assistance to the AR in the remaining three regions.

## Section X

### Reserve Component Pay, Benefits, and Entitlements

#### 7-42. Individual status

In general, RC pay and allowances are determined on the basis of the individual reservist's status. During IDT periods, members of the Selected Reserve receive one day of basic pay (based upon years of service and grade) for each attended UTA. During ADT periods, members essentially receive the same compensation (basic pay, housing, and subsistence allowances) as their AC counterparts. Depending upon assignment, some reservists may be eligible for additional special pay, such as aviation duty, medical or dental service or hazardous duty pay, all on a pro rata basis.

#### 7-43. Benefits

Eligibility for other service-associated benefits also depends upon the status of the service member. For example, members of the Army's RC, together with unaccompanied spouses with proper identification, are entitled to full use of the exchange and commissary systems. In addition, Reservists may use military clothing stores, official library services, and most clubs. Ready Reservists assigned or attached to units that schedule at least twelve drills yearly and ADT also are entitled to receive full-time Servicemen's Group Life Insurance and dental insurance. While on active duty for operational support (ADOS) or ADT, Reservists receive the same benefits and privileges as AC members. However, they generally do not receive TRICARE coverage or dental care unless the training period exceeds thirty days. Members of the Retired Reserve under age sixty, known as "Gray Area Retirees," are entitled to use the PX, commissaries, military clothing stores, official library services, and receive a burial flag. Although retired AC enlisted Soldiers with less than thirty years service are part of the Retired Reserve, their benefits differ. Upon reaching age sixty, members of the Retired Reserve receive basically the same benefits as their retired AC counterparts except for military burial assistance and a military death gratuity.

#### 7-44. Retirement

Members of the RC who accumulate twenty years of creditable service and reach age sixty are entitled to retired pay computed on the basis of accumulated retirement points. In general, a creditable year is one during which a Reservist accumulates fifty or more retirement points. Points are awarded on the basis of one point for each four-hour assembly, each day of active duty, and each three credits of completed correspondence courses. Additionally, fifteen points are awarded for membership. However, no more than ninety points per year may be awarded for IDT activities. Retirement pay, for those with a date initially entered military service (DIEMS) prior to 8 September 1980, is computed by totaling all accumulated retirement points and dividing by 360 to determine years of satisfactory service. The quotient is then multiplied by 2.5 percent. The resulting percentage is then applied to the active duty basic pay of an individual with the same grade and number of years of service either at the time of separation for those who separate prior to age 60 or at age 60 for those who elect to transfer to the Retired Reserve until reaching age 60. For those with a DIEMS on or after 8 September 1980 retired pay is determined by multiplying the years of satisfactory service times 2.5 percent times the average of the highest 36 months of basic pay. The average of the highest 36 months of basic pay is determined at separation for those under age 60 who do not elect to transfer to the Retired Reserve and at age 60 for those who transfer to the Retired Reserve.

#### 7-45. Uniform Code of Military Justice (UCMJ)

The UCMJ was extended to RC members as of 14 November 1986, when President Reagan signed into law the "Military Justice Amendment of 1986" as part of the *National Defense Authorization Act for Fiscal Year 1987*. Under these changes, Army Reserve Soldiers are subject to the UCMJ while in a drill (IDT) status. The military can now recall a Soldier to active duty for trial for crimes committed while performing ADT or IDT. The decision to activate a Soldier for trial must be approved through the Army Reserve chain of command to the SECARMY if confinement is contemplated. In other cases, the Active Army general court-martial convening authority (GCMCA) (see Chapter 19) is the final decision authority. National Guard personnel are subject to UCMJ authority when in Federal Service; when in State service, they are subject to their State military code, which is generally patterned after the UCMJ.

## Section XI

### Reserve Component Transformation Campaign Plan

#### 7-46. Army Reserve transformation

Army Transformation is a comprehensive undertaking that impacts all aspects of the Army from the Operational Army to the Institutional Army and across Army doctrine, organizations, training, materiel, leadership and education, personnel, and facilities. Implementation requires an adaptive and flexible plan that incorporates changes over time. The Army Reserve Transformation Campaign Plan (ARTCP) integrates and synchronizes the efforts of the Army Reserve with those of the Army. The goal of the Army Reserve Transformation Campaign Plan is to develop a seamless plan for transformation with the Army while maintaining near term capabilities and relevance. The ARTCP



## How the Army Runs

has been designed to complement the Army's Transformation Campaign Plan while recognizing the unique skills, capabilities and requirements of the Army Reserve.

### 7-47. Army Reserve Expeditionary Force

a. As part of integrating the Army Reserve with the Army's Transformation Campaign plan, the Army Reserve built modular force packages to leverage the two-thirds of the structure that is already organized at battalion level and below. The move toward modularity provides a framework for more effectively identifying, defining, and organizing Army Reserve capabilities relevant to today's battlefield. In FY05, the Army Reserve implemented the Army Reserve Expeditionary Force (AREF). AREF enables the Army Reserve to use its resident capabilities to support the Army in sustained joint and expeditionary operations. The objective of AREF is to provide operationally ready units, give greater predictability in deployments to Soldiers and their families, and provide a force management process that incorporates readiness, mobilization, and deployments on a rotational basis. AREF adopts the model of train-alert-deploy versus the old model of alert-mobilize-train-deploy and represents a sea change for the Reserve Component culture.

b. The AREF concept designates a number of pools called Army Reserve Expeditionary Packages (AREP). Units assigned to the AREF maintain staggered states of readiness according to which package they are assigned. Under a steady state of Presidential Reserve Call-Up (PRC), each package is eligible for a nine- to twelve-month mobilization one time in a five year period. Operational requirements and AREP assignment determine which units in the package actually mobilize. Surges in OPTEMPO will require the Army to surge AREP to meet those needs. This may require partial mobilization and extension of the mobilization period. This force management process cycles units over time and returning units "re-set" after each expeditionary mission. Each AREP contains capabilities whose readiness is formally validated prior to entering its employment window.

### 7-48. Multiple Component Units (MCU)

A Multi-COMPO Unit (MCU) combines personnel and/or equipment from more than one component on a single authorization document. The intent is to maximize integration of Active and RC resources. MCU have unity of command and control similar to that of single-component units. MCU status does not change a unit's doctrinal requirement for personnel and equipment, force packaging, or tiered resourcing. No limit has been established for the number of MTOE units that may become MCU and the concept is available to both Active and Reserve Component units. MCU selection is based on mission requirements, unique component capabilities and limitations, readiness implications, efficiencies to be gained, and the ability and willingness of each component to contribute the necessary resources. Experience has shown that this initiative works best in CS and CSS organizations. Today, Army MCU range from theater level headquarters (such as Army Service Component Commands (ASCC), Theater Support Commands, Signal Brigade HQs, and Military Police Brigade HQs) to engineer battalions and separate transportation companies. MCU will not become seamless in the near term; however, the pursuit of that goal will influence the Army's institutional systems to become more integrated. MCU have transitioned from experiment to "experience". Adjustments past and present, although difficult, enabled the initiative to become a useful tool for organizing units in an austere environment.

## Section XII

### Summary and References

#### 7-49. Summary

Over half of the Army's total deployable forces are in the ARNG and the Army Reserve. The management of these forces is of paramount importance as the Army transforms. The structure for RC management includes Congress, DOD, HQDA, ACOMs, States, and units. Two key managers at HQDA are the NGB and OCAR. At the ACOM level, FORSCOM and its subordinate First Army and the USARC have a leading role in preparing RC forces for mobilization and deployment.

#### 7-50. References

- a. Title 10 United States Code.
- b. Title 32 United States Code
- c. Public Law 90-486, The National Guard Technician Act of 1968 as amended.
- d. Public Law 90-168, The Reserve Forces Bill of Rights and Revitalization Act, 1968.
- e. Army Regulation 140-1, Army Reserve: Mission, Organization, and Training 20 January 2004.
- f. Army Regulation 140-10, Army Reserve: Assignments, Attachments, Details, and Transfers 15 August 2005.
- g. Army Regulation 140-145, Army Reserve Individual Mobilization Augmentation (IMA) Program 22 March 2007.
- h. DOD Directive 1225.6, *Equipping the Reserve Forces*, 7 April 2005.

## Chapter 8

### Force Readiness

Force readiness is an integral function supporting the Army's strategic imperatives: Sustain, Prepare, Reset, and Transform the Army. The Army's readiness reporting process supports requirements established by Congressional National Defense Authorization Acts, Office of the Secretary of Defense (OSD) Defense Readiness Reporting System (DRRS), Chairman of the Joint Chiefs of Staff's (CJCS) readiness system and the Army's Force Generation Process (ARFORGEN), reflecting the contemporary operational environment of persistent conflict.

#### Section I Introduction

##### 8-1. Maintaining readiness

As the Army continues operating in the 21st century, it confronts the major challenge of maintaining readiness to meet current operational demands. Maintaining readiness requires critical and often difficult decisions by the Army leadership, for they must strive for the proper balance between maintaining current readiness and resourcing future capability requirements. The demand on current Army capabilities continues; competing for scarce resources to build and sustain Army readiness for future demands. (Figure 8-1)

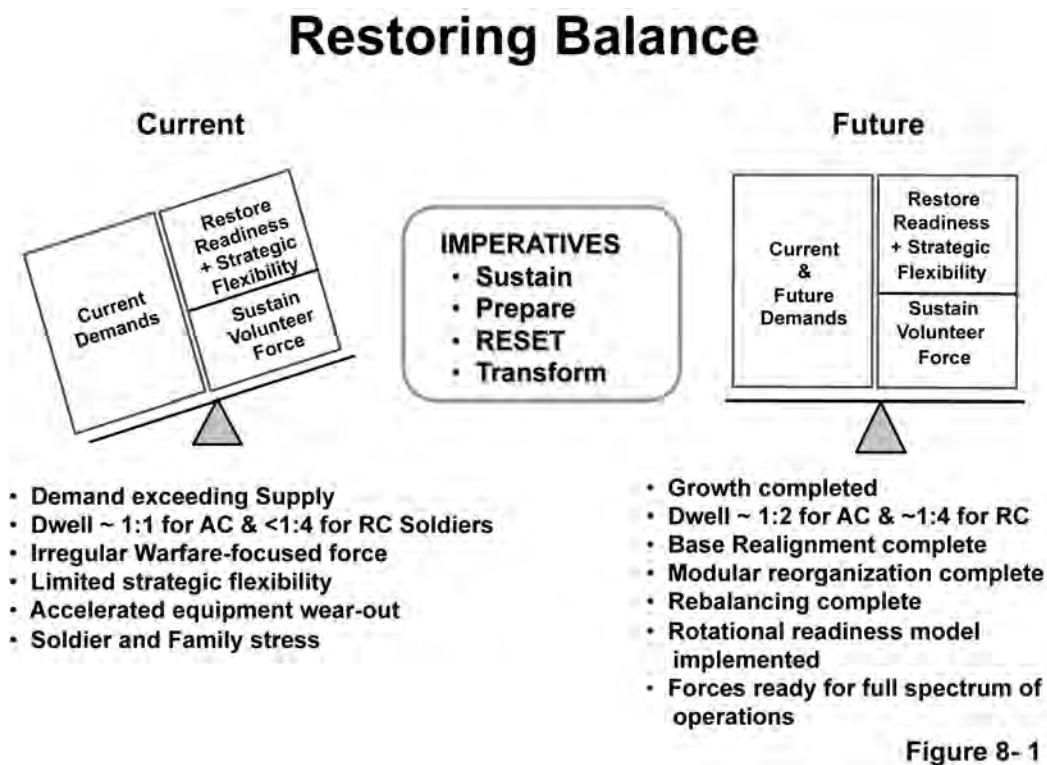

Figure 8-1. Restoring Balance

##### 8-2. Chapter content

This chapter describes the updated and emerging changes to readiness and capabilities reporting systems throughout the Department of Defense. To make the decisions necessary for achieving and maintaining a campaign-quality Army with joint and expeditionary capabilities, the DOD, the JCS, and the DA have developed reporting systems to assist the leadership at all levels in managing force readiness. This chapter discusses the methods used for measuring force readiness and the systems and procedures used to respond to force readiness issues. It provides insights regarding the processes qualitatively and quantitatively defining and describing force readiness. Further, it provides an executive overview of the Chairman's Readiness System which establishes a common framework for assessing Unit readiness

## How the Army Runs

using force readiness reporting and strategic readiness utilizing the Joint Combat Capabilities Assessment (JCCA). The JCCA process is used to provide the CJCS a strategic readiness assessment of DOD's ability to meet the demands of the National Military Strategy (NMS). Finally, the readiness levels and capability assessments of Army organizations are reported in the Defense Readiness Reporting System (DRRS). The Army component of this DOD system is DRRS-Army (DRRS-A).

### Section II Managing Army readiness

#### 8-3. Definitions of readiness

The Army has traditionally defined unit readiness as the ability of a unit to deliver the warfighting capability for which it was designed. However, continuing operational demands have required the Army to build and employ organizations capable of performing an assigned mission for which they may not have been specifically designed. This assigned mission may, in many cases, be just as important as the "designed" mission capability, and must be fully considered in the readiness reporting processes. To that end, readiness reports consider a unit's ability to conduct its designed mission as well as its ability to perform an assigned mission. Force readiness is defined as the readiness of the Army within its established force structure, as measured by its ability to station, control, man, equip, replenish, modernize, and train its forces in peacetime, while concurrently planning to mobilize, deploy, employ, and sustain them in war to accomplish assigned missions. DOD defines military capability in relation to force readiness, sustainability, force structure, modernization, and infrastructure. This definition is directly linked to how the total force is planned, programmed, and budgeted.

#### 8-4. Factors affecting force readiness

*a.* Force readiness is affected by many quantitative and qualitative factors. For example, it is fairly easy to measure the status of personnel, equipment, or war reserves. It is not so easy to assign a value to morale or cohesion. Force readiness is dynamic, encompasses many functions, and is influenced by many factors. To illustrate its complexity, consider the following partial listing of factors that impact on the force readiness of the Army:

- Unit status.
- Design of weapons systems.
- Construction of facilities.
- Availability of supplies.
- Relationship with allies.
- Strategic intelligence capability.
- Application of unit manning principles.
- Civilian personnel force planning.
- Quality of soldier/family services.
- Civilian and military airlift.
- Civilian and military sealift.
- Civilian and military land transportation assets.
- Lines of communications.
- Availability of pre-stocked equipment.
- Mobilization capability.
- Recruitment of manpower for military and industry.
- Capability to receive, process, and transport forces in theaters.
- Senior leadership-quality of strategic planning and decision-making.
- Capability of the enemy.
- Quality and morale of personnel.
- Army values and doctrine.
- Army programs and processes.

*b.* Estimating force readiness is difficult and highly situational. The American people and their elected representatives need to know how much capability is required and what it costs. Short of the military's performance in war or deterring war, a defined measure of return on the dollar that the Services can demonstrate is the level of force readiness to execute the NMS, as deduced from analytical tools and other indicators.

#### 8-5. Cost of force readiness.

*a.* Force readiness is expensive and must be balanced against other program needs (Figure 8-2). Within a finite amount of resources, the purchase of a balanced program that satisfies future investment needs such as research and development and procurement impacts and competes with current readiness needs such as spare parts, depot maintenance, and war reserves. The need for immediate response to a wide variety of requirements place great demands on the Army to maintain forces at a high state of mission capability.



Figure 8–2. The Cost of Force Readiness

*b.* Readiness costs increase sharply as higher levels of readiness are approached. At the unit level, maximum readiness is highly perishable. A unit can attain a very high level of readiness and a short time later, without continued intensive resource allocation, have the trained expertise and peak maintenance levels diminish. The availability of repair parts and supplies, length of time between training events, and personnel turbulence all have a tremendous influence on unit readiness.

*c.* In an Army-wide effort to focus high levels of mission capabilities at the needed times and places, and to provide a steady-state supply of trained and ready forces to accomplish the full range of operational missions, the Army has implemented the Army Force Generation process, or ARFORGEN. ARFORGEN has become the central process used to bring mission required units to their needed readiness levels, and employ those units as required to meet operational demand. ARFORGEN is a cyclic system and is designed to enable the Army to provide trained and ready units on a continuous basis. ARFORGEN is complex, but essential in managing total force capabilities for the Army, and is a major driver for the PPBE system as well as the justification of Army programs to Congress. The ARFORGEN process is described in greater detail in Chapter 2.

### Section III

#### Department of Defense Readiness Reporting System (DRRS)

##### 8–6. DRRS Overview

The Defense Readiness Reporting System or DRRS establishes a mission-focused, capabilities based application that provides DOD users a collaborative environment to facilitate operational decision-making via readiness evaluation of U.S. Armed Forces in support of assigned missions. DRRS is a unique network of applications identifying the capabilities of military forces. The information in DRRS goes well beyond the standard resource accounting approach of traditional readiness reporting by providing assessments of each organization’s ability to conduct assigned tasks either in the context of their core mission or other assigned operations. In addition, DRRS improves the efficiency of readiness reporting by merging previously unrelated “stovepipe” data into a single integrated, authoritative source.

*Note.* DRRS establishes a common language of tasks, conditions, and standards to describe capabilities essential to the completion of assigned missions. The valuable data within DRRS is used to provide timely, accurate readiness information including Overall Mission Readiness and Individual Task Readiness.

##### 8–7. Chairman’s Readiness System (CRS).

*a. Purpose.* The Chairman’s Readiness System (CRS) was implemented at the end of 1994. While it was incrementally modified since then, it was significantly revised in 2002, 2004, 2007 and then most recently in November of 2010. The CRS provides a common framework for conducting commanders’ readiness assessments, blending unit-level readiness indicators with combatant command (COCOM), Service, and Combat Support Agency (CSA) (collectively known as the C/S/As) subjective assessments of their ability to execute the National Military Strategy (NMS). Title 10,

USC section 117d, requires the Chairman to conduct, on a quarterly basis, a joint review to measure the level of current military readiness based upon the reporting of the capability of the armed forces to carry out their wartime missions. The quarterly Joint Combat Capabilities Assessment (JCCA) does this through the Joint Force Readiness Review (JFRR) which compiles the Services', Combatant Command and Combat Support Agency readiness assessments. Additionally, plans assessments, a readiness deficiency assessment and a quarterly readiness report to Congress are performed. The CRS, through JCCA, provides the means to meet the Chairman's statutory requirements while supporting a process that provides timely and accurate reporting to the DOD leadership.

*b. Responsibilities.* The CJCS is responsible for assessing the strategic level of readiness of the Armed Forces to fight and meet the demands of the full range of operations required by the military strategy. Readiness at this level is defined as the synthesis of readiness at the joint and unit levels. It also focuses on broad functional areas, such as intelligence and mobility, to meet worldwide demands. Joint readiness is the responsibility of the Combatant Commanders. It is defined as the commander's ability to integrate and synchronize combat and support forces to execute assigned missions. Unit readiness is the primary responsibility of the Services and USSOCOM. Unit readiness is defined as the ability to provide the capabilities required by Combatant Commanders to execute their assigned missions. The Combat Support Agencies (CSAs) are responsible for providing responsive support to the operating forces in the event of war or threat to national security. These definitions are considered key because they delineate the responsibilities of the CJCS, Service Chiefs, Combatant Commanders, and CSA directors in maintaining and assessing readiness (Figure 8-3). The forum within the CRS for the assessment of joint, unit, and CSA readiness is the Joint Force Readiness Review (JFRR).

## ***The Chairman's Readiness System How We Assess Readiness***

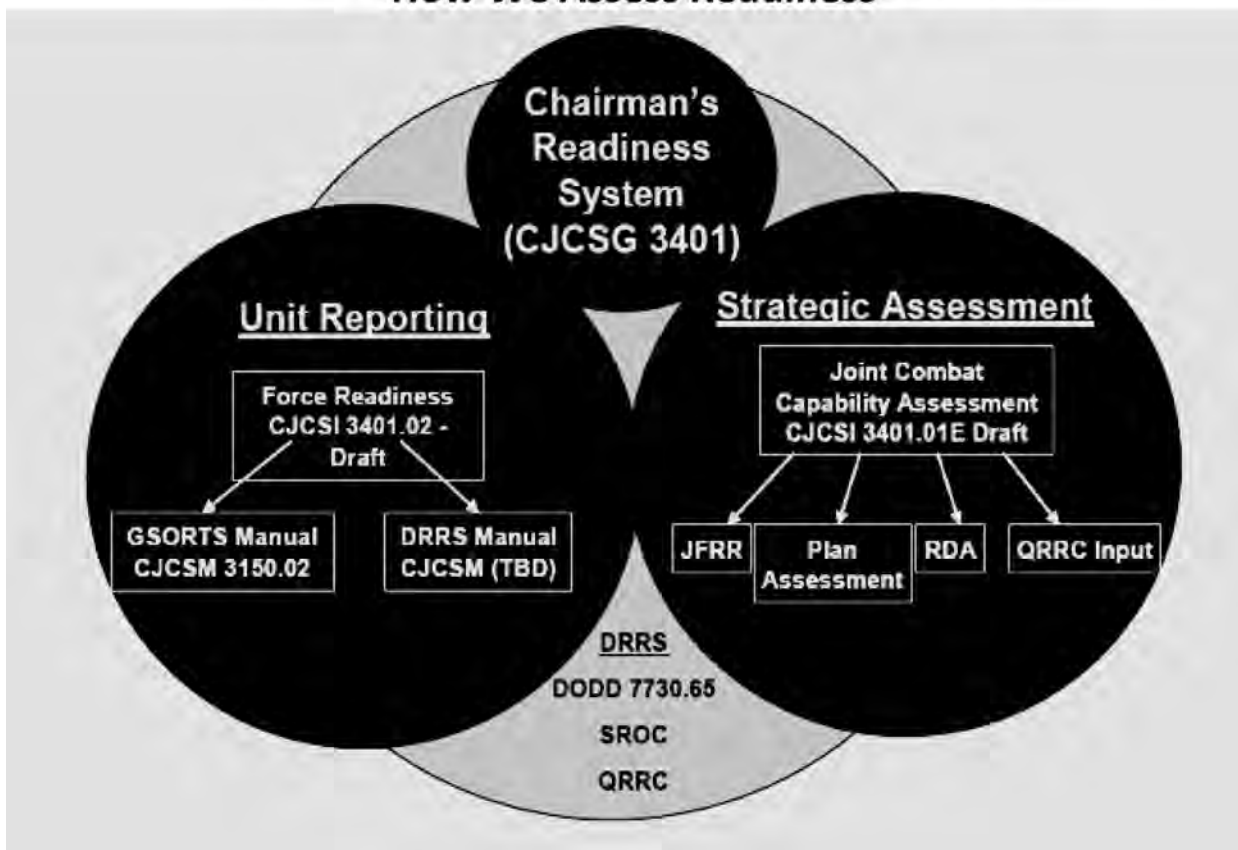

Figure 8-3. Chairman's Readiness System

**8–8. The Joint Combat Capabilities Assessment Process (Figure 8–4)**

*a. The Joint Capabilities Assessment (JCCA).* The Joint Capabilities Assessment (JCCA) process implements the Chairman’s Readiness System. The JCCA consists of a quarterly Joint Force Readiness Review (JFRR), an annual readiness deficiency assessment (RDA), a quarterly readiness report to Congress (QRRC) and a quarterly plans assessment.

*b. Quarterly Joint Force Readiness Reviews (JFRR).* The JFRR process evaluates the Combatant Commands, the Services, and the Combat Support Agencies readiness to execute their portions of mission capabilities required by the National Military Strategy.

*c. JFRR Required Data.* Each quarterly review consists of the following data points:

(1) *Overall Readiness Assessment.* The JFRR provides a snapshot of current and current plus 12-month assessment of Combatant Commands, Services and Combat Support Agencies using the 4-Tiered RA Readiness Assessment metrics shown in Figure 8–5.

(2) *Top Concerns. Combatant.* Commanders, Service Chiefs, and Directors will identify their top two readiness concerns. The purpose is to inform the Chairman of their most important, near-term readiness issues.

(3) *Y, Q, N Assessments against JMETS and JCAs.* Commanders and Agency Directors will assess the ability of their organization to accomplish a task to standard under specified conditions IAW the Universal Joint Task List (UJTL). This assessment should be informed by observed performance, resource availability, military judgment and will be measured against the 3-Tiered, Yes/Qualified Yes/No (Y/Q/N), readiness metric. (See Figure 8–5)

(4) *Y, Q, N Assessments against Core Missions and Plans.* Service Chiefs will assess the ability of their Service to provide organized, trained and equipped forces capable of executing their designed tasks and providing required capabilities to support assigned missions, reported against the Joint Capability Areas (JCAs) at an appropriate level of aggregation (tier); measured using the Y/Q/N metric.

(5) *Deficiencies.* Combatant Commands, Services and Combat Support Agencies are required to report readiness deficiencies every quarter as part of the JFRR so the Joint Chiefs of Staff and other senior leaders can maintain situational awareness on shortfalls impacting DOD’s readiness to execute the NMS. Annually the J–3 will collect all readiness deficiencies reported over a fiscal year and forward them as part of the Readiness Deficiency Report to J–8 to inform the Annual Report on Combatant Commander Requirements.

(6) *Service/SOCOM Readiness data from DRRS/GSORTS.* Service and USSOCOM readiness assessments will be reported IAW CJCSI 3401.02B, Force Readiness Reporting. The report will include current overall readiness for significant combat, combat support, and combat service support units using aggregated GSORTS data. This will include currently deployed, next to deploy (will deploy within the next 120 days) as well as non-deployed forces. Report will include deployed and next to deploy forces ability to perform assigned missions using the Percent Effective (PCTEF) readiness metric. The report also will address the ability of all remaining non-deployed forces to perform designed missions using the overall C-level assessment.

## *The Components of the JCCA Process* *How We Assess Joint Combat Capabilities*

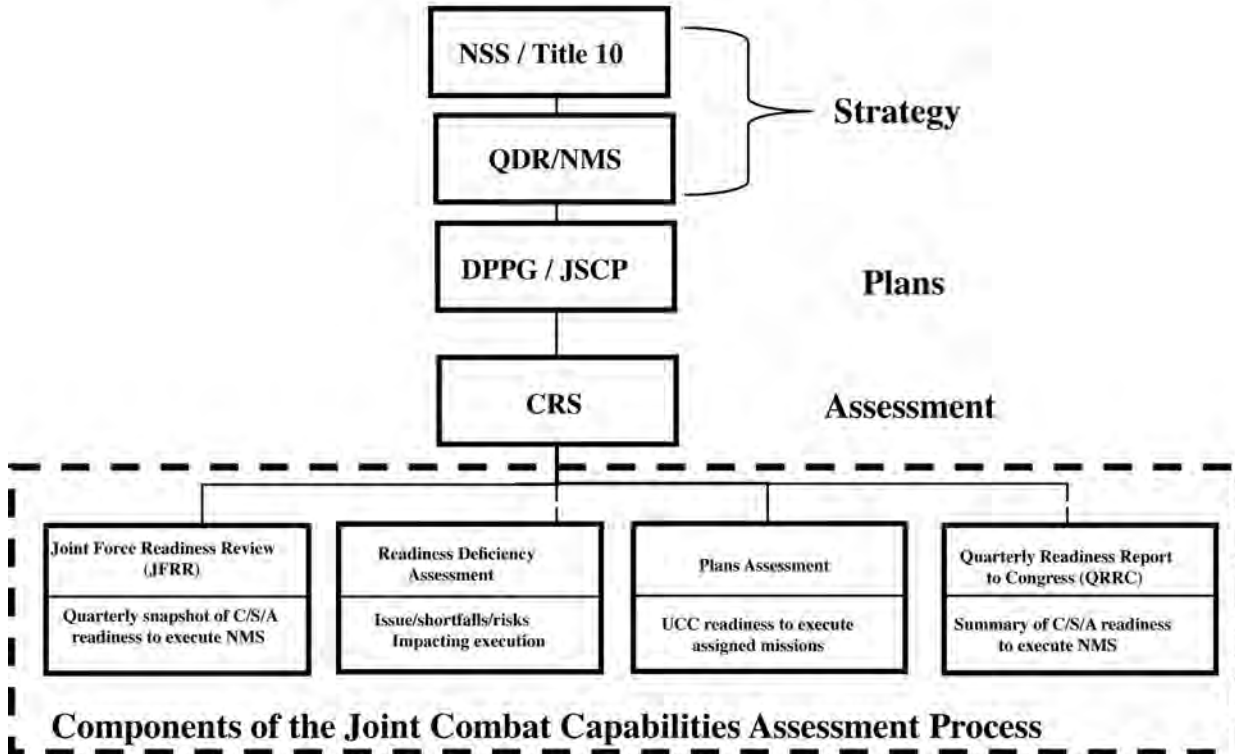

Figure 8-4. The Components of the JCCA Process

### 8-9. JFRR Metrics

JFRR Y/Q/N Criteria are defined in Figure 8-5. The Combatant Commands, and CSAs provide an overall Readiness Assessment of RA 1,2,3, or 4 and also assign a Yes, Qualified Yes, or No assessment to each of the Joint Mission-Essential Tasks (JMET) that apply to the execution of current missions, plus 12-month missions, and the required Mission Essential Tasks. The Services provide an overall Readiness Assessment of RA 1, 2, 3, or 4 and assign a Y/Q/N assessment to each of the applicable Joint Capability Areas (JCAs). The CSAs assign a Y/Q/N assessment to each of the agency mission-essential tasks (AMET) that apply to the three assessment areas.

## Readiness Assessment Definitions

- **Overall Assessment - Current, Current +12**
  - RA-1 - Negligible impact on readiness to accomplish mission(s)*
  - RA-2 - Limited impact on readiness to accomplish mission(s)*
  - RA-3 - Significant impact on readiness to accomplish mission(s)*
  - RA-4 - Shortfalls preclude accomplishing mission(s)*
- **Individual JMET / AMET / JCA Assessment**
  - Y - Issues or shortfalls have limited impact*
  - Q - Issues or shortfalls have significant impact*
  - N - Critical issues or shortfalls preclude accomplishment*

Figure 8–5. JFRR Readiness Assessment Definitions

Table 8–1  
Joint Capability Areas

Joint OPR	Joint Capability Area
J–8	Force Application
J–8	Force Support
J–5	Building Partnerships
JFCOM J–8	Command and Control
J–6	Net-Centric
J–2	Battlespace Awareness
J–8	Protection
J–4	Logistics

### 8–10. JFRR Deficiencies.

The Readiness Deficiency Assessment is a J–3 document that frames for senior leaders the cumulative impact of Combatant Command, Service and CSA reported deficiencies on DOD’s readiness to execute the NMS. Annually, the J–3 will collect readiness deficiencies reported over a fiscal year and identify readiness trends and highlight critical deficiencies, filtering all through the Defense Planning and Priorities Guidance (DPPG) in order to provide context and a relative value for each. A Joint Combat Capabilities Assessment Group (JCCAG) will review the results of the Readiness Deficiency Assessment and the DJ–3 will approve the assessment for release to inform J–8’s Annual Report on Combatant Command Requirements. (Figure 8–6)

### 8–11. JFRR Readiness Assessment (RA) Levels.

In addition to reporting deficiencies in meeting requirements and linking them to degraded JMETs, AMETs, or FAs, Combatant Commanders, Services, and CSAs assign an overall RA-level to their ability to execute current missions, plus 12-month missions, and the scenario. To determine the RA-level, the reporting commands consider accepted deficiencies, new issues identified during the current JFRR, and cumulative risk in answering the three questions listed in Figure 8–7. Based on answers to these questions, a worksheet is provided in Chairman, Joint Chiefs of Staff Instruction (CJCSI) 3401.01D to assist in determining the RA levels. RA levels are defined in Table 8–2.



**Table 8–2**  
**RA Levels Definitions**

Readiness Assessment Level	Definitions
RA–1	Issues and/or shortfalls have negligible impact on readiness and ability to accomplish assigned missions.
RA–2	Issues and/or shortfalls have limited impact on readiness and ability to accomplish assigned missions
RA–3	Issues and/or shortfalls have significant impact on readiness and ability to accomplish missions.
RA–4	Issues and/or shortfalls preclude accomplishment of assigned mission

Notes:

<sup>1</sup> Overall Assessment uses RA-levels to categorize risk to end state.

**8–12. CRS Outputs**

a. The outputs of the CRS are synchronized to inform, through the Comprehensive Joint Assessment, other Joint Staff and OSD processes to include: J–5’s Chairman’s Risk Assessment; J–8’s Annual Report on Combatant Commander Requirements and OSD’s Quarterly Readiness Report to Congress (Refer to Figure 8–6 below). Through these informative relationships the CRS:

- (1) Ensures senior leaders and staffs are operating off a common readiness picture.
- (2) Supports the development of coordinated strategic documents.
- (3) Is synchronized to facilitate timely senior leader decision making.
- (4) Helps the Secretary of Defense and Chairman fulfill their statutory requirements under Title 10, USC.

b. The strategic documents mentioned above and discussed in greater detail below help align ends, ways, means and risks to accomplishing the NMS and enable the Chairman to provide the best military advice to the President and the Secretary of Defense.

(1) Chairman’s Risk Assessment. IAW with Title 10, USC, Section 153 (b)(1), “the Chairman shall submit to the Secretary of Defense a report providing the Chairman’s assessment of the nature and magnitude of the strategic and military risks associated with executing the missions called for in the NMS.” To help fulfill this statutory requirement the JCCAG will forward to the J–5, annually, the Joint Combat Capability Assessment and the results of Plans Assessments to inform the Chairman’s Risk Assessment (Figure 8–6).

(2) Annual Report on Combatant Commander Requirements. IAW with Title 10, USC, Section 153 (c) (1), “the Chairman shall submit to the congressional defense committees a report on the requirements of the combatant commands.” In addition to consolidating the combatant command integrated priority lists, the report will “address each deficiency in readiness identified during the joint readiness review” (Title 10, USC, Section 117 (d) (1) (a)). To help fulfill this statutory requirement the JCCAG will forward to the J–8, annually, the Readiness Deficiency Assessment identifying:

- (a) Combatant Command readiness deficiencies reported over the fiscal year.
- (b) Combatant Command readiness deficiencies closed over the fiscal year.
- (c) The status of Combatant Command readiness deficiencies not yet closed.

(3) Quarterly Readiness Report to Congress. Section 482 of Title 10 USC requires that within 45 days following the end of each calendar quarter a report be sent to Congress based on military readiness. The QRRC is reviewed and approved by the Secretary of Defense, forwarded to Congress, and fulfills this requirement.

# CRS Output Flowchart

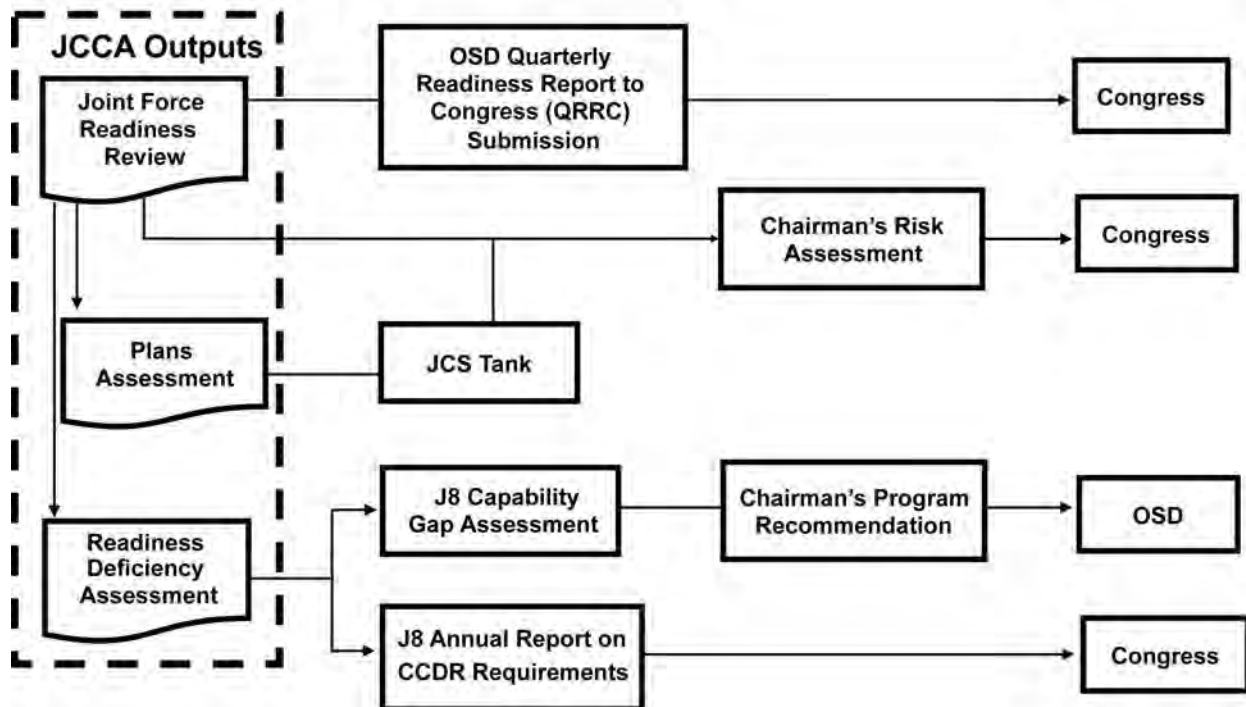

Figure 8-6. CRS Output Flow

## 8-13. Senior Readiness Oversight Council (SROC)

The SROC is an executive committee of the OSD, and is made up of the Deputy Secretary of Defense, who serves as Chair, the Secretaries of the Military Departments, the CJCS, and the Chiefs of the Services, the Under Secretaries of Defense, and other senior OSD officials with an interest in readiness. The SROC meets periodically to review significant readiness topics and issues. Functions of the SROC include: advising the Secretary of Defense on readiness policy; reviewing results of the JCCA reporting on current and projected readiness issues; coordinating DOD positions on readiness to outside audiences; and ensuring the development of the Quarterly Readiness Reports to Congress (QRRC).

## 8-14. Assessing future readiness

Broad responsibility for assessing future joint requirements falls under the purview of the Joint Requirements Oversight Council (JROC). The JROC, with membership of the VCJCS and the Vice Chiefs of each Service, reviews acquisition programs, validates requirements, and makes recommendations on the placement of scarce dollars and resources to the CJCS. The JROC provides a senior military perspective on the major weapons systems and other military capabilities required. (See Chapter 4 for discussion of JROC).

## Section IV

### Department of Defense Readiness Reporting System Army (DRRS-A)

DRRS-A is the Army-Specific Implementation of the DOD DRRS (see para 8-6 above).

## 8-15. DRRS-A overview

The Army continues to develop DRRS-A to accommodate the evolution of DRRS and also to provide the readiness reporting flexibility necessary to support the implementation of emerging Army Force Generation (ARFORGEN) concepts and processes for manning, equipping, training and readiness. The key components of DRRS-A are: (1)

## How the Army Runs

NetUSR—a web based readiness data input tool that will import data from designated authoritative sources for reference to support required commander readiness assessments. NetUSR is the Army’s official USR input tool. (2) The DRRS–A database is the Army’s official readiness reporting database of record. (3) The Army Readiness Management System (ARMS) application which is the official Army readiness reporting database output tool. ARMS provide visibility to all Army readiness data and information contained in the readiness reporting database and facilitate the detailed analysis of readiness trends and issues.

### 8–16. NetUSR purpose

NetUSR is the software application used by commanders of Army units to provide input to DRRS. The primary purpose of the reports prepared by commanders using NetUSR is to provide the President, Secretary of Defense, JCS, HQDA, and all levels of the Army’s chain of command with the current status of U.S. Army units and necessary information for making operational decisions. The NetUSR application enables commanders to measure and report on the status of resources and training level in their units at a given point in time. The reports should not be used in isolation to assess overall unit readiness or the broader aspects of Army force readiness. The reports provide a timely single source document for assessing key elements of a unit’s status. They do not provide all the information necessary to manage resources.

### 8–17. NetUSR relationship to joint readiness

CJCSI 3401.01D and DODD 7730.65 establish policy and procedures for reporting and assessing the current readiness of the U.S. Armed Forces through the Chairman’s Readiness System (CRS). Units report their METs and their status in the areas of personnel, equipment on hand, equipment readiness, and training to their Service or Combatant Commands for later incorporation to the JFRR. DRRS–A is established by Army Regulation 220–1 and provides the data required of Army organizations by the CJCSI and the DODD. The Army requires additional data that increases the value of the unit status report as a resource management and operations tool. The supplemental data required by the Army was selected by HQDA in coordination with the ACOMs, ASCCs and DRUs. This information passes through but is not retained by the JS. The higher level of detail allows units to better express their status and all levels of command to use the report to analyze key status indicators.

### 8–18. NetUSR procedures

*a.* Commanders of all measured units are required to determine and report a C-level that reflects their assessments of their units’ ability to accomplish the core missions for which the units are designed (C-Level), an assigned mission level (A-level) that reflects their assessments of their units’ ability to accomplish their primary directed missions, and also a “chemical - biological defense readiness training” (CBDRT) level indicating their units’ readiness to perform their core mission under chemical or biological conditions. The C-level, A-level and the CBDRT level are overall levels that are described in Chapter 4 of AR 220–1. There are four measurements (personnel, equipment supply status, equipment readiness/serviceability status, and training) that support the C-level determination, two measurements, Assigned Mission Manning (AMM) and Assigned Mission Equipment (AME) support the A-level determination and two measurements (Equipment On Hand (EOH) and training) support the CBDRT level determination. These resource and training status measurements are determined using the four tier rating scale. Analysis of these resource and training measurements provides insight into the measured unit’s tactical-level capability. (Figure 8–7).

*b.* Status levels are determined for each of these measured areas to support the overall assessments required. Measured area levels are determined by applying the specific resource or status criteria and/or metrics. Commanders cannot subjectively upgrade or downgrade the level of a measured area.

*c.* In general, measured units will measure and report readiness status against their currently effective MTOE/TDA document. However, in certain circumstances, units can report early against a future document. AR 220–1, Chapter 4 contains the details.

*d.* NetUSR data is transmitted through administrative control (ADCON) channels (Figure 8–8). Reporting units are required to submit a unit status report covering their specific resource and training status levels, their overall category levels (C-levels) and their individual and overall MET assessments

*e.* Overall Levels. The overall category level (C–1, C–2, C–3, C–4, C–5) indicates the degree to which a unit has achieved prescribed levels of fill for personnel and equipment, the training status of those personnel, and the maintenance status of the equipment. When assigned a current operational requirement, units also report A-Level to indicate their readiness level for the current assigned mission. The four areas for which specific levels are calculated to support the C-Level determination are: personnel, equipment on-hand, equipment readiness, and training. These measured area levels reflect the status of the unit’s resources and training measured against the resources and training required to undertake the wartime mission for which the unit is organized or designed. Category levels do not project a unit’s combat ability once committed to action. The overall unit category level will be based only upon organic resources and training under the actual control of the reporting unit or its parent unit. The C-level categories are:

(1) *C–1.* Unit possesses the required resources and is trained to undertake the full wartime mission(s) for which it is organized or designed.

- (2) C-2. Unit possesses the required resources and is trained to undertake most of the wartime mission(s) for which it is organized or designed.
- (3) C-3. Unit possesses the required resources and is trained to undertake many, but not all, portions of the wartime mission(s) for which it is organized or designed.
- (4) C-4. Unit requires additional resources or training to undertake its wartime mission(s), but it may be directed to undertake portions of its wartime mission(s) with resources on hand.
- (5) C-5. Unit is undergoing a service-directed resource action and is not prepared, at this time, to undertake the wartime mission(s) for which it is organized or designed. C-5 units are restricted to the following:
  - (a) Units undergoing activation, inactivation, or conversion.
  - (b) Units that have their levels for authorized personnel and/or equipment established so that, even when filled to the authorized level, the established level does not allow the unit to achieve level 3 or higher.
  - (c) Units that are not manned or equipped but are required in the wartime structure.

### CUSR Measured Areas

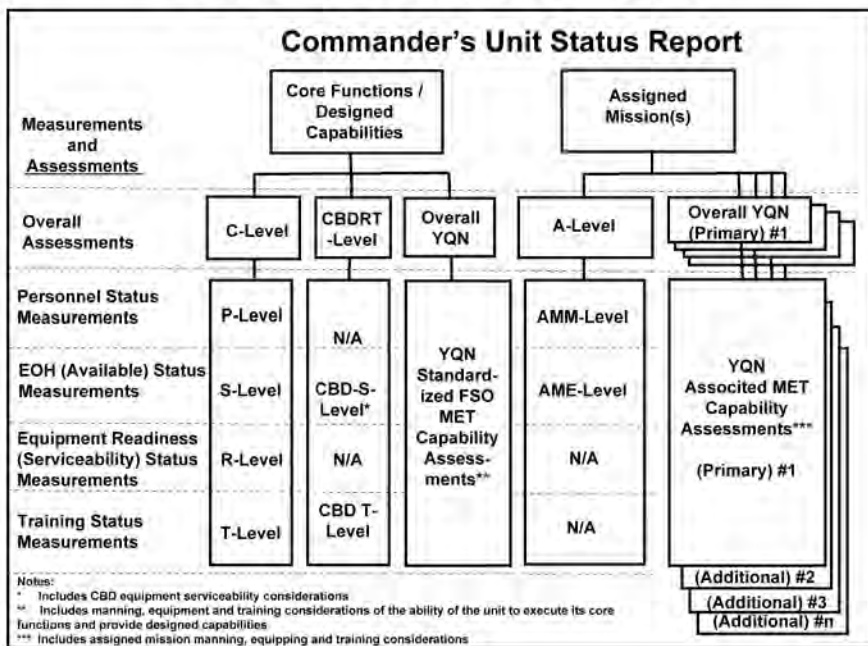

Figure 8-7. Commander's Unit Status Report Measured Areas

## Readiness Reporting Channels

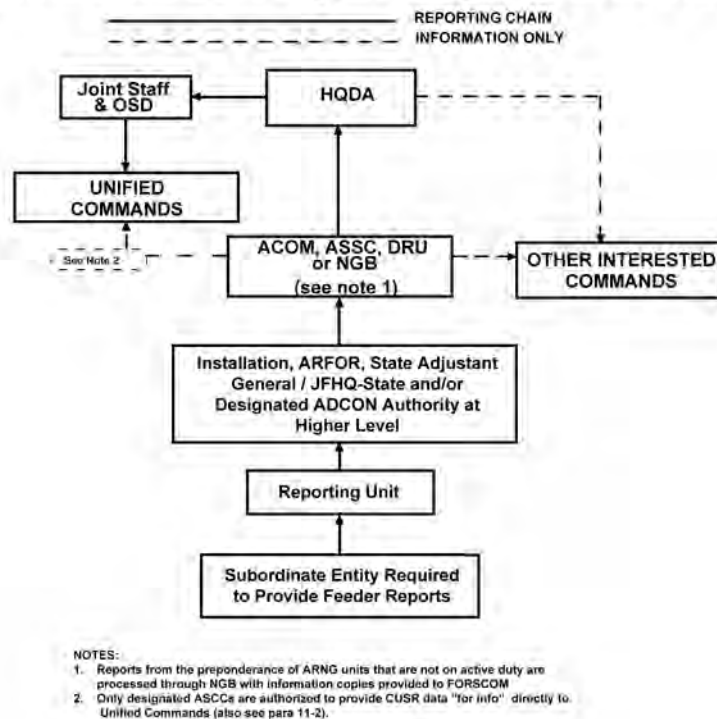

Figure 8–8. Army Unit Status Reporting Channels

*f.* MET Assessments. The individual MET assessment (Y / Q / N) indicates the degree to which a unit has achieved proficiency in a mission essential task within prescribed conditions and standards when resources and training constraints are considered. The metrics to assess task capability are: Y - YES. Organization can accomplish task to standard under specified conditions. “Yes” assessment should reflect demonstrated performance in training or operations whenever possible. Unit possesses the necessary resources, or those resources have been explicitly identified to the unit, to allow it to execute when so directed (i.e. “Fight tonight”). Q - QUALIFIED YES. Organization is expected to accomplish the task to standard, but this performance has not been observed or demonstrated in training or operations. Organizations assessing their task or mission as a “Qualified Yes” can be employed for those tasks. Unit possesses the necessary resources, or those resources have been explicitly identified to the unit, to allow it to execute when so directed (i.e. “Fight tonight”). N - NO. The organization is unable to accomplish the task to standard at this time.

*g.* Measured Area Levels.

(1) Personnel level. The USR provides indicators of a unit’s personnel status (P-level). Wartime personnel requirements are compared to assigned personnel strength, available strength, MOS qualification and personnel turnover.

(2) Equipment-on-hand (EOH) level. The USR provides indicators of a unit’s Equipment on Hand (EOH) status (S-level) by comparing full wartime requirement for a unit’s primary items of equipment to include: principal weapons systems and equipment (ERC A/P); and each individual pacing item (ERC P); with the on-hand quantities of those items.

(3) Equipment readiness (ER) level. The USR provides an indication (R-level) of how well the unit is maintaining its on-hand equipment.

(4) Training data level. The USR provides an indicator of the training level (T-level) for the unit. The T-level indicates the commander’s evaluation of the unit’s capability to employ its weapon systems and equipment to effectively perform its designed or assigned missions.

*h.* Determining the unit’s C-level. To determine the overall C-level, the commander reviews the status levels attained in the four measured resource areas. The overall unit C-level will normally be the lowest level recorded in any of the unit’s individually measured resource areas of personnel, equipment-on-hand, equipment readiness, and training. There may be circumstances in which Commanders may subjectively upgrade or downgrade a unit’s C-level based on

mission evaluation, but the status level computed for each individually measured area must be reported without adjustment.

i. Determining the unit's A-level. The A-Level is an overall readiness assessment that reflects the unit's ability to accomplish the assigned mission that it is preparing for, has been ordered to execute and / or is executing. Similar to the C-Level, the A-Level contains measured resource areas that indicate the availability status of resources (personnel and equipment) measured against the assigned mission requirements that have been established or conveyed by the Army Tasking Authority. If the core mission is directed for execution, then the A-level and C-level will coincide.

j. C-Level and A-Level details are shown in Figures 8-9 and 8-10 below.

---

## C-Levels

- |          |  |
|----------|--|
| <b>1</b> | <i>C1 = Unit is resourced &amp; trained to undertake the <u>full</u> wartime mission for which it was designed or organized. (No adverse impacts to flexibility or vulnerability.)</i>   |
| <b>2</b> | <i>C2 = Unit is resourced &amp; trained to undertake <u>most</u> wartime missions for which it was designed or organized. The unit would require little, if any, compensation for deficiencies. (Isolated increases in flexibility but no increase in vulnerability under most operational scenarios.)</i>                                     |
| <b>3</b> | <i>C3 = Unit is resourced &amp; trained to undertake <u>many</u>, but not all, portions of the wartime missions for which it was designed or organized. The unit would require significant compensation for deficiencies. (Significantly decreased flexibility and increased vulnerability under many, but not all, envisioned scenarios).</i> |
| <b>4</b> | <i>C4 = Unit requires <u>additional resources or training</u> to undertake its wartime missions, but may be directed to undertake some portions of its wartime mission with resources on hand.</i>   |
| <b>5</b> | <i>C5 = Unit is undergoing a <u>DA directed</u> resource action and is not prepared to undertake the wartime mission for which it was organized or designed. However, the unit may be capable of performing non-traditional missions.</i>  |

***C-Level:** The Unit Commander's assessment of the level at which the unit possesses the required resources and is trained to undertake the full wartime (core) mission for which it is designed/organized.*

Figure 8-9. Commander's Unit Status Report C-Levels

---

# A-Levels

**1**

***A1: The unit possesses the required resources and is trained to undertake the full directed mission.***

**2**

***A2: The unit possesses the required resources and is trained to undertake the most of the directed mission.***

**3**

***A3: The unit possesses the required resources and is trained to undertake the many, but not all, portions of the directed mission.***

**4**

***A4: The unit requires additional resources or training to undertake the directed mission, but may be required to undertake portions of the directed mission with the resources on hand.***

**Assigned Mission Level: The Unit Commander's assessment of the unit's ability to execute the primary directed mission assigned.**

Figure 8-10. Commander's Unit Status Report A-Levels

---

## 8-19. Use of DRRS-A data at HQDA

a. At HQDA, DRRS-A data is part of a larger readiness picture compiled from many functional reports and sources. It alerts senior leaders to unit readiness issues so that they can exercise the appropriate management actions and provide the required assistance. DA uses DRRS-A data in conjunction with other personnel and logistics reports to improve resource management of people, equipment, and the programming of facilities and training areas to increase the combat effectiveness of subordinate elements.

b. Unit commanders prepare their status reports using the NetUSR application and submit them through their major commands into the DRRS-A database. Subsequently, the Office of the Deputy Chief of Staff, G-3/5/7 compiles the reports and provides them to GSORTS and the DoD Defense Readiness Reporting System (DRRS). ODCS, G-3/5/7's Army Readiness Management System (ARMS) allows all DA Staff elements and other ARMS users to access for analysis via SIPRNet all unit reports in the DRRS-A database.

c. The Vice Chief of Staff receives a monthly Strategic Readiness Update from the ODCS G3/5/7, with significant input and analysis from the ODCS G-1, ODCS G-4, ODCS G-8 and other ARSTAF elements. The current readiness and capability status of major units is provided as well as trend analysis and projections

d. Each principal DA Staff element uses the information provided by the ODCS, G-3/5/7 to influence resource allocation. Aggregate data in DRRS-A also serves as a yardstick to judge how well the functional management system for personnel, logistics, and training are performing.

## Section V

### Summary and references

#### 8–20. Summary

Readiness is a primary mission of military forces. Recognizing that readiness is highly situational and subjective, it is, nevertheless, a yardstick for programming and budgeting. The Army's readiness strategy entails maximizing readiness within available resources to meet the operational demands resulting from expeditionary requirements, and contingency force requirements. The more accurately the Army captures and quantifies readiness, the better the Army can articulate resource needs to the DOD and the Congress.

#### 8–21. References

- a.* DOD Directive 5149.2, Senior Readiness Oversight Council (SROC).
- b.* DOD Directive 7730.65, Department of Defense Readiness Reporting System (DRRS).
- c.* CJCS Instruction 3401.01D, Chairman's Readiness System.
- d.* CJCS Instruction 3401.02B, Force Readiness Reporting.
- e.* CJCS Manual 3150.02, Global Status of Resources and Training System.
- f.* Army Regulation 220–1, Unit Status Reporting and Force Registration - Consolidated Policies.
- g.* Army Regulation 700–138, Army Logistics Readiness and Sustainability.
- h.* CJCS Guide 3401D. CJCS Guide to the Chairman's Readiness System
- i.* OSD (P&R), DRRS Primer for Senior Leaders



RESERVED

## Chapter 9

# ARMY PLANNING, PROGRAMMING, BUDGETING, AND EXECUTION PROCESS

Before the era of Secretary of Defense McNamara, each Service essentially established its own single-year budget and submitted it to Congress annually. Secretary McNamara, however, applied a different approach founded on a study by the RAND Corporation. He required the Services to prepare a single document, the then Five Year Defense Program, or FYDP, which detailed their resource requirements on a multi-year basis. He established himself as the sole authority for approving changes to the FYDP and Services that desired change to the approved FYDP had to obtain his approval. That formed the rudimentary beginning of the DOD Planning, Programming, and Budgeting System, or PPBS. PPBS is a continually evolving process that under Secretary of Defense Rumsfeld in 2003 changed to the Planning, Programming, Budgeting, and Execution (PPBE) process. On 9 April 2010, Secretary of Defense Gates made significant changes to the annual planning and programming process.

### Section I Introduction

#### 9–1. Chapter content

This chapter describes how, at the beginning of CY 2011, the DOD Planning, Programming, Budgeting, and Execution (PPBE) process and the Army PPBE process acquire, allocate, and manage resources for military functions. Prescribed by Army Regulation 1–1, the Army PPBE process is a component of the Department of Defense (DOD) PPBE process governed by DOD Directive 7045.14 and DOD Instruction 7045.7. This account describes the Army PPBE process in relation to its parent DOD PPBE process. It lays out the responsibilities of Army officials for overseeing Army PPBE, for managing the several phases of its process, and for performing PPBE-related operational tasks. Next, the chapter highlights principal forums and other key characteristics of the DOD PPBE process and then the Army PPBE process. After displaying a graphic representation of the process recurring events and organizational structure, the chapter concludes with a phase-by-phase discussion of the biennial process.

#### 9–2. PPBS-a dynamic system

First, however, consider the history of the former PPBS now approaching its 48th year. Significant events recorded by presidential administration show how the system has evolved, revealing a dynamic system.

##### *a. 1962–Kennedy/McNamara.*

(1) The DOD PPBS began in 1962 as a management innovation of President Kennedy's Secretary of Defense (SecDef), Robert McNamara. Before McNamara, each Military Department had prepared its budget following individual Service interests with very little guidance. Previous SecDef involvement was for the most part limited to dividing the budget ceiling of DOD between the Services. If the Services exceeded their "share of the pie," the SecDef would reduce their budget, usually by a percentage cut across all appropriations. Introducing the PPBS changed all this.

(2) Based on a concept developed at the RAND Corporation in the 1950s, the PPBS inaugurated a multi-year programmatic focus. Annual ceiling reductions gave way to analysis centered on 10 major force and support programs over a 5-year program period.

##### *b. 1969–Nixon/Laird.*

The first major change in the PPBS occurred under President Nixon's SecDef, Melvin Laird. The Laird management style stressed participatory management. The Office of the Secretary of Defense (OSD) no longer initiated detailed program proposals; it reviewed those put forward by the Services using specific budgetary ceilings.

##### *c. 1977–Carter/Brown.*

President Carter introduced zero-based budgeting to the Federal Budget. It achieved only limited success. The goal of zero-based budgeting was to identify marginal programs more clearly. Decision Packages arrayed resources at three different levels, giving OSD greater opportunity to alter Service program proposals. Each Service developed procedures to array the decision packages. As an aid in building and displaying its program, the Army installed a program development increment package (PDIP). Used internally and not reflected in programs and budgets forwarded by the Army, the PDIP has since evolved into a management decision package (MDEP). In 1979, as a result of a RAND Corporation study (the Rice Study); Secretary of Defense Brown formed the Defense Resources Board (DRB). Designed to manage the PPBS more effectively, the DRB consisted of various OSD officials and the Chairman of the Joint Chiefs of Staff (CJCS).

##### *d. 1981–Reagan/Weinberger.*

The Reagan Administration pledged to revitalize American military strength in the most effective and economical manner. This objective led to significant changes in the PPBS known as the Carlucci initiatives (Frank Carlucci was the Deputy Secretary of Defense (DepSecDef) and Chairman of the DRB). Initiatives included a greater emphasis on long-range planning, a greater decentralization of authority to the Services, closer attention to cost savings and efficiencies, a refocus of DRB Program Review to major issues only, and a general streamlining of the entire PPBS process. In addition, a restructured DRB added Service Secretaries as full members. The DRB would now review and approve policy and strategy in the planning phase, which produced defense guidance

## How the Army Runs

(DG). Moreover, one initiative invited commanders of the U.S. combatant commands to participate in crucial DRB deliberations during the development of the DG and the DRB Program Review.

*e. 1984–Enhancement of the role of commanders of U.S. combatant commands in the PPBS.* DepSecDef Taft introduced procedures to allow combatant command commanders a greater voice in the process for developing Program Objective Memorandums (POMs) and the DRB Program Review. The procedures included: submission by the commanders of prioritized requirements (via integrated priority lists (IPLs)); tracking their concerns during POM development and execution; visibility of combatant command requirements in the POMs; enhanced participation by commanders in DRB program review; and an enhanced role for the Joint Chiefs of Staff (JCS) in the review and coordination of commander concerns.

*f. 1986–Conversion from annual to biennial PPBS cycle.* In response to his Blue Ribbon Commission on Defense Management (Packard Commission) and the DOD Authorization Act of 1986 (Public Law 99–145), President Reagan issued National Security Decision Directive 219, directing that the Office of Management and Budget (OMB) and DOD produce a 2-year budget beginning with the FY 1988 and FY 1989 budget years. In response to this direction, OSD and the Military Departments implemented a biennial PPBS process. In practice, however, Congress still authorizes and appropriates annually, permitting an off cycle update of the five remaining POM years and the second budget year.

*g. 1987–Combatant command capabilities to participate effectively in the PPBS budget phase.* Earlier decisions of the DRB gave commanders of combatant commands a role in the planning and programming phases of the PPBS. In October 1987, the DRB expanded the role of the commanders to include the budget review and execution phase.

*h. 1989–Bush/Cheney.* During the early stages of DOD downsizing, President Bush instituted a series of defense management review decisions. In another initiative, SecDef Cheney modified the framework for PPBS decision-making, including in the structure a core group of DOD officials he used to help manage the Department.

*i. 1993–Clinton/Aspin, Perry, Cohen.* DOD downsizing continued under the Clinton Administration guided initially by SecDef Les Aspin's Bottom Up Review and later by the results of the Defense Performance Review, Commission on Roles and Missions of the Armed Forces and the 1997 Quadrennial Defense Review. The Clinton administration continued the PPBS framework of the Bush Administration, using a core group of DOD managers and several review forums including a program review group (PRG) expanded by the Administration.

*j. 2001–Bush/Rumsfeld.* Emphasis on Defense Transformation marked the early months of the Bush Presidency, a focus abruptly broadened by the events of September 11, 2001. U.S. Defense spending has since markedly increased due not only to additional costs of the war on terror, but also to the end of the procurement holiday of the 1990s and the needs of Transformation. In a process change, DOD introduced closer program and budget correlation, requiring agencies to prepare a combined Program Objective Memorandum and Budget Estimate Submission (POM/BES) followed by an OSD concurrent program and budget review. Another initiative established a Senior Executive Council (SEC) to counsel the SecDef in applying sound business practices. Chaired by the SecDef, the council's membership comprises the DepSecDef, Under Secretary of Defense for Acquisition, Technology and Logistics, and the Secretaries of the Army, Navy, and Air Force.

*k. 2003–. Bush/Rumsfeld.* On 22 May 2003, Management Initiative Decision 913 directed the elimination of the mini-POM and the amended budget estimate submission year and replaced them with program change proposals (PCPs) and budget change proposals (BCPs) respectively. On 31 October 2003, the SecDef agreed with the recommendation of the Joint Defense Capabilities Study (Aldridge Committee) and directed the elimination of the Defense Planning Guidance (DPG) replacing it with the SecDef Strategic Planning Guidance (SPG) and the SecDef Joint Programming Guidance (JPG). At the same time, the SecDef directed the establishment of the Enhanced Planning Process (EPP) as a joint capabilities-based forum to analyze SecDef identified issues, develop alternative solutions to resolve the issues, and determine the joint implications associated with each alternative solution.

*l. 2005 -. Bush/Rumsfeld.* Process changes continue during this administration. Principally - they include strengthening the Combatant Commander's role in the process by enhancing the Integrated Priority List process and including the Combatant Commanders in the decision process by expanding the Senior Leader Review Group to include them and calling the new body, The Strategic Planning Council.

*m. 2006 - Bush/Rumsfeld.* Process changes implemented during this administration include changing the program change proposals (PCPs) and budget change proposals (BCPs) concepts to combine both into one process renamed as Change Proposals (CPs). The ground rules for submitting change proposal effectively limited the ability of the Services to make changes to the next budget year being prepared to go to Congress.

*n. 2008- Bush/Gates.* New planning guidance documents for programming promulgated to replace the Strategic Planning Guidance (SPG). The SECDEF's strategic guidance is captured in the Guidance for the Development of Forces (GDF) and the Guidance for Employment of Forces (GEF). The SECDEF also continued the publication of the National Defense Strategy (NDS) as guidance for the Services as they begin planning for the development of the Program Objective Memorandum (POM).

*o. 2010 -. Obama/Gates.* Significant changes to the PPBE system were implemented on 9 April 2010 by Secretary of Defense Gates. He established a single document, the Defense Planning and Programming Guidance (DPPG), as guidance for building the Program Objective Memorandum (POM). He changed the POM planning years from six

years to five years. He eliminated the two-year budgeting process and established single year budgeting. He also changed the concept of even-year and odd-year budgeting with only program and budget change proposals in the odd years and returned to building a POM every year. He instituted the concept of Front End Analysis (FEA) to get early up-front decisions made in the programming process. The FEA process appears to be similar in nature to the Enhanced Planning Process as outlined in paragraph k above. In the 2009 Weapons System Acquisition Reform Act, the Congress established the position of Director Cost Assessment and Program Evaluation (CAPE) as a Presidential appointment requiring Senate confirmation and combined two organizations, The Cost Analysis Improvement Group (CAIG) and Program Analysis and Evaluation Directorate (PAE), to form the CAPE Directorate. The Army retained its PAE position.

## Section II System Responsibilities

### 9–3. Secretarial oversight

*a. PPBE oversight and Army wide policy development.* The Assistant Secretary of the Army (Financial Management and Comptroller) (ASA(FM&C)) oversees—

- (1) The PPBE process and develops and issues Army wide PPBE policy.
- (2) All Army appropriations and serves as the sponsor for all appropriations except Army National Guard (ARNG) and U.S. Army Reserve (AR) appropriations. (See para 9–10d.)
- (3) The Office of the Deputy Assistant Secretary of the Army for Cost and Economics, which performs cost analysis functions in support of the PPBE process and Executive Office of HQDA.

*b. Functional oversight.* Principal officials of the Office of the Secretary of the Army (OSA) oversee operation of the PPBE process within assigned functional areas and provide related policy and direction.

### 9–4. System management

ASA(FM&C) manages the PPBE process with the Deputy Chief of Staff, G–3/5/7, Deputy Chief of Staff, G–8, and Military Deputy for Budget and Execution acting as advisers. As provided in paragraphs 9–5, 9–6, and 9–7, below, the Assistant Deputy Chief of Staff (ADCS) G–3/5/7, the Director of Program Analysis and Evaluation (DPAE), and the Director of the Army Budget (DAB) manage functional phases of the process, each establishing and supervising policies and procedures necessary to carry out phase functions.

### 9–5. Planning phase

*a. Deputy Chief of Staff (DCS), G–3/5/7.* Responsible for operations and planning functions, the Deputy Chief of Staff, G–3/5/7—

- (1) Through the Assistant G–3/5/7—
  - (a) Manages the PPBE planning phase.
  - (b) Co-chairs the Planning Program Budget Committee (PPBC) with the Director of Program Analysis and Evaluation (DPAE), and Director of the Army Budget (DAB).
  - (c) Guides the work of Program Evaluation Groups (PEG) on planning and readiness matters to include requirements determination, prioritization, and the integration of security cooperation issues per the Army International Activities Plan. (See Table 9–1 and para 9–31)
  - (d) Assesses capabilities, deficiencies, and risks of the Program Objective Memorandum (POM) force at the end of the current POM.

**Table 9–1**  
**Program Evaluation Groups**

Title	Co-chairs
Manning	ASA(M&RA)/G–1
Training	ASA(M&RA)/G–3/5/7
Organizing	ASA(M&RA)/AASA
Equipping	ASA(ALT)/G–8
Sustaining	ASA(ALT)/G–4
Installations	ASA(I&E)/ACSIM

## How the Army Runs

(2) Serves as the principal adviser to the Chief of Staff, Army (CSA) on Joint matters, National Security Council (NSC) matters, and the politico-military aspects of international affairs.

(a) (a) Provides HQDA with strategic analysis pertaining to national security issues involving international and regional arms control treaties, agreements, and policies.

(b) (b) Plans for employment of Army forces to meet strategic requirements and shape Army forces for the future.

(3) Serves as overall integrator of Army transformation.

(a) Makes sure that military requirements reflect future Army strategy, planning guidance, and policy and that the capability and applicability of total Army forces remain synchronized with the National Security Strategy (NSS), National Defense Strategy (NDS) and National Military Strategy (NMS).

(b) Provides the HQDA focal point for the organization, integration, and synchronization of decision making, as well as for requirements definition, force structuring, training developments, and prioritization.

(4) Prepares The Army Strategy (AS), Army Planning Priorities Guidance (APPG), and Army Campaign Plan (ACP) as sections of The Army Plan (TAP); coordinates publication of the Army Programming Guidance Memorandum (APGM) as a section of TAP with Director, PAE; coordinates and publishes completed four sections of TAP.

(a) Defines Army planning assumptions.

(b) Sets requirements and priorities based on guidance from the SecDef, Secretary of the Army (SECARMY), and CSA and priorities of the combatant commanders.

(c) Sets objectives to meet requirements and overcome shortfalls.

(5) Monitors and reports on current operations.

(a) Develops and coordinates policy, programs, and initiatives to achieve directed levels of individual, leader, and unit training readiness for the Army.

(b) Oversees Army readiness reporting requirements and the reporting of Army readiness to provide an accurate picture for prioritization and resource allocation decisions within HQDA and externally.

(c) Assesses and coordinates support to US combatant commanders and, through the Army Component Command (ACC), provides the operational link between each combatant command, HQDA, and the Joint Staff.

(6) Performs all mobilization functions.

(7) Provides the HQDA focal point for executing military support to civil authorities.

(8) Executes the Continuity of Operations Program (COOP) for HQDA and OSD, the Army Infrastructure Assurance Program, and the Domestic Preparedness Program provides support for special events.

(9) Provides support for special events.

(10) Provides the vision and strategy and manages the development of models and simulations.

(11) Develops policy and acts as the principal adviser to the CSA for information operations.

(12) Serves as proponent of the Training PEG. (See para 9–31.)

(13) Serves as proponent of programs within the Future Years Defense Program (FYDP): programs 1–Strategic Forces, 2–General Purpose Forces, 4–Mobility, 10–Support of Other Nations, and 11–Special Operations Forces. Serves also as resource proponent for tactical intelligence, Army subprogram 3–Intelligence and proponent of Army subprogram 8–Training. (See para 9–12.)

(14) Manages force structure issues and manages functional requirements and program and performance for designated accounts of the Operation and Maintenance, Army appropriation. (See para 9–10 and Tables 9–2 through 9–8.)

*b. Deputy Chief of Staff, G–8.* Responsible for the execution of approved materiel requirements, the Deputy Chief of Staff, G–8—

(1) Provides the HQDA focal point for program development, materiel integration, and assessments like the QDR.

(2) With the Assistant Secretary of the Army for Acquisition, Logistics, and Technology (ASA (ALT)), prepares the Research, Development, and Acquisition Plan (RDA Plan), which is represented by the database for the FYDP augmented for the Extended Planning Period (EPP).

(3) Prepares the Army Modernization Strategy and helps prepare Army input to OSD’s Defense Program Projection and Army comments on the Guidance for Development of Forces (GDF).

(4) Serves as proponent of the Program Evaluation Group for Equipping. (See para 9–31.)

(5) Manages functional requirements for RDT&E and procurement appropriations. (See para 9–10b and Table 9–9.)

**Table 9–2**  
**Managers for manpower and force structure issues**

Issue	Manager
Force structure/Unit Identification Code (UIC)/Resource Organization (Command) Code (ROC)	G–3/5/7
Military manpower (Active)	G–1
Army National Guard manpower	Director ARNG
U.S. Army Reserve manpower	Chief AR
Civilian (end strength and full time equivalents)	G–1
Individuals account	G–1
Army Management Headquarters Activities (AMHA)	G–1
Joint and Defense accounts	G–1

**Table 9–3**  
**Budget activity management structure for operation and maintenance appropriations**

Code	Description	Manager <sup>1</sup>	
BA 1: Operating forces			
11	Land forces	G–3/5/7 Collective Training Division (DAMO–TRC)	
111	Division		
112	Corps combat forces		
113	Corps support forces		
114	Echelon above corps (EAC)-support forces		
115	Land forces operations support		
12	Land forces readiness		
121	Force readiness operations support		G–3/5/7 Collective Training Division (DAMO–TRC)
122	Land forces system readiness		G–3/5/7 Training Simulations Division (DAMO–TRS)
123	Land forces depot maintenance		G–4 Directorate of Sustainment (DALO–SM)
13	Land forces readiness support		
131	Base operations support		ACSIM Resources Division (DAIM–ZR)
132	Sustainment, Restoration, and Modernization (land forces readiness support)		ACSIM Resources Division (DAIM–ZR)
133	Management and operational headquarters		G–1 Manpower Policy, Plans, and Program Division (DAPE–PRA)
134	Unified commands		G–3/5/7 Resources and Programming Division (DAMO–TRP)
135	Additional activities		
BA 2: Mobilization			
21	Mobility operations	G–3/5/7 Collective Training Division (DAMO–TRC)	
211	Strategic mobility	G–3/5/7 Collective Training Division (DAMO–TRC) <sup>2</sup> G–4 Directorate for Force Projection/Distribution (DALO–FP) <sup>3</sup>	
212	War Reserve	G–3/5/7 Collective Training Division (DAMO–TRC) <sup>2</sup> G–4 Directorate for Force Projection/Distribution (DALO–FP) <sup>3</sup>	
213	Industrial preparedness	G–4 Directorate for Force Projection/Distribution (DALO–FP) <sup>3</sup>	
214	Prepositioned materiel configured to unit sets (POMCUS)	G–3/5/7 Collective Training Division (DAMO–TRC) <sup>2</sup> G–4 Directorate for Force Projection/Distribution (DALO–FP) <sup>3</sup>	
BA3: Training and recruiting			
31	Accession training	G–3/5/7 Institutional Training Division (DAMO–TRI)	
311	Officer acquisition		
312	Recruit training		
313	One station unit training		
314	Senior Reserve Officers' Training Corps		
315	Service Academy base support		
316	Sustainment Restoration, and Modernization		
32	Basic skill and advance training		ACSIM Resource Division (DAIM–ZR)
321	Specialized skill training		ACSIM Resource Division (DAIM–ZR)
322	Flight training		G–3/5/7 Institutional Training Division (DAMO–TRI)
323	Professional development education		G–3/5/7 Institutional Training Division (DAMO–TRI)
324	Training support		G–3/5/7 Institutional Training Division (DAMO–TRI)

# How the Army Runs

**Table 9-3**  
**Budget activity management structure for operation and maintenance appropriations—Continued**

Code	Description	Manager <sup>1</sup>
325	Base support	ACSIM Resource Division (DAIM-ZR)
326	Sustainment, Restoration, and Modernization	ACSIM Resource Division (DAIM-ZR)
33	Recruiting, and other training and education	
331	Recruiting and advertising	G-1 Resource Division (DAPE-PRR)
332	Examining	G-1 Resource Division (DAPE-PRR)
333	Off duty and voluntary education	G-1 Resource Division (DAPE-PRR)
334	Civilian education and training	G-1 Resource Division (DAPE-PRR)
335	Junior Reserve Officer Training Corps	G-1 Resource Division (DAPE-PRR)
336	Base support-recruiting and examining	ACSIM Resource Division (DAIM-ZR)
BA 4: Administration and service wide activities		
41	Security programs	G-2 Directorate for Resource Integration (DAMI-RI)
411	Security programs	
42	Logistics operations	G-4 Directorate for Sustainment (DALO-SM) G-4 Directorate for Force Projection/Distribution (DALO-FP)
421	Service wide transportation	
422	Central supply activities	
423	Logistics support activities	
424	Ammunition management	
43	Service wide support	
431	Administration	R/P-G-1 Manpower Policy, Plans, and Programs Division (DAPE-PRA)
432	Service wide communications	P-CIO/G-6 Program Execution Div (SAIS-ZR)
433	Manpower management	G-1 Resource Division (DAPE-PRR)
434	Other personnel support	G-1 Resource Division (DAPE-PRR)
435	Other service support	Various
436	Army claims and administrative support activities	TJAG
437	Real estate management	ACSIM Resource Division (DAIM-ZR)
438	Base support	ACSIM Resource Division (DAIM-ZR)
439	Defense Environmental Restoration Account (DERA) (FY 94-95)	None
44	Support of other nations	G-3/5/7 international Plans, Policy, Programs, and integration Division (DAMO-SSI)
441	International military headquarters	
442	Miscellaneous support of other nations	
45	Closed account	None
49	Defense Environmental Restoration Account (DERA) (FY96)	None

Legend for Table 9-3:

Army Manpower and total obligation authority

n Budget activity (BA)

nn Activity group (01 level)

nnn Budget sub activity

Records resources for Army Management Structure Code (AMSCO) nnn\*\*, where nnn shows budget sub activity. (See chaps AO-2020a-d, h, and j, DFAS-IN Manual 37-100-\*\*\* for further information)

Notes:

<sup>1</sup> Manager for functional requirements and program and performance except as noted.

<sup>2</sup> Manager for functional requirements

**Table 9-4**  
**Budget activity management structure for operation and maintenance appropriations-Army manpower only activity structure**

Code	Description	Manager <sup>1</sup>
Category 8: Medical activities, manpower only-reimbursable labor		
84	Medical manpower-reimbursable	TSG Manpower and Programming Division (DASG-PAE-M) <sup>2</sup>
841	Examining activities	
846	Training medical spaces	
847	Care in Army medical centers	
849	Defense medical spaces	
Category 9: Other-manpower only		
91	Special operations forces manpower-reimbursable	G-1 Manpower Policy, and Program Division (DAPE-PRA) <sup>3</sup>
92	Defense agency manpower (military only)	

**Table 9-4**  
**Budget activity management structure for operation and maintenance appropriations-Army manpower only activity structure—Continued**

Code	Description	Manager <sup>1</sup>
93	Outside Department of Defense	
94	Transients, holdees, and operating strength deviation	

Legend for Table 9-4:

Manpower-only activity structure

The PPBE database generates categories 8 and 9 to meet manpower-reporting requirements. Category 8 records resources for AMSOC 84n\*\*\* where n-1, 6, or 7 shows the budget sub activity, category 9 records resources for AMSCO 9n\*\*\*, where n=1, 2, 3, or 4 shows the 0-1 level structure.

Notes:

<sup>1</sup> Manager for functional requirement and program except as noted.

<sup>2</sup> Manager for functional requirements.

<sup>3</sup> Manager for program and performance.

**Table 9-5**  
**Budget activity management structure for operation and maintenance appropriation-Base operations support (BOS)**

Code	Account	Manager <sup>1</sup>
AMSCO	****19, ****20	
	Child develop services, family centers	ACSIM Resource Division (DAIM-ZR)
AMSCO	****53, ****54, ****56	
	Environmental conservation, pollution prevention, environmental compliance	ACSIM Resource Division (DAIM-ZR)
AMSCO	****75	
	Ant-terrorism/Force protection	ACSIM Resource Division (DAIM-ZR)
AMSCO	****79 (Real Property Services)	
.J0	Operation of utilities	ACSIM Resource Division (DAIM-ZR)
*.M0	Municipal Services	ACSIM Resource Division (DAIM-ZR)
.N0	Facilities engineering services	ACSIM Resource Division (DAIM-ZR)
.P0	Fire and emergency response services	ACSIM Resource Division (DAIM-ZR)
AMSCO	****90	
	Audio visual and visual information production, acquisition, and support	P-CIO/G-6 Program Execution Div (SAIS-ZR) <sup>2</sup> ACSIM Resource Division (DAIM-ZR) <sup>3</sup>
AMSCO	****95	
	Base communications	P-CIO/G-6 Program Execution Div (SAIS-ZR) <sup>2</sup> ACSIM Resource Division (DAIM-ZR) <sup>3</sup>
AMSCO	****96 (Base Operations Support) (BASOPS(-))	
.A0	Real estate leases	ACSIM Resource Division (DAIM-ZR)
.B0	Supply operations and management	G-4 Directorate for Sustainment (DALO-SM)
.C0	Materiel maintenance	G-4 Directorate for Sustainment (DALO-SM)
.D0	Transportation services	G-4 Directorate for Sustainment (DALO-SM)
.E0	Laundry and dry-cleaning services	G-4 Directorate for Sustainment (DALO-SM)
.F0	The Army food service program	G-4 Directorate for Sustainment (DALO-SM)
.K0	Civilian personnel management	R/P-G-1
.L0	Morale, welfare, and recreation	ACSIM Resource Division (DAIM-ZR)
.M0	Military personnel support	R/P-G-1
.Q0	Reserve component support	ACSIM Resource Division (DAIM-ZR)
.U0	Financial management	ASA(FM&C)
.V0	Management analysis	ASA(FM&C)
.W0	Contracting operations	ASA(ALT) Plans, Programs and Resources Directorate (SAAL-RI)
.X0	Information technology, management and planning	P-CIO/G-6 Program Execution Div (SAIS-ZR) <sup>2</sup> ACSIM Resource Division (DAIM-ZR) <sup>3</sup>
.Y0	Administrative services	P-CIO/G-6 Program Execution Div (SAIS-ZR) <sup>2</sup> ACSIM Resource Division (DAIM-ZR) <sup>3</sup>
.10	Provost Marshal	G-3 Security, Force Protection, and Law Enforcement (DAMO-ODL)
.20	Staff Judge Advocate	ACSIM Resource Division (DAIM-ZR)
.30	Chaplain	ACSIM Resource Division (DAIM-ZR)
.40	Public affairs	ACSIM Resource Division (DAIM-ZR)
.50	Inspector General	ACSIM Resource Division (DAIM-ZR)
.60	Installation management	ACSIM Resource Division (DAIM-ZR)
.70	Operations	ACSIM Resource Division (DAIM-ZR)



## How the Army Runs

**Table 9-5**  
**Budget activity management structure for operation and maintenance appropriation-Base operations support (BOS)—Continued**

Code	Account	Manager <sup>1</sup>
.90	Unaccompanied personnel housing management	ACSIM Resource Division (DAIM-ZR)

Legend for Table 9-5:

Base Support

Base Operations Support (BOS) applies to sub activity groups 131, 315, 325, 336, and 438

Base support refers to the resources to operate and maintain Army installations (major, minor, stations, other). It comprises two sub activity groups: Base Operations Support (BOS) and Sustainment, Restoration, and Modernization (SRM). Resources are recorded in Army Management Structure Code (AMSCO) and nnn\* yy, where nnn shows budget sub activity group (SAG) and yy designates specified subdivisions. Sometimes, resources are recorded as nnn\*yy.z0, where .z0 refers to letter accounts, as below for BASOPS (-) and SRM. (See chap A9-BSSPT, DFAS-IN Manual 37-100-\*\*\*\* for further information.)

Notes:

<sup>1</sup> Manager for functional requirements and program and performance.

<sup>2</sup> Manager for functional requirements.

<sup>3</sup> Manager for program and performance.

**Table 9-6**  
**Budget activity management structure for operation and maintenance appropriations-Sustainment, Restoration, and Modernization (SRM)**

Code	Account	Manager <sup>1</sup>
AMSCO	****76	
.L0	Minor construction	ACSIM Resource Division (DAIM-ZR)
AMSCO	****78 (Maintenance and Repair)	
.10	Surfaced areas (including bridges and other appurtenances)	ACSIM Resource Division (DAIM-ZR)
.20	Airfields, paved and unpaved (including bridges and other appurtenances)	ACSIM Resource Division (DAIM-ZR)
.40	Railroads (including bridges and other appurtenances)	ACSIM Resource Division (DAIM-ZR)
.50	Utility systems	ACSIM Resource Division (DAIM-ZR)
.A0	Maintenance and production facilities	ACSIM Resource Division (DAIM-ZR)
.B0	Training and operations facilities	ACSIM Resource Division (DAIM-ZR)
.C0	RDT&E facilities	ACSIM Resource Division (DAIM-ZR)
.D0	Supply and storage facilities	ACSIM Resource Division (DAIM-ZR)
.E0	Administrative facilities (including information technology facilities)	ACSIM Resource Division (DAIM-ZR)
.F0	Unaccompanied personnel housing facilities	ACSIM Resource Division (DAIM-ZR)
.G0	Other unaccompanied personnel housing facilities	ACSIM Resource Division (DAIM-ZR)
.H0	Dining facilities	ACSIM Resource Division (DAIM-ZR)
.Q0	Other facilities without facility category groups (FCG)	ACSIM Resource Division (DAIM-ZR)
.R0	Airfield facilities	ACSIM Resource Division (DAIM-ZR)
.S0	Training/instruction support facilities	ACSIM Resource Division (DAIM-ZR)
.T0	Ports	ACSIM Resource Division (DAIM-ZR)
.U0	Medical and hospital facilities	ACSIM Resource Division (DAIM-ZR)
.V0	Grounds	ACSIM Resource Division (DAIM-ZR)
.W0	Community support	ACSIM Resource Division (DAIM-ZR)
.X0	Family housing	ACSIM Resource Division (DAIM-ZR)
AMSCO	****93	
	Demolition of real property	ACSIM Resource Division (DAIM-ZR)

Notes:

<sup>1</sup> Manager for functional requirements and program and performance

**Table 9-7**  
**Budget activity management structure for operation and maintenance appropriations-Army National Guard**

Code	Description	Manager <sup>1</sup>
	BA 1: Operating forces	DARNG <sup>1</sup>
11	Land Forces	
111	Division	
112	Corps combat forces	
113	Corps support forces	
114	Echelon above corps (EAC)-forces	
115	Land forces operations support	
12	Land forces readiness	
122	Land forces system readiness	
123	Land forces depot maintenance	
13	Land forces readiness support	
131	Base operations support (land forces readiness support)	
132	Sustainment, restoration, and Modernization	
133	Management and operational headquarters	
135	Weapons of mass destruction	
	BA 4: Administration and service wide activities	DARNG <sup>1</sup>
43	Service wide support	
431	Staff management	
432	Information management	
433	Readiness and personnel administration	
434	Recruiting and advertising	

Legend for Table 9-7:

Army National Guard

n Budget activity (BA)

nn Activity group (01 level)

nnn Budget sub activity

Notes:

<sup>1</sup> Budget Formulation Branch (NGB-ARC-BF): Manager for functional requirements and program and performance.

<sup>2</sup> Budget Branch (DAAR-CFM): Manager for functional requirements and program and performance.

**Table 9-8**  
**Budget activity management structure for operations and maintenance appropriations-U.S. Army Reserve**

Code	Description	Manager <sup>1</sup>
	BA 1: Operating forces	CAR <sup>2</sup>
11	Land forces	
111	Divisions	
112	Corps combat forces	
113	Corps support forces	
114	Echelon above corps (EAC)-forces	
115	Land forces operations support	
12	Land forces readiness	
121	Force readiness operations support	
122	Land forces system readiness	
123	Depot maintenance	
13	Land forces readiness support	
131	Base operations support	
132	Sustainment, Restoration, and Modernization	
135	Additional activities	
	BA 4: Administration and service wide activities	CAR <sup>2</sup>
43	Service wide support	
431	Administration	
432	Service wide communications	
433	Personnel/financial administration	

# How the Army Runs

**Table 9-8**  
**Budget activity management structure for operations and maintenance appropriations-U.S. Army Reserve—Continued**

Code	Description	Manager <sup>1</sup>
434	Recruiting and advertising	

Legend for Table 9-8:  
 U.S. Army Reserve  
 n Budget activity (BA)  
 nn Activity group (01 level)  
 nnn Budget sub activity

Notes:

<sup>1</sup> Budget Formulation Branch (NGB-ARC-BF): Managers for functional requirements and program and performance.

<sup>2</sup> Budget Branch (DAAR-CFM): Manager for functional requirements and program and performance.

**Table 9-9**  
**Army appropriations-managers for functional requirements and program and performance**

Resource identification code	Appropriation (fund) <sup>1</sup>	Manager for Functional Requirements (R) Manager for Program and Performance (P)
RDTE	Investment Research, Development, Test, and Evaluation, Army	R-G-8 Programs and Priorities (DAPR-FDR) P-ASA(ALT) Plans, Programs and Resources Directorate (SAAL-RI)
ACFT (APA)	Aircraft Procurement, Army	R- G-8 Programs and Priorities (DAPR-FDR) P-ASA(ALT) Plans, Programs and Resources Directorate (SAAL-RI)
MSLS (MIPA)	Missile Procurement, Army	R- G-8 Programs and Priorities (DAPR-FDR) P-ASA(ALT) Plans, Programs and Resources Directorate (SAAL-RI)
WTCV	Procurement of Weapons and Tracked Combat Vehicles, Army	R- G-8 Programs and Priorities (DAPR-FDR) P-ASA(ALT) Plans, Programs and Resources Directorate (SAAL-RI)
AMMO (PAA)	Procurement of Ammunition, Army	R- G-8 Programs and Priorities (DAPR-FDR) R-G-4 Directorate for Sustainment (DALO-SM) P-ASA(ALT) Plans, Programs and Resources Directorate (SAAL-RI)
OPA	Other Procurement, Army	R- G-8 Programs and Priorities (DAPR-FDR) P-ASA(ALT) Plans, Programs and Resources Directorate (SAAL-RI)
	OPA 1	R- G-8 Programs and Priorities (DAPR-FDR) P-ASA(ALT) Plans, Programs and Resources Directorate (SAAL-RI)
	OPA 2	R- G-8 Programs and Priorities (DAPR-FDR) P-ASA(ALT) Plans, Programs and Resources Directorate (SAAL-RI)
	OPA 3	P-CIO/G-6 Program Execution Div (SAIS-ZR) R- G-8 Programs and Priorities (DAPR-FDR) P-ASA(ALT) Plans, Programs and Resources Directorate (SAAL-RI)
	OPA 4	R- G-8 Programs and Priorities (DAPR-FDR) P-ASA(ALT) Plans, Programs and Resources Directorate (SAAL-RI)
MCA	Military Construction, Army <sup>2</sup>	R-ACSIM Facilities Division (DAIM-FD) P-ACSIM Resources Division (DAIM-ZR)
MCNG	Military Construction, Army National Guard <sup>2</sup>	R-DARNG Engineering Directorate (NGB-AEN) P-ACSIM ACSIM Resources Division (DAIM-ZR)
MCAR	Military Construction, Army Reserve <sup>2</sup>	R-CAR Army Reserve Engineer Directorate (DAAR-EN) P- ACSIM Resources Division (DAIM-ZR)
CHEM	Chemical Agents and Munitions Destruction, Army	R- G-8 Programs and Priorities (DAPR-FDR) P-ASA(ALT) Plans, Programs and Resources Directorate (SAAL-RI)
AFHC	Family Housing, Army (Construction) Operations	R/P- ACSIM Facilities Division (DAIM-FD)
ERA	Environmental Restoration, Army and Formerly Used Test Sites	R/P-ACSIM Environmental Division (DAIM-ED)
BRAC	Base Realignment and Closure	R/P-ACSIM BRAC Office (DAIM-BO)
AFHO	Family Housing, Army (Operations)	R/P- ACSIM Facilities Division (DAIM-FD)
OMA	Operation and Maintenance, Army	See Tables 9-3 through 9-6
OMNG	Operation and Maintenance, Army National Guard	See Table 9-7
OMAR	Operation and Maintenance, Army Reserve	See Table 9-8
MPA	Military Personnel, Army	R/P- G-1 Manpower Policy, Plans, and Program Division (DAPE-PRA)
NGPA	National Guard Personnel, Army	R/P-DARNG Budget Formulation Branch (NGB-ARC-BF)

**Table 9–9**  
**Army appropriations-managers for functional requirements and program and performance—Continued**

Resource identification code	Appropriation (fund) <sup>1</sup>	Manager for Functional Requirements (R) Manager for Program and Performance (P)
RPA HAF–D	Reserve Personnel, Army Homeowners Assistance Fund Defense	R/P–CAR Budget Branch (DAAR–CFM) R/P–COE

Notes:

<sup>1</sup> ASA (FM&C) serves as appropriation sponsor for all appropriations (funds) except ARNG and AR appropriations, whose sponsors are the Chief, National Guard Bureau and Chief, Army Reserve, respectively.

<sup>2</sup> Functional proponents and their supporting Program Evaluation Groups (PEGs) bear responsibility for setting the funding level of validated military requirements and validating and funding nonmilitary requirements generated by new equipment for unit set fielding, force modernization, or other new mission or doctrine.

### 9–6. Integrated programming-budgeting phase

The Director Program Analysis and Evaluation (DPAE) and DAB jointly manage the integrated programming and budgeting phase to produce a combined POM and Budget Estimate Submission (BES).

*a. The Director of Program Analysis and Evaluation (DPAE).* The Army DPAE takes the lead on programming matters and—

- (1) Provides the SECARMY and CSA with independent assessments of program alternatives and priorities.
- (2) Provides analytical and administrative support for PPBE forums.
- (3) Co-chairs the Planning Program Budget Committee (PPBC) with the Assistant Deputy Chief of Staff G–3/5/7 and the DAB.

(4) Exercises overall responsibility at HQDA for Army program development in support of the Program Objective Memorandum (POM) and Future Years Defense Program (FYDP).

(5) With the Assistant Deputy Chief of Staff G–3/5/7 and Director of the Army Budget (DAB), guides and integrates the work of Program Evaluation Groups (PEG) throughout the PPBE process. (See para 9–32.)

(6) With functional proponents:

- (a) Prepares Army responses to OSD programming guidance documents.
- (b) Structures the Army Program Guidance Memorandum (APGM) and Technical Guidance Memorandum (TGM) to articulate direction and guidance from the Defense Planning and Programming Guidance (DPPG) and senior Army leadership.

(c) Develops the Army program, including review of integrated priority lists (IPLs) of the combatant commanders and program submissions of the ACOMs, PEOs, and other operating agencies.

(7) Codifies, and submits to OSD, the approved Army program in the POM.

(8) Serves as HQDA point of contact for the POM and FYDP within HQDA and with OSD and the Joint Staff.

(9) Manages the Management Decision Package (MDEP) architecture.

(10) Serves as host activity manager of the PPBE Enterprise System and with ASA(FM&C) and data proponents such as appropriation sponsors, manpower managers, the OSD Comptroller, OSD Director of Cost Assessment and Program Evaluation (CAPE), and Department of the Treasury.

(a) Through the PPBC has established a PPBE Strategic Automation Committee (PSAC) to implement configuration management of the PPBE Enterprise System and oversee long-term plans for investing in information technology to improve the performance of PPBE functions.

(b) Maintains the resource management architecture for automated support of PPBE processes and information systems and their integration into a common PPBE database. In particular—

1. Hosts the web services that provide coordination for the common data architecture, including program elements (PE), Army program elements (APE), resource organization (command) codes, the SSN–LIN Automated Management and Integrating System (SLAMIS) and, in coordination with the Defense Finance and Accounting Service (DFAS), the Army Management Structure (AMS).

2. Maintains an integrated data dictionary of data elements in the PPBE data element structure and disciplines its use without re-keying by database users and component databases.

3. Controls data entry and makes sure that PPBE data elements are consistent not only internally for programming, budgeting, and execution but, also externally with reporting requirements of the Standard Data Collection System (SDCS), Service Support Manpower System (SSMS), and Comptroller Information System (CIS) or their successors.

(c) Maintains the official database position for Army Program and Budget Guidance (PBG) and through the SDSCS, SSMS, and CIS or their successors updates OSD resource management databases with data that reflect the POM, BES, and the President’s Budget. Affected data include the Army BES for manpower, Army appropriations, and Army-managed Defense appropriations.

## How the Army Runs

(d) Makes sure that the Army portion of FYDP submissions to OSD includes defense appropriations managed by the Army and that force structure and manpower information match positions in the force structure and accounting databases for the Active Army, Army National Guard (ARNG), U.S. Army Reserve (AR), and civilian work force.

(e) Issues the PBG after each PPBE phase.

(11) Provides feedback to each combatant commander as to the resource status of the command's issues on forwarding the combined Program Objective Memorandum and Budget Estimate Submission (POM/BES) to OSD.

b. *Director of the Army Budget (DAB)*. The DAB takes the lead on budgeting matters and—

(1) Co-chairs the PPBC with the Assistant Deputy Chief of Staff G-3/5/7 and DPAE.

(2) Establishes budgeting policy and processes.

(3) Guides and integrates the work of the PEGs on budget matters. (See para 9-31.)

(4) Reviews and consolidates the Army National Guard (ARNG) and U.S. Army Reserve (AR) budgets with the Active Army budget.

(5) Provides feedback to each combatant commander on major budget issues affecting the command's resource requirements.

(6) Justifies the Army budget before OSD, Office of Management and Budget (OMB), and Congress.

(7) Maintains liaison and acts as point of contact with Congressional appropriations committees except for Civil Works issues.

(8) With the DPAE and data proponents, performs system and data management functions described in paragraph a (10), above.

(9) Serves as proponent of FYDP program 6—Research and Development and program 7—Central Supply and Maintenance. (See para 9-12.)

(10) Manages functional requirements and program and performance for designated appropriation accounts. (See para 9-10 and tables 9-3 through 9-8.)

(11) Manages the data architecture of Army program elements (PE) and Elements of Resource (EOR).

(12) Maintains and issues TOA controls for Army Appropriations for the BES and the President Budget cycles.

(13) Translates final budget decisions into program changes, posting program elements (PE), Army program elements (APE), MDEPs, and command distributions, as required, updating the PPBE database to produce the President's Budget position submitted to OSD and Congress.

(14) Manages the issue cycle where Resource Decision Documents (RDDs) are used at the ODS staff level to formulate issue papers challenging the Service program requests and Major Budget Issue (MBI) processes. The RDDs are internal OSD documents used to frame draft issue papers from the SecDef challenging the Service program requests with suggested changes. Because RDDs are internal OSD documents the Services often see the resulting issue papers and not the actual RDDs.

(a) Maintains coordination between the Under Secretary of Defense (Comptroller) and HQDA.

(b) Makes sure that adjustments to fiscal controls are correct on all records for each RDD. (Verifying corresponding manpower controls, however, is a Deputy Chief of Staff, G-1 responsibility.)

(15) Gives special attention to any RDD under appeal since the DepSecDef may, on review, revise pending adjustments

(16) When the SecDef makes his final decision on change to the Service programs he issues Resource Management Decision (RMDs) which directs the Services to change their programs to comply with his resourcing decisions

c. *The Assistant Deputy Chief of Staff G-3/5/7*. The ADCS G-3/5/7 ensures the optimal allocation of army resources by evaluating the integrated programming-budgeting phase for compliance with TAP and Army priorities.

### 9-7. Execution phase

a. *Military Deputy for Budget and Execution*. For the Assistant Secretary of the Army (Financial Management and Comptroller) (ASA(FM&C)), the Military Deputy for Budget and Execution—

(1) Reviews program performance and, specifically, oversees Cost and Performance Measures designed to provide the senior Army leadership with a corporate view of business efficiencies and program accomplishment.

(2) Applies funds appropriated by Congress to carry out authorized programs.

(3) Through the DAB, manages the PPBE execution phase.

b. *Director of the Army Budget (DAB)*. As provided in a(3), above, the DAB manages the PPBE Execution phase and, during financial execution—

(1) Establishes funding policy and processes.

(2) Supervises and directs financial execution of the congressionally approved budget.

(3) Allocates funds appropriated by Congress and monitors their execution

(4) Oversees accounting for and reporting on use of Army-managed funds to OSD and Congress by appropriation. As applicable to each appropriation, includes FYDP program, program element (PE), Army program element (APE), project number, budget line item number (BLIN), standard study number (SSN), quantities, budget activity (BA),

budget activity group (BAG), budget sub activity (BSA), element of resource (EOR), and financing data. Also as applicable to an appropriation, accounts for and reports on the use of the manpower-by-manpower category

(5) With functional proponents and within stated restrictions and specified dollar thresholds, reprograms funds as required to meet unforeseen requirements or changes in operating conditions.

(6) With the Defense Finance and Accounting Service (DFAS)—

(a) Oversees the development and maintenance of standard Army systems in support of financial accounting; and oversees implementation of the same standard Army systems in support of distribution, accounting, and reporting of funds.

(b) Makes sure that execution reports meet HQDA management information needs.

c. *Director of Program Analysis and Evaluation (DPAE)*. During programmatic execution, the DPAE monitors how programmed resources are applied to achieve approved objectives to gain feedback for adjusting resource requirements.

d. *The Assistant Deputy Chief of Staff G-3/5/7*. The ADCS G-3/5/7 ensures the optimal allocation of army resources by evaluating the execution phase for compliance with TAP and Army priorities,

### Section III

#### Responsibilities for PPBE-Related Operational Tasks

##### 9-8. HQDA principal officials

a. *The Assistant Secretary of the Army (Acquisition, Logistics, and Technology) (ASA(ALT))*.

(1) Exercises responsibility for, and oversees, all matters and policy related to acquisition, logistics, technology, procurement, the industrial base, and security cooperation (that is, security assistance and armaments cooperation).

(2) Serves as the designated Army Acquisition Executive (AAE).

(3) Represents the Army on the Defense Acquisition Board (DAB), the Nuclear Weapons Council Standing Committee, and the Conventional Systems Committee.

(4) Chairs the Army Systems Acquisition Review Council (ASARC).

(5) Integrates the development and acquisition of materiel into all phases of the PPBE process.

(6) With the Deputy Chief of Staff, G-8 helps prepare the Research, Development, and Acquisition Plan (RDA Plan).

(7) Manages functional requirements and program and performance for RDT&E and procurement appropriations, the Chemical Agents and Munitions Destruction, Army appropriation, and designated Miscellaneous accounts in Table 9-9, as well as the Contract Operations account of the Operation and Maintenance, Army appropriation, tables 9-3 through 9-8. (See para 9-10.)

b. *The Assistant Secretary of the Army (Installations and Environment) (ASA (I&E))*. Exercises responsibility for, and oversees, all matters and policy related to installations, housing, installation-related-military construction, real estate and environment, safety, and occupational health.

c. *The Assistant Secretary of the Army (Manpower and Reserve Affairs) (ASA (M&RA))*.

(1) Promulgates Army wide policy for and oversees, all matters related to manpower, personnel, and Reserve affairs across all Army components (Active, Guard, Reserve, civilian, and contractor).

(2) Sets policy and oversees—

(a) Army organization and force structure to include Army force management initiatives that affect the Operating and Generating Forces (Active, Guard, and Reserve).

(b) Army manpower requirements determination and resource allocation for all Army components across all major Army commands (ACOM) and separate agencies (Active, Guard, Reserve, Joint, and Defense).

(3) Reviews policies and programs pertaining to readiness, resource allocation, training, force structure, and professional and leader education and development.

d. *The Administrative Assistant to the Secretary of the Army (AASA)*.

(1) Plans, programs, budgets, and accounts for the execution of resources for Headquarters, Department of the Army and its field operating and staff support agencies.

(2) Serves as proponent (provisional) of the Organizing PEG. (See para 9-31.)

e. *The Chief Information Officer and Army G-6 (CIO/G-6)*.

(1) Exercises responsibility for Army information management functions per 10 USC 3014(c) (1) (D) and sets policy and determines objectives for, and oversees, all matters related to Army Mission Command Networks and Systems and information technology (IT) functions.

(2) Provides CIO-validation of Army Mission Command Networks and Systems and information technology requirements, and monitors the performance of information technology programs for war fighting, base operations, administrative, and other mission-related processes associated with an Army Mission Command Networks and Systems and information technology impact.

(3) Serves as Program Integrator for Information Technology. (See fig 9-1.)

(4) Serves as proponent of the Army FYDP subprogram 3-Communications. (See Table 9-11.)

## How the Army Runs

(5) Develops, maintains, and facilitates the information technology architecture, that is, the Army Knowledge Enterprise Architecture (AKEA).

(6) Makes sure through advice and technical assistance that Army acquires information technology and manages information resources in a manner that implements the policies, procedures, and goals of the Army Knowledge Management Strategic Plan.

*f. The Deputy Chief of Staff, G-1.*

(1) Develops, coordinates, and implements programs and policies directly associated with accession, development, distribution, and sustainment of military and civilian personnel readiness to include the personnel readiness of Army units and organizations.

(2) Develops human resource programs, budgets, and activities to execute life-cycle functions of manning, well-being, personnel technologies, Soldier-oriented R&D, and personnel transformation.

(3) Serves as proponent of the Manning PEG. (See para 9-31.)

(4) Serves as proponent of FYDP program 9-Administration. (See Table 9-11.)

(5) Serves as the Army proponent of Directed Military Over strength (DMO) and military manpower requirements outside the DOD.

(6) Manages issues related to Army manpower accounts except for Army National Guard and Army Reserve manpower and manages functional requirements and program and performance for the Military Pay, Army appropriation and for designated personnel accounts and Manpower-Only accounts of the Operation and Maintenance, Army appropriation. (See para 9-10 and tables 9-2 through 9-9.)

*g. The Deputy Chief of Staff, G-2.*

(1) In coordination with the Department of Defense and National Intelligence Community, sets policy for Army intelligence and counterintelligence and security countermeasures.

(2) Prepares, justifies, and submits the program and budget for the Army portion of the National Foreign Intelligence Program (NFIP) per the policy, resource, and administrative guidance of the Director of Central Intelligence and DOD NFIP Program Managers.

(3) Serves as Army Staff lead for integrating intelligence, surveillance, and reconnaissance (ISR) matters into all phases of the PPBE process.

(4) Serves as the resource proponent for operational and strategic intelligence of Army FYDP subprogram 3-Intelligence. (See Table 9-11.)

(5) Manages functional requirements and program and performance for Security Programs of the Operation and Maintenance, Army appropriation. (See para 9-10 and tables 9-3 through 9-8.)

*h. The Deputy Chief of Staff, G-4.*

(1) Develops and resources Army wide logistics operation programs for strategic mobility, supply, maintenance, war reserves and prepositioning, aviation, munitions, transportation, distribution, readiness, and integrated logistics support.

(2) Integrates and balances between acquisition and logistics the sustainment functions of readiness, supply, services, maintenance, transportation, aviation, munitions, security assistance, and related automated systems.

(3) Through the integration of logistics supportability, manages the readiness of new systems throughout the acquisition life cycle as well as current readiness of legacy systems.

(4) On behalf of the Army Acquisition Executive (AAE)—

(a) Develops policies for, and oversees, the planning, programming, budgeting, and execution of integrated logistics support.

(b) Makes sure that program executive offices have programmed and incorporated supportability requirements into the acquisition and fielding of new systems.

(5) Serves as proponent of the Sustaining PEG. (See para 9-31.)

(6) Manages functional requirements for the Procurement of Ammunition, Army appropriation and the Army Working Capital Fund and manages functional requirements and program and performance for Logistics Operations accounts of the Operation and Maintenance, Army appropriation, including those for Base Operations. (See para 9-10 and tables 9-3 through 9-9.)

*i. The Assistant Chief of Staff for Installation Management (ACSIM).*

(1) Develops and directs planning, programming, and budgeting of installation management functions and the funding of installation-related military construction, housing, environmental protection, and facilities operation and sustainment.

(2) Provides ACSIM validation of requirements for managing and funding Army installations.

(3) Makes sure that installation management and environmental programs are integrated into all aspects of Army operations.

(4) Serves as proponent of the Installations PEG. (See para 9-31.)

(5) Manages functional requirements and program and performance for military construction appropriations and environmental restoration as well as Installation Management Operations and Maintenance appropriations. (See para 9-10 and tables 9-3 through 9-9.)

*j. The Chief of Engineers (COE).*

- (1) Supports and promotes resource requirements of the engineer regiment.
- (2) Represents and promotes resource requirements of the U.S. Army Corps of Engineers.
- (3) Acts for SECARMY in executing SECARMY Executive Agent responsibilities for military construction to include construction for the Air Force, Navy, National Aeronautics and Space Administration (NASA), and selected DOD activities and foreign nations.
- (4) Manages functional requirements and program and performance for the Homeowners Assistance Fund, Defense. (See para 9–10 and table 9–9.)

*k. The Surgeon General (TSG).*

- (1) Exercises responsibility for development, policy direction, organization and management of an integrated Army wide health services system.
- (2) Represents and promotes resource requirements of the U.S. Army Medical Department.
- (3) Manages functional requirements and program and performance for reimbursable medical manpower of the Operation and Maintenance, Army appropriation. (See para 9–10 tables 9–3 through 9–9.)

*l. The Chief, National Guard Bureau (CNGB).* Through the Director of the Army National Guard (DARNG)—

- (1) Plans and administers the budget of the Army National Guard (ARNG) and serves as appropriation sponsor for ARNG appropriations.
- (2) Serves as proponent of the ARNG subprogram, FYDP program 5–Guard and Reserve Forces. (See Table 9–11.)
- (3) Manages ARNG manpower issues and manages functional requirements and program and performance for ARNG appropriations and ARNG accounts of the Operation and Maintenance, Army National Guard appropriation. (See para 9–10 and tables 9–2 through 9–9.)
- (4) Serves as Program Integrator for the statutory, Defense, and Army requirements of the ARNG. (See fig 9–1.)

*m. The Chief, Army Reserve (CAR).*

- (1) Plans and administers the budget of the U.S. Army Reserve (AR) and serves as appropriation sponsor for AR appropriations.
- (2) Serves as proponent of the AR subprogram, FYDP program 5–Guard and Reserve Forces. (See Table 9–11.)
- (3) Manages AR manpower issues and manages functional requirements and program and performance for AR appropriations and AR accounts of the Operation and Maintenance, U.S. Army Reserve appropriation. (See para 9–10 and tables 9–2 through 9–9.)
- (4) Serves as Program Integrator for the statutory, Defense, and Army requirements of the AR. (See fig 9–1.)

---

**Program Integrators**

---

**Army National Guard (ARNG)-DARNG**

Provides technical assistance to Title 10 PEGs and monitors actions to integrate into all phases of the PPBES process the statutory, Defense, and Army requirements of the Army National Guard.

Tracks ARNG program performance during budget execution.

**U.S. Army Reserve (AR)-CAR**

Provides technical assistance to Title 10 PEGs and monitors actions to integrate into all phases of the PPBES process the statutory, Defense, and Army requirements of U.S. Army Reserve.

Tracks AR program performance during budget execution.

**Information Technology(IT)-CIO/G-6**

Provides advice and technical assistance to Title 10 PEGs to make sure that the Army acquires information technology and manages information resources in a manner that implements the policies, procedures, and goals of the Army Knowledge Management Strategic Plan.

Validates information technology requirements and monitors the performance of information technology programs throughout all phases of the PPBES process. Develops, maintains, and facilitates the information technology architecture, that is, the Army Knowledge Enterprise Architecture (AKEA), across the Army.

---

**Figure 9–1. Program Integrators**

---



### 9–9. Army commanders

*a. Commanders of Army commands and heads of other operating agencies.* Commanders of Army Commands (ACOMs), Program Executive Officers (PEO), and heads of other operating agencies—

- (1) Plan, program, and budget for assigned missions, responsibilities, and functions.
- (2) Document manpower in their subordinate organizations per allocated manpower levels.
- (3) Execute the approved ACOM or agency program within allocated resources, applying the inherent flexibility allowed by law and regulation.

(4) Assess ACOM or agency program performance and budget execution and—

(a) Account for and report on use of allocated funds by appropriation and MDEP. As applicable to each appropriation, include FYDP program, Army Management Structure Code (AMSCO), Army program element (APE), project number, BLIN, SSN, BA, BAG, and EOR. Also account for and report on use of allocated manpower by unit identification code (UIC).

(b) Use manpower data and financial data from budget execution in developing future requirements.

(c) Make sure that below threshold reprogramming remains consistent with Army priorities.

*b. Commanders of Army commands serving as commanders of Army Component Commands.* ACOM commanders serving as commanders of Army Component Commands (ACC) identify and integrate with their other missions and operational requirements the requirements of the combatant command.

*c. Commander, Space and Missile Defense Command (SMDC).* Serves as proponent of Army FYDP subprogram 3–Space. (See Table 9–11.)

### 9–10. Staff managers and sponsors for congressional appropriations

The Military Deputy for Budget and Execution, the Director of Army National Guard (DARNG), Chief, Army Reserve (CAR), and designated functional managers manage and control Army resources. One set of functional managers addresses manpower and force structure issues. Another set of functional managers assists appropriation sponsors. Tables 9–2 through 9–9 list assignments of appropriation sponsors and functional managers. Their general responsibilities are as follows.

*a. Manager for manpower and force structure issues.* The manager for manpower issues and the manager for force structure issues work together to maintain a continuous exchange of information and collaboration during each PPBE phase. As appropriate, they—

(1) Coordinate instructions to the field, and the processing of requests from the field, for manpower or force changes.

(2) Align and balance manpower and unit information among such PPBE database systems as the Structure and Manpower Allocation System (SAMAS), The Army Authorization Documents System (TAADS), the PPBE Enterprise System, and the FYDP.

(3) Provide lead support on manpower issues to PEG chairs.

(4) Verify manpower affordability.

*b. Manager for functional requirements.* The manager for functional requirements—

(1) Determines the scope, quantity, and qualitative nature of functional requirements for planning, programming, and budgeting.

(2) Checks how commands and agencies apply allocated manpower and dollars to make sure their use fulfills program requirements.

(3) Prioritizes unfunded programs submitted by ACOMs, PEOs, and other operating agencies.

(4) Using Army program and budget guidance and priorities, resolves conflicts involving unfunded requirements or decrements on which ACOMs, PEOs, and other operating agencies fail to reach agreement in developing the program or budget.

(5) Recommends to the PPBC (para 9–30, below) the allocation of available resources, unfunded programs, and offsetting decrements.

(6) During program and budget reviews, and throughout the process, coordinates resource changes with agencies having responsibility for affected MDEPs and with the appropriate appropriation sponsor for relevant resources.

*c. Manager for program and performance.* The manager for program and performance—

(1) Represents the functional program and monitors its performance during each PPBE phase.

(2) As required, helps the appropriation sponsor perform the duties listed in d (2) and d (3), below.

(3) Translates budget decisions and approved manpower and funding into program changes and makes sure that data transactions update affected MDEPs and, in coordination with the appropriation sponsors, affected appropriations.

(4) Checks budget execution from the functional perspective.

- (5) For investment appropriations—
  - (a) Operates and maintains databases in support of the PPBE Enterprise System.
  - (b) During budget formulation, determines how changes in fiscal guidance affect budget estimates and reviews and approves the documentation of budget justification.
  - (c) During review of the budget by OSD and OMB and by Congress, serves as appropriation advocate, helps prepare the Army response to OSD issue papers which are the result of RDDs proposals, and prepares congressional appeals.
  - (d) During execution determines fund recipients, monitors execution, performs decrement reviews, plans reprogramming, and controls below threshold reprogramming. On RDT&E and procurement matters and otherwise as required, testifies before OSD and Congress.
    - d. Appropriation sponsor.* The appropriation sponsor-.
      - (1) Controls the assigned appropriation or fund.
      - (2) Serves as Army spokesperson for appropriation resources.
      - (3) Helps resource claimants solve manpower and funding deficiencies.
      - (4) Issues budget policy, instructions, and fiscal guidance.
      - (5) During budget formulation—
        - (a) Bears responsibility for updating the PPBE database.
        - (b) Prepares and justify budget estimates, coordinating with functional and manpower representatives to make sure appropriate exhibits and database systems match.
        - (6) Testifies before Congress during budget justification.
        - (7) Manages financial execution of the appropriation and reprograms allocated manpower and funds to meet unforeseen contingencies during budget execution.

## Section IV

### DOD PPBE Process Description

#### 9–11. Purpose

The DOD PPBE process serves as the primary resource management system for the Department’s military functions. Its purpose is to produce a plan, a program, and finally the Defense budget. The system documents the program and budget as the FYDP.

#### 9–12. The Future Years Defense Program (FYDP)

*a.* The FYDP officially summarizes forces and resources for programs developed within the DOD PPBE process and approved by the SecDef. The FYDP specifies force levels and lists corresponding total obligation authority (TOA) and manpower. For example, in addition to historical data, the FYDP for the FY 2011 budget would, as shown in figure 9–2—

- (1) Record totals for each resource group by—
  - (a) Prior fiscal year (PY), in this case FY 2010.
  - (b) Current fiscal year (CY), in this case FY 2011.
  - (c) Budget fiscal year (BY), in this case FY 2012.
- (2) Extend total obligation authority (TOA) and manpower totals 4 years beyond the FY 2012 budget to FY 2016.
- (3) Extend force totals 7 years beyond the FY 2012 budget to FY 2019.
- b.* The FYDP comprises 11 major Defense programs. Table 9–11 lists the programs together with Army sub-programs and Army proponent agencies. Each program consists of an aggregation of program elements (PE) that reflect a DOD force or support mission. PEs identifies specific activities, projects, or functions and contains the fiscal and manpower resources needed to achieve an objective or plan. PEs permit cross-Service analysis by OSD and congressional staff members.
- c.* HQDA submits the Army portion of the FYDP database to OSD at least twice each even year.
  - (1) The first submission, forwarded in August, records the position of the combined Army POM/BES.
  - (2) The second submission, forwarded in late January or early February, records the position of the President’s Budget
- d.* HQDA submits the Army portion of the FYDP database to OSD at least once each fiscal year in late January or early February recording the position of the President’s Budget.
- e.* For each FYDP position, OSD publishes a Summary and Program Element Detail volume on a CD ROM.
- f.* As prescribed by 10 USC 221(a), OSD provides the President’s Budget version of the FYDP to Congress each year at or about the time the PB is submitted to Congress.
- g.* OSD’s Director of Cost Assessment and Program Evaluation (CAPE) manages the program element data structure and serves as the approval authority for any changes to that structure. Beginning with the FY 2002–2007 POM, OSD

## How the Army Runs

began gradually replacing the nearly 40-year old FYDP database format with a new Defense Programming Database (DPD). Transition to the DPD over the succeeding several PPBE cycles seeks to standardize budget and program data while consolidating many of the FYDP's currently required supplemental reports and annexes.

**Table 9–11**  
**FYDP Programs and Subprograms with Army Proponents**

Nr	Major Defense program	Proponent <sup>1</sup>
1.	Strategic Forces	G–3/5/7
2.	General Purpose Forces	G–3/5/7
3.	Communications, Intelligence, and Space	
	Communications	CIO-/G–6
	Intelligence	G–2/G–3/5/7 <sup>2</sup>
	Space	SMDC <sup>3</sup>
4.	Mobility	G–3/5/7
5.	Guard and Reserve Forces	
	Army National Guard	DARNG
	Army Reserve	CAR
6.	Research and Development	ASA(FM&C)
7.	Central Supply and Maintenance	ASA(FM&C)
8.	Training, Health and Other Personnel Activities	
	Training	G–3/5/7
	Health	TSG <sup>4</sup>
9.	Administration	G–1
10.	Support of Other Nations	G–3/5/7
11.	Special Operations Forces	G–3/5/7

**Notes:**

<sup>1</sup> Within each applicable program, ACSIM serves as proponent for base operations and real property services and G–1 serves as proponent for management headquarters and manpower functions.

<sup>2</sup> G–2 is the resource proponent for operational and strategic intelligence. G–3/5/7 is the resource proponent for tactical intelligence.

<sup>3</sup> U.S. Army Space and Missile Defense Command.

<sup>4</sup> The Surgeon General



**Figure 9–2. Resources in the FYDP reflecting the FY12 budget**

### 9–13. Key participants

DOD officials, assisting the Secretary of Defense as key participants in the PPBE process, include the following:

*a. The Deputy Secretary of Defense (DepSecDef).* The DepSecDef assists the SecDef in overall leadership of the Department. He exercises authority delegated by the SecDef and conducts the day-to-day operation of DOD. The DepSecDef manages the PPBE process.

*b. The Chairman of the Joint Chiefs of Staff (CJCS).* The CJCS serves as the principal military adviser to the President and SecDef and helps them provide strategic direction to the armed forces. Shouldering responsibilities for planning, advising, and policy formulation, the CJCS participates in DOD's senior councils, where he speaks for the Joint Chiefs of Staff (JCS) and combatant commanders.

*c. The Vice Chairman of the Joint Chiefs of Staff (VCJCS).* The VCJCS, who is the second-ranking member of the Armed Forces, acts for the Chairman in his absence and chairs the Joint Requirements Oversight Council (JROC).

*d. The Service Secretaries.* The Service Secretaries convey the Service perspective on Defense matters to the SecDef and DepSecDef and, as key advisers, provide them with candid personal views.

*e. The Under Secretary of Defense for Acquisition, Technology, and Logistics (USD (AT&L)).* The USD (AT&L) exercises responsibility for all matters relating to Defense acquisition, technology, and logistics and serves as the Defense Acquisition Executive (DAE).

*f. The Under Secretary of Defense for Policy (USD (Policy)).* The USD (Policy) represents DOD on foreign relations and arms control matters and serves as the principal adviser to the DepSecDef for the PPBE planning phase.

*g. The Under Secretary of Defense (Comptroller) (USD (C)).* The USD (C) exercises responsibility for all budgetary and fiscal matters.

*h. The Under Secretary of Defense (Personnel and Readiness) (USD (P&R)).* The USD (P&R) exercises responsibility for all matters relating to Total Force Management as it concerns readiness, National Guard and Reserve Affairs, health affairs, training, and personnel requirements and management.

*i. The Director, Cost Assessment and Program Evaluation.* The Director, CAPE serves as the principal staff assistant to the Secretary of Defense for cost assessment and program evaluation.

## 9–14. Department of Defense Decision Bodies

The following groups have been organized to assist the SecDef in making planning, programming, budgeting and execution resource decisions.

*a.* The three bodies that counsel the SecDef in applying sound business practices in the Military Departments, DOD agencies and other DOD components include the Defense Senior Leader Conference (DSLCL), the Senior Leader Review Group (SLRG) and the Deputy's Advisory Working Group (DAWG)

(1) When determined by the chair, heads of other DOD components participate as appropriate.

(2) As appropriate, the chair may invite officials to participate from other Departments and agencies of the Executive Branch, including the Office of Management and Budget (OMB) and the National Security Council (NSC).

*b.* Defense Senior Leader Conference (DSLCL) is the senior information exchange body in the Department of Defense resource management system.

(1) The SecDef chairs the DSLCL.

(2) Membership includes the Senior Leader Review Group principals (enumerated in subparagraph c. below) and all Combatant Commanders.

*c.* The Senior Leader Review Group (SLRG) is the senior decision making body assisting the SecDef and DepSecDef in making major program decisions.

(1) The Secretary of Defense chairs the SLRG with the CJCS serving as vice chairman. The DepSecDef designates other OSD principals to participate in deliberations as necessary. SLRG members are as follows:

*(a) From OSD.* The Deputy Secretary of Defense (DepSecDef); Under Secretary of Defense (Comptroller) and Under Secretaries of Defense for Policy; Acquisition, Technology, and Logistics; Personnel and Readiness; and Intelligence; Director Cost Assessment and Program Evaluation (CAPE); Assistant Secretaries of Defense for Legislative Affairs, Public Affairs and Networks and Information Integration, and Combatant Commanders

*(b) From the Joint Staff and Services.* The Chairman of the Joint Staff, VCJCS, Director, Joint Staff and Secretaries of the Military Departments, who normally are accompanied by Chiefs of Services, Chief of the National Guard Bureau.

(2) Considering broad policy and developing guidance on high-priority objectives, the SLRG helps promote long-range planning and stability in the Defense program

(3) Among other functions, the SLRG—

*(a)* Reviews guidance for planning and programming.

*(b)* Evaluates high-priority programs.

*(c)* Considers the effect of resource decisions on baseline cost, schedule, and performance of major acquisition programs and aligns the programs with the PPBE process.

*(d)* Helps tie the allocation of resources for specific programs and forces to national policies.

*(e)* Reviews the program and budget.

*(f)* Reviews execution of selected programs.

*(g)* Advises the SecDef on policy, PPBE issues, and proposed decisions.

(4) When the SLRG meets to deliberate major issues on DOD-funded intelligence programs, it expands to include representatives of appropriate intelligence agencies. The DepSecDef and Director of Central Intelligence co-chair this Expanded SLRG (ESLRG).

(5) The Director, CAPE acts as Executive Secretary for both the SLRG and ESLRG. In this capacity, the Director manages the program review process and, with the chairs of the ESLRG, the intelligence program review. The Director also manages the preparation of Resource Decision Documents (RDDs) used to formulate Service level issue papers which challenge the Service program requests and the intelligence RMDs (IRMDs) that reflect the SecDef's program decisions.

*d.* The Deputy's Advisory Working Group (DAWG) was established to facilitate the development of the Quadrennial Defense Review 2006 and has continued to monitor its implementation as well as address other subjects as

## How the Army Runs

required. The DAWG now participates in the program review process and comments on the issue papers resulting from the review of the RDD issue papers.

(1) The Deputy Secretary and Vice Chairman, Joint Chiefs of Staff co-chair the DAWG. Membership is as follows:

(a) *From OSD.* The Undersecretaries of Defense; Acquisition, Technology, and Logistics; Comptroller, Personnel and Readiness; and Intelligence, Deputy Undersecretary for Policy, Assistant Secretary Defense Network Integration/CIO, Director and Principal Deputy, Program Analysis and Evaluation, Director Administration and Management, Assistant Secretary of Defense, Legislative Affairs and the General Counsel.

(b) *From the Joint Staff and services.* Service Undersecretaries and Vice Chiefs, the Director Joint Staff, Director J-8 and Director J-5, Director National Guard Bureau and Deputy Commander US SOCOM.

(2) The DAWG generally meets weekly to consider ongoing and cyclic issues including

(a) Capability Portfolio development and management

(b) Defense Planning Scenarios and related analytical efforts

(c) Program and Budget Review

(d) Issue papers resulting from the Resource Decision Document process - directed studies

(e) Strategy and Policy Development including periodic reviews

(f) Regional and Functional Challenges

(g) Transformation

(3) Combatant Commanders or their Deputy Commanders are welcome when issues are being considered that impact their regional or functional responsibilities.

e. The OSD Three Star Group analyzes major issues and develops decision options during program review. It forwards issues sufficiently significant to warrant action by the SLRG to that body for consideration. Supporting the endeavor, OSD principal staff assistants conduct a series of Front End Assessments (FEA). As directed by the SLRG, assessments address topics or decisions that will influence the next POM and subsequent program review. Prepared in coordination with other OSD principal assistants, representatives of the CJCS, and Service chiefs, the assessments are briefed to the Three Star Group. As appropriate they are also briefed to the DepSecDef or SLRG.

(1) *The Director, Cost Assessment and Program Review chairs the Three Star Group.* Adding other OSD principals to participate in sessions as appropriate, the Three Star Group includes the following members:

(2) *From OSD.* Representatives from the Deputy Under Secretary of Defense (Comptroller, Policy, Intelligence, and Acquisition, Technology, and Logistics) and the Assistant Secretaries of Defense for Force Management Policy, Health Affairs, and Reserve Affairs, the Principal Deputy Assistant Secretary of Defense for Networks and Information Integration, the Director of Operational Test and Evaluation and Commander USSOCOM.

(3) *From the Joint staff.* The Director for Force Structure, Resources, and Assessment (J-8).

(4) *From the Services.* The Army G-8, the Deputy Chief of Naval Operations (Resources, Warfare Requirements and Assessments), the Marine Corps Deputy Commandant (Programs and Resources), and the Air Force, Deputy Chief of Staff (Plans and Programs).

### 9-15. Intelligence Program Review Group

a. The Intelligence Program Review Group (IPRG) identifies opportunities to advance the U.S. Government's Intelligence Strategy. It evaluates potential program changes from a mission perspective, considers tradeoffs, and forwards issue analyses to the Expanded SLRG (ESLRG) for consideration.

b. The Director, PA&E and the Executive Director for Intelligence Community Affairs co-chair the IPRG. Members include representatives of all Executive Branch organizations that manage or oversee intelligence capabilities.

### 9-16. Defense Acquisition Board and Joint Requirements Oversight Council

a. The Defense Acquisition Board (DAB) oversees Defense system acquisition, providing discipline through review of major programs. At each milestone in the system's life cycle, the Board assures that programs have met established performance requirements, including program-specific exit criteria. As chairman and vice chairman, respectively, the USD (Acquisition, Technology, and Logistics) and Vice Chairman of the Joint Chiefs of Staff (VCJCS) direct the efforts of the DAB.

b. The USD (Acquisition, Technology, and Logistics), with the DAB and Joint Requirements Oversight Council (JROC) (below), helps link the acquisition process to planning, programming, and budgeting. Serving as a key adviser to the SecDef and DepSecDef, the USD (Acquisition, Technology, and Logistics) participates in all resource decisions affecting the baselines of major acquisition programs, including costs, schedules, and performance.

c. The VCJCS chairs the Joint Requirements Oversight Council (JROC). Through the Functional Capabilities Boards (FCB) and Joint Requirements Board (JRB), the JROC explores new alternatives by assessing joint military war fighting capabilities and requirements posed by the combatant commanders, Services, Joint Staff, and supported Defense agencies. The forum helps forge consensus underlying the Chairman's statutory advice to the SecDef on program and budget proposals. The JROC also helps the DAB and USD (Acquisition, Technology, and Logistics)

articulate military needs and validate performance goals and program baselines at successive milestones of each DAB program.

## **Section V**

### **Army PPBE**

#### **9–17. Army’s primary resource management system**

The PPBE process serves as the Army’s primary resource management process. A major decision-making process, PPBE interfaces with joint strategic planning and with planning conducted by OSD. Linking directly to OSD programming and budgeting, the PPBE process develops and maintains the Army portion of the Defense program and budget. PPBE supports Army planning, program development, and budget preparation at all levels of command. Similarly supporting program and budget execution, it provides feedback to the planning, programming, and budgeting processes.

#### **9–18. PPBE concept**

*a.* The PPBE process ties strategy, program, and budget all together. It helps build a comprehensive plan in which budgets flow from programs, programs from requirements, requirements from missions, and missions from national security objectives. The patterned flow from end purpose to resource cost defines requirements in progressively greater detail.

*b.* Long-range planning creates a vision of the Army 20 years into the future. In the 2- to 10-year midterm, long-range macro estimates give way to a specified size, composition, and quality of operational and support forces. Derived from joint strategic planning and intermediate objectives to achieve long-range goals, this operational and support force provides the planning foundation for program requirements.

*c.* In the midterm, guided by force requirements, the integrated program-budget process distributes projected resources. It seeks to support priorities and policies of the senior Army leadership while achieving balance among Army organizations, systems, and functions. For the 0- to 2-year near-term, the integrated process converts program requirements into budget requests for manpower and dollars. When enacted into appropriations and manpower authorizations, these resources become available to carry out approved programs.

*d.* By formally adding execution to the traditional emphasis on planning, programming, and budgeting, the Army emphasizes concern for how well program performance and financial execution apply allocated resources to meet the Army’s requirements.

*e.* Documents produced within the PPBE process support Defense decision-making, and the review and discussion that attend their development help shape the outcome. For example:

(1) The Army helps prepare the SECDEF’s Defense Planning and Programming Guidance (DPPG) and planning documents produced by the Joint Strategic Planning System (JSPS). Army participation influences policy, strategy, and force objectives considered by the SecDef and the CJCS, including policies for development, acquisition, and other resource-allocation issues.

(2) ACOM commanders, PEOs, and heads of other operating agencies similarly influence positions and decisions taken by the SECARMY and CSA. Commanders and heads of agencies develop and submit force structure, procurement, and construction requirements as well as assessments and data to support program and budget development. Through periodic commanders’ conferences held by the CSA, they also make their views known on the proposed plan, program, and budget.

(3) Combatant commanders influence Army positions and decisions through ACOM commanders serving as commanders of Army Component Commands (ACC), who integrate operational requirements of the combatant command into their program and budget submissions. Combatant commanders also highlight requirements in an integrated priority list (IPL) that receives close review during program development.

#### **9–19. PPBE objectives**

The main objective of the PPBE process is to establish, justify, and acquire the fiscal and manpower resources needed to accomplish the Army’s assigned missions in executing the National Military Strategy. Phase by phase objectives follow:

*a.* Through planning, to size, structure, man, equip, train, and sustain the Army force to support the national military strategy.

*b.* Through integrated programming and budgeting, to—

(1) Distribute projected manpower, dollars, and materiel among competing requirements according to Army resource allocation policy and priorities, making sure that requirements get resourced at defensible, executable levels.

(2) Convert resource allocation decisions into requests for congressional authorization and appropriations.

*c.* Through program execution, to apply resources to achieve approved program objectives, and adjust resource requirements based on execution feedback.

## How the Army Runs

*d.* Through budget execution, to manage and account for funds to carry out approved programs.

### **9–20. Control of planning, programming, and budgeting documents**

*a.* Papers and associated data sponsored by the DOD PPBE process give details of proposed programs and plans. The proposals often state candidate positions and competing options that remain undecided until final approval.

*b.* Access to such tentative material by other than those directly involved in planning and allocating resources would frustrate the candor and privacy of leadership deliberations. Moreover, access by private firms seeking DOD contracts would imperil competition and pose serious ethical, even criminal, problems for those involved. For these reasons, DOD closely controls documents produced through the DOD PPBE process and its supporting databases. Thus, OSD restricts access to DOD and other governmental agencies directly involved in planning, programming, and budgeting Defense resources, primarily OMB.

*c.* Exceptions to the limitations described require SecDef approval. After coordination with the General Counsel, Army proponents may request an exception, but only for compelling need. Statutes and other procedures govern disclosure of information to Congress and the General Accountability Office (GAO).

*d.* The list that follows cites some of the major PPBE and related PPBE documents and material requiring restricted access.

(1) Planning phase:

(*a*) Defense Planning and Programming Guidance (DPPG)

(*b*) Guidance for Employment of Forces (GEF)

(*c*) The Army Plan (TAP)

(2) Programming phase:

(*a*) Fiscal Guidance.

(*b*) Program Objective Memorandum (POM).

(*c*) FYDP documentation including FYDP annexes.

(*d*) Issue papers (for example, major issue papers, and cover briefs).

(*e*) Proposed Military Department program reductions (or program offsets).

(*f*) Tentative issues- in the form of draft issue papers created by the Resource Decision Documents (RDDs).

(3) Budgeting phase:

(*a*) FYDP documents for the Budget Estimate Submission (BES) and President's Budget, including procurement, Research, Development, Test, and Evaluation (RDT&E), and construction annexes.

(*b*) Resource Management Decisions (RMDs) which are implementing instructions from the SecDef on his final decisions on programs.

(*c*) Automated Program and Financing Statements.

(*d*) Reports generated by the automated Comptroller Information System (CIS).

(*e*) DD Form 1414, Base for Reprogramming Actions.

(*f*) DD Form 1416, Report of Programs.

(*g*) Congressional data sheets.

(*h*) Management Initiative Decisions (MID).

## **Section VI**

### **Recording Resources**

#### **9–21. The MDEP: what it is and how it is used**

*a.* The Army Management Decision Package (MDEP) serves as a key resource management tool. Collectively, MDEPs account for all Army resources. They describe the capabilities programmed over a 9-year period for the Active Army, Guard, Reserve, and civilian work force.

*b.* Recording the resources needed to gain an intended outcome, an individual MDEP describes a particular organization, program, or function and applies uniquely to one of the following areas for resource management:

(1) Missions of MTOE (modified tables of organization and equipment) units.

(2) Missions of TDA (tables of distribution and allowances) units.

(3) Acquisition, fielding, and sustainment of weapon and information systems (with linkage to organizations).

(4) Special visibility programs (SVP).

(5) Short term projects (STP).

*c.* In short, the MDEP—

(1) Specifies the military and civilian manpower and dollars associated with a program undertaking.

(2) Displays needed resources across relevant Army commands and relevant appropriations.

(3) Justifies the resource expenditure.

*d.* HQDA uses the MDEP to help—

- (1) Develop programs to support the requirements.
- (2) Carry out approved programs.
- (3) Check program results.
- e. HQDA uses the MDEP to link decisions by the SECARMY and CSA and their priorities to:
  - (1) FYDP accounts that record Service positions in OSD.
  - (2) Army Management Structure (AMS) accounts that record funding transactions in Army activities and installations.
- f. HQDA uses the MDEP also to link key systems within the PPBE Enterprise System, for example:
  - (1) The Structure and Manpower Allocation System (SAMAS) and The Army Authorization Document System (TAADS).
  - (2) The Army Training Requirements and Resources System (ATRRS) whose product, the Army Program for Individual Training (ARPRINT), shows valid training requirements and associated training programs.
  - (3) Depot maintenance programs.
- g. For investment accounts, managers for construction, RDT&E, and procurement first allocate program and budget resources by Army Management Structure code (AMSCO), Army program element (APE), project number, and budget line item number (BLIN). They then distribute the resources to MDEPs within the resource management areas, listed in subparagraph b, above.

**9–22. Program and budget years covered by the MDEP**

- a. The MDEP records manpower and total obligation authority over the 9 fiscal years needed to display the program and budget. Which program year or which budget year each fiscal year addresses, depends on whether interest in the MDEP centers on the program or budget. Figure 9–3 shows the fiscal year structure of an MDEP applying to the President’s FY 2010–2011 budget.
- b. The MDEP shifts forward one year in the annual POM/BES submission. At the start of the cycle for the next annual POM/BES, the PPBE database (para 9–28a, below) drops the earliest year from the database and adds 1 new year. Thus for the FY 2012–2016 POM/BES, the MDEP would display the 5 years of the new program period and the 3 preceding years (fig 9–4). The first of the preceding years is the prior fiscal year (PY). It records resources spent in executing the budget the year before the current fiscal year (CY). The CY shows resources in the budget being executed. The last preceding year is called the budget year (BY). It lists resources requested in the President’s Budget being reviewed by Congress.
- c. Another shift occurs the next year (the year in which the President submits the next Defense budget). The shift leaves each year’s resources intact but changes their relative position in the program or budget process as shown in figure 9–5. For the FY 2012-budget, budget years 10 becomes the prior year; budget year 11 becomes the current year; and the first program years become budget years 12. The last 4 years (years 13 through 16) become the remaining program years.

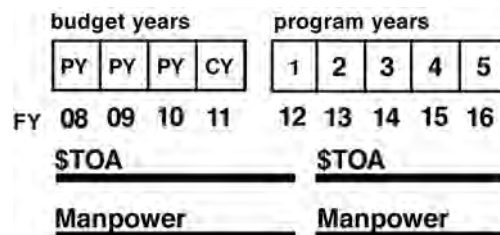

Figure 9–3. FY structure of resources in an MDEP reflecting the FY 12 budget



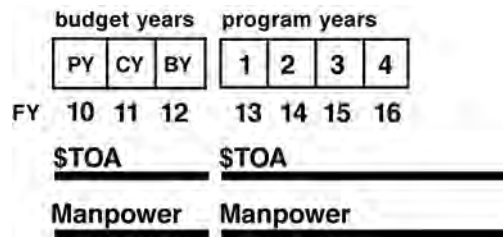

Figure 9–4. FY structure of resources in an MDEP reflecting the FY 12–16 POM

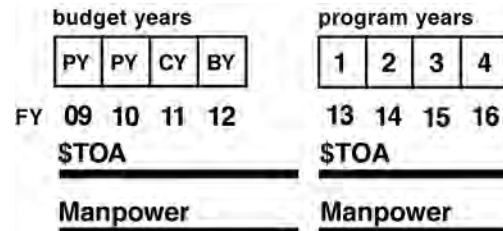

Figure 9–5. FY structure of resources in an MDEP reflecting in the FY 12 budget

**9–23. Extent that manpower and dollars can be redistributed in the MDEP**

a. The MDEP, as just described, has both budget-year and program-year increments. The two increments differ primarily by the flexibility the Army has with manpower and funds.

b. During the program or POM years, HQDA is constrained by Congress on total military end strength. HQDA determines and approves civilian work year levels by balancing workload and available funding. Similarly, HQDA restricts program dollars only by total obligation authority (TOA), not by individual appropriation. The distinctions allow redistributing previously programmed manpower and dollars to meet changing requirements. In later POM or budget submissions, for example, HQDA can, as needed, move program year resources between MDEPs, appropriations, and Army program elements (APE).

c. Once HQDA sends the BES to OSD, OSD must approve any changes to manpower and dollars. Even tighter controls govern changes in manpower and funding in the budget years after the President’s Budget has gone to Congress.

(1) HQDA can redistribute previously budgeted manpower and dollars between MDEPs or commands and agencies, but must leave current budgeted dollars unchanged until current year appropriations become law.

(2) Some flexibility during execution permits financing unbudgeted requirements to meet unforeseen needs or changes in operating conditions. Even so, congressional rules and specified dollar thresholds severely restrict spending for purposes other than those originally justified and approved. In addition, during execution, HQDA can transfer military and civilian manpower within appropriations without a corresponding transfer of funds.

**9–24. How flexibility affects the MDEP**

a. *Frequent change in MDEP resources.* Competition at each stage of program development and budget formulation can produce frequent change in an MDEP’s resource levels. Decisions resulting from OSD review of the POM/BES will further change amounts initially approved. Sometimes decisions may even affect requests in the President’s Budget already before Congress. Authorization and appropriation decisions by Congress often change amounts requested in the President’s Budget. Budget execution sometimes results in different rates and quantities of expenditure from those planned, and, at times, it results in different purposes.

b. *Keeping MDEP resources current.* Program and budget analysts continually update MDEPs through their respective feeder systems to reflect the position of the last program or budget event. The kinds of changes described require that resource managers continually weigh how the stream of program and budget actions affect the MDEP and how a change in the program year or budget year portion of the package may affect the out years. Managers continually ask, “In what ways do the changes—

- (1) Alter MDEP resource levels?
- (2) Shift resources between years?
- (3) Affect resources in related MDEPs?”

## 9–25. Resource recording structures

*a. Future Years Defense Program (FYDP).* As mentioned, the FYDP accounts for the total of all resources programmed by the Department of Defense (DOD). Using OSD program elements, DOD apportions decisions on dollars and manpower among the FYDP's 11 major force programs.

*b. Army Management Structure (AMS).* The AMS serves as a second major resource recording structure. Based on congressional appropriations, the AMS relates program dollars and manpower to a standard classification of activities and functions per DFAS-IN Manual 37–100-\*\*\*\* (where \*\*\*\* stands for the current fiscal year, e.g., 2011). Army Management Structure codes (AMSCO) help record the data in the detail needed for budgeting, execution, and accounting.

*c. Other structures.* Other fiscal management structures include the 01 level budget activity structure for operation and maintenance appropriations shown in tables 9–3 through 9–8, standard study numbers (SSN) and budget line item numbers (BLIN) for weapon systems, and project numbers for military construction.

## 9–26. Automated support

The automated Army PPBE System supports Army PPBE functions and DOD PPBE data submissions to OSD, OMB, and Congress. Known simply as the PPBE database, it encompasses forces, funds, and manpower and serves as the database of record for Army resources.

*a. PPBE database.* The PPBE database organizes and registers 9 years of dollar and manpower data used in the process, and 12 years of forces data. It gathers manpower and dollar data through keys tied to the Management Decision Package (MDEP), appropriation (appn), program element (PE), Army program element (APE), and other identifiers including the command or resource organization code. HQDA uses the database to—

- (1) Support user analysis.
- (2) Build and record the combined POM/BES.
- (3) Prepare the Army portion of the FYDP to reflect the POM/BES and later the President's Budget.
- (4) Report consistent Army resource positions to OSD through the Select and Native Programming (SNaP) Data Collection System, Standard Data Collection System (SDCS), Service Support Manpower System (SSMS), and Comptroller Information System (CIS).
- (5) Issue Army commands Program and Budget Guidance (PBG) reflecting the FYDP resource position after each FYDP update.
- (6) Provide MDEP execution and expenditure information.

*b. Future System enhancement.* The Planning, Programming and Budgeting (PPB) Business Operating System (BOS) is a project to standardize and better integrate the transactional automated information systems used in the Headquarters Department of Army level Programming and Budgeting processes. These systems are core to the PPBE business processes of the headquarters for gathering programmatic requirements, balancing resources and delivering the Army's program budget to OSD. This project is streamlining programming and budgeting business processes and significantly improving strategic analysis capabilities. The project is architecting, reengineering, streamlining and consolidating HQDA systems, feeder database systems, and streamlining the business processes associated with them. The project brings to bear powerful business intelligence analytical tools to support strategic planning, programming and budgeting within Headquarters Department of the Army. These improvements will improve capability, eliminate redundancies and reduce overall costs of operations. The PPB BOS project is a complementary to the Army's GFEBS program.

## Section VII

### Army PPBE Deliberative Forums

## 9–27. Army Resources Board

The Army Resources Board (ARB) is chaired by the SECARMY with the CSA as the vice chair. The board serves as a senior Army leadership forum, through which the SECARMY and CSA review Army policy and resource allocation issues, particularly those emanating from the Army PPBE process. It sets policy and approves guidance and priorities. The ARB approves the prioritization of Army programs and selects resource allocation alternatives. In addition, upon their completion, the ARB approves TAP, POM/BES, and Change Proposal (CP). Table 9–12 shows the composition of Army PPBE deliberative forums.

## How the Army Runs

**Table 9–12**  
**Composition of Army PPBE deliberative forums**

Forum	Chairs	OSA members	Army staff Members	Advisory and support
ARB	SecArmy-Chair CSA–Vice chair	USA ASA(ALT) ASA(FM&C) ASA(I&E) ASA(M&RA) General Counsel CIO/G–6	VCSA G–3/5/7 G–8	Other participants as required <i>Advisors</i> ADCS G–3/5/7 DPAE DAB ARB Executive Secretary, ASA(FM&C)
SRG	USA–Co-chair VCSA–Co-chair	ASA(ALT) ASA(CW) ASA(FM&C) ASA(I&E) ASA(M&RA) General Counsel CIO/G–6	G–1 G–2 G–3/5/7 G–4 G–8 ACSIM CAR DARNG	Other participants as required <i>Advisors</i> ADCS G–3/5/7 DPAE DAB SRG Executive Secretary, ASA(FM&C)
PPBC	Assistant G–3/5/7–Co-chair for Planning DPAE–Co-chair for Programming DAB–Co-chair for Budgeting and Execution	<i>Representatives of—</i> ASA(ALT) ASA(CW) ASA(I&E) ASA(M&RA) AASA CIO/G–6	<i>Representatives of—</i> G–1 G–2 G–4 ACSIM TSG CAR DARNG	Other participants as required, including— Director of Operations and Support, ASA(FM&C) Director of Investment, ASA(FM&C) Director of Force Management, G–3/5/7 Director of Requirements, G–3/5/7 Director of Training, G–3/5/7 Director of Strategy, Plans, and Policy, G–3/5/7 Director of Force Development, G–8

### 9–28. Senior Review Group

*a.* Co-chaired by the Under Secretary of the Army (USA) and Vice Chief of Staff, Army (VCSA) the Senior Review Group (SRG) serves as a senior level forum to resolve resource allocation and other issues but generally does not revisit decisions made at lower levels. The SRG monitors staff implementation of decisions of the ARB and makes recommendations to the ARB on—

- (1) The prioritization of programs.
  - (2) Resource allocation alternatives.
  - (3) Final TAP, POM/BES, and change proposals (CPs).
  - (4) Other issues as determined by the Under Secretary of the Army (USA) and VCSA.
- b.* See table 9–12 for composition of the SRG.

### 9–29. Planning Program Budget Committee

*a.* The Planning Program Budget Committee (PPBC) has three co-chairs, one of whom presides over the forum depending upon the subject matter under consideration - the ADCS G–3/5/7 for planning, the DPAE for programming, and the DAB for budgeting and execution.

*b.* The PPBC serves the PPBE process in both a coordinating and executive-advisory role. It provides a continuing forum in which planning, program, and budget managers review, adjust, and recommend courses of action on relevant issues. The PPBC may return the results of committee deliberations to the Army Staff or Secretariat for action. It may pass them, in turn, to the SRG and ARB for review or approval. Among its responsibilities, the PPBC—

- (1) Maintains overall discipline of the PPBE process.
- (2) Oversees the PPBE schedule, with each chair controlling the chair’s respective portion of the schedule.
- (3) Monitors force management and preparation of TAP, POM/BES, and President’s Budget.
- (4) Makes sure that Army policy remains internally consistent and that program adjustments remain consistent with Army policy and priorities.

*c.* The PPBC maintains the PPBE Strategic Automation Committee as a Joint DOD Committee to implement configuration management of the PPBE Enterprise System and to oversee long-term plans for investing in information technology to improve the performance of PPBE functions (para 9–6a(10), above). As required, the PPBC may set up other standing committees or working groups to resolve issues that arise in managing the program or budget.

*d.* See table 9–12 for composition of the PPBC.

### 9–30. PPBC Council of Colonels

A group of colonels or civilian equivalents, who represent PPBC members, meet throughout the PPBE process in a forum known as the Council of Colonels. The Council is co-chaired by the Chief, Resource Analysis and Integration

Office, G-3/5/7; Chief, Program Development Division, Program Analysis and Evaluation Directorate; and Deputy Director of Management and Control, ASA(FM&C). The group packages proposals, frames issues, and otherwise coordinates matters that come before the PPBC when it convenes.

### **9-31. Emerging Fora**

As this text was going to print, subsets of the three groups addressed in paragraphs 9-28 through 9-30 were becoming more active in the process. These groups called the “Budget, Requirements and Program” (BRP or “burp”) 9, 8 and 6, are composed of: the G-3, G-8 and MILDEP ASA(FM&C); ADCS, G3, Dir PAE and Dir ABO; and the Chief DAMO-CIR, Chief Program Development Division, PAE and Deputy Director Management and Control, ABO. These groups meet on a regular basis, and handle planning, programming, budgeting or resourcing decisions and issues appropriate to their level. The BRP can call meetings of the larger groups as needed to share information or gain wider perspective.

### **9-32. Program Evaluation Groups**

HQDA uses six Program Evaluation Groups (PEG) to support planning, programming, and budgeting (fig 9-6). Each is co-chaired by a representative of the Secretariat and a representative of the PEG’s proponent, who provides the PEG with executive and administrative support. Permanent members include representatives of ASA(FM&C) appropriation sponsors, G-3/5/7 program prioritizers and requirements staff officers, and G-8-PAE program integrators.

*a.* PEGs program and monitor resources to perform Army functions assigned by 10 USC, Subtitle B - Army and to support the combatant commands and OSD-assigned executive agencies. Each PEG administers a set of Management Decision Packages (MDEPs) within one of the following functional groupings: Manning, Training, Organizing, Equipping, Sustaining, and Installations.

*b.* Each PEG, subject to existing program and budget guidance, sets the scope, quantity, priority, and qualitative nature of resource requirements that define its program. They monitor PEG resource transactions and, as required, make both administrative and substantive changes to assigned MDEPs. MDEP proponents, subject matter experts, and, as appropriate, representatives of commands and agencies participate in PEG deliberations.

*c.* The DARNG, CAR, and CIO/G-6 serve as Program Integrators to the PEGs (fig 9-1). Program Integrators provide technical assistance and monitor actions to integrate priorities and statutory, Defense, and Army requirements for the ARNG, AR and information technology programs into the Army’s overall program.

*d.* PEGs, assisted by the Program Integrators, help HQDA functional proponents—

- (1) Build TAP and the Army program and help convert the program into budget-level detail.
- (2) Maintain program consistency, first during planning and later when preparing, analyzing, and defending the integrated program-budget.
- (3) Track program and budget performance during execution.
- (4) Keep abreast of policy changes during each phase of the PPBE process

<b>Program Evaluation Groups</b>	
<p><b>Manning (MM)</b></p> <p><i>Co-chaired by ASA(M&amp;RA) and G-1</i></p> <p>Provides the Active Army, ARNG, and AR with authorized personnel by grade and skill. Integrates these activities for the ARNG and AR.</p> <p><b>Training (TT)</b></p> <p><i>Co-chaired by ASA(M&amp;RA) and G-3/5/7</i></p> <p>Provides resources for Active Army, ARNG, and AR unit readiness (to include medical units) and unit and collective training (Ground OPTEMPO and the Army Flying Hour Program), fixed wing aircraft operation and maintenance, combat training centers (CTC), mobilization, theater security cooperation activities, and military contingency operations.</p> <p>Provides for collective training, institutional training (initial entry training, leader development, professional development, functional training), and officer acquisition (USMA, ROTC, OCS). Supports multinational force compatibility through integrated training, military exercises, and command control exchanges with allies and coalition partners.</p> <p>Deals with programs, systems, and activities to satisfy intelligence requirements of the President and Secretary of Defense as well as those of the senior Army leadership. (These are requirements funded in the Army portions of the NFIP under Program 31 and Army intelligence support to national agencies under Program 9. (The Equipping PEG, however, addresses most requirements for Tactical Intelligence and Related Activities (TIARA) managed by G-8-FD under Programs 2, and 4 through 10 as well as acquisitions to meet other intelligence and electronic warfare (IEW) requirements.</p> <p><b>Organizing (OO)</b></p> <p><i>Co-chaired by M&amp;RA and AASA (provisional)</i></p> <p>Provides minimum essential Generating Forces for peacetime sustainment and training and wartime mobilization and power projection capabilities for Army Operating Forces.</p> <p>Supports special programs that meet needs of The Army.</p> <p><b>Equipping (EE)</b></p> <p><i>Co-chaired by ASA(ALT) and G-8</i></p> <p>Provides resources for the integration of new doctrine, training, organization, and equipment to develop and field warfighting capabilities for the Active Army, ARNG, and AR. Focuses mainly on materiel acquisition, which</p>	<p><b>Equipping (EE)—continued</b></p> <p>comprises RDT&amp;E and procurement of weapons and equipment</p> <p>Considers operating and support costs to field weapons and equipment as well as the cost of combat development.</p> <p><b>Sustaining (SS)</b></p> <p><i>Co-chaired by ASA(ALT) and G-4</i></p> <p>Provides resources to sustain operations of the Active Army, ARNG, and AR, stressing worldwide readiness. Scope embraces strategic mobility, Army reserve stocks, industrial preparedness, and central supply, and also internal operations of Army depots and arsenals, procurement of secondary item Army reserves, and transportation. Includes depot materiel maintenance.</p> <p>Includes measures to assure the quality and timeliness of sustainment resources and to develop and maintain strategic logistics systems, manage weapon systems, provide security assistance, conduct logistics long-range planning, and reshape Army logistics.</p> <p>Addresses measures to streamline Army business operations, improve information management structure, and develop concepts of operations and procedures to further the integration, sharing, standardization, and interoperability of information systems.</p> <p><b>Installations (II)</b></p> <p><i>Co-chaired by ASA(I&amp;E) and ACSIM</i></p> <p>Provides resources to support Active Army. Reserve and National Guard installations-the operational and service support centers where soldiers, families and civilians work, live and train.</p> <p>Plans and Programs Installation funding for Base Support, Military Construction, Army Family Housing, Base Realignment and Closure and Environmental Restoration programs. Base Support is subdivided into two parts:</p> <p>Base Operations Support (BOS) consisting of Base Operations (BASOPS), Anti-Terrorism/Force Protection, Family Programs, Environment, and Audio Visual/Base Communications.</p> <p>Sustainment, Restoration and Modernization (SRM) providing for maintenance, demolition, improvement or replacement of facilities and infrastructure.</p> <p>Provides for minimal essential workforce in support of Installation Management and continuously seeks to leverage current end strength by converting non-core military to civilian employees or contract, where appropriate.</p>

Figure 9–6. Program Evaluation Groups

**9–33. A principal PPBE-related committee**

Although not a PPBE forum, the Army Systems Acquisition Review Council (ASARC) helps integrate the development and acquisition of materiel into all PPBE phases. Chaired by the Army Acquisition Executive (AAE), the ASARC serves as the Army's senior-level review body for Acquisition Category (ACAT) I and II programs. (ACAT IC and ACAT IAC programs are Major Defense Acquisition Programs for which the AAE exercises Milestone Decision Authority (MDA)). An ACAT II program is one that fails to qualify as an ACAT I program, but nevertheless meets the criteria for a major system.)

**Section VIII****Process and Structure**

Beginning with the planning phase, sections IX through XIII, which follow, present a phase-by-phase description of the DOD and Army PPBE process. First, however, a graphical overview of system process and structure sets the stage.

**9–34. System process**

Figure 9–7 (folded insert at rear of text) shows the general sequence and interrelationship of events of the biennial cycle of the PPBE process.

**9–35. System structure**

Figure 9–8 displays the structure within which the PPBE process operates.

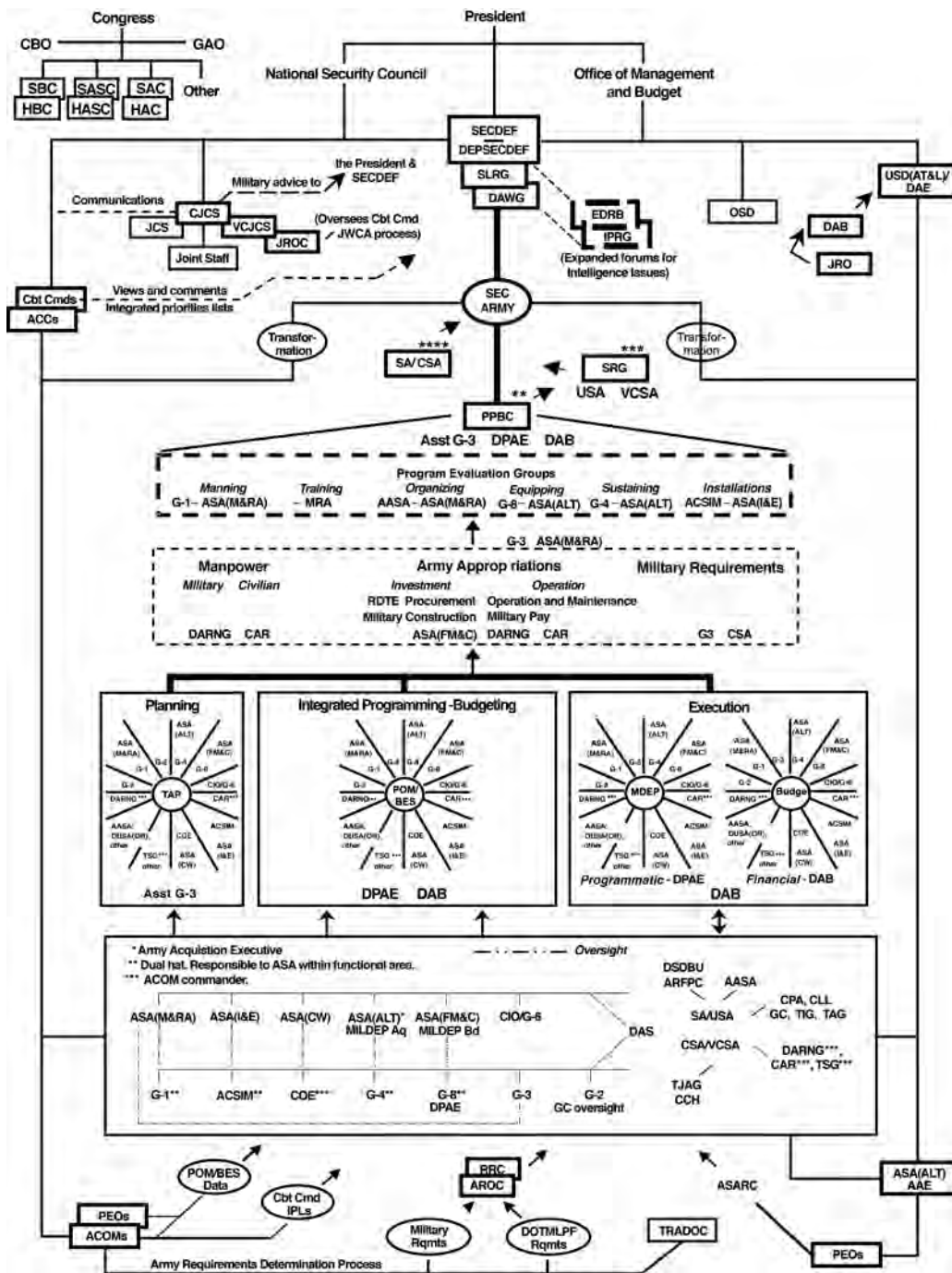

Figure 9-8A. PPBE framework and acronyms

---

**Legend**

---

**Note.**-- Bold structure lines in the diagram link decision makers and deliberative forums with key events and contributing commands and other operating agencies.

<b>Acronyms</b>			
<b>AAE</b>	Army Acquisition Executive	<b>FYDP</b>	Future Years Defense Program
<b>AASA</b>	Administrative Assistant to the Secretary of the Army	<b>GAO</b>	General Accountability Office
<b>ACDM</b>	Army command	<b>Gen</b>	General
<b>ACSIM</b>	Assistant Chief of Staff Installation Management	<b>HAC</b>	House Appropriations Committee
<b>AMC</b>	Army Materiel Command	<b>HASC</b>	House Armed Services Committee
<b>ARB</b>	Army Resources Board	<b>HBC</b>	House Budget Committee
<b>ASA</b>	Assistant Secretary of the Army	<b>Info</b>	Information
<b>ASA (ALT)</b>	ASA (Acquisition, Logistics, and Technology)	<b>JCS</b>	Joint Chiefs of Staff
<b>ASA (CW)</b>	ASA (Civil Works)	<b>JROC</b>	Joint Requirements Oversight Council
<b>ASA (FM&amp;C)</b>	ASA (Financial Management & Comptroller)	<b>MDEP</b>	Management Decision Package
<b>ASA (I&amp;E)</b>	ASA (Installations & Environment)	<b>MILDEP</b>	Military Deputy
<b>ASA (M&amp;RA)</b>	ASA (Manpower & Reserve Affairs)	<b>OSA</b>	Office of the Secretary of the Army
<b>ASCC</b>	Army Service Component Command	<b>OSD</b>	Office of the Secretary of Defense
<b>BES</b>	Budget Estimate Submission	<b>PEO</b>	Program Executive Office(r)
<b>CAPE</b>	Cost Assessment Program Evaluation	<b>PM</b>	Project or Program Manager
<b>CAR</b>	Chief, Army Reserve	<b>POM</b>	Program Objective Memorandum
<b>CBO</b>	Congressional Budget Office	<b>PPBE</b>	Planning, Programming, Budgeting, and Execution process
<b>CC</b>	Chief of Chaplains	<b>Pri</b>	Priority
<b>CJCS</b>	Chairman, Joint Chiefs of Staff	<b>RDAP</b>	Research, Development, and Acquisition Plan
<b>CLL</b>	Chief, Legislative Liaison	<b>RDP</b>	Army Requirements Determination Process
<b>COE</b>	Chief of Engineers	<b>RDTE</b>	Research, Development, Test, and Evaluation
<b>COCOM</b>	Combatant Commander	<b>SA</b>	Secretary of the Army
<b>CPA</b>	Chief of Public Affairs	<b>SAC</b>	Senate Appropriation Committee
<b>CSA</b>	Chief of Staff, Army	<b>SASC</b>	Senate Armed Services Committee
<b>DAB</b>	Defense Acquisition Board/Director Army Budget	<b>SBC</b>	Senate Budget Committee
<b>DARNG</b>	Director Army National Guard	<b>SECDEF</b>	Secretary of Defense
<b>DAS</b>	Director of the Army Staff	<b>SLRG</b>	Senior Leader Review Group
<b>DCS</b>	Deputy Chief of Staff	<b>SPG</b>	Strategic Planning Guidance
<b>G-2</b>	DSC for Intelligence	<b>Struct</b>	Structure
<b>G-4</b>	DSC for Logistics	<b>Sys</b>	System
<b>G-3/5/7</b>	DSC for Operations and Plans	<b>TAP</b>	The Army Plan
<b>G-1</b>	DSC for Personnel	<b>TIG</b>	The Inspector General
<b>G-8</b>	DSC for Programs	<b>TJAG</b>	The Judge Advocate General
<b>DEPSECDEF</b>	Deputy SECDEF	<b>TRADOC</b>	US Army Training and Doctrine Command
<b>DISC4</b>	Director of Information Systems for Command Control, Communications, and Computers	<b>TSG</b>	The Surgeon General
<b>DPAE</b>	Director of Program Analysis and Evaluation	<b>USA</b>	Under Secretary of the Army
<b>DPPG</b>	Defense Planning & Programming Guidance	<b>USA (AT&amp;L)</b>	Under Secretary of the Army (Acquisition, Technology, and Logistics)
<b>DUSA (IA)</b>	Deputy Under Secretary of the Army (International Affairs)	<b>VCJCS</b>	Vice Chairman, Joint Chiefs of Staff
<b>DUSA (OR)</b>	Deputy Under Secretary of the Army (Operations Research)	<b>VCSA</b>	Vice Chief of Staff, Army
<b>FCB</b>	Functional Capabilities Board		

---

Figure 9–8B. PPBE framework acronyms

---



## How the Army Runs

### Section IX DoD PPBE Planning Phase

#### 9–36. NSC guidance

The National Security Strategy (NSS) set by the National Security Council (NSC) bears importantly on the PPBE process. Also bearing on the process are two sets of NSC documents: Presidential Decision Directives (PDD) and Presidential Review Directives (PRD). PDDs promulgate presidential decisions implementing national security policy and objectives in all areas involving national security. PRDs direct studies involving national security policy and directives

#### 9–37. Planning by OSD and the Joint Staff

PPBE planning is conducted by drawing on guidance from the National Security Council (NSC), OSD policy and resource planning and Joint Staff strategic planning. PPBE planning examines the military posture of the United States in comparison to national security objectives and resource limitations. It develops the national military strategy, and it identifies force levels to achieve the strategy. In addition, PPBE planning provides a framework of requirements, priorities, and risk. OSD uses the framework to give each combatant commander the best mix of forces, equipment, and support attainable within defined fiscal constraints.

#### 9–38. Joint Strategic Planning System

The Joint Strategic Planning System is used by the CJCS to provide advice to the President and SecDef concerning the strategic direction of the armed forces and defense policy, programs and budgets. The system is described in detail in Chapter 4 of this text; however the two key documents produced by the system to inform the PPBE process are described here.

*a. Chairman's Program Recommendation.* Presented before publication of the Joint Programming Guidance (JPG), the Chairman's Program Recommendation (CPR) compares planning guidance and objectives with current and projected resource profiles from the most recent President's Budget and related FYDP. The CPR focuses on recommendations that will enhance joint readiness, promote joint doctrine and training, and better satisfy joint war fighting requirements. As needed, it expands, refines, or modifies initial recommendations provided in the Joint Planning Document (JPD).

*b. Chairman's Program Assessment.* The Chairman's Program Assessment (CPA) checks the balance and capabilities of composite force and support levels recommended by Service POMs. It compares recommended capabilities and levels with priorities established by the SecDef. The document helps the SecDef make decisions during OSD program and budget review reflected in RMDs.

#### 9–39. OSD Planning Process

For the building of the 12–16 Program Objective Memorandum (POM) The Secretary of Defense established new guidance documents - The Defense Planning and Programming Guidance (DPPG) and the Guidance for Employment of Forces (GEF) In May of 2008 the Secretary of Defense replaced the SecDef's Strategic Planning Guidance with the Guidance for Development of Forces (GDF) and the Guidance for Employment of Forces (GEF). In 2010 the SecDef Replaced the Guidance for Development of Forces (GDF) and the Joint Programming Guidance with the Defense Planning and Programming Guidance (DPPG).

*a.* The DPPG is largely policy and strategy guidance with some programmatic direction on issues of paramount importance to the SecDef concerning the development of the force during and beyond the POM period.

*b.* The Guidance for Employment of Forces provides guidance for the use of the force in being. It outlines strategic objectives for campaign planning as well as strategic assumptions, objectives and priorities for contingency planning, security cooperation, global posture and global force management.

*c.* The JPG which is included as part of the DPPG, is a fiscally constrained set of instructions, containing the SecDef's decisions on Joint Programs and provides direction for incorporating those decisions into the programs and budgets of the military departments and defense agencies.

### Section X PPBE Planning

#### 9–40. Army Long Range Force Planning

In response to National, Defense and Joint strategy documents the Army Concept Strategy (ACS) documents lay out future Army Warfighting concepts that will allow the Army to transform to meet the challenges of our changing national security environment. This family of concepts forms the analytical basis for determining the solutions for

capability gaps that will, when approved through the Army Capability Integration and Development System, form the basis for resource allocation decisions. The ACS considers a period extending several decades.

#### **9-41. The Army Plan**

*a.* Army planning responds to and complements OSD planning and joint strategic planning. In particular, Army planning:

- (1) Helps the senior Army leadership determine force requirements and objectives and set priorities.
- (2) Provides the basis for positions and comments supporting Army participation in OSD and joint processes.
- (3) Lays the planning basis for the Army program.

*b.* The foundation of Army planning lies in The Army Plan (TAP), which provides strategic planning, priorities, programming, and execution guidance in four sequentially developed and substantively integrated sections:

(1) The Army Strategy (AS), which forms section I of the TAP—

*(a)* Nests Army planning in National, OSD, and Joint strategic guidance.

*(b)* Gives rationale for transforming The Army per the Army Vision.

*(c)* Provides senior leader guidance.

*(d)* Identifies joint demand for Army capabilities.

(2) Army Planning Priorities Guidance (APPG), which is section II of TAP, links requirements to strategy and guides development of resource priorities for operational tasks.

(3) The Army Program Guidance Memorandum (APGM), which exists as section III of TAP, relates operational tasks to resource tasks, thereby helping link operational tasks and their associated resources to Army Title 10 functions.

*c.* The Army Campaign Plan super cedes the Army Transformation Campaign Plan (TCP) and is Section IV of TAP. The eight campaign objectives of the ACP- support global operations, Transform from the current to future force, optimize RC contribution, sustain the right all-volunteer force, adjust the global footprint, shape the future force, adapt the institutional Army, and develop a joint, interdependent logistics structure - incorporate Army transformation into the context of ongoing strategic commitments.

#### **9-42. Army Strategy**

The G-3/5/7 Strategic Plans and Policy Directorate prepare Army Strategy (AS) (TAP section I). The AS is the Army's institutional strategy. It provides strategic guidance to translate requirements "to serve the Nation"-principally in terms of trained and ready forces capable of decisive action across the range of military operations and spectrum of conflict-into fielded capabilities. The AS provides a long-term general perspective (10-20 years) for planners through a common understanding of the Army's contribution to national security and the Joint Team. It also articulates the key Army concerns that must be addressed during the next POM period.

#### **9-43. Army Planning Priorities Guidance**

The G-3/5/7 Resource Analysis and Integration Office prepare the Army Planning Priorities Guidance (APPG) (TAP section II). The APPG covers the mid-term period of the next 5-year Program Objective Memorandum (POM) plus 5-7 additional years. Adding substantial detail to Army Strategy, the APPG identifies and prioritizes enduring operational capabilities needed now and in the future to maintain The Army's core competencies cited in Field Manual 1 (FM 1), The Army. The APPG provides risk guidance as it relates to Army capabilities in accordance with the QDR Risk Framework.

#### **9-44. Army Program Guidance Memorandum**

The G-8 Program Analysis and Evaluation Directorate prepares the Army Program Guidance Memorandum (APGM) (TAP section III), which links operational capabilities and programming. Providing direction to Program Evaluation Groups (PEG), the APGM conveys Army senior leader intent as well as broad, general guidance concerning acceptable levels of risk for the initial POM/BES build. Applying readiness and war fighting requirements derived from strategic and operational capabilities in TAP sections I and II to program development, it completes the succession of guidance from strategic planning to mid-term planning to programming. Guided by planning priorities, the APGM translates operational tasks known as core competencies to resource tasks to perform Army Title 10 functions. It then prescribes other, non-operational task requirements to assure carrying out the three interdependent components of the Army Vision-People, Current Readiness, and Future Forces. Through Management Decision Packages (MDEPs), the APGM relates resource tasks to the Army's Title 10 functions, grouped under the PEG structure as Manning, Training, Organizing, Equipping, Sustaining, and Installations. A forwarding memorandum from the SECARMY and CSA provides HQDA agencies additional guidance.

#### **9-45. Army Campaign Plan**

The G-3/5/7 Army Campaign Plan and Transformation Office prepares and maintains the Army Campaign Plan. The ACAP is an order that implements Army Strategy, is informed by the CSA Vision and is integrated with the Army Imperatives. It provides campaign and other major objectives and integrates other major efforts of the department

## How the Army Runs

currently including Grow The Army, Modular Conversion and ARFORGEN. It is as much a process as a product as there is an established battle rhythm that provides continuous monitoring of progress towards its goals.

### 9-46. Required Capability determination

*a.* The Army Concept Strategy (ACS) is the process that identifies needed future capabilities and potential solutions across the DOTMLPF domains. The process is designed to maintain consistency with both Defense and Joint capabilities guidance.

*b.* The Army retains approval authority for validating military required capabilities at the level of the Chief of Staff, Army. Centralizing validation focuses efforts to develop clear value-added capabilities matched to both Joint and Army future goals. Toward this end, HQDA applies rigorous analysis of the contribution made by a required capability to overall operational objectives of the future Army force as well as to its joint interoperability and affordability.

(1) HQDA procedure employs an Army Requirements Oversight Council (AROC) chaired by the VCSA. The AROC validates DOTMLPF requirements and recommends them for approval to the CSA through the Army Requirements Review Council (RRC). In discharging its function, the AROC aligns Army requirements closely to the Joint Staff Requirements Generation System (RGS) and reviews Army and Joint requirements for validation within the Joint process.

(2) HQDA uses G-3/5/7's Directorate of Requirements (DAMO-RQ) as the Army's single point of entry for military requirements, whether emergency or routine. With representatives from selected commands and across the HQDA staff, the directorate shepherds each requirement through the validation and approval process. A major objective is to ensure that the Army program remains requirements based.

*(a)* In furtherance of that aim, the directorate coordinates closely with the PEGs. Beginning in October and November, in the early stages of program development, requirements staff officer's work with PEGs to make sure that funded programs have a clearly definable and documented link to military requirements or leadership designated capabilities. Together, PEGs and their requirements staff representatives attempt to strengthen linkages of programs meeting this criterion and to terminate those failing to do so. From January, when formal preparation of the program gets under way through April, these efforts continue during deliberations to approve the individual Management Decision Packages (MDEPs) that make up each PEG program. Once again, the aim is to make sure the unfolding PEG program links to validated military requirements and leadership-designated capabilities.

*(b)* If unresolved at the PEG level, a program earmarked for termination is forwarded through the ADCS G-3/5/7 to the PPBC for decision.

*c.* More detailed information on this process can be found in Chapters 5 and 11 of this text.

### 9-47. Army Modernization Strategy

*a.* G-8 prepares the Army Modernization Strategy (AMS). The AMS outlines the vision for modernizing the future force and a strategy for near- to mid-term force development and long-term evolution. Its modernization objectives reflect the vision and guidance of the senior Army leadership.

*b.* The AMS describes required capabilities resourced through the PPBE process. It describes the relationship between desired future capabilities and the materiel solution.

*c.* The AMS, the Army Science and Technology Master Plan (ASTMP), and the Weapons System Handbook present the total picture of the Army's RDA investment. The AMS also supports the review of the President's Budget by congressional authorization and appropriation committees and their staffs.

### 9-48. Army Research, Development, and Acquisition Plan

The G-8 with the Assistant Secretary of the Army (Acquisition, Logistics, and Technology) (ASA (ALT)) prepares the Army Research, Development, and Acquisition (RDA) Plan. The RDA Plan analyses requirements for battlefield and infrastructure capabilities and ranks the requirements in priority order. It matches the requirements to materiel solutions, that is, to RDT&E and procurement programs. Developed by HQDA and the Training and Doctrine Command (TRADOC) and guided by the National Military Strategy (NMS) and The Guidance for Development of Forces (GDF), the materiel solutions provide an integrated RDA position. What follows describes the plan in greater detail.

*a.* The RDA Plan is a 15-year plan for developing and producing technologies and materiel to advance Army modernization. Imposing mandatory TOA controls, the plan restricts modernization to those efforts that are both technically and fiscally achievable. The process truncates requirements developed through unconstrained planning into an RDA program that, within limited resources, maximizes war fighting capabilities and supporting infrastructure.

*b.* Represented by the G-8 RDA database, the plan presents the RDA program as a required set of Management Decision Packages (MDEPs) arrayed in 1-n order by G-8 and ASA(ALT). Each MDEP describes a program, function, or organization and the dollars and system quantities needed. It not only covers the 6-year FYDP but also the 9-year Extended Planning Period (EPP).

*c.* A continuous process, the RDA Plan focuses on periodic revisions to the RDA database. Revisions typically occur during preparation of the Calendar year combined POM/BES (February to August) and the President's Budget

(September to January). During these periods, HQDA adjusts the FYDP years, or first 5 years of the RDA Plan. Then, the Army's RDA community adjusts the final 9 years making sure progression from POM/BES to the President's Budget and Extended Planning Period (EPP) is not only affordable, but also executable.

*d.* Each December, TRADOC provides HQDA its recommendations on materiel requirements, arriving at the recommendations through a Capability Needs Analysis (CNA). The process takes into account such guidance as the NMS and Guidance for Development of Forces as well as the TAP, the AMS, and integrated priority lists (IPLS) of the combatant commanders. The CNA compares future capabilities required by the total force against the fiscally constrained budgeted force. The comparison determines force modernization needs that TRADOC rank orders according to their contribution to mission accomplishment.

### **9–49. Force Development and Total Army Analysis**

Force Development and its component Total Army Analysis are the systems and processes used by the Army to define military capabilities, design force structures to provide these capabilities, translate organizational concepts based on doctrine, technologies, materiel, manpower requirements, and limited resources into a trained and ready Army. These topics are addressed in detail in Chapter 5 of this text.

## **Section XI**

### **Operational Planning Link to the DOD PPBE**

#### **9–50. Operational planning**

Operational planning is addressed in detail in Chapter 6 of this text.

#### **9–51. Missions and tasks**

The JSCP carries out the NMS through unified command operation plans (OPLAN). Its accompanying intelligence estimate assesses potential threats and their impact on available U.S. Forces. Based on the assessment, the document assigns missions and planning tasks to combatant commanders. It also apportions the combat forces expected to be available. Annexes amplify guidance, capabilities, and tasks in specified functional areas.

## **Section XII**

### **Integrated Programming-Budgeting Phase**

#### **9–52. Army programming and budgeting**

An integrated decision process, Army programming-budgeting produces a combined Program Objective Memorandum and Budget Estimate Submission (POM/BES). In conjunction with OSD review, Army integrated programming and budgeting supports development of the President's Budget. Once the President's Budget goes to Congress, the Army presents and defends its portion of the budget in congressional hearings.

#### **9–53. Guidance**

*a. Guidance for the Development of the Force.* The primary products of the OSD planning phase, the Defense Planning and Programming Guidance (DPPG) provide key strategy, policy and limited programmatic guidance to the services and defense agencies. *Army Program Guidance Memorandum.* Discussed in paragraph 9–44, above, the Army Program Guidance Memorandum (APGM) provides direction to Program Evaluation Groups (PEG) to prepare them for the POM/BES build. It outlines strategic guidance and issues programming guidelines. In addition, it defines resource tasks for PEG goals, relating each task to one or more Management Decision Packages (MDEPs).

*b. Technical Guidance Memorandum.* G–8's Director of Program Analysis and Evaluation (DPAE) complement the APGM with a Technical Guidance Memorandum (TGM) outlining program intent with respect to allocating resources to attain the Army Vision. The TGM also provides coordinating instructions to guide PEGs during the POM/BES build. Additionally, PEG-by-PEG, guidance lays out programming priorities for specific programs set by the SecArmy and CSA and, for some programs, specifies a particular level of funding.

*c. Fiscal Guidance.* Before completion of the POM/BES build, OSD issues Fiscal Guidance establishing the Army's total obligation authority (TOA) over the program years. DPAE then apportions the TOA to the PEGs for building their portion of the program. The guidance includes inflation factors and other administrative instructions.

*d. Program and Budget Guidance.* DPAE issues Program and Budget Guidance (PBG) typically twice each even year, after forwarding the combined POM/BES to OSD for review and after the President's Budget is forwarded to Congress. An enterprise product, the PBG is produced jointly by ASA(FM&C)'s Budget Formulation Division (SAFM–BUC–F) and the G–8's Program Budget Data Management Division (DAPR–DPI) in coordination with G–3/5/7's Force Accounting and Documentation Division (DAMO–FMP). The PBG provides resource guidance to major Army commands (ACOM), Program Executive Offices (PEO), and other operating agencies. Narrative Guidance instructs commands and agencies, in addressing resource requirements, such as those related to flying hours, ground operating tempo (OPTEMPO), and rates for fuel, inflation, and foreign currency. A related automation file reflects the

## How the Army Runs

resource status of each command and agency. Commands and agencies use their PBG resource information to update their databases for the forthcoming PPBE cycle.

*e. Integrated program-budget data call.* HQDA publishes a multivolume Resource Formulation Guide (RFG) to facilitate the PPBE process. Issued in the fall, RFG volume 3 (Integrated Program-Budget Data Call) describes the data ACOMs, PEOs, and other operating agencies must submit to HQDA to prepare the POM and BES. Commands and agencies may propose changes to their resources over the program years. Volume 3, however, requires that changes remain zero-sum within the command or agency.

*f. Programming Data Requirements.* Before each POM submission, OSD updates a web-based manual entitled Programming Data Requirements (PDR). The PDR provides instructions for preparing and submitting data, requirements, and program justifications to support component POMs. Prescribing formats and exhibits, its instructions describe programming data requirements and some budgeting data, which components submit using OSD's Select and Native Programming (SNaP) Data Collection System.

*g. POM preparation guidance.* As required, HQDA issues RFG volume 4 augmenting OSD PDR with additional guidance for preparing the POM.

*h. BES preparation guidance.* Two OSD budget guidance documents affect content of the BES. Volume 2 of the DOD Financial Management Regulation prescribes various exhibits and displays to be used in presenting the budget. The Annual Budget Call Memorandum provides supplemental information such as current rate and pricing guidance. Complementing these documents, ASA(FM&C) also issues administrative instructions for preparing the Army's BES.

### 9-54. Resource framework

The Army Resource Framework is designed to layout the Army's resources in a consistent manner to facilitate resource decision making in all PPBE cycles. The major categories, People, Readiness, Materiel, and Service & Infrastructure align with the emerging Army Enterprise Management structure.

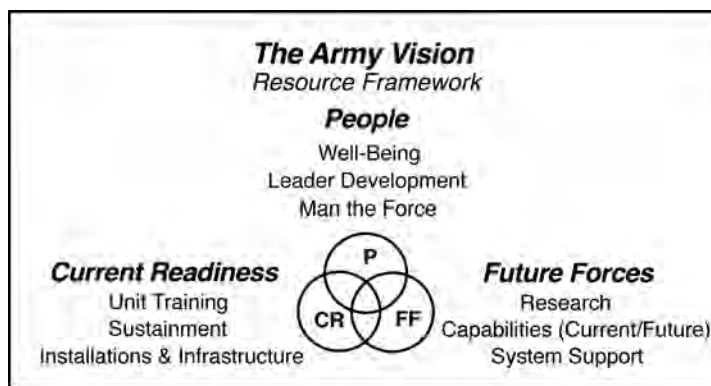

Figure 9-9. Army Resource Framework

### 9-55. POM preparation

*a. Start up.* The biennial integrated programming-budgeting phase of the process starts in October of the odd years as OSD reviews the recently forwarded change proposals. In developing the Army program, programmers translate planning decisions, OSD programming guidance, and congressional guidance into a comprehensive allocation of forces, manpower, and funds. In doing this they integrate and balance centrally managed programs for manpower; operations; research, development, and acquisition; and stationing and construction. Concurrently, they incorporate requirements presented by ACOMs, PEOs, and other operating agencies for manpower, operation and maintenance, housing, and construction.

*b. Initial programmatic review.* From October through December, HQDA—

- (1) Reviews the existing program to determine program deficiencies.
- (2) Sorts existing Management Decision Packages (MDEPs) by Program Evaluation Groups (PEGs).
- (3) Establishes force structure and civilian manpower authorizations.
- (4) Responds to changes recorded in and issue papers generated by the OSD program and budget review (para 9-64, below).

*c. Preparing the database.*

- (1) Formal preparation of the POM/BES starts once the President's Budget goes to Congress. This usually occurs

after the first Monday in January but not later than the first Monday in February. As a start point, DPAE establishes a base file in the PPBE database that reflects the President's Budget resource position. Afterwards, in a series of zero-sum adjustments that leave resource levels in the President's Budget unchanged for the budget years, HQDA revises the database. The adjustments:

- (a) Update earlier estimates with new information and revise them for inflation.
  - (b) Move resources between and among current Army Management Structure codes (AMSCO) and MDEP structures.
  - (c) Consolidate or otherwise restructure individual programs through rolls and splits to make the overall Army program more manageable.
  - (d) Re-price existing programs as needed and, when required by modified resource levels, identify offsetting deductions as bill payers.
- (2) Figure 9–10 shows timelines for updating the PPBE database and other significant events for the FY 2012–2016 POM/BES build.

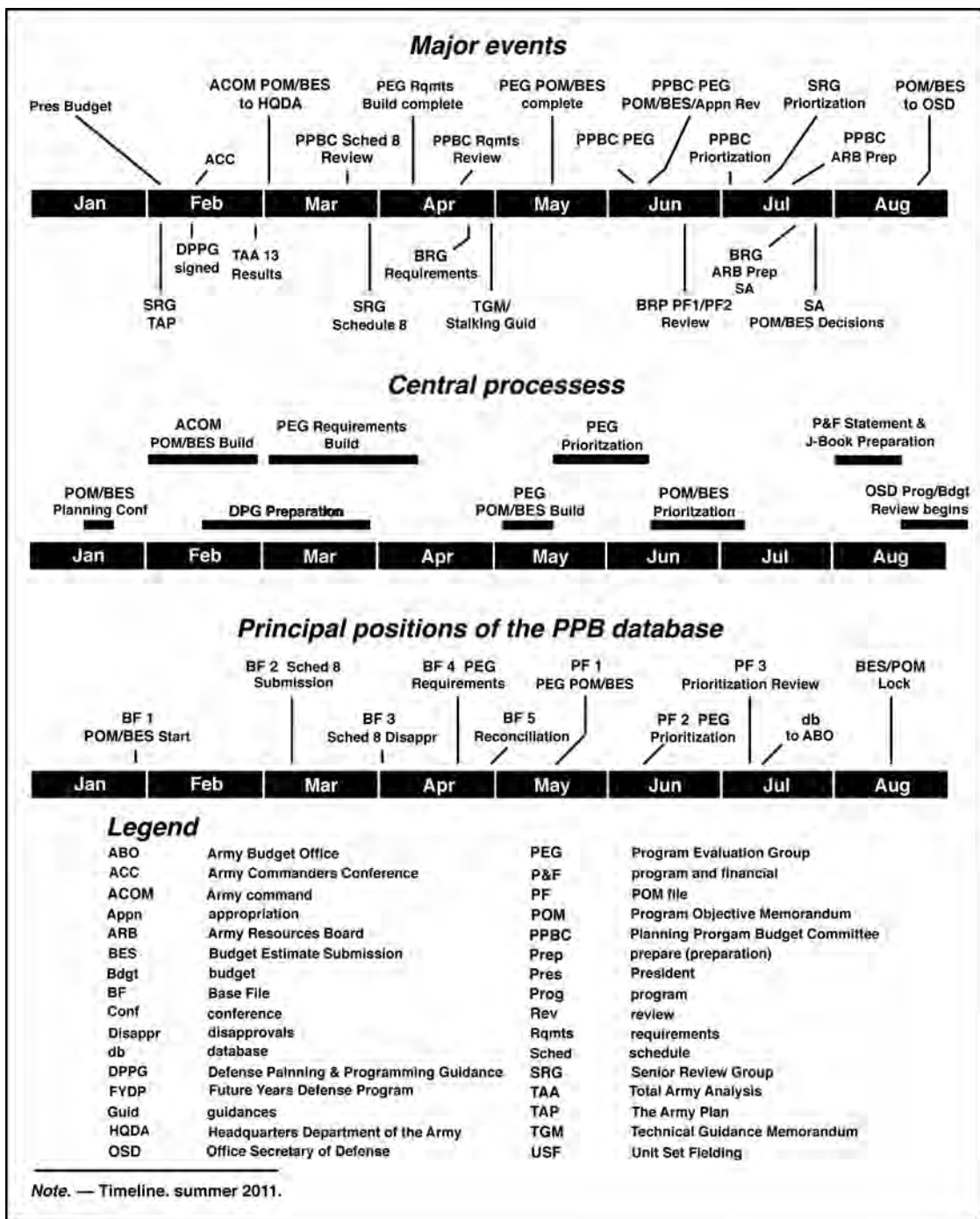

Figure 9–10. Representative Timeline for POM/BES build

*d. Command participation.* ACOMs participate in the PPBE process as do PEOs, which report through the Army Acquisition Support Center (ASC). These and other operating agencies make mission and operating requirements known through Commander’s Narratives, Command-Requested Changes, and additional data submissions prescribed by RFG volume 3. ACOM commanders serving as commanders of Army Component Commands (ACC) integrate operational requirements of the combatant command into their program and budget input. In addition, combatant commanders highlight their pressing requirements in an integrated priority list (IPL) that receives close review during program development by HQDA, the Joint Staff, and OSD.

*e. Use of Program Evaluation Groups.*

(1) As mentioned, HQDA packages program requirements into MDEPs, each associated with one of five resource management areas (para 9–21, above). HQDA then assigns each MDEP to a PEG to help build and track the Army POM that forms the Army portion of the DOD FYDP.

(2) PEG POM-building activity begins in the fall and peaks March through May of the following year. Figure 9–6, above, outlines PEG areas of interest.

(3) PEGs administer assigned MDEPs. They set the scope, quantity, priority, and qualitative nature of resource requirements that define each PEG program. They monitor PEG resource transactions, making both administrative and substantive changes to their MDEPs as required. In the process, PEGs review assigned MDEPs in terms of total obligation authority (TOA) guidance. They review command and agency requested requirements submitted via Schedule 1s and their POM. At the same time, PEGs review integrated priority lists (IPLs) of the combatant commands as well as resource needs expressed by the supporting Army Component Command (ACC). PEGs relate these command operating requirements to HQDA guidance as well as to existing MDEPs and new initiatives.

(4) Meanwhile, serving as Program Integrators, the DARNG, CAR, and CIO/G–6 provide technical assistance to the PEGs and monitor actions to integrate priorities and statutory, Defense, and Army requirements for their respective programs.

(5) Based on review of military requirements related to their Title 10 area of responsibility, each PEG builds an executable program characterized by affordability, continuity, and balance. In the process, the PEG—

(a) Validates requested changes submitted by ACOMs, PEOs, and other operating agencies.

(b) Reconciles conflicts involving unfunded requirements or decrements on which commands fail to reach agreement.

(c) Recommends the allocation of available resources and offsetting decrements to support approved unfunded programs.

(d) Rank orders validated programs as PEG input to G–3/5/7’s overall POM 1-n prioritized program list.

(e) Evaluates HQDA, command, and other agency zero-sum realignments that reallocate programmed resources to meet existing shortfalls and changed requirements.

(f) Coordinates resource changes with appropriate Service, DOD, and non-DOD agencies when required.

(g) Makes sure that proposed reallocations conform to legal restraints and Army policy and priorities, avoid imprudently high risk, and maintain the ability to execute mandatory programs and subprograms.

(h) Prices programmatic decisions that the Army can defend during review by OSD, OMB, and the Congress.

*f. Internal program review.* The Planning Program Budget Committee (PPBC) meets periodically throughout the POM/BES build to review and adjust the developing program, devising courses of action and recommendations on relevant issues as appropriate. Bearing on the PPBC review is the Army Commanders’ Conference scheduled in February, which gives field commanders the chance to express their views on the prospective program. The Senior Review Group (SRG), in turn, convenes early in the process to approve guidance and, at key stages, to ratify PPBC decisions. The Army Resources Board (ARB) convenes in one or more sessions in July to review and approve the completed even year program and associated budget estimate submission and the odd year developed program change proposals and budget change proposals.

*g. Program Objective Memorandum.* The biennial, even year POM, which documents the program decision of the SECARMY and CSA, presents the Army’s proposal for a balanced and integrated allocation of its resources within specified OSD fiscal and manpower constraints. POM subject matter remains relatively constant from cycle to cycle, but varies as required to address special issues. Topics of the FY 2010–2015 POM appear in table 9–13.

---

**Table 9–13**  
**Topics covered in POM/BES 12–16**

---

Introduction  
Forces  
Investment  
Operations and Support  
Infrastructure - Environmental  
Infrastructure - Defense agencies  
Manpower and Personnel  
Defense Working Capital Fund  
Combatant Commanders Integrated Priorities List (IPLs)

---



**9-56. Program and budget correlation**

a. The POM defines what the Army intends to do over the 6-year program period. It uses the MDEP to package required resources by mission, function, and other program objectives. Throughout program development, however, both programmers and budgeters make sure that programmatic decisions receive proper costing and that Army resource decisions can be defended during budget reviews conducted by OSD, OMB, and Congress. Working closely together, programmers and budgeters help the senior Army leadership consider all relevant information before the leaders make resource allocation decisions. The approach precludes the need, later in the integrated process, to revisit most issues. Moreover, it presents a near seamless transition from program to budget.

b. Figure 9-11 shows the complementary way that programmers and budgeters view resource requirements. The display shows from left to right the manpower and dollars needed to carry out missions and functions. From top to bottom, the display shows how these requirements are distributed among Army programs to form appropriation requests to Congress.

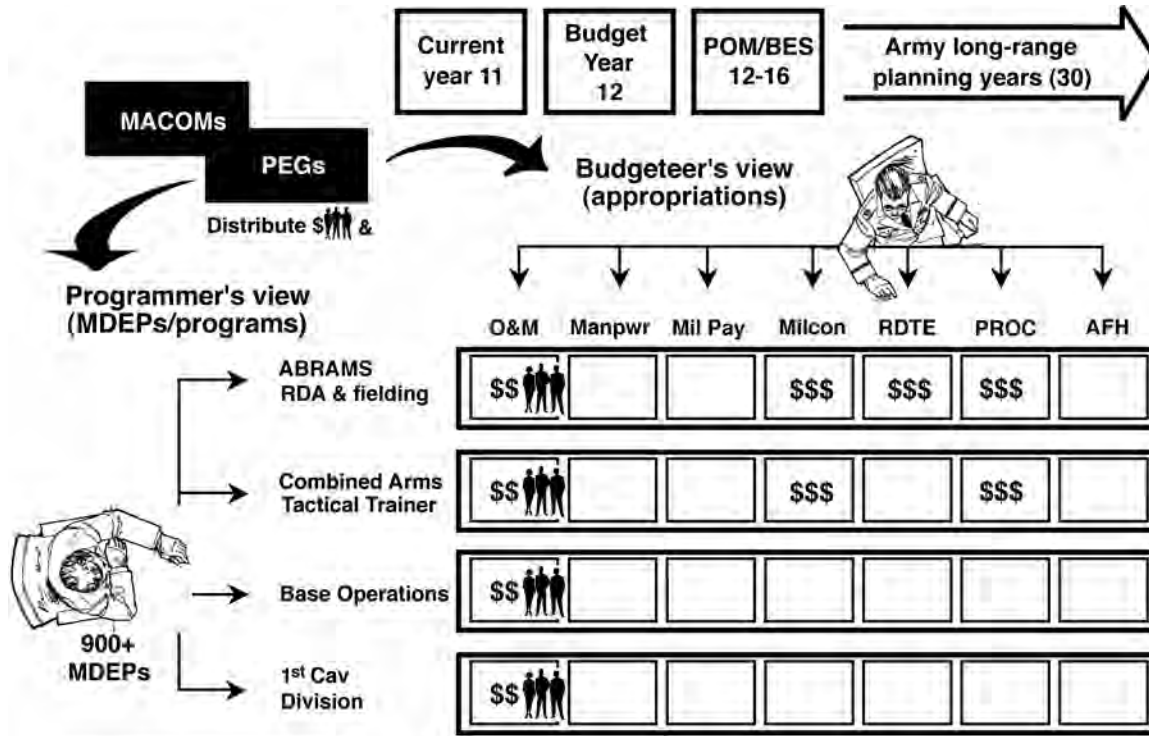

**Note.**—The PPBES goal centers on simultaneously developing a 5-year Program Objective Memorandum (POM) and 1-year Budget Estimate Submission (BES).

Figure 9-11. Program versus budget perspective

**9-57. BES preparation**

a. As mentioned, HQDA prepares the BES concurrently with the POM, submitting the combined POM/BES to OSD in August every year. The BES covers the first year of the program approved by the SECARMY and CSA.

b. In fact, however, one or more events may cause HQDA to re-address certain POM/BES decisions. For example, during program-budget preparation, Congress reviews the budget for the upcoming fiscal year. The review requires that the Army track resultant congressional actions and make appropriate adjustments in the BES. Also, after completing the POM, changes occur in rates and prices available during POM build. The later information often requires altering such rates and prices as those for the Army Working Capital Fund, pay, fuel, or inflation.

**9-58. OSD program and budget review**

OSD begins review of the combined POM/BES soon after their submission in August. The program and budget review

continues until late December. The review concludes when the Administration makes final Presidential Budget decisions. Figure 9–12 highlights events during review of POM/BES FY 12–16.

a. Issues center on compliance with the Defense Planning and Programming Guidance, the overall balance of Service programs, and late-breaking significant issues.

b. As issues arise, representatives of HQDA principal officials meet with their OSD counterparts. The Army representatives present the Army position and try to clarify the issue. If possible, the issue is resolved at this level.

c. By late November, after review officials have debated and decided program issues, the DepSecDef issues one or more Resource Management Decisions (RMDs directing specific changes to program positions of the submitted POM. Before completing the budget, if it is needed, the DepSecDef publishes a Summary RMD along with a memorandum describing the disposition of programmatic issues.

d. Budget issues during the review are decided through draft issue papers created by the Resource Decision Document (RDD) process. Focusing on proper pricing, reasonableness, and program execution, A RDD may be based on errors or on strength of justification. It may result from analytical disagreement or, it may be motivated by cost savings or changes in policy. After reviewing the issue paper responses the SecDef issues RMDs which are final decisions directed by the SecDef telling the services to change their program requests to align them with the SecDef's decisions.

e. After the DepSecDef or USD (Comptroller) has signed the RMDs, each Service selects as Major Budget Issues (MBI) certain adverse resource decisions. Army MBIs center on decrements to specific initiatives or broad issues that would significantly impair its ability to achieve its program intentions. An MBI addresses the adverse impact that would occur if the decrement were to prevail. At the end of the process, the Sec Army and CSA meet with the SecDef and DepSecDef on Major Budget Issues. After the meeting, the SecDef decides each issue, if necessary meeting with the Office of Management and Budget (OMB) or the President to request additional funds or recommend other action.

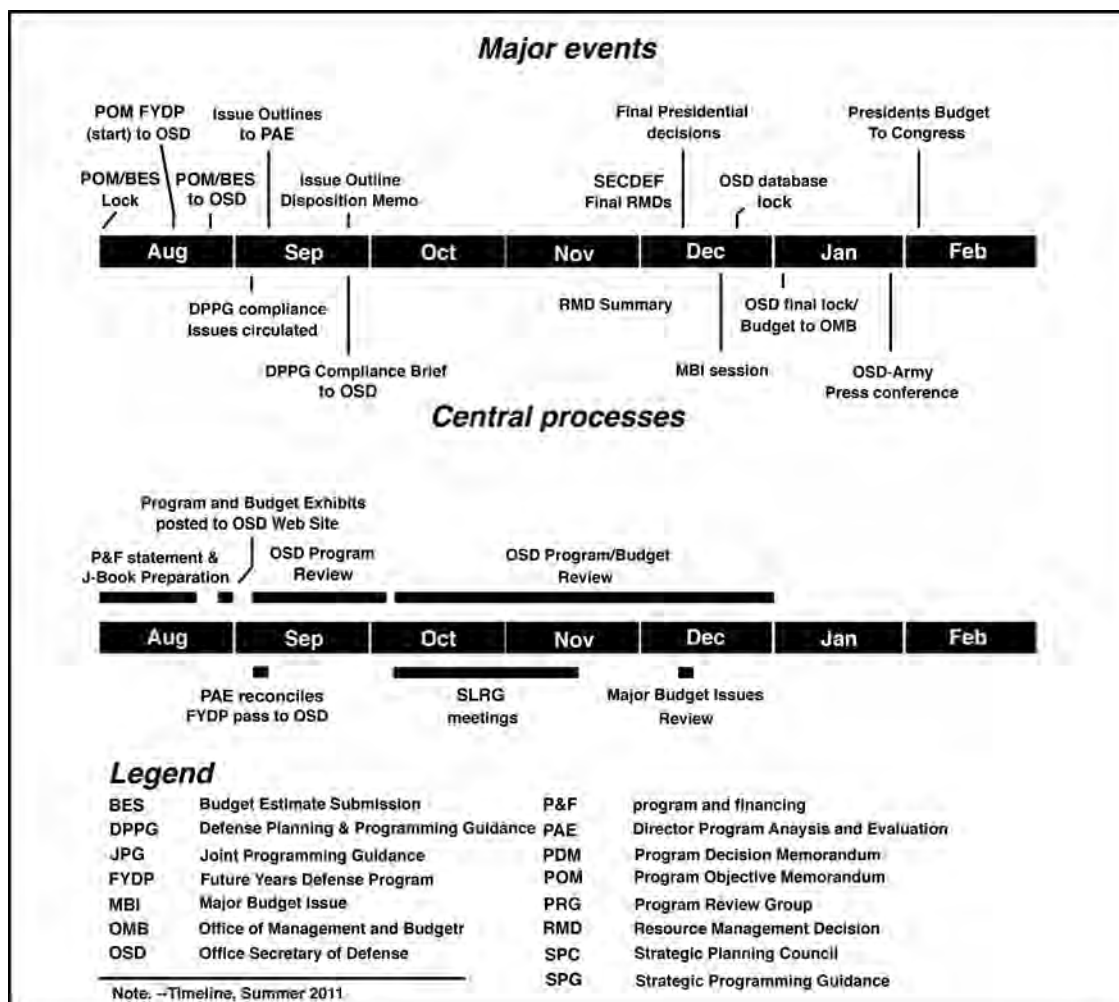

Figure 9–12. Representative timeline for program and budget review

## How the Army Runs

### 9–59. President's Budget

a. In December, OSD normally issues a final RMD or OSD memorandum incorporating any changes from deliberations on MBIs, thus completing the program and budget review process.

b. After implementing the final resource distribution at the budget activity and object class level, Army sends the information to OSD. OSD forwards the information as the Army's portion of the Defense budget to OMB and OMB incorporates the Defense budget into the President's Budget. The President's Budget covers prior year obligations and updated resource estimates for the current year. During the biennial POM/BES cycle, the President's Budget covers total obligation authority (TOA) estimates for the budget year and budget year plus 1.

### 9–60. Justification

#### a. Congressional budget hearings.

(1) During budget justification, the Army presents and defends its portion of the President's Budget before Congress. The process proceeds formally and informally under the staff supervision of the Chief of Legislative Liaison and ASA (FM&C).

(2) After the President formally submits the budget, the Army provides detailed budget justification to the authorization and appropriations committees. First, however, appropriation sponsors will have prepared material in Army justification books to conform to decisions of the President and SecDef and congressional requirements for formats and supporting information. Justification books undergo internal Army review by ASA(FM&C) and are then sent to OSD for final review.

(3) The Senate Armed Services Committee (SASC) and House Armed Services Committee (HASC) conduct authorization hearings for the various programs and appropriations. Concurrently, the Army's budget request goes before the House and Senate Appropriations Committees. In these hearings, the SECARMY and CSA normally testify first. Then with assistance from ASA (FM&C)'s Budget Liaison Office and the Office, Chief of Legislative Liaison, appropriation sponsors and functional proponents present and defend the details of the budget.

#### b. Legislative approval and enactment.

(1) When congressional committees complete their review, the Senate and House vote on the committee bills. Differences between the Senate and House versions are resolved via a joint conference.

(2) Budget justification ends when the President signs the authorization and appropriation bills for the coming fiscal year. Enacted into law, Army appropriations provide the legal authority to incur obligations and make payments.

c. *Continuing Resolution Authority.* When Congress fails to pass an appropriation by the end of September, it may pass a continuing resolution. Continuing Resolution Authority (CRA) derives from emergency legislation that authorizes the funding of Government operations in the absence of appropriations. A temporary measure, the CRA usually restricts funding to the prior year level and prohibits new initiatives. HQDA separately publishes specific policy on how the Army will operate under the CRA. Failure to pass either an appropriation or CRA could result in a temporary shutdown of government operations. Normally, however, until an appropriation or CRA is enacted, DOD would continue minimum essential operations based on national defense requirements.

## Section XIII

### Budget Execution Phase

#### 9–61. Management and accounting

During execution, the Army manages and accounts for funds and manpower to carry out approved programs. Army checks how well HQDA, ACOMs, PEOs, and other operating agencies use allocated resources to carry out program objectives. Through the Army Joint Reconciliation Program, Army strengthens financial accounting and management to make sure financial reports accurately reflect the results of budget execution. The Army (and of even greater importance) OSD, OMB, and Congress apply execution feedback to adjust resource requirements during deliberation on the Army's budget.

#### 9–62. Financial management

The budget execution process applies funds appropriated by Congress to carry out authorized programs. This process first entails apportioning, allocating, and allotting funds. It then entails obligating and disbursing the funds and then reporting and reviewing the effectiveness of executing them. The procedure also involves performing in-progress evaluations and making necessary course corrections to reallocate resources to meet changing requirements that develop during execution. Known as reprogramming, making course corrections involves financing unbudgeted requirements that result from changed conditions unforeseen when submitting the budget and having higher priority than the requirements from which funds are diverted.

*a. Funds control.*

(1) Several events must occur before the Army can execute its programs for a new fiscal year under a new appropriations act:

(a) OMB must apportion the appropriations, which provides obligation/budget authority. An apportionment distributes funds by making specific amounts available for obligation.

(b) The Department of the Treasury must issue a Treasury Warrant providing cash.

(c) The USD (Comptroller) must release program authority.

(2) Before the Army can execute its programs for the new fiscal year, it must load all these authorities into the Program Budget Accounting System (PBAS), which is operated by the Defense Finance and Accounting Service (DFAS). Additionally, PBAS must be loaded with execution restrictions in accordance with congressional language. Finally, appropriation sponsors must spread undistributed decrements in the appropriations act to the appropriate program. The Business Transformation Agency and the OSD Comptroller's Office have selected a replacement for PBAS. The new system called General Fund Enterprise Business Systems (GFEBS) is now being deployed and will be used to distribute funds to the various commands. GFEBS capabilities will provide functionality in six core financial areas: general ledger management, payment management, receiving management, funds management, cost management, and reporting. GFEBS is a new way of doing business.

(3) There is another system called the Enterprise Funds Distribution (EFD) which is a web-based system which combines Congressional tracking with funds distribution to the Army and contains specific instructions on funds control.

*b. Apportionment.*

(1) An apportionment requires a specific request. Using SF 132, Apportionment and Reapportionment Schedule, the ASA (FM&C) Funds Control Officer (SAFM-BUC-E) prepares the request within 5 days of the availability of an appropriations act or in response to approved reprogramming requests, supplementals, or rescissions. OSD approves or revises the apportionment requests and submits them to the Office of Management and Budget (OMB) for approval. OMB approves, changes, or disapproves the requests and returns apportionments through OSD to the Army for entry into PBAS. OMB apportionments—

(a) Operating accounts-Operation & Maintenance (O&M), Military Personnel (MILPERS), and Army Family Housing, Operations (AFHO)-on a fiscal quarterly basis.

(b) Investment accounts-RDT&E, Procurement, Military Construction (MILCON), and Army Family Housing (Construction) (AFHC)-at the start of the fiscal year rather than on an incremental basis, funding the entire amount of the appropriation.

(2) The apportionment determines the Budget Authority (BA) available in PBAS. For the operating accounts-even after releasing the entire program to the command-it is the cumulative amount of BA issued to commands and agencies by quarter that determines the execution level for the appropriation.

*c. Program release.*

(1) For investment accounts, the Army releases program and budget authority in equal amounts. Actual expenditure, however, depends on OSD program controls wherein the USD (Comptroller) gives the Army specific program releases that further control expenditures.

(a) For the RDT&E appropriation, the program is released at the program element (PE) level (SD Form 440, Research, Development, Test and Evaluation Program/Fund Authorization). These are the same levels as those authorized and appropriated by Congress and reported in the DD Form 1414, Base for Reprogramming Actions and DD Form 1416, Report of Programs, which are provided to Congress to show execution changes to appropriated amounts.

(b) For the procurement appropriations (Aircraft, Missiles, Weapons & Tracked Combat Vehicles, Ammunition, and Other Procurement), the program is released at the budget line item (BLIN) level (SD Form 440).

(c) Both the MILCON and the AFHC appropriations are released at the project level (OSD Format 460 for Military and Family Housing Construction accounts) as contained in the conference report accompanying the Military Construction Appropriations Act.

(2) Program releases for the operating accounts (Operation and Maintenance (O&M) and Military Personnel (MILPERS)) are contained in the obligation authority (OA) letter issued by the USD (Comptroller). OSD issues a separate OA letter for Army Family Housing (Operations) (AFHO).

*d. Allocation, obligation, and reconciliations.* Guided by HQDA appropriation sponsors and using the PBAS, ASA (FM&C) allocates apportioned funds to commands and agencies. Then—

(1) ACOMs and other operating agencies, in turn, make funds available to subordinate commands and installations by an allotment. Allotments authorize users to place orders and award contracts for products and services to carry out approved programs.

(2) Installations obligate funds as orders are placed and contracts awarded. They authorize payments as materiel is delivered or as services are performed.

## How the Army Runs

(3) Installations, commands, and appropriation sponsors conduct joint reconciliations (para 9–78, below). Reconciliations make sure financial statements and reports accurately represent the results of the apportionment, allocation, and allotment program. Reconciliations also make sure payments align properly with supporting obligations. The Deputy Assistant Secretary of the Army (Financial Operations) (SAFM–FO) manages the Army’s Joint Reconciliation Program.

*e. Changes from the President’s Budget.*

(1) After appropriations are enacted, appropriation sponsors and the Army Budget Office review the legislation to determine changes to the submitted budget. Changes include congressional adds, denial of programs, and changes to submitted funding levels. Changes also include identification of congressional special interest items, undistributed reductions, and any language relating to execution of the programs. Army applies such changes to amounts loaded into the PBAS.

(2) Appropriation sponsors must determine how to spread any undistributed reductions. In addition, they may also have to spread some unapplied reductions in the appropriations act, which are distributed to the Services (and appropriations) during the program review cycle using the RDD process to create issue papers that challenge the Service programming requests. For those reasons, the actual funding level for a particular project, budget line item number (BLIN), program element (PE), Army program elements (APE), or budget activity may not be finally set until several months into the new fiscal year. This is so even if the appropriations act is passed before October 1, and the ultimate initial funding level for individual programs will almost certainly be less than shown in the joint conference reports.

*f. Funding Letters for O&M and AFHO.* HQDA issues funding letters to commands and agencies for the Operation and Maintenance, Army (OMA) and Army Family Housing (Operations) (AFHO) appropriations. (The Army National Guard (ARNG) and U.S. Army Reserve (AR) issue their own funding letters for their operation and maintenance appropriations.) The letters indicate funded programs and give guidance on how the programs should be executed. The funding letters also provide an audit trail from the resource position in the President’s Budget to the revised, appropriated position. The OMA letter outlines the funding posture and goals set by the senior Army leadership for command execution. Preparing and issuing the funding letter takes about 60 days after the appropriations act is passed.

### **9–63. Revised approved program for RDT&E**

HQDA issues a Revised Approved Program (RAP) for the Research, Development, Test, and Evaluation (RDT&E) appropriation. The RAP shows congressional changes at both the program element (PE) and project level. In addition, the RAP spreads general reductions at the project level. It includes the amounts set aside for the Small Business Innovation Research Program (SBIR) and the Small Business Technology Transfer Pilot Program (STTR). The RAP also includes amounts withheld by the USD (Comptroller) and HQDA and provides language on congressional restrictions as well as congressional special interest items. Because of the level of detail and the extensive information included, the RAP does not become available until several months after the appropriations act is enacted.

### **9–64. Program Budget Accounting System**

*a.* The Program Budget Accounting System (PBAS) is used to issue both the program and its Budget Authority (BA) to commands and agencies for all appropriations. Once appropriation sponsors determine the revised appropriated level for each appropriation, they adjust the amounts in PBAS. The PBAS is in the process of being replaced with General Fund Enterprise Business Systems (GFEBS) which is being deployed and will be used to distribute funds to the various commands. GFEBS capabilities will provide functionality in six core financial areas: general ledger management, payment management, receiving management, funds management, cost management, and reporting. GFEBS is a new way of doing business. Each program and its Budget Authority (BA) are released in equal amounts for all appropriations except O&M, MILPERS, and AFHO. These accounts receive the total program for the fiscal year but receive Budget Authority (BA) quarterly throughout the year. Budget Authority (BA) controls the total amount of obligations a command or agency can execute through any given quarter but allows flexibility in its application against the program received.

*b.* ASA (FM&C) controls PBAS at the HQDA level. The appropriation sponsor may request release of the program and Budget Authority (BA) or below threshold reprogramming actions. ASA (FM&C)’s Funds Control Officer (SAFM–BUC–E) reviews requests for compliance with congressional language and guidance of the USD (Comptroller) before entering the action in PBAS. PBAS produces documents that display both Budget Authority (BA) and the program. The documents include a section for remarks for executing the program and footnotes that provide statutory restrictions according to provisions of 31 USC 1517.

*c.* PBAS agrees with the program detail contained in DFAS–IN Manual 37–100-\*\*\*\* (The Army Management Structure (AMS)). Changes to PBAS appropriation structure can only be made at HQDA and must be approved as a change to DFAS–IN Manual 37–100-\*\*\*\*. This manual initially agrees with the detail obtained in the President’s Budget request and is changed to incorporate congressional adds. Any additional changes may be controlled by congressional language and vary from one appropriation to another.

*d.* PBAS uses special reprogramming keys either to allow commands and agencies to move the program below threshold or to restrict the ability to reprogram below threshold at HQDA. The use of the keys in PBAS varies from

one appropriation to another. PBAS also has special keys that identify congressional special interest items or programs that have been denied by Congress.

### **9–65. Obligation and outlay plans**

*a.* During December and January, ASA (FM&C), in coordination with field activities and appropriation sponsors, develops obligation plans for each appropriation. Outlay plans are developed unilaterally at the ASA (FM&C) level. Obligation plans address unexpired funds. Outlay plans address unexpired, expired and no-year funds.

*b.* ASA (FM&C) sends completed outlay plans to the USD (Comptroller). Although the USD (Comptroller) discontinued a requirement to submit obligation plans, the Army continues their use internally since OSD still reviews Army obligation rates and requests rationale for execution rates that fall outside normal parameters.

*c.* Based on command estimates of annual obligations, both obligation and outlay plans tie to obligation and outlay controls in the President's Budget. The importance of the outlay plan is that it relates directly to projected amounts the Treasury must borrow to maintain proper balances to meet expected disbursements (outlays).

### **9–66. Financing unbudgeted requirements**

*a.* Congress recognizes the need for flexibility during budget execution to meet unforeseen requirements or changes in operating conditions, including those to address minor, fact-of-life financial changes. Congress accepts that rigid adherence to program purposes and amounts originally budgeted and approved would jeopardize businesslike performance or mission performance. Thus, within stated restrictions and specified dollar thresholds, Congress allows federal agencies to reprogram existing funds to finance unfunded requirements. Typically, reprogramming diverts funds from undertakings whose requirements have lower priority than the new requirements being financed.

*b.* Congressional reprogramming language specifying budget authority limits, which varies by appropriation, controls the Army's ability to move budget authority within appropriations (below threshold reprogramming). Moving the program in excess of specified limits requires congressional approval via a formal reprogramming request (DD Form 1415, Reprogramming Action). Moving amounts between appropriations (transfer authority) always requires a formal reprogramming request.

*c.* Provided reprogramming authority is not required, another way to finance unfunded requirements is to apply obligation authority harvested from joint reconciliations. This means using unexpired funds originally obligated against a contract or order but identified as excess to the need and subsequently deobligated. Reutilizing funds in this way gives allotment holders greater leverage in executing the budget and increases the buying power of the Army's financial resources.

*d.* Fiscal year 1991 marked the first year of the Omnibus Reprogramming procedure, which except for construction accounts (that use a different process), consolidated all non-emergency DOD prior approval reprogramming actions into one very large reprogramming action. It identified all DOD reprogramming requirements at one time. This allowed the Congress and DOD to set priorities for limited funding and to make smarter decisions.

### **9–67. Oversight of non-appropriated funds**

Applying various methods, the ASA (FM&C) also oversees non-appropriated funds. One method is by participating on the Morale, Welfare, and Recreation (MWR) Board of Directors. The Deputy Assistant Secretary of the Army (Financial Operations) is a voting member of the MWR Executive Committee. In addition, the Principal Deputy Assistant Secretary of the Army (FM&C) chairs the Audit Committee, and the Chief Resource Analysis and Business Practices serves on the Investment Subcommittee. Through these positions the ASA (FM&C) influences virtually all aspects of MWR financial policy. As part of the responsibility of overseeing non-appropriated funds, the ASA (FM&C) presents non-appropriated funds issues to the SECARMY and CSA for decision.

## **Section XIV**

### **Program Performance and Review**

#### **9–68. Program implementation**

ACOMs, PEOs, and other operating agencies carry out the approved program within manpower and funds provided. They review budget execution and account for and report on the use of allocated funds by appropriation and MDEP. As applicable to each appropriation, they include FYDP program and subprogram, Army Management Structure code (AMSCO), Army program element (APE), project number, budget line item number (BLIN), standard study number (SSN), budget activity (BA), budget activity group (BAG), and element of resource (EOR). They also account for use of allocated manpower by Unit Identification Code (UIC). The manpower and financial data obtained help commands and agencies develop future requirements.

#### **9–69. Performance Assessment**

*a.* ASA(FM&C) oversees the Cost & Performance Portal (CPP) which collects Army financial and performance data from disparate Army data systems, centralizes the data into a single data warehouse, and displays analytic information

## How the Army Runs

through various reports and graphical displays. The CPP is accessible to all Army users including resource managers, functional experts, and senior leaders through web-based interfaces with the ability to login via the Army CAC.

*b.* The CPP provides real-time, relevant, accurate and transparent financial and performance information to senior leaders and HQDA staff to support decision-making.

### **9–70. Review of selected acquisition systems**

The means for checking system program performance include milestone reviews of designated acquisition programs conducted by ASA (ALT) using the Army Systems Acquisition Review Council (ASARC) and Major Automated Information Systems Review Council (MAISRC).

### **9–71. Joint Reconciliation Program**

This program applies the skills of those responsible for various aspects of financial management. The skills include those of accountants, budget and program analysts, contracting professionals, logisticians, and internal review auditors. The program applies these combined skills to verify the validity of unliquidated obligations, contractor work in progress, billing status, and the continued need for goods and services not yet delivered. The program achieves dollar savings by identifying and canceling obligations for goods and services no longer needed or duplicative. The program also reconciles current appropriations to verify the correctness of amounts obligated. In addition, the program assures the liquidation of appropriations to be canceled by the end of the fiscal year.

## **Section XV**

### **SUMMARY AND References**

#### **9–72. PPBE concept**

The PPBE process ties strategy, program, and budget all together. It helps build a comprehensive plan in which budgets flow from programs, programs from requirements, requirements from missions, and missions from national security objectives. The patterned flow-from end purpose to resource cost-defines requirements in progressively greater detail.

#### **9–73. System products and process**

The PPBE process produces a departmental plan, program, and budget. Figure 9–10 lists typical events that occur during the process. Figure 9–8 shows the organizational framework within which the process operates.

#### **9–74. References**

- a.* DOD Instruction 7045.7, Implementation of the Planning, Programming, and Budgeting System.
- b.* CJCS Instruction 3100.01A, Joint Strategic Planning System.
- c.* Army Regulation 1–1, Planning Programming, Budgeting, and Execution Process.

## Chapter 10

### Resource Management

Stewardship and Innovation: The Army remains devoted to the best possible stewardship of the resources it is provided by the American people through Congress. The establishment of the CMO and initiatives related to the transformation of Army business practices represent the Army's effort to act as a responsible steward. Several other initiatives serve to conserve resources and to reduce waste and inefficiencies wherever possible. The Army achieved full operating capability of the new Army Contracting Command, Expeditionary Contracting Command, and Mission and Installation Contracting Command in 2009. These organizations are dedicated to ensuring professional, ethical, efficient, and responsive contracting.... Energy security is a key component of Army installations, weapons systems, and operations. The Army has developed a comprehensive energy security strategy, and is acting now to implement initiatives to make us less dependent on foreign sources of fuel and better stewards of our nation's energy resources.... The United States Army 2010 Posture Statement as Army leaders we must be responsible stewards of the funds entrusted to our care. This is particularly true now, as we strive to meet the challenges of persistent conflict in an era of constrained resources. We must make the best possible use of our limited funds and ensure that no significant resource-related issue is decided without a thorough review of its costs, its projected benefits, and the tradeoffs that might be required to pay for it. In our decision making, we need to supplement professional experience and military judgment with solid data and sound analytical techniques. Under Secretary of the Army and Vice Chief of Staff, Army Memorandum SUBJECT: Cost-Benefit Analysis to Support Army Enterprise Decision Making dated 30 December 2009.

#### Section I Introduction

##### 10-1. The need for resource management

*a.* The United States Army 2010 Posture Statement and the cost benefit analysis (CBA) memorandum emphasize the need for effective resource management throughout the Army. Because the Army has a large and complex set of missions to execute and a limited set of resources with which to accomplish its missions and supporting tasks, the necessity to maximize the spending power of every dollar the Congress appropriates to the Army becomes paramount. Further, because the Army is vested with the public's trust and confidence for defending our Nation, all Army leaders have an incumbent responsibility to exercise effective and responsible stewardship for all the resources that have been entrusted to them. As such, responsible, effective and efficient resource management is an integral part of all Army leaders' duties and functions and is essential for maintaining the Army's readiness to accomplish its assigned missions.

*b.* Resource management at the strategic level must address the issues of affordability, required force capabilities, and the entire supporting structure. Resource managers at this level must also deal with the larger questions of whether particular programs are needed, how they serve the specific missions assigned to the Army, and whether the strategies designed to accomplish the mission are correct and necessary. Programmatic and financial resource perspectives examine the efficiency with which funds are allocated and spent and how effectively particular programs are managed and integrated. At the program level this process encompasses the ways in which the soldiers, civilians, facilities, equipment, information, time, and funds are integrated into the Army.

*c.* Implicit in this programmatic resource management perspective is the recognition that all of us participate in a resource decision stream that requires some of these decisions, once made, to remain unalterable. For example, placing a new facility at an installation typically requires a minimum of two or more years. The time to train instructors and then troops on a new piece of equipment varies with the complexity of the equipment. Ordering the secondary spares for new end items requires time. Integrating all three of these resource decisions requires that we consider them to be "irreversible," otherwise we could find new facilities constructed at one installation for a new piece of equipment and soldiers trained on that equipment, while we have actually placed the equipment and soldiers on another installation.

*d.* More importantly, this "unalterable decision base" will have created "a receivables stream" such as aircraft, training packages, equipment shops, displaced equipment, and so forth of substantial proportion. Reconfiguring these "receivables" into one's own conception without considering the previous decision rationale may well create resource management disconnects which tend to surface in OSD resource review forums and Congressional hearings.

##### 10-2. Resource management-a definition

Resource management is the direction, guidance, and control of financial and other resources. It involves the application of programming, budgeting, accounting, reporting, analysis, and evaluation.

##### 10-3. Resource management terms

Throughout this chapter, there are a number of unique terms associated with resource (specifically financial or fiscal) management that if understood enable you to more readily understand and use this chapter.

*a. Obligation.* Any act that legally binds the United States Government to make a payment is an obligation. The concept of the "obligation" is central to resource management in the Government. From the central concept of



## How the Army Runs

“obligating the U.S. Government to make a payment” springs forth the foundation of our fiscal law and the legal parameters under which the Army must operate as a part of the U.S. Government. The obligation may be for a service rendered by a contractor, the acquisition of materiel items (for example, a tank), the construction or repair of a facility, salary for a soldier or civilian, and so forth.

*b. Congressional authorization.* A law passed by the Congress and signed by the President that establishes or continues a Federal program or agency, and sets forth guidelines to which it must adhere. Generally for every FY, the Congress passes a National Defense Authorization Act (for example, Public Law 111–383, Ike Skelton *National Defense Authorization Act for Fiscal Year 2011* ), which directs by law what can be purchased, what manpower resource levels each Service can have, and how many weapon and other materiel systems can be bought. It also provides additions and changes to Title 10 of the United States Code that, among other laws, guides the management of the Army and the other activities of the DOD. An authorization act however does not provide the budget authority (BA) to draw funds from the U.S. Treasury to pay an obligation.

*c. Congressional appropriation.* A law passed by the Congress and signed by the President that provides BA for the specific purpose(s) stated in the law. In the case of the annual DOD appropriations act (for example, Public Law 111–118, Department of Defense Appropriations Act, 2010, Budget Authority (BA) is provided for a number of appropriations (for example, Operations and Maintenance, Army (OMA); Military Personnel Army (MPA); Research, Development, Test and Evaluation, Army (RDT&E,A); MILCON, Army (MCA), and so forth) for a specified period of time for the Army to incur legal obligations as it executes the programs authorized by Congress and other laws that guide Army operations.

*d. Budget authority.* BA is the authority to incur a legal obligation to pay a sum of money from the U.S. Treasury. BA is not “money.” The U.S. Treasury actually disburses cash only after an agency (for example, Army DFAS accounting office activity) issues a U.S. Treasury check withdrawing money from the Treasury and thus disburses the money to pay a previously incurred obligation.

*e. Disbursement.* Payment of an obligation of the U.S. Government.

*f. Fiscal year (FY).* The FY is the Government’s accounting period. For the Federal Government it begins on 1 October and ends on 30 September. The FY is designated by the calendar year in which it ends. For example, FY 2006 begins on 1 October 2005 and ends on 30 September 2006.

*g. Outlays.* Outlays are the amount of money the Government actually disburses in a given FY.

*h. Asset leverage.* The combination of government assets with private sector knowledge, expertise, equity and or financing in a venture (partnership) which results in long term benefit to the government.

### 10–4. Key players in Army resource management

There are a number of different actors who play in the Army’s resource management arena:

*a. Congress.* Central to the function of obligating the Government to make a payment is the power invested by the U.S. Constitution in the Congress for the following: to raise revenue and borrow money (U.S. Constitution Article I, Section 8, Clause 1–2); to raise and support armies and to provide and maintain a navy (U.S. Constitution Article I, Section 8, Clause 12–13); and no money shall be drawn from the Treasury, but in consequence of appropriations made by law (U.S. Constitution Article I, Section 9, Clause 7). For Congress to meet these requirements they pass authorization and appropriation acts as described above.

*b. Office of Management and Budget (OMB).* OMB assists the President of the United States in overseeing the preparation of the Federal budget and in supervising its administration in Federal agencies. It evaluates, formulates, and coordinates management procedures and program objectives within and among Federal departments and agencies. It also controls the administration of the Federal budget, while routinely providing the President with recommendations regarding budget proposals and relevant legislative proposals. Additionally it plans, conducts, and promotes evaluation efforts that assist the President in assessing Federal program objectives, performance, and efficiency. Finally, OMB also oversees and coordinates the Administration’s procurement, financial management, information, and regulatory policies. Further details on the OMB organization and its functions can be viewed on-line at: “<http://www.whitehouse.gov/omb/>”.

*c. Under Secretary of Defense (Comptroller) (USD(C)).* Within the OSD there is appointed an USD(C). The USD(C) advises and assists the SecDef in exercising the SecDef’s budgetary and fiscal powers. As such the USD(C) supervises and directs the preparation of DOD budget estimates and establishes and supervises the execution of policies and procedures to be followed in connection with organizational and administrative matters relating to: preparation of budgets; fiscal, cost, operating, and capital property accounting; and progress and statistical reporting. Finally the USD(C) establishes and supervises the execution of policies and procedures relating to the expenditure and collection of funds administered by DOD and establishes uniform fiscal terminology, classifications and procedures used in the DOD’s fiscal management. The USD(C) is the DOD Chief Financial Officer (CFO) (see para 10–28). Further details on the Office of the USD(C) organization and its functions can be viewed on-line at: <http://www.dtic.mil/comptroller/>.

*d. Secretary of the Army (SECARMY).* Subject to the authority, direction, and control of the SecDef and subject to the provisions of section 3013 of Title 10, United States Code, the SECARMY is responsible for, and has the authority necessary to conduct all affairs of the DA, including the following functions:

- (1) Recruiting.
- (2) Organizing.
- (3) Supplying.
- (4) Equipping (including research and development).
- (5) Training.
- (6) Servicing.
- (7) Mobilizing.
- (8) Demobilizing.
- (9) Administering (including the morale and welfare of personnel).
- (10) Maintaining.
- (11) The construction, outfitting, and repair of military equipment.
- (12) The construction, maintenance, and repair of buildings, structures, and utilities and the acquisition of real property and interests in real property necessary to carry out the responsibilities specified.

(13) Further, subject to the authority, direction, and control of the SecDef, the SECARMY is also responsible to the SecDef for: the functioning and efficiency of the DA; the effective and timely implementation of policy, program, and budget decisions and instructions of the President or the SecDef relating to functions of the DA; and the performance of the functions of the DA so as to fulfill the current and future operational requirements of the unified Combatant Commands. As such the SECARMY can be considered the Army's top resource manager because of the position's inherent decision-making authority over the affairs of the DA.

*e. Assistant Secretary of the Army (Financial Management & Comptroller) (ASA (FM&C)).* Within the OSA there is appointed an ASA (FM&C). The ASA (FM&C) exercises the comptroller functions of the DA and advises the SECARMY on financial management as directed by 10 USC Sec. 3016. To execute this mission, the Office of the ASA(FM&C) is organized as follows (see Figure 10-1):

(1) *Military Deputy for Budget.* The Military Deputy for Budget is responsible for the Department of the Army's budget execution. The Director for Army Budget reports directly to the Military Deputy for Budget.

(2) *Director for Army Budget (DAB).* The DAB is responsible for the Army's budget formulation, the presentation and defense of the budget through the congressional appropriation process, budget execution and analysis, reprogramming actions, and appropriation/fund control and distribution. The DAB is a co-chairman of the HQDA Two Star Budget Requirements and Program (BRP) Board. To accomplish its missions and functions, the Office of the DAB is organized into four directorates (Operations and Support; Investments; Business Resources; and Management and Control).

(3) *Deputy Assistant Secretary of the Army (Financial Operations) (DASA (FO)).* The DASA(FO) is responsible for: policies, procedures, programs and systems pertaining to finance and accounting activities and operations; Army financial management systems and data integration activities; Army programs for management control, internal review and audit compliance, the Government Travel Charge Card, and fraud, waste and abuse; and other management evaluation activities. To accomplish its missions and functions, the Office of the DASA (FO) is organized into five directorates (Management Services, Internal Review, Financial Reporting, Finance and Accounting Oversight, and Audit Readiness). Additionally, the U.S. Army Financial Management Command, a HQDA FOA, is under the control of the DASA (FO).

(4) *Deputy Assistant Secretary of the Army for Cost and Economics (DASA(C&E)).* The Deputy is responsible for implementing the Army Cost and Economic Analysis Program through the development and promulgation of cost and economic analysis policy, cost estimating models, and cost databases for Army wide use. DASA (C&E) conducts component cost analysis for weapons and automated information systems (AIS) and manages the Army Cost Review Board and Army Cost Position (ACP) (see para 11-32.c.(6)) Process. DASA(C&E) is responsible for conducting force structure, operations and support (OPTEMPO), personnel, and installation cost analyses. Other functions include implementation of the Army Activity Based Costing/Management Strategic Plan, management of the Army Cost Research Program, and review and approval of Cost Benefit Analyses.

(5) *Director, Financial Information Management.* The Director is responsible for advising, coordinating, and directing actions to achieve financial business transformation Army wide; capitalizing on on-going programs and projects; ensuring compatibility with and interoperability between Army financial systems and Defense systems; and incorporating advances in Army information technology, communications, and Government processes and systems. She serves the Army Financial Management community as Chief Architect and Chief Information Officer as well as the functional proponent for the General Fund Enterprise Business System (GFEBS). Further details on the OASA (FM&C) organization and its functions can be viewed on-line at: <http://www.asafm.army.mil/>.

*f. Commanders of Army Commands (ACOMs) & heads of other operating agencies.* Commanders of Army commands and commanders and heads of operating agencies (for example, PEOs, PMs, President, National Defense University) are responsible for developing, justifying, presenting and defending programs supporting their assigned missions and responsibilities. Further, they are accountable for ensuring approved program budgets are properly

## How the Army Runs

executed and certified. This responsibility includes ensuring accounting and fund status reporting for appropriated and non-appropriated funds is accomplished in accordance with fiscal law and governing regulations and policies.

### 10-5. A framework to help study resource management

a. For our study of the internal workings of the Army's Resource Management System and how it functions, it helps to use a model called the "Four A's":

- (1) Acquire resources.
- (2) Allocate those resources according to the priorities generally considered in terms of dollars and manpower.
- (3) Account for those resources with a system that provides a decision support and tracking capability for the program and budget functions, and a system that performs accounting for fiscal compliance required by statutes.
- (4) Analyze the execution of those resources and implement course corrections as required.

b. As illustrated in Figure 10-2, these functions are performed in a closed-loop process. Though it is recognized that there are other models that describe the elements of resource management, for our discussion the "4-A's" model meets our needs.

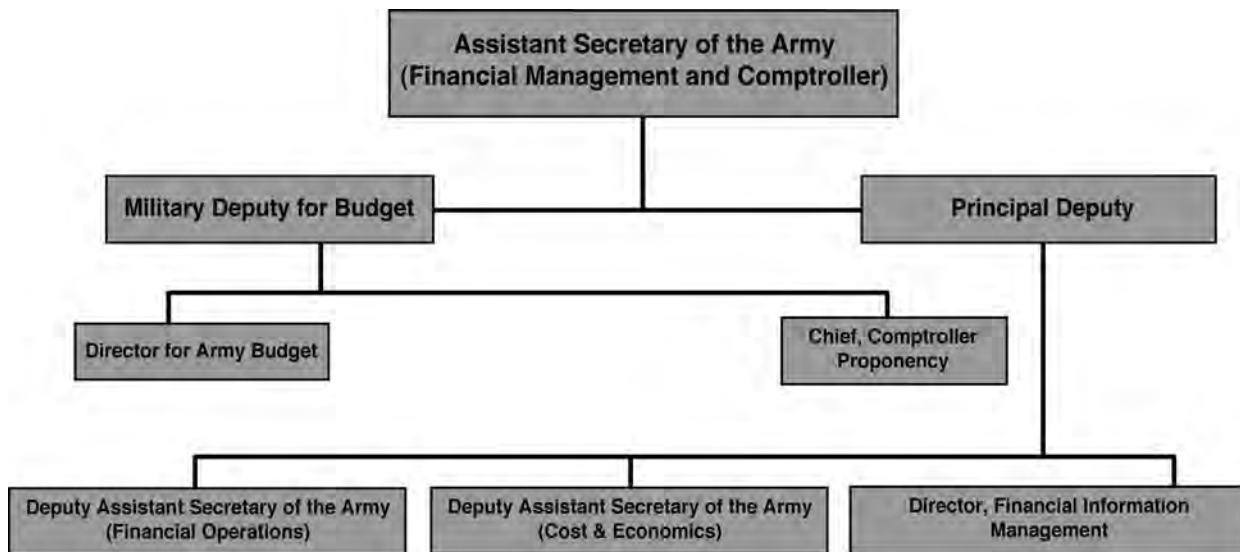

Figure 10-1. Office of the Assistant Secretary of the Army (Financial Management and Comptroller)

---

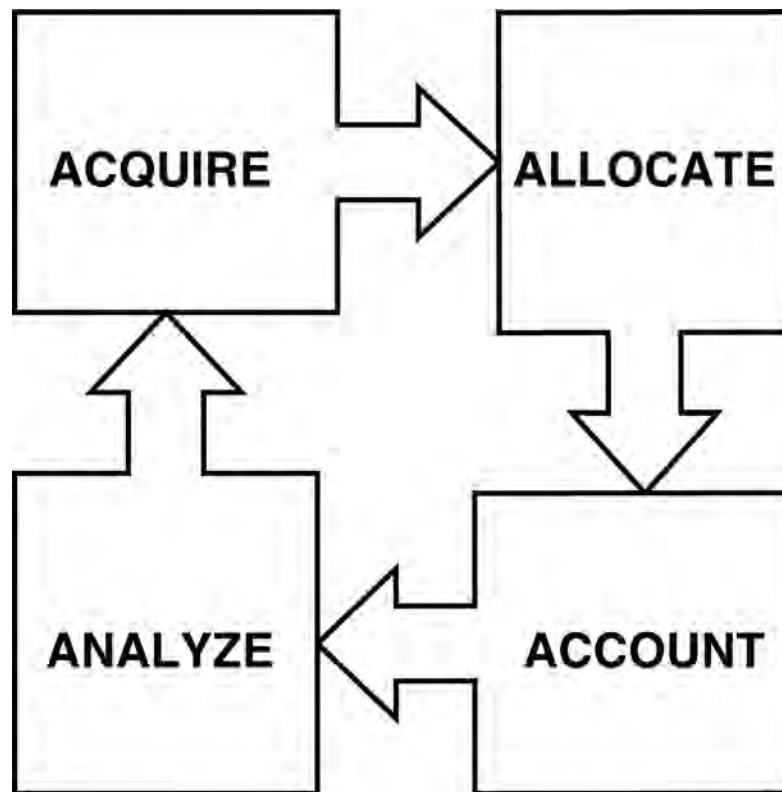

Figure 10-2. Resource Management's "4-A's"

## Section II Acquire Resources

### 10-6. Getting the fiscal resources for the Army to use

Described in detail in Chapter 9, the Army's Planning, Programming, Budgeting and Execution (PPBE) process provides the means by which the Army justifies and acquires its resources from Congress. After passage and signing into law of the authorization and appropriation acts, several interrelated functions are performed by OMB, the U.S. Treasury, OUSD(C) and OASA (FM&C) to acquire the Army's financial resources and distribute them to the field for execution. Figure 10-3 graphically portrays this process of getting resources to the Army.

*a. Apportionment requests.* Apportionment is a process for the administrative control of appropriations and funds. It is also a distribution of a specified "amount of obligation authority (OA)" in an appropriation/fund that is available for specified time periods (for example, fiscal quarter), activities, projects or a combination thereof as approved by the OMB. The amounts so apportioned limit the obligations that may be incurred by the Army. After Congress passes an appropriation bill and the President signs it into law, the OASA (FM&C) submits an apportionment of funds request through OUSD(C) to OMB. OMB reviews the request, adjusts the amounts as may be necessary based on their analysis of prior Army spending patterns, approves the request, and transmits the approved request back down through OUSD(C) to the OASA(FM&C). Within OASA (FM&C), the HQDA Funds Control Officer loads the approved apportioned amounts into the Program-Budget Accounting System (PBAS). PBAS is the official funds control management system of the DOD and is used throughout the Army financial management community to control the fund distribution process. Figure 10-3. Fund Distribution Process

*b. Program documents.* In addition to the approved apportionment mentioned above, OUSD(C) may issue further restrictions on using the OA provided in the apportionment document by withholding amounts for specific programs. These restrictions come to HQDA via an OA letter (for O&M, MILPERS, and AFHO appropriations), a DD Form 440 (for Procurement and RDTE appropriations), or a DD Form 460 (for the MILCON appropriations).

### 10-7. Treasury warrants

After the President signs the appropriations bill(s), the U.S. Treasury issues appropriations warrants to establish "bank accounts" on the books of the U.S. Treasury for each appropriation. The Treasury Warrant is a financial controlling mechanism and gives the Army the authority to disburse funds ("cut a check to pay for an obligation") from those accounts. Without this authority, the Army cannot make any payments citing the non-warranted appropriation.

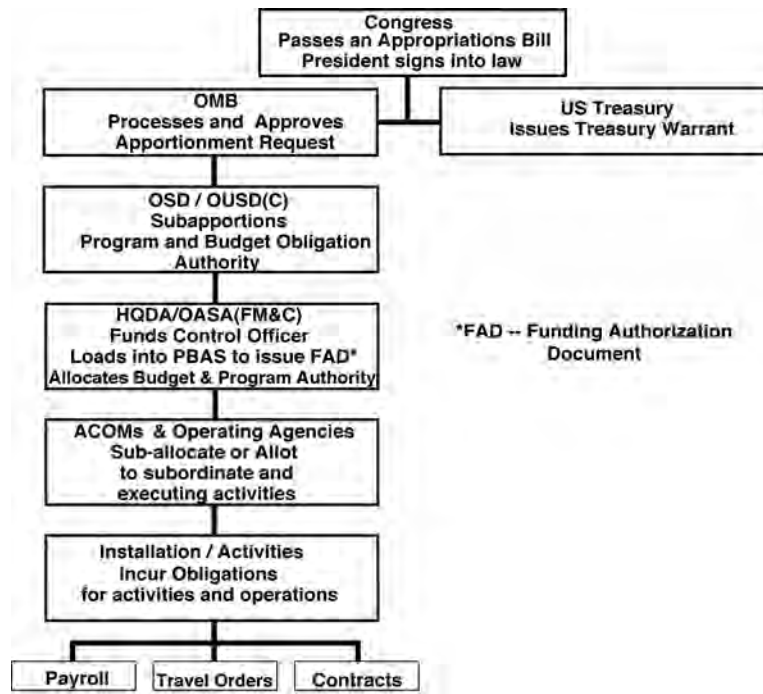

Figure 10–3. Fund Distribution Process

### Section III

#### Allocate Resources to the Field

#### 10–8. Fund distribution and control

“Pass funds through command channels and make the commander responsible for their control.” This is the basic tenet by which the Army’s funding distribution system operates. In this case the use of the term “funds” implies that the authority to create obligations, for which the U.S. Government has to pay, has been granted. Distribution of funds is any documented action that makes funds available for obligation. This distribution is made in a stated amount for specific purposes and to a specific organization for a specific time period. The commander’s authority to incur obligations is received on a funding document, which specifies the appropriation and budget program for which the funds may be used, and identifies applicable statutory limitations. This process is used to facilitate control over funds and the reporting of violations of laws (see below about *Anti-deficiency Act* (ADA) violations) and directives. Starting in FY03 however, the mission commander was no longer responsible for BASOPS funding. BASOPS funding was centrally controlled by the Installation Management Activity (a FOA of the OACSIM). And in 2006 IMA, the Community and Family Support Center, and the Army Environmental Center were consolidated under a single command, the Installation Management Command (IMCOM) a direct reporting unit to ACSIM. Today, IMCOM centrally controls BASOPS funding.

*a. The distribution procedure.* After obtaining OA from OMB and OUSD(C), HQDA directs major commands and other subordinate operating agencies to execute their approved budgeted programs (see Figure 10–3). Using the PBAS, the HQDA Funds Control Officer in the OASA (FM&C) allocates program authority and OA to ACOMs and operating agencies based upon guidance from the appropriation sponsors. Army commands and operating agencies in turn sub-allocate or allot to the appropriate subordinate organization (for example, installation, major unit, PM, and so forth) where the program will actually be executed by obligating for such things as payroll, travel orders, contracts, purchase orders, and so forth. Although this funds distribution system is a means of controlling obligations and fixing responsibility, the policy is to minimize the formal distribution and to fund an operation at the highest practical level. As an example, the MPA appropriation is held and controlled centrally at HQDA, whereas the Operations and Maintenance, Army (OMA) appropriation is decentralized through the Army Commands to the installations.

*b. Funding Guidance.* Along with program authority and BA moved out to Army activities through the PBAS, HQDA normally issues additional specific spending guidance at the beginning of the FY. The appropriation sponsors for OMA and Army Family Housing Operations (AFHO) issue annual funding letters to ACOMs with required or specialized fiscal guidance that is to be used in the execution of the budget for the FY. ACOMs and Operating

Agencies may also issue specific funding guidance to their subordinate commanders and activities for the execution of their programs and budgets. The Chief of the Army Reserve issues a funding guidance letter to subordinate Army Reserve activities for executing the Operations and Maintenance, Army Reserve (OMAR) appropriation and the Reserve Personnel, Army (RPA) appropriation. Likewise, the Director of the Army National Guard issues a funding guidance letter to subordinate Army Guard activities, principally the State adjutants general, for executing both the Operations and Maintenance, Army National Guard (OMNG) appropriation and the National Guard Personnel, Army (NGPA) appropriation.

#### **10–9. Fund Authorization Document (FAD)**

Using the PBAS, the HQDA Funds Control Officer issues Funding Authorization Documents (FADs) to allocate OA and program authority to ACOMs and operating agencies. The ACOMs and operating agencies in turn use PBAS to issue FADs to their subordinate activities (for example, installations) to allot OA and program authority. For the procurement and RDTE appropriations, an approved program document accompanies the FAD to provide further administrative limitations on the use of those funds.

#### **10–10. Fund allowance system**

Some ACOMs and operating agencies have implemented a fund allowance system whereby the lowest formal distribution of funds is at the ACOM/Operating Agency level with funding allowances being issued to subordinate installation commanders or activity heads. The advantages of this system are that it allows more flexibility in fund control and lessens the possibilities of reportable statutory violations. Commanders are still responsible for assuring the execution of their mission remains within the provided fund allowance and violations of that guidance may warrant administrative disciplinary action. Exceeding this funding allowance does not constitute a statutory violation but could cause an over-obligation or over-expenditure of the ACOM allotment provided on the Funding Authorization Document. Nevertheless, individuals responsible for exceeding their allowances will be named responsible for any resultant ADA violations (see paragraph 10–17).

#### **10–11. Delegation of funding authority**

Commanders to whom funds are made available may delegate authority to establish and maintain such administrative controls as may be necessary to comply with the provisions of Federal fiscal law and Department financial management regulations. This may be done keeping these key points in mind:

- a. Delegation of authority must be in writing. (Verbal or telephonic authorizations will not be recognized except in emergency circumstances [i.e. those jeopardizing health and/or safety of the command] and must be confirmed in writing as soon as possible).
- b. Authority may be delegated to a named individual or a position so long as the authority is vested in a readily identifiable person at all times.
- c. Delegation of authority does not relieve commanders of their fiscal responsibilities under the law.

#### **10–12. Special classified programs**

Classified programs, which are sensitive “need to know,” may be compartmentalized for security reasons. Specific funding distribution procedures have been created to accommodate the unique security requirements of such programs. Generally, the VCSA must approve the use of the procedures.

#### **10–13. Secretary of the Army Representation Funds**

Congress gives the SECARMY a specific level of authority to be utilized for emergency and extraordinary expenses from within the OMA appropriation. These authorities are identified under limitations entitled with the limit codes .0012, .0014, .0015, .0017, and .0019. They are described in AR 37–47, *Representation Funds of the Secretary of the Army*. The utilization of these authorities are very closely monitored and fall under audit responsibilities of the Army Audit Agency to ensure that funds used under these authorities are solely for the purposes intended and approved by the SECARMY. The rules for using the authorities are very specific and exceptions to deviate should be obtained from higher headquarters. A brief description of these authorities is provided below.

a. *Limitation .0012 (Miscellaneous Expenses, Category A)*. For official representation expenses, as authorized by the SECARMY, in connection with official functions at times of national holidays; dedication of facilities; visits of distinguished guests; purchase of floral wreaths, decorations, and awards upon occasions of national holidays and similar observances in foreign countries; and gifts and mementos by the authorized host, costing not more than \$200 each, used in connection with official ceremonies or functions. Commanders of ACOMs, their subordinate commanders, and installation commanders are authorized to present gifts or mementos in circumstances that they personally document as being a necessary part of the event or occasion being observed.

b. *Limitation .0014 (Miscellaneous Expenses, Category B)*. For miscellaneous expenses, other than for official representation, not provided for in other appropriations. Examples of these expenses are awards for emergency rescues, witness fees for the Armed Services Board of Contract Appeals, and settlement of meritorious claims.

## How the Army Runs

*c. Limitation .0015 (Criminal Investigation Activities, AR 195–4).* For emergency and extraordinary expenses in support of the worldwide expenses of the U.S. Army Criminal Investigation Command’s activities.

*d. Limitation .0017 (Intelligence Contingency Funds, AR 381–141).* For expenses related to worldwide intelligence activities.

*e. Limitation .0019 (Compartmented Special Operations, SECARMY Letter of Instruction (proponent ODCS, G–357)).* For emergency and extraordinary expenses related to worldwide-compartmented operations.

### Section IV

#### Account for the Use of the Resources

##### 10–14. Legally using the resources to accomplish the mission

This section gives a brief overview of the controlling principles used in accounting for the use of fiscal resources. Title 31, United States Code, Section 1301(a) states that “Appropriations shall be applied only to the objects for which the appropriations were made except as otherwise provided by law.” Congress initially enacted this statutory control in March 1809. The act, generally referred to as the “Purpose Statute,” was passed as a part of a reorganization of the War, Navy and Treasury Departments to limit the discretion of the executive branch in spending appropriations. Thus it becomes abundantly evident that the Congress, for close to two hundred years, has taken a keen interest in how the Army spends the funds that have been appropriated to it. To preclude the misappropriation/misspending of funds, a body of laws, regulations, court decisions and rules has evolved over many years to direct how fiscal resources will be used to accomplish the Army’s missions and tasks. Because Congress provides funds in specific amounts for specific purposes through the enactment of public law, the expenditure of those funds must be within the boundaries established by the law. The term “administrative control of funds,” as required by law is used to identify those actions, events, or systems that are required to ensure essentially three things:

- Funds are used only for the purposes for which they were intended.
- Amounts of funds in excess of that available, are neither obligated, neither disbursed nor further distributed.
- The agency head is capable of fixing responsibility in the event of violations of either of the first two.

##### 10–15. Availability of appropriations for obligations

Congress determines how long an appropriation or fund may be used, that is, new obligations may be made against the specified appropriation or fund. Most appropriations used by the Army have a limited time period for which new obligations can be made against them. Note: In the past Congress has made exceptions to the normal periods of availability of appropriations such as making two year or “X” year O&M appropriations, three year RDTE appropriations, and so forth, as well as continuing with the “normal” periods of availability.

*a. Annual appropriations.* These appropriations, generally having a one-year period of availability to be obligated, include:

(1) Operation and maintenance appropriations like OMA; OM Army National Guard (OMNG); OM Army Reserve (OMAR); and Army Family Housing Operations (AFHO).

(2) Military personnel appropriations like MPA, NGPA and RPA.

*b. Multi-year appropriations.* These appropriations having a multi-year period of availability include:

(1) The RDT&E,A appropriation is available for two years.

(2) Procurement appropriations (Aircraft Procurement, Army; Missile Procurement, Army; Procurement of Weapons and Tracked Combat Vehicles (WTCV), Army; Procurement of Ammunition, Army; and Other Procurement, Army (OPA)) are available for three years.

(3) MCA; MC National Guard (MCNG); MC Army Reserve (MCAR); and Army Family Housing Construction (AFHC) are available for five years.

*c. “No-year” appropriations.* These appropriations and funds have an unlimited period of availability. Examples include the appropriation for Base Realignment and Closure (BRAC) and the Army Working Capital Fund (AWCF).

*d. Expired appropriations.* Once an appropriation’s period of availability is over for incurring new obligations, it is considered “expired.” For five years after an appropriation expires (i.e.no new obligations can be incurred) both obligated and un-obligated balances of that appropriation shall be available for adjusting and liquidating (that is, disbursing against a previously incurred obligation) obligations properly charged to the account. As an example, the FY 10 Operations and Maintenance, Army (OMA) appropriation has a period of availability for obligation from 1 October 2009 through 30 September 2010. The appropriation has a five-year expiration period from 1 October 2010 through 30 September 2015.

*e. Canceled appropriations.* After the fifth year of expiration an appropriation is canceled on the books of the U.S. Treasury. The appropriation is no longer available for any purpose, for example, accounting adjustments. Obligated and un-obligated balances are canceled. Using the FY 10 OMA example above, it would cancel on 30 September 2015. Note: If an obligation adjustment, such as a final settlement to a disputed contract, has to be made from what is now a canceled appropriation, then the payment is made out of the activity’s current year appropriation subject to several

limitations such as total amounts of such transactions cannot exceed 1% of the current appropriation and cannot exceed the un-liquidated balance of the initial, now cancelled, appropriation.

### 10–16. Properly obligating the resources

An obligation is the action taken to establish a liability against the U.S. Government that will ultimately result in a disbursement from the U.S. Treasury. There are several principles that must be followed in executing and accounting for obligations. The foundations for these principles are contained in Title 31 Money and Finance of the United States Code. While only the most important “obligating” principles are outlined here, the entire listing is provided in the DOD Financial Management Regulation 7000.14–R or in DFAS–IN Regulation 37–1 (Finance and Accounting Policy Implementation).

*a. Bona fide need of the current FY.* A determination must be made that supplies or services required pursuant to contracts entered into or orders placed obligating an annual appropriation are intended to fill a bona fide need of the current FY. There are provisions when lead-time is an important factor to obligate funds in the current year for a subsequent year delivery.

*b. Intent of performance.* Contracts entered into or placed for supplies or services are executed only if there is a bona fide intent on the part of the contractor (or other performing activity) to commence work promptly or to perform the contract in accordance with its terms and conditions (to include beginning date).

*c. Assure availability.* The responsible official must ensure that proper funds are available before binding the U.S. Government in an agreement with a second party, which will result in an obligation for which the Government is required to pay.

*d. Documentary evidence.* Each obligation recorded in the official record must be supported by proper documentary evidence. These may be originals, duplicates, or copies of appropriate documents so long as signatures are visible. A memorandum of telephone conversation or an electronically received written message may be used temporarily until the actual document is received.

*e. Charge immediately.* Obligations, when incurred, must be charged immediately to the applicable account. The recording of obligations incurred cannot be deferred until additional funds are received. The obligation must be recorded even if there are insufficient funds to cover it, thereby incurring a statutory violation, which must then be reported through command channels. Failure to record an obligation will not obviate a suspected violation of the ADA statute.

*f. Prompt adjustment.* Any adjustment to previously recorded obligations, either as an increase or decrease, must be entered in the accounts as soon as the necessity for an adjustment is evident and the amount can be determined.

### 10–17. The Anti-deficiency Act (ADA)

Chapters 13 and 15 of United States Code Title 31 contain prohibitions with respect to the legal use of funds and establish punitive provisions in the event there are violations. When the ADA was codified into the United States Code, its provisions were incorporated into a number of sections of Title 31. The sections that are most frequently cited are sections 1341, 1342, and 1517.

*a. How Anti-deficiency Act violations occur.* Generally, ADA violations may occur when:

- (1) Funding authority is issued in excess of the amount available and the excess amount is obligated or expended.
- (2) There are violations of the special and recurring statutory limitations or restrictions on the amounts for which an appropriation or fund may be used.
- (3) There are violations of statutory or regulatory limitations on the purposes for which an appropriation or fund may be used.
- (4) Obligations are authorized or incurred in advance of funds being available.
- (5) Obligations or expenditures of funds do not provide for a bona fide need of the period of availability of the fund or account and corrective funding is not available.

*b. Administrative and criminal penalties for ADA violations.* The person who caused the violation may be subject to discipline, to include suspension without pay or removal from office (31 USC 1349 and 1518). The Army’s implementation procedures of these statutes are contained in DFAS–IN Regulation 37–1(Finance and Accounting Policy Implementation). If an action is taken knowingly and willfully and results in a conviction for violating the ADA, the person may be fined up to \$5000, imprisoned for not more than two years, or both (31 USC 1350 and 1519).

### 10–18. Accounting for the obligation

*a. Legal mandate to account for funds.* By law the DOD is required to maintain accounting systems that provide:

- (1) Complete disclosure of the financial results of the Department’s activities.
- (2) Adequate financial information the Department needs for management purposes.
- (3) Effective control over, and accountability for, assets for which the Department is responsible.
- (4) Reliable accounting results that will be the basis for:
  - (a) Preparing and supporting the Department’s budget requests.
  - (b) Controlling the Department’s budget execution.



## How the Army Runs

(c) Providing financial information the President requires.

(d) Suitable integration of the Department's accounting with the central accounting and reporting responsibilities of the Secretary of the Treasury.

*b. Defense Finance and Accounting Service (DFAS).* As can be surmised, if the DOD is required to account for the ways it spends its funds, so too does the Army have to account in the same way for how it uses its funds. Most of the financial management accounting required by the Army is performed by DFAS. This organization was established in January 1991 to reduce the cost and improve the overall quality of DOD financial management through consolidation, standardization and integration of finance and accounting operations, procedures and systems. DFAS took over responsibility for five finance and accounting centers and 338 installation finance and accounting offices that belonged to the military services and Defense agencies. Through its mandated consolidation efforts, DFAS now consists of a headquarters located in Washington, D.C., five centralized sites located in Indianapolis (formerly the U.S. Army Finance and Accounting Center), Cleveland, Columbus, Denver, Kansas City, and 20 field sites or operating locations (OPLOCs). Personnel staffing levels were reduced from 31,000 in 1992 to the current level of 18,000. Since 1991 DFAS has consolidated and standardized 324 finance and accounting systems down to 109 systems in 1998. In the future DFAS expects to reduce down to 32 systems.

*c. Accounting systems used by the Army.* The Army and its subordinate activities use a number of the remaining accounting systems operated by DFAS. The principal system used is the Standard Finance System (STANFINS). This system performs the accounting for the majority of Army installations. It records funding authorization, accumulates and reports on obligations and disbursements against fund authorizations for control purposes, and provides standardized accounting reports for the installation, ACOM, and HQDA financial managers. STANFINS serves as the Army's primary formal record of account at the installation level for installation-level appropriation accounting. Other accounting systems are used by the Research, Development and Acquisition activities, the U.S. Army Corps of Engineers, and the Army National Guard. However, see para 10-40 General Fund Enterprise Business System (GFEBS) for an overview of GFEBS. GFEBS implementation is underway replacing STANFINS as Army's primary accounting system.

### 10-19. The Army management structure (AMS)

The AMS provides a resource management language and coding structure that is based on congressional appropriations. It relates program dollars and manpower to a standard classification of activities and functions required and used by Congress as they deliberate on Army programs and budget requests. AMS codes (AMSCO) help record data in the detail needed for budgeting, execution, and accounting. Army activities use the AMS to record obligations and disbursements in the requisite accounting system. The details for constructing the accounting and classification codes for all funds received by the Army are contained in DFAS-IN Manual 37-100-xx, where the "xx" indicates the last two digits of the FY. For instance the AMS for FY 2011 would be outlined in DFAS-IN Manual 37-100-11. Using the AMS coding structure assists Army activities to fulfill Federal accounting requirements. A simple illustration translating an accounting classification code (as one could see on a purchase request, a set of TDY orders, and so forth) would be the following accounting fund cite on a supply purchase transaction at Fort Sill: 21 2 2020 57-3106 325796. BD 26FB QSUP CA200 GRE12344019003 AB22 WORNA S34031.

**Table 10-1**  
**Translating an accounting code**

Code	Data Element	Translation
21	Treasury Symbol:	
	Department Code	Department of the Army
2	Period Availability	FY 2002
2020	Basic Symbol	OMA Appropriation
57	Operating Agency	TRADOC
3106	Allotment Serial Number	(a locally assigned code)
325796.BD	AMS Code (AMSCO) or Project Account	Base Operations (-), Director of Logistics
26FB	Element of Resource	Supplies - Army Managed / DWCF item
QSUP	Management Decision Package (MDEP)	Installation Supply Operations
CA200	Functional Cost Account	Commercial Activities - contract furnished supplies
GRE1234019003	Standard Document Number	(a locally assigned code)
AB22	Account Processing Code	(a locally assigned code)
WORNA	Unit Identification Code (UIC)	Fort Sill Garrison
S34030	Fiscal Station Number	DFAS OPLOC, Lawton, OK

**10-20. Year end certification of accounts**

Since DFAS was established, the subordinate Defense Accounting Office (DAO) has had the responsibility for preparing and monitoring “accounting reports” at the installation. Commanders who receive FADs authorizing them to incur obligations not in excess of certain amounts and for specific purposes have a legal requirement to “certify the status” of those funds as of 30 September, that is, the end of FY. Commanders may delegate the authority to certify FY-end reports to the Deputy Commander, Chief of Staff, Garrison Commander, or Director of Resource Management.

*a.* The DAO will make the certification on the “accounting reports” substantially as follows: “I hereby certify that the attached reports and associated schedules include all transactions received which have been properly recorded and are supported by subsidiary accounting records.”

*b.* The DAO will forward the certification to the Commander or a designated representative, who, in turn, will make the following certification: “I hereby certify that the attached reports and schedules include all known transactions. Those meeting the criteria of 31 USC 1501(A) have been obligated and are so reported. All reports and schedules for all transactions for the fiscal year ended September 30, \_\_\_\_, are correct and are supported by subsidiary accounting records. All individual upward obligation and open allotment disbursement adjustments in excess of \$100,000 of expired appropriations have been properly approved and are on file for audit purposes.”

*c.* Certifications are required for all appropriations and for any reimbursable activity performed by the command or agency. The ASA (FM&C) certifies all Army appropriations to the U.S. Treasury.

**Section V****Analyze the Use of Resources****10-21. 1981 - A change in responsibilities**

The Army Chief of Staff renamed the Army’s PPBS in 1981, adding “Execution” to the process title - PPBES. This constituted a marked change from the prior decentralized concept in which PPBS execution responsibility was transferred to the field commanders. The CSA charged Army leaders with the responsibility to evaluate or analyze and report on the effectiveness of program and budget accomplishment. These evaluations and reports relate funds and personnel inputs in output terms to the Army’s Title 10 responsibilities. (Note: In 2003 DOD, the military departments, and agencies renamed their resource management processes to the Planning, Programming, Budgeting, and Execution (PPBE) process.)

**10-22. Execution reviews**

Using the information presented by the accounting systems and other data feeder systems, functional, programmatic and fiscal managers along with commanders track the course of program and budget execution in their organization or functional area. Inherent in this analysis is the need to judge program performance and effectiveness, to consider the need for more resources to accomplish the specified program, and finally to consider reallocation of resources to higher priority missions and programs. This process takes place at all of the resourcing echelons of the Army.

**10-23. HQDA Quarterly Reviews**

The Army conducts quarterly reviews of program performance and fiscal execution focusing on strategic priorities and performance metrics. The Office of the Assistant Secretary of the Army for Financial Management and Comptroller is responsible for the conduct of the quarterly reviews.

**10-24. Shifting resources**

During the course of analyzing the execution of resources, there often arises the need to shift resources outside the boundaries of programs for which Congress authorized and appropriated funds (APF) (see para 14-2a). Examples of such real life events may be an emerging contingency operation, storm damage to an installation, increasing cost of installation utilities, accelerating the procurement of an item to achieve an economic savings, new bills resulting from a newly assigned mission, and so forth. The congressional committees concerned with DOD’s operations have generally accepted the view that rigid adherence to the amounts justified for budget activities, appropriations, or for subsidiary items or purposes may unduly jeopardize the effective accomplishment of planned programs in a businesslike and economical manner.

*a.* Reprogramming procedures have been worked out with the congressional committees (House and Senate Appropriations and Authorization Committees (and for intelligence related items, the House and Senate Select Intelligence Committees)) to accommodate different degrees of interest in the reprogramming of funds; that is, certain reprogramming requires prior approval by the appropriate committees of Congress, while others require advance notification, and still others are provided notice after the fact. Reprogramming reapplies funds from one project to another within the same appropriation or transfers funds from one appropriation to another to resolve financial shortfalls or to adjust programs to meet unforeseen requirements. The process is subject to designated dollar thresholds and congressional requirements for advance approval or notification. No transfers (shifts between appropriations) are allowed without prior consent of Congress and must be requested in writing by the submission of the Congressional Reprogramming Request (DD 1415).

## How the Army Runs

b. Other flexibility is obtained through additional laws, committee reports, or by requesting supplemental appropriations. The OASA (FM&C) manages the reprogramming process for Army appropriations.

### 10–25. Analyzing the “accounting books”- Joint Reconciliation Program

The Joint Reconciliation Program is an effort combining the skills and expertise of accountants, budget and program analysts, contracting professionals, logisticians, internal review auditors, and DFAS personnel for the purpose of verifying the validity of un-liquidated obligations, contractor work in progress, billing status, and validating the continued need for goods and services that have not yet been delivered. The reconciliation must be performed by all commands and, when performed properly, will result in real dollar savings through the identification and cancellation of nonessential goods and services, reconciliation of current appropriations to ensure the correctness of amounts obligated, and liquidation of appropriations expiring at the end of the FY.

a. The primary objectives of the Joint Reconciliation Program are to “harvest” OA by:

- (1) De-obligating funds supporting invalid obligations.
- (2) Eliminating the use of current funds to pay liabilities arising from appropriations that expired.
- (3) Reconciling and liquidating delinquent travel advances.
- (4) Eliminating and avoiding unmatched disbursements (UMD).
- (5) Eliminating and avoiding negative un-liquidated obligations (NULO).

b. As a result of performing effective joint reconciliation, commands increase their purchasing power which directly enhances mission accomplishment. Purchasing power is increased in that:

- (1) Canceled account liabilities are reduced.
- (2) Current OA is harvested for reutilization.
- (3) Erroneous payments and over payments are identified and eliminated.
- (4) Visibility over contractor work in process (WIP) and contract in process (CIP) is increased.
- (5) Delinquent travel advances are eliminated.

c. Additionally, joint reconciliation increases the Army’s stewardship credibility with Congress. The integrity and accuracy of financial records has improved and the cycle time for processing financial transactions has been reduced. History has proven that using a thorough and intense joint reconciliation program is an excellent investment of time and resources and adds value to financial management, logistics, and procurement activities.

## Section VI

### Improving Management and Business Practices in the Army

#### 10–26. Efforts to improve Army management

Over the last ten years, major legislative and Army management initiatives have introduced an unprecedented focus on performance and results. These initiatives all point to the transition to more outcome-oriented program management and performance budgeting.

#### 10–27. Federal Manager’s Financial Integrity Act (FMFIA) of 1982

a. This act requires all Federal agencies to establish and maintain effective accounting and administrative controls to provide “reasonable assurance” that:

- (1) Obligations and costs are in compliance with applicable laws.
- (2) Funds, property, and other assets are safeguarded against waste, loss, unauthorized use or misappropriation.
- (3) Revenues and expenditures are properly recorded and accounted for.

b. The Act also requires agency heads to submit an annual statement to the President and the Congress indicating whether agency management controls are reasonable and, where they are not, material weaknesses are identified and corrective actions are taken.

#### 10–28. Chief Financial Officers (CFO) Act of 1990

a. The *CFO Act* was enacted to implement more effective financial management practices in the Federal Government. Its key purpose is to provide more accurate, timely, and reliable financial information for decision-makers through improved accounting systems, integrated functional and financial management, and strengthened internal controls. The law also establishes initial requirements for the “systematic measurement of performance” by shifting the management focus from resource acquisition to resource execution-not in terms of obligation and outlay rates, but in how well taxpayer dollars are spent.

b. A major provision of the Act mandated the preparation of audited annual financial statements for revolving funds, trust funds, and substantially commercial activities. The law designated ten Federal agencies- including the DA-as pilots for comprehensive, agency-wide financial statements covering all operations and activities. As the first DOD pilot under the *CFO Act*, the Army broke new ground in a number of important areas-for example, physical inventory policy, valuation of assets, interface between military pay and personnel systems, the incorporation of outcome-oriented program performance measures in financial reports, and the restructuring of the management control process. The U. S.

Government Accountability Office (GAO) and congressional committees have acknowledged Army efforts and improvements. However, the Army cannot by itself achieve full compliance with the standards of the *CFO Act*. The resolution of long-term problems with financial systems is a DOD-wide effort and there must be government-wide accounting principles and standards to support both management decision-making and public accountability.

### **10–29. Government Management Reform Act (GMRA) of 1994**

*a.* GMRA implements the requirements for audited annual financial statements “covering all accounts and associated activities of each office, bureau, and activity of the agency” for all Federal agencies. Beginning in 1998, and annually thereafter, the Secretary of the Treasury, in coordination with the Director of the OMB, is required to submit to the President and Congress government-wide audited financial statements that cover all accounts and associated activities of the executive branch of the Federal Government. With the end of the *CFO Act* pilot project and full implementation of reporting under the *Act*, the Army continues working to implement the letter and the spirit of the legislation and to improve all aspects of Army financial management and stewardship.

*b.* The most recent financial report for the U.S. Government can be viewed online at <http://www.gao.gov/financial.html>

*c.* The most recent financial statement for the Army can be viewed online at <http://comptroller.defense.gov/cfs/index.html>

### **10–30. Government Performance and Results Act (GPRA) of 1993.**

*a.* GPRA is major management reform legislation and a critical step in the inevitable transition to more outcome-oriented program management and performance budgeting. As noted above, the *CFO Act* intended to integrate financial and functional systems to provide better information for decision makers and shift management focus to how well taxpayer dollars are spent. Although implementation of the *CFO Act* and audited financial statements have led to significant improvements in financial reporting, the law itself provided only limited guidance with regard to its provisions for “the systematic measurement of performance”.

*b.* The GPRA builds on the *CFO Act* and establishes the framework for full integration of financial and functional data in all phases of the resourcing cycle. GPRA was implemented to improve government-wide programs by linking resource expenditures to results achieved. OSD has implemented GPRA by establishing corporate and annual performance goals, and linking specific performance measures to each goal. The most recently completed Quadrennial Defense Review (QDR) serves as DOD’s strategic plan in accordance with the GPRA requirements.

*c.* The purpose of the GPRA is to increase public confidence in the Federal Government and improve program effectiveness and public accountability by systematically holding agencies accountable for achieving program results. The law also is intended to improve congressional decision-making by providing more objective information on the relative effectiveness and efficiency of Federal programs and spending. *d.* FY 2010 DOD financial and performance reporting consisted of three components: Agency Financial Report (AFR) published November 15, 2010, Annual Performance Report (APR) to be published no later than 31 March, and Summary of Performance and Financial Information published February 15, 2011. The AFR contains the Management’s Discussion and Analysis that provides executive-level information on the Department’s history, mission, organization, key performance activities, analysis of the financial statements, controls and legal compliance and other challenges facing the Department. The APR is included in the Congressional Budget Justification and provides the detailed performance information and description of results by performance measures. The Summary of Performance and Financial Information, formerly the DOD Citizen’s Report, summarizes the Department’s financial and performance information from the Agency Financial Report (AFR) and the Annual Performance Report (APR), making the information more transparent and accessible to Congress, the public, and other key constituents. All three reports are available at the DOD Comptroller’s website: [www.defenselink.mil/comptroller/reports.html](http://www.defenselink.mil/comptroller/reports.html).

*d.* Through its PPBE process the Army reviews and monitors its strategic plans and mission objectives. The PPBE process supports the Army’s implementation of the GPRA by using:

(1) Army Strategic Planning Guidance (ASPG) that promulgates Army goals, strategies, objectives and the required capabilities to achieve them.

(2) Army Planning Priorities Guidance (APPG) that leads to the preparation of capabilities-based action plans and, where needed, the prioritized allocation of resources to carry them out.

(3) Army Program Guidance Memorandum (APGM) that links operational tasks and their associated resources to the Secretary of the Army United States Code Title 10 functional responsibilities.

(4) Army Campaign Plan (ACP) that establishes eight campaign objectives incorporating Army transformation into the context of ongoing strategic commitments.

*e.* The Army POM/BES that results from the PPBE integrated programming and budgeting phase allows the Army to balance program and budget resources based upon more definitive resource objectives. Management Decision Packages (MDEPs), the building blocks of the Army program, are linked to objectives, sub-objectives, and prioritized resource tasks. Program resources that govern levels of accomplishment are adjusted according to affordability.

## How the Army Runs

f. Appropriations approved by Congress in the budget phase are applied in the execution phase. Execution of programs is constantly monitored to insure congressional and other legally mandated requirements are met.

### 10-31. Federal Financial Management Improvement Act (FFMIA) of 1996

This law builds upon and compliments the acts discussed above. It requires auditors to report as part of their report on agencies' annual financial statements whether the agencies' financial management systems comply substantially with three requirements: (1) Federal financial management systems requirements; (2) applicable Federal accounting standards; and (3) the U.S. Government Standard General Ledger at the transaction level. These requirements are critical for ensuring that agency financial management activities are consistently and accurately recorded, and timely and uniformly reported throughout the Federal Government.

### 10-32. Management controls

a. Management controls are the procedures we establish to ensure that we accomplish our objectives and guard Army resources against fraud, waste, and abuse. Numerous audit and inspection reports, however, continue to find serious management control deficiencies in DOD and the Army. This damages our reputation as stewards of public resources and hinders our ability to compete effectively in Congress for additional resources. Congress has made clear that their emphasis on management controls will continue.

b. Army Regulation 11-2, *Management Control*, establishes policies and guidelines for implementing the provisions of the *Federal Financial Management Improvement Act*. It describes the Army's current management control process which was restructured effective in FY 95 to reduce the administrative burden, to provide commanders and managers with greater flexibility in scheduling and conducting their evaluations, and to make them directly accountable for the effectiveness of their management controls. The restructured process requires management control evaluations only for the most critical controls (the "key management controls") and encourages commanders and managers to use existing review and oversight processes wherever possible to accomplish evaluations.

### 10-33. Improving business practices

a. An essential element of Resource Management is the process of reviewing, revising and reengineering the business practices of the Army to increase revenues, reduce costs, and leverage Army assets. Several tools have been developed to assist in furthering business practices improvements:

(1) The Business Practices Initiatives focus on Army operations to avoid or reduce costs, generate and collect revenues, leverage assets, streamline and consolidate functions, form partnerships, and use the latest technology to help the Army better utilize scarce resources.

(2) The development of initiatives under the focused leadership of the Army Business Initiatives Council is intended to support transformation of the business sides of the Department of the Army, resulting in a more efficient and effective business environment from which the total Army is supported.

(3) The Legislative Program expedites processing of viable, high payoff, reengineering legislative proposals through OSD, OMB, and Congress.

(4) The Non-appropriated Fund (NAF) Financial Oversight prepares policy guidance and conducts reviews of NAF finances and encourages NAF activities to operate more like a business.

(5) The Waiver Program facilitates preparation, coordination, and submission of waiver requests to gain exceptions to certain policies or regulations on a case-by-case basis to improve processes.

b. The Army is implementing new and improved business practices to bridge the gap between Army resources and Army requirements. Many private sector business practices "make sense" for the DOD and can potentially be applied to optimize the use of Army resources. The overall objective is to stretch available resources by generating revenues, reducing costs, leveraging assets, and improving the delivery of service.

c. A major example of the successful use of business practices to bridge the gap between Army resources and requirements is in the area of real property assets (land and facilities). Historically, the Army relied primarily upon APFs (MILCON Funds) to build, modify, and upgrade Army facilities. The Army also relied upon APFs (Operating Funds) to maintain and repair the real property assets. The lack of sufficient funds allows construction of only the most critical facilities and causes a backlog of maintenance and repair that ultimately reduces the useful life of Army assets. As the size of the Army was reduced during the 1990's, the Army began to dispose of real property assets that were underutilized and no longer needed. There is a significant cost associated with maintaining assets, even when the assets are maintained at a minimal level. This disposal effort is continuing. However, a problem surfaces when facilities are needed, but there are insufficient APFs to construct, modify, or maintain them.

d. To address this problem, the Army began using a new private sector tool - public private ventures (PPV's). PPV's can take many forms - the Residential Communities Initiative (RCI) Program; Armament Retooling and Manufacturing Support Program (ARMS); leasing initiatives that use Title 10, Section 2267 authority; Morale, Welfare, and Recreation (MWR) Program initiatives; utilities privatization; and energy saving projects. What is unique about PPV's is (1) they involve a significant contribution of private capital and expertise to meet Army resource needs; and (2) the private sector requirements for successful business ventures must also be met. With the PPV approach, the Army is not buying

a specified product in the traditional sense. The Army is selecting a private sector “partner” to work jointly on a solution that will line up both with Army requirements and those for commercial success.

*e.* The past several years have witnessed a quantum leap forward in the planned use of PPV’s as a tool to bridge the gap between Army resources and requirements for real property assets. The Congress has repeatedly shown its general support for using this tool by passing very significant enabling legislation in areas such as housing privatization, utilities privatization, energy savings, and enhanced lease authority. These PPV efforts will have a prominent role in the way the Army manages its real property assets in the future. We will succeed if we (1) use PPV’s as part of a sound strategic plan; (2) adequately weigh the long-term implications of our actions; and (3) realize that PPV’s make new and different demands on program and financial managers.

*f.* The Army also is wrestling with similar resource management issues for activities supported by NAF. Base closures, troop realignments, and declining APF support create a challenging environment for NAF. Policy decisions for NAF must take into account a resource management strategy that considers the interrelationship between APFs and NAF. Coordination between the NAF and APF communities is essential to ensure appropriate execution of both the appropriated and NAF programs. For example, a facility built as a NAF major construction project may be authorized APFs for maintenance and repair support. In such instances, a one-time NAF expenditure could result in a significant and continuing APF operating expense. Conversely, reduction of APF support for NAF activities can force dramatic changes in the level of quality-of-life programs available to soldiers and their families.

*g.* Enabling and encouraging improved operating efficiency, better use of information, implementation of private sector practices, and enhanced utilization of Army resources through asset leveraging is essential to maximizing the use of The Army’s scarce resources. Improving business and operating practices is not only complementary to financial reform, but is in the spirit of reinventing government and the “battle on bureaucracy”, and is absolutely necessary to fully support Army transformation to meet future challenges.

#### **10–34. Cost management (CM)**

*a.* Cost management (CM) must play a critical role in support of decision-making. Managers at all levels fight a war every day in resourcing and operating today’s Army. It is a cost war. We are drawn into it and forced to fight it in order to maintain the maximum number of well-trained and properly equipped forces possible. In the cost war, we do not lose forces to an enemy on a conventional battlefield, but to the constant reduction of dollars available to resource the force. This is an unfamiliar war, fought on an unfamiliar battleground by commanders and leaders generally new to the weapons needed to win. CM, focused on the activities necessary to produce the products or services required for mission success, is the most important war-fighting “doctrine” available for employment. Given full understanding of the potential of CM and complete knowledge and use of its working parts, the cost war can be won.

*b.* The Army has chosen to implement Activity Based Costing (ABC) as a tool to assist the local manager in maximizing scarce resources and as a means of continuous process improvement. The Army Implementation Plan mandates CM/ABC implementation in the Army’s eleven support business areas. These business areas are Acquisition, Base Operations, Civilian Human Resources (CHR) (see Chapter 14), Contracting, Depot Maintenance, Information Support, Institutional Training, Ordnance, R&D Laboratories, Supply Management, and Test & Evaluation.

#### **10–35. Cost modeling**

CM/ABC focuses managerial skills and action at all levels on the results of a cost modeling process that presents useful, accurate cost data based on the activity (a product or service) that the manager wishes to accomplish. Traditional cost accounting systems and processes in DOD do not provide the same focus. Instead, they focus cost models on *bags* of money that are available to accomplish grossly defined categories of expenditures. Amounts of money are allocated to the bag by passing down a limit or budget, then managers at all levels use up the money until someone tells them that the budget is exhausted. This is and has been the conventional way of operating. In fact, using up the entire budget allocated down to low levels in the organization has generally been viewed as a good thing. The budget has come to be thought of as an entitlement to spend. This is far from a desirable way to operate at a functional level. The objective should be to use as little money as possible to achieve a defined level of quality and thereby have as much money as possible available to allocate to other command priorities. These available funds must be identified early in the FY to enable execution of other priority missions.

#### **10–36. Planning**

*a.* Managers at all levels should accurately plan their future resourcing needs just as tactical commanders plan combat engagements in order to win the next battle and the overall campaign. Relative CM/ABC success should be measured based on how much and how often that manager can reduce the resourcing need over time while accomplishing the required tasks to an acceptable level of quality. Resources saved in the production of one product or service is then available to commanders to redirect to high priority tasks otherwise destined to be unfunded. The CM/ABC process, focused on important activities, in conjunction with other leadership tools, provides the manager the information needed to know how much something needed really costs and provides a structure to do something about the unit cost of producing it.

*b.* Integration of CM/ABC practices into the twenty-first century Army is designed to enhance decision making at

## How the Army Runs

all levels. This requires a cultural change within the Army, recognizing that CM/ABC is a necessary discipline for all managers and decision makers both military and civilian. Effective CM/ABC practices will assist us in understanding the true costs of producing goods and services, improving operations, and linking execution to Army strategies. CM/ABC fully supports continuous improvement to achieve the most efficient organization. Therefore it is useful in streamlining cost competition (Competitive Sourcing), productivity and performance programs, and perhaps most of all, decision making by local managers. Executing CM/ABC doctrine controls costs and improves efficiency and effectiveness.

*c.* The support business areas will continue to be vital to the mission of the Army. CM/ABC is the Army's tool to maximize the effectiveness of existing fiscal resources. Aggressive, proactive management of existing resources is the best way to provide resources for higher priority mission needs such as improved mission support services, quality of life, and force retention.

*d.* Successful implementation of CM/ABC combines strong leadership support, a cycle of commitment and performance review, employee empowerment, and motivational incentives. With Army leadership serving as strong advocates, the CM/ABC culture establishes goals and encourages participative behavior to achieve improved performance.

### 10-37. Building an ABC model

*a.* An ABC model is needed because the traditional cost accounting system used by the DOD does not allow the assignment of all relevant costs to a product or service (activity). For example, a commander should know the total cost of activities under his control (e.g. the cost of overhauling a tactical vehicle, or training a soldier in a new MOS, or renovating a set of family quarters). More importantly, the manager that has the power to influence costs must know and understand them. By analyzing them and the process that produces them, the effective manager is prompted to discover numerous changes that will affect costs. The manager should expect subordinates to understand, explain, and improve cost performance. Unfortunately, a process of collecting and allocating costs that contribute to the creation of a product or service is not readily available. An ABC model needs to be built based on the real way the production mechanism functions in each business area and location. Building a specific model is a time consuming but necessary function to be able to deal with real data vice a template model, provided by others, that can produce only theoretical or standard costs. The creation and regular updating of a specific model is often viewed as too much work and therefore not attempted. The loser is the manager faced with more requirements than assets to get them done.

*b.* A process to build a model has to be used to capture and allocate costs. A useful model is built by allowing the people who do the work to build their model using a simple question and answer walk-through of what they do each day in performing their mission. All relevant costs are then allocated to the product or service that the tasks produce. No salary or other relevant expense can be left out. Managerial tasks commonly referred to as overhead and other costs have to be accounted for. On the other hand, precision, carried to an extreme, can overly complicate the process and diminish usefulness of the results. This outcome has been observed in many initial attempts at creating a useful cost model. Together, CM and the ABC model give the manager a structure to be as cost effective as possible.

*c.* A concrete example of the CM/ABC process at work: During the FY's first quarter CM performance review, the first-line manager in the vehicle maintenance shop presented his second quarter spending plan. During previous reviews under similar circumstances, he stated he would need many hours of overtime in the second quarter to immediately repair vehicles returning from an extended deployment. Instead for this review, because of his understanding and use of cost management and the cost model that represents what he does, he has become conscious of all costs and consistently tries to reduce them. The culture of the workforce has been changed to include reduced cost into the definition of mission success. To that end, he spent additional time and effort better allocating work throughout his workforce and managing the second quarter's employee leaves more carefully. He also gave priority to repair to only the vehicles that commanders told him were most critical to have repaired right away. This extra effort resulted in no overtime being required in the second quarter which he can now brief as a unit cost for vehicle repair that was below the planned level. This identified alternative process, discussed in the performance review, will be recognized for possible wider application throughout the organization.

### 10-38. Using the ABC model

*a.* Once a model is built and is repetitively presenting unit cost results, a managerial process to use the data has to be implemented. Leaders with power to change the way things function must view the unit cost data, be presented with managers' analyses, and approve or create new work processes and direct their implementation.

*b.* A regularly scheduled performance review and planning meeting can be the single vehicle to do all these things. The manager is presented with the data, preferably by the individuals responsible for spending the money to produce the product, and its correctness is evaluated. The best results are usually reached if the first line manager is the person explaining what the costs are and why his planned resource needs were either exceeded or improved upon. Since the overall goal is to reduce unit costs without sacrificing performance, that discussion ensues. It is important to remember that this same manager previously presented his spending plan, using his ABC model as the basis, for the quarter that is now being reviewed.

*c.* The commander or senior manager should be the leader at the review as this is the person who has the ultimate authority to implement procedural changes that result in cost reductions in the process under scrutiny. The commander

is also the one that will reallocate the savings produced to higher priorities. An integral part of the overall methodology must be to provide incentives for managers at all levels to think and work smarter.

*d.* In the previous example, the commander may choose to divide the money now available for reallocation between his desire to pay for another need and to provide a reward to the manager that is helping him win the cost war. The commander might ask the first line manager and his supervisor what is needed to improve the function of the organization that produced this improvement. The commander could choose to buy that new forklift for Supply that they have needed for a while but have not had the funds to buy. All this can happen at the same performance review thereby reducing the number of subsequent meetings that need to take place.

*e.* Commanders focus on the tactical component of CM/ABC by managing cost and performance throughout the cycle of planning and review to achieve continuous improvement. Leadership sets efficiency challenges to be achieved through the managing of activities (CM/ABC), processes, and cost. Gaining a better understanding of cost and performance will better enable managers to achieve the strategic goals set by Army leadership.

### **10-39. Cost commitment and review**

*a.* The cycle of commitment and review is the key for each business area to practice CM/ABC successfully. This process has been established through prototypes and is depicted in Figure 10-4.

*b.* Managerial costing requires commanders and senior managers to provide the leadership support and need for CM/ABC information. The necessity to pull or lead the cost reconnaissance process creates an atmosphere of cost awareness throughout the command. A cycle of forecasting and after action review provides frequent feedback and accountability that drives continuous improvement and allows for the most efficient use of resources.

*c.* A good way to look at the cycle of commitment and review of cost managing in the future is by analogy to C3I used in the tactical Army. The same principles can be applied to inform decision-makers in ways that lead to improved execution. This can easily fit the emerging requirements of better cost management.

*d.* ABC represents the intelligence or information gathering process. In battlefield management, these are the intelligence technologies that acquire information for war fighters. *Cost warrior pull* recognizes the war fighter as the customer of the management information system. The cost warrior will command what needs to be measured and how to present the information. *Cost forecasting* recognizes the value and importance of projecting the current cost situation into the future in order to control future spending. In financial terms this means that the cost control system should facilitate forecasting, what if analysis, and simulation. *After-action cost review* completes the cycle by considering actual mission execution and communicating the results. In financial terms this means that cost warriors must ultimately be measured and held accountable for cost performance. The trend of cost based performance metrics should be expected to show continuous improvement.

*e.* Effective development of CM/ABC should provide an important weapon for winning the cost war. Strategies, tactics, and weapons that improve the command, control, and communication of cost will be important.



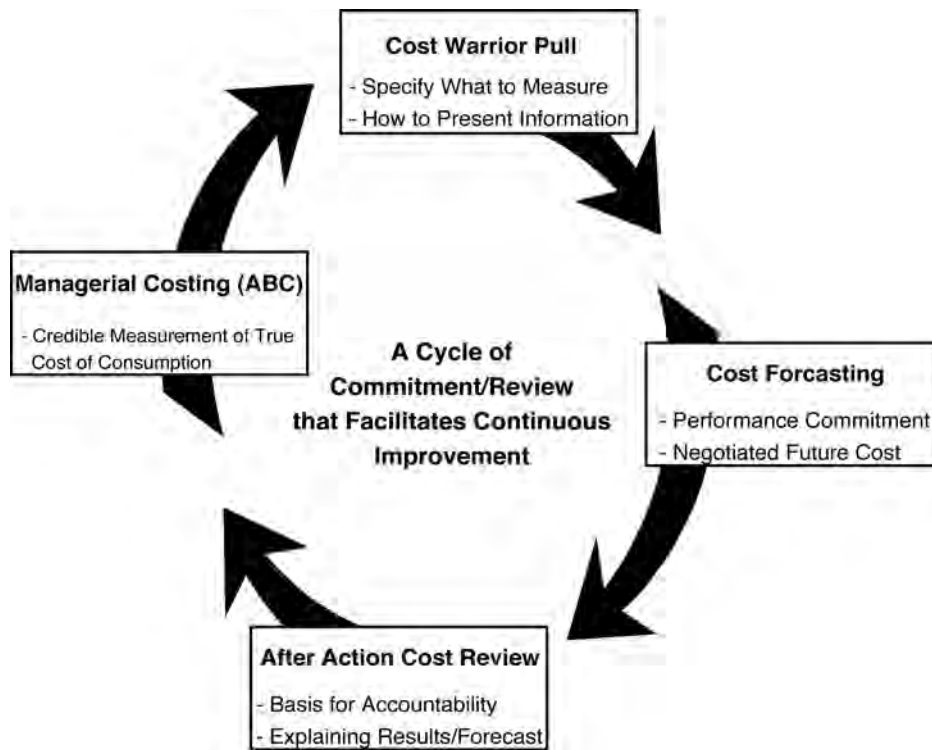

Figure 10–4. Cycle of Commitment and Review

#### 10–40. General Fund Enterprise Business System (GFEBS)

a. The General Fund Enterprise Business System (GFEBS) processes financial, real property, cost management, and performance data, and then integrates this data for decision support. GFEBS’ primary objectives include: improving performance; standardizing financial and business processes; ensuring capabilities exist to meet future needs; and complying with statutory and regulatory accounting requirements. Specifically, GFEBS goals are:

- (1) Provide decision support information to sustain Army capabilities.
- (2) Provide analytic data and tools to support Institutional Adaptation.
- (3) Reduce the cost of business operations.
- (4) Improve accountability and stewardship.

b. GFEBS will provide Army decision-makers with relevant, reliable, and timely information. The system will transform the way the Army does business by enhancing the information available for Army leadership and for managers across the Army. Decision makers will be able to better leverage current resources in day-to-day operations, or better assess the implications of planning and program decisions. Ultimately, GFEBS will replace over 80 Army legacy accounting, financial and asset management systems.

c. Once fully implemented, the GFEBS will be one of the largest enterprise resource planning systems in the world, processing 1 million transactions a day for the active Army, Army National Guard and Army Reserves from some 79,000 end users at more than 200 sites worldwide. (See Figure 10–5). The system will standardize transactional input and business processes across the Army; provide accurate, reliable, online and real-time data; enable cost management activities; and tie budgets to execution. For the first time, the Army will have a single source for financial and related non-financial data, and a single system of record for the General Fund. GFEBS will enable the Army’s workforce to focus its efforts on value-added tasks, such as analysis and decision making, as opposed to redundant data entry or extensive reconciliations, as well as empower leaders at all levels to determine the true costs of operations and the costs that affect their budgets. GFEBS is a complex initiative that blends expertise from many Army and defense organizations in developing the new enterprise business processes. For more information, go to <http://www.gfebs.army.mil/pmo/>.

d. GFEBS uses the Standard Financial Information Structure, which is the common business language that supports information and data requirements for budgeting, financial accounting, cost/performance management, and external reporting across the DOD enterprise. For additional SFIS information, go to <http://www.defenselink.mil/bta/products/>

sfis.html (Paragraph 10–40 was taken from p. 4, *Army Funds Management Data Reference Guide*, November 15, 2010, Version 1.0, see <http://asafm.army.mil/Documents/OfficeDocuments/Budget/Guidances/armyfunfs/afm-pilot.pdf>)

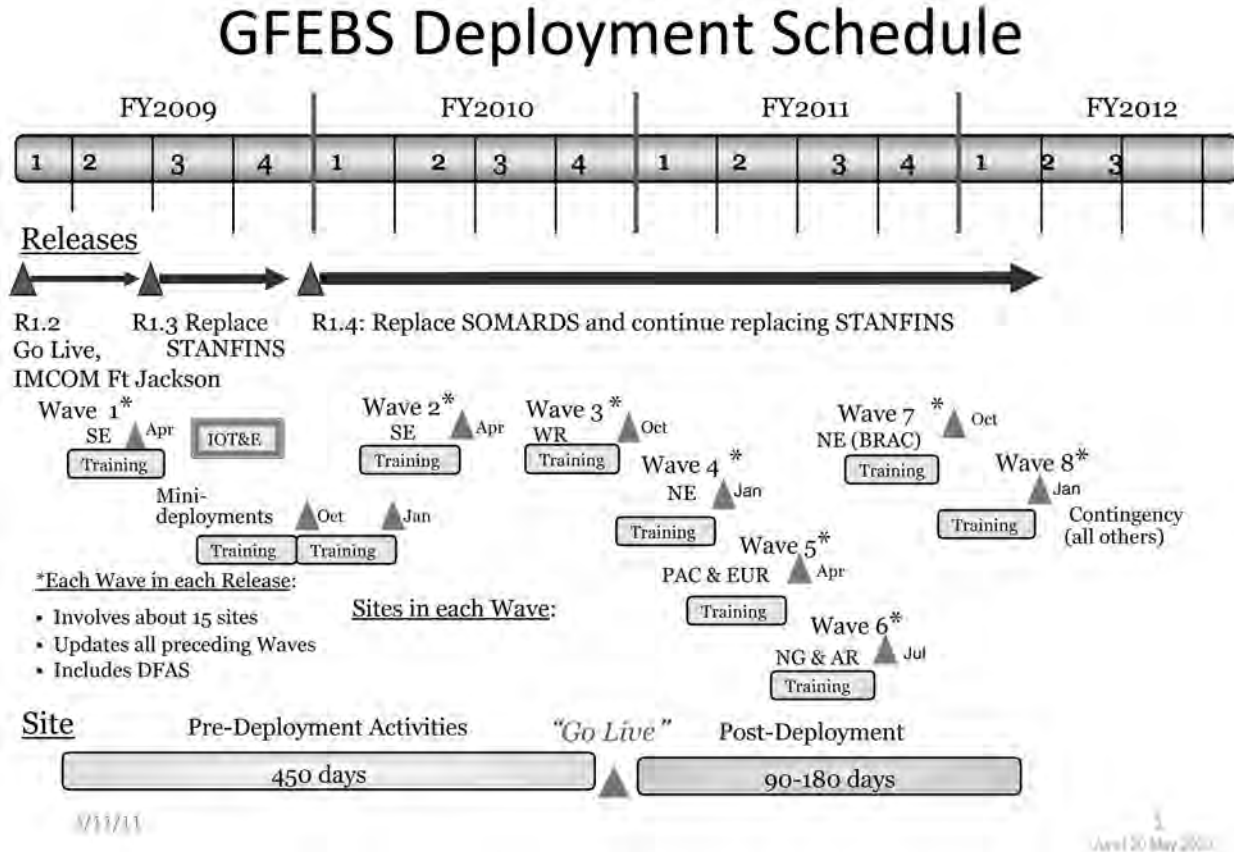

Figure 10–5. GFEBBS Deployment Schedule

### 10–41. Cost benefit analysis (CBA)

A Key Decision-Making Tool: Cost Benefit Analysis

a. In today’s resource-constrained environment, the Army must exercise wise stewardship of every dollar it manages. A key element in that stewardship is to develop and use sound CBA practices throughout all requirement/resourcing processes. For every proposed program, initiative or decision point that is presented to decision makers, it is important to provide an accurate and complete picture of both the costs to be incurred and the benefits to be derived.

b. On March 14, 2011, the Secretary of the Army directed that “All issues, proposals, or requirements must address the costs and trade-offs against projected benefits”. Secretary of the Army Memorandum, SUBJECT: Consideration of Costs in Army Decision-Making, dated 14 March 2011 at [https://cpp.army.mil/portal/page/portal/Cost\\_Performance\\_Portal/CPP\\_Main\\_Page/CBA\\_Portal/About\\_CBA/SA%20MEMO%20-%20CONSIDERATION%20OF%20COSTS%20IN%20ARMY%20DECISION-MAKING.3Mar2011.pdf](https://cpp.army.mil/portal/page/portal/Cost_Performance_Portal/CPP_Main_Page/CBA_Portal/About_CBA/SA%20MEMO%20-%20CONSIDERATION%20OF%20COSTS%20IN%20ARMY%20DECISION-MAKING.3Mar2011.pdf). Also in the memorandum, The Secretary identified the Assistant Secretary of the Army for Financial Management and Comptroller as “proponent for costs in Army decision-making, policy and guidance.” The Office of the Assistant Secretary of the Army (Financial Management and Comptroller) established the CBA Portal on the Cost and Performance Portal (CPP) (see <https://cpp.army.mil> for detailed information on CBA). The Portal provides information on a wide range of requirements, issues, tasks, and problems that require a deliberate analysis to arrive at the optimum course of action.

c. As shown in Figure 10–5, CBA is a structured methodology for forecasting and comparing the anticipated costs and benefits of alternative courses of action in order to identify the optimum solution for achieving a stated goal or objective. The goal is to produce a strong value proposition—a clear statement that the benefits more than justify the costs, risks, and bill payers. (Paragraph 10–41 information was taken from the Cost Benefit Analysis Portal in the Cost

and Performance Portal. (see [https://cpp.army.mil/portal/page/portal/Cost\\_Performance\\_Portal/ CPP\\_Main\\_Page/CBA\\_Portal](https://cpp.army.mil/portal/page/portal/Cost_Performance_Portal/ CPP_Main_Page/CBA_Portal))

## Cost Benefit Analysis

**Cost Benefit Analysis—Making the case for a project or proposal:**  
Weighing the total expected costs against the total expected benefits over the near, far, and lifecycle timeframes from an *Army enterprise* perspective.

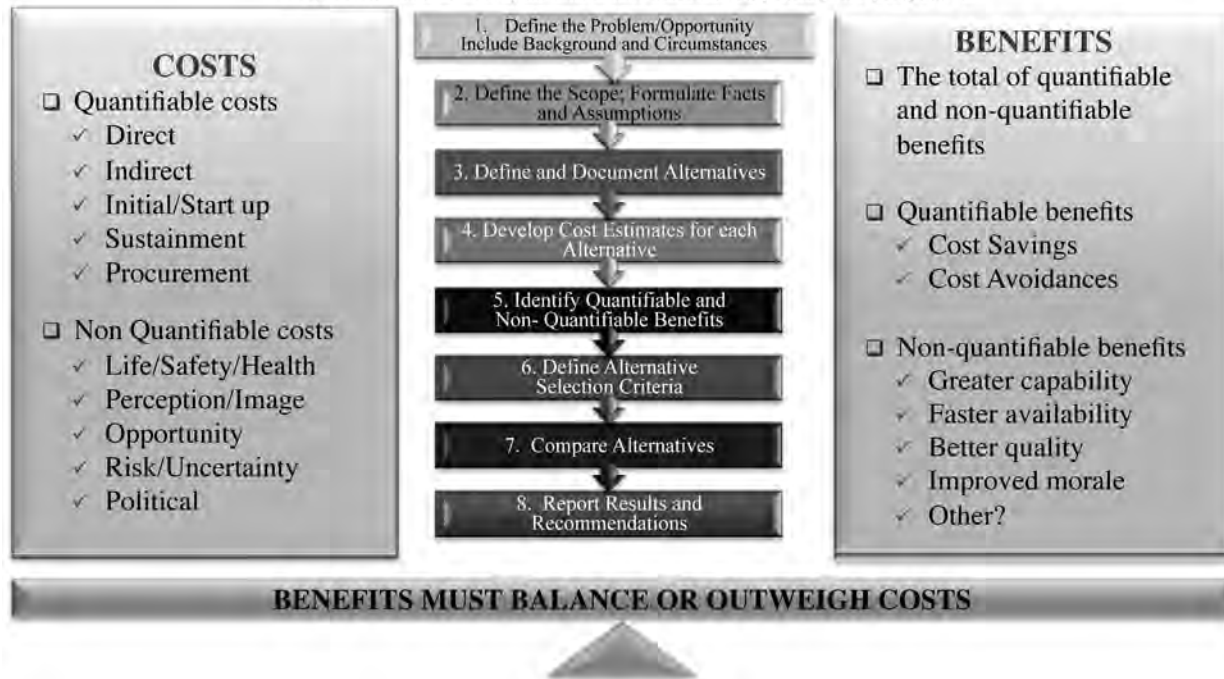

Figure 10–6. Cost Benefit Analysis

### 10–42. Links to principles

*a. Visionary leadership.* Commanders, leaders, and managers must determine the strategies for obtaining and managing costs. Their emphasis on mission accomplishment must be complemented by an emphasis on controlling mission costs.

*b. Continuous improvement and learning.* CM/ABC is not yet universally understood. Leaders must foster and encourage a continuous improvement and learning mentality within their organizations. The modeling concepts and cycle of commitment and review discussed in this chapter provide a starting point for the learning process.

### 10–43. Summary

CM principles offer Commanders greater flexibility in mission execution by providing more information in the decision making process. Planning and the ABC model provide the foundation for CM. Use of the model in the commitment and review cycle enables Commanders and other senior leaders to conserve resources within individual operations. By reducing the costs of individual operations, the manager has flexibility with funds during the execution year. These available funds must be identified early in the FY to enable execution of other priority missions. CM/ABC provides a mechanism for accomplishing the mission within the funds provided.

## Section VII

### Non-Appropriated Funds

#### 10–44. Non-appropriated funds definitions.

*a. Non-appropriated funds (NAF).* NAF are cash and other assets that are not appropriated by Congress. NAF come

primarily from the sale of goods and services to authorized patrons, DOD military and civilian personnel and their family members, and are used to support MWR programs for the collective benefit of authorized patrons who generate them. NAF are government funds, but they are separate and apart from APF that are recorded on the books of the U.S. Treasury.

*b. Non-appropriated fund instrumentality (NAFI).* A NAFI is a U.S. Government fiscal entity that performs an essential government function. It acts in its own name to provide, or assist other DOD organizations in providing, MWR and other programs for military personnel, their families, and authorized civilians.

#### **10–45. NAFI management.**

*a.* Every NAFI is legally constituted as an “instrumentality of the United States.” Funds in NAFI accounts are U.S. Government funds and NAF property including buildings and real estate is U.S. Government property. NAF are not commingled with APF and are managed separately, even when supporting a common program or activity. This means that:

(1) Each NAFI operates under the authority of the U.S. Government in accordance with applicable Federal laws and departmental regulations.

(2) Because NAFIs operate under the authority of the Federal Government, they are entitled to the same sovereign privileges and immunities as the U.S. Government accorded by Federal law.

(3) Applicable DOD directives and implementing Army regulations have the force and effect of law.

*b.* A NAFI is administered and managed by military or civilian personnel acting in an official capacity. The NAFI is generally immune from Federal taxes and exempt from most direct State, local, and host country taxes. It must account for and report financial operations through command and department channels. NAFI operations are subject to review by Congress. AR 215–1, *Military Morale, Welfare, and Recreation Programs and Non-appropriated Fund Instrumentalities*, provides more information on management of Army NAFIs.

#### **10–46. Fiduciary responsibility for NAF (10 United States Code Section 2783)**

NAF are U.S. Government funds entitled to the same protection as funds appropriated by the Congress.

*a. Individual responsibility.* There is an individual fiduciary responsibility to use NAF properly and prevent waste, loss, mismanagement, or unauthorized use. This responsibility extends to all DOD personnel to include members of the Armed Forces and appropriated funded and non-appropriated funded civilian employees.

*b. Violations.* Commanders are responsible for the prompt detection and proper investigation of possible violations and instituting appropriate corrective action. Individuals reporting NAF violations are protected from reprisal. Commanders will take appropriate administrative action against violators. Where evidence indicates criminal conduct, commanders will refer the matter to the appropriate criminal investigative organization. Penalties for violations of waste, loss, mismanagement, or unauthorized use of NAF apply to military, appropriated funded civilian personnel and NAF civilian personnel. They include the full range of statutory and regulatory sanctions, both criminal and administrative, and are the same as those under provisions of Federal law that govern the misuse of appropriations. Reporting of suspected violations at the lowest organizational level possible is encouraged. However, reports may be made to senior management, organizational inspectors general, or to the Defense Hotline.

#### **10–47. Management of MWR and NAF**

*a. MWR and NAF are managed by a Board of Directors (BOD).* Members of the BOD are the four-star commanders, the Sergeant Major of the Army and the Assistant Secretary of the Army for Manpower and Reserve Affairs. The senior military member chairs the BOD. The MWR BOD develops goals and objectives, approves financing strategies, monitors performance, prioritizes NAF major construction requirements, and ensures fiduciary responsibility for MWR.

*b. An Executive Committee (EXCOM) reports to the MWR BOD.* The EXCOM is chaired by the G1. The BOD structure also includes Strategic Planning, Finance, and Audit Committees that report to the EXCOM. An Investment Subcommittee reports to the Finance Committee.

#### **10–48. HQDA oversight of non-appropriated funds**

As part of the responsibility of overseeing NAF, the ASA (FM&C) participates in addressing non-appropriated fund issues to the SECARMY and CSA for decision. Applying various means, the ASA (FM&C) provides HQDA level financial management oversight of Army controlled NAF. One method is by participating in the various levels of the Soldier and Family Readiness Board of Directors’ (SFRBOD) various forums. A representative from the Army Budget Office participates in all SFRBOD working group level meetings where major MWR financial policy issues can be addressed. The Military Deputy for Budget advises the SFRBOD and is a voting member of the SFRBOD three star level Executive Committee. The Deputy Assistant Secretary of the Army for Financial Operations chairs the SFRBOD Audit Committee. A senior member of the Army Budget Office serves on the Investment Committee for the Army Banking and Investment Fund. The Military Deputy for Budget is also a voting member of the Army and Air Force Exchange System (AAFES) Board of Directors and its Finance Committee. The AAFES is a major revenue contributor to Army MWR. Through these positions, the ASA (FM&C) influences all aspects of MWR financial policy.

### Section VIII Summary and References

#### 10–49. Summary

a. Resource management in our Army continues to evolve. New legislation, new requirements, new management initiatives, new missions and the proviso to get the “biggest bang for the buck” out of Army resources continually force resource managers to develop new approaches to resource management. On top of this, the application of IT has literally revolutionized the resource management community. The power of the computer and its sophisticated software has provided decision makers at all levels with powerful tools to maximize the allocation and application of resources.

b. The real innovation lies, however, in the thrust of the entrepreneurial approaches being advocated in the resource management community. Recognition that Army budget levels in the 1990s were declining forced us to reexamine business practices, to integrate in a far more comprehensive manner programming and budgeting, and to look seriously at ways of enhancing the productivity of the people that constitute the Army team. The MDEP concept was a forerunner of this integration effort.

c. Third-party financing, value engineering, charge-back/direct-customer payment, self-sufficiency, organizational efficiency reviews, and output focus based on unit cost are some of the concepts that allow us to examine the way we manage our Army and to do so in a more productive way to enhance the efficiency and effectiveness of the resources that Congress and the American taxpayer provide to us to forge combat capabilities.

d. This chapter summarized the more pertinent features of resource management systems using a minimum of the complex terms associated with the process. We have identified the major players, the major steps they must take, and the various controls that guide their actions in the resource management process particularly during the execution stage.

#### 10–50. References

- a. United States Code, titles as follows:
- (1) Title 5 USC, Government Organization and Employees.
  - (2) Title 10 USC, Armed Forces.
  - (3) Title 31 USC, Money and Finance.
  - (4) Title 32 USC, National Guard.
  - (5) Title 41 USC, Public Contracts.
- b. DOD Regulation 7000.14–R, *Financial Management Regulation (FMR)*, consisting of twenty volumes.
- c. Army Regulation 5–1, Total Army Quality Management, March 15, 2002.
- d. Army Regulation 11–2, Managers’ Internal Control Program, January 4, 2010.
- e. Army Regulation 37–47, Representation Funds of the Secretary of the Army, March 12, 2004.
- f. Army Regulation 215–1, Military Morale, Welfare, and Recreation Programs and Non-appropriated Fund Instrumentalities, September 24, 2010.
- g. DFAS–IN Regulation 37–1, Finance and Accounting Policy Implementation, November 2010. DFAS–IN Manual 37–100–09, The Army Management Structure (AMS) for Fiscal Year 2011, Basic Complete Manual August 6, 2010 Current Complete Manual January 24, 2011.

## Chapter 11

### Matériel System Research, Development, and Acquisition Management

“We must ensure that our Warfighters have the capabilities they need to accomplish the Nation’s military demands in this new and emerging global environment...We must develop, acquire, and sustain key military capabilities that enable us to prevail over current challenges and to hedge against, dissuade, or prevail over future threats...The world situation demands an Army that is strategically responsive and dominant at every point on the spectrum of military operations. We are working hard to ensure that America’s soldiers continue to be the best trained, best led, and best equipped land force on earth.” Assistant Secretary of the Army (Acquisition, Logistics, and Technology)

#### Section I

##### Introduction

#### 11–1. Department of Defense (DOD) and U.S. Army Capabilities Development and System Acquisition Management

This chapter describes the DOD and U.S. Army management systems used for capabilities development and research, development, and acquisition (RDA) of matériel systems. These systems can be viewed simply as a combination of structure, process, and culture.

*a.* Structure is the sum of the guidance provided by law, policy or regulation, and the organization provided to accomplish the capabilities development and system RDA management functions.

*b.* Process is the interaction of the structure in producing the output.

*c.* Culture is the cumulative sum of past practices and their impact on interpretation of guidance and attitude toward institutional changes to the system.

#### 11–2. System focus

For the Army, the focus of the capabilities development and matériel system acquisition management systems is producing military units that are adequately trained, equipped, and sustained [we maintain equipment but sustain units] to execute the *National Security Strategy (NSS)*, *National Defense Strategy (NDS)*, and *Quadrennial Defense Review (QDR)* effectively by developing and acquiring warfighting systems that are affordable and support the national strategies. To facilitate an understanding of the process, this chapter will begin by highlighting some of the critical aspects of capabilities development.

#### Section II

##### Capabilities Integration and Development

#### 11–3. Policy

The Chairman of the Joint Chiefs of Staff Instruction (CJCSI) 3170.01G mandates policy and the supporting Joint Capabilities Integration and Development System (JCIDS) Manual mandates procedural guidance for the JCIDS. The Army supports JCIDS through the Army’s CIDS process discussed in Army Regulation 71–9 and Training and Doctrine Command (TRADOC) Regulation 71–20.

#### 11–4. Joint capabilities integration and development system (JCIDS)

*a.* The JCIDS, the Defense Acquisition System (DAS), and the Planning, Programming, Budgeting, and Execution (PPBE) process form the DOD’s three primary decision support systems/processes for transforming the military forces to support the NDS. The procedures established in JCIDS support the Chairman, Joint Chiefs of Staff (CJCS) and the Joint Requirements Oversight Council (JROC) in advising the Secretary of Defense (SECDEF) in identifying, assessing, and prioritizing joint military capabilities-based requirements (needs).

*b.* JCIDS is a need driven joint capabilities-based requirements generation process. The objective is to develop a balanced and synchronized doctrine, organization, training, matériel, leadership and education, personnel, and facilities (DOTMLPF) solution approach that is affordable, militarily useful, supportable by outside agencies, and based on mature technology that is demonstrated in a relevant operational or laboratory environment. JCIDS implements an integrated, collaborative process, based on top-level strategic direction, to guide development of new capabilities through changes in DOTMLPF. Change recommendations are developed and evaluated in consideration of how to optimize the joint force’s ability to operate as an integrated force. This integrated, collaborative approach requires a process that uses joint/service concepts and integrated architectures to identify prioritized high risk capability gaps and integrated joint DOTMLPF and policy approaches (matériel and non-matériel) to resolve those capability gaps. See para. 5–3.

#### 11–5. DOD science and technology (S&T)

Since World War II, owning the technology advantage has been a cornerstone of our *NDS*. Technologies such as radar,

## How the Army Runs

jet engines, nuclear weapons, night vision, global positioning, smart weapons, stealth, situational awareness, precision munitions, protection warfighting function, robotics, and biotechnology have changed warfare dramatically. Maintaining this technological edge has become even more important as high technology weapons have become readily available on the world market. In this environment, it is imperative that joint forces possess technological superiority to ensure success and minimize casualties across the broad spectrum of engagements. The technological advantages enjoyed by the United States in Afghanistan in 2002 and Iraq in 2003, which are still employed today, is the legacy of decades of wise investments in S&T. Similarly, our warfighting capabilities 10 to 15 years from now will be substantially determined by today's investment in S&T.

### 11–6. Defense science and technology strategy

The Defense Research and Engineering Strategic Plan (DODR&E(SP)) is supported by the DOD Basic Research Plan (BRP) and the DOD Joint Warfighting Science and Technology Plan (JWSTP). It provides DOD's S&T vision, strategy, plan, and a statement of objectives for the planners, programmers, and performers. These documents and the supporting individual S&T master plans of the services and DOD agencies guide the annual preparation of the DOD S&T budget and Program Objective Memoranda (POMs).

a. The *Basic Research Plan (BRP)* presents the DOD objectives and investment strategy for DOD-sponsored basic research (6.1) performed by universities, industry, and service laboratories. In addition to presenting the planned investment in 12 technical disciplines, the current plan highlights 6 strategic research areas (SRAs) holding great promise for enabling breakthrough technologies for 21st century military capabilities. The *BRP* is updated as necessary.

b. The *Joint Warfighting Science and Technology Plan (JWSTP)* objective is to ensure that the S&T program supports priority future joint warfighting capabilities. The *JWSTP* looks horizontally across the services and agencies ensuring that the near-, mid-, and far-term needs of the joint Soldier are properly balanced and supported in the S&T planning, programming, budgeting, and assessment activities of DOD. The *JWSTP* is structured to support the technological achievement of capabilities associated with the joint capability areas (JCAs), in accordance with the JCIDS process previously discussed. Advanced concepts and technologies identified as enhancing high priority joint warfighting capabilities, along with prerequisite research, receive funding priority in the President's Budget (PB) and accompanying Future Years Defense Program (FYDP). The *JWSTP* is updated biennially, in the even year.

### 11–7. Army science and technology (S&T)

The Army's S&T investments support the Army full spectrum operations focusing on the future force while, at the same time, seeking opportunities to provide advanced technology to the current force. This dual strategy requires a dynamic technology investment portfolio that is strategically aligned with the Army's future operational capability needs and that maintains an awareness of the lessons learned from current overseas contingency operations. Fundamentally, the Army S&T program is seeking to provide solutions that enable faster, lighter and smarter systems.

a. The S&T program supports Army full spectrum operations in three ways. First, Soldiers benefit today from technologies that emerged from the Army's past investments. Second, S&T exploits transition opportunities by accelerating mature technologies derived from ongoing efforts. Finally, Army S&T leverages the expertise of our scientists and engineers to develop solutions to unforeseen problems encountered during current operations, such as the slat armor applied to Stryker combat vehicles for enhanced rocket-propelled grenade (RPG) protection.

b. The ultimate goal of the Army's S&T program is to provide the Soldier with a winning edge on the battlefield. The accelerating pace of technological change continues to offer significant opportunities to enhance the survivability, lethality, deployability, and versatility of Army forces. High technology research and development is, and will remain, a central feature of *The Army Plan (TAP)*. The key to the *TAP* strategy is the planned transition of promising technology developments into tomorrow's operational capabilities. Technology demonstrations (TDs), discussed later, which evolve into systems and system upgrades incorporated in the *Army Modernization Strategy (AMS)* accomplish this transition.

c. The Army's S&T program is an integral part of capabilities development and system acquisition management. The S&T program consists of three stages - basic research (6.1), applied research (6.2), and advanced technology development (6.3). The identifiers—6.1, 6.2, etc.—are commonly used for identifying funds; but they are also used as a shorthand technique by members of the R&D community to identify levels of research development. For example, instead of referring to a project as being “in applied research,” it is often referred to as being “6.2”. The 6.1, 6.2, and 6.3 categories are known as the “tech base”. Basic research (6.1) includes all efforts of scientific study and experimentation directed toward increasing knowledge and understanding in those fields related to long-term national security needs. Applied research (6.2) includes all efforts directed to the solution of specific military problems, short of major development projects. Advanced technology development (6.3) includes all efforts directed toward projects which have moved into the development of hardware for testing of operational feasibility. Initiatives, such as the DOD joint capability technology demonstrations (JCTDs), discussed later in this chapter, obscure the distinction between S&T and development — pre- and post- acquisition milestone B activities.

(1) Army S&T has been at the forefront in adapting technology for urgent operational needs, as exemplified by the First Strike Ration, which reduces the weight of the daily combat food rations carried by Soldiers in initial periods of high intensity conflict by 40–50 percent. Likewise, DOD scientists and engineers continuously harvest materiel

solutions from past investments, such as the development of mine detection ground penetrating radar. They also provide extraordinary technical expertise resulting in the development and integration of technologies, such as new lightweight armor. This armor has dramatically enhanced Mine Resistant Ambush Protected (MRAP) vehicle survivability in the face of constantly evolving threats. Also, Army S&T provides the technology for many of the upgrade and modernization programs for existing systems.

(2) The S&T program will continue to invest in a diverse portfolio of technologies and research. A significant S&T investment is made in basic research areas such as advanced materials, nanotechnology, biotechnology, network science, science of autonomy, immersive technology, and quantum information science. Other large investment areas focus on protection warfighting function technologies, where we are seeking to develop technologies for active and passive protection of the Soldier, ground vehicles, and air platforms. Army S&T continues to invest heavily in mission command networks and systems, medical/force health protection, lethality, Soldier systems, logistics, rotorcraft, unmanned systems, and advanced simulation.

d. The *Army Science and Technology Master Plan (ASTMP)* is the strategic plan for the Army's S&T program. It is the Army's S&T roadmap in support of Army transformation. This plan is provided to government, industry, and academia to convey the Army's S&T vision, objectives, priorities, and corresponding strategy. This document is explicit, resource-constrained DA guidance to drive funding priorities and the S&T program as a whole. The *ASTMP* provides "top down" guidance from DA to the S&T community. It also provides a vital link between DOD technology planning and Army Commands and laboratories. The core of DOD's S&T strategy is to fuel and exploit the information technology explosion; conduct extensive and realistic demonstrations of new technology applications; and provide for early, extensive and continued involvement of Soldiers in S&T demonstration programs. S&T programs must be responsive to numerous national security considerations.

e. A mainstay of the Army strategy for military technology is a viable in-house research capability. Research, Development, and Engineering Command (RDECOM), Research, Development, Engineering Centers (RDECs) and laboratories are the key organizations responsible for technical leadership, scientific advancements and support for the capabilities development and system acquisition management processes. Activities of these organizations range from basic research to the correction of deficiencies in field systems. Academia and industry, as well as hands-on bench work contribute to the S&T mission. Technology insertion into systems is accomplished via the flow of patents, data, design criteria, and other information into TDs, ATDs, JCTDs, new designs, and fielded systems.

f. Overall, the Army's S&T strategy and programs are committed to the maintenance of technological superiority, while preserving the flexibility to cope with a wide array of possible threat, technology, and budget environments. The Army's investment in S&T is paramount and is playing a greater role in acquisition than ever, particularly since the advent of DOD JCTDs.

g. A series of reviews of current and proposed S&T activities guide focused research. The first is an annual assessment of all proposed Army funded S&T projects. It is conducted based on an appreciation of current capabilities, ongoing S&T activities and their applicability to the force operating capability (FOC) described in *TRADOC Pamphlet 525-66*. Building from the S&T project review, a list of the top Army technology objectives (ATOs) candidates—the Army's most important technology projects—is generated. There are 3 distinct types of ATOs.

(1) ATO—Research (ATO(R)) focuses on laboratory applications to determine feasibility and potentially provide technology options in the mid- and far- terms.

(2) ATO—Demonstration (ATO (D)) focuses on products and transition into the acquisition Engineering and Manufacturing Development (EMD) phase for warfighting capability.

(3) ATO—Manufacturing Technology (ATO (M)) is focused on improving affordability and producibility of new technology and reducing operation and support (O&S) cost for fielded systems.

h. Based on formal developmental milestones and achievement measures, the Army Science and Technology Working Group (ASTWG) approve each ATO, which is then listed in the *ASTMP*. The *ASTMP* and the *AMS* provide the basis for ATDs, which showcase a variety of advanced technologies and their potential military merit. In addition to advancing the technology, these S&T activities aid the TRADOC ARCIC chartered CoE standing ICDTs to better understand the "art of the possible" and refine the many requirements associated with them. See para 5-5.

i. As with some concepts, S&T research occasionally produces an item that is recognizable as a defined requirement that should be documented and resourced. Most S&T products must be evaluated in warfighting experiments before a decision is made to document them as materiel requirements.

j. Oversight of the S&T program is provided by the Army Science and Technology Advisory Group (ASTAG), which is co-chaired by the Army Acquisition Executive (AAE) and the VCSA (figure 11-1). The ASTWG, is co-chaired by the Army S&T executive (the Deputy Assistant Secretary of the Army for Research and Technology), and the HQDA DCS, G-8 Director, Force Development. The ASTWG provides general officer level resolution of pressing S&T issues prior to meetings of the ASTAG; and recommends ASTAG revisions to the Army's S&T vision, strategy, principles, and priorities; and reviews and approves ATOs.



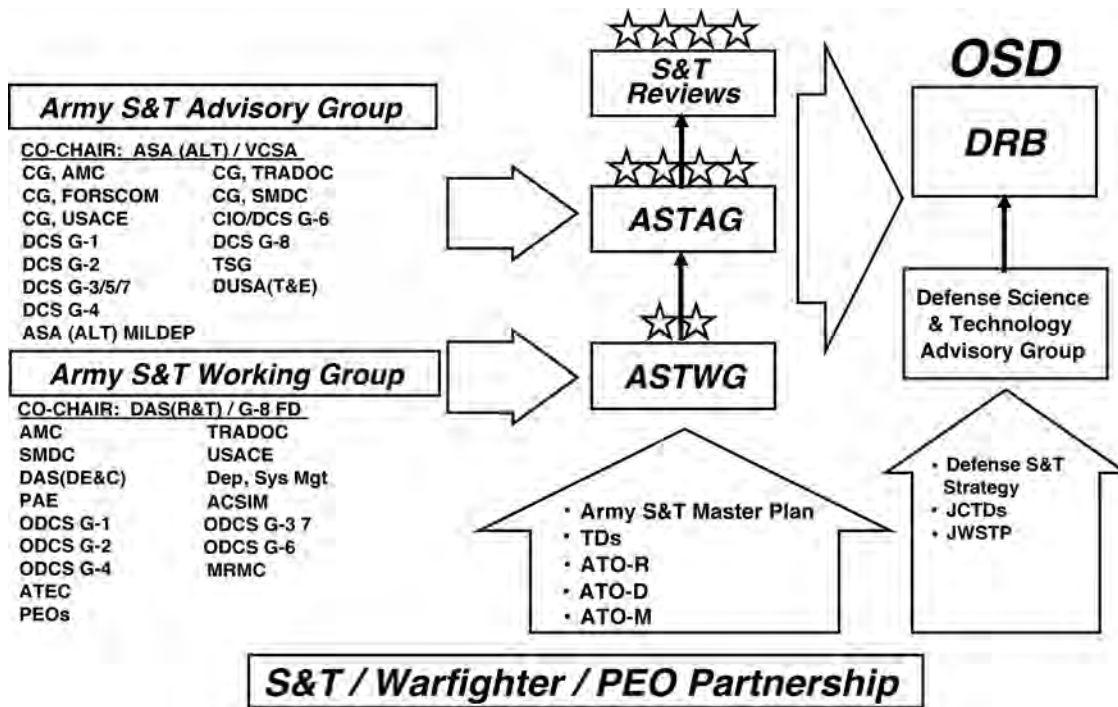

Figure 11-1. Army S&T Oversight

**11-8. Army technology transition strategy**

The basic strategy of the S&T program is to transition mature technologies into operational systems that satisfy approved warfighting capabilities-based materiel requirements. The key to this strategy is demonstrations. TDs, ATDs, and JCTDs exploit technologies derived from applied research (6.2), which in turn build on new knowledge derived from basic research (6.1) programs. These TDs, ATDs and JCTDs provide the basis for new systems, system upgrades, or advanced concepts which are further out in time. The critical challenge is to tie these programs together in an efficient and effective way. TDs are not new. What is new is the scope and depth of the TDs, the increased importance of their role in the capabilities development and system acquisition management processes, and the increased emphasis on user involvement to permit an early and meaningful evaluation of overall military capability. The following sections provide an explanation of technology maturity, TDs, ATDs, JCTDs as well as systems/system upgrades.

a. Technology maturity. Technology maturity measures the degree to which proposed critical technologies meet program objectives. Technology maturity is a principal element of program risk. A technology readiness assessment (TRA) examines program concepts, technology requirements, and demonstrated technology capabilities to determine technological maturity.

(1) TRAs for critical technologies occur sufficiently prior to Defense Acquisition System (DAS) milestone decision review (MDR) points B and C to provide useful technology maturity information to the acquisition review process.

(2) The Deputy Assistant Secretary of the Army (Research and Technology), DASA(R&T), directs the TRAs and, for major defense acquisition programs (MDAPs), submits the findings to the AAE, who submits the report to the Deputy Under Secretary of Defense for Science and Technology DUSD(S&T) with a recommended technology readiness level (TRL), figure 11-2, for each critical technology. In cooperation with the DASA(R&T), the DUSD(S&T) evaluates the TRAs and, if he/she concurs, forwards the findings to the DOD overarching integrated product team (OIPT) leader and Defense Acquisition Board (DAB) or the Information Technology Acquisition Board (ITAB). If the DUSD(S&T) does not concur with the TRA findings, an independent TRA, under the direction of the DUSD(S&T), will be required. DOD OIPTs and acquisition boards will be discussed later in this chapter.

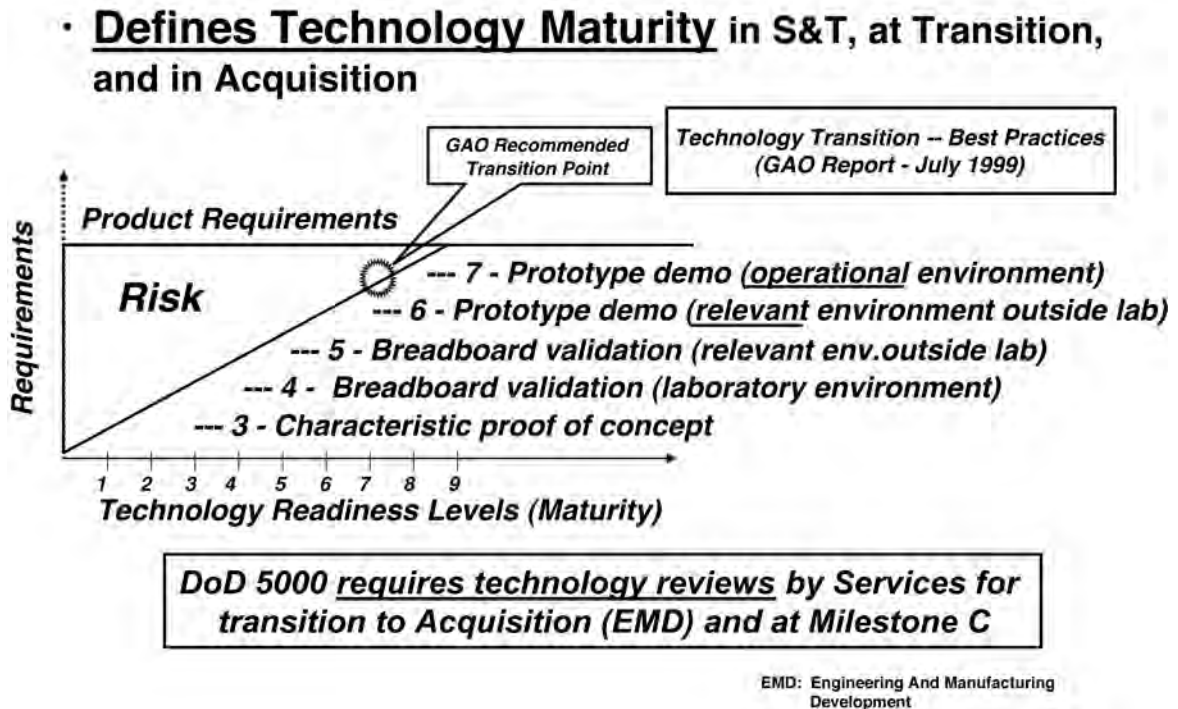

Figure 11–2. Technology Readiness Levels (TRLs)

(3) TRLs are a measure of technical maturity that enables consistent, uniform discussions of technical maturity, across different types of technologies. Decision authorities must consider the recommended TRLs when assessing program risk. TRL descriptions appear in the *Defense Acquisition Guidebook*.

b. Technology demonstrations (TDs). The primary focus of TDs is to demonstrate the feasibility and practicality of a technology for solving specific military requirements. They are incorporated during the various stages of the 6.2 and 6.3 development process and encourage technical competition. They are most often conducted in a non-operational (laboratory or field) environment. These demonstrations provide information that reduces uncertainties and subsequent engineering cost, while simultaneously providing valuable development and requirements data.

c. Advanced Technology Demonstrations (ATDs). ATDs are typically integrated demonstrations that are conducted to demonstrate the feasibility and maturity of an emerging technology. They provide a relatively low-cost approach for assessment of technical risks and uncertainties associated with critical technologies prior to the incorporation of these technologies into a system entering the formal acquisition process. They are conducted at the service and DOD agency level with internal funding. They focus on evolving a specific element of technology nominally at the 6.3 advanced technology development point (typically TRL 5–6) to reduce its risk of implementation by an acquisition program or to feed into a Joint Capability Technology Demonstration (JCTD).

d. Joint Capability Technology Demonstrations (JCTDs). DOD initiated the JCTD process in 2006 to permit the early and relatively inexpensive evaluation of mature advanced technologies. The Soldier evaluates JCTDs to determine military utility of the technologies and to develop the concept of operations (CONOPS) that will optimize effectiveness. JCTDs are structured and executed so that, when successful, DOD can proceed rapidly into formal acquisition systems.

(1) By introducing new technologies in the field prior to the initiation of formal systems acquisition, DOD allows operators, who have experience in combat, to evaluate and assess the military utility and develop the tactics to ensure that we can realize the full potential of the substantial technology base that is available—both DOD and commercial. JCTDs are not a means by which to circumvent the formal acquisition process, but rather a means to enter that process based on a user assessment of the value of the new capability that reduces the user acceptance risk. This process helps DOD make more informed acquisition decisions and improve its acquisition cycle time.

(2) The Deputy Under Secretary of Defense for Advanced Systems and Concepts (DUSD(AS&C)), designs JCTDs to transfer technology rapidly from the developers to the users. JCTDs are user oriented and represent an integrated effort to assemble and demonstrate a significant, new or improved military capability based on mature advanced technologies. Also, they are on a scale large enough to demonstrate operational utility and end-to-end system integrity.

## How the Army Runs

As key participants, the operational user and materiel development communities jointly develop and implement a demonstration. JCTDs allow the Soldier to:

- evaluate a technology's military utility before commitment to a major acquisition effort,
- develop CONOPS for employing the new technology,
- retain a low-cost, residual operational capability, if desired.

(3) When an JCTD has been completed, DUSD(AS&C) elects one of the following alternative actions based on the results of the exercises:

- based on demonstrated military utility, execute the transition of the successfully demonstrated technology directly to the Soldier making only necessary minor, or perhaps no, modifications to the existing hardware or software. This transition approach is particularly appropriate where Soldiers require only small quantities of the new equipment.
- based on demonstrated military utility, enter the formal DAS at the appropriate milestone (MS) B or C per the appropriate Materiel Development Decision (MDD).
- terminate the efforts or restructure them based on the evolved CONOPS and lessons learned during the JCTD.

(4) Over the past 4 years, the Joint Staff, unified commanders, and military services have forwarded proposals for a number of JCTDs to DOD. Also industry and many DOD research and development agencies have proposed candidate JCTDs. Some JCTDs are completed in less than 1 year and evaluate a very specific technology or address a particular mission area; others are several years long and include coordination of multiple developing technology programs into a series of specific demonstrations. The goal is to complete a JCTD within a 1 to 3 year period.

(5) DUSD(AS&C) coordinates all JCTD proposals, including recommendations on potential participants, with the Under Secretary of Defense for Acquisition, Technology, and Logistics (USD(AT&L)) and the Vice Chairman of the Joint Chiefs of Staff (VCJCS), based on prioritization from the JROC and reviews by the JCTD senior members of the Office of the Secretary of Defense (OSD), service, agency, and the combatant command (COCOM) S&T community.

*e.* Systems and system upgrades.

(1) The development of the next set of materiel systems requires prior demonstration of the feasibility of employing new technologies. "New-start" systems are those next in line after the ones currently fielded or in production. For these systems, most technical barriers to the new capability have been overcome. Generally, these systems can enter the DAS EMD phase relatively quickly as a result of the successful demonstration of enabling technologies. Based on current funding guidance and support for overseas contingency operations (OCO), the number of "new-start" systems is in a sharp decline.

(2) The Army is pursuing incremental improvements to existing systems to maintain its technological edge. As defined in the *ASTMP*, these improvements are designated as systems modifications. System modifications are brought about through technology insertion programs, service life extension programs (SLEPs), preplanned product improvements (P3I), and block improvement programs. These modifications are based primarily on the success of funded 6.3 TDs. The 6.3 TDs are the basis for the system modification or have a high probability of forming the basis for the system modification.

### 11–9. Trades in a joint, resource constrained environment

*a.* The Army must operate in a joint environment containing both complementary and redundant required capabilities (RCs). In determining RCs and proposed solutions, capability developers must consider leveraging joint capabilities. Also, capability developers must make risk assessments and trades in capability at every step of the capabilities development and system acquisition management process, from the Joint Capabilities Integration and Development System (JCIDS) Capabilities-based Assessment (CBA) to production and/or implementation of a DOTMLPF and policy solution.

(1) During the functional needs analysis (FNA) phase of the CBA, the CAPDEV must assess and recommend trades on capability needs (gaps) based upon acceptable risk. High Risk criteria include the likelihood and consequences of mission failure. Other joint and Army capabilities should be considered as a means to close the gaps outlined in the FNA.

(2) During the functional solution analysis (FSA) phase, potential solutions should provide mission success within an acceptable risk range. These informed assessments of risk can reduce the range of the gap, eliminate the gap from further analysis, and/or lead to solutions with reduced cost. These risk assessments and trades should be outlined in the CBA results to support the validation and approval of proposed capability documents such as joint DCRs and ICDs. See para. 5–7.

*b.* Trades outline supporting capabilities and/or system relationships that may be optimized to achieve a capability and/or a resource goal with acceptable risk. They capture alternatives to proposed developments, as well as other means and methods to close or mitigate capability gaps. For example, if the quantity of systems is decremented, then alternative methods for mitigating the impact of that decision will be captured. If aspects of a development effort have affordability issues, then propose less expensive alternatives. In any event, all trades must be evaluated across the

DOTMLPF to determine the impacts in a holistic fashion and consider the second and third order effects within the capability area (if any).

#### **11–10. TRADOC Capabilities Needs Analysis (CNA)/Soldier Outcomes Analysis (WFO)**

*a.* CNA is a living, evolving, interactive process, based on Army CIDS CBA, among TRADOC's CoEs, proponents and HQDA staff. The CNA process is a TRADOC-led annual macro-level assessment of the Army's ability to perform future organizational and functional missions as defined by joint and Army concepts taking into account existing, programmed, and DOTMLPF solutions. Following guidance from the HQDA DCS, G-3/5/7, the CNA identifies, assesses, integrates and prioritizes the Army's required capabilities (RCs) based on risk to mission accomplishment; DOTMLPF solutions, capability gaps and gap solution strategies associated with the RCs; and developmental priorities and big ideas guiding future capabilities development work. The CNA products are used by DA to inform the Program Objective Memorandum (POM), support JCIDS by informing and shaping the CBA, and focusing developmental priorities and requirements determination guidance in the TRADOC ARCIC Campaign Plan (ArCP).

*b.* The WFO, led by the S&T Division of the ARCIC Concept Development and Learning Directorate (CDLD), is an annual assessment utilizing the residual capability gaps developed by the CNA process, as well as inputs from stakeholders across the Army, to determine where technology might enable a solution required by or delivered to our operational forces 10–20 years in the future, commonly referred to as the extended planning period (EPP); and prioritized based on contribution to residual gaps. This assessment is performed based upon a two-way dialog with the S&T community which is imperative for Army transformation. The current top 5 WFOs are Mission Command Network, C-IED and Mines, Power and Energy, Human Dimension, and Training. The WFOs are used to assist the S&T community to focus their investments to meet future Soldier needs.

### **Section III**

#### **Material Capabilities Documents (MCDs)**

#### **11–11. Generating and documenting capabilities-based materiel requirements**

MCDs establish the need for a materiel acquisition program, how the materiel will be employed, and what the materiel must be capable of doing. As the acquisition program progresses, statements of required performance and design specifications become more and more specific. The functional area (FA) focused initial capabilities document (ICD) is the document that initiates the Defense Acquisition System (DAS). The capability development document (CDD) and the capability production document (CPD) are the documents that define the system capabilities needed to satisfy an approved materiel need (high risk capability gap).

*a.* Initial capabilities document (ICD). The ICD is a non-system specific statement of functional required materiel capability (need). It documents the need for non-materiel and/or materiel solution approaches to resolve a specific high risk capability gap derived from the JCIDS CBA process (previously discussed). It describes capability gaps that exist in warfighting functions as described in the applicable warfighting concepts and integrated architectures. The capability gap is defined in terms of the functional area, the relevant range of military operations, and timeframe under consideration.

(1) The ICD summarizes the results of the CBA analysis and identifies any changes in U.S. or Allied doctrine, operational concepts, tactics, organization, and training that were considered in satisfying the identified high risk capability gap. The ICD describes why such non-materiel changes have been judged to be inadequate in addressing the complete capability.

(2) The ICD documents the evaluation of balanced and synchronized DOTMLPF and policy approaches that are proposed to provide the RC. The ICD further proposes a recommended materiel approach based on analysis of the different materiel approaches and describes how the recommended approach best satisfies the desired RC.

(3) Once approved, an ICD is not normally updated, but is archived to the Joint Staff, J-8 Knowledge Management/ Decision Support (KM/DS) tool database, so that all approved MCDs are maintained in a single location. When approved, capability development documents (CDDs) (described below) bring the desired capability specified in the ICD into the acquisition Engineering and Manufacturing Development (EMD) phase. The CDD then serves as the living document to carry the program and its increments through the acquisition process.

(4) The ICD format and detailed content instructions are provided in the *JCIDS Manual, Appendix F, Enclosure F*.

*b.* Capability development document (CDD). The CDD is the Soldier's primary means of defining authoritative, measurable and/or testable capabilities for the EMD phase of an acquisition program. The CDD is guided by the ICD and captures the information necessary to deliver an affordable and supportable capability using mature technology within a specific increment of an acquisition strategy (AS) - the framework (roadmap) for planning, directing, and managing an acquisition program to satisfy an approved materiel requirement.

(1) The CDD is generated during the Technology Development (TD) phase of the acquisition process prior to milestone (MS) B (program initiation). The CDD describes a technically mature and affordable increment of militarily useful capability that was demonstrated in a relevant environment. The CDD supports entry into EMD phase.

(2) In an evolutionary acquisition program, the capabilities delivered by a specific increment may provide only a

partial solution of the ultimate desired capability therefore; the first increment's CDD must provide information regarding the strategy to achieve the full capability. Subsequent increments, leading to the full capability, are also described to give an overall understanding of the program strategy. This strategy is updated with each subsequent increment to reflect lessons learned from previous increments, changes in the warfighting concepts or changes in the integrated architecture.

(3) The CDD describes the operational capability; threat; integrated architectures; required capabilities; program support; supportability; force structure, doctrine, organization, training leadership and education, personnel, and facilities (DOTLPF) impact and constraints; schedule; and program affordability for the system.

(4) The CDD identifies the operational performance attributes (testable or measurable characteristics), in threshold-objective format, necessary for the acquisition community to design a proposed system and establish an acquisition program baseline (APB). The CDD states performance attributes, including key performance parameters (KPPs) that guide the development, demonstration, and testing of the current increment. The performance attributes and KPPs apply only to the current increment. Each increment must provide an operationally effective and useful capability in the intended mission environment that is commensurate with the investment and independent of any subsequent increment.

(5) The CDD articulates the attributes, KPPs, and key system attributes (KSAs) that are further refined in the capabilities production document (CPD). The CDD is updated or appended for each MS B decision.

(6) The CDD format and detailed content instructions are provided in the JCIDS Manual, Appendix A, *Enclosure G*.

c. Capability production document (CPD). The CPD is the Soldier's primary means of providing authoritative and testable capabilities for the Production and Deployment (P&D) phase of an acquisition program. A CPD is finalized after the Post Critical Design Review (CDR) Assessment and is validated and approved prior to the MS C (Low-Rate Initial Production (LRIP) approval) decision. The CPD development is guided by the ICD, CDD, developmental and operational testing results, and the Post CDR assessment. It captures the information necessary to support production, testing, and deployment of an affordable and supportable increment within an acquisition strategy (AS).

(1) The CPD provides the operational performance characteristics necessary for the acquisition community to produce and field a single increment of a specific system. The CPD presents performance characteristics, including KPPs and KSAs, to guide the production and deployment of the current increment. Since a CPD applies to only a single increment of a program's development, the performance attributes, KPPs, and KSAs apply only to the increment described in the CPD. Each increment must provide an operationally effective and useful capability in the intended environment, commensurate with the investment.

(2) The CPD refines the threshold and objective values for performance attributes and KPPs that were validated in the CDD for the production increment. Each production threshold listed in the CPD depicts the minimum performance that the PM is expected to deliver for the increment based on the Post CDR system design. The refinement of performance attributes and KPPs is the most significant difference between the CDD and the CPD.

(3) The CPD is an entrance criteria item that is necessary to proceed to each MS C (LRIP approval) decision. The CPD format and detailed content instructions are provided in the JCIDS Manual, Appendix A, *Enclosure H*.

### **11–12. MCD performance characteristics, KPPs, and KSAs.**

a. The CDD and CPD state the operational and support-related performance attributes of a system that provides the capabilities required by the Soldier - attributes so significant, they must be verified by testing or analysis. The CDD and CPD identify, in threshold-objective format, the attributes that contribute most significantly to the desired operational capability. Whenever possible, attributes are stated in terms that reflect the operational capabilities necessary to operate in the full range of military operations and the environment intended for the system, family-of-systems (FoS), or system-of-systems (SoS). These statements guide the acquisition community in making trades decisions between the threshold and objective values of the stated attributes. Operational testing (OT) assesses the ability of the system to meet the production threshold and objective values.

(1) Each attribute is supported by an operationally oriented rationale. Below the threshold value, the military utility of the system becomes questionable. The objective value for an attribute is the desired operational goal, beyond which any gain in military utility does not, according to the Soldier, warrant additional expenditure.

(2) KPPs are those system attributes considered most essential for an effective military capability. The CDD and the CPD contain a minimum number of KPPs that capture the minimum operational effectiveness and suitability attributes (testable or measurable characteristics) needed to achieve the overall desired capabilities for the system during the applicable increment. Failure to meet a CDD or CPD KPP threshold can result in the reevaluation of the selected system, program reassessment or termination, or the modification of the content of production increments.

(3) KSAs are those system attributes considered most critical or essential for an effective military capability, but not selected as a KPP. KSAs provide decision-makers with an additional level of capability prioritization below the KPP, but with senior sponsor leadership control (generally 4-Star level, defense agency commander, or OSD principal staff assistant).

(4) Net-ready (interoperability compliance) is a required KPP. The NR-KPP assesses information needs, information timelines, information assurance, and net-ready attributes required for both the technical exchange of information and

the end-to-end operational effectiveness of that exchange. The NR–KPP consists of measurable and testable characteristics and/or performance metrics required for the timely, accurate, and complete exchange and use of information to satisfy information needs for a given capability (JROC Memorandum (JROCM) 236–03, 19 December 2003).

(5) A NR–KPP is developed for all information technology (IT) and National Security Systems (NSS) used to enter, process, store, display, or transmit DOD information, regardless of classification or sensitivity. IT and NSS interoperability is defined as the ability of systems, units, or forces to provide data, information, materiel, and services to and accept the same from other systems, units, or forces and to use the data, information, materiel, and services exchanged to enable them to operate effectively together.

(6) The NR–KPP should reflect the information needs of the capability under consideration and the needs of appropriate supported systems. It should cover all communication, computing, and electromagnetic spectrum requirements involving the exchange of products and services between producer, sender, receiver, and consumer for the successful completion of the Soldier mission, business process, or transaction. The NR–KPP identified in CDDs and CPDs will be used in the information support plan (ISP) to identify support required from outside the program.

(7) Protection warfighting function and survivability are congressionally required KPPs for all manned systems and systems designed to enhance personnel survivability in an asymmetric threat environment. The Joint Staff Protection Functional Capability Board (FCB), in coordination with the lead FCB, assess these KPPs and their applicability for Joint Capabilities Board (JCB) Interest and Joint Requirements Oversight Council (JROC) Interest CDDs and CPDs and make a recommendation to the JCB or JROC on validation. The sponsoring component validates the KPPs for non-JCB/JROC Interest CDDs and CPDs. A single KPP can be developed provided it complies with the congressional direction pertaining to protection warfighting function and survivability (JROCM 120–05, 13 June 2005).

(a) Protection warfighting function KPP. Protection warfighting function attributes are those that contribute to the protection of personnel by preventing or mitigating hostile actions against friendly personnel, military and civilian. This may include the same attributes as those that contribute to survivability, but the emphasis is on protecting the system operator or other personnel rather than protecting the system itself.

(b) Survivability KPP. Survivability attributes are those that contribute to the survivability of a manned system. This includes attributes such as speed, maneuverability, detectability, and countermeasures that reduce a system's likelihood of being engaged by hostile fire, as well as attributes such as armor and redundancy or critical components that reduce the system's vulnerability if it is hit by hostile fire.

(8) Sustainment KPP (JROCM 131–06, 29 June 2006). A sustainment KPP (materiel availability) and two mandatory supporting KSAs (materiel reliability and ownership cost) are developed for all JROC Interest programs involving materiel solutions. For non-JCB/JROC Interest programs, the sponsor determines the applicability of this KPP.

(a) Materiel availability is a measure of the percentage of the total inventory of a system operationally capable (ready for tasking) of performing an assigned mission at a given time, based on materiel condition. This can be expressed mathematically as the number of operational end items/total population.

(b) Materiel reliability KSA is a measure of the probability that the system will perform without failure over a specific interval. Reliability must be sufficient to support the warfighting capability needed. Materiel reliability is generally expressed in terms of a mean time between failure (MTBF).

(c) Ownership cost KSA provides balance to the sustainment solution by ensuring that the operations and support (O&S) costs associated with materiel readiness are considered in making decisions.

(9) Selectively applied KPPs. The JROC has defined two KPPs to be selectively applied to programs - system training and energy efficiency. The sponsor will perform an analysis on the use of these parameters as KPPs.

(a) System training KPP ensures system training is addressed in the analysis of alternatives (AoA) and supporting analysis for subsequent acquisition phases and ensures projected training requirements and associated costs are appropriately addressed across the proposed acquisition program life cycle.

(b) Energy efficiency KPP includes fuel efficiency considerations for fleet purchases and operational plans consistent with mission accomplishment. Life-cycle cost analysis will include the fully burdened cost of fuel during the AoA and subsequent analyses and acquisition program design trades.

b. Joint DOTMLPF change recommendation (DCR) document. A joint DCR is a recommendation for changes to existing joint resources when such changes are not associated with a new defense acquisition program. The DCR format and detailed content instructions are provided in the *JCIDS Manual, Appendix A, Enclosure 1*.

## Section IV

### Materiel Requirements Approval

In 2007, the Army revised its warfighting requirements validation and approval process to adjust for rapidly changing technology, constraints on the Army budget, increased sustainment costs, the need to provide a concrete linkage between requirements and resources, and increasing emphasis on joint interoperability. Within the Army, the VCSA approves and the CSA retains veto authority for all warfighting materiel requirements. Requirements meeting specific threshold criteria may be approved by the HQDA DCS, G–3/5/7, in order to facilitate timely processing, if delegated by VCSA.

### 11–13. Army requirements approval

*a.* In order to provide more effective management of the total requirements process for all aspects of Army needs, the requirements process was modified to consolidate all DOTMLPF and policy requirements at HQDA for staffing, validation, and approval. This process ensures that the Army pursues requirements that can compete for and retain resources that are tied to the future Army and joint visions and goals. The changes to the current Army CIDS are evolutionary. The process places increased emphasis on analysis of the requirement, potential alternatives, affordability and joint interoperability. The goal is to evaluate all DOTMLPF requirements, regardless of origin, against the goals, vision and needs of the current and future force. The lead organization for the implementation of the JCIDS process, within the Army is the DCS, G–3/5/7.

*b.* Within the DCS, G3/5/7, the Current and Future Warfighting Capabilities Division (DAMO–CIC), is the single entry point for all Army and joint DOTMLPF requirements. DAMO–CIC is the proponent for policy development, Army CIDS process oversight, and interface with the JCIDS process. Within DAMO–CIC, the requirements staff officer (RSO) is directly responsible for leading HQDA staff integration and coordination efforts for all Army and joint DOTMLPF requirements issues. The RSO coordinates with his/her HQDA DCS, G–8 counterpart, the synchronization staff officer or system synchronization officer (SSO), to facilitate the transition from capabilities-based requirements development and approval to requirements solutions (execution and resourcing).

### 11–14. Cost-benefit analysis (C–BA)

*a.* On December 30, 2009, the Army senior leadership directed that any decisions involving Army resources be supported by a C–BA. Each unfunded requirement and new or expanded program proposal submitted to the Secretary of the Army (SA), Chief of Staff Army (CSA), Under Secretary of the Army (USA) or Vice Chief of Staff Army (VCSA), must be accompanied by a thorough C–BA. The C–BA must identify the total cost of the proposal, the benefits that will result, the bill-payers that would be used to pay for it, and the second and third level effects of the funding decision. A C–BA enables Army senior leaders and managers to make better resource-informed decisions.

*b.* C–BAs make the case for a project or proposal weighing the total expected costs against the total expected benefits over the near-term, far-term, and life-cycle timeframes from an Army enterprise perspective, which means that initiatives should be evaluated based on the benefits they provide to the Army as a whole, not to any individual organization. Army elements are connected organizationally and what happens even at the lowest levels within the Army can impact/influence higher level organizations.

*c.* A C–BA is a structured methodology of forecasting and comparing the anticipated costs and benefits of alternative courses of action (COAs) in order to identify the most effective manner of achieving a stated goal or objective. A C–BA is weighing the consequences, both good and bad, of potential actions.

*d.* All C–BAs provide decision-makers with facts, data, and analysis required to make an informed decision. In its most basic form, the C–BA is a tool to support resource informed decision-making. There is no prescribed length to a C–BA. All that is required is that it fully supports the recommendation. Therefore, quality is genuinely more important than quantity. C–BAs are reviewed and approved by the Deputy Assistant Secretary of the Army for Cost and Economics (DASA(CE)) before submission to the Army senior leadership.

*e.* In today’s resource-constrained environment, the Army must exercise wise stewardship of every dollar it manages. A key element in that stewardship is to develop and use sound C–BA practices throughout all requirement/resourcing processes. For every proposed requirement, program, initiative or decision point that is presented to decision-makers, it is important to provide an accurate and complete picture of both the costs to be incurred and the benefits to be derived.

### 11–15. Army Requirements Oversight Council (AROC)

*a.* The AROC was created in 2001 to provide a concrete linkage and synchronization between required capabilities and resources. The AROC, coordinated by DCS, G–3/5/7, Current and Future Warfighting Capabilities Division (DAMO–CIC), is responsible for advising the CSA/VCSA in the assessment and prioritization of capabilities integrated across DOTMLPF to include the disposition of materiel capabilities documents (MCDs). DAMO–CIC schedules and executes the AROC forum. TRADOC’s Army Capabilities Integration Center (ARCIC) continues to be responsible for the balanced development of concepts, capabilities (requirements), and products in DOTMLPF.

*b.* The AROC process is used to validate and approve:

(1) proposals for rapid insertion of technologies to address current capability needs when the solution extends into the Program Objective Memorandum (POM); and

(2) strategies to resolve capability gaps and resultant changes to modernization programs and plans.

*c.* The AROC validates all JCIDS documents prior to submission to the Joint Staff, JCIDS “gatekeeper”- Deputy Director, Requirements, J–8. This encompasses all JCIDS efforts including Army annexes to joint and other service MCDs and those where an Army proponent has been designated as a joint CAPDEV.

*d.* The AROC reviews JCIDS documentation for:

(1) Military need and risk. The AROC reviews and provides decisions and guidance on the capability gaps identified

in JCIDS proposals presented for validation and approval. This ensures identified gaps are linked with modernization investment priorities essential for maintaining land force dominance.

(2) Synchronization with Army and joint modernization strategies. The AROC validates that the recommended strategies to resolve capability gaps, including associated DOTMLPF changes, are consistent with Army modernization strategies. Proposals must contribute to a balanced and synchronized modernization program. The AROC reviews how the recommended strategies fit into related joint concepts, force modernization strategies and investment portfolios to ensure interoperability and synergy.

(3) Estimated program affordability. The AROC reviews the affordability, based on the DASA(CE) approved C-BA, of all proposed solutions to capability gaps and programs presented to ensure that, if pursued, they are within budgeting and programming limits for development, procurement and sustainment. The AROC considers “trades” of capability and/or performance versus cost to ensure only affordable solutions are pursued. Affordability includes potential long term supportability requirements for the concept or system.

(4) Capability definition and interoperability. The AROC ensures that the operational definition of the capability gap and the proposed solution is clear and consistent with Army and joint warfighting concepts. Key performance parameters (KPPs), and key system attributes (KSAs), serve as the pivot for AROC risk deliberations on operational improvements versus costs to field a capability at the appropriate time and in the appropriate quantities. Opportunities to integrate other service programs or alternate technologies to improve joint interoperability are also addressed in the AROC presentation.

*e.* The AROC consists of the following permanent principal members:

- (1) Vice Chief of Staff, Army (Chair)
- (2) Military Deputy, Office of the Assistant Secretary of Army (Acquisition, Logistics, and Technology)
- (3) Chief Information Officer (CIO)/Deputy Chief of Staff, G-6
- (4) Deputy Chief of Staff, G-1
- (5) Deputy Chief of Staff, G-2
- (6) Deputy Chief of Staff, G-3/5/7 (Secretary)
- (7) Deputy Chief of Staff, G-4
- (8) Deputy Chief of Staff, G-8
- (9) Director, Army Capabilities Integration Center (ARCIC)
- (10) Deputy Assistant Secretary of the Army, Cost & Economics
- (11) CG, Army Test and Evaluation Command (ATEC).

*f.* The Director of the Army Staff (DAS); Assistant Deputy Under Secretary of the Army, Test and Evaluation; the Military Deputy (MILDEP) to the Assistant Secretary of Army (Financial Management & Comptroller); Chief, Army Reserve; Chief, Army National Guard; Director, Force Development (DCS, G-8); Director, Program Analysis and Evaluation (DCS, G-8); and Director, Capabilities Integration, Prioritization, and Analysis (DCS, G-3/5/7, G-37) are permanent advisors.

*g.* The AROC Process Review Board (APRB) serves as the AROC intermediate review body inserted prior to and immediately following the initial staffing of JCIDS proposals and as required, to review and comment on other documentation, analysis, or actions. The APRB ensures topics are suitable and mature, in accordance with AROC objectives. Also, it determines the required method of presentation for approval of the submission (formal or paper AROC).

(1) The APRB meets weekly, or as required, to manage workload and ensure “value added” without unnecessarily slowing the Army CIDS staffing process. The meeting date, time, and location supports an orchestrated staff battle rhythm and provides efficiency to the overall process by ensuring document readiness and identification of special coordination requirements prior to flag-level (1-Star) staffing, resolution of complex issues across the ARSTAF prior to moving the document into the AROC for review, and providing situational awareness to senior leaders for issues not resolved or jeopardizing successful staffing/review.

(2) The APRB is co-chaired by the Chief, Current and Future Warfighting Capabilities Division DCS, G-3/5/7 (G-37); a Colonel/GS-15 representative from the DCS, G-8, Force Development Directorate, and a Colonel/GS-15 representative TRADOC ARCIC. The APRB is composed of representatives of the AROC principals and permanent advisors. Other ARSTAF elements and external organizations provide subject matter expertise as required. The APRB makes recommendations to and executes the decisions of the AROC Secretary - DCS, G-3/5/7.

*h.* The AROC may not review all Army requirements. Approval of selected JCIDS proposals may be delegated to the DCS, G-3/5/7 by the VCSA. Disapproval authority remains at the VCSA level. In addition, a “paper AROC” may be used, at the discretion of the AROC chair, to staff non-contentious issues. The VCSA/CSA receives a copy of all approved issues by the DCS, G-3/5/7.

## **11-16. Army requirements approval process**

*a.* The process of obtaining validation and approval of JCIDS proposals begins with the submission of a proposal by the TRADOC ARCIC JCIDS Gatekeeper into the Capabilities and AROC Management System (CAMS) database. CAMS is the HQDA DCS, G-3/5/7 database driven knowledge management decision support information technology



## How the Army Runs

system. CAMS supports AROC document staffing and commenting from numerous users and organizations within the Army into a centralized database repository. The system allows users to view document information and monitor document progress through AROC validation until submission to the Joint Staff (JS) staffing and approval process. Staffing continues until the document is validated and approved.

b. All JCIDS proposals are entered into CAMS by the ARCIC gatekeeper. The ARCIC gatekeeper acts as the entry and exit point for all JCIDS capability documents forwarded by TRADOC and non-TRADOC proponents for validation and other service capability documents sent to ARCIC for review. The gatekeeper manages the TRADOC staffing of the JCIDS capability documents and loads ARCIC validated and CG, TRADOC endorsed capability documents into the CAMS database for AROC/JCB/JROC validation and approval. Submission of the proposal will trigger the Army gatekeeper process. The JCIDS proposal will be subjected to HQDA staffing and coordination. All proposals undergoing the review process are considered draft until after they are validated and/or approved by the designated validation authority.

c. All Army sponsored JCIDS proposals are submitted for HQDA JCIDS gatekeeper review, to determine accuracy and completeness. Based on the content of the proposal, the gatekeeper will assign the proposal to the functional requirements staff officer (RSO) and initiate Army staffing utilizing CAMS as the staffing tool.

d. The HQDA JCIDS staffing process includes the APRB, flag-level (1–Star) initial staffing, and flag-level (3–Star) AROC principal/advisor review phases. The Army validation process optimally takes 95 to 110 business days.

e. At the conclusion of the AROC validation process, the Army JCIDS gatekeeper enters the document into the Knowledge Management/Decision Support (KM/DS) web-based staffing tool for Joint Staff (JS) staffing.

f. The HQDA JCIDS gatekeeper signals completion of Army and joint staffing, validation, and approval by publishing the DCS, G–3/5/7 approval memorandum with a Catalog of Approved Requirement Documents (CARDS) reference number. The CARDS reference number signifies an approved Army materiel requirement.

### 11–17. Joint requirements approval process

a. The process of obtaining validation and approval of JCIDS documents begins with the submission of a materiel capability document (MCD) proposal to the JS, J–8 Knowledge Management/Decision Support (KM/DS) tool and continues until the document is validated and approved by the appropriate authority. The details of the process are presented in sub-paragraphs b, c, and d.

b. Services, combatant commands, and other DOD organizations conducting a JCIDS CBA analyses (see para 5–7) may generate ideas and concepts leading to draft ICDs, CDDs, CPDs, and joint DCRs. Also JCIDS initiatives may be generated within a JS Functional Capabilities Board (FCB) as a result of analyses conducted by, or in support of the FCB. As the initiative develops into proposed DOTLmPF or materiel solutions to provide the desired capabilities, a FCB may task a lead service or component with sponsoring the initiative. Further development of the proposal would then become the responsibility of the sponsor. The FCB is responsible for the organization, analysis, and prioritization of joint warfighting capability needs within assigned functional areas. The FCB is an advisory body to the JCB and the JROC for JCIDS initiatives assigned with joint potential designators (JPDs) of JCB Interest or JROC Interest.

c. All JCIDS documents (ICDs, CDDs, CPDs, and DCRs) are submitted to the JS, J–8 KM/DS tool by the sponsoring component. Submission of the document to the KM/DS tool triggers the JS and the gatekeeper process to determine whether the document has joint implications or is sponsor unique. Normally, the document has undergone an appropriate sponsor staffing process before submission to the JS J–8 KM/DS tool.

d. The Gatekeeper. The JS J–8 Deputy Director, Requirements, serves as the “gatekeeper” of the JCIDS process. The “gatekeeper”, with the assistance of the JS J–8 Requirements Management Division (RMD), and JS J–6 Requirements and Assessments Division (RAD), evaluate all JCIDS documents submitted through the J–8 KM/DS tool database.

(1) JCIDS documents are submitted for gatekeeper review to determine whether the proposal affects the joint force. The gatekeeper review is conducted for each document regardless of potential acquisition category (ACAT), previous delegation decisions, or previous JPD decisions.

(2) An ACAT is designated as ACAT I, II, or III when the materiel requirement and manner of acquisition have been identified. *Title 10, Section 2430*, identifies dollar criteria for determining the ACAT of a potential program. The ACAT designation determines the level of review, and who will make the milestone decisions. The three acquisition categories are defined in figure 11–3A and 11–3B.

(3) Based on the content of the submission, the “gatekeeper” assigns a JPD of JROC Interest, JCB Interest, Joint Integration, Joint Information, or Independent to the ICD, CDD, CPD or DCR submitted via the KM/DS tool.

## Major Defense Acquisition Programs (MDAPs)

<u>Program Category</u>	<u>Primary Criteria</u> \$ = FY00 Constant
<b>Title 10 Sect #2430</b>	
<b><u>ACAT I</u> *</b>	
<b><u>ACAT ID</u></b>	RDTE > \$365M <u>or</u> PROC > \$2.19B
<b><u>ACAT IC</u></b>	(PEO / PM Managed)
<b><u>ACAT IA</u></b>	
<b><u>ACAT IAM</u></b>	FY Program Costs > \$32M <u>or</u> Total Program Costs > \$126M <u>or</u> Total LifeCycle Costs > \$378M
<b><u>ACAT IAC</u></b>	(PEO / PM Managed)
<div style="display: flex; justify-content: space-between;"> <div style="width: 45%;"> <p><b>Technology Transition Mechanisms to MS B Pre ACAT Technology Projects</b></p> </div> <div style="width: 50%;"> <p>* Acquisition Information Management (AIM) Database</p> </div> </div>	
* JCTDs: Joint Capabilities Technology Demonstrations	ACAT: Acquisition Category
* JWEs: Joint Warfighting Experiments	C: Component
	D: Defense Acquisition Board
	IAM: Major Automated Information System
	MS: Milestone

Figure 11-3A. Acquisition categories (ACATS)

## Major Systems

<u>Program Category</u>	<u>Primary Criteria</u> \$ = FY00 Constant
<b><u>ACAT II</u></b>	
<b><u>ACAT II</u></b>	RDTE > \$140M <u>or</u> PROC > \$660M
<b><u>Non - Major Systems</u></b>	
<b><u>ACAT III</u></b>	All acquisition programs that are not classified as an MDAP or Major System (ACAT I or II) (Includes less than major AISs)
<b><u>ACAT III</u></b>	
	AIS: Automated Information System
	MDAP: Major Defense Acquisition Program

Figure 11-3B. Acquisition categories (ACATS)-continued

(a) JROC Interest - This designation applies to all potential ACAT I/information assurance programs where the capabilities have a significant impact on joint warfighting or have a potential impact across services or interoperability in allied and coalition operations. All joint DCRs will be designated as JROC Interest. A JPD of JROC Interest will be presumed for all capabilities documents within the following Joint Capability Area (JCA) portfolios: Battlespace Awareness; Command and Control; Logistics; and Net-Centric. Also, it may apply to intelligence capabilities that support DOD and national intelligence requirements. Capability documents designated as JROC Interest will be staffed through the JROC for validation and approval. An exception may be made for ACAT IAM programs without significant impact on joint warfighting (such as business-oriented systems). These programs may be designated Joint Integration, Joint Information, or Independent.

## How the Army Runs

(b) JCB Interest - This designation applies to all potential ACAT II and below programs where the capabilities and/or systems associated with the document affect the joint force and an expanded joint review is required. These documents will receive all applicable certifications, including a weapon safety endorsement when appropriate, and be staffed through the JCB for validation and approval.

(c) Joint Integration - This designation applies to potential ACAT II and below programs where the capabilities and/or systems associated with the document do not significantly affect the joint force and an expanded review is not required. Staffing is required for applicable certifications (information technology and National Security Systems (NSS) interoperability and supportability and/or intelligence) and for a weapons safety endorsement when appropriate. All weapons and munitions will be designated Joint Integration as a minimum. Once the required certification(s)/weapons safety endorsement are completed, the document may be reviewed by the FCB. Joint Integration documents are validated and approved by the sponsoring component.

(d) Joint Information - This designation applies to potential ACAT II and below programs that have interest or potential impact across the services or defense agencies, but do not have significant impact on the joint force and do not reach the threshold for JCB Interest or JROC Interest. No certifications or endorsements are required. Once designated Joint Information, staffing is required for informational purposes only and the FCB may review the document. Joint Information documents are validated and approved by the sponsoring component.

(e) Independent - This designation applies to potential ACAT II and below programs, where the capabilities and/or systems associated with the document do not significantly affect the joint force, an expanded review is not required, and no certifications or endorsements are required. Once designated Independent, the FCB may review the document. Independent documents are validated and approved by the sponsoring component.

(4) The JS J-8, using the KM/DS tool, maintains a database of JCIDS documents processed through the gatekeeper function. The database includes the JPD as defined above; which FCBs have equity in the proposal (if any); and the lead FCB for the proposal (if any). The database helps to ensure consistency of staffing as JCIDS proposals progress through the JCIDS process.

(5) Once the JPD has been assigned, the document moves into the staffing and approval process.

e. Staffing process. The JS J-8 RMD staffs all JCB Interest and JROC Interest proposals before FCB review. During the review process, the FCB evaluates how well the proposed solution documented in an ICD, CDD, or CPD addressed the capability needs identified in the JCIDS CBA analyses.

f. Certifications and Weapon Safety Endorsement. Applicable certifications and the weapon safety endorsement will be processed as part of the staffing process for each JCIDS document. If a certification/endorsement authority determines the content is insufficient to support a required certification/endorsement, it is the sponsor's responsibility to resolve the issue with the certification/endorsement authority. If resolution cannot be achieved, the sponsor may request a review of the issue by a higher authority.

(1) Threat Validation and Intelligence Certification - JS, J-2.

(a) Threat Validation. For all Joint Integration, JCB Interest, and JROC Interest ICDs, CDDs, and CPDs, the Defense Intelligence Agency (DIA) provides validation of threat information appropriate to the proposal through the intelligence certification process. DOD components may validate intelligence information for programs designated as Joint Information or Independent proposals using DIA-validated threat data and/or data contained in DOD Service Intelligence Production Program products and data.

(b) Intelligence Certification. JS J-2 provides intelligence certification as a part of the JCIDS staffing of ICDs, CDDs, and CPDs, regardless of ACAT level, unless a waiver has been granted by the JS J-2. J-2 will assess intelligence support needs for completeness, supportability, and impact on joint intelligence strategy, policy, and architectural planning. The JS J-2 certification will also evaluate intelligence-related information systems with respect to security and intelligence interoperability standards.

(2) Information Technology (IT) and National Security System (NSS) Interoperability and Supportability Requirements Certification - JS, J-6. The J-6 certifies all CDDs and CPDs designated as JROC Interest, JCB Interest or Joint Integration for conformance with joint IT and NSS policy.

(3) Weapon Safety Endorsement. The JS J-8 Deputy Director, Protection warfighting function (DDFP), provides a weapon safety endorsement coordinated through the Protection warfighting function Functional Capabilities Board (FCB) as part of the JCIDS staffing of ICDs, CDDs, CPDs, and DCRs regardless of ACAT. A weapon safety endorsement is the means for documenting the extent to which weapon capabilities documents provide for safe integration into joint warfighting environments. Endorsement recommendations are prepared by the Joint Weapon Safety Technical Advisory Panel (JWSTAP) and submitted to the JS J-8 DDFP for appropriate staffing and coordination with the FP FCB. The endorsement will indicate that required joint warfighting environment attributes and performance parameters, from a weapon safety perspective, are judged to be adequately prescribed in the ICD, CDD, CPD, or DCR. Also, the endorsement may convey identified limitations in the prescribed attributes or performance parameters that are deemed acceptable from a weapon safety perspective, yet foreseen as potential military utility hindrances or joint operation limitations. If the weapon safety endorsement identifies restrictions/limitations, the sponsor will coordinate with the FP FCB for resolution or acceptance of the restrictions/limitations.

## 11–18. Capability portfolio reviews (CPRs)

a. On 22 February 2010, the SA directed the USA and the VCSA to implement a one-year CPR pilot process to conduct an Army-wide, all components revalidation of the operational value of Army requirements within and across capability portfolios to existing joint and Army warfighting concepts. The intent of this revalidation is to eliminate redundancies and to ensure that funds are properly programmed, budgeted, and executed against the programs that yield the most value to the Army.

b. Pilot CPRs focused on 2 categories - materiel CPRs and non-materiel CPRs. Materiel CPRs include Tactical Wheeled Vehicles; Precision Fires; Air and Missile Defense; Combat Vehicle Modernization; Radios; The Network; Engineer; Soldier Systems; Intelligence, Surveillance, and Reconnaissance (ISR); Aviation (Rotary, Fixed, Unmanned Aircraft System (UAS)); Information Technology; and Training Ammunition. Non-materiel CPRs include Installation Management; Work Force Composition; Army Training Strategy; Sustainment Accounts; and organizational Structure.

c. The review process revalidates the requirement in each portfolio using a wide-range of criteria, including: combatant commander requests; wartime lessons learned; the ability to support the ARFORGEN model; the potential for leveraging emerging technologies and affordability.

d. The output of the two-phased (session) pilot CPR process was actionable recommendations to the SA to make decisions that established Army FY 12–16 Program Objective Memorandum (POM) priorities for investment in research and development, acquisition, and life-cycle sustainment, to include force structure and training across each Army capability portfolio. HQDA, DCS G–3/5/7 is the lead agency for CPR coordination and synchronization.

(1) Phase #1: The VCSA chairs session #1. The purpose is revalidation of the operational value of Army requirements to include cost, schedule, performance, life-cycle sustainability and the Army’s plan to manage the totality of the requirement. The product is actionable recommendations that can be addressed by Army senior leadership during phase 2.

(2) Phase #2: The USA, as the Army Chief Management Officer, chairs session #2. The purpose is to address follow-on analysis from phase #1 and the programmatic (cost, schedule, performance, life-cycle sustainment) implications of the recommendations presented. The product was actionable recommendations to the SA to validate, modify, or terminate research and development (R&D) investment, procurement, and/or life-cycle sustainment requirements within capability portfolio accounts for POM 12–16 based on the results of the CPRs.

e. The analysis that has resulted from the CPRs conducted under the pilot program has clearly highlighted the utility of this new process in building an effective and affordable modernization strategy. The resulting recommendations will continue to assist the SA in establishing future priorities for investment, research, development, acquisition, and life-cycle sustainment. The SA will continue to rely on this process to help him make informed decisions on behalf of the Army.

f. CPR’s operate concurrently with, but do not supplant the authority of the Army Requirements Oversight Council (AROC), Army System Acquisition Review Council (ASARC), or Configuration Steering Board (CSB).

## Section V

### Materiel Systems Acquisition

The Defense Acquisition System (DAS) establishes a management process to translate user needs (broadly stated functional high risk capability gaps developed in the JCIDS or business needs responding to new ways of doing business), and technological opportunities (developed or identified in the S&T program based on user needs), into reliable and sustainable systems that provide capability to the user.

## 11–19. DOD system acquisition policy

a. The basic policy is to ensure that acquisition of Defense systems is conducted efficiently and effectively in order to achieve operational objectives of the U.S. Armed Forces in their support of national policies and objectives within the guidelines of the *Office of Management and Budget (OMB) Circular A–11, part 3: Major System Acquisitions*. *DOD Directive 5000.01: The Defense Acquisition Management System*, *DOD Instruction 5000.02: Operation of the Defense Acquisition Management System*, and a guidebook containing additional supporting discretionary, best practices, lessons learned, and expectations posted to the Defense Acquisition Portal at <http://dag.dau.mil>, are the documents that provide the DOD guidance for system acquisition policy and procedures. *AR 70–1* provides Army acquisition policy for materiel and information systems. These documents establish an integrated management framework for a single, standardized DOD-wide acquisition system that applies to all programs including highly sensitive, classified programs. “Tailoring” is encouraged in the process to reflect specific program needs. In accordance with *DODD 5000.01*, “There is no *one* best way to structure an acquisition program to accomplish the objective of the Defense Acquisition System.” The essential features of the DOD materiel acquisition system are:

- (1) a clear acquisition strategy (AS).
- (2) a thorough program plan.
- (3) risk management techniques.
- (4) systematic program tracking against the plan.

b. An acquisition program is defined as a directed, funded effort designed to provide a new, improved or continuing

weapon system or information technology (IT) system capability in response to a validated operational need. Acquisition programs are divided into three acquisition categories (ACATs), which are established to facilitate decentralized decision-making, execution, and compliance with statutory and regulatory requirements. Acquisition phases provide a logical means of progressively translating broadly stated mission needs into well-defined system-specific requirements and ultimately into operationally effective, suitable, and survivable systems. All the tasks and activities needed to bring the program to the next milestone (MS) occur during acquisition phases. A MS is the major decision point that initiates the next phase of an acquisition program. Major defense acquisition program (MDAP) milestones may include, for example, the decisions to begin technology development, or to begin low-rate initial production (LRIP).

**11–20. Materiel systems acquisition management**

a. In the broad sense, the event driven materiel DAS consists of a series of management decisions made within DOD or the services as the development of a materiel system progresses from a stated materiel requirement to a fielded system. Product improvements (PIs) to existing systems or acquisition of nondevelopmental items (NDI), usually occur through acquisition streamlining. The system that is used is shown in figure 11–4. A key aspect of the process is that it is divided into three distinct activities (pre-systems acquisition, systems acquisition, sustainment); five phases (materiel solution analysis, technology development, engineering and manufacturing development, production and deployment, and operations and support); and six work efforts (integrated system design, system capability and manufacturing process demonstration, low-rate initial production (LRIP), full-rate production (FRP) and deployment, sustainment, and disposal). Entry into the DAS is at one of the formal milestones (MS) decision points dependent on the appropriate Materiel Development Decision (MDD).

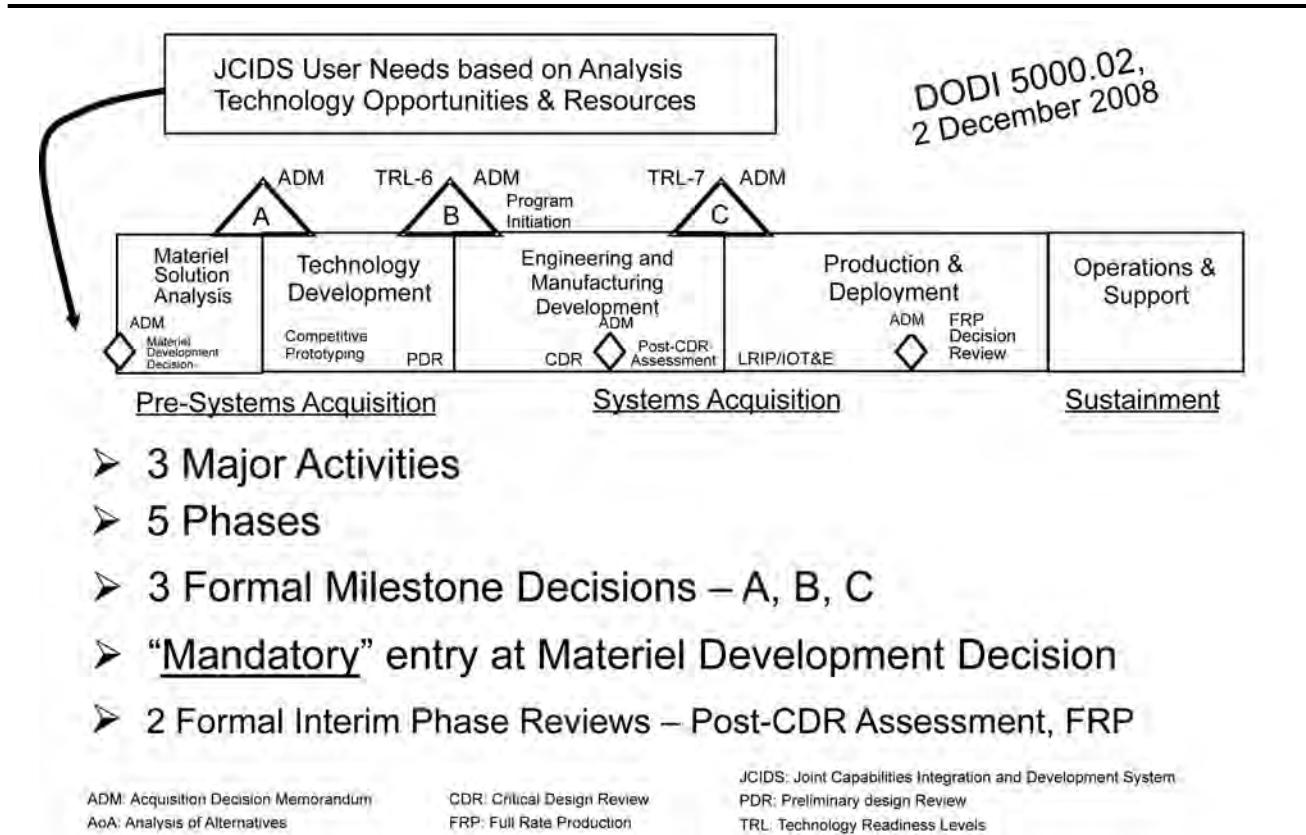

- 3 Major Activities
- 5 Phases
- 3 Formal Milestone Decisions – A, B, C
- “Mandatory” entry at Materiel Development Decision
- 2 Formal Interim Phase Reviews – Post-CDR Assessment, FRP

**Figure 11–4. Defense Acquisition System**

*b.* Key policies and principles governing the operation of the DAS are (*DODD 5000.01*):

(1) Flexibility. There is no *one* best way to structure an acquisition program to accomplish the objective of the DAS. Milestone decision authorities (MDAs) and PMs tailor program strategies and oversight, including documentation of program information, acquisition phases, the timing and scope of decision reviews, and decision levels, to fit the particular conditions of that program, consistent with applicable laws and regulations and the time-sensitivity of the capability need.

(2) Responsiveness. Advanced technology is integrated into producible systems and deployed in the shortest time. Approved, time-phased capability needs matched with available technology and resources, enable evolutionary acquisition strategies. Evolutionary acquisition strategies are the preferred DOD approach to satisfying operational needs.

(3) Innovation. Throughout DOD, acquisition professionals continuously develop and implement initiatives to streamline and improve the DAS. MDAs and PMs examine and, as appropriate, adopt innovative practices (including best commercial practices), that reduce life-cycle time and cost, and encourage teamwork.

(4) Discipline. PMs manage programs consistent with statutory and regulatory requirements. Every PM establishes program goals for the minimum number of cost, schedule, and performance parameters that describe the program over its life-cycle. Approved acquisition program baseline (APB) parameters serve as program control objectives. PMs identify deviations from approved APB parameters and exit criteria.

(5) Streamlined and effective management. Responsibility for the acquisition of systems is decentralized to the maximum extent practicable. The MDA provides a single individual with sufficient authority to accomplish MDA approved program objectives for development, production, and sustainment. The MDA ensures accountability and maximizes credibility in cost, schedule, and performance reporting.

*c.* Technology projects (e.g., JCTDs, Joint Warfighting Experiments (JWEs), concept development, and capabilities development), are efforts that occur prior to acquisition program initiation. These are referred to as pre-ACAT technology projects. The MDA for projects which will likely result in a major defense acquisition program (MDAP), if successful, will be the Under Secretary of Defense, Acquisition, Technology, and Logistics (USD(AT&L)).

*d.* The DAS is initiated as a result of output—approved warfighting materiel capabilities-based requirements—from the JCIDS process. Identified warfighting requirements are first assessed to determine if they can be satisfied by non-materiel solutions. Non-materiel solutions include changes in doctrine, organization, training, leadership and education, personnel, and facilities (DOTLPPF) and policy. If these non-materiel solutions do not satisfy the deficiency, a new materiel development program is initiated.

## 11–21. Acquisition strategies and program plans

*a.* The acquisition strategy (AS) is the framework (roadmap) for planning, directing, and managing an acquisition program to satisfy an approved materiel requirement. Acquisition strategies and their supporting program plans are tailored to accomplish established program objectives and to control risk. Also, they must provide the information essential for milestone decisions. In this regard, ASs are event-driven and explicitly link major contractual commitments and milestone decisions to demonstrated accomplishments in development and testing.

*b.* Evolutionary acquisition. Evolutionary acquisition is DOD's preferred strategy for rapid acquisition of a mature technology for the user. An evolutionary approach delivers capability in increments recognizing, up front, the need for future capability improvements. The success of the strategy depends on the consistent and continuous definition of capabilities-based requirements and the maturation of technologies that lead to disciplined development and production of systems that provide increasing capability towards a materiel concept.

*c.* Program plans provide for a systems engineering approach to the simultaneous design of the product and its associated manufacturing, test, and support processes. This concurrent engineering approach is essential to achieving a careful balance among system design requirements (for example, operational performance, producibility, reliability, maintainability, logistics and human factors engineering, safety, survivability, interoperability, and standardization). Maximum practicable use is made of commercial and other NDI. The Army's first preference is to use performance specifications; the next is to use non-government standards (NGS); and as a last resort, military specifications and standards (MILSPECs/STDs) may be used. Use of MILSPECs/STDs requires a waiver from the MDA. Additionally, changes to *DODI 5000.02* state that the AS should be tailored to the extent feasible to employ commercial practices when purchasing commercial products or other NDI.

*d.* Cost as an independent variable (CAIV). CAIV is the DOD cost reduction methodology utilized throughout the entire life-cycle of a programs acquisition process, to ensure operational capability of the total force is maximized for the given modernization investment. In other words, cost is treated as an independent variable along with others used to define a system. CAIV directly impacts the preparation of a program's materiel capabilities documents (ICDs/CDDs/CPDs), as well as acquisition documents (AS and APB).

### 11–22. Environmental considerations

Environmental impact is always considered in Defense acquisitions. *The National Environmental Policy Act (NEPA) of 1969*, mandates analysis of potential environmental effects of proposed federal actions. For materiel acquisitions, *NEPA* applies to all “new starts”, SLEP, P3I, and block modifications in all ACATs. *NEPA* analysis begins during the DAS Technology Development (TD) phase and continues through the system capability and manufacturing process demonstration, and low-rate initial production work efforts, accounting for all direct, indirect, and cumulative environmental impacts. *NEPA* compliance is key to support production, testing, and fielding of the system, as well as ensuring the system can be operated, maintained and sustained throughout the remainder of its life-cycle. The *NEPA* documentation process can be lengthy and costly, but environmental issues and concerns represent a risk to the program that must be managed. Inadequate environmental analyses can lead to dramatic increases to overall program costs, and can delay testing and fielding schedules, and may produce a system that cannot be operated or maintained at the location where Soldiers need it most. Early consideration of environmental impacts and *NEPA* requirements help protect not only the environment, but helps ensure a well-trained, protected Soldier.

### 11–23. Risk assessments and management

Program risks and risk management plans are explicitly assessed at each milestone decision point prior to granting approval to proceed into the next acquisition phase. Risks must be well understood, and risk management approaches developed, before MDAs can authorize a program to proceed into the next phase of the acquisition process. To assess and manage risk, materiel developers (MATDEVs) use a variety of techniques. They include TDs, prototyping, and T&E. Risk management encompasses identification, mitigation, and continuous tracking and control procedures that provide feedback through the program assessment process to decision authorities. PMs and MATDEVs develop a contracting approach appropriate to the type system being developed and acquired.

## Section VI

### DOD Acquisition Organization and Management

#### 11–24. DOD System Acquisition Management

a. The Under Secretary of Defense for Acquisition, Technology and Logistics (USD(AT&L)), is the senior procurement executive and the principal staff assistant and adviser to the Secretary of Defense (SECDEF) and takes precedence in DOD for all matters relating to the DAS - research and development; test and evaluation; production; logistics; command, control, and communications; and intelligence activities related to acquisition, military construction, and procurement.

b. The USD(AT&L) serves as the Defense Acquisition Executive (DAE) with responsibility for supervising the performance of the entire DAS in accordance with the laws, Congressional guidance and direction, and *OMB Circular No. A–11, part 3*. The DAE establishes policy for all elements of DOD for acquisition. The basic policies of the DAE are established and implemented by *DODD 5000.01 and DODI 5000.02*. The DAE serves as the chairman of the Defense Acquisition Board (DAB) and Information Technology Acquisition Board (ITAB), assisted by the overarching integrated product teams (OIPTs) that relate to the acquisition process. As the DAB chairman, the DAE recommends to the SECDEF acquisition resource matters and other acquisition management matters required to implement acquisition milestone decisions. A clear distinction exists between responsibility for weapon systems acquisition and budgetary authority. While the DAE, as DAB/ITAB chairman, makes recommendations whether to proceed with plans to acquire major materiel systems, the Senior Leader Review Group (SLRG), chaired by the Deputy Secretary of Defense (DEPSECDEF), makes budgetary recommendations on the same programs. Acquisition programs must operate within the parameters established by the SLRG and the SECDEF through the Planning, Programming, Budgeting, Execution (PPBE) process.

#### 11–25. Organizational linkage

The managerial process of transforming a materiel requirement into a fielded and supported system consisting of hardware, software, and personnel is conducted by various organizational structures in DOD and the services responsible for RDA. Figure 11–5 shows the primary elements involved for the Army, including the linkage between the Defense community, industry, and academia. The arrows in the figure depict the flow of business in the process of this transformation.

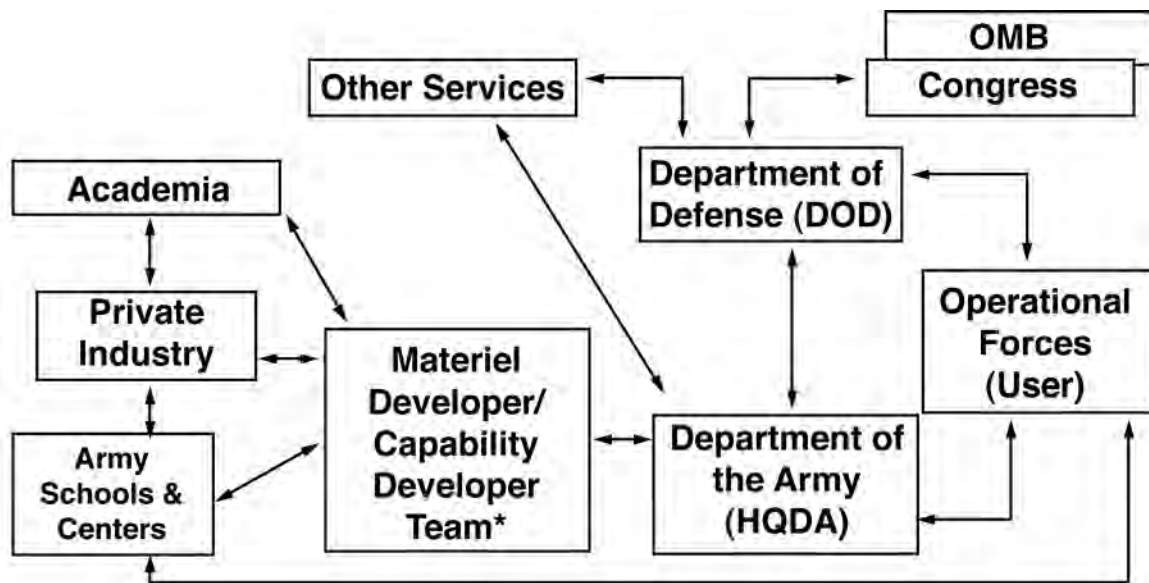

\* Materiel Developer Includes Program Executive Officers (PEOs) and Program, Project, Product Managers (PMs). The Army's primary Capability Developer (CAPDEV) is U.S. Army Training and Doctrine Command (TRADOC), Army Capabilities Integration Center (ARCIC), TRADOC CoE Capability Development and Intergration Directorate (CDIDs), Integrated Capabilities Development Teams (ICDTs) and Integrated Product Teams (IPTs) support the MATDEV/CAPDEV Team.

Figure 11-5. Organizational linkage for Army materiel acquisition

### 11-26. Defense Advanced Research Projects Agency (DARPA)

DARPA is a unique organization and management tool of the SECDEF. It consists of a mix of military and civilian scientists and engineers, and has a broad charter to conduct advanced research that fills research and development (R&D) gaps between service lines of responsibility or handles high priority problems that cross service lines. DARPA's purpose is to review ongoing R&D, determine whether or not the concept is feasible, determine its usefulness, and transfer it to the appropriate service. DARPA does not have its own in-house research facilities and relies on the services and other government agencies for technical and administrative support. Once a decision to support a research proposal is made, responsibility for contracting is generally assigned to one of the services. Examples of past DARPA contributions include the M-16 rifle, Air Force F-117 Tactical Fighter (Stealth Fighter), Unmanned Aircraft System (UAS), and the Advanced Research Projects Agency (ARPA) Net (current Internet).

### 11-27. Defense Acquisition University (DAU)

The DAU is a corporate university that includes the Defense Systems Management College (DSMC). Its operation and structure is designed to be similar to a state university with many campuses each specializing in certain acquisition disciplines. *The Defense Acquisition Workforce Improvement Act (DAWIA)* required the formation of the DAU with operation commencing in 1992.

### 11-28. Defense Systems Management College (DSMC)

a. The DSMC is the USD(AT&L) institution for ensuring the up-to-date training of military and civilian professionals in the management of materiel acquisition programs in DOD. The *DAWIA* required the establishment of a senior course for personnel serving in critical acquisition positions (CAPs), which is equivalent to existing senior professional military education programs. The USD(AT&L) has oversight authority for the acquisition curriculum of the course.

b. The DSMC, founded 1971, is a joint military professional institution, operating under the direction of the DAU Executive Board, to support acquisition management as described in *DOD Directive 5000.01*, and to assist in fulfilling education and training requirements set out in appropriate DOD directives and public laws. The mission of the DSMC is to:

- (1) conduct advanced courses of study in defense acquisition management as the primary function of the college
- (2) conduct research and special studies in defense acquisition management



## How the Army Runs

(3) assemble and disseminate information concerning new policies, methods, and practices in defense acquisition management

(4) provide consulting services in defense acquisition management.

### Section VII

#### Army Acquisition Organization and Management

##### 11–29. Army Research, Development, and Acquisition (RDA) goals

*a.* The Secretary of the Army (SA) is responsible for functions necessary for the research, development, logistical support and maintenance, preparedness, operation, and effectiveness of the Army. The SA supervises all matters relating to Army procurement. The SA executes his acquisition management responsibilities through the Army Acquisition Executive (AAE).

*b.* Special emphasis is placed on medium and long-range materiel planning, product modification, and life extension programs. Major state-of-the-art advancements are sought only in carefully selected areas. Stability of materiel acquisition programs is a matter of utmost interest, especially after the system passes the acquisition MS B program initiation decision. Reliability, availability, and maintainability (RAM) goals; manpower and personnel integration (MANPRINT); integrated logistics support (ILS); survivability; effectiveness; safety; and product quality are incorporated into system performance objectives. Contractual incentives for the improvement of RAM and ILS are encouraged.

##### 11–30. Army Acquisition Executive (AAE)

The Assistant Secretary of the Army (Acquisition, Logistics, and Technology) (ASA(ALT)) is the AAE. The AAE is designated by the SA as the Component Acquisition Executive (CAE) and the senior procurement executive within DA. The AAE is the principal DA staff official for the execution of the AAE responsibilities. When serving as the AAE, the ASA(ALT) is assisted by a military deputy (MILDEP).

*a.* The MILDEP is assigned to the Office of the ASA(ALT) and provides staff support to the AAE in managing the R&D, developmental test (DT), and the acquisition of materiel for all Army major weapon and support systems. The MILDEP, delegated down from the AAE, is also the Army Director, Acquisition Career Management (DACM). The DACM is responsible for directing the Army Acquisition Corps (AAC), as well as implementation of the acquisition career management requirements set forth in the *DAWIA* legislation. The day-to-day management of Army acquisition programs is shown in figure 11–6.

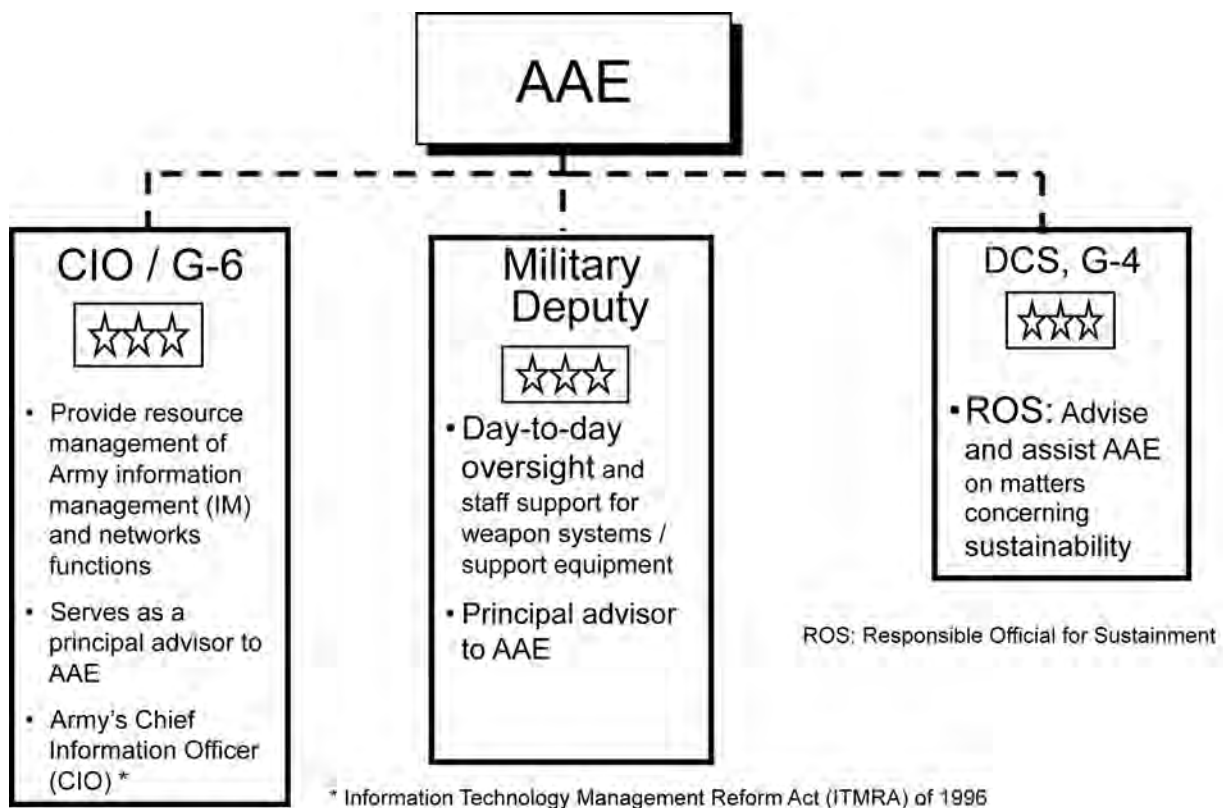

**Figure 11-6. Army acquisition executive (AAE)**

b. Similar to the DAE, the AAE develops Army acquisition policies and procedures and manages the Army's production base support and industrial mobilization programs. The AAE, acting with the full authority of the SA, is responsible for administering acquisition programs according to DOD policies and guidelines, and exercises the powers and discharges the responsibilities as set forth in *DODD 5000.01* for CAEs. In addition, the AAE:

(1) Appoints, manages, and evaluates program executive officers (PEOs) and direct-reporting program, project, or product managers (PMs).

(2) Coordinates with Office of the DCS, G-3/5/7 to establish policy and guidance for the analysis of alternatives (AoAs); for acquisition category (ACAT) I and II programs, designates the organization responsible for performing system engineering trades analyses for the AoA; and provides issues and alternatives to the DCS, G-3/5/7 for inclusion in the AoA tasking document.

(3) Carries out all powers, functions, and duties of the SA with respect to the acquisition work force within the Army, subject to the authority, direction, and control of the SA.

(4) Develops guidance, in coordination with the HQDA DCS, G-3/5/7, and serves as co-proponent, with the HQDA DCS, G-8, for the Army's Research, Development, and Acquisition (RDA) Plan.

(5) Formulates Army-wide S&T base strategy, policy, guidance, and planning.

(6) Establishes and validates Army technology base priorities throughout the planning, programming, budgeting, execution system (PPBE).

(7) Acts as the final authority of all matters affecting the Army's acquisition system, except as limited by statute or higher-level regulation. Develops and promulgates acquisition, procurement, and contracting policies and procedures.

(8) Chairs all Army System Acquisition Review Council (ASARC) meetings.

(9) Directs the Army Science Board (ASB).

(10) Appoints the source selection authority (SSA) for specified programs. The *Federal Acquisition Regulation (FAR)* is the primary contracting regulation. It is the first regulatory source to which DA acquisition personnel refer. The ASA(ALT) issues the *Army Federal Acquisition Regulation Supplement (AFARS)* to implement and supplement the *FAR* and the *Defense Federal Acquisition Regulation Supplement (DFARS)* and to establish uniform policies and procedures for use in the Army.

## How the Army Runs

(11) Reviews and approves, for ACAT ID programs, the Army position at each decision milestone before the Defense Acquisition Board (DAB) review. This includes the review and approval of acquisition program baselines (APBs). The AAE also serves as the milestone decision authority (MDA) for ACATs IC, IAC, selected ACAT II, and assigns the MDA for ACAT III programs to PEOs. The MDA is the individual designated to approve entry into the next acquisition phase. ACATs are defined in figures 11–3a and 11–3b.

(12) Approves the establishment and termination of all program management offices (PMOs) and PEOs. The AAE has authority to designate a system for intensive, centralized management and prescribe the appropriate level of management at any point in the program management process.

c. DA system coordinator (DASC). The DASC is the primary acquisition staff officer at DA. The DASC is responsible for the day-to-day support of his/her assigned programs and serves as the PM's representative and primary point of contact (POC) within the Pentagon. The DASC reports to the ASA(ALT), Deputy for Acquisition and Systems Management. The DASC is responsible for keeping the acquisition chain of command informed of the status of assigned acquisition programs. In addition, the DASC assists the PM with issue resolution at HQDA and OSD levels. The DASC is the "eyes and ears" of the PM at the Pentagon and ensures that the PM is advised of any actions or circumstances that might negatively impact their program.

d. DA logistics support officer (DALSO) is the DA representative of the logistics community, providing logistics coordination. The DALSO monitors the progress of the assigned system and ensures that all elements of ILS, as outlined in *AR 700–127*, are satisfactorily completed. Because of the interrelationships of assigned responsibilities in materiel acquisition, close and continuous coordination and cooperation is essential between the DALSO and his counterparts at TRADOC, AMC, and the ARSTAF.

(1) In addition to new items of equipment, DALSOs also have responsibility for existing weapons and materiel systems in the Army force structure. This responsibility covers all phases of logistics support to include readiness, redistribution, and disposal.

(2) The DALSO's primary mission is to provide HQDA general staff supervision over the ILS management of assigned commodity materiel/weapons systems from concept to disposal. Other responsibilities include:

(a) ARSTAF responsibility for logistical acceptability, deployability, and supportability of materiel systems, interoperability, ILS, materiel release, and logistics R&D programs for the Army.

(b) Serving as the logistician in the DAS for other than medical equipment, and conduct surveillance over logistics aspects of materiel acquisition and modification programs to ensure supportable systems.

(c) Providing policy guidance for logistics, medical, and engineer materiel acquisition.

### 11–31. The program executive officer (PEO)

a. The PEO system structure was implemented by the Army in 1987, in response to requirements established by the *Goldwater-Nichols Reorganization Act of 1986*; and the recommendation of the Packard Commission, under President Reagan, that was approved and then ordered by the *National Security Decision Directive (NSDD) 219* (figure 11–7).

b. The PEO, administering a defined number of AAE assigned MDAPs, major and/or non-major programs, is responsible for programmatics (materiel acquisition cost, schedule, and total system performance) and for the planning, programming, budgeting, and execution (PPBE) necessary to guide assigned programs through each milestone. In addition, the PEO provides program information to the AAE, HQDA, DOD, and Congress; defends assigned programs to Congress through the Army Office Chief of Legislative Liaison (OCLL); and participates in the development of data to support AAE programmatic decisions in the PPBE. Other PEO and direct-reporting PM responsibilities include assisting the CAPDEV and training developer (TNGDEV) in developing materiel capabilities documents (MCDs), by providing technical, availability, performance, anticipated materiel acquisition cost, and schedule type information as needed.

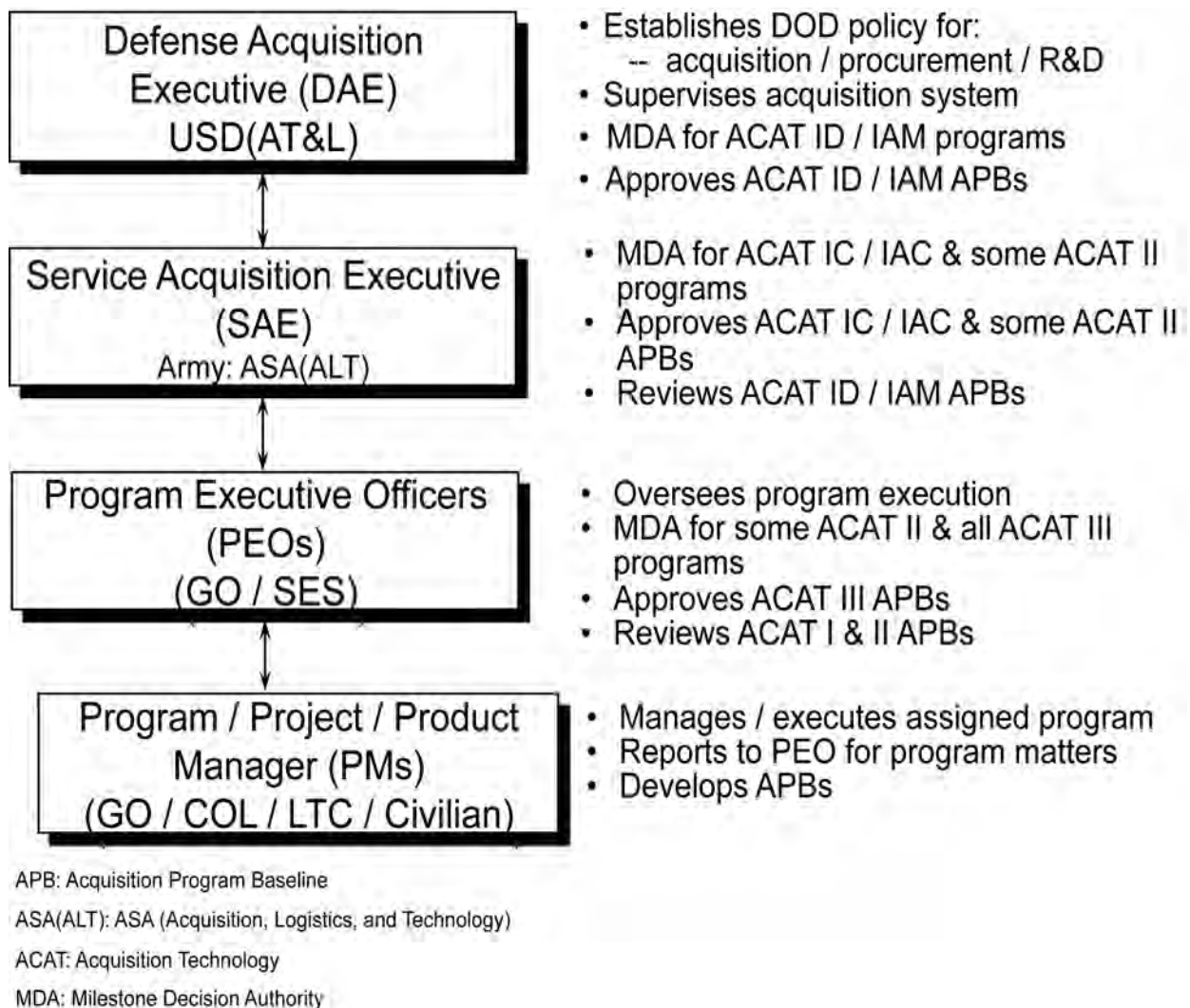

Figure 11-7. DOD Acquisition authority chain

c. The AAE has 13 PEOs-Missiles and Space; Aviation; Chemical and Biological Defense; Command, Control, Communications -Tactical; Intelligence; Electronic Warfare (EW) and Sensors; Ground Combat Systems; Combat Support/Combat Service Support Systems; Integration; Simulation, Training, and Instrumentation; Ammunition; Soldier; Chemical and Biological Defense (Joint); Joint Tactical Radio System (Joint)-responsible for the intensive management of RDA weapon and information systems. Unless a waiver is granted by the DAE or AAE, a PEO must be certified in acquisition management.

d. The Army's primary CAPDEV, referred to above, is the U.S. Army Training and Doctrine Command (TRADOC). TRADOC formulates and documents operational concepts, doctrine, organizations, and/or materiel requirements for assigned Army functions. TRADOC serves as the user representative during acquisitions for their approved materiel requirements, as well as doctrine and organization developments.

e. A materiel developer (MATDEV) is located within the RDA command, agency, or office, assigned responsibility for the system under development or being acquired. The term may be used generically to refer to the RDA community in the materiel acquisition process (counterpart to the generic use of CAPDEV).

f. A training developer (TNGDEV) is located within a command or agency that formulates, develops, and documents or produces training concepts, strategies, requirements (materiel and other), and programs for assigned mission areas and functions. The TNGDEV serves as user (trainer and trainee) representative during acquisitions of their approved training materiel requirements and training program developments. TNGDEVs perform the following functions solely in support of training systems:

## How the Army Runs

- (1) fund and conduct concept formulations for all system training aids, devices, simulations and simulators (TADSS) in support of assigned systems;
- (2) program and budget resources for TADSS, as specified in the training support requirements (TSR) annex of the capability development document (CDD);
- (3) embed system training capabilities into assigned materiel systems in accordance with the approved system MCD and in coordination with the CAPDEV;
- (4) develop, acquire, and field the subsystem training package with the materiel system;
- (5) plan and program resources for the execution of new equipment training (NET) using distance learning (DL) technology and/or contract NET as the desired training strategy in support of TRADOC developed/approved system training plans (STRAPs);
- (6) provide TNGDEV perspective through input to the *Army RDA plan* and the *Army modernization strategy (AMS)*.

### 11–32. The program/project/product manager (PM)

a. The program management approach to system acquisition management is a distinct departure from the services' traditional practice of establishing functionally oriented organizations to carry out well-defined, repetitive, and continuous long-term tasks. Organization for program management is a tailored, task-oriented process. This approach requires the PM to establish management arrangements among the PM office (PMO), other military organizations, and various contractors to coordinate their efforts and to accomplish program objectives effectively, efficiently, and economically. A variety of PMO organizations have been established. They operate on the matrix management principle and must draw all functional support from a host command or installation. In addition to the formal PM organization, the PM directs the informal MATDEV/CAPDEV team to execute the assigned materiel acquisition program. MATDEV/CAPDEV team is the terminology used to describe the informal, but essential close working relationship among the MATDEV, CAPDEV, and other players in the RDA management process (see figure 11–5).

b. The PM has authority and responsibility for all programmatic (cost, schedule, performance, and life-cycle sustainment) decisions to execute the assigned program within the approved acquisition program baseline (APB) and subject to functional standards established by regulation, secretarial direction, or law. Generically, all PMs are program managers, but they are chartered as a program manager, a project manager, or product manager based on the value and importance (visibility) of the program they manage. The criteria established for designation of a program manager are generally the same as those which cause a system acquisition to be designated as a MDAP, major, or non-major program-high defense priority, high dollar value, or major Congressional or OSD interest. Since October 26, 2001, all Army acquisition programs, regardless of acquisition category (ACAT), are managed by a program/project/product manager (PM) overseen by a program executive officer (PEO) or directly reporting to the Army Acquisition Executive (AAE). All PEOs report directly to the Defense Acquisition Executive (ACAT ID programs) or to the AAE (for ACAT IC and below). Project managers report to a PEO or the AAE. All product managers report to a project manager. As a general rule, a program manager is a general officer or Senior Executive Service (SES); a project manager is a Colonel or GS–15; a product manager is a Lieutenant Colonel or GS–14. This distinction between PMs is unique to the Army, and does not apply to the other services or within industry.

c. Normally, project managers are assigned for 4 years, with product managers staying 3 years in position. Unless a waiver is granted by the DAE or CAE, a PM must be certified in acquisition management.

### 11–33. PEO resource control

The Army has revised its resource support system structure for the PEOs to improve their control over the funding and manpower resources they need to carry out their responsibilities. PEOs and subordinate PMs receive dollars and personnel authorization resources directly from DA rather than through the materiel commands. The materiel commands continue to provide a variety of support services without duplicating any of the PEOs or PMs management functions. This enhanced resource control system ensures PEO and PM managed programs are managed with modern efficient techniques, without administrative burdens or materiel command layers being inserted into the chain of command.

### 11–34. Acquisition career management

a. As previously discussed, the MILDEP to the ASA(ALT) serves as the Army Director, Acquisition Career Management (DACM). The DACM is assisted by the Deputy Director, Acquisition Career Management (DDACM) and the Acquisition Support Center in OASA(ALT). The Deputy Assistant Secretary of the Army (Civilian Personnel Policy) and the Deputy Chief of Staff, G–1 work closely with the DACM in implementing the requirements and intent of DAWIA for the Army.

b. The Army Acquisition Corps (AAC) was established for both military and civilian personnel and is a subset of the entire Army Acquisition and Technology Work Force (A&TWF). The A&TWF consists of those personnel who work directly with acquisition in the various acquisition career fields at the CPT/GS–5 and above levels. The AAC consists of military and civilian personnel at the rank/grade of MAJ/GS–13 and above, who have met the statutory requirements for experience, education and training. Current Army policy focuses on accessing individuals at the

GS-14 and above level into the AAC. All A&TWF positions at the rank/grade of LTC/GS-14 and above are designated critical acquisition positions (CAPs) and must be occupied by AAC members. For program management and contracting positions, statute or regulation further dictates education, training, and experience requirements that must be met prior to placement of an individual in these positions.

(1) AAC vision. The strategic vision for the AAC forms the foundation for all policies and initiatives impacting the A&TWF. This vision is to develop “a corps of leaders willing to serve where needed and committed to providing Soldiers the systems critical to decisive victory now and in the future through development, integration, acquisition, fielding, and sustainment...one integrated corps ...It is these leaders the Army must develop early in their careers to ensure they possess the requisite experience and skills to successfully manage the acquisition challenges of the 21st century.” The key to developing the best possible leaders for the Army lies in educating the workforce, particularly at the lower levels, as to the DAWIA requirements and the policies, procedures, and tools available to meet those requirements.

(2) Career development as a mission. The leader development career pattern for an AAC officer is clearly defined. Military acquisition career development is covered under *DA Pamphlet 600-3, Commissioned Officer Professional Development and Utilization*. An officer should serve eight years in branch qualifying assignments prior to entering the AAC. Upon AAC selection, the officer attends functional area specific military training courses, and selected officers have the opportunity to attend advanced civil schooling (ACS). Attendance at ACS is contingent on the officer’s manner of performance, potential for academic success, and support of his/her career timeline. Graduate level education opportunities are an important part of career development within the AAC. However, job experience and strong performance across a variety of acquisition positions remains the key indicator to success. Recent initiatives seek to increase developmental acquisition experience opportunities while providing improved support for alternative advanced degree schooling. AAC officers compete for product/project management or acquisition command positions in the same manner as field commands. AAC LTCs and COLs are ineligible for selection to non-acquisition command positions. For career development of civilians, IAW Army Policy AAC-96-01, the Army has developed a civilian acquisition career model as well as a matrix of quality achievement factors as a “roadmap for success.” The focus of the career model is to begin to develop acquisition leaders and managers early in their careers, giving them a broad-based knowledge of the various acquisition functions supported by leadership and management experience. The quality achievement factors are the combination of training, education, and experience at the higher grade.

### **11-35. Headquarters, Department of the Army (HQDA)**

a. Chief of Staff of the Army (CSA). The CSA is responsible by law to the SA for the efficiency of the Army and its preparedness for military operations. The CSA acts as the agent of the SA in carrying out the plans or recommendations submitted by the ARSTAF and approved by the SA. The Vice Chief of Staff (VCSA) supports the CSA by managing the day-to-day operations of the Army. The VCSA chairs the Army Requirements Oversight Council (AROC) and in the area of RDA, the VCSA co-chairs the Army Systems Acquisition Review Council (ASARC).

b. Assistant Secretary of the Army (Financial Management and Comptroller) (ASA(FM&C)). The ASA(FM&C) has secretariat responsibility for all financial management activities and operations for appropriated funds. While the budget is in preparation, the ASA(FM&C) receives and consolidates procurement and research, development, test and evaluation (RDTE) budget forms from Army commands and PEOs. The ASA(FM&C) also:

- (1) Works with the AAE on all cost and economic analysis (EA) matters related to the acquisition process.
- (2) Carries out all financial management responsibilities assigned under *Title 10*.
- (3) Tasks the appropriate MATDEV to conduct program office estimates (POE) and/or economic analyses (EA) to milestone decision review (MDR) and PPBE requirements.
- (4) Manages all budgeting activities in support of the Army materiel requirements processes and RDA modernization program, with the framework of PPBE.
- (5) Develops statutory independent life-cycle cost estimates (ICEs) and component cost estimates (CCEs) for weapon and information systems. Chairs and oversees the Army Cost Review Board (CRB) and approves the Army cost position (ACP) for all major acquisition programs. The ASA(FM&C) Deputy for Cost & Economics, ensures that the ACP reflects the costs and risks associated with the program, in concurrence with the cost as independent variable (CAIV) process.

(6) The Military Deputy (MILDEP), ASA(FM&C) co-chairs the Army Requirements and Resourcing Board (AR2B) in support of overseas contingency operations (OCO).

c. Assistant Chief of Staff for Installation Management (ACSIM). The ACSIM is responsible for developing criteria for the mitigation of environmental impacts, and reviewing emerging Army RDA systems for environmental effects. The ACSIM is a regular member of the AR2B.

d. Deputy Chief of Staff, G-1 (DCS, G-1). The DCS, G-1 has ARSTAF responsibility for personnel management. DCS, G-1 monitors planning for the manpower and personnel aspects of new systems. Also, the DCS, G-1 is the proponent and has primary ARSTAF responsibility for the DOD human systems integration (HSI) program

## How the Army Runs

(MANPRINT program in the Army). The emphasis of the MANPRINT program is to enhance total system performance (Soldier in the loop) and to conserve the Army's manpower, personnel and training (MPT) resources. The DCS, G-1 is a regular member of the AROC, ASARC and AR2B.

(1) The DA personnel system staff officer (PERSSO) is the ARSTAF representative of the personnel community. The PERSSO provides for the continuous coordination necessary to ensure the smooth integration of new equipment, materiel systems, and new organizations.

(2) The PERSSO responsibilities include, but are not limited to:

- preparing and justifying force structure requests in conjunction with the DCS, G-3/5/7 organization integrator (OI) and DCS, G-8 synchronization staff officer (SSO);
- reviewing and coordinating the development of force structure changes;
- personnel supportability architecture; officer and enlisted issues related to new organizational concepts and doctrine;
- ensuring programming and budgeting of manpower spaces.

(3) The PERSSO participates in all HQDA actions to develop the staff position on CAPDEV proposals for potential MDAPs, the designation of a proposed system, the recommendations on the elements of system fielding, including the proposed basis of issue plan (BOIP), the initial issue quantity (IIQ), and the Army acquisition objective (AAO). The PERSSO represents the DCS, G-1 at force modernization-related, HQDA-sponsored conferences, forums, and meetings on issues of supportability concerning the introduction of new and/or reorganized existing table of organization and equipment (TOE)/ table of distribution and allowances (TDA) units.

*e.* Deputy Chief of Staff, G-2 (DCS, G-2). The DCS, G-2 provides scientific and technical intelligence and threat projections in support of all aspects of the Army RDA programs. The DCS, G-2 is a regular member of the ASARC, AROC, and AR2B.

(1) In addition, a HQDA threat integration staff officer (TISO) is designated by the DCS, G-2 to function as the HQDA threat integration coordinator for designated mission areas, programs, and systems. The TISO represents the DCS, G-2 on all aspects of threat support throughout the system life-cycle or study process.

(2) The TISO system complements the DCS, G-3/5/7 requirements staff officer (RSO) and DCS, G-8 SSO and is designed to foster closer coordination among the intelligence community, Army commands, and ARSTAF agencies to ensure the timely integration of the threat into the materiel acquisition process.

*f.* Deputy Chief of Staff, G-3/5/7 (DCS, G-3/5/7). As the Army's force manager, the DCS, G-3/5/7 serves as the HQDA proponent for all Army force structure related policies, processes, and actions. The DCS, G-3/5/7 is a regular member of the ASARC, AROC, and co-chairs the AR2B.

*g.* The DCS, G-3/5/7:

(1) Integrates Army doctrine, organization, training, materiel, leadership and education, personnel, and facility (DOTMLPF) capability-based requirements into structure.

(2) Develops and maintains force planning guidance and active and reserve component force structure through the total army analysis (TAA) force accounting, force documentation and other force management forums.

(3) Oversees the force management, training, mission command simulations and experimentation, prioritization, and requirements approval processes for the Army. The DCS, G-3/5/7 is assisted by the Director, G-37 Capabilities Integration, Prioritization, and Analysis (DAMO-CI), who has supervisory responsibility for:

(a) Analysis, Experimentation, Testing and Technology Division (DAMO-CIA):

1. Ensures key Army and DOD decisions regarding materiel requirements and materiel acquisition solutions are supported by sound analysis.

2. Serves as HQDA proponent for experimentation oversight and policy.

3. Serves as G-3/5/7 lead for test and evaluation (T&E) and science and technology (S&T) matters.

(b) Army Requirements and Resource Division (DAMO-CIB):

1. Accelerates urgent requirements to solutions for the Soldier through the Army Requirements and Resourcing Board (AR2B);

2. Synchronizes accelerated materiel solution efforts through the War Production Board (WPB);

(c) Current and Future Warfighting Capabilities Division (DAMO-CIC):

1. Validates current and future Army war fighting capability requirements;

2. Serves as the Army lead for validation and prioritization of Operational Needs Statements (ONS);

3. Serves as the Army lead for implementation of policy and procedures for the JCIDS process.

(d) Portfolio Review and Integration Division (DAMO-CIP): Leads conduct of VCSA directed capability portfolio reviews in order to identify trade-offs and to establish and revalidate priorities among programs.

(e) Resource Analysis & Integration Division (DAMO-CIR): Represents the DCS, G-3/5/7 in all phases of the PPBE process (e.g., Program, Budget, Year of Execution, and Overseas Contingency Operations (OCO) funds.

(f) DCS, G-3/5/7, Current and Future Warfighting Capabilities Division (DAMO-CIC). Within the DCS, G-3/5/7, DAMO-CIC is the single entry point, as the Army's JCIDS "gatekeeper", for all Army and joint DOTMLPF requirements. DAMO-CIC is the proponent for policy development and joint/Army CIDS process oversight. Within

DAMO–CIC, the requirements staff officer (RSO) is directly responsible for leading DA staff integration and coordination efforts for all Army and joint DOTMLPF requirements issues within Army CIDS. The RSO coordinates with his/her HQDA DCS, G–8 counterpart, the SSO, to facilitate the transition from requirements development and approval to requirements solutions (execution and resourcing). DAMO–CIC functions and responsibilities include:

1. Proponent for Army’s warfighting capabilities (requirements) determination policy (AR 71–9).
2. Army implementation of the Joint Capabilities Integration and Development System (JCIDS).
3. Army policies and procedures for execution of the accelerated Operational Need Statement (ONS) process.
4. ensures DCS, G–3/5/7 priorities and responsibilities regarding Equipping the Force are executed in support of force development and force integration processes.
5. provides support to ODCS, G–3/5/7 for equipment/system capability and employment issues:
6. DAS process (ASARC/OIPT/DAB)
7. PPBE (POM/investment reviews with DCS, G–8)
8. Congressional inquiries and testimony.
9. Serves as the HQDA Gatekeeper for JCIDS documents to support:
10. HQDA validation of TRADOC-generated documents by AROC
11. development of the official Army position on other service/COCOM documents during joint staffing
12. configuration management of Army documents during joint staffing and JROC review for approval
13. Army Requirements Oversight Council (AROC) secretariat support to the DCS, G–3/5/7 and VCSA.
14. conduct staff integration of modernization proposals to support force development planning:
15. execute JCIDS document staffing within ARSTAF/lead comment resolution process;
16. organize presentation of Army modernization proposals to AROC for approval
17. assemble Army position/input on other service JCIDS documents during joint staffing;
18. support joint review of Army proposals/input during Functional Capability Board (FCB) consideration.
19. conduct staff integration of ONSs for urgently required warfighting capabilities:
20. Serves as the HQDA Gatekeeper for ONS requests submitted by operational commanders.
21. Develops validation recommendations/conduct execution planning for DCS, G–3/5/7 in support of overseas contingency operations missions.

(4) Requirements staff officers (RSOs). Within G–37 (DAMO–CIC), RSOs, as the functional integrator for specific focus areas (e.g., Focus Logistics, Battlespace Awareness, Force Application, etc.), to facilitate the staffing, validation, approval, and prioritization of all Army DOTMLPF requirements. Primary functions and responsibilities are:

- (a) Represents HQDA DCS, G–3/5/7 equities in TRADOC CoE integrated capabilities development teams (ICDTs) for JCIDS analysis and documentation.
- (b) Responsible for integrated validation recommendations to the HQDA G–3/5/7 on urgent warfighting requirements (ONSs).
- (c) Participates in Army/OSD DAS IPTs representing “The Operational Requirement”.
- (d) Prepare congressional correspondence and testimony addressing operational requirements and future warfighting capabilities.
- (e) Provides PPBE support to the Budget, Requirements and Programs (BRP) Board regarding operational requirements and integration considerations for Army Programs.
- (f) Participates in FCB forums in support of the JROC review of JCIDS analysis and documentation.
- (g) Responsible for HQDA staffing of other service capability documents.
- (h) Produces official Army Position on Army and other service capability documents during joint staffing.
- (i) Responsible for HQDA staffing of Army capability documents, including comment resolution, in support of AROC validation decisions.

h. Deputy Chief of Staff, G–4 (DCS, G–4). The DCS, G–4 assesses the logistical supportability of materiel systems during the DAS process. The DCS, G–4 participates in all phases of the RDA management process to ensure equipment is logistically reliable, supportable, and maintainable. DCS, G–4 is responsible for secondary item requirements, such as war reserve requirements. The DCS, G–4 is a regular member of the ASARC, AROC and AR2B.

- (1) The DCS, G–4 has been designated the responsible official for sustainment (ROS) to the AAE.
- (2) As the ROS, the DCS, G–4 is assisted by the Deputy ASA(ALT) for Integrated Logistics Support (ILS), who is the HQDA focal point for a system’s ILS program.

i. Army Chief Information Officer (CIO)/Deputy Chief of Staff, G–6. The CIO/G–6 has ARSTAF responsibility for Army automated information systems (AIS) and information technology (IT) activities. These include establishing and approving policies, procedures, and standards for the planning, programming, life-cycle management, use of Army IT resources, and responding to and validating all warfighting requirements. The CIO/G–6 serves as the Army CIO as directed by the *Clinger-Cohen Act* (originally known as the *Information Technology Management Reform Act (ITMRA) of 1996*). The CIO’s primary responsibility, under the *Clinger-Cohen Act*, is the management of resources for all Army information programs. The DCS, G–6 is a regular member of the ASARC, AROC, and the AR2B.



## How the Army Runs

j. Deputy Chief of Staff, G-8 (DCS, G-8). The DCS, G-8 is the principal military advisor to the ASA (FM&C). The DCS, G-8 prepares the Army Program Objective Memorandum (POM); integrates and synchronizes the POM process; and provides analysis and evaluation of Army programs to the senior Army leadership. The DCS, G-8 is a regular member of the ASARC, AROC, Army Marine Corps Board (AMCB), and co-chairs the AR2B with the DCS, G-3/5/7 and MILDEP to the ASA (FM&C). The DCS, G-8 responsibilities include:

- k. Army program advocate to OSD, the JS, other military departments, government agencies and organizations.
- l. Overseeing materiel fielding across the Army and ensuring integration of DOTMLPF into materiel solutions in accordance with (IAW) approved Army requirements.
- m. Serving as principal advisor to the CSA on joint materiel requirements, representing the Army in the JS Functional Capabilities Board (FCB), Joint Capabilities Board (JCB), and Joint Requirements Oversight Council (JROC) process.
- n. Serving as the Army lead for all Quadrennial Defense Review (QDR) activities; and overseeing the Army Studies Program.

(1) G-8, Director, Program Analysis and Evaluation (DPAE). Within DCS, G-8, the DPAE is responsible for reviewing and analyzing requirements and programs in force structure development; providing analytical support to the Army Resources Board (ARB) and subordinate committees; developing resource guidance; developing and compiling the POM; maintaining the Army portion of the DOD Future Years Defense Program (FYDP); and presenting an affordability analysis to the ASARC. Other responsibilities include conducting and presenting affordability assessments to support DOD and HQDA ACAT I programs, and managing the programming phase of the PPBE process.

(2) G-8, Director, Force Development (Director, FD). Within DCS G-8, the Director, FD translates approved Army DOTMLPF requirements into programs, within allocated resources, to accomplish Army missions and functions. In addition, the Director, FD exercises life-cycle management of materiel programs.

(a) The FD Directorate is organized into a Directorate of Materiel (DOM), Directorate of Joint and Futures, Directorate of Integration (DOI) and a Directorate of Resources (DOR).

(b) Synchronization staff officers/system synchronization officers (SSOs). Within the FD Directorate, the SSOs focus on systems and fielding to deliver capabilities and functions to the warfighting force structure of the Army. SSOs are the single ARSTAF POCs for integration and synchronization of all Army materiel programs to achieve the *TAP* priorities, and the *Army modernization strategy (AMS)*. Generally, the SSO is responsible for the integration, synchronization, and coordination of hardware, software and associated equipment in support of the *TAP*. All equipment is fielded using the total package fielding (TPF) methodology, discussed later in the chapter, managed by DCS, G-8 Director, FD DOI (DAPR-FDH). SSOs responsibilities include:

1. Coordinates with TRADOC capability managers (TCMs) and HQDA DCS, G-37 (requirements staff officers (RSOs)/organization integrators (OIs)) during the requirements phase on affordability and total army analysis (TAA)/force feasibility reviews (FFR) resourcing.

2. Programs money to support materiel programs and insertion into the Army in the POM years in the Force Development Investment Information System (FDIIS). FDIIS is the primary planning, programming, and budgeting decision support tool for SSOs to insert data into the POM. In addition, FDIIS produces charts to explain and defend Army programs to POM CoCs and GOSCs.

3. Works with ASA(ALT) DA system coordinator (DASC) and ASA(FM&C) budget liaison (SAFM-BUL), to influence current year and budget year of execution. SAFM-BUL defends programs and the details of the President's Budget (PRESBUD) to the Congressional appropriations committees.

4. Submits requests for overseas contingency operations (supplemental) funding.

5. Works with HQDA G-37, Army Commands (ACOMS), and PMs to determine fielding plans IAW Army priorities.

6. Analyzes production and equipment on hand against requirements/authorizations.

7. Develops solutions to problems incurred due to changes in funding requirement/authorization, schedule or performance in coordination with (ICW) "stakeholders".

8. Prepares justifications for defending current programmed money and funding unfunded requirements (UFRs) to POM boards and other forums for resourcing and prioritization.

9. Coordinates with HQDA G-4 and AMC on life-cycle sustainment and disposition of materiel.

o. The Surgeon General (TSG). TSG has ARSTAF responsibility for medical research, development, test and evaluation, and is the Army medical MATDEV. The TSG is responsible for the medical aspects of all other development and acquisition programs ensuring functional area interface with CAPDEVs. The TSG serves as a member of the ASARC and AR2B for medical issues, including health hazard assessment, personnel safety, and hazards remediation. Other responsibilities include:

(1) Developing policy, responsibilities, and procedures to ensure implementation of systems acquisition policy as it applies to combat medical systems, medical readiness and health care programs, and other assigned Army and joint requirements.

(2) Assigning support responsibilities for medical materiel development and acquisition to agencies and activities under TSG for command and control.

(3) Recommending to TRADOC Army Capabilities Integration Center (ARCIC) capabilities-based materiel and non-materiel requirements and associated priorities for medical readiness and health care programs.

(4) Establishing functional area interface with TRADOC ARCIC for all medical programs, ensuring that requirements and interests of each participating service are provided full consideration in medical programs for which the Army has lead agency or executive agency responsibility.

*p.* Chief of Engineers (COE). The COE monitors requirements, research and development necessary to provide construction design criteria, construction techniques, and construction material for the Army, Air Force, and other government agencies. The COE provides fixed-facility concealment, camouflage, and deception; real estate management techniques; and engineering support for maintenance of installation and facilities. It is the COE's mission to preserve and improve environmental quality associated with construction and facilities; Army environmental quality; and R&D activities covering atmospheric, terrestrial, and topographical sciences. The COE is responsible, under the general direction of the AAE, for the RDTE of fixed and floating power systems, and high voltage generation applications (to include nuclear applications). The COE reviews all emerging Army systems for digital terrain data requirements and environmental effects such as climate, terrain, or weather. The review includes minimization of toxic and hazardous wastes and those hazardous wastes associated with normal system test, operation, use, and maintenance. The COE serves as a member of the AR2B.

*q.* The General Counsel (GC). The GC advises the AAE and the ASARC on any legal issue, which arises during the acquisition of a weapon or materiel system. The GC reviews all Army acquisition policy and supervises all attorneys providing legal advice relating to programs within the Army RDA management system. The GC is responsible for all legal advice in the negotiation, oversight, and review of international cooperative RDA programs.

### 11–36. Army Commands (Major)

*a.* U.S. Army Materiel Command (AMC). AMC performs assigned materiel and related functions for logistics support of materiel systems, and other system acquisition management functions required by HQDA. AMC is a regular member of the ASARC and AR2B. The AMC mission, in support of RDA, is to:

- (1) equip and sustain a trained, ready Army;
- (2) provide development and acquisition support to MATDEVs (PEOs and PMs);
- (3) provide equipment and services to other nations through the Security Assistance Program;
- (4) define, develop, and acquire superior technologies;
- (5) maintain the mobilization capabilities necessary to support the Army in emergencies;
- (6) verify system safety; support developmental and operational tests; and participate in the continuous evaluation (CE) process;
- (7) exercise delegated authority, under ASA(ALT) oversight, in the following areas: metrication; design to cost; production readiness reviews; manufacturing technology, standardization; reliability, availability, and maintainability; quality; risk management; value engineering; parts control; and industrial modernization improvement;
- (8) provide survivability, vulnerability, or lethality assessments and survivability enhancement expertise for all Army materiel programs;
- (9) evaluate and recommend improvements to the industrial base;
- (10) responsible for the logistics support of assigned materiel in response to approved capabilities-based materiel requirements;
- (11) plan, coordinate, and provide functional support to PEOs and PMs. Support includes, but is not limited to, procurement and contracting, legal, managerial accounting, cost estimating, systems engineering, conducting system TADSS and embedded training concept formulation, developmental test, logistics support analyses, MANPRINT, environmental, intelligence and threat support, configuration management, and conducting various independent assessments and analyses;
- (12) provide overall management of the Army's technology base (less Class VIII), including identification of maturing technologies necessary to support acquisition of warfighting materiel systems;
- (13) provide RDA science and infrastructure information to HQDA for the Army *RDA Plan*; and
- (14) provide initial and updated cost and system performance estimates for battlefield and peacetime operations as inputs to supporting analysis and program decisions.

*b.* U.S. Army Training and Doctrine Command (TRADOC). TRADOC is the Army's primary "user representative" in the capabilities development and system acquisition management processes. As the Army's principal CAPDEV, TRADOC guides, coordinates, and integrates the total capabilities development effort of the Army. Capabilities developments are a major component of force development and encompass the formulation of concepts, doctrine, organization, materiel objectives, capabilities-based requirements, and operational tests (OT) of products of the Army's capabilities integration and development system (CIDS). TRADOC is a regular member of the ASARC and the AR2B.

## How the Army Runs

- c. As the Army's primary CAPDEV/TNGDEV, TRADOC is the Army's *Architect for the Future* and is charged to chart the future course for the Army. In doing so, CG, TRADOC, guides and disciplines the Army CIDS by:
- (1) providing capabilities-based requirements generation and documentation procedures and process guidance;
  - (2) generating all Army warfighting DOTMLPF requirements prior to their submission to HQDA for approval and resourcing;
  - (3) approving integrated capabilities development team (ICDT) minutes or reports containing proposed solution sets for force level force operating capabilities (FOCs);
  - (4) coordinating materiel capabilities documents (MCDs) produced by the Army community and forwarded to HQDA DCS, G-3/5/7 Current and Future Warfighting Capabilities Division (DAMO-CIC) for staffing, validation, approval, and prioritization.
    - (a) Assists HQDA to prioritize and justify warfighting requirements by:
      1. determining applicability of current force operational needs statements (ONSs) to future Army-wide requirements and assign to a Center of Excellence (CoE)/proponent for requirement documentation;
      2. providing insights and descriptive information for materiel programs; and
      3. supporting HQDA ODCS,G-37 (DAMO-CIC), by presenting documents and information to the JCIDS capabilities-based assessment (CBA) process and assisting in issue resolution.
    - (b) Coordinates and integrates the total capabilities/training developments efforts of the Army by:
      1. providing, with appropriate support from other Army commands, the capstone and subordinate operating and functional warfighting concepts and FOCs (the start point for the Army CIDS);
      2. developing and maintaining the mission command networks and systems operational architecture (OA);
      3. being the primary source for determining the need for and preparing capabilities-based requirements and MCDs for TADSS and embedded training;
      4. determining need for and to obtain CSA approval for conduct of advanced warfighting experiments (AWEs).
    - (c) Conducts analysis of alternatives (AoA) for ACAT I, IA, and most ACAT II programs when required by HQDA. When required by the MDA, conduct AoA for all other ACAT programs.
    - (d) Serves as member of the Army S&T Advisory Group (ASTAG).
    - (e) Provides representative to Army S&T reviews and management teams.
  - (5) TRADOC is organized into integrating centers and functional area CoEs and schools. The principal integrating centers are the Army Capabilities Integration Center (ARCIC), Fort Monroe, VA ; the Combined Arms Center (CAC), Fort Leavenworth, KS; and the Combined Arms Support Command (CASCOM), Fort Lee, VA. The functional area CoEs are Mission Command CoE, Signal CoE, Intelligence CoE, Fires CoE, Aviation CoE, Sustainment CoE, Maneuver Support CoE, and Initial Military Training CoE. The CoE Capabilities Development & Integration Directorates (CDIDs) work very closely with the PEO community in the RDA management process.
    - (6) Director, Army Capabilities Integration Center (ARCIC):
      - (a) Determines and integrates force requirements and synchronizes the development of DOTMLPF solutions across the Army.
      - (b) Leads joint and Army CD&E efforts through TRADOC and non-TRADOC proponents.
      - (c) Leads the execution of the JCIDS process by TRADOC and/or non-TRADOC proponents to determine capability requirements for the force. Identifies joint and Army gaps and redundancies in capability; proposes DOTMLPF solutions to resolve or mitigate gaps; and recommends divestitures to help fund new requirements.
      - (d) Leads asymmetric warfare (AW) efforts within TRADOC. Integrates and synchronizes proponent activities within the AW areas of electronic warfare, protection warfighting function, and improvised explosive device - defeat.
      - (e) Validates research and development priorities for Army S&T needs (to include special access programs (SAP)), for the required capabilities outlined in Army concepts ICW the ASA(ALT). Conducts a review of SAP and new S&T initiatives, as required, to ensure technology is aligned with future needs.
      - (f) Provides guidance for the execution of TRADOC force design goals and objectives and recommends approval to release organizational changes and adjustments for Army-wide staffing.
      - (g) Supports the CG, TRADOC in his role as the operational architect of the Army.
      - (h) Manages, coordinates, develops and maintains the battle lab collaborative simulation environment (BLCSE) federation of models and simulations (M&S), and distributed simulation network in support of joint and Army capabilities development and experimentation. (i) Serves as the advanced concepts and requirements (ACR) domain agent for review and validation of ACR domain M&S capabilities. Manages the M&S requirements for concept development and experimentation.
      - (i) Leads the Army Brigade Combat Team Modernization Program (ABCTMP) strategic communications integrated capability development team; ABCTMP Board of Directors (BoD); identifies the requirements for HQDA approval to stand up the ABCTMP CoE; and ABCTMP General Officer Steering Committee (GOSC) efforts to integrate ABCTMP into the Army.
    - (7) Army Capabilities Integration Center (ARCIC). On February 15, 2006, the SA directed the formation of the ARCIC from the resources and organization of the TRADOC Futures Center. The Director, ARCIC, through the CG

TRADOC, is directly responsible to the SA and CSA to ensure that the ABCTMP technologies are transitioned into the current force as soon as they are ready, and the ABCTMP is integrated and coordinated with co-evolution of joint warfighting doctrine.

(a) The ARCIC has four primary responsibilities:

1. using wargaming, experimentation, and concepts, develop and integrate force capability requirements for the Army from a comprehensive perspective of DOTMLPF;
2. identify and integrate Army current and future force DOTMLPF requirements and synchronize the development of DOTMLPF solutions across the Army;
3. provide the management structure for identifying capability gaps and directing analytical support for DOTMLPF developments, including validating research and development R&D priorities for key Army S&T needs, and the development and validation of integrated operational architectures depicting warfighting capabilities;
4. serve as the lead Army agency for coordination with joint agencies and other services for identification and integration of joint RCs, including joint wargaming, concept development, and experimentation.

(b) In support of these responsibilities, ARCIC is organized in directorates:

1. Concept Development and Learning Directorate (CDLD) prioritizes, manages and synchronizes TRADOC's efforts in joint and Army concept development and experimentation. CDLD supports TRADOC's role to "think for the Army."
2. Requirements Integration Directorate (RID) analyzes concepts and identifies tasks, capability gaps, and DOTMLPF solutions to achieve the concept driven RCs. RID works on long-term and near term needs.
3. Assessment, Architecture, Mission Command Directorate (A2MCD) ensures all DOTMLPF capabilities are integrated for both the current and future forces. A2MCD helps the Army develop its resourcing strategies, leads the development, integration, and validation of operational architectures that provide the underpinnings for land warfare concepts and capabilities and support experimentation, analysis, and DOTMLPF solutions. A2MCD leads the development of mission command capabilities.
4. Force Design Directorate (FDD) is the TRADOC lead in developing operational force design and force structure solutions. FDD leads the organizational design efforts for TRADOC.
5. Future Force Integration Directorate (FFID) synchronizes the delivery, preparation, and evaluation of all ABCTMP-related products for the ABCTMP-equipped Brigade Combat Team (BCT) and the Army Evaluation Task Force (AETF) at Fort Bliss, Texas. FFID creates and sustains an environment for the successful testing, evaluation, and integration of ABCTMP technologies for the current and future forces.
6. International Army Programs Directorate coordinates TRADOC activities with multinational partners across TRADOC CoEs.

(c) The ARCIC-Forward element stationed in Arlington, Virginia, acts as liaison between the Director, ARCIC and the ARSTAF, JS, OSD, and others in the Washington DC area.

(8) Combined Arms Center (CAC). CAC provides leadership and supervision for leader development and professional military and civilian education; institutional and collective training; functional training; training support; mission command; doctrine; lessons learned; and specified areas the CG, TRADOC designates in order to serve as a catalyst for change and to support developing relevant and ready expeditionary land formations with campaign qualities in support of the joint force commander.

(9) Combined Arms Support Command (CASCOM). CASCOM, the Logistics Center of Excellence (CoE), has the mission to develop logistics leaders, doctrine, organizations, training, and materiel solutions. There are three major functions performed by CASCOM.

(a) Develops and evaluates combat service support (CSS) concepts, doctrine, organizations, systems, materiel concepts and requirements, and planning factors for the Army and in concert with joint logistics doctrine. CASCOM ensures the personnel service support, supply, maintenance, transportation, services, and facilities systems designed for the Army in the field and the CONUS-based theater logistics systems, are compatible with the sustaining base system.

(b) CASCOM acts as the TRADOC proponent for CSS training and monitors and evaluates CSS training at TRADOC schools. CASCOM ensures CSS course content is consistent with approved doctrine and assesses the training evaluation process at associated schools.

(c) CASCOM serves as a principal adviser to HQDA, TRADOC, and AMC on all CSS matters. CASCOM provides direction, guidance, and tasks to assigned capabilities development activities, associated CoEs, other Army Commands, and HQDA staff agencies for their contribution to CSS development and training.

(10) CoE Capabilities Development and Integration Directorate (CDID). CDID represents the CoE in the execution of its responsibilities for concept development, experimentation, and requirements determination. The CDID's purpose is to facilitate the development, assessment, management, validation, and synchronization of DOTMLPF-integrated combined arms capabilities that complement joint, interagency, and multinational capabilities. The CDID serves as the primary activity to develop proponent, Army and joint concepts; reviews Army and joint doctrine, support experimentation efforts, reviews requirements documentation, and reviews training material; assists in the development of training materials; and develops proponent equipment operational mode summary/mission profiles (OMS/MP). The OMS/MP describes the anticipated missions; units (active, reserve, and institutional training base); or mix of units that will use

## How the Army Runs

the system overtime to include peacetime, crisis situations, national conflict, and war; in what environments and under what conditions (climate, terrain, battlefield environment, etc.), as well as how it will be supported and maintained.

(11) TRADOC capability manager (TCM). The TRADOC counterpart to the PM, the TCM, is a central figure in the RDA process and a key member of the MATDEV/CAPDEV team. The TCM is TRADOC's focal point for coordination of the CAPDEV/TNGDEV efforts in the development and acquisition of a materiel and/or automated information systems (AIS) capability. The TCM is responsible for synchronizing all doctrine, organization, training, leadership and education, personnel, and facilities (DOTLPF) domains that are impacted by the fielding of major materiel capability. A TCM is appointed early in the development cycle, normally at the same time as the PM. The TCM is usually located in the CDID at the CoE proponent center or school.

### 11–37. Other DA agencies

*a.* U. S. Army Test and Evaluation Command (ATEC). The CG, ATEC is responsible for management of the Army's operational testing (OT), developmental testing (DT), and system evaluation (SE) processes. Their evaluations of materiel and IT systems' operational effectiveness, suitability and survivability are independent of the CAPDEV/MATDEV and are reported directly to the MDA. CG, ATEC is a member of the ASARC, AROC, and chairman of the Test Schedule and Review Committee (TSARC). The TSARC is the HQDA centralized management forum for user (operational) testing resources. ATEC provides advice and assistance to the CSA, the VCSA, other members of the ARSTAF, and other elements of HQDA in regard to Army T&E. Other responsibilities include:

- (1) Reviewing all draft materiel capabilities documents (MCDs) for T&E implications.
- (2) Assisting TRADOC ARCIC in developing evaluatable, operationally relevant, and totally system focused critical operational issues and criteria (COIC). Provide advice concerning methods and measures to evaluate the system against the COIC and advise on the resources and ability to test and evaluate the system.
- (3) Reviewing and approving all ATEC Capabilities & Limitations (C&L) Reports in support of OCO rapid fielding.
- (4) Supporting the TRADOC advance warfighting experiment (AWE) program and concept experimentation program (CEP).

*b.* U.S. Army Intelligence and Security Command (INSCOM). INSCOM is the CAPDEV for strategic signals intelligence (SIGINT) systems and INSCOM sole-user intelligence, electronic warfare (EW) systems used for formulating doctrine, concepts, organization, materiel requirements, and objectives. INSCOM responsibilities include:

- (1) Preparing MCDs and serving as the Army CAPDEV during development and fielding of new SIGINT and information security (INFOSEC) systems under the purview of the National Security Agency (NSA) and having sole application to U.S. SIGINT and INFOSEC systems. INSCOM forwards warfighting concepts and MCDs to TRADOC ARCIC for review and appropriate action.
- (2) Coordinating with the PEO/PM on matters pertaining to acquisition of INSCOM sole-user SIGINT and intelligence, security and electronic warfare (ISEW) systems.
- (3) Coordinating with the TRADOC ARCIC, on capabilities-based requirements generation for other INSCOM sole user ISEW systems and conduct capabilities and training developments for these Army systems when directed by HQDA, and/or Director, Central Intelligence (DCI), or at the request of TRADOC's ARCIC.
- (4) Ensuring documentation of requirements for training support products, system TADSS, and/or embedded training for INSCOM systems.
- (5) Providing threat documentation to HQ, TRADOC as validated and approved by HQDA DCS, G–2.
- (6) Recommending to TRADOC ARCIC capabilities-based materiel requirements and associated priorities for strategic intelligence and security readiness.

*c.* U.S. Army Special Operations Command (USASOC). In support of systems acquisition management, USASOC establishes functional area interface with TRADOC ARCIC for all programs, ensuring that requirements and interests of each participating agency are provided full consideration in programs for which the Army has lead agency or executive responsibility, and serves as the special operations trainer and user representative. The USASOC is a regular member of the Army AR2B. In addition, USASOC:

- (1) Forwards all SOC unique and non-SOC unique warfighting capability requirements and documents to TRADOC ARCIC for appropriate action.
- (2) Monitors TRADOC projects and identifies needs that affect the USASOC mission and responsibility.
- (3) Supports TRADOC field activities, conducts and supports testing, and monitors RDA projects to include potential force standardization and interoperability.
- (4) Participates in warfighting experiments, as appropriate.

*d.* U.S. Army Space and Missile Defense Command (USASMDC). USASMDC is the principal assistant and advisor to the SA and the CSA for all matters pertaining to space and strategic defense. The USASMDC is responsible for technology development programs related to strategic and tactical missile defense, space defense, and satellite technology. The command conducts missile defense technology base research and development activities in support of the Missile Defense Agency (MDA); assures transfer of technology between MDA and Army systems; and provides matrix support to PEO Air and Missile Defense. USASMDC is also chartered by CSA to be the operational advocate and focal point for theater missile defense (TMD) at Army level. The CG, USASMDC, assists in the development of Army

TMD positions, reflective of work being done in TRADOC, and represents those positions at HQDA, OSD, MDA, JS, Congressional, and other high-level forums.

e. U.S. Army Medical Command (MEDCOM). MEDCOM is the medical CAPDEV, TNGDEV, trainer, and user representative. MEDCOM conducts medical capabilities and training development activities as assigned by CG, TRADOC and TSG; reviews and evaluates materiel and TADSS requirements documents to identify and assure that adequate consideration is given to the prevention of health hazards from operating or maintaining materiel systems, and conduct the health hazard assessment (HHA) program, as required; conducts and supports assigned operational tests (OTs); and forwards all medical warfighting concepts and requirements documents to TRADOC for review and appropriate action.

f. U.S. Army Surface Deployment and Distribution Command (SDDC). SDDC provides transportability engineering advice and analyses to the MATDEV, CAPDEV and TNGDEV; provides item, unit, and system transportability assessments for milestone decision review (MDR); provides transportability approval and identifies corrective actions required to obtain approval for all transportability problem items; and reviews all materiel capabilities documents (MCDs) to assess adequacy of transportability.

g. U.S. Army Medical Research and Materiel Command (USAMRMC). USAMRMC is the medical MATDEV, logistician, and developmental tester and is responsible for RDA and logistic support of assigned materiel in response to approved materiel capabilities-based requirements. In addition, USAMRMC:

(1) Plans, programs, budgets, and executes medical RDTE tasks that support system RDA, to include required system training support products, TADSS, and/or embedded training.

(2) Plans, coordinates, and provides functional support to USAMRMC organizations. Support includes, but is not limited to, procurement and contracting, legal, managerial accounting, cost estimating, systems engineering, conducting system TADSS and embedded training concept formulation, developmental testing, ILS, MANPRINT, environmental management, configuration management, and conducting various independent assessments and analyses.

(3) Assists the medical CAPDEV/TNGDEV in the Army CIDS process.

(4) Reviews MCDs to determine their adequacy and feasibility and for logistical support aspects of materiel systems to include ILS.

(5) Develops and maintains the physiological, psychological, and medical database to support the health hazard assessment (HHA), system safety assessments (SSA), and human factors engineering analysis (HFEA).

(6) Evaluates and manages the materiel readiness functions in the medical materiel acquisition process.

(7) Functions as TSG agency for the materiel acquisition of medical non-developmental items (NDI), commercial off-the-shelf (COTS) items, and sets, kits, and outfits.

h. U.S. Army Medical Department Center and School (AMEDDC&S). AMEDDC&S is the medical CAPDEV, TNGDEV, doctrine developer, and operational tester. In addition, AMEDDC&S develops doctrine, organizations, and systems requirements within the guidelines established by the TRADOC ARCIC and in accordance with Army health care standards established by TSG.

## Section VIII

### Acquisition Activities, Phases and Milestones

#### 11–38. Pre-systems acquisition activity

Pre-system acquisition is composed of on-going activities in development of user needs, in S&T, and in materiel solution analysis (MSA) and technology development (TD) work specific to the development of a materiel solution to an identified, validated capabilities-based materiel requirement.

a. The capability needs and acquisition management systems use joint/service concepts, integrated architectures, and an analysis of doctrine, organization, training, materiel, leadership and education, personnel, and facilities (DOTMLPF) in an integrated, collaborative process to define needed capabilities to guide the development of affordable systems. The Chairman of the Joint Chiefs of Staff (CJCS), with the assistance of the Joint Requirements Oversight Council (JROC), assesses and provides advice regarding military capability needs for defense acquisition programs. This JCIDS process is described in *CJCSI 3170.01G*. See para 5–3.

b. Representatives from the services and multiple DOD communities assist the CJCS in formulating broad, time-phased, operational goals, and describing requisite capabilities in the initial capabilities document (ICD). When the ICD demonstrates the need for a materiel solution, the JROC or AROC recommends that the MDA convene a formal DAS Materiel Development Decision (MDD) Review.

#### 11–39. Materiel development decision (MDD) review

a. At the MDD review, the approved ICD is presented to the milestone decision authority (MDA). The ICD documents the need for non-materiel and/or materiel solution approaches to resolve a specific high risk capability gap derived from the JCIDS CBA process. See para 11–11. The ICD includes: the preliminary concept of operations (CONOPS), a description of the needed capability, the operational risk, and the basis for determining that non-materiel approaches will not sufficiently mitigate the capability gap. The OSD Director, Assessment & Program Evaluation (D,

## How the Army Runs

CAPE), (or service equivalent), proposes study guidance for the milestone (MS) A analysis of alternatives (AoA). The purpose of the AoA is to assess the potential system-level materiel solutions to satisfy the selected materiel concept (approach) documented in the approved ICD.

*b.* The MDA designates the lead agency to refine the initial materiel concept selected, approves the AoA study guidance, and establishes a date for a MS A review. The MDA decisions are documented in an acquisition decision memorandum (ADM). This effort normally is funded only for the MSA work. The MDA decision to begin the MSA phase does not yet mean that a new acquisition program has been initiated.

*c.* Following approval of the study guidance, the organization conducting the AoA immediately prepares an AoA study plan to assess preliminary materiel solutions, identify key technologies, and estimate life-cycle costs. Following the MDD, the MDA may authorize entry into the DAS at any point consistent with phase-specific entrance criteria and statutory requirements. Progress through the DAS depends on obtaining sufficient knowledge to continue to the next phase of development. The MDD review is the formal entry point into the DAS and is mandatory for all potential acquisition programs. The Materiel Solution Analysis (MSA) phase begins with the MDD review.

### 11–40. Materiel solution analysis (MSA) phase

*a.* The purpose of this phase is to assess potential materiel solutions, to satisfy the phase-specific entrance criteria for the next program MS designated by the MDA and develop a technology development strategy (TDS). Entrance into this phase depends upon an approved ICD resulting from the analysis of potential materiel concepts (approaches) across the services, international systems from Allies, and cooperative opportunities; and MDA guidance for conducting an AoA for the selected materiel concept, documented in the approved ICD.

*b.* The ICD and the AoA study guidance guide the AoA and MSA phase activities. The AoA assesses the critical technology elements (CTEs) associated with each proposed system-level materiel solution, including technology maturity, integration, risk, manufacturing feasibility, and, where necessary, technology maturation and demonstration needs. A CTE is a technology element which is critical if the system being acquired depends on this technology element to meet capability thresholds.

*c.* The results of the AoA provide the basis for the TDS, to be approved by the MDA at MS A. The TDS documents the following:

(1) The rationale for adopting either an evolutionary strategy (the preferred approach) or using a single-step-to-full-capability strategy (e.g., for common supply items or commercial-off-the-shelf (COTS) items). For an evolutionary acquisition, the TDS includes a preliminary description of how the program will be divided into technology development increments; an appropriate limitation on the number of prototype units that may be produced and deployed during technology development; how these units will be supported; and specific performance goals and exit criteria that must be met before exceeding the number of prototypes that may be produced under the research and development (R&D) program.

(2) A program strategy, including overall cost, schedule, and performance goals for the total R&D program.

(3) Specific cost, schedule, and performance goals, including exit criteria, for the first technology demonstration (TD).

(4) A test plan to ensure that goals and exit criteria for the first TD have been met.

*d.* MSA ends when the AoA has been completed, materiel solution options for the capability need identified in the approved ICD have been recommended and the phase-specific entrance criteria for the initial review milestone have been satisfied.

### 11–41. Milestone (MS) A

At MS A, the MDA designates a lead agency, approves Technology Development (TD) phase exit criteria, develops and issues the ADM. The leader of the CAPDEV-led integrated capabilities development team (ICDT), working with the Army Test and Evaluation Command (ATEC) system team (AST), develops an integrated evaluation strategy that describes how the capabilities in the MCD will be evaluated once the system is developed. For potential acquisition category (ACAT) I programs, the integrated evaluation strategy is approved by the DOD Director, Operational Test and Evaluation (D,OT&E) and the cognizant overarching integrated product team (OIPT). The MDA complies with the congressionally directed certification requirements at MS A. This effort normally is funded only for the advanced technology development work. TD for a MDAP cannot proceed without MS A approval. A favorable MS A decision does not mean that a new acquisition program has been initiated.

### 11–42. Technology development (TD) phase

The purpose of this phase is to reduce technology risk, determine an appropriate set of mature technologies to be integrated into a full system, and to demonstrate CTEs on prototypes. TD is a continuous technology discovery and development process reflecting close collaboration between the S&T community, the CAPDEV, and the system MATDEV. It is an iterative process designed to assess the viability of technologies while simultaneously refining user requirements.

*a.* Entrance into this phase depends on the completion of the AoA, a proposed materiel solution, and full funding for

planned TD phase activity. Full funding is for the dollars and manpower needed for all current and future efforts to carry out the acquisition strategy (AS).

*b.* The TDS and associated funding approved at MS A provides for competitive prototyping (two or more competing teams (contractors) producing prototypes of the system and/or key system elements prior to, or through MS B). Prototypes are employed to reduce technical risk, validate designs and cost estimates, evaluate manufacturing processes, and refine requirements.

*c.* The ICD and the TDS guide, and systems engineering (SE) planning support this effort. Multiple technology development demonstrations may be necessary before the CAPDEV and MATDEV agree that a proposed technology solution is affordable, militarily-useful, and based on mature, demonstrated technology. Initial life-cycle sustainment of proposed technologies is planned during this phase. Technology obtained within the S&T community or procured from industry or other sources are demonstrated in a relevant environment, preferably in an operational environment considered to be very mature.

*d.* A Preliminary Design Review (PDR) is conducted for each candidate design or capability to ensure that the system can proceed into a detailed design and meets performance requirements. All system elements (hardware and software) must be at a level of maturity commensurate with the PDR entrance and exit criteria. A successful PDR informs requirements trades; improves cost estimation; and identifies remaining design, integration, and manufacturing risks. The PDR is conducted at the system level and includes CAPDEV representatives and associated certification authorities. The PM provides a PDR report to the MDA at MS B and includes recommended requirements trades based upon an assessment of cost, schedule, and performance risk.

*e.* The proposed system-level solution exits the TD phase when an affordable program or increment of militarily-useful capability has been identified; the technology for that program or increment have been assessed and demonstrated in a relevant environment; manufacturing risks have been identified and assessed; and a system or increment can be developed for production within a relatively short timeframe (normally less than 5 years for weapon systems); or, when the MDA decides to terminate the effort. During TD, the CAPDEV prepares the capability development document (CDD) to support initiation of the acquisition program, refines the integrated architecture, and clarifies how the program will lead to warfighting capability. The CDD builds on the ICD and provides the detailed operational performance and support parameters necessary to complete the design of the proposed system. A MS B decision follows the completion of TD.

#### **11-43. Systems acquisition activity**

Systems acquisition is the process of developing system-level materiel solutions into producible and deployable products that provide capability to the user. The proposed system-level materiel solution to exploit in systems acquisition is based on the AoA conducted in the MS A phase to meet the military need, including commercial and non-developmental technologies and products and services determined through market research (a process for gathering data on product characteristics, suppliers' capabilities, and the business practices that surround them, plus the analysis of that data to make acquisition decisions). The responsible CAPDEV for the functional area in which a capability gap or opportunity has been identified, but not the MATDEV, normally prepares the AoA. The goal is to develop the best overall value solution over the system's life-cycle that meets the user's operational requirements. If existing systems cannot be economically used or modified to meet the operational capabilities-based requirement, an acquisition program may be justified.

#### **11-44. Milestone (MS) B**

MS B is normally the initiation of an acquisition program. The purpose of MS B is to authorize entry into the Engineering and Manufacturing Development (EMD) phase.

*a.* MS B approval can lead to integrated system design or system capability and manufacturing process demonstration. Regardless of the approach recommended, PMs and other acquisition managers continually assess program risks. Risks must be well understood before MDAs can authorize a program to proceed into the next phase of the acquisition process. The types of risk include, but are not limited to, schedule, cost, technical feasibility, risk of technical obsolescence, software management, dependencies between a new program and other programs, and the risk of creating a monopoly for future procurements.

*b.* There is only one MS B per program or evolutionary increment. Each increment of an evolutionary acquisition has its own MS B, unless the MDA determines that the increment will be initiated at MS C. At MS B, the MDA approves the acquisition strategy (AS) and the acquisition program baseline (APB). The MDA decision is documented in an ADM.

*c.* At MS B, the MDA determines the low-rate initial production (LRIP) quantity for MDAPs and major systems. The LRIP quantity for an MDAP cannot exceed 10 percent of the total production quantity. Any increase in quantity must be approved by the MDA. The OSD Director, Operational Test & Evaluation, (D,OT&E), following consultation with the PM, determines the number of production or production-representative test articles required for live-fire testing (LFT) and initial operational testing and evaluation (IOT&E) of programs on the OSD T&E Oversight List. For a system that is not on the OSD Oversight List, the Army Test and Evaluation Command (ATEC), following consultation with the PM, determines the number of test articles required for IOT&E.



## How the Army Runs

*d.* In general, MS B is planned when a system-level materiel solution and design have been selected, a PM has been assigned, requirements have been approved, and system-level integration is ready to begin. In no case will MS B be approved without full funding (e.g., inclusion of the dollars and manpower needed for all current and future efforts to carry out the AS in the budget and out-year program), which are programmed in anticipation of the MS B decision.

### 11–45. Engineering and manufacturing development (EMD) phase

The purpose of the EMD phase is to develop a system or an increment of capability; complete full system integration (technology risk reduction occurs during TD); develop an affordable and executable manufacturing process; ensure operational supportability with particular attention to minimizing the logistics footprint; implement manpower and personnel integration (MANPRINT); design for producibility; ensure affordability; and demonstrate system integration, interoperability, safety, and utility. The capability development document (CDD) acquisition strategy (AS) systems engineering plan (SEP), and test and evaluation master plan (TEMP) guide this phase.

### 11–46. Entrance criteria

*a.* Entrance into the EMD phase depends on demonstrated technology maturity (including software), validated and approved capabilities-based requirements, and full funding. Unless some other factor is overriding in its impact, the maturity of the technology determines the path to be followed. Programs that enter the acquisition process at MS B must have an approved ICD that provides the context in which the capability was determined, validated, and approved.

*b.* The management and mitigation of technology risk, which allows less costly and less time-consuming systems development, is a crucial part of overall program management and is especially relevant to meeting cost and schedule goals. Objective assessment of technology maturity and risk is a continuous aspect of system acquisition. Technology developed within the in S&T community or procured from industry or other sources, must be demonstrated in a relevant environment or, preferably, in an operational environment to be considered mature enough to use for product development in systems integration. Technology readiness assessments (TRAs) and where necessary, independent assessments, are also conducted. If technology is not mature, the MATDEV uses alternative technology that is mature and that can meet the user's needs.

*c.* Prior to beginning EMD, CAPDEVs identify and the requirements authority validates a minimum set of key performance parameters (KPPs), included in the CDD, that guide the efforts of this phase. These KPPs may be refined, with the approval of the requirements authority, as conditions warrant. Each set of KPPs only apply to the current increment of capability in EMD (or to the entire system in a single step to full capability). To maximize program trade space, the MATDEV, CAPDEV, and T&E communities work closely with the requirements authority to minimize KPPs and limit total identified program requirements. Performance requirements that do not support the achievement of KPP thresholds, are limited and considered a part of the engineering trade space during development. During operational testing (OT), a clear distinction is made between performance values that do not meet threshold requirements in the user capabilities document and performance values that should be improved to provide enhanced operational capability in future upgrades. At MS B, the PM prepares and the MDA approves an acquisition strategy (AS) that guides activity during EMD. In an evolutionary acquisition program, each increment begins with MS B, and production resulting from that increment begins with MS C.

*d.* Each program must have an acquisition program baseline (APB) establishing program goal—thresholds and objectives—for the minimum number of cost, schedule, and performance parameters that describe the program over its life-cycle.

*e.* The affordability determination is made in the process of addressing cost in the JCIDS process and included in each CDD, using life-cycle cost or, if available, total ownership cost. Transition into EMD requires full funding - e.g., inclusion of the dollars and manpower needed for all current and future efforts to carry out the AS in the budget and out-year program. Full funding (at least 5 years) should be done no later than MS B, unless a program first enters the acquisition process at MS C.

*f.* EMD effectively integrates the acquisition, engineering, and manufacturing development processes with T&E. T&E is conducted in a continuum of live, virtual, and constructive (LVC) system and operational environments. Developmental and operational test activities are integrated and seamless throughout the phase. Evaluations take into account all available, relevant data and information from contractor and government sources. The independent planning of dedicated IOT&E and follow-on OT&E (FOT&E), if required, is the responsibility of ATEC. The PM prepares and the MDA approves an AS to guide activity during EMD. The AS describes how the PM plans to employ contract incentives to achieve required cost, schedule, and performance outcomes.

*g.* The MDA selects the contract type for a development program at MS B. The contract type must be consistent with the level of program risk and normally is a fixed price contract.

*h.* EMD has two major work efforts: integrated system design, and a system capability and manufacturing process demonstration. Additionally, the MDA conducts a Post-Critical Design Review (CDR) Assessment to end integrated system design.

### 11–47. Integrated system design work effort

This work effort is intended to integrate subsystems and reduce system-level risk. The program enters integrated

system design when the PM has a technical solution for the system, but has not yet integrated the subsystems into a complete system. The CDD guides this effort. This effort typically includes the demonstration of prototype articles or engineering development models (EDMs).

#### **11-48. post-critical design review (CDR) assessment**

*a.* The MDA conducts a formal program assessment following system-level CDR. The system-level CDR provides an opportunity to assess design maturity, as evidenced by measures such as: successful completion of subsystem CDRs; the percentage of hardware and software product build-to specifications and drawings completed and under configuration management; planned corrective actions to hardware/software deficiencies; adequate DT; the identification of key system characteristics; the maturity of critical manufacturing processes; and an estimate of system reliability based on demonstrated reliability rates; etc.

*b.* The PM provides a post-CDR report to the MDA that provides an overall assessment of design maturity and a summary of the system-level CDR results. The MDA reviews the post-CDR report and the PM's resolution/mitigation plans and determines whether additional action is necessary to satisfy EMD phase exit criteria. The results of the MDA's post-CDR assessment are documented in the ADM. Successful completion of the post-CDR assessment ends the integrated system design work effort and continues the EMD phase into system capability and manufacturing process demonstration work effort.

#### **11-49. system capability and manufacturing process demonstration work effort**

*a.* This work effort is intended to demonstrate the ability of the system to operate in a useful way consistent with the approved KPPs, and that system production can be supported by demonstrated manufacturing processes. The program enters system capability and manufacturing process demonstration upon completion of the post-CDR assessment and establishment of an initial product baseline. This work effort ends when the system meets approved requirements and is demonstrated in its intended operational environment, using the selected production-representative article; manufacturing processes have been effectively demonstrated; industrial capabilities are reasonably available; and the system meets or exceeds exit criteria and MS C entrance requirements.

*b.* Successful DT to assess technical progress against critical technical parameters, early operational assessments, and, where proven capabilities exist, the use of modeling and simulation (M&S) to demonstrate system/system-of-systems integration are critical during this effort. T&E assesses improvements to mission capability and operational support based on user needs and is reported in terms of operational significance to the user. The completion of the EMD phase is dependent on a decision by the MDA to commit to the program at MS C or a decision to end this effort.

#### **11-50. Production and deployment (P&D) phase**

The purpose of the P&D phase is to achieve an operational capability that satisfies functional needs. OT determines the operational effectiveness, suitability, and survivability of the system. The MDA makes the decision to commit to production at MS C, and documents the decision in the ADM.

*a.* MS C authorizes entry into low-rate initial production (LRIP) for MDAPs and major systems; into production or procurement (for non-major systems that do not require LRIP); or into limited deployment in support of OT for major automated information systems (MAIS) programs or software-intensive systems with no production components.

*b.* This phase has two major work efforts - LRIP and full-rate production and deployment, and includes a full-rate production decision review. MS C can be reached directly from pre-systems acquisition (e.g., a commercial product) or from the EMD phase. For OSD D,OT&E oversight programs, a system cannot be produced at full-rate until a beyond low-rate initial production report has been completed and sent to Congress.

#### **11-51. Entrance criteria**

Regardless of the entry point, approval at MS C is dependent on the following criteria being met (or a decision by the MDA to proceed):

- acceptable performance in DT;
- an operational assessment;
- mature software capability;
- no significant manufacturing risks;
- manufacturing processes under control (if MS C is full-rate production);
- an approved ICD, if MS C is program initiation;
- approved CPD. The CPD reflects the operational requirements resulting from EMD and details the performance expected of the production system;
- acceptable interoperability;
- acceptable operational supportability;
- demonstration that the system is affordable throughout the life-cycle, optimally funded, and properly phased for rapid acquisition.

### 11–52. Milestone (MS) C

a. Prior to making the milestone decision, the MDA considers the component cost estimate (CCE); and for MAISs, the CCE and economic analysis; the manpower estimate; the program protection for critical program information including anti-tamper recommendations; and an established completion schedule for the *National Environmental Policy Act (NEPA)* compliance covering testing, training, basing, and operational support.

b. At MS C, the MDA approves an updated AS prior to the release of the final RFP and approves an updated development APB, exit criteria for LRIP (if needed) or limited deployment, and the ADM.

c. The DODD, OT&E and cognizant OIPT leader approve the TEMP for all OSD T&E oversight programs. IT acquisition programs (regardless of ACAT) that entered system acquisition at MS C are registered with the DOD Chief Information Officer (CIO) before MS C approval.

d. A favorable MS C decision authorizes the PM to commence LRIP or limited deployment for MDAPs and major systems. The PM is only authorized to commence full-rate production with further approval of the MDA.

### 11–53. Low-rate initial production (LRIP) work effort

a. This work effort is intended to result in completion of manufacturing development in order to ensure adequate and efficient manufacturing capability and to produce the minimum quantity necessary to provide production configured or representative articles for IOT&E; establish an initial production base for the system; and permit an orderly increase in the production rate for the system, sufficient to lead to full-rate production upon successful completion of operational (and live-fire, where applicable) testing.

b. Deficiencies encountered in testing prior to MS C are resolved prior to proceeding beyond LRIP (at the full-rate production (FRP) decision review) and any fixes verified in IOT&E. Test resource plans (TRPs) are provided to the D,OT&E for oversight programs in advance of the start of OT.

c. LRIP may be funded by RDTE appropriation or by procurement appropriation, depending on the intended usage of the LRIP systems.

d. LRIP quantities are minimized. The D,OT&E determines the LRIP quantity for MDAPs and major systems at MS B, and provides rationale for quantities exceeding 10 percent of the total production quantity documented in the AS. Any increase in quantity after the initial determination, must be approved by the D,OT&E. When approved LRIP quantities are expected to be exceeded because the program has not yet demonstrated readiness to proceed to full-rate production, the MDA, in coordination with the D,OT&E, assesses the cost and benefits of a break in production versus continuing annual buys.

### 11–54. Full-rate production (FRP) decision review

a. An acquisition program may not proceed beyond LRIP without approval of the MDA at the FRP decision review. Before making the full-rate production and deployment decision, the MDA considers:

- the CCE, and for MAISs, the CCE and economic analysis;
- the manpower estimate (if applicable);
- the results of operational and live fire test (if applicable);
- CCE compliance certification and certification for MAISs;
- C4I supportability certification; and
- interoperability certification.

b. The MDA approves the AS prior to the release of the final RFP, the production APB, and the ADM. The decision to continue beyond low-rate to full-rate production, or beyond limited deployment of AISs or software-intensive systems with no developmental hardware, requires completion of IOT&E, submission of the Beyond LRIP Report for D,OT&E oversight programs, and submission of the LFT&E Report (where applicable) to the USD(AT&L), to the SECDEF, and to Congress.

### 11–55. Full-rate production and deployment work effort

This work effort delivers the fully funded quantity of systems and supporting materiel and services to the users. During this work effort, units attain initial operational capability (IOC). The IOC is the first attainment of the capability by a modified table of organization and equipment (MTOE) unit and supporting elements to operate and maintain effectively a production item or system provided the following:

- the item or system has been type classified as standard or approved for limited production;
- the unit and support personnel have been trained to operate and maintain the item or system in an operational environment; and
- the unit can be supported in an operational environment in such areas as special tools, test equipment, repair parts, documentation, and training devices.

**11–56. Sustainment activity/operations and support (O&S) phase**

The objective of this activity/phase is the execution of a support program that meets materiel readiness and operational support performance requirements; and sustains the system in the most cost-effective manner over its total life-cycle. When the system has reached the end of its useful life, it must be disposed of in an appropriate manner. Planning for this phase begins prior to program initiation and is documented in the life-cycle sustainment plan (LCSP). The O&S phase has two major work efforts: life-cycle sustainment and disposal.

**11–57. Life-cycle sustainment work effort**

a. The life-cycle sustainment program includes all elements necessary to maintain the readiness and operational capability of deployed systems. The scope of support varies among programs, but generally includes supply, maintenance, transportation, sustaining engineering, data management, configuration management, manpower, personnel, training, habitability, survivability, safety (including explosives safety), occupational health, protection of critical program information (CPI), anti-tamper provisions, IT (including national security system (NSS)) supportability and interoperability, and environmental management functions. This activity includes the execution of operational support plans in peacetime, crises, and wartime. Programs with software components must be capable of responding to emerging requirements that will require software modification or periodic enhancements after a system is deployed. A follow-on operational test and evaluation (FOT&E) program that evaluates operational effectiveness, survivability, suitability, supportability, interoperability, and that identifies and ensures deficiencies are later corrected, is conducted, as appropriate.

b. Evolutionary sustainment. Supporting the tenets of evolutionary acquisition, sustainment strategies must evolve and be refined throughout the life-cycle, particularly during development of subsequent blocks of an evolutionary strategy, modifications, upgrades, and re-procurement. The PM ensures that a flexible, performance-oriented strategy to sustain systems is developed and executed. This strategy includes consideration of the full scope of operational support, such as maintenance, supply, transportation, sustaining engineering, spectrum supportability, configuration and data management, manpower, training, environmental, health, safety, disposal and security factors. The use of performance requirements or conversion to performance requirements are emphasized during re-procurement of systems, subsystems, components, spares, and services after the initial production contract.

c. The PM works with the CAPDEV to document performance and sustainment requirements in performance agreements specifying objective outcomes, measures, resource commitments, and stakeholder responsibilities. The PM employs effective performance-based life-cycle product support (PBL) planning, development, implementation, and management. Performance-based life-cycle product support represents the latest evolution of performance based logistics. Both can be referred to as PBL. PBL offers the best strategic approach for delivering required life-cycle readiness, reliability, and ownership costs. Sources of support may be organic, commercial, or a combination, with the primary focus optimizing customer support, weapon system availability, and reduced ownership costs.

**11–58. Disposal work effort**

At the end of its useful life, a system must be demilitarized and disposed of in accordance with all legal and regulatory requirements and policy relating to safety (including explosives safety), security, and the environment. During the design process, PMs document hazardous materials contained in the system, and estimate and plan for demilitarization and safe disposal. The demilitarization of conventional munitions (including any item containing propellants, explosives, or pyrotechnics) shall be considered during systems design.

**11–59. Additional considerations**

The above discussion examined the activities performed in each phase of the nominal life-cycle of an acquisition system according to the current *DODD 5000.01*, *DODI 5000.02*, and *AR 70–1*. This is not to imply that all system developments must follow this exact sequencing of life-cycle phases and activities. On the contrary, *DODI 5000.02* specifically authorizes and encourages a PEO/PM to devise program structures and acquisition strategies to fit that specific program - an approach called “tailoring.” Other aspects of acquisition planning and strategy (e.g., pre-planned product improvement (P3I) and technology insertion) can also be accommodated under the broad guidance and direction contained in *DODD 5000.01* and *DODI 5000.02*. What remains constant is the task to develop and deliver combat-capable, cost-effective, and supportable systems to our Soldiers.

**Section IX****Accelerated Capabilities and Materiel Developments**

DOD and the Army continue to improve and adapt their capabilities and materiel developments processes in response to overseas contingency operations (OCO) and transformation. Major successes are the joint urgent operational need statements (JUONS)/Joint Rapid Acquisition Cell (JRAC)/DOD immediate Soldier needs (IWNs); Joint Improvised Explosive Devices Defeat Organization (JIEDDO); operational needs statement (ONSS)/Army Requirements and Resourcing Board (AR2B) accelerated solutions process; rapid equipping force (REF); capability packages (CPs); capability development for rapid transition (CDRT); Army immediate Soldier needs (IWNs) and directed requirements.

## How the Army Runs

All rapid capabilities and materiel developments initiatives provide timely support to Soldiers deployed in combat, while facilitating Army transformation.

### **11–60. Joint urgent operational needs statements (JUONS)/Joint rapid acquisition cell (JRAC)/DOD immediate Soldier needs (IWN)**

a. In 2004, DOD initiated the Joint Rapid Acquisition Cell (JRAC) emulating the success of the Army's REF program, discussed later in this section. The JRAC is chartered to "break through the institutional barriers of providing timely, effective support" to operational commanders.

b. The cell is not attempting to introduce a new acquisition/procurement process, however it is attempting to push critical JUONS through the existing DOD process. The USD(ATL) and the DOD Comptroller established the JRAC based on DEPSECDEF guidance. Membership consists of 1–Star level or senior executive representatives from the Joint Staff, combatant commands, and each of the services empowered to go back to their organizations and carry out the JRAC's decisions. The cell works directly with the combatant commands to meet certified operational critical DOTMLPF (primarily materiel and logistics) requirements. The cell selects and focuses on high priority JUONs by identifying them as DOD immediate Soldier needs (IWNs). The goal is to act on requests for IWNs within 48 hours, or at least within 14 days to designate or decline a JUONS as a IWN, so that a contract is awarded and goods and services are delivered within 4 months to 2 years. All incoming requests for an urgent operational need must be validated and prioritized by the combatant command before forwarding to the Joint Staff via SIPRNET. The cell tracks how quickly the military responds to IWNs and periodically reports directly to the SECDEF through the DEPSECDEF. The JRAC process is discussed in *CJCSI 3470.01*.

### **11–61. Joint improvised explosive devices defeat organization (JIEDDO)**

a. In response to an urgent need to develop countermeasures to improvised explosive devices (IEDs), the VCSA established the IED Task Force (TF) on January 5, 2004. IEDs are defined as make-shift or "homemade" bombs often used by enemy forces to destroy or disrupt military convoys. They are currently the leading cause of casualties to troops deployed in Iraq. In July 2004, the Army's IED TF evolved into the joint IED TF and eventually into the JIEDDO in February 2006. The Army, Navy, Marine Corps, and Air Force all provide representatives to JIEDDO. The JIEDDO is not only inter-service, but interagency and multinational.

b. JIEDDO has rapidly expanded to provide operational capabilities in support of operational commanders wherever the IED threat may be encountered. As the enemy's use of asymmetric attacks has evolved on the battlefield, the mission of JIEDDO was broadened to include counter-mortar and counter-rocket propelled grenade programs. In addition to developing doctrine and training strategies, JIEDDO directs the accelerated development and fielding of selected doctrine, organization, training, materiel, leadership and education, personnel, and facilities (DOTMLPF) solutions.

c. JIEDDO is designed to integrate intelligence, training and materiel solutions into a holistic response. The key operational arm of JIEDDO consists of the forward-deployed field teams in Kuwait, Iraq and Afghanistan. Chartered to perform on-the-ground observation, information collection and dissemination, and IED training in-theater, these teams assist in collecting technical, operational and contextual details relating to IED events. They provide an immediate and vital link to theater intelligence and operations. Tactics, techniques, and procedures (TTPs) developed from lessons learned form the basis of a multi-echelon, predeployment training program for units identified for future rotations.

d. JIEDDO works in partnership with REF in preparing Soldiers and leaders to face the pervasive IED threat in the current operating environment (OE). JIEDDO can be viewed as a prototype of a permanent organization capable of conducting operations in support of Army and joint force commanders to mitigate and defeat identified asymmetric threats. In light of its success, the DOD senior leadership decided to make JIEDDO a permanent organization.

### **11–62. Operational needs statement (ONSs)/Army requirements and resourcing board (AR2B) process**

a. An Army capability request to HQDA constitutes a request for a materiel and/or non-materiel solution to correct a deficiency or to improve a capability that impacts upon mission accomplishment. These capability requests come to HQDA via the SIPRNET-based Army "start to finish" equipment common operating picture (ECOP) database and fall into two general categories; authorized/pre-validated equipment sourcing documents (ESDs) and operational needs statements (ONSs). The final validation, prioritization, and resourcing decision for these capability requests are made by the AR2B.

b. The AR2B is the mechanism (forum) for validating, prioritizing, and resourcing critical operational needs (ONSs and ESDs) for rapid senior leadership decision-making (accelerated fielding solutions) in support of an OCO named operation. The AR2B identifies solutions in the year of execution and/or budget year that require possible resource realignment. Established in December 2004, the AR2B replaced the Army Strategic Planning Board (ASPB) and Setting the Force Task Force. AR2B membership is shown in figure 11–8.

c. Authorized/pre-validated equipment sourcing requests (equipment and quantities already validated by HQDA, ODCS G–3/5/7):

- (1) Deployed and deploying units or other HQDA designated high priority units, may submit ESDs for authorized/

pre-validated equipment (e.g., modified table of organization and equipment (MTOE) shortages, table of distribution and allowances (TDA) shortages, brigade combat team (BCT) basis-of-issue plan (BOIP) shortages, or other equipment shortages already validated by HQDA). The unit (05 level command) submits an ESD, via the ECOP database, through the chain of command to HQDA G-8/G-4/ASA(ALT) for resourcing.

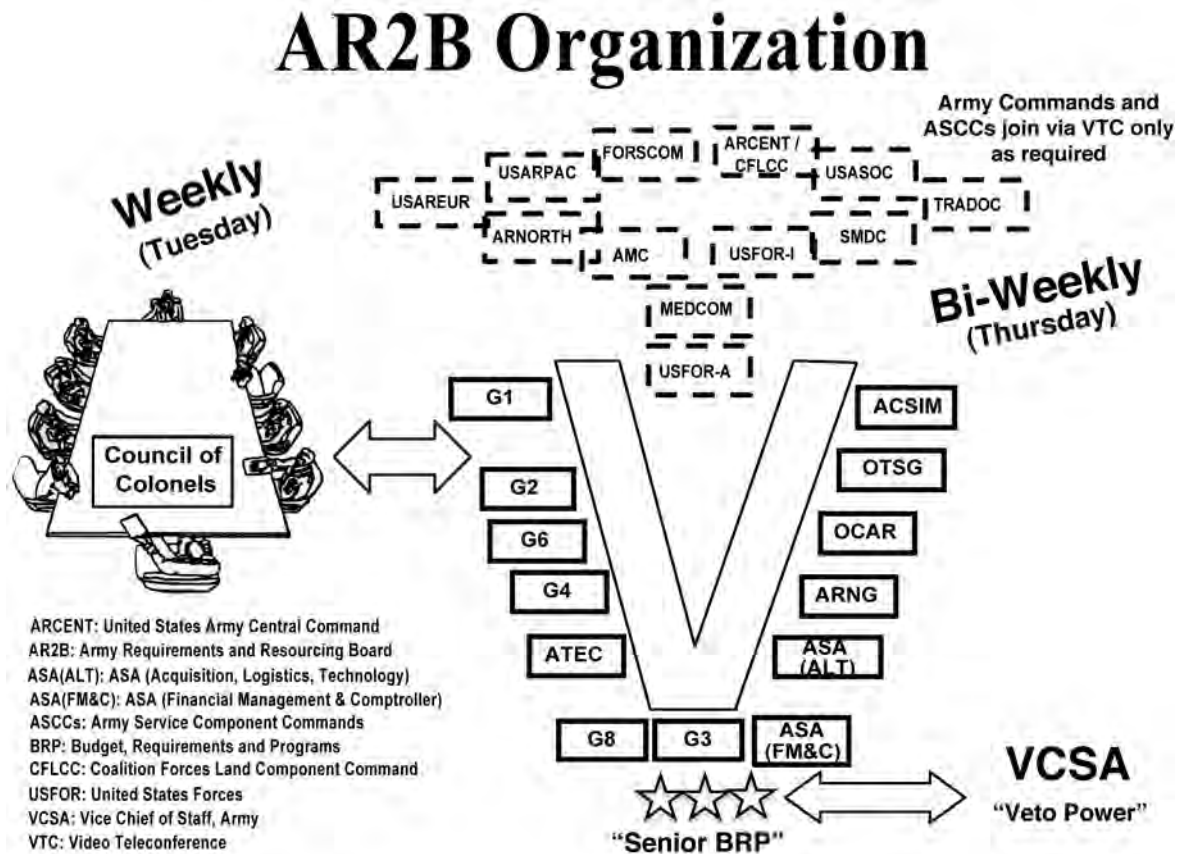

Figure 11-8. Army Requirements And Resourcing Board (AR2B)

(2) Other means are still available for units to request equipment resourcing of authorized/pre-validated equipment such as MTOE shortages. For example, units can and should continue to use the unit status report (USR) process (IAW AR 220-1) to identify critical shortages affecting unit readiness.

d. Operational needs statements (ONSs). Operational field commanders use an ONS to document the urgent need for a materiel and/or non-materiel solution to correct a deficiency or to improve a capability that impacts upon mission accomplishment in overseas contingency operations.

(1) The ONS provides an opportunity for the operational field commander (06 level) to initiate the HQDA AR2B process via the Army ECOP database.

(2) The ONS is not a materiel capabilities document (MCD). The CAPDEV, TNGDEV or MATDEV communities do not initiate or develop an ONS.

(3) Response to an ONS varies depending on the criticality of the need for the proposed item. Response can range from a HQDA directed requirement and fielding of a materiel system to the forwarding of the action to TRADOC ARCIC for review and appropriate action. HQDA may decline to favorably consider an ONS for a variety of reasons, including conflicting needs, higher priorities for funding, existence of a similar system, or non-concurrence of the criticality of the need. The response to an ONS is based on an ARSTAF validation supported by TRADOC, AMC, and MATDEV reviews. HQDA AR2B determines validity of the need, availability of technology, and sourcing of resources to fill the requirement. If the need is determined to be critical, and can be resourced (at least for the present situation), a directed requirement may result.

(4) All ONS are reviewed by the CAPDEVs/TNGDEVs to determine applicability to future requirements or

continuing need for which a standard requirement and acquisition is needed. If validation of the ONS indicates that the concept has potential for Army-wide application and development of a new system is appropriate, TRADOC ARCIC will initiate a functional area ICD and/or CDD/CPD as appropriate through the capability development for rapid transition (CDRT) program, discussed later in the chapter.

### **11–63. Rapid equipping force (REF)**

*a.* REF is a Staff Support Agency under HQDA G–3/5/7, Army Asymmetric Warfare Office (AAWO) and reporting directly to the VCSA. The REF was established in 2003 as a unique, singular organization designed to address an Army-wide, systemic deficiency in providing immediate technology solutions to deployed and pre-deploying forces.

The uniqueness stems from the REF's ability to address all aspects of the requirement and life-cycle management. The REF's mission is to rapidly provide capabilities to Army forces worldwide through current and emerging technologies in order to improve operational effectiveness. The REF accomplishes its mission by equipping operational commanders with primarily commercial and government off-the-shelf (COTS/GOTS) solutions to increase effectiveness and reduce risk. If COTS/GOTS do not fulfill the requirement, the REF conducts limited rapid prototyping efforts. The REF inserts emerging technologies and surrogates to validate concepts and speed capabilities to deployed units. The REF serves as a solutions catalyst by canvassing the military, industry, academia, and science communities for existing and emerging technologies. REF forward teams are positioned in Afghanistan and Iraq to identify and evaluate deployed force capability needs.

*b.* To date, the REF has equipped deployed units operating in theater (Iraq, Afghanistan, and Horn of Africa) with over 470 projects, consisting of over 93,000 items. Of those, over 470 projects, or 75 percent were equipped within 180 days of receipt of the requirement.

*c.* The normal model for providing materiel solutions involves letting a contract and managing a contractor's performance. The REF embodies a model (see figure 11–9) that changes the focus and requires being personally involved in responding to the warfighting commander; working with Soldiers; observing/participating in operations; and modifying systems on the spot as required. The REF concept of operations includes frequent in-theater canvassing of Soldier requirements in an operational environment. Providing materiel solutions can't always happen in 24 hours, but the REF's forward presence at operating bases in Afghanistan and Iraq helps focus and accelerate the process that produces materiel solutions. The REF coordinates closely with other key major Army organizations, primarily the HQDA Staff; Forces Command (FORSCOM); TRADOC's Combined Arms Center (CAC) and ARCIC; and AMC to complete the rapid transition process.

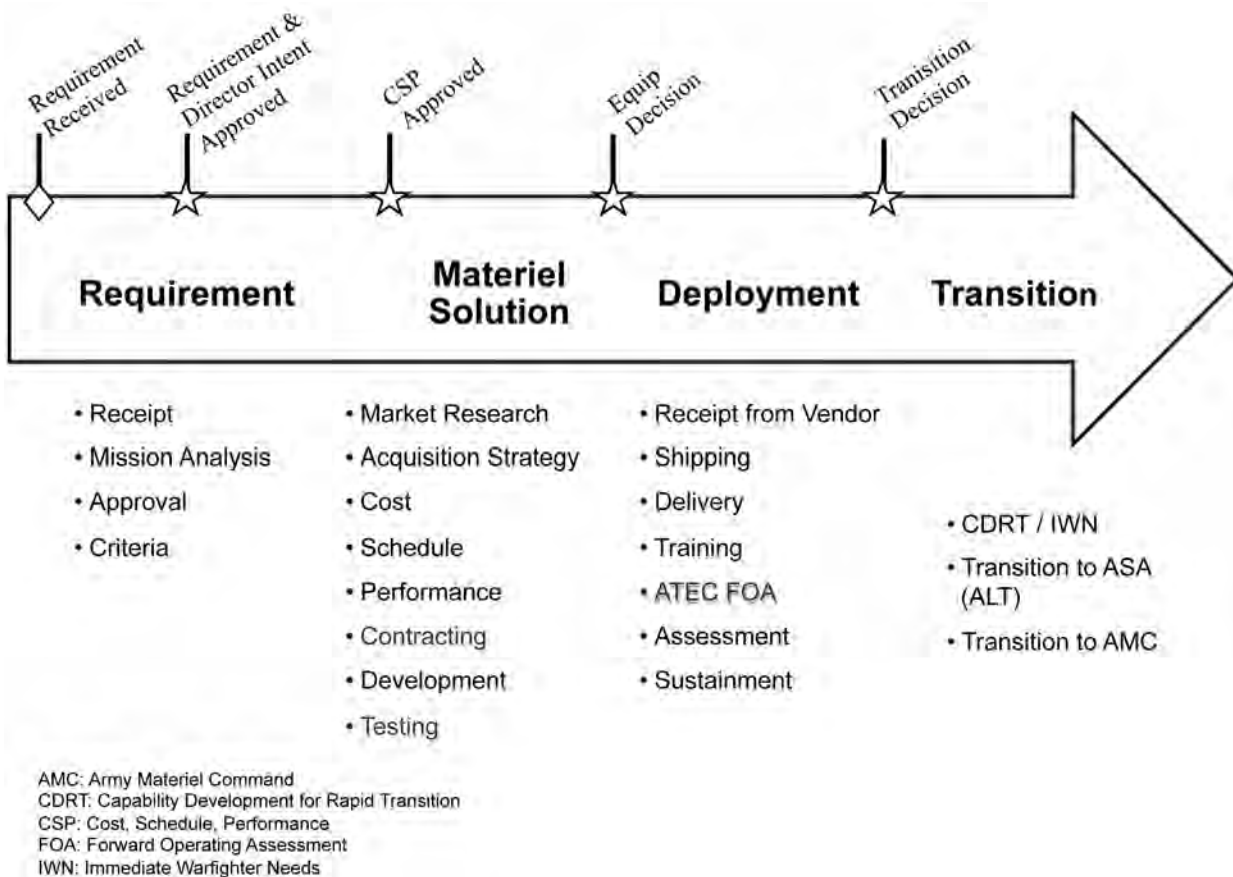

Figure 11–9. Rapid Equipping Force (REF)

d. The REF is an enduring Army organization. Its focus is to continue equipping Soldiers with materiel solutions to meet emerging capability gaps identified in the evolving asymmetrical fight. The REF impacts the fight by providing capabilities to meet Soldier-identified gaps in a relevant timeframe and to equip requesting units with materiel solutions, which enhances our ability to fight. The REF serves as a change agent that provides Soldiers with capabilities that increase lethality, improve protection warfighting function, and enhance survivability.

**11–64. Capability packages (CPs)**

a. CPs are defined as tailored, adaptive capability solutions that best mitigate the highest risk capability gaps given budgetary, technological, and production constraints. They are “REF-like” in that they target deploying Army forces, and their materiel components are likely to consist of solutions where rapid advances in technology can significantly improve a particular capability (e.g., robotics). CP governance takes advantage of existing Army processes to provide oversight and direction to the development of CPs on an annual cycle. Governance begins with strategic guidance, the Army Capstone Concept (ACC), and lessons learned to ensure we are operationally well-grounded. The TRADOC ARCIC capability needs analysis (CNA), informed by the ACC and the latest requirements from the field, identifies high-risk gaps and prioritized solutions to those gaps. Proposed solutions, across the DOTMLPF domains, are considered from PEOs, PMs, industry, academia, and force modernization proponents. ARCIC’s quarterly Capability Integration Enterprise Forum (CIEF) and TRADOC’s Quarterly Futures Forum, guide CP development and submission of CP contents as an Army Campaign Plan (ACP) Decision Point for approval by the first of November, annually. Quarterly, ARCIC tracks requirements in order to responsively adjust the CPs.

b. In an operating environment characterized by both rapidly changing technologies and threats, the Army must have the ways and means to quickly evaluate and deliver resourced DOTMLPF solutions into the hands of Soldiers. Materiel solutions to Army requirements are fielded either through the deliberate acquisition process (previously discussed) or through the rapid acquisition process. The deliberate process thoroughly evaluates candidate solutions with a life-cycle approach for sustainment, but it takes time. The rapid acquisition process gets materiel solutions to the field quickly, but candidate solutions are not thoroughly evaluated and not resourced for sustainment.



## How the Army Runs

c. Certain capabilities are considered “core” in that they are required by all brigades of a particular type. For example, company intelligence support teams and self-propelled howitzers provide capabilities that all heavy BCTs require. However, certain capability solutions are characterized by changing technologies that become obsolete in two or three years. Consider the way the Army manages its computers; an organization replaces one-third of its computers each year in order to ensure that the systems are current. Therefore, solutions to requirements characterized by changing technology should not be fielded to the entire force, as the passage of time makes these solutions obsolete. Bulk purchase of these solutions becomes unaffordable and does not make operational sense or best resource their life-cycle. We can get such solutions in the hands of Soldiers by fielding them to those units with the greatest need: brigades deploying in support of overseas contingency operations and those in the Global Response Force (GRF). Rather than core capabilities, these are tailored, “adaptive” capabilities. The Army meets Soldiers’ requirements for adaptive capabilities by buying fewer quantities (only for Army Force Generation -designated priority units), and seeking incremental improvements within regular defined periods (usually in two-year increments) - we “buy less, more often.” Thus, the concept of core and adaptive capabilities allows the Army to leverage evolving technologies in a rapidly changing operating environment. In doing so, both materiel and non-materiel capabilities are either

- (1) core,
- (2) adaptive, or
- (3) adaptive transitioning to core, while technologies, the operating environment, and Army requirements evolve.

d. As part of its modernization strategy, the Army intends to implement a resource-informed and prioritized CP composition annually, aligned with the PPBE cycle. TRADOC writes requirements for CP components; integrates, trains, and evaluates CP components; reviews CP status quarterly; and provides initial cost benefit analysis. The HQDA G-3/5/7 validates, prioritizes, and staffs the annual CP requirements recommendation for approval at the AROC. The HQDA G-3/5/7 provides the most likely course of action for high priority brigades to receive CPs. The HQDA G-8 resources the approved CP requirements and provides cross-Program Evaluation Group (PEG) support to CP development. The ASA(ALT) acquires and/or develops material components for CPs and fields them to high priority brigades. They assist in cost benefit analysis, initiate POR CP solutions at DAS Milestone (MS) C, and re-compete CP solutions between CPs, informed by sustainment costs. Finally, the DASA(CE) validates CP cost estimates. This process ensures timely capability package identification, development, approval and delivery to the operating force. The CP approach requires the Army to enter the DOD deliberate acquisition process at a modified MS C in order to rapidly get evaluated and resourced materiel solutions in the hands of the Soldiers who need them.

e. CPs are a key element of the Army’s transition to a brigade modernization strategy to build a versatile mix of mobile, networked and combat effective brigades. These activities will support the accelerated delivery of select capabilities to the current force, reducing operational risk prior to delivery.

### **11-65. Capability development for rapid transition (CDRT)/Army immediate Soldier needs (IWN)**

a. The CDRT is one of two mechanisms designed to transition rapid acquisition systems/technologies to the Army’s deliberate Defense Acquisition System (DAS). The other mechanism is the Army’s immediate Soldier needs (IWN) process.

(1) CDRT. During recent combat operations the Army developed new materiel systems and non-materiel capabilities to meet emerging requirements. Many of those that worked well in the operational theaters have value to the Army in the long term. To identify those valuable capabilities, the HQDA G-3/5/7 Current and Future Warfighting Capabilities Division (DAMO-CIC) and TRADOC ARCIC Requirements Integration Directorate (RID), Accelerated Capabilities Division (ACD) developed the CDRT process, formerly known as “Spiral to the Army at Large”. CDRT is a quarterly assessment that identifies the very best non-standard materiel and non-materiel insertion the Army should incorporate into the future force. The goal is to significantly reduce the time needed to field selected systems or capabilities to the operational Army. The process also recommends disposition for those capabilities not selected as enduring, either for retention (i.e., sustain) within the operational theaters or for termination of all Army support, saving critical resources. Operational Army unit input, through survey responses, is the basis for the recommendations.

(2) The CDRT eligibility for nomination criteria requires a capability to be operationally mature, in country for a minimum of 120 days, and have a complete forward operational assessment. The intent of the selection criteria is to qualify each materiel system for entry into the formal JCIDS process at a later stage, either beginning with a CDD at MS B or a CPD at MS C, bypassing the DAS pre-system acquisition activity. The CDRT process does not obviate the JCIDS process for materiel systems, but leverages a provision in JCIDS that provides for a military utility assessment (MUA) to enable entry into the process at a later stage if a system has performed successfully in an operational environment. Once HQDA AROC approves the CDRT recommendations, DAMO-CIC (through TRADOC headquarters), tasks a TRADOC CoE or other CAPDEV to produce the required JCIDS documentation. The Army incorporates non-materiel capabilities identified as enduring through standard DOTMLPF development processes and procedures. For example, an organizational capability change would require consideration by the force design update (FDU) process.

(3) HQDA DCS, G-3/5/7 and DCS, G-8 are critical in processing JCIDS documentation and ensuring funding is

aligned across the Program Objective Memorandum (POM). A system is considered an acquisition program once it has an approved JCIDS document (CDD or CPD), a DAS MS decision, and funding in the base budget.

(4) The TRADOC ACD and HQDA DCS, G-3/5/7 have concluded ten iterations of the CDRT process to date, with iteration 11 in the final validation phase, iteration 12 in the unit survey step, and iteration 13 gathering nominations. The process has evolved since 2004, from an annual consideration of only materiel systems to a semi-annual process considering both materiel systems and non-materiel capabilities, and now a quarterly overlapping cycle. Through iteration 10 (approved September 15, 2010), the CDRT process has considered 497 capabilities (materiel and non-materiel); 40 (plus 13 merged into other programs) selected as enduring; 118 terminated; and 326 sustained in theater. Examples of acquisition programs include the Improvised Explosive Device (IED) Route Clearance Package, the Armored Security Vehicle (ASV), and the Common Remote Operated Weapons System (CROWS). Examples of non-materiel capabilities approved include the Weapons Intelligence Team (WIT), the Joint Trauma Analysis and Prevention of Injury in Combat Program (JTAPIC), and the most recent, the Company Intelligence Support Team (CoIST) Training.

(5) The Army continues to conduct CDRT iterations, beginning a new iteration every three months. Iterations require six months to complete - resulting in overlapping iterations. The Army institutionalized the process in *AR 71-9*, *TR 71-20*, and is expected to include CDRT in the update to *AR 750-1*.

(6) The CDRT process is an example of generating force responsiveness to operational Army requirements by reducing the time to meet Army requirements for materiel and non-materiel capabilities. The process identifies, through operational Army unit input, those systems working well in operational theaters and speeds the process to get them into the hands of Soldiers throughout the Army for the long term.

*b.* The second mechanism designed to transition rapid acquisition efforts to the Army deliberate acquisition system is the immediate Soldier needs (IWN) process. The IWN ensures that rapidly fielded systems/technologies, which have not already been transitioned by the CDRT initiative, are assigned either to the Army Acquisition Executive (AAE) or to AMC and resourced for initial program management or life-cycle support.

(1) The IWN process includes representatives from the Army's Asymmetric Warfare Office (AAWO), ASA(ALT), AMC, Research, Development, and Engineering Command (RDECOM), TRADOC, and HQDA DCS, G-2, DCS, G-3/5/7, DCS, G-4, and DCS, G-8.

(2) AAWO plays a key role in the transition of new initiatives to the Army. The AAWO mission is to rapidly organize, train and equip Army organizations with the inherent ability to apply and defeat asymmetric threats, while simultaneously changing the culture of the Army to a mentally agile and adaptive force. AAWO was established in May 2006 as the Army's focal point for all AW initiatives and serve as the Army's link to the JIEDDO in the current and future IED fight. Moreover, AAWO develops the Army's service-specific broad perspective and policy/planning efforts in AW.

(3) AAWO initiated the IWN process in 2007, to formalize the transition of projects from JIEDDO, previously discussed, to the Army. The AAWO leadership soon expanded the process to include non-JIEDDO initiatives. The IWN process takes candidate initiatives/systems from REF, TRADOC, RDECOM, JIEDDO and other agencies, through a vetting process for possible transition to the Army. The IWN incorporates CDRT input, as well as candidates from other new initiatives. The process brings all of the HQDA staff principal elements together to decide what initiatives should go through the ASA(ALT), as the AAE, to a program/project/product manager (PM); and which should be managed for life-cycle support by AMC Life-Cycle Management Commands (LCMCs).

#### **11-66. Directed requirement**

*a.* If operational analysis and assessment of an ONS or joint urgent operational need (JUON) solution or results of a advanced technology demonstration (ATD) or joint capability technology demonstration (JCTD), indicates a specific limited but necessary urgent need exists, HQDA, DCS G-3/5/7, Director, DAMO-CI, may prepare and issue a directed requirement for a capability having application within the Army. Directed requirements will be approved in writing by the VCSA or HQDA, DCS G-3/5/7. While JCIDS capabilities compete in the Army prioritization process for program funding, the DCS G-3/5/7 will specify the funding source and priority for a directed requirement. Requests for directed requirements will be presented through the AROC Process Review Board (APRB), Army Requirements and Resourcing Board (AR2B) or Army Requirements Oversight Council (AROC) for decision.

*b.* The scope of a directed requirement will be limited to addressing urgent operational needs that, fall outside of the established JCIDS process, and if not addressed immediately, will seriously endanger personnel or pose a major threat to the success of ongoing operations. A directed requirement should not involve the development of a new technology or capability; however, the acceleration of an ATD or JCTD is within the scope of the directed requirements process. The directed requirement format is provided in *AR 71-9*, *Appendix D*.

#### **11-67. Rapid acquisition authority**

*a.* Congressional legislation uses the term Rapid Acquisition Authority to describe measures with respect to procurement that the SECDEF can take to eliminate a combat capability deficiency that has resulted in combat fatalities. The legislation permits the SECDEF to waive statutes and regulations for testing and procurements (contracting) short of criminal statutes; and to move up to \$100 million in authority, per fiscal year, regardless of the "color" of

## How the Army Runs

money. The \$100 million is not appropriated funding by Congress for this purpose; it is the authority to expend up to \$100 million of existing DOD funding, using this waiver authority.

b. The legislation granting the SECDEF this special authority is contained in section 806(c) of the Bob Stump National Defense Authorization Act for FY 2003 as amended by section 811 of the Ronald W. Reagan National Defense Authorization Act for FY 2005.

c. This Rapid Acquisition Authority, as well as the Iraq Freedom Fund (OCO funding), are the primary sources of funding for the accelerated capabilities and materiel development initiatives, discussed in this chapter, responding to unforeseen urgent operational needs of the military and coalition forces engaged in overseas contingency operations.

## Section X

### Acquisition Oversight and Review

The Defense Acquisition System (DAS), is controlled by decisions made as the result of various acquisition programs milestone decision reviews (MDRs) conducted by appropriate management levels at program milestones (MSs). The reviews are the mechanism for checking program progress against approved plans and for developing revised acquisition program baselines (APBs). Approval of APBs and plans in these reviews does not constitute program funding approval; allocation of funds in the PPBE process is required.

### 11–68. Integrated product teams (IPTs)

*DODD 5000.01* directs the DOD acquisition community to utilize IPTs to facilitate the management and exchange of program information. IPTs integrate all acquisition activities starting with capabilities development through production, fielding/deployment and operational support in order to optimize the design, manufacturing, business, and supportability processes. The IPT is composed of representatives from all appropriate functional disciplines working together with a team leader to build successful and balanced programs, identify and resolve issues, and make sound and timely recommendations to facilitate decision-making. There are two levels of IPTs: overarching integrated product teams (OIPTs) focus on strategic guidance, program executability (cost, schedule, risk), and issue resolution; and the working-level integrated product teams (WIPTs), that identify and resolve program issues, determine program status, and seek opportunities for acquisition reform.

a. Overarching integrated product teams (OIPTs). In support of all ACAT ID and IAM programs, an OIPT is formed to provide assistance, oversight, and review as that program proceeds through its acquisition life-cycle. The OIPT for ACAT ID programs is led by the appropriate OSD principal staff assistant (PSA). The DASD(C3ISR, Space, IT Programs) is the OIPT leader for ACAT IAM programs. Program OIPTs are composed of the PM, PEO, component staff, Joint Staff, USD(AT&L) staff, and the OSD staff principals or their representatives, involved in oversight and review of a particular ACAT ID or IAM program.

(1) In the Army, an Army Systems Acquisition Review Council (ASARC) OIPT is established at the direction of the MDA for ACAT IC, IAC, and most ACAT II programs. The ASARC OIPT is a team of DA staff action officers and the PEO/PM/TCM responsible for integration of oversight issues to be raised to the MDR forums.

(2) The secretary/facilitator of the ASARC OIPT for Army ACAT I and II programs is the DA system coordinator (DASC), in ASA(ALT), for that specific program. OIPT membership consists of empowered individuals appointed by ASARC members (ACAT IC, IAC, or selected ACAT II programs), and the MDA for ACAT III programs. Team membership is tailored based on the needs and level of oversight for the individual program. Typical ASARC OIPT responsibilities include:

- meeting together and individually with the PEO/PM throughout program development to raise and resolve issues early, providing recommendations for tailoring and streamlining the program,
- linking vertically with the PM's WIPTs,
- helping the PM successfully achieve a MS decision,
- providing an independent assessment for the MDA in preparation for the MDR,
- developing a memorandum documenting the issues/risks to be raised to the MDA with a recommendation to the MDA.

(3) The OIPT, at all levels, follow the general procedures that are described below for a typical ACAT ID and IAM program. Initially the OIPT meets to determine the extent of WIPT support needed for the potential program, who shall be members of the WIPTs, the appropriate MS for program initiation, and the minimum information needed for the program initiation review. The OIPT leader is responsible for taking action to resolve issues when requested by any member of the OIPT or when directed by MDA. The goal is to resolve as many issues and concerns at the lowest level possible, and to expeditiously escalate issues that need resolution at a higher level, bringing only the highest-level issues to the MDA for decision. The OIPT meets as necessary over the life of a program.

(4) The OSD OIPT leader provides an integrated program assessment (IPA) at MDRs, using data gathered through the IPT process. The OIPT leader's assessment focuses on core acquisition management issues and takes into account independent assessments that are normally prepared by OIPT members.

b. Working-level integrated product teams (WIPTs). WIPTs are established for all acquisition programs. The

number and membership of the WIPTs are tailored to each acquisition phase based on the level of oversight and the program needs. They are comprised of HQDA and/or service/functional action officers and normally chaired by the PM or designee. WIPTs provide advice to the PM and help prepare program strategies and plans. Each WIPT focuses on a particular topic(s), such as T&E, cost/performance, risk management (both programmatic and safety), etc.

### **11–69. The Defense Acquisition Board (DAB)**

*a.* The function of the DAB is to review DOD ACAT ID programs to ensure that they are ready for transition from one program phase to the next. The DAB is the DOD senior level acquisition forum for advising the USD(AT&L), as the Defense Acquisition Executive (DAE), on critical decisions concerning ACAT ID programs. DAB reviews focus on key principles to include interoperability, time-phased requirements related to an evolutionary strategy, and demonstrated technical maturity. The DAB is composed of DOD senior acquisition officials. The board is chaired by the USD(AT&L). Other principal members include: the Vice Chairman of the Joint Chiefs of Staff (VCJCS); Under Secretary of Defense (Comptroller); Under Secretary of Defense (Policy); Under Secretary of Defense (Personnel & Readiness); Assistant Secretary of Defense (Networks and Information Integration)/Department of Defense Chief Information Officer; Director, Cost Assessment and Program Evaluation; Director, Operational Test and Evaluation; and the Secretaries of the Army, Navy, and the Air Force. The Director, Acquisition Resources and Analysis serves as the DAB Secretary.

*b.* The United States Joint Forces Command (USJFCOM) is available to comment on interoperability and integration issues that the JROC forwards to the DAB. The DAE may ask other department officials to participate in reviews, as required.

*c.* Approximately one week prior to the DAB review, the OIPT meets to pre-brief the OIPT leader. The purpose of the meeting is to update the OIPT leader on the latest status of the program and to inform the senior acquisition officials of any outstanding issues and to insure the program is ready for a formal DAB review.

*d.* The JROC reviews all deficiencies that may necessitate development of ACAT I and ACAT IA systems prior to any consideration by the DAB or, as appropriate, the information technology acquisition board (ITAB) at MS B. The JROC validates an identified materiel need and forwards the MCD with JROC recommendations to the USD(AT&L). In addition, the JROC continues a role in validation of KPPs in program baselines prior to scheduled reviews for ACAT I and ACAT IA programs prior to all successive MDRs.

*e.* The OSD Director, Cost Assessment and Program Evaluation (D,CAPE), reviews the component (Army) cost position (ACP), prior to the scheduled MDR and determines, if additional analysis is required. The product is an independent cost position assessment and recommendations based on its independent review of the life-cycle cost estimate(s), validation of the methodology used to make the cost estimate(s), and determination if additional analysis or studies are required.

*f.* A formal DAB review is the last step of the DAB review process. The PM briefs the acquisition program to the DAB and specifically emphasizes technology maturity, risk management, affordability, critical program information, technology protection, and rapid delivery to the user. The PM addresses any interoperability and supportability requirements linked to other systems, and indicates whether those requirements will be satisfied by the acquisition strategy (AS) under review. If the program is part of a system-of-systems architecture, the PM briefs the DAB in that context.

*g.* Following presentations by the PM and a full discussion, the USD(AT&L), as DAE, decides to continue, alter, or terminate the program. This decision is published in an acquisition decision memorandum (ADM). With the approval of the DAE, other committee reviews may be held for special purposes, such as to develop recommendations for the DAE on decisions other than milestone or program reviews (e.g., release of “withhold funds,” baseline changes, AS changes).

### **11–70. The DOD Information Technology Acquisition Board (ITAB)**

*a.* The DOD ITAB provides the forum for ACAT IAM milestones, for deciding critical ACAT IAM issues when they cannot be resolved at the OIPT level, and for enabling the execution of the DOD ITAB’s acquisition-related responsibilities for IT, including National Security Systems (NSS), under the *Clinger-Cohen Act* and *Title 10*. Wherever possible, these reviews take place in the context of the existing IPT and acquisition milestone decision review (MDR) process. Where appropriate, an ADM documents the decision(s) resulting from the review.

*b.* The ITAB is chaired by the USD(AT&L). Principal participants at DOD ITAB reviews include the Joint Staff (JS) J–8; the Deputy DOD CIO; IT OIPT leader; ACAT ID OIPT leaders; cognizant PEO(s) and PM(s); CAEs and CIOs of the Army, Navy, and Air Force. Also participants, include (as appropriate to the issue being examined), executive-level representatives from the following organizations: Office of USD(AT&L); Office of the Under Secretary of Defense (Comptroller); Office of the Joint Chiefs of Staff; Office of D,OT&E; Office of the Director, Cost Assessment and Program Evaluation (D,CAPE); and the Defense Information Systems Agency (DISA).

### **11–71. The Army Systems Acquisitions Review Council (ASARC)**

*a.* The ASARC is the Army’s senior-level acquisition advisory body for ACAT IC, IAC, and selected ACAT II programs, ACAT ID programs (DAB managed) prior to a DAB, and ACAT IAM programs prior to an ITAB. The

## How the Army Runs

ASARC convenes at formal milestones to determine a program or system's readiness to enter the next phase of the materiel acquisition cycle, and makes recommendations to the AAE on those programs for which the AAE is the MDA. An ASARC may be convened at any time to review the status of a program. The ASARC is chaired by the AAE.

b. ASARC membership includes the Assistant Secretary of the Army (Acquisition, Logistics and Technology) - AAE; Vice Chief of Staff of the Army; Deputy Under Secretary of the Army - Test and Evaluation Executive; Assistant Secretary of the Army (Financial Management and Comptroller); Assistant Secretary of the Army (Installations, Energy, and Environment); Assistant Secretary of the Army (Manpower and Reserve Affairs); CG, Army Materiel Command; CG, Training and Doctrine Command; Office of the General Counsel; DCS, G-1; DCS, G-2; DCS, G-3/5/7; DCS, G-4; DCS, CIO/G-6; and the DCS, G-8. Other organizations are invited to attend, if a significant issue is identified within their area of responsibility. The AAE makes the final decision as to the attendance at the ASARC.

c. The effectiveness of the ASARC review process results from presentation of a thorough analysis of all relevant issues and face-to-face discussion among the principals from the Army Secretariat, ARSTAF, AMC and TRADOC.

### 11-72. In-process review (IPR)

a. The IPR is a formal acquisition review forum for ACAT III programs. General policies for reviews for IPR programs are the same as for ACAT I and II programs. Reviews are conducted at milestones and at other times deemed necessary by the MDA. The MDA, usually the assigned program executive officer (PEO), chairs the IPR.

b. The IPR brings together representatives of the MATDEV, the CAPDEV, the trainer, the logistician, and the independent evaluators for a joint review and decision on proceeding to the next phase of development. Their purpose is to provide recommendations, with supporting rationale, as a basis for system concept, system development, type classification, and production decisions by the appropriate level of authority. They are the forums where agencies responsible for participating in the materiel acquisition process can present their views and ensure that those views are considered during development, test, evaluation, and production. Participation is extended to the appropriate testing agencies, HQDA representatives, and to others as designated by the IPR chairman.

### 11-73. Configuration Steering Board (CSB)

a. *Section 814 of the 2009 National Defense Authorization Act (NDAA).* The NDAA requires the Secretary of each military department to establish a CSB for DAS post Milestone B ACAT I and IA programs. Meeting at least annually, the CSB is responsible for reviewing all requirements changes and any significant technical configuration changes for ACAT I and IA programs in development that have the potential to result in cost and schedule impacts to the program. Changes are not approved unless funds are identified and schedule impacts are mitigated. CSBs were designed to monitor programs and avoid requirements creep. The law does not limit the CSB process to ACAT I and IA only; it may be used for other ACAT programs.

b. *The 2009 NDAA explicitly provides PMs with the authority to challenge new program requirements.* The PM, in consultation with the PEO, identifies and proposes a set of de-scoping options, with supporting rationale addressing operational implications that reduce program cost or moderate requirements. The CSB recommends to the MDA which of these options should be implemented. The NDAA 2009 does not give the materiel development community the authority to unilaterally modify or delete requirements. Final decisions on the de-scoping option implementation are coordinated with the appropriate Joint Staff and military department requirements officials. These checks and balances provide a framework for the acquisition executive to challenge requirements without sacrificing the Services' accountabilities to ensure user requirements are met.

c. *In the Army, the CSB consists of the following principal members:.* **Section XI**

### Acquisition Documentation

Acquisition management documentation is designed to support the management process as the life-cycle development of a materiel system progresses.

### 11-74. Materiel capabilities documents (MCDs)

MCDs establish the need for a materiel acquisition program, how the materiel will be employed, and what the materiel must be capable of doing. As the acquisition program progresses, statements of required performance and design specifications become more and more specific. The initial capabilities document (ICD) is the document that initiates the Defense Acquisition System (DAS). MCDs were discussed in section III.

### 11-75. Other service requirements

The CAPDEV/TNGDEV reviews other service warfighting capability requirements documents for potential Army interest. When the Army chooses to participate in the RDA of another service program, HQDA initiates action to validate and approve the documentation. When another service's MCD, to include an approved production request for proposal (RFP), adequately describes an Army requirement, the document may be approved as the Army requirement. The Army may acquire other service equipment with a national stock number (NSN) that has been identified through

the MATDEV market investigation and meets an approved Army need. For joint programs, capabilities documents are prepared and processed in accordance with the lead services procedures. Service peculiar requirements may be documented in the other service's capabilities documents.

#### **11-76. Catalog of approved requirements documents (CARDS)**

Army CARDS is an unclassified HQDA DCS, G-3/5/7 publication that provides information on the status of all approved MCDs. It includes both active and inactive requirement documents. An active document or assignment of a CARDS reference number does not automatically authorize the expenditure of funds. Each program must compete for funds in the Army prioritization and programming process. The HQDA DCS, G-37 Current and Futures Warfighting Capabilities Division (DAMO-CIC), assigns a CARDS reference number to each MCD after approval and prior to publication and distribution.

#### **11-77. Program review documentation and program plans**

The milestone decision authority (MDA) is responsible for identifying the minimum amount of documentation necessary for milestone review purposes. Only those mandatory formats called for by statute or *DODI 5000.02* are required. All other formats are used as guidance only. Program plans are a description of the detailed activities necessary for executing the AS. Program plans belong to the PM and are used by the PM to manage program execution throughout the life-cycle of the program. The PM, in coordination with the PEO, determines the type and number of program plans, except those required by statute or DOD policy. Some of the typical program plans used to support the execution of a program is:

*a.* System threat assessment report (STAR). The STAR is the basic authoritative threat assessment that supports the development and acquisition of a particular ACAT I, IA, or II system. The STAR contains an integrated assessment of projected enemy capabilities (doctrine, tactics, hardware, organization and forces) at initial operational capability (IOC) and IOC plus 10 years, to limit, neutralize or destroy the system. It explicitly identifies critical intelligence categories (CICs), which are a series of threat capabilities that could critically impact the effectiveness and survivability of the program. The STAR is a dynamic document that is continually updated and refined as a program develops. It is approved and validated in support of milestone decision reviews (MDRs). This report is the primary threat reference for the CDD, the modified integrated program summary (MIPS), the AoA, and the TEMP developed in support of a MDR. The STAR is approved by HQDA DCS, G-2 and validated by the Defense Intelligence Agency (DIA) for all ACAT I, IA, II and DOTE Oversight List programs at MS B and updated at MS C.

*b.* Modified integrated program summary (MIPS). The MIPS, with its annexes, is the primary Army decision document used to facilitate top-level acquisition milestone decision-making. The MIPS provides a comprehensive summary of program structure, status, assessment, plans, and recommendations by the PM and the PEO. The primary functions of the MIPS include a summary of where the program is versus where it should be; a description of where the program is going and how it will get there; an identification of program risk areas and plans for closing risks; and a basis for establishing explicit program cost, schedule, and performance objectives. Also, the MIPS include thresholds in the stand-alone APB and program-specific exit criteria for the next acquisition phase. The MIPS provides answers to the following five key MDR core issues:

- (1) Is the system still needed?
- (2) Does the system work (from the viewpoints of the user, functional staffs, and the PM)?
- (3) Are major risks identified and manageable?
- (4) Is the program affordable (is adequate programming in the POM)?
- (5) Has the system been subjected to cost as an independent variable (CAIV)?

*c.* Acquisition strategy (AS). The AS is the framework (roadmap) for planning, directing, and managing a materiel acquisition program. It states the concepts and objectives that direct and control overall program execution from program initiation through post-production support. An AS is required for all Army acquisition programs regardless of ACAT. The AS documents how the acquisition program will be tailored and identifies risks and plans to reduce or eliminate risks. The AS, prepared by the PM-led working-level integrated product team (WIPT), is a living document that matures throughout the program. It provides fundamental guidance to the functional elements of the MATDEV/CAPDEV organizations. Individual functional strategies leading to the preparation of detailed program plans required to implement the AS are depicted in figure 11-10.

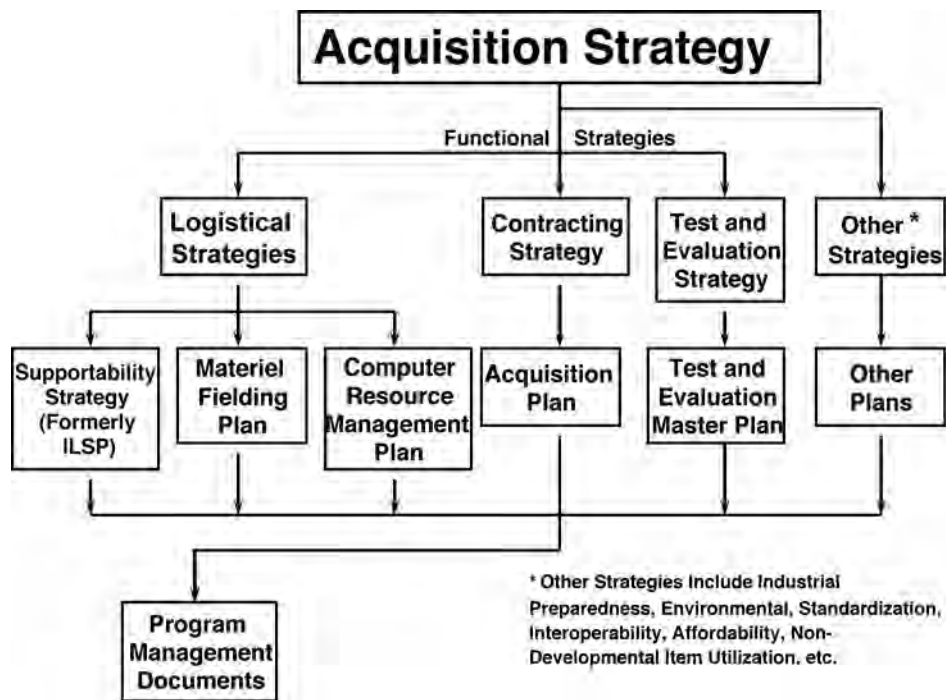

Figure 11–10. Acquisition strategy

d. Environmental analysis. This is a congressionally mandated analysis of the potential environmental impacts of weapons systems. It identifies land, sea or air space requirements of the most promising alternatives and describes the potential effects on the land, sea, and air environment. It also describes the potential impacts on public health and safety by the development, test manufacturing, basing operation, and support of the proposed system. The environmental impact data is weighed against system cost, schedule, and performance (programmatics) in deciding how to best minimize environmental harm.

e. Program office (life-cycle cost) estimate (POE) and component cost estimate (CCE). These documents are prepared in support of MS B and all subsequent MS reviews. The cost estimates are explicitly based on the program objectives, operational requirements, and contract specifications for the system, including plans for such matters as peacetime utilization rates and the maintenance concept. The estimates identify all elements of additional cost that would be entailed by a decision to proceed with development, production, and operation of the system. They are based on a careful assessment of risks and reflect a realistic appraisal of the level of cost most likely to be realized. Two cost estimates are prepared. The program office in support of MS A and all subsequent decision reviews prepare the POE. The other estimate is prepared by an organization that does not report through the acquisition chain. In the Army, this independent cost estimate, entitled CCE, is prepared by the Deputy Assistant Secretary of the Army, Cost and Economics (DASA–CE) for MDAP systems. Both estimates are based on the Cost Analysis Requirements Description (CARD). The CARD is the document that provides estimators a complete description of the system whose costs are to be estimated. It is intended to define the program to a sufficient level of detail such that no confusion exists between the many parties who may be concerned with estimating the program’s cost.

f. Army cost position (ACP). The ACP is the Army’s approved life-cycle cost estimate for the materiel system. It is used for DOD milestone reviews and is the basis for Army planning, programming and budgeting. For all MDAP programs, the Army’s Cost Review Board (CRB) develops the proposed ACP after an intensive review of both the POE and CCE. This proposal becomes the ACP when it is approved by the ASA(FM&C) and then is provided to the AAE. *DODI 5000.02* requires the component’s cost position.

g. Analysis of alternatives (AoA).

(1) The independent AoA provides information to the decision authority at the MS A review to assist in determining whether any of proposed alternatives to an existing system offer sufficient military and/or economic benefit. AoA findings provide the analytical underpinning to support the recommendation to initiate, modify, or terminate a program. An AoA is required for potential ACAT I and most ACAT II programs and is typically conducted by the TRADOC Analysis Center (TRAC) during the acquisition Materiel Solution Analysis (MSA) phase (previously discussed in para. 11–39).

(2) The AoA focuses on broad operational capabilities, potential technology concepts, and materiel solutions that could satisfy the MCD. It examines the full range of materiel alternatives (including those identified in the Materiel Development Decision review ADM). AoAs illuminate the relative advantages and disadvantages of alternatives being considered by identifying sensitivities of each alternative to possible changes in key assumptions (e.g., threat) or variables (e.g., selected performance capabilities). The AoA provides insights regarding KPPs for preferred alternatives and indicates how these parameters contribute to increases in operational capability. It identifies opportunities for trades among performance, cost, and schedule; and determines operational effectiveness and costs (including estimates of training and logistics impacts) for all alternatives.

(3) If a new program is approved (MS B), the AoA may be useful for identifying alternatives that will be refined by cost-performance trades during the EMD phase. The MDA may direct updates to the AoA for subsequent decision points, if conditions warrant (e.g., AoA may be useful for examining cost-performance trades at MS C).

*h.* Acquisition program baseline (APB). APBs consist of the concept baseline, the development baseline, and the production baseline approved at MS B, C, and full rate production (FRP), respectively. The purpose of the baselines is to enhance program stability and to provide a critical reference point for measuring and reporting the status of program implementation. Each baseline contains objectives for key cost, schedule, and performance parameters. Key parameters must meet minimum acceptable requirements, known as thresholds, at each milestone decision point. The thresholds establish deviation limits from which a PM may not trade-off cost or performance without authorization from the MDA. The APB must cross-walk to the program CDD or CPD for performance parameters. Failure to meet the threshold requires a reevaluation of alternative concepts or design approaches. APBs and deviation reporting are required for all ACAT programs.

*i.* Test and evaluation master plan (TEMP). The TEMP is the executive level planning document required for a system that focuses on the overall structure, major elements, and objectives of the T&E program. The TEMP is consistent with the AS as well as the approved CDD, CPD and information support plan (ISP). It is a reference document used by the T&E community to generate detailed T&E plans and to ascertain schedule and resource requirements associated with a given system. The TEMP provides a roadmap for integrated simulation, test, and evaluation plans, schedules, and resource requirements necessary to accomplish the T&E program. The TEMP describes what testing (e.g., developmental test and operational test) is required, who will perform the testing, what resources will be needed, and what are the requirements for evaluation. It relates program schedule, test management strategy and structure, and required resources to critical operational issues; critical technical parameters; measures of effectiveness (MOEs) and suitability; and milestone decisions points. While the PM has the overall responsibility, each T&E WIPT member contributes to the TEMP development and maintenance. The TEMP is initially developed at a system's first milestone review and is updated before each subsequent MS, when the CDD/CPD/ISP has changed significantly, or when the acquisition program baseline (APB) has been breached. Upon approval, the TEMP serves as a contract between the CAPDEV, MATDEV and T&E community for executing the system's T&E program. The TEMP provides key management controls for T&E in support of the acquisition process. Detailed TEMP procedures and format are in *DA Pamphlet 73-1*.

*j.* Life-cycle sustainment plan (LCSP). LCSP spans a system's entire life-cycle, from DAS Materiel Solution Analysis (MSA) phase to disposal. It translates force provider capability and performance requirements into tailored product support to achieve specified and evolving life-cycle product support availability, reliability, and affordability parameters. Life-cycle sustainment planning is considered during MSA, and matures throughout the DAS Technology Development (TD) phase. A LCSP is prepared for MS B. The planning is flexible and performance-oriented, reflecting an evolutionary approach, and accommodates modifications, upgrades, and reprocurement. The LCSP is part of the programs AS and is integrated with other key program planning documents. The LCSP is updated and executed during DAS Production and Deployment (P&D) and Operations and Support (O&S) phases. Life-cycle sustainment considerations include supply; maintenance; transportation; sustaining engineering; data management; configuration management; human systems integration (HSI); manpower, personnel, training, habitability, survivability, environment, safety (including explosives safety), and occupational health; protection of critical program information and anti-tamper provisions; supportability; and interoperability.

*k.* Manpower estimate report (MER). This congressionally directed report documents the total number of personnel (military, civilian, and contractor) that are or will be needed to operate, maintain, support, and train for an ACAT I program upon full operational deployment. The validity of the MER is dependent upon force structure, personnel management, and readiness requirements, as well as the acquisition decision on the size of the buy (procurement).

## 11-78. Typical waivers and reports

*a.* Live-fire test and evaluation (LFT&E) report. Independent OSD report to Congress that provides test results and assessment of realistic survivability testing on a covered major system, and realistic lethality testing on a major munitions or missile program. Congress mandates this report.

*b.* Live-fire test and evaluation waiver. This certifies to Congress when live-fire survivability testing of a covered major system would be unreasonably expensive and impractical. However, some testing must still be accomplished at the subsystem level as described in the alternate LFT&E plan.



## How the Army Runs

c. Developmental test report. This provides the results of developmental tests to include live-fire test results and reports.

d. Beyond low-rate initial production report. This provides Congress with an assessment of the adequacy of initial operational testing and evaluation (IOT&E) and whether the test results confirm the items are effective, suitable, and survivable for combat prior to the full-rate production (FRP) decision to proceed beyond low-rate initial production (LRIP). Congress mandates this report.

e. Defense acquisition executive summary (DAES). The DAES is a early-warning report to DOD's USD(AT&L). The DAES describes actual or potential program problems, and describes mitigating actions taken. The DAES is a multi-part document, reporting program information and assessments; PM, PEO, AAE comments; and cost and funding data. The PM may obtain permission from USD(AT&L) to tailor DAES content. At a minimum, the DAES reports program assessments (including interoperability), unit costs, current estimates, exit criteria status and vulnerability assessments.

f. Selected acquisition report (SAR). The SAR reports the status of total program cost, schedule, and performance; as well as program unit cost and unit cost breach information. For joint programs, the SAR reports the information by participant. Each SAR includes a full, life-cycle cost analysis for the reporting program. The SAR is provided to Congress.

g. Nunn-McCurdy unit cost breach report. A Nunn-McCurdy unit cost breach occurs when a MDAP experiences an increase of at least 15% in program acquisition unit cost (PAUC) or average procurement unit cost (APUC) above the unit costs in the acquisition program baseline (APB). For programs with unit cost increases of at least 25%, a Secretary of Defense (SECDEF) certification is required. Certification responsibility has been delegated to the USD(AT&L). Unit cost reporting is required by *10 USC 2433*.

### 11-79. Other documentation

a. Acquisition decision memorandum (ADM). The ADM documents the MDA's decision on the program AS goals, thresholds, and the exit criteria for the next phase of the program. The ADM is used to document the decision for all ACAT I, II, and III programs.

b. Integrated program assessment (IPA). Information derived from the PM's modified integrated program summary (MIPS) allows the DOD overarching integrated product team (OIPT) to develop the IPA for program MDR. The IPA summarizes the DOD independent assessment of the PM's program. It identifies critical areas, issues, and recommendations for the MDA. For ACAT ID and IAM programs, the IPA is prepared by the OIPT, approved by the OIPT leader, and submitted to the USD (AT&L).

## Section XII

### Testing and Evaluation (T&E)

There are four major sub-processes that support the overall Defense Acquisition System (DAS). The first major sub-process is T&E.

### 11-80. T&E strategy

a. All Army acquisition programs must be supported by a TEMP, previously discussed, that reflects an adequate and efficient T&E program. T&E is the principal tool with which progress in system development and acquisition is measured. T&E is structured to support the DAS and user by providing essential information to decision-makers, assessing attainment of technical performance parameters, and determining whether systems are operationally effective, suitable, and survivable for intended use. The primary reasons for conducting T&E are to facilitate learning, assess technical maturity and interoperability, facilitate integration into fielded forces, and confirm performance. Also, T&E can assess and reduce program risk (e.g., cost, schedule, technical feasibility, technical obsolescence, and software management). The primary product of the T&E sub-process is information (hard facts), plus an independent evaluation of all the credible data on a system, so that the MDA can make informed decisions.

b. The planning, programming, and budgeting for T&E begins early in the acquisition process, concurrent with coordination of the validated initial capabilities document (ICD). Early T&E integration is accomplished through the independent evaluator's involvement in the ICDT and the planning of the acquisition team within the T&E WIPT. The primary purpose of the T&E WIPT is to optimize the use of the appropriate T&E expertise, instrumentation, targets, facilities, simulations, and models to implement test integration, thereby reducing costs and decision risk to the Army. The primary product of the T&E WIPT is the TEMP. The Army Test and Evaluation Executive, within the office of the DUSA, is the TEMP approval authority for all ACAT I/IA, ACAT II, and any programs on the OSD T&E Oversight List prior to final OSD approval. The MDA approves TEMPs for ACAT II and III programs not on the OSD T&E Oversight List.

c. Continuous evaluation (CE) is used to provide a continuous flow of information and data to decision-makers, MATDEV, and CAPDEVs. The data generated in early development phases is visible and maintained as the system moves into formal testing, thereby avoiding duplication of testing. Continuous evaluation continues through a system's

post-deployment, to verify whether the fielded system meets or exceeds demonstrated performance and support parameters.

### 11–81. Developmental testing (DT) and operational testing (OT)

*a.* DT encompasses models, simulation, and engineering type tests that are used to verify that design risks are minimized, system safety is certified, achievement of system technical performance is substantiated, and to certify readiness for OT. DT generally requires instrumentation and measurements, is accomplished by engineers and technicians, is repeatable, may be environmentally controlled, and covers the complete spectrum of system capabilities. The PM designs DT objectives applicable to each phase and milestone. Examples of key DTs are the live fire test (LFT) that is mandated for covered systems, and the production qualification test (PQT), the system-level test that ensures design integrity over the specified operational and environmental range.

*b.* OT is a field test of a system (or item) under realistic operational conditions with users who represent those expected to operate and maintain the system (or item) when fielded or deployed. Examples of key OTs are:

(1) Initial operational testing and evaluation (IOT&E). It is conducted before the full-rate production (FRP) decision and is structured to provide data to determine the operational effectiveness, suitability, and survivability of a system operated by typical users under realistic conditions (e.g., combat and representative threat). Before an IOT&E commences for all programs on the OSD T&E Oversight List, OSD D,OT&E must approve the operational test agency (OTA) test plan (OTA TP).

(2) Follow-on operational test and evaluation (FOT&E). FOT&E may be necessary during (or after) production to refine the estimates made during the IOT&E, provide data to examine changes, and verify that deficiencies in materiel, training, or concepts have been corrected. A FOT&E provides data to ensure that the system continues to meet operational needs and that it retains its effectiveness in a new environment or against a new threat.

*c.* The Army's Test Schedule and Review Committee (TSARC) is a high-level centralized management forum that reviews and coordinates the resource commitment (e.g., personnel, instrumentation, and equipment), required to support the tests included in the Army's Five-Year Test Program (FYTP). The TSARC is chaired by CG, ATEC and operates under *AR 73–1*. When approved for inclusion in the FYTP, a program's test resources plan (TRP) becomes the authority for tasking in the current and budget years. The TRP is the acquisition system's formal T&E resource planning and tasking document.

## Section XIII

### Integrated Logistics Support (ILS)

The second major sub-process in support of DAS is integrated logistics support (ILS). Total Package Fielding (TPF) is also discussed in this section of the chapter.

### 11–82. ILS overview and management

*a.* ILS is a disciplined, unified, and interactive approach to the management and technical activities necessary to integrate logistics support into system and equipment design. ILS is the process used by the Army to implement the mandatory life-cycle logistics policies and procedures and includes all elements of planning, developing, acquiring, and supporting Army materiel throughout its life-cycle.

*b.* Supportability integrated product team (SIPT).

(1) The SIPT is a working-level IPT to support both the capabilities development and system acquisition management processes. The CAPDEV proponent CoE establishes an SIPT at the DAS Materiel Solution Analysis (MSA) phase for all potential ACAT I/II and selected ACAT III acquisition programs to coordinate overall ILS planning and execution. At MS B, or when the PM is assigned, the designated MATDEV integrated logistic support manager (ILSM) assumes responsibility to chair the SIPT.

(2) SIPT members develop performance-based logistics (PBL) concepts and ILS program documentation and conduct supportability/tradeoff analyses to determine the optimum PBL strategy or ILS concepts. The SIPT make recommended ILS-related planning, programming, and execution decisions to the PM. The SIPT is a working body, and the roles and responsibilities of members are prescribed in the supportability strategy (SS). The SIPT must work with other functional groups, such as the T&E WIPT and the training support work group (TSWG) to ensure an integrated effort.

(3) The SIPT considers numerous alternatives and trades. The supportability analysis (SA) is required to identify the optimum support system requirements. Both the MATDEV and CAPDEV perform SA tasks (either in-house or through contractors) applicable to their respective mission responsibilities as defined in *AR 700–127*.

*c.* ILS manager (ILSM). The ILSM is established by the MATDEV prior to MS B or when a PM is assigned to serve as the focal point for all life-cycle management supportability actions related to the acquisition program. The ILSM assumes the responsibility to chair the SIPT from the CAPDEV.

*d.* Performance-based logistics (PBL). PBL is the preferred product support strategy (PSS) for weapon systems that employs the purchase of support as an integrated performance package designed to optimize system readiness. PBL

objectives include optimizing total system availability while minimizing cost and logistics footprint. PBL is implemented on all Army ACAT programs where it is operationally and economically feasible. PBL is implemented on Army ACAT III programs at the discretion of the PM/PEO. A basic tenet of PBL is the use of high-level metrics that measures support outcomes both operationally and economically. Current overarching life-cycle metrics include: operational availability, mission reliability, cost per unit usage, logistics footprint, logistics response time, and total life-cycle cost per unit usage. PBL may be implemented on systems, subsystems, secondary items, components, assemblies, or subassemblies as well as processes that lead to business process improvements (for example, Lean or Six Sigma improvements on a depot line). PBL will meet performance goals for the system through a support structure based on performance agreements with clear lines of authority and responsibility, delineate outcome performance goals of weapon systems, ensure that responsibilities are assigned, provide incentives for attaining these goals, and facilitate the overall life-cycle management of system reliability, supportability, and total ownership costs. The PBL strategy must be addressed at each MDR and is tailored for each individual acquisition system with specific performance goals, roles, responsibilities that will be detailed in performance-based agreements (PBAs) prior to system fielding.

*e.* Supportability analysis (SA) and logistics management information (LMI). Supportability is a design characteristic. The early focus of SA should result in establishment of support-related parameters in performance terms. As system design progresses, SA will address supportability requirements and provide a means to perform trades among these requirements and the system design. In order to be effective, SA will be conducted within the framework of the systems engineering process. Examples of these analyses are analysis use studies, repair-level analysis, task analysis, reliability predictions, condition-based maintenance (CBM) analysis, reliability-centered maintenance, and life-cycle cost analysis. LMI is the support and support-related engineering and logistics data acquired from contractors and a product of SA. *MIL-PRF-49506* is the specification that provides DOD with a contractual method for acquiring these data. DOD uses these data in existing DOD materiel management processes such as those for initial provisioning, cataloging, and item management. If there is a requirement for the contractor to provide data for loading into a government database, then it will be necessary to specify the required data file format and data relationships as performance requirements for electronic data interchange.

*f.* Supportability strategy (SS). The SS (formerly known as the Integrated Logistics Support Plan), is a government-prepared working document that serves as a record of planning, programming and execution of ILS (including PBL) for an acquisition program. The SS is based upon the 10 ILS elements and defines how analysis will be used throughout the systems engineering process to define the system, design the support, and support the design. The intent of the SS is to methodically gather data, review the data, assess alternative support concepts, develop information for use in decision-making, coordinate plans and execute the selected logistics support concept. The SS is a compliance document and will serve as a record to document the actions taken during the development and implementation of the ILS management program. The SS for all ACAT levels will be approved and managed by the SIPT. All SSs will be updated prior to each milestone and major event, not to exceed 3 years from the previous update. The initial SS will be prepared by the CAPDEVs ILS lead for the system during the DAS Materiel Solution Analysis (MSA) phase and is provided to the PM ILSM upon establishment of the PM SIPT.

### **11-83. Total package fielding (TPF) process**

*a.* TPF is currently the Army's standard fielding process. In 1984, the Army began using TPF on a test basis and made it the standard fielding process in 1987. It is designed to ensure a thorough planning and coordination between CAPDEVs, TNGDEVs, MATDEVs, fielding commands, gaining Army commands and using units involved in the fielding of new materiel systems. At the same time, it is designed to ease the logistics burden of the using and supporting Army troop units. Regulatory and instructional guidance for materiel release, fielding, and transfer is contained in *AR 700-142*, and *DA Pamphlet 700-142* respectively. The TPF process is shown in figure 11-11.

**INTENT: Reduce Logistics Burdens on the Gaining ACOMs and Their Subordinate User / Support Organizations**

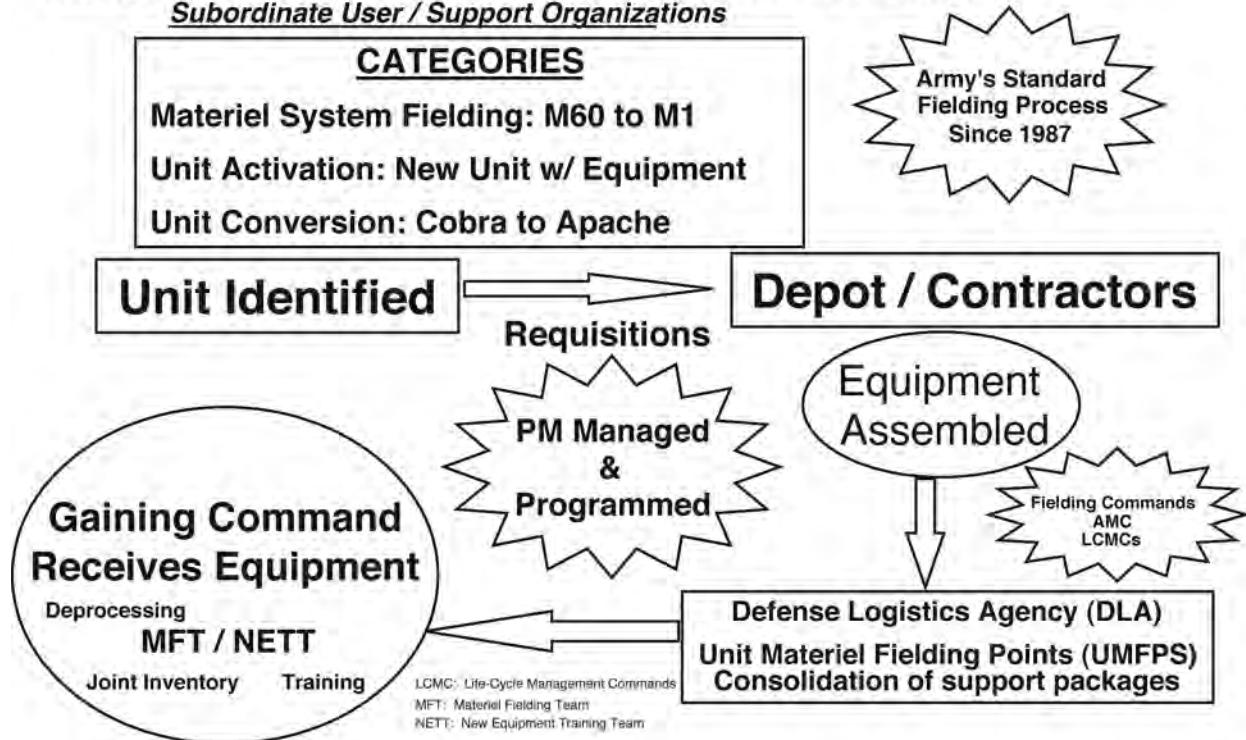

Figure 11-11. Total package fielding concept

b. Identification of the TPF package contents for a particular fielding is known as establishment of the materiel requirements list (MRL). It is the responsibility of the MATDEV/fielding command to identify everything that is needed to use and support the new system and coordinate these requirements with the CAPDEVs/TNGDEVs and the gaining Army commands. The total fielding requirements are documented, coordinated, and agreed on through the materiel fielding plan (MFP), the mission support plan (MSP) and the materiel fielding agreement (MFA).

c. The Defense Logistics Agency (DLA) operates unit materiel fielding points (UMFPs) in Pennsylvania, Texas, and California that support the Army. These 3 DLA UMFPs are sites where initial issue items are consolidated at unit identification code (UIC) level to support TPF worldwide. The staging site is the facility or location where the total package comes together. It is usually here that all end items, support equipment, initial issue spare and repair parts are prepared for handoff to the gaining units. To support TPF outside the Continental United States (OCONUS), the AMC operates a number of central staging sites in Europe, and 2 sites in Korea.

d. A joint supportability assessment takes place about 90 days before the projected first unit equipped date (FUED) and 60 days before fielding to a unit in CONUS. The MATDEV/fielding command assures that those items requiring deprocessing are inspected and made fully operational-ready before handoff to the gaining units. A joint inventory is conducted by the fielding and gaining commands to ensure all needed items are received, or placed on a shortage list for later delivery.

e. The MATDEV/fielding command provides, at the time of handoff, a tailored customer documentation package for each gaining unit that allows the unit to establish property accountability and post a receipt for TPF materiel. Logistics changes are helping the Army transform to the future force. Many of these changes apply directly to TPF.

## Section XIV

### Manpower and Personnel Integration (MANPRINT) Program

The third major sub-process in support of the DAS is the MANPRINT program. MANPRINT is the Army's application of the DOD Human Systems Integration (HSI) requirements in systems acquisition (*DODD 5000.01 and DODI 5000.02*), in compliance with *Title 10*. MANPRINT, described in detail in *AR 602-2*, is the Army's program to ensure that Soldier performance is the central consideration in system design, development, and acquisition.

### 11–84. Seven MANPRINT domains

MANPRINT is the technical process of integrating the 7 interdependent elements of manpower availability, personnel skills and abilities, training design, human factors engineering, system safety, health hazards, and soldier survivability.

*a.* Manpower availability. Manpower availability is the personnel strength (military and civilian) available to the Army. It refers to the consideration of the net effect of Army systems on overall human resource requirements and authorizations (spaces), to ensure that each system is affordable from the standpoint of manpower. It includes the analysis of the number of people needed to operate, maintain, and support each new system being acquired, including maintenance and supply personnel, and personnel to support and conduct training. It requires a determination of the Army manpower requirements generated by the system, comparing the new manpower needs with those of the old system(s) being replaced. If an increase in personnel is required to support a new (or modified) system, “bill payers” must be identified from existing personnel accounts.

*b.* Personnel skills and abilities. Personnel skills and abilities are military and civilians possessing the aptitudes, characteristics and grades required to operate, maintain, and support a system in peacetime and war. Personnel refers to the ability of the Army to provide qualified people in terms of specific aptitudes, experiences, and other human characteristics needed to operate, maintain, and support Army systems. It requires a detailed assessment of the aptitudes that personnel must possess in order to complete training successfully, as well as operate, maintain, and support the system to the required standard. Iterative analyses must be accomplished for the system being acquired, comparing projected quantities of qualified personnel with the requirements of the new system, or any system(s) being replaced, and overall Army needs for similarly qualified people. Personnel analyses and projections are needed in time to allow orderly recruitment, training, and assignment of personnel in conjunction with system fielding.

*c.* Training design. Considerations of the necessary time and resources required to impact the requisite knowledge, skills, and abilities to qualify Army personnel for operation, maintenance, and support of Army systems. It involves:

- formulating and selecting engineering design alternatives that are supportable from a training perspective;
- documenting training strategies; and
- determining resource requirements to enable the Army training system to support system fielding. It includes analyses of the tasks that must be performed by the operator, maintainer, and supporter; the conditions under which the tasks must be performed; and the performance standards that must be met. Training is linked with personnel analyses and actions, because availability of qualified personnel is a direct function of the training process.

*d.* Human factors engineering. Human factors engineering is the technical effort to integrate design criteria, psychological principles, and human capabilities as they relate to the design, development, test, and evaluation of systems. The human factors engineering goals are:

- to maximize the ability of the Soldier to perform at required levels by eliminating design-induced error; and
- to ensure materiel maintenance, support, and transport are compatible with the capabilities and limitations of the range of fully equipped Soldiers who would be using such materiel. Human factors engineering provides an interface between the MANPRINT domains and system engineers. Human factors engineering supports the MANPRINT goal of developing equipment that will permit effective Soldier-machine interaction within the allowable, established limits of training time, Soldier aptitudes and skill, physical endurance, physiological tolerance limits, and Soldier physical standards. Human factors engineering provides this support by determining the Soldier’s role in the materiel system, and by defining and developing Soldier-materiel interface characteristics, workplace layout, and work environment.

*e.* System safety. System Safety involves the design features and operating characteristics of a system that serve to minimize the potential for human or machine errors or failure that cause injury and/or accidents.

*f.* Health hazards. Health hazards are the inherent conditions in the use, operation, maintenance, support and disposal of a system (e.g., acoustical energy, biological substances, chemical substances, oxygen deficiency, radiation energy, shock, temperature extremes, trauma, and vibration), that can cause death, injury, illness, disability, or reduce job performance of personnel.

*g.* Soldier survivability. Soldier survivability within the context of MANPRINT may refer to a military or a civilian.

- System. The characteristics of a system that can reduce fratricide, reduce detectability of the Soldier, prevent attack, if detected; prevent damage, if attacked; minimize medical injury, if wounded or otherwise injured; and reduce physical and mental fatigue.
- Soldier. Those characteristics of Soldiers that enable them to withstand (or avoid) adverse military action or the effects of natural phenomena that would result in the loss of capability to continue effective performance of the prescribed mission.

### 11–85. MANPRINT objectives and concept

*a.* The MANPRINT program has three primary objectives:

- optimize both the quantity and quality of the personnel needed for systems;
- design systems that are easily useable by Soldiers, safe to operate, cause no unnecessary health problems, and maximize Soldier survivability; and
- ensure acceptable trade-offs are made among performance, design, and Soldier capabilities and limits. This ensures that Soldier readiness is not compromised by equipment that is difficult to use or maintain. The implementation of MANPRINT impacts total system performance (both effectiveness and availability), by making explicit the role that Soldier performance plays and is shaped by design factors. MANPRINT also addresses the manpower, personnel, and training (MPT) resources needed to achieve the required performance, and where possible, indicates more affordable configuration of MPT resources.

*b.* The engineering design philosophy of MANPRINT is focused on optimum system performance on the battlefield, which includes consideration of both Soldier and equipment capabilities and survivability. MANPRINT is an option-oriented process as opposed to an objective-oriented process. The MANPRINT process provides decision-makers information upon which to make trades in areas such as quality and numbers of people, training times, technology, conditions, standards, costs, survivability, safety, health hazard risks, design and interface features, and personnel assignment policy.

*c.* The body of MANPRINT expertise, formerly known as the MANPRINT joint working group, continues to function through the ICDT and IPT process, previously discussed. The MANPRINT members of the ICDT transition to the MANPRINT WIPT, when applicable. The purpose of this body is to:

- assist the CAPDEV (or functional proponent) and PM to ensure MANPRINT principles are applied to the system;
- provide MANPRINT input to the MCDs; and
- provide a tracking system and historical database of MANPRINT issues.

*d.* In FY 2010, the Army responded to OSD USD(AT&L) “to conduct and provide comprehensive reviews and assessments of MANPRINT efforts within the department.” The Army has the most successful program of all the services. For example, there are currently 81 ACAT I and II (complex, high dollar value) systems in the Army inventory, of which over 80 percent are fully covered by MANPRINT analytic efforts. Current accomplishments include:

- Soldier Information Network - Tactical (WIN-T): Current effort includes engagement with the PMs and engineers to make the user and maintainer task demands less complex, thereby increasing user-friendliness and significantly reducing training requirements.
- Blackhawk: Changes to air crew seating including dual-axis seat adjustment, now accommodates 40 percent more Soldiers.
- Fox Combat Vehicle: Crew reduced from four to three, amounting to cost savings of \$2–4 million.
- Ground Tactical Vehicles Maintenance Concept: Streamlined the number of tasks to be performed barehanded as much as possible, which has resulted in fewer tools (10 tools) to track, and less time to perform maintenance.
- Apache Longbow: Eighty MANPRINT problems, issues, and concerns were identified and resolved, so that a \$2.7 million MANPRINT investment resulted in \$286 million cost avoidance to operations and support.
- Handheld GPS Receiver Operator Performance: An evaluation with dismounted soldiers using the Defense Advanced GPS Receiver (DAGR) in the field, revealed the presence of a fratricide issue: 38 percent of the Soldiers (6 out of 16) incorrectly reported their present position rather than the target’s during a simulated call for fire scenario; MANPRINT recommended the use of a pop-up warning message, which was incorporated; and in the retest, none of the Soldiers incorrectly reported their present position.
- Stryker: An added platform for the loader on the Mortar Carrier “B” enables the loader to “drop” mortar rounds more safely and reduce physical stress; increased room in the commander’s station allows a larger portion of the Soldier population to fit into the crew station; redesigned gunner position now accommodates the body configuration of approximately 95 percent of Soldiers. These and many other significant contributions to aviation, maneuver, weapons, and logistics programs have resulted in enhanced system performance, significant cost savings, cost avoidance, and increased personnel survivability.

*e.* The Army’s combat effectiveness and readiness depend on equipping our Soldiers with equipment that meets their needs and allows them to accomplish their assigned missions rapidly, accurately, and efficiently.

*f.* The Army Research Laboratory’s Human Research & Engineering Directorate, serves as the MANPRINT focal point for coordinating domain support for CoE ICDTs and IPTs. Additional MANPRINT information and references are available online at <http://www.manprint.army.mil>.

## **Section XV**

### **Training Development**

The fourth major sub-process in support of the DAS is training development.

### 11–86. Training development (TD) overview

*a.* Training development is a vital component of TRADOC's mission to prepare the Army for war. TRADOC is responsible for developing training and providing support for individual and unit training. This responsibility includes determining requirements for range, ammunition and training devices and facilities, as well as education/training courses, products, and programs. The single manager for training in TRADOC is The Army Training Support Center (ATSC), a TRADOC field operating agency (FOA) under the Combined Arms Center-Training (CAC-T). ATSC provides training support services for the planning and integration of products and programs that support individual and collective training in the total force.

*b.* The Army's TD process, the System Approach to Training (SAT), is a systematic approach to making training/education decisions. SAT is a systematic, spiral approach to making decisions about collective, individual, and self-development training for the Army. The SAT involves 5 training related phases: evaluation, analysis, design, development, and implementation. Evaluation is continuous throughout the SAT process and the entire process must operate within a given set of resources. Doctrine, organization, training, materiel, leadership and education, personnel, and facilities (DOTMLPF), drive training and TD capabilities-based requirements.

*c.* The Army's implementation of DAS is a complex, lengthy process and training development is embedded throughout the process. The capabilities development and system acquisition management process provide a structure for system management. Training impacts and costs are vital to system performance. Coordination between the CAPDEV, MATDEV, and TNGDEV must be close and continuous to develop and field a complete material system that meets the capabilities development document (CDD) requirements (see section III).

### 11–87. System training plan (STRAP)

*a.* The STRAP is the master training plan for a new, improved, or displaced materiel system. It establishes a basis for determining resources (manpower, equipment, facilities) to ensure training can be adequately conducted and supported. It outlines the development of the total training strategy for integrating a new system into the training base and gaining units; plans for all necessary training support, training products, and courses; and sets milestones to ensure the accomplishment of the training strategy. In addition, the STRAP supports development and approval of the system MRDs and establishes milestones for managing training development.

*b.* The STRAP is developed by the proponent TRNGDEV, validated by the ATSC System Training Integration and Devices Directorate, (ATSC-STIDD), and approved by the Commander, ATSC (delegated by the CG, CAC).

### 11–88. Army modernization training (AMT)

*AR 350–1* provides policy and procedures and assigns responsibilities for the planning and execution of new systems training. The regulation provides a process for the expeditious integration of equipment into the force structure through new equipment training (NET), displaced equipment training (DET), doctrine and tactics training (DTT), and sustainment training (ST).

*a.* New equipment training (NET). NET is designed to support force integration and modernization through identification of personnel, training, and training devices required to support new or improved equipment; by planning for the orderly transfer of knowledge from the MATDEV to the trainer, user, and supporter by documenting requirements in NET plans (NETP); and the deployment of NET teams (NETT) to train Soldiers to operate, maintain, and provide instruction on modernized equipment.

*b.* Displaced equipment training (DET). DET applies to systems that are being replaced by new equipment, but remain in the inventory. Planning for and executing DET is similar to the process used in NET.

*c.* Doctrine and tactics training (DTT). DTT is conducted in conjunction with NET or DET. DTT provides commanders, operators, and trainers with a doctrinal basis for employment of new or displaced materiel.

*d.* Sustainment training (ST). ST is a command responsibility. The training base shares the responsibility for ST by assuring that a pool of trained replacements is established to support the sustainment effort. The ultimate responsibility for ST, however, remains with the commander.

### 11–89. Training requirements analysis system (TRAS)

TRAS is a long and short-range planning and management process for the timely development of peacetime and mobilization individual training. It integrates the training developments (TD) process with the Planning, Programming, Budgeting, and Execution System (PPBE), by documenting training strategies, courses, and related resource requirements. The TRAS ties together related acquisition systems for students, instructors, equipment and devices, ammunition, dollars and facilities.

### 11–90. Training aids, devices, simulators, and simulations (TADSS)

*a.* TADSS are developed and acquired to support training at the unit and/or combat training centers (CTCs) and within the institutional training base.

(1) Training aids are instructional aids to enable trainers to conduct and sustain task-based training in lieu of using extensive printed material or equipment. Examples are graphic training aids, models, and displays.

(2) Training devices are three-dimensional objects and associated computer software developed, fabricated, stand-alone, embedded, or appended and procured specifically for improving the learning process and to usually support the live fire training environment. Examples are emplaced mines; OPFOR weapons; pyrotechnics for training; and inert training rounds.

(3) Simulators are devices, computer programs, or systems that allow simulation of an essential training task and allow for skill development in that task by providing repeatable drills in a controlled assessed training situation. They include physical models, mock ups, and simulations of weapon systems that replicate major training requirements. Examples include flight simulators; HMMWV Egress Trainer (HEAT); Conduct of Fire Trainers (COFTs) with upgrades for canister munitions; and Virtual Combat Convoy Trainer (VCCT).

(4) Simulations are a method for implementing a model(s) over time; any representation or imitation of reality, to include environment, facilities, equipment, mechanical and maneuver operations, motion, role playing, leadership, and so forth. They are the representation of salient features, operations, or environment of a system, subsystem, or scenario that usually supports the constructive environment. Examples are Brigade-Battalion Battle Simulation (BBS), Corps Battle Simulation (CBS), and Joint Simulation Training.

*b.* TADSS are categorized as either system or non-system.

(1) System TADSS are designed for use with a system, family-of-systems or item of equipment, including sub-assemblies and components. They may be stand-alone, embedded, or appended. They are funded (HQDA DCS, G-8, Equipping PEG) and documented as part of the weapon system they support. The weapon system PM is responsible to procure the system TADSS.

(2) Non-system TADSS (NSTDs) are designed to support general military training and non-system specific training requirements. They are funded (HQDA DCS, G-3/5/7, Training PEG) and documented as a separate program under the training mission area (TMA). The PEO Simulation, Training, and Instrumentation is normally responsible to procure and develop non-system TADSS. Stand-alone CDDs and CPDs, with supporting STRAPs, are developed by the TRNGDEV.

## Section XVI

### Acquisition Resource Management

#### 11-91. Appropriations

The “color of money,” or kind of appropriation, is an important factor in system acquisition management. An appropriation provides limited amounts of budget authority that agencies may obligate during a specific time period for the purposes specified in the legislation that provides the appropriation. An appropriation does not represent cash actually set aside in the Treasury. In general, a particular appropriation can be expended only for specified activities, and money cannot be changed from one appropriation to another without transfer authority. Acquisition management involves at least 2 to 4 appropriations. The 2-year research, development, test and evaluation (RDTE) appropriation provides funds for research, design engineering, prototype production, low rate initial production (LRIP) for operational testing (OT), and T&E activities in the course of developing a materiel system. The 3-year procurement appropriation provides funds for procuring materiel that has been fully tested and type classified. Procurement funds are used to procure LRIP for initial spares, support and training equipment. The 1-year Operations and Maintenance, Army (OMA) appropriation, provides funds for retiring and retrograding the old equipment being replaced; for repairing systems after fielding; for fuel and ammunition for training and operations; for periodic system rebuild; for training both system operators and maintainers, except new equipment training; and, in general, anything else to keep a system in the field and operating. Some systems may require 5-year Military Construction (MILCON) appropriated funds for the construction of special facilities required for fielding that system. The period of years identified for each appropriation refers to the time period that the appropriation is available to be obligated.

#### 11-92. Program and budget process

Funds of the correct amount and appropriation must be planned and programmed into the Army budget, in general, 2 years before they are needed. In the program and budget process, funding requests are initiated and reviewed annually. Congress appropriates funds for RDTE (*Title IV, DOD Appropriations Act*) and Procurement (*Title III, DOD Appropriations Act*), as part of the annual Defense Appropriation Act. The RDTE and procurement budget requests must first be approved by DOD, submitted to Congress by the President, and then be authorized and appropriated in 2 separate Congressional actions before any money can be spent. In the year of budget execution, the Army may reprogram funds, except for Congressional interest items, within an appropriation subject to budget authority dollar limits, or in excess of dollar limits with prior Congressional approval. Below \$10 million of RDTE and below \$20 million of procurement may be reprogrammed from a lower priority program to a higher priority program without prior Congressional approval (see table 11-1). The PM is responsible for planning and programming the RDTE and procurement funds to cover a program, and the MILCON funds, when required. The PM is responsible for programming all life-cycle system costs for the system, while the system remains under his management control. This includes programming for out-year sustaining resources, as well as RDTE and procurement. Once the management responsibility transitions to the Life-Cycle Management Commands (LCMCs), it becomes that command’s responsibility to continue the depot-level



## How the Army Runs

sustaining program. The field user Army command is responsible to program day-to-day system below-depot operational support. The field user Army command is responsible for planning and programming of OMA funds needed to ensure continued readiness of the fielded system. Responsibility for planning and programming funds for product improvements and sustaining supply spare parts is complex and divided between the LCMCs and the field Army command.

**Table 11-1**  
**Below Threshold Reprogramming Levels**

APPN	MAX IN	MAX OUT	Level of Control	OBL AVAIL
RDTE	< \$ 10M	Greater of \$ 10M or 20% of Program Element	Program Element	2 Years + 5 Years (Execution)
PROC	< \$ 20M	Greater of \$ 20M or 20% of Line Item	Line Item	3 Years + 5 Years (Execution)
OMA	< \$ 15M	No Congressional Restriction	Budget Activity	1 Year + 5 Years (Execution)
MILCON	Lessor of +\$ 2M or 25% of Project	Lessor of + \$ 2M or 25% of Project	Project	5 Years + 5 Years (Execution)

### 11-93. RDTE appropriation activities

To assist in the overall planning, programming, budgeting, and managing of the various R&D activities, the RDTE appropriation is divided into 7 R&D budget activities. These categories are used throughout DOD. The current RDTE budget activities are as follows:

*a.* Budget Activity 1—Basic Research. Basic research includes all efforts and experimentation directed toward increasing fundamental knowledge and understanding in those fields of the physical, engineering, environmental, and life sciences related to long term national security needs. Basic research efforts precede the system specific research described in the *Army Science and Technology Master Plan (ASTMP)*, previously discussed.

*b.* Budget Activity 2—Applied Research. This activity translates promising basic research into solutions for broadly defined military needs, short of development projects. This type of effort may vary from systematic mission-directed research, which is beyond that in Budget Activity 1, to sophisticated breadboard hardware, study, programming, and planning efforts that establish the initial feasibility and practicality of proposed solutions to technological challenges. These funds are normally applied during the Materiel Solution Analysis (MSA) phase of the DAS life-cycle.

*c.* Budget Activity 3—Advanced Technology Development. This activity includes all efforts that have moved into the development and integration of hardware for field experiments and tests. The results of this type of effort are proof of technological feasibility and assessment of operability and producibility rather than the development of hardware for service use. These funds are normally applied during the Technology Development (TD) phase of the DAS life-cycle.

*d.* Budget Activity 4—Advanced Component Development and Prototypes. This budget activity includes all efforts necessary to evaluate integrated technologies in as realistic an operating environment as possible, to assess the performance or cost reduction potential of advanced technology. These funds are normally applied during TD, but could be applied throughout the acquisition life-cycle.

*e.* Budget Activity 5—System Development and Demonstration. This budget activity includes those projects in system development and demonstration, but not yet approved for low-rate initial production (LRIP) at MS C. These funds are normally applied during the Engineering and Manufacturing Development (EMD) phase of the DAS life-cycle.

*f.* Budget Activity 6—RDTE Management Support. Includes efforts directed toward support of RDTE installations or operations required for use in general R&D and not allocable to specific R&D missions. Included are technical integration efforts, technical information activities, space programs, major test ranges, test facilities and general test instrumentation, target development, support of operational tests, international cooperative R&D, and R&D support.

*g.* Budget Activity 7—Operational System Development. This activity includes R&D efforts directed toward development, engineering, and test of changes to fielded systems or systems already in procurement which alter the performance envelopes. Operational system development may include operational testing (OT) costs.

### 11-94. Procurement appropriations

Procurement is used to finance investment items, and covers all costs integral and necessary to deliver a useful end item intended for operational use or inventory. The Army budget includes 5 separate procurement appropriations:

*a.* Aircraft Appropriation. Aircraft procurement includes the procurement of aircraft, aircraft modifications, spares, repair parts, and related support equipment and facilities.

*b.* Missile Appropriation. Missile procurement includes the procurement of missiles, missiles modifications, spares, repair parts, and related support equipment and facilities.

c. Weapons and Tracked Combat Vehicles (WTCV) Appropriation. WTCV procurement includes tracked and combat vehicles, weapons, other combat vehicles, and repair parts.

d. Ammunition Appropriation. Ammunition procurement includes procurement of ammunition end items, ammunition production base support, and ammunition demilitarization.

e. Other Procurement, Army (OPA) Appropriation. OPA covers 4 major categories:

- tactical and support vehicles,
- communications and electronic equipment,
- other support equipment, and
- initial spares.

### **11–95. Military construction (MILCON) appropriation**

MILCON funds the cost of major and minor construction projects such as facilities. Major or specified military construction projects that exceed \$2.0M and require congressional line-item authorization. Minor or unspecified military construction projects are \$2.0M or less, but can be increased to \$3M, if the project is intended to correct a life, health, or safety deficiency. Each military department receives an appropriation for minor military construction. The military department Secretary controls expenditure of minor military construction funds and is required to notify Congress of minor military construction projects that exceed \$750K. A 21 day waiting period is required after notification before work begins. Project costs include architecture and engineering services, construction design, real property acquisition costs, and land acquisition costs necessary to complete the construction project. The OMA appropriation can be used to fund unspecified minor military construction projects up to \$750K or up to \$1.5M, if the project is intended to correct a life, health, or safety deficiency.

### **11–96. Operations and maintenance appropriation (OMA)**

OMA finances those things that derive benefits for a limited period of time, such as expenses, rather than investments. Examples are Headquarters operations, civilian salaries, travel, fuel, minor construction projects of \$750K or less, expenses of operational military forces, training and education, recruiting, depot maintenance, purchases from Defense Working Capital Funds, and base operations support.

### **11–97. Research, development, and acquisition plan (RDA Plan)**

a. Overview. The Army RDA Plan is a 14-year plan for the development and production of technologies and materiel to advance Army modernization. Modernization is “the continuous process of integrating new doctrine, training, organization and equipment to develop and field warfighting capabilities for the total force.” Under ideal circumstances, Army modernization would be fully supported by an unconstrained RDA Plan. However, the realities of limited resources restrict modernization to those efforts that are both technically and fiscally achievable. The RDA Plan, therefore, is the result of a process that converts the Army’s unconstrained planning environment into a constrained RDA Plan that maximizes warfighting capabilities and supporting infrastructure requirements within limited resources.

b. The RDA Plan assumes the form of a 1–N priority list of RDTE and procurement program packages called management decision packages (MDEPs), with funding streams for the entire 14-year planning period. An MDEP represents a particular program, function or organization and displays the resources (dollars, civilian and military manpower) needed to achieve an intended goal. An MDEP may receive its resources (funding streams) from any number of appropriations; the RDA Plan, however, includes only the RDTE and procurement funding streams of its MDEPs. There is no limitation to the number of commands to which the resources of an MDEP may be assigned. The RDA Plan is recorded in and represented by the HQDA DCS, G–8 RDA database.

c. RDA database. The DCS, G–8 RDA database represents the RDA plan. The principal elements of the RDA database, MDEPs, are grouped by joint capability area (JCA). A JCA is a set of MDEPs that represent a common function on the battlefield or a common activity of the supporting Army infrastructure (e.g., aviation, ammunition). JCAs were formerly called budget operating systems (BOS). In fact, JCA data is still named BOS in Army databases. Most JCAs are managed by a HQDA DCS, G–8 division. The division chief (known as the JCA manager), assisted by his staff and his ASA(ALT) counterpart, determines required capabilities for each of the MDEPs within his or her JCA. The Equipping (EE) Program Evaluation Group (PEG) co-chairs, determine EE PEG priority ranking of MDEPs. The EE PEG prioritization is forwarded to HQDA DCS, G–3/5/7 for Army-wide prioritization.

d. The RDA Plan is a continual process comprising periodic revisions to the 14-year planning period of the RDA database. The revisions occur during the fiscal year POM/BES cycle. During the POM/BES cycle, the Army adjusts the first 5 years (called the future years defense program (FYDP)) of the 14-year planning period. These 5 years are referred to as the Program Objective Memorandum (POM) years. After each cycle, the Army’s RDA community adjusts the final nine years, called the extended planning period (EPP), to ensure a smooth and reasonable progression from the POM to EPP. The 14-year planning period of the RDA database moves forward by 1 year in January annually. For example, the FY13–26 RDA plan began in January 2011.

### 11–98. Program stability

Achieving early program objective consensus and following a good investment strategy will yield a stable program, clearly showing where we are today and where we want to be when we bring on the new system. To be successful, new systems acquisition programs must be developed and acquired in a timely and economical manner. Life-cycle cost estimates and changes to programs and schedules must be controlled. Changes to programs affecting established goals will be fully documented in the program management documentation, providing the justification for change (e.g., budget cut, design change). After entering the DAS Engineering and Manufacturing Development (EMD) phase, design changes in system components that are meeting the approved requirement are discouraged and must be individually justified. The design should be frozen in sufficient time prior to DT and OT to provide an adequate system support package for testing. Changes to programs as a result of DT/OT must be of the “objective” nature to satisfy the requirement and not a “threshold” type of change, unless it can be demonstrated that the change will not have a significantly negative impact on the cost, schedule, producibility, and ILS aspects of the program.

## Section XVII Summary and References

### 11–99. Summary

*a.* This chapter provided a basic introduction to the management process, organization, and structure of the Joint (Army) Capabilities Integration and Development System (JCIDS) and system acquisition management process. Through the chapter description, the reader should have gained an appreciation of the logic of the process, its organization and management, including recent changes. This chapter highlights the current basic DOD and Army policies for capabilities development, materiel systems acquisition, and descriptions of capabilities development and system acquisition managers.

*b.* Difficult decisions, overseas contingency operations, a scarcity of dollar resources, and honest differences of opinion cause disruptions and delays. It is unlikely that there will be total agreement on the best technical approach to satisfy a need—or, indeed, on the need itself. The annual budget cycle and budget constraints almost ensure that some projects will not be funded at the level desired—if at all. Tests are not always successful. Estimates of time, costs, effectiveness, and technical feasibility are often wide of the mark for complex systems. After all, they are estimates that are projected well into the future based on sketchy data. These real-world problems reinforce the fact that capabilities development and system acquisition management are complex tasks of great importance to national defense. Capabilities development and system acquisition can be a wellspring of new and effective weapons systems, where effective management and professionalism can make the difference in overseas contingency operations. As with any activity involving the use of scarce resources to meet organizational goals and objectives, the people involved—the capability developers, acquisition managers and the Soldier users and maintainers—constitute the most vital link to mission accomplishment.

### 11–100. References

- a.* Federal Acquisition Streamlining Act of 1994, 13 October 1994.
- b.* The Defense Acquisition Workforce Improvement Act (DAWIA), Title 10 USC Sections 1701–1764, Defense Acquisition Workforce Improvement Act of 1990, as amended by Section 808, Public Law (PL) No. 106–398, National Defense Authorization Act for Fiscal Year 2001, October 30, 2000: Section 824, PL No. 107–107, December 28, 2001.
- c.* Weapon Systems Acquisition Reform Act of 2009 (Public Law 111–23), 22 May 2009.
- d.* National Security Strategy (NSS), May 2010.
- e.* National Defense Strategy (NDS), 16 June 2008.
- f.* Deputy Secretary of Defense Memorandum, subject: Initial Implementation Guidance of the Director of Cost Assessment and Program Evaluation, 9 June 2009
- g.* Deputy Secretary of Defense Memorandum, subject: Procedures and Schedule for Fiscal Year (FY) 2012–2016 Integrated Program/Budget Review, 9 April 2010.
- h.* DOD Directive 4630.5, Interoperability and Supportability of Information Technology (IT) and National Security Systems (NSS), 11 January 2002.
- i.* DOD Directive 5000.01, The Defense Acquisition Management System, 12 May 2003.
- j.* DOD Directive 5000.52, Defense Acquisition Education, Training and Career Development Program, 25 October 1991.
- k.* DOD Instruction 5000.02, Operation of the Defense Acquisition, 2 December 2008.
- l.* DOD 5000 Resource Center Guidebook, supporting discretionary, best practices, lessons learned, and expectations, 13 January 2010.
- m.* 2007 DOD Research and Engineering (DODR&E) Strategic Plan.
- n.* 2008 DOD Strategic Basic Research Plan (BRP), April 2008.
- o.* 2008 DOD Joint Warfighting Science and Technology Plan (JWSTP).
- p.* OUSD(S&T), Technology Readiness Assessment (TRA) Deskbook, September 2003.

- q.* DOD Directive-Type Memorandum (DTM) 09–027, Implementation of the Weapon Systems Acquisition Reform Act of 2009 (Public Law 111–23), 4 December 2009.
- r.* USD(AT&L) Memorandum, subject: Prototyping and Competition, 19 September 2007.
- s.* USD(AT&L) Memorandum, subject: Configuration Steering Boards, 30 July 2007.
- t.* USD(AT&L) Memorandum, subject: Delegation of Milestone Decision Authority (MDA) and Senior Official for Major Automated Information Systems (MAIS) Defense Business Systems, 21 May 2009.
- u.* USD(AT&L) Memorandum, subject: Designation of Subprograms for Major Defense Acquisition Programs, 23 June 2009.
- v.* USD(AT&L) Memorandum, subject: Transition of the Defense Space Acquisition Board (DSAB) into the Defense Acquisition Board (DAB), 23 March 2009.
- w.* US Joint Forces Command (JFCOM), The Joint Operating Environment (JOE) 2010, 18 February 2010.
- x.* General Orders #4, Redesignation of the United States Army Training and Doctrine Command Futures Center as the Army Capabilities Integration Center, 10 February 2006.
- y.* Secretary of the Army Memorandum, subject: The Secretary of the Army’s Capability Portfolio Review Strategy, 22 February 2010.
- z.* Office of the Under Secretary of the Army and Vice Chief of Staff, Army Memorandum, subject: Cost-Benefit Analysis to Support Army Enterprise Decision Making, 30 December 2009.
- aa.* Office of the Under Secretary of the Army and Vice Chief of Staff, Army Memorandum, subject: Secretary of the Army-Designated Capability Portfolio Reviews (Expanded Army Requirements Oversight Council) Terms of Reference, 22 February 2010.
- ab.* HQDA, DCS, G–3/5/7 Memorandum, subject: Headquarters, Department of the Army (DA) Capabilities Needs Analysis (CNA) Fiscal Year (FY) 2013–2017 and Program Objective Memorandum 2014–2019 Guidance, 4 May 2010.
- ac.* HQDA, DCS, G–3/5/7 Memorandum, subject: Army Capabilities Integration Policy, 22 May 2008.
- ad.* HQDA, DCS, G–3/5/7 Memorandum, subject: Approval of Army Warfighting Capabilities-DCS, G–3/5/7, Interim Implementation Guidance, 18 October 2007.
- ae.* HQDA, The United States 2010 Army Modernization Strategy, 28 April 2010.
- af.* HQDA, 2010 Army Science and Technology Master Plan, 14 July 2010.
- ag.* HQDA, DCS, G–3/5/7, The Army Campaign Plan, 23 April 2010.
- ah.* HQDA, Assistant Secretary of the Army for Financial Management and Comptroller (ASA(FM&C)) Memorandum, subject: Cost-Benefit Analysis Guidance and Training, 1 February 2010.
- ai.* HQDA, Deputy Assistant Secretary of the Army Cost and Economics (DASA(CE)) Memorandum, subject: U.S Army Cost-Benefit Analysis Guide, version 1.0, 12 January 2010.
- aj.* HQDA, DCS, G–8 Memorandum, subject: Army Equipping Strategy, 29 September 2009.
- ak.* HQDA, DCS, G–8 Memorandum, subject: Program Affordability Analysis on Joint Capabilities Integration and Development System (JCIDS) and other Documents, 24 April 2007.
- al.* HQDA, DCS, G–3/5/7, Equipment Common Operating Picture (ECOP) User’s Guide, version 2, 13 July 2009.
- am.* HQDA, 2011 Weapon Systems Handbook.
- an.* HQDA, 2010 Army Posture Statement, February 2010.
- ao.* Army Regulation 5–22, The Army Force Modernization Proponent System, February 2009.
- ap.* Army Regulation 70–1, Army Acquisition Policy, 30 January 2004.
- aq.* Army Regulation 71–9, Warfighting Capabilities Determination, 28 December 2009.
- ar.* Army Regulation 73–1, Test and Evaluation Policy, 1 August 2006.
- as.* Army Regulation 350–1, Army training and Leader Development, 18 December 2009.
- at.* Army Regulation 602–2, Manpower and Personnel Integration (MANPRINT) in the System Acquisition Process, 1 June 2001.
- au.* Army Regulation 700–127, Integrated Logistics Support, 17 July 2008.
- av.* Army Regulation 700–142, Materiel Release, Fielding, and Transfer, 26 March 2008.
- aw.* DA Pamphlet 70–3, Army Acquisition Procedures, 28 January 2008.
- ax.* DA Pamphlet 73–1, Test and Evaluation in Support of Systems Acquisition, 30 May 2003.
- ay.* DA Pamphlet 600–3, Commissioned Officer Professional Development and Career Management, 1 February 2010.
- az.* DA Pamphlet 700–56, Logistics Supportability Planning and Procedures in Army Acquisition, 5 December 2005.
- ba.* DA Pamphlet 700–142, Instructions for Materiel Release, Fielding, and Transfer, June 2010.
- bb.* HQ, TRADOC Memorandum, TRADOC DOTMLPF Integration Policy, 8 July 2008.
- bc.* TRADOC Regulation 10–5, U.S. Army Training and Doctrine Command, 9 March 2005.
- bd.* TRADOC Regulation 25–36, The Doctrinal Literature Program (DLP), 5 April 2000.
- be.* TRADOC Regulation 71–12, TRADOC System Management, 1 March 2002.

## How the Army Runs

- bf.* TRADOC Regulation 71–20, Concept Development, Capabilities Determination, and Capabilities Integration, 5 January 2011.
- bg.* TRADOC Regulation 350–70, System Approach to Training (SAT, 9 March 1999).
- bh.* HQ TRADOC, TRADOC Campaign Plan, 31 March 2006.
- bi.* HQ TRADOC, Army Capabilities Integration Center (ARCIC) Campaign Plan (ArCP) for Fiscal Year 2010, version 5.0, 1 October 2009 with FRAGOs.
- bj.* HQ, TRADOC Army Capabilities Integration Center (ARCIC) Memorandum, Subject: Approval of the Integrated Capabilities Development Team (ICDT) Framework for FY 10–11 Capability Development Efforts, 2 September 2010.
- bk.* TRADOC Pamphlet 525–2–1, The United States Army Functional Concept for Intelligence 2016–2028, 13 October 2010.
- bl.* TRADOC Army Capabilities Integration Center (ARCIC), Capabilities-Based Assessment Guide, version 3.1, 10 May 2010.
- bm.* TRADOC Army Capabilities Integration Center (ARCIC), Joint Capabilities Integration and Development System (JCIDS) Document Staffing Guide, version 1.3, 18 June 2010.
- bn.* TRADOC Army Capabilities Integration Center (ARCIC), Action Officer Guide for the Development of the Operational Mode Summary/Mission Profile (OMS/MP), version 2, 14 September 2009.
- bo.* U.S. Army Materiel Command Pamphlet 70–2, Integrated Product and Process Management.
- bp.* Army Materiel Command Logistics Support Activity (LOGSA) Pamphlet 700–3, Total Package Fielding (TPF).
- bq.* Memorandum of Agreement between Assistant Secretary of the Army (Acquisition, Logistics, and Technology) and Commanding General, Army Materiel Command, subject: Life-cycle Management (LCM) Initiative, 2 August 2004
- br.* HQDA, DCS, G–4 Memorandum, subject: Revision of the Urgent Materiel Release (UMR) Policy and Procedures, 15 August 2005.
- bs.* Defense Acquisition Performance Assessment Project, Defense Acquisition Performance Assessment Report, January 2006.
- bt.* Office of Aerospace Studies, Air Force Materiel Command, A Guide for Performing Analysis Studies for Analysis of Alternatives or Functional Solution Analysis, July 2004.
- bu.* Office of Secretary of Defense, Defense Acquisition Transformation Report to Congress, February 2007.
- bv.* Defense Acquisition University (DAU), Introduction to Defense Acquisition Management, 7th Edition, September 2005.
- bw.* Field Manual 3.0, Operations, February 2008.
- bx.* Field Manual 7.15, The Army Universal Task List (AUTL), change 3, 29 July 2010.
- by.* HQ Army Test and Evaluation Center (ATEC), Memorandum, subject: Army Test and Evaluation Center (ATEC) Interim Policy Guidance (IPG) 08–1, Test and Evaluation Document Name Change, 4 April 2008.
- bz.* Memorandum of Agreement (MOA) on Multi-Service Operational Test and Evaluation (MOT&E) and Operational Suitability Terminology and Definitions, October 2008.
- ca.* DODD 7045.20, Capability Portfolio Management, 25 September 2008.
- cb.* HQDA, DCS, G–3/5/7 (DAMO–CIC), Capabilities and AROC Management System User’s Guide, 23 March 2010.
- cc.* HQ TRADOC, ARCIC Memorandum, subject: Implementation of Cost-Benefit Analysis (C–BA) Guidance for JCIDS Capabilities Documents, 25 June 2010.

## Chapter 12

### Logistics

“Afghanistan and Iraq have shown us that the need to support small dispersed units over significant distances will only grow in importance; so will the need to appropriately size and reduce the logistics footprint. The evolving strategic environment will pose a series of strategic choices that we will need to examine as we adapt the character of logistics’ contributions to the fight. Over the last decade, logistics organizations, processes, tools and technology have witnessed significant adaptation, which has created a continuum of momentum that makes the next level of adaptation more readily apparent. Technology maturation will be a factor, but our continued partnering and teaming with industry and academia will help shape the progression, integration, and implementation of evolving technologies. As we move forward, we will look for capabilities that satisfy the Soldiers’ need and help us better manage the uncertainty that will continue to characterize current and future operations”. LTG Mitchell H. Stevenson, Army Deputy Chief of Staff G-4 (Logistics), Source: Sustainment Magazine-2010,

#### Section I Introduction

##### 12-1. Chapter content

*a.* The Nature of Logistics. Webster’s defines logistics succinctly as: “The procurement, maintenance, distribution, sustainment and replacement of personnel and materiel.” The logistics lessons of World War II and subsequent full-spectrum operations have taught us that the luxury of time is not always available and that planning and preparing pays off in logistics as it does in all other operations. The post-Cold War environment is no exception, and requires an adaptive and smaller force projection Army rather than relying on a Cold War-style, large, and forward-based force. This environmental change has significant logistics implications, to include requiring a smaller permanent “logistics footprint” Outside Continental U.S. (OCONUS) and relying on anticipatory, swift, and dependable “reach-back” capabilities along lengthy strategic lines of communications augmented by deployable national capabilities when dictated by operational requirements. The primary mission of the Army logistics system is to economically support the joint force commander (JFC) with resources needed, when and where.

*b.* The Paradox of Logistics. As the opening quotation reflects, logistics must be both efficient and effective, at times creating a paradox for the Department of Defense (DOD). For example, to be efficient, the Army must purchase, store, distribute, and dispose of materiel efficiently and economically. At the same time, to be effective, the numbers and types of logistics capabilities required in operations depend not only on cost effectiveness, but on factors of mission, enemy, terrain and weather, troops and support available, time available and civil (METT-TC) considerations. Efficiency and effectiveness often compete in formulating decision criteria that affect all logistics policy and activity.

*c.* Chapter Contents. This chapter provides an executive overview of the nature and structure of the Army’s national logistics system. It describes: Key definitions and concepts (End-to-End [E2E]); National Logistics (The Army G-4 and AMC); National Logistics (Other Organizations); Standard Systems; Funding.

##### 12-2. Key definitions and concepts

*a.* Principles of Logistics. Based on over 200 years of experience, the following principles have general applicability to logistics (developed by James A. Huston, *The Sinews of War*):

(1) First with the most. The primary purpose of logistics is to deliver adequate personnel, equipment, supplies, and materiel to the right places in adequate time to achieve tactical, operational, and strategic objectives.

(2) Equivalence. Strategy, tactics, and logistics together form the basis for major operations and campaigns.

(3) Materiel precedence. Materiel mobilization must precede personnel mobilization because the lead times are much longer.

(4) Economy. Logistics resources are almost always limited and it is necessary to concentrate them in the best way to achieve the primary mission.

(5) Dispersion. Within reasonable bounds, storage and other logistics activities should be dispersed, and multiple lines of communication should be used when possible.

(6) Flexibility. Since often it is not possible to count on prior strategic plans, it is necessary to be prepared to support any of a number of different plans or decisions across the entire spectrum of military operations.

(7) Feasibility. Not only are military plans limited by the feasibility of logistics support, but also logistics plans themselves are subject to the capabilities of the national economy.

(8) Civilian responsibility. Procurement activity must be coordinated with the needs of the civilian economy, and the chief reliance for the production of military goods remains with private industry.

(9) Continuity. The transformation of logistics organizations, coupled with the constant refinement and development of production models for essential systems, should be a continuous process during peacetime and full spectrum operations.

## How the Army Runs

(10) Timing. Timing must be relative to the objective, whether in high-level procurement or tactical supply.

(11) Unity of Command. Logistics is a function of command.

(12) Forward Impetus. A system of continuous replenishment from sanctuary to elements engaged in operations is vital.

(13) Information. Accurate, accountable, and up-to-date information is the key to logistics planning and distribution.

(14) Relativity. All logistics is relative to time, space, and circumstances and can never be absolute.

*b. Levels of Logistics.* The Army provides support to other services, other Departments, multinational partners and allies. Table 12–1 outlines national and theater level guidance and directives.

(1) National. “National logistics is the process of planning for and providing goods and services for the support of the nation’s military forces and its operations, a nation’s civilian economy, and its international obligations and requirements.” National-level logistics can be summarized as: strategic wholesale level support to the military industrial base; development and procurement of new materiel systems; management and improvement of the logistics infrastructure; and rebuild modification and retirement of old materiel systems when required. National logistics is governed by civilians, in both the Executive Branch, through the President and Secretary of Defense, and the Congress, through oversight activities and budget appropriations. National (strategic) logistics tasks are designed to “provide sustainment”, identified in the Universal Joint Task List (CJCSM 3500.04C). They are: Set Sustainment Priorities; Acquire Materiel; Acquire, manage, and distribute funds; Procure and distribute personnel; Provide for Base Support and Services; Provide for Personnel Support; Reconstitute National Forces and Means

(a) DOD relies on the Services, the Defense Logistics Agency (DLA), and non-DOD government agencies (such as the General Services Administration (GSA)) to manage these concerns. National-level functions have been generally performed in the Continental United States (CONUS) and are intended to support and sustain theater activities in the homeland or abroad. The Secretary of Defense issues logistics guidance to the Services as part of the Defense Programming Guidance (DPG). Within this broad guidance, the Services and defense agencies develop programs for logistics.

(b) The Army’s national logistics functions stem from its primary mission required by law. The Army shall “be organized, trained, and equipped primarily for prompt and sustained Combat incident to operations on land.” (10 USC, Sec. 3062). The Army will do this through the development of logistics functions that: Create requirements and capabilities for national logistics; Identify strategic risk to the President, Secretary of Defense, and Congress when logistics requirements exceed national and/or international capabilities; Serve as the bridge between the Nation’s economy and its military needs; Develop logistics policy, systems, and processes to create and sustain support to forces across the full spectrum of military operations; Establish reserves of equipment and supplies required for crises and mobilization. Formulate logistics doctrine (both Army and with our joint and allied partners); Acquire, distribute, maintain, and dispose of Army materiel systems; Develop equipped, trained, and ready Army logistics forces; Assure bases of operations and training are established, developed, secured, and maintained both in the homeland and overseas; Assure strategic lines of communication are created and have sustained support; Provide logistics support to other Services and allies and perform Federal-level executive agent tasks as directed.

(c) HQDA establishes broad logistics policy direction and exercises staff supervision primarily through the Assistant Secretary of the Army for Acquisition, Logistics and Technology, or ASA (ALT). The Army Deputy Chief of Staff, G-4 (“Army G-4” for short) and United States Army Materiel Command (AMC) are the Army’s national level logistics staff and operator.

(d) Other organizations that contribute to national-level logistics include: U.S. Army Corps of Engineers (USACE); U.S. Army Medical Command (USAMEDCOM); CONUS Army Commands (ACOMs); TRADOC; FORSCOM; Theater-oriented Army Service Component Command (ASCC) (such as U.S. Armies Europe, Pacific, and South, and Third U.S. Army); The Army and Air Force Exchange Service (AAFES); United States Transportation Command (USTRANSCOM); Defense Logistics Agency (DLA); Defense Contract Management Agency (DCMA); Defense Commissary Agency (DeCA); National Geospatial-Intelligence Agency (NGIA)

(2) Theater. Theater logistics is the “process of planning for and providing goods, services, and materiel in support of military forces” that operates in specified geographic areas of the world directed by the Secretary of Defense and the President in concert with the Geographic Combatant Commander (GCC). Logistics support is focused on the movement and sustainment of forces operating in joint and combined environments. Theater-level logistics is associated with sustaining full-spectrum operations both homeland-based (CONUS) and forward-based (OCONUS). The “strategic-theater” logistics tasks to “sustain theater forces,” are identified in the Universal Joint Task List (CJCSM 3500.04C). They are: Coordinate the fixing and maintaining of equipment; Coordinate support for forces in theater; Establish and coordinate distribution of supplies/services for theater campaign and the communications zone; Develop and maintain sustainment bases; Acquire, manage, and distribute funds; Minimize safety risks.

*c. Theater-level functions may be subdivided into two types of Maintenance (Sustainment and Field):*

(1) Sustainment level activities are normally concerned with area logistics support to forces within the Geographical Combatant Commander’s (GCCs) geographic area of responsibility (AOR) and in concert with a specific theater or joint operations area when designated. Sustainment is provided by echelon-above-brigade (EAB), units contained

within Sustainment Brigades (Sust Bde), Army garrison-type activities (table of distribution and allowances or “TDA” organizations), contractor, and /or Host Nation Support (HNS) activities.

(2) Field level maintenance encompasses what used to be direct support and unit level. It provides support to specific units and activities based on dedicated mission support. It also provides maintenance on unit equipment while accomplishing internal unit supply and distribution functions.

d. Table 12–1 displays national and theater logistics. It is important to note that the distinction between national and theater logistics processes is sometimes blurred by movement within the two-level maintenance system. Logistics support transcends traditional lines of communication (i.e., strategic lines of communication may extend all the way to the objective area). To that end, all logistics functions, whether performed at the national or tactical level, are referred to as sustainment.

**Table 12–1**  
**Focus of national and theater logistics**

National logistics Focus (DOD, services, Non-DOD)	Theater logistics Focus(CBT, CDR, JFC, and/or ASCC)
Mobilization and deployment Requirements	Deployment sequence/prioritization Reception, staging, onward movement and integration of Army forces
Acquisition and industrial base Stockpiling (Ammunition, and Metals) Global propositioning Strategic mobility RESET Army Forces	Combat service support of the campaign Support to other services Basing/sustainment engineering Distribution management
Redeployment Demobilization Strategic lines of communications Installation/Bases	Host nation agreements/implementation Lines of communication to the tactical units

e. Other initiatives such as Integrated Logistics Support (ILS), National Maintenance Program (NMP), and modernization of logistics automated information systems are designed to create more seamless logistics system. This system ensures that units are fielded, equipped, and sustained in an integrated manner. Logistics tasks and roles performed at the national or theater level can, when required, merge to create a seamless networked organization. The strategic Army Prepositioned Stocks (APS) war reserve program is a premier End to End (E2E) logistics process. An example, directed by HQDA, managed by AMC, and executed in theater by AMC Army Field Support Brigades (AFSBs) as illustrated in Figure 12–1 pictorially displays how lines of operation and communication could co-exist strategically and within theater.



The difference between national- and theater levels of logistics tasks are becoming blurred as the Army continues to streamline logistical processes "End-to-End (E2E)."

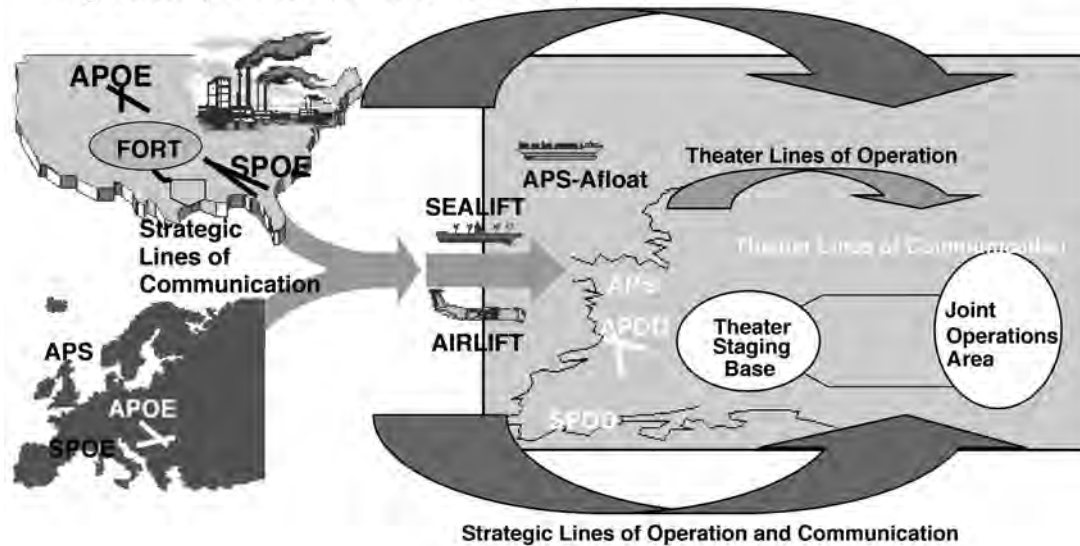

Figure 12-1. Strategic Lines of Operation and Communication

### 12-3. Army logistics

The Army's sustainment warfighting function (WFF) consists of three major sub-functions: logistics, personnel services, and health services support. Logistics is the planning and executing the movement and support of forces. It includes those aspects of military operations that deal with: design and development, acquisition, storage, movement, distribution, maintenance, evacuation, and disposition of materiel; movement, evacuation, and hospitalization of personnel; acquisition or construction, maintenance, operation, and disposition of facilities; and acquisition or furnishing of services (JP 4-0). There are some differences from joint and Army logistics. For example Army HSS is not considered a logistics function (FM 4-0). For the purposes of this chapter logistics will be defined as: supply, transportation, distribution, maintenance, services, security assistance, facilities engineering, sustainment, the Life Cycle Management process, logistics technical system development and application.

a. Supply involves acquiring, managing, receiving, storing, issuing, and maintaining visibility and control of all classes of supply required to equip and sustain forces across the full spectrum of military operations. It is a wide-ranging function that extends from determination of requirements and buying materiel at the national level down to the issue of items to the user in the joint operations arena, as well as the retrograde of both serviceable and unserviceable materiel to be made available for other requirements. Classes of supply include:

- I - Subsistence (food and water (includes ice)).
- II - General items (everything from expendable office supplies, clothing, individual equipment, tools and tents).
- III - Petroleum, oils, and lubricants (POL).
- IV - Construction materiel (fortification, barrier, and construction materiel).
- V - Ammunition.
- VI - Sundries (packages and personal items that could be purchased in a commercial store).
- VII - Major end items of equipment (such as an M1A2 Abrams tank, truck, radio, small arms).
- VIII - Medical items of supply.
- IX - Repair Parts (includes spares).
- X - Non-military or civil-governmental unique items

b. Transportation is moving and transferring unit personnel, equipment, and supplies in support of National objectives and the Joint Forces Command's (JFC) concept of operations. Transportation incorporates military, commercial, and host- or allied-nation capabilities. Transportation activities include: linking motor, rail, air, and water transportation modes; operating terminals and ports, creating and maintaining transportation infrastructure; and the movement planning and control of personnel, equipment, and supplies.

c. Distribution is the integration of personnel, supply and materiel, and transportation to ensure the users receive the right resources when needed and at the right place. It includes all actions performed to deliver required resources (units, materiel, personnel, and services) to, from, and within a theater of operation. It is sometimes called “inventory in motion.”

d. Maintenance keeps materiel in operational condition, returns it to service, and/or modernizes its capability. It includes performing preventive maintenance checks and services (PMCS). Technology allows materiel to be produced or upgraded with embedded diagnostics and prognostics. Maintenance also involves recovering and evacuating disabled equipment; diagnosing equipment faults; substituting parts, components, and assemblies; exchanging serviceable materiel for unserviceable materiel; and repairing equipment.

e. Troop support and field services involve feeding, clothing, and providing personal services to forces. It is comprised of clothing exchange, laundry, shower, textile repair, mortuary affairs, preparation for aerial delivery and airborne activities, and food services.

f. Security Assistance (SA). The Army Materiel Command (AMC) is the lead agency for SA programs. The 1961 Foreign Assistance Act (FAA) and the Arms Export Control Act, as amended, and other related statutes dictate that these programs will be managed. These programs include: Foreign Military Financing (FMF) and the International Military Education and Training (IMET) Program, which are grants; and the Foreign Military Sales (FMS) Program. FMS is a cash or financed purchases program. Although these are United States (U.S.) programs, the U.S. provides defense articles, military training, and other related services to allied and friendly foreign countries in the name of national security.

g. Facilities engineering provides daily operational support to buildings, real property, and environmental management. Engineers provide a service that supports the ability of Army logistics elements to support joint operations. Joint forces are dependent on established logistics infrastructures. The national logistics focus for engineers includes creating or developing bases, ports, roads, bridges, and waterways while providing support to mobilizing or deployed forces. Theater logistics engineer operations build infrastructure s that can support: 1) force reception; 2) staging, onward movement and integration; 3) storage facilities; 4) road and rail networks; and 5) seaports and airfields. Although the engineers do not have a doctrinal Army logistics function, engineering support is considered a logistics activity in joint doctrine. Engineers play a critical role in the delivery of logistics by enhancing theater logistics capacities. Their responsibilities include: support to other Services, agencies, and allied military forces in joint and multinational theaters of operations. Engineering planning factors include determining the size of support bases in existing Host Nation (HN) infrastructure, and protection warfighting function requirements.

h. Logistics technical system development and application. The logistics technical system is comprised of: tools, techniques, processes, devices, artifacts, methods, configurations, procedures, and knowledge management used by organizational members. These members use various systems to acquire inputs, transform inputs into outputs, and provide outputs to Services, clients or customers. The logistics system is an E2E process that relies on the input from the DOD, military organizations, and contractors working within established policy. Furthermore, Army logistics systems provide sustained support to U.S. Army forces, other Services, and allies. The Army has developed and applied many “standard” systems that provide connectivity to the logistics system (See 12–13).

## Section II

### National Logistics Organization: ASA (ALT); Army G–4; and AMC

#### 12–4. Assistant Secretary of the Army for Acquisition, Logistics and Technology, ASA (ALT).

a. The ASA (ALT) is a civilian political appointee and is responsible for providing Executive Branch/DOD civilian oversight of Army logistics. The office of the ASA (ALT) consists of the following sub-elements:

- (1) The Deputy Assistant Secretary of the Army for Research & Technology
- (2) Deputy Assistant Secretary of the Army for Procurement
- (3) Deputy Assistant Secretary of the Army for Defense Exports and Cooperation
- (4) Deputy for Systems Management
- (5) Deputy Assistant Secretary for Plans, Programs and Resources
- (6) Deputy Assistant Secretary of the Army for Acquisition Policy and Logistics
- (7) Director Acquisition Support Center
- (8) The Executive Secretary for Army Science Board (ASB).

b. ASA (ALT) serves, when delegated, as the Army Acquisition Executive (AAE), is the Senior Procurement Executive, the Science Advisor to the Secretary, and as the senior Research and Development (R&D) official for the DA.

c. The ASA (ALT) also has the principal responsibility for all DA matters related to logistics. Among these logistics responsibilities are: Advising the Secretary of the Army (SECARMY) on all matters relating to acquisition and logistics management; Overseeing the logistics management function including readiness, supply, services, maintenance, transportation, and related automated logistics systems management; Reviewing the SECARMY portions of the Army International Affairs Plan to ensure that they are logistically sound and supportable and compatible with the

## How the Army Runs

Army's Research, Development, Acquisition, and Industrial Base Programs; and Overseeing the Army Industrial Base and Industrial Preparedness Programs.

### **12-5. Deputy for Acquisition Policy and Logistics DASA (APL).**

The DASA (APL) serves as the Army logistician on acquisition programs. The DASA (APL) is responsible for providing an independent Integrated Logistics Support (ILS) assessment of equipment and weapons systems requirement documents, equipment, and systems in development and of fielded systems, to ensure supportability and sustainability is adequately addressed and maintained throughout the system's life cycle. Members of the DASA (APL) staff serve on integrated product teams as Army logisticians to influence product definition, design and supportability beginning with pre-systems acquisition planning.

### **12-6. Missions, Organization and Functions of the Army G-4**

*a. The Army G-4 exists to enhance the logistics readiness of our Soldiers and their units.* The Army G-4 is responsible for the formulation and oversight of policies, procedures, and programs that create an environment conducive to efficient and effective logistics operations.

*b. Mission and vision.* The Army G-4's mission is to enable a ready Army by providing and overseeing integrated logistics policies, programs, and plans in support of Army Force Generation. The vision is to be recognized as the preeminent source on the Army Staff for relevant, value-added logistics expertise. Actively engaged in sustaining, preparing, resetting, and transforming the Nation's Army in support of full spectrum operations. Missions are to:

- (1) Perform General Orders No. 3 responsibilities.
- (2) Establish logistics policy and programs, and overseeing their execution.
- (3) Develop logistics programs and budget input.
- (4) Ensure integration of logistics supportability throughout the acquisition life cycle for new systems and current readiness of legacy systems.
- (5) Perform duties as the principal military advisor to ASA (ALT) for logistics.
- (6) Lead and integrate logistics transformation.
- (7) Integrate Army logistics with Joint programs.
- (8) Reduce logistics life-cycle costs.
- (9) Advocate for professional development of the logistics workforce (Army G-44(S), (M) and (D)).

*c. The Army G-4 oversees seven directorates.* Each with different missions, functions, and organizational structures (see below in figure 12-2). Additionally, the Army G-4 employs a field operating agency called the Logistics Innovation Agency (LIA).

## Army G-4 Organization

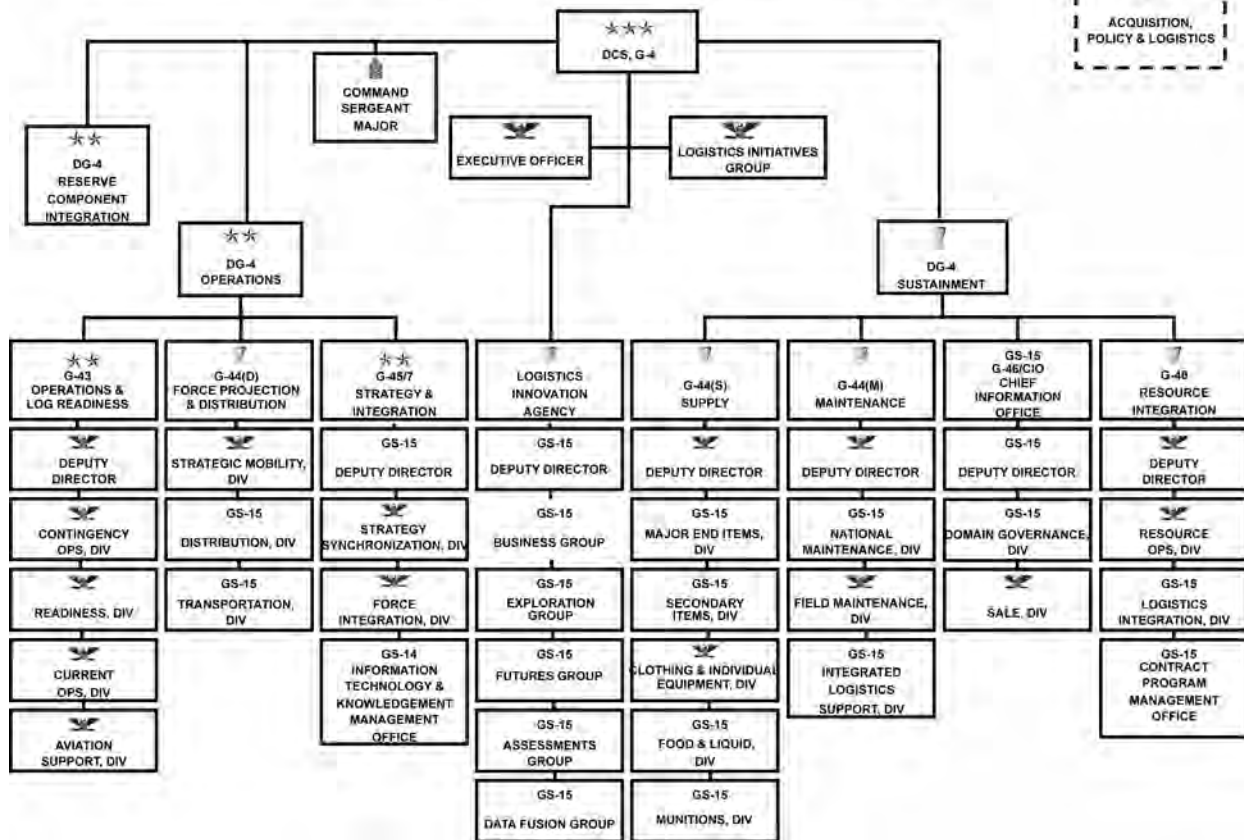

Figure 12–2. Army G–4 Organization

*d. G–43: Operations & Logistics Readiness Directorate.* The mission of the G–43 is to synchronize DA sustainment planning efforts, policies and programs in support of Army worldwide logistics current operations, contingency operations, aviation logistics, and readiness reporting and analysis. This directorate performs the following key tasks: Oversight of policies, procedures, and publications that establish or affect logistics readiness; Responses to inquiries from higher authorities, including Office of Management and Budget (OMB), OSD, Joint Staff, and Congress on matters of logistics readiness; and acts as the Chief, Logistics Operations Center. This directorate has four divisions: Contingency Operations; Readiness; Operations; and Aviation Logistics.

(1) The G–43 Contingency Operations Division. This division is responsible for policy, functional resourcing analysis, concepts, and worldwide activity of APS and Operational Contract support (OCS) that includes the ability to:

- (a) Plan, program, and provide staff management of policy, concepts, and oversight of worldwide PS activities.
- (b) Develop and disseminate overall afloat prepositioning maintenance cycle planning guidance. Coordinate final approval of cargo in the Army Strategic Flotilla program, the movement of ships, cargo maintenance timeframes, and all actions associated with the afloat program with appropriate ARSTAF offices, Military Sealift Command and JCS.
- (c) Oversee program development and funding execution for prepositioning programs and contingency contracting. Provide direction to HQDA / Resource Services Washington (OA–22) for release of OMA ship lease funds, APS exercise funds and the Oman Access Fee.
- (d) Coordinate/develop/defend requirements for Program Objective Memorandum/budget preparation and justification of operational contract and prepositioning programs to ensure program continuity.
- (e) Serve as the Army Staff coordinator to the Office of the Secretary of Defense (OSD) and the Chief of the Joint Chief of Staff (CJCS) for Operational Contractor Support (OCS) policy.
- (f) Assist in the development of Operational Contract Support (OCS) related Doctrine, Organization, Training, Materiel, Leadership and Education, Personnel and Facilities (DOTMLPF) developments.
- (g) Serve as the HQDA staff proponent for LOGCAP and approval authority for the use of the LOGCAP.

## How the Army Runs

(h) Establish policies for the disposition of Government Furnished Equipment (GFE) and Contractor Acquired Property (CAP) equipment consistent with applicable acquisition and government property regulations.

(i) Manage Army War Reserve Secondary Items (AWRSI) to ensure initial supply support in Supply Classes I (Subsistence), II (General Supplies), III (packaged petroleum products), IV (construction and barrier materials), VIII (medical) and IX (spares and repair parts) for a contingency operation until sea lines of communication are established.

(j) Develop war reserve stocks for allies' requirements in coordination with OSD, Army G-3, AMC, the Combatant Commander, and the allied nation.

(k) Provide contract support planning /- assumption data for use in TAA.

(2) The Army G-43 Readiness Division. This division's mission is to be the Army G-4 agent for Unit/materiel Readiness Reporting, and Materiel Readiness Reporting Policy Guidance. This division has staff responsibility for the following programs and actions:

(a) Perform readiness analysis to determine Army-wide readiness conditions and trends. Develop solutions and initiate/direct action to correct readiness deficiencies in the development of the Army Strategic Readiness Update (SRU).

(b) Provide materiel readiness assessments for the Army Staff on major items that affect the Army's ability to equip the force under Army Force Generation (ARFORGEN).

(c) Provide central direction within G-4 for management of activities relating to logistics readiness matters and goals as well as equipment issues of the Active and Reserve Components.

(d) Function as the G-4 POC to G-3 Joint Forces Readiness Review (JFRR), and issues associated with OSD and Chairman's Force Readiness Assessment to Congress.

(e) Provides logistics input to the Quarterly Readiness Report to Congress (QRRC) and serves as the G-4 POC to the Defense Materiel Readiness Board (DMRB).

(f) Support the Army Synchronization Meeting (ASM) chaired by the Vice Chief of Staff for Army (VCSA) Force Validation Committee (FVC) analysis.

(g) Develop and maintain the Logistics Execution Information System (LEXIS) as the G-4 back-office tool to support Logistics Readiness data analysis. Utilize data within LEXIS to perform data research/data mining/analysis and to automate reporting requirements throughout the G-4 (ASRU, FVC, G43/G44S Critical LINs, Reset Pilot Brigade Combat Team Rehearsal of Concept Drill, Reset Cost Model).

(3) The Army G-43 Operations Division. The Operations Division mission is to act as the focal point for: monitoring, identifying, filtering, coordinating, processing, and resolving logistics issues. These issues may affect the Army and other supported forces in times of emergency, increased tension, open hostilities, or exercises. The LOC provides the Army G-4 with global, current operational awareness through daily situational updates. It monitors, coordinates, and directs HQDA Title 10 activities in current operations, joint actions, exercises, and HQDA Continuity of Operations Plan (COOP). Additionally, it provides logistics support to the Army Operations Center (AOC) and has staff responsibility for the following programs and actions:

(a) Provide logistics staff expertise to the DCS G-3 in support of the Army Operations Center (AOC) and liaisons with Crisis Action Team (CAT) or for Crisis Response Cell (CRC).

(b) Provides logistics analysis, updates, charts, and briefer(s), as required, for the Operations and Intelligence (O&I) daily briefing and other briefings as required.

(c) Maintain communications with other operations centers such as the Joint Staff, GCCs, Federal Agencies, ASCCs, and ACOMs as required.

(d) Train and employ LOC Individual Mobilization Augmentees (IMAs) during contingencies.

(e) In support of the HQDA Continuity of Operations (COOP), ensure the G-4 Emergency Relocation Staffs (ERSs) are prepared to maintain the Continuity of Operations (COOP) for the G-4.

(f) Function as the G-4 lead for supporting current civil emergencies, military support to civilian agencies, and military assistance for civil disturbance requirements. Coordinates G-4 logistics input to the Directorate of Military Support (DOMS) through the G-3 to the Commander, National Capital Region.

(4) The Army G-43, Aviation Logistics Division. The Aviation division's mission is to provide doctrine, policy, and technical expertise needed to maintain visibility and control of the Army Aviation Logistics Program as a weapons system. This division's tasks are to:

(a) Interface with research and development, materiel acquisition, training, personnel, operations, logistic support of aeronautical materiel for all U.S. and foreign armed forces, and provide the capability to initiate intensive management when required.

(b) Provide functional expertise as it relates to programming, budgeting, and execution of aviation logistics support.

(c) Monitor aviation readiness trends and initiate actions required to improve readiness.

(d) Develop, review, evaluate, and make recommendations on force structure development related to Army aviation.

(5) Monitor aviation assets distribution according to the allocation priorities established by Army, G-3 and effect necessary coordination throughout the Army to ensure logistics supportability.

(a) Evaluate aviation logistics aspects of security assistance programs concerning Army aircraft and aeronautical equipment.

(b) Develop, review, evaluate, and make recommendations on aviation maintenance plans and programs as they relate to the Army.

(c) Review, evaluate, and make recommendations to the Army G-4 on all aspects of aviation life cycle management to include: Reliability Centered Maintenance (RCM); Reliability, Availability, and Maintainability (RAM) concepts; maintenance engineering factors for product improvement; Repair Cycle Float and Operational Readiness Float factors; and storage/disposition policy for Army aircraft.

(d) Responsible for all aviation safety matters.

e. *The Army G-44(D), Force Projection & Distribution Directorate.* The mission of the G-44(D) is to establish policies and provide guidance and oversight that ensures effective, responsive, flexible, and efficient force projection, transportation services, and distribution support to the Army. This directorate has three divisions: Transportation policy; Distribution; and Strategic Mobility. G-44(D) Force Projection & Distribution tasks are to:

- Monitor deployment, redeployment, and distribution operations.
- Establish policy and guidance for deployment, redeployment, and distribution operations.
- Support ARFORGEN Deployment/Redeployment Timelines by ensuring global deployment/ redeployment metrics support contingency operations.
- Ensure that all strategic mobility and distribution contracts have enforcement and performance metrics. Monitor carrier performance and reward carriers that meet or exceed standards. Deny utilization of carriers who underperform.
- Establish program oversight for Army Power Projection Platform (AP3).
- Establish Army policy and guidance on the Defense Personal Property Program and the Defense Transportation Coordination Initiative (DTCI).
- Support the reengineering of the current personal property program to better support the needs and quality of life for our Soldiers, civilian employees, and Family members.
- Forecast, defend, and manage the G-4 Second Destination Transportation (SDT) Budget.
- Develop policies for the safe movement of the Army's Ammunition and Explosives.
- Identify and develop legislative proposals that standardize and improve DOD shipment process.
- Ensure Deployment Process Standardization across ACOMs), Army Service Component Commanders (ASCCs), and Direct Reporting Units (DRUs).
- Ensure Deployment Out load Infrastructure is adequate to meet deployment timelines.
- Ensure AP3 supports DA Power Projection requirements/needs of current and future forces.
- Ensure Transportation Information Systems meet the functional requirements to enhance deployment, distribution and redeployment of forces.
- Align Army Rail fleet to meet current and future force needs.
- Ensure that E2E deployment, distribution, and redeployment metrics are established that enhance readiness and instill confidence in the supply chain.
- Provide functional expertise for In-Transit Visibility (ITV) and develop policies and procedures that enhance security of the supply chain.
- Establish policy and guidance for the management of intermodal platforms. Ensure management controls can transition readily from peace to war to include retrograde and re- deployment.
- Act as Distribution Business Process Executive to the Logistics Domain Business Process Council (BPC).

(1) The Army G-44(D) Transportation Policy Division. This division's mission is to establish Army Policy for the movement of cargo, personal property and passenger travel; manage the Army G-4 centrally funded SDT program; and serve as the Career Program (CP) 24 Transportation Command Career Program Manager for HQDA. This division is responsible for the following:

(a) Defense Transportation Tracking System (DTTS).

(b) Defense Transportation Coordination Initiative (DTCI).

(c) Administrative coordination for all Army Transportation Account Codes (TACs).

(d) Army Family Action Plan (AFAP) issues intended to improve the quality of life for military and civilian personnel and achieve efficiencies.

(e) Defense Personal Property Program (DP3).

(f) Functional proponent for Transportation Information Systems (TIS).

(g) Financial Air Clearance Transportation System (FACTS) Configuration Management Board.

(h) Administration of the U.S. Army's Syncada payment program.

(i) Cargo, policies and oversight of cargo initiatives.

(j) Personal Property/Passenger Policy.

(k) Transportation Financial Policy.

## How the Army Runs

(2) The Army G-44(D) Distribution Division. This division's mission is to provide distribution policy, guidance, integration planning, and staff functional expertise for distribution operations and ITV. This division's tasks are to:

(a) Develop policy to standardize distribution platform utilization and management (containers, flat racks, crops, 463L pallets, Containerized Ammunition Distribution System (CADS)).

(b) Establish policy and guidance for funding, procurement and leasing for ISO containers.

(c) Provide functional expertise and policy for container management and container accountability information systems.

(d) Establish input to the distribution process owner for integration within the joint transportation information systems.

(e) Establish air challenge criteria policy and guidance on air clearance procedures.

(f) Provide functional expertise on the World Wide Express (WWX) and International Heavyweight Tenders (IHX).

(g) Establish policy and guidance to ensure that intermodal platform requirements are synchronized with the ARFORGEN cycle in order to provide sufficient platforms in the correct location to support the available, reset, and training/ready components of ARFORGEN.

(h) Establish policy and guidance that establishes standard distribution practices that provide time definite delivery of materiel from the supply source to the point of consumption. In coordination with Strategic partners (USTRANSCOM and DLA), establish metrics and constantly assess ability of the distribution system to meet Soldier established required delivery date.

(i) Develop policy and guidance for integrated aerial resupply that provides combat units with freedom of movement in operational areas characterized by unsecured or nonexistent surface lines of communication.

(j) In-transit Visibility.

(k) Transportation Information Systems.

(l) Operations/Futures.

(m) Represents the Army in the Joint Intermodal Working Group (JIWG), Army distribution Forum.

(3) The Army G-44(D) Strategic Mobility Division. This division's mission is to establish general staff oversight, develop plans and policy, and provide required resources in support of strategic mobility and contingency operations. This division's key tasks are to:

(a) Write Army Regulation 525-xx (Army Deployment and Redeployment) for the Army G-3.

(b) Support Army Power Projection (AP3) Management, and respective councils and working groups.

(c) Participate as the Colonel-level voting member on the Transportation Coordinators' Automated Information for Movements System II (TC-AIMS II) configuration control board.

(d) Serve as a voting member on the Integrated Computerized Deployment System, Global Services (ICODES GS) Configuration Control Board.

(e) Provide oversight of Army Watercraft and terminal operations, plans and policy.

(f) Establish transportation and strategic mobility input to the development of mobilization, deployment, redeployment, and demobilization policy, guidance and doctrine; coordinate and review policy.

(g) Represent the Office of the G-4 in development of Joint Service strategic mobility policy.

(h) Coordinate with Joint Staff, Service staffs, and GCC staffs to develop strategic mobility requirements as needed.

(i) Represent the Army and Army equities in the OSD, JCS, USTRANSCOM strategic mobility planning and analysis. Participate in Mobility Capability Requirements Studies, and JCS and OSD-directed Studies for Policy and Doctrine Development

(j) Act as the G-4 representative to Service and Joint working groups and analysis efforts supporting strategic lift studies.

(k) Represent and defend Army requirements in development and acquisition of strategic airlift and sealift assets.

(l) Serve as Functional/Subject Matter Expert with responsibility to the user community in automated deployment systems development.

(m) Conduct, participate in, and support Army mobility studies.

(n) Support programming for resourcing deployment infrastructure projects to ensure rapid power projection of Army forces.

(o) Support strategic mobility enablers, in conjunction with DOD and Joint Service efforts, to ensure efficient strategic lift capability that supports the National Military Strategy and the Army's deployment goals.

(p) Conduct reviews and provide input into Strategic Documents (ACP, SPG, ASPG, and TAP) and other regulatory documents, Joint and Service publications, and DOD and Army regulations as required.

(q) Develop and defend rail, out-load infrastructure upgrades, and other programs to meet strategic mobility requirements of supported GCC.

(r) Review CONPLANS and OPLANs for strategic mobility applications, wartime feasibility, and transportation sufficiency.

(s) Provide DA strategic mobility input to the Joint Capabilities Integration and Development System (JCIDS) process.

(t) Develop and defend the POM for strategic mobility requirements.

(u) Execute management of approved strategic mobility related annual resources.

(v) Exercise staff oversight of the Army Rail Program, to include management of Army rail assets and the Defense Freight Railway Interchange Fleet.

(w) Serve as the G-4 functional proponent for Strategic Sealift and Airlift, to include exercising oversight of Army watercraft and Logistics over the Shore (LOTS) capabilities.

(x) Monitor and assess strategic mobility impacts and capabilities on current military operations.

f. *The Army G-44(M), Maintenance Directorate.* The mission of the G-44(M) is to enhance logistics readiness by providing integrated maintenance policy and programs to maintain a ready Army. This directorate has three divisions: Sustainment Maintenance; Field Maintenance Operations; and Integrated Logistics Support (ILS). This directorate's tasks are to:

- Serve as Army Staff Manager for the Maintenance Management Activity Career Program (program 17) and principal advisor to the Maintenance Management Functional Career Chief Representative on all career program matters.
- Establish Army maintenance policy (DA proponent) for all levels of maintenance and maintenance operations.
- Participate in periodic HQDA staff visits worldwide to assure execution of DA policy and accomplishment of DA objectives.
- Respond to inquiries from higher authority, including OSD, OMB and Congress, on maintenance-related plans, policies and procedures.
- Review Logistics Force Structure for maintenance organization and personnel aspects.
- Serve as the focal point for all maintenance aspects of the Commercial Activities Program.
- Monitor and evaluate maintenance functions in support of security assistance commitments for the Army, G-3 Directorate for Security Assistance.
- Prepare and update Maintenance Master Plan and is proponent for the Quarterly Army Maintenance Board.
- Establish DA position on and responds to audits and surveys (AAA, GAO, DAIG, etc.) within areas of responsibility.
- Develop positions relative to maintenance issues presented under Resource Management Decisions.
- Serve as G-4 functional proponent for maintenance aspects of the Army Campaign Plan and draft AR 525-XX (ARFORGEN).
- Act as Maintenance Business Process Executive to the Logistics Domain BPC.

(1) The G-44(M) Sustainment Maintenance Division. This division's mission is to exercise staff responsibility for all institutional programs/policy/issues that have a direct impact on the sustainment of Army Equipment within an efficient and effective Industrial Base. This division's tasks are to:

(a) Provide oversight for all matters pertaining to Depot Maintenance.

(b) Provide G-4 representation and support for depot maintenance conferences and reviews.

(c) Analyze requirements, costs, capabilities and reporting requirements to accomplish approved maintenance workloads.

(d) Provide functional expertise for programming, budgeting, and execution of maintenance requirements for Class VII equipment at the depot level activity.

(e) Develop planning guidance (less financial data) for the maintenance portion of the Future-Year Defense Program, Planning Programming Guidance Memorandum, Program Objective Memorandum, and the Army Force Development Plan.

(f) Provide functional expertise for the Army's Recapitalization Program.

(g) Validate desirability and feasibility of automating functional requirements for sustainment level maintenance of systems.

(h) Review new system maintenance support plans.

(i) Implement and monitor compliance with Depot Maintenance statutes.

(j) Participate in the development of plans, programming and monitoring of the Army's Sustainment level Reset program.

(k) Validate maintenance related overseas contingency operations (OCO) funding.

(l) Be responsible for Repair Cycle Float (RCF) Factors in accordance with AR 750-1, review annual calculations from Life Cycle Management Commands (LCMCs), and validate input annually from the AMC LCMCs prior to submission to G-8.

(m) Establish and provide sustainment maintenance oversight to the fleet management strategy for all weapon system platforms (Class VII). This division is responsible for the following: Depot Maintenance Core Policy and Methodology; Depot Maintenance Workload Distribution (50/50) Policy and Methodology; Distribution of Depot Maintenance Work loading; Condition Based Maintenance Plus (CBM+); Reliability Centered Maintenance Program (RCM); National Maintenance Program (NMP); Fleet Management Initiative; Coordination of the quarterly Depot



## How the Army Runs

Maintenance Corporate Board (DMCB); Review and validate Core Logistics Analysis (CLA); Review and validate Core Depot Assessment (CDA); Review and validate Depot Source of Repair (DSOR) Decision.

(2) G-44(M) Field Maintenance Operations Division. This division's mission is to exercise staff responsibility for all tactical-level maintenance programs/policy/issues lead and programs/matters that have a direct impact on the Army's ability to prepare units for combat. This division's tasks are to:

- (a) Participate in the development of plans and monitoring of the Army's unit-level equipment reset program.
- (b) Participate in the development of plans and studies associated with new Army concepts and their implications on the maintenance system and maintenance organizations in the field.
- (c) Monitor Army and joint exercises, maneuvers, and tests to determine maintenance conditions in the field and the effectiveness of maintenance management and operations.
- (d) Develop and modify the G-4 position on maintenance policies, programs, and doctrine.
- (e) Ensure validity of organizational publications related to Army maintenance policies, programs, and doctrine.
- (f) Provide guidance on implementation of Unique Item Identifier (IUID) and Serial Number Tracking Programs related to maintenance.
- (g) Act as DA proponent for Standard Information Management System (STAMIS) and automated maintenance systems.
- (h) Participate in automated maintenance systems change request (SCR) reviews, establishing priorities from SCRs and determining content of systems change packages as they relate to maintenance.
- (i) Review maintenance concepts and advise on the development of policies concerning relationships with the North Atlantic Treaty Organization (NATO) and its subordinate element, the NATO Maintenance and Supply Agency (NAMSA). COC representative to the Logistics Domain BPC in support of Maintenance Business Process Executive responsibilities.

(3) G-44(M) Integrated Logistics Support Division. This division's mission is to coordinate across the G-4, Army Staff, and Materiel Enterprise (ME) for ground and Aviation systems to evaluate the effectiveness of logistics supportability using readiness reporting and field assessment results. This division's tasks are to:

- (a) Ensure that the sustainment functions of readiness, supply, services, maintenance, transportation, aviation, munitions, security assistance, and related automated logistics systems management are fully integrated and properly balanced between acquisition and logistics for the total system life cycle.
- (b) Ensure the ILS Elements of Maintenance Planning, Manpower and Personnel, Supply Support, Support Equipment, Technical Data, Training and Training Support, Computer Resources Support, Facilities, Packaging, Handling and Transportation and Design Influence and Interface, are adequately considered and addressed from the beginning of the system acquisition process.
- (c) Participate in HQDA ILSRs and in DASA (APL) Logistics IPTs. Develop logistics systems that support Army information requirements in coordination with AMC.
- (d) Ensure that supply chain principles are considered in the ILS process and supportability analysis.
- (e) Receive, coordinate and review JCIDS requirements documents (CDDs, CPDs), ensuring all elements of ILS are adequately addressed in each document. Adjudicate comments, ensuring the G-4 provides necessary comments to develop sustainable systems.
- (f) Develop and present required briefings to prepare leadership for participation in acquisition forums such as OIPTs, CSBs, and AROCs.
- (g) Ensure Army and Joint capability documents effectively address logistics elements and key performance parameters (KPPs) to support progression through the AROC and the Joint Requirements Oversight Council (JROC) process and governance structures.
- (h) Develop the G-4 position on the sustainability of systems acquired through rapid acquisition processes to inform recommendations for transition to programs of record.

*g. G-44(S) Supply Directorate.* This directorate's mission is to enhance unit readiness by providing integrated supply policies and programs to sustain a ready Army in persistent conflict. This directorate has five divisions: Munitions; Secondary Items; Major End Items; Food, liquids, logistics, and field services; and Clothing & Individual Equipment. This directorate's tasks are to:

- Provide executive leadership, guidance, and coordination for the formulation of the Army and DOD policies, procedures, processes, and objectives for the management of Army supply, troop support, and munitions.
- Provide functional expertise for supply-based logistics information management systems.
- Direct and oversee the dissemination of supply policy guidance and plans for appropriate Army Commands and field elements.
- Establish feedback mechanisms and controls to ensure that system and processes are implemented to achieve maximum effectiveness and economy of operations.
- Develop plans and formulate policy for management of the Army Logistics programs consistent with legislative, DOD, Army, and Army G-4 directives.
- Develop Army G-4 positions on supply policy-related audits conducted by the GAO, DOD Inspector General, AAA,

- and other audit agencies to ensure compliance related to primary mission.
- Respond to inquiries from subordinate and higher authorities, other Services, as well as JCS, OSD, OMB, and Congress on issues within the area of supply.
  - Participate in field service support force structure planning, and assist in development of operational, contingency, and mobilization plans.
  - Review unit and equipment Basis of Issue Plans (BOIP), Mission Needs Statement (MNS), and JCIDS documents for adequacy and provide recommendations to Army G-3 and/or TRADOC as appropriate.
  - Serve as the Army G-4 and Army Staff proponent for the establishment, coordination, and synchronization of policy and processes for the drawdown of equipment and supplies out of forward stationed theaters and operational theaters of operation.
  - Serve as the Army G-4 staff proponent for the coordination, set up, and delivery of the monthly Equipment Distribution Review Board (EDRB), co-chaired by the VCSA and the Commander, AMC, designed to streamline the FMS and equipment redistribution processes.
  - Serve as the G-4 staff proponent for supply actions regarding IUID.
  - Serve as Supply Business Process Executive to the Logistics Domain BPC.
  - Serve as Army G-4 and Army Staff lead for the oversight and execution of the CSA's enduring Campaign on Property Accountability to bring all equipment to record, reintegrate excess into the supply system, and reestablish a culture of supply discipline at all levels across the Army.
  - Serve as the supply functional proponent for Logistics Management Information Systems.

(1) The Army G-44(S) Munitions Division. This division's mission is to provide expertise throughout the munitions materiel life cycle concerning logistics support, planning, programming, budgeting, policy, management, surveillance, and conventional ammunition demilitarization, munitions readiness for conventional ammunition and missiles, and toxic chemical storage. This division's tasks are to:

- (a) Monitor and initiate actions required to maintain munitions materiel readiness.
- (b) Evaluate the effect of force structure changes applicable to this office.
- (c) Provide munitions logistics data used in developing force packages.
- (d) Develop Army G-4 position on munitions supportability assessments.
- (e) Conduct staff visits for the purpose of coordinating management of munitions and missile systems.
- (f) Develop Army G-4 position on proposed materiel change management program.
- (g) Evaluate resource submissions by the major commands including Modernization Resource Information Submissions and Program Analysis Resource Reviews.
- (h) Exercise Army Staff responsibility for munitions sustainability data.
- (i) Serve as the lead for ammunition readiness programming and budgeting and munitions industrial base preparedness, to include Industrial Mobilization Capacity.
- (j) Serve as Army Staff lead for the War Reserve Stockpile for Allies-Israel (WRSA-I) program; War Reserve Stockpile for Allies-Korea (WRSA-K), and serve as a sitting member of the EUCOM Combined Logistics Committee (CLC) for management purposes.
- (k) Represent the DOD as a voting member of the NATO Supply and Maintenance Ammunition Support Working Partnership.
- (l) Direct and monitor the Ammunition Surveillance Program.
- (m) Serve as the Army G-4 focal point for Single Manager for Conventional Ammunition matters.
- (n) Serve as the Army G-4 POC for all Class V FMS actions.
- (o) For Conventional Ammunition Management, the following functions are performed:
  1. Develop concepts, plans, policies, and procedures for allocation and distribution, receipts, storage, issue, accountability, stockpile reliability, asset reporting, maintenance, renovation, demilitarization, toxic chemical storage, and disposal of munitions.
  2. Serve as the office of record for stockpile information and combat expenditure data.
  3. Develop policy and procedures on surveillance. Monitor Surveillance and Explosive Safety Activity reports and initiate corrective action, as required.
  4. Manage the Army Ammunition Logistics Support and Review Programs in accordance with AR 700-13 (Worldwide Ammunition Review and Assistance Program) and AR 700-20 (Ammunition Peculiar Equipment (APE) Program).
  5. Serve as the point of contact for logistics issues pertaining to the programming and budgeting of Procurement Army Ammunition (PAA) fund.
  6. Provide expertise and responsibility for policy and procedures for the safety and use of weapons and ammunition within AR 700-131 (Loan, Lease, and Donation of Army Materiel), specifically for the Avalanche Control Program.
  7. Serve as the functional proponent for the Standard Army Ammunition System-Modernized (SAAS-MOD) and

## How the Army Runs

responsible for programming, budgeting, and configuration control management for the National Level Ammunition Capability tool and the Munitions History Program.

8. Serve as the approval office for significant impact ammunition suspensions and restrictions. Provide a final decision on type, block, or serious impact suspensions or restrictions recommended by the Joint Munitions Command (JMC) or the U.S. AMCOM Life Cycle Management Command (LCMC) that affects unit or Army readiness. An example would include a munitions item (conventional or missile) that fails to function as designed because of an unsafe or expected unsafe condition, but may be used with qualifications.

9. Represent the Army G-4 as a decision maker at all Army G-3/5/7 and Army G-8-led working groups and COCs on Class V training and war reserve requirements, programming, and budgeting issues. For Missile Management, the following functions are performed:

10. Execute General Staff supervision and provides policy on distribution/redistribution of missile weapons systems.
11. Serve as the Army G-4 POC for the development of data used in support of projected asset posture for missile weapons systems.
12. Monitor secondary items and repair parts usage on an exception basis for missile weapons systems.
13. Serve as the Army G-4 POC for special studies regarding missile weapons systems.
14. Monitor depot maintenance programs for assigned missile systems to include weapon system partnership arrangements under NAMSA.
15. Provide General Staff supervision over development, publication, and distribution of the Army-wide Missile Distribution Plan.
16. Monitor missile weapon systems procurement status to ensure concurrent fielding with support materiel systems managed by other commodity offices.

(2) The Army G-44(S) Secondary Items Division. This division provides expertise regarding oversight of the supply management of Class II (expendable/durable), Class III (P), Class IV and IX items. Oversight of retrograde operations for all classes of supply and functions as the proponent for Army regulations, processes, and policies related to secondary item Class II (non-reportable), III (P), IV and IX supply management and retrograde operations. This division's tasks are to:

(a) Provide Army participation in the DOD Military Standard Requisitioning & Issue Procedures (MILSTRIP) Committee.

(b) Provide DA Focal Point for development and implementation of efforts to modernize the Defense Logistics Systems while overseeing the Army's participation in Defense Logistics Modernization System (DLMS) Work Group.

(c) Provide Army G-4 staff responsibility for implementation of Army Military Standard Transactions Reporting and Accounting Procedures (MILSTRAP), the Army Packaging Program, Army-wide Care of Supplies in Storage Program, DOD Shelf-Life Program, and Storage Serviceability Standards for Army-interest Items.

(d) Participate as a member of the DOD Defense Planning Guide Directed Study on Inventory.

(e) Develop and propagate Army supply policy as it relates to Classes II (expendable/durable), III (P), IV and IX.

(f) Perform as the Army G-4 lead for Supply Chain Management (SCM) for the purpose of incorporating logistics business process reengineering and modernization.

(g) Establish policy concerning requisitioning, issue, back-ordering, follow-up status, and the Army-wide implementation of the Military Standard Transportation Requisitioning and Issue Procedures (MILSTRIP).

(h) Provide staff responsibility for execution of Army-wide programs for inventory, storage, packaging, materiel handling, mechanization, and modernization of Army storage facilities (less Class I, III (B), V, and VIII).

(i) Develop policies and interface with DLA and DOD on DOD Lateral Distribution and Procurement Offset programs that include:

1. Logistics Transfer of Consumable items.
2. Tracking of Components in the Supply Systems that are rebuilt for the Recapitalization Program; Dormant Stock.
3. Defense Reutilization and Marketing Program.
4. The demilitarization of materiel through participation in the DOD Reclamation Work Group.
5. Establish stockage policy that includes requirements determination for consumable and repairable items and authorized retention levels.
6. Coordinate, as necessary, with the proponent offices for weapons systems, wholesale logistics item managers, appropriate ACOMs, ASCCs, DRUs, OSD, the other Services, and DLA.
7. Serve as proponent for shelf-life, packaging, storage, and disposal issues relating to supply policy.
8. Provide oversight and responsibility for spare and repair parts inventory management (including reconciliation, redistribution of excess materiel, logistics transfers, performance standards, physical inventory requirements, and asset visibility programs).
9. Provide policy in support of the development of electronic commerce initiatives that impact on supply procedures (for example, the DLA E-Mall and GSA Advantage).
- (j) Establish policy concerning centralized inventory management of Class IX materiel, spare and repair parts (AR 710-1), and serve as the functional proponent for DOD 4140.1-R (Materiel Management).

- (k) Develop integrated materiel management and stockage policy, which includes integrated materiel management assignment, stockage criteria, materiel support requests, and asset transfers.
  - (l) Implement DOD policy, establish standard forms of agreement with other military services, and monitor execution of inter-Service/interdepartmental wholesale supply support programs.
  - (m) Provide oversight of inventory management control programs including assemblage and component policy, Selected Item Management System-Expanded, positioning of stocks, Automatic Return Items Program, and disposal reviews. Serve as the Army G-4 supply chain process owner with the authority over the Army Capital Working Fund (AWCF) parameters impacting Class IX supply chain performance and cost.
  - (n) Support initiatives that institutionalize DOD SCM.
  - (o) Establish policy and monitors execution of the Army's provisioning program by providing representation to the DOD Provisioning Policy Group and overseeing the Army's participation in the DOD Expeditionary Logistics Support Group for the Federal Catalog System (FCS), Data Item Description, and Provisioning.
  - (p) Serve as Army G-4 focal point for the Army's interface with DLA and GSA on overall supply support requirements.
  - (q) Monitor GSA and DLA supply support to the U.S. Army and coordinates Inventory Management Reviews.
  - (r) Provide functional input to the Army Working Capital Fund-Supply Management Army (AWCF-SMA) program / budget issues and supports OMA/OPTEMPO issues affecting supply policy/procedures.
  - (s) Establish policy for the use of Government Furnished Material as it relates to requirements computation policy for secondary items of interest.
  - (t) Establish cataloging policy to include item identification process and the Army's implementation of the FCS.
  - (u) Serve as the Army G-4 lead proponent for all matters related to the development and modification of Army Department of Defense Activity Address Code policies and procedures.
    - aa. Provide policy guidance, reporting and performance metrics on the redistribution and retrograde of materiel for all classes of supply.
- (3) Army G-44(S), Major End Items Division. This division's mission is to provide the Army G-4 with expertise for managing Class VII equipment on-hand readiness (Non-G-8 controlled LINs) and supply policy and processes for standard and non-standard equipment (NS-E). Additionally, it provides oversight for Property Accountability and functions as the proponent for Army regulations, processes, and policies related to Class VII supply management. This division's tasks are to provide:
- (a) Staff oversight of Equipment on Hand (EOH) readiness for non-G-8-managed LIN equipment.
  - (b) Coordination of MTOE updates, LIN type classification (TC) changes and other documentation actions to improve Army EOH readiness.
  - (c) Coordination with the AMC, program and budget for Class VII shortages (non G-8-managed LINs) within the Equipping Program Execution Group.
  - (d) Army G-4 represent on the sustainment and equipping budget execution working groups and COCs.
  - (e) Army G-4 proponent for compliance with requirements for TDA equipment reporting under The Chief Financial Officers Act (CFO Act).
  - (f) Interface with the Joint Staff J-4 on Force Activity Designation (FAD), Uniform Materiel Movement and Issue Priority System (UMMIPS), and Joint Materiel Priorities and Allocation Board (JPAB).
  - (g) Manage the SLAMIS program and provide staff oversight for the logistics SLAMIS actions across.
  - (h) Establish supply policy (to include equipment cataloging) and processes to ensure the accountability, visibility, and management of the Army's standard and NS-E throughout the equipping life cycle.
  - (i) Implement policy and procedures pertaining to the loan, lease, and donation of Army materiel to DOD and non-DOD Federal activities, Coalition Partners, and foreign countries for demonstrations in connection with international programs.
  - (j) Establish supply policy and act as Army focal point for sale or exchange of non-excess personal property.
  - (k) Provide policy and process oversight to achieve and maintain enterprise-level visibility of Army major equipment and general property assets from initial receipt confirmation until disposal to meet the congressionally-mandated requirements to meet the existence and completeness metrics required to produce an unqualified financial report.
  - (l) Develop policy and procedures for state and local governments to procure equipment through DOD and GSA sources of supply to support counterdrug, homeland security, and emergency response missions in accordance with Section 1122 of the 1961 National Defense Authorization Act (NDAA).
  - (m) Provide policy and procedures for the accountability of Army equipment loaned to coalition forces and international organizations through cross-servicing agreements in Iraq and Afghanistan for protection and survivability in accordance with Section 1202 of the NDAA.
  - (n) Coordinate the Command Logistics Review Team (CLRT) supply policy procedures with LIA.
  - (o) Identify, prioritize, and validate all Major End Item Supply Depot Operations (SDO) and demilitarization requirements.
  - (p) Oversee the Army's Class VII end-of-life cycle management program to ensure the timely disposition of Class VII end items at the end of their life cycle.

## How the Army Runs

- (q) Serve as the Army G-4 POC for Class VII FMS actions.
  - (r) Serve as the COC representative to the Logistics Domain BPC.
  - (s) Serve as the lead for the Chief of Staff, Army Campaign on Property Accountability.
  - (t) Provide staff oversight of EOH readiness for non-G-8-managed LIN equipment.
  - (u) Coordinate MTOE updates, LIN TC changes and other documentation actions to improve Army EOH readiness.
  - (v) In coordination with, and in support of AMC, program and budget for Class VII shortages (non Army G-8-managed LINs) within the Equipping Program Execution Group.
  - (w) Represent the Army G-4 as a member of the sustainment and equipping budget execution working groups and COC.
  - (x) Serve as the Army G-4 proponent for compliance with requirements for TDA equipment reporting under the CFO Act.
  - (y) Serve as the interface with the Joint Staff J4 on FAD, UMMIPS, and JMPAB.
  - (z) Manage the SLAMIS program and provide staff oversight for the logistics SLAMIS actions.
    - (aa) Oversee and improve Army, unit, and fleet readiness in coordination with AMC, Army G-8, and ASA (ALT).
    - (ab) Establish supply policy (to include equipment cataloging) and processes to ensure the accountability, visibility, and management of the Army's standard and NS-E throughout the equipping life cycle.
    - (ac) Implement policy and procedures pertaining to the loan, lease, and donation of Army materiel to DOD and non-DOD Federal activities, Coalition Partners, and foreign countries for demonstrations in connection with international programs.
    - (ad) Establish supply policy and act as Army focal point for sale or exchange of non-excess personal property.
    - (ae) Provide policy and process oversight to achieve and maintain enterprise-level visibility of Army major equipment and general property assets from initial receipt confirmation until disposal to meet the congressionally-mandated requirements to meet the existence and completeness metrics required to produce an unqualified financial report.
    - (af) Develop policy and procedures for state and local governments to procure equipment through DOD and GSA sources of supply to support counterdrug, homeland security, and emergency response missions in accordance with Section 1122 of the NDAA.
    - (ag) Provide policy and procedures for the accountability of Army equipment loaned to coalition forces and international organizations through cross-servicing agreements in Iraq and Afghanistan for protection and survivability in accordance with Section 1202 of the NDAA.
    - (ah) Coordinate the CLRT supply policy procedures with LIA.
    - (ai) Identify, prioritize, and validate all Major End Item SDO and demilitarization requirements.
    - (aj) Oversee the Army's Class VII end-of-life cycle management program to ensure the timely disposition of Class VII end items at the end of their life cycle.
    - (ak) Serve as the Army G-4 POC for Class VII FMS actions.
  - (al) Serve as the Chair for the PATF responsible for policy and process oversight for property accountability and visibility across the Army.
  - (am) Serve as the COC representative to the Logistics Domain BPC.
- (4) G-44(S) Food, Liquid Logistics and Field Services Division. This division's mission is to provide the Army G-4 with expertise throughout the life cycle, concerning Soldier support policy in the Army Food Program; Field Services to include Aerial Delivery and Mortuary Affairs, Bulk Petroleum and Mobility Fuels, Tactical Water Logistics, and commissary and exchange support (Class VI) to the Army.
- (5) The Army G-44(S) Food program:
- (a) Serve as the Army G-4 functional proponent for subsistence policy and requirements forecasting through the development of policies, plans, programs, peacetime and wartime standards, and review doctrine for subsistence supply operations.
  - (b) Serve as DA functional proponent for recognition of excellence in the Army Food Program to include the Philip A. Connelly Award for Excellence in Food Service, and the Culinary Arts Program.
  - (c) Represent the Army on DOD, intra-service and inter-service committees, task forces, and study groups pertaining to legislation, policies, procedures, and standardization of the DOD Food Program.
  - (d) Serve as the ArmyG-4 functional proponent for military construction programs regarding the designing and equipping of installation dining facilities.
  - (e) Monitor the Defense Commissary Agency's (DeCA) support to Army personnel and families and defend Army's funding contribution for DeCA operations.
  - (f) Develop annual garrison and operational ration subsistence requirements and defends the Military Personnel Appropriation requirements in the PPBES and POM process by providing requested input for ASA (FM) justification documents.
- (6) Installation Food Service Program:

- (a) Develop policies, plans, programs, standards, and review doctrine for management of installation food service programs in coordination with Installation Management Command (IMCOM).
  - (b) Coordinate and defend IMCOM budget requirements for operations of installation food service facilities.
  - (c) Develop nutrition policies and programs for dining facilities consistent with The Surgeon General's nutrition policies and establish nutrition education programs for food service personnel and Soldiers consistent with the Army's Health Promotion Program.
  - (d) Serve as the Army G-4 functional proponent for the Army Food Management Information System (AFMIS) and the voting member of its Configuration Control Board.
  - (e) Develop policies for identification and accountability of Soldiers entitled to subsistence-in-kind and reimbursement policies for meals provided to Soldiers and officers receiving a subsistence allowance, civilians, and reserve components.
  - (f) Manage the memorandum of understanding (MOU) among HQDA, HQ TRADOC, and Army Center of Excellence for Subsistence on installation and field food service responsibilities.
- (7) Field Feeding System:
- (a) Provide HQDA staff support for Army field feeding system concepts, force structure, testing, and introduction of new equipment and rations.
  - (b) Consolidate ACOM/ASCC/DRU operational rations requirements, and annually provides requirements to the Defense Supply Center Philadelphia and use for subsistence budget. Field Services:
  - (c) Formulate policies for management of aerial delivery and airdrop systems.
  - (d) Serve as the Army Proponent for hazardous material management and Army proponent for the DOD Hazardous Materials Information Resource System, a repository for material safety data sheets, and related information for hazardous materials.
  - (e) Formulate policy for Mortuary Affairs management.
- (8) Petroleum and Tactical Water Logistics:
- (a) Develop and implement policy for bulk petroleum supply, distribution and accountability, and Single Fuel on the Battlefield concept.
  - (b) Assist in development of prepositioned war reserve policies, guidance, stock levels and computation factors for bulk petroleum products worldwide in coordination with Army Petroleum Center (APC) and review bulk petroleum portions of contingency plans and operational projects.
  - (c) Assist in establishing policy with APC for DA quality surveillance programs for fuels and lubricants and associated testing equipment and laboratories.
  - (d) Develop, defend, and coordinate POL systems resource requirements through the Army resourcing process.
  - (e) Manage the overall Army Fuel Card Program as the Class II Component Program Manager (for Fleet, AIR, and SEA Cards). Army and Air Force Exchange (AAFES). As the AAFES Army G-4 POC:
  - (f) Serve as functional staff supporting the Army G-4 as a member of the AAFES BOD.
  - (g) Monitor the Army and Air Force Exchange Service's support to Army personnel and their Families.
- (9) Defense Commissary Agency (DeCA). As the Army G-4 DeCA POC:
- (a) Serve as functional staff supporting the Army G-4 as a member of the DeCA Commissary Operating Board (COB).
  - (b) Monitor the Defense Commissary Agency's support to Army personnel and Families.
- (10) The G-44(S) Clothing and Individual Equipment Division. This division's mission is to provide the Army G-4 with expertise throughout the material life cycle concerning Clothing Bag, Dress Clothing, Optional Clothing, and Organizational Clothing and Individual Equipment (OCIE) Management. This division is responsible to:
- (a) Execute DOD Executive Agent and Army proponent management of the Army Clothing and Individual Equipment (CIE) program.
  - (b) Participate as member "Soldier as a System" forums with PEO Soldier.
  - (c) Chair the Army Uniform Board (AUB).
  - (d) Provide policy, management analysis and Army-wide process improvement for Army personal clothing items: Clothing Bag items, Clothing Replacement Allowance, and optional clothing items.
  - (e) Assist in resolving AUB issues regarding changes and additions to the clothing bag, mess, dress, service, and optional purchase uniform items and making recommendations to the CSA (Milestone Decision Authority-MDA) for decision.
  - (f) Review policies pertaining to the wear of new or improved clothing items.
  - (g) Serve as the functional proponent for AAFES operation of Army Military Clothing Sale Stores worldwide.
  - (h) Develop plans and formulate policies for management and funding of Clothing Bag and OCIE items, except for chemical protective clothing (such as chemical over-garments, shoes, and gloves).
  - (i) Coordinate with (PEO Soldier for concept approval and TC of personal clothing items, fielding plan and supportability plan development.

## How the Army Runs

(j) Serve as HQDA functional proponent for central issue facility (CIF) automation and re-engineering. Chair the OCIE Decision Support Tool and Installation Support Module Central Issue Facility (ISM CIF) Configuration Control Boards.

(k) Coordinate funding to support changes in ISM CIF automation to enhance efficiencies and effectiveness of Army-wide OCIE management.

(l) Establish OCIE Central Management processes and work issues that arise between the ACOMs/ ASCC/DRUs and the OCIE Central Management Office (CMO).

(m) Serve as the Army G-4 representative in all areas of OCIE management and issues that arise due to contingency operations.

(n) Coordinate with the U.S. Army Force Management Support Agency (USAFMSA) on Common Table of Allowances (CTA) 50-900 (Tables 1, 2, and 3) Clothing Bag authorizations and CTA 50-900 (Tables 4, 5, and 6) OCIE authorizations.

*h. G-45/7: Strategy & Integration Directorate.* The mission of this directorate is to provide logistics strategy and manage its implementation, shape logistics strategic planning, and Combat Service Support (CSS) force management activities to enable transformation and balancing of the Army. This directorate has two divisions: Strategy Synchronization and Force Integration and Concepts. This directorate's tasks are to:

- Direct the integration of Army logistics capabilities, concepts, and doctrine across the Joint Staff, Services, Combatant Commands and Multinational Partners to optimize logistics resource allocation.
- Oversee Information Technology and Knowledge Management capabilities within the G-4.
- Influence the strategic direction of Army logistics by delivering a coherent, integrated, and synchronized Army logistics message that is contained in national, DOD, and Joint strategic guidance.
- Serve as the G-4 lead integrator for functions and/or activities that impact on more than a single Directorate, as required.
- Serve as the G-4 lead to progress CSS force structure initiatives through the force management process and analysis of TRADOC and HQDA proposals.
- Shape Joint, Intergovernmental, Interagency and Multinational Logistics.
- Influence the Strategic Direction of Army Logistics.
- Shape Logistics Adaptive and Crisis Action Planning.
- Enable Logistics Information and Knowledge Dominance.

(1) The Army G-45/7 Strategy and Synchronization Division. The mission of this division is to produce synchronized and integrated Army logistics input to strategic guidance and support adaptive and strategic planning activities to enable Army transformation. The Army G-45/7, Strategy and Synchronization Division functions include:

(a) Synchronize Army G-4 input into OSD, Joint Staff, GCC), and Army strategic planning processes and documents.

(b) The G-4 manager for the Army Study Program and RAND Arroyo Center Research Programs. This includes development of proposals; obtaining the Army G-4 internal prioritization; and obtaining funding through Army G-8 or alternate sources to fund studies.

(c) Focal point for the TRADOC Quarterly Futures Review.

(d) Monitor G-4 performance objectives and execution and maintain a strategic management tool.

(e) Lead for execution of BRAC logistics requirements, stationing actions, and other related transformation initiatives.

(f) Provide subject matter expertise to the DCS, G-4 regarding the DOD Executive Agent and Support to Other Services responsibilities assigned to the Secretary of the Army.

(g) Provide link to OSD, the Joint Staff, Army Staff/Secretariat, ACOMs, and external agencies for review, coordination, and formalization of logistics planning guidance and logistics aspects of long/mid-range plans.

(h) Corporate logistics strategic campaign planner in supporting Combatant Commands (COCOM), ASCCs, supporting agencies, and Army Staff involved in the adaptive planning process.

(i) Assess Army Title 10 logistics responsibilities and capabilities to support and sustain planned forces supporting COCOM and ASCC campaign plans.

(j) Ensure fully vetted Title 10 logistics responsibilities and requirements are recognized during assessment and analysis of Operational Availability studies, TAA Concept of Support development and Mobility Capability Studies.

(k) Ensure appropriate Army-level logistics equities are included the DOD Analytic Agenda.

(l) The G-4 lead in developing Operation and Concept Plans ensuring a smooth transition with G-43 when plans are implemented for execution.

(m) Coordinate Army logistics issues in support of Defense Support to Civil Authorities with Army North (AR-NORTH) and United States Army Pacific (USARPAC).

(n) Army agent for DOD Logistics Sector Critical Infrastructure Protection (CIP) Initiatives. Coordinate actions

between DOD Log Sector lead (DLA) and Army Service Critical Infrastructure Risk Management branch in G-3/5/7 (DAMO-OD). This division is responsible for the:

1. Quadrennial Defense Review.
  2. Base Realignment and Closure.
  3. Military Construction IPT.
  4. Army Campaign Plan.
  5. Logistics Governance Forums.
  6. Army Posture Statement.
  7. Army Modernization Strategy
  8. Army Force Generation (ARFORGEN).
- (2) The Army G-45/7 Force Integration and Concepts Division. This division's mission is to provide:
- (a) Guidance, planning data and analysis to enable Combat Service Support (CSS) force management.
  - (b) Lead in the integration of Army logistics capabilities, concepts, and doctrine across the Joint Staff, Services, GCCs and Multinational Partners to ensure that Army logistics is a force multiplier.
  - (c) Lead integration, coordination, and evaluation of logistics concepts, capabilities and doctrine across HQDA and within Joint, Multinational, and Army forums to ensure responsive, effective, and efficient logistics in all Army endeavors. This division's tasks:
    1. Influence Army, Joint, and Multinational logistics across DOTML-PF, through bilateral staff talks and visits, NATO and ABCA participation, Joint, Interagency, Intergovernmental, and Multinational (JIIM) exercises, experiments, joint/multinational forum participation, engagements, assessments and input to doctrine and concepts.
    2. Identify and analyze logistics capabilities that shape the future force, materiel programs, and future concepts. Inform and influence Joint Logistics Capability Management Portfolio efforts.
    3. Coordinate integrated logistics positions throughout senior Army, Joint, Multinational forums and Governance structures.
    4. Lead G-4 efforts to support DOD and Joint Logistics Visions and Roadmaps (e.g., Joint Logistics J-4 Compass; DOD Logistics Roadmap).
    5. Lead logistics participation in exercises and wargames.
    6. Provide support to joint capability based assessments across logistics functional areas providing updates and process revisions as needed (Works with the Joint Staff on JCIDS).
    7. Lead the Joint Logistics Capability Portfolio Manager (JL CPM) efforts and integration of functional JL Capability Area Manager (CAM) initiatives. This includes JL capability mapping, joint assessments and taxonomy efforts.
    8. Ensure Army positions are presented to the Army G-8/Army representative in support of the Joint Logistics Functional Capability Board, Joint Logistics Capability Board and JROC (when applicable).
    9. Provide leadership support for senior level Joint and OSD boards, and forums which involve multiple logistics functional topics.
    10. Ensure thorough analysis and articulation of logistics issues advancing through senior Army, Joint and multinational forums.
    11. Ensure complete responses to actions/requests from the Joint and OSD-hosted meetings
    12. Lead for the Joint Logistics Board.
    13. Influence the agenda with critical logistics issues/topics which require senior-level joint discussion.
    14. Work with the logistics community to ensure that G-4 Leadership is well versed on agenda topics and respective Army positions.
    15. Coordinate Army G-4 input for Conference of Logistics Directors.
    16. Lead for Joint Operational Engineering Board.
    17. Gatekeeper for Army logistics doctrinal publications (Field Manuals and Army Tactics Techniques and Procedures); all Joint Logistics publications, all Multinational/Allied logistics publications and the staffing of the respective publications/doctrine throughout the G-4.
    18. Establishment and management of bilateral, multinational logistics relationships and logistics partnership and participation in U.S. Army bilateral staff talks.
    19. Focal point for addressing logistics issues within the Army Security Cooperation Strategy.
    20. Manage Army G-4 Senior Foreign Military visits that are planned and coordinated between G-4 Leadership and Foreign Military Attaché.
    21. Army G-4 lead for Service Soldier Staff Talks. Coordinate logistics issues and positions with Army G-3 leads.
    22. Evaluate Logistics Lessons Learned and assess gaps and recommendations (way ahead). Work in conjunction with Army and Joint logistics community.
    23. Army G-4 lead for the Army G-3 led Army Experimentation Program (AEP). Coordinate logistics input for experimentation and provide input to science and technology (S&T) efforts.



## How the Army Runs

24. Review, analyze, and prioritize Joint Capability Technology Demonstration (JCTD) proposals.
  25. Lead G-4 input for topics addressed and worked for the AMCBs. Ensure adequate issue and program reviews, and proper logistics representation, at all AMCBs.
  26. Lead ArmyG-4 coordination for Army logistics Modeling and Simulation (M&S) efforts.
  27. Support Army and Joint Logistics Leadership initiatives, the Defense Logistics Education Executive Workshop efforts, and the development of JIIM logisticians.
  28. Host the Surgeon General (OTSG) liaison who provides medical representation, logistics, and operations expertise to the G-4 and functional directorates.
  29. Ensure future CSS Force Sustainment is properly sized to meet Army Requirements using the TAA Process, which includes the Generating Force (Institutional Army) and Operating Force.
  30. Support the Army's transformation and modularity force structure initiatives by actively participating in all CSSFDUs and the FDU process with emphasis on EAB CSS units.
  31. Support the Institutional Army's Force Structure process by acting as the G-4's executive agent for the receipt, analysis, and recommendation for all Concept Plans and Command Implementation Plans.
  32. Lead G-4 input for the review of MTOE and TDA. Assess and advise on the impact of capability, doctrine, end-strength, and acquisition programs.
  33. The Army Staff lead for contingency basing COCs.
  34. Support the Interagency Logistics Program.
  35. The G-45/7 Force Integration and Concepts division is the responsible for:
    - a. TAA activities
    - b. Force Design Updates (FDU) Assessment
    - c. Joint Logistics Functional Capability and Integration Boards
    - d. TRADOC Capability Needs Assessments
    - e. Army and Marine Corps Board (AMCB)
    - f. North Atlantic Treaty Organization (NATO) CSS Working Group
    - g. American, British, Canadian, Australian and New Zealand (ABCA) Sustain Work Group
    - h. Chairman of the Joint Chiefs of Staff (CJCS) / GEOGRAPHIC COMBATANT COMMANDER (GCC) Exercises
    - i. Title X War games
    - j. Interagency Logistics Program.
    - i. *The Army G-46 Corporate Information Office (CIO) Directorate.* This directorate's mission is to provide Army G-4 oversight for policy, governance, investment strategy and technical integration of logistics automated information management systems. This directorate has three divisions: 1) Domain Governance; 2) Systems Synchronization & Technical Integration and 3) Single Army Logistics Enterprise (SALE). This directorate's tasks are to:
      - Exercise Army Staff responsibility for policy and coordination actions concerning design, development, fielding, sustainment, and PPBES requirements for logistics information system initiatives and all aspects of life-cycle implementation for technical information and data management.
      - Support consistent DOD implementation of corporate information management (CIM) technical initiatives.
      - Promote strategies and procedures for common systems development consistent with OSD systems review and approval policies.
      - Serve as the logistics POC for the Army enterprise strategy, which focuses on the information needs of the Army achieving the seamless information environment necessary to support future Soldiers.
      - Represent the G-4 as the functional proponent for GCSS-A at PMRs and other forums as required.
      - Manage the logistics STAMIS) configuration control process, to include definition of the process, funding and guidance.
      - Serve as the Secretariat for the Logistics Domain BPC.
      - Serve as the Domain Manager for the Logistics Domain.
      - Serve as the AWCF) Working Group POC for Logistics Automation Issues.
      - Represent the G-4 on the Command and Global Network Enterprise Construct.
      - Appoint a Chief Technical Officer (CTO) with authority to manage (IT within the Logistics Domain.
- The CTO provides oversight and recommendations on new Commercial off The Shelf (COTS) technology for logistics.
- Provides information for GAO, DODIG, and AAA investigations in coordination with the office of Business Transformation (OBT) and PEO - Enterprise Information Systems (EIS).
- Represents the Logistics domain investments at the DOD Investment Review Board (IRB).

(1) The Army G-46, Domain Governance Division. The mission of this Division is to review, revise, and create

strategic communication, policy, guidance, and regulations relative to logistics information systems and initiatives. This division's tasks are to:

- (a) Ensure regulatory compliance on all logistics information system initiatives and investments.
- (b) Develop and defend the Army Logistics IT investment strategies for the Logistics and Focused Logistics domains in the Army Posture Statement and the Army Campaign Plan.
- (c) Ensure all requirements for investments in the Logistics Domain are properly documented and processed through appropriate governance forums, ensuring regulatory compliance and enterprise goals are met in accordance with the Combined Arms Support Command (CASCOM) and PEOEIS.
- (d) Provide overall portfolio management, oversight, and database administration for the Logistics Domain using the Army Portfolio Management Solution in coordination with the OBT.
- (e) Manage, facilitate, and conduct, including scheduling and minutes, multiple Senior Leader logistics automation governance forums such as the BPC, Business Process Executives, and the 3-Star Enterprise Resource Planning (ERP) IPT. Support the BSIT-ESG chaired by the Under Secretary of the Army.
- (f) Establish the logistics data governance structure through development of a logistics domain data management strategy and the corresponding identification of proposed authoritative data sources and their associated criteria across Joint and DOD activities. Support Army Enterprise data quality program by assessing data performance.

(2) The Army G-46 System Synchronization & Technical Integration Division. This division's mission is to:

(a) Provide support for national, tactical, and field-level logistics information management systems through the employment of Staff Synchronization Officers (SSO).

(b) Support asset distribution in accordance with the allocation priorities established by the DCS G-3 and coordinate throughout the Army to ensure supportability. This Division is responsible for:

1. Army logistics IT Strategic Plan
2. Army logistics IT Implementation Plan
3. Army logistics IT Investment Governance
4. Support current Army logistics IT systems
5. Bridge to enhanced near term capabilities
6. Deliberately move to modernized ERP capabilities
7. Deliver the SALE;
8. Advocate for funding
9. Alignment with LandWarNet / Mission Command strategy
10. Alignment with Defense Business Enterprise Architecture.

(3) The Army G-46 Single Army Logistics Enterprise (SALE) Division. This division's mission is to ensure the successful integration and fielding of ERP logistics and related financial solutions while implementing federation and/or convergence strategies as directed by the senior leadership. This division's tasks are to:

- (a) Provide continuous oversight and integration of all logistics modernization efforts.
- (b) Support the strategy and integration planning of ERP systems, (GCSS-A) and LMP and others as required).
- (c) Coordinate with PEO EIS on matters concerning GFEBs to ensure GCSS-A implements the GFEBs financial solution.
- (d) Coordinate with PEO EIS on matters concerning LMP to ensure compliance with the SALE objectives.
- (e) Ensure that E2E requirements for the Logistics Domain are identified for submission into the Defense Requirements Process for changes to ERP software baselines (e.g., Oracle and SAP).
- (f) Ensure E2E business processes are defined within the Logistics Domain in accordance with the Army ERP Strategy, focusing on Business Process Re-Engineering and Business Processing Mapping.
- (g) Support the resolution of cross-project and cross-domain issues and presentation to governance bodies for decision.
- (h) Support the federation Configuration Control Board (CCB) process.
- (i) Identify and coordinate for support required from other G-4 and/or HQDA staff sections in the areas of policy and regulations. I.

j. *The Army G-48 Resource Integration Directorate.* This directorate's mission is to lead all aspects of Resource Management, to include integration of Life Cycle Strategies and delivery of effective contract support for Army G-4. This directorate has three divisions: Resource Operations; Logistics Integration; and Contracts Programs Management Office. This directorate is:

- Responsible for all aspects of the Army resourcing process, or PPBES, for logistics functions, to include the development of program requirements, budget formulation, the presentation and defense of the budget through the Congressional process, budget execution and analysis, and reprogramming actions with respect to Army logistics programs.
- Responsible for ensuring the integration of the functional program managers in the programming and budgeting process.

## How the Army Runs

- Responsible for the management of Army G-4 contracts.
- Develops and monitors corporate metrics on performance measures (metrics) and program requirements and funding.
- Prepares G-4 leadership to present their positions at decision meetings including the PPBC, SRG, BRP, WSR and briefings to the senior Army leadership; Articulates and defends PEG programs and resource decisions at HQDA and OSD reviews.
- Responds to Congressional, AAA, DODIG, and GAO queries on financial management matters pertaining to logistics programs within assigned areas of responsibility.
- Monitors annual Congressional authorization and appropriation activity, respond to inquiries and prepare inserts for the record within assigned areas of responsibility.

(1) The Army G-48 Resource Operations Division. This division's mission is to Develop Sustaining (SS) PEG programs within the Army and G-4 leadership priorities by analyzing, monitoring, defending, justifying, and programming resources throughout the DOD budget process. Formulate, coordinate and obtain supplemental funding to provide for sustainment of forces in and returning from theater. This division's tasks are to:

- (a) Manage PEG involvement in the Planning, Programming and Budget phases of PPBE.
- (b) Serve as the focal point for administration of the G-4 PPBE oversight responsibilities for coordination of the Army POM and Program Budget Review (PBR).
- (c) Prepare briefings to the PPBC, SRG, OSD, OMB, Congress, and other external organizations in support of the PEG programs.
- (d) Provide administration for the Sustaining PEG.
- (e) Maintain the resourcing database for the PEG (requirements, manpower and funding).
- (f) Maintain audit trail of resource changes from POM lock to President's Budget Submission.
- (g) Provide resource support during all phases of the PPBE.
- (h) Analyze requirements, evaluate funding positions, and recommend solutions for funding issues and assist in the justification of programs throughout the PPBE process.
- (i) Perform the G-4 programming for SS PEG programs.
- (j) Facilitate and validate the development of sound defensible program requirements during the POM/PBR.
- (k) Defend SS PEG requirements and funding, resolve PEG and Command manpower Schedule 8 issues, and articulate the PEG position on resourcing issues.
- (l) Serves as the G-4 central focal point for the management of the Resource Decision Documents (RDD).
- (m) Coordinate the distribution of RDDs to the G-4, ensure timely responses are provided to the ASA (FM&C), and orchestrate G-4 participation in Army Leadership meetings.
- (n) Formulate, justify, and defend logistics resource requirements for contingency operations.
- (o) Update the funding and requirements database for G-4, develop G-4 input into the Commanders' Narrative, and develop funding and manpower realignment for the Schedule 8 process.
- (p) Formulate and execute the internal G-4 budget (TDY, supplies, training).

(2) The Army G-48 Logistics Integration Division. This division's mission is to enhance logistics integration by analyzing costs, developing resourcing strategies, evaluating programs, and influencing resource requirements that are critical to meeting Army sustainment objectives. This division's tasks are to:

- (a) Administer the G-4 Management Control Program.
- (b) Serve as the G-4 representative for actions pertaining to the Capital Improvement Program (CIP).
- (c) Oversee AWCF - Supply Management obligation authority (OA) releases and execution; assist Army Budget Office (ABO) and AMC to resolve OA-related problems before adversely impacting readiness; monitor financial, inventory and readiness performance using comprehensive metrics.
- (d) Collaborate with the Army Budget Office (SAFM-BUR) and AMC (G-3, G-8); assist in all aspects of formulating, presenting, and justifying the AWCF-SMA budget to OSD, OMB and Congress.
- (e) Collaborate with ASA (ALT), ASA-FM&C (ODASA-CE), Army G-8, various program offices, and other stakeholders in the Army Cost Review Board (CRB); participate and represent G-4 in CRB working groups; prepare leadership to participate in CRBs.
- (f) Support ILS Division by analyzing cost analysis requirements descriptions (CARDs), program office estimates (POEs), and component cost analysis (CCA) documents; assisting in developing life cycle cost estimates (LCCs), and Army cost positions (ACPs) that reflect all costs necessary to develop, acquire, field, and sustain capabilities; integrating logistics requirements into all LCCs and ACPs.
- (g) Assist Army G-8 (PA&E) develop accurate affordability assessments that reflect LCCs;
- (h) Integrate logistics resource requirements across the appropriations and fiscal years; assess the availability of sufficient resources to meet readiness objectives throughout the life cycle.
- (i) Assess business case analysis (BCA), cost benefit analysis (CBA) and economic analysis (EA) documents; ensure logistics and resource integration to support decision making.
- (j) Collaborate with AMC, ASA (ALT), Army G-3, G-8, and other stakeholders; plan, organize, and conduct the

annual program budget review (PBR) and POM weapon system review (WSR); evaluate WSR results and out brief the SS-PEG Executive to integrate logistics and enhance PBR/POM processes.

(k) Support Army National Guard (ARNG)/U.S. Army Reserve (USAR) logistics requirements and programs; integrate ARNG logistics resource requirements in all aspects systems acquisition management and PBR/POM processes.

(l) Lead for the Financial Improvement Audit Readiness (FIAR) process.

(3) The Army G-48 Contracts Program Management Division. This division will provide Contract Management and Oversight for the Army G-4. It is responsible for all G-4 internal contracting and securing reliable logistics resources through efficient procurement, acquisition, and management oversight of contractor resources. This division will:

(a) Manage all G-4 contracts. Serve as the focal point for the G-4 in the review, analysis, and evaluation of new contract requirements and the administration of existing contracts.

(b) Be the entry point for all new, changed, or evolving contract policy, guidance.

(c) Disseminate relevant documents and information, obtain concurrence or recommended changes, integrate and evaluate input, resolve conflicts, and prepare guidance, as required, on contract issues and changes in contract guidance.

(d) Maintain Contract Database. Responsible for the review and update of information on a monthly basis with Directorates.

(e) Provide support to the G-4 Contracting Officer Technical Representatives (COTRs), and AOs in the overall development of the contract requirement package, e.g., development of the Performance Work Statement, Independent Government Cost Estimate, market research, and other required contract documents.

(f) Coordinate with various contracting commands or activities to obtain acquisition support services for G-4 requirements.

(g) Be responsible for tracking and reporting all contracts and contractors that support G-4 requirements.

(h) Serve as the focal point for the data collection for the documentation of Contractor Manpower Equivalents (CMEs). Responsible for the tracking and reporting of contractor to civilian conversions.

(i) Serve as the G-4 Contracting Officer's Representative. Provides training, oversight, and direction to G-4 COTRs and AOs, and program managers.

(j) Perform contract administration and the tracking and award of contract options.

(k) Coordinate resourcing issues on contract requirements. Track current year funding; validate Unfunded Requirements (UFRs) against proposed or existing contract requirements.

(l) Serve as the G-4 focal point for Inspection and Acceptance of deliverables and contractor invoices and resolves payment disputes with contractors, Defense Financial Accounting System (DFAS) and the assigned contracting activity.

(m) Prepare and maintains the G-4 Contract files in accordance with DA Regulations.

k. *Logistics Innovation Agency (LIA)*. The LIA mission is to provide innovative capabilities and solutions for future logistics. This Agency is responsible for:

(1) The Common Logistics Operating Environment (CLOE).

(2) Logistics Business Intelligence Tools.

(3) Create "Easy to use" software that enables an integrated user interface to an organization's disparate data providing meaningful information & analysis.

(4) Focused on G-4 metrics to help make good logistics policy & program decisions.

(5) Class IX retrograde; Supply Support Operations; Class VII visibility & readiness.

(6) Policy Support Tools.

(7) Enterprise Policy / Process Interactive Capability (EPIC).

(8) Collaborative Policy Process.

(9) Digitized Publications Management System (DPMS) Science and Technology.

## **12-7. AMC Mission: Title X and Executive Agent Responsibilities.**

Title 10, U.S. Code, Section 3013 lists 12 functions for which the Secretary of the Army is responsible. Of the 12, AMC has statutory responsibility for four of the functions: Supplying, Equipping (including research and development), Servicing, and Maintaining. More specifically, AMC's mission is to develop, deliver, and sustain materiel to ensure a dominant joint force capability for the United States and our allies. In short, AMC equips and sustains the Army as the Army's logistics integrator. AMC operates through its Major Subordinate Commands (MSCs) that execute core functions such as maintenance at depots and on installations, research and development, munitions production, storage, and demilitarization, maintaining logistics systems, contracting services, worldwide distribution, security assistance, and integration of Acquisition, Logistics, and Technology (ALT) worldwide.

a. AMC has approximately 70,000 civilian and military employees working in 50 states and 155 foreign countries. AMC has the responsibility for integrating Army logistics management information systems including the Global Combat Support System-Army (Field/Tactical) (GCSS-A (F/T)), which provides an integrated, evolutionary enterprise information system for combat service support (CSS) functions, and the Logistics Modernization Program (LMP)

## How the Army Runs

which modernizes national logistics processing. The Single Army Logistics Enterprise (SALE) supports logistics transformation through web-based information and decision support systems to produce more responsive and focused logistics support to the Soldier.

*b.* In accordance with Army Regulation 10–87, Army Commands, Army Service Component Commands, and Direct Reporting Units, the major components of the AMC mission are:

(1) Manage the Army’s logistics mobilization and contingency capability and capacity and maintains and stores a prescribed level of war reserve stocks.

(2) Provide integrated materiel life cycle management of systems and equipment in partnership with PEOs and program/project/product managers (PMs).

(3) Demonstrate advanced technologies leading to new and improved operational capabilities and facilitate technology transition and integration into current capabilities.

(4) The National-level sustainment maintenance process owner.

(5) Plan contingency contracting operations at the strategic and operational level and provide mission command of the contingency contracting mission.

(6) Provide equipment and services to other nations through the security assistance program.

(7) Manage and execute the Army’s Logistics Civil Augmentation Program (LOGCAP).

---

## U.S. Army Materiel Command

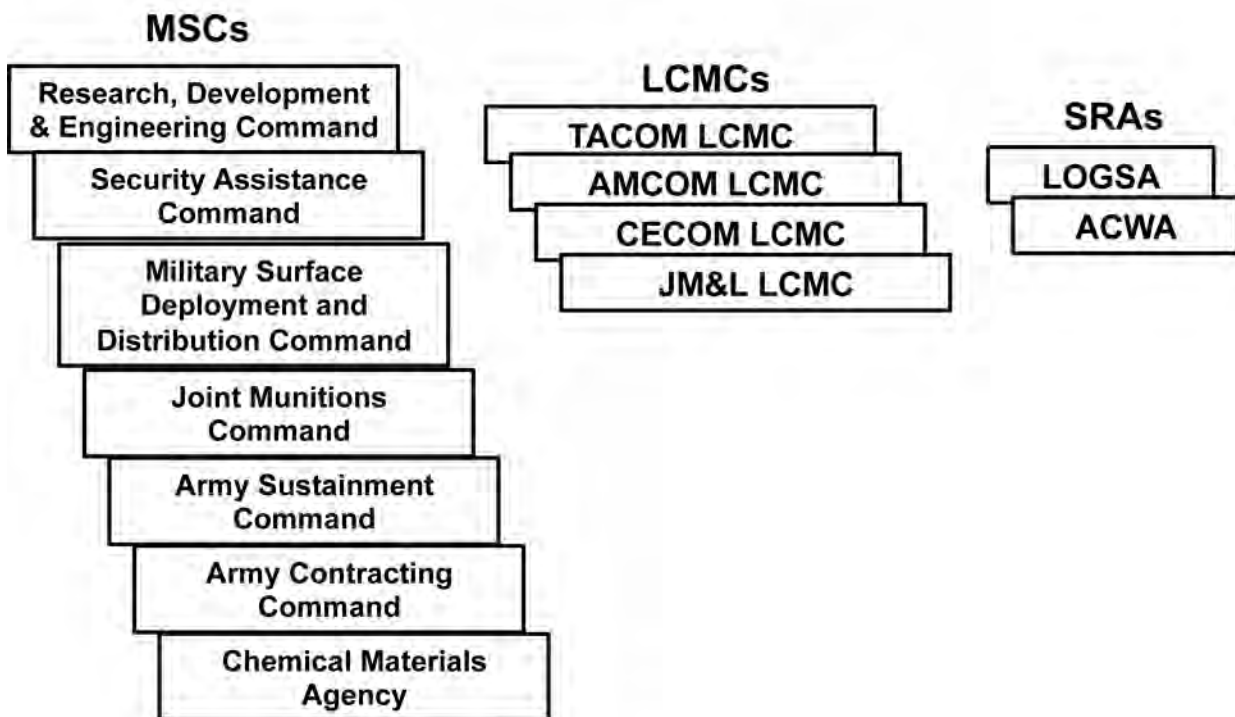

Figure 12–3. U.S. Army Materiel Command

---

# ARFORGEN

The structured progression of increased unit readiness over time, resulting in recurring periods of availability of trained, ready, and cohesive units prepared for operational deployment in support of civil authorities and combatant commander requirements.

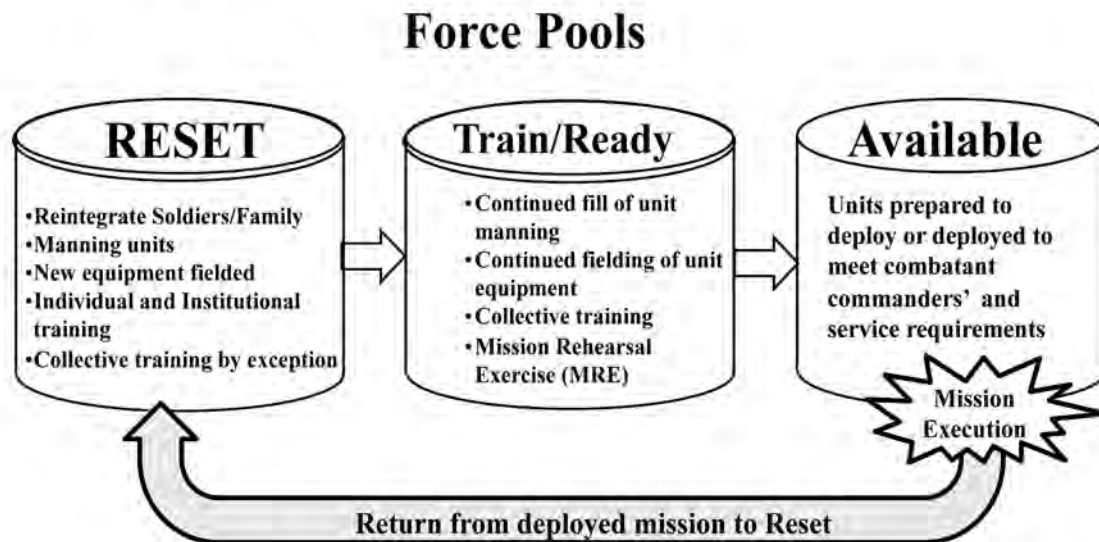

Figure 12-4. ARFORGEN

## 12-8. Maintaining the Force-Army Force Generation (ARFORGEN).

Army Force Generation is the structured progression of increased unit readiness over time, resulting in recurring periods of availability of trained, ready, and cohesive units prepared for operational deployment in support of civil authorities and combatant commander (COCOM) requirements.

a. ARFORGEN is the Army's core process for force generation, executed with supporting-to-supported relationships that cycles units through three force pools: RESET, Train/Ready, and Available. Each of the three force pools contains a balanced force capability to provide a sustained flow of forces for current commitments and to hedge against unexpected contingencies. ARFORGEN establishes the basis to plan and execute Army-wide unit resourcing.

(1) As a model, ARFORGEN supports the Army's Planning, Programming, Budgeting, and Execution process.

(2) As a process, it synchronizes the Army's efforts to provide land forces and other capabilities required by our Nation.

b. AMC's role in supporting ARFORGEN is to equip units and reset equipment in all three of ARFORGEN's phases. As the Executive Agent for equipment reset, AMC provides cyclic materiel readiness to meet rotational and contingency operational requirements.

c. AMC's objectives are to:

(1) Serve as the single Army integrator of logistics with Joint and strategic partners in the national sustainment base.

(2) Serve as the lead Army agent for sustainment-level Reset. Conduct installation maintenance activities during reconstitution and equipment Reset in partnership with Directorates of Logistics (DOLs) and Field Logistics Readiness Centers in support of ARFORGEN.

(3) Coordinate end-to-end distribution pipeline from national sustainment base to deployed forces.

(4) Execute sustainment logistics through integration of strategic partners, distribution and materiel management, DOLs, and contracted support.

## How the Army Runs

- (5) Provide technical assistance, technical oversight, and training to Army organizations concerning logistics functions.
- (6) Leverage automatic identification technologies/systems to manage ARFORGEN asset and material visibility, control retrograde of Class VII to maintenance activities, control cost, and provide management and leadership a view of the total force resource posture, condition, and location.
- d.* AMC is now shipping unit equipment directly from the Theater to our depots, alleviating the deployed unit's responsibility for maintenance and distribution of this equipment upon redeployment.
- e.* We're also sending AMC repair teams directly to installations to further ease unit reset requirements. In addition, to reduce the burden on our deploying units, AMC now secures and maintains left-behind equipment at the home station.
- f.* Support of Unit Mobilization/Deployment. The requirement to integrate sustainment and force projection operations is central to supporting ARFORGEN strategy and creates an environment that spans strategic (LCMCs), operational (Army Sustainment Command (ASC)), and tactical (Sustainment Brigade/Brigade Combat Team) logistics and processes.
- (1) This integrated effort across the National - Tactical echelons provides units in the ARFORGEN force pools freedom of action at the installation and power generation platforms to deploy and sustain operations.
- (2) The primary purpose of ASC assuming the role of the CONUS sustainment command was to achieve true logistics synergy. This allowed AMC to further leverage the capabilities of ASC and the LCMCs to support the in generating and projecting combat power.
- (3) ASC's desired outcome is to promote operational readiness of the CONUS Army force and to facilitate ARFORGEN. By attaining improved operational readiness through the partnering of efforts at the national sustainment base, AMC provides the with an enhanced planning flexibility and superior levels of logistics readiness.
- g.* The Industrial Base. The Army Industrial Base is the key element for long-term sustainment of Army weapons systems and is the heart of AMC sustainment. It is a conglomerate of five maintenance depots-Anniston (ANAD), Corpus Christi (CCAD), Letterkenny (LEAD), Red River (RRAD), and Tobyhanna (TYAD)-that are commodity-oriented and aligned with a LCMC directly responsible for their core workloads.
- (1) Aligned with TACOM LCMC is ANAD for overhaul of combat vehicles, artillery systems, bridge systems, small arms, and secondary components, and RRAD for certain light ground combat and tactical systems sustainment. RRAD is the only Army Rubber Plant for tracked vehicle components, and an ever-increasing tactical wheeled vehicle sustainment mission.
- (2) Aligned with AMCOM LCMC is CCAD for the overhaul, repair, modification, retrofit, testing and modernization of helicopters and their associated engines and components and LEAD for tactical missile systems, overhaul, and repair of power generation equipment, ground mobility equipment, Special Operations vehicles, certain tactical wheeled vehicle support, and Force Provider.
- (3) Aligned with CECOM LCMC is TYAD which provides total sustainment and integration of the full spectrum of DOD's critical Mission Command Networks and Systems, avionics, and Missile Guidance and Control Systems.
- h.* By acre, our smallest is just 158 acres, while our largest is some 18,316 acres. The three largest depots (ANAD, LEAD, and RRAD) have Munitions Centers for storage which requires considerable acreage. Although the depots were built during the World War II era, they have been continually facilitized, upgraded, and equipped to sustain not only the advanced systems of today but those planned for the future. Today, all of our depots have established partnerships with many of the original equipment manufacturers (OEMs) to ensure that we work together with industry to have better trained sustainers to support needs.
- i.* AMC has three arsenals (Rock Island (RIA), Watervliet (WVA), and Pine Bluff (PBA)) that comprise the manufacturing and maintenance centers on specific items of inventory not directly related to core workloads for the depots.
- (1) RIA's capabilities include a full purpose foundry, fabrication and welding of various metals, heat treating, and machining. In addition, RIA uses some 200 computer numerically-controlled machines and has 2 of 13 seven-axis machining centers in the world.
- (2) At WVA, capabilities include providing manufacturing, engineering, procurement, and product assurance for cannons, howitzers, mortars, and associated armaments of weapons systems. WVA is co-located with Benet Laboratories and is the Army's Center of Excellence for Large Caliber Cannon. Among its many capabilities, its rotary forging/heat treatment of large cylinders is unique. WVA is the nation's oldest, continuously active arsenal and was founded in 1813 to support the War of 1812.
- (3) PBA's mission includes ammunition production, chemical/biological defense production and repair, depot storage and surveillance, chemical weapons management and, provides homeland security support that includes first-responder equipment training and surveillance of prepositioned equipment.
- (4) Although there are other AMC activities with "arsenal" in their names, these have long since graduated from a production status but have historically retained their names.
- j.* AMC has other activities with "depot" in their names, but these are not considered the "hard iron" facilities of our industrial base. Instead, we see aspects of increasing roles dictated by transition.

(1) Within AMC, we have Chemical Depots-Umatilla, Deseret, Pueblo, Pine Bluff, Anniston, and Blue Grass-where AMC stores and demilitarizes chemical weapons. The end result is that some of these activities may eventually be closed as a result of BRAC decisions with property returned to either local community use or other DOD/AMC missions.

(2) Two unique “depots” within AMC are Sierra and Hawthorne.

(a) Sierra is a former ammunition storage and demilitarization location. It is rapidly becoming an Expeditionary Logistics Center with a strategic deployment platform capability, and is one of the Army’s main retrograde sites for equipment and other supplies returning from Southwest Asia.

(b) The other, Hawthorne, provides munitions and unit training for the Joint along with conventional ammunition maintenance and demilitarization, as well as high desert training for Special Operations and Conventional Forces. Hawthorne has also been designated as a long-term storage site of reused Industrial Plant Equipment.

k. AMC has identified its installations and activities as “*Army’s National Treasures*” for a purpose - it is a true description!

l. As Army transformation continues, transformation also takes place within AMC. We align our activities to not only achieve greater efficiencies but to configure ourselves to meet our new roles in supporting the individual Soldier, wherever the Soldier is located throughout the world. Since the Desert Shield/Desert Storm deployments in the early 1990’s, you will find AMC Industrial Base personnel alongside the providing sustainment support. Although we were there before, we were not there with the numbers and capabilities of today.

m. Reset National Level - Maintenance Depots. AMC’s maintenance depots perform national-level reset. The maintenance depots reset heavy and light combat vehicles at ANAD. Tactical wheeled vehicles and certain light combat vehicles are reset at RRAD. CCAD provides maintenance support for all aviation platforms. TYAD resets communications, electronics, and radar equipment. Finally, LEAD focuses on missiles and a limited number of tactical wheeled vehicles. The LCMCs contribute to national-level reset operations by providing work loading and ensuring repair parts availability.

n. Reset Field Level - Directorates of Logistics. Reset is a series of actions taken to restore unit equipment to a desired level of combat capability after returning from contingency operations. AMC accomplishes this through a mix of field-level maintenance, sustainment maintenance, and OEM maintenance support. The reset process brings unit equipment to full combat-ready condition, either for its next rotation in support of current operations or for other, unknown future contingencies. Reset actions include the repair of equipment, the replacement of equipment lost during operations, and the recapitalization of equipment where feasible and necessary.

o. Responsible Reset Task Force (R2TF). The R2TF is a provisional theater sustainment organization set in place to coordinate efforts in planning and executing timely retrograde, repair, redistribution, or disposal of non-consumable material and standard and non-standard equipment excess to USCENTCOM requirements. Responsible Reset is not synonymous with or limited to equipment reset of Class VII end items as defined in the ARFORGEN cycle, but rather encompasses an end-to-end process that begins with AMC assuming property accountability of material and equipment from redeploying units and ends with ultimate disposition-inventory replenishment, long-term storage, return to unit, FMS, or disposal. Responsible Reset is synchronized with the theater drawdown effort and the Army’s future force construct to optimize both the cost and time frame within which the ME regenerates the Army’s combat power. The establishment of R2TF is a key component in accomplishing the overall ME mission.



## R2TF – “Filling the Gap”

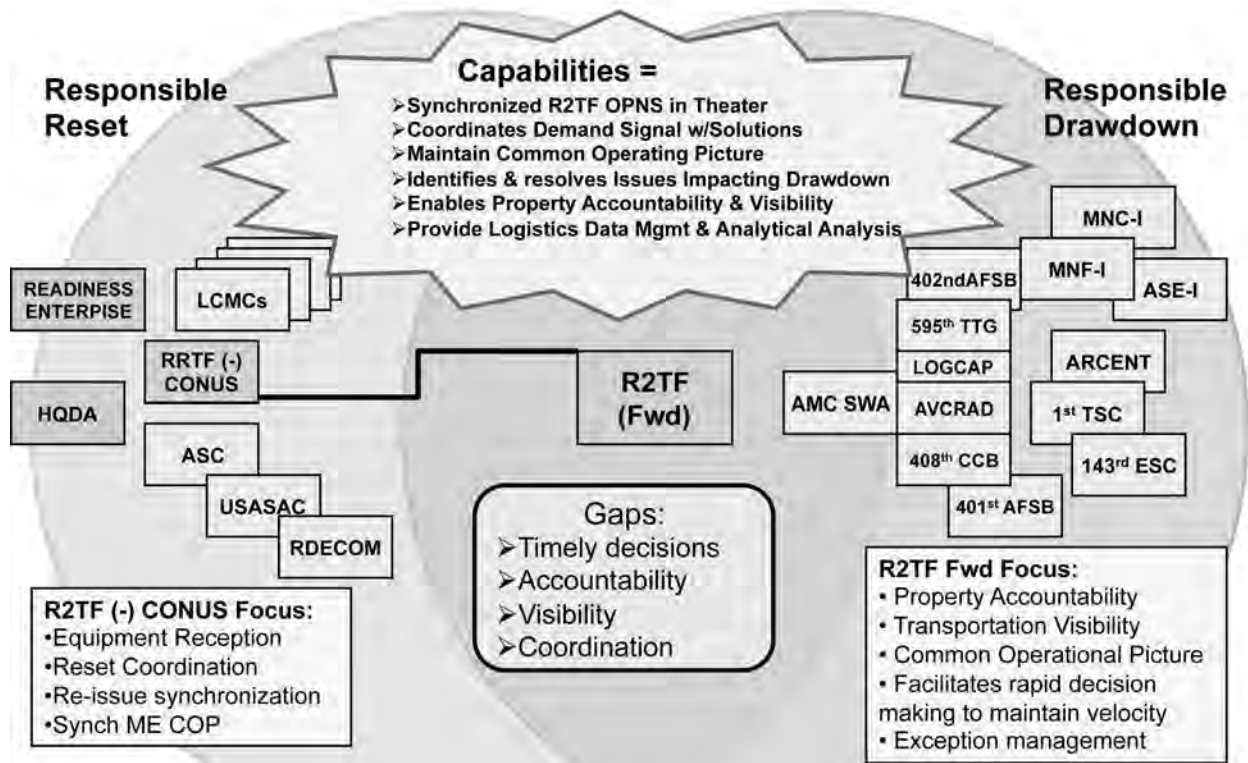

Figure 12-5. Responsible Reset Task Force (R2TF)

p. Reset Ammunition Production and Support. The mission of the Ammunition Enterprise (AE) is to execute integrated munitions and lethality systems life-cycle management through a team of world-class technology, acquisition, and logistics professionals who provide effective, available, and affordable munitions and lethality for the Joint .

(1) The Army is the DOD proponent for ammunition and in this role as the Single Manager for Conventional Ammunition (SMCA) produces all types of ammunition from small arms to 5,000 pound bombs. Our Joint Munitions Command (JMC) is responsible for the readiness and logistics management of the stockpile of conventional munitions valued in excess of \$35 billion. Our enterprise is comprised of three key players-JM&L LCMC that includes the Armament, Research, Development and Engineering Center (ARDEC); the Program Executive Officer for Ammunition, the SMCA Executor; and the JMC, the SMCA Field Operating Activity-and has over 30 strategic partnerships across DOD to help accomplish its mission.

(2) The JMC makes, manages, stores, transports, inspects, supports, and demilitarizes ammunition. This mission is accomplished through three depots (Tooele, Blue Grass, and Hawthorne) and 12 ammunition plants and centers supported by some 250 commercial producers across 45 states that include government-owned and government-operated plus government-owned and contractor-operated facilities. The enterprise produces over 1100 military items. As an example of the complexity of making ammunition, production of a single round of a 5.56mm cartridge for small arms requires components and raw materials from seven states in both government and commercial facilities. The more complex 120mm (M865) tank round has nine critical components, from nine producers located in nine states.

(3) The Ammunition Enterprise plays a significant role in supporting ARFORGEN through the preparation, transformation, reset, and sustainment of ammunition. Ammunition is one of a very few Army-managed items that are already in a Joint environment with Joint Service partnerships with the Office of the Executive Director for Conventional Ammunition (EDCA); the Single Manager for Conventional Ammunition (SMCA); the Joint Ordnance Commanders Group (JOCG); and the Joint Service Small Arms Program (JSSAP).

(4) The EDCA is located at Picatinny Arsenal, New Jersey, with the JM&L LCMC while the JMC is located at Rock Island Arsenal, Illinois.

## Defense Ammunition Center (DAC) Supports DOD/DA



Figure 12–6. Single Manager for Conventional Ammunition

*q.* Strategic storage. ASC is responsible for transferring equipment and materiel to s whenever and wherever required in support of the Army’s global power projection mission. The ASC Distribution Management Center (DMC) inherited the CONUS materiel management functions previously performed by Army Division and Corps Materiel Management Centers (DISCOM, COSCOM) upon Army transformation. During training and combat operations, ASC leverages the capabilities of APS located ashore and afloat. It maintains the readiness and accountability of the Army’s war reserve combat, combat support (CS), and CSS equipment and materiel globally prepositioned; this includes prepositioned sets, operational stocks, and sustainment stocks. ASC hands off APS, equipment, and materiel when and where required in support of the Army’s global power projection mission. It further reconstitutes APS upon completion of operations to prepare for future contingencies.

### 12–9. Theater Sustainment.

*a.* Army Sustainment Command (ASC)/Army Field Support Brigades (ASB). ASC is a global organization providing a single AMC face to the ASCC/COCOM during contingencies by exercising centralized mission command over AMC’s deployed support elements.

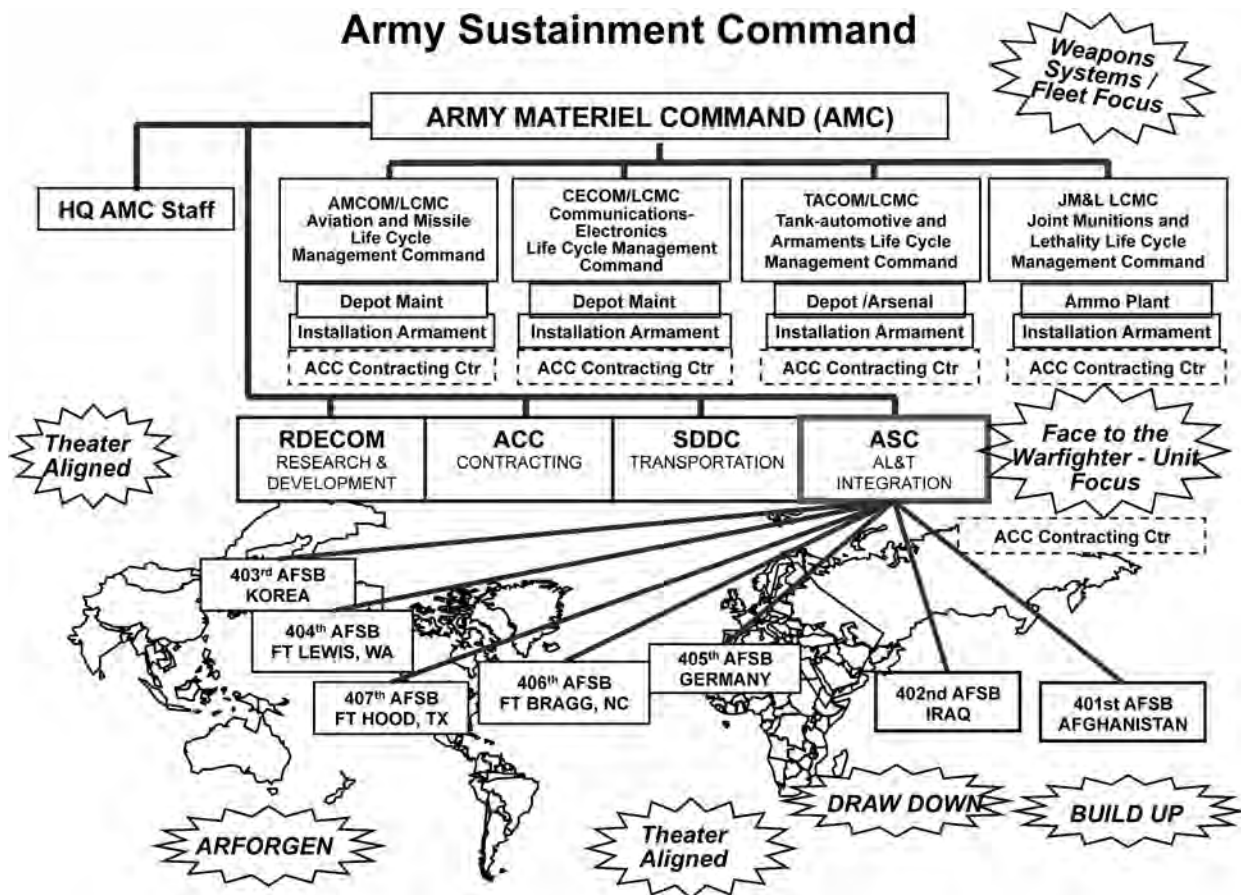

Figure 12-7. Army Sustainment Command

b. The primary mission is to enhance and sustain combat power through unified and integrated application of logistics power projection of OCONUS- and CONUS-based capabilities. During deployments and exercises, ASC provides general and direct support to combat units and deploys logistics assistance personnel in Army Field Support Battalions (AFSBN) and Brigade Logistics Support Teams (BLSTs) near forward areas. To exercise mission command, ASC has both Theater committed and deployable Army Field Support Brigades (AFSBs).

c. The AFSB integrates and coordinates ALT capabilities and addresses the need to deploy, employ, sustain, and redeploy those capabilities seamlessly from the National sustainment base to the . It is a combination of TOE, Augmentation TDA, and Contingency TDA organizations, which is capable of split-based operations in support of full spectrum operations.

d. The AFSB synchronizes deployable capabilities of its TOE and TDA organizations, which include capability plugs such as contingency contracting, accountability and deployment of contractors on the battlefield, and Life-cycle Management. The AFSB may deploy an AFSBN given METT-TC when deployed in the area of responsibility during simultaneous operations. These AFSBs have ALT capabilities across a theater. There are seven active AFSBs:

- (1) 401<sup>st</sup> AFSB—Southwest Asia
- (2) 402<sup>nd</sup> AFSB—Iraq
- (3) 403<sup>rd</sup> AFSB—Korea
- (4) 404<sup>th</sup> AFSB—Fort Lewis, Washington
- (5) 405<sup>th</sup> AFSB—Germany
- (6) 406<sup>th</sup> AFSB—Fort Bragg, North Carolina
- (7) 407<sup>th</sup> AFSB—Fort Hood, Texas

e. The AFSBs are organized with subordinate AFSBN and Logistics Support Elements (LSE). A deployed AFSB provides resources to fill gaps in functions where deployed military units may need technical or logistics assistance (e. g., ALT, maintenance support, supply support, etc.). The footprint of the AFSB in an area of operation is based on

METT-TC and the desires of the ASCC/COCOM. With the use of LOGCAP, which is coordinated by the AFSB, the AFSB can provide oversight of assigned logistics support assets. The AFSB can function in a variety of scenarios ranging from a hostile environment, such as Operation Enduring Freedom, to other contingency operations such as disaster and humanitarian relief-the cleanup in Louisiana and Mississippi after Hurricane Katrina. AFSBs also help the Joint Force Commander (JFC) plan AMC support across the full spectrum of operations. In the event of surge requirements, AMC has a rapidly deployable pool of highly skilled technicians available to augment AFSBs with additional capability. In addition to its military and DA civilians, the AFSB can call forward contractor personnel to augment the Army's force structure. The AFSBn possesses reach-back capability to the AFSB and/or the National sustainment base. The AFSBn is further sub-divided into Brigade Logistics Support Teams (BLSTs), which provide logistics liaison support to BCTs, and Logistics Support Elements (LSEs), which support Division and Corps Headquarters and other brigades, such as the Battlefield Surveillance Brigade, Sustainment Brigade, Maneuver Enhancement Brigade, and Fires Brigade. Additionally, AFSBns support APS locations and specific sustainment missions in Southwest Asia.

*f.* Logistics Civil Augmentation Program (LOGCAP). ASC serves as the LOGCAP Program Manager and uses contractor assets to augment support to units in the field. LOGCAP is a commercial acquisition program designed to plan contractor logistics services for operations by leveraging commercial contractors' global corporate assets. LOGCAP complements and augments the Army's force structure and is accounted for in Army force structure as Component ("COMPO") 9. LOGCAP replaces capabilities no longer in the force structure, providing the JFC, through his ASCC, with valuable logistics capabilities.

*g.* Army Contracting Command (ACC). The ACC, a Major Subordinate Command of AMC, provides global contracting support to s through the full spectrum of military operations. The ACC was provisionally established in February 2008, and reached full operational capability in October 2009, creating a one-of-a-kind organization responsible for the majority of Army contracting support. The ACC is comprised of two subordinate commands and seven major contracting centers, and its headquarters is collocated with AMC Headquarters. The Mission and Installation Contracting Command supports CONUS installations and provides everything except weapons systems and related support that are purchased at specialized contracting centers. The Expeditionary Contracting Command supports forward deployed forces and OCONUS installations through its seven subordinate Contracting Support Brigades. It is the primary provider of Army contracting services to forward deployed and stationed forces. ACC's seven major contracting centers support AMC's other MSCs and LCMCs. On 19 January 2011, ACC formally renamed its contracting centers to brand and standardize the naming convention, incorporating the geographical locations of the centers in their new names. The new names are:

- (1) Army Contracting Command - Aberdeen Proving Ground (Mission Command Networks and Systems)
- (2) Army Contracting Command - Aberdeen Proving Ground (Soldier, Chemical, Research, and Test)
- (3) Army Contracting Command - National Capital Region
- (4) Army Contracting Command - Picatinny
- (5) Army Contracting Command - Redstone
- (6) Army Contracting Command - Rock Island
- (7) Army Contracting Command - Warren.

*h.* If a Soldier shoots it, drives it, flies it, communicates with it, wears it, or eats it, ACC contracts for it.

*i.* Military Surface Deployment and Distribution Command (SDDC). SDDC provides global surface transportation and traffic management services to meet National Security objectives in peace and war. In supporting the , SDDC's mission is to deliver personnel, equipment, and sustainment on time, providing seamless support from Fort to Forward Operating Base. SDDC has a global presence represented by five Transportation Brigades with units stationed in 31 locations worldwide. SDDC became a MSC of AMC effective 16 October 2006 and remains an ASCC of USTRANSCOM. SDDC acts as liaison between government shippers and commercial carriers. SDDC is responsible for the establishment and maintenance of contracts, solicitations, and agreements with the carrier industry to deploy and distribute DOD supplies, personal property, and personnel worldwide. Additionally, SDDC maintains contracts with information technology firms to assist in the development of software applications to manage transportation movements, as necessary.

*j.* Army War Reserve Sustainment (AWRS). AWRS stocks are acquired by the AMC LCMCs in peacetime (based on direction and guidance from HQDA and the COCOMs) and held to meet the Army's increased wartime sustainment requirements until re-supply at wartime rates or emergency rates are established. This requirement is determined by a computer model that deploys forces on a time-phased deployment schedule, utilizing a specified scenario and applying predetermined inter-theater and intra-theater attrition factors. It should be noted that sustainment stocks are reduced by an amount equal to initial issue quantity left behind by units that deploy OCONUS and draw APS. AWRS for Allies is a DOD-directed program to assist designated allies in case of war. Computed quantities are included in this component of the gross requirement. The ASC, through its AFSBs, maintains the AWRS stocks and issues them to meet wartime requirements.

*k.* Army Maintenance Regeneration Enablers (maintenance floats). The maintenance system requires that additional equipment be available for issue while repair and maintenance of unit equipment is being performed. These are called

“floats.” Three types of floats are included in this component of the Army Acquisition Objective: the Operational Readiness Float (ORF) for unit and intermediate levels of maintenance, the Ready To Fight (RTF) vehicles for battle damage replacement comprised of vehicles that have all components installed prior to issue (such as Mission Command Networks and Systems) and are mission capable to be introduced into combat, and the Tactical Computer Exchange (TCE) float for Army Mission Command Systems. Overall management of these floats rests with the appropriate AMC LCMC.

### 12–10. Supporting Acquisition.

*a.* Engineering support. The mission of the Research, Development and Engineering Command (RDECOM) is to empower, unburden and protect the to enable dominance of the Army through technology. RDECOM’s goal is to accelerate the pace of transition from concept to fielding, improve integration across AMC, and to enhance technical agility. RDECOM promotes and facilitates coordination and agility to stay ahead of ever-changing technological advances. RDECOM vastly expands working relationships with Army elements, industry, academia, military services, government agencies, and international partners by focusing on improving management, coordination and integration of research, development and engineering. RDECOM, headquartered at Aberdeen Proving Ground, Maryland, became an AMC MSC on 1 March 2004, consolidating the Army’s core research, development and engineering capabilities under one organization. RDECOM combines AMC’s laboratories and Research, Development and Engineering Centers (RDECs) into one command. The command has established memoranda of understanding with TRADOC and the U.S. Army Test and Evaluation Command (ATEC) to increase coordination between these commands and the Army’s Science and Technology community. RDECOM’s technology expertise, analytical capabilities, and unparalleled collaboration with academia and industry provide cutting edge technology to s in all services. The RDECOM Forensic Cell ensures sharing of information throughout DOD and with other federal agencies that support the development of new systems that detect and defeat radio-controlled Improvised Explosive Devices (IEDs). RDECOM conducts jammer development and modification, develops surrogate IEDs for countermeasure system testing, training, and demonstrations. Forensics can also provide information that helps identify and locate insurgents and terrorists, as well as providing important information about adversary capabilities against all types of challenges.

*b.* Integrated Logistics Support - Modernization. Throughout the development of new weapons systems, significance is placed on sustainment of the individual systems with close coordination between the developers at every level of life-cycle management and our LCMCs. The end result is the development of a Supportability Strategy that is a coordinated effort by ASA (ALT), RDECOM, and AMC that starts with the basic design and ends in the hands of the Soldier. In general, ILS plans and directs the identification and development of logistics support and systems requirements for military systems, with the goal of creating systems that last longer and require less support, thereby reducing costs and increasing return on investments. ILS continues throughout the operational life cycle of the system. The impact of ILS is often measured in terms of Performance Based Logistics metrics such as operational reliability, operational availability, cost per unit usage, and logistic footprint and logistics response time. ILS has been categorized into the following elements:

- (1) Maintenance planning.
- (2) Supply (spare part) support/acquisition resources.
- (3) Support and Test Equipment/Equipment Support.
- (4) Manpower and Personnel.
- (5) Training and Training Support.
- (6) Technical Data/Publications.
- (7) Computer Resources Support.
- (8) Facilities.
- (9) Packaging, Handling, Storage, and Transportation.
- (10) Design Influence/Interface

*c.* All elements of ILS are ideally developed in coordination with the systems engineering effort and with each other. There will be times when “trade-offs” may be required between elements to acquire a system that is affordable, operable, supportable, sustainable, transportable, and environmentally sound. Planning for a system’s ILS is contained in a Supportability Strategy and coincides with the development of the system acquisition strategy which allows the program to be tailored accordingly. The true measure of ILS is not just in the performance of a system, but also in its sustainability and overall readiness.

*d.* Integrated Materiel Management Centers (IMMC). The LCMC is the logistics structure that incorporates activities and processes across multiple organizations to form a system of mutually dependant activities that provide warfighting capability to Soldiers as well as other allied forces using U.S. Army weapons systems. The IMMC mission is to *partner* with PEOs/PMs, s, and industry to develop, acquire, field, and *sustain* worldwide logistics support to ensure the Army’s weapons systems’ readiness in any operation. It provides centralized, integrated materiel management for all weapons systems and support equipment. In this role, it performs a variety of functions related to major and secondary item management, including inventory control, distribution management, depot-level maintenance planning and direction, and computation of worldwide requirements and centralized procurement direction. In addition, the

IMMC establishes policy and provides maintenance management guidance and direction for maintenance support planning and logistics engineering activities, to include developing maintenance concepts and procedures, maintenance engineering support, and equipment publications. In short, the IMMC is one of those essential elements involved in life-cycle management and is a readiness enhancement to all weapons systems throughout their life cycle.

*e.* Foreign Military Sales (FMS). The U.S. Army Security Assistance Command (USASAC) is headquartered at Redstone Arsenal, Alabama, and traces its origins to the Army's technical service era. It was designated a MSC of AMC in 1975. The mission of USASAC is to implement approved U.S. Army security assistance programs, including FMS of defense articles and services to eligible foreign governments. USASAC is responsible for life-cycle management of FMS cases from development to execution, including financial management, accounting, and settlement. The Command manages approximately 4,000 FMS cases. USASAC also manages the Army's co-production programs where we partner with other countries to produce U.S. Army specification equipment. In addition, USASAC is responsible for Army security assistance information management and financial policy, and provides logistics guidance to the Army security assistance community. The Command is increasingly responding to support of U.S. government emergency assistance, humanitarian relief, and operations other than war, including United Nations peacekeeping operations. Security assistance is a national program administered by the Department of State. In conjunction with the White House, Congress, and the Treasury Department, Army military security assistance programs are executed by USASAC and AMC. Security assistance promotes regional stability, deters aggression, maintains alliances, and disseminates democratic values between the United States and its allies. In carrying out the Army security assistance mission, USASAC—"The Army's Face to the World"—calls on all AMC's commands, as well as other DOD agencies and U.S. industry for support. Each sale of equipment to overseas customers comprises the same "total package" of quality materiel, spare parts, training, publications, technical documentation, maintenance support, and other services that AMC provides to U.S. Army units.

### **12-11. AMC: Changing to Satisfy Future Requirements.**

AMC is an adaptive organization responding to various critical factors: our new national security environment of persistent conflict, an era of constrained resources, and a time of rapidly evolving technology. To address these, AMC has undertaken several initiatives to successfully develop and execute management of the Army's materiel life cycle. Specifically, AMC is implementing SALE and its National-level component, LMP, and is ensuring integration with the tactical-level component, GCSS-A. AMC is also partnering with Installation Management Command (IMCOM) to transfer the installation DOLs and their materiel enterprise functions of supply, ammunition, maintenance, and transportation to AMC's ASC effective 1 October 2012. At the same time, AMC is partnering with IMCOM to transfer typical garrison Services and Infrastructure Enterprise functions, such as Department of Public Works activities, to IMCOM; AMC and IMCOM are currently conducting pilots at four installations to test the concept. Two other vital IT initiatives under development are the Logistics Information Warehouse (LIW) and Condition Based Maintenance-Plus (CBM+). These initiatives will help AMC optimize resources, increase our capabilities, and minimize our security and business risks.

*a.* Supporting Army Institutional Adaptation. AMC is a key member of the Materiel Enterprise (ME), which is a collaboration of all logistics stakeholders involved in providing materiel solutions for our Soldiers. The ME itself is not an organization; however, it incorporates all of the functions of the materiel life cycle to include research, development, acquisition, testing, distribution, supply, maintenance, industrial base operations and disposal. The ME encompasses both the strategic and operational levels. ME processes are based on collaboration and include top-level forums established and chaired by the ASA(ALT), with the CG AMC as the senior military representative. The five ME forums are:

(1) The Materiel Enterprise Executive Forum (MEEF) is the senior collaboration event that focuses on strategic direction and priorities, horizontal coordination, and identification and forwarding of recommendations for the reallocation of resources.

(2) The Materiel Enterprise Collaboration Counsel (MECC) meets to assess enterprise activities to ensure integration and synchronization of actions with the other core enterprises.

(3) The Materiel Enterprise Strategic Reviews (MESR) are commodity-based forums, hosted by each of the four Materiel Enterprise commodity teams that focus discussion on commodity-related issues.

(4) Materiel, Acquisition, Logistics and Technology Reviews (MALT-R) are acquisition-based forums that focus on strategic level acquisition, logistics, and technology issues that affect the entire ME.

(5) Industrial Base Reviews are held periodically to address specific issues related to arsenals, depots, and other facilities. These forums have enabled the ME to develop action plans for improvements, implement efficiencies, and cost reductions, and improve enterprise decision-making by identifying opportunities, risks, and mitigations within the enterprise.

*b.* Adapting the Enterprise Network.

(1) Single Army Logistics Enterprise. The three primary components of SALE are:

(a) GCSS-A (F/T) that provides an integrated, evolutionary enterprise information system for tactical Army CSS functions.

## How the Army Runs

(b) LMP that modernizes national logistics processing.

(c) Army Enterprise System Integration Program (AESIP) which manages and syndicates master data in support of the Army's business systems.

(2) The Logistics Enterprise Vision for the Future Force is an integrated digital environment stretching end-to-end that enables generating, building, and sustaining warfighting capability through a fully integrated logistics enterprise based on collaborative planning, knowledge management, and best business practices.

(a) Within SALE, logistics, financial, acquisition, and product data will be integrated in a modernized environment, which operates in a near seamless fashion across the ACOMs/ASCCs, the Services, DOD, and industry, drawing on the best business practices and technology.

(b) Implementation of SALE simplifies and standardizes operations, resulting in improved decision-making while conserving scarce resources via shared data at multiple levels. The SALE will extend from small unit level (Shop Stock, Property Book, Unit Maintenance, etc.) through the Army's national level. Further, it must work in unison with DLA, industry, the Joint warfighting community, and coalition partners. The SALE will enable our current and future forces to be capable of working concurrently in all environments. When fully implemented, SALE will provide commanders and staffs with common integrated business processes with a view of the entire Army logistics value chain from the national sustainment base end-to-end to the tactical support levels.

(3) Logistics Modernization Program. The LMP is the national-level component of the SALE. It replaces the national logistics functions formerly supported by the Commodity Command Standard System (CCSS), the Standard Depot System (SDS), and other select current systems and applications. Within an integrated business and data Enterprise Resource Planning (ERP) environment, mechanisms for identifying and fostering the use of best commercial and Government practices in data definition and data sharing are important capabilities.

(4) Logistics Information Warehouse (LIW) Developments. AMC's Logistics Support Activity (LOGSA) developed and is responsible for LIW, a logistics domain strategy providing Army-wide authoritative data warehousing and sourcing of Army logistics information and emerging Enterprise Resource Planning (ERP) data for critical, strategic business analytics and business intelligence for today's mission planners.

(a) The LIW supports the Army G-4 vision of a joint-capable logistics community that maintains a domain-wide visibility of requirements and capabilities to sustain current operations and enable the transformation necessary to support future requirements.

(b) It conforms to a second priority (Logistics Automation) by providing National-level asset, maintenance, supply chain, financial, and total cost of ownership visibility. It further enables visibility of and resulting metrics for critical logistics components enabling critical strategic analytics to be performed in support of the materiel enterprise. LOGSA is developing the proposed materiel distribution process automation capability to support a future Lead Materiel Integrator effort. By adding scheduled deliveries of new procurement to the current robust inventory of Army-owned assets, the LIW will enable further visibility and insights to a total life-cycle view of Army materiel. By continually striving to improve the quality, authority, accessibility, and utility of information for the logistics community, LOGSA intends to be the Army's preeminent provider of logistics intelligence, policy, and customer support ensuring 's dominance on current and future Battlefields.

c. Adapting Our Institutional Processes and Capabilities. AMC is committed to providing faster, more responsive and more comprehensive materiel solutions through continuous transformation. By adapting the institution and focusing on our core competencies, AMC is generating significant efficiencies and redirecting limited resources to more critical mission requirements.

(1) Fleet Management Expanded. In collaboration with TRADOC, AMC established the Fleet Management Expanded (FMX) program, under which AMC maintains and sustains more than 100,000 pieces of training-base equipment, from helicopters and tracked vehicles to night-vision goggles. This allows our TRADOC partners to focus on their core competency: training. By employing AMC's maintenance expertise, the FMX program has increased ground and aviation systems operational readiness rates from 87 percent to 95 percent and 42 percent to 73 percent, respectively. At the U.S. Army Armor School alone, AMC maintainers were able to free up enough tanks to equip an additional battalion.

(2) Directorates of Logistics Realignment. On 6 March 2009, the AMC Commander, in coordination with the IMCOM Commander, agreed to work the full transfer of the DOLs from IMCOM to AMC. This transition achieves alignment both vertically and horizontally, and internally and externally to ensure execution of stakeholder and Army priorities in support of national security objectives. End state is a leaner, more streamlined and efficient ARFORGEN logistics support operation focused on deployment, reset, and re-deployment of units and other tenants on installations. Although the transfer of DOLs to AMC will not be fully complete until the end of FY11, the results are already dramatic. AMC has been able to standardize contracting practices, reduce or eliminate redundancies, and return more than \$100 million worth of parts to the wholesale system while improving support to installation customers.

(3) Special Installations. In continuing to align competencies on installations, AMC and IMCOM are working together to transfer installation management of 21 AMC special installations that conduct industrial missions. When complete, AMC commanders will be more focused on industrial operations while IMCOM applies its expertise to reduce costs and increase the efficiency of our installation operations

(4) Condition-Based Maintenance - Plus. The CBM+ is a DOD proactive equipment maintenance capability that uses system health indications to identify and predict functional failure in advance of the event and provide the ability to take appropriate action. CBM+ is based on a set of rigorously-defined maintenance tasks derived from Reliability Centered Maintenance (RCM) analysis. The fundamental building blocks in the development of CBM+ capability are: collecting data on the platform, moving data off the platform, storing data in a data warehouse, analyzing the data, and acting on the data. These processes are described in detail in concept documents, such as the Common Logistics Operating Environment Operational Concept Descriptions, that were collaboratively developed by materiel and combat developers and the Army G-4. These documents detail the process of collecting essential logistics data from digitized platforms/systems and passing it to key information collection and decision-making nodes within the unit or BCT. The concept of CBM+ supports the evolution of condition-based maintenance from diagnostics to predictive maintenance, with some key systems advancing to prognostic capabilities. The "plus" strategy expands condition-based maintenance to include task enablers and related technologies and processes not necessarily included in current maintenance programs. The ultimate goal of CBM+ is to increase operational availability and readiness throughout the weapons systems' life cycle. CBM+ supports not only the transition to a RCM strategy, but also provides the automation needed to improve maintenance productivity, reduce the deployed footprint required to provide maintenance services to combat units, and provide visibility of equipment status needed to implement anticipatory logistics concepts to support the Soldier by generating and sustaining combat power. Initial field experience, supported by models and simulations, indicates CBM+ equipped platforms typically experience an increase in readiness in the five percent range. CBM+ capability will enable our Soldiers to be more productive, reduce maintenance services and provide visibility of equipment status needed to implement anticipatory logistics concepts. Maintenance tasks can be preventive, (i.e., scheduled in response to accumulation of specified calendar time intervals or operating hours or mileage). These tasks can be condition-based, meaning they can be dynamically scheduled based on the detection of a specified deterioration or operating condition.

*d.* Summary. The Army has been at war for nearly a decade, and AMC has been there every step of the way. From the continental United States to combat and from the factory to the foxhole, AMC's global efforts are laying the foundation for a joint force that is streamlined, affordable, adaptable, and responsive. Relying on the dedication of our Soldiers and civilians, AMC remains the premier provider of materiel readiness, technology, acquisition support, logistics power projection, and sustainment for our nation's s, giving them the decisive edge they need to win the fight we're in while transforming for the fight we face tomorrow.

### Section III

#### National logistics organization: other

#### 12-12. Other Logistics-related organizations

*a.* U.S. Army Corps of Engineers (USACE). Designated a Direct Reporting Unit (DRU), the USACE plays a major role in the Army logistics system to include the Army's responsibility in supporting joint operations. USACE performs MILCON, installation support, real estate, R&D, and civil works missions. It provides an organizational structure for rapid conversion of its resources to support general war and other national emergency conditions. The six components of the USACE mission are:

(1) Manage and execute engineering, construction, and real estate programs for the U.S. Army and Air Force and perform R&D in support of these programs.

(2) Manage and execute installation support programs for Army installations.

(3) Manage and execute civil works programs, including the design, planning, engineering, construction, and R&D functions in support of this program.

(4) Perform R&D through non-system-specific advanced development in systems, specialized equipment, procedures, and techniques relevant to engineer support of combat operations.

(5) Develop and maintain a capability to mobilize readily in response to national security emergencies, domestic emergencies, and emergency water planning programs.

(6) Develop technology, and design and construct facilities and structures in support of Army space initiatives.

*b.* TRADOC manages all individual schooling; formulates concepts, doctrine, organization, and materiel objectives and requirements for Army forces in CONUS and OCONUS; and develops and promulgates doctrine for CSS that includes the user, DS, and GS logistics. U.S. Army CASCOM, a subordinate command of TRADOC, has the mission to develop, test, integrate, and disseminate CSS doctrine and systems for CONUS Army installations and for forces deployed OCONUS. CASCOM transformed into the Sustainment Center of Excellence (COE) in September 2009. The major functions performed by CASCOM are:

(1) It develops and evaluates CSS concepts, doctrine, organizations, systems, and materiel concepts and requirements, and planning factors for the Army and in concert with joint logistics doctrine.

(2) It ensures the personnel service support, supply, maintenance, transportation, services, and facilities systems designed for the Army in the field and the CONUS-based theater logistics systems are compatible with the sustaining base system.



## How the Army Runs

(3) It acts as TRADOC proponent for CSS training and monitors and evaluates CSS training at TRADOC schools.

(4) It ensures CSS course content is consistent with approved doctrine.

(5) It assesses the training evaluation process at associated schools.

(6) It conducts CSS exercises and manages the development of CSS training materials for AC and Reserve Component (RC) units.

(7) It serves as a principal adviser to DA, TRADOC, and AMC on all CSS matters.

(8) It provides direction, guidance, and tasks to assigned combat development activities, associated schools, other Army ACOMs, and HQDA staff agencies for their contribution to CSS development and training.

*c.* FORSCOM is responsible for the administrative control of all Army forces in CONUS.

*d.* Army Service Component Commander (ASCC). Logistics in a theater of operations is tailored to support the JFC's requirements for each situation. Consideration is given to the variety of missions, which tend to make each logistics requirement different in terms of amounts and types of supplies, maintenance, transportation, and services needed. Consequently, organizations are tailored to each theater to cover a full spectrum of possibilities ranging from a large theater of operations comprised of one or more corps to support levels required by a division or separate brigade. The ASCC is responsible for providing administrative control (that includes logistics support) to all Army units and contractors in the theater. This responsibility is executed through one or more subordinate theater sustainment commands (TSC) or a functional command such as personnel, transportation, medical, or engineer commands. The Army commander manages theater logistics support by establishing broad policies, allocating critical supplies, and assigning missions in concert with the JFC's guidance. Additionally, the Army theater commander manages and controls supply, maintenance, and other logistics services through the TSC and provides for centralized movements control for U.S. Army forces through the Theater Movement Control Agency (TMCA).

*e.* SDDC, an AMC MSC (ADCON), is the DOD single surface traffic manager and provides traffic management, transportation engineering and common-user surface terminal services to all DOD customers and contractors. As a jointly staffed land component command of USTRANSCOM, SDDC's primary mission is executing the nation's military strategic mobility. In this capacity, it ensures the safe, secure, and economical worldwide movement of DOD units, personnel, and materiel. It is also responsible for the movement of personal property for Service members, DOD civilians, and other government agency members, manages the contract for commercial bus, federal rental cars, and the Army's commercial travel program; and assists the GSA in management of the city-pairs airfare program. To accomplish its role, SDDC is developing and fielding a number of information systems dedicated to the improvement of global transportation. These include the Transportation Coordinator - Automated Command and Control Information System (TC-ACCIS), which provides automation of Army user-unit deployments and peacetime transportation functions at U.S. and OCONUS mobilization stations. Global Freight Management (GFM) System provides automated electronic data interchange (EDI) / electronic commerce (EC) for the managing, rating, and routing of DOD freight movements within CONUS. It increases the efficiency and accuracy of general cargo government bill of lading (GBL) preparation. The Worldwide Ports System (WPS) supports SDDC's terminal management and cargo documentation mission during peace and war. The Strategic Deployment System (STRADS) is SDDC's mission command system for peacetime planning and wartime execution support. The Transportation Operational Personal Property Standard System (TOPS) automates and standardizes the personal property movement, storage, and management functions at DOD transportation offices worldwide. SDDC Transportation Engineering Agency provides the scientific engineering and transportation expertise to analyze and improve the transportability of military equipment, the deployability of Army units, and the effectiveness of the DOD transportation programs for national defense. The Army Theater Sustainment Command (TSC) is a subordinate command and normally falls under the ASCC. Across the full spectrum of military operations, the TSC provides direct and general supply and maintenance support to all theater units and sometimes forward to include EAC units, joint elements, allied forces, and units passing through the AOR. The Army Sustainment Brigade (SusBde) provides maintenance, supply, transportation, health services, and field services support to the Army corps' and/or divisions. Within the corps AO, non-divisional units receive supply and maintenance support from the SusBde. Additionally, the SusBde provides backup and GS to the BCTs and support brigades. The SusBde Support Operations Section provides functional materiel management and movement control to include the major tasks of managing the supply, maintenance, and transportation functions. The legacy division support commands (DISCOMs) functions and operations have been dispersed to the Sustainment Brigades and Brigade Support Battalions of the BCTs.

*f.* Army and Air Force Exchange Service (AAFES). AAFES is the provider of supply Class VI (personal demand items) for the Army and Air Force. It is a joint command of the Departments of the Army and Air Force. The AAFES commander is a general officer responsible to the AAFES Board of Directors (BOD). In turn, the BOD is responsible to the Secretaries of the Army and Air Force through their respective chiefs of staff. The chairmanship of the BOD alternates between the two Services approximately every three years. The AAFES positions of commander and vice commander alternate between the Army and the Air Force. Primarily a civilian-run organization under military leadership, AAFES employs about 52,400 people, and operates approximately 1,500 facilities worldwide. AAFES worldwide headquarters is located in Dallas, Texas and two subordinate headquarters manage operations within the Europe and Pacific Regions. The mission of AAFES is to provide merchandise and services of necessity and convenience to authorized patrons at uniformly low prices, and to generate funds to supplement appropriated funds

(APFs) for the support of MWR programs. AAFES does this in peace and wartime. To accomplish its mission, AAFES:

(1) Operates retail, food, personal service, vending centers, theaters, automotive facilities, Army military clothing sales stores, on military installations,

(2) Provides basic exchange support to military personnel engaged in contingency operations or field exercises by establishing military-run tactical field exchanges (TFEs) where regular AAFES operations are not possible. Class VI support in the field can be limited to basic health and hygiene needs or expanded to include food, beverages, and other comfort items based upon the requested needs of the theater commander,

(3) Generates earnings that support MWR programs. AAFES pays dividends to the Army, which in turn allocates funds to specific MWR programs on installations. The Army MWR BOD, which is formed under the Army Community and Family Support Center (CFSC), controls the allocation of AAFES-generated MWR funds within the Army.

g. GSA. The GSA provides general supplies and services that are common to more than one department of the Government. The GSA has multi-mission responsibility to manage the varied business activities of the Federal Government. GSA provides an extensive amount of supply support to the DOD for such commonly used items as leased commercial-style vehicles, office furniture and supplies, machine and hand tools, photo supplies, etc.

### 12–13. Defense Logistics-related organizations

a. Defense Logistics Agency (DLA). Headquartered at Fort Belvoir, VA, DLA performs its worldwide logistics with both civilian and military personnel, in facilities ranging from supply centers, to property reutilization offices. DLA is the DOD's primary source for consumable items, whether for combat readiness, emergency preparedness or day-to-day operations. DLA functions include the following:

(1) Management of nearly 5 million items through eight supply changes, and providing almost 84% of Services repair parts.

(2) Executive Agent providing 100% of Services' requirement for subsistence, fuels, medical, clothing & textiles, construction & barrier material.

(3) Execution of a worldwide distribution system utilizing 26 Distribution Depots.

(4) Worldwide property reutilization, demilitarization, scrap sales/disposition, property sales and hazardous waste guidance/waste.

(5) Management information on available excess DOD property.

(6) Management of the logistics information and cataloging systems, automated transaction services and document printing services.

(7) Management of federal strategic materials reserves.

b. Defense Contract Management Agency (DCMA). DCMA provides contract administration services in support of all the DOD components, the National Aeronautics and Space Administration, and other designated federal and state agencies, and foreign governments. These services include contract management, pre-award surveys, quality assurance, payment to contractors, support to small business and labor surplus areas, transportation and packaging assistance, and surveillance of contractor progress to ensure timely delivery of materiel. DCMA also provides contract management for Army LOGCAP.

c. Defense Commissary Agency (DeCA).

(1) The DeCA was established in May 1990 and assumed full operational control of Army and other Services' commissary operations in October 1991. DeCA is headquartered at Ft. Lee, VA. DeCA is an agency of the DOD operating under the direction and control of the Under Secretary of Defense (Personnel and Readiness) (USD (P&R)). DeCA is organized with a director and headquarters staff, three CONUS regions, a European region, and a DOD Liaison Office. The DOD Liaison Office is administratively assigned to the Director, DeCA. DeCAs' primary mission is to:

(a) Provide an efficient and effective worldwide system of commissaries for the resale of groceries and household supplies at the lowest practical price to members of the military Services, their families, and other authorized patrons, while maintaining high standards for quality facilities, products, and service consistent with standards similar to those in commercial food stores.

(b) Operate commissaries as APF activities as an integral element of the military pay and benefits package.

(c) Provide an income-effect benefit through savings on food and household items necessary to subsist and maintain the household of the military member.

(2) The Commissary Operating Board has representatives from the different military services and serves as a forum for the discussion and resolution of issues concerning the commissary services provided by DeCA, addresses operational and policy concerns, and implements broad policy as directed by Defense Management Council (DMC).

d. National Geospatial-Intelligence Agency (NGIA). NGIA provides geospatial information to the national security community. Maps, nautical charts, and aeronautical charts are essential for logisticians to plan logistics support.

**Section IV  
Standard Systems**

**12–14. Defense standard systems.**

There are a number of defense standard systems necessitated by the ever-increasing language of codes and formats readable by the computer, the supporting communications equipment, and the human operator. GSA, DLA, the LCMCs of AMC or any of the other military departments may supply items requisitioned by a single Army unit, thus the need for standard codes and formats. DLA has been assigned the responsibility for administering the 10 DOD standard systems generally referred to as the Defense Logistics Management Standards Office (DLMSO).

*a.* Defense Logistics Management System (DLMS) and Military Standard Requisitioning and Issue Procedures (MILSTRIP). The Defense Logistics Management System (DLMS) supports the Department of the Army’s data transition using current interchange business practices and eliminating MILSTRIP requisitioning.

(1) MILSTRIP procedures prescribe the uniform code and data elements to be used in requisitioning and issuing supplies. Within the DOD, a single line item requisition is used. Each requisition is for one specific item. The form and format are fixed, but some of the data elements may be manipulated and other data elements added may produce a variety of documents essential to supply operations. Common documents thus produced are requisitions, cancellations, supply status, shipment status, follow-up answers, materiel release orders, confirmations, and denials. Much of the information contained in these documents is the same. For example, each document contains the NSN, quantity, requesting unit, priority, funding data, etc. These procedures permit the requesting unit to say what they want, and provide the supply system with the necessary documents for processing the request.

(2) The DLMS is a process managed by the Defense Logistics Management Standards Office (DLMSO) located at the Defense Logistics Agency that governs logistics functional business management standards and practices rather than an automated information system. The DLMS interprets, prescribes, and implements DOD policy in the functional areas of supply, transportation, acquisition (contract administration), maintenance, and finance. Joint committees administer the requirements of these functional areas. The DLMS provides a functional infrastructure for the establishment and maintenance of procedural guidelines required for its user community to carry out DOD logistics policy. The DLMS is authorized by DODD 4140.1; and is prescribed by DOD 4140.40–1–R.

*b.* Uniform Movement and Materiel Issue Priority System (UMMIPS). In the issue and movement of supplies it is necessary to determine the relative importance of competing requisitions. The force activity designator (FAD) is what authorizes the requestor to use certain priorities based on the urgency of need. The urgency of need refers to the unit’s need for the particular item being requisitioned, that is, a repair part to get equipment off deadline, stock replenishment, etc. The application of these two factors produces a total of 15 priorities. UMMIPS establishes time standards based on priority. From requisition to receipt, the standards are in Table 12–2. These time standards are further subdivided for each activity involved in the supply and movement of materiel, that is, LCMC, depot, transportation agencies, etc.

**Table 12–2  
UMMIPS Time Standards**

Requisitioning Priority	Unit Location	
	United States	Overseas
01–03	7 days	11–12 days
04–08	11 days	15–16 days
09–15	28 days	67–82 days

*c.* Defense Transportation Regulation (DTR). This system is designed to manage, control, and document materiel (including personal property, exchange, and commissary) moving in the DTR and clearly define the responsibilities of shipping, clearance, terminal, and receiving activities. DTR is structured to interface directly with MILSTRIP and to support the movement criteria prescribed by UMMIPS. It functions through a discipline of uniform documentation procedures, formats, data elements and codes, and data transmission time standards. It also supports the performance-assessment requirements of MILSTEP through in–+–transit data collection and the inventory visibility requirements of the Services and agencies. AMC is the Army focal point for DTR.

*d.* Military Supply and Transportation Evaluation Procedures (MILSTEP). The basic tools for evaluating the strategic system are the MILSTEP reports. This system of reporting uses the uniform data elements produced by MILSTRIP and MILSTAMP as a database to produce the various MILSTEP supply and transportation reports. To produce these reports, a reduced version of the computer history file for each commodity command is extracted onto tape and forwarded to LOGSA. The supply effectiveness reports display such things as: the percentages of requisitions on which stock was available, the number and age of back-ordered requisitions, and the number of stock numbers

causing back orders. Using this same database, other reports are generated to evaluate depots, LCMCs, and AMC's overall performance in key functional areas. AMC is the Army focal point for MILSTEP.

e. Transportation Operational Personal Property Standard System (TOPS). TOPS is a joint Service system which has the capabilities to automate, streamline, and coordinate virtually every aspect of handling personal property shipments to include counseling, outbound, inbound, non-temporary storage, and quality assurance, and ends duplication of effort and documentation. The system is a network of computer systems located at a personal property shipment office (PPSO). Each site has a telecommunications link to central switching (SWITCHER), a site at SDDC, Alexandria, Virginia that serves as a data sorting and distribution point.

**12-15. Department of the Army standard systems**

The Army envisions a single, seamless, integrated logistics system under the SALE architecture and component ERP systems discussed earlier in this chapter that will provide accurate and real-time information and, improve overall responsiveness and situational awareness. There are many initiatives underway to modernize and streamline logistics. These initiatives cover the full spectrum of logistics and will support the full Joint range of military operations. The logistics systems tomorrow must:

- Enhance deployability.
- Enable Joint Interoperability/interdependence.
- Help reduce the logistics footprint in the operational environment.
- Reduce total logistics costs.

a. The Army has established logistics standard systems for use by its various elements. The overall concept for SALE was discussed under the AMC missions and functions sections of this chapter. At the time of this writing, the Army is transitioning from the STAMIS systems, wholesale and retail, to the new SALE architecture and systems. This transition is based on the fielding of the SALE ERP environment with LMP, AESIP, and GCSS-Army (F/T).

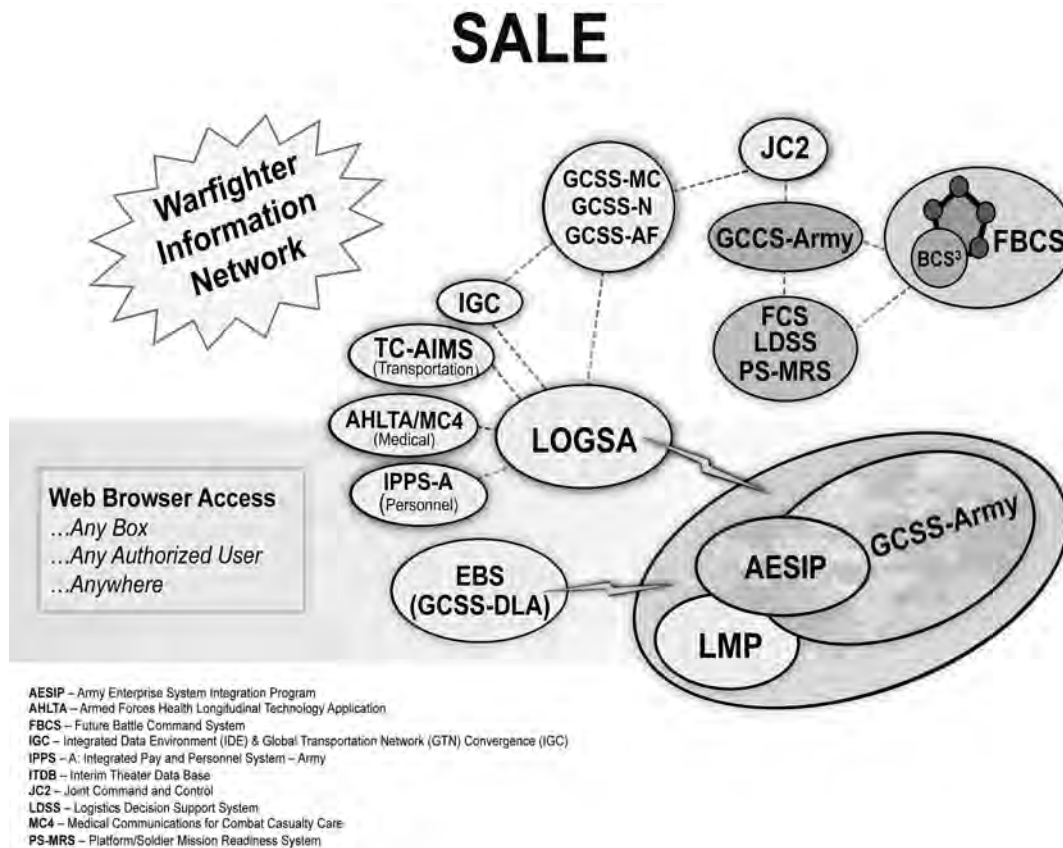

Figure 12-8. SALE Architecture and Component ERP Systems

## How the Army Runs

b. The Army is managing the transition and modernization of systems through the Portfolio Management process (PFM). All IT investments (older being retired or new being integrated) will be managed through this process. Logistics Domain governance is administered by the Army G-4 as the domain owner and provides strategic guidance through Logistics Domain Business Process Counsel. The Logistics Domain transformation objectives are documented in Logistics Domain IT Strategic Plan and IT Implementation Plan.

c. There are two wholesale standard systems developed and used by AMC that are being phased out with the fielding of LMP. They are the Commodity Command Standard System (CCSS), which is used to support the LCMCs, and the SDS, used to support depot operations.

d. Logistics Information Warehouse (LIW). LIW is the official Army database that provides accurate, timely, and auditable worldwide (down to property book level) visibility of major end items of equipment. LIW furnishes Army management with inventory numbers for equipment procurement and distribution decisions. Logistics Information Warehouse Asset Module will be phased out with the completed fielding of LMP.

e. Current/legacy systems. The Army currently employs a set of retail logistics systems that were each designed for a specific functional area. These systems will be retired with the fielding of GCSS-Army (F/T).

(1) The Standard Army Ammunition System Modernized (SAAS-Mod) supports tactical ammunition management and storage operations to produce accurate and timely Class V information during peacetime, contingency, and wartime operations. SAAS-Mod is a multilevel system providing munitions management functionality from brigade through theater level for the operational Army. SAAS-Materiel Management Center (SAAS-MMC) operates at Theater Sustainment Command levels in the Distributions Management Center (DMC) and Sustainment Brigade DMC. SAAS-MMC maintains asset visibility of munitions with the theater area of operations and requisitions munitions from the National Inventory Control Points. SAAS-Ammunition Supply Point (SAAS-ASP) is the system of record for retail level accountability at Ammunition Support Activities including Ammunition Supply Points, Corps Storage Areas, and Theater Storage Areas. SAAS-Division Ammunition Office (SAAS-DAO) (soon to be redesigned SAAS-Brigade Ammunition Office (SAAS-BAO)) operates in the Brigade Support Battalion (BSB) Support Operations section and provides Task Force munitions managements. SAAS-Ammunition Transfer & Holding Point (SAAS-ATHP) operates in the BSB Distribution Company ATHP to provide, receive, store, and issue support to maneuver forces in the Brigade Combat Team area of operations.

(2) The Standard Army Maintenance System-Enhanced (SAMS-E) is used to manage maintenance operations at the installation and in all tactical units. SAMS-E acts as a bridge between current functionality in the field and the ERP solution Global Combat Service Support - Army (Field/Tactical). Enhancements include transition from DOS to Windows XP by and merging ULLS-G, SAMS-1, SAMS-2 and now SAMS-I/TDA functionality into SAMS-E using the Oracle 10g relational database for Host-Client capability. SAMS-E systems are across the battlefield from brigade level echelons down to separate companies. Usual locations include (but not limited to) the Sustainment Brigades, Support Battalions (BSB, CSSB, STB, ASB, etc.), Company level units to include tactical (POL, MP, ENG, MI, TRANS, etc) and field support organizations (FSC, FMC, SMC, HHCs, etc.). Normally consolidated in maneuver units at the support organization within the Forward Support Company (FSC) and Field Maintenance Company (FMC) SAMS-E provides maintenance and CL IX requisitions data management. SAMS-E modernizes unit level automated maintenance status reporting including weapon systems, sub-components, day-to-day maintenance supply related and readiness repair part issues as the transition to the two-level maintenance concept continues to evolve. It currently provides interfaces with legacy SARSS, ULLS-G, SAMS-1/2/I/TDA, ULLS-A, LOGSA LIW, IMAP (National Guard AWPSS interface) and receives files from AWRDS.

(3) Standard Army Retail Supply System supports retail supply management operations. It consists of four integrated systems (SARSS-1, SARSS-2AD, SARSS-2AC/B, and SARSS-Gateway). SARSS-1 is the standard supply system for receipts, storage, issues, replenishment and storage operations. It is a real-time, transaction-oriented system where users can interactively enter, retrieve, and update supply information. SARSS-1 processes customer unit requests, cancellations, modifications, and follow-ups for supplies. SARSS-1 also provides an interactive query capability. The Materiel Release Order Capability (MROC) and the Automated Manifest System (AMS) are resident in the SARSS-1 baseline to control the flow of materiel, manage performance and produce productivity reports. SARSS-1 operates at the tactical Supply Support Activity (SSA) in the Distribution Company of Brigade Support Battalions and Combat Service Support Brigades, Installation SSAs, and other Army approved selected locations with SSA missions. SARSS-2AC/B supports the Materiel Management requirements for all Class II, IIP, IV and IX processing. SARSS-2AC/B has asset visibility of SARSS-1 activities. Processes include all SARSS2A functionality plus SARSS-2B non-time sensitive actions such as catalog, document history, demand history and interface capability with financial systems. SARSS-Gateway offers improved communications and advanced automation functionality that allows users, to place orders on the Source of Supply (SOS), the same day the customer produces them when not issued from on hand stocks. The Standard Army Retail Supply System-Gateway (SARSSS-GW) relocation of Production Operation from Defense Information Systems Agency (DISA) St. Louis, MO to AMC Logistics Support Activity (AMC LOGSA), Redstone Arsenal, AL was completed on 27 April 2008. This relocation supports the Army's

objective to collocate information technology resources. This relocation will help bridge the gap to the Global Combat Support System-Army (Field/Tactical) (GCSS-A (F/T)) system. Corps/Theater ADP Service Center (CTASC) hardware systems have been collocated to a fixed production site, at LOGSA Redstone Arsenal Alabama Facility. Relocation was completed as of April 2007. A Continuity of Operations Plan (COOP) CTASC is located at Fort Lee, Va.

(4) ULLS consisted of three applications (ULLS-G, ULLS-A, ULLS-S4). ULLS -G has been replaced by SAMS-E, ULLS-A is being upgraded to the new ULLS-A enhanced (ULLS-A (E)), and ULLS-S4 has been replaced by PBUSE. The ULLS-A (E) system provides an enhanced aviation maintenance management capability. It is a multi-user system incorporating a Local Area Network (LAN) to link the functions of Tech Supply, Production Control and Quality Control, phase team, and back shop sections within the aviation field maintenance organization. The program incorporates a back shops module that gives the maintenance units the capability to initiate and complete work orders. The Aviation Flight Records Systems (AFRS) Module will allow the user to send the DA Form 759 (Individual Flight Record and Flight Certificate - closeout) data to Flight Operations. The Aviation Maintenance Automated Tracking System (AMATS) provides the capability to automate DA Form 2410 (Component Removal and Repair/ Overhaul Record) processes. An Integrated Maintenance Phase System (IMPS) module provides a "real time" Phase Maintenance Management Tool. The program also provides decision support and ad hoc query tools.

(5) Standard Property Book System-Redesign (SPBS-R) was used for property accountability at battalion and higher levels in both tactical and installation environments. SPBS-R has been replaced by PBUSE. Property Book / Unit Supply Enhanced (PBUSE) is the Army's unclassified, web-based, property accountability system. The centralized database servers are located behind the Army Knowledge Online (AKO) firewall in the Strategic and Advanced Computer Center (SACC) at Fort Belvoir, Virginia. The system maintains accountable records for the Army's inventory of property in the hands of Modified Table of Organization & Equipment (MTOE), Table of Distribution and Allowances (TDA), and Installation's units. PBUSE is Federal Financial Management Improvement Act (FFMIA)/ Chief Financial Officer (CFO) compliant.

(6) Department of the Army Movement Management System-Redesign (DAMMS-R) system. Transportation Coordinators Automated Information for Movements System (version 2) (TC AIMS II), which is a joint Service system being developed by Army. TC-AIMS II assists force providing organizations in rapidly identifying unit equipment and personnel necessary to support a Combatant Commanders' requirements. Key functionalities of the system are: source the Time Phased Force and Deployment Data (TPFDD); organize deployment data into mode specific load planning data; support in-theater and redeployment unit movement; support installation transportation freight movement; provide source data for in-transit visibility; create actual movement documents; support theater distribution; support movement control; and provide Common-User Land Transportation Management. TC-AIMS II addresses critical shortfalls in the movement of materiel and personnel in support of DOD transportation operations. TC-AIMS II is expected to provide a single effective and efficient automated information system (AIS). This joint AIS will support force projection and transportation management of unit movements, passengers, and cargo during day-to-day and crisis operations within the Defense Transportation System (DTS). TC-AIMS II replaced the Department of the Army Movement Management System-Redesign (DAMMS-R) system.

(7) Army Food Management Information System (AFMIS) automates management of food service and subsistence supply operations at the troop issue subsistence activity (TISA), installation food advisor (IFA), and the dining facility operations (DFO). The TISA module of AFMIS tracks issues, receipts, sales, reorders, and storage. The IFA module produces reports on dining facility operation and menus. The DFO module assists the dining facility manager in menu planning, production scheduling, inventories, headcount, and requisitioning. AFMIS currently interfaces with Defense Subsistence Management Information System (DSMIS), STANFINS, and the Subsistence Total Order and Receipt Electronics System (STORES), the Joint Subsistence Prime Vendor Food Ordering System.

(8) The central issue facility (CIF) module of the installation support modules (ISM) provides a standardized Army-wide, automated, user-friendly system for the receipt, storage, issue, exchange, and turn-in of authorized organizational clothing and individual equipment OCIE at Army installations. A standard automated CIF system is needed to support peacetime operations and deployment/redeployment of Soldiers in support of both military operations and military stability and civil support operations. The Army must field an automated CIF system worldwide, which is capable of outfitting Soldiers with needed OCIE in time to meet deployment schedules while maintaining property accountability. The CIF module improves property accountability and inventory management. The module will allow CIF personnel to provide better support to Soldiers and improve management.

(9) Initiatives. Many of the legacy systems mentioned above were designed and developed based on old 1960's technology, i.e. data exchange via floppy diskette and modem, standalone workstations, fragmented/stove-piped, not dependent on constant communications, MILSTRIP, MILSTRAP data formats, just to name a few. These systems have served the Army well, but in an era of rapidly changing requirements and technology, many have reached the end of their life expectancy. As the Army moves forward to transform into a more agile, lethal, and versatile force, it must transform itself to distribution-based logistics, by reengineering its logistical capabilities. This will include inserting technology, reconfiguring logistics processes, adopting modern business rules, and modernizing automated systems.

f. The most significant modernization communication and automation initiatives include:

## How the Army Runs

(1) Bridging systems. The Army is fielding upgrades to SAMS (SAMS-E), ULLS-A, and Fielding a new property book system PBUSE as bridging systems to maintain units in the field until GCSS-Army (F/T) is fielded.

(2) Movement tracking system (MTS) incorporates digital maps in vehicles and allows two-way satellite messaging thereby allowing the transportation coordinator the ability to talk to the driver of any truck, regardless of location, without having to put up antennas or involve more Soldiers. MTS is fielding the incorporation of radio frequency (RF) technology in its current configuration. This enhances in-transit visibility of assets to the truck level. Future versions will allow automatic reporting of vehicle diagnostics, and other features that support in-transit visibility to the item level.

(3) Automatic Identification Technologies (AIT). AIT is a family of devices that facilitates the accurate capture, storage, retrieval, transfer and transmission of source data information to reduce processing times, improve accuracy, and enhance asset visibility. AIT is being integrated into Army logistics processes including the deployment of troops and equipment, logistics supply and re-supply, and maintenance. The purpose of AIT applications is to provide accurate and efficient automated means to capture, store, and retrieve source data, with a minimum of human intervention. Since no single AIT device can satisfy the Army's logistics source data automation, identification and tracking requirement, the Army embraces a family of AIT devices. These devices include linear and two-dimensional bar codes, radio frequency identification (RFID) technology, contact memory buttons, optical memory cards and smart cards. AIT initiatives include: Ammunition-AIT integration, implementation of RFID Army-wide, and maintenance-AIT integration.

(4) Army Total Asset Visibility (ATAV). ATAV is an information process that integrates data from automated systems and provides commanders and logisticians with information on location, quantity, condition, and movement of assets. It is the responsibility of AMC to ensure ATAV fits in as part of a larger Defense and Joint TAV (DTAV/JTAV) system (under constant and continuous development). The TAV system is a fully automated, near-real time, and has "open architecture" capability that is migrating to be Defense Information Infrastructure and Common Operating Environment compliant under the Logistics Integrated Database (LIDB). TAV has visibility of over 1.4 million Army NSNs (and 6 million DOD NSNs) and provides related logistics data to users throughout the Army and DOD. It has been successfully used during operations in Somalia, Rwanda, Haiti, operations Joint Endeavor and Joint Guard and Task Forces Eagle and Falcon to track assets. The Army has identified ATAV as the authoritative source for obtaining Army logistics data in support of joint programs. ATAV JTAV is being subsumed into the DLA Asset Visibility System, a modernized version of the ATAV/JTAV capability.

(5) Wireless Combat-Service-Support Automated Information Systems Interface (CAISI) and Very Small Aperture Terminal (VSAT) terminals are part of the G-4 Connect the Logistician focus area. These two enablers are being fielded to enhance the logistician's ability to communicate on the battlefield. The wireless CAISI establishes a wireless local area network capability within the support area and the VSAT provide satellite communications capability down to the brigade area. Logistics Integrated Data Base - (LIDB) The LIDB, managed by LOGSA, is the Army's Logistic Data Warehouse. It has transitioned from a set of 66 disparate individual databases to an integrated environment and enabler for Army Logistics Transformation. The LIDB does this by providing logistics intelligence, life cycle support, and technical advice and assistance to the current and future force. It Integrates force, readiness, authorization, and asset logistics information for worldwide equipment readiness, performs distribution pipeline performance analysis, and asset visibility for timely and predictive decision-making.

(6) The LIDB is evolving from a multi-system data repository to an integrated analysis-based logistics intelligence source for the Army called the Logistics Information Warehouse (LIW). It is an integral part of team developing Army's enterprise (LMP, GCSS-A (F/T) and AESIP) and provides a full suite of automated tools for weapon system lifecycle management.

## Section V Funding

### 12-16. Appropriations

Congressionally approved funds and the Army budget structure are divided into appropriations, which support both the AC and RC. For logistics management purposes, these appropriations can be addressed in two categories; procurement appropriations and operations and maintenance appropriations.

*a.* Procurement appropriations are used to buy all major items and other selected end items. Selected end items with a unit price in excess of \$25,000 are purchased with procurement appropriations. The current expense/investment threshold cost is established at \$100,000 for budget purposes. This same threshold is also used for accounting and capitalization purposes.

*b.* Operations and maintenance appropriations support day-to-day operations. It pays for such things as training; unit and major item depot maintenance; and administrative and associated activities. The operations and maintenance appropriation is allocated by Department of Army, to Army commands worldwide based upon their mission and the importance of that mission to the Army. These funds are referred to as consumer funds. Between consumer funds and the procurement appropriations, the field commander purchases all of his or her secondary items.

## 12-17. Army Working Capital Fund (AWCF)

a. The AWCF is an important financing mechanism used to support Army materiel readiness. The key thing that distinguishes the AWCF from other financing mechanisms is that the fund operates on a reimbursable basis by selling goods and services to customers. The AWCF is a no year money fund and is not subject to the annual appropriation cycle. It operates similar to a commercial enterprise, and so its ability to incur costs is limited primarily based on projected workload. The basic tenet of the working capital fund structure is to create a customer-provider relationship between military operating units and support organizations. This relationship is designed to make managers of the AWCF and decision-makers at all levels more aware of the cost to provide goods and services.

b. Working capital funds were established by Congress to more effectively control and account for the cost of programs and work performed in the Department of Defense. Under the provisions of Title 10 United States Code § 2208, the Secretary of Defense may establish working capital funds to finance inventories of supplies and industrial-type activities that provide common services, such as repair, manufacturing, or remanufacturing. Unlike profit-oriented commercial businesses, the goal of working capital fund activities is to break even by returning monetary gains to appropriated fund customers through lower future rates or collecting monetary losses from customers through higher future rates. Prices are generally stabilized or fixed during the year of execution to protect customers from unforeseen fluctuations that would impact their ability to execute the programs approved by Congress.

c. Figure 12-9 below shows the interaction of customer appropriated funds, AWCF business operations, and cash. Customer appropriated funding is synchronized with the AWCF workload forecast during budget development. During the year of execution, appropriated fund customers submit funded orders (1) to AWCF providers requesting services (repair, overhaul, or manufacturing) or supplies (spares or repair parts). This obligates appropriated funds. In step 2, AWCF managers purchase such things as labor, supplies, contract support, and inventories based on customer workload (CASH OUT). In step 3, the customer receives the completed product or service and a bill (4) for payment. The customer pays the AWCF (5) for the materiel or services (CASH IN). Proper pricing of inventory and services, and accurately forecasting workload allows a balance between CASH OUT and CASH IN. Variance between these actions results in either a gain or loss of AWCF cash. Gains are returned to customers through lower future prices while losses are recouped through higher future prices.

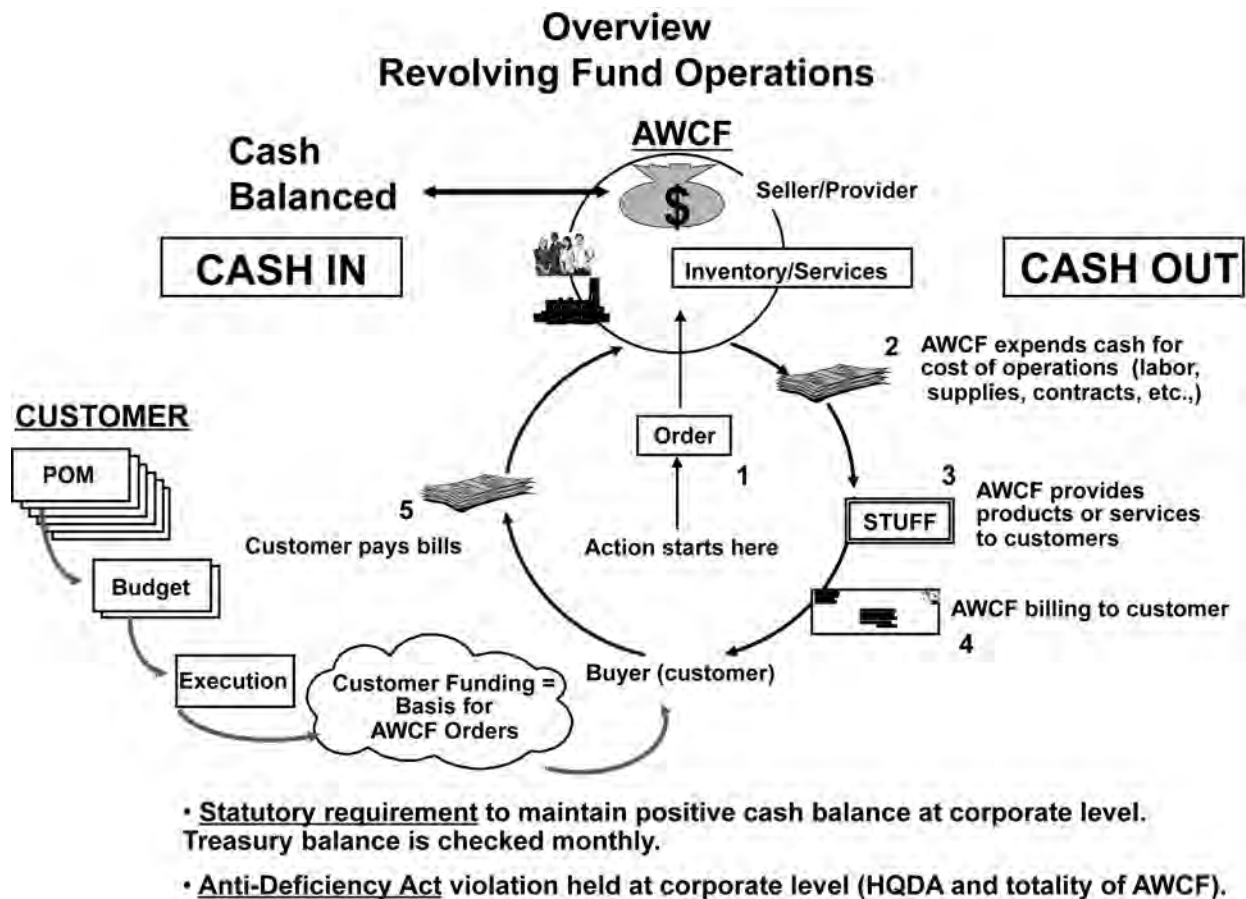

Figure 12-9. Army Working Capital Fund



## How the Army Runs

*d.* Because of the cyclical nature of business operations as portrayed above, working capital funds are also sometimes known as revolving funds. The Army's revolving fund activities evolved from two separate types of funds: stock funds, which procure materiel in volume from commercial sources either to sell to customers or hold in inventory for future use; and industrial funds, which provide services such as depot maintenance, munitions manufacturing, and ammunition storage. The AWCF is comprised of two businesses or activity groups:

*e.* The Supply Management activity group buys and manages spares and repair parts for sale to its customers, primarily Army operating units. This activity group supports and builds readiness for today's and tomorrow's challenges. The Army's equipment and operational readiness, and the strength to win the Nation's wars are directly linked to the availability of materiel. The activity group is managed by the Life Cycle Management Commands of the Army Materiel Command. Supply Management administers spares inventory for Army managed items, Non-Army managed items (NAMI), and war reserve secondary items. Supply Management consists of four major commodity groups: aviation and missile; communications-electronics; tank-automotive and armament; and NAMI. Pre-positioned war reserve materiel is retained in protected inventory and released to support deploying combat units. The war reserve stocks contain materiel from all commodity groups. As new equipment is added to Army's operational and training forces, new spares are also scheduled for inclusion in the Supply Management inventory.

*f.* The Industrial Operations activity group provides the Army an organic capability to conduct depot level maintenance, repair and upgrade; produce munitions and large caliber weapons; and store, maintain, and demilitarize materiel for all branches of DOD. Industrial Operations is comprised of thirteen government owned and operated installation activities, each with unique core competencies. These include five hard-iron maintenance depots, three arsenals, two munitions production facilities, and three storage sites.

## Section VI Security

### 12–18. Security Assistance Responsibilities (SA)

*a.* The Secretary of State is responsible for the overall supervision and general direction of the SA program. The primary responsibility of the Secretary of Defense is to determine military equipment and training requirements, and to procure and supervise the use of equipment by each recipient country. The military departments execute and manage their portion of the SA program under the general direction of the Defense Security Cooperation Agency (DSCA). They also provide technical support and information for use in negotiations on acquisition and co-production agreements that will ultimately affect their plans and programs.

*b.* The President, through Department of State (DOS) channels, determines which foreign countries are eligible to purchase defense articles, training, and other services from U.S. sources. Purchase requests from foreign countries of major items of equipment are sent to their respective U.S. Embassy with copies to DOS, DSCA, and the military departments. Purchases of parts and other non-major items can be addressed directly with the military departments. Congress must be notified of any offer to sell defense articles and services valued at \$50,000,000 or more, major defense equipment valued at \$14,000,000 or more, and design and construction services valued at \$200,000,000 or more.

*c.* ARSTAF SA responsibilities are to develop and issue overall policy and program guidance. Operations are assigned to ACOMs/ASCCs/DRUs. The major SA policy player in the ARSTAF is the Deputy Assistant Secretary of the Army (Defense Exports and Cooperation (DASA [DEC])). The DASA (DEC) coordinates the development and issuance of Army-wide SA policy in coordination with the Army G-3, Army G-1, Army G-2, USACE, Judge Advocate General, and the various agencies within the ARSEC. The SA responsibilities of the various DA staff elements are focused on overall program guidance with coordination of the various functional areas a prime responsibility of the DASA (DEC). The operational aspects of the SA program including management of FMS cases, FMF, and IMET are assigned to ACOMs/ASCCs/DRUs. AMC, as the Army executive agent for materiel services, is responsible for the operational aspects of approved FMF (except training and design and construction services) and military assistance programs (MAP). TRADOC manages the operational aspects of FMS training at CONUS and OCONUS schools, and IMET programs.

*d.* Again, the DASA (DEC) is the principal ARSTAF spokesman and ARSTAF proponent for SA and is responsible for SA policy and procedural guidance. He or she has direct access to and interacts with the VCSA, the Under Secretary of the Army and other members of the ARSEC, OSD, other Military Departments, agencies, commands, and activities relative to SA matters. The DASA(DEC) has DA tasking authority over all ARSTAF agencies, ACOMs/ASCCs/DRUs, and field activities on matters pertaining to SA. As the ARSTAFF spokesman for SA, the DASA(DEC) is responsible for providing policy and guidance to the Army executive agent and other agencies or ACOMs/ASCCs/DRUs for SA when required.

*e.* AMC is the Army's principal agent for supplying FMS materiel. It fulfills its responsibilities through USASAC. USASAC, working with other AMC elements, develops the necessary data to consummate sales and supervise their

execution. This operational responsibility extends from the initial long-range planning, which involves the development of requirements for materiel and services, to the signing of agreements, coordination of all aspects of support, delivery of the goods and services, and completion of final accounting. USASAC is the focal point between the U.S. Army and friendly nations, ensuring that actions remain on course throughout the life cycle of the SA process.

*f.* USASAC also oversees AMC's participation in the Munitions Control Program. This program involves the development of Army positions on commercial export license applications for the export of military items, technical data, and services to foreign countries. Export license applications, commonly called munitions cases, pertain to the export of defense articles and services, or technical data, described in the U.S. Munitions List contained in the DOS's International Traffic in Arms Regulation. The DOS and the Office of the Deputy under Secretary of Defense (Trade Security Policy) refer certain export license applications to the Army for evaluation. The objectives of this evaluation are to control the export of classified or critical technology for which the United States has the technological lead, and which has the potential to significantly threaten U.S. national security if provided to certain foreign governments; to provide the Army position on the effect of proposed exports on national security; and to control export sales that could interfere with Army programs. Through coordination with appropriate AMC technical elements, USASAC provides a recommended position on whether particular export license applications should be approved.

### **12-19. Co-production**

Another facet of USASAC's SA responsibilities is co-production, which encompasses any program that enables an eligible foreign governmental organization, or designated commercial producer, to acquire substantial "know-how" to manufacture or assemble, repair, maintain, and operate a specific system or individual military item. The "know-how" furnished by the United States is on a reimbursable basis and may include research, development, production data, and/or subassemblies, managerial skills, procurement assistance, or quality control procedures. Co-production may be limited to the assembly of a few end items with a small input of in-country produced parts, or it may extend to a major manufacturing effort requiring the build-up of capital industries. As in the case of conventional military sales and associated supply support arrangements, the co-production programs perpetuate utilization of items common to U.S. forces, thereby promoting rationalization, standardization, and interoperability.

## **Section VII**

### **Summary, references, annexes, websites, & professional reading list**

#### **12-20. Summary**

15. This chapter addressed the nature and structure of the Army logistics system. It is a large, complex system that must be properly managed if it is to perform to the expectations of the Geographic Combatant Commander's (GSSs). The struggle continues to find balance between logistics effectiveness and logistics efficiencies. 16. The Army G-4 provides policy, with overall responsibility to assure that the individual pieces fit together and operate in harmony, one with the other. To do this, the Army G-4 establishes broad policies and procedures, and monitors and guides the development of standards and Logistics systems for use at all echelons. The Army's national-level logistics system is operated by the AMC in concert with other key Army, joint and non-DOD agencies. AMC operates through its major subordinate commands, LCMCs and SRAs to fulfill the Army's need for national logistics support. The Army's materiel requirements are divided into commodity groupings with each LCMC assigned one or more of these groupings. The LCMCs collectively determine the Army's requirements to: procure or overhaul assets; position them in the appropriate depots; and issue in response to the Army's needs.

#### **12-21. Selected official military references**

- a.* DOD Directive 5105.22, Defense Logistics Agency (DLA)
- b.* DOD Directive 5134.1, Undersecretary of Defense for Acquisition, Technology, and Logistics USD(ATL)
- c.* CJCS Manual 3500.04C, Uniform Joint Task List
- d.* Army Regulation 10-5, Organizations and Functions, Headquarters, Department of the Army
- e.* Army Regulation 10-25, United States Army Logistics Innovation Agency
- f.* Army Regulation 12-1, Security Assistance, International Logistics, Training, and Technical Assistance Support and Responsibilities
- g.* Army Regulation 60-10, Army and Air Force Exchange Service General Policies
- h.* Army Regulation 700-4, Logistics Assistance
- i.* Army Regulation 700-127, Integrated Logistics Support (ILS)
- j.* Army Regulation 700-137, Logistics Civil Augmentation Program (LOGCAP)
- k.* Army Regulation 700-138, Army Logistics Readiness and Sustainability
- l.* Army Regulation 725-50, Requisition, Receipt, and Issue System
- m.* Army Regulation 750-1, Army Materiel Maintenance Policy
- n.* Joint Publication 4-0, Doctrine for Logistics Support in Joint Operations
- o.* Field Manual 3-0, Operations

## How the Army Runs

- p.* Field Manual 3–31, Joint Force Land Component Command (JFLCC) Handbook
- q.* Field Manual 63–3, Corps Support Command
- r.* Field Manual 63–4, CSS–Theater Army Area Command. (Under revision to address the restructured and re-named Theater Support Command (TSC))
- s.* Field Manual 63–11, Logistics Support Element, Tactics, Techniques, and Procedures
- t.* Field Manual 100–10, Combat Service Support
- u.* Field Manual 100–10–1, Theater Distribution
- v.* Field Manual 100–10–2, Contracting Support on the Battlefield
- w.* Field Manual 100–16, Army Operational Support
- x.* Field Manual 100–17–3, Reception, Staging, Onward movement, and Integration
- y.* Field Manual 100–21, Contractors on the Battlefield.
- z.* AR 220–1, Unit Status Reporting.
- aa.* AR 715–9, Operational Contract Support Planning and Management.
- bb.* AR 700–137, Logistics Civil Augmentation Program (LOGCAP)
- cc.* AR 700–4, Logistics Assistance (LAP Regulation).
- dd.* AR 700–138, Army Logistics Readiness and Sustainability.
- ee.* AR 70–62, Airworthiness Qualification of U.S. Army Aircraft Systems.
- ff.* AR 95–1, Flight Regulations
- gg.* AR 95–20, Contractors Flight and Ground Operations.
- hh.* DA Pam 738–751, Functional Users Manual for The Army Maintenance Management System - Aviation (TAMMS–A).
- ii.* AR 75–1, Ammunition Malfunctions
- jj.* AR 700–19, Standard Army Ammunition System, the Worldwide Ammunition Reporting System and the Guided Missile and Large Rocket Report
- kk.* AR 700–20, Ammunition Peculiar Equipment.
- ll.* AR 700–28, Committee for Ammunition Logistics Support.
- mm.* AR 700–100, Emergency Munitions Support for Joint Operations.
- nn.* AR 700–13, Worldwide Ammunition Review and Assistance Program.
- oo.* AR 700–116, Ammunition Management in the Pacific.
- pp.* AR 702–6, Ammunition Stockpile Reliability Program.
- qq.* AR 702–12, Quality Assurance Specialist, Ammunition Surveillance.
- rr.* DA Pam 700–19, U.S. Army Munitions Reporting Systems.
- ss.* AR 710–1, Centralized Inventory Management of the Army Supply System.
- tt.* AR 700–15, Packaging of Materiel.
- uu.* DA Pam 700–32, Packaging of Army Materiel.
- vv.* AR 740–26, Physical Inventory Control.
- ww.* AR 740–1, Storage and Supply Activity Operations.
- xx.* AR 725–50, Requisition, Receipt, and Issue System.
- yy.* DA Pam 710–2–1, Using Unit Supply System (Manual Procedures).
- (zz)* DA Pam 710–2–2, Supply Support Activity Supply System (Manual Procedures).
- aaa.* AR 711–6, Army Participation in the DLA Weapon System Support Program.
- bbb.* AR 700–18, Provisioning of Army Equipment.
- ccc.* AR 710–2, Supply Policy Below the National Level.
- ddd.* AR 710–3, Inventory Management Asset and Transaction Reporting System.
- eee.* AR 708–1, Log Data Management & Cataloguing.
- fff.* AR 725–1, Special Authorizations and Procedures for Issues, Sales and Loans.
- ggg.* AR 700–82 (Joint Regulation) Uniform Source Maintenance and Recoverability Codes.
- hhh.* AR 700–131, Loan Lease Donation of Army Materiel.
- iii.* AR 700–144, Demil and Trade Security Controls.
- jjj.* DA PAM 700–60, Department of the Army Sets, Kits, Outfits and Tools.
- kkk.* DA PAM 708–1, Cataloging of Supplies and Equipment, Management Control Numbers.
- lll.* DA PAM 708–2, Cataloging and Supply Management Data Procedures for the Army Central Data Bank.
- mmm.* DA PAM 708–3, Cataloging Supplies and Equipment, Army Adopted Items of Materiel and List of Reportable Items (SB 700–20).
- nnn.* AR 735–5, Policies and Procedures for Property Accountability.
- ooo.* AR 735–11–2, Reporting of Supply Discrepancies.
- ppp.* AR 735–17, Accounting for Library Materials.

- qqq*. DA PAM 735-5, Financial Liability Officer's Guide.
- rrr*. DA PAM 30-22, Procedures for the Army Food Program.
- sss*. AR 30-22, Army Food Program.
- ttt*. AR 600-38, Meal Card Management (Food, Liquid Logistics and Field Services).
- uuu*. AR 59-4, Joint Airdrop Inspection Records Malfunction Investigation and Activity Reporting .
- vvv*. AR 700-101, Joint Operating Procedures, Management and Standardization Mobile Electric Power Generating Sources.
- www*. AR 700-135, Soldier Support in the Field.
- xxx*. AR 700-136, Tactical Land Based Water Resources Management.
- yyy*. AR700-141, Hazardous Materials Information Resource System.
- (zzz)* AR 700-143, Packaging of Hazardous Material.
- aaaa*. DA PAM 710-7, Hazardous Material Management Program.
- bbbb*. AR 750-32, Airdrop Parachute Recovery and Aircraft Personnel Escape.
- cccc*. AR 32-4, Special Measurement Clothing and Footwear, Orthopedic Footwear, Guide ons, Streamers, and Flags.
- dddd*. AR 32-5, Introduction of New Clothing and Textile Items into the DOD Supply System .
- eeee*. AR 32-31, Clothing and Textiles Requirements Data.
- ffff*. AR 670-1, Wear and Appearance of Army Uniform & Insignia.
- gggg*. AR 700-84, Issue and Sale of Personal Clothing.
- hhhh*. AR 700-80, Army In-Transit Visibility (ITV).
- iiii*. AR 56-4, Distribution of Material and Distribution Platform Management.
- jjjj*. AR 56-3, Management of Army Rail Equipment.
- kkkk*. AR 56-9, Watercraft.
- llll*. AR 59-3 Movement of Cargo by Scheduled Military Air Transportation.
- mmmm*. AR 59-9 Special Assignment Airlift Mission Requirements.
- nnnn*. AR 702-7-1, Product Quality Deficiency Report Program.
- oooo*. DA Pam 750-8, Functional Users Manual for The Army Maintenance Management System (TAMMS).
- pppp*. DA Pam 700-24, Sample Data Collection.
- qqqq*. AR 11-1, Command Logistics Review Program.
- rrrr*. AR 700-4, Logistics Assistance.
- ssss*. AR 700-132, Joint Oil Analysis Program (JOAP).
- tttt*. AR 700-139, Army Warranty Program Concepts and Policies.
- uuuu*. AR 702-7, Product Quality Deficiency Report Program.
- vvvv*. AR 750-1, Army Materiel Maintenance Policy and Retail Maintenance Operations.
- wwww*. AR 750-6, Ground Safety Notification System.
- xxxx*. AR 750-10, Army Modification Program.
- yyyy*. AR 750-43, Army Test, Measurement and Diagnostic Equipment Program.
- zzzz*. AR 750-59, Army Corrosion Prevention and Control Program.
- aaaaa*. DA Pam 750-1, Leader's Unit Maintenance Handbook.
- bbbbb*. DA Pam 750-3, Soldier's Guide For Field Level Maintenance.
- ccccc*. DA Pam 750-35, Guide for Motor Pool Operations.
- ddddd*. DA Pam 750-43, Army Test Program Set Procedures.
- eeeee*. AR 700-127, Integrated Logistics (ILS Division).
- fffff*. AR 700-48, Management of Equipment Contaminated with Depleted Uranium or Radioactive Commodities.
- ggggg*. DA PAM 700-48, Handling Procedures of Equipment Contaminated with Depleted Uranium or Radioactive Commodities.
- hhhhh*. AR 702-16, Chemical Materiel Stockpile Reliability Program.

RESERVED

## Chapter 13

### Military Human Resource Management

Our mission is to develop, manage and execute all manpower and personnel plans, programs and policies - across all Army Components - for the entire Army team. Our vision for the human resource enterprise is a team of HR professionals dedicated to supporting and empowering Soldiers, Civilians, Families and Veterans worldwide in an era of persistent conflict. We will recruit, retain and sustain a high quality volunteer force through innovative and effective enterprise solutions. We will ensure HR readiness of the Total Army across the full spectrum of operations. -Deputy Chief of Staff, Army G-1

#### Section I Introduction

##### 13-1. Military human resource management (MHRM)

The term “human resource management” (HRM) has been accepted by the Army leadership and over time has been integrated into policy and doctrine formerly used to describe the functions of “personnel management” and “personnel administration.” In the most general sense, HRM is a series of integrated decisions about the employment relationship that influences the effectiveness of employees and organizations. Military HRM is the major component of the Army’s overall HRM operations. It has evolved from a supporting role to that of a strategic enabler for the Army. Today’s challenges require informed decisions on force structure requirements, recruiting and retention programs, well-being programs, and personnel readiness from both individual and unit perspectives. HR leaders must possess professional and specialized skills to meet these challenges and manage the programs that comprise the functions and integrating systems of the HR life cycle model.

##### 13-2. Personnel transformation (PT)

These are dynamic times for the Army as it energetically pursues transformation in order to become more relevant and responsive to contingencies across the entire spectrum of military operations. The HR community is active in this process. Personnel Transformation (PT) is integral to the success of the Army’s Campaign Plan. PT is a comprehensive strategy to ensure the military HR system is relevant and responsive for Soldiers and commanders now and in the future. PT is multi-faceted, but has four primary components as briefly described below:

*a. Business Process Redesign.* Personnel management procedures of the past included in excess of 1200 processes that were primarily stubby-pencil, work intensive actions that were designed to involve personnel specialists at every level, as well as the chain of command at every level until the specified action reached the appropriate approval authority. Not only did it take an extraordinary length of time to obtain decisions, the prescribed procedures unnecessarily demanded time from numerous individuals. Under PT, all these business processes have been thoroughly reviewed in order to eliminate those that are not necessary, streamline others to cut out unnecessary contacts, and to apply web technology where possible. Thus far, the result has been a much more responsive HR system that is faster (often times immediate/real time), and more accurate because there are fewer steps and individuals handling the action. Often, Soldiers and commanders are empowered to interact with the top of the system without direct involvement with personnel specialists.

*b. Web Technology.* Closely related to the initiative above is the leverage of automation and web technologies for HR activities. While the number of processes enabled or improved as a result of web applications is growing dramatically a few examples of this initiative today are: Assignment Satisfaction Key (ASK), which allows enlisted Soldiers to update their assignment preferences on-line and to volunteer for assignments; Officer Preference Statement is on-line for the officer corps; Interactive Web Response System (IWRS) allows officers and rating officials to check on-line if evaluation reports have been received and processed; “2X a Citizen” is a portal for USAR Soldiers at Army-Human Resources Command (HRC) that provides an abundance of information and allows them to verify documents and data in their official file and in some cases update that information on-line; OMPF On-line allows AC Soldiers to review their official files on-line from anywhere in the world and negates the need to request a copy of their OMPF on microfiche; Army Knowledge On-Line (AKO) permits email communication with, and between, every Soldier in the Army and allows Soldiers access to enormous amounts of information; DA Photo Management Information System (DAPMIS) permits Soldiers to review and transmit their official photo digitally; Civilian Personnel Online (CPOL) is an information portal for all to obtain information regarding the dynamic world of civilian personnel management; and eArmyU.com is a web application that allows Soldiers access to education opportunities no matter where they are in the world, 24 hours a day, 7 days a week. These are but a few of the ways PT is exploiting web technology.

*c. Corporate Data Base.* There are two databases that support the AC (separate databases for officers and enlisted personnel although integrated within TAPDB (Total Army Personnel Database)). The USAR and the NG also have their own personnel databases. The goal of PT is to have a corporate database (Integrated Total Army Personnel Data Base (ITAPBD)) to integrate all these databases, improve data accuracy, allow us to better account for personnel in multi-component units, facilitate manifesting Soldiers of all components for deployment, and to perform other HR

## How the Army Runs

missions and provide management information to HR managers and commanders that will facilitate operational decisions.

*d. Organizational Change.* Personnel organizations (i.e. Personnel Detachments, Personnel Services Battalions, Personnel Groups, and Theater Personnel Commands (PERSCOMs) historically provide direct and general support to units and organizations usually on a geographic basis. PT demanded the conversion of HR support to a more organic, operational G-1 concept. While the central aspects of PT outlined above remain valid and have, or will be, implemented, the conversion of the Army to a modular, brigade centric force has caused some significant changes in direction for providing personnel service support. Personnel Services Delivery Redesign (PSDR) migrates the core of HR support for essential personnel services to professionalized brigade and battalion S1 sections (e.g. Bde S1 will be an AG officer vice an Infantry officer in an infantry BCT). PSDR provides additional personnel and equipment resources to the brigade S1 to better perform the strength management mission, a function that shifted to the brigade S1 as a result of modularity, thus greatly reducing division G1 sections. PSDR also provides theater level units for casualty reporting, postal operations and R5 (reception, return to duty, rest and recuperation, replacement, and redeployment). Migrating tasks formerly performed by Personnel Services Battalions to brigade and battalion S1s is the key element in supporting the Army's concept of developing modular, expeditionary forces; making brigades capable of independent personnel operations regardless of location. PSDR empowers commanders to care for Soldiers with organic HR professionals, and also provides equipment to access HR systems and the authority to accomplish new and expanded tasks.

*e. Defense Integrated Military Human Resources System (DIMHRS).* DIMHRS was a DOD system designed to fully integrate personnel and pay functions and provide a single system for all the services. The concept is to have a DOD system for functions that are common to all the services versus separate Army, Navy, Air Force and Marine systems. In January 2009 the Deputy SecDef announced that the DIMHRS development strategy would change to give services more control of their DIMHRS-developed solutions. As a result the Army is developing a new strategy with an unspecified timeframe, but implementation is continuing. The new system is identified as the Integrated Personnel and Pay System-Army (IPPS-A) and is designed to leverage the knowledge and insights gained during DIMHRS development and apply that to Army systems.

### 13-3. Military HR life cycle functions

In a broad sense, MHRM describes the process of managing people by performing the essential functions of planning, organizing, directing, and supervising effective procedures necessary in administration and operation of personnel management. The life-cycle HR management functions are derived from the Army's life cycle, as follows.

*a. Personnel structure.* The HR portion of the Army's force development function where personnel requirements and authorizations are determined and documented.

*b. Acquisition.* This function ensures the Army is staffed with the correct grades and skills in numbers sufficient to satisfy force requirements, and has three components.

(1) *Manpower management.* The process of linking accession, retention, and promotion targets to Army requirements as measured against the military manning program in the PPBE.

(2) *Accession and retention management.* The process that converts manpower targets to missions and oversees execution.

(3) *Training integration.* The establishment of a demand for training programs and a system to control input and tracking of trainees and students.

*c. Distribution.* The function of assigning available Soldiers to units based on Army requirements and priorities.

*d. Development.* This function begins with accession training and continues throughout a Soldier's entire period of service. It includes institutional training, self-development, leader development and supporting programs such as the voluntary education, evaluation, promotion, and command selection systems.

*e. Deployment.* This function enables the Army to transition from the "prepare mode" to the "conduct of military operations" mode. Deployment includes mobilization, deployment, redeployment, demobilization, reset, non-combatant evacuation, and repatriating.

*f. Compensation.* This function encompasses the management of all pay, allowances, benefits, and financial entitlements for Soldiers, retirees, and annuitants. The dollars involved exceed one-third of the Army's total obligation authority.

*g. Sustainment.* This function involves the management of programs to maintain and advance the well being of Soldiers, civilians, retirees, and family members.

*h. Transition.* As individuals leave the Active Component (AC) for either the Reserve Components (RC) or civilian life, this function provides assistance to Soldiers, Army civilians, and family members.

### 13-4. Human resources (HR) leadership

*a.* Assistant Secretary of the Army (Manpower and Reserve Affairs (ASA (M&RA)) has principal responsibility for the overall supervision of manpower, personnel, and RC affairs.

*b.* The Deputy Chief of Staff (DCS), G-1, as the Army's personnel proponent, determines the broad objectives of

the military personnel management system. The DCS, G-1 establishes policy for and exercises ARSTAF proponent supervision of the system's functions and programs.

c. The CG, U.S. Army Human Resources Command (AHRC) is the Army's functional proponent for the military personnel management system and operates the Army's military HR systems within the objectives set by the DCS, G-1. The CG, AHRC also supports the MHRM system's automation requirements in the design, development, and maintenance of personnel databases and automation systems.

d. The CG, U.S. Army Soldier Support Institute (USASSI) develops and coordinates operational concepts, materiel requirements, organization and force design requirements, and integrates training into courses of instruction at the Adjutant General School.

### 13-5. Key military human resource (HR) publications

a. *Army Regulation 600-8, Military Personnel Management*. This regulation establishes the military personnel management system. It describes the functional structure of the system and sets forth the organizational structures that direct, integrate, and coordinate the execution of the system. The AR 600-8 series addresses specific subjects within the military personnel management arena.

b. *Field Manual 1-0, Human Resource Support*. This field manual describes the Army's personnel doctrine and how it fits into the Army's operational concept across the full spectrum of conflict, as well as how it supports unit commanders and Soldiers. It provides a common understanding of human resource support and encompasses the management concepts of personnel information and readiness; replacement, casualty, and postal operations; personnel accounting and strength reporting, mobilization and demobilization and other essential personnel services.

c. *AR 600-3, The Army Personnel Proponent System*.

(1) The HRC manages the personnel proponent system, designating personnel proponents, assigning their basic responsibilities, and defining the personnel life-cycle management functions. The objectives of the personnel proponent system are to:

(a) Identify a single agent (proponent) responsible for all personnel matters for each career field (officer, warrant, enlisted, and civilian).

(b) Fix responsibility for all career field-related matters.

(c) Ensure the civilian work force is integrated into the personnel proponent system.

(d) Ensure personnel management policies and programs established by HQDA incorporate career field-related considerations.

(e) Foster awareness and achievement of the objectives of the Officer Personnel Management System (OPMS), the Total Warrant Officer System (TWOS), the Enlisted Personnel Management System (EPMS), and the Civilian Integration into the Personnel Proponent System (CIPPS).

(2) The functions of personnel proponenty are accomplished through approximately 54 personnel proponent offices in conjunction with HRC. Together the proponents assist the DCS, G-1 in all personnel-related matters.

(3) The framework for proponenty consists of the eight life-cycle management functions. The personnel proponent system serves as the "honest broker" ensuring fairness, completeness, accuracy, and timeliness of all aspects of the personnel system.

### 13-6. Military occupational classification and structure system (MOCS)

a. The MOCS system translates manpower requirements into specific skills and grade levels. System policy is set forth in AR 611-1, *Military Occupational Classification and Structure Development and Implementation*. DA PAM 611-21, *Military Occupational Classification and Structure*, contains the procedures and detailed officer, warrant officer, and enlisted classification and structure guidance. Both publications are available as electronic publications on the U.S. Army Publishing Agency (USAPA) web site ([www.usapa.army.mil](http://www.usapa.army.mil)).

b. Changes to occupational identifiers within the MOCS are generally driven by the requirements determination process (see Chapter 2). Personnel proponents submit proposed changes to the system in accordance with responsibilities in AR 600-3 for recommending classification criteria. The Personnel Occupational Specialty Code Edit (POSC-Edit) System, an automated system maintained by HRC DCSOPS, is the official military occupational edit file used to edit and update data on authorized automated personnel systems. The file is updated based on approved revisions to the MOCS. It contains a listing of all authorized commissioned officer, warrant officer, and enlisted identifiers; grades associated with those identifiers; and other personnel information.

### 13-7. Key terms and interrelated documents and systems at the heart of the human resources (HR) process

a. *End strength (ES)*. The total number of personnel authorized by the Congress to be in the Army on the last day of the FY (30 September). This is normally provided in the *National Defense Authorization Act*.

b. *Force structure allowance (FSA)*. The sum of authorized spaces contained in all MTOE units and TDA type organizations.



## How the Army Runs

c. *Total strength.* The total of all personnel serving on active duty in the Army, including Soldiers in units and organizations and those in the individuals account.

d. *Operating strength (OS).* Those Soldiers available to fill spaces in MTOE units and TDA organizations sometimes referred to as the “distributable” inventory.

e. *Individuals account.* This account, often referred to as the Trainees, Transients, Holdees, and Students (TTHS) account, is comprised of those personnel unavailable to fill spaces in units. The six sub-accounts are trainees, officer accession students, transients, holdees, students, and USMA cadets.

f. *The Active Army Military Manpower Program (AAMMP).* The manpower program is produced as monthly updates and as decision programs for the POM, OSD budget submission, and President’s Budget. It is the report produced by the Enlisted Grades (EG) Model. Using a linear program, the EG Model operates within constraints such as end strengths, man years, and recruiting capability to develop an OS that matches the FSA as closely as possible. It also carries up to seven years of historical loss behavior to use as a projective (predictive) database. Inputs are the latest available strength, gains, and loss data. Vital data for the AAMMP comes from (or will come from) several manpower systems, most of which are discussed later in this chapter. These systems include the suite of forecasts that constitute the Officer Forecasting Model (OFM); Enlisted Strength (ES) model; the Individuals Account (IA) Model; and the ATRRS. The AAMMP records and/or projects strength of the Army; losses and gains; FSA; training inputs; officer, cadet, and female programs; and the TTHS account.

g. *Total Army Personnel Database (TAPDB).* An automated, standardized database containing military personnel data to fully support manning and sustaining functions during peacetime and under mobilization required by HRC and the NGB. It consists of integrated but physically distributed databases (Active Officer (TAPDB–AO), Active Enlisted (TAPDB–AE), USAR, ARNG, and Core). TAPDB Core contains selected data elements from each component database needed to support mobilization.

h. *eMILPO.* This web-based automated personnel information system is the Army’s database of record and primary Human Resources system. eMILPO provides commanders with management information reports; performs automated field records maintenance; and provides automated personnel information to TAPDB (AE, AO), the EDAS (AE) and TOPMIS (AO). eMILPO is web based, uses a centralized database and provides near real-time, Army-wide visibility on personnel information.

i. *Enlisted Specialties (ES) Model.* This is part of the HQDA decision support system. It is a personnel planning optimization model that computes recommended MOS and grade mix, enlisted accessions, training to support accessions, and in-service reclassification/ reenlistment and promotions to maintain force alignment through the POM cycle.

j. *Officer Forecasting Model (OFM).* The OFM uses time-series forecasting techniques to demonstrate the aggregate impact of current proposed manpower policies. It maintains force alignment by minimizing the difference between the desired and projected OS in each competitive category and grade. The major inputs are authorizations data, inventory data, loss rates, and promotion targets. The model provides output data that can be imported into spreadsheets or word processing documents for analysis and reporting. The OFM outputs support program and budget development, policy analysis, and other management activities and serves as an input or constraint into EG.

k. *Active Army Strength Forecaster (A2SF).* This system developed and used by DCS, G–1, replaced several legacy systems used in forecasting officer and enlisted strengths, gains, losses, and force manning. Using updated methodologies, the object-oriented design of this system provides more accurate and timely forecasting, as well as significantly enhanced detail (rates for specific populations, gender, etc.) to support DCS, G–1 decisions. It draws upon TAPDB for personnel source data and produces the AAMMP as one of its primary reports.

l. *Army Training Requirements and Resources System (ATRRS).* ATRRS is the Army’s system of record for training. It is an automated information system that provides personnel input to training management information for HQDA, commands, schools, and training centers during both peacetime and mobilization operations. The system contains information at the course level of detail on all courses taught by and for the Army. A major product of ATRRS is the ARPRINT.

m. *Army Program for Individual Training (ARPRINT).* The ARPRINT is a mission document that provides officer and enlisted training requirements, objectives, and programs for the AA, Army RC, DA civilians, other U.S. Services, and foreign military. Training is planned and executed on a FY basis and the goal is to train sufficient numbers in each MOS/branch and functional area to equal the projected authorizations as of the end of the FY.

## Section II

### The structure function

#### 13–8. Military manpower management

In Chapter 5, we addressed unit structure and force planning, describing how the force is sized and configured and how that force is accounted for in the documentation system. This paragraph, which should be viewed as an extension of Chapter 5, will focus on how the Army manages manpower and personnel once the force is configured and sized.

a. Manpower management at the macro level is the function of determining requirements, obtaining manpower, and allocating resources. It includes the determination of minimum-essential requirements, alternative means of providing

resources, and policies to be followed in utilization of manpower. It involves the development and evaluation of organizational structure and review of utilization. It includes Soldiers in the AC, ARNG, and USAR, Army civilian manpower assets, and certain contractor assets when a requirement is satisfied by contractual services rather than by Army military or civilian personnel.

*b.* Manpower managers deal with HR requirements from the perspective of the organizational structure in which they will be most efficiently and economically used. First, they focus on requirements demanding explicit grades and skills to perform specific tasks. Then, they focus on determining which requirements will be supported with authorizations (“spaces”). Finally, they combine force structure authorizations with requirements in the TTHS Account, also referred to as the Individuals Account, to determine the needs of the Army by grade and skill within constraints that exist. Simultaneously, HR managers focus on supporting requirements through the acquisition, training, and assignment of personnel (“faces”) to authorized positions.

*c.* The Congress, the OMB, OSD, and the OSA are not directly involved in the management of individual military personnel. They do, however, establish policies that prescribe the availability of this resource and the management latitude available to those involved in personnel management. For example, policies which limit permanent changes of station (PCS), establish tour lengths, set officer grade limitations, or place a ceiling on the hire of local national personnel affect the flexibility of personnel managers. OSD and, to a more limited extent, OMB, are involved in the force-structuring process. Managers, above the DA level, are concerned primarily with the management of spaces, while at descending levels below HQDA, they are increasingly concerned with the management of people and their associated costs. Much of the work at the departmental level involves decisions dealing with the aggregate of the force structure and inventory rather than the subsets of grade and skill. At lower levels, the HR process turns its focus more towards the “faces” and the management of people. Whenever the force structure changes, there is a significant cause and effect relationship on the many systems that support manpower planning and HR management.

### **13–9. Manpower management at HQDA**

*a.* In managing military manpower at the macro level, the key measurement used by HR managers is the Operating Strength Deviation (OpSD). OpSD is a measurement of how much the OS (faces) is deviating from the FSA (spaces). The OS must not be confused with the FSA. The anticipated size of the OS, however, gives a good idea as to how large a structure can realistically be manned. Throughout the year there can be many causes for these deviations, such as unpredicted changes in retention rates and seasonal surges in acquisitions. Personnel managers must constantly monitor the OpSD and adjust personnel policies to ensure the Army has an optimum match of faces to spaces. At the same time, the Army must comply with the congressional mandate to be at the authorized end strength on the last day of each FY.

*b.* Although the goal is to minimize the difference (delta) or deviation between the FSA and the OS, some deviation, the OpSD, almost always exists. A positive deviation (OS greater than FSA) means personnel are present in units in excess of structure requirements. A negative deviation (FSA exceeds OS) means the structure is larger than the quantity of personnel available to fill it. The OS is easily computed by subtracting TTHS personnel from the total strength. The OpSD is computed by subtracting the FSA from the OS.

*c.* The size of the OS is affected by fluctuations in the two elements employed in its calculation: the total strength (“ES” at year end) and total TTHS at any particular time. Changes in the OS over time and the magnitude of the FSA affect the OpSD. Often these quantities are compared only at the end of the FY (end strength). It is, however, often much more meaningful to view the situation on an average throughout the year by calculating man year values for each of these quantities. This provides more information than the frequently atypical and skewed end strength picture, which represents only one day in the entire year. Figure 13–1 illustrates the relationships between the components of the force just discussed.

*d.* The total number of personnel in TTHS will fluctuate considerably throughout the year due to a variety of reasons, such as the seasonal increase in transients during the summer and in trainees during the fall and winter. Past experience and estimates of the effects of policy changes make the number of personnel in this account fairly predictable. In the recent past, it has averaged about 13 percent of the total strength.

*e.* By knowing the TTHS and total strength projections, manpower planners can easily determine the size of the OS and use that as a basis for developing a FSA for building authorized units. TTHS, FSA, and OSD projections are all contained in the AAMMP.

*f.* The number of personnel in the TTHS is often directly attributable to the personnel policies in effect. Soldier casualties, fill of projected deploying units, and training requirements and policies are but a few examples of policies which affect the size of TTHS. Since TTHS has a direct effect on the faces available for FSA manning, these same policies have a direct impact on the number of units and organizations which the Army can field. Thus, manpower and personnel managers face a constant challenge to ensure a balance exists between the use of authorized spaces and the acquisition, training, and distribution of personnel assets to meet the needs of the Army. The stated personnel needs of the Army as expressed in its various organizational documents change on a daily basis as different units and organizations are activated, inactivated, or changed. However, the process of providing personnel to meet these changing needs is much slower.

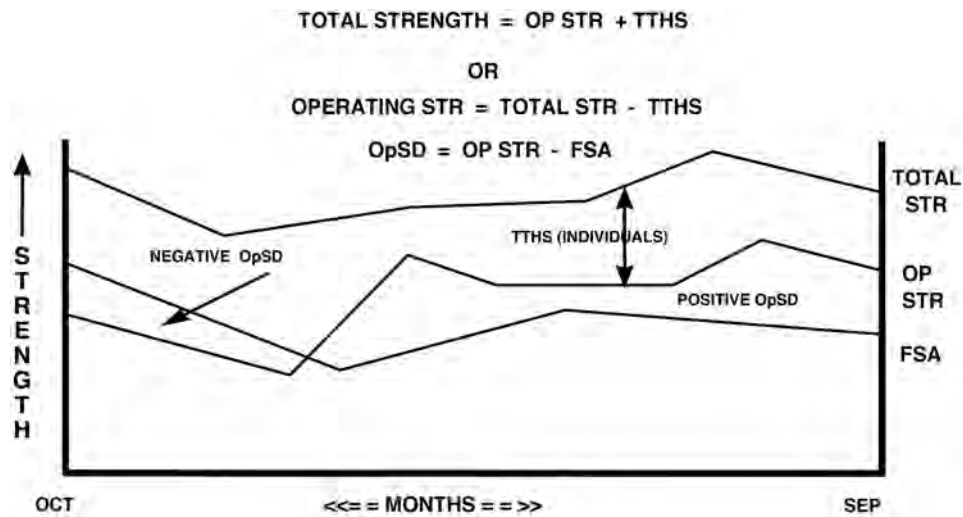

Figure 13-1. Strength Relationships

**13-10. Personnel management authorization document (PMAD) and Updated Authorizations Document (UAD)**

a. The PMAD and UAD are the Army’s documents of record for active component military authorizations. The PMAD and UAD provide authorizations data at the Unit Identification Code (UIC), Military Occupational Specialty (MOS), and grade level of detail for the current year through the end of the program. The PMAD and UAD support the distribution of personnel, strength forecasting, programming, budgeting, accessions, promotions, and training.

b. The primary inputs to the PMAD and UAD are built from annual updates of the force structure files provided by reflected in the HQDA DCS, G-3/5/7 Force Management Division: Structure and Manpower Allocation System (SAMAS) and The Army Authorization Documents System (TAADS) files. A PMAD is based on a “locked” SAMAS file. A normal year sees two locked SAMAS files and two corresponding PMADs. In between command plans, decisions are often made which cause significant changes to authorizations. An Updated Authorizations Document (UAD) which makes adjustments to PMAD authorizations is produced periodically to capture such changes. The publication of PMADs, the Army will publish UADs to capture emerging changes to personnel structure. A normal year sees the publication of two UADs. The personnel community uses PMAD and its most current UAD as the sole source of AC authorizations to Unit Identification Code (UIC), Military Occupational Specialty (MOS), grade, and ASI level of detail for the current and budget years. The focus of the PMAD and UAD is on detail for near-term distribution. The PMAD is the basis for decisions regarding accessions, training, force alignment, promotions, and distribution of personnel. Throughout this text the term PMAD refers to the PMAD itself or its most current UAD.

**13-11. Notional force (NOF) system**

As needed the Army may also publish a NOF. A NOF provides the same authorizations data as a PMAD or UAD — active component military authorizations at the UIC, MOS, and grade level of detail for the current year through the end of the program. The difference is that a NOF reflects force structure or personnel structure decisions that have not received approval. The purpose of a NOF is to support analysis only and its distribution is limited.

**13-12. Military force alignment**

Force alignment is “managing changing faces and spaces” simultaneously by grade level and CMF/MOS—reshaping a force today to also meet tomorrow’s needs. The always changing AAMMP, PMAD, and budget are intensively managed monthly for the PPBE six-year cycle (see Chapter 9); ensuring military personnel strength is skill-qualified and available for distribution. Force alignment strives to synchronize military personnel programs: promotions, recruiting, accessions, training, reenlistment, reclassification, and special and incentive discretionary pay. Simultaneously, every effort is made to provide professional career development consistent with Army force manning levels for qualified Soldiers. Management forums are the functional review (FR), personnel functional assessment (PFA), structure manning decision review (SMDR), monthly military personnel review (M2PR), training requirements arbitration panel/process (TRAP), and Career Management Field (CMF) reviews. Representation in shaping the officer and enlisted forces involves the entire personnel community in varying degrees of programming and execution. ES is a

major planning tool for enlisted force alignment analysis. The goal: to achieve a PMAD grade-CMF/MOS match to OS for the current year, budget year, and program years.

### Section III The acquisition function

#### 13–13. Enlisted procurement

a. Based on input from the PMAD (authorizations by skill and grade), TAPDB–AE (skills and grades on hand), and the AAMMP (projected accessions in the aggregate), the ES projects the numbers and training requirements for the various MOSs. This in turn is used to develop the annual program (ANNPRO) and the ARPRINT and feeds the personnel input to the ATRRS which is linked to the Recruiting and Training Reservation System (REQUEST) and the Reenlistment Reservation System (RETAIN) (Figure 13–2).

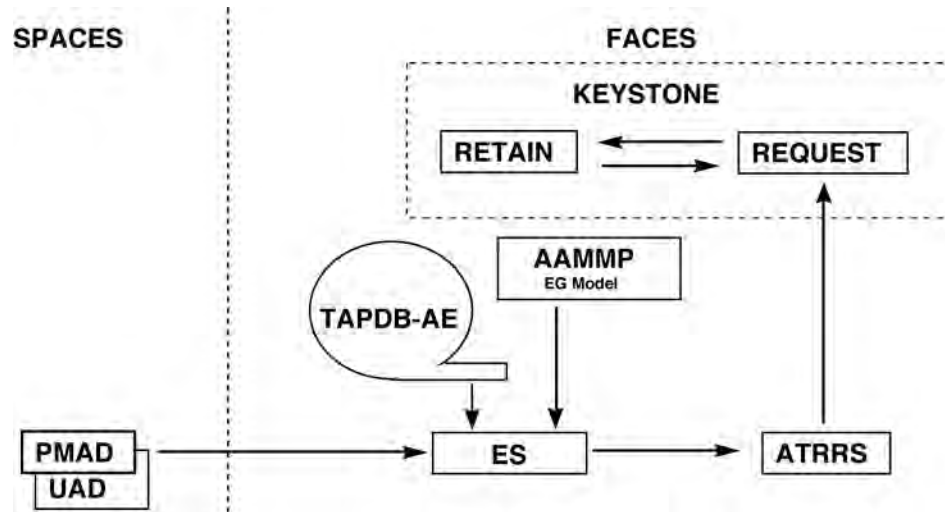

Figure 13–2. Enlisted Procurement

b. The mission of the US Army Recruiting Command (USAREC) is to obtain the quantity and quality of recruits to meet both AC and USAR requirements. Active Component enlistment options provide the vehicle by which Army applicants are attracted. The option packages vary and contain such incentives for applicants as training guarantees, unit/station of choice assignments (used primarily for Prior Service applicants), and payment of bonuses or education incentives. Additionally, the length of the enlistment period varies for certain options and skills.

(1) *Quality constraints.* The recruiter is constrained by quality standards which must be met. A potential enlistee is classified as a result of an Armed Services Vocational Aptitude Battery (ASVAB) which has 10 aptitude areas. ASVAB results place individuals into test score categories and determine both basic enlistment and specific MOS eligibility. Both law and Army policy constrain the number of certain test categories the recruiting force may enlist. The Army non-prior service (NPS) accession quality program seeks to maximize the number of high school diploma graduates and those in the upper test score categories, with a ceiling established for the lower test score categories.

(2) *MOS training targets.* All new Soldiers receive a minimum of twelve weeks of initial entry training (IET) prior to becoming available for deployment. All new Soldiers recruited by USAREC contract for a specific MOS, which is supported by a resourced training seat. Using projections from ES, HRC projects annual IET requirements for new Soldiers in the ANNPRO for each MOS. These requirements then feed into the ATRRS. In ATRRS, IET requirements combine with professional development and other training requirements and are presented at the SMDR for resourcing. Once approved by the Army leadership, all training requirements and approved training programs are identified in the ARPRINT.

(3) *Management of recruiting objectives.* The Recruit Quota Enlistment System (REQUEST) is an automated enlistment and training space management system designed to support the Army's recruiting and RC retention missions. The system is a worldwide, real-time, interactive system and is the controlling element for recruiters and RC retention NCOs in translating aggregate mission objectives to the MOS needs of the Army. It uses a worldwide telecommunications network with remote data terminals accessing a common data bank containing the Army's training

## How the Army Runs

programs determined by the ARPRINT and modified in the year of execution by TRAPs which either increase or decrease the SMDR ANNPROG to meet current requirements. ATRRS provides class schedules and quota allocations to REQUEST, which becomes visible to Army recruiters to enlist Soldiers to fill those quotas. The system provides reservation processing for enlistment options, accession controls, and management information reports from remote data terminals.

(a) REQUEST, designed to enhance the efficiency of Army recruiting, provides the Army with a means of allocating training resources to accessions. Enlistment options during periods of non-mobilization result from a review of the applicant's qualifications based on the ASVAB, physical testing, individual preference, and Army MOS requirements. An automated matching algorithm aligns the applicant's qualifications, desires, and aptitudes to the Army's needs. Qualification checks and other features of the system preclude erroneous enlistments into skills for which the applicant does not qualify.

(b) The REQUEST Unit Distribution Program (RUDIST) adds a unit vacancy and distribution guidance file to the REQUEST System. A portion of the training spaces for, MOSs available under an enlistment option, guarantees a first assignment is allocated to specific units and stations. Allocations of first assignment are based upon projected unit requirements and distribution policies. This is primarily used for Prior Service Soldiers. For Non-Prior Service applicants, the majority are contracted as uncommitted, providing maximum flexibility to the distribution system to assign them to a unit where they best meet an army requirement.

(c) The REQUEST System is the controlling element for recruiters in translating aggregate recruiting objectives to the MOS needs of the Army.

### (4) *Military Entrance Processing Station (MEPS).*

(a) The MEPS is a jointly staffed Service activity charged with aptitude testing, medical examination, moral evaluation, and administrative processing of applicants for the Armed Forces. DA is the DOD Executive Agent for the MEPS. The Military Entrance Processing Command (MEPCOM) commands and controls the MEPS.

(b) Once the recruiter has determined the applicant's desire to enlist and his or her areas of interest, he or she can administer an enlistment screening test which gives an informal indication of how the applicant might fare on the ASVAB. If the applicant continues his or her interest, he or she goes to MEPS for processing.

## 13–14. Warrant officer (WO) Procurement

a. Warrant officers are highly specialized officers, appointed based on technical competence and leadership abilities. USAREC procures warrant officer candidates for the AC. DCS, G–1 develops a recruiting goal by MOS for each FY. USAREC uses this and an internally created lead refinement list, to direct recruiting efforts, especially for hard-skill MOSs with existing or projected critical shortages. Applicants come from the best of the NCO ranks, outside the Army (primarily aviation applicants), other in-service sources such as other Services, commissioned officers, and members of the RC.

b. Applications of all eligible individuals are evaluated by a HQDA selection board. USAREC conducts the board which is composed of a field grade officer president and warrant officer members from each branch with applicants to be considered. Those recommended by the board on an order of merit list are slated to attend the Warrant Officer Candidate School (WOCS), in a candidate status, as procurement openings present themselves. Each new WO1 then attends the appropriate warrant officer basic course (WOBC) to complete certification training.

c. The recruitment, application processing, and selection of warrant officers for the USAR is performed in a similar manner as the AC. However, USAREC recruits warrant officer candidates against specific USAR unit vacancies. In addition, USAREC accepts and processes applications for Active Guard/Reserve (AGR), IMA, and IRR vacancies. The USAR uses boarding and school-slating procedures similar to those used by the AC. The ARNG solicits applications through announcement of vacancies via an internal recruiting effort. The boarding and school-slating procedures are as determined by each individual State Adjutant General. All RC WO applicants attend WOCS and WOBC. RC versions for many WOBCs are available.

## 13–15. Commissioned officer procurement

The PMAD is the authoritative source for officer requirements. Authorizations are defined by unit, by Area of Concentration (AOC), and by grade for all grades except WO1. There are no authorizations for WO1s in the US Army. Procurement each year is based on an analysis of the current inventory and the losses projected by the DCS, G–1. This annual procurement number is then disaggregated by HRC into an allocation for each branch. The G–1 then distributes an allocation of branches to each commissioning source. Sufficient officers must be procured each year to ensure an adequate number of trained individuals by grade, AOC, and skill is available for utilization in the future. There are constraints associated with the management of officer end-strength contained in Title 10, USC. There is no specific force structure allowance for the officer corps within the authorized end-strength of the Army. However, for field grade officers, Title 10, USC restricts the number of officers serving at each grade as a proportion of the size of the officer corps. Training constraints limit the number of officers that can be procured in each branch.

a. *Officer sources.* The sources of officer procurement for the basic branches are OCS, ROTC, and USMA. Requirements are determined by the DCS, G–1 and filled through the various commissioning programs and special branch programs. To supplement these appointments, recall of reserve officers, recall of retired officers, direct

appointments and inter-service transfers are also used. The inter-service transfer program allows the Army to access members of the Air Force, Navy, Marine Corps or Coast Guard to fill shortages in the mid-grade ranks and has proven effective as the other services have been decreasing officer strength. All commissioned officers incur a statutory eight year military service obligation (MSO) which may be supplemented by concurrent or consecutive obligations like those described in AR 350–100. Officers may serve their MSO in a variety of ways depending on the source of their commission as outlined below:

*b. The Officer Candidate School (OCS).*

(1) OCS at Fort Benning, Georgia, trains and commissions officers for both the Active Component (AC) and Reserve Component (RC). AC OCS graduates incur a three-year active duty service obligation (ADSO) and may serve the remainder of their 8 year MSO on AD or in the RC. RC graduates receive a reserve appointment and return to reserve status after completing their initial officer training requirements such as BOLC, Airborne or Ranger School. RC graduates incur not only the statutory MSO, but must serve 6 years of that in a TPU as a drilling reservist.

(2) In-service candidates are enlisted Soldiers serving on active duty. Semi-annual selection boards at HRC select qualified Soldier applicants for OCS. Branches are assigned base on the needs of the Army and candidate's preferences. In-service candidates incur a 3 year ADSO within their 8 year MSO.

(3) Enlistment option candidates are qualified college graduates who elect to enlist in the Army in order to attend the OCS. These candidates enlist in the Army and attend basic training followed by the 12-week OCS course. Enlistment option candidates incur a 3 year ADSO within their 8 year MSO.

(4) Additionally, each state runs a National Guard OCS to commission officers into the RC.

*c. Reserve Officer Training Corps (ROTC).* The ROTC trains and commissions officers for both the AC and the RC. Branching is accomplished through Cadet Command and HQDA boards based on the needs of the Army and the cadet's qualifications, standings on the Order of Merit List, and individual preferences.

(1) *AC.* Upon accession, scholarship cadets incur a 4 year ADSO within their 8 years MSO, while non-scholarship cadets incur a 3 year ADSO with their 8 year MSO. The remainder of any MSO may be served in the AC or in the RC.

(2) *RC.* Scholarship cadets must serve in a TPU all eight years of their MSO, while non-scholarship cadets must serve at least six years in a TPU. The remainder of the MSO may be spent in the IRR.

*d. United States Military Academy (USMA).* The USMA trains and commissions officers for the AC. A formal branch selection process matches the needs of the Army with cadet preferences based on a strict order of merit list. The active duty service obligation for USMA graduates is five years and the remainder of the MSO may be spent in the AC or RC.

*e. Special branches.* The special branches - Judge Advocate General (JAG), the medical branches, and the Chaplains Corps procure officers through their individual programs, and service obligations vary depending upon the program. Procurement for most medical officers and Chaplains has been assigned to USAREC while JAG is responsible for its own recruiting.

## Section IV

### The compensation function

#### 13–16. Compensation overview

*a.* Compensation is a relatively recent addition to the military HR life cycle. Over one third of the Army's total obligation authority relates to compensation and only through controlling the cost drivers (number, grade, and skill of Soldiers) can the Army manage the dollars appropriated by the Congress.

*b.* The Army's personnel assets are centrally managed as are Army resources tied to these assets. The Army pays against the inventory (assigned strength), but authorizations and personnel policies are the cost drivers.

*c.* Personnel management policies, force structure decisions, and content of the force influence the MPA appropriation requirement. Among these cost drivers are the following:

- Pay rates
- Retirement rates, including number of medical retirements vice normal retirements, and early retirements (less than 20 years of service)
- Cost of food
- Social Security and Medicare rates
- Basic Housing Allowance (BAH), including programs similar to Residence Community Initiative (RCI) privatize housing, privatize barracks
- Military Health Care
- Stationing plans and manpower
- Clothing bag
- Entitlements
- Special Pays (Medical, Aviation, Special Duty Assignment Pay (SDAP), etc)
- Assignment Incentive Pay (AIP)

## How the Army Runs

- Enlistment bonuses
- State of the Economy
- Reenlistment rates/bonuses
- Separation Pays
- Marital status
- Size of the Army OCONUS and overseas station allowances
- Tour lengths
- Force changes
- Grade and skill content
- Active Duty Operational Support (ADOS)
- Unemployment Compensation
- ROTC pay/scholarships
- JROTC support

*d.* The MPA account pays the force, moves the force, subsists the force, and supports the force. Pay includes pay and allowances for officers, enlisted, and cadets. Movement is managed under the Permanent Change of Station (PCS) account, which is sub-divided into accessions, separations, training, operational, rotational, and unit moves. Subsistence provides payment for the basic allowance for subsistence and subsistence in kind. Finally, support comes in other military personnel costs such as education, adoption, unemployment, death gratuities, and survivor benefit programs.

### 13–17. Manning Program Evaluation Group (PEG)

At the departmental level, all personnel related programs are contained within the Manning PEG. The Manning PEG has responsibility to determine the valid requirements for those programs in Figure 13–3. All should come together in providing the right skills, at the right place and time.

---

<b>Pay</b> Military Pay, Army (MPA) National Guard Pay, Army (NGPA) Reserve Pay, Army (RPA) Military Technicians (ARNG)	<b>Readiness</b> Examining (MEPCOM) HRC/HRC-STL Reception Battalions Recruiting & Advertising Reserve Recruiting/Retention/Fam Spt Officer accession programs
<b>Service Wide Support</b> Acquisition Corps Army Broadcasting Chaplain Support Agency Correctional Facilities Disposition of Remains Regional CPOC	<b>Automation Support</b> e-MILPO ACPERS ATRRS KEYSTONE PERMS MEPCOM Automation HRC-STL Automation Total Army Personnel DB (ITAPDB) HRC Automation Spt USAREC Automation Spt
<b>Special Programs</b> Army Career Alumni Program Bands (Special & Garrison) Boy/Girl Scouts Golden Knights Junior ROTC Army Museum Program Veterans Education Assistance Pgm	<b>Leader Development</b> Army Continuing Education System Tuition Assistance Army Civilian Training & Education Development System (ACTEDS) Civilian Intern Program ARNG Continuing Education

Figure 13–3. Manning Programs

---

## Section V

### The distribution function

#### 13–18. Enlisted distribution and assignment

*a. Distribution challenge.* In theory, the distribution planning and assignment processes place the right Soldier with the right skills at the right place at the right time. In fact, the system does a very credible job for those MOSs and grades which are nearly balanced, those for which the overseas-to-sustaining base ratio is supportable, and for those in which there is a high density of personnel in substitutable skills. The problem arises in the MOSs where these conditions do not exist, and a sharing of shortages is required for all commands. When certain commands, or organizations, are exempted from “shortage-sharing” based upon special guidance, it compounds shortages to be shared by the organizations lower in priority. The readiness cost of this compounded “shortage-sharing” comes to light when each organization must assess its mission capable status in the monthly readiness reporting. The personnel component of the report involves several calculations, but its principal factors are assigned strength, available strength, available senior grade personnel (SGT and above), and MOS qualification.

(1) Enlisted personnel distribution is a very complex business, replete with pitfalls and shortcomings because of the rapidly changing variables which exist—force structure changes, recruiting success, training attrition rates, retention rates, military personnel authorizations, dollar constraints, and most of all, the unpredictability of the individual Soldier, his or her health, and his or her family. All of these variables point up the critical factors which govern successful distribution - the accuracy and timeliness of the databases being used for analysis. Authorizations not approved and posted expeditiously to PMAD and individual change data not properly reported for posting on the TAPDB–AE make the already complicated distribution system less responsive.

(2) Soldiers have the ability to influence their assignment in several ways. One is by submitting an assignment preference. They do so via a web based application called ASK (Assignment Satisfaction Key), which allows the Soldier to update his/her assignment desires and volunteer for valid requirements directly with HRC in real-time.

*b. Distribution planning and priorities.*

(1) The Army introduced the program of Force Stabilization in FY04, in order to provide Soldiers and their families more predictability and stability during periods of high OPTEMPO, and build more cohesive, combat-ready units. This program has two primary components: Stabilization and Unit Focused Stability. Stabilization is designed to assign Soldiers, on their initial assignment, for much longer periods of time than in the past. During this extended period, the soldier may deploy several times, but his/her family would enjoy a level of stability. Also during the Soldier’s career, he/she would return to that installation repeatedly, if possible. Unit Focused Stability synchronizes the Soldier’s tour with the unit’s operational cycle, but also allows commanders flexibility to manage turbulence within their unit by focusing training around replacement periods.

(2) The basic document which defines priorities for the distribution of enlisted personnel to all units/activities is the FY HQDA Manning Guidance. DCS, G–1 publishes and distributes this guidance to HRC and to Army commands for implementation after the CSA approves. The guidance provides responsibilities at all levels for manning units and expected level of fill commands can expect. Distribution is driven by requirements to fill approved authorizations documented in PMAD/UAD, DMO, and overstrengths in specific high priority units. Distribution is affected by recruiting and retention goal achievement; unprogrammed losses; and fiscal constraints affecting promotions, PCS movements, and end strength. Special priorities are based on operational and training requirements for special skills, such as Ranger qualifications and linguists.

(3) In 1999, the CSA dramatically changed the distribution priorities in the Army, by establishing four general priorities. The priorities were: 1) AC divisions, ACRs, and other high priority organizations/positions (e.g. Drill Sergeants, prison guards, recruiters, 75<sup>th</sup>Ranger Regiment, AC/RC positions, CTCs, etc.); 2) early deploying units; 3) the remainder of the TOE Army not previously filled; 4) TDA Army. These priorities were designed to first fill warfighting formations, but had to be accomplished without breaking any organizations in the process. Manning the Force in accordance with the CSA priorities, a key ingredient of the Personnel Transformation initiative, postured the Army very well to respond to Operation Enduring Freedom (OEF) and Operation Iraqi Freedom (OIF). As these operations became more protracted enlisted distribution guidance changed in FY04 to focus primarily on units that were deployed, units preparing to deploy, and other high priority units based on policy or statute and the guidance has been adjusted almost annually. FY10–11 G–1 distribution guidance employs a phased readiness methodology and is reflected in Figure 13–4.

(4) The HQDA Active Component (AC) Manning Guidance for Fiscal Year (FY) 2011 establishes AC manning priorities, manning goals, and responsibilities at all levels for the accomplishment of these goals. The Army remains in an environment of high demand with critical shortages preventing the meeting of all manning requirements. Manning priorities, strategies, and goals are designed to support our Army in this environment. Personnel distribution decisions continue to be a function of a unit’s mission and deployment status: deployed; preparing to deploy; or not expected to deploy. FY 2011 will be a transition year as we move toward implementation of ARFORGEN Interim Aim Points in



FY12. This transitional Manning Guidance will provide Transitional Aim Points, based on assigned strength, for deploying units. Based on our successful rebalancing of the force and a projected decrease in demand, we expect to be positioned to begin implementing ARFORGEN Interim Aim Points in 2d Quarter FY12. The manning methodology is reflected in Figure 13-4.

**FY 2011 Manning Priorities & Standards**

<u>Deployers (Goal &gt;=100% Assigned)</u>			
GRF BCTs	USCENTCOM	ARCENT HQ (93%)	AFPAC Hands
Transition Teams	AAB	Special Msn Units	USFOR-A
Deploying Units	ODRP	USASOC	TF 435
CSTCA	TF Paladin	USSOCOM	NTM-A

<u>Priority Missions (Goal 90-100% Assigned)</u>			
CSF & MRTC*	IET CDR/XO*	Old Guard	CCMRF BCT*
PMS	WTU Cadre*	AETF	20 <sup>th</sup> Support Cmd (CBRNE)
162d Inf Bde	USF-I	JTF-GTMO	Drill Sergeants*
USAREC-Co Cdrs*	USA Ele WHCA	RTB	ARNORTH
NATO PE	EUSA	JIEDDO	

<u>Remainder of Units</u> (Filled in accordance with available Army inventory)			
---	--	--	--

GRF-Ground Reaction Force	AAB-Advisory & Assist Bde	BCT-Brigade Combat Team
USCENTCOM-US Central Command	ARCENT-Army Central	AFPAC Hands- Afghanistan/Pakistan Emersion Program
NTM-A- Nato Tng Mission-Afghanistan	CSF-Comprehensive Soldier Fitness	MRTC-Master Resiliency Trainer Course
USASOC-USA Special Opns Cmd	USSOCOM-US Special Opns Cmd	USF-I- US Forces Iraq
PMS-Professor of Military Science	IET-Initial Entry Training	CCMRF-CBRNE Consequence Mgt Response Force
WTU-Warrior Transition Unit	AETF-Army Evaluation Task Force	CSTCA-Combined Security Transition Cmd-Afghanistan
GTMO-Guantanamo Bay	CBRNE-Chemical, Biological, Radiological, Nuclear or High Explosive	
USAREC-USA Recruiting Command	WHCA-White House Communication Agency	RTB-Ranger Training Brigade
EUSA-Eighth US Army	JIEDDO-Joint Improvised Explosive Device Defeat Organization	
ARNORTH-Army North		(*)-Will be Manned at 100%

Figure 13-4. Manning Priorities and Standards

*c. Enlisted Distribution Target Model (EDTM).*

(1) The EDTM is an automated system which creates enlisted distribution targets by MOS, grade and UIC. The model fills each UIC reflected in the PMAD with projected available inventory from the ES in accordance with the DCS, G-1 distribution policy. This results in an optimum distribution of scarce resources consistent with distribution policy fill priorities. The EDTM constrains the assignment process to coincide with the projected OS targets. It represents the assets the Army realistically expects to be available for distribution.

(2) The EDTM is maintained by the Enlisted Readiness Division, Enlisted Personnel Management Directorate (EPMD), HRC. The targets are produced monthly with EDTM targets for grade bands E1-4, E5-8 and E9. Current month (CM) through CM+18 are visible to field personnel managers via Personnel Network (PERNET) using the Enlisted Distribution and Assignment System (EDAS).

*d. Management systems.* HRC uses several automated data-processing systems to distribute, manage, and develop active duty enlisted personnel. These systems are described below and reflected in Figure 13-5.

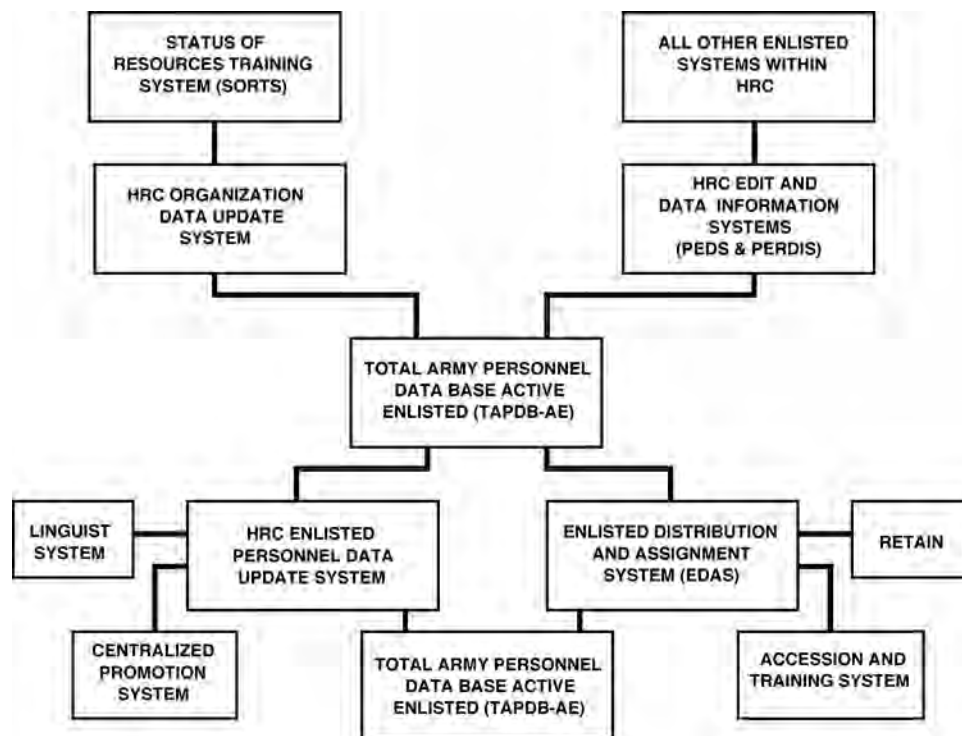

Figure 13-5. Enlisted Automation Management System

(1) TAPDB is the heart of the overall system. It consists of three logical components containing personnel, requisition, and organizational data. The personnel component (PER DB) contains personnel information on every active duty Soldier. HRC and DCS, G-1 use this information to determine Army readiness, strength, promotion eligibles, reassignable personnel, and training requirements. The requisition component (REQ DB) contains information on requirements to move individuals and information on those who have been directed to move (assignments). The organization component (ORG DB) contains information on location and status of Army units; it does not contain any authorization or unit strength information.

(2) HRC Enlisted Personnel Data Update System (PEPDUS) is one of the major systems used to update the data on the TAPDB. It consists of two components, a batch component and an on-line, interactive component that allows managers worldwide to query and update personnel data.

(a) The batch component receives transactions daily from other systems. The primary source is eMILPO, but other sources such as the Centralized Promotion System and the EDAS submit transactions. PEPDUS is also designed to support mobilization. During a mobilization scenario it is able to process over 500,000 transactions daily. As PEPDUS updates the TAPDB, it also creates transactions that are passed back to eMILPO (receipt notices, update transactions, DA error notices, etc.), in order to update the TAPDB Mobilization Databases (TAPDB-MOB), and provide feedback to other systems.

(b) The on-line interactive component allows EPMD managers to update data items on the PER DB. Some examples are CONUS and OCONUS assignment preferences, assignment eligibility, and date eligible for return from overseas (DEROS). As EPMD managers update, PEPDUS updates the eMILPO Personnel File.

(3) Enlisted Distribution and Assignment System (EDAS) is an on-line system which allows EPMD managers to create, review and update requisition and assignment data. It also provides reports for those managers for strength management of the force. It has several batch programs that exchange information with external systems. EDAS allows EPMD distribution and assignment managers to work with one collection of information on the same computer. Under previous systems, updates to information occurred only during the weekend; updates are now instantaneous. Consequently, decisions made by one manager are immediately available to all other managers. Moreover, EDAS provides field users the capability to view and in some cases update the same information that distribution and assignment managers use to make decisions. Finally, EDAS reduces the time to validate a requirement, select a Soldier to fill the requirement, and transmit the assignment instructions to the field. A more detailed explanation on how EDAS is used in distributing and assigning Soldiers is presented in a subsequent section.

## How the Army Runs

(4) Assignment of newly trained personnel.

(a) Permanent unit assignments are based on input to HRC from basic and advanced individual training centers via the Student/Trainee Management System-Enlisted (STRAMS-E), a module within the ATRRS. Information is passed by ATRRS to EDAS which processes newly trained personnel for assignment.

(b) If an individual has an enlistment agreement for a unit in an area, he or she is assigned according to the enlistment contract upon satisfactory completion of training. Soldiers who have no unit/area options are assigned against requirements in accordance with a distribution plan prepared by HRC. Assignment instructions are generated by EDAS and sent directly to losing commands. The transaction is processed through EDAS and is posted to the TAPDB. EDAS advises the gaining command of the assignment.

e. *Enlisted distribution management.* HRC Enlisted Readiness Division manages the strengths of major overseas commands, Army commands, and special management and functional commands worldwide. HRC established a direct requisition authority to each of the BCTs/ACRs to ensure projected gains to those organizations were not diverted by installation strength managers. Under modularity and brigade centric organizations, brigades with organic military HR assets will requisition and receive replacements directly from HRC. Strength managers at HRC project the assigned strength of an activity ranging from the current month's strength out to 12 months, and determine how many Soldiers are needed each month to ensure the commands meet targets established by the FY enlisted distribution policy (Figure 13-4). These aggregate totals (arranged by individual rank and rank bands, i.e., private-specialist, sergeant-staff sergeant, sergeant first class-master sergeant, and sergeant major) are the basis for transition into individual MOS requirements. These "top of the system" strength managers then determine how many requisitions for replacements should be placed in EDAS, by either directly building the requisitions or coordinating with field commanders.

f. *Overseas requisitions.* Requirements for Korea, USAREUR, and USARPAC are analyzed 10 months into the future (8 months for USARPAC). Using the EDTM targets, distribution managers allocate requisitions to each command at the 4-character MOS level, allowing commands 2 weeks to submit requisitions at the 9-character MOS level, including any other special requirements.

g. *CONUS requisitions.*

(1) For CONUS installations, requisitioning is partially constrained through a process known as requisition allocation plan-CONUS (RAP-C). Since fill of vacancies in CONUS commands is partially based on eligible overseas returnees, RAP-C keys on DEROS data in the TAPDB-AE and calculates the number of Soldiers in an MOS and grade who are expected to return to CONUS in a requisition month (two months after DEROS month). CONUS requisitions are normally validated 12 months out. Distributors at HRC, using the EDTM, allocate these Soldiers. If the EDTM requires more requisitions than Soldiers returning from overseas, additional requisitions are loaded, which will require CONUS-to-CONUS moves.

(2) The next effort for HQDA distribution managers is validation, whether for CONUS or OCONUS. If an apparent over or under requisitioning exists, the manager attempts to resolve the discrepancy with the command/installation prior to making a decision to validate, or not validate, requisitions. Discrepancies in the two projections may be caused by a proponent-approved authorization change at the unit level not yet recorded in the Personnel Structure and Composition System (PERSACS), or by more current authorizations data available to HRC through the use of the PMAD, or by more current gain and loss data. The problem is resolved prior to the submission of the validated requisitions for assignment processing in the EDAS.

(3) Distribution managers continually monitor command and installation strength projections and adjust accordingly. Deletions, authorization changes, and other variables may create need for top loading or canceling requisitions.

h. *EDAS.* EDAS consists of several major subsystems: management information, requisition, policy, assignment, and personnel.

(1) EPMD distribution managers use the management information subsystem to determine an organization's authorized, assigned, and projected strength. Managers can obtain this information by MOS, skill, CMF, grade, special qualification identifier (SQI), ASI, language, Distribution Management Level/Sub-Level (DML/DMSL), location (installation, state, and country), command, requisition activity code, TPSN, and/or UIC. This information is used to determine the number of valid requisitions needed to maintain that organization at an acceptable strength level.

(2) After the distribution managers determine the number of valid requisitions, the assignment managers must fill them. The policy and nomination subsystems assist assignment managers by recommending which Soldier should be assigned to each requisition and also provide alternate recommendations.

(3) The policy subsystem allows EPMD managers to enter assignments into EDAS that are in accordance with current policies. For example, Soldiers with Homebase/Advanced Assignment Program (HAAP) agreements can only be recommended for assignments which fulfill HAAP agreements.

(4) In addition to making assignments, the assignment subsystem provides the capability to delete or defer Soldiers. If field users have the authority to approve a deletion or deferment, they can complete the action interactively through the assignment subsystem as an alternative to submitting it through eMILPO. If field users do not have the authority to approve the action, they can request a deletion or deferment electronically through EDAS. Throughout this entire process, the field user can interactively monitor the current status of the request.

(5) One important aspect of EDAS is that the system tightly controls access and what the user can do in the system.

Some modules allow users to query data, while others allow updates. EDAS controls access by individual user and provides system managers with audit trails which can be used to determine who accessed or changed data in the system. Additionally, EDAS controls which records a user can query and/or update.

(6) The EDAS promotion points update module allows field personnel managers to post promotion point data for Soldiers in grades E4 and E5 directly to the TAPDB. This function allows personnel managers to review and update the information that is resident on the TAPDB. This information is then used by HRC to determine the numbers of promotions for each month by MOS. By using the promotion subsystem, field managers can see those Soldiers, by name, which were considered eligible for promotion when the calculations were performed. If the data on the Soldiers is incomplete or in error, field managers use the EDAS promotion point update and promotion update functions to update the data, promote the Soldier, or alert HRC managers as to why Soldiers will not be promoted. EDAS returns the promotion on the Soldier to eMILPO which then updates local databases and the DFAS.

(7) EDAS fully supports mobilization scenarios. The policy subsystem can store and maintain any number of scenarios (peace, limited mobilization, full mobilization, etc.) and the user can invoke any one of the scenarios in seconds. The system can also evaluate “what if” questions.

*i. The Army Automated Reenlistment/Reclassification System (RETAIN).* RETAIN is a real-time automated system that identifies and reserves training spaces or assignment vacancies for potential reenlistees and determines MOS availability for Soldiers undergoing reclassification based upon the individual’s qualifications and the needs of the Army. It is also used to process enlisted Soldiers for reenlistment or reclassification assignments.

(1) If the Soldier is requesting a MOS training space, RETAIN accesses the REQUEST system to determine if there are any AC in-service quotas available for the school the Soldier desires. If the seat is available, it allows the retention NCO or reclassification authority to make a reservation and puts the record on the RETAIN wait list for an ultimate assignment in the new MOS upon completion of training. The wait list manager is required to give the Soldier an ultimate assignment 120 days prior to the start date of the school. RETAIN is also used to process potential reenlistees for assignments. RETAIN will determine if there are any vacancies available for the installation/overseas area the Soldier desires. If a vacancy exists, it will be offered to the Soldier. If a vacancy does not exist, the Soldier may elect to be put on the RETAIN wait list.

(2) The RETAIN wait list is for those Soldiers desiring an installation/overseas area which was not available and no other area/location was available at the time of entry into RETAIN. Weekly, the RETAIN system attempts to match Soldiers on the wait list to the place they desire to go.

(3) RETAIN is a valuable tool that commanders, career counselors, and personnel service centers use in counseling Soldiers for reenlistment and reclassification. Since RETAIN is a real-time automated system it can provide current, accurate information to the potential reenlistee or Soldier involved in reclassification.

*j. Reclassification.* RETAIN also addresses reclassification. Reclassification is a process which provides for migration from one MOS to another. It supports policies and goals to reduce MOS overstrength and alleviate shortages. In addition to individual voluntary requests, mandatory reclassifications are necessary when a Soldier loses qualification, for example, loss of security clearance, or disqualifying medical condition. Special reclassification programs, such as “Fast Track,” realign MOS overages through reenlistment and reclassification. Soldiers possessing the overstrength MOS may be allowed to reclassify or reenlist for retraining without regard to expiration of term of service (ETS).

### 13–19. Officer distribution and assignment

The Army continues to adapt and change its officer assets by branch, functional area and grade equal the sum total found in authorization documents, taking into consideration PME schools and training programs for each branch and functional area. In fact, force structure change and growth due to modularity is by far outpacing the Army’s ability to meet authorizations in certain skills and grades.

*a. Distribution planning.* The officer distribution planners and managers at HRC are influenced by three principal factors: officer assets (inventory), authorizations, and priorities. All three are in a constant state of change. Therefore, there is a need for a master distribution plan that will ensure that all commands, agencies, and activities receive, according to priority, an appropriate share of the available officer assets/inventory. The foundation of this master plan is a management tool known as the Dynamic Distribution System (DDS), formerly the Officer Distribution Plan (ODP), and also formerly the Officer Distribution System (ODS). The DDS brings assets/inventory, authorizations, and priorities into balance and is one of the Army’s most important systems for officer distribution planning. DDS allows the Army to be more flexible during times of war and transformation, as DDS allows us to shift with the Army’s changing priorities.

*b. The DDS process.* If available officer assets matched the requirements identified through the PMAD, by branch, functional area, and grade, officers would simply be assigned against authorizations. However, this is rarely the case. As with most resources, there is generally a greater demand than there is a supply, and officer shortages in certain units is a result. Some system of priorities is needed to help manage these shortages. After the available officer inventory has been compared with the authorizations in the PMAD, a computer system, Statistical Analysis Software (SAS) runs a program model to determine officer needs based on current Army Manning Guidance initiatives and any special distribution guidance as determined by HQDA (Figure 13–6). Under DDS, an available officer fits into one of two categories: non-discretionary or discretionary. An important concept to keep in mind is what defines an available

officer. An available officer is defined differently for each type of unit. Generally speaking, a deploying BDE needs a non-dwell restricted, deployable, PME graduate that needs key development time. The opposite is true for the National Training Center which needs a KD complete officer with recent deployment experience. A non-discretionary move includes those moves that involve hard dates in an officer's career, e.g. a DEROS from an overseas assignment, a report date to a professional school, a graduation date from a school, a command selection, a PMS selection, a joint tour completion, a sequential assignment report date, or a retirement date. These can generally be determined from data analysis from TOPMIS. A discretionary move includes those moves that are triggered by an assignment officer working to ensure an officer continues appropriate career development e.g., an officer needs a new skill set (Joint or Army Staff), an officer's skills are no longer applicable to the current assignment, or where an officer is pre-positioned for a career enhancing position (Command, Schools, etc.). Moves driven by the individual needs of the officer are also included in this category e.g. EFMP, joint domicile, and compassionate reassignments and personal preference.

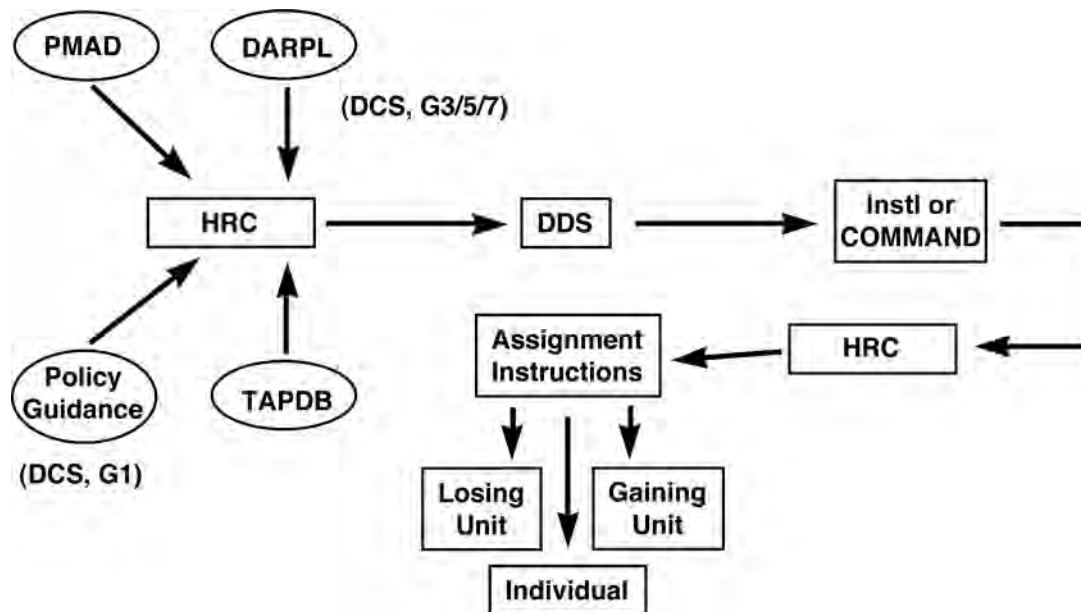

Figure 13-6. Officer Distribution

*c. Officer requisition system.* The officer requisition system is designed to fill the officer requirements of all commands and activities.

(1) *Total Officer Personnel Management Information System (TOPMIS).* This is a fully integrated management information system which supports the officer management process within HRC and at worldwide requisitioning activities. TOPMIS is composed of seven operational modules:

(a) The control module provides security of access and updating, creates individual user profiles, and provides on-line electronic mail service to all TOPMIS users.

(b) The strength module displays operating and projected strength down to the CMF level for requisitioning activities in various report formats.

(c) The goaling and monitoring module displays assignment goals for the FY by grade and CMF. It is also used to plan the DDS and monitor its progress.

(d) The requisition module allows distribution managers and the requisition activity managers to generate, edit, validate (based on the DDS), and update requisitions. This module generates and maintains requisitions based on projected strength. The final product is a list of requisitions for career managers to fill.

(e) The asset/officer record brief (ORB) module provides an on-line version of the ORB and the capability for on-line updating of ORB fields by career managers. This module also provides access to by-name reports of officers assigned and/or on orders.

(f) The assignment module provides access to personnel, requisition, and organization data; provides on-line extract/update capability from the TAPDB-AO via TOPMIS; and processes assignments generated by HRC managers in the

Officer Personnel Management Directorate (OPMD). Assignment instructions are transmitted electronically on a daily basis to the gaining and losing requisition activity.

(g) The user assistance module allows users to review data name definitions and tables of valid codes used in officer management.

(h) TOPMIS interacts with the TAPDB-AO and is used by assignment and distribution managers of the basic branches, medical department branches, the Chief of Chaplains, and JAG offices. Worldwide requisition/officer management activities can access TOPMIS through the Defense Data Network (DDN) or a variety of host-to-host systems.

(2) *Requisition cycles.* Officer requisitions are generated on an alternating bimonthly basis for either overseas or CONUS. As a general goal, requisitions are validated so that officers will arrive 12 months after validation, which also allows a 12 month notification to the officer concerned. As a normal rule, overseas returnees, school requirements and units preparing to deploy drive the assignment system because these officers must move on time and deploying units must have necessary officer assets. Overseas returnees and various school requirements are largely due to tour length policies and graduation dates respectively. Others are assigned to replace these personnel and the cycle continues.

(3) *Assignment challenge.* Assignment officers within the divisions and branches of OPMD must take into consideration a wide variety of competing factors in the process of identifying the right officers to fill valid requisitions. Some, but by no means all, of these factors are listed below. They are in no particular order, because each assignment action is unique.

- Army requirements
- Gaining and losing organizations' requirements
- Tour equity (CONUS vs OCONUS)
- Time-on-station and Dwell time
- Professional development
- Officer preference
- Joint domicile
- Compassionate situations
- CTC experience
- Joint duty

## Section VI

### The development function

#### 13–20. Enlisted development

There must be a way of developing leadership, evaluating, and rewarding those who do well, and eliminating those who do not measure up. This section will address some of the programs designed to accomplish these tasks and to create an environment which will motivate men and women to become career Soldiers.

#### 13–21. Enlisted personnel management system (EPMS)

a. The EPMS provides a logical career path from private to sergeant major, career-long training, and performance-oriented evaluation. Additionally, it is designed to eliminate promotion bottlenecks, provide all Soldiers with promotion opportunities, make assignments more flexible, and provide greater challenge by making MOSs more multi-functional.

b. A key feature of EPMS is to associate five standardized skill levels for the enlisted ranks, with privates and specialists having skill level 1 and master sergeants and sergeants major having skill level 5. EPMS skill levels were selected so that the vital middle-grade NCOs would be distinct and visible for management purposes.

c. Another major feature of EPMS is the Noncommissioned Officer Education System (NCOES) which is discussed in detail in Chapter 15 of this text. EPMS and NCOES are part of the same continuum.

#### 13–22. Enlisted evaluation system (EES)

At the heart of EPMS is the EES. It is used to assist in the identification of Soldiers for assignment, promotion, reenlistment, reclassification, special training, elimination, and other personnel management actions. The EES consists of academic evaluation reports (AER) and a NCO evaluation report (NCOER) for sergeant and above. Both reports serve as the official evaluation of duty performance and academic success and provide a record of each individual NCO's potential.

#### 13–23. The NCO leader self-development career model

a. The NCO Leader Self-Development Career Model provides enlisted Soldiers a guide in the selection of self-development activities recommended by CMF proponents. Career models have been developed by SMEs for each CMF and are published in DA Pamphlet 600–25.

b. The career models correspond to the Army's leader development process relating self-development activities to

## How the Army Runs

institutional training and operational assignments. The models can help Soldiers establish planned, progressive, and sequential self-development programs which enhance and sustain military competencies as well as required skills, knowledge, and attributes (SKAs). The career models also contain CMF-proponent recommended goals, e.g., licensure, certification, or academic degree, and allow Soldiers to combine experience and training with self-development activities for career progression as well as goal achievement.

*c.* Activities and goals are recommendations, not requirements, and do not preclude mission assignments and training. Completion does not guarantee advancement. The career models are tools for use by supervisors and professional education counselors to help guide Soldiers in their professional and personal growth. They also may be used to help Soldiers prepare for NCOES and NCO functional resident courses.

*d.* The elements in the leader development process—education, training, experience, assessment, feedback, and reinforcement—create a dynamic synergy to prepare Soldiers for increasing responsibilities. Self-development is the only aspect of that process over which the Soldier has direct control. The career model can stimulate involvement in this vital imperative, which should be the goal of every career Soldier. To foster this desire requires close cooperation between commanders, supervisors, education counselors, and the Soldier.

### 13–24. Enlisted promotions

*a.* The objectives of the enlisted promotion system are to ensure advancement of the best qualified Soldiers, to provide career incentive, to promote Soldiers based on potential rather than as a reward for past service, and to identify and preclude promotion of Soldiers who are nonproductive and ineffective. Three programs make up the promotion system: the decentralized program which controls advancements from private through specialist; the semi-centralized program which controls promotions to SGT and SSG; and the centralized program which controls promotions to SFC through SGM/CSM.

*b.* Under the decentralized program, authority to appoint and promote Soldiers is delegated to local commanders, but there must be compliance with standard policies and procedures established by HQDA. Promotion boards are not required.

*c.* Authority to promote Soldiers under the semi-centralized program is delegated to field commanders who are serving in an authorized lieutenant colonel or above command position in accordance with guidance from HQDA. In this case, eligible Soldiers compete Army-wide on the basis of relative standings by points attained on a standardized point system. Soldiers recommended for promotion are required to appear in person for evaluation by a selection board. Names of Soldiers recommended for promotion by the board are placed on a locally maintained recommended list and grouped by MOS in an order of merit based on the total points attained under the point system. HQDA controls the number of Soldiers who can be promoted in each MOS by establishing cut-off scores according to the needs of the Army. Soldiers whose scores equal or exceed the announced cut-off scores are promoted without regard to assignment. Those not immediately promoted remain on the recommended list until promoted, unless they are removed for administrative reasons or for cause. Soldiers on a recommended list may request reevaluation to improve their standing. Recent program changes due to SGT shortages mandate that Specialists and Corporals (E–4) meeting minimum time-in-grade and time-in-service requirements for promotion to SGT be automatically integrated on the promotion standing list without local board action unless his/her commander takes action to prevent such action.

*d.* Promotions to sergeant first class through sergeant major are centralized and a board, convened by HQDA, makes selections. Selections are based on the “whole person concept.” No one single factor should be considered disqualifying, but rather an individual’s entire record is given careful consideration. Selections are made on a best-qualified basis in conjunction with Army needs.

### 13–25. Command sergeants major program

This program ensures the selection and assignment of the best-qualified sergeants major, first sergeants, and master sergeants for command sergeant major positions. These positions are the principal enlisted assistants to commanders of organizations with enlisted troop strength equivalent to a battalion or higher level and commanded by a lieutenant colonel or above. Boards convened by HQDA make selections. A list of those selected is published and maintained within HRC for use in appointing personnel to fill vacancies. Command sergeants major are assigned only to positions which have been designated by the DCS, G–1.

### 13–26. Total army retention program

This program consists of the AA Retention and RC Transition Programs and is responsible for assisting in manning the force with quality Soldiers by achieving and maintaining a balanced career content in the Regular Army enlisted force. The Retention Program also focuses on improving quality through the retention of trained, qualified, and experienced enlisted Soldiers in the correct MOS and grade. Those not retained in the Active Force, being otherwise qualified, are recruited to serve in USAR or ARNG units. AC Retention and RC Transition Program objectives are assigned to commands by DCS, G–1 while HRC provides overall program and personnel management of the programs. Personnel and fiscal support of the RC Transition Program is provided by the ARNG and USAR.

**13–27. Qualitative management program (QMP)**

a. This program was developed as a means of improving the enlisted career force and consists of two subprograms—qualitative retention and qualitative screening.

b. The qualitative retention subprogram specifies that a Soldier cannot reenlist beyond the time-in-service limits established for the Soldier’s rank. These limits are called retention control points (RCPs). The qualitative screening subprogram is the DA bar to reenlistment aspect of the QMP. Regularly scheduled, centralized promotion/selection boards for sergeant first class, master sergeant, sergeant major/command sergeant major select individuals for promotion or retention in grade, as well as those Soldiers to be barred. These boards consider the Soldier’s entire record using the “whole person concept,” not just his or her current job or term of service. Soldiers separated with a DA bar receive a reenlistment eligibility code of “4” (no further military service authorized any branch of Service). Bars to reenlistment were designed as a personnel management tool to assist commanders in denying further service to Soldiers whose separation under administrative procedures is not warranted, but where service beyond current ETS is not in the best interest of the Army. There are two types of bars to reenlistment: field imposed and DA imposed (QMP). Locally imposed bars and DA-imposed bars to reenlistment are two distinct and separate actions. Imposition of one does not preclude imposition of the other. Reenlistment is deemed a privilege and not a right. It is the responsibility of commanders, at all levels to ensure that only those Soldiers of high moral character, personal competence, and demonstrated performance are allowed to reenlist in the Army. Reenlistment should be denied Soldiers who by their performance, conduct, and potential indicate further service will be non-progressive and unproductive. Under QMP, commanders must initiate separation actions not later than 60 days following the date the Soldier is notified of the bar unless the Soldier elects to retire, appeal, or requests voluntary discharge. If an appeal is denied, commanders will initiate separation action not later than 60 days from the date of notification of denial. Appeals must be submitted within 90 days of completion of the option statement. Soldiers who have less than 90 days to ETS and who submit appeals may be extended until results of the appeal have been received from CG, HRC. Soldiers who have a DA-imposed bar to reenlistment must separate within 90 days of decision not to appeal or denial of appeal. Soldiers who have 18 but less than 20 years of service on that date may remain on active duty to attain retirement eligibility.

c. Under the Army Mobilization Operation Plan, Annex E, Personnel, the QMP program can be suspended for the period the Army is under partial mobilization.

**13–28. Warrant officer development**

a. The implementation of TWOS in 1986, the *Warrant Officer Management Act (WOMA) of 1991*, the Warrant Officer Leader Development Action Plan (WOLDAP) (see Para 15–19) in 1992, the Warrant Officer Education System (WOES) (see Para 13–29 and 15–19) in 1993 and the Army Training and Leader Development Panel (ATLDP) decisions in 2002, have had a major impact on the management and professional development of warrant officers. The Army’s current goal is to recruit warrant officers earlier in their careers, train them better, and retain them longer. About half of all warrant officers retire after 23 years of combined (enlisted and warrant officer) active Federal service. Under WOMA, decisions on promotions, training, and assignments are based on years of warrant officer service (WOS). A careerist will have an opportunity to serve 30 years of warrant officer service if selected for CW5. All others will have an opportunity to serve up to 24 years of warrant officer service unless twice nonselect for promotion to the next higher grade.

b. Every Active Army warrant officer position in authorization documents is classified by rank based on the skills, knowledge, abilities, and experience needed in that position. Formerly there was no rank differentiation in warrant officer positions.

**13–29. Warrant officer management act (WOMA)**

a. WOMA provided a comprehensive and uniform personnel management system, similar to DOPMA, for warrant officer appointments, promotions, separations, and retirements. The key provisions of WOMA include:

(1) Authorized the grade of CW5, to include pay and allowances. Maximum number of CW5s on active duty is limited to five percent of the total number of warrant officers on active duty.

(2) Eliminated the dual promotion system and established a DOPMA style promotion system for warrant officers.

(3) Established minimum time in grade (TIG) requirement for consideration for promotion.

(4) Established authority to convene selective retirement boards (SRB) to consider retirement eligible warrant officers for involuntary retirement.

(5) Established the management of warrant officers by years of WOS rather than by active Federal service (AFS). A CW5 may serve for 30 years WOS. Retirement eligibility at 20 years AFS remains unchanged.

(6) Established selective continuation for warrant officers twice nonselected for promotion (very limited use and normally in shortage skills).

(7) Modified the involuntary separation date from 60 days to the first day of the seventh month after board results are approved. This provision applies to warrant officers twice nonselected for promotion and those selected for involuntary retirement.

b. WOMA modernized warrant officer life cycle management, offers all warrant officers the potential for a full



## How the Army Runs

career, provides tools to shape the force, and enhances readiness by providing the Army with a highly qualified and experienced WO cohort.

### **13–30. Warrant officer education system (WOES)**

Warrant officer education is integrated within the Officer Education System (OES). Warrant officer specific courses are depicted in Figure 13–7. Chapter 15 provides additional information on these courses and other warrant officer training and education.

*a.* The Warrant Officer Basic Course (WOBC) is the first course encountered by all newly appointed WO1s. WOBC certifies the new WO1 within his branch and specialty.

*b.* The Warrant Officer Advanced Course (WOAC) is a combination of common core and MOS proponent training that prepares warrant officers to serve in CW3 level positions. WOAC is provided in a non-resident common core phase and a resident phase, which includes a common core module and a MOS specific module. Completion of the Action Officer Development Course (AODC) is a prerequisite for WOAC attendance

*c.* The Warrant Officer Staff Course (WOSC) provides senior CW3s and new CW4s with the intermediate level education and influential leadership skills necessary to apply their technical expertise in support of leaders on tactical and operational level joint, interagency, intergovernmental, and multinational (JIIM) staffs during full spectrum operations.

*d.* The Warrant Officer Senior Staff Course (WOSSC) is the capstone for WO PME conducted at the WOCC, Fort Rucker, AL. WOSSC provides senior CW4s and new CW5s with the senior level education, knowledge, and influential leadership skills necessary to apply their technical expertise in support of leaders on strategic level JIIM staffs during full spectrum operations.

*e.* The Warrant Officer Career College (WOCC) serves as the TRADOC executive agent for warrant officer common core education. The WOCC evaluates common core instruction within the proponent specific program of instruction for WOBC and WOAC.

## Warrant Officer Training and Education

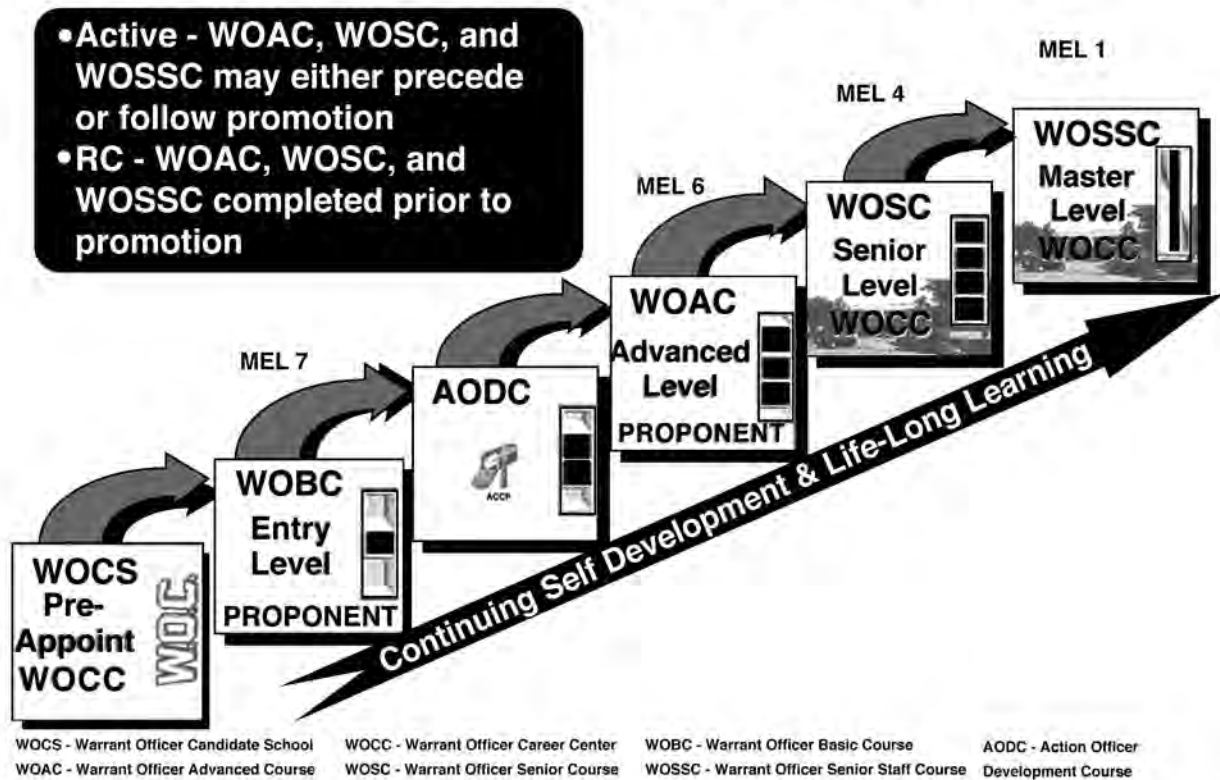

Figure 13-7. Warrant Officer Training and Education

### 13-31. Warrant officer promotions

Warrant officers are promoted under a single permanent promotion system similar to the commissioned officer system.

*a.* Promotions to CW3, CW4 and CW5 for warrant officers on the active duty list (ADL) are administered at HQDA. Promotion authority to CW2 is delegated to commanders in the rank of lieutenant colonel and above. Warrant officers may be promoted to CW2 after completion of 24 months in the grade of WO1 under current policy. WOMA allows CW2 promotion consideration after 18 months in grade. Time in grade for promotions to CW3, CW4 and CW5 are depicted in Table 13-1, but vary with Army requirements.

*b.* Warrant officers twice nonselected for promotion to the next higher grade will be discharged or retired, if eligible, unless selectively continued on active duty to meet a valid Army requirement.

Table 13-1 Warrant Officer Promotion Goals		
To grade	Promotion opportunity	Years AWOS
W2	Fully qualified	2
W3	80%	7 +/-0
W4	74%	12 +/-1
W5 <sup>1</sup>	44%	17 +/-1
Notes: <sup>1</sup> By law the number of CW5s is limited to 5% of the warrant officer force.		

**13-32. Warrant officer retention programs**

a. Regular Army integration and commissioning is concurrent with promotion to CW2. Officers who decline Regular Army integration will not be promoted and shall be separated 90 days after the declination date or upon completion of any active duty service obligation, whichever is later.

b. Separate Regular Army integration boards were discontinued during the Army drawdown. Future boards are planned to only consider exceptions; for example, an USAR CW3 who requests and is called to active duty to fill a valid requirement.

c. Warrant officers are released from active duty after being twice non-selected for promotion to the next higher grade unless they are selectively continued.

**13-33. Officer development**

The OPMS provides a framework for developing the required number of officers with the necessary skills and for managing the careers of all commissioned officers, except those assigned to the special branches (AMEDD, JAGC, and Chaplain Corps). This framework consists of all OPMS functional categories, with each one being a grouping of duty positions whose skill, knowledge, and job requirements are mutually supportive in the development of officers to successfully perform in the functional category. Each functional category contains sufficient duty positions to support progression to the grade of colonel. Military and civilian educational opportunities are also geared to the officer's functional category. Army requirements and an individual's qualifications and preference are the major considerations in determining the designation of functional categories. OPMS consists of three major and interrelated subsystems: strength management, professional development, and evaluation.

**13-34. Officer personnel management system (OPMS)**

In May 1997, the CSA approved implementation of several changes in OPMS as a result of the recommendations of the OPMS XXI Task Force. During 2002, the DCS, G-1 changed the name to OPMS III (vice OPMS XXI) to reflect the system as progressive and evolving to support emerging needs for the 21<sup>st</sup> century. In 2006 the DCS, G1 eliminated the numerical designation in recognition that OPMS was designed to be a continual evolution.

*a. Historical perspective.*

(1) OPMS exists to balance the needs of the Army with the aspirations and developmental requirements of the officer corps. OPMS was instituted in 1972 as a result of the U.S. Army War College Study on Military Professionalism and a follow-on analysis directed by the DCS, G-1. After passage of the DOPMA by Congress in 1981, the CSA ordered a major review to examine the impact of the legislation on OPMS policies. As a result, OPMS II was developed in 1984 to accommodate the changes brought about by DOPMA, including the creation of functional areas, dual tracking and Regular Army integration. In 1987, the CSA directed a review of officer leader development to account for the changes in law, policy, and procedures that had occurred since the creation of OPMS II. As a result of the study, the Leader Development Action Plan was approved for implementation in 1989.

(2) During the last decade plus, the Army has undergone significant changes with widespread affect on the officer personnel system, brought about by the drawdown at the end of the Cold War and by major legislative initiatives. The *DOD Reorganization Act of 1986* ("Goldwater-Nichols") required the Services to improve interoperability and provided the statutory requirements for joint duty assignments, joint tour credit and joint military education. In 1986, Congress also passed Public Law 99-145, which specified the acquisition experiences and education necessary for an officer to be the project manager of a major weapons system. This law later led to the creation in 1990 of the Army Acquisition Corps (AAC). The *Defense Acquisition Workforce Improvements Act of 1990 (DAWIA)* placed additional requirements on Acquisition Corps officers and directed them to single track in their functional area. Congressional Title VII (1992) and XI (1993) Legislation placed additional officer requirements on the AA in their support of the RC. The *Reserve Officer Personnel Management Act (ROPMA) of 1996* brought the RC officer promotion systems in synchronization with the AC. This legislation established a best-qualified promotion system for RC officers, thereby replacing the fully qualified system previously used.

*b. Initiation of OPMS III.*

(1) In 1994, a team of senior field grade officers was assembled to examine a series of OPMS-specific issues and to determine whether a general review of the OPMS was warranted. This OPMS XXI Precursor Study Group ultimately reviewed more than 60 individual issues. Based on the collective body of these issues, the OPMS XXI Task Force convened in July 1996 to review and revise the personnel management system as necessary to ensure its viability for meeting future challenges. The Task Force focused on the development and career management of officers of the Army Competitive Category (ACC). The special branches (Chaplain, JAG, and the branches of the AMEDD) were not specifically addressed although some OPMS XXI issues and solutions dealing with education, officer evaluation, and general promotion policies will apply to them as well.

(2) The Task Force linked its work with other ongoing Army planning efforts: Force XXI for the near-term, Army XXI initiatives for the mid-term, and Army After Next projections for the long-term planning environment. In designing the personnel system for the future, the CSA directed the Task Force also create a conceptual framework that integrated OPMS with the Leader Development System, ongoing character development initiatives and the then new officer evaluation report (see Para 13–40).

(3) The Task Force concluded that, in order for OPMS III to work effectively, three sets of strategic recommendations for change must be jointly addressed.

(a) The first recommendation called for the creation of an officer development system (ODS) as part of an overall Army development system. ODS will encompass and integrate officer leader development, character development, evaluation and personnel management.

(b) The second recommendation recognized the need to adopt a holistic, strategic human resource management (SHRM) approach to officer development and personnel management for the 21st Century.

(c) The final strategic recommendation by the Task Force called for the creation of an officer career field-based management system composed of four career fields: Operations, Operational Support, Institutional Support and Information Operations. Under OPMS III, officers are designated into a single career field after selection for major and serve and compete for promotion in their designated career field from that point on.

(d) The results of these strategic recommendations, approved by the CSA in December 1997, formed the basis for the changes to OPMS until 2005.

(e) In 2005 the CSA directed that OPMS be reviewed to determine if the system met the developmental needs of the officer corps for the future. After study by a new OPMS Task Force, and a vetting process for recommendations with subject matter experts, a Council of Colonels representing all stakeholders, and General Officer Steering Committees, many changes have been approved or are under consideration at this writing. Driving many of the changes is the Army leadership's view that the future officer corps needs to be more multi-skilled and afforded assignment and educational opportunities that fosters this end. Among the changes approved was changing the four career fields to three functional categories as depicted in Figure 13–8. The new design is considered more conducive to bringing balance to the officer corps - breadth and depth, was less prescriptive, and provided multiple career paths. There have been some changes to this initial construct as functional areas were eliminated or consolidated (e.g. Comptroller, HR) and other created (e.g. Logistics Corps).

## Functionally Aligned OPMS Design

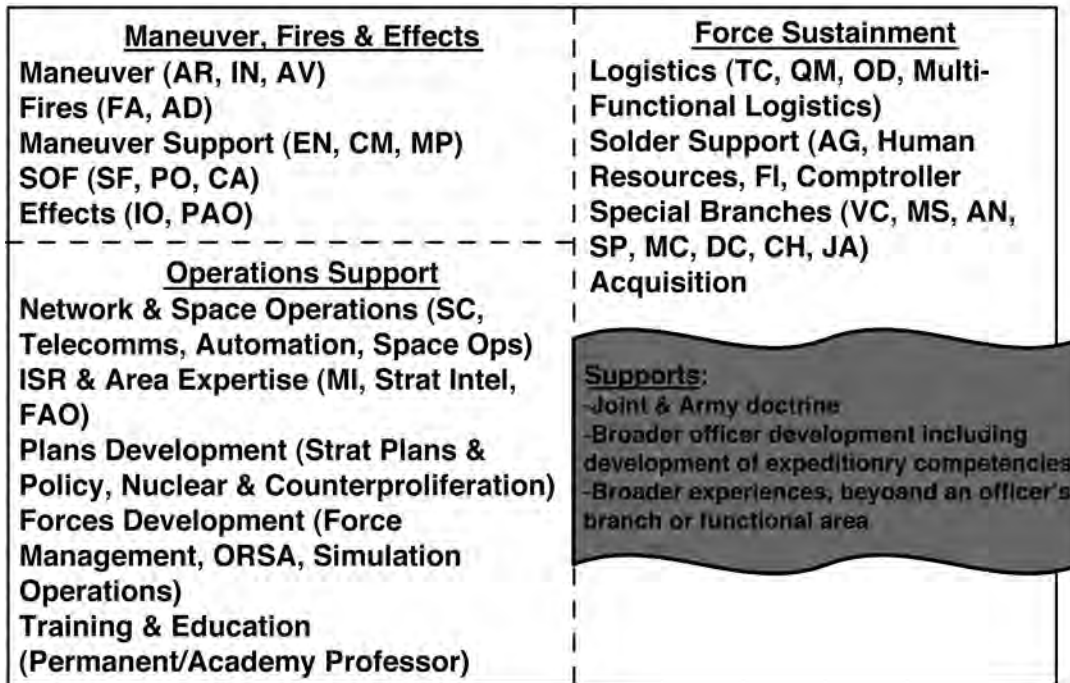

Figure 13–8. Functionally Aligned OPMS Design

### 13–35. Fundamentals of officer management

The Army needs, and will continue to need, the finest officers imbued with the warfighting ethos and with the right skills, knowledge and experience to effectively meet any challenges. Further, the Army continues to be a values-based organization, steeped in core principles and beliefs that set the “muddy boots” Soldier apart as a unique professional. In order to grow an Officer Corps with the right skills, knowledge and attributes to respond to evolving future challenges—to remain ready not only today, but also tomorrow—OPMS changed many aspects of how officers are managed, developed and promoted.

*a. Functional category based management.* Officers are developed in only one branch, and the branch remains primary for approximately the first ten years of an officer’s career (an exception exists for those officers being branch detailed as a new lieutenant and a small number of officers in selected functional areas). Career field or functional category designation will occur at four years of service for a small number of officers and at seven years of service for the remainder. Officer preference will be a key factor in terms of board selection criteria in the functional category designation process, but Army requirements are always paramount.

*b. Functional areas.* Functional areas are not directly related to any specific branch. Incorporating what are referred to as non-accession specialties, functional areas provide a management and development system to effectively use the vast talents of a diverse officer corps and meet Army requirements.

### 13–36. Functional categories

Officers compete for promotion only with other officers in the same functional category. Each functional category, or branch or functional area within a functional category, has its own unique characteristics and development track for officers which reflects the readiness requirements of the Army today and into the 21st century. DA PAM 600–3 outlines all aspects of OPMS, officer training, education and development. Officers from every branch and functional area will also fill officer generalist and combat arms generalist (01A/02A) positions across the Army. Functional categories are depicted in Figure 13–8. As of this writing, there are numerous actions and pending decisions relative to these new functional categories that will impact promotion consideration, command opportunity, and education.

### 13–37. Functional category assignment

Functional categories are assigned through a career field or functional category designation process, under the direction of HRC. An important part of the process is the convening of a formal board to recommend functional categories for

individual officers. HRC identifies officers in the window for functional category designation and notifies them of required actions to be taken in advance of the board. HRC also provides the board with the number of officers to be designated into each functional category, as well as the branches from which these officers will be drawn, based on Army requirements. This process is similar to the way in which promotion requirements by branch and functional area are determined. The board is charged to identify and take into consideration officer preference, aptitudes, and abilities in order to best meet the needs of the Army. The functional category designation process includes the following considerations:

**13-38. Centralized selection for command and key billet positions**

OPMS III changed the name of this process from command designated position list (CDPL) to centralized selection list (CSL). This process emphasizes the preference-based approach to an officer's career pattern. The CSL includes four functional categories of commands and key billets as depicted in Figure 13-9. The CSL commands include all LTC and COL command positions approved by the Army. The list of centrally selected command positions changes regularly. In FY04 key division staff positions (G1, G2, and G6) were added to the list of centrally selected positions. Prior to convening each command selection board, officers being considered will be given the opportunity to indicate the functional category (or categories) in which they desire to compete for selection. The board selects officers for command within the given categories and HRC conducts the slating process and recommends the specific unit or organization for the officer to command. The CSA has the final decision on the command slate.

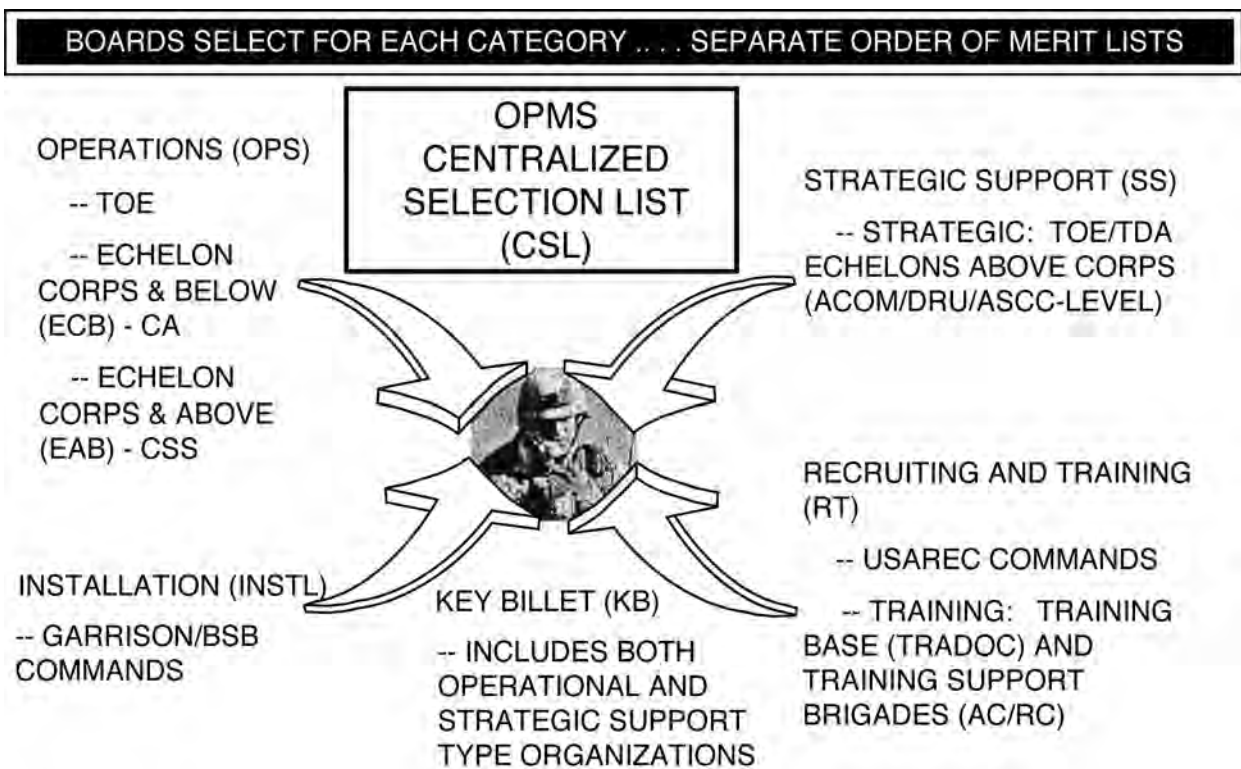

Figure 13-9. Centralized Selection List Categories

**13-39. Army acquisition corps (AAC)**

a. The mission of the AAC is to create a corps of dedicated military and civilian acquisition managers capitalizing on their operational experience and technical skills. Successful weapon system development, and all the support activities required throughout its life cycle, requires a balance between keen regard for current operational realities and technical knowledge.

b. The AAC program develops world-class acquisition specialists to fill approximately 3850 critical positions. Critical positions require the level of education, training, and experience stated in the DAWIA and the DOD implementing instructions. The positions include Program Managers (PMs), Program Executive Officers (PEOs)

## How the Army Runs

(general officer/ Senior Executive Service level), deputy or assistant PEOs/PMs, senior contracting officials, and selected positions in procurement commands, matrix support commands, and headquarters staffs.

*c.* The Army Acquisition Executive (AAE), Assistant Secretary of the Army (Acquisition, Logistics and Technology) (the ASA (ALT)), is dual-hatted as the AAE, acting for the SECARMY through established structure, implements DOD Acquisition Workforce policy and tailors the Army program. The Director, Acquisition Career Management (military deputy to the AAE) provides requirements to the DCS, G-1.

*d.* DCS, G-1 provides personnel policy management for the AAC as for the rest of the Army. The AAC Management Office (AACMO), OPMD, HRC, centrally manages all officer and civilian AAC members. The AACMO consists of a Military Acquisition Management Branch and a Civilian Acquisition Management Branch. Each branch manages members of its component from accession through the members' entire career life cycle.

*e.* Only qualified officers and civilians may fill critical positions. The AAC targets branch-qualified captains and civilians in grade GS-13 as candidates for competitive entry into the AAC. Once accessed into the AAC, members attend schooling and obtain acquisition experience to meet acquisition certification requirements for critical positions.

*f.* Recognizing the difficulty in pursuing branch qualification for battalion and brigade command and at the same time achieving the acquisition requirements, AAC members are precluded from TOE command. AAC officers compete for acquisition-related TDA commands and product manager (battalion-level command equivalent) and project manager (brigade-level command equivalent) positions.

*g.* DA Acquisition Selection Boards select AAC commanders and product and project managers. Commanders normally serve three-year tours and product/project managers four years.

*h.* AAC TDA commands include the research & development centers and laboratories, and procurement and contracting offices. Product/project managers are charged with managing and executing the day-to-day activities for development, production, and fielding of a system in accordance with approved performance, schedule, and cost requirements.

*i.* DA Pamphlet 600-3 details the professional development requirements for commissioned officers within the AAC. AR 690-950 and the Army Civilian Training, Education, and Development System (ACTEDS) list requirements for AAC civilians.

### 13-40. Officer evaluation system

*a.* The Officer Evaluation System is the Army's method of identifying those officers most qualified for advancement and assignment to positions of increased responsibility. The system includes assessments of officer performance and potential accomplished in the organizational duty environment; in an academic environment, both military and civilian; and at joint and departmental levels.

*b.* The potential assessment of an officer is a subjective judgment as to the officer's capability to perform at a specified level of responsibility, authority, or sensitivity. Although potential is normally associated with the capability to perform at a higher grade, judgments are also made by DA on retention and increased responsibility within a specified grade. The assessment is based on three major factors: the Army's officer requirements, the individual officer's qualifications, and a summation of the individual officer's performance.

*c.* The performance assessment by DA differs significantly from that accomplished in the organizational duty environment. Whereas the organizational duty assessment involves a personal knowledge of the situations surrounding a specific period of time, DA assessment is accomplished by an after-the-fact assessment of a series of reports on performance over a variety of duty positions and covering the officer's entire career.

### 13-41. Officer evaluation reporting system

*a.* The Officer Evaluation Reporting System is a subsystem of the Officer Evaluation System. It includes the methods and procedures for organizational evaluation and assessment of an officer's performance and an estimation of potential for future service based on the manner of that performance. The official documentation of these assessments is the OER and the AER.

*b.* The primary function of the Officer Evaluation Reporting System is to provide information from the organizational chain to be used by DA for officer personnel decisions. The information contained in the OER is correlated with the Army's needs and individual officer qualifications providing the basis for personnel actions such as promotion, elimination, retention in grade, retention on active duty, reduction in force, command designation, school selection, assignment, and functional category designation.

*c.* A secondary function of the Officer Evaluation Reporting System is to encourage the professional development of the officer corps. To enhance this, emphasis is placed on the responsibility of senior officers to counsel their subordinates. While this has always been a major aspect of leadership, continual reemphasis is necessary. The Officer Evaluation Reporting System contributes significantly by providing a natural impetus to continual two-way communication between senior and subordinate. It is through this communication that the rated officer is made aware of the specific nature of his or her duties and is provided an opportunity to participate in the process. The rater uses the communication to give direction to and develop his or her subordinates, to obtain information as to the status and progress of his or her organization, and to plan systematically for the accomplishment of the mission. The senior/

subordinate communication process also facilitates the dissemination of career development information, advice, and guidance to the rated officer. This enables the rated officer to take advantage of the superior's experience when making functional category or assignment-related decisions.

*d.* There have been nine OER systems since WWII. The first seven experienced a relatively rapid system turnover because inflation had gotten out of hand. The eighth (DA Form 67–8), which introduced the support form process and senior rater concept, was effective far longer (18 years, 1 month) than any previous system. The current OER, (DA Form 67–9), is an evolution of the 67–8 and has been in use even longer. The Army is preparing to revise the OER again to accommodate changes in officer career development processes and goals.

### 13–42. Officer promotions

As of 15 September 1981, the DOPMA amended Title 10 for officer promotions. DOPMA, as implemented, is applicable to all officers on the Active Duty List (ADL). It does not apply to warrant officers. The act provides for a single promotion system for all officers (Regular Army and OTRA), thus eliminating the previous dual (AUS/RA or AUS/USAR) system of promotions. The intent is for promotions to be made within fairly uniform promotion timing and opportunity goals, as vacancies occur. Eligibility for consideration for promotions is based on minimum time in grade (TIG) and time in service (TIS) with the below-the-zone selection rate established at a maximum of 10 percent (or 15 percent when so authorized by SecDef) of the list for any grade above captain. Goals for promotion opportunity and phase point (i.e., TIS when most officers are promoted) are listed in Table 13–2, as found in DODI 1320.13 dated 13 July 2009. (Actual promotion percentages and TIG/TIS may vary considerably.)

**Table 13–2**  
**Career Progression Pattern**

To grade	Promotion opportunity	DOPMA phase point
First Lieutenant	Fully Qualified	18 MOS TIS/TIG min
Captain	90%	Not less than 2 years TIG
Major	80%	10 +/-1 year
Lieutenant Colonel	70%	16 +/-1 year
Colonel	50%	22 +/-1 year

Notes:

<sup>1</sup> Opportunity and TIS are set by policy. TIG for promotion to 1LT and CPT is set by law.

### 13–43. Officer quality management

*a.* The goal of the officer management program is to ensure that only those individuals demonstrating satisfactory performance and possessing acceptable moral and professional traits be allowed to serve on active duty, retain their commissions, and remain on DA promotion lists.

*b.* Commanders and DA agencies are continually striving to maintain the quality of the officer corps by identifying and processing for involuntary separation those officers whose performance or professional or moral traits are deficient. To this end, the records of officers are screened continually to identify those whose degree of efficiency and manner of performance and/or misconduct, moral or professional dereliction require separation.

*c.* Whenever an officer is identified to “show cause”, the officer is afforded the opportunity to resign in lieu of undergoing the entire process. Similarly, DA agencies are tasked to review promotion lists and CSLs to ensure that no officer is promoted or allowed to command who has become mentally, physically, morally, or professionally disqualified after being selected. The records of officers whose fitness for promotion or command has become suspect are referred to a DA Promotion/Command Review Board, which will recommend to the SA whether the officer should be retained on or removed from the promotion/CSL.

*d.* The promotion system also serves as a qualitative management tool through the mandatory separation from active duty of officers who fail to be selected for promotion to certain grade levels. However, an officer non-selected for promotion may be selectively continued in his current rank upon recommendation by the DA promotion board that non-selected him for promotion.

*e.* No person has an inherent right to continue service as an officer. The privilege of service is his or hers only as long as he or she performs in a satisfactory manner. Responsibility for leadership and example requires officers accomplish their duties effectively and conduct themselves in an exemplary manner at all times.

### 13–44. Officer strength management

When manpower reductions are necessary, the Army has several programs that may be applied to reduce the number of officers on active duty. When possible, reductions are accomplished through normal attrition and voluntary release programs coupled with reduced officer accessions. In the past, Congress directed the Services to include senior as well as junior officers when implementing officer strength cuts, selective early retirement boards (SERBs) and reductions-



## How the Army Runs

in-force (RIFs) may be implemented when required. RIFs target all officers by year while SERBs select a fixed number of retirement-eligible officers for involuntary early retirement. RIFs and SERBs are quantitative measures that are qualitatively administered.

### 13–45. Defense Officer Personnel Management Act (DOPMA)

DOPMA evolved from the continued inability of the *Officer Personnel Act (OPA) of 1947*, as changed by the *Officer Grade Limitation Act (OGLA) of 1954*, to meet the changing requirements for a modern and equitable officer management system for the active forces. The intent of DOPMA was to provide all Services with an equitable, effective, and efficient system to manage their officer corps below the brigadier general level.

*a.* The management objective is to provide consistent career and promotion opportunities across all Services in order to attract and retain high-caliber officers, and promote them at a point in service conducive to effective performance. The integration into a single promotion and grade authorization system of the dual-track Regular Army/Reserve system mandated by OGLA and OPA provided a more favorable environment in which to achieve this goal.

*b.* The provisions for selective continuation of captains and majors, combined with the capability to instruct promotion boards on skill needs, provides a mechanism through which specialty needs can be filled, while enhancing an officer's opportunity to stay on active duty until retirement. Under DOPMA, a first lieutenant who twice fails to be selected for promotion to captain is involuntarily released from active duty. By law, captains and majors may be selectively continued to remain on active duty until 20 and 24 years respectively. DOPMA establishes uniform, general constructive provisions for all Services, thus recognizing that special skills acquired are essential for effective performance in special branches. This provision impacted AMEDD, Chaplain, and the JAG Corps accessed after the effective date of the act.

### 13–46. DOD Reorganization Act of 1986 ("Goldwater-Nichols")

The congressional goal of this act was to improve the performance of officers in joint duty positions by establishing management procedures for their selection, education, assignment, and promotion. Key provisions of the law are listed below.

*a. Assignments.* The qualifications of officers assigned to joint duty assignments will be such that they are expected to meet certain specified promotion rates comparable to their Service headquarters and the overall board selection rate. Officers assigned to joint duty assignments will be assigned in anticipation that they will serve the prescribed tour length for their grade: two years for general officers and three years for others. Assignments for officers possessing critical occupational specialties, which for the Army are defined as the combat arms branches, may be curtailed to a minimum of 24 months under certain conditions. All graduates of professional joint education (e.g., National War College and ICAF) who are designated as joint specialty officers (JSO), and a high proportion (greater than 50 percent) of those graduates not designated as JSO, will be assigned to a joint duty assignment immediately following graduation.

*b. Promotions.* Selection boards considering officers serving in, or who have served in, joint duty assignments will include at least one officer designated by the CJCS who is currently serving in a joint duty assignment. The letter of instruction for selection boards includes the following guidance: "You will give appropriate consideration to the performance in joint duty assignments of officers who are serving in, or who have served in such assignments." Prior to approval by the Secretary of the Military Department, the results of selection boards considering officers who are serving in, or who have served in, joint duty assignments will be forwarded by the Secretary to the CJCS. The CJCS will review the results to determine whether appropriate consideration was given to performance in joint duty assignments.

*c. Reports.* Each Secretary of a Military Department must provide periodic progress reports on their promotion rates in relation to the promotion objectives specified above.

*d. General/flag officer actions.* In the absence of a waiver (waiver authority was eliminated in the 2007 NDAA) by the SecDef, officers selected to the grade of O–7 subsequent to 1 January 1994 must have completed a full joint duty assignment before selection or their first assignment as a general/flag officer will be in a joint duty assignment. A capstone military education course has been created and all newly promoted general/flag officers must attend this course within two years after selection, unless such attendance is waived by the SecDef.

## Section VII

### The sustainment function

#### 13–47. Sustainment function overview

The sustainment function includes a broad range of activities that are focused on the well being of Soldiers, retirees, and their families. The range includes, but is not limited to, quality of life activities, awards and decorations, casualty and memorial affairs, housing, morale, recreation, personnel actions, and Soldier readiness.

#### 13–48. Army continuing education system (ACES)

*a.* ACES is a critical element in the recruitment and retention of a quality force. ACES exist to ensure Soldiers have

opportunities for personal and professional self-development. Education opportunities are offered through education centers, regional and state education offices, and learning centers located worldwide. Educational programs include:

- (1) On-duty functional academic skills training, which provides job-related instruction in the academic areas of reading, mathematics, and English grammar at no cost to the Soldier or adult Family member?
- (2) High school completion programs for Soldiers without a high school diploma.
- (3) Undergraduate and graduate college courses and programs which provide financial assistance, such as the Tuition Assistance Program.
- (4) Foreign language programs for qualified Army linguists assigned overseas.
- (5) Skill development programs to prepare non-commissioned officers for NCOES training.
- (6) Counseling to establish challenging yet attainable short and long-term goals
- (7) Academic testing through the Defense Activity for Non-Traditional Education Support (DANTES).
- (8) Army personnel testing, and training support for skill specific and unit training, leader's self-development and language and computer laboratories.

*b.* In addition, the Service members Opportunity College Army degree system of college and university networks promoting credit transferability and the Army/American Council on Education Registry Transcript System (AARTS) documenting recommended credit for Soldier training and experience help Soldiers earn degrees despite frequent transfers and rotations. The ACES, focused on Soldiers, Family members and available to DA civilians, represents a primary Family Covenant program.

*c.* To further enable Soldiers to continue their education, the Army has implemented a web-based portal, GoArmyEd.com, so that Soldiers and Family members have anytime, anywhere access to education programs and services. Soldiers use GoArmyEd to request funding for college level courses wherever they are in the world. GoArmyEd.com provides Soldiers maximum flexibility to continue to pursue their individual educational goals.

### **13-49. Equal opportunity program**

*a.* Army's Military Equal Opportunity (MEO) Program formulates, directs, and sustains a comprehensive effort to maximize human potential and to ensure fair treatment for all persons based solely on merit, fitness, and capability in support of readiness. This program strive to eliminate incidents of discrimination based on race, color, gender, religion, or national origin and provide an environment free of unlawful discrimination, or offensive behavior. Army Equal Opportunity Program is resonant in leadership that is rooted in taking care of Soldiers and is crucial to unit cohesion, readiness, and mission accomplishment. Ensuring Soldiers are treated with fairness, justice, and equity is central to an Army culture dedicated to the highest professional and personal standards, and to sustaining our most important resource-people.

*b.* The Army reorganized the prevention of sexual harassment (POSH) to the Sexual Assault Prevention Response (SAPR) Program in March 2009. The new office is Sexual Harassment/Assault Response Prevention (SHARP) Program. This initiative transferred POSH from MEO to infuse the full spectrum of Army Operations and strategically focused on the interrelationship in one program (SHARP) within the Army. The EO Program is currently in the process of transforming by integrating diversity and other human relations programs to better serve the Total Army Family.

*c.* Commanders are assisted in sustaining MEO goals and objectives by an Equal Opportunity Program Manger (EOPM) at division level and above, Equal Opportunity Adviser (EOA) at brigade level and above, and an EO leader (EOL) collateral duty at battalion and company level. These MEO practitioners assist the commander in EO training, reporting and continuously assess the command climate to identify indicators of individual and institutional barriers. Soldiers volunteer or selected as EOPMs and EOAs receive 10 weeks of intensive training at Defense Equal Opportunity Management Institute (DEOMI), receive an ASI of "T" for officers and a SQI of "Q" for NCOs, and serve a 24 month tour as an EOPM or EOA. EOL receives 80 hours of training at the installation. The EO practitioner provides the commander a valuable subject matter resource for sustaining a positive EO climate, training, and developing remedies to eliminate practices or treatment, which affects readiness.

### **13-50. The army casualty system**

*a.* The casualty operations functions include casualty reporting, notification, assistance, and fatal accident family brief program. Casualty reporting is the source of information provided to the next of kin (NOK) concerning a casualty incident. It is of the utmost importance to provide that information accurately, promptly and in as much detail as possible so that the NOK receive as full an accounting as possible of the casualty incident.

*b.* Defense Casualty Information Processing System (DCIPS) provides casualty, mortuary affairs, personal effects tracking and processing, remains tracking, line of duty (LOD) and Freedom of Information Act (FOIA) management capability for casualties from current and prior conflicts for ALL Services. DCIPS is the DOD required system for casualty management (DODI 1300.18). All information contained in the DCIPS data base is classified FOUO. his information is governed under the Privacy Act Laws and should not be discussed with those not having a need to know.

### Section VIII

#### The transition function

##### 13–51. Transition function overview

The transition function includes a broad range of activities focused on ensuring Soldiers and their families are treated with dignity and respect and assisted in every way possible as they transition from the AC to a RC and/or civilian status. Selected transition activities are described in greater detail below.

##### 13–52. The Army Career and Alumni Program (ACAP)

*a.* The ACAP orchestrates a broad spectrum of programs and services designed to assist Soldiers in making critical career and transition decisions. ACAP provides transition services to Soldiers, DA civilians, retirees, and their family members. RC personnel are also eligible to receive ACAP services upon serving a minimum of 180 consecutive days of active duty immediately prior to separation.

*b.* ACAP is not a job placement service but instead a program through which a wide range of services are made available to users through a combination of DOD, Department of Labor, Department of Veteran Affairs, U.S. Army, and contractor provided services. Transition counseling and career planning are the cornerstone services that assist the user to properly focus on their career path and the value of their experience should they remain on active duty or transition to civilian life. Individuals using ACAP services have access to an abundance of reference materials and a wealth of information about benefits, civilian employment opportunities, career planning and services available through many Federal, State and local government agencies.

*c.* Participation in ACAP is mandatory for all active duty Soldiers who are separating or retiring. Individuals are encouraged to start using ACAP services 180 days before their separation date. Eligible individuals may continue to use ACAP for up to 90 days after separation. Retirees and their Families are eligible to use ACAP services for life on a space available basis. Referral to ACAP is mandatory for civilians who are departing because of force alignments, reductions in force or base closures. ACAP participation is optional for transition of family members and eligible RC Soldiers.

*d.* ACAP establishes a strong partnership between the Army and the private sector, creates a recruiting multiplier, improves employment prospects for transitioning personnel, reduces unemployment compensation costs to the Army and allows career Soldiers to concentrate on their mission. ACAP is an enduring program, institutionalized into the Army culture and life cycle functions.

##### 13–53. Army retirement services program

*a.* The DA has a worldwide network of retirement services offices to assist retiring Soldiers and their families make a smooth and successful transition into retirement. Each major Army installation has a full-time, paid employee, called a retirement services officer (RSO), to administer this program. The program prepares Soldiers and family members for retirement by providing assistance and information on their benefits and entitlements. These services are available to the surviving spouses of retired Soldiers.

*b.* The RSO conducts a periodic pre-retirement briefing, which covers subjects from computation of retired pay to survivor benefits. Soldiers must attend a pre-retirement briefing between submission of their retirement application and no later than 120 days before retirement. Spouses are encouraged to attend. The RSO also provides mandatory Survivor Benefit Plan (SBP) counseling to these individuals. By law, retired pay stops with a Soldier's death unless the Soldier is enrolled in SBP. The Soldier must make the SBP decision before retirement.

*c.* The DA Retirement Services Office provides policy guidance and program oversight to the installation RSOs and is also responsible for publishing "Army Echoes," the newsletter sent (also available on-line) to all retirees, surviving spouses, and retirement eligible reserve component personnel. The DA RSO also administers the Army Chief of Staff's Retiree Council, the SBP and Reserve Component SBP Programs and monitors the operation of the Armed Forces Retirement Homes.

##### 13–54. Separation

Separation includes voluntary and involuntary release from active duty, discharge, non-disability retirement, and physical disability retirement. Because the type of discharge and character of service are of such great significance to the service member, it must accurately reflect the nature of service performed. Eligibility for veterans' benefits provided by law, eligibility for reentry into service, and acceptability for employment in the civilian community may be affected by these determinations.

##### 13–55. Enlisted separation

*a.* An enlisted Soldier may be separated upon ETS or prior to ETS by reason of physical disability (see below), sentence of general or special court-martial, or one of the administrative separation programs prescribed in AR 635–200. Both voluntary and involuntary administrative separation actions are outlined in AR 635–200.

*b.* Voluntary separations are initiated by the Soldier. Reasons include hardship/ dependency, surviving family members, acceptance into an ROTC program, orders to active duty as an officer or warrant officer, defective

enlistment, pregnancy, for the good of the service in lieu of trial by court-martial, and early separation when denied reenlistment. Soldiers who have tested positive for the HIV antibody may request discharge under Secretarial authority. Soldiers may also be allowed to separate early to further their education.

c. Commanders may initiate involuntary separation proceedings for parenthood, personality disorder, concealment of an arrest record, fraudulent or erroneous entry, alcohol or drug abuse rehabilitation failure, failure to meet body composition/weight control standards, entry-level performance and conduct, unsatisfactory performance, misconduct, or homosexual conduct (pending the implementation of the Don't Ask, Don't Tell Repeal Act of 2010). To separate a Soldier involuntarily, the unit commander must notify the Soldier in writing. Any involuntary separation action involving a Soldier with six or more years of total active and reserve military service entitles the Soldier to a hearing by an administrative separation board. If the Soldier has 18 or more years, the board is mandatory and cannot be waived. Administrative discharges of Soldiers with 18 or more years of AFS must be approved at the Army Secretariat level.

d. Discharge certificates are furnished only to Soldiers who are honorably discharged or discharged under honorable conditions. All Soldiers leaving active duty are issued a DD Form 214, Certificate of Release or Discharge from Active Duty. The DD Form 214 documents the characterization of service, except when a Soldier is separated while in an entry-level status. Entry-level separations normally have service described as "uncharacterized." Honorable, general, and under other than honorable conditions characters of service are assigned administratively. Bad conduct and dishonorable discharges (see Para 20–19d) are issued upon conviction by a court-martial.

### **13–56. Enlisted non-disability retirement system**

To qualify for voluntary retirement, an enlisted Soldier must be on active duty and have completed 20 or more years of Active Federal Service (AFS) on the retirement date. A Soldier who has completed 20 years, but less than 30 years AFS, and who has completed all required service obligations may be retired at his or her request. Enlisted Soldiers who have completed 30 years AFS have the vested right under law to retire and may not be denied unless other provisions of law are invoked (e.g. stop loss). DA policy requires that all service obligations incurred by promotion, schooling, or PCS be completed prior to approval of voluntary retirement of Soldiers with less than 30 years' service. However, a Soldier may request waiver of a service obligation, and approval would depend upon whether the best interests of the Service are involved or whether a substantial hardship might exist should retirement be denied. Enlisted retirements are normally approved by field commanders of general officer rank. Enlisted Soldiers retire in the grade they hold on the date of retirement unless they have 10 years active commissioned service. Additionally, enlisted Soldiers who have completed 30 years combined active and retired list service may be eligible for advancement on the retired list to the highest grade held satisfactorily. Requests for grade determination are acted upon by HQDA.

### **13–57. Officer non-disability retirement system**

a. There are two types of retirement - voluntary and mandatory. To qualify for voluntary retirement, officers must have completed at least 20 years AFS on their retirement date. All service obligations incurred must be completed unless waived by HQDA. Mandatory retirement dates are established by law and only in very rare cases are individuals retained on active duty beyond these dates. Majors, lieutenant colonels and colonels may remain until 24, 28 and 30 years of active federal commissioned service (AFCS) respectively, unless involuntarily retired through the SERB process.

b. While majors and below must have served six months in their grade to retire at that grade, lieutenant colonels and colonels must serve three years in grade to retire in that grade unless waived by HQDA. Some programs like the Voluntary Early Release and Retirement Program (VERRP) can waive one year of the three-year obligation, subject to limitations and provisions imposed by Congress. Officers who are selected by SERB retain their grade regardless of time held.

### **13–58. Physical disability separation**

The laws governing physical disability separation from the Army provide for the medical retirement or separation of a Soldier who is determined to be unfit by reason of physical disability when the physical/mental condition(s) significantly interferes with their ability to perform the duties of his or her office, grade, rank, or rating. The severity of the condition(s) determines eligibility for disability benefits, disability retirement and severance pay. It is possible to receive a non-disability separation and still have physical disabilities, which could affect potential for civilian employment and retirement benefits. Disability compensation for any medical condition that affects a Soldier's quality of life may be determined by Department of Veteran Affairs and is separate from the service separation.

## **Section IX**

### **Summary and references**

#### **13–59. Summary**

a. The primary purpose of the MHRM system is to satisfy valid Army requirements and, insofar as practicable, accommodate the legitimate needs of its members. The system is a complex, dynamic, multifaceted mosaic of

## How the Army Runs

interacting subsystems, which interface in a variety of ways with all other major Army systems. It must keep up with the rate of change occurring in the Army so that Soldiers are properly supported, and commanders have timely, relevant information on which to base operational decisions.

*b.* The processes designed to structure, acquire, train, educate, distribute, sustain, professionally develop, and separate Soldiers must be continuously evaluated and refined to ensure they support current and future Army requirements. The subsystems within these processes must have flexibility to meet the needs of the Army. Whether the Army is reducing or expanding, there are a few critical operating principles to guide decision makers as they choose between difficult, challenging options in either scenario: maintain force readiness at the prescribed levels; maintain quality in recruiting, retention, and development programs; make changes in a balanced and orderly way throughout all grades and specialties, both officer and enlisted; maintain current board selection functions to continue to build on the best; rely on RC; protect well being; and, finally, in order to reduce uncertainty, ensure there is an understandable, comprehensive plan.

*c.* This chapter was designed to provide a broad overview of major personnel management systems. During the next several years, the policies, functions, and processes within every one of the subsystems will be continuously challenged to ensure Army requirements are satisfied and to care for its most important resource-people.

*d.* The following web sites contain valuable current information on military HRM policy and programs:

- [www.army.mil](http://www.army.mil)
- [www.armyg1.army.mil/](http://www.armyg1.army.mil/)
- [www.asamra.army.pentagon.mil](http://www.asamra.army.pentagon.mil)
- [www.usarec.army.mil](http://www.usarec.army.mil)
- [www.goarmy.com](http://www.goarmy.com)
- <https://www.hrc.army.mil/>
- <https://www.goarmyed.com/>

### 13–60. References

- a.* Army Regulation 600–Series Publications, *Personnel - General*
- b.* Army Regulation 601 - Series Publications, *Personnel Procurement*
- c.* Army Regulation 614 - Series Publications, *Assignments, Details, and Transfers*
- d.* Army Regulation 621 - Series Publications, *Education*
- e.* Army Regulation 623 - Series Publications, *Evaluations*
- f.* Army Regulation 624 - Series Publications, *Promotions*
- g.* Army Regulation 635 - Series Publications, *Personnel Separations*
- h.* Army Regulation 680 - Series Publication, *Personnel Information Systems*
- i.* Field Manual 1–0, Human Resources Support

## Chapter 14

### Civilian Human Resource Management

#### Section I Introduction

##### 14–1. Chapter content

*a.* Civilians have been an important component of the Army since the Revolutionary War. They are an integral part of the force utilized to accomplish today's multiple complex missions. On 19 June 2006 the Secretary of the Army (SA) established the "Army Civilian Corps" and the Army Civilian Corps Creed. This name unifies the Army civilian service and embodies the commitment of the dedicated individuals who serve as a fundamental part of the Army team. Army civilians serve in all theaters and are deployed worldwide to support the Army mission and the Overseas Contingency Operations. The purpose and role of the Army civilian is defined by the Army Civilian Corps Creed:

- (1) I am an Army Civilian - a member of the Army Team.
- (2) I am dedicated to our Army, our Soldiers and Civilians.
- (3) I will always support the mission.
- (4) I provide stability and continuity during war and peace.
- (5) I support and defend the Constitution of the United States and consider it an honor to serve our Nation and our Army.
- (6) I live the Army values of Loyalty, Duty, Respect, Selfless Service, Honor, Integrity, and Personal Courage.
- (7) I am an Army Civilian.

*b.* The Army Civilian Corps includes both Appropriated Fund (APF) and Non-Appropriated Fund (NAF) employees, as well as foreign or local national employees. (See Figure 14–1 for details.) These civilians are employed in over 530 different occupations with the highest concentrations in logistics, research and development, and base operations (BASOPS) functions. Civilians are excluded from positions that by law require military incumbents but are increasingly being used in combat service support functions as formerly military positions are being converted to civilian occupancy.

*c.* An understanding of the types of employees and the rules and regulations that govern each of them is necessary to understand the management and administrative environment within which civilian personnel management systems operate. The laws, regulations, personnel policies, and practices differ for Army civilian employees based on their fund source.

# Civilians Supporting the Army

As of end December 2010

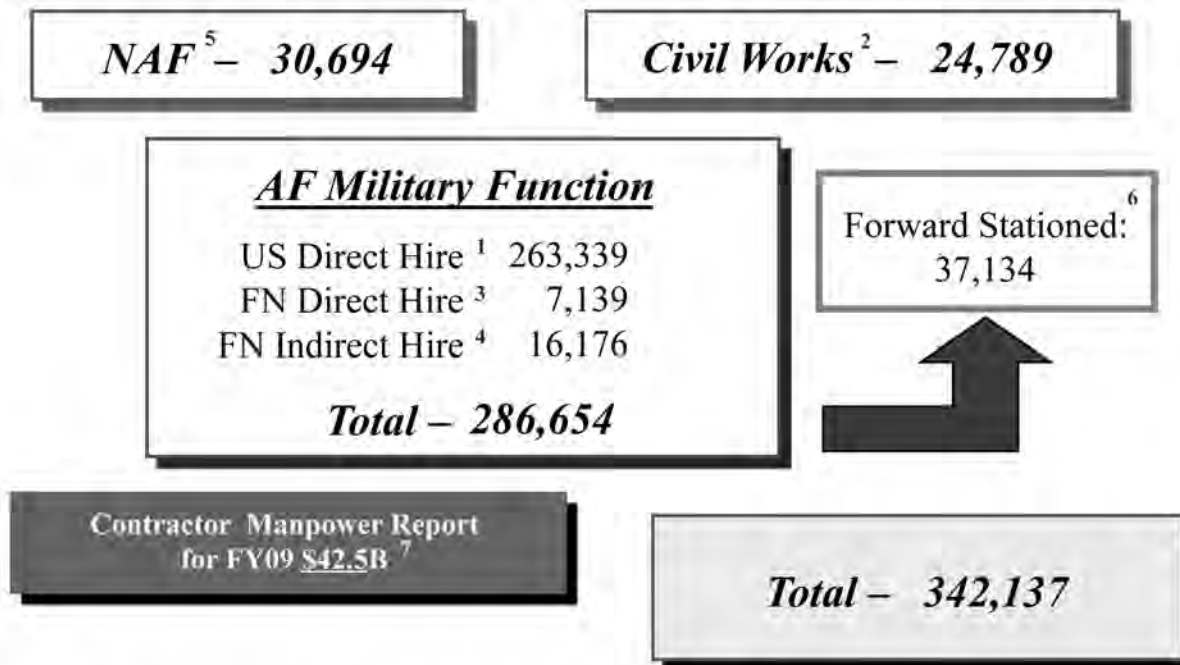

Data Sources: 1 - HQ ACPERS SF-113A Supplement #7 Direct Hire employees, less FN Direct employees; figure includes 27,225 NGB Civ Techs  
 2 - HQ ACPERS SF-113A Civil Works & Cemeterial reports  
 3 - HQ ACPERS SF-113A Supplement #6 4 - HQ ACPERS SF-113A Supplement #6 5 - HQ ACPERS NAF Strength Report (including DD)  
 6 - HQ ACPERS SF-113A Supplement #1 total + Supplement #3 grand total 7 - SAMR-FMMR

Figure 14–1. Civilians Supporting the Army in FY 10

## 14–2. Categories of civilian personnel

*a. Appropriated Fund (APF) civilians.* The term “appropriated funds” refers to those funds provided by the Congress, normally in annual *Defense Appropriations Act* legislation. U.S. citizens and eligible U.S. aliens are paid from APFs and are managed within a structure of Federal civil service laws. APF employees are further divided into two categories based on the nature of work performed. Military-function civilians perform support duties associated directly with the Army’s National Military Strategy (NMS) objectives. Civil-function civilians perform duties associated with the Army’s Civil Works Program, administered by the Army Corps of Engineers. Civil works includes planning, design, construction, operation and maintenance of projects that improve the nation’s water resource infrastructure (e.g., navigation, flood control, and hydroelectric power, plus other civil functions prescribed by law). The laws governing APF employees are administered by the U.S. Office of Personnel Management (OPM) and will be discussed in more detail in subsequent sections of this chapter.

*b. Non-Appropriated Fund (NAF) civilians.*

(1) NAF employees are paid from funds generated from sales, fees, and charges to authorized patrons. This category is comprised of U.S. civilians, foreign nationals (usually from the local labor market), and enlisted service personnel working part-time during off-duty hours. All compete for employment on the basis of merit.

(2) NAF employees play an important role in providing Family and Morale, Welfare and Recreation (FMWR) services to military personnel and their family members. Army clubs, guest houses, child care centers, craft shops, bowling centers, swimming pools, gymnasiums, and many other NAF activities employ a considerable number of employees at most Army installations and contribute to the overall quality of life.

*c. Foreign/local national civilians.* The Army also employs foreign and local nationals in both APF and NAF positions in overseas areas. The Status of Forces Agreement (SOFA) in effect with a given host country forms the basis of the employment systems for these employees. Within this framework, employee administration must be consistent

with host country practice, U.S. law, and the management needs of the Army. In some cases the host government may reimburse the salary and associated personnel costs in whole or in part.

**14-3. Army workforce mix**

a. The Army’s fighting environment has changed, causing the Army to transform. The number and scope of the missions that the Army must perform has grown significantly since the end of the Cold War. Following the post-Cold War drawdown that ended in 1999, the number of Army civilian employees increased modestly through FY 04. During FY 05 to FY 10, the numbers increased significantly due to migration of Overseas Contingency Operations missions to base missions, “Grow the Army” budget initiatives such as increases for base support functions, contractor to civilian conversions, military pay re-capitalization, and conversion of military billets to civilian positions. Civilian increases are not likely to continue into the future, considering budget and deficit reduction deliberations currently underway.

b. The Army is undergoing a fundamental change in how it defines its total manpower. The challenge is achieving the right balance of civilian employees, contractors, and Soldiers in our Army.

**14-4. Decentralized management**

The systems for recruiting, utilizing, developing, and sustaining Department of Army (DA) civilians are in large part decentralized. Decentralized management of civilians is very different from the centralized management of military personnel (Figure 14-2). Most authorities for the supervision and management of civilians have been delegated through the chain of command to the lowest practicable level. Certain civilian personnel functions are performed on a regional, Command wide, or DA-wide basis when doing so results in more efficient operations (e.g., the Army Benefits Center-Civilian (ABC-C) at Fort Riley provides individual employees across the Army with counseling on their benefits and automated support for benefits changes) or when a managerial perspective above the local level is required to meet program objectives (e.g., Headquarters, Department of the Army (HQDA) manages the intake and training of interns in DA career programs). The management of Senior Executive Service (SES) employees is also centralized.

<u>Military</u>		<u>Civilian</u>
Title 10, USC	<u>Statute</u>	Title 5, USC
Rank in Person	<u>Authority</u>	Rank in Job
Fill based on structure and authorizations. Managed by USAREC, USMA, Cadet Cmd, PERSCOM, DCSPER.	<u>Acquisition</u>	Fill based on position vacancy. Managed by supervisor, Cdr, CPAC/CPOC, Career Pgm Mgr, ASA(M&RA)
Hierarchy of schools for military and leadership skills.	<u>Individual Training</u>	Functional training primarily occupation related.
Mandatory movement to meet worldwide requirements.	<u>Distribution</u>	Voluntary mobility - (generally).
Based on Army requirements- (involuntary).	<u>Deployment</u>	Voluntary-(unless part of job criteria).
Central selection and management.	<u>Professional Development</u>	Heavy decentralized management.
Contractual obligation and forced separation/retirement.	<u>Transition</u>	More individual choices and longer tenure.

Figure 14-2. Differences between the military and civilian systems



### Section II

#### Organization of civilian personnel management

##### 14-5. Merit System Principles

a. The Merit System Principles are nine basic standards governing the management of the executive branch workforce. The principles are part of the Civil Service Reform Act of 1978 and can be found at 5 United States Code (USC) §2301. The following merit principles govern all personnel practices:

(1) Recruitment should be from qualified individuals from appropriate sources in an endeavor to achieve a work force from all segments of society. Selection and advancement should be determined solely on the basis of relative ability, knowledge and skills, after fair and open competition which assures that all receive equal opportunity.

(2) All employees and applicants for employment should receive fair and equitable treatment in all aspects of personnel management without regard to political affiliation, race, color, religion, national origin, sex, marital status, age, or handicapping condition (*sic* - the preferred term is disability), with proper regard for privacy and constitutional rights.

(3) Equal pay should be provided for work of equal value, with appropriate consideration of both national and local rates paid by employers in the private sector, and appropriate incentives and recognition should be provided for excellence in performance.

(4) All employees should maintain high standards of integrity, conduct, and concern for the public interest.

(5) The Federal work force should be used efficiently and effectively.

(6) Employees should be retained on the basis of adequacy of their performance. Inadequate performance should be corrected. Employees should be separated who cannot or will not improve their performance to meet required standards.

(7) Employees should be provided effective education and training in cases in which such education and training will result in better organizational and individual performance.

(8) Employees should be protected against arbitrary action, personal favoritism, or coercion for partisan political purposes, and prohibited from using their official authority or influence for the purpose of interfering with or affecting the result of an election or a nomination for an election.

(9) Employees should be protected against reprisal for the lawful disclosure of information which an employee reasonably believes evidences a violation of any law, rule, or regulation, or evidences mismanagement, a gross waste of funds, an abuse of authority, or a substantial and specific danger to public health or safety.

b. Twelve prohibited personnel practices are defined by law at, §2302(b) of Title 5 of the USC. Generally stated, §2302(b) provides that a federal employee may not authorize to take, direct others to take, recommend, or approve any personnel action that may:

(1) discriminate for or against an employee or applicant based on race, color, religion, sex, or national origin;

(2) solicit or consider employment recommendations based on factors other than personal knowledge or records of job-related abilities or characteristics;

(3) coerce the political activity of any person (including the providing of any political contribution or service), or take any action against any employee or applicant for employment as a reprisal for the refusal of any person to engage in such political activity;

(4) deceive or willfully obstruct anyone from competing for employment;

(5) influence anyone to withdraw from competition for any position so as to improve or injure the employment prospects of any other person;

(6) give an unauthorized preference or advantage to anyone so as to improve or injure the employment prospects of any particular employee or applicant;

(7) engage in nepotism (i.e., hire, promote, or advocate the hiring or promotion of relatives);

(8) engage in reprisal for whistle blowing (i.e., take, fail to take, or threaten to take or fail to take a personnel action with respect to any employee or applicant because of any disclosure of information by the employee or applicant that he or she reasonably believes evidences a violation of a law, rule or regulation; gross mismanagement; a gross waste of funds; an abuse of authority; or a substantial and specific danger to public health or safety (if such disclosure is not barred by law and such information is not specifically required by Executive Order (EO) to be kept secret in the interest of national defense or the conduct of foreign affairs - if so restricted by law or EO, the disclosure is only protected if made to the Special Counsel, the Inspector General, or a comparable agency official);

(9) take, fail to take, or threaten to take or fail to take a personnel action against an employee or applicant for exercising an appeal, complaint, or grievance right; testifying for or assisting another in exercising such a right; cooperating with or disclosing information to the Special Counsel or to an Inspector General; or refusing to obey an order that would require the individual to violate a law;

(10) discriminate based on personal conduct which is not adverse to the on-the-job performance of an employee, applicant, or others;

(11) take or fail to take, recommend, or approve a personnel action if taking or failing to take such an action would violate a veterans' preference requirement; and

(12) take or fail to take a personnel action, if taking or failing to take action would violate any law, rule or regulation implementing or directly concerning merit system principles at 5 U.S.C § 2301.

#### **14–6. U.S. Office of Personnel Management (OPM)**

*a.* OPM is the personnel agency of the executive branch charged with the mission to administer most Federal laws and EOs dealing with all aspects of civilian personnel management and administration in the Federal sector. Some laws and EOs place certain personnel management responsibilities directly on agency and department heads, subject to OPM policy and review. In other cases, OPM retains the authority to establish specific program standards and regulate and control the means of carrying out major aspects of agency or departmental personnel management operations.

*b.* OPM develops proposals for Federal personnel legislation and EOs and develops and publishes specific policies, procedures, and regulations implementing Federal personnel laws and EOs. It also provides testing, evaluation, and referral of job applicants to agencies; evaluates agency personnel management systems; and provides advice and assistance to agencies in the development of effective personnel management programs and provides oversight on DOD (Department of Defense) evaluations and assessments of human capital policies, programs, and practices. In addition, OPM develops standards by which jobs are classified (i.e., pay systems, title, job series, and grades); administers retirement, health, and life insurance programs; and adjudicates position classification appeals.

*c.* OPM executes, administers, and enforces civil service rules and regulations through audits, reviews and inspections. Failure on the part of agencies to observe the prescribed standards, requirements, and instructions may result in the withdrawal of personnel management authority delegated by OPM.

#### **14–7. Other agencies with federal government-wide authority**

In addition to OPM controls and procedures, four separate, independent Federal agencies also provide oversight to ensure that agencies adhere to principles of merit, labor relations guarantees, and equal employment rights:

*a. U.S. Merit Systems Protection Board (MSPB).* The MSPB is an independent, quasi-judicial agency in the Executive branch that serves as the guardian of Federal merit systems. The Board's mission is to protect Federal merit systems and the rights of individuals within those systems. MSPB carries out its statutory responsibilities and authorities primarily by adjudicating individual employee appeals and by conducting merit systems studies. In addition, MSPB reviews the significant actions of the OPM to assess the degree to which those actions may affect merit.

(1) Cases arising under the MSPB jurisdiction include:

(*a*) Employee appeals of agency adverse actions, including removals, suspensions of more than 14 days, reductions in grade or pay, furloughs of 30 days or less, reduction-in-force actions, denials of within grade salary increase;

(*b*) OPM suitability determinations;

(*c*) OPM determinations in retirement matters;

(*d*) Disciplinary actions brought by the Office of Special Counsel (OSC) alleging violations of the Hatch Act (coercion of government employee political activity);

(*e*) Corrective and disciplinary actions brought by the OSC against agencies or Federal employees who are alleged to have committed certain prohibited personnel practices, or to have violated certain civil service laws, rules and regulations;

(*f*) Requests for stays of personnel actions alleged by the OSC to result from certain prohibited personnel practices;

(*g*) Requests for review of regulations issued by OPM or of implementation of OPM regulations by an agency; and

(*h*) Informal hearings in cases involving proposed performance-based removals from the senior Executive Service.

(2) The MSPB also has jurisdiction over allegations of employment discrimination in connection with actions otherwise appealable to the MSPB and certain employee allegations subject to a negotiated grievance procedure covering actions otherwise appealable to the MSPB.

*b. Office of Special Counsel (OSC).* The OSC is an independent federal investigative and prosecutorial agency. OSC's authority comes from four federal statutes: the Civil Service Reform Act (CSRA), the Whistleblower Protection Act, the Hatch Act (legal restrictions on government employee political activity), and the Uniformed Services Employment & Reemployment Rights Act (USERRA). OSC's primary mission is to safeguard the merit system by protecting federal employees and applicants from prohibited personnel practices, especially reprisal for whistle blowing. Sexual orientation and parental status employment discrimination have been designated as prohibited personnel practices by EO. Allegations of employment discrimination on these bases may be filed with and subject to investigation by the OSC.

*c. Federal Labor Relations Authority (FLRA).* The FLRA is an independent administrative federal agency which adjudicates federal employee collective bargaining disputes, including resolving complaints of unfair labor practices, determining appropriateness of units for labor organization representation, adjudicating exceptions to arbitrator's

## How the Army Runs

awards, adjudicating legal issues relating to duty to bargain and negotiability, and resolving impasses during negotiations.

*d. The Equal Employment Opportunity Commission.* (EEOC) is an independent federal agency responsible for enforcing Federal laws which prohibit employment discrimination in both the private and public sector based on race, color, national origin, sex, age (40 and older), religion, genetic information, mental or physical disability or in reprisal for engaging in protected activity such as opposing discrimination or participating in a discrimination complaint or lawsuit. The EEOC provides oversight and coordination of all federal sector equal employment opportunity regulations, practices and policies, and submits an annual report on the federal workforce to the President, Congress and appropriate Congressional committees. The EEOC's regulation implementing the federal sector EEO program (29 Code of Federal Regulations (CFR) 1614), requires each federal agency to implement and maintain effective EEO programs. The EEOC administrative judges (AJ) play an adjudicative role in formal federal sector EEO complaints as well as at the appellate level of the administrative complaint process. EEOC findings of discrimination are not appealable by agencies in federal court.

### 14–8. Department of Defense (DOD)

Under EO 9830, the President has delegated authority to agency heads, including the Secretary of Defense, to act in civilian human resource matters in accordance with applicable policies, program requirements, standards, and instructions.

*a. Office of the Secretary of Defense (OSD).* Within OSD, the Under Secretary of Defense (Personnel and Readiness (USD (P&R))) and the Deputy Assistant Secretary of Defense (Civilian Personnel Policy (DUSD (CPP))) have responsibility for DOD-wide Civilian Human Resources (CHR) policy. The DUSD (CPP) develops plans, policies, and programs to manage the DOD civilian workforce, including NAF and local national employees in coordination with the services and within the framework established by Federal law, EOs and government-wide regulations. Through its Civilian Personnel Management Service (CPMS), the DUSD (CPP) also provides certain civilian human resource services on a DOD-wide basis.

*b. DOD Investigations and Resolutions Division (DOD IRD).* The IRD investigates and facilitates the resolution of EEO Complaints and formal employee grievances not covered by negotiated grievance procedures. In a complex formal grievance of a NAF employee, or a formal grievance of an APF employee under the Administrative Grievance System, the deciding official may elect to retain the services of the IRD to review the facts and make recommendations.

### 14–9. Assistant Secretary of the Army for Manpower and Reserve Affairs (ASA (M&RA))

*a. DA authority for civilian personnel management is further delegated by the Secretary of Defense to the SA. The SA in turn has delegated some of the civilian personnel management responsibilities including responsibility for personnel policy, programming and oversight to the Assistant Secretary of the Army for Manpower and Reserve Affairs ASA (ASA (M&RA)) through General Order No. 3. (9 July 2002) and amendment No. 2002–03. The SA retains appointing and pay setting authority for civilian Executive and Senior Professional (ESP) personnel (except for those appointed by the President of the United States or other higher level authority). This includes positions in the SES, Defense Intelligence Senior Executive Service (DISES), Scientific and Technical Professionals (STs), Senior Level (SL) and Defense Intelligence Senior Level (DISL), as well as Highly Qualified Expert (HQE) positions. By memo dated 3 Aug 2009, the SA delegated to the ASA (M&RA) authority, direction, and control over missions, functions, and personnel of the Civilian Senior Leader Management Office (CSLMO). The Deputy Chief of Staff, G–1 (DCS G–1), is the responsible official to the ASA (M&RA) in developing, coordinating, and implementing programs and policies directly associated with accession, development, distribution and sustainment of military and civilian personnel. The Assistant G–1 for Civilian Personnel (AG–1 CP) has responsibility for supervision of civilian personnel policy, management, and related civilian personnel functions.*

*b. Appointing authority, which is the authority to approve personnel actions, is delegated to the Commanders of the Army Commands, the Commanders of the Army Service Component Commands, the Commanders/Superintendent of the Direct Reporting Units and the Administrative Assistant to the Secretary of the Army. In order to streamline the execution of the Department of the Army's civilian personnel program, The Army's Civilian Human Resources Agency (CHRA), through the CHRA Regional Directors or their designees, authenticates civilian personnel actions for their serviced organizations. Such personnel officials will "act for" the appointing authorities in authenticating actions. Authenticating officials may electronically approve a personnel action only after the responsible management official has approved the action, determined its accordance with law and regulation, as well as exercised appropriate fiduciary responsibility to ensure fiscal soundness. The authenticating official is responsible for ensuring that personnel actions are in compliance with applicable civilian personnel laws, rules, regulations and governing policies before processing the actions and thus serves as the appointing official. An example is provided to illustrate the "act for" relationship: Whenever the regional processing center approves and processes an official personnel action (such as the appointment of someone to a position), it is doing so on behalf of the commander of the serviced organization, exercising that*

commander's personnel management authority. Regional and Civilian Personnel Advisory Center (CPAC) directors are directly responsible to each of the commanders they service for the proper exercise of this authority.

#### **14-10. Other Army organizations with civilian personnel responsibilities**

*a. U.S. Army Civilian Personnel Evaluation Agency (USACPEA).* USACPEA is responsible for conducting civilian personnel management and administration surveys and special Army-wide reviews. The purpose of these surveys and special reviews is to fulfill the SA oversight responsibility by assessing program effectiveness, efficiency, and compliance.

*b. U.S. Army Family and Morale, Welfare and Recreation Command (FMWRC).* FMWRC is a subordinate command to Installation Management Command (IMCOM). FMWRC's mission is to develop and administer systems and programs for the Army family and community activities under the general heading of Family and Morale, Welfare and Recreation (MWR). The FMWRC administers a central referral program for specified MWR managerial jobs (both APF and NAF) and a benefits program for all Army NAF employees.

*c. Intelligence Personnel Management Office (IPMO).* The IPMO is a subordinate element of the Office, Deputy Chief of Staff, G-2, HQDA. It serves as the focal point in the Army for policy and management of the Defense Civilian Intelligence Personnel System (DCIPS) and reports jointly to the Army Deputy Chief of Staff for Intelligence (G-2) and the Army Deputy Chief of Staff for Personnel (G-1). It maintains liaison with the rest of Federal intelligence on civilian personnel management issues, develops policies and programs, and develops and provides training and guidance. The IPMO also provides personnel management advice and assistance to CPACs that, in turn, provide civilian personnel management support to intelligence organizations or those with DCIPS employees.

### **Section III CHR Service Delivery**

#### **14-11. Civilian Personnel Advisory Centers (CPACs)**

*a.* Advisory functions requiring face-to-face interaction between personnel specialists and managers and employees typically reside at the CPAC (installation/activity level). Action processing, record keeping and database management functions are centralized at regional processing centers. The Army has established seven geographically based regions, each with a regional processing center. The two OCONUS (outside the Continental United States) regions and their regional processing center locations are: Europe Region-Germany; and Far East Region-Korea. Five regions are in the CONUS (Continental United States): Southwest Region-Fort Riley, Kansas; Northeast Region-Aberdeen Proving Ground, Maryland; North Central Region-Rock Island Arsenal, Illinois; South Central Region-Redstone Arsenal, Alabama; and, the West Region-Fort Huachuca, Arizona. Within the regions are a total of 99 CPACs. Each CPAC is typically located at or near the installation(s) to which it provides advisory services.

*b.* Specific responsibilities of the CPACs are:

(1) Providing the civilian personnel service and assistance necessary to obtain, compensate, develop, use, and retain an effective civilian work force.

(2) Promoting equality of opportunity in the organizational units serviced.

(3) Coordinating personnel management requirements and needs of the organizations serviced.

(4) Providing information and staff assistance and guidance to managers and supervisors to assist them in obtaining the most effective use of civilians through improved management.

(5) Establishing labor management relationships focused on supporting and enhancing the Army's national security mission and creating and maintaining a high performance workplace that delivers the highest quality products and services at the lowest possible cost. Such relationships should be committed to pursuing solutions that promote increased quality and productivity, customer service, mission accomplishment, efficiency, quality of life, employee empowerment, organizational performance, and military readiness. Consensual means of resolving disputes, such as alternate dispute resolution and interest based bargaining, should be sought.

#### **14-12. Automation tools**

*a.* The Defense Civilian Personnel Data System (DCPDS) is an automation tool used throughout DOD. DCPDS contains the world's largest relational database; housing and processing all of DOD's civilian human resources (HR) data. The system is designed to support APF, NAF, and local national HR operations. It offers a comprehensive array of state-of-the-art personnel processing capabilities. Managers can access organizational, historical, and employee data through a variety of reports and individual screens. Human Resource Specialists can process personnel actions, automatically interface with APF payroll, and generate confirming documents that can print at the originating manager's office printer. Along the way, the personnel action can be acted upon by those with the need and access, such as resource management for coding and budgetary data.

*b.* Automated tools have been developed to support remote processing and enable fewer human resource specialists to provide the same or better customer service. These tools include:

(1) *PERMISS.* The Personnel Management Information and Support System (PERMISS) is an on-line supervisors'

## How the Army Runs

and employees' handbook. It contains over 800 articles providing general civilian personnel guidance and information, with links to source and reference documents (e.g. applicable laws and regulations). PERMISS may be accessed through the Army Civilian Personnel Online (CPOL) website on the Internet. Although PERMISS is not designed to answer questions pertaining to a specific individual's entitlements or job status, it does provide access to many of the general concepts and logic involved in making personnel decisions. It is not a forum for raising situation-specific questions, which should be answered through the supervisory chain of command or by the servicing CPAC.

(2) *CPOL. The Civilian Personnel Online* (. CPOL) system contains policy and guidance documents on the management and administration of the Army civilian workforce, including newsletters, bulletins, operating manuals, directives, forms, per diem rates and salary schedules.

(3) *RESUMIX*. RESUMIX is a staffing support tool that helps an HR specialist rate, rank, and refers applicants by utilizing electronic formats. Applicants can submit resumes electronically for vacancies listed on the link on the CPOL website, or through OPM's electronic job vacancy sites. Personnelists can create vacancy announcements electronically and electronically match resumes received to the skills identified by the manager and the position description.

(4) *Résumé Builder*. Résumé Builder is an on-line program for applicants to use in creating and submitting resumes for consideration against vacancy announcements. It replaces a cumbersome paper application process and provides significant efficiencies to help specialists quickly rate large number of applications. RESUMIX and Résumé Builder also reduce the time it takes the specialist to provide a manager or commander with a referral list of candidates.

(5) *ANSWER*. The Applicant Notification System Web-Enabled Response (ANSWER) tool is designed to allow users to check the status of the résumé, track application history, view self-nomination history and view current résumé and supplemental data listed in the Central Resumix Database. Users can toggle between the Résumé Builder and ANSWER.

(6) *FASCLASS*. The Fully Automated System for Classification (FASCLASS) delivers position classification and position description information to the customer's desktop. It provides on-line access to active position descriptions and organizational information.

(7) *ABC-C*. The Army Benefits Center-Civilian (ABC-C) enables customers to access and change their civilian benefits, such as health and life insurance, over the telephone or on the Internet. ABC-C processes employee retirements. ABC-C also has skilled and knowledgeable operators to provide counseling over the phone.

(8) *CHRTAS/ ATRRS*. The Civilian Human Resource Training Application System (CHRTAS) and the Army Training Requirements and Resources System (ATRRS) provide a web-based training tool for supervisors, employees and training course managers. Capabilities include training registration and approval, Individual Development Plans (IDPs), and Training History Management. Completed training is recorded in CHRTAS, ATRRS, and DCPDS. All three systems are utilized for training provided by CHRA, Regional HRD Divisions, as well as the Civilian Education System (CES) leadership courses managed by the Army Management Staff College. CHRTAS is evolving to become Army's enterprise Competency-Based Career Development System.

## Section IV

### Personnel management at installation/activity level

#### 14-13. Personnel management responsibility and authority.

The responsibility for providing day-to-day leadership of Army civilians resides primarily at installation and activity level with the supervisor, manager and commander. The SA has delegated personnel management authority, except for management of ESP resources, to commanders with authority to further delegate to commanders of independent field activities. Thus, the actual management of DA civilians, including professional development, incentive awards, discipline, evaluation, labor relations, and almost all other life cycle personnel functions is decentralized to installation and activity commanders and local managers and supervisors. The CPAC assists the chain of command in exercising this responsibility. In the case of ESPs, centralized management is the responsibility of CSLMO.

#### 14-14. Commander responsibilities

Installation commanders are responsible for leading and managing civilian employees and are held accountable for effective utilization of their HR assets. Responsible commanders develop, empower, and utilize subordinate supervisors, managers, and the CHR staff to establish a work environment for positive employee motivation and high performance. Specific command responsibilities are to carry out civilian personnel management policies, procedures and programs as set forth in Title 5, United States Code - "*Government Organizations and Employees*;" Title 5, Code of Federal Regulations - "*Administrative Personnel*;" and DOD 1400.25-M - "*DoD Civilian Personnel Manual*;" 5 CFR Parts 410 and 412, *Training; Supervisory, Management and Executive Development*, and other applicable laws and regulations, consistent with applicable negotiated agreements.

#### 14-15. Supervisor responsibilities

a. Commanders generally delegate authority for leading and managing civilian employees to subordinate managers and supervisors. This carries with it specific responsibilities to:

- (1) Maintain accurate position descriptions.
  - (2) Recruit, select, assign, and set pay for employees.
  - (3) Evaluate employee performance, and train and develop employees.
  - (4) Administer award and incentive programs.
  - (5) Maintain management-employee communications.
  - (6) Communicate employee expectations, administer constructive discipline, and promptly address employee performance deficiencies.
  - (7) Maintain a positive labor-management relations program.
- b. Supervisor responsibilities in each of these areas and the functional systems established to assist in carrying out these responsibilities are described below.
- c. The Army has an informal civilian mentoring program for mentoring civilians. The Army Mentorship Program was created to reemphasize, reinvigorate, and increase mentorship throughout the Army. The Army's Mentorship Resource Center is located at <http://www.armyg1.army.mil/hr/mentorship/default.asp>
- (1) Supervisors should motivate employees to seek mentors through the Army's Mentorship Resource Center.
  - (2) DA pamphlet 690-46 *Mentoring for Civilian Members of the Force* provides further guidance.

#### **14-16. Position classification and pay**

##### *a. Position classification and pay for APF positions.*

(1) Position classification authority is delegated to managers and supervisors within the Army, who may further delegate to CHRA for day to day operation. Individual positions are classified by comparison with the appropriate classification standards or guides. These are developed by OPM or DOD based on comprehensive occupational studies of representative work found in the Federal service. Army regulations assign responsibility for maintaining accurate job descriptions to supervisors. Differences in grades and pay must be attributed to differences in the difficulty, responsibility, and skill requirements of jobs.

(2) Most positions are covered by the following pay systems: the General Schedule (GS); Personnel demonstration projects (which cover white-collar workers in professional, administrative, technical, clerical, and protective occupations), and the Federal Wage System (FWS) which covers workers in trades, crafts, labor, and similar occupations. Salary rates for most GS positions, including locality pay, are based on surveys of private sector salary rates conducted by the Department of Labor. FWS wage rates are established based on local surveys of private sector rates conducted by Federal agencies in accordance with OPM policies. Personnel demonstration projects operate under broad pay band systems rather than the GS schedule. The National Security Personnel System (NSPS) covered some workers but was repealed by the National Defense Authorization Act for Fiscal Year 2010. It will no longer in use as of 1 January 2012.

(3) Personnel demonstration projects authorized by the *Defense Authorization Acts of FY95 FY96, and FY98*, operate under broad pay band systems rather than the GS schedule. Classification authority in these systems is delegated only to appropriate management officials. These officials classify positions by a comparison of duties and responsibilities with the appropriate broadband or factor level descriptors as outlined in the demonstration projects' Federal Register notices. Typically occupations with similar characteristics are grouped together into career paths, such as Engineering/Science, Business/Technical and General Support. Depending on the demonstration project, each career path may have two to six pay bands. Pay bands allow managers flexibility in setting pay within a band. Salary rates for personnel demonstration project employees generally include staffing supplements which are usually administered in the same manner as locality pay for GS. Employees progress through pay bands according to job performance. Management officials may also use recruitment, retention, and relocation incentives and other pay flexibilities as discussed in paragraph 14-17 below.

##### *b. Position classification and pay for NAF positions.*

(1) The DOD NAF uses a pay band system for position classification and pay. Pay banding involves the establishment of several broad salary bands and allows managers to set individual salaries within an established pay band. It is easier for managers to provide high performing NAF employees with greater compensation short of a promotion action or performance award. The DOD pay band system includes all NAF clerical, administrative, sales, technical, managerial, executive, professional, and personal service positions, exclusive of child care giving and crafts and trades positions.

(2) There are six pay bands which are referred to as pay levels and identified using codes NF-1 through NF-6. They have minimum and maximum pay rates that are overlapping. The minimum and maximum rates for the first two levels and minimum level for NF-3 are determined by locality-based wage surveys of comparable private sector jobs. The maximum rates for NF-3 and the rates for NF-4 through NF-6 are related to the GS and SES pay range.

(3) Child caregiving pay band positions are covered by a separate pay band system implemented in consonance with the DA Caregiving Personnel Pay Program. There are two pay bands, also referred to as pay levels, and they are distinctly identified through use of terms Pay Band I or Pay Band II. The range in pay for child care giving pay band positions is equal to the hourly rate of pay for a GS-2, Step 1, through GS-5, Step 10, and pay rates prescribed for GS child care giving positions also apply. The DA Child Personnel Pay Program (CPPP) was expanded in February 1999 to include positions in Youth Services that had similar duties and responsibilities. The program continues to follow the

## How the Army Runs

same guidelines that were established for the CPPP and is now known as the Child and Youth Personnel Pay Program (CYPPP).

(4) Crafts and trades positions are not affected by pay banding. Pay is determined through the prevailing rate system used for those positions covered under the Federal Wage System (FWS).

*c. Position classification and pay for foreign national positions.* These positions are generally not included in either of the pay systems described above. Employees in these positions are paid under local host-nation pay scales and conditions.

### 14–17. Recruitment, Selection, and Assignment

*a.* Management has the right to consider candidates from all appropriate sources, including but not limited to merit promotion, reinstatement and transfer eligibles, *Veterans Employment Opportunity Act (VEOA)* eligibles, individuals with severe physical or mental disabilities, family member eligibles under EO 12721 and 13473, and those certified as eligible for appointment by OPM or under a delegated examining authority. In deciding which sources to tap, consideration should be given to those which are expected to produce candidates who will meet the agency's mission requirements, contribute new ideas and viewpoints, and meet the agency's affirmative action and special employment programs. Recruitment sources also encompass the Pathways Programs created under Executive Order 13562, *Recruiting and Hiring Students and Recent Graduates*. The Pathways Programs includes the Internship Program, Recent Graduates Program and the Presidential Management Fellows (PMF) Program and are described below. Persons with statutory or priority placement rights to a vacancy must be given appropriate consideration before the normal recruitment process may proceed.

(1) Recent Graduates Program. This program targets recent graduates of trade and vocational schools, community colleges, universities and other qualifying institutions. To be eligible, applicants must apply within two years of degree completion (except for veterans precluded from doing so due to their military service obligation, who will have six years after degree completion). Successful applicants will be placed in a two-year career development program. Those who successfully complete the program may be considered for noncompetitive conversion to career/career conditional appointments.

(2) Internship Program. The program provides students in high schools, community colleges, four year colleges, trade schools, career and technical education programs, and other qualifying educational institutions and programs with paid opportunities to work in agencies and explore Federal careers while still in school. Students that successfully complete the program may be eligible for noncompetitive conversion to career/career conditional appointments.

(3) Presidential Management Fellow (PMF) Program. This program aims to attract to the Federal service outstanding men and women from a variety of academic disciplines at the graduate level who have a clear interest in, and commitment to, the leadership and management of public policies and programs. Successful completion may lead to noncompetitive conversion to a career/career conditional appointment. Personnel selection decisions must be based solely on merit based and job-related reasons.

*b.* In recent years the DA, like other employers, has found the recruitment and retention of highly skilled employees a challenge, particularly for jobs in shortage occupations or in locations with an especially tight labor market. Due to an anticipated wave of retirements, completion of the Base Realignment and Closure (BRAC) process, and the proposed downsizing of the Federal government, for the next several years DA anticipates difficulty in filling mission critical vacancies in a highly competitive environment. It is important, therefore, that supervisors and managers are aware that special incentives are available for staffing positions with unusual recruitment and retention problems. These incentives may include recruitment incentives, relocation incentives, retention incentive superior qualifications appointments (appointment at a rate above the minimum for the GS grade because of superior qualifications or a special need for the candidate's services), and special salary rates (minimum rates and rate ranges above those of the GS). NSPS provided additional flexibility and options with the construct of pay bands and targeted local market supplements. However, NSPS was repealed by the National Defense Authorization Act for Fiscal Year 2010, and is no longer in use as of 1 January 2012. In addition, activities may identify local shortage positions for purposes of paying first duty station and pre-employment interview travel expenses for permanent positions. Information about these and other incentives is available in PERMISS. Army employment also offers attractive leave, insurance, and retirement benefits, and typically provides a family friendly environment, meaningful public service work, and good opportunities for training and advancement based on merit. All of these can be important tools in marketing the Army as an employer.

### 14–18. Evaluation of employee performance and administration of awards/incentives programs

*a.* Administration of the evaluation and performance incentive functions of civilian personnel management requires managers and supervisors to exercise both leadership and fiscal responsibilities. It also requires an appreciation of the workplace environment and an understanding of individual needs for counseling, recognition, and reward. The civilian incentive awards program includes monetary and honorary awards. Civilian incentive award decorations and award approval authority are aligned with the military awards system to the extent practicable. The following Army civilian performance management programs are detailed in regulations, pamphlets, and DOD and OPM guidance listed in the reference section of this chapter:

(1) Performance planning and evaluation programs for ESPs, white-collar, blue-collar and NAF employees.

(2) Base pay adjustment policy and procedures for all civilian employees (ESP pay increases; GS and FWS within-grade increases; and NAF pay increases).

(3) Cash and honorary award programs to recognize significant individual and group contributions (SES performance bonuses; GS, NAF, and FWS performance awards; GS quality step increases; and time-off and honorary awards).

(4) Policy and procedures for dealing with employees who fail to meet performance expectations.

(5) Personnel demonstration projects and ESPs use systems that reward high performance or contributions to mission, and place less emphasis on longevity for pay and retention.

*b.* As with the military performance evaluation systems, the civilian evaluation process is designed to enhance supervisory/employee communications and day-to-day relationships to improve overall performance. At the beginning of each rating period, the rating supervisor and the employee determine job requirements and develop a performance plan for the year. The performance plan should reflect the organization's mission and goals and the duties and responsibilities of the employee in concert with individual position descriptions. The performance plan may change during the year if the mission requires a re-ordering of responsibilities and priorities. At least once during the performance cycle (usually at the midpoint of the rating period), the rating official must conduct an in-progress review of employee performance. This typically involves discussion of employee achievements, any changes to expectations, and ways to improve performance, if applicable. At the end of the rating period, the rating chain compares the individual's contributions to the requirements in the performance plan and renders a rating of record. The rating of record is used to make promotion/pay increase and training decisions, document justification for performance-based cash awards and honorary awards, and give additional credit for reduction-in-force/workforce shaping purposes. The evaluation process is also used to assist employees who experience performance problems. Performance counseling sessions may be used to help employees improve to an expected level or the evaluation can serve to support removal from the position if employees fail to meet standards. The keys to successful performance management are frequent, two-way communication and timely, appropriate action to either recognize significant contributions or correct performance which fails to meet expectations.

#### **14–19. Training and development of employees**

On 10 December 2009, significant federal changes governing the training, supervisory, management, and executive development of employees went into effect. These changes were published by OPM in the federal register and they pertain to 5 CFR Parts 410 and 412 (*Training; Supervisory, Management, and Executive Development*). Based on these new requirements, the Army is developing and maintaining training programs to include all types of training activities in support of organizational missions and to support the very first of this federal requirement to evaluate on a regular basis, Army training programs and plans with respect to the accomplishment of our agency's specific performance plans and strategic goals. Coordinating with the CPAC's, the CHRA and Regional Human Resources Development Divisions aide organizational managers and supervisors to develop, coordinate, and administer their training and development programs. Army executives, managers and supervisors are required to define their training requirements in support of the life-cycle management of employee development through competency-based training.

*a. Training programs.* Training categories cover a broad field from executive and management courses to adult basic education. Training is classified as either short- or long-term (more than 120 days). The actual training can be delivered through on-the-job training at local activities, Army schools, DOD schools, CHRA locations, interagency schools, formal schools, and a host of other government and non-government sources as well as online sources. Civilians can also compete for attendance in formal training programs such as Senior Service Colleges and other training opportunities. The Army Regulation (AR) 215 series of documents establishes training requirements for both APF and NAF employees in MWR activities. This training is met largely through courses sponsored and/or conducted by the FMWRC at the MWR Academy.

*b. Career management system.*

(1) To establish basic policies and program requirements for the intake, assignment, training, and development of employees in designated occupations, the Army developed The Army Civilian Training, Education and Development System (ACTEDS) as outlined in AR 690–950, Career Management. These systems support supervisors in recruiting candidates for long-term career opportunities and ensure a steady flow of capable, fully qualified, and trained personnel for Army positions in 23 civilian career professional, technical, and administrative fields. The relative strength in these fields is shown in Figure 14–3.



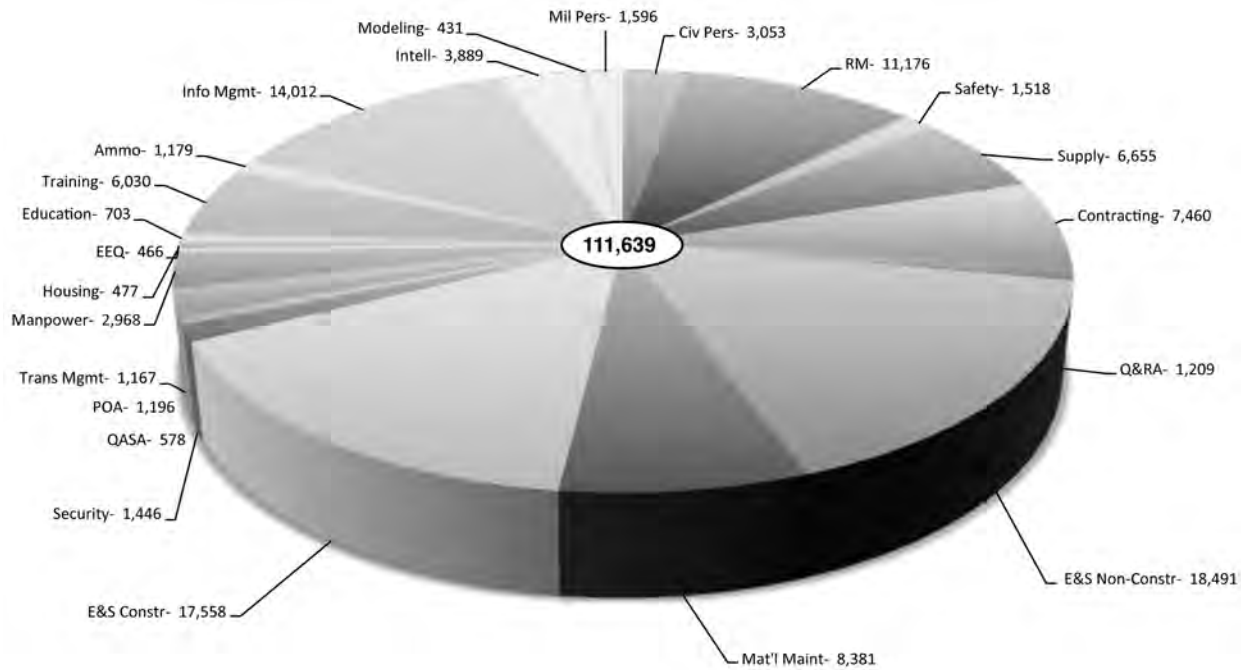

Figure 14-3. Civilian Career Program Strength as of 31 Dec 2010

(2) The career management system provides clear lines of progression to successively more responsible positions and a coordinated training and development program for occupational specialties, using both Army and outside facilities. Procedures are provided for counseling employees; planning individual development programs; and appraising employee competencies. New employees participate in planned work or rotational assignments designed to develop technical and leadership competencies to prepare for future managerial responsibilities. The ACTEDS is the DA-wide program by which these objectives are accomplished and funded.

(3) At the higher-grade levels, typically for promotion to grades GS-13 through GS-15, candidates are considered on an Army-wide basis. Application procedures depend on the particular career program.

(4) The above procedures apply to APF personnel, including those working in MWR programs. NAF employees also benefit from a central referral program. FMWRC is the executive agent for NAF MWR career programs and maintains a central roster of NAF pay band employees eligible for level NF-4 and above positions. Outside applicants may also register in the program. The system provides selecting officials with names and information on employees who are interested in being considered for a given NAF position.

#### 14-20. Workers Compensation Program

a. Federal employees who are injured or become ill as a direct result of their employment are entitled by the Federal Employees Compensation Act (FECA) to medical care and also salary replacement (compensation) while they are not working. Benefits are also available for a surviving spouse and dependents if the death is job related. Additionally, employees are entitled to a lump sum if there is a permanent loss or impairment of a body part because of their employment. The Workers Compensation program is very expensive to the Army, both in dollars and in lost human potential. The majority of the cost stems from workers who never return to Army employment and continue to draw salary replacement for their lifetime.

b. To maintain control of these costs, each installation is required to have a FECA Working Group, composed of the Injury Compensation Program Administer (ICPA) and representatives of management, medical, safety, and investigative service staff. The FECA Working Group should meet at least quarterly to analyze trends and develop cost-containment initiatives. Installations have the obligation to ensure that all workplaces are as safe as possible, that employees are trained on safe work practices, issued appropriate safety equipment, and that safety standards are constantly enforced. All workplace injuries and illnesses should be investigated by the supervisor and by the safety office to ensure the cause of the injury or illness is corrected. The ICPA, located in the CPAC, has the lead in operating the Workers Compensation program at the installation level. The ICPA has the dual responsibility of seeing that the injured or ill worker receives the medical care needed to recover and that the worker returns to employment,

either to the same position held at the date of injury position, light duty, or a new position if necessary. Every employee who is never returned to productive employment is entitled to salary replacement (compensation) for the employee's lifetime. The ICPA also is responsible for ensuring that all questionable claims of injury or illness are challenged so that Army is not charged for undue expenses. The ICPA should be in frequent contact with all injured employees, and ensure that each treating physician understands that Army is eager to offer light duty or modified employment.

c. NAF employees are entitled to worker's compensation benefits established under provisions of the Nonappropriated Fund Instrumentalities (NAFI) Act of 1958 (5 USC Sections 8171–8173), which extends the provisions of the Longshore and Harbor Workers Compensation Act (LHWCA) (33 U.S.C. 901 et seq.) Worker's compensation provides benefits to NAF employees who are disabled because of job-related illness or injury or to surviving spouse and dependents in cases of death from job-related causes. Benefits apply to employees of NAFI/entities employed inside the continental United States; or employees of NAFIs/entities who are U.S. citizens, permanent residents of the U.S. or a territory or possession of the U.S. and employed outside the continental United States. Benefits will not apply to active duty military personnel employed by NAFIs/entities or local civilians employed by NAFIs/entities overseas. Army Regulation (AR) 215–3, *Nonappropriated Funds Personnel Policy*; Chapter 5 and AR 215–1, *Morale, Welfare, and Recreation Activities and Nonappropriated Instrumentalities*; Chapter 19 outline established processes and procedures related to Worker's Compensation for NAF employees.

#### **14–21. Communication, discipline, and labor-management relations.**

Supervisors are responsible for striving to develop a cooperative labor-management relationship: administering labor-management agreements; communicating management objectives, decisions, and viewpoints to their subordinates; and communicating their subordinates' views to higher-level management. Supervisors must analyze problems, develop solutions, and evaluate the results of decisions. The CPAC is responsible for assisting management in the day-to-day business of employee performance, discipline, individual adverse actions, effective use of recognition and awards, labor-management-employee relations, administration of leave, hours of work, and monitoring of health and safety conditions.

a. If an employee believes that his or her rights have been denied, or that improper procedures have been followed, or that an action taken by management is unwarranted, he or she may utilize appropriate forums for relief. Such forums may include, but are not limited to Administrative Grievance Procedures, Negotiated Grievance Procedures, Alternative Dispute Resolution (ADR), Merit Systems Protection Board (MSPB), and Equal Employment Opportunity (EEO) channels. The MSPB may be used for adverse actions (except in cases of a short suspension defined as 14 days or less). Short suspensions and reprimands may be contested through the Administrative Grievance System or Negotiated Grievance Procedures. Subsequently the courts may also be used

b. The grievance procedures (both in policy and through negotiated agreements) set forth specific steps to be followed for resolving employee dissatisfaction with any aspect of working conditions, working relationships, or employment status. Army policy encourages timely resolution at the lowest level practical; however, grievances can escalate up the chain of command, or, if under a negotiated grievance procedure, to binding arbitration.

c. Negotiated grievance procedures are outlined in labor contracts which are jointly developed by management and the local labor union granted exclusive recognition to represent all bargaining member employees (whether or not the employees are union members). The legal basis for the labor-management relations program for Federal employees is 5 U.S.C. Chapter 71. It states that labor organizations and collective bargaining in the civil service are in the public interest. The rights and obligations of employees, unions, and agency management are also established in AR 215–3 which provides the framework for addressing labor-management relations for NAF employees.

d. Supervisors are obliged to maintain a willingness to bargain collectively with labor organizations. Despite earnest efforts, there may be a time when an impasse will result, and if both parties fail to resolve their differences, the law provides for a neutral third party to resolve the impasse. This is the job of the Federal Mediation and Conciliation Service (FMCS) and the Federal Service Impasses Panel (FSIP). The FMCS assists the parties in reaching a voluntary agreement. Failing this, the FSIP may impose a settlement on the parties.

e. Management should strive to ensure that non-adversarial labor-management relationships are nurtured so mission accomplishment is enhanced rather than inhibited by the labor relations process. Management is also responsible for:

(1) Negotiating in good faith regarding conditions of employment (e.g., personnel policies, practices, and matters affecting working conditions).

(2) Furnishing official time to union representatives for negotiating collective-bargaining agreements and for other representational purposes as provided for by negotiated agreement.

(3) Deducting union dues from the pay of eligible employees who authorize such deductions and allotting those deductions to recognized unions.

(4) Notifying recognized unions and giving them the opportunity to be present at formal discussions between management and one or more employees.

(5) Allowing the union the opportunity to be represented at any examination of an employee pursuant to an

## How the Army Runs

investigation if the employee reasonably believes that the examination may result in disciplinary action and if the employee requests representation. (This is called the Weingarten Right).

f. Certain ground rules are established to safeguard the basic intent of the law. The FLRA is an independent, administrative agency presided over by three members appointed by the President. The FLRA is the central policymaking body of the Federal labor-management relations program. It decides representation questions (whether a union is eligible to represent certain groups of employees or whether particular employees fall within the certified bargaining unit), adjudicates negotiability disputes (whether there is an obligation to negotiate on specific proposals), adjudicates unfair labor practices (ULPs) (i.e., a violation of the provisions of Title VII), and decides appeals to arbitrators' awards.

g. Responsibilities of CPAC Directors: The CPAC Director is the designee of the installation/activity commander and, as head of the CPAC, is responsible for administering the civilian personnel program. Note that the commander retains overall responsibility for management and leadership of the civilian work force. The CPAC director has responsibility for the implementation, maintenance, and evaluation of local personnel programs designed to assist supervisors with their personnel management responsibilities and achieve activity mission objectives. The CPAC Director interprets personnel policies and regulations and provides guidance and assistance in personnel matters in his or her assigned areas of responsibility. The CPAC Director must seek to ensure that management actions affecting civilian employees will enhance the Army's reputation as a good and fair employer, ensure employee productivity, support EEO, and maintain effective community relations. The CPAC Director also has oversight of the local NAF personnel program. The CPAC director is assisted in the administration of the NAF discipline and labor relations programs by a NAF Human Relations Officer as well as the NAF personnel program in general.

h. Executive Order 13522. On December 9, 2009, President Obama signed EO 13522, *Creating Labor-Management Forums to Improve Delivery of Government Services*. Among other things, this EO provides for the establishment of labor-management councils at the level of recognition and other appropriate levels agreed to by labor and management. These councils are intended to help identify problems and propose solutions to better serve the public and the agency mission. In addition to councils, the EO provides for employees and their union representatives to have pre-decisional involvement in all workplace matters to the fullest extent practicable. The CPAC can provide additional guidance and instruction on the local implementation of the provisions of the EO.

## Section V

### Equal Employment Opportunity (EEO) in the Army

#### 14–22. Equal Employment Opportunity laws and regulatory requirements

a. Discrimination in the workplace negatively affects employee morale, productivity and teamwork, increases employee absenteeism and turnover, and takes focus away from mission readiness. Title VII of *The Civil Rights Act of 1964* (as amended), *The Equal Pay Act of 1963* (as amended), *The Age Discrimination in Employment Act of 1967* (as amended) and *The Rehabilitation Act of 1973* (as amended) prohibit employment discrimination in the federal government on the basis of race, color, national origin, religion, sex, age (40 and older), mental or physical disability, genetic information or in reprisal or retaliation for engaging in protected EEO activity such as opposing discrimination or participating in an EEO complaint.

b. With oversight by the Equal Employment Opportunity Commission (EEOC), the federal sector EEO program provides federal agencies the opportunity to resolve allegations of employment discrimination quickly and without the need and expense for the parties involved to litigate in federal court. It also provides federal agencies the opportunity to achieve their own model EEO Programs through implementation and assessment of their own affirmative employment programs, identification of barriers to employment for protected groups and implementation of strategies and goals to overcome barriers to employment. Authority to administer the Army's EEO Program is the responsibility of the Deputy Assistant Secretary of the Army for Diversity and Leadership (DASA (D & L)).

c. Within the office of the DASA (D&L), the Diversity and Equal Employment Opportunity (DEEO) Division is responsible for the administrative oversight of the Army's Affirmative Employment Program (AEP) and is the proponent lead for AR 690–12 *Equal Employment Opportunity and Affirmative Action* which implements the Army's AEP. The Army AEP focuses on analyzing the Army workforce based on race and national origin, sex, and disability compared to civilian labor force statistics, identifying barriers to employment for these groups and implementing strategies, using existing federal programs designed to assist these groups and (with input from senior leaders) overcome identified barriers to employment. DEEO documents the status of the Army's AEP in the annual EEOC Management Directive 715 State of the Agency Report. DEEO is responsible for oversight of complaints involving accessibility of Army facilities and information for individuals with disabilities. DEEO is also responsible for administration of Career Program 28 (Equal Employment Opportunity).

d. Commanders are responsible and accountable for execution of effective EEO programs and (with the support from other senior leaders within the command) should strive to create a command climate in which it is clear to all soldiers and civilians that unlawful discrimination and harassment will not be tolerated. EEO policy memorandums should be signed and issued by the Commander. Commanders are responsible for providing sufficient resources to the EEO program to ensure efficient and successful operations.

e. On behalf of the Commander, the EEO Officer is charged with the duty to impartially execute the EEO Program. To emphasize the importance of the position, the Commander should be involved in the selection and performance review of the EEO Officer. A reporting structure should be maintained that provides the EEO Officer with regular and direct access to the Commander and other senior leaders for reporting on the effectiveness, efficiency and legal compliance of the command's EEO program. The EEO Officer should be a regular participant in senior staff meetings and regularly consulted on human resources issues within the command. To maintain impartiality of the EEO program, Commanders should avoid unnecessary conflicts of interest, such as assigning the role of investigator in a Commander's Inquiry, or temporarily reassigning EEO personnel to positions in HR, CPAC, the Command Section, or other positions that involve making management decisions outside of the EEO office. The EEO staff takes the lead, with input from senior leaders, in the development of all program initiatives on programs covered by EEOC Management Directive 715. The EEO Officer documents the status of elements of the command's AEP in various mandatory reports, including the annual EEOC Management Directive 715 Report, which is reviewed and signed by the Commander. Commanders and other senior leaders should ensure that policies and posters containing information about EEO programs and processes, including contact information for the servicing EEO office, are posted prominently and accessible to the public throughout the workplace and on the command's web site.

#### **14–23. The Equal Employment Opportunity complaints program and process**

a. Within the office of the DASA D&L, the Equal Employment Opportunity Compliance and Complaints Review (EEOCCR) Division is responsible for the administrative oversight of the Army's EEO Complaints Program, and is the proponent lead for AR 690–600, *Equal Employment Opportunity Discrimination Complaints* which implements the complaints program. EEOCCR monitors Army compliance with laws, statutes and regulations governing EEO complaint processing, reports the Army's compliance status to the EEOC annually, and is the complaint records custodian for the Army. EEOCCR is also the Army's adjudicator of the merits of formal EEO complaints when final agency decisions are requested or required.

b. EEO offices generally have one of two roles: operational and administrative. Operational EEO offices are responsible for processing EEO complaints and providing training and information to the workforce. Many operational EEO offices are located on Army installations and provide services to tenant commands on the installations as well as their own commands. Administrative EEO offices are responsible for monitoring complaint activity within their area of responsibility, but generally do not process EEO complaints themselves. Army commands (ACOM), Army Service Component Commands (ASCC) and Direct Reporting Units (DRU) headquarters EEO offices are generally administrative. Some administrative EEO offices have oversight and support responsibilities for operational EEO offices.

c. On behalf of the Commander, the EEO Officer is charged with the duty to impartially execute the EEO Complaints Program and ensure that due process is preserved. Commanders should be briefed on the status of current complaints within the command, the use of ADR, the timeliness of complaint processing, the office complaint load overall (if the EEO office processes complaints for tenant organizations as well as the command), and trends in complaints that impact the command. Other senior leaders should also be briefed on the status of complaints within their area of responsibility as appropriate.

d. The Complaints Process. Army employees, former employees, applicants for employment and contractors who believe they have been discriminated against by the Army with respect to a term, condition or benefit of employment on the basis of race, color, national origin, religion, sex, age (40 and over), mental or physical disability, genetic information, or in reprisal or retaliation for having engaged in protected EEO activity have the right to initiate an EEO complaint with the Army. Examples of employment actions which may give rise to a complaint include, but are not limited to, hiring and promotion decisions, performance evaluations, reassignments, disciplinary actions, and harassment.

e. Individuals must contact the EEO office, or anyone reasonably connected to EEO, to initiate a precomplaint. Contact must be made within 45 calendar days from the date the individual knew or should have known of the alleged discrimination. An employee from the EEO office will conduct a precomplaint intake interview with the individual, called the aggrieved, and document the claim and the narrative information. An EEO Counselor will be assigned to conduct a limited inquiry into the claims alleged. When deemed appropriate by the EEO officer, and after coordination with Labor and Management Employee Relations (LMER), legal officials, and Army management, ADR may be offered to the aggrieved as a means of trying to settle the complaint. If resolution of the complaint is reached at any point in the process, the terms of the resolution will be documented in a written negotiated settlement agreement. Commanders and other senior leaders can promote ADR programs and encourage managers and supervisors in their organizations to participate in ADR. If the complaint cannot be resolved, the aggrieved will receive a Notice of Right to File a Formal Complaint of Discrimination, and will have 15 calendar days from the date of receipt of the notice to file a formal complaint.

f. Upon receipt of a written formal complaint, the EEO officer will determine if the claim(s) alleged can be dismissed for procedural reasons provided in 29 CFR 1614 and AR 690–600. Any claim(s) that cannot be dismissed will be accepted. The EEO officer will issue a letter accepting and/or dismissing claims identified in the complaint within 15 calendar days of receipt of the formal complaint. If a claim is accepted, a formal investigation is arranged and ADR may be offered again. The EEO office will request the assignment of an investigator from the Department of

## How the Army Runs

Defense Investigations and Resolutions Division (IRD). IRD charges a flat administrative processing fee for requests for investigators. The activity where the discrimination is alleged to have occurred is responsible for paying the IRD fee and identifying the activity point of contact (POC) who will make the payment. Once an investigator is assigned, the EEO office will coordinate the investigation. IRD investigations are conducted via Fact Finding Conference (FFC), the Army's preferred method of investigation. The FFC is attended by the investigator, the complainant and complainant's representative, and any responding management officials, witnesses, agency representatives, and a certified court reporter. Commanders and other senior leaders are required to ensure that their organizations cooperate with any request from an EEO for documentation or the testimony of a soldier or civilian within the command identified as a witness. Testimony is taken under oath and on the record from the complainant, the responding management official and other witnesses. The activity where the discrimination is alleged to have occurred is also responsible for paying for a certified court reporter to take a verbatim transcript of the investigation. The investigator will use the verbatim transcript and complaint documents to draft a Report of Investigation (ROI). The ROI is a compilation of facts and evidence taken under oath to be used to make a decision on the merits of the complaint at a later time. The Army is responsible for ensuring that investigations are completed within 180 calendar days of the formal filing date or within 120 calendar days where the complaint involves an issue appealable to the MSPB. The investigation officially ends when the EEO office receives the ROI.

*g.* Once the EEO office receives the ROI, a copy is sent to the complainant, along with a Post-Investigative Options Notice. This notice provides the complainant the option of either requesting a hearing before an EEOC Administrative Judge (EEOC AJ), or requesting a Final Agency Decision (FAD) from the EEOCCR. If the complainant fails to select an option, the EEO office will request a FAD on the complainant's behalf. If the complaint involves an issue appealable to the MSPB, the complaint will be sent to the EEOCCR for a FAD. If the complainant elects to request a hearing, the hearing request, along with a copy of the complaint file, is sent to the appropriate EEOC regional or field office, and the EEOC AJ is appointed to hear the complaint. Once the hearing is scheduled, witnesses will be required to attend and provide sworn testimony at the hearing. The activity where the discrimination is alleged to have occurred will again be required to pay for the services of a court reporter to take a verbatim transcript of the hearing. After the hearing, the EEOC AJ will issue a decision stating if discrimination was or was not found to have occurred. The EEOC AJ decision is forwarded to the Army (EEOCCR) for issuance of a Final Agency Action (FAA) implementing the AJ's decision. The complainant has the option of appealing a FAA or a FAD to the EEOC Office of Federal Operations (OFO) or filing suit in federal court. The Army may choose to appeal an EEOC AJ's finding of discrimination to the EEOC OFO instead of issuing a FAA.

*h.* Failure to cooperate with the complaint process places the Army at risk. A finder of fact, such as an EEOC AJ or EEOCCR, may determine that the failure to cooperate constitutes sufficient grounds to presume that unlawful discrimination occurred. This is called an adverse inference, and essentially means that a prima facie case of discrimination is established, and the agency bears the burden of providing evidence to rebut the adverse inference. When a finder of fact determines that discrimination has occurred, the activity where the discrimination occurred is responsible for providing any relief the complainant is deemed entitled to, such as money damages (including attorney fees), initiating personnel actions, and conducting a culpability study of management officials found to have discriminated to determine what, if any, disciplinary action should be taken. A management official found to have discriminated against an employee may be subject to discipline, including termination, in accordance with AR 690–700, Chapter 751 Table of Penalties. A finding of discrimination may also prevent a management official from being eligible for certain awards and prevent an officer from promotion into or up through the General Officer ranks.

## Section VI

### Executive and Senior Professional (ESP) Personnel

#### 14–24. ESP Structure and Composition

*a.* Civilian senior leadership is crucial to the support of military operations in a wide range of functions that are necessary for the Army to achieve battlefield success. This includes roles in procurement, logistics, research and development, finance, and human capital management. Executive and Senior Professional (ESP) positions are above the GS–15 level, and salaries can range as they do for general officers. OPM establishes the regulations and allocations for ESP positions. DA requests allocations through the OSD. Army's authorized ESP positions include a broad range of occupational series which span across the U.S. and overseas. However, almost half of the Army's ESP positions are located in the Washington, DC Metro area.

*b.* On 9 August 2010 the SA signed the Executive Resources Board (ERB) Charter. The ERB plays an active, robust role in formulating policies for, and in the management, governance and oversight of all Army ESP programs, and reviews and renders decisions or opinions on certain actions affecting ESP members and positions, including ESPs assigned to COCOMS (combatant commands) to which the Army provides administrative and logistical support. The ERB advises the SA on matters relating to the hiring, training and development, utilization, performance evaluation, and compensation of the Army's ESP workforce, which includes career SES, SL, ST, Defense Intelligence Executive Service (DISES) and DISL personnel. The ERB may also provide advice on, and oversight of, matters relating to other Army executive-level positions.

**Table 14–1**  
**Executive Service Personnel**

Acquisition/Contracting	53
Comptroller	32
Engineer & Science	103
General Administration	47
Human Resources, EEO & Manpower	21
Intelligence	30
International Relations	4
IT, Record Management	6
Legal	15
Medical	14
Military Human Resources	3
Morale, Welfare & Recreation	2
Operations and Plans	5
Public Affairs	1
Real Estate	3
Installation/Business Management	15
Safety/Occupational	3
Transportation/Supply	17
Training	3

**Table 14–2**  
**Executives Organizationally**

OSA	96
AMC	94
USACE	40
ARSTAF	74
TRADOC	17
JOINT ACT	11
IMCOM	9
USAREUR	7
SMDC	7
MEDCOM	19
FORSCOM	5

### 14–25. Qualifications of Senior Executive Service (SES) Members

*a.* There are five executive core qualifications (ECQs) that all potential SES members must possess:

(1) **Leading Change.** This core qualification involves the ability to bring about strategic change, both within and outside the organization, to meet organizational goals. Inherent to this ECQ is the ability to establish an organizational vision and to implement it in a continuously changing environment.

(2) **Leading People.** This core qualification involves the ability to lead people toward meeting the organization's vision, mission, and goals. Inherent to this ECQ is the ability to provide an inclusive workplace that fosters the development of others, facilitates cooperation and teamwork, and supports constructive resolution of conflicts.

(3) **Results Driven.** This core qualification involves the ability to meet organizational goals and customer expectations. Inherent to this ECQ is the ability to make decisions that produce high-quality results by applying technical knowledge, analyzing problems, and calculating risks.

(4) **Business Acumen.** This core qualification involves the ability to manage human, financial, and information resources strategically.

(5) **Building Coalitions.** This core qualification involves the ability to build coalitions internally and with other Federal agencies, state and local governments, nonprofit and private sector organizations, foreign governments, or international organizations to achieve common goals.

*b.* The executive development of employees in GS–14 and 15 grade levels or equivalent is an important command responsibility. ESP members are expected to possess leadership competencies that parallel those of Army general officers. Therefore, attendance at a Senior Service College program is a highly desirable experience for civilians who aspire to ESP positions. Appointment to the ESP marks achievement of the highest nonpolitical civilian executive position. These positions are given protocol precedence equivalent to lieutenant general, major general, and brigadier general.

*c.* For more information on these positions go to <http://www.opm.gov/ses/index.asp>.

### Section VII

#### Defense Civilian Intelligence Personnel System

##### 14–26. Structure and composition of the Defense Intelligence Personnel System (DCIPS)

a. DCIPS employees are U.S. citizens paid from APFs. Unlike most other APF civilians, they are managed through a statutorily based excepted personnel service administered by the OSD for the DOD Intelligence Community.

b. There are currently approximately 5,500 civilians in the Army under this personnel system. The Army has included in DCIPS all employees in series and specialties with clear ties to intelligence wherever they are found. Some examples are intelligence specialists in the 132 series and intelligence assistants in the 134 series regardless of function as well as security specialists in the 080 series and security assistants in the 086 series where 51% or more of their duties are intelligence related (not law enforcement related). DCIPS coverage by series/function has resulted in most major commands having at least some DCIPS employees. The Army has also included in DCIPS all employees (except local nationals) in commands that have a primary intelligence mission. Many of the administrative, technical and support series, and a few wage grade employees in DCIPS, as well as the Army's intelligence and security professionals, are found in such commands as the U.S. Army Intelligence and Security Command.

##### 14–27. Relationship of DCIPS to the Army civilian personnel program

a. DCIPS is considered a part of the Army's overall civilian personnel program and has tested innovative personnel management features for Army and the DOD. As a statutory alternative personnel system, DCIPS is exempt from Title VII job classification provisions and has adopted the use of the National Security Agency's (NSA) classification system to better align grades with the rest of the intelligence community. It is also exempt from many OPM hiring provisions and can directly consider applications from non-government employees through its own merit system. DCIPS is presently being revised by DOD to encompass all of DOD's intelligence community and not just the military services. DCIPS will be a pay for performance and pay banded system.

b. Civilian personnel servicing support for CONUS intelligence activities are consolidated at the Ft. Huachuca CPAC and West Regional Processing Center at Fort Huachuca, AZ. This consolidation improved HR understanding and system expertise and increased servicing effectiveness and efficiency.

c. DCIPS was implemented in FY90, first as a tri-service system known as the Civilian Intelligence Personnel Management System (CIPMS), and then evolving into DCIPS when a provision of the *DOD Authorization Act of 1997* (known as the *Department of Defense Civilian Intelligence Personnel Policy Act of 1996*) combined all civilian personnel management systems for intelligence components in DOD into one broad excepted service system. DCIPS legislation and supporting initiatives continually strive to achieve a broad common architecture of policies, systems and standards while protecting individual Service and agency prerogatives. Common employment and compensation architectures are planned along with inter-community rotational and development programs. Common senior executive and leader programs have also been developed. These include the DISES for intelligence executives and the DISL program for senior experts Section VIII Civilian Expeditionary Workforce (CEW)

##### 14–28. Civilian Expeditionary Workforce (CEW)

a. On 23 January 2009, DOD issued a new DOD Directive (DODD), 1404.10, *DOD Civilian Expeditionary Workforce*. This new Directive reissued the previous DODD 1404.10, *Emergency-Essential (E-E) DoD U.S. Citizen Civilian Employees* (dated April 10, 1992) under a new title to establish the policy through which an appropriately sized subset of the DOD civilian workforce is pre-identified to be organized, trained, and equipped in a manner that facilitates the use of their capabilities for operational requirements. These requirements are typically away from the normal work locations of DOD civilians, or in situations where other civilians may be evacuated to assist military forces where the use of DOD civilians is appropriate. These employees are collectively known as the DOD Civilian Expeditionary Workforce. The DODD 1404.10 also superseded any conflicting portions of other DOD issuances. Members of the DOD CEW are to be organized, trained, cleared, equipped, and ready to deploy in support of combat operations by the military; contingencies; emergency operations; humanitarian missions; disaster relief; restoration of order; drug interdictions; and stability operations of the Department of Defense in accordance with DODD 3000.05.

b. The new DODD 1404.10 updates policies and responsibilities for the designation of part of the DOD CEW using the existing category of Emergency-Essential (E-E) civilian employee positions, and establishes policies and responsibilities for the designation of part of the DOD CEW using new categories of Non-Combat Essential (NCE) positions and Capability-Based Volunteers (CBV) employees and former DOD employees.

c. Implementation of the CEW program within the Army will require that commands identify and designate a portion of their workforce as CEW. Additionally, Commanders of commands will be responsible for ensuring all designated CEW employees are properly trained, equipped and ready to deploy. This also includes the assurance that all employees returning from a deployment complete the required Post Deployment Health Assessments (i.e., 30, 90, and 180 days after deployment). To aid Commanders in ensuring the readiness of their designated CEW employees various readiness processing centers are available to validate readiness prior to deployment. The majority of the Army's employees are to be processed through the CONUS Replacement Center (CRC) located at Ft. Benning, GA. The US Army Corps of Engineers (USACE) has a readiness processing center located in Winchester, VA. The USACE

processing center is primarily established to process USACE employees, but others can be processed via a Memorandum of Agreement/Understanding between the requesting command/organization and the USACE. A third processing center is located at Camp Atterbury, IN. This processing center has been established by the OSD as a primary means of processing employees who have volunteered to deploy in support of CEW positions advertised and sponsored by OSD.

*d.* CEW designations and definitions

(1) Emergency-Essential (E-E): Position-based designation to support the success of combat operations or the availability of combat-essential systems in accordance with USC section 1580 of title 10 and designated as “Key”.

(2) Non-Combat Essential (NCE): A position-based designation to support the expeditionary requirements in other than combat or combat support situations and designated as “Key”.

(3) Capability-Based Volunteer (CBV): An employee who may be asked to volunteer for deployment, to remain behind after other civilians have evacuated, or to backfill other DOD civilians who have deployed to meet expeditionary requirements in order to ensure that critical expeditionary requirements that may fall outside or within the scope of an individual’s position are fulfilled.

(4) Capability-Based Former Employee Volunteer Corps: A collective group of former (including retired) DOD civilian employees who have agreed to be listed in a database as individuals who may be interested in returning to Federal service as a time-limited employee to serve expeditionary requirements or who can backfill for those serving other expeditionary requirements.

(5) Key Employees: DOD civilian employees in positions designated as E-E and/or NCE are to be designated Key in accordance with DODD 1200.7

## **Section VIII**

### **Army personnel transformation**

#### **14–29. Current and transforming CHR administration**

The current CHR force is vital to the Army’s mission. Each CPAC staff member is a strategic partner with serviced commands, managers and supervisors. Today, the Army faces significant challenges as it transforms to a more agile, and technology-based force. With both external and internal drivers such as BRAC, Global Defense Posture Strategy (GDPS), Joint Basing, and OPM HR Lines of Business (LOB), the CHR workforce must also transform as it positions to be the premier HR provider for all DOD. The CHR community will utilize Lean Six Sigma methodology to redesign business processes and delivery of services and reinvest those savings into the organization to continue to provide world-class customer service.

#### **14–30. Transforming CHR Administration**

The establishment of NSPS changed the administration of human resources in DOD and the Army with its initial implementation in 2006. In October 2009, the National Defense Authorization Act for Fiscal Year 2010 (NDAA 2010) was passed, repealing NSPS as of 1 January 2012, and directing the return of NSPS employees to the personnel systems that last applied to them prior to the establishment of NSPS. NDAA 2010 also directed DOD and OPM to develop a new hiring system and an enterprise performance management system for the Department. DOD began efforts to develop these new systems in 2010; their completion and implementation are expected to bring about comprehensive change in human resources administration in DOD and Army.

#### **14–31. Hiring Reforms**

Army’s HR community will continue to support recruitment and hiring reform objectives developed to improve the quality and speed of the hiring process. In addition, these hiring reforms require managers and supervisors to assume a greater responsibility and accountability in the planning, recruitment and selection of the employees under them.

## **Section IX**

### **Summary and references**

#### **14–32. Summary**

*a.* The purpose of the Army Civilian Personnel Management System is to provide a motivated and technically qualified work force to meet Army requirements. The civilian work force is an integral part of the Army team. Army civilians play an important role in all our missions and share in the organization’s accomplishments. The Army employs civilians because they possess unique skills, ensure operational continuity, are economical, and permit military personnel to perform purely military duties. The civilian personnel management system and its supporting policy and service organizations contribute to the overall mission.

*b.* More than half of Army civilian positions are bargaining unit positions represented by labor unions. Army leaders, both civilian and military, must accept their labor-management responsibilities. The efficiency of our operations cannot be allowed to fail due to an unhealthy labor climate where leaders did not accept obligations to advise, consult, and bargain, as the law requires.



## How the Army Runs

*c.* As the force downsized and underwent initiatives to convert formerly military positions to civilian occupancy, more and more civilians have assumed key roles in headquarters and support activities, schools and training centers, and BASOPS. For many of these important positions it may not be possible to hire people with the necessary skills. Therefore, the Army must develop civilians from within the current ranks.

*d.* This chapter was designed to provide only a broad overview of the Civilian Personnel Management System in order to describe how the major processes are designed to support Army leaders. It is important to understand the legal basis for the Federal Civil Service, how the Army's system works within the Federal system and also the regulatory basis and practices for the Army's NAF Personnel System. Furthermore, commanders and managers at all levels must have a clear understanding of the nature of the civilian personnel structure, programs, and mission, as well as their responsibilities to provide effective leadership and management. DA civilians are part of an Army team comprised of a diverse workforce dedicated to doing the best job possible to ensure Army missions are accomplished effectively. The Army and DOD civilian personnel web sites contain a great deal of helpful information and may be accessed at [www.cpol.army.mil](http://www.cpol.army.mil) and [www.cpms.osd.mil](http://www.cpms.osd.mil), respectively. The CSLMO also has a secure website which may be accessed by anyone holding a CAC card registered with AKO at <https://www.cslmo.army.mil>.

### 14-33. References

*a.* 5 Code of Federal Regulations (CFR) Parts 410 and 412, Training; Supervisory, Management, and Executive Development

- b.* The Age Discrimination in Employment Act of 1967.
- c.* The Americans with Disabilities Act of 1990.
- d.* The Architectural Barriers Act of 1968.
- e.* Army Regulation 10-89, U.S. Army Civilian Personnel Evaluation Agency.
- f.* Army Regulation 215-1, Morale, Welfare, and Recreation Activities and Nonappropriated Fund Instrumentalities.
- g.* Army Regulation 215-3, Nonappropriated Funds Personnel Policy.
- h.* Army Regulation 570-4, Manpower Management.
- i.* Army Regulation 600-3, The Army Personnel Proponent System.
- j.* Army Regulation 600-7, Nondiscrimination on the Basis of Disability in Programs and Activities Assisted or Conducted by the Department of the Army.
- k.* Army Regulation 672-20, Incentive Awards.
- l.* Army Regulation 690-11, Use and Management of Civilian Personnel in Support of Military Contingency Operations.
- m.* Army Regulation 690-12, Equal Employment Opportunity Program and Affirmative Action.
- n.* Army Regulation 690-13, Civilian Intelligence Personnel Management System (CIPMS) - Policies and Procedures.
- o.* Army Regulation 690-400, Chap.432, Reduction in Grade and Removal Based on Unacceptable Performance.
- p.* Army Regulation 690-400, Chap. 4302, Total Army Performance Evaluation System (TAPES).
- q.* Army Regulation 690-600, Equal Employment Opportunity Discrimination Complaints.
- r.* Army Regulation 690-700, Chap.751, Discipline.
- s.* Army Regulation 690-900, Chap. 920, Senior Executive Service.
- t.* Army Regulation 690-950, Career Management.
- u.* Army's Mentorship Resource Center is located at <http://www.armyg1.army.mil/hr/mentorship/default.asp>.
- v.* The Civil Rights Act of 1991.
- w.* The Civil Service Reform Act of 1978.
- x.* DA Pamphlet 672-20, Incentive Awards Handbook.
- y.* DA Pamphlet 690-11, Guide to Civilian Personnel Management
- z.* DA Pamphlet 690-30, Administering the Labor Agreement.
- aa.* DA Pamphlet 690-46, Mentoring for Civilian Members of the Force.
- ab.* DA Pamphlet 690-47, DA Civilian Employees Deployment Guide.
- ac.* The Department of Defense Civilian Intelligence Personnel Policy Act of 1996.
- ad.* DOD Authorization Act of 1997.
- ae.* DOD Manual 1400.25 Subchapter 920, Executive and Senior Professional Pay and Performance.
- af.* DOD 1400.25-M, Civilian Personnel Manual.
- ag.* DoD Directive (DODD), 1404.10, DOD Civilian Expeditionary Workforce.
- ah.* DODI, 1400-25, DOD Civilian Personnel Management Systems: Volume 250, Civilian Strategic Human Capital Planning (SHCP).
- ai.* The Equal Employment Opportunity (EEO) Act of 1972.
- aj.* Equal Employment Opportunity Commission Management Directive 715 (EEOC MD 715).
- ak.* The Equal Pay Act of 1963.

- al.* Executive Order 9830, Amending the Civil Service Rules and providing for Federal personnel administration
- am.* Executive Order 12721, Eligibility of Overseas Employees for Noncompetitive Appointments.
- an.* Executive Order 13473, To Authorize Certain Noncompetitive Appointments in the Civil Service for Spouses of Certain Members of the Armed Forces.
- ao.* Executive Order 13522, Creating Labor-Management Forums to Improve Delivery of Government Services.
- ap.* Executive Order 13562, Recruiting and Hiring Students and Recent Graduates.
- aq.* The Federal Anti-Discrimination and Retaliation Act of 2002
- ar.* The Genetic Information Nondiscrimination Act of 2008.
- as.* The Hatch Act of 1939.
- at.* HQDA General Orders No. 3, 9 July 2002, and amendment No. 2002-03.
- au.* The Longshore and Harbor Worker's Compensation Act (33 U.S.C., 901 et seq.).
- av.* Management Directive 715 State of the Agency Report.
- aw.* "National Security Personnel System, downloaded at <http://cpol.army.mil/library/general/nsps/> (Note that this site will not be available as of 1 January 2012 when NSPS is repealed.)
- ax.* The Nonappropriated Fund Instrumentalities Act of 1958 (5 U.S.C., Sec 8171 – 8173).
- ay.* The Rehabilitation Act of 1973.
- az.* The Uniformed Services Employment & Reemployment Rights Act of 1994.
- ba.* Title 5 United States Code, Government *Organizations and Employees*.
- bb.* Title 10 United States Code, Section 1580: Emergency essential employees: Designation.
- bc.* Title 33 United States Code, *Navigable Waters*
- bd.* The Whistleblower Protection Act of 1989.

RESERVED

## Chapter 15

### Army Training

“We are facing an era of persistent conflict where the character of conflict is more likely to future hybrid threats—diverse combinations of irregular, terrorists, criminal, and conventional forces employed asymmetrically to counter our strengths.... Our doctrine states that Army formations will simultaneously conduct offense, defense, and stability or civil support operations to achieve decisive results across the spectrum of conflict. Together, these factors will require us to adapt how we think about training if we are to build units and leaders capable of full-spectrum operations.” — GEN George W. Casey, Jr., Army Training and Leader Development Guidance, 31 July 2009

#### Section I

##### Introduction - Army Training Strategy

##### 15–1. The Army Training Strategy

*a.* The Army Training Strategy provides guidance on how the Army will maintain its combat edge and prepare units for full spectrum operations. It also provides a balance between the need to succeed in the current war and to build agility to prevail in future conflicts. The specific time frame for this strategy is the near-term requirements of the budget and execution years (FY 2011–2012) and the longer-term requirements of the Program Objective Memorandum (POM) years FY 2013–2017.

*b.* Army training will be realistic, tough, demanding, fast-paced, and adapted for full spectrum operations against hybrid threats. As units have more time for training, they will train against a broader range of environments (both materiel and cyberspace). Our training must challenge the combat seasoned leaders who will maintain our combat edge and we must provide them with the skills and systems to deal with the impact of persistent conflict.

*c.* Army Training Strategy tasks and subtasks are derived from or support specific Army Campaign Plan major objectives, to include:

- (1) Train Units for Full-Spectrum Operations in a changing operational environment.
- (2) Train and educate individual Soldiers and Civilians by enabling institutional training, education, and self-development initiatives which support ARFORGEN.
- (3) Grow competent leaders who are strategic and creative thinkers.
- (4) Deliver relevant Live, Virtual, Constructive, and Gaming (LVCG) training enablers through the Army’s Training Support System (TSS).
- (5) Increase the human resilience, enhance performance, and optimize the ability and likelihood of Soldiers and Civilians to face successfully the physical and psychological challenges of sustained operations.

*d.* Army Training Strategy tasks have metrics in order for progress to be assessed and to establish our return on investment. The primary management tool for the Army Training Strategy is the Training General Officer Steering Committee, which meets semi-annually (see AR 350–1), with the Department of the Army G–3/5/7 approving changes within this forum. Concurrently, the Department of the Army Secretariat oversight of the Army Campaign Plan may impact strategic training-related programs and initiatives.

##### 15–2. Chapter organization

This chapter examines Army training by systems. The discussion is presented in seven sections listed here. The chapter concludes with a summary and a list of pertinent references.

- Section I: Introduction - Army Training Strategy
- Section II: Army Training Overview.
- Section III: The Policy, Requirements, and Resourcing Process.
- Section IV: TRADOC Organization and Training Development Systems.
- Section V: The Army School System (TASS).
- Section VI: Training in Units.
- Section VII: The Training Support System (TSS).
- Section VIII: Summary and References.

#### Section II

##### Army Training Overview

##### 15–3. Army Training

*a.* Army Forces Generation “ARFORGEN”.

(1) The Army generates operationally ready units through a structured progression of training and mission preparation called Army force generation (ARFORGEN). U.S. Army Forces Command is the supported command for

## How the Army Runs

ARFORGEN. The ARFORGEN ensures that every deploying unit is the best trained, led, and equipped force possible. It is a continuous and structured process for generating active Army and reserve component forces that provide increasing unit readiness over time.

(2) Mission essential task lists. The Chief of Staff, Army (CSA) directed Army-wide implementation of standardized full-spectrum operations mission essential task lists (FSO METL) down to brigade level. The FSO METL is based on the tasks the unit is designed and organized to perform.

(3) Force pools. The Reset, Train-Ready, and Available force pools provide a framework for the structured progression of increasing readiness in ARFORGEN. Each force pool is defined by designated unit activities, capability levels, and the period of time allocated to each force pool. The Army uses the force pools in addition to mission requirements to prioritize resources over time, and to synchronize unit manning, equipping, resourcing, and training.

(a) Reset force pool. The Reset Force Pool begins with the establishment of a unit's return date or the transition from the Available Force Pool. Units generally perform some of all of the following activities: Soldier-family reintegration; block leave; unit reconstitution; changes of command; behavioral health, medical, dental readiness reintegration; PME, limited individual, team, and/or crew training tasks, The ACOM, ASCC, or DRU may approve by exception external off-post taskings. Units will use CATS to develop unit training plans.

(b) Train-ready force pool. A unit enters the train-ready force pool following the Reset force pool. The Train-ready force pool has no fixed duration. Units in the Train-ready force pool will increase training readiness and capabilities as quickly as possible, given resource availability. Units may receive a mission to deploy while in the Train-ready pool. Units' transition to the Available pool after meeting required training and readiness proficiency levels described in AR 220-1, Army Unit Status Reporting and Force Registration.

(c) Available force pool. Units in the Available force pool are at the highest state of training and readiness capability and are ready to deploy when directed. Units deploy when directed or continue to train on their FSO METL or other specific contingency operation tasks. Units move from the available pool and back to the Reset pool following a deployment or at the end of their designated window of availability.

(4) FM 7-0, Training Units and Developing Leaders for Full Spectrum Operations, provides training doctrine within the context of the ARFORGEN process. ARFORGEN training is supported by the Combined Arms Training Strategies (CATs). CATs provide strategies to train brigade and higher level organizations through standardized FSO METLs, as well as battalion and lower level units through METLs. Progress on the FSO METL is assessed and reported by unit commanders after priorities have been established. CATs events ranging from individual/crew/squad levels through company/battalion/brigade/division and corps are scheduled and resourced in accordance with the expectations of each ARFORGEN force pool and any other specified guidance. FSO METL focused training will conclude with a Combat Training Center (CTC) or Culminating Training Event (CTE) event prior to transitioning to the Available pool.

## Army Force Generation (ARFORGEN)

A versatile mix of tailorable and networked organizations, operating on a rotational cycle

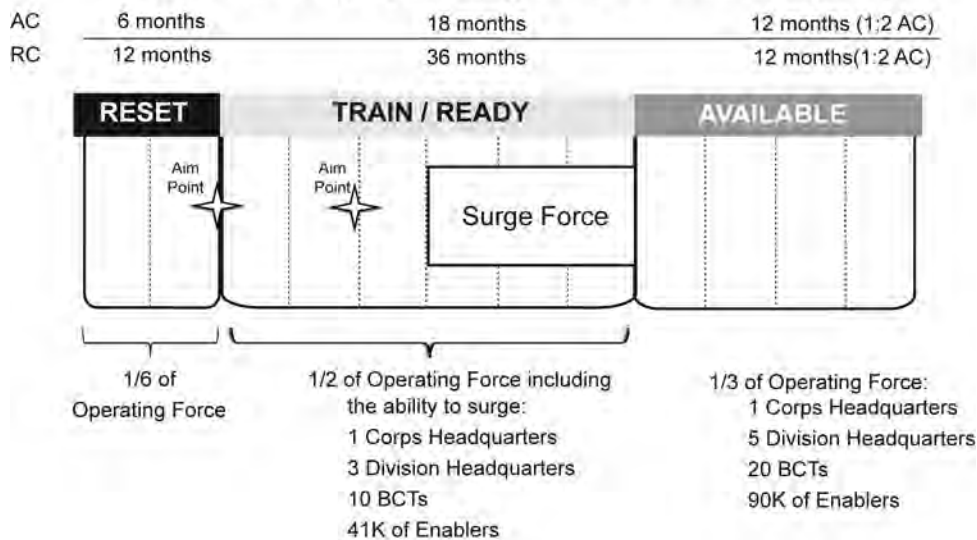

Figure 15-1. Army Force Generation

b. Leader development. Leader development involves all we do as an Army or as individuals to prepare potential or current leaders for success at the next level of responsibility. The Army Leader Development Model (Figure 15–2) portrays the system and its major components. CG, TRADOC is the supported commander and single responsible official for development of the Army’s Leader Development Program. The Army’s Leader Development Strategy, 25 November 2009, identifies eight imperatives linking initiatives, learning concepts, technological innovations, and execution of training and education by schools, centers, and units. A ninth imperative, the Profession of Arms was added in 2011. These imperatives drive the synchronization and implementation of the strategy.

(1) Encourage an equal commitment by the institution, by leaders, and by individual members of the profession to life-long learning and development.

(2) Balance our commitment to the training, education, and experience pillars of development.

(3) Prepare leaders for hybrid threats and full spectrum operations through outcomes-based training and education.

(4) Achieve balance and predictability in personnel policies and professional military education in support of ARFORGEN.

(5) Manage the Army’s military and civilian talent to benefit both the institution and the individual.

(6) Prepare our leaders by replicating the complexity of the operational environment in the classroom and at home station.

(7) Produce leaders who are mentors and who are committed to developing their subordinates.

(8) Prepare and select leaders for responsibility at the national level.

(9) Strengthen Army leaders’ understanding of their profession of arms and inspire commitment to the professional military ethic.

c. The basic concepts, techniques of training, and methods of measuring and evaluating training have constantly evolved over the years and continue to do so today. FM 7–0 Training Units and Developing Leaders for Full Spectrum Operations February 2011, supplemented by the Army Training Network (ATN), contains the Army’s standardized training doctrine and other information applicable to all levels of leaders and organizations. They provide the necessary guidelines on how to plan, prepare, execute, and assess training at all levels. FM 7–0 and the ATN provide authoritative foundations for Soldier, leader, and collective training. Army Regulation 350–1, Army Leader Development, prescribes how the Army will create efficient and effective education and training.

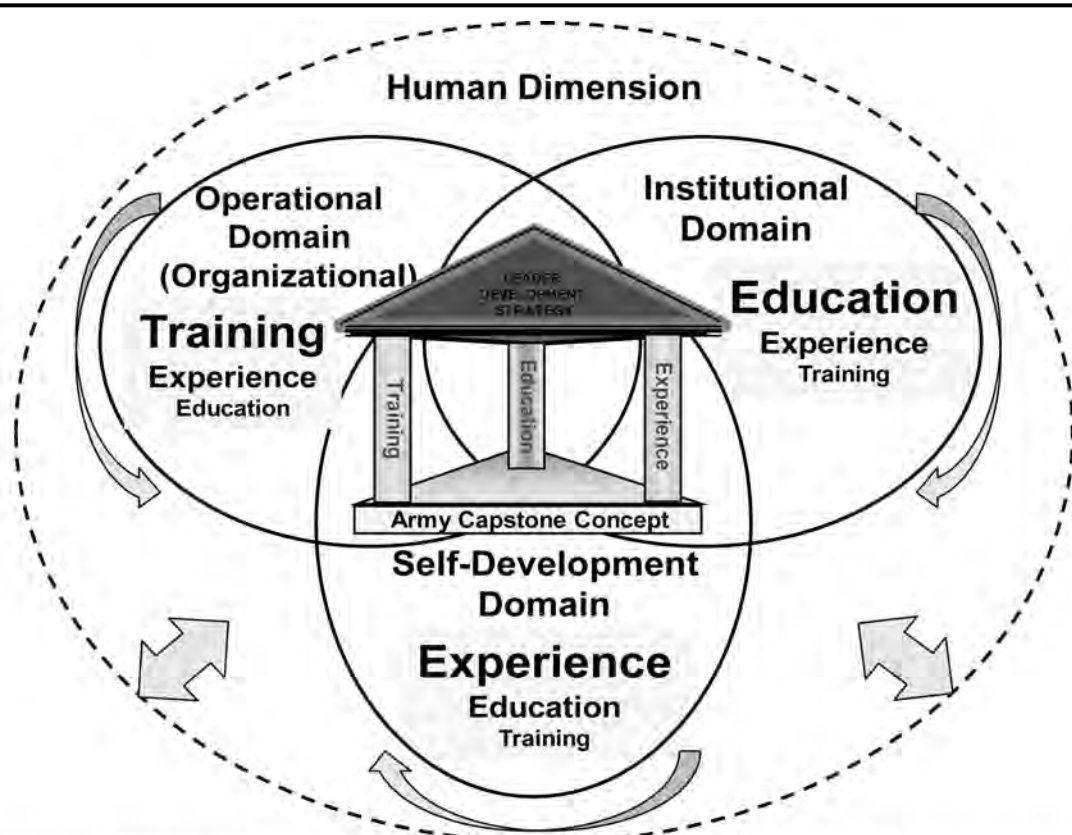

**The model recognizes Institutions/PME Schools, Commanders/Leaders and Individual self development are mutually responsible for leader development**

Figure 15–2. Army Leader Development Model

#### 15–4. Combined Arms Training Strategy (CATS)

a. *Overarching strategy.* CATS is a start point for determining events for long-range training plans. Within CATS, the commander consults various resources such as training templates, event menus, and unit-specific and functional strategies. The CATS provide options and menus for the training events that can go into the training plan to achieve FSO METL readiness." CATSs are digitized publications that provide commanders with a template for task-based, event-driven organizational training. They can be adapted to the unit's requirements based on the commander's assessment. CATSs state the purpose, outcome, execution guidance, and resource requirements for training events. Commanders can modify these to meet unit training objectives. Each CATS describes how a particular unit type can train to and sustain the Army standard. CATS identify and quantify training resources required to execute long- and short-range collective training.

(1) There are two types of CATS: those that are unique to a unit type (unit CATS), and those that address a functional capability common to multiple units (functional CATS). Unit CATS are based on the core capabilities described in a unit's authorization document and doctrine. The unit FSO METL is published in the CATS for that unit type. Functional CATS are based on standard capabilities performed by most Army units, such as command and control, protection, and deployment.

(2) Each CATS is a training management tool for commanders, leaders, and other unit trainers. A variety of links takes the user directly to applicable supporting individual and collective tasks. This automation capability decreases the need to sort through training materials used to develop training plans, schedules, and resource cost estimations (such as fuel and ammunition) and allows more time on designing challenging training. CATS identify and group the supporting collective tasks into task groups for each mission-essential task. The discussion of each task group includes guidance for training the task group, resource requirements, and training support requirements for each proposed training event

(3) CATS support both short-term and long-term training development efforts. Short-term training is intended to allow for planning over a roughly 2 year cycle. It is task based and focused on the unit's Army Training and

Evaluation Plan Mission Training Plan. It describes one way of organizing task-based, multi-echelon training into a set of events that will achieve and maintain a high state of readiness in today's environment of high personnel turbulence and leader turnover. Long-range planning is based on the third year and beyond. Its focus is on who (individuals and units) needs training, the type of training that is required and when/where training will take place.

*b. Training strategies development by units.* The development of training strategies is the first step in designing training. A training strategy describes the ways and means the commander intends to use to achieve and sustain training proficiency on mission-essential tasks. The strategy is based on the commander's assessment and discussions with the higher commander. Training strategies include the following:

- Tasks to be trained.
- Training audience.
- Training objectives.
- Order in which the tasks are to be trained, given limited time and other resources.
- Frequency at which tasks are trained.
- Types of events used to create conditions for training tasks.
- Conditions under which the tasks are to be trained.
- Resources required to execute the training strategy.
- Alternative ways of training tasks.

(1) There are both long and short-range individual and collective training strategies. Development of these strategies involves decisions on who (unit), what (job or task), where (site) when, why (higher guidance, commander's assessment) and how (media, method) to attain and sustain critical task performance proficiency. They establish the need for training programs, courses, products, and materials. These decisions are identified in supporting plans/models.

(2) A process overview would appear as follows:

(a) Long-range Strategies (3–10 years after current year)

(b) Short-range Strategies (current plus 2 years)

(c) Program/product design (current year)

*c. Long-range training strategies.* Long-range training strategies are an initial determination of who (individuals or units) needs training, what type of training is needed, and where and when the training will take place. They cover the third year following the execution year and beyond. Training proponents add these requirements to appropriate plans/models to ensure resources are available for product development and/or training support. At the unit level, long-range plans identify the major training events for the unit along with the resources required to execute the training events. A long-range plan normally covers 12 months for Active Component and mobilized Reserve Component units. It covers two years to an entire ARFORGEN cycle for other Reserve Component units.

*d. Short-range or current training strategies.* Short-range or current training strategies are based on task analysis data. They are the training design (plan) to attain and sustain the desired level of performance proficiency on each critical task contained in the unit FSO METL. Units refine and expand on the appropriate portions of a long range plan, tying training events together with specific objectives, near term planning, done typically at battalion equivalent and below, refine this in detail, allocating resources and publishing detailed training schedules.

*e. Self-development.* Self-development strategies are part of a lifelong learning culture that enable Soldiers and Army Civilian employees to supplement their professional growth in the skills and competencies they need as leaders and technical specialists. All individuals are responsible for acquiring and sustaining the skills, knowledge, and experience needed to successfully perform the duty position requirements of current and future assignments. Self-development is the individual's responsibility. Self-development is a continuous process that takes place during institutional training and the operational assignments.

## 15–5. The Future of Army training

*a. Overview.* Army education and training is being changed from the traditional classroom, instructor presented lessons to a combination of resident, distributed learning (dL), and unit training. This approach leverages automation technologies to improve the efficiency of producing, distributing, and implementing instruction. This change affects individual and collective training. The automation network serves as the conduit for producing and distributing learning material to Soldiers, leaders, and units to meet their specific needs to train and prepare for a broad spectrum of global contingencies. The use of automation technologies doesn't change performance standards expected of Soldiers and units. Reliance on traditional training methods will continue, but will be enhanced by the availability and communications power of the commercial World Wide Web, Internet, and other information transfer systems. To attain this vision the Army has initiated a number of projects to provide a solid education and training information foundation. Registration for formal Army education/training including dL courses will be accomplished in the ATRRS.

*b. Distributed learning (dL).* To meet the challenge of the future, the Army is in the process of implementing dL to deliver education and training to the Soldier when and where needed. Types of dL include Interactive Multimedia Instruction (individualized self-paced instruction), Video Teleconferencing, web-managed instruction, and simulations. Army dL does not fundamentally change the way the Army trains, it enhances the way it conducts training by using



current and emerging technologies for management and delivery of training to the Soldier when and where it is needed. Exploiting these technologies takes the classroom to the unit, and the unit to the classroom, providing training in a worldwide virtual training environment. Soldiers in the field, at units, institutions, and at home will train by accessing the informational databases through the Army Knowledge Online website (AKO) (note: may become the Defense Knowledge Online (DKO) website). Units will select training options (resident and non-resident) based upon their need, time available to train, distance from the “on-site” training site, and other resource constraints. The Army dL Program documents and related materials are available on the Internet at <http://www.tradoc.army.mil/tadlp/index.htm>.

*c. The Army Learning Management System (ALMS).* The ALMS is the heart of the Army’s Distributed Learning System. The ALMS streamlines, consolidates, and provides overall direction to the Army’s training processes. ALMS is a Web-based information system that delivers training to Soldiers, manages training information, provides training collaboration, scheduling, and career planning capabilities in both resident and non-resident training environments. Additionally, the ALMS assist Army trainers and training managers in conducting and managing the training of Soldiers and Army Civilians throughout their Army careers. In addition to the training at Digital Training Facilities (DTFs), Army personnel can access training from wherever they have access to a computer and the Internet with the development of the new ALMS, which is currently being fielded at TRADOC installations world-wide. From the office, home or DTF, Soldiers and Army Civilians will be able to meet their distributed learning needs 24/7.

(1) *The Army is fielding Digital Training Facilities (DTFs).* DTFs provide training access for the Army’s Soldiers and civilians at Active Army installations and Reserve Component (RC) training sites. DLS uses an integrated learning management support system, which automates student enrollment, scheduling, and training records. DLS delivers digital courseware to include real-time video teletraining (VTT), video and audio recordings, Web- and computer-based training materials, and simulations.

(2) *The Army Distributed Learning Program (TADLP) Classroom XXI (CR XXI) Capabilities.* CR XXI is a training environment in which the military and civilian personnel of the 21st century will train. Technology will transform current classrooms from an instructor-centered environment to a student-centered multimedia environment with worldwide access to approved training materials. It’s capabilities include the following:

(a) Data/video projection system with audio for display of instructor-led computer training and video teletraining. VTT capability will be two-way video/audio.

(b) Classroom control panels allow instructors to operate equipment, electronically group students, and control and assist students at the desktop.

(c) Fully-networked classrooms provide internet access to worldwide sources of information as well as deliver multimedia to the user’s desktop.

(d) Foundation for collaborative training among branches and schools; alternative training strategies using governmental, educational, industrial, and commercial sources; and the platform to support the delivery of distance learning.

(e) Full-motion video-on-demand and digital video over the Local Area Network(LAN), to include the Commander’s channel, national news channels or video teletraining for one-way receive to each user’s desktop. Users can view the same multimedia at the same time or each student can view different training courseware simultaneously.

(f) Instructor and students have multimedia computer workstations, giving both the capability to access Interactive Multimedia Instruction (IMI) courseware, designed for student interaction and participation, from the Digitized Training Access Center (DTAC), a centralized storage facility for proponent-approved courseware.

(g) Current training is designed and developed for individual, self-paced instruction.

*d. Embedded training.* Embedded training is an emerging technology that shows great promise and already has limited practical application. By adding simulation hardware and software to a combat vehicle, the crew would have training capability onboard their vehicle similar to that of the large simulators such as the Close Combat Tactical Trainer (CCTT) or the Advanced Gunnery Training System (AGTS). By being embedded in the vehicle, the training would be available anytime or anywhere, and would deploy as an integral part of the vehicle. An Embedded Simulation (ES) has application beyond training for testing, situational awareness, mission planning and rehearsal, and after action review and reporting.

*e. Integrated training environment.* The integrated training environment is one solution to unit training required capabilities. It will link selected TADDS, infrastructure, mission command/knowledge management systems and a training framework that approximates the conditions of the operational environment for full spectrum operations within the Army’s training domains-operational, institutional, and self-development. The Army uses live, virtual, constructive and gaming training environments. Currently, these environments are partially interoperable, but not fully integrated among themselves or with the Army’s Mission Command Systems. By 2012, the training environment will begin incorporating training enablers that are integrated and seamless to execute ARFORGEN multi-echelon training requirements.

*f. Learning environment.* Classroom learning will shift from instructor-centered, lecture-based methods, to a learner-centered, experiential methodology. Knowledge and comprehensive learning objectives and individual learning activities such as reading, self-paced technology-delivered instruction, or research is done outside the classroom. Discussion, collaborative learning activities, identification of problems, and solving those problems is done in the small group environment. Engaging the learner in collaborative practical and problem-solving exercises that are relevant to their

work environment provides an opportunity to develop critical competencies such as initiative, critical thinking, teamwork, and accountability along with specific knowledge content.

g. *Digital Training Management System (DTMS)*. DTMS is a Web-based, commercial, off-the-shelf software application customized to provide the ability to plan, resource, and manage individual and unit training. DTMS provides access to proponent approved CATS, collective and individual tasks. Additional information is provided at the DTMS Web site at <http://dtms.army.mil/dtms>.

### Section III

#### The Policy, Requirements, and Resourcing Process

##### 15–6. General

Input is provided by manpower programs (Chapter 5), force structure changes (Chapters 4, 6, and 7), and resourcing actions (Chapters 9, and 10). Training activities draw Operations and Maintenance, Army (OMA) appropriation funds from Budget Activity 3 (Training), and Budget Activity 2 (General Purpose Forces). Other contributing appropriations are National Guard Personnel, Army (NGPA); Operations and Maintenance, ARNG (OMNG), Reserve Personnel, Army (RPA); and Operations and Maintenance, Army Reserve (OMAR).

##### 15–7. Organization

The Deputy Chief of Staff (DCS), G–3/5/7 combines the functions of institutional and unit training and training support. The G–3/5/7 approves and manages Army military individual, collective, and modernization training and education programs. It provides the Army a single point of entry for issues which have impact training. The G–3/5/7 exercises HQDA supervision for defining concepts, strategies, resources, policies, and programs for Army training, education, and leader development. Other DA staff elements which have a direct or indirect impact on the training systems are:

a. *The Assistant Secretary of the Army, (Manpower and Reserve Affairs) (ASA (M&RA))*. ASA (M&RA) has a training division to assist in the development, implementation, and review of policies and programs related to achieving the Army goal of effective and efficient training and education for the Army. The (ASA (M&RA)) advises the Secretary of The Army on all matters relating to human resources and reserve affairs, to include, readiness and training.

b. *The Assistant Secretary of the Army, (Installations and Environment) (ASA (I&E))*. ASA (I&E) provides secretariat management for the formulation, execution, and review of policies, plans, and programs relating to the Range and Training Land Program (RTLTP); environment, safety and occupational health; the National Environmental Policy Act; and Land Use Requirements Studies.

c. *The Assistant Secretary of the Army (Acquisition, Logistics, and Technology) (ASA (ALT))*. ASA (ALT) manages the life cycle of materiel and non-materiel items used by individuals and units in mission performance (Chapter 11). The (ASA (ALT)) provides policy and guidance to research, develop, and procure system and non-system TADSS and other approved requirements for training support materials. Additionally, the (ASA (ALT)) funds and coordinates New Equipment Training.

d. *The Assistant Secretary of the Army (Financial Management) (ASA (FM))*. Formulates the Army budget, issues manpower and dollar guidance, distributes funds to commands and agencies, and monitors obligation rates and reprogramming actions (Chapter 9).

e. *DCS, G–1*. The G–1 is responsible for integrating personnel readiness and training, and manages the Army Training Requirements and Resources System (ATRRS), the system that supports the Army's Program for Institutional Training (ARPRINT) management process. The G–1 manages execution year training program change requests driven by personnel readiness requirements through the Training Requirements Arbitration Panel (TRAP). The DCS, G–1 also manages the administration of the manpower requirements of the pre-commissioning programs for officers (USMA, ROTC, and OCS); and training for equal opportunity, and alcohol and drug abuse (Chapter 13 and 14).

f. *U.S. Army Accessions Command (USAAC)*. Recruits and obtains the quantity and quality of volunteers to meet Army requirements (Chapter 13).

g. *Army Human Resources Command (AHRC)*. Projects training requirements for the AC, both officer and enlisted, by FY. The DCS, G–3/5/7 allocates training spaces for AC officers and enlisted based on projected unit requirements and distribution policies.

h. *Human Resources Command-Army Reserve (HRC St Louis)*. Commands and controls all individual ready reserve (IRR) members. Provides individual training management to the IRR, officers and enlisted (Chapter 7). It is responsible for OPMS–USAR and EPMS–USAR, and projects training requirements for USAR, both officer and enlisted, by FY. HRC allocates training spaces for USAR officers and enlisted based on projected training requirements.

i. *Assistant Chief of Staff for Installation Management*. Provides policy and guidance for facility engineering programs and environmental compliance, restoration, pollution prevention, conservation, environmental program management, and real property master planning; and provide direction and assistance in land acquisition in support of the

## How the Army Runs

Range and Training Land Program. Provide utility and manpower infrastructure facility support for installation Training Support Centers (TSC) operations.

*j. DCS, G-4.* Responsible for logistics readiness of Army forces, to include supportability/maintainability of equipment (to include training assets) in troop units (Chapter 12).

*k. DCS, G-2.* Responsible for Opposing Force (OPFOR) program and assisting the DCS, G-3/5/7 on intelligence training policy.

*l. The Army Chief of Information Operations (CIO)/G-6.* Provides policy and procedural guidance for Army visual information and multimedia support. Manages the Information Management PEG which resources Army Commands (ACOM), Army Service Component Commands (ASCC), Direct Reporting Units (DRU) and installation visual information/training support center (VI/TSC) operations.

*m. The Inspector General (IG).* The IG will conduct Army-wide assessments of training development and training management to assess the implementation of training policy and impacts of training on readiness, sustainability, and units' ability to fight and win. Assessments will focus on training resources and provide feedback to commanders in order to promote efficiency in training.

*n. Office of The Surgeon General (OTSG).* Projects training requirements and allocates course spaces internal to AMEDD.

*o. Chief, National Guard Bureau (CNGB).* The NGB promulgates training policy for ARNG units through National Guard Regulation 350-1. CNGB also programs the resources for NG training and allocates training spaces to the State. NG unit commanders are responsible for their units' training. FORSCOM establishes training criteria and supervises training of ARNG units. Policy and guidance are contained in FORSCOM/ARNG Regulation 350-2.

*p. Chief, Army Reserve (CAR).* The CAR programs training resources for the Army Reserve and monitors USAR training activities. The CAR manages professional development training for USAR officers, warrant officers, and senior NCO through HR (Chapter 7).

### 15-8. Requirements and resourcing

*a. Training Program Execution Group (PEG).* As one of the Army's six Title X PEGs, the Training PEG programs Army resources each year. The PEG manages all aspects of training dollars within components, individual through unit. The Training PEG has 124 Management Decision Packages (MDEP). The Training PEG is chaired by the Director of Training, ODCS, G-3/5/7 and the ASA (M&RA). MDEP managers articulate and defend resource requirements to the PEG during the building of the Program Objective Memorandum (POM). MDEP managers use various costing models to determine requirements.

*b. ATRRS.* The Army Training Requirements and Resource System (ATRRS) is the Department of the Army Management Information System of record for managing student input to training. The on-line system integrates manpower requirements for individual training with the process by which the training base is resourced and training programs are executed. This automation support tool establishes training requirements, determines training programs, manages class schedules, allocates class quotas, makes seat reservations, and records student attendance. It supports numerous Department of the Army processes to include the Structure Manning Decision Review (SMDR). The product of the SMDR is the Army Program for Individual Training (ARPRINT), the mission and resourcing document for the training base. ATRRS supports the Training Requirements Division of the Office of the Army G-1 in its army wide mission of integrating all phases of input to training management, during peacetime and mobilization. The system supports the planning, programming, budgeting, and program execution phases of the training process and is utilized by the agencies responsible for those phases.

### 15-9. Development of the Army individual training requirements

*a. Development of individual training requirements.* The development of individual training for the Active Army (AA) begins with the identification of force structure authorizations from the Personnel Management Authorizations Document (PMAD) and AA Military Manpower Program (AAMMP). PMAD is produced semiannually, usually in August and January. PMAD displays authorizations at the MOS and grade level. The AAMMP is produced monthly and contains manning data such as AA end strength, monthly recruiting requirements, and inputs to training for seven FYs.

*b. Military Occupational Specialty Level System (MOSLS).* Using the PMAD, the MOSLS process predicts AA (enlisted) skill requirements. MOSLS compares MOS and grade inventory, aged to the FY under consideration by applying gain, loss, and promotion factors. The difference between the authorizations and the aged (to the FY) inventory constitutes the number of trained Soldiers, by skill that the training base must produce (output). Applying training attrition rates at the skill level provides the number of Soldiers required to begin training (input).

*c. Other training requirements.* Other training requirements are identified by HRC for officer and enlisted in-service personnel who require training and education to support professional development, reenlistment or reclassification programs, and mission requirements. Additionally, HRC solicits in-service training requirements from other ACOM, ASCC, DRUs, States' Adjutant Generals, and other Services and agencies via the Total Army Centralized Individual Training Solicitations (TACITS). The TACITS survey is conducted annually. The accession-driven, in-service, and

other task based training requirements are combined as total raw training requirements within the ATRRS. The ATRRS' automated databases include a list of Army task based training courses that includes length, capacity, frequency, and location. It also includes other Services' courses attended by Army personnel. The task-based requirements are translated into course requirements and become the Army's training requirements at the course level of detail by component and FY.

d. *Training program development for each MOS/AOC.* After the training requirements for courses are developed, the next major task in the process is the development of the training program for each MOS/AOC. The first step in establishing a training program is the SMDR, co-chaired by ODCS, G-1 and ODCS, G-3. It includes representatives from ODCS, G-1, ODCS, G-3/5/7, OTSG, TRADOC, AMC, AMEDD Center and School, HRC, FORSCOM, NGB, OCAR, USAREC, ODCS, G-4, OCE, other services, FMS, IMET, and the individual proponent school. The purpose of the SMDR (Figure 15-3) is to reach a consensus within the Army for the institutional training program for the first and second POM years and any major changes for the upcoming budget year. Additionally, the SMDR validates training requirements (Soldiers to be trained in formal education/training courses), compares training requirements with schoolhouse current resource capabilities (facilities, billeting, manpower), and adjusts training requirements or training resources to form recommended training programs. The SMDR is conducted annually in October. Individual training requirements are initially established for the third POM year, validated for the second POM year (the primary focus of the SMDR), and "fine tuned" for the first POM year.

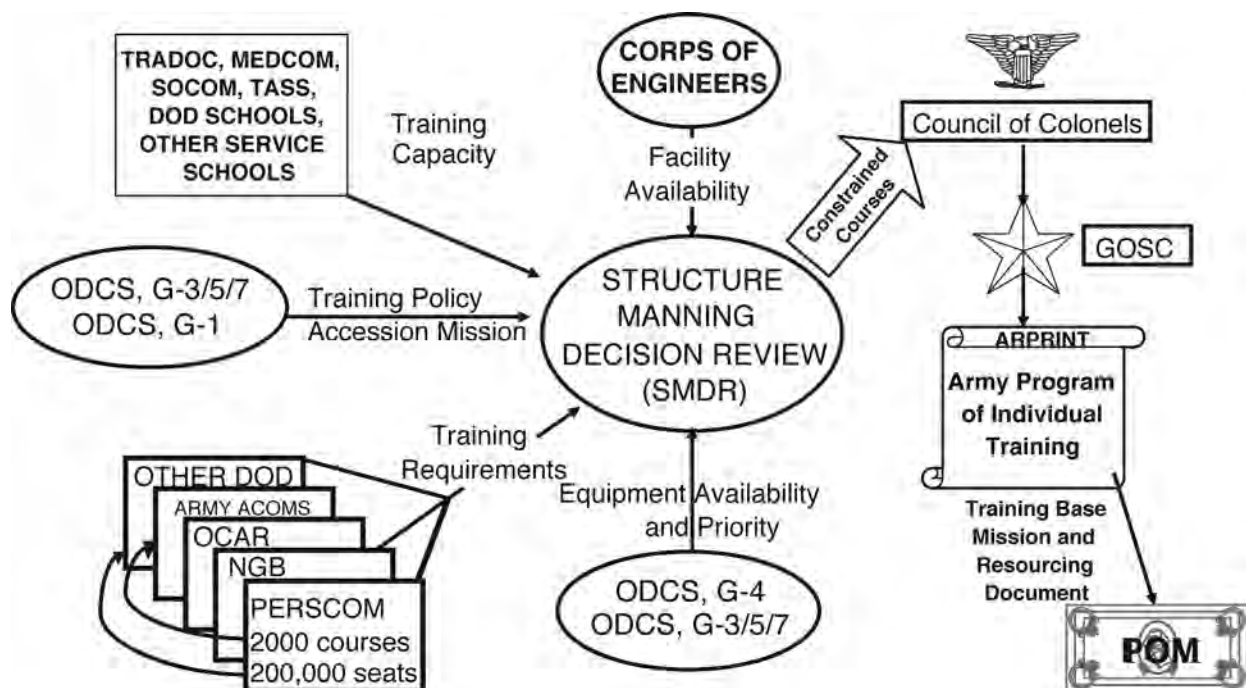

Figure 15-3. Structure Manning Decision Review (SMDR)

e. *SMDR categorization by course.* The SMDR categorizes each course. The first category is composed of those courses where the total training requirement can be trained with available resources. The second category consists of courses where the requirements exceed the resourced capability of the training base. In the 2<sup>nd</sup> category, resources can be provided or requirements reduced to the resourced level without significant impact on the manning program. The third category is those courses where the requirement exceeds the capacity, requires significant resources, and cannot be reduced without significant impact on the manning program. These courses are termed "constrained." The results of the SMDR are briefed to a COC which attempts to confirm category two adjustments/resources and move as many courses as possible from category three to category two.

f. *General officer steering committee (GOSC).* The courses in categories two and three are then referred to a GOSC. At this meeting, general officers take action on the recommendations of the COC. Each course remaining constrained is reviewed as to current authorizations, projected operating strength, training requirements, training capability, source of constraint, resources required to eliminate the constraint, availability of required resources, and a recommended course

## How the Army Runs

of action. That review results in a resourced training requirement that is called an approved training program for each course for that FY.

g. *ARPRINT*. After the GOSC is completed, both the training requirement and the training program are published by ODCS, G-1, Training Requirements Division, in the ARPRINT. The ARPRINT is a mission document for the training base as well as the Army in terms of recruitment and professional development education. The ARPRINT identifies, by FY, projected individual training requirements for established courses and for task-based courses, where new courses are required. Based on identified training requirements, subsequent actions are taken to provide resources (manpower, money, facilities, ammunition, and equipment) to train the required number of Soldiers. The desired flow of Soldiers into the schools and training centers aids in development of class schedules to support the ARPRINT for each course. The class schedules are entered into ATRRS. TRADOC reviews the class schedules to ensure they support the ARPRINT requirement and TRADOC scheduling policy.

h. *Mobilization Planning System (MPS)*. MPS is a subsystem of ATRRS and is designed to give training managers, at or above installation level, prompt access to information necessary to plan for implementation of the mobilization of the Army training base. MPS is used to produce the Mobilization Army Program for Individual Training (MOB ARPRINT) which provides a projection of trainee and student inputs by task based course to satisfy post mobilization requirements for trained manpower as determined by Mobilization Manpower Planning System (MOBMAN).

i. *The Sustainable Range Program (SRP)*. SRP is the Army's overall approach for improving the way it designs, manages, and uses its ranges to ensure long-term sustainability. SRP is defined by its two core programs, the Integrated Training Area Management (ITAM) Program and the Range and Training Land Program (RTLTP), which focus on the doctrinal capability of the Army's ranges and training land.

(1) *The Integrated Training Area Management (ITAM)*. The ITAM program mission is a subset of the Army's Sustainable Range Program, which has a goal of maximizing the capability, availability, and accessibility of ranges and training land by minimizing restrictions brought about by external factors. The Integrated Training Area Management (ITAM) program provides the Army with the capabilities to manage and maintain training and testing lands by integrating mission requirements with environmental and land management practices. The objectives of the Army's ITAM program are to:

(a) Achieve optimal sustained use of lands for the execution of realistic training and testing by providing a sustainable core capability that balances usage, condition, and level of maintenance.

(b) Implement a management and decision-making process that integrates Army training and other mission requirements for land use with sound natural resources management.

(c) Advocate proactive conservation and land management practices by aligning Army training land management priorities with the Army training and readiness priorities.

(2) *RTLTP*. The Army's Range and Training Land Program provides for the central management, programming, and policy for modernization of the Army's ranges and their day-to-day operations. Objectives include:

(a) Integrate mission support, environmental stewardship, and economic feasibility and define procedures for determining range projects and training land requirements to support live-fire and maneuver training.

(b) Define the quality assurance and inspection milestones for range development projects and the standard operating procedures to safely operate military training, recreational, or approved civilian ranges under Army control and support FSO METL and Army training strategies.

(c) Establish the procedures and means by which the Army range infrastructure is managed and maintained on a daily basis in support of the training mission.

## Section IV

### Training and Doctrine Command (TRADOC) Organization and Training Development Systems.

#### 15-10. Training in institutions-general

HQDA authorizes direct communication between ACOM, ASCC, DRUs and TRADOC; moreover, HQDA authorizes TRADOC to task non-TRADOC commands, schools, and agencies (except the Army Medical Department Center and School (AMEDDC&S) and the U.S. Army John F. Kennedy Special Warfare Center and School (USAJFKSWCS)) to provide specialized subject materials for instruction with the TASS. AMEDD provides training on medical tasks and JFKSWCS provides training on special operations tasks to TRADOC. The CG, TRADOC, administers training functions outlined in AR 350-1, AR 600-100, AR 140-1, and AR 10-87 and is responsible for developing training doctrine, policy and procedures for approval by HQDA. Most institutional training (proponent schools) is managed by TRADOC.

a. *Training and Doctrine Command (TRADOC)*. <http://www-tradoc.army.mil/>. TRADOC is the Army's institutional base for education and training. TRADOC develops the Army's Soldier and Civilian leaders and designs, develops and integrates capabilities, concepts and doctrine in order to build a campaign-capable expeditionary Army in support of joint warfighting commanders through Army Force Generation (ARFORGEN). TRADOC has more than 27,000 Soldiers and 11,000 civilians working daily to accomplish its mission. It has 32 schools and centers, and trains more than 500,000 Soldiers a year. Their footprint spreads throughout the continental United States at 20 different locations.

HQ, TRADOC is located at Eustis, VA. TRADOC has several major subordinate commands: U.S. Army Accessions Command (USAAC), headquartered at Fort Monroe; Combined Arms Center (CAC), headquartered at Fort Leavenworth, KS; and the Army Capabilities Integration Center (ARCIC), headquartered at Fort Monroe. The CGs of these commands also serves as TRADOC's DCGs for initial military training, combined arms and futures, respectively. Other major organizations of TRADOC are the Combined Arms Support Command (CASCOM), Fort Lee, VA.; TRADOC Analysis Center (TRAC), Fort Leavenworth; the Center for Army Lessons Learned (CALL), Fort Leavenworth; and the 32 schools.

*b. The TRADOC mission.* Central to the TRADOC mission are the following tasks:

(1) *Recruiting and Training Soldiers.* TRADOC builds the Army on a solid foundation of quality people by selecting recruits and transforming them into Soldiers, who are physically tough, mentally adaptive and live the Warrior Ethos. Soldiers are the Army's ultimate asymmetric advantage and cannot be matched by our adversaries - current or future.

(2) *Developing Adaptive Leaders.* TRADOC trains leaders for certainty and educates them for uncertainty. Leader development produces innovative, flexible, culturally astute professionals expert in the art and science of the profession of arms and able to quickly adapt to the wide-ranging conditions of full spectrum operations.

(3) *Designing today's Army Modular Force and the Future Combat Force.* TRADOC identifies and integrates comprehensive solutions for the Army Modular Force, both today and tomorrow.

(4) *Maximizing Institutional Learning and Adaptation.* As an integral component of an innovative Generating Force, TRADOC shapes and links it seamlessly to the Operating Force to maximize Army Learning and Adaptation.

*c. G3/Deputy Chief of Staff for Operations & Training (DCSOPS&T).* The single manager for training in TRADOC is the G3/Deputy Chief of Staff for Operations & Training (DCSOPS&T). Within TRADOC, the DCSOPS&T interfaces with the G1/G4/Deputy Chief of Staff for Personnel, Infrastructure and Logistics (DCSPI&L); Deputy Chief of Staff for Developments(DCSD); Deputy Chief of Staff for Doctrine, Concepts and Strategy (DCSDC&S); G8/Deputy Chief of Staff for Resource Management (DCSRM); G6/Deputy Chief of Staff for Command, Control, Communications, and Computers (DCSC4); Deputy Chief of Staff for Simulation and Analysis (DCSSA); and the Deputy Chief of Staff for Intelligence (DCSINT). The G3/DCSOPS&T coordinates with HRC for management of trainee accessions.

*d. TRADOC directorates and activities.* The DCSOPS&T has the following directorates and activities to manage the TRADOC training program:

- (1) Individual Training Directorate (ITD)
- (2) Training Development and Delivery Directorate (TDADD)
- (3) Leader Development and Education Directorate (LDD)
- (4) Training Operations Management Activity (TOMA)
- (5) Security Assistance Training Directorate (SATD)
- (6) Training Plans and Capabilities Review (TPCRD)
- (7) Training Program Analysis and Evaluation (TPA&E)
- (8) Personnel Proponency Directorate (PPD)
- (9) TASS Directorate (TASSD)
- (10) Operations, Mobilization and Readiness Directorate (OMRD)
- (11) Command Provost Marshal Directorate (CPMD)
- (12) Joint and Combined Arms Training Directorate (JCATD).

*e. Army Training Support Center (ATSC).* The Army Training Support Center (ATSC), <http://www.atsc.army.mil/tsaid/dtst/> is a field operating agency (FOA) under the DCSOPS&T. It manages plans, integrates, implements, and sustains specific Training Support System (TSS) programs, products, services, and facilities that support training across all training domains, TRADOC's core missions, and the Army. It serves as the HQDA Lead Agent for:

- (1) Graphic Training Aids (GTA) Management.
- (2) Training Aids, Devices, Simulators and Simulations (TADSS), including Tactical Engagement Simulation (TES).
- (3) Fielded Devices Inventory and Management.
- (4) Training Mission Area (TMA).
- (5) Sustainable Range Program, including the Range and Training Land Program and Integrated Training Area Management (ITAM).

*f. U.S. Army Accession Command (USAAC).* The U.S. Army Accessions Command (USAAC), <http://www.usaac.army.mil/>, was established by general order on 15 February 2002. It is a subordinate command of TRADOC charged with providing integrated command and control of the recruiting and initial military training for the Army's officer, warrant officer, and enlisted forces. Designed to meet the human resource needs of the Army from first handshake to first unit of assignment, the command transforms volunteers into soldiers and leaders for the Army.

*g. Combined Arms Center (CAC).* The Combined Arms Center (CAC), <http://usacac.army.mil/cac2/overview.asp>, is engaged in the primary mission of preparing the Army and its leaders for war. At present, this mission is divided between preparing the Army for the Global War on Terrorism and transforming it to meet future threats. In order to

## How the Army Runs

accomplish these critical missions, CAC provides Army-wide leadership and supervision for leader development and professional military and civilian education; institutional and collective training; functional training; training support; battle command; doctrine; lessons learned; and other specified areas that the TRADOC Commander designates. These are focused toward making CAC a catalyst for change and to support the development of a relevant and ready ground force to support joint, interagency and multinational operations anywhere in the world.

*h. U.S. Army Capabilities Integration Center (ARCIC), <http://www.arcic.army.mil/>.* ARCIC leads the development and integration of force capabilities across the DOTMLPF for the Army within a Joint and Multinational environment to support Joint Force Commanders. The ARCIC is the Army's leader in the identification, design, development, and synchronization of capabilities into the Army current Modular Force and the future Modular Force, bringing together all Army agencies as well as Joint, Multinational and other DOD agencies to manage rapid change. The ARCIC supports TRADOC in providing adaptive Soldiers, leaders and units by contributing to the development of doctrine, TTPs, and the collective training experience.

*i. Combined Arms Support Command (CASCOM), <http://www.cascom.lee.army.mil/default.asp>.* CASCOM provides training and leader development, and develops concepts, doctrine organizations, life-long learning, and materiel solutions, to provide the combat service support to sustain a campaign quality Army with joint and expeditionary capabilities.

*j. U.S. Army TRADOC Analysis Center (TRAC). <http://www.trac.army.mil>.* TRAC provides analysis to enable decisions and technical products. The TRAC program of operations research and analysis is forward-looking and addresses a wide range of military topics. TRAC leads TRADOC's major studies of new warfighting operations and organization (O&O) concepts and requirements, as well as the Army's analysis of Advanced Warfighting Experiments (AWEs), and the Army's Analysis of Alternatives (AoA). The analysis topics span doctrine, training, leader development, organization, materiel, and soldier support. Scenarios are used by the U.S. Army for education, training and force development. TRAC develops scenarios of potential military operations set in the future for use in modeling and analysis. The family of scenarios undergoes continual review and change in anticipation of emerging threats and new operational environments around the world based on intelligence estimates.

*k. Center for Army Lessons Learned (CALL), <http://usacac.army.mil/cac2/call/about.asp>.* CALL collects and analyzes data from a variety of current and historical sources, including Army operations and training events, and produces lessons for military commanders, staff, and students. CALL disseminates these lessons and other related research materials through a variety of print and electronic media. Individuals requiring additional information, articles, publications, research material, etc., may request them at the CALL RFI site, located at this address: <https://call-rfi.leavenworth.army.mil/rfisystem>

### *l. The systems approach to training (SAT).*

(1) Education and training is developed using the SAT model IAW AR 350-1, Appendix B. SAT is used to develop training and training courses, products, and materials, to include products to support new systems development, digital training, and experimental force development. It is a systematic decision-making approach to design individual, collective, and self-development training for the Army. The process is used to identify all requirements for training. It identifies what tasks, skills, and knowledge will be included in the training; who will receive the training; and how and where the training will be presented. It determines what training products will be required and the level of support resources required for producing, distributing, implementing, and evaluating those products. TRADOC serves as the Army's proponent for training development policy and procedures.

(2) The approach, based on the model shown at Figure 15-4, helps users decide whether or not education/training is needed. Users then apply the approach described in Table 15-1 to be certain that critical performance requirements of the Army establish the content of training in the training base and in the fielded force. The SAT involves five training-related phases: evaluation, analysis, design, development, and implementation. Each builds upon the preceding phases.

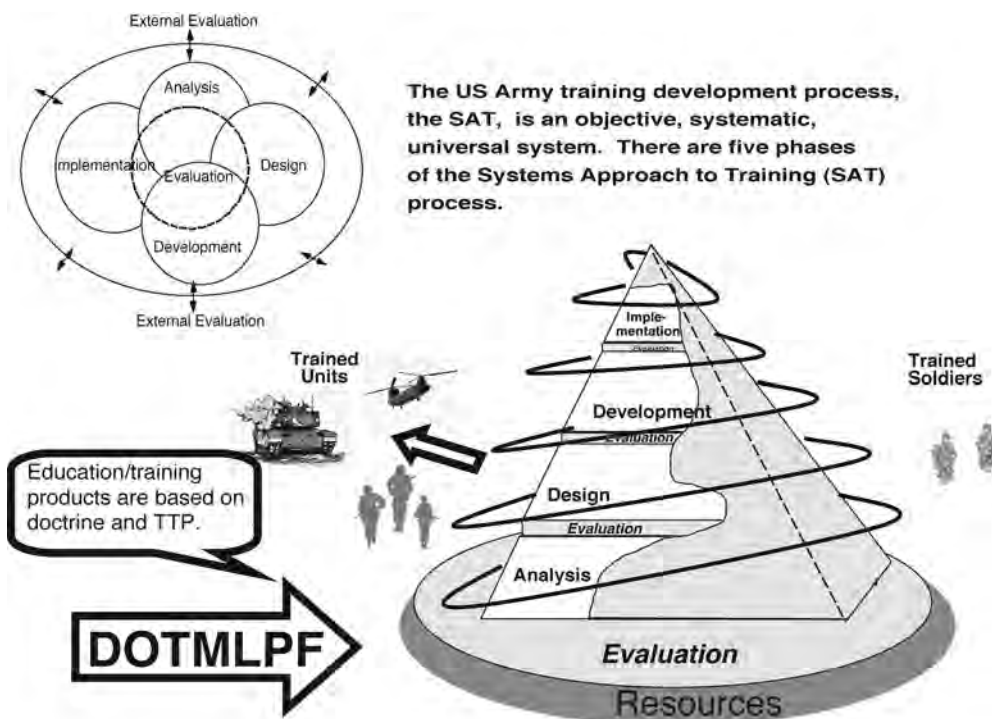

The US Army training development process, the SAT, is an objective, systematic, universal system. There are five phases of the Systems Approach to Training (SAT) process.

Figure 15-4. Systems Approach to Training (SAT)

Table 15-1 SAT Phase Functions Requirements													
SAT Phase	Requirements												
Evaluation determines how well the training takes place, Army personnel / units perform, and products support training	Evaluation reports with identified deficiencies and corrective actions. Follow-up on identified deficiencies. Validated training courses/products. Accredited training institutions IAW accreditation schedule. Certified instructors; qualified evaluators and training developers. Validated evaluation instruments. Master Evaluation Plan and supporting TD Project Management Plans as required.												
Analysis identifies-	There are different types of analysis:												
Need for training. Who gets the training. What tasks (collective and individual (including leader) tasks) and supporting skills and knowledge are critical. Note: A critical task is a collective or individual task a unit or individual must perform to accomplish their mission and duties and to survive on the battlefield and across the entire spectrum of military operations.	<table border="1"> <tr> <td>Type</td> <td>Identify—</td> </tr> <tr> <td>Needs analysis</td> <td>Training solutions to the performance deficiency (ies).</td> </tr> <tr> <td>Mission analysis</td> <td>Recommendation(s) for non-training solutions to the performance deficiency (ies).</td> </tr> <tr> <td>Collective critical task analysis</td> <td>The requirement to improve training efficiency and effectiveness.</td> </tr> <tr> <td>Job analysis</td> <td>TD requirement(s).</td> </tr> <tr> <td>Individual critical task analysis</td> <td>Mission list. Critical collective task list. Supporting individual tasks (as appropriate). Collective task performance specifications. Individual tasks performed as part of the critical collective task. Command-approved critical task list for a specific job/special category. Total task inventory by job; Individual task performance data; Statistical Analysis Report; Nominated critical task list; and, Collective-to-individual task matrix. Individual task performance specifications, including task performance standard. Task analysis report. Soldier training publications (STP) task summary data. Individual-to-collective task matrix. Individual-to-skill/knowledge matrix.</td> </tr> </table>	Type	Identify—	Needs analysis	Training solutions to the performance deficiency (ies).	Mission analysis	Recommendation(s) for non-training solutions to the performance deficiency (ies).	Collective critical task analysis	The requirement to improve training efficiency and effectiveness.	Job analysis	TD requirement(s).	Individual critical task analysis	Mission list. Critical collective task list. Supporting individual tasks (as appropriate). Collective task performance specifications. Individual tasks performed as part of the critical collective task. Command-approved critical task list for a specific job/special category. Total task inventory by job; Individual task performance data; Statistical Analysis Report; Nominated critical task list; and, Collective-to-individual task matrix. Individual task performance specifications, including task performance standard. Task analysis report. Soldier training publications (STP) task summary data. Individual-to-collective task matrix. Individual-to-skill/knowledge matrix.
Type	Identify—												
Needs analysis	Training solutions to the performance deficiency (ies).												
Mission analysis	Recommendation(s) for non-training solutions to the performance deficiency (ies).												
Collective critical task analysis	The requirement to improve training efficiency and effectiveness.												
Job analysis	TD requirement(s).												
Individual critical task analysis	Mission list. Critical collective task list. Supporting individual tasks (as appropriate). Collective task performance specifications. Individual tasks performed as part of the critical collective task. Command-approved critical task list for a specific job/special category. Total task inventory by job; Individual task performance data; Statistical Analysis Report; Nominated critical task list; and, Collective-to-individual task matrix. Individual task performance specifications, including task performance standard. Task analysis report. Soldier training publications (STP) task summary data. Individual-to-collective task matrix. Individual-to-skill/knowledge matrix.												



Table 15-1 SAT Phase Functions Requirements—Continued	
SAT Phase	Requirements
Design determines— When, where and how the training takes place. Training resource requirements (instructors, equipment, ammo, ranges, facilities)	Establish unit, individual, and self-development long-range combined arms training strategies (CATS)/milestones. Establish short-range unit, individual, and self-development CATS /milestones. Design training media/TADSS. Design individual training courses. Produce student performance measurement documents, e.g., tests; exercises. Ensure all training courses and products have disclosure adjudication and application of appropriate restriction statements prior to release of training to foreign nationals.
Development produces validated training/ training products.	Write the training material, e.g., lessons plans, TSPs. Produce training media/TADSS. Validate the training material, including tests. Prepare material for reproduction. Reproduce the training material. Acquire training resources. Train instructor, training management, staff, faculty, and cadre. Prepare facilities and equipment.
Implementation executes— Standardized training at resident and unit training sites. Distribution of training products. Use of training products.	Distribute the training material. Schedule the training. Train the students/Soldiers/units. Administer the tests/exercises. Counsel students/Soldiers. Conduct After-Action Reviews (AARs). Maintain student records.

**15-11. Education and Training Automation**

a. *The Army Knowledge On Line (AKO)*. Soldiers and Department of Army Civilians (DACs) have individual accounts through which they can access education, training, doctrine and other data and information.

b. *Army Training Network (ATN)*. Army Training Network (ATN) is the newest online tool designed for trainers and educators to provide best practices, and includes a database of training solutions and collaborative tools such as a Blog and Battle Command Knowledge System forum. Accessible through a secure Army Knowledge Online (AKO) sign-in, ATN is an important source of information for the many Army training resources available.

(1) ATN replaces FM 7-1, Battle Focused Training. ATN is not doctrine. It provides an intuitive, easy to navigate website focused on Army training best practices, solutions and collaborative tools. Through Army-wide calls for training products, the ATN team has collected over 500 products from the field, and posted the best of them to the products portion of the Web site. ATN is growing and will mature with time.

(2) Because ATN is online, it is available to the Army 24/7. Because it is "virtual" it will remain current with no physical copy to maintain. Training solutions are at the fingertips of trainers by down loading text documents and training examples with embedded links for easy use. Training management is streamlined to provide best practices and unit-provided examples. The Combined Arms Center manages ATN.

(3) Training techniques must adapt at least as rapidly as operations change. The Army wants leaders who are adaptive to the operational environment. Full- spectrum operations, modular forces, versatile adversaries and the reality of persistent conflict, forces the Army to think differently about training. A Web-based system allows Army leaders to share best ideas on training more intelligently, more effectively and more efficiently.

c. *Automated Systems Approach to Training (ASAT)/Training and Doctrine Development Tool (TDDT)*. Provides the capability to produce education/training and doctrine products. TDDT is the next generation (web based) training developmental tool, which will replace the ASAT in all schoolhouses and other organizations producing Army education/training, i.e. contractors. This program will provide standardized products such as field manuals, mission training plans (MTP) drill books, courses, and Soldier training publications (STP) as well as produce unlimited ad hoc outputs like task analysis matrices and Combined Arms Training Strategies (CATS) when fully programmed. This program provides an electronic staffing capability.

d. *Digital Training Management System (DTM)*. The Digital Training Management System is a web based Commercial off the Shelf software application customized to facilitate unit training management. Optimized for use at Brigade and below, DTMS provides the ability to plan, resource and manage unit and individual training at all levels. DTMS is used for Mission Essential Task List (METL) development and can track separate METL for a unit, the unit's HHC,

and unit staff. DTMS has the ability to develop AARs and commanders' assessments of training events. It compiles and displays a unit roll-up of training conducted through a series of customizable tabs to track weapons qualification, APFT, Army Warrior Training, AR 350–1 common military training, MOS training, and deployment tasks from “Enlistment to Retirement”. DTMS is an unclassified FOUO system that requires both AKO logon and User Permissions (managed by units) to access training data.

*e. Digital Libraries.* Reimer Digital Library (RDL) and Army Publishing Directorate (APD), <https://rdl.train.army.mil/soldierPortal/soldier.portal>, <http://www.apd.army.mil/>. The digital libraries store education, training, and doctrinal data. Data stored is generated by the other ATIA supporting programs. They can be accessed through the Army Knowledge Online (AKO) /Department of Defense Knowledge Online (DKO) website (<https://www.us.army.mil>) or through the Army Home Page (<http://www.army.mil>)

*f. Army proponent school web-sites are available to enhance one's professional education.* This link, <https://www.us.army.mil/suite/portal/index.jsp>, provides a consolidated list of websites.

*g. Other training development and training resource support systems include. :*

(1) Individual Training Resource Module (ITRM). Collects individual training implementation resource requirements for budgeting and POM submission. It uses ASAT/TDDT information.

(2) TD2. Used to plan for the education/training and doctrine development. It calculates the training development manpower requirements by school for building TDA and POM submission.

(3) Training Resource Module (TRM). Collects resource data for unit training which is used to build the unit training budget and the POM.

## Section V

### The Army School System (TASS)

#### 15–12. Overview of The Army School System (TASS)

*a.* TASS is a composite school system made up of AA, ARNG, USAR, and Army civilian institutional training systems. TASS conducts initial military training, reclassification training, professional military education, and functional training. This is accomplished through both standard resident and distributed-learning courses. The RC TASS units are functionally aligned and linked to appropriate AA training proponents. This promotes quality assurance, instructor certification, TASS courseware, use of the Army Training and Education (ATED) process, and a distributed learning strategy.

*b.* Army training proponents, to include TRADOC, USASOC, MEDCOM, INSCOM, SMDC/ARSTRAT, ARNG, and USAR provide the structure to establish, maintain, and operate TASS education from a common automated management system.

*c.* The USAR provides component infrastructure organized into Training Commands with functionally-aligned brigades, regiments, and battalions. These elements deliver institutional training at multiple resident and distributed-learning locations.

*d.* TASS training missions are validated during the SMDR process, reflected in the ARPRINT, and documented in ATRRS.

#### 15–13. The Army Training System (TATS)

A TATS course is a single course designed to train the same MOS/AOC skill level or additional skill identifier (ASI), language identifier code (LIC), and skill qualification identifier (SQI) within the Army. It also includes MOS–T, (formerly known as reclassification), Army leadership, and functional and professional development courses. The TATS course structure (phases, modules, tracks, lessons, and tests) and media ensure standardization by training all Soldiers, regardless of component, on course critical tasks to task performance standard. Method of presentation and conditions may vary IAW TR 350–70.

#### 15–14. Enlisted initial military training/Initial Entry Training (IET)

*a. Initial Entry Training (IET).* IET is the introductory training given to all personnel upon initial entry into the Army and is governed by TRADOC Regulation 350–6 (NOV 10). The mission of enlisted IET is to transform volunteers into Soldiers who demonstrate the requisite character and values, possess a warrior spirit, are competent and confident in their warfighting and technical skills, and who can successfully contribute to their first unit of assignment. As a result, IET transforms civilians into Soldiers. Transformation is the deliberate physical and psychological development/progression of a person with an uncertain set of values and level of commitment, discipline, and knowledge of the Army into a contributing member of the Army profession who demonstrates an appropriate level of commitment, discipline, task proficiency, and adherence to the Army values. IET provides an orderly transition from civilian to military life, and the motivation to become a dedicated and productive member of the Army who is proficient in warrior tasks, battle drills and selected MOS-related technical skills, and to understand, accept, and live by the Army values and Warrior Ethos. At HQDA, the DCS, G–3/5/7 exercises general staff supervision of initial entry-

## How the Army Runs

level training except for AMEDD personnel. The CG, TRADOC is responsible for conducting IET, which is accomplished through the CG, U.S. Army Accessions Command (USAAC)/Deputy Commanding General for Initial Entry Training (DCG, IET), the Commandants of the TRADOC schools and commanders of the U.S. Army Training Centers (USATCs). The CG, USAAC/DCG IET focus is to ensure that IET remains challenging, safe, relevant, realistic, and is executed to Army standards. The Army Medical Department Center and School performs this function for AMEDD personnel.

*b. Basic combat training (BCT).* The CG, BCT Center of Excellence, Fort Jackson is the proponent for BCT. BCT is ten weeks of training in basic military skills given to all newly enlisted personnel who have no or limited prior military service. BCT provides a logical progression of training to transition civilians into Soldiers who are well disciplined, motivated, physically fit, and proficient in basic combat survivability skills. All Soldiers receive TRADOC Pam 600–4 and Soldier Training Publication (STP) 21–1, Soldier’s Manual of Common Tasks, Warrior Skill Level. The two publications provide Soldiers with a pocket reference for subjects taught and tested in BCT/OSUT, along with Warrior Skills needed upon arrival at their first unit of assignment.

*c. Advanced individual training (AIT).* AIT occurs after completion of BCT. AIT builds on the soldier skills acquired in BCT while developing each Soldier to the level of proficiency required for the award of an MOS. Soldiers take one of two AIT paths:

- MOS training at a USATC.
- MOS training at a school.

*d. One station unit training (OSUT).* OSUT is conducted at one installation, in the same company-size unit, with the same cadre, and with one program of instruction. The OSUT model is used for most combat arms MOSs (except Air Defense and Aviation) and selected combat support MOSs. OSUT integrates common skill and MOS-specific training into a single program.

*e. Split training option (STO).* STO permits selected individuals to enlist in the ARNG or USAR and complete Initial Active Duty for Training (IADT) in two phases separated by a period of not more than 12 months. The program is designed to attract students and seasonal workers to enlist in the ARNG or USAR by minimizing the time lost from education or employment.

### 15–15. Noncommissioned officer (NCO) training

Institutional training is the primary source of the formal military training and education NCOs receive throughout their military career. NCOs train to perform critical tasks to standard and develop supporting skills and knowledge that are essential for developing high-quality leaders. NCOs are continuously developed and trained through a train-ahead approach. Institutional training and education provides the foundation upon which leader development rests. The purpose of institutional training is to develop the values, attributes, critical warfighting skills, and actions that are essential to quality NCO leadership. When these same values, attributes, skills, and actions are tested, reinforced, and strengthened by follow-on operational assignments and meaningful self-development programs, NCOs attain and sustain competency and confidence in their profession of arms. The Noncommissioned Officer Education System (NCOES) and certain other functional courses (for example, First Sergeant Course and Battle Staff Course) form the institutional training pillar of NCO leader development. The NCOES is designed to prepare NCOs to lead and train Soldiers who work and fight under their direct leadership, and to assist their assigned leaders to execute unit missions. The NCOES accomplishes this preparation through progressive and sequential training using small group instruction throughout four levels of schooling: primary, basic, advanced, and senior (Table 15–2). Functional courses are based on specific skills required for special assignments or duties. The Army uses resident and distance learning instruction to deliver institutional training.

**Table 15–2**  
**Enlisted Training Program**

Rank	Skill Level	Courses	Training Level and Location
SGM	5	SGM Course	SR (SGM Academy)
MSG/1SG	5	1SG Course	SR (SGM Academy)
SFC	4	Senior Leader Course	Advanced (NCOA)
SSG	3	Advance Leaders Course	Basic (NCOA)
SGT/CPL/SPC	2	Warrior Leaders Course	Primary (NCOA)
PVT	1	OSUT (CA) or BCT/AIT (CS/CSS)	Initial Military (ATC & Service Schools)

**Notes:**

<sup>1</sup> WLC, ALC, and SLC RC configured courses are taught at ARNG academies/schools and USARF.

<sup>2</sup> The multi-skilled NCO must always lead by example, train from experience, maintain and enforce standards, take care of Soldiers, and adapt to a changing world. The Army recognizes that in an era of persistent conflict and full spectrum operations this is not enough. The Army’s senior leadership identified attributes for leaders to include: critical and creative thinking.

## 15–16. Non-Commissioned Officer Education System (NCOES)

*a. Warrior Leaders Course (WLC).* The WLC, 17 days in residence, is the first leadership course Non-Commissioned Officers (NCOs) attend. It is a nonmilitary occupational specialty (MOS) specific, field-oriented leadership course built around warrior leader tasks. The WLC trains eligible Soldiers at NCO academies throughout the Army. The training focuses on values, attributes, skills, and actions needed for team leadership responsibilities at the rank of sergeant (SGT).

*b. Advanced Leaders Course (ALC).* ALC is the branch basic level course of NCOES and it consists of two or more phases. Phase I (dL) is a standalone common core that uses the small group instruction process to teach the theories and principles of battle-focused common core training, leadership, and warfighting skills required to lead a squad-sized element in combat. Phase II (resident) is “hands-on,” performance-oriented, technical training that is specific to the MOS. The level of training received at ALC progressively and sequentially improves on the previous instruction received in the WLC and operational assignments.

*c. Senior Leader Course (SLC).* The branch advanced level course for NCOES is SLC. SLC is structured similar to ALC and prepares NCOs to assume duties and responsibilities needed to lead a platoon-sized element. It has proponent phases that include hands-on and performance-oriented training emphasizing war-fighting skills. As the Centers of Excellence have matured, SLC has started to provide common curriculum for multiple MOSs (i.e. Benning, as the Maneuver Center of Excellence provides Maneuver training to both Armor and Infantry NCOs attending their SLC).

*d. U.S. Army Sergeants Major Course (USASMC).* USASMC prepares selected master sergeants (MSG) to perform duties of a sergeant major (SGM) and a command sergeant major (CSM) in staff and troop assignments. The SMC is the pinnacle of NCOES and trains senior NCOs in full spectrum operations, the contemporary operational environment, and the Joint Interagency, Intergovernmental, Multinational environment. SMC is a prerequisite for promotion to sergeant major and appointment to the duty position of command sergeant major. For both AC and RC NCOs, this senior-level training is obtained through a 9-month permanent change-of-station (PCS) resident course taught at the United States Army Sergeants Major Academy (USASMA), Fort Bliss, TX, or through the two-year Nonresident Course (NRC). The NRC is the primary method for RC NCOs to receive the SMC of instruction.

## 15–17. Officer education system (OES)

The Army OES objective for leader development is the means for growing competent, confident, self-aware leaders who are prepared for the challenges of the future in combined arms Joint, interagency, inter-Governmental, and multinational (JIIM) operations. Future force leaders must be multifunctional, capable of supporting the range of military operations within the JIIM environment, comfortable with ambiguity, information systems literate, and capable of intuitive assessments of situations for rapid conceptualization of friendly courses of action. Through the leader development process, the Army develops leaders with character and competence for today and tomorrow to be trainers, role models, and standard bearers. The Army’s leader development and education system trains, educates, and grows Army leaders that are the centerpiece of a campaign quality Army with a Joint expeditionary mindset. Leader development is accomplished within three training domains: operational, institutional, and self-development. The Army intends to achieve this objective by improving and sustaining leader development through an experientially based education and training model enabled by leveraging technological capabilities. Additionally, the Warrant Officer Education System is a subset of OES. Due to lessons learned from on-going conflicts, developments in equipment and training methodologies, and the natural evolution of the Army, the Army’s leadership recognized it must transform the Army’s education system in order to train and educate leaders who will command and control the Future Force. The Army decided to implement changes in the institutional training and education programs for lieutenants, captains, and majors. The Basic Officer Leader Course (BOLC) which consists of two phases (A and B) ensures a tough, standardized, small-unit leadership experience that flows progressively from pre-commissioning to the initial entry field leadership experience and then to branch technical/tactical training.

*a. Warrant Officer (WO) Training.* The Army Training and Leader Development Panel (ATLDP) Warrant Officer Study recommended the Army more fully integrate WOs into the larger officer corps. In recognition of expanding leadership roles for WOs in the future force, the study called for a single world-class leader development education system having distinct components for WO, company-grade, and field-grade officers. The study also recommended combining WO, company grade and field grade officer training, as appropriate, wherever required common officer skills are taught. The goal of WO training and education within OES is to produce highly specialized expert officers, leaders, and trainers who are fully competent in technical, tactical, and leadership skills; creative problem solvers able to function in highly complex and dynamic environments and proficient operators, maintainers, administrators, and managers of the Army’s equipment, support activities, and technical systems. Warrant officer leader development is a continuous lifelong learning process beginning with pre-appointment training and education. OES prepares WOs to successfully perform in increasing levels of responsibility throughout an entire career. OES provides the pre-appointment, branch MOS-specific, and leader development training needed to produce technically and tactically competent WO leaders for assignment to platoon, detachment, company, battalion, and higher-level organizations. The Warrant Officer (WO) Education System (WOES) is configured as shown in Figure 15–5. The Warrant Officer Career Center (WOCC) located at Fort Rucker, AL, is the executive agent for all common WO training. The WOCC exercises

## How the Army Runs

command and control over the Warrant Officer Candidate School (WOCS) as well as the Warrant Officer Staff Course (WOSC) and Warrant Officer Senior Staff Course (WOSSC).

(1) *Pre-appointment applicants.* Pre-appointment training qualifies individuals to serve as officers. The three purposes of pre-appointment training are to educate and train candidates, assess their readiness and potential for appointment to WO, and prepare them for progressive and continuing development. All Active Army and USAR WO candidates must attend the resident Warrant Officer Candidate School (WOCS) at Fort Rucker, AL. ARNG WO candidates can attend various states' two-phased WOCS at Regional Training Institutes (RTIs) in lieu of WOCS at Fort Rucker. WOCS graduates are appointed to WO1. The appointment is contingent upon certification by the MOS proponent that the WO is technically and tactically qualified to serve in the authorized WO MOS.

(2) *Branch Warrant Officer Basic Course (WOBC).* Immediately following WOCS, newly appointed WOs attend their branch WOBC to be certified as MOS qualified. It is a branch-specific qualification course that ensures newly appointed WOs receive the MOS-specific training and technical certification needed to perform in the MOS at the platoon through brigade levels. Training is performance oriented and focuses on technical skills, leadership, effective communication, unit training, maintenance operations, security, property accountability, tactics, and developing subordinates.

(3) *Warrant Officer Advanced Course (WOAC).* The WOAC focuses on advanced technical training and common leader development subjects designed to prepare officers for assignment in CW3 level positions. WOAC is a combination of common core and MOS proponent training that prepares the officer to serve in senior positions at the CW3 level. The WOAC includes two phases: a non-resident common core module and a resident phase, which includes a common core module and MOS specific module.

(a) *Prerequisite studies.* A nonresident phase administered by the WOCC. This phase includes training in common skills needed by all WOs regardless of MOS. It includes instruction in staff skills and roles, communicative arts, decision-making, quantitative skills, personnel Service support, staff leadership and management, training management, mobilization, and tactical sustainment. The course objective is to enhance and sharpen communicative and staff skills, which help prepare the officer for the resident WOAC and subsequent CW3 assignments. Army RC WOs will be scheduled for attendance shortly after promotion to CW2.

(b) *Resident course.* CW2s are eligible to attend their MOS WOAC. ADL WOs will attend the advanced course at their respective proponent school not later than one year after promotion to CW3. National Guard WOs complete this training prior to promotion to CW3. USAR WOs not on the ADL must complete this training prior to selection for CW3. The branch phase varies in length depending on the branch. Primary focus is directed toward leadership skill reinforcement, staff skills, and advanced MOS-specific training. The course consists of in-depth training in MOS specific and branch-immaterial tasks. Graduates of the WOAC receive the designation of Military Education Level (MEL) code 6.

(4) *Warrant Officer Staff Course (WOSC).* WOSC is a branch-immaterial resident course which focuses on staff officer and leadership skills needed to prepare them for duty in W4 grade technician and staff officer positions at battalion and higher levels. Instruction includes decision-making, staff roles and functions, organizational theory, structure of the Army, budget formation and execution, communication, training management, personnel management, the contemporary operational environment (COE), and special leadership issues. It is designed to produce officers with a Warrior Ethos who are grounded in warfighting doctrine and possess the technical, tactical, and leadership competencies to be successful at more senior levels.

(5) *Warrant Officer Senior Staff Course (WOSSC).* WOSSC is currently the capstone course for WO professional military education. It is a branch-immaterial resident course which provides master-level professional WOs with a broader Army level perspective required for assignment to WO5 grade level positions as technical, functional, and branch systems integrators, trainers, and leaders at the highest organizational levels.

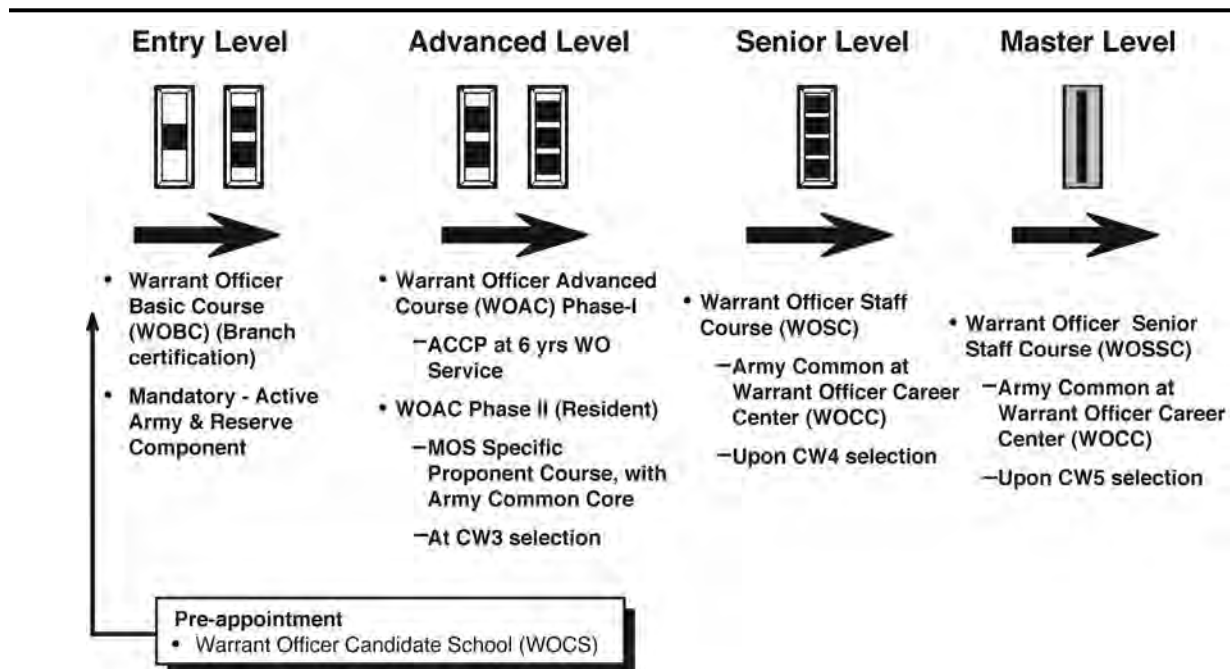

Figure 15-5. Warrant Officer Education System

*b. Officer training and education.* The Officer Education System (OES) is the progressive and sequential education and training process for officers in the Army that begins in the pre-commissioning phase and continues in schools at the basic entry level, captain level, intermediate command and staff level, and senior level. See Figure 15-6 (Officer Education System). The primary schools and their objectives are as follows:

(1) *Basic Officer Leadership Course (BOLC).* The objective of BOLC's two-part program is to develop technically competent and confident platoon leaders, regardless of branch, who are grounded in leadership and basic technical and tactical skill proficiency, are physically and mentally strong, and embody the Warrior Ethos. To achieve this objective, BOLC capitalizes on experience-based training, logically structured to build upon and reinforce previous lessons. BOLC A consists of pre-commissioning training, either through Reserve Officers' Training Corps, Officer Candidate School, or the United States Military Academy. For direct commissioned officers (generally available only to doctors and lawyers), BOLC A consists of a 4 week Direct Commissioned Course (DCC) Course at Fort Benning, GA. BOLC B develops Army values and core leadership attributes in junior officers as well as branch-defined technical and tactical skills for demonstrated proficiency at platoon and company levels.

(2) *Captains' Career Course (CCC).*

(a) The branch CCC prepares company grade officers to command Soldiers at the company, troop, or battery level and to serve as staff officers at battalion and brigade levels. Active Army officers incur a one-year Active Duty Service (ADSO) obligation for attendance at a branch CCC upon completion or termination of the course. Officers attend CCC following selection for promotion to the grade of captain, normally before company level command. Select captains who have demonstrated superior performance in their basic branches may be selected to receive this training at other than their branch schools. (For example, a Field Artillery officer might attend the CCC for Armor officers.) This cross training benefits officers of both branches. Officers seeking accession into Special Forces will normally attend the infantry CCC.

(b) Captains Professional Military Education (PME) focuses on the technical, tactical and leadership competencies needed for success in follow-on assignments. The branch CCC prepares company grade officers to command and train at the company, battery, or troop level and to serve as staff officers at battalion and brigade levels. There is a 1-year active duty service obligation (ADSO) for attendance at a branch CCC. Captains learn how to think critically and creatively; they learn how to think as opposed to merely being thought what to think. Instruction focuses around combined arms operations at company, battalion, and brigade levels within the COE. Students plan and conduct a variety of operations against an array of opposing forces. Training includes planning and executing offensive and defensive operations against conventionally trained, equipped, and structured threat as well stability and reconstructive operations against unconventional forces possessing a mixture of capabilities. The training scenarios present the student with constantly changing situations against a learning, cunning, and adaptive enemy.

## How the Army Runs

(c) Instruction also includes an introduction to Joint, interagency, and multinational operations. Classes include an emphasis on urban operations and cultural awareness as an aspect of modern conflict. Captains also receive training on how to leverage learning technologies and the importance of lifelong learning and self-development. The instruction is a realistic, hands-on experience that stimulates effective recall in combat and training environments following graduation. The program of instruction (POI) aims to develop well rounded, multi-skilled officers who have the competencies and confidence to lead Soldiers in the COE. There are two ways RC captains may fulfill their PME requirements: Attend the Active Army version of CCC, or attend a CCC (RC) which consists of two, two-week ADTs spaced one year apart, plus up to 295 hours of advanced distributed learning.

(3) *Intermediate Level Education (ILE)*. ILE is the Army's formal education program for majors. It is a tailored resident education program designed to prepare new field-grade officers for their next 10 years of Service. It produces field-grade officers with a Warrior Ethos and a Joint, expeditionary mindset, who are grounded in warfighting doctrine, and who have the technical, tactical, and leadership competencies to be successful at more senior levels in their respective branch or functional area (FA). ILE consists of a common core phase of operational instruction offered to all officers and a tailored education phase (qualification course) tied to the technical requirements of the officer's branch or FA.

(a) Select branch and Functional Area officers will receive the common core course at Fort Leavenworth, Kansas during the first 16 weeks of ILE and follow on attendance at AOWC for 24 weeks. The remaining officers who do not attend resident ILE at Fort Leavenworth will receive the common core course from CGSC instructors at one of the satellite campuses and as prescribed through ADL and the TASS. Following the common core FA officers attend individual qualification course ranging from two to 178 weeks in length. Qualification courses provide officers the technical preparation for assignments in their respective FAs. Completion of the ILE common core and the respective branch or FA qualification course qualifies the officers for award of MEL 4 and JPME I.

(b) Some officers may attend the Navy, Marine, or Air Command and Staff Colleges, the Western Hemisphere Institute for Security Cooperation (WHINSEC), or a foreign school that has been granted ILE equivalency. School selections result from a comparative appraisal of all eligible officers, including a careful review of these elements: the scope and variety of tasks performed and how well they were performed, the degree or level of responsibility, the trend of efficiency up or down, intelligence and independent judgment in implementing decisions, and an estimate of potential. Officers selected for attendance at other than the Army Intermediate Staff College may attend the ILE common core at a satellite site, TDY en route.

(4) *The Advanced Military Studies Program (AMS)*. AMSP is a yearlong resident course taught by the School of Advanced Military Studies (SAMS) at the U.S. Army Command and General Staff College. The purpose of the AMSP is to provide the Army and the other services with specially educated officers for command and general staff positions at tactical and operational echelons. The program provides its graduates an advanced education in the military arts and sciences focused at the operational level. Additionally, the program provides training in the practical skills needed to plan and conduct battles, major operations, and campaigns and in adapting doctrine and techniques to the changing realities of war. Applicants must be ILE qualified or resident students in ILE or Sister Service resident programs. The focus of this school is on planning and executing full-spectrum operations in joint, interagency, intergovernmental, and multinational contexts.

(5) *Pre-Command Course (PCC)/Tactical Commander's Development Program/Branch PCC (PCC/TCDP)*. AC and RC commanders selected for battalion and brigade command attend a 3 phase command preparation program that includes the PCC, TCDP, and branch/functional training prior to assuming their assignments. Officers attend Phase I, a one week branch immaterial course conducted at Fort Leavenworth, KS. Here, the command designees are introduced to Army policy as it affects their commands, self assessment tools to improve leadership, command team training for the commander, CSMs and spouses. Selected commanders are then enrolled in Phase II, a two-week Tactical Commanders' Development Program, a course that focuses on command decision making, COE, and synchronization of combat power across the full spectrum of operations. Other selected designees are enrolled for additional training for TRADOC specific requirements. Designees then attend Phase III branch or functional pre-command training that familiarizes future commanders with the technical / tactical / and procedures relating to their particular disciplines/branches. Designees may also attend legal, logistics, and language training based on their specific requirements.

(6) *Senior Service College (SSC)*. The SSCs are at the apex of the military schools system and award MEL 1 credit. SSCs prepare officers for senior command and staff positions within the Army and DOD. These colleges include the AWC, the NWC, the ICAF, the Naval War College, the Air War College, the Inter-American Defense College (IADC); other accredited international senior military Service colleges, or any one of approximately 20 civilian and military fellowship programs.

(a) The SSC, in accordance with National Defense Appropriation Act of 2005, teaches JPME II. The Army's SSC, the AWC, prepares military, civilian, and international leaders to assume strategic leadership responsibilities in military or national security organizations. It educates students about employment of the U.S. Army as part of a unified, Joint, or multinational force in support of the national military strategy; researches operational and strategic issues; and conducts outreach programs that benefit the nation.

(b) The AWC Distance Education Course provides an alternate means of attaining MEL 1 schooling. Eligible officers who apply are compared against the most current promotion list to colonel and most current SSC Selection

Board Order of Merit List (approximately 1,300 names) to determine the final slate. AR 350-1 describes the details of the selection and application processes. The course is the only nonresident program that results in the awarding of MEL 1 upon completion. Once officers have enrolled in the correspondence course, they are no longer eligible for resident SSC attendance.

(7) *Joint Professional Military Education (JPME)*. The JPME program is a Joint Chief of Staff approved body of principles and conditions that prescribe, at both the Intermediate Level Colleges (ILCs) and SSC levels, the educational requirements for Joint specialty officer nomination. The ILCs incorporate JPME Phase I into their curricula. The SSCs incorporate JPME II into their curricula. JPME I is awarded on completion of ILE common core and AOWC or the appropriate credentialing course. In the National Defense Appropriations Act of 2005, the AWC now teaches JPME II.

(8) *General Officer training*. General officer training has historically not been formalized. Preparation has been through varied assignments over the course of a career. General officer training now consists of various functional and assignment-specific courses. Initiatives to institutionalize training (some as a result of the Professional Development of Officers Study) include:

(a) The “CAPSTONE” seven-week course through the National Defense University, which includes visits to ACOM, ASCC, DRUs and Services to enhance understanding of key factors influencing planning for and employment of U.S. forces in joint and combined operations.

(b) Brigadier General transition (“charm school”), eight days.

(c) Army Force Management GO/SES Course.

(d) Leadership Development Program through several accredited civilian institutions.

(e) Division/Assistant Division Commander Course at Fort Leavenworth, one week.

(f) Joint Force Land Component Commander Course conducted by the U.S. Army War College at Carlisle Barracks, one week.

(g) Joint Warfighting Course conducted jointly by the U.S. Army War College and Air War College at Maxwell AFB, two weeks, on campaign planning and employment of Services and joint forces.

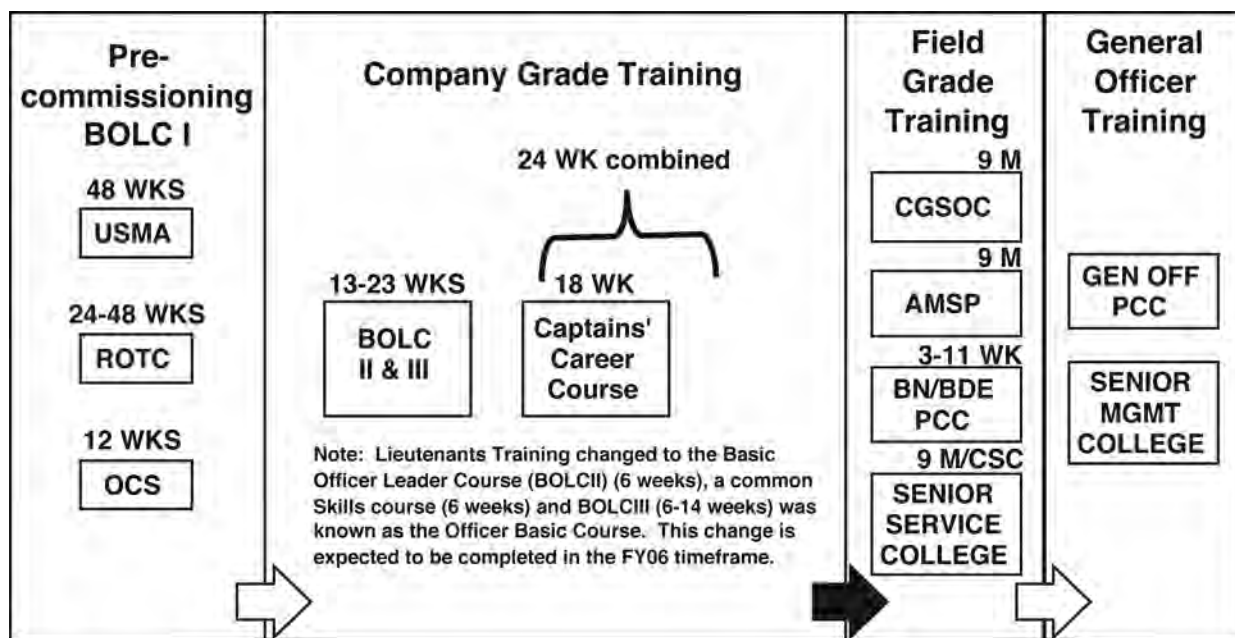

AMSP - ADVANCED MILITARY STUDIES PROGRAM  
 CAS<sup>3</sup> - COMBINED ARMS AND SERVICES STAFF SCHOOL  
 CGSSOC - COMMAND AND GENERAL STAFF OFFICER COURSE  
 CSC - CORRESPONDING STUDIES COURSE (2YR PROGRAM)  
 MOD - MODULE  
 OAC - OFFICER ADVANCED COURSE  
 OBC - OFFICER BASIC COURSE  
 OCS - OFFICER CANDIDATE SCHOOL  
 PCC - PRE-COMMAND COURSE

Figure 15-6. Officer Education System



### 15–18. Civilian education system (CES)

a. The goal of the CES is to prepare agile and innovative civilians who can lead during times of change and uncertainty; are prepared for the rigors of service as multiskilled leaders; and are armed with the values, skills, and mindset to serve as competent, resilient supervisors and managers. Leader development for civilians is a continuous process that is accomplished through a blend of work assignments, formal training, and self-development opportunities as individual's progress from entry to senior level positions.

b. CES Structure. (Figure 15–7). The CES courses are designed using leadership competencies derived from the U.S. Office of Personnel Management (OPM) leadership competencies and additional competencies identified by the Center for Army Leadership in FM 6–22, Army Leadership. CES is a structured, progressive, sequential program which broadens the targeted civilian educational training base. Designated courses are required for interns, team leaders, supervisors and managers. A brief description CES courses follows:



Figure 15–7. Civilian Education System

---

(1) Action Officer Development Course (AODC), Supervisory Development Course (SDC), and Management Development Course (MDC). These DL courses are available through the Army Reimer Library website. They are available as self-development to supplement other training opportunities and to increase employee's knowledge and skill at any point in their career. Interns are required to complete the AODC before the completion of their intern program. SDC is required to be completed by individuals in supervisory and managerial positions before they complete their one-year probationary period. MDC provides self-development opportunities for all Army Civilians and leaders.

(a) AODC. This course describes "staff work" as it is generally practiced Army-wide. The AODC covers organization and management; conducting completed staff work; managing time and priorities; conducting meetings and interviews; solving problems and making decisions; communications; writing to the Army standard; coordinating; conducting briefings; and ethics.

(b) SDC. SDC provides supervisors or managers with civilian personnel administration skills such as work management and basic supervision. This course is mandated by Headquarters, Department of the Army, to fulfill the statutory requirements that Congress set for in the National Defense Authorization Act of 2010. SDC is a DL course that covers all specified supervisor training, and it is valid for new supervisors of civilians who have already taken at least one approved Army leader development course (either through CES or as prior military).

(c) MDC. MDC assists supervisors and managers with basic skills for managing work and leading people. MDC includes modules in organizational culture; time management; objectives and plans; problem solving and decision making; planning, programming and budgeting; manpower management; communications; information technology applications; the Army Environmental Program; equal employment opportunity; professional ethics; internal management control; and Army family team building.

(2) Foundation Course (FC). The FC is designed for employees to gain an understanding of the structure of the U.S. Army, the Army's leadership doctrine, and the personnel system for Department of Army civilians. The course objectives are to orient one to the U.S. Army and also to provide leader development at the LEAD SELF level. It is a DL course that covers self-awareness as it relates to their profession, team building, problem solving, ethics, effective communication, and how to manage professional advancement and leverage career potential.

(3) Basic Course (BC). BC is designed for civilian leaders who exercise direct leadership to effectively lead and care for teams. Education focuses on basic development in leadership and counseling fundamentals, interpersonal skills and self-awareness. BC consists of a DL phase and a two week resident phase. The resident phase will be taken after successful completion of the DL phase and takes place in a university setting encompassing a classroom environment and small group seminars.

(4) Intermediate Course (IC). The IC is designed for civilians in supervisory or managerial positions. This target population is by necessity more adaptive, innovative, self-aware, and prepared to effectively lead and care for personnel and manage assigned resources. Developmental exercises focus on “mission” planning, team building, establishing command climate, and stewardship of resources. IC consists of a DL phase and a three week resident phase. The resident phase will be taken after successful completion of the DL phase and takes place in a university setting encompassing a classroom environment and small group seminars.

(5) Advanced Course (AC). AC is designed for civilian leaders who exercise predominately indirect supervision and who are adaptive, innovative, self-aware, and capable of effectively leading a complex organization, guiding programs, and managing associated resources. The focus is on strategic thinking and assessment, change management, developing a cohesive organization, managing a diverse workplace, and management of resources. AC consists of a DL phase and a four week resident phase. The resident phase will be taken after successful completion of the DL phase and takes place in a university setting encompassing a classroom environment and small group seminars.

(6) Continuing Education for Senior Leaders (CESL). CESL is designed to meet the needs of senior civilians who want continuing education on major Army issues, hot topics, and strategic direction. It also emphasizes strategic thinking, external awareness, vision, and a global perspective. CESL consists of a DL phase and a 4.5 day resident phase.

(7) Senior Service College (SSC). SSC is at the apex of the civilian education system and prepares civilians for positions of greatest responsibility in the Department of Defense. SSC provides advanced level educational opportunities for those who have completed CES training through the Advanced Course or equivalent training. Leaders who attend must have an understanding of complex policy and operational challenges and increased knowledge of the national security mission. Attendance is a competitive process and a HQDA Secretariat Board makes selections. Like the Officer Corps, civilians graduating from SSC are centrally placed in a position of greater responsibility in another assignment or organization where they can apply the advanced education they have received.

(8) Defense Senior Leader Management Program (DSLDP). DSLDP is the premier civilian leader development program for the Department of Defense. DSLDP institutes a competency-based approach to the deliberate development of senior civilian leaders with the enterprise-wide perspective needed to lead organizations and programs, and achieve results in the Joint, interagency, and multi-national environments. Created in response to our changing environment, DSLDP is the successor program to the Defense Leadership and Management Program (DLAMP), which ended at the end of Fiscal Year 2010.

### **15–19. Self-development training**

Learning is a lifelong process. Institutional, organizational, and operational training alone cannot provide the insight, intuition, imagination, and judgment needed in combat. The gravity of our profession requires comprehensive self-study and training. In no other profession is the cost of being unprepared so high. Soldiers and leaders at all levels continually study our profession in preparation to fight and win our Nation’s wars. This requires commanders at all levels to create an environment that encourages subordinates to establish personal and professional development goals. Further refinement of those interests should occur through personal mentoring by commanders and first line leaders. Applications of battle-focused officer and NCO professional development programs are essential to leader development. Exploiting reach-back, distributed learning, and continuing education technologies support these programs. Self-development is continuous and should be emphasized in both institutional and operational assignments. Successful self-development requires a team effort. Self-development starts with an assessment of individual strengths, weaknesses, potential, and developmental needs. Commanders and leaders provide feedback to enable subordinates to determine the reasons for their strengths and weaknesses. Together, they prioritize self-development goals and determine courses of action to improve performance. Self-development is:

*a.* A planned process involving the leader and the subordinate being developed. It enhances previously acquired skills, knowledge, behaviors, and experience; contributes to personal development; and highlights the potential for progressively more complex and higher-level assignments. Self-development focuses on maximizing individual strengths, minimizing weaknesses, and achieving individual development goals.

*b.* Initial self-development is very structured and generally narrow in focus. The focus broadens as individuals understand their strengths and weaknesses, determine their individual needs, and become more experienced. Each Soldier’s knowledge and perspective increases with experience, institutional training, and operational assignments. It is accelerated and broadened by specific, goal-oriented self-development actions.

### **15–20. Mobilization training base**

The mobilization-training base is tasked to ensure that Soldiers arrive, in-theater, ready to fight as teams or individual replacements. It must provide combat-ready Soldiers who are proficient in those skills that ensure their immediate

## How the Army Runs

contribution and survival as members of teams/crews/units in a theater of operations. A detailed process for the execution of the mobilization training base is discussed in Chapter 6 (Planning for Mobilization and Deployment).

*a. Levels of mobilization.* The training base will accomplish its task by planned expansion geared to varying levels of mobilization. During Presidential Reserve Call Up (PRC) and partial mobilization, existing USATCs and Service Schools are augmented by elements of USAR Divisions (institutional training). Reserve Reception Battalions are also activated during phased mobilization to augment reception stations. USAR assets scheduled to expand or augment the training base are under the peacetime control of USARC, but placed under the command of TRADOC during the establishment and execution of the mobilization training base. Primary planning emphasis for mobilization expansion of the training base is on partial mobilization, with pre-deployment MOS/AOC certification of mobilized IRR members the primary mission.

*b. PRC and partial mobilization.* During PRC and Partial Mobilization, all peacetime training programs continue, with the IRR in-processing certification training mission being added.

*c. Mobilization planning guidance.* Detailed planning guidance for mobilization is contained in the Army Mobilization and Operation Planning and Execution System (AMOPES) and TRADOC Mobilization and Operations Planning and Execution System (TMOPES). AMOPES provides a source document for issuing policies, procedures, guidance, and planning assumptions for the functional areas of training, exercises, mobilization, deployment, employment, sustainment, and expansion of forces beyond the approved force structure, redeployment, demobilization, and reconstitution of Army forces.

## Section VI

### Training in units

#### 15–21. General

*a.* The Army's mission is to provide the necessary forces and capabilities to the combatant commanders (COCOM) in support of the National Security and Defense Strategies. The Army's strategic goals are to remain relevant and ready by providing the Joint Force commander with essential capabilities to dominate across the full range of military operations. Army leaders and units must be ready to perform with joint, interagency, intergovernmental, and multinational (JIIM) team members in a contemporary operating environment against an adaptive enemy. A unit commander has two major training responsibilities: (1) develop Soldiers/leaders for future responsibilities and (2) prepare their unit to accomplish the assigned mission. In the absence of a directed mission, commanders must prepare their unit to perform those core missions for which the unit was doctrinally designed to execute across the full range of military operations. The Army's training challenge is to optimize, synchronize, and support training in schools, training in units, and self-development to produce forces ready to respond across the full range of military operations.

*b.* The challenges of today's operational environments require a change in the Army mindset. Army forces must be trained to conduct full spectrum operations under the conditions of any operational environment, anywhere along the spectrum of conflict. The Army must train, organize, and develop capabilities for stability operations with the same intensity and focus that it does for combat operations.

*c.* To be successful in future operations, the Army cannot look at operations today as temporary interruptions in preparing for major combat operations against a near-peer enemy. Nor can it afford to view operations dominated by the offense and defense and those dominated by stability as either/or propositions. Both usually occur simultaneously. Army forces must be well-trained and able to deploy rapidly to conduct and win engagements and wars while remaining ready to conduct sustained stability operations. Similarly, in operations dominated by stability they must remain prepared to conduct offensive and defensive operations. The predominate operation; offense, defense, or stability, is determined by the situation, objectives, or conditions to be achieved, desired end state, and level of violence. Commanders consider the simultaneous execution of these three elements of full spectrum operations in their mission analysis.

*d.* Leaders in Joint units (that is, Joint Task Forces, Joint Land Component Commands, and Combatant Command HQs) manage training using procedures in the Chairman of the Joint Chiefs of Staff Training Manual (CJCSM), CJCSM 3500.03. Leaders in Army units (for example, TDA units and modified table of organization and equipment (MTOE) units within ACOMs and Army Service component commands) manage training using procedures in FM 7–0 and the Army Training Network, which support and are consistent with Joint training management procedures. Training and readiness oversight/support is provided through the administrative control (ADCON) chain. Leaders in Army units will:

- (1) Use an Army-approved automated system, like the Digital Training Management System, to manage training.
- (2) Focus training on FSO METL.
- (3) Plan and execute training events that enable the unit to build and sustain Soldier, leader, and unit proficiency in mission essential tasks. The CATS and STRAC strategies are the doctrinal templates of training events, frequency, and duration that a commander uses in developing unit training guidance, strategy, and calendars. The critical training events in CATS and STRAC are the common building blocks for the commander's plan.
- (4) Minimize risk in training activities by conducting a composite risk assessment when planning all training events.

- (5) Manage activities so that training land is protected, rehabilitated, and maintained.
- (6) Given a directed mission, use available time to rehearse mission execution.
- (7) Assess performance in training and operations and provide feedback to unit personnel and Army lessons learned processes.

### **15–22. Organization for training in units**

*a. Troop units.* FORSCOM; USAREUR; EUSA; USARSO; USASOC; and USARPAC. All are tasked to organize, equip, station, train, and maintain the readiness of assigned units.

*b. U.S. Army Materiel Command (AMC).* AMC's mission is to provide superior technology, acquisition support and logistics to ensure dominant land force capability for Soldiers, the United States and our allies. The training mission for AMC is directed toward specialized training of personnel in the materiel area, to include planning for and conducting NET in coordination with FORSCOM, TRADOC, and other commands. AMC is further tasked to assist TRADOC and FORSCOM on matters associated with supply and maintenance concepts, doctrine, training and individual and collective training products. The education and training products produced must be IAW TRADOC policy.

*c. The U.S. Army Medical Command (USAMEDCOM).* USAMEDCOM's mission is to provide, sustain, and enhance Soldier health. They are responsible to train, develop, and equip, the medical force supporting the Army and to then deliver leading edge health services. The AMEDD center and school is responsible for the execution of the training management function for the AMEDD. It provides training and education to all AMEDD personnel, on a worldwide basis and provides standardized TSPs on common medical tasks for use throughout the Army.

### **15–23. Training of Soldiers and leaders in units (FM 7–0 Training Units and Developing Leaders for Full Spectrum Operations February 2011)**

*a. There are 11 principles of training.*

- (1) Commanders and other leaders are responsible for training.
- (2) Noncommissioned officers train individuals, crews, and small teams.
- (3) Train to standard.
- (4) Train as you will fight.
- (5) Train while operating.
- (6) Train fundamentals first.
- (7) Train to develop operational adaptability.
- (8) Understand the operational environment.
- (9) Train to sustain.
- (10) Train to maintain.
- (11) Conduct multiechelon and concurrent training.

*b. There are seven principles of leader development.*

- (1) Lead by example.
- (2) Take responsibility for developing subordinate leaders.
- (3) Create a learning environment for subordinate leaders.
- (4) Train leaders in the art of mission command.
- (5) Train to develop adaptive leaders.
- (6) Train leaders to think critically and creatively.
- (7) Train your leaders to know their subordinates and their families.

### **15–24. Soldier training publications (STP)**

Training Publications (TPs) are Army Doctrine and Training Literature Program (ADTLP) publications that contain critical tasks and other training information used to train soldiers and serve to standardize individual training for the whole Army; provide information and guidance in conducting individual training in the unit; and aid the soldier, officer, noncommissioned officer (NCO), and commander in training critical tasks. STPs consist of Soldier's Manuals (SMs) (common task and branch specific) and Soldier's Manuals/Trainers Guides (SM/TGs). STP 21–1, Soldier's Manual of Common Tasks (SMCT), Skill Level 1, is the only soldier's manual projected to be printed under the ADTLP in the future. Training/Task (TD) Proponents may publish branch-specific STPs. All other STPs can be published in electronic form through the ADTLP.

*a. STP.* STPs support training of common, shared, and branch-specific individual critical tasks in the unit. Each task summary describes the minimum acceptable standard and the operational conditions under which the task must be performed, lists the references Soldiers need to master the task, and provides a guide to assess hands-on performance. Proponent schools develop branch-specific STPs that provide conditions, standards, and performance information to support training and evaluation of tasks at each skill level.

*b. Training Guide (TG).* The TG is a tool to guide the unit trainers and individual Soldiers in establishing an

individual training plan. TGs give commanders and unit trainer's information needed to plan and conduct soldier training and evaluations in the unit.

### 15–25. Collective training

*a.* Collective training requires interaction among individuals or organizations to perform tasks, actions, and activities that contribute to achieving mission-essential task proficiency. Collective training includes performing collective, individual, and leader tasks associated with each training objective, action, or activity. Unit training occurs at home station, maneuver CTCs, and mobilization training centers. It also takes place in joint training exercises and while operationally deployed. Unit training develops and sustains an organization's readiness by achieving and sustaining proficiency in performing mission-essential tasks. Installations ensure units have access to the training enablers needed to enhance readiness. This training can be conducted in any or all of the live, virtual, constructive, or gaming environments.

*b.* Collective training refers to developing in a group of Soldiers those interdependencies and teamwork that go to make up team performance. The terms "collective training" and "unit training" cannot be used interchangeably. Unit training includes collective and individual training (the training of Soldiers and leaders). The primary features of collective training are that it is decentralized and performance-oriented. Performance-oriented collective training is training units to do the same tasks or missions that they will do in wartime, and to do them well enough to ensure success on the battlefield. The performance objective is the basis of the performance-oriented approach. Training is conducted to attain the objective. Included within the training objective are the tasks, conditions, and evaluation standards. The standards are used to determine the unit's ability to accomplish the task and are measured in GO/NO GO terms. The evaluation is designed to be used to develop timely remedial training programs. The units are provided with training products to assist in this training. The primary products are: CATS, battle drills, exercises, Training Support Packages (TSPs), short-range unit training strategies, and training aides, devices, simulators, and simulations.

### 15–26. Composite Risk Management (CRM)

*a.* FM 5–19, CRM, defines CRM as the Army's primary decision-making process for identifying hazards and controlling risks across the full spectrum of Army missions, functions, operations, and activities

*b.* Unidentified and unmanaged threats and risks impede successful Army missions, undermine readiness, decrease morale, and deplete resources. The holistic approach of CRM provides commanders a tool to recognize, evaluate, eliminate, and control all the diverse threats and risks to mission execution. The underlying principle of CRM is that a loss is a loss. The loss can be either one of the following:

- (1) Tactical (threat-based) loss.
- (2) An accidental (hazard-based) loss.
- (3) A loss due to terrorism, suicide, homicide, illness, or even substance abuse.

*c.* The training mission cannot be considered fully successful if it is not accomplished with appropriate risk mitigation. The principles of integration and composite risk management have special relevance to the training situation. Commanders must integrate safety as a training management factor from the moment the mission is defined and the FSO METL is developed. When safety is realistically integrated in training, the benefits extend to the garrison environment, off-duty activities, and most importantly, to the combat arena. The Mishap Risk Management Process is used to identify, evaluate, and manage risks to missions, personnel, equipment, and the environment during peacetime, contingency operations and wartime due to safety and occupational health factors, design and construction of equipment, and other mishap factors

*d.* The Mishap Risk Management Process is the process of identifying and assessing hazards; determining their risk; developing, evaluating and selecting controls; making risk decisions; and implementing and managing those decisions to improve operational effectiveness and conserve Army resources. The process consists of the following five steps shown:

- (1) Identify hazards.
- (2) Assess hazards to determine risk.
- (3) Develop possible countermeasures and make risk decisions.
- (4) Implement controls.
- (5) Supervise and evaluate.

*e.* The risk assessment consists of the first two steps of the risk management process. In Step 1, individuals identify the hazards that may be encountered in executing an activity. In Step 2, they determine the impact of each hazard on the activity. The risk assessment provides for enhanced situational awareness. This awareness builds confidence and allows Soldiers, units, civilians, and organizations to implement timely, efficient, and effective protective control measures.

*f.* Steps 3 through 5 are the essential follow-through actions to manage risk effectively. In these steps, leaders balance risk against costs and take appropriate actions to eliminate unnecessary risk. During execution, leaders continuously assess the risk to the overall mission and to those involved in the task. Finally, leaders and individuals evaluate the effectiveness of controls and provide lessons learned so that others may benefit from the experience.

g. The U.S. Army Combat Readiness/Safety Center is the Army Executive Agent for Safety. Their website is at <https://safety.army.mil/Default.aspx>.

### 15–27. Mission Training Plans (MTPs) and drills

There are MTPs for each type TOE platoon, company, battalion, combined arms task forces, and brigade, division, and corps staffs. The MTPs provide a clear description of “what” and “how” to train to achieve critical wartime mission proficiency for each unit echelon. Each MTP contains mission outlines, sample situational and field training exercises (STXs and FTXs), and comprehensive detailed training and evaluation outlines. MTPs provide other training management aids such as leader tasks, resource requirements, and evaluation methods. Included are matrices linking collective tasks to missions, references to collective tasks, drills/ collective tasks to individual tasks, and STXs to missions. These products are also available in digitized format in the digital library.

### 15–28. Combat Training Center (CTC) Program

a. *Mission.* The CTC program consists of the National Training Center (NTC), Fort Irwin, CA; the Joint Readiness Training Center (JRTC), Fort Polk, LA; the Joint Multinational Readiness Center (JMRC), Hohenfels, Germany; and the Mission Command Training Program at Fort Leavenworth, KS; and the Exportable Training Capability (ETC) events. The Combat Training Center Program objectives are to: increase unit readiness; develop battlefield leaders; embed doctrine; provide feedback on unit tactical effectiveness to participants; and provide data to improve doctrine, organization, training, materiel, leadership and education, personnel, and facilities (DOTMLPF) input to the combat and training development processes. AR 350–50 establishes Army policies for the management of the CTC program. The CTC program provides realistic joint and combined arms training, according to Army and joint doctrine, approximating actual combat. They are integrated into operationally deploying unit training schedules and often serve as Mission Rehearsal Sites. The CTC Program:

- (1) Provides commanders, staffs, and Soldiers an operational experience focused on leader development.
- (2) Produces bold, innovative leaders through stressful tactical and operational exercises.
- (3) Increases unit readiness for deployment and warfighting.
- (4) Embeds doctrine throughout the Army.
- (5) Provides feedback to the Army and joint participants to improve warfighting.
- (6) Provides a data source for lessons learned to improve doctrine, organizations, training, material, leadership and education, personnel, and facilities (DOTMLPF) domains to win in combat.

b. *Rigor.* During a CTC experience, commanders will fight with the equipment they would expect to take to war during their command tenure.

- Train to standard.
- Conduct doctrinally based AARs focused on performance, which enable Soldiers and leaders to discover for them what happened, why it happened, and how to sustain strengths and improve weaknesses.
- Stress all warfighting functions (WFF) in decisive ground combat operations.
- Provide a freethinking, opportunities-based, OPFOR with an equal chance to win.
- Develop tactical scenarios where the outcome is not assured.
- Ensure consequences of tactical decisions are fully played out.
- Retrain to underscore the unit’s adherence to standards and mastery of the task. (Retraining is not an indication of failure.)

(1) *Mission Command Training Program (MCTP).* MCTP, located at Fort Leavenworth, KS, is the Army’s capstone CTC. MCTP supports realistic, stressful training and leader development for Army Force/ASCCs and corps, division, and brigade commanders and their staffs to assist the Chief of Staff, United States Army (CSA), in fulfilling his obligation to provide trained and ready units to win decisively on the modern battlefield and to conduct contingency operations worldwide. MCTP conducts full spectrum operations and mission rehearsal computer-assisted command post exercises at the mid-to-high intensity level of combat. The MCTP also provides a vital source of experience-based information and data essential to DOTMLPF to improve the Army and supports contingency operations and deployed unit training.

(2) *Joint Multinational Readiness Center (JMRC).* JMRC, in a forward deployed environment at Hohenfels, Germany, provides realistic joint and combined arms training focused on developing Soldiers, leaders, and units for success on current and future battlefields. JMRC trains up to a brigade combat team and elements of Functional and Multi-Functional brigades in full spectrum operations. Although not part of the CTC program, JMRC trains allied military units deploying to support OEF and as part of USAREUR theater engagements. It also provides DOTMLPF feedback to improve the Army.

(3) *Joint Readiness Training Center (JRTC).* JRTC, at Fort Polk, LA, provides realistic joint and combined arms training focused on developing Soldiers, leaders, and units of our nation’s joint contingency forces for success on future battlefields. JRTC trains up to a brigade combat team and elements of Functional and Multi-Functional brigades, and special operations forces in full spectrum operations against a hybrid threat. Training occurs under tough, realistic,

## How the Army Runs

combat like conditions across a wide range of likely tactical operations and mission rehearsal exercises capable of full integration into higher level exercises and scenarios. It also provides DOTMLPF feedback to improve the Army.

(4) *National Training Center (NTC)*. NTC, at Fort Irwin, CA, provides realistic joint and combined arms training focused on developing Soldiers, leaders, and units of America's Army for success on the 21st-century battlefield. The NTC trains brigade combat teams and elements of Functional and Multi-Functional brigades in full spectrum operations against a hybrid threat. It also provides DOTMLPF feedback to improve the Army.

c. *CTC Training Strategy*. Unit CTC rotations are linked to the ARFORGEN cycle. Generally, all Deploying Expeditionary Forces (DEF) units execute a CTC rotation during the Train/Ready Pool at approximately 90 days prior to their Available Force Pool date or their Latest Arrival Date (LAD). Contingency Expeditionary Forces (CEF) Brigade Combat Teams execute a CTC rotation nine to twelve months into the Train/Ready Force Pool. Corps and division headquarters execute a maneuver CTC supported full spectrum exercise once in their ARFORGEN cycle prior to entering the Available Force Pool.

### 15–29. Unit training management

Effective training programs and exercises must be designed to get the most use from available resources. The central challenge for the next several years is to get the Army back in balance, where we are generating forces that are trained and ready for Full Spectrum Operations (FSO) at sustainable levels. To meet this objective we must re-establish our Major Combat Operations (MCO) skills without burning out our forces or losing our skills in Irregular Warfare (IW). Army training and leader development programs must prepare units and leaders to conduct FSO across the five operational themes of Peacetime Military Engagement, Limited Intervention Operations (LIO), Peace Operations, Irregular Warfare and Major Combat Operations. For the foreseeable future, all operations, to include Major Combat Operations, will be executed among the populace, with the populace as the ultimate objective. This requires a fundamentally different approach from how we trained to fight the Cold War, Desert Storm, and OIF1.

a. *Training management*. Training management is the process used by Army leaders to identify training requirements and subsequently plan, prepare, execute, and assess training. It identifies the related resources needed to conduct and evaluate training. It involves all echelons and applies to every unit in the Army regardless of strength, mission, organization, or equipment. Training management must work in unison with other unit programs to achieve excellence in training. FM 7–0 applies to all leaders at all organizational levels. Leaders include officers, warrant officers, noncommissioned officers, and Army Civilians in leadership positions. FM 7–0 applies to the Active Army, Army National Guard/Army National Guard of the United States, and U.S. Army Reserve unless otherwise stated. It has application for every type organization.

b. *Army training management publications*. The FM 7 series manuals, TRADOC PAM 350 series pamphlets, and AR 350–1, *Army Training and Leader Development* establish the doctrine and provide guidance for Army unit training management system. The manuals provide commanders with a management system they can use to plan training; take necessary resource actions; and evaluate Soldier and unit proficiency, training, and training management. They describe long-range, short-range, and near-term planning and the related resource actions. Execution of training, evaluation, and organizational assessment are also described. The methods and examples presented in these manuals have proved successful in units throughout the Army

c. *FSO METL*. The core METL function is full spectrum operations–offense, defense, stability or civil support–not MCO. Units will have only one METL, and units will train to only one METL at a time. Non-deployed commanders, in dialogue with their commander, will determine the FSO METL supporting tasks and the operational environment in which they will train during their ARFORGEN cycle.

d. *The Digital Training Management System (DTMS)*. DTMS provides unit commanders with automation support to facilitate the execution of the training management process described in FM 7–0, FM 3–0 Operations, and other related documents. It integrates key management functions, which support developing the FSO METL to determine training requirements, planning, resourcing, scheduling, and the assessment of training in units. It assists in the management of training from company through corps, and serves as the Army's single, standard training management tool. Army organizations often provide Army forces within joint force formations. DTMS accomplishes this by enabling unit commanders to use their existing office and tactical automation systems to:

- (1) Access relevant training management documents and records, such as CATS, STPs, drills.
- (2) Perform nearly all analyses inherent in the training management process, such as ammunition forecasts and assessments.
- (3) Identify resource requirements for training activities.
- (4) Prepare and print required schedules, calendars, and reports.

e. *Automated Systems Approach to Training*. DTMS uses data created by the ASAT/TDDC software application. ASAT/TDDC is used by proponent developers to create task-based data and associated information necessary for units to effectively and efficiently conduct training. It compiles and displays a unit roll-up of training conducted through a series of customizable tools to track such things as weapons qualification, APFT scores, AR 350–1 mandated training, and deployment tasks from "enlistment to retirement".

- (1) *Battle focus*. DTMS supports the Battle Focus concept by providing CATS, the Universal Joint Task List

(UJTL), the Army Universal Task List (AUTL), FSO METL, assignment of Battle Tasks, and supporting collective and individual tasks. It also provides for the development of non-documented local missions and tasks that may not appear in CATS. In addition it facilitates the cross walking of individual Soldier common and MOS tasks to each approved METL task along with other supporting collective tasks associated with the METL.

(2) *Planning*. Training strategies, long and short range plans, training calendars, coordination details, training schedules, and training resource projections are also developed based on proponent provided data and UTMC.

(3) *Execution/assessment*. Training and evaluation outlines (T&EOs) may be printed to assist in unit evaluations. Training Execution Matrices (TEM) can be exported to the Training Feedback Module (TFM), allowing evaluation of training either using paper T&EOs or the automated TFM. Evaluation results are then input back into the system. The commander's subsequent assessment of task preparedness and the recording of the actual resource expenditures are then completed in DTMS.

(4) *TSP*. The TSP automatically extracts task, unit, and planning data from DMTS for the creation of a unit TSP to support all forms of training. TSPs developed with this module can be created at any level and shared with other units Army wide using this module. The TFM also extracts the same type of data for the purpose providing an automated observer/controller tool. The TFM will provide task evaluation and after-action reporting data back into DTMS for unit commander assessments, to the Center of Army Lessons Learned (CALL) for archive and general information, and to the ASAT/TDDC for product improvement.

(5) *School*. DTMS has a schools management tool to resource and allocate seats for training events such as NET, digital systems training, safety courses, etc.

*f. Reserve Component Automation System (RCAS)*. RCAS is an automated information system that supports the decision-making needs of all commanders, staffs, and functional managers responsible for RC forces. The RCAS uses state-of-the-art office automation, telecommunications, databases, and processing capability to provide timely and accurate information for planning, preparation, and execution of mobilization and to improve the accomplishment of routine administrative demands. It is a self-sufficient system capable of exchanging data with related information systems. The RCAS will link all Army Reserve Component (ARNG and USAR) units, mobilization stations, and ACOM, ASCC, DRUs. It will be able to interface with ATRRS.

### 15–30. Army modernization training (AMT)

Chapter 6 of AR 350–1, *Army Training and Leader Development*, provides policy and procedures and assigns responsibilities for the planning and execution of new systems training. The regulation provides a process for the expeditious integration of equipment into the force structure through new equipment training (NET), displaced equipment training (DET), doctrine and tactics training (DTT), and sustainment training (ST). New, improved, and displaced equipment is provided to Army units by planning, acquiring, and fielding a unit set (to include training capability) to a designated AA or RC unit (usually a Brigade Combat Team) during a single modernization window. Doing so synchronizes all DOTMLPF activities required to field and support the individual systems that comprise unit sets. To the extent possible, a system-of-systems approach is used for capabilities/ requirements generation, materiel development and acquisition, manpower and personnel, funding, testing, fielding, transfer, training, sustainment, and support facilities. The Army Modernization Schedule, published biennially, identifies units being modernized and corresponding infrastructure and training base requirements. Unless exigencies require otherwise, lifecycle units are modernized when the unit reconstitutes, with training for operators provided previously in MOS producing schools and training for unit leaders exported to their home station.

*a. New Equipment Training (NET)*. NET is designed to support force integration and modernization through identification of personnel, training, and training devices required to support new or improved equipment. The NET provides the initial transfer of knowledge on the operation and maintenance of this equipment from the materiel developer to the tester, trainer, supporter, and user. The NET will assist commanders achieve operational capability in the shortest time practical by training Soldiers/crews how to operate and maintain the new/ improved equipment and by providing unit leaders with training support components needed to sustain proficiency of operators and maintainers on the new/improved equipment after NET. NET is tied to the System Acquisition Management Process (Chapter 11).

*b. Displaced Equipment Training (DET)*. DET applies to systems that are being replaced by new equipment, but remain in the inventory. Displaced equipment and its software, while not new to the Army, are new to the receiving unit. Because displaced equipment has established training base schools for operators and maintainers, units receiving displaced equipment may not need extensive training and may not need extensive formalized planning for that training. This determination will be made by the training developer, in coordination with the gaining command and the PM of the displaced system. Planning for and executing DET is similar to the process used in NET.

*c. Doctrine and Tactics Training (DTT)*. DTT is conducted in conjunction with NET or DET. The requirement for DTT will be based on two determinations- does the new/improved system significantly change the unit's how-to-fight doctrine, and does the unit need help learning how to employ the new/improved system to accomplish its wartime/ design mission? DTT provides commanders, battle staffs, operators, and trainers with a doctrinal basis for employment of new or displaced materiel.

*d. Sustainment Training (ST)*. The ST sustains the proficiency of operators and maintainers of the new/improved system achieved during NET/DET or during training-base schools and sustain any proficiency of unit leaders to employ



## How the Army Runs

the new improved system achieved during DTT or training-base schools. Accordingly, it builds on the training and training support used for NET/DET and DTT. The training base shares the responsibility for ST by assuring that a pool of trained replacements is established to support the sustainment effort. The ultimate responsibility for ST, however, remains with the commander.

### 15–31. The Security Assistance Training Program (SATP)

*a. SATP.* Security assistance includes all training of international military personnel conducted within DOD activities under the *Foreign Assistance Act (FAA) of 1961*, as amended, and the *Arms Export Control Act (AECA)* as amended. The components of the SATP are the following:

(1) International Military Education and Training (IMET) (under the FAA) represent education and training provided for which the military departments are reimbursed from foreign assistance appropriations.

(2) Foreign Military Sales (FMS) (under AECA) covers the sale of defense articles, services, and training to eligible foreign governments and international organizations. These sales are reimbursed as required by law.

(3) The Professional Military Exchange (PME) program, which is under the FAA, authorizes the exchange of U.S. and foreign personnel on a one-for-one basis at MILDEP command and staff and war colleges.

(4) Unit Exchange, which is under the AECA, authorizes the provision of informal training and related support on a reciprocal basis.

*b. HQDA executive agent.* The CG, TRADOC, will serve as executive agent for development and implementation of the SATP. TRADOC is responsible for the central financial management and distribution of decentralized IMET and FMS training funds for all operating agencies as required by Headquarters, Department of the Army (HQDA). The CG, TRADOC, will oversee, through the commander, Combined Army Center (CAC), the operation of the U.S. Army Western Hemisphere Institute for Security Cooperation (WHINSEC). The CG, TRADOC, operates and administers the SATP through the Director, Security Assistance Training Directorate (SATD), who is dual-hatted as Director, Security Assistance Training Field Activity (SATFA).

*c. Objectives of the SATP.* The objectives of the SATP are to:

(1) Assist the foreign country in developing expertise and systems needed for effective management and operation of its defense establishment.

(2) Foster the foreign country's development of its own professional and technical training capability.

(3) Promote U.S. military rapport with the armed forces of foreign countries to operate in peacekeeping missions and in coalition environments.

(4) Promote better understanding of the United States, its people, political system, institutions, and way of life.

(5) Increase the international military student's (IMS) awareness of the U.S. commitment to the basic principles of internationally recognized human rights.

(6) Develop skills needed for effective operation and maintenance of equipment acquired from the United States.

## Section VII

### The Training Support System

#### 15–32. Training Support System (TSS)

*a.* The TSS provides the foundation on which the Army training system runs. As described in AR 350–1, and FM 7–0, it is the system of systems that provides networked, integrated, interoperable training support capabilities that are necessary to enable operationally-relevant, full-spectrum, Joint, Interagency, Intergovernmental, and Multinational (JIIM) training for Soldiers, units, and Army Civilians anytime, anywhere. TSS includes products (instrumentation and training aids, devices, simulations and simulators), services (training support operations and manpower) and facilities (ranges, simulation centers, training support centers) that are necessary for creating the conditions to realistically portray the operational environment and enable training strategies focused on FSO METL. These training enablers underpin the Army training strategies and institutional POIs by providing commanders with tools to execute Soldier, leader, battlestaff, and unit collective training to standard at home station, Combat Training Centers, TRADOC Schools/Centers of Excellence, and while deployed.

*b.* TSS is an integrated enterprise that encompasses five major programs:

(1) The Sustainable Range Program, that includes range operations, range modernization, and Integrated Training Area Management.

(2) A Battle Command Training Support Program that includes constructive and high level (above crew) virtual TADSS, gaming, battle command training center operations and facilities, and overall battle command capability.

(3) A Soldier Training Support Program that includes Soldier through crew level virtual and live TADSS, and training support centers operations and facilities.

(4) A unique CTC Modernization Program that supports the Instrumentation/TADSS and Mission Facility pillars of the CTCs (NTC, JRTC, and JMRC).

(5) The Training Support Infrastructure and Management Program.

### 15-33. Training Support System Management

*a. The HQDA, DCS, G-3/5/7 Training Simulations Division (DAMO-TRS).* Provides overall management and policy for TSS plans, programs, and budget. TRADOC manages the TSS Enterprise and provides executive agency support, to include TSS requirements validation. The IMCOM garrisons execute TSS in coordination with the TRADOC TSS Enterprise. The IMCOM HQ and regions oversee execution. USAREUR, EUSA, and the ARNG execute TSS in coordination with the TRADOC Enterprise. The ACOMs/ASCCs/DRUs that are responsible for operational and institutional training maintain a staff that validates and prioritizes TSS requirements from their subordinate commands.

*b. Enterprise organization.* The TRADOC organizations listed below represent the core of the TSS Enterprise and support DAMO-TRS in the following areas: policy development and dissemination; requirements development; integration validation and prioritization; resource allocation; and execution oversight and tasking.

(1) TRADOC's Army Training Support Center is the overall integrator of TSS. They manage the TSS Master Plan and database, and provide analytical support capability.

(2) TRADOC's capability managers, e.g., live virtual, gaming, aligned with each major TSS program, identify program requirements and support the planning, programming, budgeting, development and acquisition of products, facilities, and services to the field.

(3) TRADOC Schools/Centers of Excellence develop requirements that support their institutional/school POI training, and, as a proponent, TSS requirements to support operational unit training.

*c. Management Process.* The TSS Management Process includes periodic Program Management Reviews to ensure TSS planning, programming, and execution is synchronized with current and future training needs. The Training Support Working Group (TSWG) provides oversight and is the integration and decision forum for major TSS programs. The TSWG will consider issues generated by management reviews and modernization reviews of each TSS program and identify issues that need to go forward to HQDA, DCS, G-3/5/7 TGOSC Council of Colonel's or the TGOSC for review and action. The TSWG is co-chaired by HQDA, G-3-5-7 and TRADOC's Army Training Support Center. Voting members include TSS representatives from the ACOMs/ASCCs/DRUs TRADOC capability managers, and PEO STRI, TSS Modernization Reviews and Program Management Reviews meet semiannually. The TSWG meets immediately following the Program Management Reviews.

*d. TSS Capability Assessment.* The TSS undergoes continuous assessment to ensure capabilities support to Army training strategies and the Army Campaign Plan.

(1) Assessment Metrics

(a) Mission essential requirements (MER)-products services, facilities and sustainment identified by the major TSS programs. The MERs define what is needed to support training strategies.

(b) Use cases-define the level of MER delivered to each location where TSS is executed. Each TSS major program sets the parameters by which use cases are determined.

(c) Bench Marks-normally, by fiscal year, in which MER is required at each use case. Bench marks are derived from the Army Campaign Plan and reflect applicable PPBES cycles.

(2) Assessment Process

(a) Major assessments are conducted biennially to support POM development. These are done by conducting TSS Theater IPRs to determine TSS requirements based on the above metrics.

(b) Installation site visits are conducted biennially by the TRADOC TSS agencies.

(c) TSS Reviews are conducted annually with the Proponent Service Schools in order to determine broad functional approaches to TSS by battlefield function.

### 15-34. Simulation Training Technologies

*a. Simulations.* OPTEMPO and ammunition costs are expected to continue to increase for the foreseeable future. This coupled with a decline in maneuver and range land will warrant the continued expansion and integration of simulations into the training base. Embedded or strap-on simulation systems in the future will provide the leaders and operators with realistic training within units by training on the actual equipment. Seamless simulation technologies can expand training horizons available beyond the confines of a unit. Simulations are cost effective tools for increased training of commander's and staff without the need for unit participation and cost.

*b. Gaming Strategy.* The TRADOC Capability Manager Gaming is the Executive Agent for Army Gaming; the Army buys these games COTS and GOTS, meaning less upfront investment. Although integration of gaming is still in development stages, it makes use of geo-specific terrain where appropriate; it can be used for mission planning and mission rehearsal; and it will have an After Action Review capability. These games will have low overhead and are easily incorporated into Crawl-Walk-Run training. When used in conjunction with the Eight Step Training Model and the eleven principles of training in FM 7-0, games have the ability now to help close existing training gaps. Leaders can incorporate them early in the Reset-Train phase to practice small unit tactics, individual, and collective tasks. Leaders can hone their Battle Command skills of understand, visualize, describe, direct, lead, and assess. Leaders also can develop, practice and revise Standard Operating Procedures (SOPs) and Battle Drills.

*c. Distributed Interactive Simulation (DIS).* The Army's DIS program provides the lead for coordinating and integrating multi-Service, DARPA, and Defense Modeling and Simulation Office (DMSO) activities toward advancing

## How the Army Runs

the underlying open architecture, standards, data bases, and general purpose designs necessary for achieving seamless synthetic environments. Through use of the DARPA established Defense Simulation Internet (DSI) as the backbone for computer communication services, a wide array of simulation and modeling capabilities located at multiple facilities can be linked to form synthetic environments ranging in scale and resolution suited for a variety of uses. This concept calls for the linking of all types of unit training into the same network. This capability would permit the wide-scale integration of various simulation systems and live training without regard to geographical constraints. Thus, an early-deploying RC unit could play the same scenario as its forward-deploying counterpart.

(1) The Defense Science Board (DSB) Task Force on Simulation, Readiness, and Prototyping defines simulation as "everything except combat" with three integral components—live [operations with real equipment in the field]; constructive [war games, models, analytical tools]; and virtual [systems and troops in simulators fighting on synthetic battlefields]. While the first two components are technically mature (but still improving), the virtual component is significantly evolving. Virtual capability is improving through technology advances in high-performance computing, communication, artificial intelligence (AI), and synthetic environment realization.

(2) Simulation networking technology. One of the first steps taken toward achieving this concept was the development and fielding of Simulation Networking Technology. This proof of principle demonstration of technology was jointly developed and fielded by the Defense Advanced Research Projects Agency (DARPA) and the U.S. Army and showed that large numbers of simulators could participate in a virtual battlefield.

(3) Soldier Training Support Program (STSP) provides enablers that facilitate Combined Arms Training Strategy (CATS)-prescribed execution of individual and collective training for units and by Programs of Instruction at Army Schools. It synchronizes requirements and resources necessary for combat and materiel development of these training enablers. It also provides personnel, facilities, capabilities, and operational support for Soldier training, and identifies emerging requirements associated with modularity, transformation, and rebasing. The following are the major Programs of Record.

(a) Engagement Skills Trainer (EST) 2000 is a unit/institutional, indoor, multipurpose, multi-lane, small arms, crew-served and individual anti-tank training simulation. EST 2000 provides the capability to build and sustain individual marksmanship, squad and team fire distribution and control, and judgmental use of force skills using computer-generated imagery. The Engagement Skills Trainer provides realistic marksmanship and combat scenario training for 12 of the most common small arms and crew -served weapons and individual anti-tank weapons in the Army inventory. It has the feel, weight, recoil, fit and sounds of the actual weapons, provides multilane individual marksmanship training from zero to qualification, and provides multilane individual and collective gunnery training for static dismounted individual, squad, team, or element levels. It contains realistic Shoot-Don't Shoot Scenarios for both urban combat and guard/security tasks. The computer generates targets, terrain, and weapons effects in a real-time three-dimensional display that also includes OPFOR weapons and sounds. The EST 2000 provides the capability to build and sustain marksmanship skills for squad and team fire distribution. It also contains control and judgmental use of force training with computer-generated imagery. The system provides immediate feedback of hit/kill/miss for each firer that permits leaders to evaluate the effectiveness of their unit. It has been deployed into theater to sustain critical marksmanship and collective skills/proficiency for Soldiers and small units, especially when they are not able to conduct live-fire training.

(b) Common Gunnery Architecture (CGA) is an initiative that offers an integrated approach to meet common gunnery training requirements. CGA is an extension of the One Semi-Automated Forces (OneSAF) product line architecture and its software components. CGA will be with the Stryker Mobile Gun System (MGS) Advanced Gunnery Training system. It provides a flexible and adaptive gunnery solution that permits realistic training in the COE, CGA will be more responsive to changes in doctrine and procedures than current systems, thus eliminating the duplication of training solutions and promoting sharing of capabilities. The Common Gunnery Architecture (CGA) initiative standardizes the capability of all virtual gunnery training systems by using common architecture and common software products. This will aide long-term growth potential in training capability and effectiveness and will reduce total lifecycle cost. CGA will not combine or collapse other systems into a single gunnery trainer. It retains system-/platform-specific hardware solutions (thereby continuing to replicate crew operating environments). CGA will standardize the use of software baselines to enable the training of crews across the full spectrum of operations, in urban and complex terrain, as well as more conventional environments (desert, woodland, etc.) using geo-typical and geo-specific terrain databases. The CGA eliminates the costs and developmental time lines associated with maintaining separate software baselines for each individual system.

(c) Common Driver Trainer (CDT) is a virtual reality and motion based simulator that is easily reconfigured for multiple vehicle cabs. It utilizes a large collection of terrain, weather, and hostile force models. CDT will be used as a training gate in driver or equipment operator's initial and sustainment training. The ability for one simulator to model multiple vehicles reduces the inventory of real vehicles at institutions as well as the operating costs of those live vehicles that are used for driver training. The CDT provides business economies when compared to developing and fielding separate simulators by vehicle type or model. The first version of CDT is the Stryker family of vehicles being fielded in FY07. The CDT/ Stryker Variant (CDT/SV) consists of a simulated vehicle cab, instructor/operator station (IOS), After Action Review (AAR) station, visual system, motion system, and a computational system. Via the IOS,

the instructor is capable of selecting a visual scene, viewing the scene, introducing malfunctions and emergency control situations, monitoring each trainee's performance and providing recorded AAR feedback. The reconfigurable common platform will allow driver training for various U.S. Army tactical vehicles. Future variants are the tank, High-Mobility Multipurpose Wheeled Vehicle (HMMWV), Bradley and tactical wheeled vehicle. The Stryker Driver Trainer is the baseline of a CDT architecture.

(4) Battle Command Training Support Program (BCTSP) Virtual Simulation Training is part of Battle Command Training Support and is conducted in a synthetic natural environment. Virtual simulations provide individuals, leaders, crews, and units with a realistic, immersive training environment that involves real people operating simulated systems using human in-the-loop simulations or embedded training capabilities. In the virtual environment, simulators and simulations operating on virtual geo-specific or non-geo-specific terrain take the place of real systems and can be linked with components of the Live, Virtual, and Constructive Integrated Architecture to provide a training environment that replicates the operational environment. Virtual training systems provide commanders with "walk-level" training, sustainment training, gated training events, leader development and mission rehearsal capabilities. Through frequent and repetitive use and an immediate and total replay AAR capability, virtual training systems assist commanders with the building and sustaining of training readiness. Virtual training also has the advantage of allowing Soldiers to perform highly dangerous or restrictive tasks too dangerous for the live environment (such as calling for artillery fires on or near an occupied friendly position), provides the capability for rapid changes for COE relevant scenarios, and facilitates retraining specific tasks until training objectives are met. Virtual simulations allow repetitive training under varying conditions to enable the individual or team to conduct live training at a higher state of readiness, potentially reducing OPTEMPO costs. The Combined Arms Tactical Trainer (CATT) represents the family of the virtual simulators.

(5) Synthetic Environment Core (SE Core) is the Army's virtual component of the LVC-IA. It is a program that will integrate the various functions and components of virtual simulations and link the virtual environment to the LVC training environment (TE) to support DOD's training transformation and the Army's training strategy. SE Core will develop new, and integrate existing, hardware and software products creating the Army's common virtual environment (CVE), linking system and non-system virtual simulations into a fully integrated training capability. SE Core requirements grouping includes:

- (a) Objective OneSAF (OOS) integration as the common SAF.
- (b) Virtual simulation architecture (VSA).
- (c) Master terrain database design facilities.
- (d) Common virtual components.

(6) The CVE enables the Army to execute combined arms and joint training and mission planning and rehearsals at home station, en route and at deployed locations. SE Core is a key element in the Army's training transformation plan and a complementary training system for the Future Combat Systems.

*d. Close Combat Tactical Trainer (CCTT).* CCTT is the ground maneuver component of the Combined Arms Tactical Trainer (CATT) family of simulators, and is a system of computer-driven, combat vehicle simulators such as the M1 Abrams Tank, the M2 Bradley Fighting Vehicle (BFV), the M3 Cavalry Fighting Vehicle, the Fire Support Team Vehicle, the HMMWV, and emulators that control other vehicle models and that work interactively, similar to the vehicles and functions they replicate. These simulators and emulators are connected via a local area network (LAN) and have the capability to be networked with multiple simulation facilities. The system's computers create an immersive battlefield that creates the illusion of moving and fighting over actual terrain while operating or riding inside the actual vehicles, and employing the actual weapon systems mounted on each respective the vehicle variant. CCTT is fielded primarily in company/team sets to the Active Component and in mobile platoon sets to the Army National Guard. A Reconfigurable Vehicle Simulator (RVS) and Reconfigurable Vehicle Tactical Trainer (RVTT) have been developed and will be used to support modular formations and a wider training audience. RVTT, as the objective convoy defense and wheeled-vehicle maneuver trainer provides leaders and Soldiers the ability to train highly perishable command and control skills, collective tasks and crew drills in a variety of vehicle types in simulated weather, urban operations and complex virtual terrain environments.

*e. Aviation Combined Arms Tactical Trainer (AVCATT).* AVCATT is the aviation component of the CATT that provides a system for staff/crew collective and combined arms training, mission rehearsal and joint exercises. AVCATT is fair-fight interoperable with Close Combat Tactical Trainer (CCTT), is capable of linking with other AVCATT systems via LAN or wide area network (WAN), can be networked to the Army Tactical Command and Control System (ATCCS) workstations and will be interoperable with future CATT systems. It is a multifunctional aviation training system, tailorable to specific unit needs such as mission planning and rehearsal and combined arms collective training through use of Distributed Interactive Simulation (DIS) protocols and Tactical Simulation Interface Units (TSIUs). AVCATT incorporates current and future force aviation aircraft, including attack helicopters AH-64A Apache and AH-64D Apache Longbow, armed observation helicopters OH-58D Kiowa Warrior, utility helicopters UH-60A/L/M Black Hawk, cargo helicopters CH-47D/F Chinook, and future Armed Reconnaissance Helicopters. The AVCATT is a mobile system that can support unit collective training at multiple sites including home station, CTCs and National Guard training sites.

## How the Army Runs

*f. Non-rated Crewmember Trainer (NCMT).* NCMT is a virtual training system that is reconfigurable (UH-60 and CH-47), self-contained, and transportable providing training for helicopter door gunners and non-rated crew members of cargo and utility helicopters in the conduct of door gunnery, sling-load operations, crew coordination, actions on contact, and sectoring and coordinating fires in a virtual environment.

*g. Virtual Combat Convoy Trainer (VCCT).* VCCT provides a critical training capability to support unit collective training in convoy defense and mounted maneuver operations. VCCT provides a capability for frequent, repetitive, standards-based training to build and sustain task proficiency on convoy operation tasks. It is a mobile, immersive virtual simulator allowing Soldiers, as part of a vehicle crew, to participate in a convoy of manned and unmanned computer-generated vehicles. Soldiers come under attack in a virtual training environment and must engage the enemy using realistic weapons and correct weapons engagement techniques. Soldiers encounter shoot/don't shoot scenarios and are trained to develop judgment to know when to make the transition. VCCT enables training on the full spectrum of operations, in urban and complex terrain environments, as well as more conventional environments (desert, woodland, home stations), using geo-typical and geo-specific terrain databases. VCCT will eventually be replaced by a more capable simulator, RVTT. RVTT will be managed within the CCTT program, and provide training capabilities for light and medium and forces in a variety of high-density combat and combat support vehicles.

*h. Embedded training.* A function hosted in hardware and/or software, integrated into the overall equipment configuration. Embedded training supports training, assessment, and control of exercises on the operational equipment, with auxiliary equipment and data sources, as necessary. Embedded training, when activated, starts a training session, or overlays the system's normal operational mode, to enter a training and assessment mode. Embedded training is a concept that involves a number of discrete technologies. It focuses on system-peculiar tasks. Hardware will be configured either as an integral part of the tactical system or as a strap-on. Embedded training will allow the weapon system to be used as an individual and crew trainer. Ultimately networking of embedded systems will permit crews to interact with other crews as required in an actual tactical scenario (as MILES does today). Embedded training, like distributed training, will dramatically change the way the Army is organized to train. From both a training and cost-effectiveness perspective, more training will shift to the unit, as tools like embedded training become the rule rather than the exception. Embedded Training will provide a fully integrated means to train in the live, virtual and constructive environments allowing both units and institutional environments to practice and interact in a cost effective manner.

(1) *Virtual reality.* Psychologists have long known that the sense of sight can dominate the other senses. Theme parks, such as Disney World, have capitalized on this dominance. For example, wide-screen, stereophonic presentations of roller coaster rides create the physical sensations of the actual rides. The same phenomenon is observable in high-fidelity flight simulations, which create sensations of nausea or vertigo especially in the novice. Until recently training applications have been limited. Virtual reality is a new and emerging technology that melds the real world with a computer-generated world. It is an outgrowth of research and development efforts by NASA to simulate space conditions and to link human beings with robots so that complex repairs and maintenance can be performed without humans leaving the confines of the spacecraft. Virtual reality can be used to insert the individual into a world that is too hostile, too expensive, or too remote to duplicate in a training environment. Furthermore, the computer could simulate interaction with these images. Thus, the prospect of surrogate travel exists to permit a tank commander to perform in a virtual battlefield. For example, if tank crew members were wearing virtual reality helmet visor systems, computer imaging could turn an open field into a city, which the tank commander could drive through. This technology coupled with an embedded training system, which would allow the fighting of a realistic battle without ever leaving the motor pool.

(2) *Voice input/output.* Current hindrances associated with computer use in training and combat includes the primary reliance on either a keyboard or mouse to input commands. The rapidly maturing technology of voice recognition is beginning to allow hands free operation of computers as well as translation capabilities. Examples of voice input technology and software used during OEF and OIF include Rosetta Stone and Tactical Iraqi.

(3) *Artificial intelligence (AI).* As with the other technologies discussed, AI will greatly alter the way the Army currently trains, maintains, and fights on the battlefield. Industry has found that by utilizing AI technologies in diagnostic equipment they could reduce training time for a journeyman from three years to three months with improved on-the-job performance. Since AI will provide round-the-clock expertise to unit-level maintenance, it should cause a restructuring of the current maintenance echelon structure. This will add credence to shifting the training focus from predominantly service school to a unit orientation in the future. AI will also have a great impact in improving target acquisition, engagement, and command and control. It will minimize human interaction and the chance for human error during periods of combat stress. It will be the precursor of passive engagement systems that identify and engage targets automatically. As in maintenance training, these technologies will reduce training time associated with mastering gunnery/operator/maintainer MOS.

## Section VIII Summary and References

### 15–35. Summary

*a. FM 7–0. Training Units and Developing Leaders for Full Spectrum Operations.* This publication establishes the Army’s key doctrine for training units and for developing leaders for full spectrum operations, on a rotational cycle, using ARFORGEN. It addresses the fundamentals of training modular, expeditionary, Army forces in an era of persistent conflict. To emphasize that the unit mission-essential task list (METL) must reflect full spectrum operations, this manual uses the phrase “full spectrum operations METL.” Conducting effective training for full spectrum operations must be a top priority for Army leaders.

*b. Training mission and focus.* Full spectrum operations require mentally agile leaders able to operate in any operational theme across the spectrum of conflict. Effective command and control focuses on commanders rather than staffs. Commanders, not staffs, drive effective decision-making. Commanders must be able to mass fires at decisive points and times and effects over time. Decentralized rather than centralized operations are the norm today and will likely remain so. All leaders, from the highest to the lowest levels, must understand both the art and the science of operations and battle command. The training focus is on the unit’s FSO METL. Realistic, sustained, multi-echelon, integrated combined arms training must be continuously stressed at all levels. Every individual training and collective training program must be carefully planned, aggressively executed, and thoroughly assessed.

(1) *Battle focus.* Battle focus is the concept used to derive peacetime training requirements from wartime missions. Battle focus guides the planning, execution, and assessment of each organization’s training program to ensure its members train as they are going to fight. Battle focus is critical throughout the entire training process and is used by commanders to allocate resources for training based on wartime mission requirements. FSO METL provides a shared start point for training.

(2) *Five training systems.* This chapter discussed five training systems: policy, requirements, and resourcing; training development; training in schools; training in units; and training support. Training policy, requirements, and resourcing are the responsibility of HQDA, ODCS, G–3/5/7, specifically the Director of Training (DAMO–TR). Resourcing necessitates some historically-related interfaces with other systems. The ARPRINT, for example, relies on input from ODCS, G–1 as well as DCS, G–3/5/7.

(3) *TRADOC.* TRADOC is the proponent for leader development and the center for establishing Army training standards worldwide and as such develops policy and procedures for creating, implementing, and evaluating training and provides ongoing resident/nonresident training to AA and RC alike. This influence impacts the institutional, operational, and self-development training domains, following the guidance set forth in FM 7–0 and the 350-series of regulations and pamphlets.

(4) *FORSCOM.* FORSCOM trains, mobilizes, deploys, sustains, transforms, and reconstitutes conventional forces. They are the lead for the Readiness Core Enterprise and manage the ARGORGEN process and its outputs. In addition, FORSCOM commands two Combat Training Centers-NTC, and JRTC.

(5) *Training support.* The provision of the materials, personnel, equipment, and facilities when and where needed to implement the training is the challenge of the training support system. It includes such functions as the reproduction and distribution of training products and materials, scheduling and resourcing training across all domains, and student record maintenance. Training support manages the distribution of training materials and services supporting the training base and unit training programs; as such, it provides for the ability of our Commanders and leaders to train their Soldiers.

(6) *The future challenge.* “It will be imperative that we remain focused on tough, demanding training at home station and at our training centers to ensure that our soldiers and units sustain their combat edge. This training must be accomplished at an appropriate tempo and while meeting the unique challenges associated with increased time at home after nine years of war. If we are not thoughtful in making this transition, combat-seasoned soldiers, used to the fast-paced conditions of combat and the increased level of autonomy and authority associated with small-unit operations, may feel stifled in a garrison environment. We must find the right balance in restoring our administrative skills and systems to deal with the continuing impacts of war as we maintain our combat edge.” — GEN George W. Casey, Jr., October 2010

### 15–36. References

- a.* AR 5–13, Total Army Munitions Requirements Process and Prioritization System, DEC 09.
- b.* Army Regulation 12–15, Joint Security Assistance Training, JUN 00.
- c.* Army Regulation 25–1, Army Knowledge Management and Information Technology, DEC 08.
- d.* Army Regulation 25–30, The Army Publishing Program, MAR 06.
- e.* Army Regulation 350–1, Army Training and Leader Development, DEC 09.
- f.* Army regulation 350–2, Opposing Force Program, APR 04.
- g.* Army Regulation 350–10, Management of Army Individual Training Requirements and Resources, SEP 09.
- h.* Army Regulation 350–19, The Army Sustainable Range Program, AUG 05.

## How the Army Runs

- i. Army Regulation 350–38: Training Device Policies and Management, OCT 93.
- j. Army Regulation 350–50, Combat Training Center Program, JAN 03.
- k. Army Regulation 525–29, Army Force Generation, MAR 11
- l. Army Regulation 600–100, Army Leadership, MAR 07.
- m. Army Regulation 220–1, Army Unit Status Reporting and Force Registration, APR 10.
- n. Army Regulation 600–8–19, Enlisted Promotions and Reductions, APR 10.
- o. Army regulation 600–8–29, Officer Promotions, FEB 05.
- p. DA Pamphlet 350–38, Standards in Training Commission, MAY 09.
- q. DA Pamphlet 600–3, Commissioned Officer Professional Development and Career Management, FEB 10.
- r. DA Pamphlet 600–25, U.S. Army Noncommissioned Officer Professional Development Guide, JUL 08.
- s. Field Manual 7–0, Training Units and Developing Leaders for Full Spectrum Operations, FEB 11.
- t. TRADOC Regulation 350–18, The Army School System (TASS), JUL 10.
- u. TRADOC Regulation 350–70, Systems Approach to Training Management, Processes, and Products, MAR 99.
- v. Army Training and Leader Development Guidance, 31 JUL 09.
- w. Army Training Strategy, 4 APR 11.
- x. The U.S. Army Training Concept 2012–2020, 23 NOV 10.
- y. The U.S. Army Learning Concept for 2015, 14 SEP 10.
- z. CSA Article, *The Next Decade*, Army Magazine, OCT10.

### 15–37. Training websites with links

- a. <http://www.tradoc.army.mil>
- b. <http://www.apd.army.mil/>
- c. <http://www.tradoc.army.mil/dcsopst/sites.htm>
- d. <http://www.tradoc.army.mil/tpubs/pamndx.htm>
- e. <http://www.atsc.army.mil/ATSCnav.asp>
- f. <http://www.tradoc.army.mil/tadlp/index.htm>
- g. <http://www.adtdl.army.mil/>
- h. <http://www.dls.army.mil/>
- i. <https://rdl.train.army.mil/soldierPortal/soldier.portal>
- j. <http://www.army.mil/usapa/index.html>
- k. <https://forums.bcks.army.mil/secure/communitybrowser.aspx>
- l. <https://www.us.army.mil/suite/portal/index.jsp>
- m. <https://atn.army.mil>
- n. <https://www.atrrs.army.mil>
- o. <http://usacac.army.mil/cac2-t/index.asp>

## Chapter 16

# Army Knowledge Management and Information Technology

### Section I

#### Introduction

The Army Knowledge Vision - A transformed Army, with agile capabilities and adaptive processes, powered by world class network-centric (net-centric) access to knowledge, systems and services, interoperable with the Joint, Interagency, Intergovernmental, and Multinational (JIIM) environment.

#### 16-1. Information Management Transformation

*a.* The Army is operating in an era of global persistent conflict against both synchronous and asynchronous threats; Joint Force Commanders will judge the Army's relevance by its responsiveness and expeditionary capability. Key to providing the Army with an expeditionary capability is the need to operationalize LandWarNet; transforming to deliver a global, standardized, protected and economical network enterprise that is centralized, more secure, sustainable, and capable of seamlessly delivering network capabilities and services as Soldiers transition throughout all operational phases.

*b.* Operational experiences in Iraq and Afghanistan support the continued need to eliminate barriers to gaining network access, establishing overall control and situational awareness of LandWarNet, and ultimately utilizing LandWarNet to share information across Army, joint, interagency, intergovernmental and multinational (JIIM) organizations. A variety of opponents will continually contest the environment with differing synchronous and asynchronous threats across the full spectrum of conflict, from stable peace to general war. The Army must ensure freedom of action in Army cyberspace, and when directed to deploy network assets, fight through a threat event when it occurs, restore normal operations after an event and transition virtual areas of operations to other authorities if and when required.

*c.* To achieve these ends, LandWarNet must transform to achieve unprecedented levels of mission command, interoperability and compatibility; protection; governance; standardization; and fiscal transparency. Improving LandWarNet's response to rapidly changing, increasingly complex capability and service requirements will ensure Army forces achieve information superiority when engaged in expeditionary, JIIM operations throughout all phases of military operations. The Global Network Enterprise Construct (GNEC) is the Army-wide strategy that will transform LandWarNet (LWN) to an enterprise activity. GNEC is the focused, timed-phased, prioritized, resource sensitive Army-wide strategy to transition LWN from many loosely-affiliated independent networks into a truly global capability that is designed, deployed and managed as a single integrated enterprise.

#### 16-2. Information Management Transformation Implementation

*a.* Transforming Information Management and LandWarNet to an enterprise capability adheres to four operating principles: (1) **Aggregate**: Collect or aggregate all data regarding IT assets, infrastructure, operations and governance (what we have now); (2) **Consolidate**: Make best use of collected data and systems by way of federation (make use of agreed standards, still allow organizations to manage their own systems and networks); (3) **Standardize**: Achieve a common technical and operational picture to ensure like-capabilities and services are delivered seamlessly across the enterprise network; and (4) **Modernize**: Systems and operations.

*b.* Execution of these operating principles does not necessarily occur sequentially - these activities can and will happen in parallel. GNEC near-term focus will resolve specific LandWarNet capability gaps that: (1) establish new procedures to *operationalize LandWarNet*; (2) improve the overall security of network services and capabilities, and dramatically *improve network defense posture*; (3) *realize economies and efficiencies* while improving effectiveness; and (4) enable *Army Interoperability* and collaboration with mission partners.

(1) GNEC will operationalize LandWarNet through Army Network Service Centers (NSC). The NSC provides connectivity - a global plug and play ability to connect to Army, Joint and commercial networks through all phases of joint operations. The Network Service Center (NSC) is an Army global enterprise capability that links LandWarNet to the . The NSC will fill a key capability gap between the Army's operational and generating forces and delivers seamless LandWarNet capabilities to each during day-to-day operations, training, simulation, emergency response, and wartime operations.

(2) GNEC will dramatically improve the network defense posture. Protection of the LandWarNet occurs through the active and passive measures that protect against, monitor for, detect, analyze, and respond against malicious and non-malicious, unauthorized activity through Army cyberspace. It denies adversaries and others the opportunity to exploit vulnerabilities for their own purposes. The secure and uninterrupted flow of information allows Army forces to multiply their combat power and synchronize with other Joint capabilities.

(3) Protection activities include:

- (a) budgeting for and implementing minimum mandatory security controls;
- (b) training and awareness;
- (c) certification and accreditation;



## How the Army Runs

- (d) security architecture and systems engineering;
- (e) Information Assurance and protection;
- (f) computer network defense and incident response; and
- (g) proactively monitoring emerging cyber threats in coordination with the intelligence community.

c. The Army CIO/G-6 sets direction and strategy for the development and implementation of Army-wide Network Enterprise security and privacy policy, standards, guidelines and procedures to ensure delivered services are in accordance with federal laws and policies. The Army's Network Operations and Security Centers, both Global and Theater, directly supported by their respective Regional Computer Emergency Response Teams (RCERT), are the centerpieces of the Army's Cyberspace Operations "Operate and Defend the Network" strategy.

(1) GNEC will realize Economies and Efficiencies while Improving Effectiveness. Information services must work in austere, tactical environments in the same fashion they work at home station; yet today many information services are designed to work in robust network architectures and often do not scale down to the deployed user. This separation between home station and deployed capabilities requires the user to ineffectively and inefficiently transition from garrison IT services to tactical IT services, often losing functionality in the deployed environment.

(2) Information Services to the Edge: Achieving and maintaining an information advantage down to the tactical edge as a critical element of combat power requires a concentrated effort in order to provide a single, seamless information environment optimized for the . Core enterprise information services consist of collaboration, applications, messaging, discovery, mediation, enterprise service management, user assistance, and storage. Enterprise data management and warehousing will allow the Army to achieve a single authoritative source for all data while reducing the number of data centers and computer rooms - reducing risk, providing improved service, and subsequently better defending Army data. It will move the Army to a single standard set of technologies and facilitate the retirement of legacy systems and applications. Information services "to the edge" will provide seamless interaction and knowledge transfer across functional, tactical, institutional, and organizational units; and support the goal of the GNEC strengthening the Army's ability to operate in JIIM environments.

(3) Common Policies and Standards: Establishing strong, unwavering strategic partnerships are essential as LandWarNet capabilities and services affect all business processes, warfighting capabilities, and subsequently, all Army organizations. GNEC delivers LandWarNet capabilities and services for policy makers, s, and other decision-makers by improving Army IT business operations and their integration with Army and DOD business processes within the Joint enterprise. Specifically, it will (a) deliver structured, controlled, repeatable, measureable processes that drive accountability and compliance for the management of the Army's information enterprise; (b) provide data-driven decision-making; (c) deliver LandWarNet capabilities and services to Army leadership and s; and (d) enable rapidly changing operational requirements for Army and Joint missions. The value to the enterprise will be disciplined IT investments, integrated enterprise activities, increased LandWarNet security, and synchronized capabilities delivery.

(4) Governance: Enterprise IT Governance is the component of GNEC that ensures direction-setting, decision-making, and that Information Management oversight boards are established and, if necessary realigned, to ensure Information management and LWN transformation objectives are achieved. The integration of governing and advisory bodies will improve: (a) guidance on Army LWN activities; (b) accountability and effectiveness of Army Network Enterprise programs and operations; (c) issue resolution that assures representation of operating and generating force customers; and (d) improve the effectiveness and efficiency of the Army's LWN enterprise activities and service delivery within GNEC. The key objective is to achieve a synchronized approach and execution of Network Enterprise activities and services Army-wide.

(5) Resources Management: Implementing GNEC will require significant up-front investments to transitioning our current unsecure disparate networks that are labor intensive to manage to an enterprise network with enhanced security and centralized remote management capability. Concurrently, continuing on-going efforts with the Army Budget Office, Army Audit Agency, and NETCOM to aggregate the IT investments by the Army will identify duplicate investments. GNEC resources management will oversee IT investments to support the Army's business and warfighting objectives.

d. GNEC will enable Army Interoperability and Collaboration with Mission Partners. In this era of persistent global conflict, Army s must freely exchange information routinely with joint, interagency, intergovernmental and multinational (JIIM) partners that span from the generating force to the tactical edge. The must deploy and connect no matter where they are located, pull information needed for their missions, and be given timely, accurate information on any threats they may face. A 's ability to leverage the right information at the right time is the difference between mission success and mission failure. Therefore, it is no longer sufficient for the Army Network Enterprise to provide segments of the network that are independently developed and managed. The network enterprise must be seamless between the sustaining base and the tactical edge to enable operational agility. This translates into the need for enterprise wide systems engineering, a common strategy and architecture, a single concept of operations for network operations, configuration control, and situational awareness that comprehensively spans the sustaining base to the tactical edge. This requires the Army to adopt innovative ideas and processes to deliver capabilities and services that our forces are able to use with agility. Through GNEC, the Army will enforce standards, processes, and architecture for data accuracy; increase the speed and flexibility of delivering capabilities and services; and tailor oversight and governance

to be commensurate with risk. The intent of transforming LandWarNet is simple - close the gaps between the availability of technologies; field them for warfighting advantage; and sustain the advantage for decision superiority.

### 16-3. AKM Transformation Strategy

a. The Army is undergoing its most fundamental change in over a century while remaining fully dedicated to supporting the . Army Transformation is about transitioning from information-based to knowledge-based operations. Achieving the Army Knowledge Vision will provide the ability to achieve decision superiority and take decisive action across the spectrum - including both deployed and generating forces.

b. A knowledge-based organization demands new organizational definitions, disciplines and structures to respond effectively to new challenges and opportunities. Leaders must communicate their vision and expectations throughout the Army and articulate clearly our strategic courses of action to achieve our future Army and CIO/G-6 mission. This total Army transformation must embrace the principles of effective change management and focus on building a framework for knowledge management that has a strong human capital infrastructure that promotes sharing knowledge and transferring it across the Army Enterprise. The Office of the Army Chief Information Officer/G-6 continues to work toward and achieve the enterprise vision of a single Army network, one enterprise Army portal, and universal access to all Army personnel. Achieving the enterprise vision of a single Army network will be accomplished through established governance forums and working groups such as the Network Synchronization Working Group. The CIO/G6 vision will ensure that the Army and mission partners have the right information at the right time at the right place.

c. With the advice and consultation of the Army CIO Enterprise Guidance Board (EGB) and Information Technology General Officer Steering Committee (IT GOSC), the CIO/G-6 institutionalized strong governance procedures for the enterprise control of information technology (IT) budget, realigned information management organizations, and defined the AKM strategy.

d. Army transformation is changing the way the Army acquires and employs IT assets and, ultimately, how it conducts daily business and operations. To remain relevant to the Future Force, the Army must adapt to the new culture as future military operations will be conducted in a different and changing operational environment, which will enhance decision dominance. The operational environment is characterized by the responsiveness, agility, and full spectrum capability to dominate unstable situations which requires the Army to focus its cultural thinking on the enterprise management of IT resources. This requirement means that organizational IT investments must support the Army's enterprise-wide goals under AKM.

e. The successful implementation of AKM requires the following:

- (1) The infrastructure must accommodate faster processing capabilities and dissemination of requirements;
- (2) Enterprise-wide systems must be easily accessible with net-centric processes and services available through a single portal;
- (3) The information that leads to knowledge must be well organized and structured through content management, metadata, and data hierarchies;
- (4) The ability to generate knowledge requires the transfer and sharing of knowledge across the enterprise using such techniques as collaborative processes, virtual teams, and communities of practice; and
- (5) The Army must recruit, train, and retain an interdisciplinary workforce (Soldiers and Civilians) empowered to share knowledge.

f. The CIO/G-6 supports the development of a knowledge-based workforce by leveraging intellectual assets and empowering the Army's human resources through effective workforce planning, cutting-edge recruitment and retention initiatives, broad-based education and training, and cross-functional professional development opportunities.

## Section II

### CIO/G-6 Roles and Responsibilities

#### 16-4. Office of the CIO/G-6

The Army has consolidated the Army's CIO and the Army Staff G-6 as the Army CIO/G-6 to achieve enhanced *standardization, compatibility, interoperability, security, compliance, and fiscal discipline* to deliver a joint, Net-centric information enterprise enabling decision superiority Army-wide.

a. The Army CIO/G-6 is the principal staff assistant and advisor to the Secretary of the Army and Deputy Secretary of the Army on Army Information Management (IM), pursuant to 10 U.S.C. 3014(c)(1)(D), including but not limited to information enterprise (IE) networks and network-centric policies and concepts; command, control, communications, and computers (C4); non-intelligence space matters; and enterprise-wide integration of Army information matters. The CIO/G-6 provides strategic direction, determining objectives, and supervising the DA's enterprise information functions; including information resources management (IRM); spectrum management; network operations; information systems; information assurance (IA); information protection, data security, cyber security, sensitive information integration; business continuity, disaster recover, contingency support and migration planning; and related matters. Pursuant to chapter 113, subchapter III of 40 U.S.C., the Army CIO/G-6 has responsibilities for integrating information enterprise

## How the Army Runs

and related activities and services Army-wide. The Army CIO/G-6 also serves as the Army-wide strategist and business executive for IM, IT and IRM; and the Army's IT architect.

*b.* The Army CIO/G-6 exercises sole responsibility for the conduct of the information management (IM) function. The CIO sets the strategic direction, determines objectives for, and supervises DA command, control, communications, and computers (C4) and IT functions. The CIO reports to the SA and ensures that the CSA receives such staff support as is necessary in performing CSA duties and responsibilities. The mission of the Army CIO/G-6 is to provide architecture, governance, portfolio management, strategy, IT acquisition oversight, and operational capabilities to enable joint expeditionary net-centric information dominance for the Army. Among the specific responsibilities of the CIO are—

- (1) Serving as the Army CIO.
- (2) Serving as the ARSTAF G-6 for information and signal operations, network and communications security, force structure, and the equipping and employment of signal forces, and in this capacity supporting the CSA in the exercise of his responsibilities as the senior military officer of the DA and as a member of the Joint Chiefs of Staff.
- (3) Providing policy and oversight and ensuring that the IT infrastructure supports mission and business strategies.
- (4) Developing policy and guidance on information management and C4/IT (including automation, telecommunications, visual information, and related activities, services, and programs).
- (5) Planning, coordinating, and implementing AKM, the Army Enterprise Architecture (AEA), the total Army Enterprise Information Infrastructure, and the Army enterprise portal.
- (6) Developing, coordinating, and implementing an IT portfolio management process and corresponding governance policies and structures
- (7) Developing, coordinating and implementing a C4/IM capital planning, and investment strategy for the enterprise (includes investment policies, oversight and control) and the planning, programming, budgeting, and execution of all C4/IT resources.
- (8) Providing CIO validation of requirements for warfighting, base operations, and administrative and other mission-related processes associated with a C4/IT impact.
- (9) Recommending and advising the SA and the ASA(AL&T) on major resource allocations, investment, and acquisition strategies pertaining to IT and national security systems (NSS).
- (10) Providing CIO assessment of NSS and IT systems as defined in the Clinger-Cohen Act (CCA) (U.S.C. Title 40, Subtitle III) and CIO certification of CCA compliance for all major automated information systems.
- (11) Certification Authority for Army Interoperability Certification (AIC) for all Army systems, platforms, and applications to ensure integration and interoperability of warfighting capability in an Army, Joint, Coalition or National environment.
- (12) Providing policy and guidance on and validation of business process initiatives and programs with a C4/IM impact.
- (13) Providing policy and oversight for the Information Technology Management Career Program and developing and implementing the C4/IM human capital strategy and programs.
- (14) Developing policy for information assurance (IA) and providing oversight of the Army IA Program.
- (15) Providing policy, guidance, and oversight of the public key infrastructure, the common access card, and other enabling technology programs.
- (16) Developing policy and providing oversight of the Army Spectrum Management Program.
- (17) Developing policy and providing oversight of multimedia/visual information.
- (18) Ensuring that the Army's military satellite communications usage conforms to joint military satellite program policies and standards.
- (19) Developing policy and providing oversight and direction for programs in support of e-Government initiatives.
- (20) Serving as the Chair of the Army CIO EB, representing the DA on boards, committees, and other groups and representing the SA on matters outside the Department, in coordination with the ASA(AL&T) and ASA(FM&C), as required by the missions and functions prescribed herein.

### 16-5. CCA Implementation

*a.* The CCA directs that each executive agency appoint a CIO who reports directly to the head of the agency. The requirements of the CCA increase agencies' responsibility, authority, and accountability for the use of IT in performing the agency's missions, maximizing value, managing programs, and assessing risks of IT acquisitions.

*b.* The specific requirements of the CCA include:

- (1) Analyze the missions of the executive agency and based on the analysis, revise the executive agency's mission-related processes and administrative processes, as appropriate, before making significant investments in IT to be used in support of those missions.
- (2) Monitor the performance of IT programs of the agency, evaluate the performance of those programs based on the applicable performance measurements, and advise the head of the agency regarding whether to continue, modify, or terminate a program or project.

(3) Ensure that information security policies, procedures, and practices are adequate.

(4) Assess requirements established for agency personnel regarding knowledge and skill in information resource management (IRM) and adequacy of such requirements for facilitating achievement of the IRM performance goals. Assess the extent to which the executive and management levels of the Army meet the IRM knowledge and skills requirements and develop strategies and specific plans for hiring, training and professional development in the areas of IRM and IT.

c. In addition to the CCA responsibilities described in paragraph 16-4b (9) above for managing IT, DOD and military department CIOs are responsible for national security systems per Title 10, Section 2223.b. Accordingly, the Army CIO/G-6 has the following additional responsibilities: Reviewing budget requests for all IT and national security systems (IT/NSS), Ensuring that IT/NSS are in compliance with standards of the Government and the DOD; Ensuring that IT/NSS are interoperable with other relevant information technology and national security systems of the Government and the DOD; and Coordinating with the Joint Staff with respect to IT/NSS.

d. The provisions of the CCA apply to all Army Acquisition Category (ACAT) programs. Mandatory compliance certification occurs at Milestones A, B, C, and at the Full Rate Production (FRP) decision.

## 16-6. Army IT Governance

a. Army CIO Enterprise Board (EB) is a platform to share Army CIO/G-6 strategies, policies, actions and guidance with ACOMs, ASCCs, DRUs, and HQDA as well as receive feedback and questions from the field. The Board shares decisions made out of the CIO/G-6 Enterprise Guidance Board (EGB) through this platform. The Army CIO/G-6 chairs the Army CIO EB. The CIO EB is a strategic communications forum and is a platform used to advocate the EGB decisions, provide and receive feedback to and from Army echelons, as well as keeping the community abreast of the key enterprise strategic initiatives. Board membership consists of General Officers, Senior Executive Service and other senior-level participants from Army Staff, Army Commands and select Army Service Component Commands and Direct Reporting Units.

b. Army Enterprise Guidance Board (EGB) is the senior Army enterprise information technology (IT) governance decision and advisory body. The Deputy CIO/G-6 leads this decision forum to ensure that all enterprise IT decisions are in the best interest of the Army enterprise, are fiscally responsible, pose acceptable risk, and meet capability and customer requirements. The EGB consists of one- and two-star General Officers and SES equivalents. The Army EGB's scope encompasses matters related to the Army CIO's Title 10, 40 and 44 with the following responsibilities:

- (1) Approve and oversee implementation of the Army IT enterprise strategic plan.
- (2) Plan, approve, prioritize and direct execution of Army enterprise IT initiatives and resources.
- (3) Establish and implement Army enterprise IT standards and architecture.
- (4) Execute risk management through policy implementation and compliance enforcement.
- (5) Identify and approve enterprise-level CIO functional system integration initiatives, policies and procedures that will enhance CIO oversight and integration of IT programs and systems within and across functional areas, to include horizontal integration of technology.
- (6) Identify, prioritize and approve initiatives for submission to the Chief of Staff of the Army Executive Board and DoD IT governance bodies.
- (7) Identify and approve initiatives for transfer to or acceptance from other Army and DOD governance bodies and decision forums and processes.
- (8) Establish subordinate IT governance boards, tiger teams and integrated process teams as needed.
- (9) Resolve issues that cannot be adjudicated by subordinate IT governance boards.
- (10) Resolve issues raised by members that span the Army enterprise.

c. Army Information Technology General Officer Steering Committee (IT GOSC)

(1) The IT GOSC will: advance compliance with Title 40 (Clinger-Cohen Act) and other statutes and regulations governing information technology; review IT resource analysis, including IT-related MDEP and portfolio-based reviews, Program Evaluation Group (PEG) assessments, IT system assessments (as specified between LandWarNet/Battle Command and the Business Systems Information Technology Enterprise Steering Group), Cost-Benefit Analyses (CBAs) and Business Case Analyses (BCAs), in order to identify capability gaps and recommend investment prioritization, elimination of unnecessary redundancies and/or investment tradeoffs that meet Army requirements and ensure balance across the IT investment portfolio; and inform decisions by the PEG, Planning Programming Budget Committee (PPBC), the LandWarNet/Battle Command GOSC (LWN/BC GOSC), the Business Systems Information Technology Enterprise Steering Group (BSIT-ESG), the Enterprise Guidance Board (EGB) and the office of the CIO/G-6.

(2) The Army IT GOSC consists of One-Star General Officers/Senior Executive Service equivalents. The Directors of CIO/G-6 Information Resources Integration Directorate; Architecture, Operations, Networks and Space Directorate; and G-3/5/7 LandWarNet/Battle Command tri-chair the IT GOSC.

(3) Based on the authorities outlined in USC Titles 10, 40 and 44, and in coordination with the established governing bodies for Business Systems Information Technology and the LandWarNet/Battle Command, the IT GOSC reviews IT resource requirements and makes program development and resource allocation recommendations affecting the following Army portfolios:

## How the Army Runs

(a) Network Services (CIO/G-6 Lead). Provides network services, applications and data within the Army Enterprise; or visibility and the ability to access all DOD information and DoD-wide information services to all authorized users. This includes: enterprise e-mail, service desk, directory services, enterprise architecture, data center consolidation (area processing centers/federal data centers), data transformation, commercial-off-the-shelf (COTS) IT, computing infrastructure, enterprise-wide applications, Everything over Internet Protocol, and implementation of enterprise solutions for end-user devices.

(b) Network Operations (CIO/G-6 Lead). Provides the organizations and capabilities to operate and ensure network support, enterprise network management, network defense and content management for all DoD missions through synchronization, de-confliction, coordination and awareness.

(c) Transport (CIO/G-6 Lead). Provides the communications capability, from the wall plate to internal point-to-point or multipoint capability, to include release to external (non-DoD-controlled) networks. This includes satellite, aerial and surface/terrestrial communications, such as localized and long-haul communications and Regional Hub Nodes (RHNs). The deployed tactical network shall be coordinated with LWN/BC for a comprehensive portfolio review.

(d) Coordinates with the G-3/5/7 LWN/BC and the Office of Business Transformation (OBT) to ensure that Network enterprise capabilities are vertically aligned and delivered in accordance with the Capability Set Management Process.

### 16-7. C4/IT Investment Strategy

a. The efficient and effective use of IT resources has a direct affect on the Army's ability to perform its missions. The Army CIO/G-6 manages IT investments and develops a coordinated, consolidated investment strategy. The Capital Planning and Investment Management (CPIM) process develops the IT Investment Strategy, recommending a prioritized list of IT investments and/or whether to continue, modify, or terminate an IT program/project according to mandates from the CCA. The recommended prioritization listing is a reference and support tool within Program Evaluation Groups (PEG) throughout the PPBS and acquisition processes. The prioritization process addresses capability gaps, investment risks, IT interdependencies and timing issues across all areas of IT investments.

b. The IT GOSC, described in Section 16-7 above, governs C4/IT Investment Strategy process.

c. Army Transformation drives requirements for new and enhanced IT capabilities. To ensure proper use of the limited resources for Army IT, stove-piped, unnecessarily redundant, and non-compliant IT capabilities must be eliminated and funds reprogrammed to support higher-priority capability requirements.

## Section III

### Army Enterprise Management

#### 16-8. Army Enterprise Management

The challenges presented by Army Transformation require management of the IT infrastructure across the spectrum of activity. Our networks, systems, and information need to be enterprise-based, accessible, seamless, reliable, secure, and deployable wherever the mission occurs.

#### 16-9. Army Data Management

a. *Data Management*:. Data is a strategic asset. The Army CIO is responsible for and prescribes the Army's information management policy at the strategic level. Consistent with this responsibility the Army CIO establishes and oversees data transformation through the Army Data Management Program. The Army CIO appoints the Army's Chief Data Officer (CDO); the CDO is responsible for developing, implementing, and enforcing Army and Federal data standards and strategy for the Army. Each Mission Area/Joint Capability Area will identify a Data Steward empowered by the Army CIO to perform the same Chief Data Officer responsibilities within their functional areas. As a team, they will lead the data transformation that is fundamental to Net-Centricity.

b. *Data Warehousing and Storage*:. The need for centralized data processing arose from the realization that Army's predominantly decentralized computing environment had reached unsustainable levels from operational, financial, technological, and security perspectives. Implementing enterprise data management and warehousing will increase operational performance and reliability; introduce standardization, provide needed agility to respond efficiently and effectively to change, enhance security, and allow for economies of scale in terms of operations and maintenance costs. Centralized data processing will also enhance cyber security and information protection, secure and non-secure, and will enable the Army to implement continuity of operations and disaster recovery planning.

(1) Enterprise data management and warehousing allows the Army to achieve a single authoritative source for all data while reducing the number of data centers and computer rooms to manage IT operations.

(2) Enterprise data management and warehousing will move the Army to a single standard set of technology, facilitate the retirement of legacy systems and applications, and allow for standardize, compatible and interoperable connectivity to the GIG.

(3) Due to the size and scale of the Army's LandWarNet, It is crucial that that the Army implements a more efficient data processing environment that maximizes opportunities for knowledge transfer and security.

(4) Managed virtual data and information architectures must be provided and storage architecting strategies must present mission data and information in effective and consumable ways to Army and partnering joint, interagency, intergovernmental and multinational (JIIM) warfighting and business communities.

(5) Traceable data elements must be available to both communities to enable decision superiority.

*c. The Army Data Management Program.* The Army Data Management Program allows the Army to achieve a single authoritative source for all data while reducing the number of data centers and computer rooms to more effectively manage IT operations. Data management will move the Army to a single standard set of technology and will facilitate the retirement of legacy systems and applications. A more efficient data management environment will maximize opportunities for greater information and knowledge sharing. The need for centralized data management arose from the realization that Army's predominantly decentralized computing environment had reached unsustainable levels from operational, financial, technological, and security perspectives. Implementing enterprise data management and warehousing increases operational performance and reliability; introduces standardization, provides needed agility to respond efficiently and effectively to change, enhance security, and allows for economies of scale in terms of operations and maintenance costs.

## 16–10. Enterprise Services

*a.* The CIO/G–6 is responsible for overseeing the Army's integrated enterprise portal for accessing information, conducting business, and managing operations. Integral to Army transformation, enterprise services cross the warfighting, business, and intelligence mission areas to support the Current and Future Force. The network is a critical enabler for the execution of Army activities, on the Non-classified Internet Protocol Router Network (NIPRNet) and Secret Internet Protocol Router Network (SIPRNet). The Army networks provide an array of enterprise services, including reach-back capabilities to deployed forces; self-service information and personnel actions for Soldiers (e.g., medical readiness, financial, etc.); single sign on (SSO) application support; and support to family support groups. In accordance with Army directives, all Soldiers (Active, Reserve, and National Guard) and DA civilians must have an approved enterprise portal account accessed via the Common Access Card. The CIO/G–6 determines and integrates enterprise resources, plans and policy to ensure business and warfighting requirements are met.

*b.* The CCA requires management, integration, and accountability for use of IT resources in performing Army missions and functions (reference paragraph 16–5 above). In the execution of these tasks, the CIO/G–6 employs an enterprise approach for maximizing IT resources. Operation of the Army enterprise portal provides for the widespread use of capabilities (services, tools, or applications) to facilitate end-to-end linkage of the Army's operational and institutional processes. Using enterprise capabilities reduces the total cost of ownership and security risks related to using stove-piped or legacy solutions to meet individual staff and functional requirements.

*c.* Future enterprise services and the current enterprise portal. Enterprise Email, Enterprise Identity Management Services, Enterprise Collaboration Services, and the Common Operating Environment keep the Army in compliance with Federal CIO, DOD, and Joint requirements.

## 16–11. Enterprise Architecture

*a.* The Army uses the AEA and architectural views to analyze operational concepts and systems and to support new capabilities and requirements as required by Chairman of the Joint Chiefs of Staff Instruction (CJCSI) 3170.01, Joint Capabilities Integration and Development System (JCIDS); the DOD 5000 series of acquisition documents; Information Support Plan (ISP) process; and other authorities. The AEA helps drive the Army's investment strategy for IT by providing a mechanism for addressing capability gaps, investment risks, interdependencies, and alignment with key Army and Joint doctrine. The AEA supports Army transformation.

*b.* The AEA consists of the architectural views describing the Army's and business missions and functions, Battle Command Architecture (BCA) and Army Business Enterprise Architecture (ABEA), respectively, and the enabling enterprise network, LandWarNet (LWN). These three integrated architectures are nested in Joint initiatives as detailed below:

(1) BCA is the Army's alignment to Joint Battle Management Command and Control (JBMC2) architecture. JBMC2 offers integrated capabilities to the operational .

(2) ABEA is the Army's initiative that relates to DOD's Business Enterprise Architecture and Business Management Modernization Program.

(3) LWN is the Army's part of the DOD Global Information Grid (GIG) and consists of all globally interconnected end-to-end sets of Army information capabilities, associated processes, and personnel for collecting, processing, storing, disseminating, and managing information on demand to support s, policy makers, and support personnel.

*c.* Architecture Views. There are three major perspectives, or views, which logically combine to describe a single architecture. These three architecture views are the Operational View (OV), Systems View (SV), and Technical View (TV). The views provide different perspectives on the same architecture. The most useful architecture description is an integrated description—a description that consists of multiple views.

(1) The OV describes the tasks and activities, operational nodes or elements, and information exchange requirements between nodes for each software block or unit in a given architecture. The OV defines the type of information, the

## How the Army Runs

frequency and timeliness of the information exchanges, and the tasks supported by these information exchanges that warfighting, support, or combat service support functions require. An OV consists of the aggregation of missions, functions, tasks, information requirements and business rules.

(2) The SV is a physical implementation of the OV. The SV provides graphical and textual descriptions of the command, control, communications, computer, intelligence, surveillance, and reconnaissance systems and interconnections used to satisfy operational needs. The SV identifies the physical connections and locations of key nodes, circuits, and networks. SV construction occurs per standards defined in the technical view.

(3) The TV identifies services, interfaces, standards, and their relationships; and it provides the framework for engineering specification development, product line development, and common building blocks.

*d.* AEA Architects.

(1) The Training and Doctrine Command is the Army Operational Architect.

(2) The Assistant Secretary of the Army for Acquisition, Logistics, and Technology is the Army Systems Architect, with the support of Program Executive Officers and Program Managers who develop the systems views.

(3) The CIO/G-6 is the Army Technical Architect. The Technical Architect provides the technical framework for the evolving blueprint guiding the enterprise technology life cycle. The Technical Architect influences both technical management and engineering practices and focuses on enterprise-wide integration issues.

### 16-12. Information Assurance (IA)

CIO/G-6 is the Army proponent for IA, which supports Army Transformation by proactively protecting its networks and information infrastructure, infusing and driving technology requirements, streamlining and improving operational processes, and training and educating the force. The CIO/G-6:

*a.* Manages the Army IA Program.

*b.* Establishes and issues Army IA policy and procedures for achieving acceptable levels of IA in engineering, implementation, operation, and maintenance for all IT connecting to or crossing any U.S. Army managed network.

*c.* Prioritizes and defends Army IA resource requirements in the planning, programming, and budgeting process.

## Section IV

### CIO/G-6 Organization

#### 16-13. Chief Integration Office

*a.* The Chief Integration Officer (CXO) is the integrator of Army Information Management, Knowledge Management and Information Technology initiatives. The CXO incorporates vision, strategic planning, and elements of quality management into the full range of its functions, encouraging creative thinking and innovation; influencing others toward a spirit of service; and designing and implementing new or cutting-edge programs and processes.

*b.* The CIO/G-6 CXO Directorate performs the following functions:

(1) Lead the development and integration of the CIO/G-6 input into the Army's strategic planning documents, to include the integration of the supporting Information Management and Information Technology strategy, and ensuring the alignment of the IT investment strategy with Army strategic vision, goals, and objectives.

(2) Provide overall framework and management of strategic communications initiatives to enhance awareness of Army-wide IM/IT objectives. Responsibilities also include media relations, social media, and the management of congressional responses.

#### 16-14. Information Resource Integration (IRI)

The CIO/G-6 is responsible for oversight of IT resources and assessment, and develops and coordinates investment decisions at the enterprise level for IT expenditures. Decision-making at the enterprise level transforms the workforce, processes and information infrastructure by providing accountability, standardization and efficiencies. Strategic resourcing decisions are made through the IT investment strategy process in coordination with ARCYBER and NETCOM/9<sup>th</sup> SC(A), ACs, Combatant Commands, and Army Headquarters stakeholders. Based on the authorities outlined in USC Titles 10, 40 and 44, and in coordination with the established governing bodies for Business Systems Information Technology and the LandWarNet/Battle Command, the IT GOSC reviews IT resource requirements and makes program development and resource allocation recommendations affecting the Army portfolios. All allocations of IT resources undergo this review process for approval. The IRI Directorate represents the CIO/G-6 on the PPBE process. The IRI Directorate is responsible for resources expended for any IT systems and programs not otherwise managed by an Army PEO. Specific oversight functions include compliance with CCA requirements, Army enterprise initiatives, and financial management guidelines. The IRI Directorate:

*a.* Serves as focal point for CIO/G-6 on resource matters.

*b.* Guides CIO/G-6 participation in the PPBE events.

*c.* Serves as the CIO/G-6 contact office for requests for resource information for the Office of the President, the Congress, and the Office of the Secretary of Defense.

*d.* Coordinates the CIO/G–6 participation on PEG resourcing meetings.

### **16–15. Governance, Acquisition, and Chief Knowledge Office (GA&CKO)**

*a.* Knowledge Management (KM). The KM Division is responsible for KM functions across the Army and establishes policy and procedures for the use of KM and collaborative tools for use in both the tactical and institutional Army. The KM Division is also the program office and functional proponent for two major programs: Enterprise Collaboration Services and Unified Communications and Collaboration.

*b.* Acquisition. The Acquisition Division supports the Army CIO/G–6 by meeting mandates set forth by the CCA, including:

(1) Providing advice and other assistance to the executive agency to ensure that information technology acquisition and information resource management occur in a manner consistent the priorities of the executive agency.

(2) Developing, maintaining, and facilitating the implementation of sound and integrated information technology architecture for the executive agency.

(3) Promoting the effective and efficient design and operation of all major IRM processes for the executive agency, including improvements to work processes of the executive agency.

(4) The Acquisition division of the Army CIO/G–6 is responsible for Office of Acquisition Oversight and CCA certification.

(5) The Acquisition division serves as the proponent for the Army Enterprise Service desk, an enterprise acquisition program for Enterprise IT Help Desk services.

*c.* Human Capital. The Human Capital Division supports the Army’s goals of attracting individuals with diverse backgrounds and promoting a highly qualified and flexible workforce. A key to the success of a knowledge-based organization is the continuous learning and the transformation of the Army’s most valued asset - its human capital. Accordingly, education, training, mentoring, and professional development opportunities will provide Soldiers and DA civilians with a global perspective; empower them to embrace and lead change; and make them adaptable to rapid changes taking place in the workplace.

*d.* Governance Division. The Governance Division serves as Secretariat for CIO Boards, focal point for all CIO/G–6 policies and related Federal policy, standards, and initiatives as well serving as the CIO focal point for the management and integration of Federal, DOD and Army CIO EBs and other events. The Governance Division processes and maintains Privacy Impact Assessments for the Army. The Division AOs also develop and implement IT portfolio management guidance for issuance to the Army by the CIO/G–6 in accordance with Secretary of the Army directives.

*e.* In relation to policy, the division:

(1) Formulates strategies and proposes priorities for institutional policy development, guidance, and dissemination for CIO-proponent responsibilities.

(2) Serves as Army proponent for the IM/IT capstone publications (i.e. AR 25–1 and DA Pamphlet 25–1–1) and other publications, as assigned.

*f.* In relation to coordinating meetings and representing the Army CIO/G–6 at meetings, the division:

(1) Plans and coordinates the Army CIO Executive Board quarterly meetings. For a full description of the activities of the division in relation to the boards, reference paragraph 16–7 of the handbook.

(2) Serves as Army component coordinator for DOD CIO Executive Board, the Enterprise Guidance Board, and the Information Technology General Officer Steering Committee meetings and conducts IPRs for the CIO/G–6 as the Army member for quarterly and other unscheduled DOD CIO meetings.

### **16–16. Architecture, Operations, Networks and Space,**

*a.* The CIO/G–6 provides functional management and oversight of the transformation of the Army’s tactical information infrastructure and strategic "reachback" enablers.

*b.* The CIO/G–6 oversees, coordinates, and monitors IT systems and programs through their life cycle; formulates strategies; advocates base level systems and programs; and manages functional programs such as space and networks, C2 systems, combat service support systems, C2 Protect, and Visual Information.

*c.* The CIO/G–6 supports Transformation Communications Architecture concept maturation and system development for strategic and tactical Satellite Communications (SATCOM) systems.

(1) provides management and technical expertise to ensure horizontal integration of SATCOM system elements (terminals, satellite and control) to meet current and future operational requirements;

(2) manages the Army’s equities and investments in satellite communications to meet the Army’s future satellite requirements to support the , Joint interoperability objectives, and the Assistant Secretary of Defense for Networks, Information and Integration net-centricity mandate.

*d.* The CIO/G–6 is responsible for AIC of all platforms, systems and applications IAW applicable DOD and Federal guidelines and regulations.

(1) Execution of the AIC test and certification process occurs under the Federated Net-Centric Sites (FaNS), a series of CIO/G–6 accredited test centers/facilities used in distributed testing.



## How the Army Runs

(2) A rigorous configuration control process tracks and maintains software/hardware/system configuration management changes or improvements during the lifecycle of the platform, system, or application as part of the Army Interoperability Certified Fielded Baseline (AICFB), and controls the certification process.

*e.* Participates under the leadership of U.S. Joint Forces Command (JFCOM) in the development of the Joint Mission Thread (JMT) process and the assessment of the produced JMTs.

(1) Ensures the process is repeatable, uses common terminology, is Universal Joint Task (UJT)-based, and architecturally supported.

(2) Coordinates with the Army organizations to ensure proper participation in the process so Tier 1 JMTs are appropriate for extension to meet Joint Test Thread (JTT) requirements.

### 16–17. Cyber Directorate

*a.* The mission of the CIO/G–6 Cyber Directorate is to integrate efforts across the Federal, DOD Joint, and Army staffs to provide policy, oversight, and guidance that will enable information dominance, create and maintain a secure information environment, and ensure the confidentiality, integrity, authentication, availability and non-repudiation of the 's data.

*b.* The vision of the Cyber Directorate is secure information environment resistant to known and emerging cyber threats. We are a globally networked society increasingly dependent on the cyberspace domain, essential process controls in manufacturing, public utilities distribution, banking, communications, and national security have shifted to integrated networked systems. The exposure of our economy and national security to the associated risks will continue to steadily increase; resources for conducting harmful attacks are widely available and inexpensive, creating a low cost of entry for any adversary. Cyberspace has emerged as a global domain within the information environment consisting of the interdependent network of information technology infrastructures, including the Internet, telecommunications networks, computer systems, and embedded processors and controllers. War-fighters rely upon cyberspace to command and control forces in the 21st century. Revolutionary technology has presented cyber capabilities, which can provide decisive effects traditionally achieved only through kinetic means. Mastery of cyberspace is essential to America's national security. Controlling cyberspace is the prerequisite to effective operations across all strategic and operational domains-securing freedom from attack and freedom to attack. Some of the responsibilities of the Director of the CIO/G–6 Cyber Directorate include:

(1) Identify, Track, and Coordination on Cyber Issues Development and Resolution within the CIO/G–6 and across the Army Staff

(2) Assist in the defense of the Army's LandWarNet by employing a robust defense-in-depth strategy that integrates people, technologies, and processes.

(3) Manage the Army Information Assurance (IA) program which provides policy, mandates, and procedures targeted to protect information and information systems (ISs) from unauthorized access, modification, or denial of service; and ensures the provisioning of access and service to authorized users.

(4) Manage, Plan, Coordinate and Implement cyber technology for appropriateness and compliance to allow for a secure trusted computing environment to enable the Army to leverage IT and share information & data in support of its mission.

## Section V

### Other Strategic Partnerships with the Army CIO/G–6

#### 16–18. Program Executive Office Enterprise Information Systems (PEO EIS)

*a.* The PEO EIS provides joint service and Army s with information dominance by developing, acquiring, integrating, deploying and sustaining net-centric knowledge-based IT and business management systems, communications, and infrastructure solutions through leveraged commercial and enterprise capabilities. PEO EIS provides information infrastructure and information management systems. PEO EIS develops, acquires and deploys tactical and non-tactical IT systems and communications

*b.* PEO EIS reports to the Assistant Secretary of the Army for Acquisition, Logistics and Technology and to the Army CIO/G–6.

*c.* Two programs in which the PEO EIS is involved are:

(1) Army Computers, Hardware, and Enterprise Software Services (CHES) Office. The CHES office, an activity reporting to PEO EIS, provides a full range of IT, IT infrastructures, and information systems (hardware, software, peripherals, networking, and infrastructure support services) to Army, DOD, foreign military, Soldiers, and Federal agencies consistent with DOD and DA policy on standardization and interoperability.

(2) AKO is the Army's current integrated enterprise portal for accessing information referenced in paragraph 16–11. The Army is transitioning to enterprise services and enterprise email so the approved enterprise solutions and tools may change as well. Future Force

### 16–19. AKM Transformation Strategy

*a.* Army Transformation changes the force from a discipline-specific, stove-piped, platform-centric organization designed for the linear fight to a net-centric, knowledge-enabled force optimized for full-spectrum operations. The Future Force integrates vertically and horizontally with joint and coalition forces and interagency teams. This will allow unfettered movement of large and, most importantly, relevant volumes of data, information, and knowledge between the commander’s critical decision nodes. The clear purpose of the knowledge support schema is to enable commanders to achieve dominant operational environment understanding as a precondition for rapid, decisive action.

*b.* An example of the transformation to net-centric operations is the Mission Command network. This joint, integrated network shares information both vertically and horizontally across warfighting functions (WFF), Service, agency, and national network boundaries and allows for the rapid transmission of data to those individuals who require it. The end result is to give the commander both information superiority and decision superiority in any situation.

### 16–20. Cultural Changes

*a.* The future Modular Force will fight as a part of a networked joint force, integrated at every level, and interdependent in the joint areas of battle command, force projection, air and missile defense, sustainment, and fires. The strategic environment and demands of Soldier-centric, network-enabled expeditionary operations will significantly increase network reliance.

*b.* Although LandWarNet currently enables various operational and generating force capabilities, there are significant capability gaps for Army units as they prepare and deploy during the Joint Phases of Operations. LandWarNet enterprise enabling capabilities are limited because of multiple networks, applications and services that are independently managed, and tied to fixed base infrastructure. Several Army networks do not integrate either in the same infrastructure or at the operational command post. This not only complicates C2 for the commander but limits the capability to share information such as common operating picture (COP) and Situation Awareness (SA) with Joint forces and coalition partners. Additionally, LandWarNet operational functionality currently does not fully support the commander’s critical needs such as joint distributive planning, virtual task organization and sharing vital mission critical information while preparing for and deploying to a theater of operations.

*c.* The ARFORGEN process when fully implemented across the entire Army will allow GNEC to introduce new LandWarNet infrastructure capabilities to a unit during a “Reset” period. Once these new LandWarNet enterprise capabilities are fully incorporated into the unit, the unit then progresses to a “Train/Ready” state, and finally an “Available” state at which time the unit is fully mission ready and can be deployed to execute an operation or mission. To meet these challenges, LandWarNet integrates into a portfolio construct that facilitates the synchronization, coordination and prioritization of all LandWarNet and Battle Command activities across the entire force. GNEC will ensure the Army has a common set of applications and information resources, no matter where it deploys, to manage the Army Enterprise and enable operations with our Joint, Coalition, and interagency partners. LWN must be secure, sustainable, and capable of supporting an expeditionary Army that is interoperable and in collaboration with mission partners. The Army Enterprise Network will be a single, secure, standards-based, versatile infrastructure linked by networked, redundant transport systems, sensors, warfighting and business applications, and data to provide our Soldiers and Civilians the information they need, when they need it, and in any environment.

*d.* The Army CIO/G–6 in conjunction with the Deputy Chief of Staff, G–3/5/7 LandWarNet/Battle Command (LWN/BC), Deputy Under Secretary of the Army and TRADOC, is transforming Army processes to deliver relevant, affordable, and interoperable LWN/BC infrastructure capability sets to the Generating and Operational Forces within the ARFORGEN process - modernizing net-enabled capabilities over time. The LWN/BC Capability Sets Development Strategy establishes deliberately planned capability increments or sets, transforming LandWarNet into an enterprise-managed activity that effectively and efficiently delivers trained and ready expeditionary forces in a deliberate, synchronized method within the ARFORGEN process.

*e.* The challenge is to synchronize its systems engineering activities to deliver affordable and interoperable infrastructure capabilities to the designated ARFORGEN units as a Capability Set. LWN/BC Capability Sets, designated in two-year increments, serve as the basis for fielding capabilities to the Army within the ARFORGEN. A LWN/BC capability set portfolio consists of all the new and existing DOTMLPF solutions inclusive of all LandWarNet segments.

*f.* GNEC’s role is to ensure delivery, relevant, affordable, and interoperable LandWarNet/BC capabilities sets to the Generating and Operational Force within the ARFORGEN process over time. This System of Systems portfolio approach built on the development of Capability Sets for modular formations to synchronize and integrate all generating force processes to deliver improved capabilities over time.

### 16–21. AKM Implementation

*a.* The objective of AKM is to transform the Army into an information age, net-centric organization that leverages intellectual capital to better organize, train, equip and maintain a strategic land combat force. AKM enables the Army to be a full spectrum force; organized, manned, equipped, and trained to be more strategically responsive, agile, deployable, versatile, lethal, survivable, and sustainable.

*b.* The Office of the Army Chief Information Officer/G–6 continues to work toward the enterprise vision of a single Army network, one enterprise Army portal, and universal access to Army knowledge. With the advice and consultation

## How the Army Runs

of the Army CIO Executive Board (EB), the CIO/G-6 has institutionalized strong governance procedures for the enterprise control of the information technology (IT) budget, realigned information management organizations, and defined the AKM strategy.

*c.* Army transformation is changing the way we acquire and employ IT assets and, ultimately, how we conduct daily business and operations. To remain relevant to the Future Force, the Army must adapt to the new culture as future military operations will occur in a different and changing operational environment, which will enhance decision dominance. The operational environment is characterized by the responsiveness, agility, and full spectrum capability to dominate unstable situations that requires the Army to focus its cultural thinking on the enterprise management of IT resources. This requirement means that organizational IT investments must support the Army's enterprise-wide goals under AKM.

### Section VI

#### Summary and References

##### 16-22. Summary

*a.* Army transformation will enhance the Service's ability to conduct operations. The goal of the CIO/G-6 is to provide the AKM strategy to enable better and faster decisions than the opponent.

*b.* AKM provides for the integration and the interoperability of processing, storing, and transporting information over a seamless network, allowing access to universal and secure Army knowledge across the enterprise. In an effort to align with the AKM Strategy, current operational systems undergo examination relative to the results they achieve and benefits they provide to the Army's. If they do not contribute to a world-class net-centric knowledge system, they face elimination or migration to systems that do.

*c.* The CIO/G-6 is committed to meeting the challenges that transform the Army into a force that is strategically responsive and dominant. As such, the CIO/G-6 is investing in today's technology to stimulate the development of doctrine, organizational design, and leader training to improve the future force. Doing so will extend the Army's technological overmatch.

##### 16-23. References

- a.* Army Regulation 10-87, Army Commands, Army Service Component Commands, and Direct Reporting Units.
- b.* Army Regulation 25-1, Army Knowledge Management and Information Technology.
- c.* Army Regulation 25-2, Information Assurance.
- d.* Department of the Army Pamphlet 25-1-1, Information Technology Support and Services.
- e.* Army Regulation 70-1, Army Acquisition Policy.
- f.* General Order 3, Assignment of Functions and Responsibilities Within the HQDA, <http://www.army.mil/usapa/epubs/pdf/go0203.pdf>
- g.* General Order 5, Establishment of the U.S. Army Network Enterprise Technology CMD/9th Army Signal CMD; Transfer and Re-designation of the HQ and HQ Company, 9th Army Signal CMD; Discontinuance of the Communications Electronics Services Office and the Information Management Support Agency
- h.* The Army Campaign Plan h.

## Chapter 17

### Installation Command and Management

IMCOM Vision - We are The ARMY'S HOME - "Our mission is to provide Soldiers, Civilians and their Families with a quality of life commensurate with the quality of their service."

#### Section I

#### Introduction

##### 17-1. Chapter content

This chapter describes how the Army manages installations. It includes:

- a. An overview of the Army's installation environment.
- b. Installation Management Command mission and organization.
- c. A description of key installation management positions.
- d. Installation management professional development.
- e. Organization of installation staffs.
- f. The Army Installation Management Strategy.
- g. Major installation management initiatives and programs.

##### 17-2. The Army's installation environment

a. To achieve the Army's vision-a Balanced Army for the 21<sup>st</sup> Century-we need an Army that is a versatile mix of tailorable and networked organizations, operating on a rotational cycle, to provide a sustained flow of trained and ready forces for Full Spectrum Operations and to hedge against unexpected contingencies-at a tempo that is predictable and sustainable for our All-Volunteer Force. Installations play an important role because:

- (1) They sustain our Soldiers and Families through standardized services, access to quality health care, improved housing and installation facilities, schools and youth services, and education and employment opportunities
- (2) They provide land and training ranges to support Soldiers and units preparing for current operations.
- (3) They provide the services to revitalize our Soldiers, Families, and Civilians as they reset for future deployments.
- (4) They are transforming to integrate Grow the Army initiatives, Base Realignment and Closure, and Global Defense Posture Realignment.

b. What is an installation? Installations are platforms of readiness supporting Senior Commanders' current and future requirements through regular modernization and new construction of standardized facilities to maintain efficient and sustainable operations and enable the provision of effective services to Soldiers, Families and Civilians.

c. Installations are the Army's "face" to the nation and the world. Although the focus is on installations, the Senior and Garrison Commander play an important role interfacing with the civilian community. Garrison Commanders are expected to be involved in community relations events and may represent the command in business and civic organizations, such as Chamber of Commerce, Rotary and Lions Clubs, etc. Installations in the continental United States (CONUS) are the only Army installations most Americans see on a regular basis, while outside the continental United States (OCONUS) installations provide a unique perspective of our culture to the international community. Most CONUS installations today are more than 50 years old while many are more than 100 years old. Most OCONUS installations were acquired directly after World War II and the Korean War in the European and Pacific theaters of operation for those conflicts. Installations are assigned to Army Commands (ACOM's), Army Service Component Commands (ASCC's), or Direct Reporting Units (DRU's) based on the missions/functions of the units/activities located at the installations.

d. To foster effective CONUS state and community partnerships while improving the quality of life for Active and Reserve Component Soldiers and their Families, the Secretary of the Army launched the Army Community Covenant (ACC). The ACC is tailored at the local level, with leaders at both local and state levels participating in covenant signings that started in April 2008. The covenant recognizes the strength of the Army, its Reserve Components, its Army Families, and the support of the Civilian community in which Soldiers and their Families live. To highlight community initiatives around the country that focused on support for Soldiers and Families, selected initiatives known as "best practices" are featured from local, state, and national organizations. Installation Management Command (IMCOM), National Guard Bureau through each state headquarters, Army Reserve Ambassadors, and Civilian Aides to the Secretary of the Army identified and reported best practices to the ACC Task Force for consideration across the Army. The current list of best practices can be found at [www.communitycovenant.army.mil](http://www.communitycovenant.army.mil).

e. Installations are big business. The Assistant Chief of Staff for Installation Management (ACSIM), HQDA, manages Defense and Army budget in excess of \$15 billion. Approximately 75,000 persons, paid by military funds, appropriated funds (APF), and non-appropriated funds (NAF), perform installation management functions. Installations cover over 14 million acres of land, more than the combined acreage of the States of Maryland, Connecticut and Rhode

## How the Army Runs

Island. Installations maintain more than 130,000 buildings covering more than 900 million square feet. Army facilities represent a replacement value of more than \$250 billion.

f. Installations are home to the Force and home to the Army family - where the Army lives, works, trains, deploys, sustains and prepares to meet tomorrow's challenges. Army posts and surrounding communities are home to well over one million service members and their families. Installations house half of Army families and nearly 200,000 single soldiers. Army posts are where a quarter of a million civilian employees and tens of thousands of contract employees come to work every day.

g. What is installation management? Installation management is defined as the process of directing and integrating the provision of all functions, to include base support, MILCON, and Army family housing, as well as the resources needed to operate the installation on a day-to-day, long-term, and strategic basis. During the 1980s and early 1990s a host of inspections, studies, and surveys determined that installations could be managed far more efficiently and effectively. As a result, the Army leadership in the mid-1990s took these major actions:

- (1) Establishment of the ACSIM in 1993.
- (2) Establishment of centrally selected garrison commanders in 1993.
- (3) Establishment of pre-command courses for both garrison and installation commanders in 1994.
- (4) Publication of the first installation management doctrine, FM 100-22, *Installation Management*, in 1994.

h. These actions were taken to improve integration of the widely varying, often competing, installation management functions to better train commanders for the increasingly complex and important work of running installations.

i. On 1 October 2002, the Installation Management Agency (IMA) was activated to support the Transformation of Installation Management (TIM). The IMA was structured to provide efficient installation management worldwide through 'best practice' management programs to establish quality installations and maintain the well-being of the entire Army family. The SECARMY's intent for TIM was to:

- (1) Provide corporate structure focused on installation management.
- (2) Support and enable Mission Commanders.
- (3) Enable Army Command (formerly, Major Army Command (MACOM) Commanders to provide strategic guidance through the Installation Management Board of Directors (IMBOD.)
- (4) Eliminate migration of Installation Support dollars (Base Operations (BASOPS) Environment, Family Programs, Base Communications, Sustainment, Restoration and Modernization (SRM).
- (5) Achieve regional efficiencies.
- (6) Provide consistent and equitable services through established standards.
- (7) Integrate Reserve Components.
- (8) Enhance Army Transformation.
- (9) Support Information Technology (IT) and Contracting centralization efforts.

j. In October 2006, the Army reorganized its structure for managing installations with the activation of the Installation Management Command (IMCOM). The Army established IMCOM to improve its ability to provide critical support programs to Soldiers and their families. The IMCOM's mission is to provide the Army with the installation capabilities and services to support expeditionary operations in a time of persistent conflict, and to provide a quality of life for Soldiers and Families commensurate with their service.

k. IMCOM transformed the Army's current installation management structure into an integrated command structure. This consolidation of the installation management structures of Family, Morale, Welfare and Recreation Command (FMWRC) and Army Environmental Command (AEC) under IMCOM sought to optimize resources, protect the environment and enhance well-being of the Army community. The IMCOM mission requires fast, efficient and agile support to commanders in the performance of their tactical, operational, and strategic missions. This initiative is part of the Army's efforts to reorganize its commands and specified headquarters to obtain the most effective, efficient command and control structure for supporting the Modular Force. The new Modular Force structure identifies three types of headquarters; Army Commands (ACOM's), Army Service Component Commands (ASCC's) and Direct Reporting Units (DRU's).

l. As a DRU, IMCOM is accountable to the Assistant Chief of Staff for Installation Management (ACSIM) for effective garrison support of mission activities, and serves as the Army's single authority and primary provider of base support services. The Commanding General, IMCOM is dual-hatted as the Assistant Chief of Staff for Installation Management (ACSIM), the principal military advisor to the Secretary of the Army and Chief of Staff, Army, for installation readiness. The primary objective of this reorganization and command activation was to create a more effective, efficient and capable organization to ensure that the world's best Army is supported on the world's best installations. Additionally, Community and Family Support Center (CFSC) was reflagged as the Family and Morale, Welfare, and Recreation Command (FMWRC) and AEC as the Army Environmental Command. These commands, along with headquarters of IMCOM moved to Fort Sam Houston, Texas, as part of Army Base Realignment and Closure (BRAC) in September 2011.

### 17-3. ACSIM mission and functions

The Assistant Chief of Staff for Installation Management (ACSIM), as responsible official to the Assistant Secretary of

the Army (Installations, Energy and Environment) ASA (IE&E), provides advice and assistance to the ASA (IE&E) and other OASA (IE&E) officials, in addition to responsibilities and authorities as ACSIM on the Army Staff (ARSTAF). Among the duties as responsible official to the ASA (IE&E) are—Serving as the principal military advisor to the ASA (IE&E) and providing independent professional military advice in the functional areas of installation management, military construction, housing and environmental protection, and sustainment.

*a.* Ensuring readiness through availability of efficient, effective base services and facilities, adequate and environmentally safe infrastructure, and enhanced Soldier and Family well-being.

*b.* Advising the ASA (IE&E) on all matters relating to overall management and resourcing of Army installations worldwide.

*c.* Developing, coordinating, and implementing programs based on ASA(IE&E) policies directly associated with installation services and management in a manner that will facilitate efficient and effective execution.

*d.* Developing, coordinating, and implementing programs and policies directly associated with military construction.

*e.* Ensuring the integration of installation management and environmental programs in all aspects of Army operations.

*f.* In coordination with the OASA(IE&E), advising the Army leadership and others on planning development implementation and evaluation of comprehensive installation management resources, environment, facilities, housing and morale and Family support programs to meet Army needs. Among the responsibilities of the ACSIM are:

(1) Ensuring that approved policy, program, and budget initiatives developed by the ASA (IE&E) are executed.

(2) Executing plans, policies, programs, and procedures on matters relating to overall management and resourcing of Army installations and environmental programs worldwide.

(3) Directing execution of Army programs and management concepts to ensure installation readiness to train, project, sustain, recover, reconstitute and protect forces and to provide high standards of environmental quality, public outreach, and quality of life for soldiers and their families.

(4) Developing and directing planning, programming, and budget execution involving installation management and resourcing of installations for the Army.

(5) Recommending standards for and evaluating the condition of installation facilities, environmental quality and base operations services.

(6) Serving as the proponent for installation management doctrine, and professional development of installation and garrison commanders and staff, executing approved operational programs for the reorganization, realignment and closure of installations.

(7) Ensuring consistent and equitable delivery of services among installations, tenants, and components.

(8) Validating requirements for managing and resourcing Army installations.

(9) Serving as the technical advisor for all environmental matters across the full spectrum of Army operations.

## **Section II**

### **Installation Management Command (IMCOM) organization**

#### **17–4. General**

*a.* Army installation “ownership” transferred from functional Major Army Commands (MACOMs) to the IMA effective 1 October 2002. On 24 October, 2006 the IMA was deactivated and its installation management role was assumed by the IMCOM, which was activated on the same day. IMCOM is commanded by a lieutenant general who also retains the position of ACSIM on the Army staff. Another leadership change designated the former IMA director position, a major general, as the IMCOM’s Deputy Commanding General (DCG). The deputy ACSIM remained a Senior Executive Service civilian. In activating the IMA and subsequently IMCOM, a HQ and Regional organizational structure was established to exercise management and supervision of Army installations.

*b.* Strategic direction from Army senior leadership is provided through the Soldier and Family Readiness Board of Directors (SFRBOD). The SFRBOD resulted from the merger of the Installation Management BOD and the Morale, Welfare and Recreation Board of Directors (MWRBOD). The SFRBOD is co-chaired by the Secretary of the Army and the Chief of Staff of the Army. The board includes Senior Army Executives, the Commanders of U.S. Army Forces Korea, Forces Command, Training and Doctrine Command, U.S. Army Europe, U.S. Army Pacific, Army Materiel Command, the Chief of Army Reserves, Director of the Army National Guard, and the Sergeant Major of the Army.

#### **17–5. HQ & Regions**

*a.* The IMCOM HQ is currently located in Fort Sam Houston, Texas, in accordance with requirements of the 2005 BRAC round. The DCG, IMCOM, relocated to Texas, while the Commander IMCOM and ACSIM functions remain at the Pentagon. There are four geographically based regions. Two of them are overseas: Europe, and the Pacific. Two CONUS regions are the Northeast, Southeast that merge in July 2011, and West. All regions report to HQ IMCOM. Each is directed by a SES Region Director (RD), except Korea, whose Director is a Brigadier General/O–7 Army officer.

*b.* IMCOM HQ accomplishes integrated program execution of installation management related policies, plans, and

## How the Army Runs

programs as developed and promulgated by the ACSIM. It directs and oversees regional program execution. IMCOM functions include: funding the garrisons; disseminating planning, programming and budgeting guidance as prepared by the ARSTAF; implementing operational plans & Army-wide standards; and seeking Army-wide installation management initiatives and standardizing implementation of those initiatives. IMCOM, in coordination with ACSIM and ASA (IE&E), also provides liaison with Congress. The Region implements, directs, and oversees program and policy execution. The Region supports garrisons by being responsible for: enforcing Army-wide standards and ensuring equity among installations; adopting best business practices; identifying and tracking performance metrics; optimizing use of technology; identifying and implementing regional efficiencies and partnerships; and interfacing with ACOM's, ASCC's, DRU's and other services/agencies.

c. All installation management accountability and reporting is conducted through the IMCOM regions. Region directors are rated by the IMCOM DCG (formerly Director, IMA) and senior rated by the ACSIM/IMCOM Commander. Garrison Commanders (GC) are rated by Region Directors and senior rated by the designated Senior Commander (SC). This rating scheme keeps the SC linked to the base support process and optimizes mission support.

### 17-6. Installation management organization

Each Army installation has a garrison command reporting to its geographic region. Garrison commanders support and enable mission commanders by providing the full range of installation and base support services to all local units, tenants and customers. Their mission is to command, control, and operate a garrison to support and enable missions and readiness of stationed units and care for people; conduct daily operations to provide installation support to mission commanders; maintain and improve installation services, infrastructure and environment; plan for and, on order, conduct contingency operations; maintain garrison operational and situational awareness and maintain liaison with mission commanders and leaders. Garrison commanders are responsible for local program execution, implementing and managing to Army-wide standards, and maintaining real property.

## Section III

### Key installation management positions

#### 17-7. IMCOM Garrisons

a. Senior Commanders (SC) and Garrison Commanders (GC) perform specific installation management missions. On the Installation, the leaders who have responsibilities for installation management services and operations include the SC and the GC. Each contributes to the delivery of installation management services and the quality of life on the installation.

b. The Senior Commander (SC) is normally, though not always, the senior general officer at the installation. The SC's mission is the care of Soldiers, Families, and Civilians and to enable unit readiness. While the delegation of Senior Command authority is direct from HQDA, the SC will routinely resolve installation issues with IMCOM and, as needed, the associated ACOM, ASCC, or DRU. The SC uses the Garrison as the primary organization to provide services and resources to customers in support of accomplishing this mission. All applicable commands support the SC in the execution of his responsibilities; therefore, the SC is the supported commander by the IMCOM Regional Director (RD), the garrison and tenants. The Senior Commander:

(1) Normally is a dual-hatted position. When this occurs the commander exercises discrete authorities as the SC and as a mission commander. The SC responsibilities and authorities are installation focused; the responsibilities and authorities as the mission commander are mission focused.

(2) In rare cases, can be an HQDA-appointed Civil Servant, rather than a uniformed Senior Commander, who will assume the Senior Commander roles and responsibilities with the exception of Uniform Code of Military Justice (UCMJ) and command authority. In these instances, the individual will be referred to as the Senior Manager (SM). Prior to appointment of the SM, command and UCMJ authorities for the installation will be specified.

(3) Responsible for synchronizing and integrating Army priorities and initiatives at the installation. On IMCOM managed installations there is a requirement for a strong collaborative relationship between the SC and the IMCOM RD. The SC commands the installation but funding of almost all installation activities flows through the RD.

(4) Assumes the duties and responsibilities of the Installation Commander where that title is mentioned in US Code or DOD or Army Policies and Regulations.

(5) Unless prohibited by law or regulation, the SC may delegate, as necessary, assigned duties and responsibilities to the Garrison Commander (GC). Such delegation shall be made in writing and specifically state the duties and responsibilities so delegated and the termination date of the delegation.

(6) Establishes installation priorities among all resident and supported units.

(7) Prioritizes base operations (BASOPS) support consistent with HQDA priorities and approved Common Levels of Support (CLS) bands.

(8) Oversees the CLS services and capabilities provided to customers. Ensuring that those services are provided within the HQDA guidance, designated priorities, and approved CLS bands and coordinates with the IMCOM Regional Director (RD) to change HQDA approved CLS from green, amber or red.

(9) Approves and submits the installation master plan consistent with HQDA long range plans and goals through the ACOMS, ASCCs, or DRUs and IMCOM. For IMCOM installations, the SC collaborates with the IMCOM RD before the SC submits the installation master plan.

(10) Approves the Military Construction Army (MCA) and Military Construction Army Reserve (MCAR) project priority list at the installation level. For IMCOM installations the SC collaborates with the IMCOM RD before the SC approves the MCA and MCAR project priority list for the installation. The US Army Corps of Engineers (USACE) executes MCA/MCAR projects for the Army.

(11) Reviews and approves the prioritization of Family and installation programs. For IMCOM installations the SC collaborates with the IMCOM RD before the SC approves Family and installation programs for the installation.

(12) Installation protection warfighting function is as follows:

(a) CONUS SC: as directed by US Army North (USARNORTH) and in coordination with installation management headquarters (IMCOM and Non-IMCOM), oversees protection warfighting function on the installation.

(b) OCONUS SC: in coordination with the ASCC and IMCOM is responsible for protection warfighting function oversight on the installation.

(13) Is normally designated as a General Court-Martial Convening Authority (GCMCA). GCMCA orders will specify the appellate and review channels for SC GCMCA actions.

(14) The appellate and review authority for administrative actions taken by the SC pertaining to individual soldiers and DA Civilians will flow through ACOM/ASCC/DRU channels unless otherwise specified in Army regulations. The terms “next superior authority”, “next higher authority”, “next higher command” and “next higher headquarters” as used in other Army regulations, mean ACOM, ASCC or DRU commander or headquarters.

(15) Serves as the senior Army representative to the surrounding community.

(16) Senior rates the GC.

#### **17–8. Garrison Commander.**

a. The GC is a military officer, lieutenant colonel or colonel, selected by the Department of the Army. The GC commands the garrison, is the SC’s senior executive for installation activities, is rated by the IMCOM RD, and is senior rated by the SC. The garrison commander is responsible for day-to-day operation and management of installations and base support services. The GC ensures that installation services and capabilities are provided in accordance with HQDA directed programs, SC guidance, CLS, and IMCOM guidance. The GC provides additional service support IAW HQDA directives and provides reimbursable services IAW Memoranda of Understanding or Agreement (MOU/MOA). The GC is responsible to deliver Family and installation programs, coordinates and integrates the delivery of support from other service providers, and obtains SC approval of the installation master plan. The GC may be appointed as a Summary Courts-Martial Convening Authority or the Special Courts-Martial convening authority for the installation and its support area; in rare cases the GC may be appointed as GCMCA. In some cases, the senior official on an installation may be the garrison manager. A garrison manager (the civilian equivalent of a garrison commander) has the same responsibility and authority as the military counterpart with the exception of Uniform Code of Military Justice and command authority. Additionally the GC:

(1) Represents the Army and the installation in the surrounding community as directed by the SC.

(2) Approves and issues garrison policies in accordance with respective Army regulations, or installation level policies involving tenant units as directed by the SC.

(3) Approves and issues policies for IMCOM civilian workforce.

(4) Develops and implements the protection warfighting function program.

(5) Supports mobilization station requirements.

b. The deputy to the garrison commander is a civilian position. The incumbent may act in the absence of the commander on all matters except that involving command authority. A civilian deputy is generally responsible for the overall administrative management within the garrison, coordination of requirements and activities between the garrison and multiple clientele, and assistance to the commander in implementing all policies, programs and services in support of BASOPS. This position may serve as a target assignment for BASOPS civilian employees engaged in cross-functional professional development.

### **Section IV**

#### **Installation management professional development**

##### **17–9. Additional skill identifier (ASI) 6Y (Installation Management)**

The complexity of installation management presents a challenge to the managerial expertise of military garrison staff officers. Officers having performed effectively in their BASOPS capacity may be recommended by their commander for ASI 6Y validation. The garrison commander is the certifying official for awarding of the 6Y skill identifier at the garrison level. This ASI identifies positions requiring personnel trained in installation functions such as resource management, engineering management, logistical management, contract management, plans and training management,



## How the Army Runs

and community and family support management. This personnel designation may lead to assignments as a garrison commander, other region or garrison principal staff officer or HQDA staff officer.

### **17–10. Garrison pre-command course (GPC)**

The Army Management Staff College (AMSC) conducts this course, with a target population of lieutenant colonels and colonels centrally selected for garrison command. The course is also available to civilian deputies. It is an intensive 4-week curriculum of personnel, financial, facility engineering, environmental, anti-terrorism/protection warfighting function, FMWR practices and issues, as well as other related topics. It is taught in small group seminars that focus on real-world issues, problems, options and relationships. Hands-on experience is achieved through staff walks, roundtable discussions with current garrison commanders and a series of computer aided, crisis response simulations. In addition, presentations are made by the ACSIM or Deputy ACSIM and the DCG, IMCOM.

### **17–11. General officer installation commander's course (GOIC)**

The Army's Family and Morale, Welfare and Recreation Command (formerly, Community and Family Support Center (CFSC)), in conjunction with the Army Management Staff College (AMSC) offers this 5-day course for general officer installation commanders which focuses on installation management and FMWR functions. The Chief of Staff of the Army (CSA) has designated the course as mandatory for all installation commanders, deputy installation commanders, and ACOM's, ASCC's, or DRU's staff principals with installation responsibilities. The course is conducted as a small group seminar and requires active participation by the attendees. Attendees are presented with computer-aided protection warfighting function/anti-terrorism/crisis management scenarios for discussion. The course utilizes group processes and case study techniques to challenge assumptions and provide important information and tools for the execution of BASOPS and FFMWR program responsibilities.

### **17–12. Garrison Command Sergeants Major course (GCSMC)**

This 6-day course is conducted at AMSC and is designed for garrison command sergeants major. It is focused at the command group level and deals with the decisions that the garrison commander/commander sergeant major team will be asked to make on a daily basis, and on the information that they will need to make those decisions. The course encompasses fundamental installation management subject areas such as: financial management, civilian personnel management, energy, facilities and infrastructure management, environmental stewardship, and FMWR management, as well as current and emerging doctrine and policy. Employing panels, case studies, practical exercises and computer aided crisis response simulations; the program explores actual garrison situations, and the tools, techniques, and procedures in use by garrison commanders and command sergeants major to achieve mission requirements under conditions of limited resources. The course is conducted in an interactive, seminar format. Each GCSMC is conducted concurrently with a GPC so that there is interface between the participants of both programs. The course includes senior Army leaders and functional area experts as guest presenters, addressing current and future garrison issues.

## **Section V**

### **Garrison Staff Organization**

#### **17–13. US Army Garrison (USAG) Standard Garrison Organization**

The Standard Garrison Organization (SGO) was approved by the Army G3 in 2004 and has been only slightly modified since then. SGO aligns installation management functions in a common organizational structure. SGO drives Army doctrine for installation management by standardizing management and organizational terminology, roles, responsibilities, position descriptions and terms of reference. Under the GC/Deputy/CSM office, SGO prescribes garrison staff organization from Directorate level down only to Division level. It does not prescribe organizational level down to Branch level. There are different types of Directorates or Offices reporting to the GC:

*a.* Garrison Management & Control Offices.

- (1) Resource Management Office (RMO).
- (2) Plans, Analysis & Integration Office (PAIO).
- (3) Admin Office.
- (4) Headquarters and Headquarters Company/Detachment (HHC/HHD) (selected installations).
- (5) Civilian Personnel Services (CPAC), Under operational control to the GC

*b.* Installation Support Directorates.

- (1) Human Resources (DHR).
- (2) Family, Morale, Welfare & Recreation (DFMWR).
- (3) Plans, Training, Mobilization & Security (DPTMS).
- (4) Emergency Services (DES).
- (5) Logistics (DOL).
- (6) Public Works (DPW).
- (7) Information Management (DOIM)

- c. Installation Support Offices.
  - (1) Office of the Staff Judge Advocate (SJA).
  - (2) Public Affairs (PAO).
  - (3) Religious Support (RSO).
  - (4) Equal Employment Opportunity (EEO).
  - (5) Safety
  - (6) Internal Review (IRACO).
  - (7) Contracting

#### **17–14. Installation management personnel designations**

AR 600–3, The Army Personnel Proponent System, reflects the following career designations for Army installation management proponenty:

- a. Additional Skill Identifier (ASI) 6Y, Installation Management.
- b. Career Field 29, Installation Management.
- c. Career Field 27, Housing Management.
- d. Career Field 51, Morale, Welfare and Recreation.
- e. Career Field 18, Engineers and Scientists (Resources and Construction) (limited to facilities engineering and environmental management responsibilities).

### **Section VI**

#### **Installation management strategy**

#### **17–15. Army Campaign Plan (ACP) - Transformation**

a. The Army is pursuing the most comprehensive transformation of its forces since World War II. Transformation is a process that shapes the changing nature of military competition and cooperation through new concepts, capabilities, people, and organizations that exploit the Nation’s advantages and protect against asymmetric vulnerabilities to sustain strategic position, which helps underpin peace and stability in the world. Army transformation is an integral component of Defense transformation. The Army Campaign Plan (ACP) directs the planning, preparation, and execution of Army operations and Army transformation within the context of ongoing strategic commitments including the Global War On Terrorism (GWOT). The ACP provides direction for detailed planning, preparation, and execution of a full range of tasks necessary to create and sustain a campaign-capable joint and expeditionary Army.

b. The ACP has two levels of objectives, Campaign Objectives and Major Objectives. Campaign Objectives are clearly defined, measurable, decisive, and attainable goals, which enable the Army to achieve the strategic imperatives, identified within Army Strategic Planning Guidance (ASPG). These strategic imperatives enable the Army to transform through four overarching and interrelated strategies:

- (1) Sustain the Army’s Soldiers, Families and Civilians.
- (2) Prepare Forces for Victory in the Current Conflict.
- (3) Reset Forces to Rebuild Readiness and for Future Deployments and Contingencies.
- (4) Transform to Meet the Demands of Persistent Conflict in the 21<sup>st</sup> Century Through major objectives, the ACP creates an active management system with senior Army leadership for synchronizing execution.

c. In order to provide combatant commanders with tailored, strategically responsive forces that can dominate across the spectrum of conflict in an uncertain threat environment, the Army continues to transform our operating force by building versatile, agile units capable of adapting to changing environments. We continue to convert brigades to more deployable, tailorable and versatile modular organizations while rebalancing our skills to better prepare for the future. This process not only positions us to win today’s conflicts, but it also sets the conditions for future success.

d. To support the operating force, our generating force must become a force driven by innovation, able to adapt quickly and field what our Soldiers and their Families will require. We must transform the business systems of our generating force by developing a fully integrated management system, improving the ARFORGEN process, adopting an enterprise approach and reforming the requirements and resource processes that synchronize materiel distribution, training and staffing. Transformation of the generating force is a key to our ability to effectively manage, generate and sustain a balanced Army for the 21st Century.

e. The Army is repositioning units and transforming posts in one of the greatest structural and basing changes in its long and distinguished history. This effort called “stationing” has created a requirement for over 1,800 individual unit actions through the end of Fiscal Year 2013. The goal of this effort is to posture our forces, logistics activities, and power projection infrastructure to respond to current and future demands as efficiently and effectively as possible. The ACSIM, in coordination with HQDA, G–3 and G–8, support CG FORSCOM, CG USAREUR, and CG USARPAC in developing stationing options for Brigade Combat team (BCT) activations and unit stationing resulting from the 2003 Integrated Global Presence and Basing Strategy (IGPBS) and the 2004 Global Defense Posture Review (GDPR) decisions. The ACSIM directs DCG, IMCOM to program requirements and provide sustainment, restoration and

## How the Army Runs

modernization, and other critical resources for installation support of stationing and basing of BCTs, support brigades, functional brigades, theater armies, and theater subordinate commands. In coordination with gaining ACOM's, ASCC's and DRU's, IMCOM determines investment strategies, resources, and integrated processes to ensure facilities and installation infrastructure support stationing, basing, and deployment support decisions. ACSIM integrates, coordinates, and manages execution of all BRAC actions throughout the Army and expedites and monitors National Environmental Policy Act (NEPA) documentation as required for restationing.

*f.* Another important initiative shaping the Army Transformation is the Department of Defense is the Global Defense Posture Review (GDPR) announced by the President in 2004. Following in the footsteps of the IGPBS, this initiative is a comprehensive review that scrutinizes all aspects of America's global defense posture - including personnel, facilities, infrastructure, equipment, sourcing, and surge capabilities. The goal of this initiative is to ensure that U.S. military capabilities are configured to make them optimally deployable and best able to meet the challenges of the new global strategic environment. The GDPR also helped inform the decisions for BRAC 2005. Conversely, the BRAC process helps align the domestic infrastructure for forces that are returning to or departing from U.S. territory.

### **17-16. Installation Management Campaign Plan**

*a.* The Installation Management Campaign Plan (IMP) document represents the shared vision and supporting strategy of leaders in the Installation Management Community (IMC), including the Assistant Secretary of the Army, Installations, Energy and Environment (ASA (IE&E)); Assistant Secretary of the Army, Manpower and Reserve Affairs (ASA (M&RA)); Assistant Chief of Staff for Installation Management (ACSIM) and the Headquarters, Regions and Garrisons of the Installation Management Command (IMCOM). The IMC Shared Vision has six key dimensions:

- (1) Situational Dominance (situational awareness plus a common situational understanding).
- (2) Roles and Relationships (clarifying roles and exercising discipline in how we get things done).
- (3) Strategic Communications (consistent themes and messages communicated at high frequency across multiple media).
- (4) Fiscal Sustainability (obtaining, managing and executing resources to sustain our mission).
- (5) Leader and Workforce Development (building the bench of leaders and workforce we need today and for tomorrow).
- (6) Energy and Environment (reducing the consumption of energy while preserving the natural environment).

*b.* Purpose and Scope: ICP describes the vision of the Installation Management Community to bring effective and efficient services, programs and infrastructure to bear on the challenges faced by Commanders, Soldiers, Civilians and Families in a fluid operating environment, and the Campaign Plan for achieving that vision. It lays out our strategy, through Lines of Effort and Keys to Success, and metrics by which we will track progress.

*c.* Mission: To provide Soldiers, Civilians and their Families with a quality of life commensurate with the quality of their service.

*d.* Vision: Army installations are the DOD standard for infrastructure quality and they are the provider of consistent, quality services that are a force multiplier in supported organizations' mission accomplishment, and materially enhance Soldier and Family well-being and readiness.

### **17-17. IMCOM Commanders Intent.**

To provide the facilities, programs and services required to support Army readiness, sustain the All-Volunteer Force, and provide the infrastructure for current and future mission requirements. IMCOM will do so through six Lines of Effort: (1) Soldier, Family and Civilian Readiness; (2) Soldier, Family and Civilian Well-being; (3) Leader and Workforce Development; (4) Installation Readiness Safety; (5) Energy and Water Efficiency; (6) Security.

## **Section VII**

### **Major installation management initiatives and programs**

#### **17-18. Strategic communications**

*a.* Strategic communications reflect installation management key themes of taking care of our Soldiers and their Families, supporting SC's and leading transformation. Strategic communications are aimed at external and internal audience segments, each with respective goals and elements. The communications goals for the external audience are to accurately and consistently define and promote installation management and its services with a focus on the organization's contributions to freeing Soldiers to fight while providing quality of life targeted to attract and retain the All Volunteer Force. The goal for communicating with internal audiences is to accurately and consistently inform employees and Garrison Commanders on how they impact the organization's delivery of services to customers in support of Overseas Contingency Operations.

*b.* ACSIM and DCG, IMCOM make every effort to keep garrison commanders and other members of the installation management community informed. ACSIM and IMCOM have established web sites on the Internet at [www.hqda.army.mil/acsim](http://www.hqda.army.mil/acsim) and [www.imcom.army.mil](http://www.imcom.army.mil) respectively that provide news of current initiatives, guidance from the

ACSIM and DCG, IMCOM, and an on-line newsletter as well as links to ACSIM and IMCOM directorate sites, installation websites, and other installation management-related websites

### 17–19. Doctrine

The ACSIM established installation management doctrine with the publication of FM 100–22, *Installation Management*, on 11 October 1994. The doctrine describes how installations support the Army's role in the National Military Strategy (NMS) and warfighting doctrine. It serves as the authoritative foundation for organizing, structuring and managing garrison operations. However, since FM 100–22 does not address Army Installation Management Transformation (AIMT), it is in the process of being revised. The principles for AIMT, however, are delineated in AR 5–3, published 01 October 2004.

### 17–20. Privatization and outsourcing

a. Outsourcing is a powerful tool that the Army uses to re-engineer, streamline, become more business-oriented, and ultimately to make better use of resources. Outsourcing is defined as the transfer of a function previously performed in-house by the activity to an outside provider. Privatization is a subset of outsourcing that involves the transfer or sale of government assets to the private sector that continues to provide the service to the installation.

b. Privatization and outsourcing provide opportunities to leverage technology and achieve cost savings. These management tools can assist in increasing the share of resources applied to other Army priorities such as modernization. The installations conducting studies and implementing initiatives related to these issues are key to the success or failure of the effort. Installations take the broadest possible view of outsourcing, one that explores innovative partnerships with both private enterprise and the public sector, i.e., state/local governments, other DOD/Federal entities, and non-profit agencies. If outsourcing is narrowly viewed as simply contracting out in-house functions, other opportunities for economies and efficiencies will be missed. As privatization and outsourcing opportunities continue to be examined, risks and capabilities must be assessed before taking action.

c. Private industry support is embedded in many of the Army's functions today. Army training, maintenance and other logistics functions, research and development, manufacturing, and base level services are all carried out with substantial industry support. The current Army outsourcing focus is on the DOD effort to address and implement the Commission on Roles and Missions (CORM) recommendations in the areas of depot maintenance, material management, housing, base commercial activities, education and training, data centers, and finance and accounting. The Army is researching and implementing solutions to problems through greater reliance on private industry in other areas as well. Specific initiatives are cited below. The 1996 Defense Authorization Bill, now Public Law 104–106, known as the Military Housing Privatization Initiative, provides the Services with alternative means for construction and improvement of military housing (family and unaccompanied personnel). Under these authorities, the Services can leverage appropriated housing construction funds and government-owned assets to attract private capital in an effort to improve the quality of life for our Soldiers and their Families. This legislation provides a way to maximize use of limited APFs, land, and existing facilities to encourage private sector investment. Under the Residential Communities Initiative (RCI), whose purpose is to achieve the DOD/Army goal of eliminating all inadequate military family housing using:

- (1) Traditional MILCON
- (2) Basic Allowance for Housing (BAH) increases
- (3) Privatization

d. The Army plans to establish long-term business relationships with private sector developers for the purpose of improving military family housing communities. The RCI program leverages appropriated funds and on-post housing assets to obtain private capital and expertise to build, renovate, operate, and maintain adequate Family housing for the long term. The program conveys existing units, and leases the underlying ground, for a 50-year term, to a qualified development partner. The partner collects rent from tenants (military families), equal to the soldier's basic allowance for housing. The Army may make an equity contribution when necessary to ensure adequate funds for the required scope of work. By 2010, over 98 percent of Army housing in the United States has been privatized - over 86,000 units at 45 installations.

e. Owning and operating utilities are not Army core functions. Privatizing installation utilities frees the Army of ownership responsibilities and leverages the financial, technical and management capabilities of public and private utility organizations. The DOD has provided guidance to assist military services and defense agencies in privatizing nearly 1,600 utility systems located on military installations worldwide. The guidance will significantly enhance DOD efforts to privatize its roughly \$50 billion inventory of electric, natural gas, water and sewage utility systems. As a key feature, the guidance requires the military services to use a DOD-approved cost analysis model, which will better evaluate the costs and benefits of privatization. The guidance also supports the DOD goal to upgrade all facilities by fiscal 2010.

f. The guidance and additional information may be found at: <http://www.acq.osd.mil/ie/irm/utilities/utilities.htm>.

### 17–21. Competitive sourcing

a. Competitive Sourcing is a process whose goal is to use competition to obtain the most cost effective commercial

## How the Army Runs

services the Army needs to accomplish its mission. The process is defined in OMB Circular A-76, *Commercial Activities*. Studies are conducted at the installation level, under the guidance of OMB Circular A-76. The circular provides for competition between the government and commercial sources and specifies how to conduct cost comparisons. Army Regulation 5-20 and DA Pamphlet 5-20 provide the Army's policy and instructions for meeting the statutory and other regulatory guidelines. Commanders have access to a variety of lessons-learned and other documented experience, audit and inspection reports, and standard study and contracting documents that can help reduce the work of the study process so that efficiencies and economies can be achieved (See: [http://www.hqda.army.mil/acsim\\_ca/](http://www.hqda.army.mil/acsim_ca/) ).

*b.* In conducting an A-76 competition, installations:

- (1) Develop a Performance Work Statement.
- (2) Streamline the in-house organization into a most efficient organization (MEO) and develop an Agency Tender.
- (3) Solicit bids/proposals from the Agency being competed and private firms.
- (4) Select the lowest bid or best value proposal from the solicitation, and add 10 percent of the personnel-related in-house costs to account for intangible transition costs.

(5) If the result is lower than the "in-house bid," convert to contract; if the result is higher, reorganize into the MEO.

*c.* The FY08 National Defense Appropriations Act brought about fundamental changes to Competitive Sourcing. Most significantly, it removed the requirement to re-compete MEOs at the end of their period of performance (typically five years), and introduced new legislation that requires a review of contracted services to ensure that inappropriate personal services contracts and contracts that include inherently governmental functions are discontinued or in-sourced.

*d.* During FY08, OMB also renamed Competitive Sourcing to Commercial Services Management. The change reflects a broadening of this President Management Agenda initiative to recognize that Agencies can improve performance utilizing alternatives to A-76 competition such as Business Process Reengineering (BPR) and High Performing Organization (HPO) development efforts. Under Commercial Services Management, the Army is now able to improve effectiveness and efficiency by strategically conducting BPR, HPO, and A-76 competition initiatives as appropriate.

### 17-22. Environmental cleanup strategy

*a.* The primary purpose of this Strategy is to identify common objectives for creating consistency and establishing accountability across the Army's Cleanup Program. This Strategy supports the Army Environmental Program and Army Transformation, and it demonstrates the Army's sustained commitment to addressing contamination resulting from past operations. Formerly, the Army managed its cleanup programs under the separate environmental "pillars" of compliance and restoration. This Strategy provides overarching guidance to all cleanup personnel-regardless of the program driver or funding source-indicating that cleanup to protect human health, public safety, and the environment is an integral element of supporting the Army mission. This cleanup strategy is in addition to, but separate and distinct from, the Army Strategy for the Environment, which includes other environmental programs such as conservation and pollution prevention. The IMCOM is the Program Manager (PM) responsible for executing compliance-related cleanup, which is funded through the OMA account, to include funds expended overseas. Beginning in FY09, compliance related cleanup projects at CONUS will become DERP eligible, thus funded by the Environmental Restoration, Army (ER,A) account. During requirements development, requirements pass from installations through the IMCOM using the Army Environmental database for Cleanup (AEBD-CC) process, but validation of requirements occurs at the ACSIM level. In addition, the IMCOM is the PM responsible for ensuring that mission or Army Working Capital Funds (ACWF) used for cleanup are executed in accordance with the strategy's established objectives and targets.

*b.* Headquarters elements of the Army Secretariat and Army Staff develop a comprehensive Army Environmental Cleanup Strategy (AECS) encompassing all cleanup program areas under a unified vision and overarching objectives. Strategy development occurs in consultation with the program managers for each cleanup program area, and is used as Army input to the Defense Planning Guidance. This Strategic Plan presents a framework for AECS implementation that incorporates the ISO 14001 principles of continual improvement. The Army implements this AECS in alignment with its mission priorities using the ISO 14001 process. This process entails five steps that are described below:

(1) Environmental Strategy Headquarters elements of the Army Secretariat and Army Staff develop a comprehensive Strategy (the AECS) encompassing all cleanup program areas under a unified vision and overarching objectives. Strategy development occurs in consultation with the program managers for each cleanup program area, and is used as Army input to the Defense Planning Guidance. This Strategic Plan presents a framework for AECS implementation that incorporates the ISO 14001 principles of continual improvement.

(2) Planning Program managers for each cleanup program area establish guidance and procedures for implementing the Strategy within their respective program area in consultation with the Headquarters Army Staff and relevant installations or USACE Districts. Guidance and procedures include direction concerning MAP preparation for use by installations or USACE District project managers. Stakeholders may provide their input to Army project managers. Program managers also prepare input to the programming and budgeting process described earlier.

(3) Implementation and Operation. Installations or USACE Districts execute cleanup in accordance with guidance and procedures for their respective program area and consult and coordinate with federal and state regulators through

the cleanup process. Public members of Restoration Advisory Boards (RABs) provide advice concerning the cleanup process.

(4) Checking and Corrective Action Program managers check cleanup execution to achieve targets and make corrections as necessary. For example, if targets are not being met, program managers may recommend resource management changes in the planning, programming, or budgeting portions of the cleanup budget process.

(5) Management Review. The Army Secretariat and Headquarters Army Staff review cleanup progress and consider improvements to the AECS and the Strategic Plan, as well as any necessary resource management changes required.

### **17–23. Hazardous Material Management System (HMMS)**

The Army utilizes the Hazardous Material Management System as the standard management information system supporting the business practices of the Army Hazardous Material Management Program (HMMP). It is designed to provide an accurate means of authorizing, ordering, receiving, distributing, and accounting for hazardous materials and their component chemicals, as well as the accumulation and disposition of hazardous wastes at a garrison or depot. HMMS maintains an inventory of all hazardous products, materials, and chemicals on the installation. It also produces data and reports that can assist garrison commanders and managers in reducing or even preventing pollution. HMMS currently supports limited environmental report writing and will be upgraded in the future to produce all required federal, state and local environmental reports.

### **17–24. Toxics management program**

*a.* The Toxics Substances Control Act (TSCA) sets regulations to control the development, commerce, testing, and use of certain potentially hazardous chemicals. Under the TSCA, the U.S. Environmental Protection Agency (EPA) has the authority to regulate the entire life cycle of a chemical, from manufacture to disposal. The toxics management program addresses four key areas that impact the Army: asbestos, lead and lead-based paint, polychlorinated biphenyl (PCBs), and radon. In order to protect the public and the environment from these toxic substances, the Army has implemented management plans, which include:

- (1) Complying with legally applicable and appropriate federal, state, and local regulations on asbestos, lead, PCBs and radon.
- (2) Eliminating the use of potentially dangerous substances, such as lead-based paints containing above .06 percent lead by weight.
- (3) Recognizing potentially harmful situations in renovation and/or demolition projects.
- (4) Establishing contacts for health-related and exposure issues.
- (5) Certifying all persons performing activities that involve these substances.
- (6) Properly disposing of waste containing any potentially harmful substance.
- (7) Budgeting resources to identify, manage, and control exposure to various substances.
- (8) Assessing exposure and risk of each location containing a toxic substance.
- (9) Maintaining and updating records of assessments.

*b.* The Facilities Policy Division of the ACSIM has primary responsibility for most Army toxic management. The AEC assists them in managing environmental issues (disposal) as required. The TSCA management also includes exposure related health risk assessments where the Center for Health Promotion and Preventive Medicine (CHPPM) has the lead in coordination with the Garrison Safety and Environmental Office. The Garrison DPW has the responsibility for resourcing most TSCA related removal actions through demolition, renovation or management in place.

### **17–25. Army Environmental Management Systems and Sustainability Planning**

*a.* Installation Readiness is achieving mission excellence through streamlined processes, strategic partnerships, and good stewardship of resources that address Army priorities and meet the mission requirements of senior commanders. It translates into the ability to provide a growing and transforming Army with the infrastructure and support services it needs to remain a highly effective, expeditionary and campaign-quality force, today and in the future.

*b.* The rapid, continuous rate of change in the current environment requires installations to be resilient and agile. IMCOM will manage installation facilities and provide services to support senior commander requirements throughout the ARFORGEN cycle within the limits of its resources. Installations will improve their ability to meet commanders' needs by embedding Army Communities of Excellence principles into their action planning and by implementing innovative business practices to enhance the relevance of installations to senior commanders' mission success.

*c.* Communities of Excellence are cost-conscious integrators of key sustainability initiatives and communicators that share information and best practices across and between all levels of management. In an effort to communicate these strategies, HQs will provide a systematic approach to converting good ideas, best practices and benchmarked methodologies into quality products and services for its customers.

*d.* Sustainability is a major facet of installation readiness. Today, the interdependence between mission excellence, energy security, environmental stewardship and community relations has never been more apparent. IMCOM will produce an Energy Portfolio, Water Portfolio, and Environmental Portfolio which recognizes successes at installations in each of these areas. IMCOM will emplace a strategy of environmental sustainment through everyday actions, such

## How the Army Runs

as replacing high energy light bulbs or instituting a plastic water bottle reduction program, and through education, incentives and alternatives. The efforts to support installation sustainability will yield multiple benefits for the Army. IMCOM will collaborate with industry and Army Commands to establish installations that are more energy efficient and self-sustaining than in the past. IMCOM will work with our community partners as we pursue sustainability in our long range goals, address encroachment issues and reaffirm our installations as valued neighbors. IMCOM will build healthy, inviting communities and quality housing that allow Soldiers and Families to thrive and will continue to modernize installation training facilities to support Full Spectrum Operations (FSO) training and create training conditions that realistically portray the operational environment. IMCOM will provide training areas and facilities that provide Soldiers with realistic experience, thoroughly preparing them for all contingencies. IMCOM will continue to focus our attention on current and emerging technologies, leveraging opportunities to conserve energy, promote water conservation, reduce waste, preserve natural resources, enhance training realism, and reduce supply chain vulnerability.

*e.* A fully integrated Installation Protection Program will not only protect but enable readiness and resilience of loved ones, facilities, information and equipment at all locations and in all situations. Leaders will ensure adequate prioritization of efforts and funding for all facets of installation protection/emergency management activities (prevention, preparedness, response, recovery and mitigation) as reflected in the National Response Framework.

*f.* A fully capable Emergency Services program provides a safe and secure environment for Soldiers, Family Members, and Civilians working and living on our installations. First responders will be trained, and equipment will be maintained and exercised as required. Risk assessments will be conducted in order to prioritize and fund programs. Community leaders outside our fence lines will be engaged to improve the quality of services available to Soldiers, Families and Army Civilians, improve public awareness and involvement in quality of life issues, and complete joint long-range planning to ensure mutual long-term growth and viability.

*g.* IMCOM will follow a comprehensive Facilities Investment Strategy to manage its facility footprint, improve facilities quality and complete the buy-out of facilities shortfalls in a resource-constrained environment. That strategy will sustain required facilities, focus on increased space utilization, demolish/divest excess facilities, improve existing facility quality and build out facilities shortfalls.

### 17–26. Recycling

*a.* Army installations must recycle to be in compliance with Executive Order 12873, *Acquisition, Recycling and Waste Prevention*, 20 Oct 93; Executive Order 13101, *Federal Acquisition, Recycling and Waste Prevention*, 14 Sep 98; and DOD Instruction (DODI) 4715.4, *Pollution Prevention*, 18 Jun 96. The DODI requires installations to have, or be associated with, a Qualifying Recycling Program (QRP) which is available to all tenants. This recycling policy includes contractors and contractor facilities on installations. QRPs may sell their recyclable materials directly on the open market or through the local Defense Reutilization Marketing Office (DRMO). DRMO will return 100 percent of the proceeds from sales of recyclable materials, including firing range scrap (expended brass and mixed metal gleaned from firing range clearance) to installations with a QRP. Sales proceeds must first be used to reimburse installation-level costs incurred in the operation of the recycling program. The installation commander may then use up to 50 percent of the remaining proceeds for pollution abatement, energy conservation, and occupational safety and health projects. Finally, any remaining sale proceeds may be transferred to the non-appropriated FMWR account of the installation. Additional financial benefits of recycling, beyond the revenues generated, are reduction of current year solid waste handling and landfill costs, extension of landfill capacity, and avoidance/deferral of future landfill costs.

*b.* Installation reporting of recycling activities is captured in the Solid Waste Annual Reporting (SWAR), a data management system designed to facilitate tracking and reporting of solid waste and recycling data at DOD facilities. SWAR combines the tasks of day-to-day tracking and data management, with reporting required meeting DOD regulations. This eliminates the need for installation Solid Waste Managers to enter the same data into two separate systems. SWAR tracks solid waste collection, disposal, and recycling methods at the installation and Command/HQ levels. It provides local data management, upward reporting capabilities, and trend analysis. SWAR Web, a DOD web-based program, calculates diversion rate and economic benefits as required by the DOD Solid Waste Measures of Merit. SWAR Web provides remarkable flexibility in tracking recyclable and disposed materials, and solid waste program costs. Recyclables can be tracked to any degree of detail, by adding material types to a pre-loaded list of materials. Both recycling and disposal transactions can be entered in either weight or volume units. A portion of disposal transactions can be automatically credited to diversion for situations where separation of an installation's solid waste stream is conducted off-site. SWAR Web can accommodate program costs ranging from one-time costs to those spanning multiple years. This program does not apply to Army Working Capital Fund (AWCF) operations.

### 17–27. Army's energy and water management program

*a.* The Army envisions providing secure, efficient, reliable, and sustainable energy and water services coupled with equitable, effective, and proficient management of commodities and site infrastructure to fully support the mission of installations and surrounding communities. Energy management on Army installations is focused on improving efficiency, eliminating waste, and enhancing the quality of life while meeting mission requirements. Accomplishing these objectives will reduce costs and ensure that the program goals are achieved. Executive Order 13423 established the facilities energy reduction goal of 30 percent by FY 2015, using FY 2003 as the baseline year.

b. The Army Energy Strategy for Installations emphasizes energy awareness; working with industry, community, and other stakeholders; investing in innovative technologies; maximizing the use of renewable energy to replace fossil-generated power; and investing in sustainable and energy-efficient facilities. The Strategy sets forth the Army's energy goals for 25 years and the Army Energy and Water Campaign Plan defines the intermediate actions, approaches, initiatives and funding over the 25 years to ensure the Army successfully achieves long-range energy and water management goals. The Strategy sets the general direction for the Army in five major initiatives:

(1) *Eliminate energy waste in existing facilities.* Eliminate and reduce energy inefficiencies that waste natural and financial resources, and do so in a manner that does not adversely impact comfort and quality of the facilities in which Soldiers, Families, Civilians and contractors work and live.

(2) *Increase energy efficiency in new construction and renovations.* Increase the use of energy technologies that provide the greatest cost-effectiveness, energy efficiency and support environmental considerations.

(3) *Reduce dependence on fossil fuels.* Increase the use of clean, renewable energy to reduce dependency on fossil fuels and to optimize environmental benefits and sustainability.

(4) *Conserve water resources.* Reduce water use to conserve water resources for drinking and domestic purposes.

(5) *Improve energy security.* Provide for the security and reliability of energy and water systems in order to provide dependable utility services.

c. The Army Energy and Water Campaign Plan for Installations is a detailed road map for achieving the Strategy. The Campaign Plan:

(1) Provides the way ahead for developing initiatives, approaches and funding strategies to meet the Army energy and water goals.

(2) Identifies tools, technologies, policies, management and institutional requirements to achieve initiatives and approaches.

(3) Describes the desired "end state" for the goals and identifies the metrics of success.

(4) Provides a year-by-year resource requirement and investment plan that coordinates all Army energy/water users and policy components (e.g., security, privatization, procurement, technology, construction, and environment) into cohesive and measurable objectives designed to meet the initiatives.

d. The goals of the Army's energy and water management program are to: be good stewards of energy and water resources; carry out the vision for the Army's future potential; establish guiding principles of operation; meet the goals of the Energy Policy Act of 2005, EO 13423, the Energy Independence and Security Act of 2007 and other goals established by DOD and the Army; deliver the desired outcomes, by synchronizing management and technical support initiatives, and organize and implement strategies to achieve the goals.

## 17–28. Energy Savings Performance Contracts (ESPC)

a. Energy savings performance contracts (ESPC) are partnerships with private sector companies known as energy service companies (ESCOs). These contracts allow installations to improve their infrastructure and implement energy projects while paying for the measures with the guaranteed savings being generated by the project over time (up to 25 years). With the issuance of EO 13423 in 2007, the Army started a review of its use of ESPCs. In order to meet the new milestone of 30% energy reduction by 2015, the Army requires substantial contractor investment to improve Army facilities and reduce energy usage. The Army's current processing rate of awards will not meet the reduction requirement. Perhaps more importantly, ESPCs give Army facility managers a solution to facility problems with minimal up-front cost. Applied with care and consideration, ESPCs can help facility managers:

(1) Reduce equipment breakdowns and emergency repair requests.

(2) Provide better, more productive living and working conditions for our people.

(3) Reduce costs.

(4) Meet environmental mandates such as CFC phase-out.

(5) Save energy and meet management goals.

b. The Energy Independence and Security Act of 2007 permanently reauthorized Energy Savings Performance Contracts.

## 17–29. Army environmental restoration program

a. The Army's Installation Restoration Program (IRP) for active and excess installations has a goal to complete the cleanup of 1,080 installations by the end of FY14. Installation restoration is the Army's environmental program that addresses the cleanup of contaminated Army property from past practices. The installation restoration mission is to perform appropriate, cost-effective cleanup so that the property is safe for use and to protect human health as well as the environment. Currently, the Army has achieved 90 percent of the goal at a cost of \$4.9 billion. The IRP is part of the DOD Defense Environmental Restoration Program (DERP) that was formally established by Congress in 1984 under Title 10 USC 2701–2707 and 2810. The IRP provides centralized management for cleanup of hazardous waste sites consistent with provisions of the *Comprehensive Environmental Response, Compensation, and Liability Act of 1980 (CERCLA)*, as amended by *Superfund Amendments and Reauthorization Act of 1986 (SARA)* and certain corrective actions required by the *Resource Conservation Recovery Act (RCRA)*.



## How the Army Runs

b. The IRP is funded by the Defense Environmental Restoration Account (DERA), established by Section 211 of the SARA. The IRP complies with state, regional and local requirements applicable to the cleanup of HAZMATs substances released to the environment. Installations perform only essential studies necessary to ascertain the need for remedial action, identify the preferred remedial alternative, and implement the selected remedial action. The IRP has the following goals:

- (1) Reduce risk to acceptable levels to protect the health and safety of installation personnel and the public.
- (2) To restore the quality of the environment.

### 17–30. Army conservation program.

The Army's conservation program, with overall guidelines detailed in AR 200–1, is focused on compliance with a wide variety of natural and cultural resource laws. The program's goals outlined therein are to: manage installation natural resources to provide the optimum environment which sustains the military mission; develop, initiate, and maintain progressive programs for land management and utilization; and maintain, protect, and improve environmental quality, aesthetic values and ecological relationships. Major areas of conservation compliance fall within the *Sikes Improvement Act of 1997*, *Endangered Species Act of 1973*, *Clean Water Act*, *National Historic Preservation Act*, *Native American Graves Protection and Repatriation Act*, *American Indian Religious Freedom Act*, *Archeological Resources Protection Act* and the *Federal Insecticide, Rodenticide and Fungicide Act*. The Army Conservation Program emphasizes the integration of compliance requirements into natural and cultural resources management plans. These required plans are designed for installation commanders to make informed decisions regarding the management of natural and cultural resources to enable maximum short and long term availability of Army lands for mission use and ensure compliance with law.

### 17–31. Military construction army (MCA) program

a. MCA is the program by which Army facilities are planned, programmed, designed, budgeted, constructed, and disposed of during peacetime and under mobilization conditions. The program also includes the acquisition of real estate and other supporting activities. Installation commanders may see MCA projects completed and occupied on their installations that were initiated by a predecessor, or previous commanders. Normally an installation commander will plan and program projects that will not be completed during his/her assignment. The HQ DA and the ACOM's, ASCC's, or DRU's issue programming guidance with the expectation of submittal of MCA projects in November/December timeframe. It will likely be more than 36 months from the project submittal date before construction of an MCA project would begin, and another 18 to 24 months for construction to be completed.

b. Because of the length of time involved in the process, and because of the competitiveness of the process, the installation commander must be farsighted and determined in programming MCA projects, especially in the current fiscal environment. He or she must be farsighted in order to envision, plan, and program years ahead of the projected requirement, and must be determined in order to fully justify and support a project through the planning and programming years.

### 17–32. Army facility reduction program

a. The Army Facility Reduction Program (AFRP) was established in fiscal year (FY) 92 by the Department of the Army. Its purpose is to reduce excess building square footage within the Army. Budget cuts have forced the Army to be more efficient with allocated funds. This has served as an incentive to identify and demolish excess buildings to allow the Army to focus maintenance and repair funding only on the buildings that have a longer useful life. This mandated program applies to all Army installations throughout the United States. As with the BRAC initiatives FRP seeks to realize a more efficient and cost-effective management and utilization of installation assets and infrastructure.

b. In May 1997, the OSD issued Management Reform Memorandum (MRM) #8 that endorsed the Army's emphasis on the demolition of excess facilities. OSD required the services to submit a list of excess facilities and plan for disposal. OSD subsequently issued Defense Reform Initiative Directive (DRID) #36 in May 1998, which resulted in the disposal of 80 million square feet (MSF). OSD is continuing this initiative and has identified 9 MSF per year to be eliminated by the Army from FY 2008 through FY 2013. The Facility Reduction Program (FRP), managed by the Army Corps of Engineers Huntsville District, assists the DPW on Army installations in the removal of facilities, which are excess and no longer meet today's standards. The FRP is responsible for the removal of facilities with Operation and Maintenance (O&M) funds for the active and reserve components. One for one demolition is a requirement for MILCON projects. This requires one square foot of demolition for each square foot of new construction. If an installation does not have enough excess facilities on the installation to meet the one for one requirement they need to request the HQDA managed demolition bank to cover the requirement. Facilities within the footprint of the MILCON project should be included in the cost of the MILCON project. Also, if the MILCON is replacing a dilapidated facility then that facility's demolition should be included in the MILCON project regardless of whether it is in the footprint or not.

c. The FRP's responsibility for the removal of installation facilities includes the requirement of sharing information with installation decision-makers. Continuous evaluation of methodologies and practices, and cutting-edge studies and programs creates a growing body of "best practices" knowledge which is consolidated on the FRP Toolbox Web site:

<https://frptoolbox.erd.usace.army.mil/frptoolbox>. This compilation/sharing are part of the FRP's mission directive. The information is also designed to provide guidance in calculating which method of demolition or deconstruction will best serve each individual removal situation.

### 17–33. Revitalization of housing

a. The Secretary of Defense directed the Services to eliminate all inadequate family housing by FY 2007. Later this goal was re-set to 2007 for U.S. and 2009 in foreign areas. The annual FY 2000 Military Construction Appropriations Act (Public Law 106–52) directed each Service to submit a Family Housing Master Plan (FHMP) to demonstrate how they will meet the Secretary's goal. The Army's FHMP provides a centralized plan for programming and execution required to eliminate inadequate housing. It encompasses the management of assets, the distribution of resources, and schedule for investment and privatization projects. The Army submitted their first FHMP to Congress in June 2000, which used a combination of traditional MILCON, operation and maintenance support, as well as increased reliance on privatization to reach the goal. Although an annual update was required, the most recent FHMP was completed in 2004. Since then, the Army has included metrics in each annual budget submission (i.e. PRESBUD) which substitutes for a stand-alone FHMP. The Army has sufficiently funded AFH to meet this goal of eliminating all inadequate family housing. When family housing at an installation is privatized, all units are removed from the Army inventory, both adequate and inadequate units. When stationing decisions create apparent shortfalls, the Army adjusts each annual plan. As of the end of FY 2008, almost 98 percent of the owned family housing in the fifty states had been privatized.

b. As for the barracks program, Public Law 105–621, *the Strom Thurmond National Defense Authorization Act for FY 1999*, requires the Secretary of Defense to provide an annual report to Congress on the Services' plans, and estimated costs, to improve housing for unaccompanied members. The Army has plans to fund elimination of inadequate permanent party barracks by FY 2013, and to eliminate inadequate trainee barracks by FY 2015. For each goal, funding provides usable facilities on the ground (i.e., 'beneficial occupancy') two years after the funding year. Barracks are known more formally as Unaccompanied Personnel Housing (UPH), and include Unaccompanied Enlisted Personnel Housing (UEPH), and training barracks (both permanent party and trainee).

c. Revitalization gives new life to old facilities; it is the cornerstone of the Army's vision to provide excellent facilities. For barracks complexes and infrastructure, the Army must revitalize systematically, so that the facilities are repaired, upgraded to modern standards, or replaced. The ACSIM has developed programs to focus scarce resources onto barracks revitalization so that the greatest benefit is achieved.

(1) *Army Barracks Modernization Program*. The Army's Barracks Modernization program combines funding from Military Construction (MILCON) and Operations and Maintenance Army (OMA) dollars to modernize all permanent party barracks to the current DOD standard — a standard configuration module of two bedrooms and a shared bath, with cooking area with appliances. The complex includes laundry facilities. To offset increased construction costs, the separate Soldier community building was eliminated. Started in FY 1994, the Army Barracks Modernization Program upgrades permanent party enlisted unaccompanied personnel housing through two programs: the Whole Barracks Renewal Program (WBRP) and the Barracks Upgrade Program (BUP). The WBRP is a MILCON-funded program primarily for new construction. The BUP is a centrally funded Operation and Maintenance, Army (OMA) Real Property Management (RPM) program predominantly for major renovations of earlier style barracks, like those from the Volunteer Army era, where they get their name 'VOLAR.' The Army renovates these older barracks to the DOD '1+1' barracks standard where it is more cost effective than replacing the entire building. This '1 + 1' standard module prescribes 11 square meters (118.4 square feet) of net floor area for living and sleeping quarters. Each module is composed of two individual living/sleeping rooms with closets, and they have a shared bath and kitchenette service area. Each module will normally house two Soldiers up to rank of Corporal or Specialist (pay grade E–4) or one Sergeant or Staff Sergeant (E–5 or E–6). The OSD has allowed each of the Services to alter their arrangement where missions, or overall conditions, dictate. The BUP has modernized more than 21,000 barracks spaces through FY 2008 at a cost of more than \$900M.

(2) *Training Barracks Modernization Program (TBMP)*. The Army's TBMP has the goal to buyout all inadequate training barracks by FY 2015. This has a goal to rid the Army of all old 'World War II wood' barracks and operations buildings and a project for a basic training complex integrates buildings for barracks with those for operations, training, and dining. As a subset of this program, the Training Barracks Upgrade Program (TBUP) uses OMA funding to modernize existing barracks. In FY 2007 and FY 2008, The Army modernized more than 7,000 trainee spaces for less than \$300M.

(3) *The Training Barracks Improvement Program (TBIP)*. This TBIP is an extension to the Barracks Improvement Program to repair Initial Entry and Advanced Individual Training barracks, cadet barracks, and some Reserve Component barracks to correct health and safety issues using Operation and Maintenance, Army (OMA) funding. For example, in FY06 alone, more than \$200M was provided to fix buildings at 19 sites.

(4) *Whole neighborhood revitalization*. Finally, for Family Housing, the Whole Neighborhood Revitalization (WNR) initiative supports the Secretary of Defense three-prong initiative to improve Family Housing to: eliminate out-of-pocket housing expenses for Soldiers living in private housing in the United States, increase the use of housing privatization, and continue to rely on traditional MILCON when practical. Projects are based on life-cycle economic analyses and funded by AFH. In foreign areas, privatization is impractical, so WNR is the only alternative to replacing

## How the Army Runs

housing facilities, which is far more costly. Over the years, various requirements have been added to military housing (e.g., fire extinguishers, sprinklers, and hardening for ATFP). These added requirements make revitalizing the older buildings a far less economic alternative to replacing those existing buildings with new houses built to the new standards.

### 17-34. Army Stationing and Installation Plan (ASIP)

*a.* The ASIP is the official Headquarters Department of the Army (HQDA) database for installation planning population and is the basis for determining facility requirements and Base Operations Support (BOS) services by location to support Army Soldiers and Families. ASIP reporting is outlined in Army Regulation (AR) 5-18, Army Stationing and Installation Plan Guide, and in quarterly technical guidance to the Installation Management Command, Army National Guard and US Army Reserves.

*b.* The ASIP is based on the official HQDA force structure authorizations, and therefore provides population for the current year and six planning years. ASIP integrates force structure documented in the Structure and Manpower Allocation System (SAMAS), The Force Management System (FMS), and the Defense Readiness Reporting System-Army (DRRS-A).

*c.* The ASIP includes Active and Reserve Component military and civilian population, students, trainees, transient loads, tenants, and contractors by location.

*d.* The Army Training Resources and Requirements System (ATRRS) is the source of the student and trainee loads by course and course location. These loads include Temporary Duty (TDY) students, Permanent Change of Station (PCS) students, Basic Training (BT), One Stop Unit Training OSUT), Advanced Individual Training (AIT), and Reception loads.

*e.* The ASIP also includes Tenants Other Than Army (TOTA) assigned and supported at each location including other Military services, Department of Defense (DOD) agencies, Federal and State agencies, private organizations, transient/rotational loads and contactors. This tenant population is input by each reporting location. The ASIP is updated quarterly after reconciliation with HQDA G3 Force Management and certified annually by the Army Garrison. The ASIP provides key baseline data used to generate facility requirements in the Real Property Planning and Analysis System (RPLANS), supports stationing and re-location analysis, estimates school age dependents, and supports BOS service measures. ASIP data is used to respond to Congressional inquiries related to population increases/decreases and local school impacts.

### 17-35. Real Property Planning and Analysis System (RPLANS).

*a.* The RPLANS is the Army's automated master planning tool that generates facility allowances by location for the current year and six planning years using the Army force structure, ASIP population, space planning algorithms, marriage rates, and DOD cost factors. Space planning algorithms used by RPLANS are developed and reviewed annually by the HQDA functional proponents for each facility type.

*b.* The RPLANS produces a Tabulation of Existing and Required Facilities (TAB) required by AR 210-20, Real Property Master Planning for Army Installations. The TAB identifies facility excesses and shortfalls by facility type (category code) and location and calculates a buyout cost to build out the facility deficit with new construction.

*c.* RPLANS includes a planning module that supports stationing analysis associated with moving units in accordance with AR 5-10, Stationing. RPLANS calculates the cost and impacts of moving a unit from one location to another or to a new location (green grass). The planning module can also be used to prepare installation master plans and conduct "what if" drills related to changes in the composition of unit personnel and equipment and the effects on facility allowances.

*d.* RPLANS is updated quarterly. Each Active and Reserve Component (RC) reporting location has the ability to edit RPLANS facility requirements to reflect local needs. Edits must be entered to reflect facility requirements associated with tenant organizations; other military services, DOD organizations, Federal/State agencies, private organizations, and contractors that by contract are provided space in Army facilities.

*e.* RPLANS data is used to justify and prioritize new construction projects for the POM, to develop the quantity rating for the Installation Status Report- Infrastructure (ISR-I), to conduct unit stationing and re-location analysis, to prepare the Army's facility strategy, to populate Facility Assessment Charts, and support development of installation master plans.

### 17-36. Installation Geospatial Information & Services (IGI&S)

*a.* The Army's IGI&S program is focused on improving the Army's geospatial business practices through a centralized approach that will decrease operational costs and reduce unnecessary work and rework. The IGI&S program and mission is based on four cornerstone goals:

- (1) Provide baseline geospatial capability across the Army Installation Energy & Environment (IE&E) domain
- (2) Develop standardized IE&E geospatial data and tools through an enterprise Architecture
- (3) Increase the availability of geospatial capabilities across the Army
- (4) Reduce redundant Army IE&E geospatial capabilities

b. IGI&S is a capability for capturing, displaying, and analyzing geographically referenced information to support installation management. It consists of hardware, software, people, and data referenced to a location on the Earth's surface. It is also a program to ensure IGI&S capabilities are readily available to support efficient and effective operations of Army installations. Business mission areas include base planning and management operations, environmental management, emergency planning and response, and training and ranges. The program is led by the Office of the Assistant Chief of Staff for Installation Management (OACSIM) which provides IGI&S policy, guidance and standards. IMCOM G6 is responsible for executing the Army's IGI&S program's enterprise geospatial solution - Army Mapper.

c. The Army Mapper system, located at <https://mapper.army.mil>, supports the functional implementation of the goals and objectives of the IGI&S program. Army Mapper is the enterprise geospatial system for the Army's IE&E Domain whose goal is to provide a current and consistent picture of the Army's installation assets. It provides the infrastructure foundation for secure sharing of geospatial capabilities and data in accordance with Army and DOD enterprise architecture standards. As the geospatial database of record, Army Mapper's common tool set directly supports Army business system requirements through centralized access to geospatial data stored, managed, and maintained centrally. Army Mapper supports every commander, civilian, Soldier, and supporting contractor who needs IGI&S.

### 17-37. Installation Status Report (ISR)

a. The ISR Program assists the Army leadership in making informed and responsible decisions required to sustain or improve the management of the installation's facilities, environmental programs, and services. The program provides HQDA, Army Commands, Army Service Component Commands, Direct Reporting Units, and the leadership of reporting installations with executive level information focused on the installation's real property assets, major environmental programs, and installation support services.

b. The ISR is comprised of three components:

(1) **ISR Infrastructure.** The purpose of ISR infrastructure is to document and display an ISR reporting installation's infrastructure status by assessing the quantity of facilities available for installation requirements and comparing the quality of installation facilities to established Army standards.

(2) **ISR Natural Infrastructure.** ISR - NI will focus on three Program Areas: Mission Support, Sustainability, and Environmental Quality. It is designed to give a comprehensive overview of the current environmental compliance status of Army installations, and decision support information on the capacity and capability of the Army's natural infrastructure assets (Land, Water, and Air) to support the current and future mission.

(3) **ISR Services.** This ISR-S component focuses on evaluating quality, efficiency, and availability of services provided on an installation. Since July 1993, OACSIM has used Installation Status Report Services (ISR-S) performance and cost data as the basis for developing the Base Operations Support (BOS) requirements.

c. The ISR program provides an overall picture of an installation's status and shows how deficiencies are the "pinnacle" of the system. The Army's Scorecard or Mission Map was approved by the CSA on 13 in installation condition affect the environment and mission performance. It provides information which links installation conditions, priorities and resources to readiness. While serving the needs of different customers—HQDA, Army Commands, Army Service Component Commands, Direct Reporting Units, and installations—the ISR is also the installation commander's opportunity to influence the Army's Installation Management strategy. The ISR provides a common standard and language for the Army to speak with one voice. Details concerning the ISR are contained in AR 210-14, *Installation Status Report Program*. Additionally, ISR data supports HQDA decisions on funding for the Strategic Readiness System (SRS). The SRS is an integrated strategic management and measurement system developed by the Army G3. The system uses the Balanced Scorecard approach and the Army's overall scorecard March 2002. The objectives of the SRS are to:

- (1) Communicate in a single document the Army's Strategy, Vision, Priorities, and Focus.
- (2) Evaluate the readiness of all Army elements against their ability to accomplish the strategy.
- (3) Focus on results - reported against performance measures - to assist in making policy and resourcing decisions.
- (4) Enable leaders to use leading indicators to plan policy and resource decisions.
- (5) Link Strategy/Purpose/Mission to day-to-day activities throughout the Army.

### 17-38. Base realignment and closure (BRAC)

a. BRAC is the process used by DOD to resize and reorganize its installation infrastructure to more efficiently and effectively support its forces, increase operational readiness and facilitate innovative ways of doing business. BRAC also allows the Army to re-allocate resources from closed or realigned installations to other high priority requirements. The FY 2002 Defense Authorization Act included the authority to conduct a fifth round of base closure and realignment actions—as Congress did four times from 1988 to 1995—which was concluded in 2005.

b. The Army's BRAC 2005 strategy and process supported the development of recommendations that will enhance Military Value, streamline the Army, both Active and Reserve Components, rebalance these forces, contribute to Joint operations and Joint business functions, and reduce facilities cost of ownership. These recommendations maintain

## How the Army Runs

necessary surge capabilities in both the operational force and the industrial base, enhance homeland defense missions, and continue the transformation to a more relevant and ready Joint and Expeditionary Army.

c. Under BRAC 2005, Army will close 12 Active Component installations, one Reserve Component installation, 387 Reserve Component installations and eight leased facilities. BRAC 2005 realigns 53 installations and/or functions and enables the Army to establish multi-component Headquarters, Joint and Army Training Centers of Excellence, Joint Bases, Joint power projection platforms, a Human Resources Center of Excellence, and joint technical and research facilities. To accommodate the relocation units from the closing Reserve Component installations, BRAC 2005 authorized 125 multi-component Armed Forces Reserve Centers and realigned the Army Reserve command and control structure.

### 17–39. Managing installations to standards

a. Managing to standards. Installation readiness is an important aspect of the Army Vision and the Army's Transformation process, which is an integral part of the Army's Campaign Plan. As Army Transformation evolves and progresses, we must:

- (1) Focus investments to gain the most benefit from limited resources.
- (2) Identify required infrastructure and support services necessary for the desired level of readiness.
- (3) Make a dedicated effort to stop further deterioration of existing infrastructure and prevent erosion of services.
- (4) Target limited modernization dollars to mission critical and well being requirements.

b. Army Base Operations (BASOPS). A viable standard process for determining Mission/Base Operations military construction projects is a fundamental condition for the success of managing installations to standards. The streamlined components of this process include the following actions:

(1) Garrison Commander forwards the Senior Commander's (SC) prioritized listing of all projects to the IMCOM Region.

(2) Region prioritizes all BASOPS projects within their Region and forwards to HQ IMCOM.

(3) HQ IMCOM prioritizes all BASOPS projects and forwards to ACSIM.

(4) Army Commands, Army Service Component Commands, or Direct Reporting Units prioritize all their mission projects and forward prioritizations to ACSIM.

(5) Army Commands, Army Service Component Commands, or Direct Reporting Units may offer their suggested prioritization of BASOPS projects for installations where the SC reports to the Army Commands, Army Service Component Commands, or Direct Reporting Units. This suggested prioritization would be forwarded to ACSIM and IMCOM.

(6) Upon receipt of prioritized project listing from the Army Commands, Army Service Component Commands, Direct Reporting Units and HQ IMCOM, and using guidance provided by Senior Army Leadership, ACSIM builds the corporate Army prioritized project listing.

(7) ACSIM forwards the corporate Army prioritized project listing through the Army G-3 to the VCSA for approval. This listing will contain the Army Commands, Army Service Component Commands, or Direct Reporting Units mission project prioritizations and their suggested prioritization of BASOPS projects. The IMCOM's prioritization of BASOPS projects will also be included.

c. Establishing Standards. The Army's installation long-range plan conveys direction for installation management during the next 20 plus years. The plan identifies efficiency programs, determines funding requirements, and describes the metrics used to measure success. The goal of the plan is to provide quality, cost-effective, and efficient mission-ready installations that are the right size, in the right place, and available when needed. Management planning for installations focuses on streamlining, realigning and standardizing services and the workforce, recapitalizing investments and reducing costs. For this purpose, ACSIM acts for and exercises authority of the CSA in dissemination of policy and integration of doctrine pertaining to the operation of Army installations. The ACSIM/IMCOM is responsible for establishing performance metrics and implementing Army-wide standards for installation management and BASOPS.

d. Common Output Level Standards (COLS):

(1) Common Output Level Standards (COLS) is a DOD initiative intended to create common language and toolsets for common delivery of installations support applicable across all U.S. military installations in a host-tenant relationship. The COLS framework is intended to assist DOD Components in apportioning and managing limited resources. The military components have different service delivery expectations and standards. As a result, the service delivery is measured by different metrics. OSD must evaluate and establish common service delivery standards for operations in a joint environment in order to meet each component's mission specific and base support requirements. Common Output Level Standards (COLS) is this framework of common delivery standards, metrics and costs for installation services. This framework articulates common standards for service delivery, metrics, cost of service delivery, and high-level host-tenant relationship in a joint military component environment. This support includes professional program management services, data collection, and data analysis.

(2) The Office of the Secretary of Defense is in the process of determining how best to deliver installation management services in situations where two or more military components are stationed together on the same

installation. OSD is especially interested in examining how services common among the military components can be delivered more effectively and efficiently in this joint environment. OSD has established a working group made up of members from each of the military components to address this issue. This group has authored a draft DOD Directive that provides “DOD policy for the Common Delivery of Installations Support in order to enhance joint utilization of national infrastructure assets through the efficient delivery of common installation services in a consolidated manner.”

*e.* Common levels of support (CLS).

(1) CLS is a decision process that enables successful uniform delivery of the Army’s highest priority installation services, within available funds. The CLS process is based on a comprehensive understanding of the Army’s Base Operations Support (BOS) services, standards, and costs. CLS provides the Army with the ability to:

- o Provide definitive performance guidance to Garrisons for the execution of core services delivered to standard, based on available funding
- o Distribute available resources among installations to execute the guidance
- o Measure Garrison performance to make sure that expected performance is being achieved
- o Inform customers on the levels of support they can expect from Garrisons across the Army.

(2) CLS is built on the principle that IMCOM installations will provide non-reimbursable Base Operations Support (BOS) to Army customers across all its installations. This support will be standard but adaptable to local realities for the installation (e.g., requirements of mission, demography, or geography).

(3) Garrisons are required to deliver installation management support services IAW with the Army’s Installation Status Report (ISR) - Services program, which specifies content and pacing measures for each service component. The total dollar requirement for garrisons to deliver these services is calculated to fund the full scope of service as defined in the ISR. However, garrisons historically do not receive 100% of the required dollars for each service. Garrisons therefore cannot deliver the full scope of services, and must have some way of determining which service components can be delivered with the dollars available. CLS provides the approach for making this decision across the Army, in a way that will lead to quality, consistency, and predictability.

*f.* Army Baseline Standards. The effort to develop performance-based measures initially was focused on those ISR services where the quality of the service provided was felt to be a key to the resourcing required and potential performance measures could easily be identified. For these services, quality was expected to play a significant role and was needed to supplement the data from Army Service Based Costing (SBC) - a model to capture the cost of base operations at the service level - to facilitate development of good cost estimating relationships (CERs) for resource program development purposes. That effort resulted in performance measures and standards for almost all 95 standard services developed by the Army Baseline Standards Task Force appointed by the ACSIM in late FY03. The resulting standards have been developed into performance measures that are included in the ISR.

*g.* Army Installation Design Standards. Provide the mandatory common facility and infrastructure standards for all Army installations. The Installation Design Standards (IDS) enables a roadmap for efficient, harmonious, secure and visually compatible physical environment conducive to attracting and retaining skilled and motivated personnel. They foster a culture of innovation through continuously improving living and working facilities and spaces by incorporating enhanced facilities standards and emerging technologies into everyday business practices. IDS improve predictability and quality of life for our Soldiers over the long term and contain Army Standards (mandatory facility functional criteria) and Army Standard Designs (notional layout and mandatory design items) for key facility types. These standards cover site planning, buildings, circulation (vehicle and pedestrian movement), landscaping, site elements (signage, lighting, etc.), and protection warfighting function. It is also designed to serve as a model from which Army installations, using the required Army standards and guidelines given throughout the document, can build their installation specific Installation Design Guide (IDG), as a tool for implementing the Army Installation Design Standards. The IDG, in conjunction with mission requirements and technical designs and specifications, defines the requirements for an installation’s maintenance, repair, and construction projects. When executed, these projects improve the functional and visual aspects of Army installations. Every installation will have an IDG governing the improvement of quality on an installation’s facilities and infrastructure. Quality is dependent upon the standards implemented, appearance of the lay out, and physical components of the installation. The IDG is a comprehensive reference source providing standards for that quality. Use the IDG for design decisions on all new construction, renovation, maintenance and repair projects. The Army IDG template provides installations with a format, Army-wide standards, and examples to follow in preparation of their own IDG.

## **17–40. Institutional Adaptation.**

*a.* Institutional Adaptation is the next stage in Army transformation. Its goals are to improve Army Force Generation (ARFORGEN), adopt an enterprise approach to strategic decision-making and reform the requirements and resource processes. By organizing around the Army’s core process, ARFORGEN, Institutional Adaptation enhances the Army’s versatility in response to a complex strategic environment. It isn’t a change to organizational structure but is instead a drive to improve collaboration, synchronization and integration across the entire force. Improved cooperation will yield better decisions faster and lead to increased predictability and reduced turbulence for our Soldiers and Families.

*b.* The Services & Infrastructure Core Enterprise (SICE) provides essential services, infrastructure, and operational support worldwide to enable an expeditionary Army and sustain Soldiers and their Families. SICE integrates Army

## How the Army Runs

services, infrastructure, and operational support functions and organizations to gain economies of scope and scale, increased efficiency, and improved effectiveness in support of ARFORGEN.

(1) Leadership: ASA (I&E), VCSA and Commanding General, IMCOM.

(2) Focused output: At the strategic level, the SICE develops and subsequently uses an Army Services and Infrastructure Strategy to advise the SA on services and infrastructure issues that sustain readiness and preserve the All Volunteer Force. At the operational level, SICE provides essential services, infrastructure, and operational support enabling an expeditionary Army to support ARFORGEN and sustain Soldiers and their Families.

(3) Stakeholders in the SICE:

(a) US Army Reserve Command (Office of the Chief of the Army Reserves).

(b) US Army National Guard (Director, ARNG).

(c) U.S. Army Medical Command, (Office of the Surgeon General).

(d) U.S. Army Corps of Engineers (Office of the Chief of Engineers).

(e) U.S. Army Intelligence and Security Command (G2).

(f) U.S. Army Network Enterprise Technology Command (G6).

(g) US Army Criminal Investigation Command (Office of the Provost Marshal General).

(h) Army Corrections Command, (ACC).

(i) US Army Combat Readiness Center (Tentative).

(j) Office of the Judge Advocate General (OTJAG).

(k) Finance Command (Tentative).

(l) EEO Civil Rights Office (Tentative).

### 17–41. IMCOM Transformation

a. The transformation and relocations of IMCOM's Headquarters and Regions realigns IMCOM's organizational structure, strengthens customer service focus on mission and requirements, and institutionalizes an enterprise mindset based on collaboration and communication with supported organizations. Key elements include:

(1) A transfer of functional capability from Regions to the Headquarters to create a series of dedicated, region-focused Functional Support Teams (FSTs) collocated with the Headquarters core staff. This transfer affords the Region Director and staff more time to focus on directing garrisons to best support the Senior Commanders' priorities.

(2) Narrowing the span of control that exists today by employing RISTs to coordinate between the Region and a limited number of garrisons (typically three to six). The RIST to FST relationship will strengthen lines of communication by prioritizing the Region Director's issues to the Headquarters and ensuring the Region receives the support needed to respond to Senior Commanders' requirements. Garrison structures and service delivery do not change, nor does the relationship among the Garrison Commander, the Senior Commander, and the IMCOM Region Director.

b. IMCOM at End State:

(1) Garrisons: Garrisons retain their current structure and functions, with manning levels determined by installation size and mission. The Garrison Commander's role and relationship to the Senior Commander does not change. At each Region, dedicated groups of highly skilled professionals (RISTs) will represent garrisons. As the Region Directors' representatives, the RISTs facilitate resolution of problems, advocate on behalf of assigned garrisons and help integrate work efforts. They are the garrison staff's avenue to IMCOM Headquarters for issues requiring command intervention. Garrisons will gain a greater ability to deliver services through these Region enablers.

(2) Regions: Regions were originally set up as extensions of the IMCOM Headquarters; the transformed Regions will integrate a management structure used successfully by many Fortune 500 Companies. The four structurally identical Regions will consist of multiple RISTs that typically support three to six garrisons.

(3) The Region Director, supported by the Command Sergeant Major, provides the necessary leadership to ensure garrisons implement IMCOM's strategic goals and objectives as well as the Senior Commander's priorities. The Region Director and Region staff:

(a) Collaborate with Senior Commanders, Army Service Component Commands (ASCC) and supported commands to mitigate risks, set priorities, and keep commanders informed.

(b) Set purpose and direction necessary to sustain capabilities, services, and flexibility.

(c) Resolve issues at the lowest effective level.

(d) Maintain control over Region resources and champion garrison resource requirements.

(e) Direct and evaluate garrison progress using appropriate metrics and tools.

(f) Prescribe professional development for the Region workforce.

(4) The Region Director remains the Garrison Commander's rater and the command's principal connection with Senior Commanders. The revised structure reinforces the Region Director's ability to represent supported commands while directing, coaching, teaching and mentoring Garrison Commanders and staff.

c. IMCOM Headquarters: IMCOM Headquarters relocated to Fort Sam Houston, where it houses the majority of the command and staff, including its subordinate commands FMWRC and AEC. In close coordination with the Regions and garrisons, FMWRC and AEC continue to provide mission-specific support across the Army enterprise. Liaison

Offices will relocate when the Army Commands they support (FORSCOM, TRADOC and AMC) move to their new BRAC locations.

#### **17–42. Business Transformation**

*a.* The Army's Business Transformation mission is to fundamentally change how the Army does business by applying proven business principles to the Army's business processes in order to effectively and efficiently provide the necessary capabilities to the Combatant Commanders in support of National Security and Defense strategies. The overall goal of Army Business Transformation is to streamline or eliminate redundant operations to free financial and human resources to redirect to the core warfighting mission. With that goal in mind, the objectives of Business Transformation Governance are:

- (1) Identify the policies, business rules, roles and responsibilities through which Business Transformation will be governed.
- (2) Establish and maintain alignment between Army strategic guidance and Business Transformation.
- (3) Implement the decision processes, controls, and enforcement necessary for Business Transformation.
- (4) Integrate Business Transformation Governance with existing OSD and Army decision processes, and where necessary modify existing Army processes.
- (5) Establish performance management and measures, timelines and milestones to track Business Transformation progress.
- (6) Define Enterprise Process Portfolios that enable Army capabilities, and make decisions to approve, continue, or terminate initiatives in the portfolios based on performance measures and risk analysis.
- (7) Baselines, simplify, and ultimately optimize Enterprise Process Portfolios in support of Army capabilities.
- (8) Enable the culture of innovation in the Army that challenges the status quo and seeks Continuous Process Improvement.

*b.* In keeping with the Army's Business Transformation strategy, IMCOM is deploying Lean Six Sigma (LSS) to evaluate business processes and to increase productivity and reduce costs. These efforts will maintain or improve the quality of service offered by IMCOM to effectively respond to Soldiers, families and Army Civilians who live and work on Army installations. LSS is a business improvement methodology that maximizes shareholder value by achieving the fastest rate of improvement in customer satisfaction, cost, quality, process speed, and invested capital. LSS is a combination of two business improvement techniques, Lean and Six Sigma. Lean focuses on eliminating waste and constantly shortening the cycle time. On the other hand, Six Sigma has a focus on quality and variability reduction. The combination of the two, Lean Six Sigma, methodologies helps improve lead time, cost and quality. Lean Six Sigma is IMCOM's primary method for business transformation to Improve effectiveness, increase productivity while maintaining quality to standard, improve customer satisfaction and enable a culture of continuous process improvement through Lean Six Sigma training and execution. IMCOM will rely on LSS to identify business processes for improvement and conduct LSS Projects/Business Improvement Events (BIE) based on current enterprise-wide business processes for delivering services to installation customers (Enterprise Implementation) and on local Opportunities for Improvement (OFI) for service delivery at the HQ IMCOM, Regions, and Garrison Local Implementation. IMCOM will utilize LSS and other productivity improvement tools and techniques to achieve cumulative efficiency goals including:

- (1) Enterprise and Local LSS Business Improvement Events
- (2) A-76/Competitive Sourcing • Strategic Sourcing
- (3) BRAC and Global Deployment Posture Review GDPR
- (4) Divestitures/Program Reductions

#### **17–43. Army communities of excellence (ACOE)**

*a.* The ACOE program is a commander's self-assessment process that is broad enough to accommodate a variety of approaches that can be tailored to any organization, command or installation. Leaders and managers take advantage of the entrepreneurial genius of the people within the community to develop better ways of helping people and getting work done. It is a program that encourages ideas and initiatives to float upward.

*b.* ACOE now integrates Malcolm Baldrige National Quality Award criteria in the Army Performance Improvement Criteria (APIC) for installation assessments. The APIC is used to guide the writing of the award. The Baldrige criteria are the standard for world-class quality. The Baldrige criteria are a comprehensive and integrated change management framework, allowing an organization to assess its approach, deployment, and results of its effort to change. All posts, regardless of size, are assessed against the criteria, not against each other. The Baldrige criteria focus on self assessment to identify strengths/weaknesses in planning and execution with emphasis on customer satisfaction.

*c.* APIC has three important roles in strengthening mission performance:

- (1) To help improve organizational performance practices, capabilities, and results.
- (2) To facilitate communication and sharing of best practice information among organizations of all types.
- (3) To serve as a working tool for understanding and managing performance and for guiding planning and opportunities for learning



## How the Army Runs

*d.* The mission of the ACOE Program is to provide in a quality environment, excellent facilities and services. Continuing to strive for greater excellence in customer service and facilities will contribute significantly to the improvement of Army readiness.

*e.* The ACOE program is a multiyear/component program that spans the current year, prior year, and one out year.

(1) HQ IMCOM is responsible for evaluating ACOE submissions and arranging and conducting the ACOE award ceremony.

(2) Out-year funding presents incentive award dollars to winning communities in the first quarter following the competition (October/November).

## Section VIII

### Summary and references

#### 17–44. Summary

The IMCOM concept provides effective Army-wide installation management through use of best corporate business models, comprehensive adherence to Army standards, and partnership with ACOM's, ASCC's, or DRU's and mission commanders, who receive focus on their unique issues, while geographic efficiencies are realized through economies of scale. IMCOM regions ensure mission commanders receive personalized support. The concept cares for people while ensuring readiness is not compromised; it positions installations for Army and DOD transformation initiatives and represents the Army's commitment to improve installations, preserve the environment, enable well-being of Soldiers, civilians and Family members, and support mission readiness of all stakeholder units.

#### 17–45. References

*a.* General Order Number 4, Assignment of Functions and Responsibilities within Headquarters, Department of the Army (as pertains to Assistant Chief of Staff for Installation Management (ACSIM)), 09 July 2002.

*b.* Office of Management and Budget (OMB) Circular A–76 (Revised), Performance of Commercial Activities.

*c.* Army Regulation 1–1, Planning, Programming, Budgeting, and Execution System.

*d.* Army Regulation 5–1, Total Army Quality Management.

*e.* Army Regulation 5–9, Area Support Responsibilities.

*f.* Army Regulation 5–20, Competitive Sourcing Program.

*g.* Army Regulation 115–11, Geospatial Information and Services

*h.* Army Regulation 200–1, Environmental Protection and Enhancement.

*i.* Army Regulation 210–14, Installation Status Report Program.

*j.* Army Regulation 210–20, Master Planning for Army Installations.

*k.* Army Regulation 210–35, Civilian Inmate Labor Program.

*l.* Army Regulation 405–70, Utilization of Real Property.

*m.* Army Regulation 405–90, Disposal of Real Estate.

*n.* Army Regulation 420–1, Army Facilities Management.

*o.* Army Regulation 420–41, Acquisition and Sales of Utilities Services.

*p.* Army Regulation 600–3, The Army Personnel Proponent System.

*q.* Field Manual 100–22, Installation Management.

*r.* Useful Links:

(1) Deputy Under Secretary of Defense for Installations & Environment (DUSD–I&E) <http://www.acq.osd.mil/ie/index.shtml>.

(2) Assistant Secretary of the Army for Installations & Environment (ASA–I&E) <http://www.asaie.army.mil/Public/IE/default.html>.

## Chapter 18

### The Army Health Service Support System

“The U.S. Army Medical Command and the Office of the Surgeon General play a vital role in the Army’s conduct of protracted overseas contingency operations. The many professionals who fill the ranks of the Command - uniformed and civilian, officer and enlisted, drawn from eight professional corps - are a formidable team dedicated to promoting and maintaining the health of our Warriors, sustaining their Families and restoring ill and injured Soldiers. The critical nature of our contributions has never been more clearly demonstrated in the 232-year history of the U.S. Army than now - from the battlefields in Iraq and Afghanistan, to our casualty evacuation facilities in Europe, our medical centers, community hospitals, health centers and clinics in the Homeland and by the creativity of our bio-scientific and industrial enterprises. We cannot, and will not, fail in this complex and unremitting mission.” LTG Eric B. Schoomaker, Surgeon General, U. S. Army, 2007–Present

#### Section I Introduction

##### 18–1. The revolution in military medicine

Since 1775, innovations in technology, the development of new treatment modalities and the evolution of human goals have revolutionized the practice of military medicine. Military medicine has made a dedicated effort to keep pace with the constantly changing operational doctrine to meet the needs of both commanders and Soldiers. The Army Medical Department (AMEDD) is taking major steps to incorporate advanced technology into patient care. What was science fiction yesterday is in the laboratory today, and tomorrow will be put to use by combat medics and hospital staffs. The current Military Health System support is based on the Joint Health Service Support Strategy that directly supports the National Military Strategy through Global Force Health Protection Programs that focus on: - Promoting and sustaining a healthy and fit force - Casualty prevention - Casualty care and management

##### 18–2. Scope of the AMEDD

*a.* The AMEDD encompasses those Army special branches that are under the supervision and management of The Surgeon General. Specifically, these special branches are the Medical Corps (MC), Dental Corps (DC), Veterinary Corps (VC), Medical Service Corps (MSC), Army Nurse Corps (ANC), and Army Medical Specialist Corps (AMSC). The AMEDD is one of the world’s largest health systems and includes all levels of medical, dental, veterinary, and other related health care from the policy and decision-making level to the combat medic in the field.

*b.* The Surgeon General (TSG) directs health services within the Army and commands AMEDD units and facilities of the U.S. Army Medical Command (USAMEDCOM), a Direct Reporting Unit (DRU). USAMEDCOM has about 27,000 soldiers and 28,000 civilian employees. Another 20,000 active-duty medical soldiers are in field units. The National Guard and Army Reserve have over 30,000 medical soldiers. USAMEDCOM currently manages a \$9.7 billion budget and cares for more than 5 million beneficiaries-active-duty members of all services, retirees and their Family members.

*c.* TSG also monitors and manages health services Army-wide through the Office of TSG (OTSG), the AMEDD element of the ARSTAF. Hand in hand with other Army management processes (TAA, PPBE), the AMEDD conducts various programs specifically designed to meet the force modernization, unit readiness, research and development, preventive medicine, and patient care missions for the armed forces.

*d.* Through the Warrior Transition Command, the AMEDD is responsible for every aspect of the Army’s Warrior Care and Transition Program which provides a holistic patient and Family centered approach to recovery, rehabilitation, and reintegration of wounded, ill, and injured Soldiers.

##### 18–3. Army health system support

The Army Health System (AHS) and Army medical and dental benefits are an important element of overall military compensation. Providing comprehensive, quality health care to military personnel is required by law. Other eligible Army categories, such as retirees and Family members, are entitled to medical and dental care subject to availability of space, facilities, and medical and dental staff as defined by Title 10, United States Code, and other regulatory requirements. Health services are essential to recruiting and retaining a quality force. Soldiers’ confidence on the battlefield is enhanced by the knowledge that they are supported by a superb medical evacuation and treatment system. A highly integrated and synchronized medical “system of systems” will be focused upon the health preservation and care for Soldiers - and their Families - throughout their entire period of military service. This concept of complete Soldier “life cycle health management” will begin with accession and training and extend throughout the cycles of stationing and deployment/redeployment until ultimate transition from the Army rolls. The military health system embodies the concept that the Army cares for its own.

### 18–4. Medical support to the transforming Army.

The Soldier has always been and will continue to be the pacing item for the Army. Army Medicine will maintain its focus on the sustainment of that most precious asset. The Future Force Soldier will be protected from disease and other environmental and biological health threats and be supported by a highly capable and responsive medical system that instills confidence in Soldiers, their leaders, and their Families. The joint doctrine of Global Force Health Protection will be achieved through operational and institutional medical capabilities that are linked and delivered seamlessly across Service and organizational boundaries and synchronized and coordinated by joint medical mission command.

*a.* Empower Soldiers with health knowledge and programs to prevent the onset of disease. Through the advancement of vaccines, fitness and wellness studies, and a variety of predictive interventions Soldiers will avoid common health issues of today providing a healthy and fit force.

*b.* Enabled by advanced medical and information technologies, medical training, and organizational linkages that allow Army medicine to draw from the resources and capabilities of all military medical services as well as industry and partnerships with private and other federal health agencies. Global Force Health Protection will include the capability to rapidly project a multi-capable medical force that is tailored to the health threat, highly adaptable to emerging and changing missions, and superbly effective in providing health protection and treatment.

## Section II

### AMEDD mission and support to commanders

#### 18–5. Mission of the Army Medical Department

The mission of the AMEDD is to “maintain the health of members of the Army, to conserve the fighting strength, to provide health care for eligible personnel, and to prepare health support to members of the Army in time of war, international conflict, or natural disaster.” This mission has two facets, both relating directly to Army combat readiness:

*a.* Army Health System Support, consisting of health service support and Force Health Protection (FHP). The AMEDD is responsible for maintaining the clinical, technical, and combat readiness of medical units and personnel to support forces in the theater of operations.

(1) The deployable medical units of the Army carry out this task, with a heavy reliance on the Reserve Components (which constitute approximately 68 percent of the Army’s medical forces). These units are apportioned to combatant commands around the world.

(2) The TDA AMEDD mission includes the delivery of health care to Soldiers and Family members at medical centers (MEDCEN), community hospitals, and medical clinics; dental clinics; veterinary services; medical research and development; education and training, combat developments, test, and evaluation; rehabilitative care and training; and health promotion and preventive medicine. Fixed installation TDA medical units assigned to the AMEDD directly support operational units, on an area basis, as it relates to medical equipment and training of assigned medical personnel.

(3) The recruitment and retention of health care professionals and sustainment of their skills are central to the maintenance of a high quality; combat ready health medical force. Deploying the medical force is one of the AMEDD’s primary missions. Readiness to accomplish this essential function can only be ensured through the practice of medicine and its related disciplines in a patient care environment. In peacetime, the vast majority of health care professionals and technical support personnel who deploy with medical units are employed within the Army’s fixed hospitals, MEDCENs and other health care facilities. The day-to-day practice of health care professionals and their support staff in these environments is the basis for maintaining the clinical skills and teamwork necessary to care for sick and wounded Soldiers during operations.

*b.* Beneficiary Care and TRICARE. The second but equally important aspect of the AMEDD mission is to help maintain the personnel readiness of the entire Army by maintaining the health of individual Soldiers and their Families.

(1) Quality health care for Soldiers, retirees and their Families is an essential and valuable benefit. Physical readiness, good health and the knowledge that Family members will be cared for contribute to the ability of each Soldier to deploy and perform his or her mission in the operational environment. Projecting a healthy and protected force and caring for Soldiers and their Families are responsibilities of the Army Medical Command and its subordinate commands. These responsibilities are accomplished through the delivery of patient care, health promotion, preventive medicine activities, education and training, and medical research and development.

(2) To meet readiness requirements and serve Soldier and Family health needs better, Congress directed the DOD to develop and implement a new model for military health care that would improve patients’ access to health care, assure high quality of care, and control rising health care costs. The result, TRICARE, is now the medical program for active duty service members, their Family members, retirees and their Family members, and survivors of all uniformed service members. TRICARE relies on inter-service and civilian-military sharing of medical resources to improve accessibility of care and achieve efficiencies. A DOD program under the oversight of the Assistant Secretary of Defense (Health Affairs) (ASD(HA)), it is managed by the military in partnership with civilian contractors. Each TRICARE region has an Army, Navy, or Air Force lead agent (usually the commander of a military treatment facility or Regional Medical Command) responsible for the program.

(3) Details for each TRICARE program is available at <http://www.tricare.mil>

#### **18–6. AMEDD support to commanders**

*a.* Commanders are responsible for the health and physical fitness of their Soldiers. The AMEDD supports commanders by acting as the proponent for medical doctrine, advising commanders in all health related matters, and executing command policy in the area of AHS. The AMEDD:

- (1) Advises the command of measures to assure the health, fitness, and vigor of all members of the Army.
- (2) As directed, acts as the proponent to provide those measures needed to assure health and fitness.
- (3) Develops, trains, and maintains forces necessary for medical FHP to the Army in a operational environment
- (4) Conducts routine Medical Surveillance to identify leading injury and disease trends affecting Soldier's readiness and health.
- (5) Conducts field investigations of outbreaks of potential health threats from disease, environmental hazards and injuries.

*b.* The importance of the AHS in the operational environment is paramount. It supports the prevention of disease and non-battle injury to ensure maximum operational capability. When casualties occur, the medical system provides for rapid initial treatment, stabilization and evacuation to medical treatment facilities. The prompt evacuation of combat casualties is not only essential for the preservation of life, but also assists the combat commander in continuing the battle by clearing the battlefield of wounded Soldiers.

### **Section III The Army Health System**

#### **18–7. Key elements**

*a.* The Surgeon General (TSG)/Office of The Surgeon General (OTSG). TSG is responsible for development, doctrine, policy direction, organization, and overall management of an integrated AHS; is the medical material developer for the Army; and is the SECARMY's representative for diverse DOD joint medical training, research and health services Executive Agencies. OTSG is the ARSTAF element that develops doctrine, policy and regulations for the AHS, health hazards assessment, the establishment of health standards, and medical materiel. TSG also has pronency for personnel management within the AMEDD.

*b.* Health services. Health services are all services performed, provided, or arranged for (regardless of location) which promote, improve, conserve, or restore the physical or behavioral well-being of individuals or groups, and those services which contribute to the maintenance or restoration of a healthy environment. Health services include, but are not limited to, preventive, curative, and restorative health measures; medical doctrine; medical aspects of Chemical, Biological, Radiological, and Nuclear (CBRN) defense; health promotion; assessment of health threats and counter-measures; medical operations planning; medical intelligence; health professional education and training; health-related research; transportation of the sick and wounded; selection of the medically fit and disposition of the medically unfit; health care administration; medical logistics; medical equipment maintenance; medical facility life cycle management; and the delivery of medical, nursing, dental, veterinary, laboratory, optical, and other specialized services.

*c.* Programming and budgeting. Since 1991, military health care has been funded through the DOD Unified Medical Program and the Defense Health Program (DHP) Appropriation, rather than the services' budgets. The ASD(HA) issues policy guidance and the TRICARE Management Activity (TMA) manages and monitors Service execution of the DHP Appropriation and the DOD Unified Medical Program. The DHP appropriation consisting of operation and maintenance; research, development, test, and evaluation; and procurement funds designed to finance the non-military personnel requirements of the MHS. In FY 2003, the Department implemented the DOD Medicare Eligible Retiree Health Care fund, an accrual-type fund to pay for health care provided to Medicare eligible retirees, retiree Family members and survivors.

(1) The OTSG/USAMEDCOM Staff (see "One Staff," below) programs funds and manpower using both the Defense Health Program (DHP) and Army appropriations. DHP funds provide for most peacetime health care operations in TDA units such as Army MEDCENs and community hospitals and for TRICARE Managed Care Support Contracts. The vast majority of AMEDD manpower is funded by the DHP. Army funding supports deployable medical TOE units and medical readiness missions.

(2) The OTSG/USAMEDCOM Staff programs for Army funds and provides its input to the Army's POM. It programs for DHP funds and provides input to the DHP POM through the TMA. Military personnel costs are programmed by TMA in the DHP POM and the programmed total obligation authority (TOA) transfers to the MPA appropriation when the budget estimate submission is prepared. Civilian personnel costs are reimbursable from DHP Operations and Maintenance Defense funds during the year of execution. Authorizations for both military and civilian personnel are on Army manpower documents.

#### **18–8. Staff relationships and responsibilities**

*a.* Office of the Assistant Secretary of Defense (Health Affairs). The ASD(HA) has statutory responsibility for

## How the Army Runs

overall supervision of health affairs within DOD and is the principal staff assistant and adviser to Secretary of Defense for all DOD health policies, programs, and activities.

*b.* TRICARE Management Activity. The TMA is a DOD field activity of the Under Secretary of Defense for Personnel and Readiness (USD(P&R)) that operates under the authority, control, and direction of the ASD(HA). The mission of TMA is to administer and manage TRICARE and administer, manage, and monitor Service execution of the DHP appropriation and the DOD Unified Medical Program. TRICARE lead agents coordinate health care within each TRICARE region, ensuring cooperation among military treatment facilities of all Services and efficient management of the regional managed care support (MCS) contract. MCS contractors organize networks of civilian providers to augment the military direct care system, process health care claims, and provide other services for the region.

*c.* OTSG has the following ARSTAF responsibilities:

(1) Assisting the SECARMY and the CSA in discharging Title 10 responsibility for health services for the Army and other agencies and organizations entitled to military health services.

(2) Representing the Army to the executive branch, Congress, DOD agencies, and other organizations on all health policies affecting the Army.

(3) DOD focal point for NATO Medical Chemical, Biological, Radiological, and Nuclear (CBRN) actions. Provides U.S. Head of Delegation for the NATO CBRN Medical Working Group and General Medical Working Group.

(4) Manage all aspects of medical CBRN defense programs.

(5) Advising and assisting the SECARMY and CSA and other principal officials on all policy issues pertaining to health and military health service support to include:

(a) Policies and regulations concerning the health aspects of Army environmental programs.

(b) Health professional education and training for the Army, to include training programs for all medical, nursing, dental, and veterinary specialty areas.

(c) Research and development activities for nutrition and wholesomeness in support of the DOD Food Service.

(d) Medical materiel life-cycle management.

(e) Medical materiel concepts, requirements, validity and viability.

(f) Technical review and evaluation of medical and nonmedical materiel to determine the existence of possible health hazards.

(g) Program management for Army health care automation.

(h) Army execution of the Defense Medical Systems Support Center (DMSSC).

(i) Medical aspects of the Security Assistance Program.

(j) Program sponsor for Operations and Maintenance, Army - Program 84 (Medical).

(k) Executive agent of the SECARMY for all DOD veterinary services.

(l) Medical facility life cycle management.

(m) Field medical support concepts, doctrine, training and leader development programs and user test.

(n) Medical intelligence training.

(o) Medical mobilization training.

## Section IV

### Command and management

#### 18–9. AMEDD Organization

In 1998, TSG directed the implementation of the One Staff concept, consolidating the staffs at OTSG and Headquarters, USAMEDCOM, Fort Sam Houston, Texas. Personnel at both locations now function as a single staff with one set of leaders who coordinate ARSTAF functions, along with Army command functions (Figure 18–1).

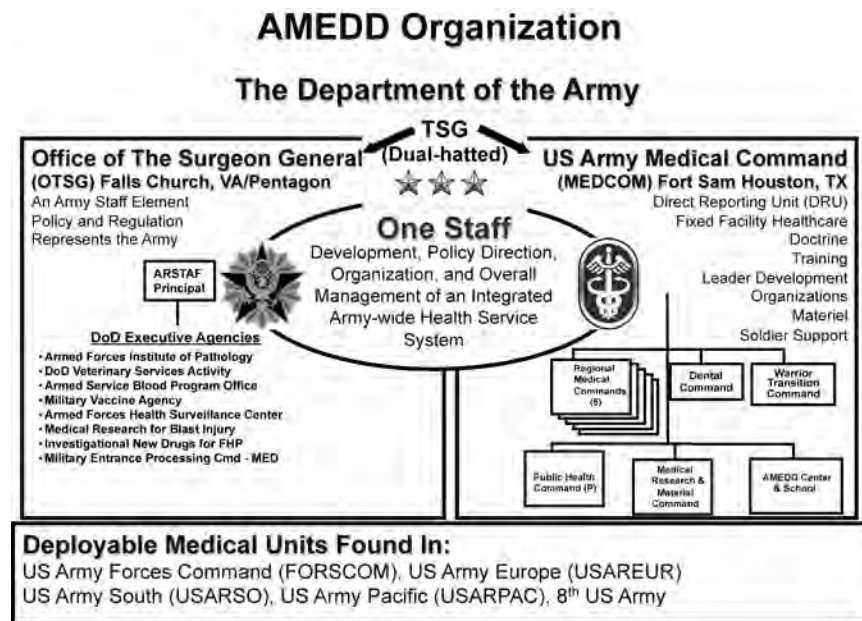

Figure 18–1. The Army medical department

### 18–10. U.S. Army Medical Command (USAMEDCOM)

a. The major subordinate commands of USAMEDCOM include:

- (1) U.S. Army Medical Research and Materiel Command.
- (2) U.S. Army Dental Command.
- (3) U.S. Army Veterinary Command.
- (4) U.S. Army Public Health Command (PROV)
- (5) U.S. Army Medical Department Center and School.
- (6) Warrior Transition Command
- (7) Five regional medical commands (RMC).

b. The consolidation of worldwide medical assets under the USAMEDCOM in 1996 greatly enhanced mission command efficiency to meet the health care needs of the Army of the 21st Century. Implementation of the One Staff concept to achieve the most efficient and effective mission command structure underscored the AMEDD's commitment to continuous quality improvement and poised the AMEDD for its role in the Army Transformation.

c. The OTSG/USAMEDCOM Staff ("One Staff") is responsible for AMEDD policy, planning, and operations worldwide, with a focus on strategic planning. Its mission is to:

- (1) Provide the vision, direction, and long-range planning for the AMEDD.
- (2) Develop and integrate doctrine, training, leader development, organization, materiel, and Soldier support for the AHS.
- (3) Allocate resources, analyze health services utilization, and conduct assessments of performance worldwide.
- (4) Coordinate and manage graduate medical education programs at the Army MEDCENs.
- (5) MEDCOM is designated by the Chairman, Joint Chiefs of Staff as the Theater Lead Agent for Medical Materiel (TLAMM) to NORTHCOM.

### 18–11. U. S. Army Medical Research and Materiel Command (USAMRMC)

USAMRMC is a complex and diverse organization with a mission to sustain the health and fighting ability of Soldiers, Sailors, Airmen and Marines through its programs in medical research, medical materiel development, medical logistics planning, medical information systems, and development of new technologies to improve military health care on the battlefield. USAMRMC is engaged in a broad spectrum of activity, from basic research in the laboratory, to innovative product acquisition, to the fielding and life-cycle management of medical equipment and supplies for deploying units. Mission responsibilities include:

- a. Serving as materiel developer and logistician for medical materiel (Class VIII).

## How the Army Runs

*b.* Conducting basic research, exploratory testing, engineering development and deployment development for medical materiel systems.

*c.* Performing research, development, testing, and evaluation under four critical Research Area Directorates (RADs) areas: - Military infectious disease research program. - Combat casualty care research program. - Military operational medicine research program. - Medical chemical and biological defense research program.

*d.* Functioning as the DOD executive agent's representative for medical research and development in the areas of biological and chemical defense, infectious diseases, combat dentistry, nutrition, HIV research, global emerging infections, accession standards and research, Gulf War research, and investigational new drugs.

*e.* Planning and executing medical logistics mobilization support and management of the Medical War Reserves Materiel Program.

*f.* Operating the National Maintenance Program (NMP) for medical equipment.

*g.* Providing the Army Service Item Control Center for medical, dental, and veterinary equipment and supplies.

### **18-12. U.S. Army Dental Command**

The mission of the Dental Command (DENCOM) is to ensure dental readiness and enhance wellness by providing dental care and promoting oral health for the Army by:

*a.* Serving as the proponent for meeting the dental health needs of the Army and eligible beneficiaries.

*b.* Providing mission command of the Army Dental Laboratory, Regional Dental Commands, Dental Activities, and Dental Clinic Commands worldwide.

*c.* Allocating resources, analyzing utilization trends, and assessing performance across the DENCOM.

*d.* Training and providing qualified dental personnel for contingency operations.

*e.* Supporting mobilization of the total force by integrating Reserve Components into the Command and expanding dental capacity, as required, to receive and treat dental casualties at all levels of care.

### **18-13. U.S. Army veterinary service**

The Army is the DOD executive agent for veterinary services, and provides veterinary support to all the military services. The Army Surgeon General is responsible for providing DOD veterinary support and directs the DOD Veterinary Service Activity, the U.S. Army Veterinary Command, and the veterinary assets in the Medical Research and Materiel Command. In addition, veterinary personnel are assigned to other Army commands and DOD activities, agencies, and organizations to accomplish the DOD mission. Army veterinarians and veterinary specialists support Army and DOD operations worldwide. Their missions include:

*a.* Prevention and control of animal diseases communicable to humans that may affect any aspect of military operations.

*b.* Complete veterinary care for government-owned animals. Provide emergency medical treatment of privately owned animals and medical care with emphasis on veterinary preventive medicine and diseases that present a community health threat.

*c.* Development of sanitary and food defense standards for commercial food plants providing products to DOD components.

*d.* Developing lists of subsistence suppliers approved for DOD procurement.

*e.* Inspection of food products for wholesomeness at all joint procurement and storage facilities or other facilities under control of the Departments of the Army and Navy.

*f.* Provision of laboratory support for diagnosis of animal disease and ensuring wholesomeness of subsistence.

*g.* Provision of professional support to training programs and research protocols involving animal models.

*h.* Provide for humane medical treatment, care, use, and handling of animals.

### **18-14. U.S. Army Public Health Command (Provisional)**

*a.* The mission of USAPHC(PROV) is to promote health and prevent disease, injury, and disability of Soldiers and military retirees, their Families, and Department of the Army civilian employees; and assures effective execution of full spectrum veterinary service for Army and Department of Defense Veterinary missions. Mission responsibilities include but are not limited to:

(1) Disease & Injury prevention control.

(2) Health Promotion & Wellness.

(3) Environmental/Medical Surveillance.

(4) Occupational & Environmental Health Surveillance.

(5) Health Risk Communication.

(6) Health Threat Assessment & Countermeasures.

(7) Health Risk Assessments.

(8) Medical, Occupational, and Environmental Epidemiology.

(9) Population and Environmental Health Risk Assessments.

- (10) Health Policy Development and Review.
- (11) Graduate Medical Education.
- (12) Continuing Medical Education.
- (13) Disease outbreak investigation.

*b.* The Commander, USAPHC (PROV) is designated as the Army's Functional Proponent for Preventive Medicine (FPPM). The Proponency Office for Preventive Medicine (POPM) is the staff element that supports the FPPM in all issues of preventive medicine policy and strategy development.

### **18–15. U.S. Army Medical Department Center and School**

The mission of the AMEDD Center and School is to:

- a.* Develop, integrate, coordinate, implement, evaluate and sustain training and training products for active and reserve medical forces worldwide in accordance with AR 350–1.
- b.* Develop, integrate, analyze, test, validate, and evaluate concepts, emerging doctrine and medical systems, and doctrine and training literature.
- c.* Conduct all AMEDD officer, enlisted, and civilian proponency functions, personnel inventories, and life-cycle management of all career fields.
- d.* Develop concepts, systems, and force structure for combat health service support.
- e.* As the integration center for all doctrine and training requirements; systematically develop courses, training devices, manuals and sustainment materials for readiness.
- f.* Provide training, education, and evaluation of AMEDD personnel.
- g.* Test and evaluate new and replacement items of medical equipment.
- h.* Serve as proponent for Force Health Protection in operational areas.
- i.* Plan, program, perform, and publish complex, organized analytical assessments and evaluations in support of decision- and policy-making, management, and administration of Army medicine.
- j.* Provide statistical and analytical consultation to the AMEDD, with secondary support to subordinate organizations within the MEDCOM; provide decision support expertise to AMEDD senior leadership; promote data quality, integrity, and standardization across the AMEDD; provide biometric database management and programming expertise to the AMEDD; provide the AMEDD with medical record coding guidance and training for medical records personnel.
- k.* Function as the DOD executive agent's representative for joint training and pharmaceutical standardization in the areas of defense medical readiness training, joint medical executive skills, and the pharmacoeconomic center.

### **18–16. Warrior Transition Command**

The mission of the Warrior Transition Command is to successfully transition Soldiers and their Families back to the Army, or to civilian life, through a comprehensive program of medical care, rehabilitation, professional development, and personal goal-setting. The core competencies of the command include:

- a.* Serving as the proponent for the execution of the Army's Warrior Care and Transition Program.
- b.* Providing mission command oversight to ensure full execution of the Army Wounded Warrior Program.
- c.* Coordinating with DA staff, other Services, other Departments of Government, and Congress.
- d.* Establishing and executing a program of standardization and evaluation to ensure optimization of compliance with established policy governing the operation of Warrior Transition Units and Community-Based Warrior Transition Units.
- e.* Assuming responsibility for the movement of Warriors in Transition between Military Treatment Facilities, Warrior Transition Units, Veterans Affairs Medical and Poly-Trauma Centers, Community-Based Warrior Transition Units, and civilian health care providers.
- f.* Ensure that all Warriors in Transition receive the same level and scope of care and support regardless of Component through enforcement of fair and comprehensive policy and capable Reserve Component management.

### **18–17. Regional Medical Commands (RMCs)**

*a.* RMCs are the key operational element for the delivery of health care services for geographical regions within USAMEDCOM. RMCs are major subordinate commands (MSCs) operating under the supervision of the commander. Figure 18–2 reflects regional boundaries for medical and dental commanders. Mission responsibilities include:

- (1) Regional mission command of an affordable, multidisciplinary, customer-focused, quality military health service system.
  - (2) Supporting the readiness requirement of the Army.
  - (3) Developing and sustaining technical health care and leader skills in support of USAMEDCOM readiness goals.
  - (4) Allocating resources, analyzing utilization, and assessing performance across the RMC.
- b.* As the primary integrator of medical readiness, the RMC is responsible for:
- (1) Daily utilization of TOE/TDA medical assets, integrating Active and Reserve training, and development of mobilization requirements.



## How the Army Runs

- (2) Budgeting, defending, and allocating readiness costs and funding.
- (3) Preplanning Medical Treatment Facilities (MTF) professional backfill requirements during deployment by expanding network coverage, shifting RMC assets, and coordinating Reserve Component coverage.
- (4) Ensuring that Army medical readiness requirements are fully integrated into the activities of DOD health care regions.
- (5) Conducting training exercises in MTF mobilization, professional backfill activities, and deployment actions.
- (6) Providing medical planning and preparation programs for worldwide contingency operations.
- (7) Sponsoring readiness-based clinical research.

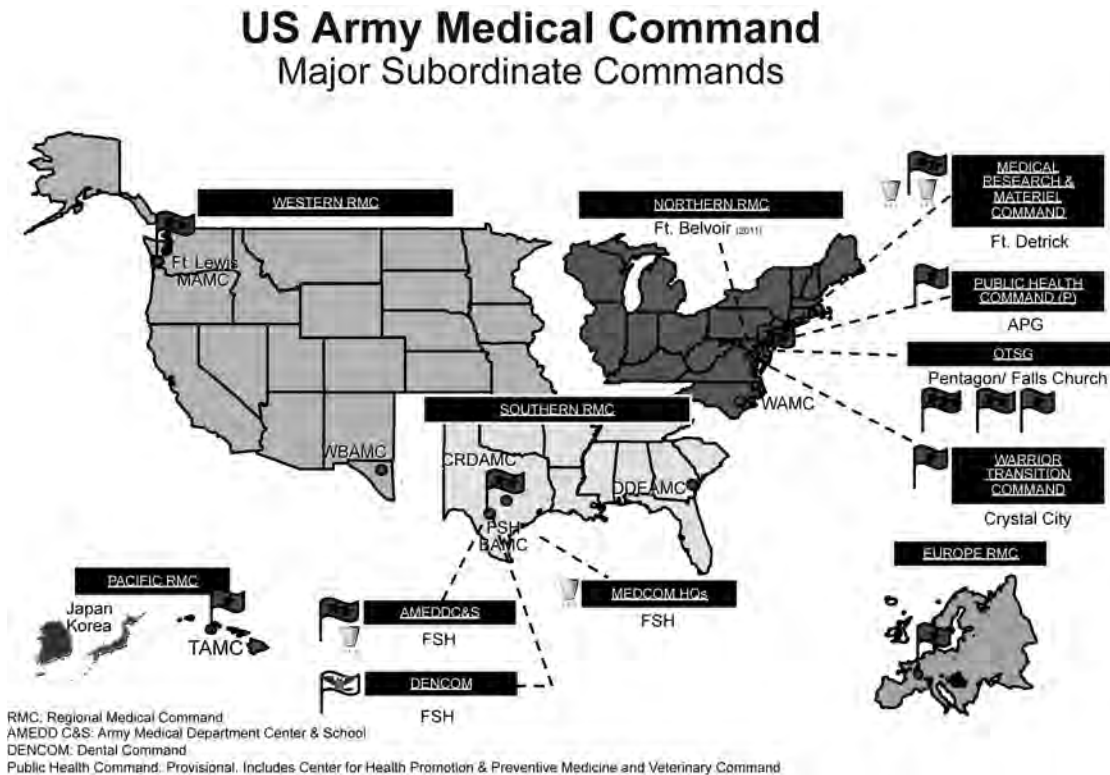

Figure 18–2. Regional boundaries for medical and dental commanders

### 18–18. AMEDD role in sustainment units

*a.* In addition to its fixed MTFs, the Army maintains medical units with a sustainment mission within all deployable commands. These medical units work in concert with logistics and personnel units to form the sustainment core for Army forces. The deployable medical assets consist of TOE units in both the Active and Reserve Components. Continental United States (CONUS) AC medical units are assigned to United States Forces Command (USFORSCOM). Outside the Continental United States (OCONUS) medical units are assigned to the Army Service Component Command. Deployable medical units range in size, scope of mission, and capacity from medical detachments to theater hospitals. Collectively they establish an integrated continuum of medical evacuation and treatment from point of injury on the battlefield, to the echelons above corps, and eventually to specialized treatment in CONUS.

*b.* In the event of mobilization, AMEDD Reserve Component medical units will often be among the earliest deploying forces. With approximately 68 percent of the medical force in the Reserve Components, the AMEDD truly exemplifies The Army. Well-trained and combat ready Reserve Component medical units are absolutely essential for ensuring that the FHP missions of the Army are accomplished during periods of mobilization. Under the Professional Filler Information System (PROFIS) qualified Active Army personnel serving in TDA units are designated to fill USFORSCOM deploying MTOE units, USARPAC, USAREUR, and EUSA forward deployed units upon execution of an approved JCS OPLAN or upon execution of a contingency operation. Individuals pre-designated from fixed Army health care facilities will provide a large portion of the professional personnel to units deploying to and already stationed in the operational area.

c. A key operational enabler is the Medical Communications for Combat Casualty Care (MC4). MC4 integrates a medical information management system for Army tactical medical forces, enabling a comprehensive, lifelong electronic medical record for all Service members, and enhancing medical situational awareness for operational commanders. MC4 integrates Theater Medical Information Program (TMIP); the Battlefield Medical Information-Theater (BMIS-T); Armed Forces Healthcare Longitudinal Application (AHLTA); the US Transportation Command (TRANSCOM) Regulating and Command and Control Evacuation System (TRAC2ES); the Defense Medical Logistics Standard Support (DMLSS); and the Defense Medical Surveillance System (DMSS). MC4 fully integrates the global medical network with a fully integrated operational architecture and a Global Information Grid (GIG) infrastructure. MC4 will enable commanders to effectively synchronize medical care on any battlefield, worldwide.

### **18–19. Staff surgeons**

a. The senior AMEDD officer present for duty with a headquarters (other than medical) will be officially titled:

- (1) The “Command Surgeon” of the ACOM and ASCC.
- (2) The “Surgeon” of the field command (e.g. corps, CONUSA).
- (3) The “Director of Health Services (DHS)” at the installation level.

b. The surgeon and DHS are responsible for the staff supervision of all health matters and policies, except dental and veterinary matters. The DHS and the director of dental services (DDS) will serve on the installation commander’s staff. Normally, the commander of the MEDCEN or medical department activity (MEDDAC) is the DHS, and the commander of the Army dental activity (DENTAC) is the DDS.

### **18–20. Health service logistics**

a. Health service logistics is integral to the AHS and is managed by the AMEDD as a core functional area of MHS. This gives the command surgeon the ability to influence and control the resources needed to save lives. TSG establishes medical logistics policies and procedures within the framework of the overall Army logistics system. Health service logistics includes the management, storage, and distribution of medical materiel (to include medical gases), blood and blood products, optical fabrication, and medical equipment maintenance which are inherent to the provision of health care. The medical commodity (Class VIII) has characteristics that make it distinctly different from other classes of supply. Medical materiel includes pharmaceuticals, narcotics, and blood products that are potency and shelf life (dated) that require special handling and security. Most items are subject to the regulations and standards of external agencies such as the Food and Drug Administration, the EPA, the Drug Enforcement Agency and The Joint Commission (JTC). Medical logisticians have extensive knowledge of those requirements as they relate to health service support.

b. The Single Integrated Medical Logistics Manager (SIMLM) mission designates a single organization or Service component to manage and provide health service logistics support to joint forces operating in the theater. Blood is the only medical material not directly under control of the SIMLM. Blood supplies are coordinated and managed by the Joint Blood Program Officer in each of the Combatant Unified Commands.

c. The Theater Lead Agent for Medical Materiel (TLAMM) provides a single theater medical materiel distribution and supply chain management, providing the intensive management required for the medical commodity in close concert with FHP operations and industry partners at the national level.

d. USAMEDCOM established Medical Equipment Reset operations for medical equipment and sets for re-deploying units and Theater Provided Equipment (TPE)-Medical. Redeploying units conduct field-level Reset operations at home station in coordination with the Regional Medical Commands and their Installation Medical Supply Activities. Sustainment Reset (Depot Level) activities occur at one of three depot locations: Hill AFB, UT; Tracy Army Depot, CA; and Tobyhanna Army Depot, PA. TPE-Medical Reset is provided to units in theater in order to reduce equipping requirements for deploying units and to maintain continuity of care in support of operations. High utilization and harsh conditions result in increased maintenance requirements and accelerated wear-out rates. TPE-Medical is owned by theater and life-cycle managed by theater stakeholders in partnership with USAMEDCOM.

e. Army Medical Logistics Enterprise (AMLE). In 2009, TSG established the AMLE comprised of generating and operating MEDLOG organizations that work within a collaborative and networked framework to meet the medical logistics needs of the AHS in delivering medical support to the Army and/or JFC. Figure 3 reflects key organizations that provide the strategic ‘core’ as well as the “extended” enterprise organizations that comprise the Army Medical Logistics Enterprise and deliver MEDLOG capabilities to the AHS.



Figure 18–3. Army Medical Logistics Enterprise

**18–21. Secretary of the Army’s executive agent representative for DoD executive agencies (DOD EA)**

*a.* Executive Agent representative: An Executive Agent is the Head of a DOD Component (SECARMY) to whom the Secretary of Defense or the DepSecDef has assigned specific responsibilities, functions, and authorities to provide defined levels of support for operational missions, or administrative or other designated activities that involve two or more of the DOD Components. The DOD Executive Agent may delegate, to a subordinate designee within that official’s Component (TSG), the authority to act on that official’s behalf for any or all of those Executive Agent responsibilities, functions, and authorities assigned by the Secretary of Defense or the DepSecDef.

*b.* In addition to the DOD EAs embedded in AMEDD Major Subordinate Commands, TSG serves as the Executive Agent’s representative for other essential joint medical agencies, to include:

- (1) Accession Medical Standards Analysis and Research Activity
- (2) Armed Forces Epidemiological Board
- (3) Armed Forces Medical Library
- (4) Armed Forces Pest Management Board
- (5) Armed Services Blood Program
- (6) Civilian Employee Occupational Health and Medical Services Program
- (7) Defense Medical Readiness Training Institute
- (8) DiLorenzo TRICARE Health Clinic
- (9) DOD/Army Medical Surveillance System
- (10) DOD Global Emerging Infections Systems
- (11) DOD/VA Clinical Practice Guidelines Development
- (12) DOD Pharmacoeconomic Center
- (13) DOD Veterinary Services Activity
- (14) DOD Serum Repository
- (15) Joint Readiness Clinical Advisory Board
- (16) Joint Medical Executive Skills Institute
- (17) Military Infectious Disease Research Program

- (18) Military Vaccine Office
- (19) National Vaccine Healthcare Center Network
- (20) Medical Materiel Enterprise Standardization Office

## **Section V**

### **Summary and references**

#### **18–22. Summary**

This chapter has discussed the mission, organization, functions, and staff relationships of the AMEDD. The AHS encompasses all levels of medical, dental, veterinary, and other related health care, from the policy and decision-making level to the combat medic in the field. Health services within the Army are directed and monitored by TSG through USAMEDCOM and the OTSG. TRICARE has markedly altered the peacetime military health system and continues to evolve to ensure the provision of world class healthcare to all beneficiaries. After nine years of sustained conflict the AHS continues to transform to meet the needs of the Army and the Nation.

#### **18–23. References**

- a.* DOD Directive 5101.1 DOD Executive Agencies
- b.* DOD Directive 5136.1, Assistant Secretary of Defense for Health Affairs.
- c.* Army Regulation 10–5, Headquarters, Department of the Army.
- d.* Army Regulation 10–87, Organization and Functions Army Commands, Army Service Component Commands, and Direct Reporting Units.
- e.* Army Regulation 40–1, Composition, Mission, and Functions of the Army Medical Department.
- f.* Army Regulation 40–4, Army Medical Department Facilities/Activities.
- g.* Army Regulation 40–61, Medical Logistics Policies.
- h.* Field Manual 4–02, Force Health Protection In A Global Environment.
- i.* USAMEDCOM Regulation 10–1, Organization and Functions Policy.
- j.* USAMEDCOM Memorandum 10–2, Organizations and Functions, Headquarters,
- k.* USAMEDCOM/OTSG Regulation 10–32.
- l.* U.S. Army Medical Department Website, [www.armymedicine.army.mil](http://www.armymedicine.army.mil).
- m.* Army Medicine White Paper, Transforming Medical Support to a Modular Army, 24 October 2004

RESERVED

## Chapter 19

### Management Of Legal Affairs

“I find it scarcely possible to get on without some legal person in the situation of Judge Advocate.” *Duke of Wellington in letter to Earl of Bathurst, 1815*

#### Section I Introduction

##### 19–1. Law and the commander

The Army provides legal advice to commanders and Soldiers, primarily through or under the supervision of judge advocates (JA) of the Judge Advocate General’s Corps (JAGC). JAs are Soldier-lawyers who are commissioned officers of the Army and licensed attorneys. Close and full communication with legal advisors is an essential tool for command success. To use JAs and other legal resources effectively, commanders should understand the general organization and functions of the servicing Staff Judge Advocate (SJA) or Command Judge Advocate (CJA) office. This chapter surveys the core legal disciplines of judge advocates: administrative and civil law; claims; contract and fiscal law; legal assistance; military justice; and, international and operational law. Operational law is that body of domestic, foreign, and international laws that directly affect the conduct of operations and may include all six of the above-named core legal disciplines.

##### 19–2. Office of the Staff Judge Advocate (OSJA)

An OSJA is organic to units commanded by a general court-martial convening authority. An organization with a general officer in command may also be assigned an OSJA, even if there is no general court-martial convening authority. The OSJA has sections or divisions within its office structure that may include one or more of the core legal disciplines. For example, an OSJA may commonly consist of five sections: military justice, administrative and civil law, claims, international law, and legal assistance. However divided with the office, the OSJA provides all legal services except those that must, by law be independent, such as judicial and defense counsel support. It is further noted that under the recent modular force design, two judge advocates and a senior paralegal noncommissioned officer are assigned and organic to each brigade combat team (BCT). The BCT legal section is responsible for the full spectrum of legal services required by the BCT or, where it is beyond its capabilities, for coordinating with the OSJA for the delivery of such legal services.

##### 19–3. Staff Judge Advocate

The SJA is a member of the commander’s personal staff and, as such, communicates directly with the commander to provide legal advice for all matters affecting morale, good order, and discipline of the command. The SJA is also a member of the commander’s special staff. As such, the SJA serves under the supervision of the Chief of Staff, provides legal services to the staff, and coordinates with other staff members to provide responsive legal services throughout the organization.

#### Section II Administrative and civil law, legal assistance, claims

##### 19–4. The Army as an administrative agency

The Army is an armed force, but it is also a large Federal administrative agency that encounters significant internal and external legal issues every day. Administrative and civil law is the body of law containing the statutes, regulations, and judicial decisions that govern the establishment, functioning, and command of military organizations. The practice of administrative and civil law includes advice to commanders and litigation on behalf of the Army involving many specialized legal areas, including military personnel law, government information practices, and investigations, relationships with private organizations, labor relations, civilian employment law, military installations, regulatory law, intellectual property law, government ethics, and environmental law. It is worth noting that legal assistance and claims (subsections 19–11 and 19–12 below) are major, co-equal legal disciplines with administrative and civil law.

##### 19–5. Corrective administrative personnel actions

*a. Commanders and administrative law.* Commanders spend an inordinate amount of their time on comparatively few Soldiers. Some of these Soldiers, for a variety of reasons, cannot or will not perform their duties. Some corrective administrative actions by the commander educate, train, rehabilitate, or correct without adverse consequences. Others are adverse and implicate important legal rights and responsibilities. The procedures in Army regulations governing the use of adverse actions protect the legal rights of Soldiers to ensure that commanders only impose adverse actions on Soldiers who deserve them, and do so in a fair and lawful manner.

*b. Corrective, adverse actions short of separation.* In many instances, commanders want to motivate Soldiers to

## How the Army Runs

improve duty performance or be more efficient, or to ensure mission accomplishment. A number of useful administrative actions are available to deal with problem Soldiers whose conduct or performance does not warrant action under the Uniform Code of Military Justice (UCMJ), or administrative separation. These include counseling, extra training, written or oral reprimands, bars to reenlistment, adverse-performance evaluation reports, relief for cause, suspension or revocation of security clearance, suspension or revocation of on-post driving and other privileges, MOS reclassification, administrative reduction for misconduct or for inefficiency, administrative reprimand, removal from promotion list, and suspension of favorable personnel actions (flagging).

*c. Adverse administrative separations.* The Army invests substantial assets in recruiting, training, equipping, and other resources when it transforms civilian men and women into Soldiers. Separation before the end of an enlistee's obligated term of service wastes resources and requires expensive recruiting and training of a replacement. Moreover, the impact of adverse separations on Soldiers can be severe, as some separations can result in discharges under other than honorable conditions. Senior commanders must understand the fundamentals of the administrative separation system. AR 635–200, *Active Duty Enlisted Administrative Separations*, and AR 600–8–24, *Officer Transfer and Discharges*, are the Army regulations that govern administrative separations; and they specify the proper processes and provide substantive and procedural protections. Official roles in administrative separations vary; commanders may review the action and forward the file to the separation authority with recommendations; or, they make the decision. Commanders should advise and educate subordinates on the correction or separation of problem Soldiers. JAs are a resource available not only to advise the commander on corrective and administrative actions, but also to assist the commander in such leader development.

### 19–6. Improper relationships

#### *a. Improper superior-subordinate relationships.*

(1) This section highlights the various relationships subject to the punitive regulatory requirements of AR 600–20, *Army Command Policy*. Relationships between Soldiers of different ranks, as regulated conduct, is considerably broader than the specific UCMJ offense of fraternization. Furthermore, these provisions of AR 600–20 pertaining to improper relationships are punitive. Violations may be punished under Article 92, UCMJ.

(2) Relationships between Soldiers of different rank (without regard to the individuals' sex) are prohibited if they compromise, or appear to compromise, the integrity of supervisory authority or the chain of command; cause actual or perceived partiality or unfairness; involve, or appear to involve, the improper use of rank or position for personal gain; are, or are perceived to be, exploitative or coercive in nature; or, create an actual or clearly predictable adverse impact on discipline, authority, morale, or the ability of the command to accomplish its mission.

(3) In addition, certain types of personal relationships between officers and enlisted personnel are prohibited. The policy applies to relationships between Soldiers and also between Soldiers and personnel of other military services. These prohibited relationships include:

(a) On-going business relationships between officers and enlisted personnel, with certain exceptions.

(b) Dating, shared living accommodations other than those directed by operational requirements, and intimate or sexual relationships between officers and enlisted personnel, except as specifically authorized pursuant to this regulation.

(c) Gambling between officers and enlisted personnel.

(4) These prohibitions are not intended to preclude normal team building associations that occur in the context of activities such as community organizations, religious activities, family gatherings, unit-based social functions, or athletic teams or events. In any relationship between Soldiers of different grades or ranks, however, the senior member is generally in the best position to terminate or limit the extent of the relationship. Nevertheless, all members may be held accountable for relationships that violate this policy.

(5) Commanders should seek to prevent inappropriate or unprofessional relationships through proper training and leadership by example.

#### *b. Other prohibited relationships.*

(1) *Improper trainee and Soldier relationships.* Any relationship between permanent-party personnel and trainees not required by the training mission is prohibited.

(2) *Improper recruiter and recruit relationships.* Any relationship between permanent-party personnel assigned or attached to the USAREC and potential prospects, applicants, members of the Delayed Entry Program (DEP), or members of the Delayed Training Program (DTP) not required by the recruiting mission is prohibited.

(3) *Fraternization, Article 134, UCMJ.* Unlawful fraternization is a specific offense under the UCMJ, although most such cases will also involve violations of AR 600–20. Commanders should consult the SJA before acting on reports of this type of misconduct.

### 19–7. Standards of conduct

*a.* Ethical violations of standards of conduct impair the trust and confidence placed in officers by superiors and subordinates, and undermines the public's respect for the Army.

*b.* Standards of Ethical Conduct for Employees of the Executive Branch went into effect in 1993. Published by the

Office of Government Ethics (OGE), these standards are reprinted in and supplemented in DOD Directive 5500.7-R, *Joint Ethics Regulations (JER)*. The JER also reprints other OGE regulations that govern the conduct of DOD personnel, and provides additional guidance and regulations on ethical issues, such as acceptance of travel benefits from non-Federal sources.

c. Commanders are responsible for being familiar with the JER and its established standards of conduct. Commanders should ensure that all personnel are properly trained and fully aware of expected ethical conduct.

d. The Army General Counsel is the Army's Designated Agency Ethics Official. The Chief, Army Standards of Conduct Office, is responsible for overseeing the Army's ethics program and for ethics support for HQDA. Army commands, installations, and organizations should have an assigned ethics counselor, who usually is located within the OSJA.

e. Ethics counselors advise and assist with common ethics problems, such as gifts to superiors; acceptance of gratuities and benefits from outside sources; use of government facilities, property, and personnel for unofficial purposes; improper use of benefits received as a result of official travel; post-government employment restrictions; and commercial solicitations.

## 19-8. Legal basis of command

a. *Who commands.* Command is the responsibility of the senior, regularly assigned officer present for duty, unless that individual is ineligible for command by law, under Army regulations, or preempted by the authority of the President. The term "command" has two distinct meanings. It describes the authority of military officers over Soldiers in their charge; and legal aspects of the actions of a garrison commander as a manager of real property and activities occurring upon that property.

b. *Command authority.*

(1) Commanders are vested with the authority to command by virtue of their military office. Commanders are responsible for the welfare of their command mission success, and have the authority to demand obedience to lawful orders.

(2) The U.S. Constitution, laws, and regulations by higher authority determine the lawfulness of orders. Courts have described a commander's authority as "inherent" and "broad," and will defer to a commander's decision in an appropriate exercise of discretion. Nevertheless, courts insist that decisions be reasonable and consistent with law and regulation, not arbitrary or capricious. A commander should seek the advice of a supporting JA should that commander have doubts as to the reasonableness and/or consistency of a pending decision.

c. *Maintenance of law, order, and discipline on post. The garrison.* commander may maintain law and order over civilians on post pursuant to his or her inherent authority and by enforcing the *Assimilative Crimes Act (ACA)*, 18 USC § 13, and the *Federal Trespass Law*, 18 USC § 1382.

(1) *Inherent authority.* As recognized by the United States Supreme Court, a garrison commander has the inherent authority and responsibility to maintain law and order, security, and the discipline necessary to ensure the proper functioning of the installation.

(2) *Assimilative Crimes Act (ACA).* The ACA provides that Federal authorities, including military commanders, may sometimes "assimilate," that is, apply state criminal law. This is a complex matter of law, policy, and civil-military relations; prudent commanders work closely with the SJA and other staff on these issues.

(3) *Trespass.* Under the Federal Trespass Statute, a garrison commander may bar an individual, in writing, from the installation when that person has committed a crime or has violated a post regulation. If the individual violates the commander's directives in the written bar not to enter the installation, then the individual may be criminally prosecuted for trespass in federal court. Upon conviction, the trespasser may be punished with a fine (as specified under 18 USC 3571) or not more than six months' imprisonment, or both.

d. *Free speech and dissent by civilians.* Regulating speech on the installation is dependent on whether the installation, or a part of it, can be characterized as a "public forum." Generally, military installations are not public forums for First Amendment statements. However, installations, or portions of them, can become public forums by allowing access to persons or groups who engage in statements not supportive of the military mission. The courts recognize the right of a commander to prohibit demonstrations and similar protests by civilians on military installations. Thus, the commander should know what such persons or groups are going to say and do before permitting access and should consult with the SJA to determine the limits of command authority in a given case.

e. *Free speech and dissent by Soldiers.* The courts apply a similar analysis when reviewing command authority over Soldiers' exercise of free speech. The UCMJ prohibits certain speech, such as disrespectful words and gestures toward superiors. Regarding other aspects of expression, the courts have not adopted an "area" approach in determining the extent of a commander's authority to limit a Soldier's activities. They have insisted that any regulatory prohibitions specifically describe the prohibited activity. AR 600-20 prohibits Soldiers from participating in partisan or nonpartisan political meetings or rallies, picket lines or any other public demonstrations that may imply Army sanction of the cause.

f. *Distribution of literature on the installation.*

(1) Unlike demonstrations and protest activities, Army installations are open forums for news publications, even



## How the Army Runs

those critical of government policies or officials. The general rule is that literature is allowed on the installation, rather than kept off. Installation commanders may, however, require that distribution of printed media be made only through regularly established and approved distribution outlets, such as post exchanges. An exception is available if those seeking distribution obtain prior approval from the commander or authorized representative.

(2) Commanders must weigh literature restrictions against the standard of “clear danger to loyalty, discipline, and morale.” The garrison commander may delay distribution subject to review for final decision by HQDA.

*g. The Commander’s regulatory authority.* Commanders may publish regulations and policies necessary to the functioning of their commands, as long as they are not arbitrary, capricious, or unlawful. JAs can provide assistance to the commander in formulating regulations and policies that will withstand legal challenge.

### 19–9. Environmental law

*a. The challenge.* Environmental protection poses an increasing challenge to military leaders. Environmental laws control all sources of pollution, and protect many natural and cultural resources. Under most environmental statutes, the Army is as much a member of the regulated community as any corporation. Commanders must integrate Federal, state, and local environmental requirements within the defense mission. JAs are a vital resource in guiding the commander through environmental issues. With the establishment of the US Army Installation Management Command, and its subordinate command, the US Army Environmental Command, the focus of Army environmental concerns has been placed within their responsibility.

*b. Environmental regulation of military installations.*

(1) Until about 1970, the Constitution insulated Federal entities from most State efforts to enforce State laws.

(2) This isolation changed with the enactment of the *National Environmental Policy Act (NEPA)*, 42 USC §4321, et seq. NEPA directed the DOD (and all other Federal agencies) to identify, quantify, and evaluate environmental impact before any Federal undertaking, and to consider alternative courses of action. Failure to properly address its requirements can expose a command to injunctions that can restrict or entirely halt military operations.

(3) Congress enacted numerous environmental statutes after NEPA. A common component of each statute was the Federal Government’s ability to delegate the administration of the program to the individual State. The delegation of authority to the individual State and the waiver of sovereign immunity in some statutes potentially expose Federal agencies to lawsuits if they fail to implement State laws. For example, the *Clean Air Act* (Title 42, Chapter 85) requires all major sources of air pollutants within the United States, including most Army installations, to obtain a state-issued, facility-wide operating permit, or cease to operate without a presidential exemption. Army installations must submit detailed permit applications, which commanders must certify as true, accurate, and complete.

(4) Almost all current Federal environmental statutes require the Army to comply with an extensive complex of Federal, state, and local laws in the:

- (a) Installation, operation, and maintenance of air- and water-pollution control technology.
- (b) Quantitative and qualitative limitations on air and water emissions.
- (c) Pollution monitoring, record keeping, and reporting requirements.
- (d) Operating permits for pollution sources and the payment of reasonable permit fees.
- (e) Handling, transportation, storage, treatment, and disposal of solid waste and hazardous waste.
- (f) Reporting and cleanup of spills.
- (g) Monitoring virtually all-underground storage tanks for leaks.
- (h) Cleanup of active and closed hazardous-waste disposal sites.
- (i) Conservation of endangered and threatened species and wetlands.

*c. Compliance.*

(1) Army compliance with environmental laws and regulations was once largely voluntary, but no longer. The *Federal Facility Compliance Act (FFCA) of 1992* expanded the waiver of sovereign immunity under the *Resource Conservation and Recovery Act (RCRA)*, 42 USC §6901, et seq. The Federal EPA and State regulators can now assess punitive fines against Federal agencies, including the Army, for violations of Federal, state, and local solid- and hazardous-waste laws and regulations. Amendments to the *Safe Drinking Water Act (SDWA)*, 42 USC §300f, make it the second major environmental statute to waive the Federal Government’s sovereign immunity to punitive fines. Army installations are required to maintain compliance at all times or face enforcement actions that may prevent mission-essential training and operations.

(2) Current environmental laws affect many daily activities at military installations, and enforcement of the laws is strengthening. Federal environmental statutes specifically authorize individual citizens to act as private attorneys-general by initiating lawsuits to force compliance through injunctions and fines. Finally, Army leaders are not immune from the threat of personal criminal liability for environmental crimes. Again, JAs can be a valuable resource to Army leaders in avoiding personal liability.

(3) The FFCA is silent on the source of payment of fines and penalties, but Presidential, DOD, and DA policies provide that installation or activity operational accounts of those most directly responsible for the violation will pay environmental fines.

(4) Commanders must handle environmental matters skillfully or risk substantial disruption of crucial training and other operations that may reduce combat readiness. Even relatively minor compliance problems can be costly to taxpayers, the Army, and local installations.

*d. Pollution prevention and conservation.*

(1) Army leaders must also stress pollution prevention and hazardous-material minimization.

(2) Commanders are increasingly required to ensure that mission activities conserve natural resources on Army installations. The *Endangered Species Act (ESA)*, 16 USC §1531, et seq., requires all Federal agencies to carry out programs for the conservation of federally listed endangered and threatened species. Actions that may affect such species are subject to formal consultation with the U.S. Fish and Wildlife Service or the National Marine Fisheries. Commanders must also protect the quality and quantity of the installation water supply, conserve the water source, and seek to preserve wetlands that provide important habitat for fish and wildlife.

## **19–10. Federal labor relations and the role of the labor counselor**

*a. Unions.*

(1) Unions represent many Federal employees within DA. Federal labor law requires the Army to notify unions before implementing changes in working conditions including, but not limited to, changes in office hours, changes in shifts, major task/objective changes for the division/directorate, and reassignment of personnel. Commanders should consult the installation labor-relations specialists and labor counselors on all matters concerning unions or employees who are covered by collective bargaining agreements to ensure compliance with the existing negotiated labor agreement and applicable laws and regulations. Commanders also should be careful not to make adverse comments regarding unions and/or their effectiveness or worth. The SJA can advise on the specifics of these restrictions.

(2) The installation labor counselor, a JA or an Army civilian lawyer, is the primary adviser to the commander, supervisor, and the CPAC on legal aspects of civilian personnel and labor relations.

(3) The labor counselor's duties include review of proposed adverse civilian personnel actions and pending equal employment opportunity (EEO) complaints; participating in contract negotiations with labor unions, particularly when opposing lawyers are involved; representing management in third-party proceedings, such as bargaining-unit determinations, unfair-labor-practice complaint proceedings, Equal Employment Opportunity Commission hearings, Merit System Protection Board hearings, and arbitration hearings; advising activity negotiating committees; and advising on interpretation and application of negotiated labor agreements.

*b. Discipline of civilian employees.*

(1) Commanders will likely supervise numerous Federal civilian employees or command those who do. DOD 1400.25–M, *DOD Civilian Personnel Manual* establishes two categories of disciplinary actions. The first is informal disciplinary action. This includes oral admonishments, oral counseling, and written warnings. The second category, formal disciplinary actions, includes letters of reprimand, suspensions, reductions in grade or pay, and removal. Similarly, employee conduct requiring discipline falls into two categories, corrective and punitive. Corrective discipline includes behavioral offenses for which progressive discipline, aimed at correcting the behavior is appropriate. Punitive measures are appropriate for more serious matters, such as fraud, waste, and abuse.

(2) Informal discipline is appropriate for most minor unacceptable behavior. Supervisors take informal action on their own initiative, and should advise the employee that continued misbehavior might result in formal disciplinary action.

(3) Formal disciplinary action is appropriate because of the severity of conduct or when informal discipline for minor misbehavior has not worked. The CPO and the labor counselor advise and assist supervisors concerning appropriate penalties and related concerns.

(4) The severity of the imposed penalty and the status and union affiliation of an employee determine the appeal rights available to the disciplined employee. If the employee raises a discrimination claim in conjunction with the appealed action, the appeal rights may vary. The Army defends disciplinary and performance actions in administrative hearings and Federal court.

(5) Civilian personnel laws and regulations also permit supervisors to take appropriate action against employees whose job performance is unacceptable. These include, but are not limited to, adverse appraisals, special appraisals, and extra training.

*c. Equal employment opportunity allegations of discrimination.* One of the labor counselor's most important duties is advising the installation EEO officer and commander on equal employment opportunity. Civilian employees are protected by law, executive order, and regulation from discrimination based on race, color, sex, national origin, religion, age, disability, and sexual orientation. They are also entitled to be free from sexual harassment. Finally, civilian employees have the right to complain about conduct they perceive to be discriminatory.

*d. Deployment considerations.* The civilian work force is vital to mission accomplishment. Civilian employees accompany Army units in exercises and operations worldwide. Commanders should thus include the many legal issues of civilian employee support, administration, and discipline in deployment planning.

### 19–11. Legal assistance

The legal assistance program is designed to meet the continuing legal needs of Soldiers and their families. Legal assistance also helps to support military readiness, high morale, good discipline, recruiting, and retention of a quality force.

*a. Mission.* As stated in AR 27–3, *The Army Legal Assistance Program*, this program exists to assist Soldiers and their families with personal legal affairs. The first part of this mission is preventive: legal-assistance officers inform Soldiers and their families of legal pitfalls, issues, and services, so Soldiers may avoid difficulties and unnecessary expense in garrison, during field training, and when deployed. The second part of this mission is providing legal assistance directly to eligible clients.

*b. Readiness.* Senior leaders often overlook their own personal and legal affairs. Soldiers preoccupied with such matters may not be effective; leaders with similar problems affect unit readiness and mission accomplishment. Lessons learned from deployments and operations repeatedly highlight that leaders can do more to ensure that Soldiers have their personal legal affairs in order, e.g., wills and powers of attorney. Routine legal assistance appointments can satisfy most Soldiers' legal needs well before deployment. Having accurate and needed wills and powers of attorney, for example, is a beneficial practice for all clients regardless of their deployment status, and the proper preparation of such documents requires adequate time for counseling, advising, preparing, and reviewing. Commanders should earnestly avoid delaying provision of this important legal assistance for themselves and their Soldiers until a Soldier Readiness Program (SRP) is administered immediately before deployment when time is limited. In sum, early SJA participation in the planning process and in the SRPs will enhance readiness.

*c. Client eligibility.* The authorization of personal legal assistance is subject to availability of legal resources. Generally, all Active Component (AC) and retired Soldiers and their families are entitled to legal assistance as are, with some restrictions, Reserve Components (RC) Soldiers and their families. In addition, Army civilian employees may be eligible for legal assistance if deploying, or in such matters as responding to reports of survey.

*d. Client services.*

(1) Army legal offices provide legal assistance on many issues, including family law, wills, leases, contracts, powers of attorney, disputes with creditors, veteran reemployment rights, torts, taxes, and appeals of adverse efficiency reports or reports of survey findings.

(2) Legal assistance may include notary services, legal counseling, telephone calls and letters on behalf of clients, preparation of some legal documents, and helping Soldiers prepare Federal and State income tax returns. Some legal offices help clients in local courts on uncontested or simple legal matters, such as adoptions, uncontested divorces, or small claims. Where offered, eligibility for in-court representation is generally limited to Soldiers in pay grades E4 and below if they have substantial financial hardships.

(3) Soldiers do not pay for Army legal assistance. If the legal assistance office cannot solve a legal problem, it will ordinarily refer the client to the appropriate local bar association so that the client can get a civilian lawyer. Sometimes, referral may be to RC JAs or units that provide legal assistance for retirement points without cost to the Soldier. Furthermore, RC JA units and individuals often perform drill by supplementing legal assistance at AC legal offices.

*e. Preventive law.*

(1) Legal assistance offices accomplish preventive law, educating Soldiers and their families to avoid personal legal problems.

(2) Direct action against unscrupulous merchants is an effective method of solving widespread problems. The local Armed Forces Disciplinary Control Board can recommend placing establishments off-limits for a variety of reasons, including business practices that have an adverse effect on command health, discipline, or morale.

### 19–12. Claims

*a. Army Claims System.* The Army Claims System investigates, processes, adjudicates, and settles claims on behalf of and against the United States world-wide under the authority conferred by statutes, regulations, international and interagency agreements, and DOD directives. Categories of claims include claims for property damage by Soldiers and other employees arising incident to service, torts alleged against Army or DOD personnel acting within the scope of employment, and claims by the United States against individuals who injure Army personnel or damage Army property. The Army's implementing regulation is AR 27–20, *Claims*.

*b. Supporting commanders.* The Army Claims System supports commanders by preventing distractions to the operation from claimants, by promoting the morale of Army personnel by compensating them for property damage suffered incident to service, and by promoting good will with the local population by providing compensation for personal injury or property damage caused by Army or DOD personnel.

*c. U.S. Army Claims Service.* Under The Judge Advocate General's (TJAG) supervision, the U.S. Army Claims Service (USARCS) administers the Army Claims System and designates Army claims officers (ACOs), claims processing offices, and claims attorneys. SJAs or other supervisory JAs operate each command's claims program and supervise the (ACO) or claims processing office (CPO) designated by USARCS for the command. ACOs and CPOs investigate, process, adjudicate, and settle claims against the United States; and identify, investigate, and assert claims on behalf of the United States.

*d. Soldier misconduct.* When the claim results from Soldier misconduct AR 27–20 permits deducting from the wrongdoer’s pay to compensate the victim.

### 19–13. Command authority and judicial review of military activities

*a. Federal courts.* Federal courts have consistently held that control and operation of the military establishment are functions of the executive and legislative branches, not the judicial. Judges do not try to command or interfere unduly with military operations. Notwithstanding this fundamental judicial and political philosophy, no individual or organization is above the law.

*b. Commander response.* Commanders should know what kinds of military decisions and activities Federal courts will review; the extent the courts recognize the unique requirements and conditions of command; how to respond to a court order; internal command procedures for proper handling of court orders and other legal process; and DA requirements when a command is sued.

*c. Scope of judicial review.*

(1) Courts defer to the military.

*(a)* In the important military case, *Parker v. Levy*, the U.S. Supreme Court remarked that: “While the members of the military are not excluded from the protection granted by the First Amendment, the different character of the military community and of the military mission requires a different application of those protections. The fundamental necessity for obedience, and the consequent necessity for imposition of discipline, may render permissible within the military that which would be constitutionally impermissible outside it.”

*(b)* When the Constitution clearly confers a function to the executive or legislative branch of government, the courts generally refrain from reviewing the merits of a controversy. Even where the Constitution is not specific, courts are reluctant to become involved in questions about the military. Most courts ask first whether the complaint alleges a violation of regulation, statute, or constitutional provision.

(2) Failure to follow military regulations and statutes may result in judicial sanctions. Military officials may not legally ignore Army regulations in carrying out their mission. Courts will generally view violations of regulations written for the benefit of the Government as harmless but will overturn actions that violate regulations intended for the benefit of an individual

(3) Denial of Soldiers’ constitutional rights usually leads to judicial intervention. Army violations of Soldiers’ rights to a limited form of free speech or to due process in courts-martial and adverse administrative personnel actions have led to numerous lawsuits against commanders and other military officials.

(4) Commanders may face individual liability for their acts.

*(a)* People usually sue the Government to force it to act or to reverse an action previously taken. Frequently, these lawsuits allege that the decision maker violated the person’s constitutional rights. A personal liability lawsuit seeks money damages from the individual governmental officer.

*(b)* The Department of Justice (DOJ) will represent most government defendants who are sued for acts within the scope of their assigned duties. Officers sued for alleged constitutional violations receive protections known as qualified immunity. In cases involving constitutional violations, qualified immunity results in the dismissal of a plaintiff’s claim if the officer acted in good faith and if constitutional guidelines are not clearly established or a reasonable person would not know that clearly established guidelines exist.

*d. Response to litigation.*

(1) There are strict requirements for complying with Federal court orders, notifying HQDA of lawsuits, and forwarding litigation reports from commands to the Army Litigation Division. JA advice should be sought and the OSJA notified immediately upon receipt of any written legal process to ensure proper response to such legal actions.

(2) The primary objectives of JAs in litigation are early dismissal of lawsuits, minimizing interference with command activities by ongoing lawsuits, and insulating official defendants against suits for money damages.

## Section III

### Military Justice

#### 19–14. Background

*a. Military justice purpose.* Military justice is more than merely criminal law in battledress. The purpose of military criminal law is to promote justice, assist in maintaining good order and discipline in the armed forces, and promote efficiency and effectiveness in the military establishment.

*b. Uniform Code of Military Justice (UCMJ) and Manual for Courts-Martial (MCM).* From Bunker Hill to Bastogne, the Army administered military justice under the Articles of War. These Articles, which George Washington and others adopted from the British early in the Revolutionary War, traced their origins to Roman models that were refined during the Renaissance. The Articles worked well enough for our own small army for almost two centuries. Nevertheless, abuses noted during World War II led to calls for reform. In 1950, Congress passed the UCMJ to provide uniform rules for all services. The UCMJ is found at Title 10, United States Code, Sections 801–946, but the sections are commonly referred to as Articles 1 through 146 of the UCMJ. Pursuant to the constitutional authority as

## How the Army Runs

Commander-in-Chief, and the authority granted by Congress in the UCMJ, the President signed an Executive order creating the Manual for Courts-Martial (MCM). The MCM consists of a preamble, rules for courts-martial, military rules of evidence, punitive articles, and nonjudicial punishment (NJP) procedures (see para 19–19b below). AR 27–10, *Military Justice*, is the implementing Army regulation.

### 19–15. Providing military justice legal services

*a. TJAG responsibility.* TJAG is responsible for the overall supervision and administration of military justice within the Army. The commander is responsible for the administration of military justice in the unit, and must communicate directly with the SJA about military justice matters.

*b. SJA responsibility.* The SJA is responsible for military justice advice and services to the command. The SJA advises commanders concerning the administration of justice, the disposition of alleged offenses, appeals of NJP, and action on court-martial findings and sentences. The SJA also supervises the administration and prosecution of courts-martial, preparation of records of trial, the victim-witness assistance program, and military justice training.

*c. Trial Defense Service (TDS).* JAs of the U.S. Army Trial Defense Service (TDS), under the supervision of the Chief, U.S. Army Trial Defense Service, not the SJA, advise and represent Soldiers before courts-martial. TDS attorneys also represent Soldiers in adverse administrative hearings. Again, it is noteworthy that TDS JAs are not within the local chain of command.

*d. Military Judges.* Military judges of the U.S. Army Trial Judiciary, who are not within the local chain of command or technical chain of the SJA, preside at general and special courts-martial, promulgate rules of court, maintain judicial independence and impartiality, conduct training sessions for trial and defense counsel, and perform or supervise military magistrate functions (review of pretrial confinement and issuance of search, seizure, or apprehension authorizations).

### 19–16. Active Army jurisdiction

As a result of the Supreme Court's 1987 ruling in *Solorio v. United States*, jurisdiction of a court-martial depends solely on the accused's duty status as a member of the armed forces, and not on whether the offense is service-connected. The *Solorio* ruling means that both the military and civilian authorities may have jurisdiction over a Soldier who commits an offense off post. This is commonly referred to as concurrent jurisdiction. Army policy is not to prosecute Soldiers for offenses if civilian authorities are prosecuting the same Soldiers for similar or like offenses.

### 19–17. Jurisdiction over reservists

*a. Military Justice Amendments of 1986.* As a part of the Military Justice Amendments of 1986, Congress amended the UCMJ to extend jurisdiction over members of the RC during both active duty and Inactive Duty for Training (IDT). In short, RC Soldiers are subject to the UCMJ for misconduct committed during training periods. One significant change allows the military more flexibility to exercise court-martial jurisdiction over reservists who commit crimes during weekend drill, IDT, and over members of the National Guard of the United States when in Federal service.

*b. Continuing jurisdiction.* Recognizing that IDT periods are brief, usually lasting only one weekend per month, the amendments provide for continuing jurisdiction during the entire period of IDT, including those short periods when the Soldier is not physically present at the IDT site. Additionally, the Government can involuntarily order to active duty (for Article 32 investigations, courts-martial, and NJP) RC Soldiers accused of violating the UCMJ during a training period.

*c. Trial.* AC convening authorities should be familiar with changes in RC jurisdiction, because all general and special courts-martial are tried at the active duty post that supports the RC unit (including ARNG units when federalized). In addition, only the AC General Court-Martial Convening Authority (GCMCA) can authorize involuntary recall of an RC Soldier to active duty for UCMJ action. The SECARMY must give prior approval for the involuntary recall if pretrial restraint will be imposed or if there is possibility of confinement as the result of a court-martial sentence.

### 19–18. The commander's role

*a. The commander's prosecutorial discretion.*

(1) One of the commander's greatest powers in the administration of military justice is the exercise of prosecutorial discretion, for example, deciding whether a case will be resolved administratively, or if referred to a trial, determining what level of court-martial is appropriate, or what the charge will be. Although commanders should seek advice from the SJA and review available investigative reports, the commander alone must ultimately decide. Commanders should resolve cases at the lowest level appropriate for the offense and the offender, a fundamental theme of military justice.

(2) A variety of administrative alternatives exist, including:

(a) Counseling.

(b) Written or oral reprimands and admonitions.

(c) Withdrawal of pass privileges.

- (d) Extra training.
- (e) Withdrawal or limitation of privileges (commissary, PX, on-post driving, etc.).
- (f) Alcohol and drug rehabilitation programs.
- (g) Administrative separations.
- (h) Officer and NCO evaluations.
- (i) MOS reclassification.
- (j) Reduction for inefficiency.
- (k) Bar to reenlistment.
- (l) Reassignment or transfer.

(3) The decision to refer offenses to a court-martial is often difficult and there may be pressure on a commander to “do something” in serious cases. A case should not be referred to trial unless the convening authority finds: reasonable grounds to believe that an offense subject to court-martial has been committed, reasonable grounds to believe the accused committed the offense(s), the specification alleges an offense, and a court-martial is warranted (Rules for Courts-Martial 601(d)(1)). If the crime is minor, NJP or administrative alternatives are generally a first consideration.

(4) The standard for referral does not conflict with the lawful presumption of innocence surrounding the accused at a court-martial. The perceptive commander will find occasions when the accused’s conduct satisfies the legal elements of a crime, but for reasons of compassion, interests of justice, or other considerations, punitive action is not required. Similarly, commanders must resist the temptation to avoid use of the military justice system in order to create a misleading statistical picture of morale and discipline. Serious crime should be prosecuted in accordance with the law.

*b. The commander and the defense function.* Commanders should understand that our Constitution, laws, regulations, and ethical codes require defense counsel to represent their clients. Representation does not mean halfway measures, but zealous advocacy within the bounds of ethics and the law. Any suggestion by a commander that defense counsel do less is improper, and may lead to loss of authority to convene courts-martial and to other adverse action. The defense counsel who does not fully and vigorously represent a client is professionally derelict under the UCMJ, and liable to punishment, as well as sanctions under AR 27–26, *Rules of Professional Conduct for Lawyers*, and discipline by the State licensing bar association.

### 19–19. Options available to the commander

This section discusses the various measures for dealing with an accused before trial, and examines the various forums and administrative measures a commander may use.

*a. Pretrial restraint.* Soldiers pending military justice action, including trial by court-martial, should ordinarily continue to perform duty (AR 27–10, para. 5–15a). If required to ensure the Soldier’s presence at trial or to prevent further serious criminal misconduct, the MCM allows pretrial restraint. Because there is no military bail system, such restraint may not be more restrictive than necessary under the circumstances.

*b. Nonjudicial punishment (Art. 15, UCMJ).* One of the most valuable disciplinary tools available to the commander is NJP. This option is proper in cases of minor offenses for which administrative measures are considered inadequate or inappropriate, unless it is clear that NJP is not sufficient to meet the ends of justice. There are three levels of NJP, each with increasing severity of punishment: Summarized; Formal Company Grade; and Formal Field Grade. Maximum punishments are listed in Table 3–1, AR 27–10. A Soldier may demand trial by court-martial at any time before the commander imposes punishment. Commanders may find the details in the UCMJ, MCM, and AR 27–10. Soldiers who accept an Article 15 and do not demand trial by court-martial are not admitting guilt, but are merely agreeing to NJP procedures.

*c. General considerations in referring charges to a court-martial.*

(1) *Be objective.* A court will consider the case objectively on its merits; commanders should do the same.

(2) *Act promptly.* Commanders and subordinates should act rapidly on reports of misconduct. Unexplained delays in the administrative processing of charges may result in the dismissal of charges for lack of speedy trial. Generally, the Government should bring an accused to trial within 120 days of referral of charges, or imposition of pretrial restraint, which may require bringing the Soldier to trial even more quickly.

(3) *Ensure evidence supports charges.* No matter how convinced a commander may be of an individual’s guilt, there will be no conviction if there is insufficient competent evidence. Trial counsels assist commanders in evaluating evidence to ensure that trial is warranted.

(4) *Consider the individual.* Commanders should select the option that fits the Soldier and the offense, considering the background of the accused and the effect on the unit.

*d. Types of courts-martial.*

(1) *Summary Court-Martial (SCM).*

(a) The SCM is the lowest level trial court in the military justice system, and is designed to dispose of minor offenses under simple procedures. It is composed of one commissioned officer, ordinarily of field grade.

(b) SCM convening authority is generally vested in battalion-level and higher commanders. SCM can only try

## How the Army Runs

enlisted Soldiers, and is sometimes used after an accused has been offered and refused NJP for the offense. An accused may also decline trial by SCM. The punishment powers of the SCM are listed in Table 19–1.

(2) *Special Court-Martial (SPCM).*

(a) The SPCM is the intermediate military court. The SPCM convening authority is usually a brigade-level commander. Table 19–1 depicts the punishment powers of the SPCM.

(b) SPCM membership normally consists of at least three members and a military judge, or solely of a military judge, if the accused so requests. If an enlisted accused so requests, at least one-third of the court members must be enlisted.

(c) SPCMs also have trial counsel (prosecutor) and defense counsel. The trial counsel need not be a lawyer. The accused, however, has a regulatory right to representation at trial by an appointed military lawyer certified by The Judge Advocate General. As a matter of practice, both trial and defense counsel are usually qualified lawyers. At all courts-martial, the accused is entitled to representation by civilian counsel at no expense to the Government and may retain detailed military counsel in addition to a retained civilian attorney.

(3) *Bad Conduct Discharge (“BCD”) Special Court-Martial.* The “BCD” SPCM is the same type of court as the “regular” SPCM, except that this court-martial has the additional power to impose a bad-conduct discharge (BCD) as part of the sentence. In addition to detail of a qualified defense counsel and a military judge, a verbatim record of the trial must be made. In the Army only a GCMCA may convene a “BCD” SPCM. Table 19–1 depicts the punishment powers of the “BCD” SPCM.

(4) *General Court-Martial (GCM).*

(a) The GCM is the highest trial court in the military justice system and deals with the more serious crimes. Only a GCMCA, usually a commander at division-level or above, may convene a GCM, and then only upon the written pretrial recommendation of the SJA. GCM punishment is limited only by the maximum punishments for each offense found in Part IV of the MCM. Table 19–1 depicts the punishment powers of the GCM. A GCM may sentence Soldiers to death, life imprisonment, a term of imprisonment, or dishonorable discharge (DD). Any officer requiring trial by court-martial is also ordinarily tried by GCM, as only that court may sentence a convicted officer to confinement or dismissal.

(b) A GCM may consist of a military judge and not fewer than five members, or a military judge alone, if the accused so requests. The accused may elect trial by judge alone in all cases except those referred to trial as capital (with potential for the death penalty). A military judge is detailed to the court in all cases. As with SPCM and BCD–SPCM, an enlisted Soldier is also entitled, on request, to trial before a court-martial panel that includes at least one-third enlisted members.

(c) Trial and defense counsel, lawyers certified by The Judge Advocate General, represent the parties at all GCM.

(d) Unless the accused waives the right, Article 32, UCMJ, requires that a GCM can only try charges that a field grade officer or an officer with legal training and experience has thoroughly and impartially investigated. The purposes of the investigation are to inquire into the truth of the charges, determine the correctness of the form of the charges, and to get information to decide the proper disposition of the case.

(e) The accused and counsel are present during the investigation’s hearings. The Article 32 investigating officer’s recommendations are advisory only, and not binding upon the convening authority.

*e. Administrative elimination in lieu of court-martial.* Not all misconduct warrants trial. Administrative separation instead of court-martial may sometimes serve the interests of justice. Chapter 10, AR 635–200, provides that enlisted Soldiers charged with an offense punishable by a BCD or DD may submit a request for discharge for the good of the service in lieu of trial by court-martial. The GCMCA is normally the approval authority for these requests.

*f. Pretrial agreements.* The accused and the convening authority may agree that in return for the accused pleading guilty, the convening authority will either drop certain charges or limit the sentence the accused will serve. The agreement must be in writing, so that all parties and reviewing authorities know exactly what was agreed.

**Table 19–1**  
**Court Martial maximum punishments**

Type	Confine	Forfeiture	Reduction <sup>1</sup>	Punitive Discharge
Summary	1 MO <sup>2</sup>	2/3 Pay per MO (1 Month)	E–5 One Grade <E–4 to E–1	None
Special	1 YR <sup>3,4</sup>	2/3 Pay per MO (1 Year) <sup>4</sup>	To E–1	None
BCD SP <sup>4</sup>	1 YR <sup>3,4</sup>	2/3 Pay per MO (1 Year) <sup>4</sup>	To E–1	BCD Enlisted Only

**Table 19–1**  
**Court Martial maximum punishments—Continued**

Type	Confine	Forfeiture	Reduction <sup>1</sup>	Punitive Discharge
General	See Part IV, MCM	All Pay and Allowances	To E–1	BCD (Enlisted) DD (Enlisted & Warrant Off) Dismissal (Comm Off)

Notes:

<sup>1</sup> 1. Only enlisted Soldiers may be reduced by CM.

<sup>2</sup> 2. A summary CM may impose confinement and hard labor without confinement only on Soldiers in grade of E–4 and below.

<sup>3</sup> 3. A special CM may impose confinement only on enlisted Soldiers.

<sup>4</sup> 4. A BCD, confinement for more than 6 months, and forfeiture for more than 6 months may only be imposed if the member is defended by qualified counsel and tried by a military judge.

## 19–20. 19–20. Unlawful command influence

Article 37, UCMJ, makes it unlawful for a convening authority to attempt to influence counsel, the military judge, or the members of a court-martial as to the outcome of the trial. Commanders must exercise great care that their actions not constitute or be construed as unlawful command influence.

### *a. Pretrial stage.*

(1) Commanders may personally investigate allegations, but in more serious cases, should rely on the reports of law enforcement professionals such as the U.S. Army Criminal Investigation Command (USACIDC) or military police investigators (MPI).

(2) When taking punitive action, the commander acts in a judicial capacity and must make an independent determination that punishment is appropriate. For example, if a field-grade commander believes that a Soldier's misconduct, if proven, deserves company-grade punishment, that commander can either impose the appropriate punishment personally or send the case to the company commander for disposition. The higher commander may not, however, send the case to the company commander with instructions to administer a company-grade Article 15 or impose a specific type of punishment, because that would prevent the subordinate commander from exercising independent discretion.

(3) Commanders who believe that a case demands a more serious disposition than can be administered at their level may forward the case to a higher authority with a disposition recommendation. An accused is entitled to a fair and independent recommendation as to disposition at each level of command. A commander cannot have a fixed, inflexible policy regarding level of disposition, and cannot establish guidelines suggesting an "appropriate punishment" for any category of case or offenses.

(4) Although commanders may not direct subordinate commanders to impose designated punishments or to refer cases to courts-martial, they may exercise authority to dispose of certain cases in any lawful manner. For example, a senior commander may direct subordinates to forward all cases of alleged officer misconduct or all illegal drug cases together with recommendations for disposition.

### *b. Trial stage.*

(1) Once trial begins, commanders usually are not actively involved beyond authorizing administrative support. GCMCAs can grant immunity to witnesses to facilitate their testifying, but subordinate commanders should scrupulously avoid statements of favorable treatment or negotiating "deals" with witnesses or accused under circumstances that could be construed as involving a promise, express or implied, of immunity.

(2) The rarest but egregious incidents of unlawful command influence are those that impact directly on the trial process by pressuring court members to convict or punish contrary to their actual conscience. It is criminal to subvert justice by putting command pressure on court members or witnesses.

(3) The more common problem is actual or perceived discrimination against Soldiers who participate as witnesses at a court-martial. Some subordinates, eager to obey their commanders, may read more into their superior's remarks than the superior intended. If subordinates reasonably misunderstand or misinterpret the superior commander's actions or statements in a manner that deprives an accused of a fair trial, unlawful command influence exists.

### *c. Post-Trial stage.*

(1) After trial, the commander has the opportunity to review the results of the trial, to approve or disapprove findings, and to approve, suspend, reduce, or defer the adjudged sentence. The SJA provides a written recommendation in all GCM and BCD–SPCM cases regarding their disposition before the convening authority acts.

(2) Article 37 prohibits commanders from censuring, reprimanding, or admonishing any court-martial member, military judge, or counsel about the findings or sentence adjudged by the court, or about any other exercise of judicial duties. It also prohibits giving unfavorable evaluations or ratings to court members because of court-martial participation.



### Section IV

#### International and Operational Law

##### 19–21. International law

a. International law is the application of international agreements, international customary practices, and the general principles of law recognized by civilized nations to military operations and activities. Within the Army, the practice of international law also includes foreign law, comparative law, martial law, and domestic law affecting overseas, intelligence, security assistance, counter-drug, and civil-assistance activities.

b. The SJA's international law responsibilities include: ? implementation of the DOD Law of War Program, including Law of War training, advice concerning the application of the law of war to military operations, and supervision of war crime investigations and trials; ? assistance with international legal issues relating to U.S. Forces overseas, including the legal basis for conducting operations, SOFAs, and the impact of foreign law on Army activities and personnel; ? monitoring of foreign trials and confinement of Army personnel and their dependents; ? assistance with legal issues in intelligence, security assistance, counter-drug, and civil assistance activities; ? advice to the command concerning the development of international agreements; and, ? legal liaison with host or allied/coalition nation legal authorities.

##### 19–22. Operational law (OPLAW)

a. OPLAW is that body of domestic, foreign, and international law that directly affects the conduct of military operations. OPLAW tasks support the military decision-making process, mission command, and sustainment of military operations. OPLAW encompasses the law of war and international stationing arrangements, but goes beyond these traditional international law concerns to incorporate all relevant aspects of military law that affect the conduct of operations. JAs provide operational law support in all operations. A comprehensive resource is The Judge Advocate General's Legal Center and School *Operational Law Handbook*; but it should be kept in mind that this resource does not negate the imperative to consult with the SJA/OPLAW JA before conducting operations to ensure the legality of those operations.

b. The OPLAW JA supports the commander's military decision-making process by performing mission-analysis, preparing legal estimates, designing the operational legal support architecture, war-gaming, writing legal annexes, assisting in the development and training of Rules of Engagement (ROE), and reviewing plans and orders. The OPLAW JA supports mission command by advising and assisting with targeting, ROE implementation, information operations, and by facilitating the delivery of legal support in the core legal disciplines. As many operations now are joint operations, useful guidance may be found in Joint Publication 1–04, *Legal Support to Military Operations*. It provides the doctrinal basis for interagency coordination and for US military involvement in multinational operations. It provides military guidance for the exercise of authority by combatant commanders and other joint force commanders (JFCs) and prescribes joint doctrine for operations and training. It also provides military guidance for use by the Armed Forces in preparing appropriate plans.

c. The Center for Law and Military Operations (CLAMO) is a resource organization for land-based operational lawyers. CLAMO examines legal issues that arise during all phases of military operations and devises training and resource strategies to address those issues.

d. A more specialized area of OPLAW is AC and RC involvement in Homeland Defense. The SecDef has established the overarching principles and policies to promote and support management of the Reserve Components as an operational force (DOD Directive 1200.17, *Managing Reserve Components as an Operational Force*). More specific to the issue of domestic operations is DOD Directive 3025.12, *Military Assistance for Civil Disturbances (MACDIS)*, which is the base document for domestic operations in support of civil authorities (Garden Plot). With the current concern with international terrorism and weapons of mass destruction, it should be anticipated that AC and RC units will plan for and participate in domestic operations in support of Homeland Defense. The OPLAW JA can provide current guidance on legal considerations during such operations, and more specifically regarding any specific operation to be undertaken.

##### 19–23. U.S. Forces stationed overseas under a Status of Forces Agreement (SOFA)

a. *Status of Forces Agreement (SOFA)*. A SOFA is an international agreement that defines the privileges and obligations of U.S. Forces deployed or stationed overseas. Members of the command must be thoroughly familiar with the SOFA and any supplements to that agreement. Key terms to be addressed and defined in any SOFA include the *forces, the civilian component, and dependents*.

###### b. *Military justice*.

(1) Jurisdiction is the key consideration in military justice. The SOFA must specify whether the sending state (United States) or the receiving state (host nation) possesses the authority to exercise jurisdiction over certain offenses. Ideally, the U.S. will have the exclusive right to exercise criminal jurisdiction over members of the U.S. Forces, but host nations are usually reluctant to relinquish jurisdiction over more serious offenses. Typically, the host nation will retain the prerogative to exercise jurisdiction over crimes committed against its property or citizens.

(2) Furthermore, although SOFAs generally do not address this issue, U.S. law generally does not permit trial by

court-martial, in peacetime, of U.S. members of the civilian component, contractors, or dependents. However, Congress has enacted provisions (18 USC §§ 3261–3267) that give jurisdiction over civilians to U.S. District Courts. Procedures to implement these provisions are found in DOD Instruction 5525.11, *Criminal Jurisdiction Over Civilians Employed By or Accompanying the Armed Forces Outside the United States, Certain Service Members, and Former Service Members*. Also, Article 2(10), UCMJ, provides for court-martial jurisdiction over civilians serving with or accompanying an armed force in the field in time of declared war or contingency operations. The SJA should be consulted regarding the use of these provisions.

(3) Other areas of concern are double jeopardy, production of witnesses for courts-martial, search and seizure, and host-nation confinement of members of the U.S. Forces.

(4) If jurisdiction is assumed by the host nation over U.S. Forces personnel, the Army will hire competent local counsel to represent the accused military member. The SJA will monitor the trial.

(5) SOFAs should also address administrative law, for example, provisions in the SOFA establish entry and exit requirements; specify the facilities to be provided U.S. Forces; establish requirements for the payment of customs, duties, and taxes; and indicate whether local labor laws will apply to civilians who are employed by the U.S. Forces); Overseas procurement (e.g., ensure that the stationing agreement stipulates that U.S. and not host-country law will govern U.S. acquisitions); and Payment of claims (the Foreign Claims Act will apply to determine whether the foreign claim may be paid).

*c. Legal assistance.* SOFAs generally do not address domestic-relations issues and consumer matters. The law of the receiving state or U.S. law will ordinarily apply. However, language barriers and unfamiliarity with the legal remedies and procedural rules may limit effective recourse in foreign courts.

*d. NATO. Partnership for Peace Status of Forces Agreement.* In 1995, the North Atlantic Council approved the Partnership for Peace (PFP) SOFA, which was thereafter ratified by the United States. The provisions of this agreement are essentially those of the NATO SOFA, with minor modifications. The Alliance currently includes 28 independent member countries.

## 19–24. Deployment for conventional combat missions

The SJA is responsible for providing legal advice to the commander concerning the broad range of legal issues associated with the preparation for and deployment of U.S. Forces on combat missions.

*a. International agreements.* Members of the command must be familiar with international agreements, if any, in effect between the U.S. and that country to which U.S. Forces are deploying and any countries with which the U.S. has over flight, transit, staging, or other arrangements. Consideration should be given, time permitting, to requesting the SJA to provide appropriate briefings regarding such agreements.

*b. Case Act.* The Case Act (1 USC § 112b) limits the ability of members of the executive branch to negotiate agreements with foreign governments. The Case Act also requires that the Secretary of State transmit the text of written international agreements to Congress.

*c. International agreements and Combatant Command (COCOM) authority.* DOD Directive 5530.3, *International Agreements*, delegates authority to negotiate and conclude international agreements to the SECARMY and the CJCS. The CJCS has delegated this authority to the combatant commander (CCDR).

*d. Authority and responsibility for negotiating, concluding, forwarding and depositing of international agreements.* AR 550–51, *International Agreements*, implements the Case Act and DOD Directive 5530.3 for the Army and delegates, subject to certain restrictions, authority to negotiate and conclude agreements to the heads of staff agencies and ACOM/ASCC/DRUs.

*e. Legal bases for U.S. intervention.* The commander should be aware of the legal bases for the use of U.S. Forces abroad. These bases define, and possibly restrict, the objectives and execution of military operations. An operation to protect U.S. nationals, for example, could not be used to justify other military objectives. The legal bases for use of force or forces overseas include:

- (1) Protection of U.S. nationals.
- (2) Collective self-defense, by treaty or request, assisting a state in resisting armed attack/aggression, to include externally-supported insurgent activity within a state.
- (3) Unilateral self-defense against armed attack undertaken against U.S. forces or property overseas.
- (4) Participation in properly authorized enforcement actions under Chapter VII of the UN Charter.
- (5) Disaster relief and humanitarian assistance.

*f. War Powers Resolution (WPR).* Absent a declaration of war or specific congressional approval for use of U.S. Forces abroad, the WPR imposes consultation and reporting requirements and time constraints upon the President when U.S. Forces are introduced into actual or potential hostilities. Generally, Congress must approve deployments falling within the purview of the WPR which last more than 90 days.

*g. Review of OPLANs.* Operational lawyers should review every operations plan, concept plan (CONPLAN), contingency plan, and operations order during each step of the planning process. SJAs must focus on assisting commanders in developing plans that will enable them to accomplish the mission within the limits of the law. The following documents set forth the operational lawyer's role in the planning process.

## How the Army Runs

(1) The DOD Law of War Program. DOD Directive 2311.01E, *DOD Law of War Program*, requires that all services ensure that their military operations comply with the law of war and designates the SECARMY as the executive agent for implementing the program. CJCS Instruction (CJCSI) 5810.01B, *Implementation of DOD Law of War Program*, provides further guidance in the area of joint operations.

(2) Legal operations. FM 1–04, *Legal Support to the Operational Army*, provides valuable additional guidance concerning operational law issues and legal support during war and small-scale contingencies.

*h. Rules of engagement (ROE).* ROE is a self-defining term, but the longer, official definition is that ROE are directives that a government may establish to delineate the circumstances and limitations under which its own military forces will initiate and/or continue combat engagement with enemy forces. (Joint Publication 1–02, *Department of Defense Dictionary of Military and Associated Terms*). Each command will establish ROE consistent with guidance from higher headquarters. In the absence of superseding ROE, this guidance may be found in JCS standing ROE. See CJCS Instruction 3121.01B, *Standing Rules of Engagement/Standing Rules for Use of Force for US Forces*.

*i. Rules of deadly force.* Broader than standing ROE addressed above, the rules of deadly force policies are grounded in DOD Directive 2000.12, *DOD Antiterrorism (AT) Program*, and DOD Directive 5210.56, *Use of Deadly Force and the Carrying of Firearms by DOD Personnel Engaged in Law Enforcement and Security Duties*. Overseas, they apply primarily as a matter of force protection and are triggered by the mere presence of U.S. Forces, whether conducting operations, exercises, transit, or leave in theater. DOD Directive 2000.12 has been further supplemented by the regional commands. Nevertheless, commanders must know the consequences of using force, particularly in a host nation that retains criminal jurisdiction and may regard the U.S. application of force as criminal. Accordingly, legal review and advice should be obtained prior to implementing local rules of deadly force.

*j. Law of war.* Commanders must be sensitive to law of war issues and must plan for providing instruction to the members of the command concerning the essential provisions of The Hague and Geneva Conventions, as well as other conventions and treaties. The following discussion highlights the areas of the law of war most critical to commanders.

(1) Regulation of hostilities.

(a) Three general principles form the foundation for this area of the law of war:

1. Military Necessity. This principle justifies those actions not forbidden by international law that are indispensable for securing complete submission of the enemy in the shortest period of time. This enables commanders to act in furtherance of the military mission (Para 3, FM 27–10, *The Law of Land Warfare*).

2. Prevention of Unnecessary Suffering. Military necessity does not allow the commander to employ arms, projectiles, or material calculated to cause unnecessary suffering (Para. 34, FM 27–10).

3. Proportionality. The loss of life and damage to property must not be out of proportion to the military advantage to be gained (Para. 41, FM 27–10).

(b) In addition to the three principles stated above, commanders must be aware of the lawfulness of certain weapons, targets, stratagems, and reprisals (Para. 497, FM 27–10). The commander must be aware of the U.S. policies toward nuclear weapons (Para. 35, FM 27–10), biological, and chemical weapons (Executive Order No. 11850, 40 FR 16187 (1975)) and (Para. 38, FM 27–10)), including limitations on the use of riot control agents and herbicides in combat (Chemical Weapons Convention, 1993, and additional Protocols I & II).

(2) Geneva Conventions. The 1949 Geneva conventions prescribe how commanders must treat prisoners of war (Chapter 3, FM 27–10), and sick and wounded on the battlefield and at sea (Chapter 4, FM 27–10). Commanders also have legal obligations to civilians in the area of operations. At division and above, commanders have an assistant chief of staff, G–5 (CA) to coordinate the political, social, cultural, and economics aspects of military operations in foreign areas. During deployments, organic assets may be augmented by CA units, drawn mainly from the Reserve Components [see FM 3–05.40, *Civil Affairs Operations*].

(3) War crimes. Commanders have an affirmative obligation to investigate and report war crimes, and to discipline those who commit such crimes (FM 27–10). Further, under certain circumstances, commanders may be criminally liable for war crimes committed by their subordinates (FM 27–10).

*k. Post-conflict governance-the law of occupation.* Belligerent occupation is the military occupation of enemy territory. Two familiar examples are post-war Germany and Japan, and more recently Iraq.

(1) Territory is considered occupied when it is actually placed under the authority of the hostile army. The occupation extends only to the territory where such authority has been established and can be exercised. A state of occupation exists when two conditions are satisfied: first, the invader has rendered the invaded government incapable of publicly exercising its authority; and second, the invader has successfully substituted its own authority for that of the legitimate government. Military occupation does not transfer sovereignty to the occupant, and the occupant's powers are provisional only; the occupant may take only those measures necessary for the maintenance of law and order and proper administration of the occupied territory. The Hague and Geneva Conventions address criteria for the occupying power such as authority of the occupant, administration of occupied territory, rights of the occupied population, property, services of occupied population, finance, and security of the occupant.

(2) No proclamation of occupation is legally necessary, but the fact of military occupation should be made known (Para. 357, FM 27–10). In post-WWII Germany, General Eisenhower issued Proclamation Number 1. In Operation

IRAQI FREEDOM, L. Paul Bremer, civilian administrator of the Coalition Provisional Authority (CPA) issued Coalition Provisional Authority Regulation Number 1 on 16 May 2003.

(3) Termination. Occupation does not end upon cessation of *hostilities*, but *continues* until full sovereignty of the occupied area is returned to the displaced sovereign, or until sovereignty is assumed by another *state*. However, with restoration of sovereignty, U.S. Forces may remain and operate within the country under authority of a SOFA (19–23 above).

## 19–25. Security assistance missions

### a. Mission's responsibility.

(1) Security assistance consists of those statutory programs and authorities under which the U.S. may provide or regulate forms of assistance and sales to foreign governments (and international organizations) for the purpose of enhancing U.S./mutual security.

(2) These programs are designed to assist allies and friendly countries in meeting their security threats.

(3) The NSC establishes overall strategic planning and goals. Security assistance programs, as one means of accomplishing these goals, are managed by the Under Secretary of State for Security Assistance, Science, and Technology. The Under Secretary is responsible for coordinating security assistance plans and programs normally conducted by the U.S. military; the Under Secretary also chairs the Arms Transfer Management Group (ATMG), which provides policy planning and reviews security assistance matters.

(4) Under direction of the U.S. Ambassador, coordination is accomplished in a given nation by the U.S. country team, consisting of representatives of all in-country U.S. Government departments, including a military officer who normally is in charge of the security assistance organization.

(5) Within DOD, the Under Secretary of Defense for Policy is the principal point of contact and policy spokesman for security assistance matters. The Director, Defense Security Cooperation Agency (DSCA) is responsible for the day-to-day management, control, and implementation of approved and funded security assistance programs.

(6) The JCS develop plans and systematically review ongoing security assistance programs for specific countries and geographical regions in order to ensure their compatibility with U.S. global security interests and to confirm that military assistance resources are being utilized in ways that promote U.S. strategic objectives.

(7) The military departments develop, negotiate, and execute agreements pertaining to security assistance programs. They also provide logistical advice and resources and administrative support necessary to move assets to a recipient country.

(8) CCDRs exercise authority, direction, and control over U.S. Forces within a particular country that are assigned or attached. CCDRs are responsible for ensuring that all security assistance programs within their geographical areas of responsibility are coordinated, integrated, and in consonance with regional U.S. defense plans. CCDRs also identify and apply the security assistance resources required to achieve U.S. strategic goals at the regional level.

(9) Component commands of COCOMs participate in the planning and execution of security assistance programs.

b. *Role of the operational lawyer.* Operational lawyers are prepared to advise commanders concerning the various security assistance and arms transfer programs. They can advise on applicable legislative and regulatory requirements and interpretations of law, in order to avoid legal difficulties and actual or perceived abuses of security assistance aims.

c. *Security assistance programs.* Congress appropriates security assistance funds to the State Department, which affects overall coordination of the security assistance process. Congress funds specific programs annually on a program-by-program and country-by-country basis, a reflection of the significant Congressional interest and participation in security assistance.

(1) *The Foreign Assistance Act (FAA) (22 USC § 2151 et seq.), Part I.* This act provides economic, agricultural, medical, disaster relief, and other forms of assistance to various countries. Part II of the FAA authorizes the U.S. to furnish security assistance to friendly countries and international organizations, upon request and after Congressional approval.

(2) *Foreign Military Financing Program (FMFP).* The purpose of FMFP is to enable U.S. allies and friends to enhance their self-defense capabilities through the acquisition of U.S. military articles, services, and training. The high cost of modern weapon systems means that FMFP is primarily a grant program. FMFP is the primary component of military assistance to other nations under the security assistance policy.

(3) *International Military Education and Training (IMET) (22 USC § 2347).* IMET authorizes the President specific dollar amounts each FY to furnish military education and training to military and related civilian personnel of foreign countries. This education and training may be provided in both the U.S. and abroad.

(4) *Expanded IMET (22 USC § 2347).* Expanded IMET permits the President to train foreign civilian officials with defense oversight responsibility and their military forces about human rights, the role of the military in a democracy, and effective military-justice systems, as well as counter-narcotics.

(5) *Antiterrorism assistance (22 USC § 2349aa, et seq.).* This program authorizes the President specific dollar amounts each FY to assist foreign countries in order to improve the ability of their law enforcement personnel to deter terrorist activities.

(6) *Economic Support Fund (ESF) (22 USC § 2346, et seq.).* This program authorizes the President to provide, when

## How the Army Runs

U.S. national interests dictate, economic support in certain amounts to specified countries. ESF is designed to promote economic or political stability in recipient countries, although ESF may not be used for military or paramilitary purposes.

(7) *Peacekeeping Operations (22 USC § 2348, et seq.)*. This program authorizes assistance to friendly countries and international organizations for peacekeeping operations. This authority may be used to provide financial resources, equipment and supplies, or services.

(8) *Police training prohibition (Section 660, FAA, 22 USC § 2420)*. The Army cannot use FAA funds to provide training, advice, or financial support to police, prisons, or other law-enforcement forces of a foreign government or for any program of internal intelligence or surveillance on behalf of a foreign government. Longtime democracies, with no standing armed forces and which do not violate human rights, are exempt from Section 660 prohibitions. Other countries may also enjoy specific legislative exemption. There are also narrow exceptions for training foreign police personnel who primarily engage in counter-drug activities. There also is an exception for post-conflict restoration of police forces.

(9) *Arms Export Control Act (AECA) (22 USC § 2751 et seq.)*.

(a) The AECA provides for the transfer of arms and other military equipment, as well as various defense services, through government-to-government agreements. AECA establishes the FMS Program. Under this program, DOD purchases military equipment or services from U.S. firms or takes equipment from U.S. stocks (under limited conditions) and sells the equipment or services to a foreign government or international organization. The services of DOD personnel, such as training or management advice, may also be sold. Authority is provided for the leasing of defense articles in DOD stocks to eligible recipients. The AECA also authorizes the President to finance sales of defense articles and services or to guarantee financing to friendly foreign countries or international organizations. Note that the FMS program established under the AECA is not a grant program. Defense articles and services may not be provided to countries, under the AECA, on a nonreimbursable basis.

(b) The AECA is subject to revision on an annual basis and contains complex and sensitive legislative requirements, prohibitions, and limitations. A principal example of this is Section 2761 (c)(1), which prohibits personnel performing defense services under the AECA from any duties of a “combatant nature.” This provision effectively bars U.S. military trainers or advisers from accompanying units from AECA-recipient countries engaged in combat activities.

(c) The Letter of Offer and Acceptance (LOA) is a document used to affect transfers under the AECA and details the status of DOD personnel providing defense services to a particular country. Such personnel are usually given certain administrative and technical privileges and immunities (P&I). In other words, they receive limited diplomatic immunity.

*d. Other legislation.* Commanders should also be aware of country and issue-specific security assistance legislation. Examples of the latter include provisions that:

(1) Limit or prohibit the provision of assistance to countries that violate human rights (22 USC § 2304, Human Rights and Security Assistance).

(2) Prohibit the provision of security assistance to countries that illegally expropriate U.S. property.

(3) Prohibit the provision of security assistance to countries that deliver nuclear enrichment or nuclear reprocessing equipment, materials, or technology to any other country, or receive such equipment, materials, or technology from any other country. The United States also denies security assistance to countries that transfer nuclear explosive devices to non-nuclear states. Non-nuclear weapon states that receive or detonate nuclear explosive devices likewise may not receive security assistance funds. These prohibitions are subject to limited exceptions that require the President to certify that termination of assistance to such a country would be detrimental to the national security of the U.S.

(4) Completely stop foreign assistance to any country more than six months in arrears on payment of accrued debts to the U.S.

### 19–26. Deployment for overseas exercises

*a. Potential legal issues.* Before overseas exercise deployments, the SJA must consider every aspect of the operation to ensure that planning addresses all potential legal issues. This process will closely parallel that required for deployment for conventional combat missions.

*b. Overseas training exercises.* The expanded use of overseas training exercises requires the commander to be aware of legislation concerning construction activities, training activities, and exercise-related civic and humanitarian assistance undertaken in conjunction with overseas exercises.

*c. Construction in support of training exercises.*

(1) Congress has passed legislation (10 USC § 2805, *Unspecified Minor Construction*), concerning the funding of exercise-related construction and unspecified minor military projects coordinated or directed by the JCS outside the U.S. during any FY.

(2) Congress has also established certain guidelines for determining the cost of projects constructed in support of military training exercises:

(a) Transportation costs of materials, supplies, and government-furnished equipment are excluded.

(b) Travel and per diem costs applicable to troop labor and costs of material, supplies, services, and fuel furnished by sources outside of DOD on a non-reimbursable basis are excluded.

(3) Congress has also reaffirmed a Comptroller General determination that the structures of a minor and temporary nature (such as tent platforms, field latrines, range targets, and installed relocatable structures) completely removed at the termination of an exercise may be funded through operation and maintenance (O&M) exercise accounts.

(4) Given the evolving law and regulations applicable to exercise-related construction, theater operators and planners should consult with the COCOM's legal adviser before planning exercise construction.

*d. Training activities.* Units deployed on overseas exercises may familiarize host-nation forces with U.S. equipment for interoperability and safety purposes. The Army must meet security assistance requirements when the instruction before a combined exercise rises to a level of formal training comparable to that normally provided through security assistance. 10 USC § 2011, *Special Operations Forces: Training with Friendly Foreign Forces*, permits U.S. Special Operations Forces to conduct training missions with friendly foreign forces, provided the missions are designed primarily to train U.S. special operations forces.

*e. Humanitarian and civic assistance (HCA) (10 USC § 401).*

(1) The SJA is prepared to provide advice to commanders concerning the scope and nature of HCA that may be provided to nationals of a host country. DOD Instruction 2205.2, *Humanitarian and Civic Assistance (HCA) Activities*, and DOD Instruction 2205.3, *Implementing Procedures for the Humanitarian and Civic Assistance (HCA) Program*, implement the HCA program and give detailed procedures.

(2) HCA activities are designed to promote foreign policy, the national security interests of the U.S. and the country where the HCA is carried out, and the specific operational readiness skills of the U.S. Armed Forces that participate in the activity. HCA consists of:

(a) Medical, dental, and veterinary care provided in rural areas.

(b) Construction of rudimentary roads and bridges.

(c) Well drilling and construction of basic sanitation facilities.

(d) Rudimentary construction and repair of public facilities.

(e) Detection and clearance of landmines, including the furnishing of education, training, and technical assistance related to such.

(3) HCA may be provided only to those countries that are specifically approved by the Secretary of State acting upon DOD request.

(4) Except for "minimal" expenditures, only funds specifically appropriated for HCA may be used for that purpose. O&M funds may be used for the minimal expenditures.

### **19–27. Smaller-scale contingencies (SSC)**

SSC often occur within the context of one of three levels of conflict discussed below. The U.S. response to a given situation is based upon the level of the conflict and applicable international law. The SJA must advise commanders of the legal basis for U.S. responses to situations and the legal issues associated with security assistance programs and exercises conducted by the U.S. in conjunction with such responses. Examples of SSC include peace enforcement, peacekeeping, noncombatant evacuation operations, show of force demonstrations, strikes, raids, counterinsurgency, counterterrorism, antiterrorism, counterdrug, nation assistance, disaster relief, and civil support. (See Joint Pub 3–0, *Joint Operations*, for a detailed discussion of these missions.)

*a. Levels of conflict.* It is useful to categorize conflict into three levels:

(1) *Level I—Disruptive actions against a constituted government.*

(a) This level of conflict involves actions committed by individuals and small, loosely organized groups. They foment discontent through propaganda, protests, and demonstrations. They also engage in subversive, violent, and nonviolent acts of sabotage and/or terrorism.

(b) The domestic law of the state applies to these individuals and groups. The state may treat them as common criminals, as their activities have no international legal status.

(c) Third-party states may not aid those engaged in such activities. These states have a duty to prevent their territory from being used as a base of operations by those engaged in disruptive activities.

(d) U.S. actions with the recognized government generally consist of security assistance, arms transfer programs, and combined training exercises.

(2) *Level II—Insurgency.*

(a) Insurgencies are characterized by organized military operations against the constituted government. Insurgents may exercise de facto control over portions of a state's territory and portions of the population and may engage in all forms of disruptive activity against the constituted government.

(b) Insurgents must be treated in accordance with the law of the state. They are, however, protected by the provisions of common Article III of the 1949 Geneva Conventions.

(c) Third-party states may not aid the insurgents, but may recognize that the insurgents exercise control over portions of the territory and population. The legality of third-party state assistance to the constituted government may

## How the Army Runs

be largely dependent upon whether insurgent activity is externally supported or controlled. Assistance to the constituted government may be viewed as illegal intervention in some cases. Just as in Level I, third-party states have a duty to prevent their territory from being used as insurgent bases of operations.

(d) Assuming the U.S. intervention is not illegal, it may employ and exercise the full range of security assistance activities in support of the constituted government, and the use of U.S. combat/combat support forces on a unilateral or regionally collective basis may be required.

### (3) *Level III–Belligerency.*

(a) A conflict rises to the level of belligerency when the insurgents have governmental and military organizations of their own, their military operations are conducted in accordance with the law of war, they have a determinate percentage of territory and population under effective control, and the conflict becomes conventional in nature.

(b) The law of armed conflict applies to belligerencies, which have similar status under international law as wars between sovereign states. Any assistance afforded to either belligerent by a third-party state constitutes an act of war against the other. Further, participation in the conflict by third-party states gives the conflict an international character requiring application of the international law norms of neutrality.

(c) U.S. response may consist of appropriate unilateral or regional military actions. The U.S. may also participate in peacekeeping operations following a cease-fire in the conflict. FM 3–07, *Stability Operations*, and Joint Pub 3–07.3, *Peace Operations*, describe categories of such operations and missions.

b. *Special Operations.* Special operations missions are legally and politically sensitive, particularly in the absence of international armed conflict. The commander must consider not only traditional law of war issues, but also the requirements of domestic United States law (such as fiscal, security assistance, and intelligence oversight laws or DOD Directives relating to PSYOP) and broader international law requirements (such as those in mutual defense treaties and host nation support agreements (FM 1–04)). JAs assigned to special operations units must actively participate in all phases of mission planning and execution to ensure compliance with applicable U.S. law and policy.

## Section V

### Contract and Fiscal Law

#### 19–28. Overview

a. Contract law is the application of domestic and international law to the acquisition of goods, services, and construction. Fiscal law is the application of domestic statutes and regulations to the funding of military operations. The practice of contract and fiscal law includes battlefield acquisition, contingency contracting, bid protests and contract dispute litigation, procurement fraud oversight, economy act transfers, commercial activities, acquisition and cross-servicing agreements, and support to non-Federal agencies and organizations. Useful guidance may be found in DoD Financial Management Regulation 7000.14–R, *Department of Defense Financial Management Regulations (FMRS)*, Volumes 1–15, Volume 10, Contract Payment Policy and Procedures, and Volume 14, Administrative Control of Funds and Antideficiency Act Violations.

b. The SJA's contract and fiscal law responsibilities include furnishing legal advice and assistance to procurement officials during all phases of the contracting process, to include advice on the labor, environmental, intellectual property, and tax law applicable to contractors; determining the proper use and expenditure of funds; overseeing an effective procurement fraud abatement program; and providing legal advice to the command concerning battlefield acquisition, contingency contracting, Logistics civil augmentation Program (LOGCAP), the commercial activities program, interagency agreements for logistics support, overseas real estate and construction, FMS cases, and support to non-Federal agencies and organizations.

#### 19–29. Contract legal review

a. Commanders should ensure that their contracting officers work closely with legal support. DA policy requires that legal counsel:

(1) Participate fully in the entire acquisition process.

(2) Participate as a member of the contracting officer's team, and advise as to the legal sufficiency of actions taken.

b. Legal counsel shall inform the contracting officer whether the proposed action is legally sufficient, the details of any insufficiency, and a recommended course of action to overcome the insufficiency. The head of contracting activities (HCA), ordinarily at ACOM/ASCC/DRU level and higher, decides differences between the contracting officer and the legal counsel as to legal sufficiency that cannot be resolved at the contracting-office level. Other acquisition areas in which legal counsel may assist the commander include:

(1) Bid protests by disappointed bidders.

(2) Contract performance problems.

(3) Contractor requests for equitable adjustment or contract modification.

(4) Contract litigation pursuant to the "Disputes Clause" of a contract or pursuant to the Contract Disputes Act of 1978 (41 USC §§ 601–613).

(5) Issues relating to the Commercial Activities Program.

- (6) Issues relating to NAF contracting.
- (7) Issues relating to funding of Government contracts.

### 19–30. Fiscal law

*a. Fiscal limitations.* The Constitution gives Congress the authority to raise revenues, borrow funds, and appropriate money for Federal agencies. Under these express constitutional powers, Congress strictly limits the obligation and expenditure of public funds by the executive branch. Congress regulates virtually all executive branch programs and activities through the appropriations process. Violating congressionally enacted fiscal procedures subjects the offender to potential serious adverse personnel actions or even criminal penalties. There are three major fiscal limitations:

- (1) An agency may only obligate and expend appropriations for a proper purpose.
- (2) An agency must obligate within the time limits applicable to the appropriation (for example, O&M funds are available for obligation for one FY).
- (3) The obligation must be within the amounts established by Congress.

*b. Availability as to purpose.*

(1) The “purpose statute,” 31 USC 1301(a), provides that appropriations shall be applied only to the objects for which the appropriations were made, except as otherwise provided by law. DOD has discretion in determining how to accomplish the purpose of an appropriation. A particular expenditure not specified in the statute must be either reasonably necessary in carrying out an authorized function or contribute materially to the effective accomplishment of the function.

(2) By regulation, DOD has assigned most types of expenditures to a specific appropriation. These separate appropriations include O&M for day-to-day operations, contingency funds, military construction (MILCON), and more specifically military family housing. There are specific rules and requirements for each of these “purposes.” Close coordination with the SJA is strongly encouraged.

(3) Finally, money spent on general officer quarters is closely scrutinized. Many general officer quarters are older and larger than the vast majority of family housing units. Many are also historic and architecturally significant. These factors tend to make these units the most expensive to operate and maintain. Chapter 3, Section XIII, AR 420–1, *Army Facilities Management*, establishes detailed procedures for spending money on general officer quarters and must be consulted regularly. General officers are responsible for knowing how much money is spent to maintain their quarters, and must be familiar with cost limitations and approval authority levels. Accidental or intentional abuse may lead to allegations and embarrassing and expensive investigations.

*c. Availability as to time.*

(1) Appropriations are available for limited periods. An agency must incur a legal obligation to pay money within the period of availability. If funds are not obligated before they expire, they are no longer available.

(2) The “bona fide needs” statute, 31 USC § 1502(a), provides that the balance of an appropriation or fund limited for obligation to a definite period is available only for payment of expenses properly incurred during the period of availability or to complete contracts properly made within that period of availability.

*(a) Supplies.*

1. Supplies are bona fide needs of the period in which they are needed. Thus, supplies needed for operations during a given FY are bona fide needs of that year.

2. Supplies ordered in one fiscal period that will not be required until subsequent fiscal periods are bona fide needs of the first period under two circumstances: ? The Inventory Exception. A bona fide need for supplies exists when there is a present requirement for supply items to meet an authorized stockage level (replenishment of operating stock levels, safety levels, mobilization requirements, authorized backup stocks, etc.); and ? The Lead-Time Exception. If goods or materials will not be obtainable on the open market at the time needed for use because the time required to order, produce, fabricate, and deliver them requires that they be purchased in a prior FY, such supplies are a bona fide need of the first year.

*(b) Services.* As a general rule, services are presumed to be bona fide needs of the FY in which they are performed. There is a statutory exception to the general rule (see 10 USC § 2410a). Defense agencies may enter into a contract for procurement of severable services for a period that begins in one FY and ends in the next FY if (without regard to any option to extend the period of the contract) the contract period does not exceed one year. Funds made available for a FY may be obligated for the total amount of an action entered into under this authority.

*d. Availability as to amount.*

(1) *Apportionment.* The OMB apportions appropriations to agencies for obligation over their period of availability. Agencies subdivide these funds among their activities. In the Army, the operating agency/ACOM/ASCC/DRU is the lowest command level at which the formal administrative subdivisions of funds required by 31 USC § 1517, *Prohibited Obligations and Expenditures*, are maintained. Below the ACOM/ASCC/DRU level, subdivisions are informal targets or allowances.

(2) *Prohibitions. The Antideficiency Act.* 31 USC §§ 1341, 1342, 1349, et seq., and 1517 et seq., prohibits any government officer or employee from:

- (a) Making or authorizing an expenditure or obligation in excess of the amount available in an appropriation.



## How the Army Runs

- (b) Incurring an obligation in advance of an appropriation, unless authorized by law.
- (c) Making or authorizing expenditures or incurring obligations in excess of formal subdivisions of funds; or more than amounts permitted by regulations prescribed under 31 USC § 1514(a).
- (d) Accepting unauthorized voluntary services from government employees or contractors (31 USC §1342).
- (3) *Commander responsibilities.* Commanders who become aware of possible violations of the *Antideficiency Act* must investigate and report them promptly. If substantiated, the violation must be reported to the DOD, Congress, and the President.
- e. Government operations during funding gaps and continuing resolutions.* During a continuing resolution, the Army is generally not allowed to initiate or increase the scope of existing programs, projects, and activities. Operations continue at the rate of funds available during the previous FY, or at some specified lower amount. Army activities can expect to receive guidance from OMB and the Army Comptroller addressing what activities the Army can continue during the absence of appropriations. While certain employees and activities are exempt from Government suspension or shutdown during a funding gap, the Army must suspend other activities and may not accept voluntary performance of non-exempt services by non-exempt employees.

## Section VI Summary and references

### 19–31. Summary

This chapter is intended as a guide to the various legal issues that Commanders and others may encounter in carrying out their duties. As law and regulations are ever changing, this chapter is useful as a reference, but it should be kept in mind that servicing Army Judge Advocates and Army civilian lawyers are the most current resource for given situations. Army JAs and civilian lawyers stand ready to advise commanders on myriad and complex legal issues that confront Army leaders every day. Commanders should form close professional relationships with the command legal adviser. SJAs can do much more than advise on the legality of an action. They can assist commanders in accomplishing legitimate command objectives, and can provide sound advice and judgment to commanders and their staffs. Editor Note: At the time of review, the implications of the repeal of Don't Ask, Don't Tell (DADT) have not been implemented as to its effect on both regulatory prohibitions (para 4–19, AR 600–20) and selected punitive articles of the UCMJ, e.g., Article 125, Sodomy. Accordingly, close coordination with the servicing SJA is indicated when dealing with matters associated with this issue.

### 19–32. References

- a. Manual for Courts-Martial United States,
- b. DOD Directive 1200.17, Managing the Reserve Components as an Operational Force.
- c. DOD 1400.25M, DOD Civilian Personnel Manual.
- d. DOD Directive 2000.12, DOD Antiterrorism (AT) Program.
- e. DOD Directive 2311.01E, DOD Law of War Program.
- f. DOD Directive 3025.12, Military Assistance for Civil Disturbances (MACDIS),
- g. DOD Directive 5210.56, Use of Deadly Force and the Carrying of Firearms by DOD Personnel Engaged in Law Enforcement and Security Duties.
- h. DOD Directive 5500.7–R, Joint Ethics Regulation (JER).
- i. DOD Directive 5530.3, International Agreements.
- j. DOD Instruction 2205.2, Humanitarian and Civic Assistance (HCA) Activities.
- k. DOD Instruction 2205.3, Implementing Procedures for the Humanitarian and Civic Assistance (HCA) Program.
- l. DOD Instruction 5525.11, Criminal Jurisdiction Over Civilians Employed By or Accompanying the Armed Forces Outside the United States, Certain Service Members, and Former Service Members.
- m. DoD Financial Management Regulation 7000.14–R, Department of Defense Financial Management Regulations (FMRS), Volumes 1–15, Volume 10, Contract Payment Policy and Procedures, and Volume 14, Administrative Control of Funds and Antideficiency Act Violations.
- n. Joint Publication 1–02, Department of Defense Dictionary of Military and Associated Terms.
- o. Joint Publication 1–04, Legal Support to Military Operations.
- p. Joint Publication 3–0, Joint Operations.
- q. Joint Publication 3–07.3, Peace Operations.
- r. CJCS Instruction 3121.01B, Standing Rules of Engagement/Standing Rules for Use of Force for US Forces.
- s. CJCS Instruction 5810.01B, Implementation of DOD Law of War Program
- t. Army Regulation 27–3, The Army Legal Assistance Program.
- u. Army Regulation 27–10, Military Justice.
- v. Army Regulation 27–20, Claims.
- w. Army Regulation 27–26, Rules of Professional Conduct for Lawyers.

- x. Army Regulation 420–1, Army Facilities Management.
- y. Army Regulation 550–51, International Agreements.
- z. Army Regulation 600–8–24, Officer Transfer and Discharges.
  - (1) Army Regulation 600–20, Army Command Policy.
  - (2) Army Regulation 635–200, Active Duty Enlisted Administrative Separations.
  - (3) Field Manual 1–04, Legal Support to the Operational Army.
  - (4) Field Manual 3–05.40, Civil Affairs Operations.
  - (5) Field Manual 3–07 Stability Operations.
  - (6) Field Manual 27–10, The Law of Land Warfare (INCL C–1).
  - (7) The Judge Advocate General’s Legal Center and School, *Operational Law Handbook*.
  - (8) Office of Government Ethics (OGE), Standards of Ethical Conduct for Employees of the Executive Branch.

RESERVED

## Chapter 20

### Civil Functions of the Department of The Army

“I am firmly convinced that but for the existence of the Corps of Engineers peacetime organization and its resources of men, methods, training and supply and its close association with the military through the years, the history of the Pacific area in World War II would have been written more in blood than in achievement.” GEN Dwight D. Eisenhower, Chief of Staff, U.S. Army Testimony before House Armed Services Committee on H.R. 3830, 1947

#### Section I Introduction

##### 20–1. Civil functions defined

A number of activities traditionally carried out by the Department of the Army (DA) are commonly referred to as civil functions. The most extensive of these functions is the Civil Works Program managed by the U.S. Army Corps of Engineers (USACE, or “the Corps”). The Civil Works Program focuses on responsible development, protection and restoration of the Nation’s water and related land resources. Civil Works projects are implemented and operated for commercial navigation, flood risk management, environmental restoration, hydroelectric power, recreation, municipal and industrial water supply, and allied purposes. Civil functions also include USACE engineering and construction support to non-Defense-related activities of the Federal Government, State and local agencies; and USACE foreign activities not exclusively in support of U.S. forces overseas.

##### 20–2. Authorization, congressional oversight and funding

Financial and personnel resources associated with the Civil Works Program are principally authorized under Water Resources Development Acts (WRDAs) and funded by the annual Energy and Water Development Appropriations Acts - not the Defense appropriation. Program funding under these acts is generally \$5 to \$6 billion a year. Additional funds may be provided through Supplemental Appropriation Acts. One for FY 2009 provided over \$5.7 billion for reconstruction and improvement of flood protection works in the New Orleans area. The American Recovery and Reconstruction Act (ARRA, better known as the Stimulus Bill) provided an additional \$4.6 billion for construction, operation, maintenance and other activities across the Nation, bringing the total estimated program for that year to above \$16.56 billion. Funding for FY 2010 included a regular appropriation of \$5.445 billion, a supplemental appropriation of \$217 million, and use of funds carried over from prior years. The Water Resources Development Act of 1986 and subsequent WRDAs require cost-sharing contributions from State and local government project sponsors for most Civil Works activities. USACE support activities for other, non-Defense agencies are reimbursed by those agencies - to include emergency response activities funded by the Federal Emergency Management Agency (FEMA). Congressional committees like the Subcommittee on Water Resources and Environment of the House Transportation and Infrastructure Committee or the Subcommittee on Transportation and Infrastructure of the Senate Environment and Public Works Committee provide legislative oversight and authorizing legislation, while the Energy and Water Development Subcommittees of the House and Senate Appropriations Committees provide funding. Although they differ from other Army programs in financing and oversight, the civil functions are an integral part of the overall mission of the Army and the service it provides to the Nation.

##### 20–3. Relationship to warfighting competencies

The civil functions complement and augment the Army’s warfighting competencies, providing the capability to respond to a variety of situations across the spectrum of conflict. They provide a valuable tool with which to support the National Security Strategy (NSS) by maintaining a trained and ready engineer force at virtually no additional expense to the DOD military budget and at minimum expense to personnel allocations. More than 10,000 Corps of Engineers employees in jobs funded by the Civil Works program have deployed for short tours in Iraq, Afghanistan and other overseas areas, and there were (as of 30 Sep 2010) 1,060 Corps of Engineers Civilians serving in Iraq and Afghanistan. Engineering expertise resident in the Civil Works program is also made available to combatant commanders through USACE’s “Reachback” programs.

##### 20–4. Leadership and organization

*a. The Assistant Secretary of the Army (Civil Works).* Through specific statutory provisions, General Orders from the SECARMY (SA), and internal DA regulation, the Assistant SECARMY (Civil Works) ((ASA (CW)) has been assigned responsibilities for civil functions. The ASA (CW) reports directly to the SA. Congress established the position of the ASA (CW) in Section 211 of the *Flood Control Act of 1970*, Public Law (PL) 91–611, and reaffirmed it in Section 501 of the *Goldwater-Nichols Department of Defense Reorganization Act of 1986*, PL 99–433. The *Goldwater-Nichols Act* specifies that the Assistant Secretary’s duties include overall supervision of the functions of the Department of Army relating to programs for conservation and development of water resources, including flood risk management, navigation, environmental restoration and stewardship, and related purposes

## How the Army Runs

*b. USACE.* Most of the Army's civil functions are executed by the USACE, a Direct Reporting Unit consisting of about 800 military and 35,000 civilians, which also:

- provides real estate services
- conducts research & development
- conducts planning & engineering studies
- designs and builds military facilities for the Army, Air Force, other Federal agencies, and foreign governments.
- Approximately 300 military personnel and 23,200 civilian employees in the USACE are involved in civil functions.

*c. The Chief of Engineers.* The Chief of Engineers holds positions as both a principal HQDA Staff officer and a commander, commands the USACE. The Chief of Engineers and the Corps' Deputy CG for Civil and Emergency Operations report to the ASA (CW) on the Civil Works Program. Under the Chief's command are nine divisions, eight of which have Civil Works missions. Under the divisions there are 45 districts, 38 of which are within the United States. Division and district boundaries for the Civil Works Program within the CONUS generally follow watersheds and drainage basins, as shown in Figure 20-1. These delineations reflect the water resources mission of the Corps of Engineers. (Military Construction (MILCON) districts generally follow State boundaries.)

*d. Overseas Offices.* The Corps also includes a number of overseas offices with missions in construction in support of U.S. Forces, assistance to other countries and international organizations, and support to other U.S. agencies.

(1) The Pacific Ocean Division, headquartered in Honolulu, Hawaii, includes subordinate districts in Hawaii, Alaska, Japan, and Korea.

(2) The North Atlantic Division includes the Europe District as well as five stateside districts.

(3) In October 2009, the USACE stood up the Transatlantic Division, with headquarters in Winchester, VA, and two subordinate districts in Afghanistan, one in Iraq, and one responsible for USACE activities elsewhere in the Middle East.

(4) Several CONUS-based districts also carry out overseas missions, such as Mobile District's support of USSOUTHCOM.

(5) There are several other organizations within the Corps of Engineers:

(a) Engineer Research and Development Center, (ERDC) Vicksburg, MS - the Corps of Engineers research and development command. ERDC consists of seven laboratories (See Section 20-6).

(b) U.S. Army Engineering and Support Center, Huntsville, AL - provides engineering and technical services, program and project management, construction management, and innovative contracting initiatives, for programs that are national or broad in scope or not normally provided by other Corps of Engineers elements.

(c) U.S. Army Corps of Engineers Finance Center, Millington, TN - provides operating finance and accounting functions throughout the Corps of Engineers.

(d) Humphreys Engineer Center Support Activity, Fort Belvoir, VA - provides administrative and operational support for Headquarters, U.S. Army Corps of Engineers and various field offices.

(e) Marine Design Center, Philadelphia, PA - provides planning, engineering, and shipbuilding contract management in support of Corps, Army, and national water resource projects in peacetime, and augments the military construction capacity in time of national emergency or mobilization.

(f) Institute for Water Resources, Fort Belvoir, VA - supports the Civil Works Directorate and other Corps of Engineers commands by developing and applying new planning evaluation methods, polices and data in anticipation of changing water resources management conditions.

(g) USACE Logistics Activity, Millington, TN - Provides logistics support to the Corps including supply, maintenance, readiness, materiel, transportation, travel, aviation, facility management, integrated logistics support, management controls, and strategic planning.

(h) Enterprise Infrastructure Services - designs information technology standards for the Corps, including automation, communications, management, visual information, printing, records management, and information assurance. EIS outsources the maintenance of its IT services, forming the Army Corps of Engineers Information Technology (ACE-IT). ACE-IT is made up of both civilian government employees and contractors.

(i) Deployable Tactical Operations System (DTOS) - provides mobile mission command platforms in support of the quick ramp-up of initial emergency response missions for the Corps. DTOS is a system designed to respond to District, Division, National, and International events.

(j) 249th Engineer Battalion (Prime Power) - generates and distributes prime electrical power in support of warfighting, disaster relief, stability and support operations as well as provides advice and technical assistance in all aspects of electrical power and distribution systems. It also maintains Army power generation and distribution war reserves.

(k) 911th Engineer Company -provides specialized technical search and rescue support for the Washington, D.C. metropolitan area; it is also a vital support member of the Joint Force Headquarters National Capital Region, which is charged with the homeland security of the United States Capital Region. 412th Theater Engineer Command, US Army Reserve, located in Vicksburg, MS.

(l) 416th Theater Engineer Command, US Army Reserve, located in Darien, IL.

e. *The role of the private sector.* The private sector is an essential element of the Engineer team. Private construction firms carry out practically all of its construction work, employing about 300,000 people at a time on Corps activities. The Corps also employs private architectural, engineering and construction firms for over half of its design and all of its construction work. In FY 2009, the USACE let over \$9 billion in contracts for Civil Works activities. Of this amount, \$3.87 billion (42.7%) went to small businesses, including \$973 million (10.7%) to small disadvantaged firms. The partnership between the USACE and the private sector represents a force multiplier of several hundred thousand architects, engineers, and builders, ready to support the Nation in times of emergency.

## Section II

### Civil works program

#### 20–5. Civil works program activities

a. *The program.* The Civil Works Program provides for nationwide development and management of water and related land resources, including the planning, design, construction, rehabilitation, operation and maintenance of flood risk management, navigation, and ecosystem and other environmental restoration, and multiple-purpose water resource projects. The Civil Works Planning function is the foundation of the overall Corps of Engineers Civil Works Program in the development and authorization of new water resources construction projects. Completed Corps projects may include hydroelectric power, water supply, recreation, and natural and cultural resource management. Collectively, they include approximately 12 million acres of land and water. In addition to this direct Federal investment program, the Civil Works Program includes an important regulatory mission in which the Corps regulates construction in navigable waters under the *Rivers and Harbors Act of 1899*. The Corps also regulates the deposition of dredged and fill material in waters of the United States, including wetlands, under the *Clean Water Act of 1972*. In addition, the Civil Works Program includes emergency flood fighting, recovery operations, and repair and restoration of flood control works — all performed under the USACE’s own authority as specified in *PL 84–99*. USACE also carries out DOD’s responsibilities under the National Response Plan (NRP) (see Chapter 22) as the lead planning and operating agent for public works and engineering (Emergency Support Function #3) (see Chapter 22), in support of the Federal Emergency Management Agency (FEMA) and other Federal agencies.

b. *Funding sources.* The Civil Works Program receives its principal funding through the annual *Energy and Water Development Appropriations Acts*, which include funds from the Inland Waterways and Harbor Maintenance Trust Funds as well as general revenues. The program also receives funding from non-Federal project sponsors who share in feasibility study and construction costs according to formulas established by Congress in *PL 99–662*, the *Water Resources Development Act of 1986*, and subsequent water project authorization acts. The Civil Works Program funding in FY 2010 totaled \$6.652 billion. Of this amount, \$5.445 billion was appropriated by Congress in the regular appropriation, \$217 million in Supplemental Appropriations; about \$893 million by non-Federal project sponsors, \$85 million from the Coastal Wetlands Trust Fund for work in Coastal Louisiana, and \$17 million from license and use fees. This figure does not include \$2 billion in reimbursable support to other agencies.

c. *Economic infrastructure.*

(1) The USACE has been the Nation’s major contributor to the development, construction, and maintenance of a sound water resources infrastructure. Commercial navigation and flood risk management are long-standing missions of the Civil Works Program. The navigation function includes improvement and maintenance of harbors handling all of the Nation’s seaborne commerce and that of the Great Lakes. With funds from the Harbor Maintenance Trust Fund, the Corps maintains navigability in 183 harbors handling more than 250,000 tons of cargo per year, and 743 smaller harbors. With more than 15 million American jobs dependent on U.S. import and export trade, the Nation’s commercial ports are vital to the economic security of the United States. The Corps has built an intracoastal and inland commercial waterway network of 12,000 miles, and operates 238 lock chambers at 192 sites. Major segments of this network include:

- (a) The lower Mississippi River (1,015 miles);
- (b) The upper Mississippi River (936 miles);
- (c) The Ohio River (981 miles);
- (d) The Tennessee River (785 miles);
- (e) The Missouri River (735 miles);
- (f) The Arkansas and White Rivers (706 miles);
- (g) The Columbia-Snake River System (468 miles);
- (h) The South Atlantic Coast (1,111 miles);
- (i) The Gulf Intracoastal Waterway (GIWW)-West (1,501 miles);
- (j) GIWW-East (431 miles). Major improvements to inland waterway facilities are financed in part by the Inland Waterway Trust Fund. More than 600 million tons of commerce is moved every year on these waterways. Maintaining

## How the Army Runs

the system of ports and inland waterways involves removing more than 200 million cubic yards of dredged material each year.

(2) USACE shares with the U.S. Department of Homeland Security's Federal Emergency Management Agency (FEMA), both the expertise and mandate to address the nation's vulnerabilities to flood related disasters and damages. USACE has been involved in Flood Control activities, largely on the Ohio and Mississippi Rivers, since the 19<sup>th</sup> Century (the levees protecting St. Louis, MO, were designed by none other than Engineer LT Robert E. Lee in 1837) and this involvement was ramped up with the Mississippi River & Tributaries Flood Control Project in 1928, in the aftermath of widespread flooding in the Mississippi Basin the year before. The Flood Control Act of 1936 established a Federal role in flood management, and since then the Corps' authorized responsibilities have expanded to include developing structural and non structural solutions to managing flood risks, inspecting the condition of existing flood management infrastructure, providing technical and planning support to states and communities, conducting advance emergency measures to alleviate impending flooding, and rehabilitating levees and other flood management infrastructure damaged by flooding. The Nation's investment in flood risk management has prevented more than six dollars in flood damage reduction for each dollar invested, even after adjusting for inflation. Civil works projects seek to reduce flood-related damages with structural measures such as reservoirs, levees, improved channels, and floodwalls. Non-structural measures, such as advice and encouragement for local zoning regulations, flood proofing of individual homes, and setting aside land in the floodplain as open space also contribute to this mission. Flood risk management efforts range from small, local protection projects to large lakes and dams. Today, 383 dams and reservoirs are maintained and operated by the Corps for the purpose of flood damage prevention. Since passage of the *Water Resources Development Act of 1986*, most of these projects have been constructed as joint ventures between the Federal Government and non-Federal sponsors. The Corps operates and maintains most of its dams, but most other projects, once built, including about 11,750 miles of levees, are operated and maintained by the sponsor.

(3) The Corps can provide flood management assistance through a wide variety of authorities and programs. For example, through its Flood Plain Management Services Program (FPMS), the Corps can provide information, technical assistance and planning guidance (paid for by the federal government) to states and local communities to help them address flood management issues. Typical focus areas are flood hazard evaluation, dam break analysis, flood warning preparedness, flood plain management and much more. In cases where the risk of flooding is imminent in a specific area, the Corps is authorized to take immediate advance measures to protect life and property, such as constructing temporary flow restriction structures and removing log debris blockages. The responsibility for managing the Nation's flood risks does not lie exclusively with Federal agencies, such as the Corps and FEMA. Rather, it is shared across multiple federal, states, and local government agencies with a complex set of programs and authorities, including private citizens and private enterprises such as banking and insurance firms and developers. Both the Corps and FEMA have programs to assist states and communities reduce flood damages and promote sound flood risk management. However, the authority to determine how land is used within floodplains and enforce flood-wise requirements is entirely the responsibility of state and local government. Floodplain management choices made by state and local officials can impact the maximum effectiveness of federal programs to mitigate flood risk and the performance of federal flood damage reduction. However, the federal investment is protected by the execution of agreements between the federal and non-federal partners.

(4) In November 2007, the Corps established a Levee Safety Program, an important step to ensure the public is aware of the risks associated with levees in Corps programs. The mission of the program is to assess the integrity and viability of levee systems and recommend actions to ensure these systems do not pose unacceptable risks. The main objectives are to hold public safety paramount, reduce adverse economic impacts, and develop reliable and accurate information. Within the program, a National Levee Database has been created to serve as a national source of information to facilitate and link activities, which include flood risk communication, levee certification, levee inspection, floodplain management, and risk assessments. The database presently includes levees within a Corps program or FEMA's National Flood Insurance Program (NFIP). The Water Resources Development Act (WRDA) of 2007 extended the Corps authority and allows the inclusion of all nonfederal levees on a voluntary basis. Also, a methodology for performing technical risk assessments of existing levee infrastructure is under development to serve as a consistent risk based framework to evaluate levees nationally. Additional activities within this program include the creation of national teams to focus on developing new policies in other areas concerning levee safety, such as inspections of existing levee systems, verification or establishment of existing geodetic control, minimum standards for new levee systems and interim risk reduction measures. Key policy issues in which close collaboration between the Corps, FEMA, and other stakeholders is necessary relate directly to the Levee Safety Program. Specifically, these areas include levee inventory, mapping the flood hazard, inspection and assessment of levees, operation and maintenance of levees, and emergency response and evacuations.

(5) The Corps operates 75 power plants, which represent almost one fourth of the Nation's hydroelectric capacity or three percent of the Nation's total electric power generating capacity. Dams built by the USACE provide water storage for drinking water, irrigation, and fish and wildlife habitat. Additionally, 422 of the projects mentioned above (mostly lakes) are developed for recreational use. These projects accommodate nearly 370 million visits a year. The Corps estimates that one in 10 Americans visit a civil works project at least once a year. Visitors to these recreation areas

generate 350,000 private and public sector jobs. USACE is the Federal government's largest provider of outdoor recreation, hosting 20% of visits to Federal recreation areas on 2% of Federal land.

(6) The transportation infrastructure developed in the Civil Works Program plays a role in national defense. Ports and waterways serve as vital logistics links when large volumes of materiel and personnel must be moved around the country and around the world. The USACE works with the Surface Deployment and Distribution Command (SDDC) and local port authorities to ensure that ports are ready to support movement of military equipment and supplies when needed. This partnership was especially effective in moving nearly all the Army's equipment and supplies necessary for Operations *Enduring Freedom* and *Iraqi Freedom*. Waterways built and operated and maintained by the USACE similarly have direct military uses for strategic mobility. Units of the Texas, Oklahoma, and Arkansas National Guard have conducted successful movements over the Arkansas, Mississippi, and Illinois Rivers to their summer training sites, and the 101st Air Assault Division has conducted movements by waterway from Ft. Campbell, Kentucky to Louisiana. The USACE flood control projects also contribute to force projection by protecting important highway and railway links. Thus, through activities as diverse as facilitating the movement of materiel to protecting vital infrastructure, the Civil Works Program contributes to National security.

*d. The environment.*

(1) *Project activities and regulatory programs.* The Civil Works Program makes important contributions toward meeting the Nation's environmental goals by constructing projects for restoration and protection of ecosystem and other environmental functions and values. Much of this work proceeds in partnership with other Federal and State agencies or recognized American Indian Tribes, Alaska Natives, and local communities. In 2002, the Corps entered into a partnership with The Nature Conservancy to improve the management of U.S. Rivers for restoration purposes while maintaining the projects' economic services. In addition, the Corps has agreements with the National Fish and Wildlife Federation and Ducks Unlimited to advance restoration of important ecological resources.

(2) *Project authorities.*

(a) Legislation passed in 1990 established environmental restoration and protection as one of the primary missions in the planning, design, construction, operation, and maintenance of water resources projects - equivalent to navigation and flood risk management. This new direction stimulated the Corps and its non-Federal project sponsors to plan and implement new projects with environmental restoration as a primary project purpose.

(b) Like other major Corps projects, Congress must authorize large restoration projects. In one of the largest environmental restoration and protection projects ever undertaken, the Departments of the Army and the Interior have been cooperating with the State of Florida to restore the hydrologic regime of the Everglades in South Florida. Congress approved the Corps' Comprehensive Everglades Restoration Plan as a planning framework as well in Title VI of the *Water Resources Development Act of 2000*, PL 106-541. The first feasibility study for a component of this project requiring specific authorization was completed in 2002.

(c) The Corps and the State of Louisiana are working together to restore and protect that State's shrinking coastal wetlands and stem an ongoing loss of 25 to 35 square miles per year. This ecosystem is vital to the Nation's environmental health for naturally filtering out water pollution and for providing critical winter habitat for 70% of the Nation's waterfowl. This ecosystem is also vital to the Nation's economy as the home of a major seafood industry. The wetlands and barrier islands also protect inland urban, industrial, and agricultural areas from hurricanes and coastal storms - including New Orleans and dozens of other communities that are home to a culture unique in America. Work in Coastal Louisiana took on added urgency after Hurricane Katrina focused national attention on the role of coastal wetlands in attenuating storm surge and wave action.

(d) In addition to specifically authorized projects such as the Everglades and Coastal Louisiana restoration projects described above, environmental restoration is accomplished through three programmatic authorities for small projects. Under Section 1135 of the *Water Resources Development Act of 1986*, PL 99-662, the USACE is authorized to modify projects it constructed earlier in the interest of making them "greener." Section 1135 also authorizes the USACE to accomplish environmental restoration when the original Corps project contributed to environmental loss. Section 204 of the *Water Resources Development Act of 1992* provided authority for beneficial uses of dredged material. This authority allows the USACE to use material from the dredging of navigation projects for environmental restoration. The third authority is Section 206 of the *Water Resources Development Act of 1996*. This provision established a program for Aquatic Ecosystem Restoration under which small projects may be constructed; no link to an existing Corps' project is required. Working toward a national goal of "no net loss of wetlands," the Civil Works Program is undertaking projects to restore existing wetlands and to create new ones.

(3) *Regulatory program.*

(a) The USACE's regulatory program has a long history of protecting the Nation's waters. The *Rivers and Harbors Act of 1899* authorizes the USACE to regulate, by permit, dredging, construction, and similar activities in navigable waters of the United States. A principal objective of this program is to ensure that waterways are improved and maintained for commercial and recreational users. Over time, the Corps' "public interest review" has become an important part of the decision process used by Corps district commanders in granting, modifying or denying permit applications.

(b) The *1972 Clean Water Act* authorized USACE to regulate, by permit, dredging and fill material discharge



## How the Army Runs

activities in waters of the United States, including wetlands. This Act expanded the Corps' regulatory responsibilities beyond those contemplated in the *Rivers and Harbors Act of 1899*. Also, other environmental laws that were enacted at about the same time require Federal decision makers to consider and take responsibility for the environmental consequences of their actions. Section 103 of the *Marine Protection, Research and Sanctuaries Act of 1972*, as amended, authorizes the SECARMY to issue permits for the transportation of dredged material for ocean disposal. In its determination, the Corps ensures that the dumping will not unreasonably degrade or endanger human health, welfare, or amenities, or the marine environment, ecological system, or economic potentialities. However, the Supreme Court has ruled that the USACE regulatory jurisdiction does not extend to all wetlands. Its *Solid Waste Agency of Northern Cook County* decision in 2001 excluded wetlands wholly within one state and not connected to a navigable waterway, while the *Rapanos* and *Carabell* rulings of 2006 required a "significant nexus" to a navigable waterway for the Corps to assert jurisdiction.

(c) Today the regulatory program consolidates the public interest and environmental consequence reviews into a comprehensive evaluation process for decision-making. The evaluation process promotes the balancing of environmental protection with responsible economic growth. In FY 2010, the Corps granted permission for nearly 68,800 activities in the Nation's waterways and wetlands. Of these, about 48,500 were permitted under blanket nationwide or regional permits for certain types of work; the rest required individual permits. The Corps required modifications at 3,100 of these projects, denied 275 applications, and saw another nearly 10,200 withdrawn by the applicant. The Corps regulatory program provides the public a valuable service - protection of the Nation's waters and wetlands.

(4) *Stewardship*. The Corps is steward for about 12 million acres of land and water in 42 States. Conservation of forests, range wildlife habitat, fisheries, and soils involves multiple uses of resources and sound ecosystem management principles. The USACE accomplishes this through a mix of its own management capabilities, partnerships with State and local governments, volunteers, and working agreements with a wide range of interest groups.

(5) *Compliance*. The Corps conducts compliance assessments at all of its projects on a five-year cycle through the environmental compliance assessment program. The Environmental Review Guide for Operations (ERGO), the tool used to conduct assessments, is a checklist containing Federal and State environmental statutes and Corps requirements. Project and facility managers, as well as external organizations, use ERGO to systematically locate and correct environmental deficiencies.

(6) *Civil environmental activities' relationship to Army missions*. Environmental activities in the Civil Works Program are essential elements of the Army's Environmental Strategy for the 21st Century. People who learn their specialties in civil missions that concern natural and cultural resources, water quality, flood plain management or hazardous waste management help the Army go "beyond compliance" to take on a leadership role in natural resources stewardship. Civil works expertise helped the Army develop such tools as the Environmental Compliance Assessment System (ECAS) and Integrated Training Area Management (ITAM). The Civil Works Program is responsible for about half the Army's land holdings, and is familiar with balancing preservation of the natural environment with human use - a major issue facing the Army. This program is also the Army's reservoir of cultural resources expertise, which the Army has used on several priority missions.

(7) *Nonstructural Flood Risk Management*. In recent years the Corps has placed an increasing emphasis on nonstructural approaches to flood management. Nonstructural alternatives focus on efforts and measures to reduce flood damages in an area by addressing the development in the floodplain. Alternatives include such measures as floodplain zoning, participating in the National Flood Insurance Program (NFIP), developing and implementing flood warning systems (coordinated with the National Oceanic and Atmospheric Administration's (NOAA's) flood warning program) and emergency evacuation plans, and flood proofing individual structures as well as removing structures from the extreme flood hazard areas.

(8) *Environmental Operating Principles*. In 2002, the Chief of Engineers announced a set of Environmental Operating Principles to guide all the Corps' activities. The essence of these principles is that environmental concerns are integral to all Corps missions, decision-making, programs, and projects.

- Strive to achieve environmental sustainability. An environment maintained in a healthy, diverse and sustainable condition is necessary to support life.
- Recognize the interdependence of life and the physical environment. Proactively consider environmental consequences of Corps programs and act accordingly in all appropriate circumstances.
- Seek balance and synergy among human development activities and natural systems by designing economic and environmental solutions that support and reinforce one another.
- Continue to accept corporate responsibility and accountability under the law for activities and decisions under our control that impact human health and welfare and the continued viability of natural systems.
- Seek ways and means to assess and mitigate cumulative impacts to the environment; bring systems approaches to the full life cycle of our processes and work.
- Build and share an integrated scientific, economic, and social knowledge base that supports a greater understanding of the environment and impacts of our work.
- Respect the views of individuals and groups interested in Corps activities, listen to them actively, and learn from their perspective in the search to find innovative win-win solutions to the nation's problems that also protect and

enhance the environment. These principles illuminate ways these missions integrate with environmental laws, values, and sound environmental practices, and serve as a roadmap for all USACE functional areas to follow in ensuring that the effects of their activities upon the environment are included in the decision process at the earliest possible juncture.

*e. Emergency preparedness and disaster response.*

(1) The USACE responds to the Nation's needs in case of natural or man-made disasters and emergencies. The USACE programs provide a wide variety of assistance to protect human life and improved property, reduce human suffering, help communities recover from the effects of disasters, and mitigate damage and future threats. Response and recovery activities supplement State and local efforts.

(2) Under PL 84-99, the USACE undertakes planning and preparedness activities for all types of natural disasters, and provides response and recovery activities necessitated by floods and coastal storms. The Flood Control and Coastal Emergencies (FCCE) appropriation funds all PL 84-99 activities. Included in these preparedness and response efforts are:

- disaster preparedness measures
- advance measures to alleviate high potential flood threats
- flood fighting activities
- preservation of threatened Federally-constructed shore protection projects
- life-saving rescue operations.

(3) Recovery and mitigation measures include repair and rehabilitation of damaged flood control works and shore protection projects or nonstructural projects in place of structural rehabilitation. PL 84-99 also authorizes the USACE to provide emergency supplies of clean water to localities whose water source has been contaminated and to drought-affected areas. In addition, the USACE is authorized to provide essential services and restore essential public infrastructure for a period of up to 10 days in any area victimized by a natural disaster for which the Governor of a State has requested Federal assistance under the *Stafford Act* authority.

(4) Under The *Robert T. Stafford Disaster Relief and Emergency Assistance Act* (42 USC 5121 et seq.) (88 Stat.143) (The *Stafford Act* ), the USACE uses its engineering expertise and its response and recovery capabilities to carry out DOD's responsibilities under the National Response Plan (NRP) as the lead planning and operating agency for the Public Works and Engineering Emergency Support Function in responding to disasters and emergencies of all kinds. Under authority of the *Stafford Act*, the FEMA, now part of the Department of Homeland Security, has developed the NRP, which coordinates the execution of response and recovery operations of the 28 Federal signatory departments and agencies. Under the NRP, DOD has delegated its responsibility for Emergency Response Function (ERF) Number 3, Public Works and Engineering, to the USACE.

(5) As the lead DOD (and Federal) agency for ESF #3, the USACE has a number of standing missions, to include provision of water, ice, emergency power, debris removal, temporary housing, and temporary roofing. Other missions in the Public Works and Engineering area are assigned by the FEMA to the USACE, as needed. All of these missions are tailored to the needs of, and coordinated with the impacted State. FEMA funds all of these missions. Each mission assignment is based on the capabilities of the USACE, including its significant and responsive contracting capability. The Joint Staff, J-3, Joint Directorate of Military Support (JDOMS), coordinates DOD requirements not in the realm of ESF #3 missions.

(6) In response to the World Trade Center and Pentagon Terrorist Attacks of September 11, 2001, Corps emergency management personnel were on the scene within hours: providing structural engineers to monitor unstable buildings; supporting urban search and rescue work; providing a mobile command center and teams to support the New York Fire Department; and developing a debris management plan. Corps expertise was crucial in providing urban search & rescue, conducting structural assessments to determine when buildings were safe enough for rescuers and, later, determining when buildings were safe for occupancy. The 249th Engineer Battalion (Prime Power) provided the electric power that got the New York financial district back in business while Corps contractors removed 1.7 million tons of debris from the World Trade Center site and transported it by barge to the landfill in Staten Island. However, this work was similar to what the Corps does every year to support FEMA, State, and local authorities in natural disasters.

(7) In the aftermath of Hurricane Katrina on August 29, 2005, the USACE received over \$4 billion in taskings from FEMA for recovery activities. A major success was the removal of nearly all floodwater from New Orleans and vicinity within 60 days - a task that many experts said would take well into 2006. Another major undertaking was the removal of 56 million cubic yards of debris - a figure eclipsing the record of 42 million cubic yards removed after Hurricane Andrew in 1992.

*f. Homeland Security.* The Corps has developed in-depth anti-terrorism/protection warfighting function expertise, including many skilled engineers with experience on Khobar Towers, in Oklahoma City, the World Trade Center, the Pentagon, and other sites. It leverages that expertise to protect critical water resources infrastructure from terrorists. Over past few years the Corps has been working with other agencies, including the Bureau of Reclamation, Department

## How the Army Runs

of Energy, TVA, EPA, and FBI to develop comprehensive security assessment processes to identify risks to critical facilities such as locks, dams and hydropower facilities. In the wake of the September 11th attacks, the Corps instituted increased protection measures at its projects. It restricted public access, increased standoff distances to critical structures, increased patrol activities and contract guard support, and increased coordination with local law enforcement.

### 20-6. Research and development (R&D)

a. The Army Corps of Engineers Civil Works Program pursues an R&D effort to take advantage of rapidly developing technologies and techniques that will promote significant monetary savings and greater reliability, safety, enhanced efficiency and environmental sustainability of its assigned civil works activities. The R&D program is formulated to support each of the assigned Civil Works missions and their supporting core of technical competencies, environmental restoration and stewardship, economics and decision support, cold regions engineering and dredged sediments management. Technology infusion is pursued, in conjunction with the Regional Business Centers and established Centers of Expertise as part of the Corps' overall efforts to maintain a trained and ready engineering force capable of responding to a wide range of contingency situations.

b. The Corps conducts Civil Works-related R&D through its U.S. Army Engineer Research and Development Center (ERDC) and its Institute for Water Resources (IWR). The ERDC is headquartered at the Waterways Experiment Station facility, Vicksburg, MS. It consists of seven individual research laboratories:

- (1) Coastal and Hydraulics Laboratory, Vicksburg, MS
- (2) Cold Regions Research and Engineering Laboratory, Hanover, NH
- (3) Construction Engineering Research Laboratory, Champaign, IL
- (4) Environmental Laboratory, Vicksburg, MS
- (5) Geotechnical and Structures laboratory, Vicksburg, MS
- (6) Information Technologies Laboratory, Vicksburg, MS
- (7) Topographic Engineering Center, Fort Belvoir, VA

c. The IWR is headquartered at Fort Belvoir, VA, where it provides economic and decision support-related R&D support. Its Hydrologic Engineering Center is located at Davis, CA.

## Section III

### Support to other government agencies

#### 20-7. Overview of support to other government agencies

The USACE provides engineering and construction support to about 70 non-DOD Federal agencies, plus numerous States, local, tribal and foreign governments under the Interagency and International Services Program. Funds for this program are provided by the agencies receiving support. The USACE support of other entities' infrastructure programs includes support to the Department of Homeland Security by managing the design and construction of border control and detention facilities for the Customs and Border Protection Agency and emergency management assistance to the Federal Emergency Management Assistance Agency, construction of facilities in Iraq for the State Department, and renovation of health care facilities for the Department of Veterans Affairs. The USACE also supports programs and projects of other Federal agencies designed to meet important national environmental objectives. These include the Superfund Program of the United States Environmental Protection Agency (EPA). Since September 11, 2001, the Corps infrastructure security support to others has increased.

#### 20-8. Value of support activities

In FY 2010, the value of the engineering and construction effort managed by USACE was approximately \$2 billion. Non-DOD entities having Corps support costing more than \$40,000,000 in FY 2008 are listed in Table 21-1.

**Table 20-1**  
**Construction support for non-DoD Agencies**

Major Agency Customer	Value of Support
Department of State (mostly Iraq construction)	\$630,000,000
Department of Veterans' Affairs	\$348,700,000
Environmental Protection Agency	\$308,200,000
Department of Homeland Security - Customs & Border Protection	\$254,200,000



Figure 20-1. USACE division and districts with Civil Works missions

**Section IV  
Engineer Overseas Activities**

**20-9. Overview of engineer overseas activities**

The USACE conducts a broad range of foreign activities. Many are exclusively in support of U.S. forces overseas. All others are considered part of the civil functions of the Army. In coordination with the Director of Strategy, Plans, & Policy (Army G3/5/7), the ASA (CW) provides program direction to the foreign activities of the Corps, except those which are exclusively in support of U.S. military forces overseas. In FY 2010, the Engineers supported U.S. foreign policy in about 90 countries. The largest Corps overseas programs were in Afghanistan and Iraq, where, in addition to providing support to U.S. and coalition forces, the USACE was involved in restoring oil, electricity and other infrastructure; carrying out environmental work performing construction management for the U.S. State Department and the Agency for International Development (USAID); and providing advisors to ministries in the host nation governments. In Afghanistan, the USACE is involved in construction of roads and other civilian infrastructure as well as facilities for the new Afghan Army. The USACE support overseas includes humanitarian assistance projects (schools, clinics, water wells, etc.) for the Combatant Commands, assisting the Millennium Challenge Corporation with major infrastructure projects and support to the US Agency for International Development, The USACE is also supporting US objectives by using its water resources expertise for capacity development for developing nations such as technical advice and consensus building for the Mekong River Commission and strategic water resources engagement with the Brazilian Army Engineers.

**20-10. Foreign military sales (FMS)**

As the DoD Construction Agent in many parts of the world, the Corps provides international security assistance to eligible foreign nations as an instrument of the NSS and DOD Policy. Under the authorities of the FMS Program, the Corps provides reimbursable design and construction services for defense infrastructure to eligible foreign nations as approved by the Deputy Assistant SECARMY for Defense Exports and Cooperation (DASA-DEC) and authorized by the Defense Security Cooperation Agency (DSCA). FMS assistance provided in FY10 to various countries in the Middle East, Central Asia, Africa, Regions had value of approximately \$1 billion

**20-11. Partnership for peace**

This program is an annual series of initiatives with Partnership for Peace (PfP) nations, focusing U.S. emergency

## How the Army Runs

management information know-how and the PfP Information Management System (PIMS) for use by evolving civil protection and civil defense structures of selected nations and their neighbors. Simultaneously, Civil-Military Emergency Planning (CMEP) facilitates the understanding of U.S. concepts and doctrine of military support to civilian authorities in an inter-ministerial and trans-boundary information-sharing environment. CMEP develops, through real time and tabletop exercises, co-operation at the provincial level for assistance in technological and natural disasters. CMEP establishes regional cooperation among emergency planners, creates common data bases for uses in catastrophes, acquaints high level decision makers with decision support tools, creates joint operational systems for national reaction centers and develops information exchange on legal and response procedures for large catastrophes with international implications.

### 20–12. Support for U.S. agencies

The Corps is also called upon to provide support for U.S. agencies overseas. For example, the Corps:

- Supports the United States Agency for International Development following natural and man-made disasters.
- Builds border facilities for the Republic of Georgia Border Guard and U.S. Customs and Border Protection.
- Provided hydrologic modeling training for Ethiopia and Kenya for Task Force Horn of Africa, technical.
- Performs government due diligence for major infrastructure projects funded by the Millennium Challenge Corporation.

## Section V

### Support To Unified Combatant Commanders

#### 20–13. Benefits to warfighting capabilities

The Civil Works Program provides the USACE with a unique capability in DOD. The USACE's extensive professional staff of engineers, scientists, economists, etc; provide the critical teamwork necessary to plan engineer infrastructure improvements and institution building at the national level. The training and experience gained from the Civil Works program is leveraged by the USACE's Field Force Engineering (FFE) capabilities to provide support to unified combatant commanders and their Army Component Commands. The infrastructure the engineers build provides the facilities and enablers for operations in the future. An excellent example is the infrastructure built by the USACE for the Government of Saudi Arabia in the 1970s and 1980s.

#### 20–14. Overview of support to unified combatant commanders

Expertise in water resource development, flood risk management, waterway operations, dredging, coastal engineering, environmental stewardship, and disaster response supplement the skills maintained through the Army's MILCON and installation support programs. These expert capabilities are routinely called upon by the warfighting Combatant Commanders and other DOD agencies. USACE supplies this expertise on a reimbursable basis. When the Army goes to war, USACE personnel use the experience they have gained in the Civil Works and military programs to provide timely analysis and solutions to the war fighters. The USACE's knowledge of beach dynamics including the Sea State Prediction Models developed at the Engineer Research & Development Center's Coastal & Hydraulics Laboratory, Vicksburg, Mississippi, helps determine the sites for shore landings. When combined with its terrain mobility models, the USACE can provide commanders with the most effective plan for logistics-over-the-shore sites in combination with the inland road network to optimize reception, staging, and onward movement in the area of operations. Corps expertise in soil mechanics determines the best routes for armored vehicles. Often roads are built using technologies developed in the Civil Works Program. Corps experience gained from work on winter navigation helps the Army to cross frozen rivers. Commanders at all levels make use of geospatial products and satellite-based navigation systems developed at the Topographic Engineering Center at Fort Belvoir, VA.

#### 20–15. Examples of support to unified combatant commanders

The USACE is supporting Operations *Iraqi Freedom* and *Enduring Freedom* in USCENTCOM on several fronts. The 249th Engineer Battalion (Prime Power), a unique strategic asset, provided stable electric power to U.S. and coalition forces on a daily basis in several austere locations in the area of operations. The USACE military and civilian personnel have deployed and provided technical assistance, and facility and camp designs for the Soldiers. Corps teams in the USCENTCOM area of operations have supported the 101st Airborne and 10th Mountain Divisions as well as non-combat units such as the Combined Joint Civil Military Operations Task Force. Equipped with "TeleEngineering" kits, engineers anywhere on the battlefield were able to communicate real time to Corps experts through a secure, satellite-linked system. Their missions included runway repair analysis, structural evaluations, airfield lighting, and base camp design. Also noteworthy are the Contingency Real Estate Support Teams (CRESTs), who can deploy within 24 hours to acquire the troop housing, workspace, and covered storage areas the entering force will need. Corps real estate teams executed leases at various locations in Iraq, Kuwait, Afghanistan, Uzbekistan, and Kyrgyzstan. USACE also supports the Combatant Commands by performing exercise related and humanitarian assistance (HA) construction.

For example, the Pacific Ocean Division is implementing 60 HA projects in the countries of Bangladesh, Cambodia, Vietnam, Indonesia and Laos.

### **Section VI** **Summary and References**

#### **20–16. Summary**

The Army, through its civil functions, provides valuable services in maintaining and enhancing the economic and environmental health of the Nation. Civil functions also continue to prove invaluable in furthering national security objectives, both directly and indirectly. The financial and personnel resources associated with these functions are principally authorized and funded under the biennial *Water Resources Development Acts* and annual *Energy and Water Development Appropriations Acts*, respectively. Consequently, civil functions activities, as well as the significant training of the USACE personnel they provide, are at virtually no cost to the DOD's military budget.

#### **20–17. References**

- a. Public Law 84–99, Amendment of Flood Control Act of August 18, 1941 (Emergency Flood Control Work)
- b. Public Law 91–611, Flood Control Act of 1970.
- c. Public Law 93–288, Disaster Relief Act of 1974 (also known as the Stafford Act).
- d. Public Law 99–433, *DOD Reorganization Act of 1986* (also known as the Goldwater-Nichols Act)
- e. Public Law 99–662, Water Resources Development Act of 1986
- f. Public Law 105–245, Energy and Water Development Appropriations Act, 1999
- g. Public Law 105–277, Omnibus Consolidated and Emergency Supplemental Appropriations Act, 1999
- h. Public Law 106–541, Water Resources Development Act, 2000
- i. Public Law 110–114, Water Resources Development Act, 2007
- j. HQDA General Orders No. 3, Assignment of Functions and Responsibilities within Headquarters, Department of the Army, 9 July 2002.

RESERVED

## Chapter 21

### Public Affairs

The Public Affairs mission - Public Affairs fulfills the Army's obligation to keep the American people and the Army informed, and helps to establish the conditions that lead to confidence in America's Army and its readiness to conduct operations in peacetime, conflict and war. FM 46-1, Public Affairs Operations

#### Section I Introduction

##### 21-1. Chapter content

*a.* Army commanders and senior officials have a legal and moral responsibility to the elected leadership and American public to account for resources entrusted to their care. These resources include fiscal accounts, equipment, real property, and most importantly, the individuals who are the Army - the sons and daughters of America. Army Public Affairs is a fundamental tool of competent leadership, a critical element of effective mission command, and an essential part of successful mission accomplishment. The perception of America's Army and how it conducts its operations can be as important to the Army's success as actual combat. This chapter is designed to give senior commanders and civilian officials an insight into the functions and systems involved in the prosecution of the commander's responsibility to communicate the Army's story. This requires direct and indirect communication through the mass media to the American public. The commander must also keep the internal Army audience informed via information tools at their disposal.

*b.* Public affairs (PA) are a command function and responsibility. The commander can communicate through a command spokesperson, but the success or failure of that spokesperson and the commander's public affairs program hinges on his or her support and direct involvement. No matter how good the public affairs officer (PAO) or NCO is, they can never fully substitute for the commander in either the public's or the Soldier's eyes.

*c.* The commander's staff cannot substitute for him or her; however, they can provide specialized advice and counsel and assist in the execution of assigned missions. The PA professional is no exception and serves as the commander's primary advisor with regard to communicating the command's messages to its internal and external publics. By integrating public affairs into the decision-making process, and considering public affairs in the assessment of the situation and development of the courses of actions, the PA staff can assist the commander into making the best possible decision and translating this decision into effective PA strategy and operations.

##### 21-2. Specialized and specific terms used in public affairs

*a. Public affairs.* Those public information, command information and community relations activities directed toward both the external and internal publics with interest in the DOD (Joint Pub 3-61).

*b. Public information.* A general term describing processes used to provide information to external audiences through public media (FM 46-1).

*c. Command information.* Communication by a military organization with Service members, civilian employees, retirees and family members of the organization that creates an awareness of the organization's goals, informs them of significant developments affecting them and the organization, increases their effectiveness as ambassadors of the organization, and keeps them informed about what is going on in the organization. Also called internal information (Joint Pub 3-61).

*d. Community relations.* Those public affairs programs that address issues of interest to the general public, business, academia, veterans, Service organizations, military-related associations, and other non-news media entities. These programs are usually associated with the interaction between U.S. military installations and their surrounding or nearby civilian communities. Interaction with overseas non-news media civilians in an operational area is handled by civil-military operations with public affairs support as required (Joint Pub 3-61).

*e. Global information environment (GIE).* All individuals, organizations or systems, most of which are outside the control of the military or National Command Authorities that collect, process, and disseminate information to national and international audiences (FM-46-1).

*f. Public affairs guidance (PAG).* A package of information that supports public discussion of defense issues and operations. Such guidance can range from a telephonic response to a specific question to a more comprehensive package. Included could be an approved public affairs policy, news statements, answers to anticipated media questions and community relations guidance. Public affairs guidance also addresses the methods(s) timing, location and other details governing the release of information to the public (FM-46-1).



### Section II

#### Public affairs principles

##### 21–3. Public affairs strategic goals

FM 46–1 is the keystone doctrinal manual for U.S. Army public affairs operations. The manual is the basis for Public Affairs force design and materiel acquisition. It supports the doctrinal requirements of the Concept Based Requirements System and is the authoritative foundation for the integration of Public Affairs into Army doctrine, individual and unit training, leader development, force design and materiel acquisition initiatives. Conducting operations in the GIE requires an understanding of basic public affairs principles. Army leaders at all levels need to understand the fundamental concepts which underlie the development of public affairs strategies and guide the planning and execution of public affairs operations.

*a. Soldiers and families come first.* Internal audiences include Soldiers, civilian employees, retirees and all affiliated family members throughout the Army's active and reserve components. These audiences must be thoroughly and appropriately informed to ensure maximum effectiveness and the highest sustainable morale. The information needs of Soldiers, families, civilian employees, retirees and employers of reservists must be considered first.

*b. Truth is paramount.* Trust and confidence in America's Army and its conduct of operations result when external and internal audiences understand the Army and the reasons for its actions, decisions and policies. It involves teaching them about the Army's culture. The quickest way to destroy credibility is to misrepresent the truth.

*c. If news is out, it's out.* The GIE makes more information easier to disseminate and more accessible to wide audiences. As the value of information continues to increase, the ability to limit or restrict its flow continues to decrease.

*d. Not all news is good news.* In the GIE, the presentation of information about the Army and its operations will be both positive and negative. PAOs cannot control media coverage or guarantee positive media products. DOD policy is that information will not be classified or otherwise withheld to protect the government from criticism or embarrassment. Information can only be withheld when its disclosure would adversely affect national and operations security or threaten the safety or privacy of members of the military community.

*e. Telling our story is good for the Army.* In stability and support operations in particular, but also in war, providing accurate and timely information about the force and its operations will contribute to mission accomplishment.

*f. Public affairs must be deployed early.* During deployments an Army commander's first contact will often be with a news reporter. Reporters and journalists will be present in the area of operations before Army forces arrive and will often be well established, with a fully functional logistical framework and long-standing coordination and liaison arrangements. Media interest will be particularly intense at the outset of operations and early deployment of the PAO can significantly reduce distractions to the mission created by the media.

*g. Media are not the enemy.* While military professionals and journalists both serve the American people, their philosophies, values and basic outlook don't always correspond. Good reporters will thoroughly investigate issues, and ask tough, challenging questions. Soldiers may need to educate them on military operations and help them understand the significance of the events on which they report.

*h. Practice security at the source.* The characteristics of the military and global information environments essentially render field censorship impractical in its traditional sense, as well as impossible. All individuals must be responsible for sensitive information. The standard must be to practice security at the source by not sharing information which policy has determined to be inappropriate for release.

##### 21–4. Public affairs vision

The Public Affairs Vision presented in FM 46–1 also defines the critical parameters that the PA functional area must meet if it is to achieve the strategic goals and accomplish the mission in the evolving communication environment. "Our vision is to build a trained, readily deployable force of Public Affairs professionals, resourced, capable, and organized to conduct operations in peace, conflict and war, and to maintain a timely flow of accurate, balanced information to the American people."

### Section III

#### Public affairs doctrine and processes

##### 21–5. The Constitution and First Amendment

There is no mention of the press in the Constitution as originally drafted. The First Amendment reads only that "Congress shall make no law . . . abridging the freedom of speech, or of the press." As the First Amendment has been variously interpreted in the courts, the media today enjoys significant freedom to pursue their mission of keeping the American public informed. The requirement for the Army to conduct public affairs derives from Title 10, U.S. Code which states the Secretary of the Army is responsible for public affairs. Implicit in the government is the right for people to know about the activities of the government and the government has an obligation to inform people about its activities. One of the most significant conduits through which information is passed to the people is the free press

guaranteed by the Constitution. Since the nation's founding, the Army has communicated information to the American people through the media.

### **21-6. Freedom of Information Act**

The *Freedom of Information Act (FOIA)* allows anyone, including foreign citizens, to query the U.S. Government in writing for specifically described records in its possession. DOD policy regarding media requests for information known to be releasable under FOIA is to provide requesting media representatives with the information requested through PA channels without requiring them to submit a FOIA request.

### **21-7. Privacy Act**

The *Privacy Act* is designed to balance the individual's right to privacy with the public's right to know. Items contained in Army records generally releasable concerning a Soldier, and any living person under the *Privacy Act*, includes: name, age, rank, and duty address. The Soldier's name and duty address is not routinely releasable if the unit is sensitive, routinely deployable or stationed in a foreign territory. Also releasable is a Soldier's hometown (not street address but city and state), education, marital status and dependents, awards, duty status, the results of judicial actions, board (e.g., promotion board) results and their official photo. Items generally not releasable under the *Privacy Act* include the Soldier's social security number, race, religion, investigative findings or the results of nonjudicial/administrative boards or actions.

### **21-8. DOD principles of information**

*a.* DOD Directive (DODD) 5122.05 serves as the cornerstone for DOD policy with regard to providing information to the media. The policy requires support provided by Army public affairs.

*b.* It is DOD policy to make available timely and accurate information so that the public, Congress, and the news media may assess and understand the facts about national security and defense strategy. Requests for information from organizations and private citizens shall be answered in a timely manner. In carrying out that DOD policy, the following principles of information shall apply:

(1) Information shall be made fully and readily available, consistent with the statutory requirements, unless its release is precluded by current and valid security classifications. The provisions of the "*Freedom of Information Act*" will be supported in both letter and spirit.

(2) A free flow of general and military information shall be made available, without censorship or propaganda, to the men and women of the Armed Forces and their dependents.

(3) Information will not be classified or otherwise withheld to protect the Government from criticism or embarrassment.

(4) Information shall be withheld when disclosure would adversely affect national security, threaten the safety or privacy of the men and women of the Armed Forces, or if otherwise authorized by statute or regulation.

(5) The DOD's obligation to provide the public with information on DOD major programs may require detailed Public Affairs planning and coordination within the DOD and with the other Government Agencies. The sole purpose of such activity is to expedite the flow of information to the public; propaganda has no place in DOD public affairs programs.

### **21-9. Guidelines for coverage of DOD combat operations**

In the aftermath of Desert Storm, representatives from the military and the media developed nine principles that have served since then to define the media's role in covering DOD operations. The principles that are published in DODD 5122.05 are—

*a.* Open and independent reporting shall be the principal means of coverage of U.S. military operations.

*b.* Media pools (limited number of news media who represent a larger number of news media organizations for news gatherings and sharing of material during a specified activity), are not to serve as the standard means of covering U.S. military operations. However, they sometimes may provide the only means of early access to a military operation. In this case, media pools should be as large as possible and disbanded at the earliest opportunity (in 24–36 hours, when possible). The arrival of early-access media pools shall not cancel the principle of independent coverage for journalists already in the area.

*c.* Even under conditions of open coverage, pools may be applicable for specific events, such as those at extremely remote locations or where space is limited.

*d.* Journalists in a combat zone shall be credentialed by the U.S. military and shall be required to abide by a clear set of military security ground rules that protect U.S. Armed Forces and their operations. Violation of the ground rules may result in suspension of credentials and expulsion from the combat zone of the journalist involved. News organizations shall make their best efforts to assign experienced journalists to combat operations and to make them familiar with U.S. military operations.

*e.* Journalists shall be provided access to all major military units. Special operations restrictions may limit access in some cases.

## How the Army Runs

f. Military PA officers should act as liaisons, but should not interfere with the reporting process.

g. Under conditions of open coverage, field commanders should be instructed to permit journalists to ride on military vehicles and aircraft when possible. The military shall be responsible for the transportation of pools.

h. Consistent with its capabilities, the military will supply PA officers with facilities to enable timely, secure, and compatible transmission of pool material and shall make those facilities available, when possible, for filing independent coverage. If government facilities are unavailable, journalists, as always, shall file by any other means available. The military shall not ban communications systems operated by news organizations, but electromagnetic operational security in battlefield situations may require limited restrictions on the use of such systems.

i. These principles listed in paragraph h. above shall apply as well to the operations of the standing DOD National Media Pool system.

### 21–10. Operational security

The media's desire to publish timely information and the military's desire to safeguard information that could compromise an operation could place the two entities at odds. It therefore becomes incumbent on the military to practice "security at the source" in dealing with the media and to establish clear, concise, intuitively understandable ground rules that the media can easily follow and abide by with regard to the protection of information that could have operational security considerations. The PAO will clear all information with possible operational security concerns with the operations staff prior to release. Should a journalist inadvertently gain access to information considered operationally sensitive, he or she should be so informed of the reasons why the information is considered sensitive and asked to observe an embargo on the information until such time as it would no longer be considered sensitive.

### 21–11. Core processes

Within the framework of the three broad public affairs functional areas, public information, internal information and community relations, the core processes allow Army public affairs to meet the challenges of supporting Army XXI in the Information Age. The public affairs core processes are—

a. *Public affairs planning.* Public affairs planning is an integral element of the decision-making process at every level and across the continuum of operations. Done in concert with operational planning, it enhances the commander's range of options. Public affairs planning begins with the receipt of a mission. PAOs prepare the public affairs estimate, and advise the commander and other staff personnel on GIE issues (such as expected media interest) which might impact on the mission. They provide input during the development of possible courses of action and the war gaming of those potential courses of action. They identify critical public affairs risk factors, consider branches and sequels, judge the impact on internal audiences and external community relations, develop a public affairs strategy, prepare the Public Affairs Annex to the Operation Plan/Operation Order and publish Public Affairs Guidance.

b. *Execute information strategies.*

(1) The proliferation of personal computers, the World Wide Web, the Internet, social media outlets, on-line services, fax machines, e-mail, cable television, direct broadcast satellites, copying machines, cellular communication, wireless communication and many other information technologies have created an endless stream of data and information that flows into a world filled with images, symbols, words, and sounds. Much of this information is a strategic asset, capable of altering high-level decisions by the National Command Authority, and senior civilian and military leaders.

(2) To deal effectively with this barrage of information, public affairs professionals must be skilled at informing their publics, both internal (command information) and external (public information). Information strategies are synchronized plans for using all available and appropriate methods of communication to achieve specific goals of informing target audiences. The process includes acquisition, production, distribution and protection.

c. *Media facilitation.* The commercial news media are major players in the GIE. Fewer than 150 reporters covered the 1944 D-Day invasion of Europe. More than 800 covered Operation Just Cause in 1990, and more than 1500 journalists from around the world covered the Persian Gulf War in 1991. There is no question that the news media will continue to cover current and future military operations, and in most cases will be on the ground before American forces arrive. Images of events as they happen, in real-time, from both sides of the conflict will be transmitted to the world. It is the commander's task, through the public affairs officer and staff, to develop a well-resourced and responsive infrastructure to facilitate media operations. Media facilitation includes—

- (1) Assisting media entry into the area.
- (2) Registering media representatives.
- (3) Orienting them on ground rules for coverage.
- (4) Ensuring they understand security policies.
- (5) Arranging interviews and briefings.
- (6) Coordinating unit visits and escorts.
- (7) Providing thorough and timely responses to media queries.
- (8) Embedding media in operational units.

d. *Public affairs training.*

(1) The underlying principle of Army training is to train in peacetime in a way that replicates expected wartime conditions. Public affairs training includes—

- (a) Training for public affairs Soldiers.
- (b) Media interaction training for non-public affairs Soldiers, civilian employees and family members.

(2) The goal of public affairs training is to prepare Soldiers to interact with and operate under the scrutiny of the press. It teaches Soldiers that journalists are not adversaries, and focuses on providing accurate, balanced coverage. It helps soldiers understand that the media is a communication channel to the American public as well as to audiences worldwide.

(3) Training for public affairs personnel expands on Soldier and leader training. It stresses individual as well as collective tasks with an aim of developing units fully prepared to accomplish the range of public affairs missions. It integrates public affairs into the battle staff. It ensures public affairs is involved in mission assessment, planning and execution.

(4) Public affairs training can also be conducted for journalists. They should be educated on the rights and responsibilities of military community members, as well as the roles and missions of particular units and the Army.

*e. Community relations.*

(1) The active Army relies on communities and regions surrounding its installations for direct and indirect support of both the Army and its people. The U.S. Army Reserve and Army National Guard are equally integral parts of their hometown communities. Maintaining effective community relations not only contributes to the morale of Soldiers and their families, but also enhances the projection and sustainment capabilities of Army posts and hometown support, directly affecting the combat power potential of mobilized or deployed Army forces. Communities can provide the Army access to resources needed to train and maintain readiness and also can extend support to the families of deployed Soldiers. Public Affairs helps commanders build and sustain the community relationships that in turn generate support for America's Army.

(2) Overseas, host nation civilians are often employed as media and community relations specialists. They advise public affairs officers and commanders of host nation sensitivities, local political issues and press reaction to American activities.

(3) The objectives of Army community relations programs are to—

- (a) Increase public awareness of the Army's mission, policies and programs.
- (b) Inspire patriotism.
- (c) Foster good relations with the various publics with which the Army comes into contact at home and abroad.
- (d) Maintain the Army's reputation as a respected professional organization responsible for national security.
- (e) Support the Army's recruiting and personnel procurement mission.

## **Section IV**

### **Army public affairs organizations**

#### **21–12. The Office of the Chief of Public Affairs (OCPA), Department of the Army**

*a.* The OCPA is established by Title 10, USC, section 3014, and is designated by the Secretary of the Army the responsibility to conduct public affairs operations across the U.S. Army. The Chief of Public Affairs (CPA) formulates, manages, conducts and evaluates public affairs policies, plans and programs for the active and reserve components of the U.S. Army. The CPA is responsible to the Secretary of the Army and is responsive to the Chief of Staff, Army.

*b.* Among the responsibilities of the CPA:

(1) Preparing, coordinating and monitoring the worldwide implementation of Army Public Affairs plans, strategies, policies and programs for internal and external information.

(2) Developing public affairs plans and programs to support other Army plans and programs.

(3) Managing the review and clearance of information for release outside DOD by the Army Secretariat (OSA) and the Army Staff (ARSTAFF).

(4) Managing the Army's Public Information Security Review Program.

(5) Operational control of the U.S. Army Field Band.

(6) Serving as the proponent for all public affairs issues across doctrine, training, leader development, organization, materiel, and Soldier and civilian support.

#### **21–13. ACOM, ASCC, DRU and installation public affairs**

The ACOM, ASCC, DRU and installation PAO is responsible for:

*a.* Advising commanders regarding the PA needs of the command.

*b.* Assisting in the formulation and release of command messages.

*c.* Developing PA plans.

*d.* Serving as liaison between the command and the next higher headquarters PAO.

*e.* Supervising the preparation, production, and distribution of printed and electronic PA information.

## How the Army Runs

- f.* Assisting in the development and acquisition of print and visual information products in support of PA programs used on installation command channels by the authorized cable television franchise.
- g.* Advising the commander on audience attitudes about and perceptions of policies, programs, and information needs.
- h.* Conducting regular assistance visits to command units to assess their PA programs and determine unit commanders' needs for support.
- i.* Assisting in the coordination of on-post distribution of non-DOD commercial publications.
- j.* Developing materials and products to meet the command's special PA needs.

### **21–14. Organic public affairs sections**

Public affairs sections are embedded in the headquarters of separate Army brigades, divisions and echelons above division. These sections provide PA support to the command and serve as the commander's principal advisor on public affairs issues. Ranging from a single senior noncommissioned officer to a colonel with a small staff these sections conduct public affairs planning and limited operations. Personnel and materiel constraints require that these organic PA sections be augmented by separate PA TOE units for most operations.

### **21–15. Theater Army Public Affairs Section**

A Theater Army PAO is a colonel serving on the commanding general's personal/special staff. The PAO is responsible to the Theater Army commander and to units assigned or aligned to the Army, training for, mobilized or deployed in support of combined or joint operations. The Army PA section has personnel and equipment: for developing information strategies and campaigns; to conduct PA planning and analysis; to provide services and facilities, when augmented by a Mobile Public Affairs Detachment (MPAD), for media representatives; to support higher echelon PA requirements for information, media facilitation, planning and training; to tactically communicate to other PA units at echelons above and below corps and all supported units; and to provide limited ground transportation for personnel, equipment, media in and around the area of operation. When deployed, the Army Headquarters public affairs staff will be augmented by a MPAD and will assume all the missions and capabilities of that organization.

### **21–16. Corps and Theater Army Area Command (TAACOM) PA Sections**

A Corps PAO is a lieutenant colonel or a colonel serving on the personal/special staff of the Corps commander. A TAACOM PAO is a lieutenant colonel serving on the personal/special staff of the TAACOM commander. When the Corps or TAACOM commander is deployed the PA section will be augmented by a public affairs operations center (PAOC) and up to three MPADs. The Corps is augmented by one MPAD for every three combat brigades in the task force.

### **21–17. Division and Corps Support Command (COSCOM) Public Affairs Sections**

A Division PAO is a major or a lieutenant colonel serving on the personal/special staff of the Division commander. A COSCOM PAO is a major serving on the personal/special staff of the COSCOM commander. When deployed the COSCOM PA section is augmented by an MPAD; when the Division is deployed, the section is augmented by one MPAD per three combat brigades and one public affairs detachment (PAD).

### **21–18. U.S. Army Reserve and Army National Guard component public affairs**

The vast majority of public affairs assets are in the Reserve and National Guard components, more than 65 percent of the total public affairs force and 85 percent of the deployable TOE unit structures. These Reserve and Army National Guard units and personnel must be seamlessly integrated with the active component and focused on supporting the overall Army goals and objectives. The four types of TOE PA organizations, predominately positioned in the Guard and Reserve, are discussed in the following paragraphs.

### **21–19. Public Affairs Operations Center (PAOC)**

The PAOC is commanded by a lieutenant colonel and is modularly organized, staffed, trained and equipped to rapidly deploy in support of military operations. The PAOC is capable of performing all core public affairs processes and has transportation and audio-visual equipment sufficient to produce radio, television and print products for an internal audience as well as resources to credential, brief, escort and support visiting media. When deployed in support of Army operations a Broadcast Operations Division (BOD) and one MPAD will augment the PAOC. The PAOC is further augmented by one MPAD per three brigade-sized units in the operation when those units do not have separate PA support.

### **21–20. Mobile Public Affairs Detachment (MPAD)**

The MPAD is commanded by a major and can be task organized into two or three teams and is assigned to the theater, corps or Joint Task Force headquarters under the operational and tactical control of the senior public affairs officer or PAOC commander. It is staffed, trained and equipped to rapidly deploy in support of brigade, division or corps-size

task force operations. Its equipment and capabilities are similar to a PAD (see description below) but more robust. MPADS are assigned at a ratio of one per three brigade-sized elements.

### **21–21. Broadcast Operations Detachment (BOD)**

The BOD is commanded by a major and consists of a command element, two broadcast teams and a maintenance team. It has transportation assets and audio-visual equipment sufficient for the BOD to establish and operate field radio and television broadcast facilities in support of Armed Forces Radio and Television Service operations or merges with other independent facilities to form a theater of operations network.

### **21–22. Public Affairs Detachment (PAD)**

A PAD is commanded by a captain and comes with its own transportation and sufficient still and video equipment to produce print, radio and television products for internal audiences. The PAD typically supports division or brigade-sized task force operations.

## **Section V**

### **Joint and combined public affairs organizations**

#### **21–23. Assistant Secretary of Defense (Public Affairs) (ASD(PA))**

As established by DOD Directive 5122.05, the ASD (PA) is the principal staff advisor and advisor to the Secretary and Deputy Secretary of Defense for DOD news media relations, public liaison, internal communications, community relations, public affairs, visual information training, and audiovisual matters. The ASD (PA) is charged with developing communications policies, plans and programs in support of DOD objectives and operations and with ensuring a free flow of information to the news media, the general public, the internal audiences of the Department of Defense and other applicable forums limited only by national security restraints in DODD 5200.1 and any other applicable statutory mandates or exemptions. The ASD(PA) reports directly to the SecDef and acts as the sole spokesperson and the release authority for DOD information and audiovisual materials to news media representatives. The ASD(PA), or his or her designated representative, conducts news media conferences in the Pentagon with the Pentagon Press Corps.

#### **21–24. Joint Information Bureau (JIB)**

A JIB is a facility established by the joint force commander to serve as the focal point for the interface between the military and the media during the conduct of joint operations. A JIB varies in size and composition in accordance with the requirements of the mission and the degree to which the different Services are involved. At a minimum, the Army element will staff an Army cell within the JIB. More likely, however, will be PA Soldiers serving in all sections of the JIB, including planning, media facilitation, and internal information cells.

#### **21–25. Combined Information Bureau (CIB)**

A CIB is similar to the JIB in organization and functions except it is operated in support of multinational operations. It can also be called an Allied Press Information Center. These multinational information bureaus allow various allies or coalitions to collectively “speak with one voice” as well as explain the roles of the individual nations.

#### **21–26. Pentagon correspondents**

There have been media representatives at the Pentagon since the establishment of the DOD in 1947. Some 20–25 journalists keep rent-free offices in the Pentagon, courtesy of the DOD, paying for their own furniture, telephones and office supplies. These 20–25 resident journalists as well as 75 others representing major wire services, newspapers, weekly news magazines, trade journals and radio and television networks are issued regular DOD Pentagon building passes that allow unescorted access to unrestricted areas inside the Pentagon. The practice benefits both the media and the military in that information about DOD of interest to the public can be readily disseminated to correspondents who are already familiar with and reasonably well educated regarding DOD’s mission, operations and structure. These correspondents are regular attendees at the ASD(PA) media conferences conducted at the Pentagon.

#### **21–27. DOD National Media Pool**

The DOD National Media Pool is a limited number of news media who represent a larger number of news media organizations for news gathering and sharing of material during a specified activity. Pooling is typically used when news media support resources cannot accommodate a large number of journalists. The DOD National Media Pool is available for coverage of the earliest stages of a contingency. Additionally, the combatant commanders may also find it necessary to form limited local pools to report on specific missions. Approximately 16 media representatives from various national news organizations comprise the pool. Supported commanders are responsible for providing operational support to the DOD National Media Pool. At a minimum, the pool members require: daily, comprehensive and unclassified operational news briefings; access to ongoing combat operations; reasonable access to key personnel; an escort - usually a lieutenant colonel or colonel - to coordinate pool support and access; transportation and itinerary

## **How the Army Runs**

planning and coordination. As soon as open access to the operational area can be allowed, the DOD National Media Pool should be disbanded.

### **21–28. Joint combat camera**

Joint combat camera provides the joint force commander a sophisticated capability to enhance both operational and public affairs missions. The still and video images obtained provide a balance of useful operational information and, once cleared for OPSEC, products are available for distribution to news media representatives and military public affairs organizations. Combat camera (COMCAM) teams often have access to events and areas unavailable to news media representatives and military journalists. They bring with them a technological capability allowing for the timely transmission of images from the military information environment. Since deployed COMCAM teams support the entire spectrum of an operation, it is essential that public affairs imagery requirements be identified and prioritized throughout the planning cycle.

## **Section VI Information mediums**

### **21–29. News media**

The specific medium, through which the news media present their work, creates different needs and expectations on the part of media representatives in their dealings with the military. As in just about any military operation, timing is everything, and a basic analysis of media deadlines, requirements and abilities to reach the American public with the command's story can assist the commander's public affairs program as well as serve to better satisfy the media. Advances in communications technology today enable virtually simultaneous reporting worldwide from anywhere in a satellite footprint. News media coverage will be highly competitive, with a tendency to seek access to the operational area and report events as they happen.

### **21–30. Television**

Television news broadcasts are typically pegged to specific times of the day. Television thrives on video pictures, a script written to what the camera has seen and some carefully chosen 5–8 second "sound bites" from interviews conducted on camera with witnesses to the event, experts or participants whose words fit the video the cameraman has taken of the event. Long answers from commanders and staff officers rarely make it to the screen, so PAOs will recommend the use of talking points to assist commanders and interviewees in getting the command's message out in a format television will be most likely to use.

### **21–31. Television "news magazines"**

Television news programs entertain as much or more than they inform. The command's messages can be transmitted through a variety of media, and dealing with the entertainment media will require some imaginative work. While the commander should not deny access (thereby creating a story in and of itself), he or she should be prepared to prioritize his or her effort in supporting the media and has every right to pursue getting his or her command message out through the media to reach the American public.

### **21–32. Radio**

Radio is an immediate medium. Live radio news broadcasts are easily changed even in progress. "Hot" stories can easily be inserted into normal programming. The voice is the only medium, and details from commanders or their spokespersons will get more airtime than on television because the voice and words alone must paint the picture for the audience. A radio news desk is only as far away as a communications line, and the story can be on the air within minutes.

### **21–33. Print**

Newspapers tend to follow strict deadlines to get their product to American breakfast or dinner tables. Reporters may be able to spend hours, even days, with a unit before having to file their stories. The unit will likely garner more "space" in the articles by virtue of the attention the print journalist can give the story. The longer a reporter stays with the unit, the more attached he or she becomes to the unit. Daily newspapers differ from weekly publications in terms of immediacy and pictorial requirements. Weeklies tend to want lots of colored pictures and will focus on more analytical, more timeless aspects of the mission, whereas daily newspapers focus on what has happened since their last deadline and will settle for a good black and white photograph transmitted electronically. A reporter for a specific newspaper gives the commander access to one newspaper, whereas wire services such as Associated Press offer the commander and his or her PAO greater access to the American public because many newspapers subscribe to the services and therefore the story may run in numerous newspapers.

### **21–34. Motion picture industry support**

The Office of the Chief of Army Public Affairs maintains branch offices in Los Angeles and New York primarily to

interface with the entertainment industry and networks headquartered in those areas. The offices assist radio, television and film professionals in all matters relating to the U.S. Army. They serve as a local, authoritative source of information about the Army and provide authentication, verification and limited research for producers, writers, property masters, wardrobe supervisors, film editors, etc. They also provide assistance and advice to scriptwriters, including reviewing rough drafts and suggestions for changes prior to script finalization. Army support of a project is contingent on scripts realistically portraying the Army and its personnel. These offices can also arrange for and coordinate use of Army equipment and supplies not commercially available, coordinate requests for Army's stock footage, arrange for and coordinate with Army installations or properties for location filming and arrange for Soldier volunteers to participate in the project if requested.

### **21–35. Internet**

One of the most dynamic news sources has become the Internet. More than 60 percent of Americans get some of their news from the internet. The Army now uses the Internet for recruiting and informational purposes, since it is one of the most powerful mediums available at relatively low costs. The Internet has evolved from being a news delivery mechanism to an important force in breaking news. The downside in publishing news on the Internet is the weakness of editorial review. The immediacy of information is more important than validating factual accuracy. Email is another important news mechanism to inform Soldiers, their families, civilians and contractors. The command needs to establish a single source of internal information on the web and the public affairs office, in accordance with DOD policy, should have responsibility for the content of the command's web site. The Internet can be a powerful and effective means to provide information to a wide audience and to allow for two-way communication and for use in providing accurate, timely information to the public. The Army is also employing use of social media, such as Facebook and Twitter to communicate with the American public and the Army's internal audiences. This new and rapidly expanding network that relies on "real-time updates" is global. There are numerous incidents in which Twitter, for example, became the primary source of communication in the absence of typical news outlets: the 2011 earthquake and tsunami in Japan, the revolutionary protests in Tunisia, Egypt and Libya, and even a 2010 DARPA research project. Realizing the efficacy and immediacy of such a prolific network, commanders need to be acutely aware of the strategic implications of tactical conversations using this media and ensure their message is properly framed.

## **Section VII**

### **Summary and references**

#### **21–36. Summary**

*a.* The GIE has made possible virtually simultaneous transmission of breaking news into the American living room bridging the gap between strategic and tactical levels of operations. Technology has made 24-hour news organizations and internet news possible. This has decreased the dominance of traditional news organizations and increased competition for news and the attention of the American public. The elements of what makes news, however, have remained constant and the American public is, as it always has been, interested in what happens to its sons and daughters in uniform, especially when they are executing an operational mission. The increasing number, variety and complexity of real-world operations in which the U.S. Army has been involved has attracted considerable public and media interest and will continue to do so in the future.

*b.* The need for operational security will always be of concern to the military; however, it should not prevent the Army from communicating in real time with the American public. With media able to transmit words, voice or pictures via satellites in future conflicts, the most viable solution to assure operational security will include the practice of security at the source, a clear set of ground rules accepted and understood by the media and honest interaction between the military and the media covering the operation. Maintaining OPSEC in this environment also implies that Soldiers and their leaders are trained to deal with the media before the next conflict.

*c.* Gone are the days when the commander could expect to provide information separately to his or her troops, the American public and the enemy. Information operations involve civil affairs, psychological operations and public affairs messages that by definition overlap and that are picked up simultaneously by Soldiers, the media and the enemy. The importance of consistency and truth in the message has never been more paramount. The GIE environment and continually evolving information technologies make it imperative that information and messages be consistent at all levels.

*d.* It is conceivable that a commander could win the battle and lose the information war by excluding or attempting to exclude the media from his or her operations. What is worse is that excluding the media from an operation or creating ill will with the media during the operation means the Army's story goes untold or misrepresented, and the American public is allowed or even encouraged to lose sight of why they have an Army in the first place. As long as the U.S. Army believes it has a role to play in the National Military Strategy of the United States, it owes the American public a look at how it is accomplishing the missions assigned it in the pursuit of that strategy's objectives.

#### **21–37. References**

*a.* DOD Directive 5105.74, Defense Media Activity.



## How the Army Runs

- b.* DOD Directive 5120.20, Armed Forces Radio and Television Service.
- c.* DOD Directive 5122.05, Assistant Secretary of Defense for Public Affairs.
- d.* DOD Directive 5122.11, Stars and Stripes Newspapers and Business Operations.
- e.* DOD Directive 5400.4, Provision of Information to Congress.
- f.* DOD Directive 5400.07, DOD Freedom of Information Act Program.
- g.* DOD Directive 5400.11, DOD Privacy Program.
- h.* DOD Directive 5410.18, Public Affairs Community Relations Policy.
- i.* DOD Instruction 5040.04, Joint Combat Camera Program.
- j.* DOD Instruction 5120.4, DOD Newspapers, Magazines and Civilian Enterprise Publications.
- k.* DOD Instruction 5200.01, DOD Information Security Program and Protection of Sensitive Compartmentalized Information.
- l.* DOD Instruction 5400.13, Public Affairs Operations.
- m.* DOD Instruction 5400.14, Procedures for Joint Public Affairs Operations.
- n.* DOD Instruction 5405.3, Development of Proposed Public Affairs Guidance.
- o.* DOD Instruction 5410.15, DOD Public Affairs Assistance to Non-Government, Non-Entertainment-Oriented Print and Electronic Media.
- p.* DOD Instruction 5410.16, DOD Assistance to Non-Government, Entertainment-Oriented Motion Picture, Television, and Video Productions.
- q.* DOD Instruction 5410.19, Public Affairs Community Relations Policy Implementation.
- r.* DOD Instruction 8910.01, Information Collection and Reporting.
- s.* Joint Publication 3-61, Public Affairs.
- t.* Army Regulation 25-55, The Department of the Army Freedom of Information Act Program.
- u.* Army Regulation 340-21, The Army Privacy Program.
- v.* Army Regulation 360-1, The Army Public Affairs Programs.
- w.* Field Manual 3-13 (formally 100-6), Information Operations: Doctrine, Tactics, Techniques and Procedures.
- x.* Field Manual 3-61.1, Public Affairs Tactics, Techniques and Procedures.
- y.* Field Manual 46-1, Public Affairs Operations.

## Chapter 22

# Defense Support of Civil Authorities

### Section I Introduction

#### 22–1. DSCA Overview

*a.* The U.S. military primarily organizes itself, trains, equips forces, plans and conducts combat and stability operations. However, when requested by civil authority or directed by the President, it also has enormous capability to rapidly respond and provide support to a wide variety of domestic emergencies and disasters. The Department of Defense (DOD) conducts these operations under civilian control and in accordance with the fundamental tenet of its professional ethos - subordination to civilian authority. Federal military forces normally respond in support of another federal agency, often after a Presidential declaration to supplement the efforts and resources of state and local governments. Based on our form of government, and consistent with our historic experience, the military should not lead the federal response for any but perhaps the most severe domestic emergency or disaster.

*b.* DOD Directive 3025.18 defines Defense Support of Civil Authorities (DSCA) as, “Support provided by U.S. Federal military forces, DoD civilians, DoD contract personnel, DoD Component assets, and National Guard forces (when the Secretary of Defense, in coordination with the Governors of the affected States, elects and requests to use those forces in title 32, U.S.C. status) in response to requests for assistance from civil authorities for domestic emergencies, law enforcement and other domestic activities, or from qualifying entities for special events.” It notes that DSCA is also known as Civil Support. As this version of HTAR goes to print, a new term is emerging. National Guard Civil Support is expected to be adopted in National Guard Regulations 500–1 with the definition: “support provided by the National Guard of the several states while in state active duty or Title 32 duty status to civil authorities for domestic emergencies, and for designated law enforcement and other activities.”

*c.* DSCA is a critically important mission for the Armed Forces, and particularly the Army which will usually provide the main effort. At one time, FM–1 identified Support of Civil Authority as an Army core competency. Within existing processes and procedures, the Armed Forces have a well-defined basis for participation in domestic emergencies and disasters. They perform specific and appropriate roles and are postured to refine those roles in response to evolving threats and domestic needs.

#### 22–2. Constitutional and Policy Basis for DSCA

*a.* Use of the military to support civil authorities stems from our core national values as expressed in the Constitution which anticipates the use of Federal military forces within U.S. borders. Article I, Section 8 states, “Congress shall have power... to provide for calling forth the Militia to execute laws of the Union, suppress Insurrections, and repel Invasions.” Article II, Section 3 states the President, “...shall take care that the Laws be faithfully executed.” The 10<sup>th</sup> Amendment provides the basis that Federal government assistance, including DOD, is provided in support of State and local authorities. It reads in part, “The powers not delegated to the United States by the Constitution, nor prohibited by it, are reserved to the States respectively...,”

*b.* The National Security Strategy (NSS) identifies key national interests such as protecting the lives and safety of Americans, maintaining the sovereignty of the United States and providing for the prosperity of the nation and its people. The National Strategy for Homeland Security further focuses on securing the U.S. homeland from terrorist attacks and calls for the military to support civil authorities during emergencies. In June 2005, the Department of Defense (DOD) published its first Strategy for Homeland Defense and Civil Support. All these strategies recognize that America’s military may respond to a variety of national needs other than waging war and that DSCA contributes significantly to satisfying America’s national security requirements.

#### 22–3. Historic Context for Domestic Military Support

*a.* From our nation’s inception, the Army has supported civil authorities in times of need. Floods, riots, hurricanes, earthquakes, and forest fires are all examples of situations that have caused states to deploy the National Guard and occasionally request the assistance of federal armed forces. Achieving national goals with regard to terrorism, WMD and illegal drug trafficking have also led to supplementing civilian efforts with military forces. DSCA law and policy evolved as our nation grew and responded to repeated crisis and disaster.

*b.* When our founding fathers met to draft the U.S. Constitution in Philadelphia in 1787, Shay’s Rebellion was a recent memory and insurrection a concern. To protect the viability of government, they created mechanisms to suppress rebellions or insurrections and enforce the law. The 1794 Whiskey Rebellion led to the fundamental precept, codified in current law that the military is in support of civil authority. A taxpayer revolt and increasing violence led to a Presidential response and deployment of federalized militia. Throughout this threat to federal governance, President Washington’s guidance was that the military was to support local magistrates, not pre-empt them, and this principle remains the foundation of DSCA law, policy and processes.

## How the Army Runs

*c.* After the Whiskey Rebellion, the military established a long history of assisting civil authorities enforce the nation's laws. Significant with regard to current law and policy is the April 1995 domestic terrorist attack on the Alfred P. Murrah building in Oklahoma City. In the wake of that attack, President Clinton issued Presidential Decision Directives 39 and 62 that clarified the roles and missions of various federal agencies with regard to countering and combating terrorism. These documents defined terms such as: Crisis Response (CrM), Consequence Management (CM), Lead Federal Agency (LFA) that have since been given new meaning by more recent documents, particularly Homeland Security Presidential Directive (HSPD)-5.

*d.* Current disaster response organizations, systems and processes evolved from the civil defense mission of the U.S. Army Continental Army Command (CONARC) that was inactivated in 1973. President Carter's 1979 Executive Order 12148 established the Federal Emergency Management Agency (FEMA) and transferred many of the missions formerly performed by CONARC to FEMA. The 1988 Stafford Disaster Relief and Emergency Assistance Act and Executive Order 12656 that delegated most of the President's Stafford Act authority to the FEMA Director were instrumental in establishing current interagency responsibilities. The military also has a history ensuring the continuity of government in the event of a national emergency and EO 12656 identified agency responsibility and refined those processes as well.

*e.* In the wake of the September 2001 terrorist attacks and Hurricane Katrina in 2005, we remain in another period of evolving change with regard to how the military supports civil authority. DOD's Executive and Action Agent responsibilities moved from the Army to the Office of the Secretary of Defense and the Joint Staff respectively. Homeland Security Presidential Directive (HSPD)-5 directed alignment of federal, state and local coordinating structures, capabilities and processes into a unified, all-discipline, all-hazards approach to domestic incident management. HSPD-5 integrated CrM and CM, recognizing that all agencies responding to a disaster or emergency do so while retaining their own authorities and responsibilities under law and policy.

### 22-4. DOD Role in Homeland Security (HS) Today

*a.* The National Strategy for Homeland Security (2002) defined HS as "A concerted national effort to prevent terrorist attacks within the United States, reduce America's vulnerability to terrorism, and minimize damage and recover from attacks that do occur." In the wake of Hurricane Katrina, many observers expected the next NSHS to expand the definition of Homeland Security to include natural and other manmade disasters. However recognizing the unprecedented threat to our national security posed by Chemical, Biological, Radiological and Nuclear (CBRN) Weapons of Mass Destruction (WMD), the 2007 NSHS definition was unchanged, remaining focused on terrorism. In the decade since September 11, 2001, this clear and present threat to our homeland has resulted in dramatic change to DOD's Homeland Security culture and capabilities, particularly the Civil Support or DSCA mission. As DOD continues to contribute through its military missions overseas and homeland security efforts, the pace of change has slowed, although the mission set continues to evolve.

*b.* The DOD Strategy for Homeland Defense and Civil Support (2005) identifies two broad mission areas: Homeland Defense (HD) and Civil Support (CS) or Defense Support of Civil Authorities (DSCA). The DOD Strategy uses a lead, support or enable construct to categorize DOD's activities to secure the U.S. from direct attack. DOD has lead responsibility for HD and is the primary federal agency for this mission. HD is DOD's primary responsibility and is defined as "the protection of US sovereignty, territory, domestic population, and critical defense infrastructure against external threats and aggression, or other threats as directed by the President." This chapter does not deal with HD, only DSCA.

*c.* DOD has had a past reluctance to take on the civil support mission, considering it a mission to accept when we could or had the resources available to assist. Perhaps the most significant change for DOD today is that with the unprecedented threat to the U.S. homeland, DOD must be able to conduct Chemical, Biological, Radiological, Nuclear and High-Yield Explosive (CBRNE) Consequence Management (CM) as an integrated part of our national security efforts. For the first time, the 2008 National Defense Authorization Act (NDAA) directed DOD to budget monies against this mission and this chapter will explain how DOD is spending those monies to evolve its DSCA role.

*d.* Also associated with DOD's homeland security construct is Mission Assurance (MA) which includes activities to ensure DOD support of the President and Secretary of Defense during a national security emergency. MA has traditionally been described as providing a foundation for both HD and DSCA by supporting national continuity of government (COG) and continuity of operations (COOP) programs designed to ensure Enduring Constitutional Government (ECG). At the federal level, COG is a coordinated effort within each branch of government to ensure capability to continue minimum essential functions in a crisis; COOP are internal efforts within various governmental department, agencies and organizations to ensure capability to continue operations in support COG and ECG.

### 22-5. DSCA Principles

*a.* DOD almost always provides DSCA when requested by civil authorities and approved by the Secretary of Defense. We can also provide support when directed by the President or the SECDEF, or when authorized under separate established authorities.

*b.* DOD remains in support of civil authority and generally in support of a primary federal agency.

*c.* The DOD Strategy for Homeland Defense and Civil Support (2005) reaffirms that protecting the U.S. homeland

from attack is DOD's highest priority. Unless otherwise directed by the Secretary of Defense (SECDEF), on-going military or homeland defense missions have priority over DSCA missions.

*d.* DOD provides DSCA in accordance with applicable laws, Presidential Directives, Executive Orders and DOD policy with absolute, public accountability of officials involved in the oversight of DSCA processes and while maintaining our constitutional principles and civil liberties.

*e.* As a general rule, civil resources should be used first and DSCA should generally be provided only when requirements exceed the capabilities of civil authority as determined by FEMA or another federal agency with primary responsibility. DSCA should emphasize DOD's unique skills and structures, and should be limited in scope and duration.

*f.* DOD usually provides DSCA through designated federal agencies using established agreements and plans, guided by civilian law and the principle that the federal government assists state agencies, except in terrorism and other incidents where the federal government has primary jurisdiction.

*g.* DoD Components shall not procure or maintain supplies, materiel or equipment exclusively for providing DSCA unless set forth in law or directed by the Secretary of Defense.

*h.* Military forces remain under military mission command and the authority of the DoD Executive Agent at all times.

*i.* DOD components shall not perform any function of civil government unless absolutely necessary and then only on a temporary basis.

*j.* While there are exceptions, DSCA should be provided on a cost reimbursable basis, primarily through the Stafford Act for presidentially declared disasters or the Economy Act for other situations. Only the SECDEF or the President is authorized to grant a reimbursement waiver.

## **22-6. DSCA Mission Sets**

*a.* As of this version HTAR, many current DOD Directives, Instructions and Manuals in this field are obsolete. Although some have begun to be replaced (e.g.: DODD 3025.18 (DSCA), dtd: 29 Dec 2010), many still pre-date September 2001. The term Military Assistance to Civil Disturbances (MACDIS) has been replaced by Civil Disturbance Operations (CDO). While Military Support to Civil Authorities (MSCA) is still used by the National Guards of many states, it is no longer a federal term and should soon be replaced by National Guard DSCA. The reader should be cautioned about DOD documents still needing update that use the term MACA as an overarching construct with three subordinate mission sets: Military Assistance to Civil Authorities (MACA), Military Assistance to Civil Disturbances (MACDIS), and Military Assistance to Civil Law Enforcement Agencies (MSCLEA).

*b.* The DSCA environment is so complex and dynamic that it is difficult and perhaps impossible to clearly and consistently create simple categories of missions. The categories used by Joint Publication 3-28 (Civil Support) are used here (they are a bit different than the recently published Army FM 3-28), but the reader should understand that these categories overlap and may be in effect simultaneously. For example, an incident at a special event could result in a presidential declaration and become a declared emergency. Subsequent sections explain the categories and describe many but not all of the various mission sets DOD could be called on to support.

(1) Disasters and declared emergencies will likely be presidentially declared, but may not be. In fact, most instances of local commanders invoking Immediate Response authority are in this category. Disasters and emergencies can be natural or manmade. Examples include: natural disasters (flood, blizzard, earthquake, etc.); wild land fire suppression; CBRNE consequence management and more.

(2) Restoring public health and services and civil order includes civil disturbance operations and support in the event of strikes or work stoppage by public service employees (e.g., 1970 postal strike and 1981 air traffic controller strike). It also includes presidentially directed critical infrastructure protection. If not a declared emergency, this category could also include mass immigration emergencies, border security, animal disease eradication and more.

(3) Special events encompass any special event, usually categorized by the DHS Special Events Working Group that warrants defense support. Examples include: Boy Scout Jamboree, Olympics, Super Bowl, World Series and many more. National Special Security Events (NSSEs) are sub-category of such magnitude or importance that the Secretary of Homeland Security designates them an NSSE. The U.S. Secret Service assumes responsibility for the security planning and execution. Recent examples include Presidential Inaugurations, Democratic and Republican National Conventions and State Funerals.

(4) Periodic planned support is a wide ranging category of support to civil authorities that routinely takes place to enhance civil-military relations and meet the needs of local communities, states and even other federal agencies.

## **Section II Domestic Emergency Management Environment**

### **22-7. National Incident Management**

*a.* Tiered Response. One of the most important concepts for those new to the DSCA arena to understand is that our country has traditionally utilized a "bottom-up" as opposed to a "top-down" approach to emergency management with

## How the Army Runs

three tiers of support: local, state and federal as shown in Figure 22–1. Primary responsibility for responding to domestic disasters and emergencies rests with the lowest level of government able to effectively deal with the incident. If a situation exceeds local capability, local authorities are generally expected to seek assistance from neighboring jurisdictions under a mutual aid agreement before requesting state assistance. Similarly, if a state’s capability proves insufficient, state authorities ask for assistance, to include non-federalized National Guard, from other states under existing agreements and compacts before requesting Federal assistance. In the event of a very large or catastrophic event, federal aid may be provided while mutual aid agreements and compacts are still being coordinated. Defense resources are provided when circumstances warrant; military support can be provided at state (National Guard forces under state control) and federal level. Not a designated tier of support or a level of elected authority, regional response both within a state and among states is increasingly important.

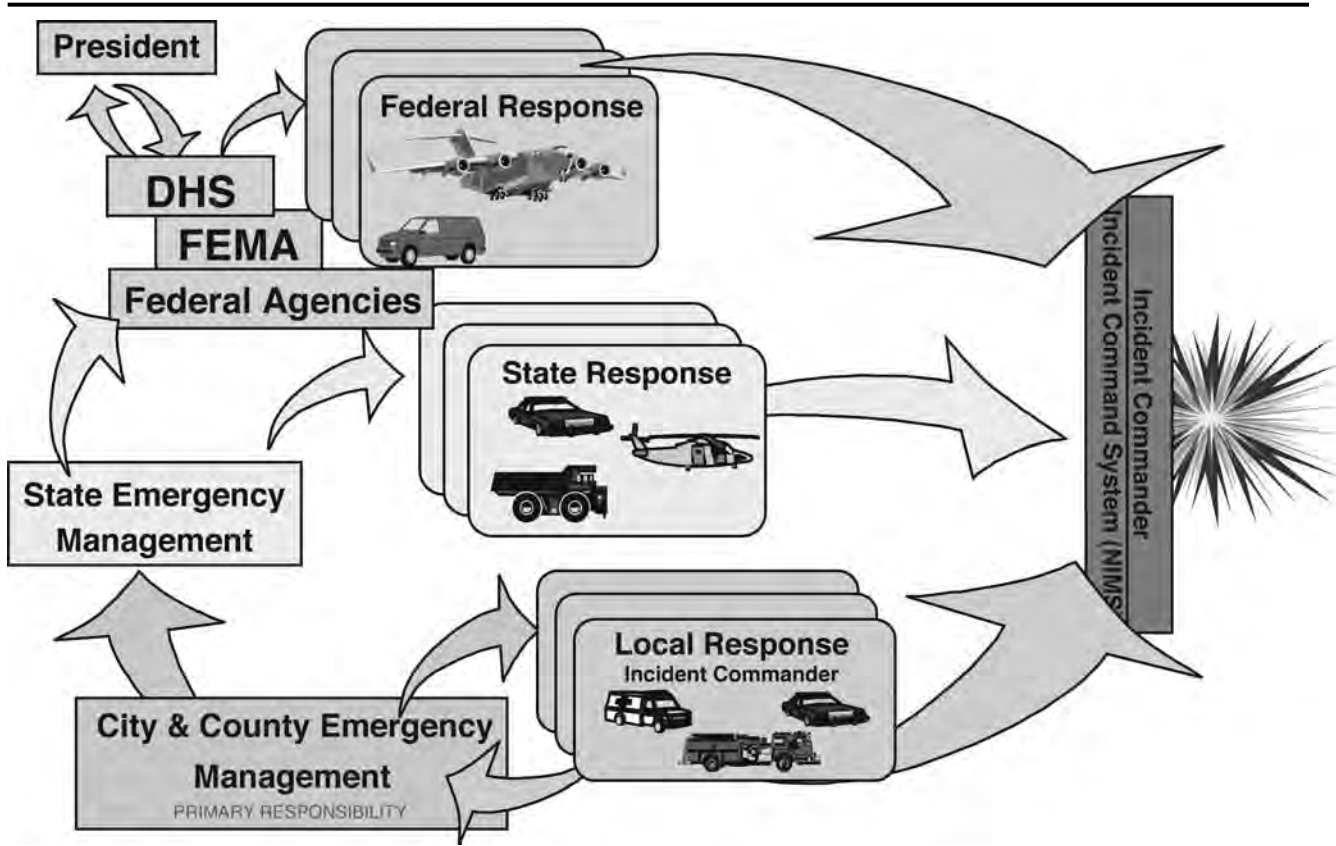

Figure 22–1. Tiered disaster/emergency response

*b.* Key National Response Documents: In combination with each other, the National Incident Management System (NIMS) and National Response Framework (NRF) provide a single, comprehensive, nation-wide approach to incident management. The NIMS provides an action template for incident management. The NRF provides the policy structure and mechanisms for national-level policy for incident management and can be considered a framework for integrating Federal support into state and local government efforts.

(1) The National Incident Management System (NIMS) establishes a core set of concepts, principles, terminology and organizational processes to enable effective, efficient and *collaborative* incident management at all levels of government. Responding agencies retain all their jurisdictional authorities and responsibilities, and they maintain operational control of their functions. Thus, another critical concept for those new to DSCA is that domestic emergency management operations are much more about unity of effort than about unity of command with which most service members are familiar. Some additional NIMS facts:

(a) HSPD–5, Management of Domestic Incidents, directed the Secretary of Homeland Security to develop and administer the NIMS. HSPD–5 requires all Federal departments and agencies to adopt NIMS and makes adoption by State and local governments a condition for Federal preparedness assistance.

(b) The NIMS objective is to provide a consistent nationwide template to enable Federal, State, local and tribal

governments and private-sector and nongovernmental organizations to work together effectively and efficiently to prepare for, prevent, respond to, and recover from domestic incidents regardless of cause, size or complexity.

(2) The National Response Framework( NRF) specifies an all-discipline, all-hazards approach for the Federal government to prepare and respond to incidents in a national unity of effort sort of way. It establishes a single, comprehensive approach to domestic incident management to prevent, prepare for, respond to, and recover from terrorist attacks, major disasters and other emergencies. The NRF, utilizing NIMS, is the core operational framework for national incident management.

(a) The NRF applies to all incidents requiring a coordinated Federal response in concert with State, local, tribal, private-sector and nongovernmental entities. The NRF is applicable to all Federal departments and agencies that participate in a coordinated Federal response. The NRF also applies to the nongovernment responders such as the American Red Cross and National Voluntary Organizations Active in Disaster (NVOAD).

(b) The NRF is always in effect although the selective implementation of various elements allows flexibility to meet the unique requirements of any situation. It enables effective interaction among Federal, State, local, tribal, private-sector, and other nongovernmental entities.

(c) There are two broad categories of federal assistance for disasters and emergencies. The Robert T. Stafford Disaster Assistance and Emergency Relief Act provides the authority for coordinating federal responses to most disasters; Figure 22–2 provides a schematic of initial federal involvement under the Stafford Act. Figure 22–3 provides a diagrammatic overview of federal-to-federal support in non-Stafford Act situations.

(d) The Catastrophic Incident Annex is a stand-alone supporting document to the NRF that is particularly noteworthy. It establishes an overarching strategy for implementing and coordinating an “accelerated, proactive response” to a catastrophic event.

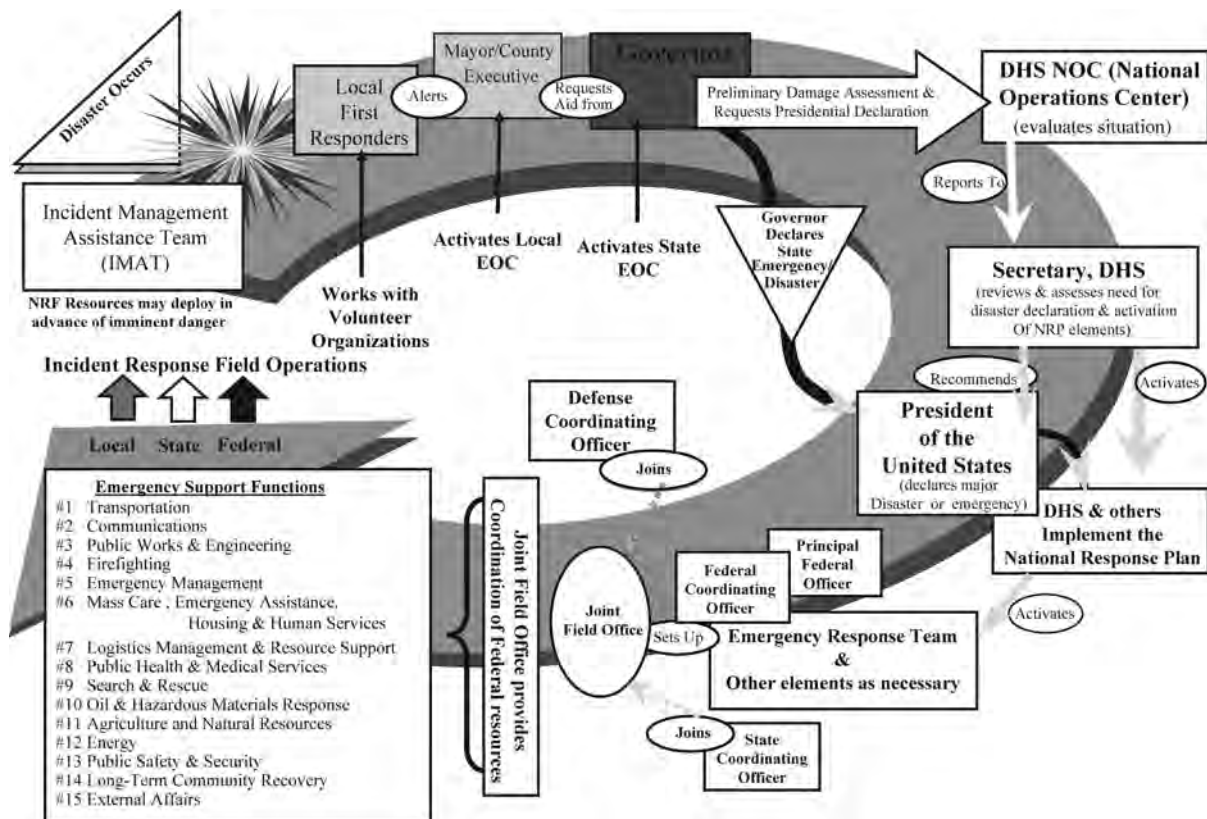

Figure 22–2. The National Response Plan (Under the Stafford Act)

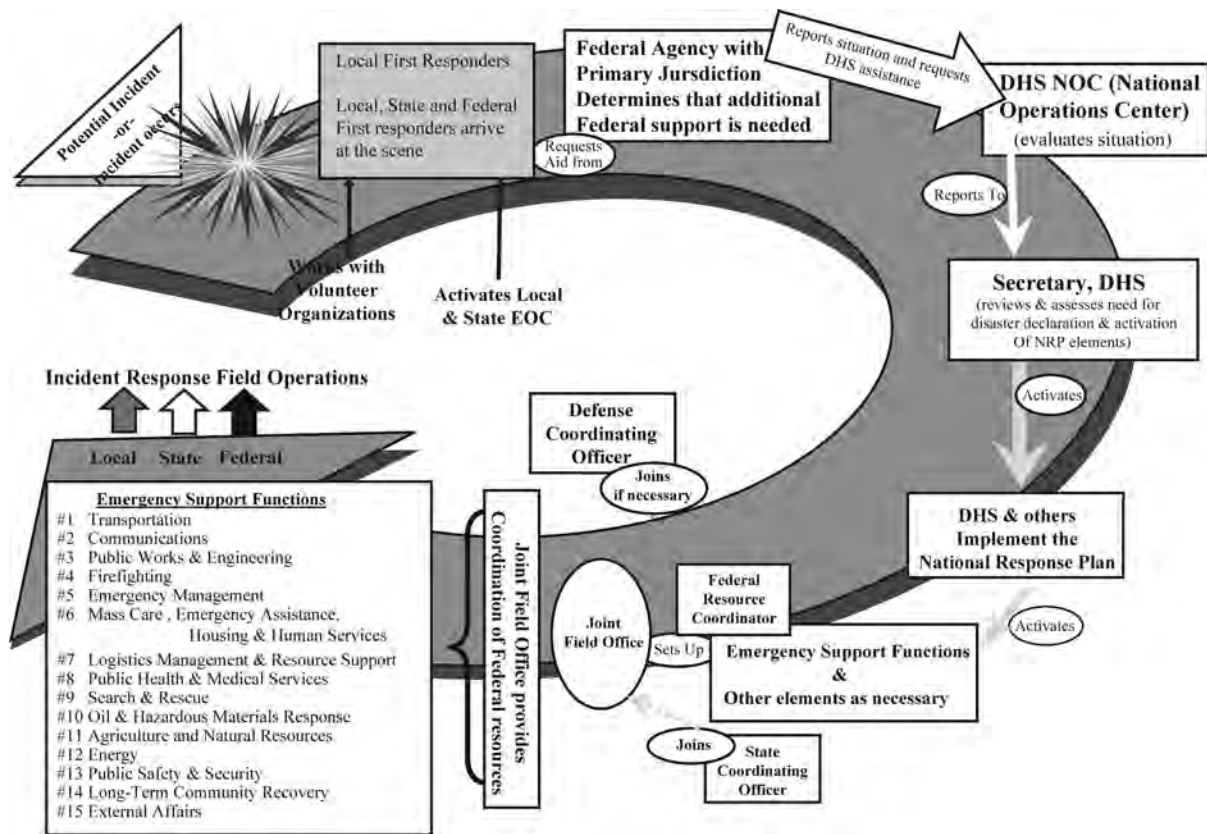

Figure 22–3. The National Response Plan (Non-Stafford Act Situations)

## 22–8. Local Response

a. In the immediate aftermath of a disaster, local responders will arrive first on the scene. First responders normally include law enforcement, fire, emergency medical services (EMS), and HAZMAT teams. At the incident site, local authorities organize the various responders under the Incident Command System (ICS), a major component of the NIMS. Military forces conducting DSCA will interact with and be a part of an ICS structure.

b. Incident Command System. NIMS establish ICS as the standardized organizational structure for the management of all domestic incidents, yet ICS provides more than just structure. ICS characteristics include: common terminology; modular organization; management by objective; reliance on an incident action plan; manageable span of control; and integrated communications. Within the ICS, there are five major functional areas: command, operations, logistics, planning, and finance. Traditionally, information and intelligence functions are located in the Planning Section but if the situation warrants, NIMS ICS can break intelligence out and add a sixth functional area. An ICS hallmark is flexibility to accommodate all circumstances including floods, hazardous material accidents, aircraft crashes, earthquakes - it is an all-hazard system. Flexible enough to manage catastrophic incidents involving thousands of response personnel, several levels of command are possible:

(1) A single command structure provides one commander a reasonable span of control. The incident commander is normally the senior responder of the organization with the responsibility for the event, e.g., fire chief or police chief. There is only one incident commander; he establishes an incident command post to direct operations.

(2) Unified Command (UC). ICS has the flexibility for one or more agencies to coordinate and combine independent efforts should the situation dictate. ICS can transition from a single Incident Commander (IC) to a unified command structure to enable agencies with different legal, geographic and functional responsibilities to coordinate, plan and interact effectively. In a UC structure, the individuals designated by their jurisdictional authorities jointly determine objectives, plans, and priorities and work together to execute them. UC as used by NIMS ICS is where the aforementioned unity of effort is manifested as all responding agencies and organizations work to support the IC without giving up individual agency authorities, responsibilities or accountability. An incident large enough to require DOD support will almost certainly be multi-jurisdictional UC.

(3) Area Command is established either to oversee the management of multiple incidents being handled by separate

ICS organizations or to oversee the management of a very large incident that involves multiple ICS organizations. Area Command is activated only if necessary, depending on the complexity of the incident and span-of-control considerations. Area Command does not have operational responsibilities. Functions include: setting priorities; allocating resources according to established priorities; ensuring effective communications; ensuring that incident management objectives are met and do not conflict with each other or with policy.

c. To supplement their capabilities, local governments establish mutual aid agreements with surrounding communities. They are usually activated before local authorities request state assistance.

## **22–9. State Support**

a. State Governors are empowered by the U.S. Constitution and their state constitutions to execute the laws of their states. They are the Commanders in Chiefs of the state National Guard when serving in state status. Similar authorities are given to the governors of U.S. territories and possessions. Once a disaster occurs, the Governor decides whether to honor a local government request for assistance and if appropriate, declares a state of emergency, activates the state response plan and call up the National Guard under state orders. The Governor informs the FEMA regional director of his actions and when state resources are insufficient, requests federal assistance.

b. State office of emergency services (OES). All states have an agency that coordinates and conducts emergency preparedness planning, training and exercises, and serves as the coordinating agency for the Governor in an emergency. The titles of these offices vary from state to state (e.g.: Emergency Management Agency, Department of Public Safety, State Emergency Management Office, and Office of Emergency Preparedness). The OES is generally organized as a standalone office under the Governor, or aligned under The Adjutant General (TAG) or state police. The senior official in charge of OES varies by state. Some states have a separate Director of Emergency Services and Director of Homeland Security. Some states combine the positions and some states dual-hat their TAG as the Director of Emergency Services. Previous editions of HTAR attempted to identify those states where TAG was dual-hatted but they change so often we no longer do so.

c. State National Guard forces are particularly well suited to provide military support to local and state agencies. The National Guard in state status is the primary military responder during most natural or man-made disasters and emergencies. It is familiar with local conditions and geography, and acting as a state militia, is not constrained by limitations on federal troops, principally the Posse Comitatus Act.

(1) The National Guard operates under one of three statuses. State status (state funding and state control); Title 32 status (Federal funding and State control) or Title 10 status (Federal funding and Federal control). State Civil Support missions are authorized by executive order of the Governor who reimburses the Federal government for utilization of federal equipment and facilities. Employment of National Guard assets by the Governor will be in accordance with State laws and constitutions.

(2) State National Guard Joint Force Headquarters (JFHQ) organizes, trains, plans, and coordinates the mobilization of National Guard units and elements for state and federal missions. Deployment and employment of the state National Guard is directed through the JFHQ.

d. In times of emergency, states often call on other states for help through standing agreements or emergency assistance compacts.

(1) The largest and best known is the Emergency Management Assistance Compact (EMAC). The EMAC expedites the employment of interstate emergency response assets and may involve all types of support to include National Guard forces. Assets provided by another state are under control of the Governor of the requesting state while assistance is being provided.

(2) Since it was first approved by Congress in 1996 as Public Law 104–321, EMAC has been ratified by all 50 states, the District of Columbia, and two territories (Puerto Rico and the US Virgin Islands). Requests for EMAC assistance are legally binding, contractual arrangements and states that ask for help are responsible for reimbursing out-of-state costs for out-of-state personnel. FEMA recognizes cross-state support under EMAC as reimbursable. States are not required to assist each other unless they are able.

## **Section III**

### **Federal Role in the National Response Process**

#### **22–10. Primary Federal Departments and Agencies**

a. *Secretary of Homeland Security; Department of Homeland Security (DHS) & FEMA.* Pursuant to HSPD–5, the Secretary of Homeland Security is the principal Federal official for domestic incident management within the United States to prepare for, respond to, and recover from terrorist attacks, major disasters and other emergencies. Acting through FEMA, the Secretary has responsibility to effectively manage Federal response and recovery efforts. FEMA also initiates proactive mitigation activities, trains first responders, and manages the National Flood Insurance Program. FEMA Headquarters is in Washington, DC and there are ten regional offices, three logistics centers, two training centers and other special purpose sites.

b. *Attorney General of the United States; Department of Justice (DOJ) & FBI.* Pursuant to HSPD–5, the Attorney



## How the Army Runs

General has responsibility for criminal investigations of terrorist acts or threats inside the United States, or directed at U.S. citizens or institutions abroad, where such acts are within the Federal criminal jurisdiction of the United States. He is also responsible for related intelligence collection within the U.S. subject to the National Security Act of 1947, other applicable laws and Executive Order 12333. Generally acting through the Federal Bureau of Investigation, the Attorney General, in cooperation with other Federal departments and agencies, also coordinates the activities of the law enforcement community to detect, prevent, preempt, and disrupt terrorist attacks against the United States.

*c. Department of Defense (DOD):*. Understanding that DOD has significant resources that might be available to support Federal domestic incident management efforts, HSPD-5 states, “The Secretary of Defense shall provide military support to civil authorities for domestic incidents as directed by the President or when consistent with military readiness and appropriate under the circumstances and the law. The Secretary of Defense shall retain command of military forces providing civil support.”

*d. Other Primary Departments and Agencies:*. There is insufficient space in this section to cover the long list of Federal organizations that have primary responsibility for various emergencies and other activities for which DOD could provide support. There are a tremendous number of directives, memorandums of agreement/understanding, laws and other arrangements involving DOD. Many but not all primary Federal agencies DOD could support are codified in the NRP’s Emergency Support Function (ESF) framework (Table 23-1). Others are identified throughout this chapter.

### 22-11. Federal Structure for NRF Response & Recovery

This section describes significant organizations and key personnel that are involved with implementing the National Response Framework.

*a. Regional Response Coordination Center (RRCC)* located in each of the ten FEMA regions, the RRCC is a standing facility operated by DHS/FEMA that coordinates regional response efforts, establishes Federal priorities and when disaster strikes, coordinates Federal support until a Joint Field Office (JFO) is established. The RRCC establishes communications with affected State Emergency Operations Centers (EOC) and the DHS National Operations Center (NOC). FEMA and interagency representatives staff the RRCC as needed.

*b. Joint Field Office (JFO)* is a temporary Federal facility established in a disaster area to provide a central point for Federal, State and local executives to coordinate their actions. Although the JFO uses an ICS structure and adapts to the magnitude of the situation, it does not manage on-scene operations. Instead, it focuses on providing support to on-scene efforts and conducting broader support operations that may extend beyond the incident site. When incidents impact multiple States or localities, multiple JFOs may be established. Utilizing NIMS ICS principles of Unified Command, JFO activities are directed by a JFO Coordination Group which may include the following officials:.

(1) Principal Federal Official (PFO) is personally designated by the Secretary of Homeland Security as her representative locally to oversee, coordinate and execute the Secretary’s incident management responsibilities. The NRF states the PFO does not replace the incident command structure and does not have directive authority over the Federal Coordinating Officer (FCO) or the Senior Federal Law Enforcement Officer (SFLEO). It is most likely that the Secretary will designate a PFO only for complex, high-visibility catastrophic disasters, terrorist events or complex emergencies with significant national impact.

(2) Federal Coordinating Officer (FCO) manages and coordinates the overall Federal response and recovery activities for Stafford Act disasters and emergencies. The FCO is head of the JFO and works in partnership with the SCO to determine and satisfy State and local support requirements. He/she coordinates and tasks Federal departments and agencies as required.

(3) Federal Resource Coordinator (FRC) in non-Stafford Act situations when a Federal department or agency acting under its own authority requests DHS assistance to obtain support from other Federal Departments and agencies, DHS designates a FRC instead of an FCO. In these situations, the FRC coordinates support through interagency agreements and memorandums of understanding.

(4) Senior Federal Law Enforcement Officer (SFLEO) is the senior law enforcement official from the agency with primary jurisdictional responsibility. He directs intelligence and investigative law enforcement operations and supports the law enforcement component of the Unified Command on scene. In the event of a terrorist incident, this official will normally be the FBI Special Agent in Charge (SAC).

(5) Officials representing other Federal departments or agencies with primary statutory responsibility for certain aspects of incident management are Senior Federal Officials (SFOs). SFOs employ existing authorities, expertise and capabilities in coordination with the PFO, FCO, SFLEO and other members of the JFO Coordination Group.

(6) The State Coordinating Officer (SCO) manages the State’s incident management activities; he is counterpart to the FCO. Another important official is the Governor’s Authorized Representative (GAR). The JFO Coordination Group may also include tribal/local area representatives with primary statutory authority for incident management.

(7) Defense Coordinating Officer (DCO) represents DOD as the single point of contact, except for ESF #3, Public Works & Engineering, in the JFO. In this capacity, his reporting chain remains through NORTHCOM but he responds to the FCO. The DCO is responsible for validating all requests for DOD support from the FCO or his representative.

*c. The NRF organizes emergency response into 15 Emergency Support Functions (ESFs) according to the capabilities and resources most likely to be requested by State officials. ESFs are the primary means through which the Federal*

government provides assistance during a disaster or emergency. They are shown in Table 22–1, along with coordinating or primary agency. Some departments and agencies are most involved with the early response to an event, while others are more prominent in the recovery phase. DOD is more active in response as opposed to recovery.

(1) During an emergency, some or all of the ESF may be activated based on the nature and scope of the event and the level of federal resources required.

(2) DOD is the Primary Coordinating Agency for ESF #3 (Public Works and Engineering), with the USACE as the DOD lead. DOD is considered a support agency to all ESFs.

## 22–12. Emergency Support Function (ESF) - 3 (Public Works and Engineering)

*a.* The U.S. Army Corps of Engineers (USACE)'s long history of providing civil support for flood control, water quality, and hazard mitigation under Public Law 84–99 make it the logical organization to serve as primary agency for ESF–3, Public Works and Engineering. The geographically dispersed location of USACE offices facilitates timely response to disasters in almost any area. The USACE is divided by watershed drainage basins into regional divisions that are subdivided by smaller drainage basins into districts. Personnel are also assigned to various field offices throughout each district. During disasters, USACE personnel quickly mobilize to assist in response and recovery.

*b.* Each USACE division and district has an emergency operations manager and each office develops plans based on hazards unique to its area, coordinates with appropriate agencies, and identifies response teams to support the assigned missions in the NRF. Types of assistance provided by USACE under ESF #3 include: technical advice and evaluations; engineering services; construction management and inspection; emergency contracting; emergency repair of wastewater and solid waste facilities; real estate support. Some ESF–3 activities include emergency debris clearance; restoration of critical public services and facilities, including supply of adequate amounts office and potable water; temporary restoration of water supply systems; technical assistance; structural evaluation of buildings; and damage assessment. By law, USACE assistance is limited to the preservation of life and protection of residential and commercial developments, to include public and private facilities that provide public services. Exclusive assistance to individual homeowners and businesses, including agricultural businesses, is not authorized. However, during periods of extreme drought, such assistance may be provided to farmers and ranchers under some circumstances.

**Table 22–1.**  
**Federal Response Plan Emergency Support Functions**

	Responsibility	ESF Coordinator
ESF 1: Transportation	Provide civilian & military transportation support	Department of Transportation
ESF 2: Communications	Provide telecommunications support	DHS, National Communications System
ESF 3: Public Works and Engineering	Restore essential public services & facilities	DOD, U.S. Army Corps of Engineers
ESF 4: Fire Fighting	Detect and suppress wild land, rural & urban fires.	Department of Agriculture, U.S. Forest Service
ESF 5: Emergency Management	Support overall Federal activities for domestic Incident Management	DHS, FEMA
ESF 6: Mass Care, Emergency Assistance, Housing & Human Services	Manage and coordinate food, shelter and first aid for victims; provide bulk distribution of relief supplies; operate a system to assist family reunification.	DHS, FEMA
ESF 7: Logistics Management & Resource Support	Provide equipment, materials, supplies and personnel to Federal entities during response	General Services Administration (GSA) and DHS, FEMA
ESF 8: Public Health & Medical Services	Provide assistance for public health and medical care needs	Department of Health and Human Services (HHS)
ESF 9: Search and Rescue	Locate, extricate and provide initial medical treatment to victims trapped in collapsed structures.	DHS, FEMA
ESF 10: Oil & Hazardous Materials Response	Support Federal response to actual or potential releases of oil and hazardous materials	Environmental Protection Agency (EPA)
ESF 11: Agriculture & Natural Resources	Provides nutrition assistance, assurance of food safety and food security, control and eradication of devastating animal disease or plant pest infestation	Department of Agriculture
ESF 12: Energy	Restore power systems and fuel supplies.	Department of Energy
ESF 13: Public Safety & Security	Provide non-investigative/non-criminal law enforcement, safety and security capabilities	Department of Justice

**Table 22–1.**  
**Federal Response Plan Emergency Support Functions—Continued**

	Responsibility	ESF Coordinator
ESF 14: Long Term Community Recovery	Provides a framework for Federal support to enable community recovery from the long-term consequences of Incidents of National Significance	DHS, FEMA
ESF 15: External Affairs	Provide public affairs, community relations, Congressional affairs, state & local coordination	DHS, FEMA

c. Each FEMA regional office is responsible for maintaining an Incident Management Assistance Team (IMAT) and developing appropriate procedures for its notification and deployment. Composed of staff from FEMA and other agencies, it provides administrative, logistical, and operational support to the regional response activities in the field. Likely the first Federal response element to arrive in a disaster area, the IMAT can form the core of the Joint Field Office (JFO) once it is established. It also provides support for the dissemination of information to the media, Congress, and the public.

d. There are numerous other Federal special teams available to support incident management and domestic response and recovery to include:

- (1) *Hurricane Liaison Team (HLT).*
- (2) *Mobile Emergency Response Support (MERS).*
- (3) *DHS Situational Awareness Team (DSAT).*
- (4) *Damage assessment teams.*
- (5) *Federal Incident Response Support Teams (FIRSTs).*
- (6) *Nuclear Incident Response Team (NIRT).*
- (7) *Disaster Medical Assistance Teams (DMATs).*
- (8) *HHS Secretary’s Emergency Response Team.*
- (9) *DOL/OSHA’s Specialized Response Teams.*
- (10) *Veterinarian Medical Assistance Teams (VMATs).*
- (11) *Disaster Mortuary Operational Response Teams (DMORTs).*
- (12) *National Medical Response Teams (NMRTs).*
- (13) *Scientific and Technical Advisory and Response Teams (STARTs).*
- (14) *Donation Coordination Teams.*
- (15) *Urban Search and Rescue (US&R) task forces.*
- (16) *Federal Type 1 and Type 2 Incident Management Teams.*
- (17) *Domestic Emergency Support Team.*
- (18) *Domestic Animal and Wildlife Emergency Response Teams and mitigation assessment teams.*

**22–13. Department of Defense DSCA Structure**

a. The Secretary of Defense (SECDEF) may delegate approval of most requests for support by civil authorities to the Executive Agent, the Assistant Secretary of Defense for Homeland Defense and America’s Security Affairs. The SECDEF retains approval authority for civil disturbance support, response to CBRNE events and for situations with potential for lethality.

(1) The Assistant Secretary of Defense for Homeland Defense and America’s Security Affairs (ASD (HD & ASA)) is the DOD Domestic Crisis Manager and Executive Agent for homeland security activities under the authority, direction and control of the Under Secretary of Defense for Policy (USD(P)). Regarding DSCA matters, ASD(HD & ASA) serves as the primary interagency point of contact for DOD coordination and assists the SECDEF, through the CJCS as appropriate, in providing DOD policy direction and supervision.

(2) The Assistant Secretary of Defense for Special Operations/Low Intensity Conflict (ASD(SO/LIC)) is the principal staff advisor to the SECDEF and USD(P) for special operations and crisis management support to FBI matters and supports planning by the DoD Domestic Crisis Manager for the contingent use of U.S. counterterrorism forces in response to domestic terrorist incidents.

(3) The Assistant Secretary of Defense for Health Affairs (ASD(HA)) provides recommendations, guidance and support for domestic crisis situations or emergencies that may require health or medical related DSCA, including situations involving the National Disaster Medical System (NDMS).

(4) The Assistant Secretary of Defense for Reserve Affairs (ASD(RA)) develops DOD policy and provides oversight for reserve component involvement with domestic emergency situations.

(5) The Joint Staff J–34, Director of Military Support (JDOMS) is the DoD Action Agent. JDOMS has responsibility for communicating and coordinating policy guidance and for the execution of DSCA missions. JDOMS conducts

planning and prepares warning and execution orders that task DOD resources. Essentially, JDOMS ensures DSCA planning and execution.

*b.* Combatant commands serve as the DOD principal planning agents and supported organizations for geographic areas designated in the Unified Command Plan. They validate requests for military assistance in their areas of responsibility (AOR) and provide DSCA. There are two Combatant Commands with responsibility for parts of the U.S. homeland.

(1) U.S. Northern Command (USNORTHCOM) is responsible for planning, organizing, and executing all aspects of homeland defense and performing civil support or DSCA missions within the continental United States, Alaska and territorial waters. The 17 December 2008 Unified Command Plan also puts Puerto Rico and the U.S. Virgin Islands back in the NORTHCOM AOR. NORTHCOM has few permanently assigned forces but will have combatant command authority over forces necessary to execute missions directed by the President or Secretary of Defense. Selected NORTHCOM subordinate commands:

(2) Army Forces North (ARNORTH), Fifth United States Army, located at Fort Sam Houston, Texas provides NORTHCOM with a dedicated Army Service Component Command for homeland defense and civil support. A multi-component organization (active, guard and reserve), ARNORTH also became a standing Joint Force Land Component Command in 2008.

*(a)* There are ten Defense Coordinating Officers (DCOs) permanently assigned to ARNORTH (. When not deployed, these Army Colonels are assigned to ARNORTH with duty in one of the ten FEMA Regions. An eleventh DCO was recently stationed in Hawaii to support PACOM. There is some discussion about assigning future DCOs from the other services.

*(b)* Defense Coordinating Element (DCE). The DCE is manned by military and civilian personnel and functions as the DCO's staff. The Emergency Preparedness Liaison Officers (EPLOS - described below) are organized into a Defense Liaison Element that, once activated for a disaster or emergency, is essentially integrated with the DCE in the JFO. Recent GAO criticisms have pointed to inefficiencies in the current relationship between the DCO, DCE and DLE (explained in the EPLO section). While it remains to be seen whether the 'good politics' can be aligned with 'good policy' to effect change, there are emerging proposals to restructure this staff organization into a Defense Planning and Coordination Unit (DPCU) that integrates the DCE and DLE. The DPCU would be ICS compliant. JTF-Civil Support (JTF-CS) is subordinate to ARNORTH and is a standing JTF with the mission to plan and integrate DOD domestic CBRNE consequence management support. When deployed, JTF-CS establishes mission command of designated DOD forces at the incident site and provides DSCA.

*(c)* JTF-North (JTF-N) is subordinate to ARNORTH and is a standing JTF tasked to detect, monitor and support the interdiction of suspected counter-drug and transnational threats within the approaches to the continental United States. JTF-N fuses and disseminates intelligence, contributing to an interagency common operational picture; coordinates support to primary Federal agencies; and supports security cooperation initiatives to enhance regional security.

(3) Restructured CBRNE Consequence Management Response Force (RCCMRF) is a joint, multi-component organization that provides a Federal military CBRNE response of about 5,200 troops to augment ten National Guard regional Homeland Response Forces (HRF). As this version of HTAR goes to print, it appears there will likely be two additional CCMRF mission command headquarters of about 1200 personnel each.

(4) Directly subordinate to USNORTHCOM, JFHQ-NCR plans, coordinates, maintains situational awareness and employs forces as directed in the National Capital Region to safeguard the nation's capital.

(5) SJFHQ-N is a standing joint force headquarters element embedded within the NORTHCOM commander's staff that provides a C2 capability that is trained, equipped and organized to conduct planning and develop situation awareness. SJFHQ-N can deploy on little notice to rapidly stand-up a JTF headquarters.

(6) U.S. Pacific Command (USPACOM) has DSCA responsibility for Hawaii and U.S. territories, possessions and freely associate states in its assigned AOR.

*c.* Each state, territory, and FEMA region has assigned Reserve officers from the Air Force, Army, Navy, and Marines who are trained in disaster preparedness and military support matters. There are over 425 Emergency Preparedness Liaison Officers (EPLOs), Regional Emergency Preparedness Liaison Officers (REPLOs), State EPLOs (SEPLOs) or Headquarters EPLOs (HEPLOs) assigned nationwide. They have a comprehensive knowledge of their service facilities and capabilities within their assigned area. EPLOs assist in determining what DOD resources exists within the state, territory, or region. EPLOs may be placed OPCON/TACON to the DCO once appointed, but unfortunately, the Services and other stakeholders have not yet agreed about the EPLOs proper relationship with the DCO and so the relationship varies across each FEMA Region. The Army and Air Force have given responsibility for their EPLOs to ARNORTH and AFNORTH respectively. As of this writing, Navy and Marine EPLOs are still managed by the Service, and US Coast Guard EPLOs are managed by Coast Guard Headquarters. DODD 3025.16 governs the EPLO program.

## **Section IV**

### **Defense support process**

## How the Army Runs

This section describes the general process that applies to all types of DSCA; subsequent sections briefly describe the unique aspects of each category.

### 22–14. Planning Considerations

Paragraph 22–5 described DOD’s Philosophic DSCA Principles and these principles become the basis for planning and executing DSCA missions; some additional considerations follow:

*a.* National Guard forces serving on state active duty status have primary responsibility for providing military assistance to state and local authorities in emergencies. DSCA planning and execution must foster a close and continuous coordination with the National Guard to ensure unity of effort.

*b.* Reserve forces have extensive capability beyond the EPLO program. USAR personnel may be employed for civil emergencies in a volunteer status, be ordered to active duty for annual training, or be called to active duty after the President has declared a national emergency. IAW 10 USC 12304, they may not be involuntarily ordered to active duty in response to a domestic emergency except for authorized response to a WMD event. Despite several attempts to change this statutory constraint, as this version of HTAR goes to print, it remains the law.

*c.* Military support will generally be of short-duration (generally not exceeding 30 days) to assist civil agencies with establishing essential safety and security.

*d.* The termination of DSCA and disengagement of DOD resources is a sensitive topic that requires planning consideration from the beginning.

*e.* Rules of the Use of Force (RUF) serve essentially the same purpose for domestic operations that Rules of Engagement (ROE) serve overseas. Chairman, Joint Chiefs of Staff Instruction (CJCSI) 3121.01B provides standing RUF. These RUF do not apply to National Guard forces in State status.

*f.* Military intelligence assets are prohibited from engaging in intelligence collection activities against U.S. persons (with very limited exceptions clearly specified in law and Executive Order 12333). While there are legal provisions allowing for the use of defense intelligence collection resources in support of domestic incident management, DSCA planners need to be particularly sensitive to statutory limitations on the use of such resources.

*g.* Defense Planning and Coordination (DPC) is a proposed concept to make use of existing DOD DSCA planning and liaison assets as an effective mechanism for supporting State and Federal disaster planning and coordination. Some readers may be familiar with the Task Force for Emergency Readiness (TFER), a model that was co-sponsored by DOD and DHS. The TFER model has been discontinued, but DPC will be able to fill the gap.

### 22–15. DSCA Request and Approval Process

*a.* A primary Federal agency usually initiates a request for defense support and submits that request to the DoD Executive Secretary. The ExecSec assesses and processes the request by sending it simultaneously to ASD(HD & ASA) and the Joint Staff, JDOMS. Under the principle of civilian control, the Executive Agent (Office of the Secretary of Defense) approves the order while the Action Agent (Joint Staff) coordinates with the appropriate Combatant Command and prepares and processes appropriate orders. Once the Executive Agent approves the order, JDOMS issues an execute order designating the supported Combatant Commander to conduct DSCA. Figure 22–4 depicts the approval process for an initial request for DOD assistance.

*b.* Request Review & Validation: Before acting on a request for DOD support, consideration is given to the operational, legal, and policy aspects of the response. Operational review ensures that providing support will not unduly impact operational readiness; legal review ensures DOD support is consistent with regulatory guidance and approved by the appropriate authorities. Policy review ensures that such support is in the best interests of DOD. To assist decision makers, DOD policy establishes six criteria against which each request for support is assessed: legality (compliance with laws), lethality (potential use of lethal force by or against DOD forces), risk (safety of DOD forces), cost, appropriateness (includes consideration of the impact if the request is denied), and readiness. These six criteria are used to review Requests for Assistance at all levels from a deployed DCO in the field to JDOMS and ASD(HD & ASA) in the Pentagon.

# REQUEST FOR ASSISTANCE

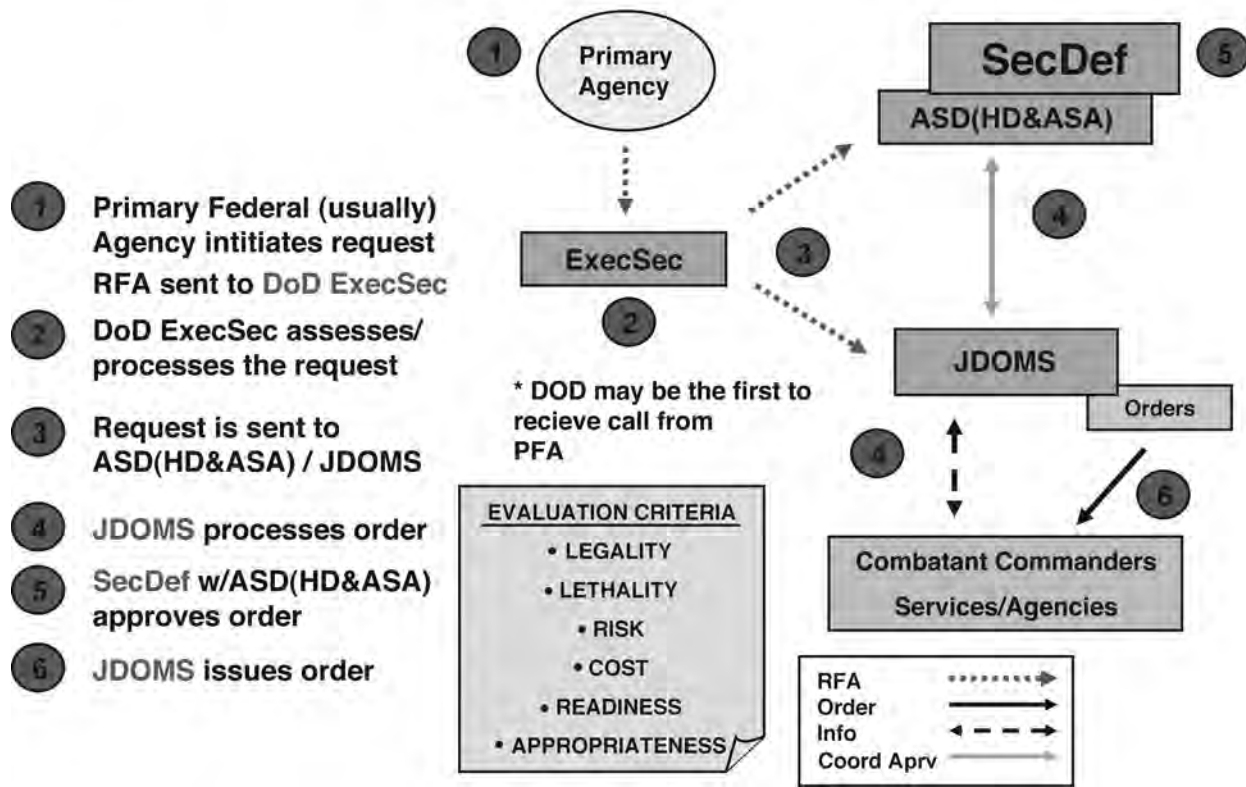

Figure 22–4. Initial Request for DOD Assistance

c. Once the initial request has been approved and a DCO deployed, requests for DOD assistance are processed through the DCO. If local and state resources, to include those available through mutual aid agreements and compacts are insufficient, the State Coordinating Officer will pass a request for assistance to FEMA's Federal Coordinating Officer. The FCO will validate the requirement and query the Joint Field Office ESFs to determine whether support is available. If not, he may pass the request to the DCO. If the DCO validates the requirement and can fill it with capability already deployed, then he will do so. If he validates the requirement but cannot meet it with capability already deployed, he forwards the RFA through his reporting channels to NORTHCOM who in turn sends it to JDOMS for processing and approval similar to the process for the initial request.

## 22–16. Immediate response

Unique circumstances allow commanders to respond immediately, without requesting approval, to imminently serious conditions that are beyond the capability of local authorities. Local commanders can respond on their own authority to requests for assistance to save lives, to prevent human suffering, and to mitigate great property damage. Once initiated, the commander must inform the DoD Executive Agent through command channels as soon as possible but no less than three hours; this notification is not a request for approval. Associated costs should be recorded for potential reimbursement later. Immediate response is normally of short duration, DOD policy suggests no longer than 72 hours after which formal approval should be obtained if continued support is required.

## 22–17. Emergency Authority

This authority is provided in DoDD 3025.18. In extraordinary emergency circumstances where prior authorization by the President is not possible and duly constituted local authorities are unable to control a situation, Federal military commanders have the authority to engage temporarily in activities that are necessary to quell large-scale, unexpected civil disturbances. Such activities need to be necessary to prevent significant loss of life or wanton destruction of property and should be necessary to restore governmental function or public order. The other circumstance appropriate

## How the Army Runs

leading to the implementation of Emergency Authority is when duly constituted Federal, State or local authorities are unable to decline to adequately protect Federal property or Federal governmental functions.

### 22–18. Media Considerations

*a.* During DSCA operations, the news media provide invaluable service that can benefit both responding organizations and the public. When considering what information can and should be released to the media, leadership should consider the need to get accurate and timely information to the public; sensitivity of the information; the possibility of causing public panic; building confidence and hope within the affected communities; correction of false information caused by rumors and distorted reporting. Leadership should strive to ensure the media get as complete and accurate a story as possible, while ensuring that their activities do not adversely affect public safety or compromise the response activities.

*b.* Normally, a joint information center (JIC) is established to deal with the media. While DOD representatives are usually represented, it is generally in the nation's interest that, whenever possible, there is a local or state spokesman engaging the media as opposed to a Federal, including active duty military, spokesman.

*c.* For major incidents, DOD will publish public affairs guidelines applicable to all participating DOD organizations. The guidance will outline any constraints and the policies for media interaction. Two common themes will usually be addressed - civilian authorities are in charge, and military forces are supporting the nation in time of need.

## Section V

### DSCA Mission Category: Disasters and Declared Emergencies

#### 22–19. DoD NRF Response Process

*a.* When a disaster occurs and local and state resources are inadequate, the President invokes the Stafford Act with a Presidential disaster declaration, thereby releasing Disaster Relief Fund (DRF) monies. While DOD will often take risk with regard to reimbursement and execute some pre-declaration actions, DOD involvement formally begins after the declaration. FEMA requests DOD support as already described in paragraph 22–15. The JDOMS execute order (EXORD) designating the supported Combatant Commander will also designate supporting DOD agencies and direct the Combatant Commander appoint a DCO.

*b.* The DCO activates the DCE and deploys to the JFO to coordinate DOD support for the disaster. Once the DCO deploys to the disaster site, State and regional EPLO work for the DCO and co-locate with the DCE. Designated federal forces respond to taskings for support validated by the DCO. The DCO has OPCON of all DOD personnel (less ESF #3) deployed in support of the disaster unless a JTF is established. The DCO will receive requests for assistance from the FCO as already described.

*c.* Tiered mission command Options. Based on the type and magnitude of an emergency or disaster, NORTHCOM will establish mission command relationships based on a flexible, tiered construct.

(1) Small Scale Events can be handled by a DCO, his DCE and EPLOs.

(2) Medium Scale Events require deployment of a mission command headquarters such as JTF–CS or one of ARNORTH's two Operational Command Posts. While there could be exceptions, a medium scale Joint Task Force (JTF) is likely to be commanded by a two star flag officer. The NRF directs that if a JTF is established, its mission command element will be collocated with the PFO at the JFO to ensure coordination and unity of effort.

(3) Large Scale Events, usually employing multiple JTFs, require an overarching JTF or functional component command. While there could be exceptions, these headquarters will most likely be commanded by a three star flag officer.

(4) Any level headquarters can be augmented with special expertise such as JTF–CS's Joint Planning Augmentation Cell (JPAC)

*d.* Dual-Status Command Option. One mission command option to further the Unity of Effort between National Guard and federal forces is a Dual Status Command whereby a JTF Commander serves in both a Title 10 status in command of Federal forces while simultaneously serving in a Title 32 status in command of State National Guard forces. Only the commander holds dual-status, not his staff(s) and the forces under his command retain their Federal and State chains of command. The dual status commander must therefore exercise his authority in a mutually exclusive manner, respecting the often different laws and policies, as well as commanders in chief, applicable for both types of forces under his command. A Memorandum of Agreement must be signed by both the Governor and President, although the Office of the Secretary of Defense is expected to request from the President standing delegation authority to the Secretary of Defense to approve/appoint a Dual Status Commander. Recent experience indicates that the dual-status C2 structure may work best for events where there is an extensive amount of time available for advance coordination and development of the MOA. Either party can terminate the agreement at any time. Designed to allow a National Guard officer to command federal forces, 32 USC 315 authorizes an active duty commander to assume dual-status command if a governor would commission him/her in the State National Guard.

*e.* The supported Combatant Commander will designate a Base Support Installation (BSI), generally at least one for each disaster. A BSI is a military installation designated to provide joint administrative and logistical support to DOD

forces. Selection is based on geographic proximity to an operation, functional capability, and coordination with service regional planning agents.

## 22–20. Improving DoD Incident Response:

*a.* In the aftermath of Hurricane Katrina, DOD recognized the need to respond more quickly during severe or catastrophic incidents, all the while maintaining respect for the jurisdictional authorities and the political responsibilities of elected officials. DOD and NORTHCOM implemented several specific measures to improve responsiveness to civil requirements:

*b.* Standing Execute Orders (EXORD) empowers the combatant commander to more rapidly respond in support of a primary Federal agency. There are Standing EXORDs for natural or manmade disasters short of terrorist attack and a separate EXORD for a CBRNE incident. The DSCA Standing EXORD specifies four distinct categories of combatant commander authorizations from assigned forces (Category 1) to those forces required for large-scale response (Category 4).

*c.* Pre-scripted Mission Assignments (PSMAs) assist with ensuring support is delivered as rapidly as possible. PSMAs are “fill-in-the-blank” templates for the most likely capabilities to be requested of DOD.

*d.* Request For Forces (RFF): As an exception to the usual RFA process, NORTHCOM authorizes DCOs to more quickly respond to anticipated requirements by using the RFF process, anticipating reimbursement by including a cost estimate.

*e.* Some but not all of NORTHCOM’s DSCA related plans:

- (1) CONPLAN 2501 (Defense Support of Civil Authorities)
- (2) FUNCPLAN 2505 (Nuclear Weapons Accident Response Plan)
- (3) CONPLAN 2591 (Pandemic Influenza)
- (4) CONPLAN 0500–02 (CBRNE Consequence Management)
- (5) CONPLAN 2707 (Caribbean Mass Migration)
- (6) CONPLAN 2502 (Civil Disturbance Operations)
- (7) CONPLAN 2400 (Emergency Preparedness in the National Capital Region)

*f.* Joint Publication 3–28 (Civil Support) provides commanders and staffs overarching doctrine for conducting Civil Support operations. It specifies five phases which can be conducted simultaneously:

- (1) Phase I: Shaping
- (2) Phase II: Staging
- (3) Phase III: Deployment
- (4) Phase IV: Civil Support Operations
- (5) Phase V: Transition (and Redeployment)

## 22–21. Unique CBRNE Response Considerations:

*a.* CBRNE versus WMD: CBRNE is defined as a chemical, biological, radiological, nuclear or high-yield explosive situation or incident including industrial accidents, acts of nature, war or terrorism. A WMD is a CBRNE device designed to produce casualties or terror. The most likely CBRNE threat is a high-yield explosive; the most dangerous are nuclear weapons. The greatest threat in the sense of a combined most likely/most dangerous combination would be a contagious biological pathogen.

*b.* CBRNE Planning Considerations: Unique considerations for CBRNE planning include the fact that incidents may not be recognized as CBRNE until there are multiple casualties. Once identified as a CBRNE event, an incident location will probably be treated as a crime scene. Responders will be at a higher risk of becoming casualties and the effects may contaminate critical facilities and infrastructure in the area. The public reaction will have to be managed as fear and panic are likely to set in. Planners must anticipate mass casualty and mortuary affairs support; “worried well” are likely to be a problem. In addition to expecting state and local capabilities to be overwhelmed, planners must remain ready for multiple attacks. It is worth noting that of the fifteen DHS National Planning Scenarios for use in preparedness activities and exercises, twelve are CBRNE events.

*c.* State National Guard CBRNE Structure: In October 1998, to enhance the national capability to deal with CBRNE consequence management, Congress authorized and funded the first ten National Guard Rapid Assessment and Initial Detection (RAID) Teams that the SECDEF renamed WMD–Civil Support Teams (CST) in January 2000.

(1) *WMD–CSTs.* Are comprised of full-time Title 32 National Guard experts, highly trained in a cross-discipline of functional areas. Their mission is to deploy; assess a situation; advise local, State, and Federal response elements and facilitate sound public safety decisions. CSTs are unique, in that they are one of a few DOD units authorized by Congress to conduct CBRNE response within CONUS. CSTs are a national resource and can move across state lines and provide support to another state.

(2) *CBRNE Enhanced Response Force Package (CERFP).* Designed to rapidly deploy in less than 96 hours, the twelve National Guard CERFP teams provide a regional response capability to augment the CSTs. They can locate and



## How the Army Runs

extract victims from a CBRNE incident site, perform mass casualty decontamination, medical triage and stabilization. CERFPs are comprised of mobilization day soldiers and are task organized from existing units.

(3) *Homeland Response Force (HRF)*: As it became clear that the Federal CCMRF was too slow to respond to a catastrophic CBRNE incident, the idea of creating a regional response from National Guard assets was proposed. The ten HRFs (one in each FEMA region) will be about 566 personnel and consist of CBRN Assessment, Search/Extraction, Decontamination, Emergency Medical, Security and C2.

d. It is beyond the scope of this chapter to detail Federal CBRNE response assets but the reader should know that significant Federal capabilities exist and have an appreciation for the roles and missions of organizations DOD might encounter or support. These resources are listed before the section on DOD capabilities to reinforce the idea that defense resources are employed only after the capacity of civilian resources at all levels of government has been exceeded.

(1) Department of Energy (DOE) Nuclear Emergency Support Teams (NEST) provide specialized response to the technical aspects of an unresolved incident involving nuclear or radiological devices. Capabilities include search and identification of nuclear materials, diagnostics and assessment of suspected nuclear devices, technical operations in support of render safe procedures and packaging for transport to final disposal.

(2) Environmental Protection Agency Environmental Response Teams (EPAERT) and Radiological Emergency Response Team (RERT) deal with the human health and environmental impact of terrorist attacks. The EPA's research laboratories offer field monitoring and technical support to quality-assurance programs for air, water, wastewater and solid waste. Some of these laboratories are capable of deploying mobile units to a contaminated site.

(3) The FBI Hazardous-Materials Response Unit (HMRU) has specialized sampling, detection and identification capabilities of NBC agents. Evidence Response Teams (ERTs) provide crime-scene documentation and evidence collection in support of criminal investigations.

(4) USCG National Strike Force is trained and equipped to assist in responding to major oil or hazardous material spills, particularly in a maritime environment.

(5) Department of Health and Human Services (HHS) coordinates the National Medical Response Teams for WMD that deal with the medical consequences of incidents involving CBRNE. In addition, HHS' Centers for Disease Control and Prevention has special responsibilities in the event of terrorism involving infectious agents.

e. DOD has many organizations that can assist with the response to a CBRNE event.

(1) Defense Threat Reduction Agency (DTRA) exists to safeguard the U.S. and its allies from WMD (CBRNE) by providing capabilities to reduce, eliminate and counter the threat and mitigate the effects.

(2) Joint Task Force-Civil Support already described in paragraph 23-14.b (1) (b).

(3) USMC Chemical-Biological Incident Response Force (CBIRF) responds to CBRNE incidents to assist local, State or Federal agencies and designated Combatant Commanders with consequence management operations. CBIRF capabilities include agent detection and identification, casualty search and rescue, personnel decontamination and emergency medical care to stabilize contaminated victims.

(4) Restructured CBRNE Consequence Management Response Force (RCCMRF) was addressed in paragraph 22-13.b.(3)

(5) U.S. Army 20<sup>th</sup> Support Command (CBRNE) integrates, coordinates, deploys and provides trained and ready forces. It is also prepared to mission command CBRNE operations. The 20<sup>th</sup> Support Command provides training and readiness oversight of Army CBRNE assets (active, guard and reserve) to include the 22<sup>nd</sup> Chemical Battalion (Technical Escort) and 52<sup>nd</sup> Ordnance Group. The Technical Escort Unit (TEU) provides no-notice capability to conduct field sampling, identification and verification, monitoring, dismantlement, recovery, decontamination, escort and mitigation of hazards associated with chemical and biological materials.

(6) The services have a wide variety of other CBRNE assets too numerous to explain in detail. All the services have Explosive Ordnance Disposal (EOD) units; the Army has chemical brigades, battalions and companies; the Army also has Biological Integrated Detection System (BIDS) companies. Much of the Army capability is resident in the US Army Reserve. The Edgewood Chemical Biological Center is the principal research and development center for chemical and biological defense technology.

(7) U.S. Army Medical Command also provides a variety of CBRNE support. The USA Medical Research Institute of Chemical Defense (USAMRICD) and USA Medical Research Institute of Infectious Diseases (USAMRIID) not only conduct research but provide teams to advise and assist with the medical aspects of incidents. USAMEDCOM also provides operational Special Medical Augmentation Response Teams (SMART) to provide emergency medical response and a variety of other related services in support of a terrorist attack. These teams can also respond to a non CBRNE natural disaster.

## Section VI

### DSCA Mission Category: Restore Public Health and Services and Civil Order

#### 22-22. Support to Law Enforcement:

a. The use of military force to enforce U.S. laws inside the homeland is an appropriately sensitive topic and

restrictions apply to such use. When armed and so used, military forces, will adhere to the standing rules for the use of force (SRUF) unless the Secretary of Defense has approved mission-specific RUF.

(1) The *Posse Comitatus Act of 1878 (PCA)*, subsequent amendments and policy decisions prohibits the use of federal military forces (to include Reserve forces) to perform internal police functions. PCA thus restricts the type of support DOD can provide domestic law enforcement organizations.

(2) There are a wide variety of exceptions to the PCA and we teach at the US Army War College that the law essentially gives the President all the authority he needs to employ DOD forces inside the U.S. although there may appropriately be political consequence that would inhibit such employment. The PCA law itself makes provision for the President's Article II Constitutional authority. The Act does not pertain to the National Guard when in State status, nor does it apply to the U.S. Coast Guard. There are also a variety of statutory exceptions such as the Protection of Nuclear Materials Act (18 USC 831), Chemical-Biological Terrorism (10 USC 382) and Secret Service Assistance (10 USC 3056). The most renowned statutory exception is The Insurrection Act (10 USC 331–334) used primarily for civil disturbances.

b. The President is authorized by the Constitution and Title 10 (10 USC 331–334) to suppress insurrections, rebellions, and domestic violence by using Civil Disturbance Operations (CDO). After issuing a Cease and Desist Order, the President issues an executive order that directs the Attorney General and the SECDEF to take appropriate steps to disperse insurgents and restore law and order. The Attorney General is then responsible to coordinate the federal response to domestic civil disturbances. The restrictions of the *Posse Comitatus Act* no longer apply to federal troops executing the orders of the President to quell the disturbance in accordance with Rules of the Use of Force (RUF) approved by the DoD General Counsel and the Attorney General.

(1) USNORTHCOM Concept Plan (CONPLAN) 2502 (Civil Disturbance Operations), is the plan for supporting state and local authorities during civil disturbances. This plan serves as the foundation for any CDO operation and standardizes most activities and command relationships. Tasks performed by military forces may include joint patrolling with law enforcement officers; securing key buildings, memorials, intersections and bridges; and acting as a quick reaction force.

(2) The JTF commander, a general officer, coordinates all DOD support with the Senior Civilian Representative of the Attorney General (SCRAG), see Figure 22–5. DOD will usually establish a JTF headquarters near where the Attorney General's local representative is based.

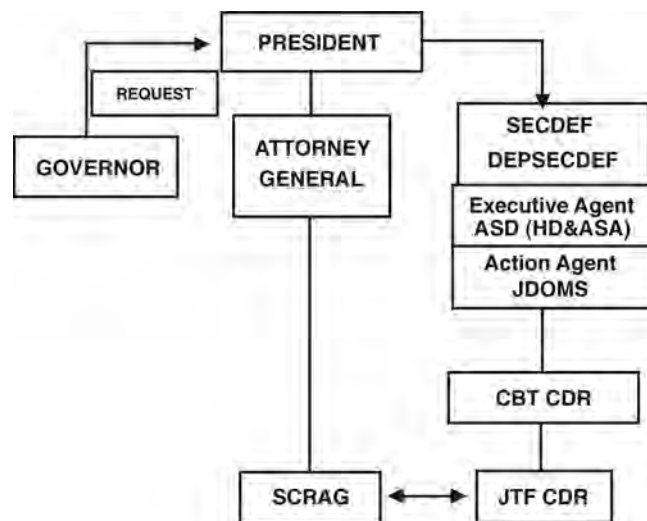

Figure 22–5. Civil disturbance support mission command

## How the Army Runs

c. Combating terrorism is predominantly a civilian law enforcement function. DOJ and specifically the FBI have primary Federal responsibility for combating and countering terrorism. Responsibilities include measures to anticipate, prevent, and/or resolve a threat or act of terrorism.

(1) The FBI continually assesses intelligence and reports of terrorist activity. When there is a credible threat, the FBI is responsible to disrupt it and prevent an attack. Should there be an incident, the FBI is responsible to neutralize any on-scene threat and for criminal investigation. The FBI Special Agent in Charge (SAC) supervises the law enforcement activities at the incident scene. The FBI will establish a Joint Operations Center (JOC) to orchestrate the interagency law enforcement and investigative efforts. The NRF directs the JOC be located with the Joint Field Office (JFO). Other FBI actions can include deploying a domestic emergency support team (DEST), a rapidly deployable special interagency team that provides advice to the FBI on-scene coordinator. The SAC may also request the FBI Hostage Rescue Team (HRT).

(2) If necessary, the FBI may request specialized DOD support that could include a joint special operations task force (JSOTF). The FBI on-scene coordinator notifies the FBI Director and the Attorney General. The FBI also informs the Assistant Secretary of Defense for Special Operations/Low Intensity Conflict (ASD (SO/LIC)) of the pending request and provides details of the incident. The ASD (SO/LIC) advises the SECDEF and the Attorney General confers with SECDEF on the deployment request. They, in turn, confer with the President. The President must approve all requests that may potentially lead to DOD use of lethal force in support of law enforcement.

(3) After Presidential approval of DOD support, the SECDEF personally approves deployment orders. Normally DOD provides a JSOTF and special mission units (SMU) with unique capabilities, such as those to render safe WMD. The JSOTF deploys to the site and coordinates proposed actions with the FBI SAC. At the appropriate time, the FBI employs the JSOTF to execute those operations approved by the President. DOD assets deployed in support of law enforcement operations do not normally remain to support response and recovery.

d. Public Law 97-86, passed in 1982, amended the *Posse Comitatus Act* to authorize indirect military involvement such as equipment loan, personnel support, training, and sharing information in Drug Interdiction and Counter-Drug Activities.

(1) Indirect support must be incidental to the military mission, or provide substantially equivalent military training. Further, it cannot degrade combat readiness or the capacity of the DOD to fulfill its defense mission.

(2) Federal, state, and local law enforcement agencies (LEA) originate requests for DOD counterdrug operational support in CONUS and submit them to Joint Task Force-North located at Fort Bliss, Texas and charged with the responsibility of validating such requests. The approval process for the use of forces is retained at the highest level. Defense support to Drug Law Enforcement Agencies (DLEA) can include: ground reconnaissance; detection monitoring; communications; aerial reconnaissance; counterdrug related training of LEA personnel; nonherbicidal cannabis eradication; linguist support; aerial and ground transportation; intelligence analysis; tunnel detection; engineering support; maintenance support and much more. Non-operational support can include facilities, formal military school training opportunities, equipment loans, and more.

### 22-23. Other types of Public Health and Services DSCA:

a. In the event of a work stoppage or disaster leading to disruption of mail service, DOD may be required to provide support to the United States Postal Service (USPS) to safeguard process and deliver the mail to areas in which service has been impaired.

b. DOD would provide the US Department of Agriculture (USDA) assistance for emergencies requiring the containment and eradication of plant or animal diseases.

c. DOD medical support would generally be provided to Department of Health and Human Services (DHHS) using the mechanisms of NRP ESF#8 (Health and Medical Services) and the Catastrophic Incident Annex. There has also been significant and recent interagency effort to develop and exercise specific Pandemic Influenza plans. An important aspect of the ESF#8 process is the National Disaster Medical System (NDMS), a public, private sector partnership involving DHS, DHHS, DOD, and Department of Veteran Affairs. NDMS provides a nationwide medical response system to supplement state and local medical resources during domestic disasters and emergencies, and provides backup medical support to DOD and the VA medical care systems during overseas conflicts.

d. The Environmental Protection Agency (EPA) and DHS-U.S. Coast Guard have responsibilities for oil and hazardous substance spills.

e. The National Interagency Fire Center (NIFC), a joint Department of Agriculture and Department of Interior organization is responsible for coordinating the Federal response to wild fires. DOD provides resources for the containment, control and extinguishing of wild fires on lands owned by the Federal government.

f. Mass immigration emergencies could result in DOD providing other Federal agencies with support such as

installations and services associated with housing migrants while the Immigration and Naturalization Service resolves the administrative requirements for migrants to enter the U.S.

## Section VII

### DSCA Mission Categories: Special Events & Planned Periodic Support

#### 22–24. DSCA Mission Category: Special Events

*a.* Pursuant to HSPD–7, the Secretary of Homeland Security, after consultation with the Homeland Security Council, is responsible for designating events a National Special Security Event (NSSE). These special events of national significance can be political, economic or international sporting events. They all present a lucrative target for terrorists. A large number of people or a limited number may attend it; they may encompass a wide geographical area or be restricted to a specific site. When an event is designated a NSSE, the Secret Service assumes its mandated role as lead for security planning and DOD supports the USSS. Examples of military assets that may be deployed include EOD, technical escort unit teams and CBRNE assets. If an incident occurs at an NSSE, the FBI leads the law enforcement and criminal investigation efforts, and FEMA leads response and recovery efforts. Most events are not designated NSSEs, but may still receive DOD support.

*b.* JDOMS plans, coordinates, and monitors execution of approved DOD support to other special events as categorized by the DHS Special Events Working Group. Events of a lesser significance are designated Special Events for Homeland Security (SEHS) levels 1 to 4, SEHS Level 4 being the lowest priority. DOD focuses on support related to public safety and security, including but not limited to, physical security, aviation, logistics, communications, joint operations and command centers, and explosive ordnance disposal support. DOD support for events may be reimbursable or non-reimbursable depending on the type of support provided and the nature of the event.

*c.* DOD is authorized under Title 10, USC 2554 to provide support to international sporting competitions (SISC) if the Attorney General certifies that support is essential to the safety and security of the event. Congress has established a revolving fund to cover SISC operational expenditures.

*d.* DOD supports other special events as demonstrated by the many State Designated Special Events that National Guard forces support while on state status under a governor's control.

#### 22–25. DSCA Mission Category: Periodic Planned Support

*a.* This category enhancing civil-military relations includes DOD laboratory support; specialized and mobile training programs; participation in local, state and federal emergency management exercises; support provided to the Secret Service under 18 USC 112; and provision of military bands or honorary fly-over at civic events. It includes Military community affairs programs and community relations programs administered by the Assistant Secretary of Defense for Public Affairs.

*b.* Installation commanders are authorized under the Installation Mutual Aid Agreements, USC Title 42, Section 1856a-c to enter into limited mutual aid agreements with local communities, usually for fire, emergency medical or hazardous material response. It should be noted that while such memorandums may improve understanding about what resources DOD may be able to provide, they do not constitute preapproved support. Requests must be approved or be provided under some established authority such as Immediate Response authority.

*c.* Military Assistance to Safety and Traffic (MAST) is governed by DODD 4500.9 that authorizes medical helicopter units to provide emergency assistance if local resources are not available or are not sufficient to respond to emergencies. Under this directive, there is no reimbursement, units may not relocate to provide service and they must operate within their allocated training hour program.

## Section VIII

### Summary and references

#### 22–26. Summary

*a.* Our nation has a time-tested tradition of civilian control over the military and of limiting military activity within the United States. Balancing that valued tradition with the need for military support in response to disaster and acts or threats of terrorism within the United States requires approval by the most senior civilian officials within our government.

*b.* The military has available a unique blend of skilled personnel and equipment capable of rapid and effective responses in support of appropriate civil authority. By policy, requests for military resources are only approved when the capacity or resources of other federal, state, and local agencies is exceeded and the crisis remains unresolved.

*c.* While DSCA normally involves military units performing tasks related to their wartime missions, the commitment of those units detracts from their ability to respond to possible combat missions and usually adversely affects readiness. DOD leaders must be very judicious in determining when and how to provide support to civil authorities, scrupulously adhere to approval and employment rules, and be mindful that DOD resources are always in a support role. Existing local, state, and national response systems provide a solid framework within which DOD can provide support.

## How the Army Runs

d. The military continues to provide reliable and responsive DSCA. Moreover, The Army's extensive experience in supporting civil authorities during peacetime disasters, national security emergencies, and special events enhances HS and has kept The U.S. Army in the forefront of domestic disaster response. The military's force projection capability, designed to respond quickly and decisively to global requirements, also allows its rapid response to domestic incidents that occur within the United States, its territories and possessions. The judicious use of military forces in support of civil requirements complements the military's war fighting and force projection capabilities, while insuring the American people get maximum return from their military investment.

### 22–27. References

#### a. Law.

- (1) Public Law 84–99.
- (2) Public Law 100–707, *The Stafford Act* (with revisions)
- (3) Public Law 104–201, Defense Against Weapons of Mass Destruction Act of 1996 (Nunn-Lugar-Domenici)
- (4) Public Law 106–65, National Defense Authorization Act for FY 2000, Section 1023
- (5) Public Law 107–56, *The Patriot Act*
- (6) Public Law 107–296, The Homeland Security Act of 2002
- (7) Public Law 109–364, National Defense Authorization Act for FY 2007, Section 1042
- (8) 10 U.S. Code, Section 331–335, Enforcement of the Laws to Restore Public Order
- (9) 10 U.S. Code, Section 372–380, Military Support for Civilian Law Enforcement Agencies
- (10) 10 U.S. Code, Section 12304, Reserve and IRR Order to Active Duty Other Than During War or a National Emergency
- (11) 10 U.S. Code Section 2553, Presidential Inaugural Ceremonies
- (12) 10 U.S. Code Section 2554, *Boy Scout Jamboree*
- (13) 10 U.S. Code Section 2564, Sporting Events (Olympics, Goodwill, World Cup, etc)
- (14) 18 U.S. Code, Section 1385, *Use of Army and Air Force as Posse Comitatus* (with revisions)
- (15) 31 U.S. Code, Section 1535, *Economy Act*

#### b. Presidential Directives and Executive Orders.

- (1) Executive Order 12148, *Establishment of FEMA*, 1979
- (2) Executive Order 12656, Assignment of Emergency Preparedness Responsibilities, 1988
- (3) HSPD–5, Management of Domestic Incidents, 2003
- (4) HSPD–7, Critical Infrastructure Identification, Prioritization and Protection, 2003
- (5) HSPD–8, National Preparedness, 2003
- (6) PDD #39, U.S. Policy on Counterterrorism , 1995
- (7) PDD #62, Combating Terrorism, 1998
- (8) PDD #67, Continuity of Government and Continuity of Operations , 1998

#### c. U.S. Government Strategies.

- (1) National Security Strategy
- (2) National Strategy for Homeland Security
- (3) National Strategy to Combat Weapons of Mass Destruction
- (4) National Strategy for Combating Terrorism
- (5) National Strategy for Pandemic Influenza
- (6) National Strategy for Physical the Protection of Critical Infrastructure and Key Assets
- (7) Maritime Strategy for Homeland Security
- (8) National Defense Strategy
- (9) National Military Strategy
- (10) DoD Strategy for Homeland Defense and Civil Support

#### d. DOD Directives, Instructions and Manuals & CJCS documents.

- (1) DODD 1100.20, Support and Services for Eligible Organizations and Activities, 2004.
- (2) DODD 2000.12, DoD Antiterrorism (AT) Program, 2003
- (3) DODD 3020.26, Defense Continuity Program (DCP), 2004
- (4) DODD 3020.36, National Security Emergency Preparedness (NSEP), 1988
- (5) DODD 3020.40, Defense Critical Infrastructure Program (DCIP), 2005(6) DODD 3025.18, *Defense Support of Civil Authorities*, 29 December 2010(7) DODD 2000.15, Support to Special Events, 1994
- (6) DODD 3025.12, Military Assistance to Civil Disturbances (MACDIS), 1994
- (7) DODD 5030.46, Assistance to District of Columbia in Combating Crime, 1971
- (8) DODD 5030.50, Employment of Department of Defense Resources in Support of the United States Postal Service, 1972

- (9) DODD 5525.5, DoD Cooperation with Civilian Law Enforcement Officials, 1986
  - (10) DODD 3025.13, Employment of DOD Capabilities in Support of the United States Secret Service, 8 October 2010.
  - (11) DODD 3025.16, Military Emergency Preparedness Liaison Officer Program, 2000
  - (12) DODD 3150.5, Response to Improvised Nuclear Devices (IND), Incidents, 1987
  - (13) DODD 3150.8, Response to Radiological Accidents, 1996
  - (14) DODD 4500.9, Transportation and Traffic Management, 2005
  - (15) DODD-S 5210.36, Provision of DoD Sensitive Support, 1986
  - (16) DODD 5410.19, Public Affairs Community Relations Policy, 2001
  - (17) DODD 6010.22, National Disaster Medical System, 2003
  - (18) DOD Instruction 6055.6, DoD Fire and Emergency Services Program, 2000
  - (19) DOD Instruction 3025.dd, DRAFT Processing Requests for DSCA, 2006
  - (20) DOD Manual 3025.dd, *DRAFT DSCA Manual*, 2006
- e. DOD Plans and Policy Documents.*
- (1) DoD Civil Disturbance Plan, *GARDEN PLOT*
  - (2) Unified Command Plan 2008
  - (3) Chairman of the Joint Chiefs of Staff Concept Plan 0500, Military Assistance to Domestic Consequence Management Operations in Response to a Chemical, Biological, Radiological, Nuclear or High-Yield Explosives Situation.
  - (4) CJCS Instruction 3110.16, Military Capabilities, Assets and Units for Chemical, Biological, Radiological, Nuclear or High-Yield Explosives Operations.
  - (5) CJCSI 3121.01B, Standing Rules of Engagement/Standing Rules for the use of Force for U.S. Forces.
  - (6) CJCSI 3125.01, Military Assistance to Domestic Consequence Management Operations in Response to a Chemical, Biological, Radiological, Nuclear or High-Yield Explosives Situation.
  - (7) CJCSI 3710.01A, DOD Counterdrug Operational Support.
  - (8) NORTHCOM Concept Plans (CONPLAN) and Functional Plans (FUNCPLAN):
    - (a) CONPLAN 2501 (Defense Support of Civil Authorities)
    - (b) FUNCPLAN 2505 (Nuclear Weapons Accident Response Plan)
    - (c) CONPLAN 2591 (Pandemic Influenza)
    - (d) CONPLAN 0500-02 (CBRNE Consequence Management)
    - (e) CONPLAN 2707 (Caribbean Mass Migration)
    - (f) CONPLAN 2502 (Civil Disturbance Operations)
    - (g) CONPLAN 2400 (Emergency Preparedness in the National Capital Region)
  - (9) USPACOM Functional Plan 5210-95, (Domestic Disaster Response)
- f. Doctrinal Publications:*
- (1) Joint Publication (JP) 3-07.2, *Counterdrug Operations*, 1998
  - (2) JP 3-26, *Homeland Security*, 2005
  - (3) JP 3-27, *Homeland Defense*, 2006
  - (4) JP 3-28, *DRAFT Civil Support*, 2006
  - (5) JP 3-41, *CBRNE Consequence Management*, 2006
  - (6) Army Field Manual 3-28 (Civil Support Operations), August 2010
- g. DHS Documents.*
- (1) National Incident Management System (NIMS), 2004
  - (2) National Response Framework (NRF), 2008
- h. Miscellaneous Documents: Domestic Operational Law Handbook for Judge Advocates.*

RESERVED

## Glossary

### Section I Abbreviations

#### **A2MCD**

Assessments, Architecture, Mission Command Directorate (ARCIC) 11–35b (4) (b)

#### **A2SF**

Active Army Strength Forecaster 13–7k

#### **AAC**

Army Acquisition Corps 11–29a

#### **AACMO**

Army Acquisition Corps Management Office 13–39d

#### **AAE**

Army Acquisition Executive 3–8b (2)

#### **AAFES**

Army and Air Force Exchange Service 10–48

#### **AAMMP**

Active Army Military Manpower Program 13–7f

#### **AAO**

Army Acquisition Objective 5–26b (1)

#### **AAR**

After Action Review 15–34c (3) (c)

#### **AARTS**

Army/American Council on Education Registry Transcript System 13–48b

#### **AASA**

Administrative Assistant to the Secretary of the Army 9–8d

#### **AAWO**

Army Asymmetric Warfare Office 11–62a

#### **ABC**

Activity based costing 10–34a

#### **ABCA**

American, British, Canadian, Australian and New Zealand Sustain Work Group 12–6 (2) (c) 35 g

#### **ABC–C**

Army Benefits Center-Civilian 14–4a

#### **ABCS**

Army Battle Command System 11–18e (3)

#### **ABEA**

Army business enterprise architecture 16–11b

#### **ABO**

Army Budget Office 5–24d (4)

#### **AC**

Advanced Course 15–18b (5)



## **How the Army Runs**

### **AC**

Active Component 7-1

### **ACA**

Assimilative Crimes Act 19-8c

### **ACAP**

Army Career and Alumni Program 13-52

### **ACAT**

Army acquisition category 9-33

### **ACC**

Army capstone concept 5-4b

### **ACC**

Army component command 9-18e (3)

### **ACC**

Army Community Covenant 17-2d

### **ACE-IT**

Army Corps of Engineers Information Technology 20-4h

### **ACES**

Army Continuing Education System 13-48

### **ACF**

Acquisition Career Field 2-4a (1) (a)

### **ACF**

Army concept framework 5-4b

### **ACO**

Army claims office 19-12c

### **ACOE**

Army Community of Excellence 17-43

### **ACOM**

Army Command 1-5a

### **ACP**

Army Campaign Plan 1-5a

### **ACP**

Army cost position 11- 34b

### **ACRB**

Army Cost Review Board 11-32b (5)

### **AC/RC**

active/reserve component 5-19b (1) (b)

### **ACS**

Advanced civilian schooling 11-33b (2)

### **ACS**

Army Concept Strategy 9-40

**ACSIM**

Assistant Chief of Staff for Installation Management 3–4e

**ACT II**

Advanced Concepts and Technology II 11–12b (7)

**ACTD**

advanced concept technology demonstration 11–17j (6) (b)

**ACTEDS**

Army Civilian Training, Education and Development System 13–39i

**ACWF**

Army Working Capital Funds 17–22a

**ADA**

Anti-deficiency Act 10–8

**ADCON**

Administrative control 8–18d

**ADL**

active duty list 13–31a

**ADM**

acquisition decision memorandum 11–38a

**ADOS**

active duty for operational support 7–43

**ADR**

Alternative Dispute Resolution 14–21a

**ADS**

Authoritative data source (ADS) 5–28a

**ADT**

active duty for training 7–17

**ADTLP**

Army Doctrine and Training Literature Program 15–24

**AEA**

Army enterprise architecture; 16–4b (5)

**AEBD–CC**

Army Environmental database for Cleanup 17–22a

**AEC**

Army Environmental Command 17–2k

**AECA**

Arms Export Control Act 15–31a

**AECS**

Army Environmental Cleanup Strategy 17–22b

**AE2S**

The Army Equipping Enterprise System 2–8a

## **How the Army Runs**

### **AEF**

American Expeditionary Force 7–5

### **AEP**

Affirmative Employment Program 14–22c

### **AEP**

Army Experimentation Plan 5–6e (1)

### **ABCTMP**

Army Brigade Combat Team Modernization Program 5–6e (2) (a)

### **AEPI**

U.S. Army Environmental Policy Institute 3–4e (1) (f)

### **AER**

academic evaluation report 13–22

### **AETF**

Army Evaluation Task Force (TRADOC ARCIC) 11–35b (4) (b)

### **AESIP**

Army Enterprise System Integration Program 12–11b (1) (c)

### **AFAMC**

Air Force Air Mobility Command 6–11e (2) (e) (4)

### **AFAP**

Army Family Action Plan (AFAP) 12–6e (1) (d)

### **AFARS**

Army Federal Acquisition Regulation Supplement 11- 29b

### **AFC**

Army functional concepts 5–4c

### **AFCS**

Active Federal Commissioned Service 13–57a

### **AFHC**

Army Family Housing (Construction) 9–62b (1) (b)

### **AFHO**

Army Family Housing (Operations) 9–62c (2)

### **AFM**

Army Flow Model 2–8a

### **AFMIS**

Army Food Management Information System 12–15e (7)

### **AFPD**

available force pool date 2–7b (3)

### **AFR**

Agency Financial Report 10–30c

### **AFRP**

The Army Facility Reduction Program 17–32a

**AFRS**

Aviation Flight Records System 12–15e (4)

**AFS**

Active Federal Service 13–56

**AFSB**

Army Field Support Brigade 12–2e

**AFSBn**

Army Field Support Battalions 12–9b

**AG–1 CP**

Assistant G–1 for Civilian Personnel 14–9a

**AGR**

Active Guard Reserve 7–17

**AGTS**

Advanced Gunnery Training System 15–5d

**AHLTA**

Armed Forces Healthcare Longitudinal Application 18–18c

**AHRC**

Army Human Resources Command 13–4c

**AHS**

U.S. Army Headquarters Services 3–4e (1) (g)

**AHS**

Army Health System 18–3

**AI**

Artificial Intelligence 15–3h (3)

**AIC**

Army Interoperability Certification 16–4b (11)

**AICFB**

Army Interoperability Certified Fielded Baseline 16–16d (2)

**AIMT**

Army Installation Management Transformation 17–19

**AIP**

Assignment Incentive Pay 13–16c

**AIS**

automated information systems 10–4e (4)

**AIT**

advanced individual training 7–27b

**AIT**

Automatic Identification Technologies 12–15f (3)

**AJ**

Administrative Judges 14–7d

## **How the Army Runs**

### **AKEA**

Army Knowledge Enterprise Architecture 9–8e (5)

### **AKO**

Army Knowledge Online 2–8a

### **ALMS**

Army Learning Management System 15–5c

### **AMA**

Analysis of Materiel/non-materiel Approaches 2–4 a (1) (b)

### **AMATS**

Aviation Maintenance Automated Tracking System 12–15e (4)

### **AMC**

Army Materiel Command 3–4b

### **AMC**

Air Mobility Command 4–17c (7)

### **AMCB**

Army Marine Corps Board 11–34i

### **AMCOM**

Aviation and Missile Command 11–83 (b) (1)

### **AME**

Assigned Mission Equipment 8–18a

### **AMEDD**

Army Medical Department 15–7n

### **AMEDDC&S**

Army Medical Department Center and School 5–9a

### **AMET**

Agency Mission-Essential Tasks 8–9

### **AMET**

Assigned Mission Essential Task List 2–7b (3)

### **AMHA**

Army Management Headquarters Activities 9–5

### **AMLE**

Army Medical Logistics Enterprise 18–20e

### **AMM**

Assigned Mission Manning 8–18a

### **AMOPES**

Army Mobilization and Operations Planning and Execution System 6–3

### **AMS**

Army management structure 9–6a (10) (b) 1

### **AMS**

Army modernization strategy 2–2a

**AMT**

Army modernization training 11–88

**AMS**

Automated Manifest System 12–15 e (3)

**AMSC**

Army Management Staff College 17–11

**AMSC**

Army Medical Specialist Corps 18–2a

**AMSCO**

Army management structure code 5–23d

**AMSP**

Advanced Military Studies Program 15–17b (4)

**AMT**

Army modernization training 11–83

**ANAD**

Anniston Army Depot 12–8g

**ANC**

Army Nurse Corps 18–2a

**ANNPRO**

annual program 13–13a

**ANSWER**

Applicant Notification System Web-Enabled Response 14–12b

**AOC**

area of concentration 5–11e

**AOC**

Army Operations Center 12–6d (3)

**AOC**

Army operating concept 5–4c

**AODC**

Action Officer Development Course 15–18b (1)

**AOI**

area-of-interest 5–13b

**AOLCM**

Army Organizational Life Cycle Model 2–2

**AOR**

Area of responsibility 12–2c (1)

**AOS**

Army Organization Server 5–28a

**AP3**

Army Power Projection Program 12–6e

## **How the Army Runs**

### **APAOG**

U.S. Army Public Affairs Operations Group 3-4e (1) (e)

### **APB**

acquisition program baseline 11-11b (4)

### **APD**

Army Publishing Directorate 15-11e

### **APE**

Ammunition Peculiar Equipment 12-6g (1) (o) 4.

### **APE**

Army Program elements 9-6a (10) (b) 1.

### **APEX**

Adaptive Planning and Execution Process 4-16a

### **APF**

appropriated fund 12-12f

### **APFT**

Army physical fitness test 7-30

### **APGM**

Army Programming Guidance Memorandum 9-5a (4)

### **APIC**

Army performance improvement criteria 17-43b

### **APPG**

Army Planning Priorities Guidance 9-5a (4)

### **APR**

Annual Performance Report 10-30c

### **APRB**

AROC Process Review Board 11-14f

### **APS**

Army Posture Statement 1-4

### **APS**

Army pre-positioned stocks 3-4b (6)

### **APUC**

average procurement unit cost 11-77g

### **ARB**

Army Resources Board 9-29

### **AR2B**

Army Requirements and Resourcing Board 2-7b (1)

### **ARCIC**

Army Capabilities Integration Center 2-7b (1)

### **ArCP**

Army Capabilities Integration Center Campaign Plan 5-6e (1)

**ARDEC**

Armament, Research, Development and Engineering Center 12–8p (1)

**AREF**

Army Reserve Expeditionary Force 7–29a

**AREP**

Army Reserve Expeditionary Packages 7–38

**ARFORGEN**

Army Force Generation 1–4a

**ARFPC**

Army Reserve Forces Policy Committee 7–24c

**ARMS**

Army Readiness Management System 8–15

**ARNG**

Army National Guard 5–19b (1) (a)

**ARNORTH**

Army Forces North 22–13b (2)

**AROC**

Army Requirements Oversight Council 2–4a (1) (b)

**ARPA**

Advanced Research Projects Agency 11–25

**ARPRINT**

Army Program for Individual Training 9–21f (2)

**ARRA**

American Recovery and Reconstruction Act 20–2

**ARSTAF**

Army Staff 2–2c (5)

**ARSTRUC**

Army structure 5–16b (4)

**ARTEP**

Army Training and Evaluation Program 2–2c (7)

**AS**

Acquisition strategy 11–11b

**ASA(ALT)**

Assistant Secretary of the Army (Acquisition, Logistics, and Technology) 2–6a

**ASA(CW)**

Assistant Secretary of the Army (Civil Works) 20–4a

**ASA(FM&C)**

Assistant Secretary of the Army (Financial Management and Comptroller) 5–23e

**ASA(I&E)**

Assistant Secretary of the Army (Installation and Environment) 9–8b



## **How the Army Runs**

### **ASA(M&RA)**

Assistant Secretary of the Army (Manpower and Reserve Affairs) 3–4e

### **ASARC**

Army Systems Acquisition Review Council 9–8a (4)

### **ASAT**

Automated Systems Approach to Training 15–11c

### **ASB**

Army Science Board 11–12b (11)

### **ASC**

Acquisition Support Center 9–55d

### **ASC**

Army Sustainment Command 3–4b (6)

### **ASCC**

Army Service Component Command 1–5a

### **ASD(HA)**

Assistant Secretary of Defense (Health Affairs) 18–5b (2)

### **ASD(HD & ASA)**

Assistant Secretary of Defense for Homeland Defense and America’s Security Affairs 22–13a (1)

### **ASD(RA)**

Assistant Secretary of Defense for Reserve Affairs 7–40

### **ASD(SO/LIC)**

Assistant Secretary of Defense for Special Operations/Low Intensity Conflict 7–35

### **ASD(PA)**

Assistant Secretary of Defense (Public Affairs) 21–23

### **ASI**

additional skill identifier 2–2c (3)

### **ASIOEP**

associated support items of equipment and personnel 2–2c (2)

### **ASIP**

Army Stationing and Installation Plan 17–34

### **ASK**

Assignment Satisfaction Key 13–2b

### **ASL**

authorized stockage list 2–2c (6)

### **ASM**

Army Synchronization Meeting 12–6d (2) (f)

### **ASORTS**

Army Status of Resources and Training System 6–11o (2)

### **ASOS**

Army Support to Other Services 5–18b (5) (a)

**ASP**

ammunition supply point 12–15e (1)

**ASPB**

Army Strategic Planning Board 11–61b

**ASPG**

Army Strategic Planning Guidance 10–30d (1)

**AST**

Army Test and Evaluation Command System Team 11–40

**ASTAG**

Army Science and Technology Advisory Group 11–7i

**ASTMP**

Army's Science and Technology Master Plan 5–6d (1)

**ASTWG**

Army Science and Technology Working Group 11–7g

**ASVAB**

Armed Services Vocational Aptitude Battery 13–13b (1)

**ASV**

armored security vehicle 11–64a(4)

**A&TWF**

acquisition and technology work force 11–33b

**AT**

annual training 7–4

**AT**

Antiterrorism 19–24i

**ATAV**

Army Total Asset Visibility 12–15f (4)

**ATCCS**

Army Tactical Command and Control System 15–34e

**ATD**

advanced technology demonstration 11- 7e

**ATEC**

Army Test and Evaluation Command 3–4e

**ATED**

Army Training and Education 15–12a

**ATIA**

Army Training Information Architecture 15–10e

**ATLDP**

Army Training and Leader Development Panel 3–28a

**ATMG**

Arms Transfer Management Group 19–25a (3)

## **How the Army Runs**

### **ATN**

Army Training Network 15–11b

### **ATO**

Army technology objectives 11–7g

### **ATO (D)**

advance technology objectives (demonstration) 11–7g

### **ATO(M)**

Army technology objectives (manufacturing technology) 11–7g

### **ATO(R)**

advance technology objectives (research) 11–7g

### **ATRRS**

Army Training Requirements and Resources System 9–21f (2)

### **ATSC**

Army Training Support Center 11–86a

### **AUB**

Army Uniform Board 12–6g (10) (c)

### **AUGTDA**

augmentation table of distribution and allowances 5–24a (2) (b)

### **AUTL**

Army universal task list 5–7b (2)

### **AUTS**

Automatic Update Transaction System 5–25d

### **AVCATT**

Aviation Combined Arms Tactical Trainer 15–34e

### **AW**

asymmetric warfare 11–35b(3) (d)

### **AWCF**

Army Working Capital Fund 10–15c

### **AWCF–SMA**

Army Working Capital Fund, Supply Management Army 12–6g (2) (r)

### **AWE**

Advanced warfighting experiment 11–36a

### **AWRS**

Army War Reserve Sustainment 12–9j

### **AWRSI**

Army War Reserve Secondary Items 12–6d (1) (i)

### **BA**

Budget activity 9–7b (4)

### **BA**

Budget authority 9–62b (2)

**BAG**

Budget activity group 9–7b (4)

**BAH**

Basic Allowance for Housing 13–16c

**BASOPS**

Base Operations 17–2i (4)

**BBS**

Brigade-Battalion Battle Simulation 11–90a (4)

**BC**

Basic Course 15–18b (3)

**BCA**

Battle command architecture 16–11b

**BCA**

Business case analysis 12–6j (2) (i)

**BCD**

bad conduct discharge 19–19d (3)

**BCP**

Budget Change Proposal 9–2k

**BCT**

Basic combat training 15–14b

**BCT**

Brigade combat team 5–18b (6) (a)

**BCTP**

Battle Command Training Program 15–34b (4)

**BDA**

U.S. Army Biometric Defense Agency 3–4e

**BES**

Budget estimates submission 5–25d (4)

**BFV**

Bradley Fighting Vehicle 15–34d

**BIDS**

Biological Integrated Detection System 22–21e (6)

**BLCSE**

Battle Lab Collaborative Simulation Environment 11–35b (3) (h)

**BLIN**

Budget line item number 9–21g

**BLST**

Brigade Logistics Support Teams 12–9b

**BLTM**

Battalion Level Training Model 5–25d (3)

## **How the Army Runs**

### **BMDR**

Ballistic Missile Defense Review 5–18a (1)

### **BMIS–T**

Battlefield Medical Information-Theater 18–18c

### **BOD**

Board of directors 10–47a

### **BOD**

Broadcast operations detachment 21–19

### **BOG**

Boots on Ground 7–37

### **BOIP**

Basis-of-issue plan 2–2c (6)

### **BOIPFD**

Basis-of-issue plan feeder data 5–14b

### **BOLC**

Basic Officer Leader Course 2–2c (3)

### **BOS**

Battlefield operating systems 11–97c Now Warfighting Functions (WFF)

### **BOS**

Business Operating System 9–26b

### **BPC**

Business Process Council 12–6e

### **BPR**

Business Process Reengineering 17–21d

### **BRAC**

base realignment and closure 1–5b

### **BRP**

Basic research plan 11–6

### **BRP**

Budget Requirements & Programs 10–4e (2)

### **BSA**

Budget subactivity 9–7b (4)

### **BSI**

Base support installation 22–19d

### **BTOE**

Base table of organization and equipment 5–11c

### **BUF**

Barracks Upgrade Program 17–33c (1)

### **BY**

Budget fiscal year 9–12a (1) (c)

**C&L**

Capabilities and limitations 11-36a

**CA**

civil affairs 4-21b (5)

**CAA**

U.S. Center for Army Analysis 3-4e

**CAC**

Combined Arms Center 15-10a

**CAC-T**

Combined Arms Center-Training 11-86a

**CADS**

Containerized Ammunition Distribution System 12-6e (2) (a)

**CAE**

Component Acquisition Executive 11-29

**CAIG**

Cost Analysis Improvement Group, OSD 9-20

**CAISI**

Combat-Service-Support Automated Information Systems Interface 12-15f (5)

**CAIV**

Cost as an independent variable 11-20d

**CALL**

Center for Lessons Learned 15-10a

**CAM**

Capability Area Manager 12-6 (2) (c) 7

**CAMS**

Capabilities and AROC Management System 11-15

**CAP**

Contractor acquired property 12-6d (1) (h)

**CAP**

Crisis action (time sensitive) planning 6-3 i (3)

**CAP**

Critical acquisition position 11-27a

**CAPDEV**

Capability developer 5-6d (2)

**CAPE**

Cost Assessment and Performance Evaluation 4-12

**CAR**

Chief, Army Reserve 7-26a

**CARD**

Cost Analysis Requirements Description 11-76e

## **How the Army Runs**

### **CARDS**

Catalog of approved requirements documents 11- 15f

### **CARDs**

Cost analysis requirements descriptions 12-6j (2) (f)

### **CASCOM**

U.S. Army Combined Arms Support Command 5-18b (5) (a)

### **CAT**

Crisis Action Team 12-6d (3) (a)

### **CATS**

Combined arms training strategy 15-11c

### **CATT**

Combined Arms Tactical Trainer 15-34c (4)

### **CBA**

Capabilities based assessment 5-4b

### **CBA**

Cost benefit analysis 10-1a

### **CBM**

Condition based maintenance analysis 11-81e

### **CBM+**

Condition Based Maintenance Plus 12-6f (1) (m)

### **CBRIF**

USMC Chemical-Biological Incident Response Force 22-21e (3)

### **CBRN**

Chemical, Biological, Radiological, and Nuclear 18-8c (3)

### **CBRNE**

Chemical-biological-radiological-nuclear and high yield explosives 22-4c

### **CBS**

Corps Battle Simulation 11-90 a (4)

### **CBV**

Capability-Based Volunteers 14-28b

### **CBTDEV**

Combat developer 5-9a

### **CBDRT**

Chemical - biological defense readiness training 8-18a

### **CCA**

Clinger-Cohen Act 16-4b (10)

### **CCA**

Component cost analysis 12-6j (2) (f)

### **CCAD**

Corpus Christi Army Depot 12-8g

**CCB**

Configuration Control Board 12–6i (3) (h)

**CCC**

Captains' Career Course 15–17b (2)

**CCDR**

Combatant Commander 2–2a

**CCDOR**

Combatant Commander's daily operational requirements (CCDOR) 5–18

**CCJO**

Capstone concept for joint operations 2–4a (1) (a)

**CCSS**

Commodity Command Standard System 12–11b (3)

**CCTT**

Close Combat Tactical Trainer 15–5d

**CD&E**

Concept Development and Experimentation 5–6

**CDA**

Core Depot Assessment 12–6f (1) (m)

**CDD**

Capability Development Document 4–13b

**CDLD**

Concept Development and Learning Directorate (ARCIC) 11–10b

**CDO**

Chief Data Officer 16–9a

**CDO**

Civil Disturbance Operations 22–6a

**CDPL**

Command designated positional list 13–38

**CDR**

Critical design review 11–11c

**CDRT**

Capability development for rapid transition 11–64a

**CDT**

Common Driver Trainer 15–34c (3) (c)

**CDT/STV**

CDT/ Stryker Variant 15–34c (3) (c)

**CE**

Continuous evaluation 11–35a

**CEAC**

U.S. Army Cost and Economic Analysis Center 9–3a (3)



## **How the Army Runs**

### **CECOM**

Communications-Electronics Command 11-83 b (3)

### **CEF**

Contingency Expedition Force 2-7b (3)

### **CEP**

Concept experimentation program 11-36a

### **CERCLA**

Comprehensive Environmental Response, Compensation, and Liability Act 17-29a

### **CERFP**

CBRNE Enhanced Response Force Package 22-21c (2)

### **CERS**

cost estimating relationships 17-39f

### **CES**

Civilian Education System 14-12b (8)

### **CESL**

Continuing Education for Senior Leaders 15-18b (6)

### **CEW**

Civilian Expeditionary Workforce 14-28a

### **CFO**

Chief Financial Officer 10-4c

### **CFR**

Code of Federal Regulations 6-17a

### **CFSC**

Community and Family Support Center 12-12f (3)

### **CGA**

Common Gunnery Architecture 15-34c (3) (b)

### **CG CAP**

Coast Guard Capabilities Plan 6-3

### **CG LSCP**

Coast Guard Logistic Support and Capabilities Plan 6-3

### **CHESS**

Computers, Hardware, and Enterprise Software Services 16-18c (1)

### **CHPPM**

Center for Health Promotion and Preventive Medicine 17-24b

### **CHRTAS**

Civilian Human Resource Training Application System 14-12 b

### **CP**

Change proposal 9-27

### **CHR**

Civilian human resource 10-34b

**CHRA**

Civilian Human Resources Agency 3–4e

**CI**

Counterintelligence 9–8g

**CIA**

Central Intelligence Agency 6–7k

**CIB**

Combined information bureau 21–25

**CIC**

Critical intelligence category 11–76a

**CIDS**

Capabilities integration and development system 5–6e

**CIE**

Clothing and Individual Equipment 12–6g (10) (a)

**CIEF**

Capability integration Enterprise Forum (ARCIC) 11–63a

**CIF**

Central Issue Facility 12–6g (10) (j)

**CIM**

Corporate information management 12–6 (2) (c) 35 i

**CIO**

Chief Information Officer 9–8e

**CIO**

Corporate Information Office 12–6 (2) (c) 35 i

**CIP**

contract in process 10–25b (4)

**CIP**

Critical Infrastructure Protection 12–6g (10) (n)

**CIPMS**

Civilian Intelligence Personnel Management System 14–27c

**CIPPS**

Civilian Integration into the Personnel Proponent System 13–5e

**CIS**

Comptroller Information System 9–6a (10) (b) 3

**CJA**

Comprehensive Joint Assessment 4–6a

**CJA**

Command Judge Advocate 19–1

**CJCS**

Chairman of the Joint Chiefs of Staff 5–3

## **How the Army Runs**

### **CJCSI**

Chairman of the Joint Chiefs of Staff Instruction 4–8a

### **CJCSM**

Chairman Joint Chiefs of Staff Memorandum 6–3i

### **CLA**

Core Logistics Analysis (CLA) 12–6f (1) (m)

### **CLAMO**

Center for Law and Military Operations 19–22b

### **CLC**

Combined Logistics Committee 12–6g (1) (j)

### **CLRT**

Command Logistics Review Team 12–6g (3) (n)

### **CLS**

Common Levels of Support 17–39e

### **CM**

Current month 13–18c (2)

### **CM**

Command Manager 2–6c (3)

### **CM [FS]**

Command managers (force structure)

### **CM**

Consequence Management 22–4c

### **CM**

Cost management 10–34

### **CMA**

U.S. Army Chemical Materiel Agency 3–4b (6)

### **CME**

Contractor Manpower Equivalents) 12–6j (3) (h)

### **CMEP**

Civil-Military Emergency Planning 20–11

### **CMETL**

Non-Core Mission Essential Task List 7–30

### **CMF**

career management field 7–41i

### **CMH**

U.S. Army Center of Military History 3–4e (1) (g)

### **CMICS**

Civilian Manpower Integrated Costing System 5–23e

### **CMO**

Central Management Office 12–6g (10) (l)

**CMO**

Civil-military operations 21–2d

**CMTC**

Combat Maneuver Training Center 15–31b (2)

**CNA**

Capability Needs Analysis 5–6e (2) (a)

**CNGB**

Chief, National Guard Bureau 7–25a

**CNN**

Cable News Network 21–36

**COCOM**

Combatant Command (Command Authority) 3–4b (6)

**COC**

Council of colonel's 5–18b (6) c

**COE**

Chief of Engineers 9–8j

**CoE**

Center of Excellence 5–5b

**COE**

Contemporary operational environment 5–1

**COFT**

Conduct of Fire Trainer 11–90a (3)

**COG**

Continuity of government 22–4d

**COIC**

Critical operational issues and criteria 11- 36a

**COIST**

Company Intelligence Support Team 11–64 a (4)

**COLS**

Common Output Level Standards 17–39d

**COMCAM**

Combat Camera 21–28

**COMPO**

Component 5–21b

**CONOPS**

Concept of Operations 11–8d

**CONOPS**

Continuity of operations 5–6c

**CONPLAN**

Concept plan 2–6c (3)

## **How the Army Runs**

### **CONUS**

Continental United States 3–2b (6)

### **CONUSA**

Continental U.S. Army/Armies 6–11o (1)

### **COOP**

Continuity of operations 9–5a (8)

### **COP**

Common operating picture 16–20b

### **CORM**

Commission on Roles and Missions 9–2i

### **CORTRAIN**

Corps and Division Training Coordination Program 7–36

### **COSCOM**

Corps support command 12–8q

### **COTR**

Contracting Officer Technical Representatives 12–6j (3) (e)

### **COTS**

Commercial off-the-shelf 11–36g

### **CP**

Capability packages 11–63a

### **CP**

Career Program 12–6e (1)

### **CP**

Change Proposals 9–2m

### **CPA**

Chairman's Program Assessment 4–10c

### **CPA**

Chief of Public Affairs 21–12a

### **CPAC**

Civilian Personnel Advisory Center 14–9c

### **CPD**

Capability Production Document 4–13b

### **CPI**

critical program information 11–56a

### **CPIM**

Capital planning and investment management 16–7a

### **CPMD**

Command Provost Marshal Directorate 15–10d

### **CPMS**

Civilian Personnel Management Service 14–8a

**CPO**

claims processing office 19–12c

**CPOL**

Civilian Personnel Online Library 13–2b

**CPP**

Cost & Performance Portal 9–69a

**CPPP**

Caregiving Personnel Pay Program 14–16b

**CPR**

Chairman’s Program Recommendation 4–10c

**CPR**

Capability Portfolio Review 11–13g (4)

**CRA**

Chairman’s Risk Assessment 4–10c

**CRA**

continuing resolution authority 9–60c

**CRB**

cost review board 12–6j (2 (e))

**CRC**

CONUS replacement center 6–11d(3)

**CRC**

Crisis Response Cell 12–6d (3) (a)

**CREST**

Contingency Real Estate Support Teams 20–15

**CRM**

Composite Risk Management 15–26

**CrM**

Crisis Response 22–3c

**CROWS**

Common Remote Operated Weapons System 11–64 a (4)

**CRS**

Chairman’s Readiness System 8–7

**CRXXI**

Classroom Twenty One 15–5c (2)

**CS**

Civil support 22–4b

**CS**

Combat support 6–3j (3)

**CSA**

Chief of Staff, U.S. Army 4–7

## **How the Army Runs**

### **CSA**

Combat Support Agencies 4–11c (6)

### **CSB**

Configuration Steering Board 11–17f

### **CSB**

CONUS support base 7–38

### **CSL**

centralized selection list 13–38

### **CSLMO**

Civilian Senior Leader Management Office 14–9a

### **CSRA**

Civil Service Reform Act 14–7b

### **CSS**

combat service support 6–3j (3)

### **CST**

Civil Support Team 22–21c

### **CSTC**

Combat Support Training Centers 7–37

### **CTA**

common table of allowance 11–64 a (3)

### **CTASC**

Corps/Theater ADP Service Center 12–15e (3)

### **CTC**

combat training center 2–2c (7)

### **CTE**

critical technology element 11–39b

### **CTE**

Culminating Training Event 15–3c (4)

### **CTO**

Chief Technical Officer 12–6 (2) (c) 35 i

### **CTS**

Contingency Tracking System 6–1

### **CTT**

Collective training task 2–2c (7)

### **CVE**

common virtual environment 15–34c (5)

### **CXO**

Chief integration officer 16–13a

### **CY**

current fiscal year 9–12a (1) (b)

**CYPPP**

Child and Youth Personnel Pay Program 14–16b

**DA**

Department of the Army 7–35a

**DAB**

Defense Acquisition Board 9–8a (3)

**DAB**

Director of the Army Budget 9–4

**DACIL**

DA critical items lists 6–19b

**DACM**

Director, Acquisition Career Management 11–29a

**DADT**

Don't Ask, Don't Tell 19–31

**DAE**

Defense Acquisition Executive 9–13e

**DAES**

Defense Acquisition Executive summary 11–77e

**DAGR**

Defense Advanced GPS Receiver 11–85d

**DALSO**

DA logistics support officer 11- 29d

**DAMMS–R**

Department of the Army Movement Management System-Redesign 12–15e (6)

**DAMPS**

Department of the Army mobilization processing system 6–12

**DANTES**

Defense Activity for Non-Traditional Education Support 13–48a (7)

**DAO**

Defense Accounting Office 10–20

**DAPMIS**

DA Photo Management Information System 13–2b

**DARNG**

Director, Army National Guard 7–25c

**DARPA**

Defense Advanced Research Projects Agency 11–25

**DARPL**

Dynamic Army Resourcing Priority List 2–2c (6)

**DAS**

Defense Acquisition Management System 5–3a



## **How the Army Runs**

### **DASA(APL)**

Deputy for Acquisition Policy and Logistics 12–5

### **DASA(CE)**

Deputy Assistant Secretary of the Army for Cost and Economics 11–13e

### **DASA(D&L)**

Deputy Assistant Secretary of the Army for Diversity and Leadership 14–22b

### **DASA–DEC**

Deputy Assistant Secretary of the Army for Defense Exports and Cooperation 12–18c

### **DASA (FO)**

Deputy Assistant Secretary of the Army (Financial Operations) 10–4e (3)

### **DASA(R&T)**

Deputy Assistant Secretary of the Army (Research and Technology) 11–8a (2)

### **DASC**

DA Systems Coordinator 2–6a

### **DASD (IP)**

Deputy Assistant Secretary of Defense for Industrial Policy 6–15b

### **DAU**

Defense Acquisition University 11–23

### **DAWG**

Deputies Advisory Working Group 4–7

### **DAWIA**

Defense Acquisition Workforce Improvement Act 11–26

### **DC**

Dental Corps 18–2a

### **DCAPE**

Director of Cost Assessment and Program Evaluation (OSD) 11–38a

### **DCC**

Direct Commissioned Course 15–17b (1)

### **DCE**

Defense Coordinating Element 22–13b (2) (b)

### **DCG/CofS**

Deputy Commanding General/ Chief of Staff (DCG/CofS) 3–4a (4)

### **DCI**

Director, Central Intelligence 11–36b

### **DCIPS**

Defense Casualty Information Processing System 13–50b

### **DCIPS**

Defense Civilian Intelligence Personnel System 14–10c

### **DCLM**

Department of Command, Leadership, and Management 1–8b

**DCMA**

Defense Contract Management Agency 12–2b (1) (d)

**DCO**

Defense coordinating officer 22–13b (2) (a)

**DCPDS**

Defense Civilian Personnel Data System 14–12a

**DCR**

DOTMLPF change recommendation 4–13b

**DCS, G–1**

Deputy Chief of Staff, G–1 11–34d

**DCS, G–2**

Deputy Chief of Staff, G–2 11–34e

**DCS, G–3/5/7**

Deputy Chief of Staff, G–3/5/7 11–10a

**DCS, G–4**

Deputy Chief of Staff, G–4 11–34g

**DCS, G–6**

Deputy Chief of Staff, G–6 11–34h

**DCS, G–8**

Deputy Chief of Staff, G–8 11–7i

**DSCA**

Defense Support of Civil Authorities 22–4b

**DCSD**

Deputy Chief of Staff for Developments 15–10c

**DCSDOC**

Deputy Chief of Staff for Doctrine 15–10c

**DCSOPS&T**

Deputy Chief of Staff for Operations & Training 15–10c

**DCSIM**

Deputy Chief of Staff for Information Management 15–10c

**DCSPI&L**

Deputy Chief of Staff for Personnel, Infrastructure and Logistics 15–10c

**DCSRM**

Deputy Chief of Staff for Resource Management 15–10c

**DCSSA**

Deputy Chief of Staff for Simulation and Analysis 15–10c

**DC&S**

Deputy Chief of Staff for Concepts and Strategy 15–10c

**DDACM**

Deputy Director, Acquisition Career Management 11–33a

## **How the Army Runs**

### **DDN**

Defense Data Network 6–3c (7)

### **DDS**

Dynamic Distribution System 2–2c (6)

### **DDS**

Director of Dental Services 18–19a (3)

### **DeCA**

Defense Commissary Agency 12–2b (1) (2)

### **DEF**

Deployment Expeditionary Force 2–7b (3)

### **DENCOM**

Dental Command 18–12

### **DENTAC**

dental activity 18–19a (3)

### **DEOMI**

Defense Equal Opportunity Management Institute 13–49c

### **DEP**

Delayed Entry Program 19–6b (2)

### **DepSecDef**

Deputy Secretary of Defense 7–35

### **DERA**

Defense Environmental Restoration Account 17–29b

### **DEROS**

date eligible to return from overseas 13–18d (2) (b)

### **DERP**

Defense Environmental Restoration Program 17–29a

### **DES**

Directorate of Emergency Services 17–13b (4)

### **DEST**

domestic emergency support team 22–22c (1)

### **DET**

displaced equipment training 11–88b

### **DFARS**

Defense Federal Acquisition Regulation Supplement 11–29b

### **DFAS**

Defense Finance and Accounting Service 9–6a (10) (b) 1

### **DFAS-IN**

Defense Finance and Accounting Service-Indiana 9–25

### **DFM**

HQDA, G–3/7, Director of Force Management 5–19b (1) (b)

**DFMWR**

Directorate of Family, Morale, Welfare & Recreation 17–13b (2)

**DFO**

dining facility operations 12–15e (7)

**DG**

Defense guidance 9–2d

**DHHS**

Department of Health and Human Services 22–23c

**DHP**

Defense Health Program 18–7c

**DHR**

Directorate of Human Resources 17–13b (1)

**DHS**

Director of Health Services 18–19a (3)

**DHS**

Department of Homeland Security 22–10

**DI**

Document Integrator 2–6a

**DIA**

Defense Intelligence Agency 6–7k

**DIEMS**

Date initially entered military service 7–44

**DIMHRS**

Defense Integrated Military Human Resources System 13–2e

**DIR, FD**

Director, Force Development (HQDA G–8) 11–34 i (2)

**DIS**

Distributed interactive simulation 15–34c

**DIS**

distributed interactive simulation 15–34e

**DISA**

Defense Information Systems Agency 6–7k

**DISCOM**

Division Support Command 12–8q

**DISES**

Defense Intelligence Executive Service 14–9a

**DISL**

Defense Intelligence Senior Level 14–9a

**DKO**

Defense Knowledge Online 15–11e

## **How the Army Runs**

### **DL**

distance learning 11–30f

### **DLA**

Defense Logistics Agency 6–4g (3) (c)

### **DLAMP**

Defense Leadership and Management Program 15–18b (8)

### **DLEA**

drug law enforcement agencies 22–2d (2)

### **DLMS**

Defense Logistics Management System 12–6g (2) (b)

### **DLMSO**

Defense Logistics Management Standards Office 12–14

### **DMATs**

Disaster Medical Assistance Teams 22–12d

### **DMC**

Distribution Management Center 12–8q

### **DMC**

Defense Management Council 12–8q

### **DMCB**

Depot Maintenance Corporate Board 12–6f (1) (m)

### **DMETL**

Non-Directed Mission Essential Task List 7–30

### **DML/DMSL**

Distribution Management Level/Sub-Level 13–18h (1)

### **DMLSS**

Defense Medical Logistics Standard Support 18–18c

### **DMO**

directed military overstrength 9–8f (5)

### **DMORTs**

Disaster Mortuary Operational Response Teams 22–12d

### **DMRB**

Defense Materiel Readiness Board 12–6d (2) (e)

### **DMSO**

Defense Modeling and Simulation Office 15–34c

### **DMSS**

Defense Medical Surveillance System 18–18c

### **DMSSC**

Defense Medical Systems Support Center 18–8c (5) (h)

### **DOC**

Department of Commerce 6–16a

**DOD**

Department of Defense 5–28b

**DODD**

Department of Defense Directive 11–18a

**DODI**

DOD Instruction 11–20c

**DOD IRD**

DOD Investigations and Resolutions Division 14–8b

**DODR&E(SP)**

DOD Research and Engineering Strategic Plan 11–6

**DOE**

Department of Energy 22–21d (1)

**DOI**

Director of Integration (HQDA G–8) 11–34 I (2) (a)

**DOIM**

Director of Information Management 17–13b (7)

**DOJ**

Department of Justice 6–7l (1)

**DOL**

Directorate of Logistics 12–8c (2)

**DOM**

Director of Materiel (HQDA G–8) 11–34i (2) (a)

**DOMS**

Directorate of Military Support 12–6d (3) (f)

**DOPMA**

Defense Officer Personnel Management Act 13–45

**DOR**

Director of Resources (HQDA G–8) 11–34i (2) (a)

**DOS**

Department of State 6–7k

**DOT**

Department of Transportation 6–7k

**D,OT&E**

Director, Operational Test and Evaluation 11–40

**DOTmLPF (non-material)**

doctrine, organization, training, leadership and education, personnel, and facilities 5–7d (2)

**DOTMLPF**

Army’s Doctrine, Organization, Training, Materiel, Leadership and Education, Personnel and Facilities 1–1a

**DP3**

Defense Personal Property Program 12–6e (1) (e)

## **How the Army Runs**

### **DPAE**

Director of Program Analysis and Evaluation 9–4

### **DPAS**

Defense Priorities and Allocations System 6–16

### **DPC**

Defense Planning and Coordination 22–14g

### **DPCU**

Defense Planning and Coordination Unit 22–13b (2) (b)

### **DPD**

Defense Programming Database 9–12g

### **DPG**

Defense Planning Guidance 9–2k

### **DPP**

dedicated procurement program 7–33

### **DPPG**

Defense Planning and Programming Guidance 4–3

### **DPS**

Defense planning scenarios 5–6c (2) (b)

### **DPTM**

Directorate of Plans, Training, Mobilization and Security 17–13b (3)

### **DPW**

Directorate of Public Works 17–13b (6)

### **DRB**

Defense Resources Board 4–7

### **DRF**

Disaster Relief Fund 22–19a

### **DRID**

Defense Reform Initiative Directive 17–32b

### **DRMO**

Defense Reutilization and Marketing Office 2–2c (8)

### **DRRS**

Defense Readiness Reporting System 8–2

### **DRRS–A**

Defense Readiness Reporting System-Army (DRRS–A) 8–2

### **DRU**

Direct Reporting Unit 3–1a

### **DSAB**

Defense Space Acquisition Board 11–100v

### **DSAT**

DHS Situational Awareness Team 22–12d

**DSB**

Defense Science Board 15–34c (1)

**DSCA**

Defense Security Cooperation Agency 12–18a

**DSCA**

Defense Support of Civil Authorities 5–18b (1)

**DSLCL**

Defense Senior Leader Conference 9–14b

**DSLDP**

Defense Senior Leader Management Program 15–18b (8)

**DSMC**

Defense Systems Management College 11–26

**DSMIS**

Defense Subsistence Management Information System 12–15e (7)

**DSOR**

Depot Source of Repair 12–6f (1) (m)

**DT**

developmental test 11–29a

**DTAC**

Digitized Training Access Center (DTAC) 15–5c (2) (f)

**DTCI**

Defense Transportation Coordination Initiative 12–6e (1) (b)

**DTF**

Digital Training Facilities 15–5c

**DTMS**

Digital Training Management System 15–5g

**DTOE**

draft table of organization and equipment 5–13b

**DTOS**

Deployable Tracking Operations System 20–4i

**DTP**

Delayed Training Program 19–6b (2)

**DTR**

Defense Transportation Regulation 12–14 c

**DTRA**

Defense Threat Reduction Agency 22–21e (1)

**DTS**

Defense Transportation System 12–15e (6)

**DTT**

doctrine and tactics training 11–88c



## **How the Army Runs**

### **DTTS**

Defense Transportation Tracking System 12–6e (1) (a)

### **DUSD(AS&C)**

Deputy Under Secretary of Defense for Advanced Systems and Concepts 11–8d (2)

### **DUSD(AT&L)**

Under Secretary of Defense for Acquisition, Technology, and Logistics 9–16a

### **DUSD(CPP)**

Deputy Undersecretary of Defense (Civilian Personnel Policy) 14–8a

### **DUSD(S&T)**

Deputy Undersecretary of Defense (Science and Technology) 11–8a (2)

### **E2E**

End to End 12–1 c

### **E–E**

Emergency Essential 14–28a

### **EA**

economic analysis 11- 34b

### **EAB**

echelons above brigade 2–7b (3)

### **EB**

Executive board 16–6a

### **EC**

electronic commerce 12–12e

### **ECAS**

Environmental Compliance Assessment System 20–5d (6)

### **ECG**

Enduring Constitutional Government 22–4d

### **ECOP**

equipping common operating picture 11–61a

### **ECQ**

Executive Core Qualifications 14–25a

### **EDAS**

Enlisted Distribution and Assignment System 13–18c (2)

### **EDATE**

effective date 5–12

### **EDCA**

Executive Director for Conventional Ammunition 12–8p (3)

### **EDI**

electronic data interchange 12–12e

### **EDM**

engineering development model 11–46

**EDRB**

Equipment Distribution Review Board 12–6g

**EDTM**

Enlisted Distribution Target Model 13–18c

**EE PEG**

equipping program evaluation group 11–97c

**EEO**

Equal Employment Opportunity 14–21a

**EEOC**

Equal Employment Opportunity Commission 14–7d

**EEOCAJ**

Equal Employment Opportunity Commission Administrative Judge 14–23g

**EEOCCR**

Equal Employment Opportunity Compliance and Complaints Review 14–23a

**EES**

Enlisted Evaluation System 13–22

**EFD**

Enterprise Funds Distribution 9–62a (3)

**EG**

Enlisted Grades 13–7f

**EGB**

Enterprise Guidance Board 16–6a

**EIS**

Enterprise Information System 12–6 (2) (c) 35 i

**EMAC**

emergency management assistance compact 22–9 d (1)

**EMD**

engineering and manufacturing development 11–7g

**EMS**

emergency medical services 22–8a

**EOA**

equal opportunity advisor 13–49c

**EOC**

State emergency operation center 22–11a

**EOD**

Explosive Ordnance Disposal 22–21e (6)

**EOH**

equipment on hand 8–18a

**EOL**

Equal Opportunity Leader 13–49c

## **How the Army Runs**

### **EOPM**

Equal Opportunity Program Manager 13-49c

### **EOR**

Element of resource 9-7b (4)

### **EPA**

Environmental Protection Agency 17-24

### **EPAERT**

Environmental Protection Agency Environmental Response Teams 22-21d (2)

### **EPLO**

emergency preparedness liaison officer 22-13c

### **EPMD**

Enlisted Personnel Directorate, PERSCOM 13-18c (2)

### **EPMS**

Enlisted Personnel Management System 7-17b (2)

### **EPP**

enhanced planning process 9-2k

### **EPP**

Extended planning period 9-5b (2)

### **EPW**

enemy prisoners of war 6-4g(3)(b)

### **EQ4**

Equipping the Force 5-26b

### **ER**

Equipment readiness 8-18g (3)

### **ER,A**

Environmental Restoration, Army 17-22a

### **ERB**

Executive Resources Board 14-24b

### **ERC**

equipment readiness code 5-23d

### **ERDC**

U.S. Army Engineer Research and Development Center 20-4d (5) (a)

### **ERF**

Emergency Response Function 20-5e (4)

### **ERGO**

Environmental Review Guide for Operations 20-5d (5)

### **ERP**

Enterprise Resource Planning 12-6i (1) (e)

### **ERS**

Emergency Relocation Staffs 12-6d (3) (e)

**ERTs**

Evidence Response Teams 22–21d (3)

**ES**

Embedded simulation 15–5d

**ES**

End strength 2–2c (2)

**ES**

Enlisted Strength (Model) 13–7f

**ESCO**

Energy Services Company 17–28a

**ESD**

equipment sourcing document 11–61a

**ESF**

Economic Support Fund 19–25c (6)

**ESF**

Emergency Support Functions 22–10d

**ESGR**

National Committee for Employer Support of the Guard and Reserve 7–22c

**ESLRG**

Expanded Senior Review Group 9–14c (4)

**ESP**

Executive and Senior Professional 14–9a

**ESPC**

energy savings performance contracts 17–28a

**EST**

Engagement Skills Trainer 15–34c (3) (a)

**ETC**

Exportable Training Capability 15–28a

**ETS**

expiration of term of service 13–18j

**EUSA**

Eighth United States Army 3–6a (2) (f)

**EW**

electronic warfare 11–36b

**EXCOM**

Executive Committee 10–47b

**EXORD**

Execute order 22–19a

**FA**

functional area 11–11

## **How the Army Runs**

### **FA-TRAC**

Foreign Army Training Assistance Command 7-29b

### **FAA**

Final Agency Action 14-23g

### **FAA**

Foreign Assistance Act 12-3f

### **FAA**

functional area assessment 2-4a (1) (b)

### **FACTS**

Financial Air Clearance Transportation System 12-6e (1) (g)

### **FAD**

Final Agency Decision 14-23g

### **FAD**

force activity designator 12-6g (3) (f)

### **FAD**

fund authorization document 10-9

### **FaNS**

Federated Net-Centric Sites 16-16d (1)

### **FAR**

Federal Acquisition Regulation 11- 29b

### **FASCLASS**

Fully Automated System for Classification 14-12b

### **FBI**

Federal Bureau of Investigation 22-10b

### **FC**

Foundation Course 15-18b (2)

### **FCB**

Functional Capabilities Boards 4-10c (1)

### **FCCE**

flood control and coastal emergencies 20-5e (2)

### **FCO**

Federal coordinating officer 22-11b (2)

### **FCS**

Federal Catalog System 12-6g (2) (o)

### **FDD**

Force Design Directorate (TRADOC ARCIC) 11-35b (4) (b)

### **FDIIS**

Force Development Investment Information System 11-34i (2) (b)

### **FDO**

Flexible deterrent option 6-3k

**FDU**

force design update 2–4a(2)

**FEA**

Front End Analysis 9–2o

**FECA**

Federal Employees Compensation Act 14–10a

**FEMA**

Federal Emergency Management Agency 6–7k

**FFC**

Fact Finding Conference 14–23c

**FFCA**

Federal Facility Compliance Act 19–9c (1)

**FFID**

Future Force Integration Directorate (TRADOC ARCIC) 11–35b (4) (b)

**FFMIA**

Federal Financial Management Improvement Act 10–31

**FFE**

Field Force Engineering 20–12

**FFR**

force feasibility review 5–19b (3)

**FHMP**

Family Housing Master Plan 17–33a

**FHP**

Force Health Protection 18–5a

**FI**

force integrator 2–6a

**FIAR**

Financial Improvement Audit Readiness 12–6j (2) (1)

**FIFA**

Force Integration Functional Area 5–9b

**FIRSTs**

Federal Incident Response Support Teams 22–12d

**FLRA**

Federal Labor Relations Authority 14–7c

**FMC**

Field Maintenance Company 12–15 e (2)

**FMCS**

Federal Mediation and Conciliation Service 14–21d

**FMF**

Foreign Military Financing 12–3f

## **How the Army Runs**

### **FMFIA**

Federal Manager's Financial Integrity Act 10-27

### **FMFP**

Foreign Military Financing Program 19-25c (2)

### **FMR**

Force Management Review 5-23b

### **FMS**

Force Management System 2-3

### **FMS**

foreign military sales 2-2c(8)

### **FMWR**

Family and Morale, Welfare, and Recreation 14-2b

### **FMWRC**

Family and Morale, Welfare, and Recreation Command 14-10b

### **FMX**

Fleet Management Expanded 12-11c (1)

### **FNA**

Functional Needs Analysis 2-4a (1) (b)

### **FOA**

field operating agency 3-2b (8)

### **FOC**

force operating capability 2-4a(1)(a)

### **FOIA**

Freedom of Information Act 13-50b

### **FORMDEPS**

FORSCOM Mobilization and Deployment Planning System 6-11d (1)

### **FORSCOM**

U.S. Forces Command 3-6a (1)

### **FoS**

family-of-systems 5-7c(2)

### **FOT**

Follow-on operational test 11-45f

### **FPMS**

Flood Plain Management Services Program 20-5c (3)

### **FPPM**

Functional Proponent for Preventive Medicine 18-14b

### **FR**

Functional review 13-12

### **FRC**

Federal Resource Coordinator 22-11b (3)

**FRP**

Facility Reduction Program 17–32c

**FRP**

Full rate production 11–19a

**FS**

Force Structure (FS) 5–23c

**FSA**

force structure allowance 13–7b

**FSA**

Functional Solutions Analysis 2–4a (1) (b)

**FSC**

Forward Support Company 12–15 e (2)

**FSIP**

Federal Service Impasses Panel 14–21d

**FSO**

Full Spectrum Operations 15–29

**FSO METL**

Full Spectrum Operations Mission Essential Task List 2–7b (3)

**FST**

Functional Support Teams 17–41a (1)

**FTS**

full time support 7–40

**FTSTDA**

Full Time Support TDA (FTSTDA) 5–24 (2) (c)

**FTX**

field training exercises 15–27

**FUED**

first unit equipped date 11–82d

**FWS**

Federal Wage System 14–16a

**FVC**

Force Validation Committee 12–6d (2) (f)

**FYDP**

Future Years Defense Program 4–1

**FYTP**

Five Year Test Program 11–80c

**FYDP**

Future Years Defense Program 9–5a (13)

**GA&CKO**

Governance, Acquisition, and Chief Knowledge Office 16–15



## **How the Army Runs**

### **GAO**

General Accounting Office 10–28b

### **GAR**

Governor’s Authorized Representative 22–11b (6)

### **GBL**

government bill of lading 12–12e

### **GC**

The General Counsel 11–34k

### **GC**

Garrison Commander 17–5c

### **GCC**

Geographical Combat Commander 12–2c (1)

### **GCCS**

Global Command and Control System 6–3c (7)

### **GCM**

general court-martial 19–19d(4)

### **GCMCA**

general court martial convening authority 7–48

### **GCSMC**

Garrison Command Sergeants Major course 17–11

### **GCSS–A (F/T)**

Global Combat Service Support System Army (Field/Tactical) 12–7a

### **GDF**

Guidance for Development of the Force 9–2n

### **GDPR**

Global Defense Posture Realignment 1–5b

### **GDPS**

Global Defense Posture Strategy 14–29a

### **GEF**

Guidance for Employment of the Force 4–3

### **GF**

Generating Forces (GF) 5–18

### **GFE**

Government Furnished Equipment (GFE) 12–6d (1) (h)

### **GFEBs**

General Fund Enterprise Business Systems 9–62a (2)

### **GFM**

Global Force Management 4–7a

### **GFM**

Global Force Management Data Initiative 5–28

**GFM**

Global Freight Management 12–12e

**GIE**

Global Information Environment 21–2(e)

**GIG**

Global Information Grid 16–11b (3)

**GIWW**

Gulf Intracoastal Waterway 21–5c (1) (i)

**GNEC**

Global Network Enterprise Construct 16–1c

**GMRA**

Government Management Reform Act 10–29

**GOIC**

General Officer Installation Commander's Course 17–11

**GOSC**

general officer steering committee 5–19b (2)

**GOTS**

government-off-the-shelf 11–62a

**GPC**

Garrison Pre-Command Course 17–10

**GPRA**

Government Performance and Results A 10–30

**GRF**

Global Response Force 11–63c

**GSA**

General Services Administration 12–1b (1) (a)

**GSORTS**

Global Status of Resources and Training System 8–8c (6)

**GTA**

Graphic Training Aids 15–10e

**GWOT**

Global War on Terroism 17–15a

**HA**

Humanitarian assistance 20–15

**HAAP**

Homebase/Advanced Assignment Program 13–18h (3)

**HASC**

House Armed Services Committee 7–21a

**HCA**

Humanitarian and civic assistance 19–26e

## **How the Army Runs**

### **HCA**

head of contracting activities 19–29b

### **HD**

Homeland Defense 5–18b (1)

### **HEAT**

HMMWC Egress Trainer 11–90 a (3)

### **HEPLOs**

Headquarters Emergency Preparedness Liaison Officers 22–13c

### **HFEA**

Human factors engineering analysis 11–36g

### **HHA**

Health hazard assessment 11–36g

### **HHS**

Health and Human Services 22–21d (5)

### **HLS**

Homeland security 1–1a

### **HLT**

Hurricane Liaison Team 22–12d

### **HMMP**

Hazardous Material Management Program 17–23

### **HMMS**

Hazardous Material Management System 17–23

### **HMMWV**

High mobility multipurpose wheeled vehicle 15–34c (3) (c)

### **HMRU**

Hazardous-Materials Response Unit 22–21d (3)

### **HN**

Host nation 12–3g

### **HNS**

Host nation support 5–18b (5) (b)

### **HPO**

High Performing Organization 17–21d

### **HQDA**

Headquarters, Department of the Army 3–4a (4)

### **HQE**

Highly Qualified Expert 14–9a

### **HR**

Human resource 2–2c (2)

### **HRC**

Human Resources Command 3–2b (12)

**HRC-STL**

Human Resources Command- St Louis 7-26b

**HRF**

Homeland Response Forces 22-21c (3)

**HRM**

human resource management 13-1

**HRT**

Hostage Rescue Team 22-22c (1)

**HS**

Homeland security 22-4

**HSC**

Homeland Security Council 4-4

**HSI**

Human Systems Integration 11-34d

**HSPD**

Homeland Security Presidential Directive 5 22-3c

**IAW**

in accordance with 11-34i

**IA**

Individual Account (Model) 13-7f

**IA**

Information assurance 16-4a

**IADC**

Inter-American Defense College 15-17b (6)

**IADT**

initial active duty for training 7-27b

**IC**

Incident Commander 22-8b (2)

**IC**

Intermediate Course 15-18b (4)

**ICD**

Initial Capabilities Document 4-13b

**ICDT**

integrated capabilities Development team 2-4a(1)(b)

**ICE**

independent life-cycle cost estimate 11-34b

**ICODES**

Integrated Computerized Deployment System, Global Services 12-6e (3) (d)

**ICPA**

Injury Compensation Program Administrator 14-20b

## **How the Army Runs**

### **ICS**

Incident Command System 22–8a

### **ICW**

in coordination with 11–34i(2) (b)

### **IDG**

Installation Design Guide 17–39g

### **IDP**

Individual Development Plan 14–12b

### **IDS**

Installation Design Standards 17–39g

### **IDT**

In a drill 7–45

### **IDT**

inactive duty training 7–17a(1)

### **IE&E**

Installation Energy & Environment 17–36a (1)

### **IEDs**

Improvised Explosive Devices 11–60a

### **IET**

Initial Entry Training 13–13b (2)

### **IFA**

installation food advisor 12–15e (7)

### **IGI&S**

Installation Geospatial Information & Services 17–36

### **IHX**

International Heavyweight Tenders 12–6e (2) (f)

### **IIQ**

initial issue quantity 5–26b(1)

### **ILE**

Intermediate Level Education 7–41g

### **ILS**

Integrated Logistics Support 12–2e

### **ILSM**

integrated logistic support manager 11–81b (1)

### **IM**

Information Management 16–4b

### **IMA**

Installation Management Agency 17–2i

### **IMA**

Individual Mobilization Augmentee 6–11e (2) (e) (1)

**IMAT**

Incident Management Assistance Teams 22–12c

**IMBOD**

Installation Management Board of Directors 17–2i (3)

**IMCOM**

Installation Management Command 3–4c (2)

**IMET**

International Military Education and Training 12–3f

**IMI**

Interactive Multimedia Instruction 15–5c (2) (f)

**IMMC**

integrated material management center 12–10d

**IMPS**

Integrated Maintenance Phase System 12–15e (4)

**IMRD**

Intelligence Resource Management Decision 9–14c (5)

**IMS**

international military student's 15–31c (5)

**IMT**

Initial Military Training 7–13

**INFOSEC**

information security 11–36b

**ING**

Inactive National Guard 6–11e (2) (e) (1)

**INSCOM**

U.S. Army Intelligence and Security Command 11–36b

**IOC**

initial operational capability 11–54

**IOS**

instructor/operator station 15–34c (3) (c)

**IOT**

initial operational test 11–43c

**IPA**

integrated program assessment 11–67a(4)

**IPL**

integrated priority list 9–2f

**IPMO**

Intelligence Personnel Management Office 14–10c

**IPM**

industrial preparedness measure 6–14a(5)

## **How the Army Runs**

### **IPP**

industrial preparedness planning 6-14a(4)

### **IPPL**

industrial preparedness planning list 6-19c

### **IPPS-A**

Integrated Personnel and Pay System-Army 13-2e

### **IPR**

in-process review 11-71a

### **IPRG**

Intelligence Program Review Group 9-15a

### **IPT**

Integrated process team 2-6a

### **IPT**

integrated product team 11-67

### **IR**

Irregular warfare 15-29

### **IRACO**

Internal Review 17-13c (6)

### **IR&D**

independent research and development 5-6d(2)

### **IRD**

Investigation and Resolutions Division 148b

### **IRI**

Information resource integration 16-14

### **IRM**

Information resource management 16-4a

### **IRP**

Installation Restoration Program 17-29a

### **IRR**

individual ready reserve 6-11e (2) (e) (1)

### **ISC**

Integrated Security Campaigns (ISCs) 5-18b (1)

### **ISEW**

intelligence, security and electronic warfare 11-37b (2)

### **ISM**

installation support modules 12-15e (8)

### **ISM CIF**

Installation Support Module Central Issue Facility 12-6g (10) (j)

### **ISP**

information support plan 11-d (6)

**ISR**

In-Service Review 11–17b

**ISR**

installation status report 17–37b (3)

**ISR–I**

Installation Status Report- Infrastructure 17–35e

**IT**

information technology 3–4c(1)

**IT–GOSC**

Information Technology General Officer Steering Committee 16–3c

**ITA**

U.S. Army Information Technology Agency 3–4e (1) (g)

**ITAB**

Information Technology Acquisition Board 11–8a (2)

**ITAPBD**

Integrated Total Army Personnel Data Base 13–2c

**ITAM**

Integrated Training Area Management 15–9i

**ITD**

Individual Training Directorate 15–10d

**ITMRA**

Information Technology Management Reform Act of 1996 11–34h

**ITRM**

Individual Training Resource Module 15–11g

**ITV**

In-Transit Visibility 12–6e

**IW**

Irregular Warfare 15–31

**IWN**

immediate warfighter needs 11–59a

**IWR**

Institute for Water Resources 20–6a

**IWRS**

Interactive Web Response System 13–2b

**JA**

Judge Advocate 19–1

**JAGC**

Judge Advocate General's Corps 19–1

**JBMC2**

Joint battle management command and control 16–11b (1)



## **How the Army Runs**

### **JCA**

joint capability areas 8–8c (4)

### **JCATD**

Joint and Combined Arms Training Directorate 15–10d

### **JCB**

Joint Capability Board 4–12b

### **JCCA**

Joint Combat Capability Assessment 4–9a

### **JCCAG**

Joint Combat Capabilities Assessment Group 8–10

### **JCD**

Joint Capabilities Document 4–13b

### **JCIDS**

Joint Capabilities Integration and Development System 2–4a (1) (a)

### **JCLL**

Joint Center For Lessons Learned 6–4g (1) c

### **JCS**

Joint Chiefs of Staff 1–8c

### **JCTD**

Joint Capabilities Technology Demonstrations 5–7g (1)

### **JDOMS**

Joint Directorate of Military Support 20–5e (5)

### **JFC**

Joint Force Commander 12–9e

### **JFCOM**

Joint Forces Command 12–3b

### **JFHQ–State**

Joint Forces Headquarters-State 7–28c

### **JFLCC**

Joint Forces Land Component Command 3–2b (10)

### **JFO**

Joint Field Office 22–11a

### **JFP**

Joint Force Providers 4–7b

### **JFRR**

Joint Force Readiness Review 8–7

### **JIB**

joint information bureau 21–24

### **JIC**

Joint information center 22–18b

**JIC**

joint Integrating concepts 4–13a

**JIEDDO**

Joint Improvised Explosive Devices Defeat Organization 5–7g (3)

**JIIM**

Joint, interagency, inter-Governmental, and multinational 12–6 (2) (c) 1

**JIWG**

Joint Intermodal Working Group 12–6e (2) (m)

**JLCPM**

Joint Logistics Capability Portfolio Manager 12–6 (2) (c) 7

**JMC**

Joint Munitions Command 12–6g (1) (o) 8

**JM&L**

Joint Munitions and Lethality Life Cycle management command 11–83b (4)

**JMET**

Joint Mission-Essential Tasks 8–9

**JMRC**

Joint Multinational Readiness Center 15–28a

**JMT**

Joint Mission Thread 16–16e

**JOC**

Joint Operating Concepts 4–13a

**JOC**

Joint operations center 22–21c (1)

**JOpsC**

joint operations concepts 5–6b (1)

**JOCG**

Joint Ordnance Commanders Group 12–8p (3)

**JOE**

joint operating environment 2–4a (1) (a)

**JOPES**

Joint Operations Planning and Execution System 2–3a

**JOpsC**

Joint Operations Concept 2–4a (1) (a)

**JPAB**

Joint Materiel Priorities and Allocation Board 12–6g (3) (f)

**JPAC**

Joint Planning Augmentation Cell 22–19c (4)

**JPD**

joint planning document 9–38b

## **How the Army Runs**

### **JPD**

joint potential designator 11–16b

### **JPEC**

Joint Planning and Execution Community 6–3f

### **JPG**

Joint Programming Guidance 9–2k

### **JPME**

joint professional military education 15–17b (7)

### **JRAC**

Joint Rapid Acquisition Cell 11–59a

### **JROC**

Joint Requirements Oversight Council 4–7

### **JROCM**

Joint Requirements Oversight Council Memorandum 11–11d (4)

### **JRTC**

Joint Readiness Training Center 15–28a

### **JSCP**

Joint Strategic Capabilities Plan 4–6c

### **JSO**

joint specialty officer 13–46a

### **JSOTF**

joint special operations task force 22–22c (1)

### **JSPS**

Joint Strategic Planning System 2–3a

### **JSR**

Joint Strategy Review 4–6a

### **JSSAP**

Joint Service Small Arms Program 12–8p (3)

### **JTA/JTD**

Joint Table of Authorizations/Joint Table of Distribution 5–24a (2) (d)

### **JTAPIC**

Joint Trauma Analysis and Prevention of Injury in Combat Program 11–64 a (4)

### **JTAV**

Joint Total Asset Visibility 12–15F (4)

### **JTC**

The Joint Commission 18–20a

### **JTF**

joint task force 3–2b (10)

### **JTF–CS**

Joint Task Force-Civil Support 22–13b (2) (b)

**JTF-N**

Joint Task Force North 22-13b (2) (c)

**JTT**

Joint Test Thread 16-16e (2)

**JULLS**

Joint Utilization Lesson Learned System 6-4g (1) c

**JUONS**

joint urgent operational needs statement 5-7g(4)

**JWE**

joint warfighting experiment 11-19c

**JWSTAP**

Joint Weapon Safety Technical Advisory Panel 11-10f (3)

**JWSTP**

Joint Warfighting Science and Technology Plan 11-6b

**KFL**

key facilities list 6-18

**KM**

knowledge management 16-15a

**KM/DS**

Knowledge Management/Decision Support Tool (JS) 11-10b (3)

**KPP**

key performance parameter 11-11b (4)

**KSA**

knowledge, skills, and abilities 11-9b(4)

**KSA**

key system attribute 11-11b (5)

**LAD**

Latest Arrival Date (LAD) 2-7b (3)

**LAN**

Local area network 12-15e (4)

**LCCE**

life cycle cost estimates 12-6j (2) (f)

**LCMC**

Life Cycle Management Command 11-64b (3)

**LCSP**

life-cycle sustainment plan 11-55

**LDD**

Leader Development and Education Directorate 15-10d

**LEA**

law enforcement agencies 22-22d (2)

## **How the Army Runs**

### **LEAD**

Letterkenny Army Depot 12–8g

### **LEXIS**

Logistics Execution Information System 12–6d (2) (g)

### **LFA**

Lead Federal Agency 22–3c

### **LFT&E**

live fire test and evaluation 11–77a

### **LHWCA**

Longshore and Harbor Workers Compensation Act 14–20b

### **LIA**

Logistics Innovation Agency 3–4e

### **LIC**

language identifier code 15–13

### **LIDB**

Logistics Integrated Databases 12–15f (5)

### **LIO**

Limited Intervention Operations 15–29

### **LMER**

Labor and Management Employee Relations 14–23e

### **LMI**

logistics management information 11–81ea

### **LMP**

Logistics Modernization Program 12–7a

### **LIN**

line item number 5–23d

### **LIW**

Logistics Information Warehouse 12–11

### **LOA**

letter of offer and acceptance 19–25c(9)(c)

### **LOB**

Lines of Business 14–29

### **LOD**

Line of duty 13–50b

### **LOGCAP**

Logistics Civil Augmentation Program 12–7b (7)

### **LOGSA**

Logistics Support Activity 12–11b (4)

### **LOGSACS**

Logistics Structure and Composition System 2–4a (5) (b)

**LOI**

letter of instruction 6-4g(3)(c)

**LOTS**

logistics over the shore 12-6e (3) (w)

**LRIP**

low rate initial production 11-11c

**LSE**

logistics support element 12-9e

**LSS**

**Lean Six Sigma 17-42b**

**LVC**

live, virtual, constructive 5-6e

**LVCG**

Live, Virtual, Constructive, and Gaming 15-1c (4)

**LWN**

LandWarNet 16-1c

**LWN-BC**

LandWarNet/Battle Command 16-20d

**LWN-BC GOSC**

LandWarNet/Battle Command GOSC (LWN/BC GOSC 16-6c (1)

**M&S**

modeling and simulation 5-18b(5)(a)

**M2PR**

monthly military personnel review 13-12

**MA**

Mission assurance 22-4d

**MACA**

military assistance to civil authorities 22-6a

**MACDIS**

military assistance for civil disturbance 22-6a

**MACOM**

Major Army Command 17-2i (3)

**MAISRC**

major automated information system review council 9-70

**MALT-R**

Materiel, Acquisition, Logistics and Technology Reviews 12-11a (4)

**MANPRINT**

manpower and personnel integration 11-28b

**MAP**

military assistance programs 12-18c

## **How the Army Runs**

### **MARC**

manpower requirements criteria 2–6c(4)(a)

### **MAST**

military assistance to safety and traffic 22–25c

### **MATDEV**

materiel developer 5–14a

### **MBI**

major budget issue 9–6b (14)

### **MC**

Medical Corps 18–2a

### **MC4**

Medical Communications for Combat Casualty Care 18–18c

### **MCA**

Military Construction, Army 10–3c

### **MCAR**

Military Construction, Army Reserve 10–15b (3)

### **MCNG**

Military Construction, Army National Guard 10–15b (3)

### **MCM**

Manual for Courts-Martial 19–14b

### **MCO**

Major Combat Operations 5–18b (2) (e)

### **MCP**

Marine Corps Capabilities Plan 6–3

### **MCS**

managed care support 18–8b

### **MCTP**

Mission Command Training Program 15–28b (1)

### **MCU**

Multi-COMPO Unit 7–48

### **MDA**

Missile Defense Agency 11–36d

### **MDA**

milestone decision authority 9–33

### **MDC**

Management Development Course 15–18b (1)

### **MDD**

Materiel Development Decision 11–8d (2)

### **MDEP**

management decision package 9–2c

**MDR**

milestone decision review 11- 8a(1)

**MDW**

Military District of Washington 3-4e

**MECC**

Materiel Enterprise Collaboration Counsel 12-11a (2)

**MEDCEN**

Medical center 6-11e (2) (j) 2

**MEDCOM**

U.S. Army Medical Command 3-2 b (11)

**MEDDAC**

medical department activity 6-11e (2) (j) 2

**ME**

Materiel Enterprise 12-6f (3)

**MEEF**

Materiel Enterprise Executive Forum 12-11a (1)

**MEO**

Military Equal Opportunity 13-49a

**MEO**

most efficient organization 17-21b (2)

**MEPCOM**

Military Entrance Processing Command 6-11e (2) (h) 1

**MEPS**

military entrance processing station 6-11e (2) (h) 1

**MER**

manpower estimate report 11-76k

**MER**

Mission Essential Requirements 15-33d (1) (a)

**MERS**

Mobile Emergency Response Support 22-12d

**MESR**

Materiel Enterprise Strategic Reviews 12-11a (3)

**METL**

mission essential task list 7-30

**METT-TC**

mission, enemy, terrain and weather, troops and support available, time available and civilians considerations 6-7e (7) (b)

**MFA**

materiel fielding agreement 11-82b

**MFORCE**

Master force 5-18d (4)



## **How the Army Runs**

### **MFP**

materiel fielding plan 2-6c(4)

### **MFTB**

Multifunctional Training Brigades 7-41h

### **MHRM**

military human resource management 13-1

### **MID**

Management Initiative Decisions 9-20e (3)

### **MILCON**

military construction 9-62b (1) (b)

### **MILPERS**

Military Personnel 9-62b (1) (a)

### **MILSPECs/STDs**

military specifications and standards 11-20c

### **MILSTAMP**

military standard transportation and movement procedures 12-14d

### **MILSTEP**

military supply and transportation evaluation procedures 12-14 d

### **MILSTRAP**

Military Standard Transactions Reporting and Accounting Procedures 12-6g (2) (c)

### **MILSTRIP**

military standard requisitioning and issue procedures 12-6g (2) (a)

### **MIL-Techs]**

Military Technicians 7-17a (4)

### **MIPS**

modified integrated program summary 11-76b

### **MMC**

materiel management center 12-15e (1)

### **MMEWR**

minimum mission essential wartime requirement 2-6c(4)

### **MMG**

Master Mobilization Guide 6-9a

### **MNS**

Mission Needs Statement 12-6g

### **MOA**

Memorandum of Agreement 11-83b

### **MOB-ARPRINT**

Mobilization Army Program for Individual Training 15-9h

### **MOBMAN**

Mobilization Manpower Planning System 15-9h

**MOBTDA**

mobilization TDA 5-24a(2)(a)

**MOCS**

Military Occupational Classification and Structure System 13-6

**MOE**

measures of effectiveness 11-76i

**MOI**

memorandum of instruction 6-4g(3)(b)

**MOS**

military occupational specialty 2-2c(3)

**MOSLS**

Military Occupational Specialty Level System 15-9b

**MOS-T**

military occupational specialty-training 7-41d

**MOU**

Memoranda of Understanding 12-6e (6) (f)

**MPA**

Military Personnel, Army 10-3c

**MPAD**

mobile public affairs detachment 21-15

**MPI**

Military Police Investigator 19-20a (1)

**MPLAN**

Marine Corps Mobilization Management Plan 6-3

**MPS**

Mobilization Planning System 15-9h

**MPSA**

U.S. Military Postal Service Agency 3-4e

**MPT**

manpower, personnel, and training 11-34d

**MRAP**

mine resistant ambush protected vehicle 11-7c (1)

**MRD**

material requirements document 11-87a

**MRL**

materiel requirements list 11-82b

**MRM**

Management Reform Memorandum 17-32b

**MROC**

Materiel Release Order Capability 12-15e (3)

## **How the Army Runs**

### **MS**

milestone 11–18b

### **MS**

Medical Service Corps 18–2a

### **MSC**

Military Sealift Command 4–17c (7)

### **MSC**

Major Subordinate Command 3–4a (1)

### **MSCA**

Military Support to Civilian Authorities 22–6a

### **MSCLEA**

Military Assistance to Civil Law Enforcement Agencies 22–6a

### **MSF**

million square feet 17–32b

### **MSO**

Military service obligation 13–15a

### **MSP**

mission support plan 11–82b

### **MSPB**

Merit Systems Protection Board 14–7a

### **MTBF**

mean time between failure 11–11d (7) (b)

### **MTF**

medical treatment facility 18–17b (3)

### **MTMC**

Military Traffic Management Command 4–17c (7)

### **MTOE**

modification table of organization and equipment 2–4b (5) (a)

### **MTP**

mission training plan 15–11c

### **MTS**

movement tracking system 12–15f (2)

### **MUA**

military utility assessment 5–7g(1)

### **MUL**

master urgency list 6–15c

### **MUSARC**

Major U.S. Army Reserve Commands 6–11o (1)

### **MUTA**

multiple unit training assemblies 7–17a(2)

**MUTA-4**

four consecutive assemblies 7-17a(3)

**MWR**

morale, welfare, and recreation 9-67

**MWRBOD**

Morale, Welfare and Recreation Board of Directors 17-4b

**NAF**

non-appropriated funds 10-33a (4)

**NAFI**

non-appropriated funds Instrumentalities 10-44b

**NAMI**

non-Army managed item 12-17e

**NAMSA**

NATO Maintenance and Supply Agency 12-6f (2) (i)

**NAP**

not authorized prepositioning 6-11e(2)(a)

**NASA**

National Aeronautics and Space Administration 9-8j (3)

**NATO**

North Atlantic Treaty Organization 4-17c (3)

**NCE**

Non-Combat Essential 14-28b

**NCMP**

Navy Capabilities and Mobilization Plan 6-3

**NCMT**

Non-rated Crewmember Trainer 15-34f

**NCO**

noncommissioned officer 7-17a (2)

**NCOA**

noncommissioned officer academies 7-41g

**NCOER**

NCO evaluation report 13-22

**NCOES**

Noncommissioned Officer Education System 7-41g

**NDAA**

National Defense Authorization Act 11-72a

**NDI**

nondevelopmental item 11-19a

**NDMS**

National Disaster Medical System 22-13a (3)

## **How the Army Runs**

### **NDS**

National Defense Stockpile 6–17

### **NDS**

National Defense Strategy 5–1

### **NEO**

Noncombatant evacuation operations 6–4e

### **NEPA**

National Environmental Policy Act of 1969 11–21

### **NEST**

Nuclear Emergency Support Teams 22–21d (1)

### **NET**

new equipment training 11–30f

### **NETCOM/9<sup>th</sup> SC(A)**

Network Enterprise Technology Command/9<sup>th</sup> Signal Command (Army) 16–14

### **NETP**

new equipment training plan 2–6c(4)

### **NETT**

NET Teams 11–88a

### **NFIP**

National Flood Insurance Program 20–5c (4)

### **NFIP**

National Foreign Intelligence Program 9–8g (2)

### **NGB**

National Guard Bureau 7–25a

### **NGIA**

National Geospatial-Intelligence Agency 12–2b (1) (2)

### **NGPA**

National Guard Personnel, Army 10–8b

### **NGREA**

National Guard and Reserve Equipment Appropriation 7–33

### **NGS**

non-government standards 11–20c

### **NIFC**

National Interagency Fire Center 22–23e

### **NIMS**

National Incident Management System 22–7b

### **NIPRNet**

Non-classified internet protocol router network 16–10a

### **NIRT**

Nuclear Incident Response Team 22–12d

**NJP**

nonjudicial punishment 19–14b

**NMP**

National Maintenance Program 12–2e

**NMRTS**

National Medical Response Teams 22–12d

**NMS**

National Military Strategy 4–2

**NOAA**

National Oceanic and Atmospheric Administration 20–5d (7)

**NOC**

National Operations Center 22–11a

**NOF**

notional force 13–11

**NOK**

Next of kin 13–50a

**NPR**

Nuclear Posture Review (NPR) 5–18a (1)

**NR–KPP**

Net-Ready Key Performance Parameter 11–11d (4)

**NRF**

National Response Framework 22–7b

**NRP**

National Response Plan 20–5a

**NS–E**

non-standard equipment 12–6g (3)

**NSA**

National Security Agency 6–7k

**NSC**

National Security Council 4–4

**NSCS**

National Security Command System 6–3d

**NSN**

national stock number 11–74

**NSS**

national security strategy 5–7a (2)

**NSS**

National Security System 11–11d (5)

**NSSE**

National Special Security Events 22–6 b (3)

## **How the Army Runs**

### **NSTD**

Non-standard training aids, devices, simulations, and simulators 11-90b (2)

### **NTC**

National Training Center 5-24a (2) (b)

### **NULO**

negative un-liquidated obligations 10-25a (5)

### **NVOAD**

National Voluntary Organizations Active in Disaster 22-7b (2) (a)

### **O/M**

Operator and Maintainer 5-14c

### **O&I**

Operations and Intelligence 12-6d (3) (b)

### **O&M**

operations and maintenance 9-62b (1) (a)

### **O&S**

operations and support 11-7g

### **OA**

obligation authority 9-62c (2)

### **OA**

operational architecture; operational assessment 11-35b(1) (c)

### **OA**

Operational availability 5-18

### **OA-22**

HQDA / Resource Services Washington 12-6d (1) (c)

### **OACSIM**

Office of the Assistant Chief of Staff for Installation Management 17-36b

### **OBT**

office of Business Transformation (OBT) 12-6 (2) (c) 35 i

### **OCAR**

Office of the Chief, Army Reserve 6-11e (2) (c)

### **OCIE**

organizational clothing and individual equipment 11-64a (3)

### **OCLL**

Office, Chief of Legislative Liaison 11-30b

### **OCO**

overseas contingency operations 1-3c

### **OCONUS**

outside of the continental United States 7-41h

### **OCPA**

Office of the Chief of Public Affairs 21-12

**OCS**

Officer Candidate School 2–2c (3)

**OCS**

Operational Contract support 12–6d (1)

**OCSA**

Office of the Chief of Staff of the Army 3–4e

**ODP**

officer distribution plan 13–19a

**ODS**

Officer distribution system 13–19a

**ODT**

overseas deployment training 7–39

**OE**

operational environment 5–1

**OEF**

Operation Enduring Freedom 13–18b (3)

**OEM**

Original equipment manufacturers 12–8h

**OER**

officer evaluation report 13–41

**OES**

officer education system 7–41g

**OES**

State office of emergency services 22–9b

**OF**

Operating Force 5–18

**OFM**

Officer Forecasting Model 13–7f

**OFO**

Office of Federal Operations 14–23g

**OGE**

Office of Government Ethics 19–7b

**OGLA**

Officer Grade Limitation Act of 1954 13–45

**OI**

organization integrator 2–6a

**OIF**

Operation Iraqi Freedom 13–18b (3)

**OIPT**

overarching integrated product team 11–8a (2)



## **How the Army Runs**

### **OMA**

Operations and Maintenance, Army 10–3c

### **OMAR**

Operations and Maintenance, Army Reserve 10–8b

### **OMB**

Office of Management and Budget 3–7a

### **OMNG**

Operations and Maintenance, Army National Guard 10–8b

### **OMRD**

Operations, Mobilization and Readiness Directorate 15–10d

### **OMS/MP**

operational mode summary/mission profiles 11–35b (7)

### **OneSAF**

One Semi-Automated Forces 15–34c (3) (b)

### **ONS**

operational needs statement 2–7b (1)

### **OOS**

Objective OneSAF 15–34c (5) (a)

### **OPA**

Officer Personnel Act of 1947 13–45

### **OPA**

Other Procurement, Army 10–15b (2)

### **OPFOR**

opposing forces 5–23a (2) (b)

### **OPLAN**

operation plan 6- 4a (1)

### **OPLAW**

Operational Law 19–22

### **OPLOC**

operating location 10–18b

### **OPMD**

Officer Personnel Management Directorate 13–19c (1) (f)

### **OPMS**

Officer Personnel Management System 7–17b (2)

### **OPORD**

operation order 6–3c(1)

### **OpSD**

operating strength deviation 13–9a

### **OPSEC**

operational security 6-b

**OPTEMPO**

operating tempo 5–25d(3)

**ORB**

officer record brief 13–19c(1)(e)

**ORF**

operational readiness float 5–26b(1)

**OS**

operating strength 13–7d

**OSA**

Office of the Secretary of the Army 7–24c

**OSC**

Office of Special Counsel 14–7a

**OSD**

Office of the Secretary of Defense 4–1

**OSJA**

Office of the Staff Judge Advocate 19–2

**OSUT**

one station unit training 7–27b

**OTA**

Operational Test Agency 11–80b (1)

**OTA TP**

Operational Test Agency test plan 11–80b (1)

**OTIG**

Office of the Inspector General 3–4e

**OTJAG**

Office of the Judge Advocate General 3–4e

**OTOE**

objective TOE 2–4b (5) (b)

**OTSG**

Office of the Surgeon General 6–11e (2) (j) 2

**OV**

Operational view 16–11c

**P&D**

production and deployment 11–11c

**P&I**

Administrative and Technical Privileges and Immunities 19–25c (9) (c)

**P3I**

preplanned product improvement 11–58

**PA**

Public Affairs 21–1b

## **How the Army Runs**

### **PAA**

Procurement Army Ammunition 12–6g (1) (o) 5.

### **PA&E**

Program Analysis and Evaluation 5–23e

### **PAD**

public affairs detachment 21–17

### **PAED**

Program Analysis and Evaluation Directorate 9–2o

### **PAG**

Public Affairs Guidance 21–2f

### **PAIO**

Plans, Analysis & Integration Office 17–13a (2)

### **PAO**

public affairs officer 17–13c (2)

### **PAOC**

public affairs operations center 21–16

### **PAUC**

program acquisition unit cost 11–77g

### **PBA**

performance-based agreements 11–81d

### **PBA**

Pine Bluff Arsenal 12–8i

### **PBA**

Production base analysis 6–19d

### **PBAS**

Program-Budget Accounting System 10–6a

### **PBD**

program budget decision 5–9c

### **PBG**

Program and Budget Guidance 9–26a (5)

### **PBL**

Performance Based Logistics 11–56c

### **PBR**

Program Budget Review 4–10c (1)

### **PBUSE**

Property Book / Unit Supply Enhanced) 12–15e (5)

### **PCA**

Posse Comitatus Act of 1878 22–22a (1)

### **PCC**

Policy coordination committee 6–71 (1)

**PCC**

Pre-Command Course 15–17b (5)

**PCP**

Program Change Proposals 9–2m

**PCS**

Permanent Changes of Station 13–8c

**PCTEF**

Percent Effective 8–8c (6)

**PD**

Program directive 2–4a (1) (b)

**PDD**

Presidential Decision Directive 9–36

**PDIP**

program development increment package 9–2c

**PDR**

Preliminary Design Review 11–41d

**PE**

program element 9–26a

**PEG**

program evaluation group 9–44

**PEO**

program executive officer 5–14a

**PEO EIS**

Program Executive Office Enterprise Information Systems 16–18

**PEPDUS**

PERSCOM Enlisted Personnel Data Update System 13–8d (2)

**PER DB**

personnel component of TAPDB 13–18d (1)

**PERMISS**

Personnel Management Information and Support System 14–12b

**PERNET**

Personnel Network 13–18c (2)

**PERSACS**

Personnel Structure and Composition System 2–4a (5) (b)

**PERSCOM**

Personnel Support Commands 13–2d

**PERSO**

personnel system staff officer 2–6a

**PFA**

personnel functional assessment 13–12

## **How the Army Runs**

### **PFM**

Portfolio management 12–15b

### **PPF**

Partnership for Peace 20–11

### **PFO**

Principal Federal Official 22–11b (1)

### **PI**

Product improvements 11–19a

### **PIM**

Pre-trained individual manpower 6–11e (2) (e) (1)

### **PIMS**

Partnership for Peace Information Management System 20–11

### **PKO**

Peace keeping operations 6–4e

### **PLL**

prescribed load list 2–2c(6)

### **PM**

Program manager 5–14a

### **PMAD**

Personnel Management Authorizations Document 5–25d (1)

### **PMCS**

preventive maintenance checks and services 12–3d

### **PME**

Professional Military Education 7–13

### **PME**

Professional Military Exchange 15–31a (3)

### **PMF**

Presidential Management Fellows 14–17a

### **PMJ**

professional military judgment 5–7a

### **PMO**

program manager/project manager/product manager office 11–29b

### **POC**

point of contact 11–29c

### **POE**

program office estimate 11–17c(3)

### **POL**

Petroleum, oils, lubricants 12–3a

### **POM**

Program Objective Memorandum 2–4a (5) (b)

**POM/BES**

Program Objective Memorandum and Budget Estimate Submission (POM/BES) 9–2j

**POP**

Proponency Office for Preventive Medicine 18–14b

**POR**

Preparation for Overseas Replacement 6–11e (2) (e) (4)

**POR**

program of record 5–5b

**POSC–Edit**

Personnel Occupational Specialty Code Edit 13–6b

**POSH**

prevention of sexual harassment 13–49b

**PPB**

Planning, Programming and Budgeting (PPB) 9–26b

**PPBC**

Planning Program Budget Committee 9–5a (1) (b)

**PPBE**

Planning, Programming, Budgeting, and Execution 1–2b

**PPBS**

Planning, Programming, and Budgeting System 9–2

**PPD**

Personnel Proponency Directorate 15–10d

**PPP/PSP**

Power Projection Platforms/Power Support Platforms 6–10b

**PPSO**

personal property shipment office 12–14e

**PPV**

Public private ventures 10–33d

**PQT**

production qualification test 11–80a

**PRC**

Presidential Reserve Call-up 6–11e (2) (i) 5

**PRD**

Presidential Review Directive 9–36

**PREPO**

pre-positioned 6–11e (2) (a)

**PRG**

program review group 9–2i

**PROBE**

Program Optimization and Budget Evaluation 5–23e

## **How the Army Runs**

### **PROFIS**

Professional Officer Filler Information System 18–18b

### **PSDR**

Personnel Services Delivery Redesign 13–2d

### **PSA**

principal staff assistant 11–67a

### **PSMA**

Pre-scripted Mission Assignments 22–20c

### **PSS**

product support strategy 11–81d

### **PSYOPS**

psychological operations 4–21c (5)

### **PT**

Personnel Transformation 13–2

### **PURE**

PREPO Unit Residual (left behind) Equipment 6–11e (2) (f) 1

### **PY**

prior fiscal year 9–12a(1)(a)

### **QAO**

Quality Assurance Office 7–41f

### **QDR**

Quadrennial Defense Review 2–4a (1) (a)

### **QMP**

Qualitative Management Program 13–27

### **QRP**

qualifying recycling program 17–26a

### **QRRC**

Quarterly Readiness Report to Congress 8–8a

### **R2TF**

Responsible Reset Task Force 12–8o

### **R&D**

research and development 2–3a

### **RAB**

Restoration Advisory Boards 17–22b (3)

### **RAD**

Requirements and Assessment Division (J–8) 11–16d

### **RAD**

Research Area Directorates 18–11c

### **RAID**

Rapid Assessment and Initial Detection 22–21c

**RAM**

reliability, availability, and maintainability 11–28b

**RAP**

revised approved program 9–63

**RAP–C**

requisition allocation plan–CONUS 13–18g (1)

**RC**

Reserve Component 7–1

**RC**

required capabilities 5–4b

**RCAS**

Reserve Component Automation System 15–29f

**RCCC**

Reserve Component Coordination Council 7–24b

**RCCMRF**

Restructured CBRNE Consequence Management Response Force 22–13b (3)

**RCERT**

Regional Computer Emergency Response Teams 16–2c

**RCF**

repair cycle float 5–26b(1)

**RCI**

Residential Communities Initiative 10–33d

**RCM**

Reliability Centered Maintenance 12–6d (5) (c)

**RCP**

retention control point 13–27b

**RCRA**

Resource Conservation and Recovery Act 19–9c (1)

**RCSOF**

Reserve Component Special Operations Forces 6–11d (2)

**RD**

Region Director 17–5a

**RDA**

research, development, and acquisition 11–1

**RDAP**

research, development, and acquisition plan 9–5b(2)

**RDD**

Resource Decision Documents 9–14c (5)

**RDEC**

Research, Development, Engineering Centers 11–7e



## **How the Army Runs**

### **RDECOM**

U.S. Army Research, Development and Engineering command 11-7e

### **RDL**

Reimer Digital Library 15-11e

### **RDS**

Requirements Documentation System 2-8b

### **RDT&E**

research, development, test, and evaluation 9-20d(5)(a)

### **RDT&E,A**

Development, Test, and Evaluation, Army 10-3c

### **REF**

rapid equipping force 11-62a

### **REP-63**

Reserve Enlistment Program of 1963 7-27b

### **REPLOs**

Regional Emergency Preparedness Liaison Officers 22-13c

### **REQ DB**

Requisition Component of TAPDB 13-18d (1)

### **REQUEST**

Recruiting and Training Reservation System 13-13a

### **RERT**

Radiological Emergency Response Team 22-21d (2)

### **RETAIN**

Reenlistment, Reclassification and Assignment System 13-13a

### **RF**

radio frequency 12-15f (2)

### **RFC**

request for capabilities 4-7b

### **RFF**

request for forces 4-7b

### **RFG**

resource formulation guide 9-58e

### **RFID**

radio frequency identification 12-15f (3)

### **RFP**

request for proposal 11-51b

### **RFPB**

Reserve Forces Policy Board 7-22b

### **RHN**

Regional Hub Nodes 16-6c (3) (c)

**RI**

resource integrator 2–6a

**RIA**

Rock Island Arsenal 12–8i

**RID**

Requirements Integration Directorate (ARCIC) 11–35b (4) (b)

**RIF**

reduction in force 2–2c(8)

**RMC**

regional medical command 18–10a (7)

**RMD**

Resource Management Decision 9–6b (16)

**RMD**

Requirements Management Division (J–8) 11–16d

**RMO**

Resource Management Office 17–13a (1)

**ROE**

rules of engagement 19–22b

**ROI**

Report of Investigation 14–23f

**ROPMA**

Reserve Officer Personnel Management Act 7–17b (2)

**ROS**

responsible official for sustainment 11–34g (1)

**ROTC**

Reserve Officers Training Corps 2–2c (3)

**RPA**

U.S. Army Resources and Programs Agency (RPA) 3–4e

**RPA**

Reserve Personnel, Army 10–8b

**RPLANS**

Real Property Planning and Analysis System 17–35

**RPM**

real property maintenance 17–33c (1)

**RRAD**

Red River Army Depot 12–8g

**RRCC**

Regional Response Coordination Center 22–11a

**RSC**

Regional Support Commands 17–17a (5)

## **How the Army Runs**

### **RSO**

Religious Support Office 17–13c (3)

### **RSO**

Requirements Staff Officer 2–6a

### **RSO**

retirement services officer 13–53a

### **RTF**

Ready to Fight 12–9k

### **RTI**

Regional Training Institutes 15–17a (1)

### **RTLTP**

Range and Training Land Program 15–10i

### **RTSM**

Regional Training Site Maintenance 7–41f

### **RUDIST**

REQUEST Unit Distribution Program 13–13b (3) (b)

### **RUE**

Rules of the Use of Force 22–14e

### **RVS**

Reconfigurable Vehicle Simulator 15–34d

### **RVTT**

Reconfigurable Vehicle Tactical Trainer 15–34d

### **SA**

Secretary of the Army 1–4

### **SA**

Security assistance 12–3f

### **SA**

Situation Awareness 16–20b

### **SA**

supportability analysis 11–81b (3)

### **SAAG**

Office of the Auditor General - U.S. Army Audit Agency 3–4e (1) (d)

### **SAAS–ASP**

SAAS–Ammunition Supply Point 12–15 e (1)

### **SAAS–ATHP**

SAAS–Ammunition Transfer & Holding Point 12–15 e (1)

### **SAAS–Mod**

Standard Army Ammunition System Modernized 12–15 e (1)

### **SAAS–BAO**

SAAS–Brigade Ammunition Office 12–15 e (1)

**SAAS-DAO**

SAAS-Division Ammunition Office 12-15 e (1)

**SAAS-MMC**

SAAS-Materiel Management Center 12-15 e (1)

**SAC**

Special agent in charge 22-11b (4)

**SAC**

Strategic Air Command 6-11e (2) (k) 3

**SACEUR**

Supreme Allied Commander, Europe 4-17c (3)

**SACS**

Structure and Composition System 2-4a (5) (b)

**SALE**

Single Army Logistics Enterprise 12-6 (2) (c) 35 i

**SAMAS**

Structure and Manpower Allocation System 2-4a (5) (a)

**SAMS**

School of Advanced Military Studies 15-17b (4)

**SAMS-E**

The Standard Army Maintenance System-Enhanced 12-15e (2)

**SAP**

special access program 11-35b(3)(e)

**SAPR**

Sexual Assault Prevention Response 13-49b

**SAR**

selected acquisition report 11-77f

**SARA**

Superfund Amendments and Reauthorization Act of 1986 17-29a

**SARSS**

Standard Army Retail Supply System 12-15e (3)

**SARSSS-GW**

Standard Army Retail Supply System-Gateway 12-15e (3)

**SAS**

Statistical Analysis Software 13-19b

**SASC**

Senate Armed Services Committee 7-21a

**SAT**

Systems Approach to Training 15-10l

**SATCOM**

Satellite communications 16-16c

## **How the Army Runs**

### **SATD**

Security Assistance Training Directorate 15–10d

### **SATFA**

Security Assistance Training Field Activity 15–31b

### **SATP**

Security Assistance Training Program 15–31a

### **SBCT**

Stryker Brigade Combat Team 5–7h

### **SBIR**

Small Business Innovation Research Program 9–63

### **SBP**

Survivor Benefit Plan 13–53b

### **SBR**

Standby Reserve 6–11e (2) (e) (1)

### **SC**

Senior Commander 17–5c

### **SCI**

Sensitive compartmented information 6–3c (11)

### **SCM**

summary court-martial 19–19d(1)

### **SCM**

Supply Chain Management 12–6g (2) (f)

### **SCO**

State coordinating officer 22–11b (6)

### **SCR**

systems change request 12–6f (2) (h)

### **SCRA**

Service members Civil Relief Act 7–21b

### **SCRAG**

Senior Civilian Representative of the Attorney General 22–22b (2)

### **SDAP**

Special Duty Assignment Pay 13–16c

### **SDC**

Supervisory Development Course 15–18b (1)

### **SDCS**

Standard Data Collection System 9–6a (10) (b) 3

### **SDDC**

Surface Deployment and Distribution Command 3–6a (1)

### **SDO**

Supply Depot Operations 12–6g (3) (o)

**SDS**

Standard Depot System 12–11b (3)

**SDT**

Second Destination Transportation 12–6e

**SDWA**

Safe Drinking Water Act 19–9c (1)

**SE**

systems engineering 11–36a

**SEAL**

sea, air, land (Navy) 4–17c (5)

**SEC**

Senior Executive Council 9–2j

**SECARMY**

Secretary of the Army 10–4d

**SECDEF**

Secretary of Defense 22–5b

**SE Core**

Synthetic Environment Core 15–34c (5)

**SEHS**

Special Events for Homeland Security 22–24b

**SEP**

systems engineering plan 11–44

**SEPLos**

State Emergency Preparedness Liaison Officers 22–13c

**SERB**

selective early retirement board 13–44

**SES**

Senior Executive Service 5–18b (7) (a)

**SFLEO**

Senior Federal Law Enforcement Officer 22–11b (1)

**SFO**

Senior Federal Official 22–1b (5)

**SFRBOD**

Soldier and Family Readiness Board of Directors 17–4b

**SG**

standards of grade 2–6c(4)

**SGO**

Standard Garrison Organization 17–13

**SHARP**

Sexual Harassment/Assault Response Prevention 13–49b

## **How the Army Runs**

### **SICE**

Services & Infrastructure Core Enterprise 17–40b

### **SIGINT**

signals intelligence 11–36b

### **SIMLM**

single integrated medical logistics manager 18–20b

### **SIPRNET**

secret internet protocol router network 11–59b

### **SIPT**

supportability integrated product team 11–81b (1)

### **SISC**

support to international sporting competitions 22–24c

### **SJA**

Staff Judge Advocate 17–13c (1)

### **SKA**

skills, knowledge and attributes 13–23b

### **SL**

Senior Level 14–9a

### **SLAMIS**

SSN–LIN Automated Management and Integrating System 9–6a (10) (b) 1.

### **SLDA**

Senior Leaders of the Department of the Army 5–16a

### **SLEP**

service life extension program 11–8e (2)

### **SLRG**

Senior Leader Review Group 9–14a

### **SM**

Senior Manager 17–7b (2)

### **SM**

Soldier's Manual 15–24

### **SMA**

Supply Management, Army 12–6g (2) (r)

### **SMART**

Special Medical Augmentation Response Teams 22–21e (7)

### **SMC**

Sergeants Major Course 15–16d

### **SMCA**

Single Manager for Conventional Ammunition 12–8p (1)

### **SMCT**

Soldier's Manual of Common Tasks 15–24

**SMDC**

Space and Missile Command 9–9c

**SMDR**

structure manning decision review 13–12

**SME**

subject matter expert 5–25a

**SMSP**

Security Management System 6–17

**SM/TG**

Soldier's Manuals/Trainers Guides 15–24

**SMU**

Special Mission Unit 22–22c (3)

**SNaP**

Select and Native Programming 9–53f

**SOF**

special operations forces 4–17c (5)

**SOFA**

status of forces agreement 14–2c

**SoS**

systems of systems 5–6e (2) (a)

**SOS**

Source of Supply 12–15 e (3)

**SPBS**

Standard Property Book System-Redesign 12–15e (5)

**SPCM**

special court-martial 19–19d(2)

**SPG**

Strategic Planning Guidance 9–2k

**SQI**

special qualification identifier 5–13

**SRA**

strategic research areas 11–6a

**SRA**

separate reporting activity 12–20

**SRC**

standard requirements code 5–19a(1) (c)

**SRG**

Senior Review Group 9–28a

**SRM**

Sustainment, Restoration and Modernization 17–2i (4)



## **How the Army Runs**

### **SROC**

Senior Readiness Oversight Council 8–13

### **SRP**

soldier readiness program 7–31

### **SRP**

Sustainable Range Program 15–9i

### **SRS**

Strategic Readiness System 17–37c

### **SS**

supportability strategy 11–81b (2)

### **SSA**

source selection authority 11–29b

### **SSA**

system safety assessment 11–36g

### **SSC**

Senior Service College 15–17b (7)

### **SSMS**

Service Support Manpower System 9–6a (10) (b) 3

### **SSN**

standard study number 5–14c

### **SSO**

Single sign on 16–10a

### **SSO**

synchronization Staff officer 2–6a

### **ST**

sustainment training 11–88d

### **STAMIS**

Standard Information Management System 12–6f (2) (g)

### **STANFINS**

Standard Financial System 10–18c

### **STAR**

system threat assessment report 11–76a

### **STARTs**

Scientific and Technical Advisory and Response Teams 22–12d

### **STO**

Split training option 15–14e

### **STORES**

Subsistence Total Order and Receipt Electronics System 12–15e (7)

### **STP**

Short term projects 9–21b (5)

**STP**

soldier training publications 15–11c

**STRADS**

Strategic Deployment System 12–12e

**STRAMS–E**

Student/Trainee Management System-Enlisted 13–18e (4) (a)

**STRAP**

system training plan 11–30f

**STSP**

Soldier Training Support Program 15–34c (3)

**STTR**

Small Business Technology Transfer Pilot Program 9–63

**STX**

situational training exercises 15–27

**SUST BDE**

Sustainment Brigades 12–2c (1)

**SV**

System view 16–11c

**SVP**

special visibility program 9–21b (4)

**SWAR**

Solid Waste Annual Reporting System 17–26b

**TEO**

U.S. Army Test and Evaluation Office 3–4e (1) (h)

**T&E**

test and evaluation 11–48b

**T&EO**

training and evaluation outline 15–29e (3)

**TAA**

total Army analysis 2–4a (4)

**TAACOM**

Theater Area Army Command 21–16

**TAADS**

The Army Authorization Documents System 2–4a (5) (a)

**TABDB**

Total Army Personnel Data Base 13–2c

**TAC**

Transportation Account Code 12–6e (1) (b)

**TACITS**

Total Army Centralized Individual Training Solicitations 15–9c

## **How the Army Runs**

### **TACOM**

Tank-Automotive and Armaments Command 12–8g (1)

### **TADLP**

The Army Distributed Learning Program 15–5c (2)

### **TADSS**

training aids, devices, simulations, and simulators 11–30f

### **TAEDP**

The Army Equipment Distribution Program 5–26b (2)

### **TAG**

The State Adjutants General 7–25b

### **TAMMS**

The Army Maintenance Management System 12–21hh

### **TAP**

The Army Plan 1–5a

### **TAPDB**

Total Army Personnel Databases 13–7g

### **TAPDB–AE**

Total Army Personnel Databases-Active Enlisted 13–7g

### **TAPDB–AO**

Total Army Personnel Databases-Active Officer 13–7g

### **TASS**

The Army School System 7–41

### **TASSD**

The Army School System Directorate 15–10d

### **TATS**

Total Army Training System 15–13

### **TBE**

Training base expansion 7–38

### **TBIP**

Training Barracks Improvement Program 17–33c (3)

### **TBMP**

Training Barracks Modernization Program 17–33c (2)

### **TBUP**

Training Barracks Upgrade Program (TBUP) 17–33c (3)

### **TC**

Type classification 12–6g (3) (b)

### **TC–ACCIS**

Transportation Coordinator-Automated Command and Control Information System 12–6e (3) (c)

### **TCE**

Tactical Computer Exchange 12–9k

**TCM**

TRADOC capability manager 11-34i (2) (b)

**TCP**

Planning, Programming and Budgeting 9-41c

**TD**

technology demonstration 11-7b

**TD**

training development 11-8b

**TDA**

tables of distribution and allowances 2-4b (5) (a)

**TDADD**

Training Development and Delivery Directorate 15-10d

**TDDC**

Training and Doctrine Development Configuration 15-29e

**TDDT**

Training and Doctrine Development Tool 15-11c

**TDS**

technology development strategy 11-39a

**TDS**

Trial Defense Service 19-15c

**TE**

Training environment 15-34c (5)

**TEM**

training execution matrices 15-29e (3)

**TEMP**

test and evaluation master plan 11-44

**TEO**

U.S. Army Test and Evaluation Office 3-4e (1) (i)

**TES**

Tactical Engagement Simulation 15-10e

**TEU**

Technical Escort Unit 22-21e (5)

**TF**

task force 11-60a

**TFE**

tactical field exchange 12-12f (2)

**TFER**

Task Force for Emergency Readiness 22-14g

**TFM**

Training Feedback Module 15-29e (3)

## **How the Army Runs**

### **TG**

Training Guide 15–24b

### **TGM**

technical guidance memorandum 9–53b

### **TIG**

time in grade 13–42

### **TIM**

Transformation of Installation Management 17–2i

### **TIS**

time in service 13–42

### **TIS**

Transportation Information Systems 12–6e (1) (f)

### **TISA**

troop issue subsistence activity 12–15e (7)

### **TISO**

threat integration staff officer 11–34e(1)

### **TJAG**

The Judge Advocate General 19–12c

### **TLAMM**

Theater Lead Agent for Medical Materiel 18–10c (5)

### **TMA**

training mission area 11–90b (2)

### **TMA**

TRICARE Management Activity 18–7c

### **TMCA**

Theater Movement Control Agency 12–12d

### **TMD**

theater missile defense 11–36d

### **TMIP**

Theater Medical Information Program 18–18c

### **TMOPEs**

TRADOC Mobilization Operation Planning and Execution System 6–11d (3)

### **TNGDEV**

training developer 5–6c(2)

### **TOA**

total obligation authority 9–12a

### **TOE**

table of organization and equipment 5–8

### **TOMA**

Training Operations Management Activity 15–10d

**TOPMIS**

Total Officer Personnel Management Information System 13–19c (1)

**TOPS**

Transportation Operational Personal Property Standard System 12–12e

**TOTA**

Tenants Other Than Army 17–34e

**TP**

Training Publication 15–24

**TPA&E**

Training Program Analysis and Evaluation 15–10d

**TPCRD**

Training Plans and Capabilities Review 15–10d

**TPE**

Theater Provided Equipment 7–35a

**TPF**

total package fielding 11–34i (2) (b)

**TPFDD**

time -phased force and deployment data 6–4a (2)

**TPSN**

troop program sequence number 5–23d

**TPU**

troop program unit 7–17a (5)

**TRA**

technology readiness assessment 11–8a (1)

**TRAC**

TRADOC Analysis Center 3–4a (1)

**TRAC2ES**

US Transportation Command (TRANSCOM) Regulating and Command and Control Evacuation System 18–18c

**TRADOC**

U.S. Army Training and Doctrine Command 2–4a (1)

**TRAP**

training requirements arbitration panel 13–12

**TRAS**

Training Requirements Analysis System 11–89

**TRL**

technology readiness level 11–8a (2)

**TRM**

Training Resource Model 5–25d

**TRP**

test resource plan 11–52b

## **How the Army Runs**

### **TSARC**

test schedule and review committee 11–36a

### **TSB**

Training Support Brigade 7–37

### **TSC**

Theater Sustainment Command 12–12d

### **TSC**

Training Support Center 15–7i

### **TSCA**

Toxics Substances Control Act 17–24

### **TSG**

The Surgeon General 9–8k

### **TSIU**

Tactical Simulation Interface 15–34e

### **TSP**

training support package 15–25b

### **TSR**

training support requirements 11–30f

### **TSS**

Training Support System 15–1c (4)

### **TSWG**

Training Support Working Group 11–81b (2)

### **TTHS**

trainees, transients, holdees and students 7–17a (6)

### **TTP**

tactics, techniques, and procedures 5–6a (1)

### **TV**

Technical view 16–11c

### **TVA**

Tennessee Valley Authority 20–5f

### **TWOS**

Total Warrant Officer System 13–5e

### **TYAD**

Tobyhanna Army Depot 12–8g

### **UAD**

updated authorizations document 13–10

### **UAS**

unit activation schedule 6–11e(2)(d)

### **UAS**

Unmanned Aircraft System 11–18b

**UCMJ**

Uniform Code of Military Justice 7–48

**UCP**

Unified Command Plan 4–17a

**UEPH**

Unaccompanied Enlisted Personnel Housing 17–33b

**UFR**

unfunded requirement 11–34i(2)(b)

**UIC**

unit identification code 5–20

**UID**

Unique Item Identifier 12–6f (2) (f)

**UJT**

Universal Joint Task 16–16e (1)

**UJTL**

universal joint task list 5–7b(2)

**ULLS**

Unit Level Logistics System 12–15e

**ULP**

unfair labor practice 14–21f

**UMD**

unmatched disbursements 10–25a (4)

**UMFP**

unit materiel fielding points 11–82c

**UMMIPS**

Uniform Movement and Materiel Issue Priority System 12–6g (3) (f)

**UNAAF**

Unified Action Armed Forces 6–4g (1) (a)

**UPH**

Unaccompanied Personnel Housing 17–33b

**URS**

unit reference sheet 2–4a(1)(b)

**US&R**

Urban Search and Rescue 22–12d

**USA**

Under Secretary of the Army 9–28a

**USAAC**

U.S. Army Accessions Command 15–10a

**USAASC**

U.S. Army Acquisition Support Center 3–4e



## **How the Army Runs**

### **USACE**

U.S. Army Corps of Engineers 3–4e (2)

### **USACIDC**

U.S. Army Criminal Investigation Command 3–2b (11)

### **USACPEA**

US Army Civilian Personnel Evaluation Agency 14–10a

### **USAFINCOM**

U.S. Army Finance Command 3–4e

### **USAFMSA**

U.S. Army Force Management Support Agency 2–4a (3)

### **USAFRICOM**

U.S. Africa Command 4–17c (10)

### **USAG**

United States Army Garrison 17–13

### **USAHRC**

U.S. Army Human Resources Command 3–4e

### **USAID**

U. S. Agency for International Development 20–9

### **USAIGA**

U.S. Army Inspector General Agency 3–4e

### **USAISMA**

U.S. Army Installation Support Management Activity 3–4k (6)

### **USAJFKSWCS**

U.S. Army John F. Kennedy Special Warfare Center and School 15–10

### **USAMEDCOM**

U.S. Army Medical Command 12–2b (1) (2)

### **USAMRICD**

USA Medical Research Institute of Chemical Defense 22–21e (7)

### **USAMRIID**

USA Medical Research Institute of Infectious Diseases 22–21e (7)

### **USAMRMC**

U.S. Army Medical Research and Materiel Command 11–36g

### **USAPA**

U.S. Army Publishing Agency 13–6a

### **USAPHC (PROV)**

U.S. Army Public Health Command (Provisional) 18–14

### **USARC**

U.S. Army Reserve Command 3–4e

### **USARCENT**

U.S. Army Central 3–6a (1)

**USARCS**

U.S. Army Claims Service 19–12c

**USAREC**

U.S. Army Recruiting Command 3–2b (6)

**USAREUR**

U.S. Army, Europe 3–6a (1)

**USARF**

United States Army Reserve Forces 6–11e (2) (h) 3

**USARNORTH**

U. S. Army North 3–6a (1)

**USARPAC**

U.S. Army, Pacific 3–6a (1)

**USARSO**

U.S. Army, South 3–6a (1)

**USASAC**

U.S. Army Security Assistance Command 3–4b (6)

**USASMC**

U.S. Army Sergeants Major Course 15–16d

**USASMDC**

U.S. Army Space and Missile Defense Command 3–6a (1)

**USASOC**

U.S. Army Special Operations Command 3–6a (1)

**USASSI**

U.S. Army Soldier Support Institute 13–4d

**USATC**

U.S. Army Training Center 15–14a

**USAWC**

U.S. Army War College 1–8b

**UC**

Unified Command 22–8b (2)

**USC**

United States Code 14–5a

**USCENTCOM**

U.S. Central Command 4–17c (2)

**USCG**

United States Coast Guard 6–7k

**USDA**

US Department of Agriculture 22–23b

**USD(Policy)**

Under Secretary of Defense (Policy) 9–13f

## **How the Army Runs**

### **USD(AT&L)**

Under Secretary of Defense (Acquisition, Technology, and Logistics) 9–13e

### **USD(C)**

Under Secretary of Defense (Comptroller) 9–13g

### **USD(P&R)**

Under Secretary of Defense (Personnel and Readiness) 9–13h

### **USERRA**

Uniform Services Employment and Reemployment Rights Act 7–21b

### **USEUCOM**

U.S. European Command 4–17c (3)

### **USAISMA**

U.S. Army Installation Support Management Activity 3–4e (1) (n)

### **USJFCOM**

U.S. Joint Forces Command 4–17c (1)

### **USMA**

United States Military Academy 2–2c (3)

### **USNORTHCOM**

U.S. Northern Command 4–17c (9)

### **USP**

United States Postal Service 22–23a

### **USPACOM**

U.S. Pacific Command 4–17c (4)

### **USPFO**

U.S. Property and Fiscal Officer 7–28d

### **USR**

unit status report 2–6c (4)

### **USSOCOM**

U.S. Special Operations Command 4–17c (5)

### **USSOUTHCOM**

U.S. Southern Command 4–17c (6)

### **USSTRATCOM**

U.S. Strategic Command 4–17c (8)

### **USTRANSCOM**

U.S. Transportation Command 3–4b (6)

### **UTA**

unit training assemblies 7–17

### **UJTL**

Universal Joint Task List 8–8c (3)

### **VC**

Veterinary Corps 18–2a

**VCCT**

Virtual Combat Convoy Trainer 11-90 a (3)

**VCJCS**

Vice Chairman of the Joint Chiefs of Staff 4-12

**VCSA**

Vice Chief of Staff, Army 11-7i

**VEOA**

Veterans Employment Opportunity Act 14-17a

**VERRP**

Voluntary Early Release and Retirement Program 13-57b

**VI/TSC**

visual information/training support centers 15-7k

**VMATs**

Veterinarian Medical Assistance Teams 22-12d (10)

**VOLAR**

Volunteer Army 17-33c (1)

**VSAT**

Very Small Aperture Terminal 12-15f (5)

**VSA**

Virtual simulation architecture 15-34c (5) (b)

**VTT**

Video Teletraining 15-5c (1)

**WBRP**

Whole Barracks Renewal Program 17-33c (1)

**WFF**

Warfighting function 5-5a

**WFO**

warfighter outcomes analysis 11-10a

**WHINSEC**

Western Hemisphere Institute for Security Cooperation 15-17b (3) (b)

**WIN-T**

Warfighter Information Network-Tactical 11-85d

**WIP**

work in process 10-25b (4)

**WIPT**

working-level integrated product team 11-67

**WIT**

Weapons Intelligence Team 11-64 a (4)

**WLC**

Warriors Leader Course 15-16a

## **How the Army Runs**

### **WMD**

Weapons of Mass Destruction 22–4a

### **WMP**

Air Force War and Mobilization Plan 6–3

### **WNR**

Whole Neighborhood Revitalization 17–33c (4)

### **WO**

Warrant officer 13–14

### **WOAC**

Warrant Officer Advanced Course 13–30b

### **WOBC**

Warrant officer basic course 13–14b

### **WOCC**

Warrant Officer Career Center 13–30e

### **WOCS**

Warrant Officer Candidate School 13–14b

### **WOES**

Warrant Officer Education System 13–28a

### **WOLDAP**

Warrant Officer Leader Development Action Plan 13–28a

### **WOMA**

Warrant Officer Management Act 13–28a

### **WOS**

Warrant officer service 13–28a

### **WOSC**

Warrant Officer Staff Course 13–30

### **WOSSC**

Warrant Officer Senior Staff Course 13–30

### **WPB**

War production board 11–34f (3) (b)

### **WPR**

War Powers Resolution 19–24f

### **WPS**

Worldwide Ports System 12–12e

### **WRDA**

Water Resources Development Act 20–2

### **WRMR**

war reserve materiel requirement 6–11e (2) (f) 2

### **WRMS**

war reserve materiel stock 6–11e (2) (f) 2

**WRSA**

war reserve stocks for allies 12-6g (1) (j)

**WRSA-I**

war reserve stocks for allies-Israel 12-6g (1) (j)

**WRSA-K**

war reserve stocks for allies-Korea 12-6g (1) (j)

**WSR**

weapon system review 12-6j (2) (j)

**WTCV**

weapons and tracked combat vehicles 10-15b (2)

**WVA**

Watervliet Arsenal 12-8i

**WWX**

World Wide Express 12-6e (2) (f)

**ZLIN**

developmental line item number 5-14c

**Section II**

**Terms**

No entries for this section

**Section III**

**Special Abbreviations and Terms**

No entries for this section

**UNCLASSIFIED**

**PIN 999999-999**





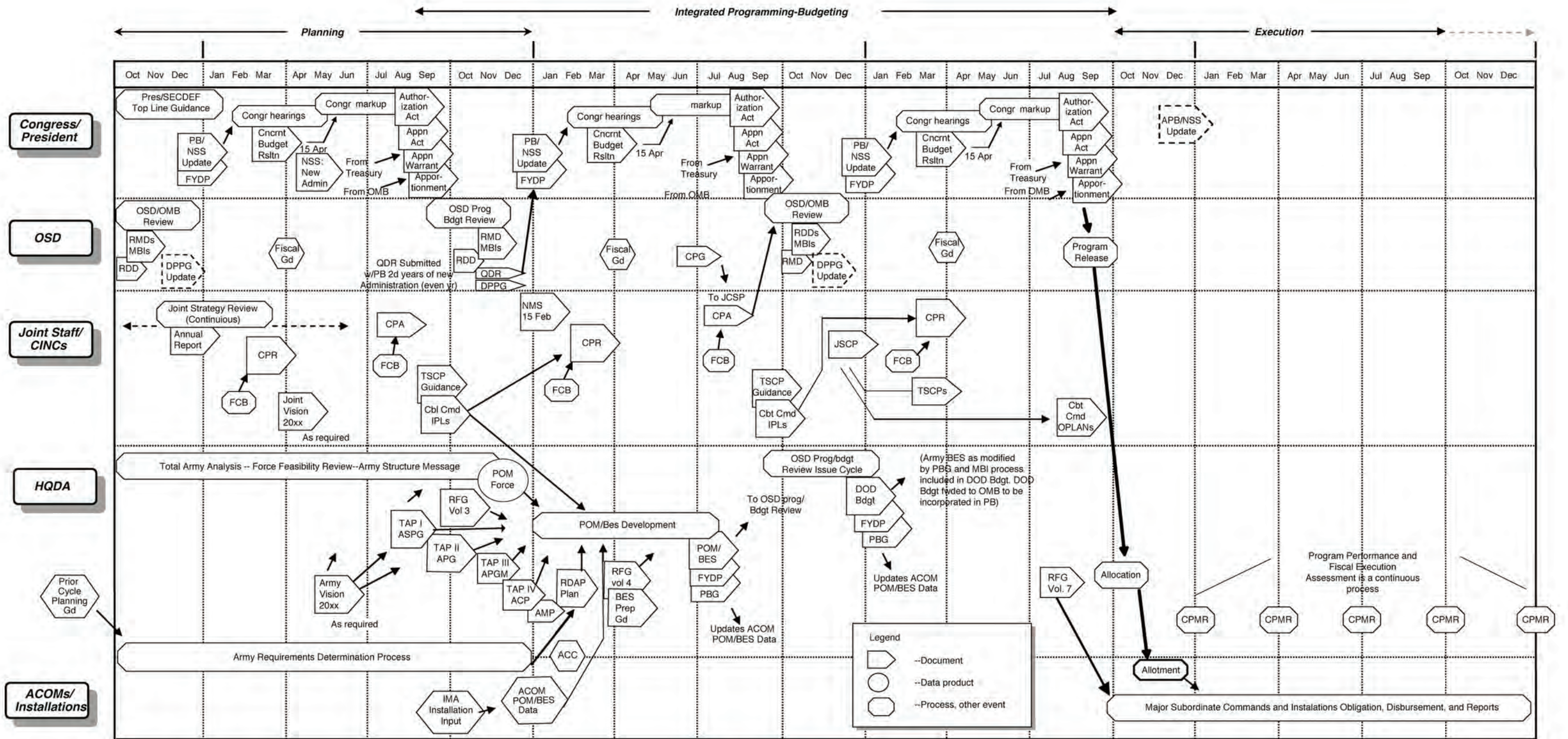

- |   |   |  |  |   |
|---|---|--|--|---|
| <b>ACC</b> Army Commanders' Conference        | <b>Cmdr</b> Commander, unified command              | <b>GEF</b> Guidance for Employment of Force      | <b>OMB</b> Office of Management and Budget                         | <b>QDR</b> Quadrennial Defense Review                 |
| <b>ACOM</b> Army command                      | <b>Cncrnt</b> Concurrent                            | <b>HQDA</b> Headquarters, Department of the Army | <b>OSD</b> Office of the Secretary of Defense                      | <b>RDA</b> Research, Development, and Acquisition     |
| <b>ACP</b> Army Campaign Plan                 | <b>Congr</b> Congress                               | <b>IMA</b> Installation Management Agency        | <b>PA</b> Program Assessment                                       | <b>RDD</b> Resource Decision Document                 |
| <b>AMS</b> Army Modernization Strategy        | <b>CPA</b> Chairman's Program Assessment            | <b>IPL</b> Integrated Priority List              | <b>PB</b> President's Budget                                       | <b>Rev</b> Review                                     |
| <b>APB</b> Amended President's Budget         | <b>CPG</b> Contingency Planning Guidance            | <b>JPG</b> Joint Programming Guidance            | <b>PBD</b> Program Budget Decision                                 | <b>RMD</b> Resource Management Decision               |
| <b>APGM</b> Army Program Guidance Memorandum  | <b>C-PLAN</b> Command Plan                          | <b>JSCP</b> Joint Strategic Capabilities Plan    | <b>PBG</b> Program and Budget Guidance                             | <b>Rsltn</b> Resolution                               |
| <b>APPG</b> Army Planning Priorities Guidance | <b>CPMR</b> Cost and Performance Measures Review    | <b>MBI</b> Major Budget Issue                    | <b>PDD</b> Presidential Decision Directive                         | <b>SECDEF</b> Secretary of Defense                    |
| <b>Appn</b> Appropriation                     | <b>CPR</b> Chairman's Program Recommendations       | <b>NDS</b> National Defense Strategy             | <b>Pol</b> Policy  | <b>TAP</b> The Army Plan                              |
| <b>AS</b> Army Strategic                      | <b>DOD</b> Department of Defense                    | <b>NMS</b> National Military Strategy            | <b>PPBE</b> Planning, Programming, Budgeting and Execution process | <b>TPG</b> Transformation Planning Guidance           |
| <b>Bdgt</b> Budget                            | <b>DPPG</b> Defense Planning & Programming Guidance | <b>NSS</b> National Security Strategy            | <b>Pres</b> President  | <b>TRADOC</b> U.S. Army Training and Doctrine Command |
| <b>BES</b> Budget Estimate Submission         | <b>FYDP</b> Future Years Defense Program            | <b>OPLAN</b> Operation plan                      | <b>Prog</b> Program  | <b>TSCP</b> Theater Security Coordination             |
| <b>Cbt</b> Combatant                          | <b>Gd</b> Guidance                                  |  |  | <b>Vol</b> Volume                                     |

Figure 9-7. Events of the biennial PPBE process cycle



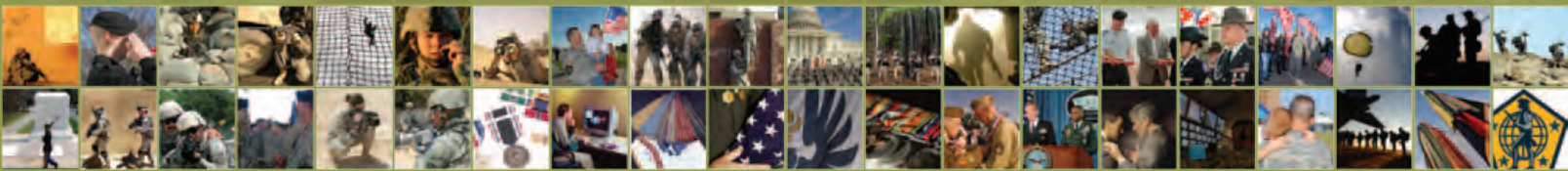

2011-2012  
**HOW THE ARMY RUNS**  
*A Senior Leader Reference Handbook*

