



**DEPARTMENT OF THE ARMY  
UNITED STATES ARMY INFORMATION  
SYSTEMS ENGINEERING COMMAND  
FORT HUACHUCA, ARIZONA 85613-5300**



**TECHNICAL CRITERIA  
FOR THE  
INSTALLATION INFORMATION  
INFRASTRUCTURE ARCHITECTURE**

**BY**

**IMPLEMENTATION ENGINEERING  
SUBJECT MATTER EXPERT**

**FEBRUARY 2010**

**FORT DETRICK ENGINEERING DIRECTORATE**

**Distribution C**

**Distribution authorized to U.S. Government agencies and their contractors only, for administrative or operational use, February 2010. Refer other requests for this document to Commander, U.S. Army Information Systems Engineering Command, ATTN: ELIE-ISE-DE, Fort Detrick, MD 21702.**

#### **DISCLAIMER**

**The use of trade names in this document does not constitute an official endorsement or approval of the use of such commercial hardware or software. Do not cite this document for advertisement.**

#### **CHANGES**

**Refer requests for all changes that affect this document to: USAISEC, ATTN: ELIE-ISE-DE, Fort Detrick, MD 21702-5047.**

#### **DISPOSITION INSTRUCTIONS**

**Destroy this document when no longer needed. Do not return it to the organization. Safeguard and destroy this document with consideration given to its classification or distribution statement requirements.**

**TECHNICAL CRITERIA  
FOR THE  
INSTALLATION INFORMATION  
INFRASTRUCTURE ARCHITECTURE**

**BY  
IMPLEMENTATION ENGINEERING  
SUBJECT MATTER EXPERT**

**FEBRUARY 2010**

**FORT DETRICK ENGINEERING DIRECTORATE  
U.S. ARMY INFORMATION SYSTEMS ENGINEERING COMMAND**

**Distribution C**

Distribution authorized to U.S. Government agencies and their contractors only, for administrative or operational use, February 2010. Refer other requests for this document to Commander, U.S. Army Information Systems Engineering Command, ATTN: ELIE-ISE-DE, Fort Detrick, MD 21702.

Approval Dates:

SME:

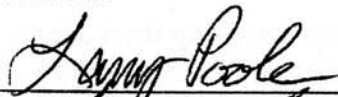

SSE:

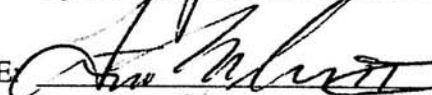

Director:

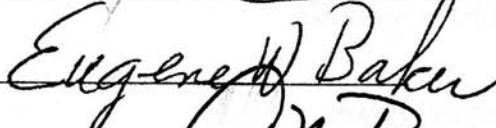

Technical Director:

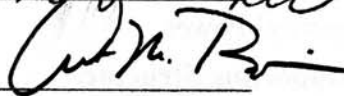

## SUMMARY OF CHANGES

The following information summarizes the changes or additions to this version of the TC for I3A.

### General

- Changed document title from “Technical Guide” to “Technical Criteria.”
- Changed release date from July 2008 to February 2010.
- Replaced Director of Information Management (DOIM) with Network Enterprise Center (NEC) throughout the document.
- Created active hyperlinks for all Universal Resource Locators (URLs) throughout document.
- Updated the Glossary.

### 2.3.5 Outlet Types and Density

- Added clarification to Table 1, Outlet Types.

#### 2.4.1.1 Copper Voice and Data

- Added clarification for patch panels.
- Added further direction for cable slack and service loops.

#### 2.4.2.2 Copper Termination

- Added further details on MDF and Frame.

#### 2.4.2.3 FO Backbone Cable

- Added requirement for fusion spliced, factory-produced pigtails.

### 2.5.2 TR Sizing

- Added statement that TRs shall not have windows.
- Changed minimal TR sizing from 11’x 7’ to 10’ x 8.’

### 2.5.4 Room Door

- Added change to TR door requirements for buildings requiring strict access. (Some facilities such as Child Development Centers may have exterior TR doors to limit unwanted traffic in buildings.)

### 2.5.13 Room Climate Control

- Added statement that TRs shall not have windows.

### 2.5.15 Electrical Power

- Increased requirements for TR Electrical Power.

### 2.6.4 Telecommunications Rack and Supporting Structure

- Added details regarding the bonding and grounding of telecommunications racks and horizontal distribution supporting structures.

## 2.9 Installation Practices

- Added the paragraph entitled “Installation Practices” requiring workmanship conformance to the *BICSI Information Transport Systems Installation Methods Manual (ITSIMM)*.

### 2.10.5 Test Plan

- Added new paragraph, “Test Plan.”

### 3.7.4.3 Bends and Sweeps

- Removed the following requirement: Where the radius is less than 40 feet (12 m), 15-foot (4.6 m) radius-manufactured bends shall be used.
- Added the statement that radius-manufactured bends should be used to the maximum extent possible.

### 3.7.4.5 Minimum Duct Bank Sizing

- Defined subsidiary duct in Subparagraph 3.7.4.5.f.

### 3.7.7.2 Mandrelling

- Removed the sample mandrel size for DB 60.

### 3.7.8 Sub-duct/Innerduct/Multi-duct/Fabric-mesh Innerduct

- Added new requirements for projects with fiber optic cables only. A minimum of two out of every four new ducts shall be subdivided with innerduct, sub-duct, multi-duct, or fabric-mesh innerduct.

### 3.7.10.6 Duct Installed by Directional Boring

- Added Table 5, Duct Standards for Directional Boring.

## 3.13 General Airfield and Air Traffic Control (ATC) Information Infrastructure Design

- Added requirements for General Airfield and Air Traffic Control (ATC) Information Infrastructure Design.

### 3.15.4.2 Fiber Types

- Changed the Maximum Attenuation dB/km values in Table 7 (Single-mode Dual-windowed Fiber Cable Characteristics) from 0.35, 0.25 to 0.5.

## Appendix C

- Corrected drawings.

## Appendix D

- Updated the references list.
- Added requirement to use the most recent version of all standards (such as TIA/EIA) referenced in the TC.

## TABLE OF CONTENTS

	Page
1.0 INTRODUCTION .....	1
1.1 Background.....	1
1.2 Scope.....	1
1.3 Supporting Appendices or Attachments .....	2
2.0 BUILDING TELECOMMUNICATIONS CABLING SYSTEM SPECIFICATIONS ...	2
2.1 Classified Information Infrastructure.....	2
2.2 Building Telecommunications Cabling System Overview.....	3
2.3 Workstation Outlet.....	3
2.4 Building Telecommunications Wiring.....	8
2.5 Telecommunications Spaces.....	15
2.6 Grounding .....	19
2.7 Telecommunications System Labeling.....	21
2.8 Building Entrance Facility .....	22
2.9 Installation Practices .....	23
2.10 Testing .....	23
3.0 OUTSIDE PLANT TELECOMMUNICATIONS CABLING SYSTEM SPECIFICATIONS.....	24
3.1 Classified Information Infrastructure.....	24
3.2 System Overview.....	25
3.3 System Architecture.....	25
3.4 Environmental and Historical Considerations .....	26
3.5 General Considerations.....	26
3.6 Outside Plant Cable Placement Options .....	30
3.7 Underground (Maintenance Holes, Cable Vaults, and Ducts).....	32
3.8 Direct Buried Cable Installation .....	48
3.9 Crossing Obstructions.....	49
3.10 Aerial Cable .....	50
3.11 Free Space Optics .....	51
3.12 General Range Information Infrastructure Design .....	54
3.13 General Airfield and Air Traffic Control Information Infrastructure Design .....	56
3.14 Pier Installation .....	57
3.15 General Cable Specifications.....	58
3.16 Main Distribution Frame (MDF).....	68
3.17 Building Terminations .....	69
3.18 Grounding .....	69
3.19 Final Acceptance Test.....	71
4.0 VOICE SWITCHING, CENTRAL OFFICE/END OFFICE, AND CONVERGENCE	77
5.0 NETWORK ARCHITECTURE .....	77
6.0 NETWORK AND SYSTEMS MANAGEMENT .....	78
6.1 Introduction.....	78
6.2 Purpose.....	78

## TABLE OF CONTENTS (CONTINUED)

	Page
7.0 WIRELESS LOCAL AREA NETWORK.....	78

### Appendices

Appendix A. Technical Criteria Checklist for the Installation Information Infrastructure Architecture .....	A-1
Appendix B. Building Cabling System Diagrams.....	B-1
Appendix C. North America and Europe Drawings.....	C-1
Appendix D. References.....	D-1
Glossary. Acronyms and Abbreviations.....	Glossary-1

### Tables

Table 1. Outlet Types .....	5
Table 2. Coaxial Cable .....	12
Table 3. Maximum Length of Conduit Containing Bends .....	40
Table 4. Extending the Point of Entrance.....	41
Table 5. Duct Standards for Directional Boring.....	47
Table 6. Multimode Dual-windowed Fiber Cable Characteristics .....	63
Table 7. Single-mode Dual-windowed Fiber Cable Characteristics .....	64
Table 8. Non-zero Dispersion-shifted Single-mode FOC Characteristics.....	64
Table 9. Fiber Sizing Between Buildings.....	66
Table 10. Standard Cable Reel Lengths and Diameters .....	72
Table 11. European Standard Cable Reel Lengths and Diameters.....	76
Table 12. Cable Spreadsheet Sample.....	76
Table A-1. TC Checklist.....	A-1
Table D-1. Outside Plant References.....	D-4

### Figures

Figure B-1. Telecommunications Room Entrance and Backbone Diagram.....	B-1
Figure B-2. Telecommunications Room Horizontal Distribution .....	B-2
Figure B-3A. Telecommunications Room Standard Premise Distribution .....	B-3
Figure B-3B. Standard Premise Distribution.....	B-4
Figure B-4. Telecommunications Room Standard Supporting Structure and Riser.....	B-5
Figure B-5. Telecommunications Room Small Facility/Warehouse.....	B-6
Figure B-6. Telecommunications Outlet Types.....	B-7
Figure B-7. Systems Furniture Wiring .....	B-8
Figure B-8. Premise Distribution Supporting Structure - Renovations.....	B-9
Figure B-9. Typical Floor Plan.....	B-10
Figure C-1. OSP Infrastructure Standards – North America.....	C-1
Figure C-2. Drawing Symbols – North America and Europe .....	C-2
Figure C-3. Conduit Placement/Cut and Resurface – North America.....	C-3
Figure C-4. Typical Maintenance Hole – North America (1 of 2).....	C-4

**TABLE OF CONTENTS (CONTINUED)**

	<b>Page</b>
Figure C-5. Typical Maintenance Hole – North America (2 of 2) .....	C-5
Figure C-6. Pedestals and Building Entrance Details – North America (1 of 2).....	C-6
Figure C-7. Pedestals and Building Entrance Details – North America (2 of 2).....	C-7
Figure C-8. MDF and Cable Vault Schematic – North America.....	C-8
Figure C-9. OSP Infrastructure Standards – Europe.....	C-9
Figure C-10. Conduit Placement/Cut and Resurface – Europe .....	C-10
Figure C-11. Typical Maintenance Hole – Europe (1 of 2).....	C-11
Figure C-12. Typical Maintenance Hole – Europe (2 of 2).....	C-12
Figure C-13. Pedestals and Building Entrance Details – Europe (1 of 2) .....	C-13
Figure C-14. Pedestals and Building Entrance Details – Europe (2 of 2) .....	C-14
Figure C-15. MDF and Cable Vault Schematic – Europe .....	C-15



# TECHNICAL CRITERIA FOR THE INSTALLATION INFORMATION INFRASTRUCTURE ARCHITECTURE

## 1.0 INTRODUCTION

This Technical Criteria (TC) document provides the baseline requirements for the planning, design, and implementation of the Installation Information Infrastructure Architecture (I3A) for Army installations worldwide. This document establishes an implementation concept that can be used to shape architectural templates and to influence the design process for the I3A. It identifies proven infrastructure construction techniques, defines common practices, and serves as an authoritative implementation criterion.

### 1.1 Background

In previous engineering designs, each area of communications was addressed separately, to include design standards, schedules, and funding. This approach led to confusion, design re-engineering, and duplication of effort. The I3A concept was initiated to synchronize the efforts and formulate a more efficient and effective design process. The I3A, developed by the U.S. Army Chief Information Officer/G6 (CIO/G6), establishes an Army-wide Information Technology (IT) architectural design standard. The I3A is the source to fuel effective Army Knowledge Management (AKM) necessary to support the Army Transformation Campaign Plan. The I3A captures installation infrastructure, synchronizes the implementation of automation programs, provides for analysis of operational force and sustaining base connectivity, and identifies the costs associated with information technology (IT) modernization.

The I3A Configuration Control Board (CCB), chaired by the CIO/G6, manages I3A issues and tracks developments in IT, information assurance, enterprise systems management (ESM), and automation information systems (AIS). The CCB, which oversees several working groups that address IT issues, meets quarterly. The Army Standing Committee on Information Technology in Support of Military Construction meets annually and is chaired by the U.S. Army Information Systems Engineering Command's Fort Detrick Engineering Directorate (USAISEC FDED) and Headquarters, U.S. Army Corps of Engineers (HQ USACE). This committee addresses any and all issues related to the incorporation of information systems (IS) in support of Army military construction (MILCON) projects.

### 1.2 Scope

This TC document is intended to support gathering the necessary requirements, conducting site surveys, and performing analysis, design, and implementation of IT. It specifically assists the designer in the integration of the telecommunications and information systems. This TC is also synchronized with the Unified Facilities Criteria (UFC), which are mandated under Department of Defense (DOD) policy. The UFC system is prescribed by Military Standard (MIL-STD) 3007, *Standard Practice for Unified Facilities Criteria and Unified Facilities Guide Specifications* and provides planning, design, construction, sustainment, restoration, and modernization criteria. The standard applies to military departments, defense agencies, and DOD field activities in accordance with (IAW) the Under Secretary of Defense for Acquisition Technology and Logistics (AT&L) Memorandum dated 29 May 2002.

The Unified Facilities Criteria are "living" documents and will be periodically reviewed, updated, and made available to users as part of the Services' responsibility for providing

technical criteria for military construction. Headquarters, USACE; the Naval Facilities Engineering Command (NAVFAC); and the Air Force Civil Engineer Support Agency (AFCESA) are responsible for administration of the UFC system. Defense agencies shall contact the preparing Service for document interpretation and improvements. Technical content of each UFC is the responsibility of the pertinent DOD working group. Recommended changes with supporting rationale shall be sent to the respective Service proponent office by Criteria Change Request (CCR). The Unified Facilities Criteria are effective upon issuance and are distributed only in electronic media from the following source: *Whole Building Design Guide* at website <http://dod.wbdg.org/>. Hard copies of UFC printed from electronic media shall be checked against the current electronic version prior to use to ensure the hard copies are current.

### **1.3 Supporting Appendices or Attachments**

This TC document is divided into four sections: Introduction; Building Telecommunications Cabling Systems; Outside Plant (OSP); and Installation Guidelines. Four appendices and a glossary of acronyms and abbreviations are also included.

- Appendix A: Technical Criteria Checklist for the I3A
- Appendix B: Building Cabling System (BCS) Figures
- Appendix C: North America and Europe Drawings
- Appendix D: References
- Glossary: Acronyms and Abbreviations

## **2.0 BUILDING TELECOMMUNICATIONS CABLING SYSTEM (BCS) SPECIFICATIONS**

The BCS is designed to satisfy I3A policy IS requirements within a facility. The BCS shall be installed IAW the Telecommunications Industry Association (TIA) and Electronic Industries Alliance (EIA) Building Telecommunications Wiring Standards' general guidelines with modifications and clarifications provided below. (Refer to Appendix D for the applicable standards.) The TIA/EIA specifications can be purchased at <http://www.tiaonline.org/standards/>. Telecommunication designs shall be rendered and stamped by a Registered Communications Distribution Designer (RCDD). This BCS paragraph is synchronized with UFC 3-580-01, *Telecommunications Building Cabling Systems Planning and Design*. The objective of this UFC is to provide planning guidance for the development of an input to the BCS telecommunications portion of DD Form 1391 (Military Construction Project Data, July 1999). The UFC-3-580-01 is designed to satisfy I3A policy or IS requirements within a facility as per UFC 3-580-10, *Design: Navy and Marine Corps Intranet (NMCI) Standard Construction Practices*.

### **2.1 Classified Information Infrastructure**

Engineers engaged in the design of classified (collateral or higher) information infrastructure shall coordinate the infrastructure design with the Certified Transient Electromagnetic Pulse Emanation Standard (TEMPEST) Technical Authority (CTTA) and Designated Accreditation Authority (DAA) responsible for that area.

The designer shall also refer to the USAISEC *Technical Guide for the Integration of the SECRET Internet Protocol Router Network (SIPRNET)*. This document may be obtained from Army Knowledge Online (AKO) under U.S. Army, Army Materiel Command (AMC);

the Communications-Electronics Command (CECOM), and USAISEC FDED. Anyone with an AKO account may register for the guide.

The USAISEC SIPRNET Technical Guide (TG) is an IT systems security engineering guide for communicators supporting the Warfighter. The TG may be used to assist Army personnel in developing access solutions for SIPRNET connectivity to support the Warfighter's increased use of secure networking and methods of interfacing with secure IT in the Continental United States (CONUS). Although the document may contain some information that may be useful in locations outside the continental United States (OCONUS), the exact specifications and requirements in that theater may differ from those of the CONUS theater. The USAISEC SIPRNET TG is based upon applicable National Security Agency (NSA), DOD, Defense Information Systems Agency (DISA), and Department of the Army (DA) documents.

## **2.2 Building Telecommunications Cabling System Overview**

Design a complete, standards-based, flexible building telecommunications system for Army buildings based upon the functional purpose of the various spaces within the facility. An acceptable BCS encompasses, but is not limited to, copper and fiber optic (FO) entrance cable, termination equipment, copper and fiber backbone cable, copper and fiber horizontal distribution cable, workstation outlets, racks, cable management, patch panel(s), cable tray(s), cable ladder(s), conduit, grounding, and labeling. Figure B-1 of Appendix B provides an overview of the telecommunications room (TR) entrance and backbone diagram. Figure B-2 of Appendix B provides an overview of the TR horizontal distribution.

## **2.3 Workstation Outlet**

The following specifications pertain to telecommunications outlets and connectors.

### **2.3.1 Outlet Box**

Specify double gang electrical boxes of at least 2-1/8 inches (in) (54 millimeters [mm]) depth to provide dedicated space for current and possible future fiber optic cable (FOC) installation. For single connector outlets, such as voice-only; cable or community antenna television (CATV); or closed circuit television (CCTV), use a single gang, 2-in by 4-in by 2 1/4 -in (51-mm x 102-mm x 57-mm) electrical box, recess-mounted, with the faceplate flush with the wall surface. Locate a service power outlet within 6 inches (152 mm) of the CATV or CCTV outlet. Designers shall specify 4-11/16-in (119 mm) square by 2 1/4 -in (57 mm) boxes for 1-in (27 mm) conduit installations and outlet boxes that have or may require fiber optic cabling.

### **2.3.2 Outlet Faceplate**

Use a full (double gang) faceplate for standard administrative outlet locations, with connectors for all copper and, if used, FOC. Standard administrative outlets may, by specific user request, use single gang outlet faceplates in conjunction with a reducing ring. For single gang outlet boxes, use a single gang outlet faceplate with appropriate connector locations and, if required, mounting lugs for wall telephones. The outlet faceplate shall include two blank positions for future applications.

### **2.3.3 Outlet Connector**

The following specifications pertain to copper, FO, and coaxial cable outlet/connectors. The category for cable, jacks, termination blocks, and patch panels shall be the same throughout

each circuit and system. Specify more than one category only if providing more than one system requiring different categories. Use Category (CAT ) 6 cable for all horizontal voice and data circuits unless otherwise specified by the Government.

### **2.3.3.1 Copper Outlet/Connector**

Copper outlets/connectors shall be TIA/EIA CAT6 for all projects. All connectors shall be 8-pin/8-position insulation displacement terminations wired as per T568A (default configuration) or T568B (if required to maintain system configuration uniformity, security or other user-specified reasons). Category 5-, CAT5e-, and CAT3-rated connectors shall not be used in new construction or in rehabilitation projects. The copper outlet/connector and plugs shall be un-keyed unless (1) the user requires a keyed outlet/connector and plugs to maintain system uniformity, security, or (2) there are other user-specified reasons.

### **2.3.3.2 FO Outlet/Connector**

Terminate all FO work area cables in dual 568SC connectors. Provide FO connectors IAW subparagraphs 2.4.1.2a and 2.4.2.4, entitled “FO Termination,” in this TC. The default choice for the FO outlet/connector shall be TIA/EIA “SC” type (568SC). Other type connectors (small-form-factor), e.g., LC, MT-RJ, VF-45, etc., may be substituted as required by the user. Small form factor connectors (available from several manufacturers) offer a potential for significant installation cost reduction. Any type of fiber connector used shall meet the performance requirements specified within Annex A of TIA/EIA-568-C.3 and shall meet the requirements of the corresponding TIA FO Connector Intermateability Standard (FOCIS) document.

### **2.3.3.3 Coaxial Outlet/Connector**

Coaxial outlets/connectors shall normally be “F” type connectors. Use of other type connectors (i.e., Bayonet Neill Concelman [BNC], etc.) shall be considered only if specifically required by the user. The designer shall coordinate with the cable service provider where franchise agreements are in place. All passive CATV devices shall support 1 Gigahertz (GHz) bandwidth.

### **2.3.4 Outlet/Connector Markings**

Each communications outlet shall have a unique identifying number IAW TIA/EIA 606-A. In the TR, this unique identifying number shall be associated with the position on the patch panel or cross-connect to which the outlet is connected. Each horizontal cable shall be labeled both at the outlet and patch panel or cross-connect position in the TR. Connector voice and data dedication use may be reassigned as requirements dictate. **Note:** In the standard cabling scheme, the designations “voice” and “data” are arbitrary and do not imply that one outlet is better than the other; the outlets are identical in capability.

### **2.3.5 Outlet Types and Density**

Table 1 lists the outlet types that are commonly used in military construction projects. Sketches of these outlets are included in Figure B-6 of Appendix B. The outlet types do not cover all possible user required configurations. The designer shall certify that all user-defined outlets have a corresponding valid requirement, such as fiber for various levels of classification. Outlet configurations shall comply with this TC and the current versions of TIA/EIA-568 and 569. Outlet densities are provided for planning purposes, when actual outlet locations are not known and cannot be determined with available information. The designer can develop reasonably accurate total outlet count estimates based on the size and

dedicated usage of the space. Actual designs shall include outlets in work areas, office automation outlets, private office outlets, and wall or access phones as necessary. Private (fixed wall) offices or areas where it would prove difficult to add telecommunications outlets at a later date shall have a minimum of two (2) dual outlets on different walls to accommodate furniture layouts. These factors fall within the ranges given in TIA/EIA-569-B and are based on gross area (overall building footprint without deducting for equipment rooms, restrooms, etc.). Refer to Figure B-9 of Appendix B for a typical building floor plan.

**Table 1. Outlet Types**

<b>Facility Space Category</b>	<b>Outlet Configuration</b>	<b>Planning Area (SF(SM)) per Outlet</b>
Administrative space, to include classrooms, and medical/clinics	Two 8-pin modular (RJ45 type) outlet/connectors in a double gang outlet faceplate; one connector labeled for voice use and one labeled for data use.	80(7.5)
Private Offices – fixed wall (Administrative space)	Two 8-pin modular (RJ45 type) outlet/connectors in a double gang outlet faceplate; one connector labeled for voice use and one labeled for data use.	80(7.5) Minimum of two per private office.
Office Automation (printers, faxes, networked copiers, scanners, etc.)	Two 8-pin modular (RJ45 type) outlet/connectors in a double gang outlet faceplate; one connector labeled for voice use and one labeled for data use.	One per every 10 work stations.
Headquarters and special users	Minimum of two 8-pin modular (RJ45 type) outlet/connectors in a double gang outlet faceplate; one connector labeled for voice use and one labeled for data use, with additional 8-pin modular and/or fiber outlet/connectors as required.	80(7.5)
Systems furniture	Two 8-pin modular (RJ45 type) outlet/connectors in a modular furniture outlet faceplate with outlet box extender; one connector labeled for voice use, and one connector labeled for data use.	See Paragraph 2.3.5.3 Systems Furniture below.
Intermediate Space	Two 8-pin modular (RJ45 type) outlet/connectors in a double gang outlet faceplate; one connector labeled for voice use and one labeled for data use.	200(18.5)

**Table 1. Outlet Types (continued)**

Facility Space Category	Outlet Configuration	Planning Area (SF(SM)) per Outlet
Non-admin spaces (CDCs, chapels, recreation centers, etc.)	Two 8-pin modular (RJ45 type) outlet/connectors in a double gang outlet faceplate; one connector labeled for voice use and one labeled for data use.	500(46.5)
Barracks space/Bachelor Officers' Quarters (BOQ)	See Quarters paragraph below.	See Paragraph 2.3.5.2 Quarters below.
Warehouse space, unit storage, maintenance facilities	Two 8-pin modular (RJ45 type) outlet/connectors in a double gang outlet faceplate; one connector labeled for voice use and one labeled for data use.	5000(465)
Wall and pay telephone outlets in barracks halls and public areas	One 8-pin modular (RJ45 type) connector in a single gang outlet faceplate with mounting lugs, labeled for voice use.	As needed.
Family housing units	See Family Housing paragraph below.	See Paragraph 2.3.5.1 Family Housing below.
Wireless access points	One 8-pin modular (RJ45 type) connector in a single gang outlet faceplate labeled for data use.	See Paragraph 2.3.5.4 Wireless Access Point below.

### **2.3.5.1 Family Housing Units**

The designer shall determine the minimum outlet quantity for Army Family Housing (AFH) units based upon the number of rooms in the AFH unit. In general, provide one telephone outlet and one CATV outlet (as a minimum) in each of the following: kitchen, living room, dining room, family room/area, each bedroom, and any other logical location deemed appropriate. Copper outlet/connectors shall be TIA/EIA CAT6 for U.S. Army and U.S. Air Force projects.

### **2.3.5.2 Quarters**

For U.S. Army barracks projects, provide one 8-pin modular (RJ45 type) connector in a single gang outlet faceplate, labeled voice use, and one CATV outlet per sleeping/living area. In Unaccompanied Enlisted Personnel Housing (UEPH), BOQ, Senior Enlisted Bachelor Quarters (SEBQ)/etc., provide one single RJ-45 outlet and one CATV outlet in each room of the suite; i.e., bedroom and living room, configured per TIA/EIA-570.

### **2.3.5.3 Systems Furniture Wiring**

The designer shall specify a minimum of one systems furniture outlet per single occupancy cubicle. The designer shall specify a minimum of two systems furniture outlets per cubicle designated for servers, printers, copiers, or facsimile (FAX) machines. When systems

furniture is installed as part of the construction contract, ensure that systems furniture specifications include the American National Standards Institute (ANSI)/TIA/EIA-568-C.0 and ANSI/TIA/EIA-569-B cabling and raceway standards. Multi-user telecommunication outlet assembly (MUTOA) may be used in lieu of fixed furniture outlets. However, the distribution of work area cables from the MUTOA to the desktop shall be addressed and accounted for in the telecommunications and the furniture designs.

#### **2.3.5.4 Wireless Access Point (WAP) Cabling**

Wireless access points may be required for wireless local area networks (WLANs) in some situations and are required for wireless intrusion detection systems (WIDS). If the project management for IT has approved the inclusion of wireless in the design, the recommendations herein shall be followed. For each wireless AP outlet, the designer shall specify one CAT6 unshielded twisted pair (UTP) cable terminated on a standard 8-pin modular connector. The CAT6 cable can be used in conjunction with Power over Ethernet (PoE) to provide both power and data to the AP.

The TIA Technical Committee TR-42 has published Technical Service Bulletin 162 (TSB-162), *Telecommunications Cabling Guidelines for Wireless Access Points*. The intent of this TSB is to provide a pre-cabled grid to support 802.11 WLANs. The current guidance is to place one WAP at the center of each 55 by 55-foot square grid for up to 20 users. For grid locations with over 20 users, provide two UTP cables. The TSB is based upon International Organization for Standardization (ISO)/International Engineering Consortium (IEC) Technical Report 24704, *Information Technology Customer Premises Cabling for Wireless Access Points*. Both the TIA and ISO utilize a 39-foot (12-meter [m])-diameter circle for WAP coverage. The designer shall note that a wireless survey will be required after the completion of construction to ensure proper wireless coverage. The WAP grid provides a foundation for implementing wireless but does not eliminate final wireless design. Provide WAP outlets at a minimum of one every 25,000 square feet within each building to support the WIDS installed by the Network Enterprise Center (NEC).

#### **2.3.5.5 General Range Information Infrastructure Design**

The telecommunications sections of range construction projects shall follow the general provisions of this I3A TC for new construction and renovations. Several distinct types of information networks are present in a range environment: administrative, range control, and tactical. The administrative networks support telephone and data requirements to the occupants of the range buildings, and safety telephones. The special Range Control networks control downrange targets, sensors, and monitors and transport this information to off-site locations. The tactical networks support the unit training requirements in a field environment. Security and alarm networks may also be present.

#### **2.3.6 Utility Rooms and Closets**

All utility rooms and closets, such as electrical, mechanical, and telecommunications, shall be wired with at least one wall-mounted telecommunications outlet with a mounting lug faceplate to accommodate wall-mounted phones.

#### **2.3.7 Elevators**

In buildings with elevators, a four-pair copper cable with an eight-position modular outlet adapter shall be installed for each elevator. The exact location of the outlet assembly shall be verified with the elevator installer or contractor.

### **2.3.8 Safety, Courtesy, and Convenience**

Wall outlets shall be provided at all logical locations to support safety, courtesy, and convenience. Examples include the following:

- a. Safety: barracks hall, laundry room.
- b. Courtesy: building lobby/entrance, stairways.
- c. Convenience: break rooms, rear (unmanned) entrances.

### **2.3.9 Building Automation Systems (BAS)**

When requested by the building support systems planner, provide wall outlets at identified locations to support BAS. For example, one such outlet may be a direct digital controller (DDC) outlet for the heating, ventilation, and cooling (HVAC) system. The IS/IT designer does not have primary responsibility for identifying these circuits and shall defer to the building support systems planner. Applying a BAS requires close coordination between the IT designer and the various utilities and automated systems designers.

The TIA/EIA published TIA/EIA-862, *Building Automation Systems Cabling Standard for Commercial Buildings* in April of 2002 to specify a generic cabling system for building automation systems. The TIA/EIA-862 defines the TR and equipment rooms, BAS outlets, connection points, cross-connects, device terminations, and interconnection point details for the building utilities. The TIA/EIA-862 uses the same cabling technology and architecture as TIA/EIA-568-B, and Section 6 of TIA/EIA-862 provides coverage area planning for typical BAS links. The TIA/EIA-862 states that BAS controllers shall be located and cabling shall be terminated in the TRs serving that area. Additionally, Section 7.3 states “Because the scope of ANSI/TIA/EIA-569-B does not cover BAS cabling, additional pathway and space capacity may be required.” Actual building systems equipment shall be located in the respective mechanical rooms and shall be distinct from the TR.

## **2.4 Building Telecommunications Wiring**

The following information pertains to horizontal cable and backbone cable. All horizontal and backbone wiring shall be designed in a star-configuration as defined in TIA/EIA-568-B.1. All cables shall be terminated within TRs, Telecommunications Equipment Rooms (TERs), and work areas.

### **2.4.1 Horizontal Cable**

The following information pertains to copper, FOC, and cable run lengths.

#### **2.4.1.1 Copper Voice and Data**

For general projects, one CAT6, UTP cable shall be installed to each standard 8-pin modular connector provisioned at the outlet. For example, two 4-pair UTP cables shall be installed to a standard administrative outlet, or one 4-pair UTP cable to each single connector outlet. Copper cables shall not be split between multiple modular connectors. Only cable that has passed the Underwriters Laboratory (UL) LAN certification program and is labeled with UL-acceptable markings shall be used. Plenum cables shall be provided IAW National Fire Protection Association, Inc. (NFPA) 70, or as required by the facility safety officer or local building code. Terminations shall be provided IAW the paragraph entitled “Copper Termination” in this TG. The designer shall not use 150 ohm shielded twisted pair for new construction. CAT5-, CAT5e-, and CAT3-rated cable shall not be used in new construction or rehabilitation projects. A minimum of 3 m (10 feet) of cable slack shall be provided at



the TR/TER and 1 m (3.28 feet) in the suspended ceiling for the telecommunications outlets. Service loops are not allowed for CAT6 cabling; slack shall be stored above the accessible ceiling in its natural lay, or in the cable tray, as shown in Figure 8.

a. Copper Termination: Terminations shall be performed using an 8-pin (RJ45 type) connector, rated for the category of the installed cable. In the standard Army cabling scheme, horizontal cables are arbitrarily designated “voice” and “data” to identify and differentiate their purpose. This designation in no way indicates a difference in the capability of the cable. Copper distribution cable shall be terminated at the TR on insulation displacement cabinet or rack-mounted patch panels compliant with CAT6 for general projects. Very small projects (i.e., fewer than ten users) may use a TIA/EIA category-qualified block or backboard-mounted patch panel. Cables from the same outlet shall be terminated in the same equipment rack to either the same or separate patch panels and shall be individually identified. All terminations shall be wired to the TIA/EIA T568A configuration. The T568B wiring configurations shall not be used unless they are specifically requested by the user and approved by the authority having jurisdiction. Copper cables shall not be split between multiple modular connectors.

b. Copper Patch Cables: Copper patch cables shall be 4-pair, 24 American Wire Gauge (AWG) stranded UTP cable, rated for CAT6, with 8-pin modular connectors at each end. Provide sufficient copper patch cables, of various appropriate lengths, to terminate all copper patch panel appearances.

c. Category 6 Augmented and Category 7: CAT6A and CAT7 have not been authorized for use in the I3A because of the following unresolved issues. The TIA/EIA is the United States’ trade organization and standards body that specifies structured cabling systems. The ISO/IEC is a network of the national standards institutes of 151 countries and is the international standards body responsible for specifying structured cabling systems. The TIA committee TR-42 has approved for publication the standard for 10G Base-T cabling, or augmented CAT6 (CAT6A): ANSI/TIA/EIA-568-B.2-10. The comparable ISO/IEC standard is ISO/IEC 11801 Addendum 1 Class EA. The ISO/IEC currently has a standard for a shielded-twisted pair (STP) cabling system, designated as Class F. The TIA/EIA has not yet formed a task group to explore the standardization of ISO/IEC 11801 Class F as Category 7. CAT6A cable is 15-20 percent larger in diameter than CAT6 and CAT5e cable. USAISEC, as of the publication of this TC, has not yet been able to evaluate the impact to cable tray fill and the cost increase associated with the use of CAT6A cable. Class F (CAT7) cabling also introduces the following issues: larger cable diameter, proper grounding of shields, and non-compatible connectors.

#### **2.4.1.2 Fiber Optic Cable (FOC)**

Provide FOC to each outlet only at the specific request of the user, the DAA, or in accordance with a specific USACE standard design. As a minimum, administrative (including hospital) outlet boxes and faceplates shall be sized and configured to allow for the future installation of two strands of FOC. When the user requires FOC, install multi-mode 50/125-micron laser optimized cable. Single-mode FOC may be substituted as required by the user. Provide plenum cables IAW NFPA 70, or as required by the facility safety officer or local building code.

a. FO Termination: Terminate all FO distribution cable in cabinet/rack-mounted patch panels and at the outlet. Do not use smart terminal (ST) style adapters for new construction

unless specifically required for interface with existing equipment reused on installations. Check with the activity for specific requirements for ST adapters. The default choice for FO adapters and connectors shall be TIA/EIA “subscriber connector (SC)” type (568SC). TIA/EIA 604-3A “SC” type connectors are preferred in new systems as the international standard now accepted by the U.S. Government. Other type connectors (small-form-factor), e.g., LC, MT-RJ, VF-45, etc., may be substituted as required by the user. Provide FO adapters and connectors IAW TIA/EIA-604 FOCIS and the corresponding FOCIS for the type of connector used.

b. FO Patch Cables: Fiber optic patch cables shall use the same type of FOC and connectors as the patch panels they are interconnecting. Utilize duplex patch cables for all patch panels. Provide sufficient FO patch cables, plus 25 percent spare, of various appropriate lengths, to terminate all fiber optic patch panel (FOPP) appearances.

### **2.4.1.3 Cable Length**

Copper data cable length shall be limited to 295 feet (90 m) from patch panel termination in the TR to the data outlet termination IAW TIA/EIA-568-C.1. The linear footage between the TR and the outlet should not exceed 250 feet, as this will allow for all horizontal cabling to be within the 295-foot tested length. The average cable length, i.e., average measured length, shall be adjusted for planning purposes as required. Exception: Buildings with collapsed backbones that use FOC for all data and use copper UTP for voice-only may exceed the 295-foot length.

### **2.4.2 Backbone Cable**

The following subparagraphs pertain to copper and fiber optic backbone cable. The building backbone shall have no more than two hierarchical levels of cross-connects. Copper backbone cable shall be used only for voice circuits. Fiber optic cable shall connect the data backbone.

#### **2.4.2.1 Copper Backbone Cable**

Multi-pair voice backbone cable shall meet the requirements of Insulated Cable Engineers Association (ICEA) S-80-576 and TIA/EIA-568-B.2 for riser-rated UTP cable. Conductors shall be solid untinned copper, 24 AWG, with a nominal characteristic impedance of 100 ohms. The copper backbone cable originating in the main TR or main cross-connect shall be terminated in each TR on 110-type, insulation-displacement wiring blocks mounted on the telephone backboard. As a minimum, two backbone cable pairs for each outlet connected to the TR served by the backbone cable shall be provided. Plenum cables shall be provided IAW NFPA 70, or as directed by the facility safety officer. The ICEA specifications are listed in Appendix D and can be purchased at <http://global.ihs.com>.

#### **2.4.2.2 Copper Termination**

Termination shall be performed using 110-type connectors, rated for the installed cable. All terminations shall be wired IAW TIA/EIA T568A. Twisted pair outside plant (OSP) cable is terminated on the Protected Entrance Terminal (PET); refer to Paragraph 3. Refer also to Figures B-5 and B-6 of Appendix B for details. Cross-connects can then be placed from the PET to the first set of 110-type terminal blocks as needed. The first set of terminal blocks provides connection for all backbones and for outlets served by the main TR. For main TRs that contain a telephone distribution frame, the horizontal main distribution frame (MDF) blocks shall serve as the main cross-connects. Refer to the MDF description in the section

on Dial Central Offices (DCO) in the USAISEC *Technical Guide for Telephone Switching*, September 2006.

Post backbone communications nodes shall have an MDF for copper OSP cabling. For larger buildings with over 1200 pair copper, consider the use of an MDF frame. For example, in a three-floor building, one backbone cable shall be terminated on 110-type blocks on the same backboard as the PET; one backbone cable shall be terminated on 110-type blocks in the second floor TR; and one backbone cable shall be terminated on 110-type blocks in the third floor TR. A backbone cable connects a second set of 110-type blocks in each TR to a rack-mounted, 8-pin (RJ45 type) connector voice patch panel. This panel can be patched to the distribution patch panel which, in turn, terminates the CAT6 outlet wiring. Cross-connects can be installed by NEC/telephone personnel, and jumpers can be installed by the user/Information Mission Area (IMA) department, providing the desired connectivity between the OSP and the inside plant wiring. This design allows maximum flexibility for future moves, additions, and changes.

#### **2.4.2.3 FO Backbone Cable**

For all projects, a minimum of 12 strands single mode FOC shall be installed between the main TR or main cross-connect and each TR. Plenum cables shall be provided IAW NFPA 70, or as required by local regulations. Backbone fibers shall be fusion-spliced to factory-produced pigtailed.

**Note:** The U.S. Army Installation and Campus Area Network (ICAN) architecture dictates the use of single-mode FOC between TRs.

#### **2.4.2.4 FO Termination**

Terminate all FO backbone cable in cabinet/rack-mounted patch panels, at each end. Do not use ST style adapters for new construction unless specifically required for interface with existing equipment reused on installations. Check with the activity for specific requirements for ST adapters. The default choice for FO adapters and connectors shall be TIA/EIA “SC” type (568SC). TIA/EIA 604-3A “SC” type connectors are preferred in new systems as the international standard now accepted by the U.S. Government. Other type connectors (small-form-factor), e.g., LC, MT-RJ, VF-45, etc., may be substituted as required by the user. Provide FO adapters and connectors IAW TIA/EIA-604 FOCIS and the corresponding FOCIS for the type of connector used.

#### **2.4.3 CATV or CCTV Cable**

When CATV or CCTV requirements are identified, either a 75-ohm broadband coaxial cable or single-mode FOC system shall be installed. Refer to the paragraphs above for FOC installation. When a coaxial system is installed, care shall be taken to ensure the correct cable is used. The designer shall coordinate with the cable service provider where franchised agreements are in place. Plenum cables shall be provided IAW NFPA 70 or as directed by the facility safety officer. Table 2 lists the cable types with their corresponding distance limitations. The information in Table 2 is derived from vendor specifications (Anixter) for coaxial cable. The RG-59 cable shall not be used for CATV projects; however, RG-6 shall be used for outlet locations, and RG-11 shall be used for feeder and trunk cables.

**Table 2. Coaxial Cable**

<b>Cable</b>	<b>Distance (feet)</b>	<b>Distance (meters)</b>
RG-6	<=250	<=76
RG-11	<=400	<=122
625 Series	>400	>122

### **2.4.3.1 CATV Systems**

Community antenna TV systems are generally referred to as cable TV (CATV). The CATV systems shall be designed as follows: (1) where required, provide a complete system to be owned and maintained by the U.S. Government, including a backbone consisting of backboards/cabinets and wire and conduit with outlets and jacks in all offices, and (2) in other locations as required by the user. The system shall be designed IAW applicable TIA/EIA, Building Industry Consulting Service International (BICSI), and NFPA 70 standards, and shall be coordinated with the local CATV service provider. The system shall include a head end amplifier when required by the local provider, amplifiers, splitters, combiners, line taps, cables, outlets, tilt compensators, and all other parts, components, and equipment necessary to provide a complete and usable system. The system shall provide a high-quality signal to all outlets with a return path for interactive television and cable modem access. The system shall be designed to operate within the 5 to 1000 Megahertz (MHz) bandwidth using 1000 MHz passive devices and a minimum of 750 MHz active devices. Each outlet shall have a minimum signal level of 0 decibel millivolts (dBmV) (1000 microvolts) and a maximum of 15 dBmV at 55 and 750 MHz.

The distribution system shall be star topology with each outlet connected to a TR with a feeder cable or a drop cable and each TR connected to the head end equipment with a trunk cable.

Provide cable installed in conduit as follows:

- Backbone Cable: RG-11 or 625 series
- Feeder cable: RG-11
- Drop Cable: RG-6

### **2.4.4 Building Infrastructure**

Refer to Figures B-1 through B-8 of Appendix B for details. Figure B-9 of Appendix B provides a typical floor plan used in designing a building or office cabling system. Design a complete telecommunications pathway system that provides a flexible, re-usable, expandable pathway for premise distribution of telecommunications services throughout the facility. The required pathway system is cable tray from the TERs and TRs throughout the serving areas. The required pathway methods for distribution from the cable tray to the telecommunications outlet are conduit (preferred) and non-continuous support to a conduit stub-up. For non-continuous pathways, provide suitable supports that provide an accessible pathway for cables not supported by conduit. Non-continuous cable support shall not be used as a substitute for the cable tray.

#### 2.4.4.1 Cable Tray

A solid bottom, slotted bottom, or welded wire cable tray shall be used to provide a centralized cable management/distribution system. The cable tray shall be used for horizontal distribution to the maximum extent possible (80 percent to 90 percent of the horizontal cable length). Refer to Figure B-5 of Appendix B for details. Cable trays shall be designed to accommodate a maximum calculated fill ratio of 50 percent to a maximum inside depth of 6 inches (150 mm). For planning purposes, the maximum pathway fill shall be 25 percent. For barracks, the designer shall provide 1 square inch (650 square mm) cross-sectional area of the tray or wire way for each barracks unit, not to exceed the 50 percent fill ratio. Ladder cable trays and center spine cable trays shall not be utilized for horizontal distribution. Provide 12 inches of clearance above cable trays for future access as per TIA/EIA-569-B, Paragraph 4.5.6.2. Designers shall coordinate with other disciplines to ensure clearances can be achieved. Cable ladders shall not be used in lieu of cable trays. All metallic cable trays shall be bonded to the ground busbar. Individual sections of the cable tray run shall be bonded together.

#### 2.4.4.2 Enclosed Duct (Perimeter Raceway)

When a building design does not provide for installation of cable tray(s), enclosed square duct may be installed. Enclosed duct may also be used in place of cable tray(s) when the cable plant requires physical security. For initial design guidance, follow TIA/EIA-569-B, which states "Pathway (raceway) fill is calculated by dividing the summation of the cross-sectional area of all cables by the most restrictive cross-sectional area of the raceway system." During actual design, the designer shall plan for an optimal fill ratio of 40 percent. Under no circumstances shall a fill ratio exceed 60 percent.

#### 2.4.4.3 Conduit

Electrical metallic tubing (EMT) conduit shall be installed from the cable backbone distribution system, whether cable tray or enclosed duct, to each outlet or installed from a receptacle box into an accessible ceiling space directly above the receptacle box (stub-up). Conduit for standard outlets shall be a minimum of 1-inch (27 mm) EMT conduit. When cable tray or enclosed duct is not used, individual conduits shall be installed from the TR to each outlet. Conduit bend radii shall be coordinated with the cable bend radius. Conduit entries at outlet and junction boxes shall be arranged so that cables passing through the box shall enter and exit at opposite sides of the box. Do not use metal flex conduit for telecommunications wiring except when installing floor-access boxes in a raised floor, where the floor-access box shall be relocated within a specified service area, i.e., typically within a 15-20 foot radius. The designer and installer shall follow the maximum allowable fill as defined in Table 9 of TIA/EIA-569-B. Under no circumstances shall the designer exceed a fill capacity designated in the table. Conduits shall be bonded to either the telecommunications main grounding busbar (TMGB), to a telecommunications grounding busbar (TGB), where present, or to the cable tray. Stub-up/stub-out conduits are generally not grounded.

**Note:** Conduit shall not be used in family housing projects unless the dwelling is a high-rise apartment building.

#### 2.4.4.4 Pull Boxes

Pull boxes shall be placed in conduit runs where a continuous conduit length exceeds 100 feet or where there are more than two 90-degree bends. Pull boxes shall be placed in straight runs of conduit and shall not be used in lieu of a bend.

#### 2.4.4.5 Non-continuous Cable Supports

Provide suitable supports that provide a continuous accessible pathway for cables not supported by conduit or cable tray. Non-continuous cable supports shall not be used in place of the cable tray system. Non-continuous cable supports (J-hooks, etc.) shall be specifically designed to support category-rated cabling. Supports shall not exceed 20 cables or 50 percent of the fill capacity, whichever is less. Spacing between supports shall not exceed five feet.

#### 2.4.4.6 Open Office Wiring

a. Systems Furniture Wiring: Design systems furniture wiring connections IAW TIA/EIA-569-B.

b. Multi-user Telecommunication Outlet Assembly (MUTOA): The ANSI/TIA/EIA-568-C.1 allows MUTOAs in an open office environment. This option provides greater flexibility in an office that is frequently reconfigured. A multi-user telecommunications outlet assembly facilitates the termination of single or multiple horizontal cables in a common location within a furniture cluster or similar open area. The cables from MUTOAs to workstations in system furniture or open office configurations are long, work area cables supported by the system furniture's raceway. The MUTOAs do not include an additional connection and are limited to terminating a maximum of 12 users. Follow the guidance of ANSI/TIA/EIA-568-C.1, Section 9.3.1 for MUTOA application and design. A MUTOA may be used in lieu of fixed furniture outlets. However, the distribution of work area cables from the MUTOA to the desktop shall be addressed and accounted for in the telecommunications and the furniture designs.

c. Consolidation Point (CP): The CP is an interconnection point within the horizontal cabling using ANSI/TIA/EIA-568-B.2- or ANSI/TIA/EIA-568-C.3-compliant connecting hardware. The CP differs from the MUTOA in that the CP requires an additional connection for each horizontal cable run. The CP is limited to terminating a maximum of 12 users. Follow the guidance of ANSI/TIA/EIA-568-C.1, Section 9.3.2 for CP application and design.

d. Direct Connection: Figure B-8 of Appendix B shows two possible solutions for direct wiring to the systems furniture. This concept is one of a continuous "home run" from the TR to the furniture outlet. Continuous runs are not the recommended method and shall only be used in open office environments that cannot be readily reconfigured. Providing an end-to-end circuit, without an additional connection point, will simplify testing of the installed cable plant. Follow the guidance of ANSI/TIA/EIA-569-B, Section 8.9.1 for direct connection application and design.

e. Under-floor Conduits: Under-floor conduits shall be used only if no other alternative exists for feeding systems furniture. Under-floor conduits shall be designed and installed IAW TIA/EIA-569-B. Under-floor outlet boxes shall contain a spare conduit for future expansion.

f. Protection and Separation: The designer and implementer shall ensure the telecommunications cable is protected at all transition points and that metallic separation is provided between telecommunication and power wiring in the power pole, under-floor conduit, and/or systems furniture track IAW TIA/EIA-569-B and Article 800-52 of NFPA 70.

#### **2.4.4.7 Small Facilities and Renovations**

In new construction involving small, mixed-use (non-administrative) facilities, or in construction projects involving renovation of existing buildings, the use of “J” hooks, flexible cable trays, and alternative support systems specifically certified for CAT6 cable is permissible. All alternative telecommunications supporting structures shall be TIA/EIA-569-B-compliant and shall be designed and installed in accordance with TIA/EIA-569-B, NECA/BICSI 568, and the manufacturers’ specifications. Alternative support systems shall not exceed a 50 percent fill ratio. “J” hooks shall not exceed 20 cables or 50 percent of the fill capacity, whichever is less. Surface-mounted, non-metallic raceway may be used in renovation projects where access to the walls for installation of conduit and outlet boxes is not possible or where historical requirements prohibit the alteration of the building structure. Refer to Figure B-9 of Appendix B for details.

#### **2.4.4.8 WAPs**

The WAP cabling infrastructure shall be installed in the same manner as other telecommunications outlets within this TC. The infrastructure shall include the cable tray and conduit or J-hooks to support the CAT6 cable connected to the WAP. The use of “J” hooks, flexible cable tray(s), and alternative support systems specifically certified for CAT6 cable is permissible to support the WAPs from the cable tray. “J” hooks shall not exceed a 50 percent fill ratio. Horizontal cabling to distribution areas shall be supported in cable tray(s).

### **2.5 Telecommunications Spaces**

Provide a TER and/or TRs within each building or facility as described in this TC. Refer to Figures B-4 through B-6 of Appendix B for sample closet layouts. Provide a TER as the Main TR for each building. TIA/EIA-568-B.1 has replaced telecommunications closet (TC) with telecommunications room (TR). The engineer shall use the reference to TR to more accurately describe the space needed for telecommunications equipment. In new construction or renovation, take into account the heat load of all active electronic equipment to be installed in TRs and equipment rooms. The designer shall estimate these loads and coordinate HVAC requirements. HVAC shall be included in the design of the TR to maintain the same temperature as the adjacent office area. Follow the requirements of ANSI/TIA/EIA-569-B-1 when active electronics are to be located in TRs and equipment rooms.

#### **2.5.1 Multi-story Buildings**

In multi-story buildings, a minimum of one TR shall be located on each floor. Small facilities, i.e., air traffic control towers, firing ranges, storage facilities, etc., may use one TR for the entire facility. The designer shall consider the outlet density (Table 1) when determining whether additional TRs are required for non-administrative facilities. Collapsed backbone buildings, i.e., major command and control (C2) facilities, may reduce the number of TRs to a minimum, in line with the collapsed wiring architecture. The TRs on successive

floors shall be vertically stacked wherever possible. A minimum of four 4-in (103 mm) sleeves shall be installed between stacked closets on successive floors IAW TIA/EIA-569-B.

### **2.5.2 TR Sizing**

The TRs shall be sized IAW TIA/EIA-569-B for all new construction projects with a primarily administrative function. (Small, mixed-use facilities shall not require full compliance with TIA/EIA-569-B.) Generally, the TR shall be sized to approximately 1.1 percent of the area it serves. For example, a 10,000-square foot (1,000-square meter) area shall be served by a minimum of one 11-foot x 10-foot (3.4 m x 3 m) TR. Facilities with requirements exceeding those of the average administrative building (i.e., C2 facilities, etc.) will require TRs sized to approximately two percent or more of the area served.

Large floor areas shall be divided into “serving areas” with TRs for each serving area. Each serving area can be no larger than 10,000 square feet (1,000 square m) as stipulated in TIA/EIA-569-B. The TR sizing allowances shall be made only in cases of construction projects involving building renovation, and under most circumstances a TR shall not be smaller than 10 feet x 8 feet (3 m x 2.2 m). The designer shall avoid irregular-sized TRs, such as narrow rooms or odd shapes. TRs shall not contain windows. Adequate space shall be provided in TRs to facilitate tenant-owned telecommunications system support equipment requirements in tenant-installed freestanding cabinets or racks. Total TR space (as a percentage of the building’s area) shall be scaled upward to reflect the increased number of circuits in buildings with more than the standard number of circuits to each workspace. Smaller building TRs are covered in TIA/EIA-569-B.

The designer shall consult with the architectural designer or facilities engineer if the TR is to house Voice over Internet Protocol (VoIP), wireless, PoE, or large numbers of network switches. The architectural designer may have to compensate for the additional rack space required to house the VoIP and PoE equipment, uninterruptible power supply (UPS), and servers supporting VoIP and wireless systems.

#### **2.5.2.1 Range Considerations**

In multi-story buildings, a minimum of one TR shall be located on each floor. Small facilities, i.e., air traffic control towers, firing range towers, etc., may use one TR for the entire facility. TRs on successive floors shall be vertically stacked wherever possible. A minimum of three 4-inch rigid conduits shall be installed between stacked closets on successive floors, IAW EIA/TIA-569-B.

#### **2.5.2.2 Barracks Considerations**

Standard I3A or TIA/EIA-569-B TRs are normally too large for barracks facilities. Within barracks facilities, provide a 8-foot by 10-foot Main TR on the first floor, and provide one 6-foot by 8-foot TR on subsequent floors. Provision the barracks TRs IAW TIA/EIA-569B. Telecommunications enclosures are acceptable in barracks with non-linear designs. The Main TR shall meet the basic requirements of TIA/EIA-569-B.

### **2.5.3 Room Interior Finishes**

Floors, walls, and ceilings shall be treated to eliminate dust. Finishes shall be light in color to enhance room lighting. Dropped ceilings shall not be installed in TRs.



#### **2.5.4 Room Door**

The TR doors shall be a minimum of 36 in (1 m) wide, 80 in (2 m) tall, without doorsill or windows, hinged to open outward and shall be fitted with a lock to control access to the room. Doors shall open to the inside of the building served, except when strict controlled access is required (i.e., child development centers, youth centers, and dependent schools).

#### **2.5.5 Room Location**

The TRs shall be dedicated spaces not shared with other functions (i.e., electrical rooms, mechanical rooms, etc.). The TRs shall be located centrally in the area which they serve. The TRs shall be located in such a manner that the maximum copper cable distance from the patch panel through the structured cabling system to the furthest outlet does not exceed 295 feet. In rehabilitation projects, rooms containing transformers, air handling units, etc., shall be avoided if at all possible. If shared facilities cannot be avoided, ensure that proper electrical/telecommunications cable separations are maintained per the National Electrical Safety Code (NESC) and the National Electrical Code.

#### **2.5.6 Telephone Backboards**

A minimum of two walls shall be covered with rigidly-fixed,  $\frac{3}{4}$ -in (20 mm) A-C plywood, preferably void-free, 8 feet (2440 mm) high, capable of supporting attached equipment. Plywood shall be fire-rated. Fire-rated backboards are TIA/EIA approved and are easier to field verify than fire-retardant paint. When renovating an existing TR that does not have adequate space, the backboard shall be sized as large as possible to accommodate the PET and 110-type blocks. Refer to Figure B-5 and B-6 of Appendix B for sample backboard layouts.

#### **2.5.7 Equipment Racks**

Equipment racks shall be floor-mounted, 84 in (2100 mm) high and 19 in (475 mm) wide. located at or near the center of the TR. Equipment racks are normally 7 feet (2.1 m) high but may be adjusted for special conditions. If mounting requirements for oversized equipment are anticipated, 23 inches (580 mm) may be substituted. In narrow or crowded TRs, equipment racks may be floor-mounted adjacent to a wall but shall provide a minimum 36 inches (900 mm) of space both in front of and behind the rack and behind any installed equipment. A minimum side clearance of 24 inches (600 mm) shall be provided on end racks. Provide 100 percent spare rack capacity based on the amount of rack capacity utilized by the patch panels provided. Spare racks shall be provided for the mounting of Government-purchased and -installed LAN equipment. Wall-mounted racks may be utilized in small buildings or for small systems.

#### **2.5.8 Equipment Cabinets**

Equipment cabinets shall be used where physical security is required, to mount secure or mission-critical equipment, in circumstances where controlled access is desired, such as CATV or CCTV, distribution in barracks, or by specific user request. Equipment cabinets are normally 7 feet (2.1 m) high but may be adjusted for special conditions. Cable may be terminated in an enclosed 19-inch (475 mm) cabinet to provide enhanced protection for terminations and patching facilities. Cabinets shall provide, at a minimum, sufficient space for current and anticipated future equipment requirements. Equipment cabinets may be floor- or wall-mounted and shall be logically grouped based on the purpose of the equipment they enclose. Cooling fans shall be provided in all equipment cabinets.

### **2.5.9 UTP Patch Panels**

The UTP patch panels shall be installed in, or adjacent to, the equipment racks or cabinets which will house LAN equipment. Patch panels shall consist of eight-position modular jacks with rear-mounted, type 110 insulation displacement connectors, category-rated for the UTP system being installed and arranged in rows or columns on 19-inch (475 mm) rack-mounted panels. Nineteen-inch (475 mm) wall-mounted panels may be utilized when necessary. The jack pin/pair configuration shall be T568A per ANSI/TIA/EIA-568-B. The modular jacks shall conform to the requirements of ANSI/TIA/EIA-568-B and shall be rated for use with the installed cable plant. Provide a minimum spare capacity of 10 percent in the installed patch panels.

### **2.5.10 FOPPs**

Fiber optic patch panels shall be installed in, or adjacent to, the equipment racks or cabinets which will house LAN equipment. Patch panel connectors and couplers shall be the same type and configuration as those used elsewhere in the system. Utilize 568SC duplex connectors on 19-inch (475 mm) rack-mounted panels unless otherwise directed. Twenty-three-inch (580-mm) rack-mounted panels or minimum 12x10-in (300x250-mm) wall-mounted enclosures may be utilized when necessary, such as at small facilities in U.S. Army projects. A 3-foot (1-meter) slack loop of fiber shall be provided within each panel, and panels shall provide strain relief for cables. Patch panels shall properly provide termination, splice storage, routing, radius limiting, cable fastening, storage, and cross-connection. Provide a minimum spare capacity of 10 percent in the installed patch panels. Single-mode and multi-mode fiber optic cables shall be terminated on separate fiber optic patch panels.

### **2.5.11 Ladder, Wire Cable Tray, and Fiber Wire Way**

Ladder type or welded wire cable tray shall be used in the TR to provide distribution between the telephone backboard, equipment racks, backbone conduits, and the distribution cable tray. All metallic cable tray sections will be bonded, and the cable tray system will be grounded to the TMG or TMGB. Plastic or composite wire ways designed for fiber optic cables are permissible for the fiber optic system. Copper cabling shall not be installed in any dedicated fiber optic support systems.

### **2.5.12 Room Lighting**

Light fixtures shall be mounted a minimum of 9 feet (3 meters) above the finished floor and shall provide a minimum of 50 foot candles (500 lx) of illumination measured 3 feet (1 meter) above the finished floor.

### **2.5.13 Room Climate Control**

Each TR shall be independently climate-controlled, capable of providing year-round ambient temperature control (24 hours/day, 365 days/year) to protect all installed electronic equipment in accordance with TIA-569-B-1. Rooms shall be provided with positive atmospheric pressure to exclude dust. The designer shall consult with the mechanical designer or facilities engineer if the TR is to house blade servers, PoE, or large numbers of network switches. These devices can generate a considerable amount of heat; therefore, the mechanical designer may have to compensate for these additional loads. TRs shall not contain windows, as windows may increase heat load.

#### **2.5.14 Room Contaminants**

Information system equipment shall not be installed in spaces where moisture, liquid or gaseous spillage, or other contaminants may be present.

#### **2.5.15 Electrical Power**

Provide a dedicated electrical panel for each TR with the following minimal requirements: 120/208 volt (V), 3-phase, 30-space panel with a minimum 100-Ampere (A) total capacity. All loads within the TR shall be fed from the dedicated TR panel and not from other branch circuits. Loads shall include, but are not limited to, receptacles, servers, UPS, data switches, and HVAC systems (including exterior units for split systems). A minimum of 30A spare capacity shall be reserved in each TR panel with a minimum of four unused spaces for future loads. In accordance with TIA/EIA-569-B, lighting fixtures should not be powered from the TR's electrical panel.

Additional 110V, 20A duplex convenience receptacles shall be provided at 6 feet (1800mm) intervals around the perimeter walls of the TR.

For all projects, provide a dedicated power circuit and receptacle for each 19 inch (480 mm) rack or cabinet. These receptacles shall be installed on the bottom of or immediately adjacent to racks or cabinets to avoid equipment power cords from being placed across the TR floor. The designer shall consult with the facilities engineer to determine the necessary power requirements since the rack or cabinet may contain devices requiring 110V and/or 220V circuits. Stackable type data switches serving smaller user populations users may only require 110V, 20A circuits, while blade servers, PoE switches, or larger network switches may require multiple 110V circuits or 220V circuits.

If there is a SIPRNET room adjacent to a TR, the TR's electrical panel shall also be used and sized for all circuit requirements for the operation of the SIPRNET room.

Design note for renovations: The designer shall specify a disconnecting means as defined in the National Electrical Code, Article 645.10, if the existing panel is not collocated or in close proximity to the branch-circuit power panel.

#### **2.5.16 Voice Communications**

Each TR shall have one wall-outlet installed at or near the entry door for emergency or voice communications.

### **2.6 Grounding**

All unclassified TRs shall be connected to the building earth electrode subsystem (EES) IAW MIL-STD-188-124-B for U.S. Army installations, and as clarified in the USAISEC *Technical Guide for Lightning Protection, Power Quality Analysis, Grounding, Bonding, and Shielding (LPAGBS)*, March 2009. Information on grounding of classified facilities can be found in MIL-STD-188-124-B and Military Handbook (MIL-HDBK)-419-A. (Refer to Appendix D.) Figures 10 and 11 in Appendix C provide detailed schematics for the signal grounding system. An acceptable grounding system encompasses fault protection grounds, lightning protection grounds, signal reference grounds, and direct current (DC) power grounds (when applicable). Refer to NFPA 780 and MIL-HDBK-419-A for proper lightning protection and to NFPA 70 for proper fault protection grounding. The telecommunications designer shall review the project drawing(s) to ensure that the lightning and fault protection

grounds are addressed by the appropriate disciplines. The telecommunications designer shall ensure that the different grounding systems are not mixed within the building.

### **2.6.1 Building Earth Electrode Subsystem (EES)**

The building EES forms the primary electrical, life-safety grounding system. Typically, a grounding electrode conductor connects the main building-grounding electrode to the main electrical entrance panel or cabinet. NFPA 70, Article 250 Section III provides guidance on the grounding electrode system and conductor. End user buildings (EUBs) and area distribution nodes (ADNs) shall have a resistance-to-earth of 10 ohms or less, following MIL-STD-188-124-B. The switch manufacturers may specify the resistance-to-earth as 5 ohms or less for a telephone switch or DCO. The designer shall be aware of the proposed utilization of the facility and shall plan accordingly. Sites shall provide proper supporting documentation and specifications to the designer to support resistance-to-ground requirements more stringent than those of NFPA 70 or MIL-STD-188-124-B for non-voice switch buildings. Proper documentation includes international, national, or local codes; DOD and DA standards; or manufacturers' equipment specifications.

### **2.6.2 Cable Entrance Grounding**

All metallic shields and strength members for OSP cable entering a building shall be connected to the lightning protection ground system. The designer shall ensure that the lightning protection is IAW MIL-STD-188-124-B and NFPA 780, *Standard for the Installation of Lightning Protection Systems*, current issue.

#### **2.6.2.1 Building Point of Entrance**

The NFPA 70 defines the point of entrance as the location where "the wire or cable emerges from an external wall, from a concrete floor-slab, or from a rigid metal conduit or an intermediate metal conduit (IMC) grounded to an electrode IAW 800.100-(B)." The Telecommunications Entrance Facility (TEF) is the space housing the point of entrance of the telecommunications service.

#### **2.6.2.2 Copper Cable Entrance**

The OSP copper cable shield, armor, and metallic strength member shall be bonded to the Lightning Protection Subsystem as close to the building's point of entrance as possible with a No. 6 AWG or larger ground wire IAW NFPA 70 800.100. The designer shall use a non-bonded splice case for the transition from OSP rated cable to interior rated cable or shall indicate that the implementer shall not install the splice case carry-through bonding conductor. If the designer extends the OSP copper cable past 50 feet (15 m) IAW NFPA 70 Section 800.113, the metallic strength member shall be bonded to the lightning protection ground with a No. 6 AWG or larger copper ground wire, as close to the conduit egress point as possible.

#### **2.6.2.3 Fiber Cable Entrance**

The OSP FOC armor and metallic strength member shall be bonded to the Lightning Protection Subsystem as close to the building's point of entrance as possible with a No. 6 AWG or larger ground wire. The designer shall use a non-bonded splice case for the transition from OSP rated cable to interior rated cable or shall indicate that the implementer shall not install the splice case carry-through bonding conductor. If the designer extends the OSP fiber cable past 50 feet IAW NFPA 70 Section 770.113, the metallic strength member shall be bonded to the lightning protection ground as close to the conduit egress point as

possible with a No. 6 AWG or larger copper ground wire. If inside/outside cable is used, a cable shield isolation gap shall be incorporated.

#### **2.6.2.4 Copper Protector Block**

All OSP copper cables shall be terminated on primary protector blocks equipped with 5-pin solid state or gas protector modules. The protector blocks shall be bonded to the Lightning Protection Subsystem with a No. 6 AWG or larger copper ground wire. Blocks shall be UL-listed. The protector block shall be placed as close to the lightning protection ground as possible.

#### **2.6.3 Telecommunications Room Signal Ground**

All TRs shall have a high frequency signal ground designed IAW MIL-STD-188-124-B. The signal ground shall consist of either of the following: a ground plane in the room, a ring around the inside perimeter of the room, or a ground bus bar. The signal ground ring or bar shall be connected to the building's EES by using the building's steel girders or a ground cable if the girders are not accessible. The size of the grounding electrode conductor of a grounded or ungrounded alternating current (AC) system shall be no less than that given in the National Electrical Code, Table 250.66. The values in Table 250.66 are based on the size of the service-entrance conductors, but the grounding electrode conductor is not required to exceed 3/0 AWG copper or 250-kcmil aluminum. The telecommunications designer shall ensure that the different signal grounding system does not interconnect with the fault protection and lightning protection sub-systems within the building.

#### **2.6.4 Telecommunications Rack and Supporting Structure**

All telecommunications racks and horizontal distribution supporting structures (cable trays, ladders, conduits, and baskets) shall be bonded to the TR signal ground plane, ring, or bus bar as defined in TIA/EIA-569-B and NECA/BICSI 568. All individual sections of all metallic cable tray and ladder systems throughout the facility shall be bonded to each other and to the raceway which they support. The horizontal distribution metallic cable tray and ladder systems shall be bonded to the signal ground plane, ring, or bus bar at each TR.

### **2.7 Telecommunications System Labeling**

The following subparagraphs pertain to patch panel, distribution facilities, and outlet labeling.

#### **2.7.1 Outlet/Patch Panel Labels**

The telecommunications systems labeling shall be IAW TIA/EIA-606-A. All outlets and patch panel positions shall be labeled as to their function and with a unique identifier code. All devices, outlet locations, and designations shall also appear on the system drawings. As a minimum, the following shall be reflected in the outlet/patch panel labeling:

- Security level (if applicable)
- Room number
- Alpha or numeric designator

Labeling shall be a minimum of ¼-inch (6mm) high. Handwritten labels shall not be used for the final configuration.

### **2.7.2 Conformance to Existing Standards**

It is desirable that the labeling system conforms to any existing labeling, to the National Electrical Code standard, or, if neither exists, to the method described above. All designations shall be in standard commercial labeling. Handwritten labels shall not be used for the final configuration.

### **2.7.3 Telecommunications Outlet Labeling**

Outlet labeling shall be IAW TIA/EIA-606. Each outlet location shall be labeled with a unique designator and level of classification, in sequence starting with "A" or "1" and proceeding clockwise around the room. The left or top 8-pin (RJ-45 type) CAT6 or other compliant connector shall be designated for voice and shall be labeled "VOICE." The right or bottom 8-pin (RJ-45 type) CAT6 or other compliant connector shall be designated for data and be labeled "DATA." All LAN components in the system shall also be labeled with similar designations IAW TIA/EIA 606. For FO connections, the left or top FO connection shall be labeled "A," and the right or bottom FO connection shall be labeled "B."

### **2.7.4 Telecommunications Patch Panel Labeling**

Patch panel labeling shall be IAW TIA/EIA 606. Each position shall be labeled with a unique designator corresponding to the outlet location. In addition to TIA/EIA-606-A requirements, the top or left 8-pin (RJ-45 type) CAT6-compliant port for each outlet location shall be designated for voice and be labeled "VOICE." The bottom or right 8-pin (RJ-45 type) CAT6-compliant port for each outlet location shall be designated for data and shall be labeled "DATA." Fiber optic port labeling shall be IAW TIA/EIA 606. The left or top connection shall be labeled "A." The right or bottom connection shall be labeled "B." Color-coding IAW TIA/EIA-606-A may be added to the labeling.

### **2.7.5 Distribution System Labeling**

The distribution system, as described in TIA/EIA-606-A for pathways, shall be labeled. In addition, all transitions and changes in distribution system size and type shall be labeled. Each cabinet or rack shall be labeled at the top with a unique designation.

### **2.7.6 Grounding System**

The grounding system shall be labeled to include bus bars, bonding cables, and connections. Labels shall be provided at both ends of a grounding conductor and at each connection point.

## **2.8 Building Entrance Facility**

The building entrance facility (equipment room) is the demarcation point between the OSP cabling and the inside plant distribution cabling.

### **2.8.1 Telecommunications Entrance Facility (TEF)**

The TEF is the space housing the point of entrance of the telecommunications service. The TEF is also the space where the inter- and intra-building backbone facilities join. Telecommunication-related antenna entrances and electronic equipment may also be located in the TEF.

## **2.8.2 PETs**

### **2.8.2.1 Protector Modules**

The PET shall be equipped to protect the inside plant wiring and equipment from power surges. Refer to Paragraph 3.17 for a description of the PET. The PET shall be bonded to the EES with an insulated No. 6 AWG or larger ground wire.

### **2.8.2.2 Sheath Limitations**

If the OSP sheath distance from the building entrance point to the PET or FO connector housing location is greater than 50 cable feet (15 m), the use of EMT or a splice case with transition to riser-rated cable is required.

### **2.8.2.3 Stencils**

All PETs shall be stenciled with the terminal number and cable count.

## **2.8.3 Fiber Termination Device**

Terminate the OSP FOCs on optical patch panels. Terminate the inside plant FO backbone cables on optical patch panels in the same or adjacent equipment racks. Connect patch cables between the patch panels to provide the desired connectivity. Stencil all patch panels with their panel number and the cable count.

## **2.9 Installation Practices**

Building telecommunications infrastructure and cabling shall be installed in accordance with NECA/BICSI 568-2006, *Standard for Installing Commercial Building Telecommunications Cabling*. Workmanship shall conform to the practices described in the BICSI *Information Transport Systems Installation Methods Manual (ITSIMM)*.

## **2.10 Testing**

The designer shall specify that all telecommunications cable installed as part of a project be tested to the commercial standards for that cable system.

### **2.10.1 UTP Tests**

All metallic cable pairs shall be tested for proper identification (ID) and continuity. All opens, shorts, crosses, grounds, and reversals shall be corrected. Correct color-coding and termination of each pair shall be verified in the TR and at the outlet. Horizontal wiring shall be tested from, and including, the termination device in the TR to, and including, the modular jack in each room. Backbone wiring shall be tested end-to-end, including termination devices, from terminal block to terminal block, in the respective TRs. These tests shall be completed and all errors corrected before any other tests are begun.

### **2.10.2 CAT6 Circuits**

All CAT6 circuits shall be tested using a test set that meets the accuracy requirements of the most recent revision of the ANSI/TIA/EIA-568 standards for cabling.

### **2.10.3 Coaxial Cable**

Cable shall be tested for continuity, shorts, and opens. Characteristic impedance shall be verified over the range of intended operation. Cable length shall be verified. Cable shall be sweep-tested for attenuation over the range of intended operation.

#### **2.10.4 FOC**

All category FO circuits shall be tested using a test set that meets the accuracy requirements of the most recent revision of the ANSI/TIA/EIA-568 standards for cabling.

Unless stated otherwise, tests shall be performed from both ends of each circuit. Connectors shall be visually inspected for scratches, pits, or chips and shall be re-terminated if any of these conditions exist.

#### **2.10.5 Test Plan**

The contractor shall submit for Government review a draft test plan of all proposed cabling and equipment being installed under the project. Upon the draft's approval, the contractor shall prepare a finalized test plan to the Government. After the contractor has completed the installation and testing of the BCS, the contractor shall submit a test report for all fiber and copper cabling. A Registered Communications Distribution Designer (RCDD) shall approve both the test plan and the test report.

### **3.0 OUTSIDE PLANT TELECOMMUNICATIONS CABLING SYSTEM SPECIFICATIONS**

This section provides engineering and installation standards for the OSP infrastructure for projects that support the core enterprise information infrastructure at Army posts, camps, bases, and stations worldwide. The OSP System is designed to satisfy I3A policy IS requirements on a facility. System design, integration, and quality assurance (QA) services are also part of this documentation. The OSP shall be installed IAW the specifications referenced within this document, with modifications and clarifications provided below. Telecommunications design shall be performed and stamped by an RCDD.

#### **3.1 Classified Information Infrastructure**

Engineers engaged in the design of classified (collateral or higher) Information Infrastructure shall coordinate the infrastructure design with the CTTA and DAA responsible for that area. This TC does not replace the publications that have been produced to support the design of the Red/Black infrastructure. The engineer shall consult the following applicable documents for consideration and design guidance.

If a hardened carrier distribution system (HCDS) is implemented, as detailed in the design drawings, the HCDS shall include only the HCDS, the FOC, and a lock box or cabinet. The HCDS hand holes and maintenance holes shall be considered part of the HCDS system and are expected to be fully compliant with NSTISSI 7003, *Protected Distribution Systems (PDS)*. (Refer to Appendix D.) Specifically, the walls of the installed HCDS hand holes and/or maintenance holes shall meet or exceed the minimum requirements for encasing the HCDS.

If a CTTA review is required, and the review determines that TEMPEST countermeasures are required, the CTTA shall consider a variety of methods that can be applied to the system/facility to achieve TEMPEST security. The Red/Black guidance contained in NSTISSAM TEMPEST/2-95 (For Official Use Only (FOUO)) shall be considered by the CTTA along with other measures (e.g., TEMPEST Zoning, TEMPEST suppressed equipment and shielding) to determine the most cost-effective countermeasures to achieve TEMPEST security. Only those Red/Black criteria specifically identified by the CTTA shall



be implemented. Additional information on grounding can be found in MIL-STD-188-124-B and MIL-HDBK-419-A. (Refer to Appendix D.)

### **3.2 System Overview**

Items included in the OSP infrastructure are maintenance hole and duct; copper cable; FOC; the MDF; terminations; cable vaults; multiplexing equipment; environmentally-controlled housings; cross-connects; and copper and FO entrance cable. An overall schematic for OSP sizing of duct and cable is provided in Figure C-1 (Figure C-9 for Europe) – OSP Infrastructure Standards.

### **3.3 System Architecture**

The DOD currently employs a number of architecture topologies for the OSP design; these include ring, star, and mesh configurations. The topologies are based upon telephone or dial central offices (CO/DCO), MCNs), ADNs, and EUBs. The Army's goal is to migrate to a fiber-only cable plant, but this migration will occur over time as the voice network switches on the installation migrate from a copper-only capability to the ability to attach to either fiber or copper. The intent is to provide data and voice service at the lowest possible cost, to include total cost of ownership. Each installation and situation has to be individually analyzed to determine the best technical solution, based on the sources of investment. The DOD is spearheading the effort to converge voice and data over the same transport layer. Connectivity between nodes, and from the nodes to EUBs, provides the post transport backbone. The OSP designer shall design the OSP infrastructure to support the topology of the service that has authority over the construction project, and the design shall allow for future migration to a converged network.

#### **3.3.1 Minimum New Cable Requirements**

If the design requires installation of new cable, the following minimum requirements and Section 3.15.4.5 apply.

##### **3.3.1.1 MCN to MCN**

For planning purposes, a minimum of 24 strands of single-mode FOC between MCNs shall be used to provide load balancing, network reliability, and growth.

##### **3.3.1.2 MCN to ADN/ADN to ADN**

Design a minimum of 12 strands of single-mode FOC between the ADN and MCN. Design a minimum of 24 strands of single-mode FOC between each ADN and two adjacent physical ADN locations, or to one ADN and one MCN location.

##### **3.3.1.3 ADN to EUB**

Design a minimum of 12 strands of single-mode FOC to connect an EUB with fewer than 300 users to an ADN. Design a minimum of 24 strands of single-mode FOC to connect an EUB with between 300 and 600 users to an ADN. Design a minimum of 24 strands of single-mode FOC from an EUB with more than 600 users, to an ADN location. Include four additional strands for 100-user increments above 600 users, up to 48 strands.

#### **3.3.2 MCN/ADN Cable Paths**

The physical path of the cable from a physical ADN location to each adjacent MCN/ADN shall be directly to the connected MCN/ADN without routing through or patching through any other building, with the exception of stand-alone cable huts or vaults.

### **3.3.2.1 Copper**

Calculate the number of OSP copper pairs by multiplying the number of users, outlets, or jumpers in the building by 1.5 pairs. For new construction or renovations, multiply the number of estimated outlets by 1.5. This factor shall add in some additional pairs for faxes, modems, and special circuits. Then, size the cable to the next largest industry standard cable size. For example, a building with 85 users would require a 200-pair cable ( $85 \times 1.5 = 128 \rightarrow 200$  pair).

### **3.3.3 Redundant Cable Paths**

The backbone networks are normally constructed with a concrete-encased path so that a single cable cut cannot isolate any core node or critical node from other core nodes. The user shall present official justification for placing two physically diverse cable routes from an EUB location to a node location. Such justification shall include DOD directives and DAA certification.

## **3.4 Environmental and Historical Considerations**

Most military installations contain areas that may be affected by environmental or historical matters. Environmental hazards may include toxic waste, fuel spillage/leakage, asbestos, unexploded ordnance, etc. Wildlife preservation may be another area of concern at some sites. Compliance with historical restrictions shall require special engineering considerations (type of exterior facing, mounting of terminals, placement of pedestals, etc.). These types of situations shall be further defined in the design package. Disposal of waste materials shall be accomplished by the installer IAW the site's documented procedures for clean and/or environmentally hazardous material as specified in the design package.

### **3.4.1 Price of Conformance**

Although these issues may not appear to have a high impact on the engineering solution, the price of conformance to site restrictions may add considerable cost to the project. Special conditions shall be discussed with the NEC, and agreements shall be documented.

## **3.5 General Considerations**

### **3.5.1 Digging Permits**

The installer shall coordinate with the site Directorate of Public Works (DPW) to schedule all excavation and obtain the required digging permits. Permission (approved digging permits) shall be obtained from the site prior to the start of any excavation and/or construction.

### **3.5.2 Utility Location**

Unless otherwise stated in the design package, the NEC or DPW shall be responsible for the location and marking of utilities. The installer shall furnish a schedule of proposed excavation involving utility locations to the NEC/DPW in sufficient time to allow marking. Since each NEC/DPW has different operating requirements, the location's lead-time shall be stated in the design package. An acceptable utility mark shall be within 24 inches (600 mm) of the edge of the utility. After the utilities are located and marked, the installer is responsible for maintaining the marks until they are no longer required. The intent is that the utilities shall be located and marked only once and not after each rainfall.

### **3.5.3 Pot Holing**

The installer, either U.S. Government or contractor, is responsible for positively determining the exact location and depth of all marked utilities suspected to be within 24 inches (600 mm) of the proposed excavation or directional drilling. The installer shall make this determination by hand-digging and/or pot-holing to ensure the trenching or boring/drilling equipment does not damage the utilities. When pot-holing in road surfaces prior to boring operations, the installer shall create an initial hole no larger than 12 in x 12 in (300 mm x 300 mm). However, the installer may increase the hole's size as needed to determine the exact size and depth of the utility being located.

### **3.5.4 Slot Trenching**

With the approval of the U.S. Government, the installer may use vacuum excavation equipment to dig slot trenches. Slot trenches may be used for the installation of conduit or cable through congested areas having poorly marked utilities that cannot be avoided by adjusting cable routes.

### **3.5.5 Road Crossings**

The designer shall plan the cable route to cross the road only as necessary to serve subscribers. Such crossings shall be constructed by cutting or sawing perpendicularly across the road, by trenching perpendicularly across the road, by directional boring under the road, or by pipe pushing under the road. Aerial infrastructure shall not be used. Pavements shall not be cut where the traffic detection wires of traffic light control systems are embedded.

### **3.5.6 Cuts and Resurfaces**

Cuts shall typically extend at least 6 inches beyond either side of the trench to provide a stable base for the surface material, unless the design package directs otherwise. Roads, streets, parking lots, etc., shall only be closed for as long as is necessary to complete the work required to place the duct (including tamping the backfill) and to allow the slurry, concrete, and/or asphalt to set IAW the manufacturer's specifications.

Once the concrete or slurry has set, the surface shall be restored to its original condition within 72 hours, unless otherwise approved by the Government. Certain streets or roadways may have cutting restrictions or special requirements that require traffic be resumed as soon as possible. Contractors shall be prepared to comply with these restrictions and requirements. As an option, steel plates may be used in order to open the street to traffic while the material is curing.

#### **3.5.6.1 Dowels**

Construction joints resulting from restoration in concrete pavement over 180 mm (7 inches) thick or subjected to heavy vehicle traffic shall be doweled. Dowels may be required in thicknesses of under 7 inches (180 mm), as specified by the DPW or its equivalent.

#### **3.5.6.2 Right-of-Way Permits and Easements**

The U.S. Government will verify and document that for any crossing requiring a right-of-way permit or easement, such a permit shall be available to the installer. The installer shall be responsible for obtaining the appropriate permits and approvals in a timely manner to ensure compliance with established completion dates.

### 3.5.7 Materials

The following are materials that may be encountered.

#### 3.5.7.1 Rock

Pavement shall be not considered as rock. Rock shall be defined as the following which cannot be moved without systematic drilling and blasting or the use of a rock saw:

- a. Boulders measuring  $\frac{1}{2}$  - cubic yard ( $\text{yd}^3$ ) (0.382-cubic meter [ $\text{cm}^3$ ]) or more.
- b. Other material such as rock in ledges, bedded deposits, un-stratified masses, and conglomerate deposits.
- c. Below-ground concrete masonry structures.

Rock shall be excavated to a minimum of 4 inches (100 mm) below the trench depths required for the placement of duct bank or cable. Prior to placing the duct or cable, the installer shall backfill the rock excavation and all excess trench excavation with a cushion of sand at least 4 inches (100 mm) deep. Refer to Unified Facilities Guide Specifications (UFGS) UFGS-02300, *Earthwork*, July 2004, for additional excavation details.

#### 3.5.7.2 Unstable Soil

When wet or otherwise unstable soil that is incapable of properly supporting the conduit or maintenance hole is encountered in the trench bottom, the installer shall, at no additional cost to the U.S. Government, remove such soil to the depth required, establish a sound base, and backfill the trench to trench bottom grade with coarse sand or fine gravel. The site's U.S. Government representative shall determine whether or not the soil is unstable. Refer to UFGS-02300 for additional details on trenching. Applicable safety procedures, including Occupational Safety and Health Administration (OSHA), host nation, and local guidance shall be followed for shoring or sloping.

#### 3.5.7.3 Select Backfill

The direct buried (DB) duct system shall be buried in layers of select backfill whenever the DB duct system is not concrete-encased. The backfill shall be placed IAW commercial standards and UFGS-02300, whichever is more stringent. Prior to placing any backfill over the duct, the installer shall obtain the signature of the on-site U.S. Government Quality Control (QC)/Quality Assurance (QA) representative, signifying the acceptability of the duct placement and spacing.

#### 3.5.7.4 Flowable Fill or Slurry

The preferred method for backfilling the portion of the trench above concrete-encased duct systems under roads and parking lots is flowable fill, also known as slurry. The flowable fill shall have a compression strength rated between 50 to 100 pounds per square inch ( $\text{lb/in}^2$ ) (345 and 689 kilopascal [ $\text{kPa}$ ]). Flowable fill shall not be used as a substitute for concrete encasement. Backfilling the portion of the trench above concrete-encased duct systems under roads and parking lots with clean backfill is acceptable only with Government approval.

### 3.5.8 Backfilling

In accordance with UFGS-02300, all excavated areas around the new maintenance holes, ducts, or cables shall be backfilled with approved excavated materials consisting of earth, loam, sandy clay, sand, gravel, and soft shale, all of which shall be free from large clumps.

### **3.5.8.1 Placement**

Backfill materials shall be deposited and tamped in 6-inch (150-mm) layers until the conduit has a cover of not less than 1 foot (300 mm). The remainder of the backfill materials shall be placed into the excavation and then tamped in 1-foot (300-mm) layers. The earth shall be graded to a reasonable uniformity, mounded, and left in a uniform and neat condition.

### **3.5.8.2 Unsatisfactory Materials**

Blasted rock, large boulders, broken concrete, or pavement shall not be used as backfill materials.

### **3.5.8.3 Other Materials**

A slurry or flowable fill type backfill can be used in lieu of a tamped backfill. The slurry or flowable fill shall have a compression strength rated between 50 to 100 lb/in<sup>2</sup> (345 and 689 kPa) once it has set. Flowable fill shall not be used as a substitute for concrete encasement.

### **3.5.9 Restoration**

Restoration to the same condition as found prior to construction shall be completed within 72 hours for all areas where no additional intrusion is required. Roads, streets, parking lots, etc. shall be closed only for as long as is required to complete the work and to allow the slurry, concrete, and/or asphalt to properly set IAW the manufacturers' specifications. Installations may have cutting restrictions or special requirements for certain streets or roadways that require the contractor to reopen the road as soon as possible. Designers shall ensure that the contractors are prepared to comply with these restrictions and requirements.

#### **3.5.9.1 Improved Areas**

Roadways, walks, paved areas, and other surfaces disturbed by the installer shall be resurfaced with same type of material and to the same thickness as the original surface. Roadways shall have a minimum thickness of 3.5 inches (90 mm) of resurfaced pavement.

#### **3.5.9.2 Grass**

All grass surfaces shall be leveled and reseeded unless stated otherwise (such as the placement of sod) in the design package. For grassy areas where the installer shall have to bring heavy equipment back onto the construction site, the areas shall be rough-graded and covered with protective matting to prevent erosion. For durations longer than two weeks between construction and final disturbance, the installer shall rough-seed the area to provide cover until final grading and seeding are accomplished.

#### **3.5.9.3 Dowels**

Construction joints resulting from restoration in concrete pavement in excess of 7 inches (180 mm) thick or that is subjected to heavy vehicle traffic shall be doweled. Dowels may be required in thicknesses of fewer than 7 inches (180 mm) as specified by the DPW or equivalent.

#### **3.5.9.4 Clean-up**

Areas impacted by the installer's construction (roads, sidewalks, parking lots, etc.) shall be kept free of waste, debris, washout, etc. The installer shall clean any mud tracks built up on roads, parking lots, etc., and/or any washouts within 24 hours of occurrence or as specified by the U.S. Government.

### **3.5.10 Detection of Buried Cables and Underground Conduits**

#### **3.5.10.1 Warning Tape**

All warning tape shall be polyethylene (PE) plastic tape, a minimum width of 150 mm (6 inches), IAW the APWA Uniform Color Code, and imprinted with the words "WARNING - TELECOMMUNICATION CABLE BELOW" at not more than 1.2-m (48-inch) intervals. Minimum thickness of the tape shall be 0.10 mm (0.004 in). Tape shall have a minimum strength of 12.0 Megapascal (MPa) (1750 pounds per square inch [PSI]) lengthwise and 10.3 MPa (1500 PSI) crosswise. Tape shall be manufactured with integral wires, foil backing, or other means of enabling detection by a metal detector or underground cable detector typically used in the OSP industry when tape is buried up to 920 mm (3 feet) deep. The materials in the warning tape shall be chemically inert and will not degrade when exposed to acids, alkalis, and other destructive substances found in soil.

#### **3.5.10.2 Detection Wire for Non-metallic Piping**

Detection wire shall be insulated, single strand, solid copper with a minimum of 12 AWG coated with a minimum 30-mm PE jacket designed specifically for buried use.

#### **3.5.10.3 Detectable Warning Tape Installation**

Detectable warning tape shall be installed at a minimum of 305 mm (12 in) to 405 mm (18 in) above all new non-metallic conduit formations and DB cable installations, and it shall not exceed the manufacturer's recommended depth below grade. The tape shall be placed at a depth of no less than 310 mm (12 inches) below surface grade. Buried cables include cables placed in open trenches and cables placed by plowing.

#### **3.5.10.4 Permanent Tracer Wire**

Permanent tracer wire shall be installed in all new duct banks. One tracer wire shall be installed per duct bank. The tracer wire shall be placed as centrally as possible in the top conduit formation. When dielectric cable is installed in existing conduit formations that do not contain toneable cables, a tracer wire shall be installed along with the dielectric cable. Splices in the tracer wire shall be connected by means of a compression type connector to ensure continuity. Wire nuts shall not be used. After installation, tracer wire shall be tested to verify continuity of the tracer wire system and a report indicating continuity shall be submitted to the permitting authority as part of the as-built construction records.

### **3.6 Outside Plant Cable Placement Options**

#### **3.6.1 Building Entries**

The standard method for entering buildings with new cable is as follows:

- a. Underground cable: Underground through subsidiary or lateral conduits.
- b. Direct-buried (DB) cable: Through galvanized rigid steel conduit (RSC) stub-outs from the building.

The use of above-ground entries in lieu of underground entries is permissible with Government approval.

##### **3.6.1.1 Underground Entrance**

Typical foundation types encountered include slab-on-grade, crawl space, full basement, and deep drilling on piles. Footers encountered may be continuous or non-continuous. The footer portion of the foundation shall not be cut. Entrance conduits shall pass below footers

or through the building foundation wall. Galvanized RSC shall be placed where the entrance conduits pass through foundation walls. Annular spaces between the conduits and floors and walls shall be sealed to prevent water intrusion and shall be fire stopped as required by the National Electrical Code and local codes. Conduits shall extend between four to six inches above the finished floor or below the ceiling to aid in pulling cables. Entrance conduits shall be plugged or sealed to prevent water intrusion. Where conduits cannot be placed within 75 mm (3 in) of a wall, as shown in Figure C-7, Pedestals and Building Entrance Details (Figure C-14 for Europe), the conduits shall enter a pull box within the building.

### **3.6.1.2 Above Ground Entrances**

Entrance conduits shall not be mounted on the exteriors of buildings unless previously approved by the U.S. Government. The location of existing main telephone terminal rooms on floors above the ground level is insufficient cause to justify mounting entrance conduits on the exteriors of buildings. Where approved by the U.S. Government, the number of conduits mounted on the external walls of buildings shall be minimized. Pull boxes shall be placed where conduits penetrate external walls.

### **3.6.1.3 Pull Boxes**

Pull boxes shall be sized IAW the guidance in Article 314.28 of the National Electrical Code 2008 (NFPA 70) and the cable manufacturer's recommended cable bending radius (whichever is greater) to accommodate the fiber optic and copper cables sized for the building. A basic premise of Article 314 for a pull box used for an angle turn is that the distance between raceway entries enclosing the same conductor (cable) shall not be less than six times the metric designator (trade size) of the larger raceway. For a 4-inch conduit, that distance measured on a straight line would be 24 inches. The pull box shall be sized to accommodate the copper cable for the building even if installation of the copper cable is not part of the project. Electrical metallic tubing (EMT) shall not be used on the exteriors of buildings. Conduits mounted on the exteriors of buildings shall be hidden from view in a manner directed and approved by the U.S. Government.

### **3.6.1.4 Transition**

The transition from plastic to RSC for entrance conduits shall take place at the bottom of the trench prior to sweeps or bends to the building.

### **3.6.1.5 Demarcation Point**

For the purposes of this document, the demarcation point between OSP work/functions and inside plant work (ISP)/functions shall be the building entrance terminal (BET), also referred to as a protected entrance terminal (PET), for both copper and fiber optic cables. In other words, the OSP work shall include installing a cable into a building, installing the BET, and terminating the cable on this BET.

### **3.6.2 Underground**

Underground pathways and spaces shall be dedicated for cable placement, e.g., DB cable, buried duct/conduit, maintenance holes, hand holes, and shared space, such as a utility tunnel providing other services. An underground maintenance hole and duct system, as required due to utility congestion, high traffic, or high building density, shall be used as the preferred method for placement of outside cable plant in new construction and rehabilitation within the site cantonment areas, unless otherwise specified in the design package. For the

purposes of this document, “cantonment” is defined as that part of the military installation where the following buildings/functions are permanently located/concentrated: administrative offices, headquarters, operations buildings, motor pools, logistic facilities, troop barracks, dining facilities, garrison support functions, theaters, post exchanges, or any similar “concentration of buildings.” More than one cantonment area may be present on an installation, e.g., an airfield’s hangars, control tower, operations center, etc., may be considered a separate cantonment area. Family housing, rail heads, and maintenance facilities may or may not be included in the cantonment area. Ranges, training areas, drop zones, impact areas, ammunition storage areas, recreation areas, etc., are not part of the cantonment area. The existing maintenance hole and duct system shall be leveraged to the maximum extent possible by repairing and reusing damaged existing conduit runs and maintenance holes (where economically feasible) and by reinforcing the existing full conduit runs with new conduits. With U.S. Government approval, existing maintenance holes may be overbuilt to an adequate size.

### **3.6.3 Direct Buried**

The DB cable plant system is the preferred method for placement in less congested areas.

### **3.6.4 Aerial**

Aerial cable plant systems are not a preferred solution but may be used as specified in the design package. Exceptions may include range cables or other long runs through undeveloped areas; locations where underground systems cannot be installed; or locations where compliance with local mandates is required. The desired or required reliability (i.e., “five nines” or 99.999% reliability) of some communications systems may preclude the use of aerial pathways. Aerial pathways and spaces may consist of poles, messenger wire, anchoring guy wires, splice closures, and terminals.

### **3.6.5 Pier and Bridge Telecommunications**

Pier and bridge telecommunication systems shall be installed in ducts; pull boxes shall be placed at critical points. These critical points may be where the structure has a change of direction, where access for ship berths is required, or at a 90-degree bend. Duct expansion joints are required at each pier expansion joint and where the conduit enters a distribution point approximately 5 feet (1.5 m) from the point of entrance. For conduit systems on piers, the designer shall use polyvinyl chloride (PVC)-covered Galvanized Iron Pipe (GIP) or “red thread” fiberglass conduit and shall employ approved hardware hangers.

## **3.7 Underground (Maintenance Holes, Cable Vaults, and Ducts)**

Supporting documentation for the design and construction of maintenance holes, cable vaults, and duct systems is found in ANSI/TIA/EIA-758, *BICSI Customer Owned Outside Plant Telecommunications Cabling Standard*; Rural Utilities Service (RUS) Bulletin 1751F-643/RUS Form 515C; RUS Bulletin 1751F-644; and RUS Bulletin 1753F-151. Refer to Table D-1 for the complete listings of these references.

### **3.7.1 Maintenance Holes**

Maintenance holes are used to facilitate the placement and splicing of cables. Telecommunications maintenance holes shall not be shared with electrical installations other than those needed for the telecommunications equipment.



Maintenance holes are reinforced concrete units provided with a removable lid that permits internal access to the housed components via ladder or rungs. The maintenance holes accommodate cables, splice closures, racking systems, and low-voltage electronic equipment. Maintenance holes shall be equipped with corrosion-resistant pulling irons and cable racks that are grounded and with a sump for drainage. The quality of the concrete pour and the construction of the maintenance hole shall be such that the rebar or visible rock shall not be seen in the surface of a maintenance hole wall. In other words, the pour shall not have any voids.

Maintenance holes shall be installed on a leveled, crushed, washed gravel base of sufficient depth, i.e., a minimum thickness of 6 inches (150 mm) under the entire maintenance hole, to allow for drainage and stability. Where maintenance holes are installed in roadways, the structure and lid (cover) shall support heavy vehicular traffic. Refer to Figure C-4 (Figure C-11 for Europe), Typical Maintenance Hole, for additional details.

### **3.7.1.1 Type**

The preferred maintenance hole is a pre-cast reinforced concrete, splayed or non-splayed, multi-directional type with cast-in single or multiple plastic terminators to accept the conduits. Thin concrete knockout sections may be provided for terminating multiple-bore conduits. The preferred maintenance hole interior size is 12 feet x 6 feet x 7 feet (3.7 m [length] x 1.8 m [width] x 2 m [height]). Other sizes may be used only with U.S. Government approval. Splayed maintenance holes shall be provided near DCOs and remote switching units (RSU), where future duct expansion is expected. Maintenance holes shall have a load rating of HS-20 for heavy vehicular traffic.

### **3.7.1.2 Basic Layout**

Maintenance holes in main or lateral duct runs shall be placed as defined below. Measurements between maintenance holes are from lid-to-lid (center-to-center) (C/C), unless otherwise indicated. Measurements from maintenance holes to buildings, to pedestals, to riser poles, etc., are from the maintenance hole lid to the outside wall, bottom of pole, etc. (center-to-point). New maintenance holes shall be placed to support the locations of junction points, offsets, load points, and curvature in the duct line.

The spacing of access points (maintenance holes or hand holes) in a maintenance hole and duct system is determined by the environment (containment area or range area); media to be installed (copper cables only, copper and fiber cables, or fiber cables only); proximity to cable origination points (DCO or nodes); and allowable pulling tension of the media. The following are a few design guidelines:

- a. Maintenance holes and hand holes in duct systems in cantonment areas that have or will potentially have multiple cables (copper and fiber) shall not be spaced more than 600 feet apart.
- b. Maintenance holes and hand holes in duct systems in sparsely populated areas or at the ends of runs that will contain only fiber or small copper cables (not to exceed 100 pair copper) can be spaced up to 1000 feet apart.
- c. Maintenance holes and hand holes in duct systems in sparsely populated areas or at the ends of runs that will contain only fiber cables can be spaced up to 2000 feet apart.
- d. Maintenance holes and hand holes used as splice points in direct buried systems (typically in ranges) can be placed as required (typically at the ends of reel splices).

The following are caveats:

- a. Do not use a hand hole for copper cable splice points or for more than one fiber splice case.
- b. Do not place maintenance holes or hand holes so far apart as to exceed the manufacturer's recommended pulling tension for the cables.
- c. Maintenance holes and hand holes may be placed closer together to accommodate distribution designs.
- d. The maintenance holes near a DCO or node need to be full-sized (6 feet x 12 feet x 7 feet H) due to existing or potential multiple cables and multiple splice cases.
- e. Any deviations from these guidelines require prior approval of the U.S. Government.

### **3.7.1.3 Accessories**

Each new maintenance hole shall be equipped with a lid, sump, pulling-in irons, ground rod, bonding ribbon, cable racks, and hooks. Accessories shall be designed for use in a telecommunications maintenance hole. Cable hooks shall be placed IAW RUS Bulletin 1751F-643, RUS Bulletin 1753F-151, and the Lucent Technologies Document 900-200-318, *Outside Plant Engineering Handbook*, October 1996, Practices 632-305-215 and 919-240-300, to support the weight of the cable and splice case.

a. **Maintenance Hole Lids:** A maintenance hole shall include a point of egress for maintenance personnel. The maintenance hole lid shall be circular and not less than 30 inches (765 mm) in diameter and shall not violate the H-20 load rating of the maintenance hole. Additional lids or oversized lids may be provided for maintenance holes with special uses, i.e., oversized maintenance holes, maintenance holes containing carrier or loading equipment, or maintenance holes located outside a DCO. The lid shall fit in a steel ring or frame and be equipped with a concrete collar to be at grade level, as required. The frame and collar shall be attached to the maintenance hole IAW the manufacturer's instructions, but as a minimum, the lid shall form a watertight seal and shall resist lateral movement if accidentally bumped. When stacked, collar sections shall be precisely matched with each other to prevent snagging of personnel or equipment when entering or exiting the maintenance hole. There shall be no overhangs between collar sections.

b. **Locking Covers:** The first maintenance hole outside a DCO or wire node; maintenance holes at critical junctions; or maintenance holes equipped with carrier equipment will have a lockable cover. Additional maintenance holes requiring lockable covers may be identified as such in the Statement of Work (SOW)/Engineering Design Plan (EDP). The preferred lockable lid cover is one that utilizes a lever and clamp mechanism placed into a receiver that is installed into the cover. The mechanism will allow the cover to be replaced without indexing the cover to the frame. When locked, the mechanism will be flush with the frame surface, minimizing the potential for the cover to be dislodged. The bolt used to secure the cover is available in many configurations and can only be turned with a socket provided by the manufacturer. The U.S. Government will select the bolt configuration. A disposable tamper-evident plastic cap snaps into the lock body covering the recessed bolt head, keeping dirt and debris out of the bolt area. An alternative means of securing the maintenance hole utilizes an inner, water-resistant cover that can be locked by means of a General Services Administration (GSA)-approved, changeable combination lock. The U.S. Government will provide the locks.

c. Sump: A sump shall be cast into the floor of the maintenance hole. The floor shall slope toward the sump to provide drainage into the sump from all areas. The sump shall be approximately 13 in x 13 in (330 mm x 330 mm), or a 13-in (330-mm) diameter circle, and shall be 4 inches (100 mm) deep, covered with a removable perforated or punched plate to permit drainage. The cover shall be fastened to the housing by a chain, rope, or hinge.

d. Pulling-in Irons: Cable pulling-in irons shall be installed on the wall opposite each main conduit entrance location, 3½ to 9 inches (90-230 mm) from the floor of the maintenance hole and in line with the conduit entrance. The pulling-in irons shall be placed and embedded during the construction of the maintenance hole wall.

e. Grounding in maintenance holes: All new maintenance holes installed shall include ground rods and bonding ribbon. The ground rod and bonding ribbon may only be omitted when the following conditions apply:

(1) A maintenance hole has been designed and constructed with an integral ground system with all ironwork bonded together.

(2) The maintenance hole bears a visible manufacturer's label certifying that the structure contains an integral ground system.

(3) U.S. Government approval has been obtained.

All existing maintenance holes that require new splices, or those where existing splices are opened, shall be bonded and grounded. If no bonding ribbon and ground rod exist, they shall be installed, and all other existing splice cases shall be bonded and grounded. New cables installed in maintenance hole and conduit systems shall be bonded and grounded a minimum of every 1,000 feet (305 m). In accordance with RUS 1751F-802 and National Electrical Code, Article 250, the resistance for OSP grounding shall be nominally 25 ohms ( $\Omega$ ).

f. Ground Rod: A ground rod of iron or steel that is galvanized or copper-clad and is a minimum of 5/8-in (16-mm) in diameter and a minimum of 9 feet (2.75 m) long shall be installed in the floor of each new maintenance hole. Four inches (100-mm) of the rod, plus or minus ½ inch, (1.3 mm) shall extend above the finished floor level. The rod shall not enter the maintenance hole more than 3 inches (80 mm) or less than 2 inches (50 mm) from the vertical surface of the adjacent wall. All maintenance hole splices shall be bonded to the maintenance hole ground. In existing maintenance holes, new ground rods and/or bonding ribbon shall be designed at each splice location if neither presently exists. The ground rod shall be installed and bonded IAW the National Electrical Code, Article 250.

g. Bonding Ribbon: A bonding ribbon shall be installed in all new maintenance holes. The bonding ribbon shall be attached to all rack anchors and be pre-cast into the maintenance holes. The bonding ribbon shall be installed around the interior of each maintenance hole so that splice cases can be bonded to it.

h. Hardware: A minimum of five cable racks, each containing at least 47 hook spaces mounted vertically, shall be provided on each long wall. Two of the cable racks shall be installed flush to the wall, and three shall be installed with standoffs to create splice bays. Refer to Figure C-4 (Figure C-11 for Europe). End wall maintenance hole racks shall be provided at the T-end of multi-directional maintenance holes. Corner racks shall be provided at the in-line end of the maintenance hole. Offset-cable racks shall set out from the wall a minimum of 3 inches (80 mm). Each cable rack shall be equipped with hooks to

support all existing or new cables. If there are no existing/new cables, each rack shall be equipped with two cable hooks (minimum length 7½ inches, or 190 mm). All racks and hooks shall be of galvanized metal. A device or method to lock the hooks to the rack (i.e., Step Locks) shall be provided for the hooks that will support splice cases. Figure C-4 (Figure C-11 for Europe), Typical Maintenance Hole, shows a typical rack installation.

i. Water Resistance: Reasonable efforts shall be made to prevent water from entering a telecommunications maintenance hole. The manufacturer's instructions for installing a maintenance hole shall be followed. As a minimum, the following guidance shall apply as long as it does not violate a manufacturer's recommendations or warranty. Additional requirements may be identified in the design package.

(1) A water-resistant gasket or seal shall be placed between the sections of pre-cast maintenance holes.

(2) Water-resistant gaskets or seals shall be placed between the lid frames, collars, and maintenance hole tops.

(3) The area around ducts penetrating the maintenance hole walls shall be sealed with a permanent, water-resistant material.

(4) Vacant ducts shall be sealed with a mechanical, screw-type, reusable duct plug.

(5) Ducts containing cables shall be sealed with water-blocking foam or another manufacturer-recommended sealant designed for this purpose.

(6) Ducts containing innerduct or multi-cell fabric mesh innerduct shall be sealed with the manufacturer's recommended materials or methods.

#### **3.7.1.4 Duct Assignment and Cable Racking**

Duct assignment and cable racking shall be engineered and installed IAW the Lucent Technologies Document 900-200-318, *Outside Plant Engineering Handbook*, Practices 632-305-215 and 919-240-300, and standard drawings, unless otherwise directed in the design package. Copper cables shall be racked to the maintenance hole sidewalls in such a manner so as to make the best use of the available wall space. When placing cables, care shall be taken to avoid blocking ducts in the sidewalls or access to splice cases. Fiber optic cables shall be engineered with a 20-foot (6-m) service loop installed in each pull-through maintenance hole or a 50-foot (15-m) splice loop installed on each side of a splice case. The service and splice slack shall be coiled and lightly secured in loops that do not violate the bending radius. The slack shall be placed in the maintenance hole in such a manner that the cables are out of the way and not wrapped around other cables or lying on the floor.

Main conduits entering poured-in-place or precast maintenance holes shall be located in the lower portion of the end wall and centered between end walls. Conduits entering side walls shall be located a minimum of 4 inches (102 mm) from the end walls which are located farthest from the central office or serving node. Clearances of 12 inches (305 mm) shall be maintained between main conduit formations and the roofs or floors of maintenance holes. Unless the construction drawings indicate otherwise, wall recesses shall be provided at conduit entrances. Subsidiary conduits entering maintenance holes shall be located to provide clearances of 4 inches (102 mm) from roofs and adjacent walls.

### **3.7.1.5 Stenciling**

All new maintenance holes shall be stenciled with a number designated by the NEC.

### **3.7.1.6 Depth of Cover**

A minimum of 24 inches (600 mm) of top cover shall be provided above the top of the maintenance hole.

## **3.7.2 Hand Holes**

Hand holes are reinforced concrete units provided with a lid that permits internal access to the housed components. Hand holes are typically used as pull points for small-diameter cables used for building access. A hand hole shall not be used in place of a maintenance hole in lateral runs or in a main conduit system. Hand holes shall not be used in runs of more than three 4-inch conduits. Hand holes shall not be used for splicing cables without prior U.S. Government approval. Telecommunications hand holes shall not be shared with electrical installations. The acceptable hand hole size is 4 feet x 4 feet x 4 feet (1.2 m x 1.2 m x 1.2.m). Hand holes installed where vehicular traffic may be present shall be load-rated as H-20 and shall be equipped with round maintenance hole lids.

### **3.7.2.1 Accessories**

Each new hand hole shall be equipped with a lid, pull irons, cable racks, and hooks designed for use in telecommunications systems. Cable hooks shall be placed to support the weight of the cable.

### **3.7.2.2 Stencil**

All new hand holes shall be stenciled with a number designated by the NEC.

## **3.7.3 Cable Vault**

A schematic of an MDF and cable vault is provided in Figure C-8 (Figure C-15 for Europe), MDF and Cable Vault Schematic.

### **3.7.3.1 Size**

The cable vault shall be sized to provide for future projected growth. As a minimum, it shall extend the entire length of the MDF.

### **3.7.3.2 Layout**

A center rack shall be provided for splicing the tip cables to the OSP cables. However, wall racking, if cited in the design package, is permissible for small to medium central offices. The vault shall be designed to allow ample space for splicing of the cables. For planning, a typical vault splice is 1 foot x 3 feet (300 m x 900 m).

## **3.7.4 Conduit/Duct**

Underground conduit structures consist of pathways for the placement of telecommunications cable between points of access. Underground installation of ducts/conduits shall be achieved by trenching, boring, or plowing.

- a. Examples of conduit types include the following:
  - Encased Buried (EB)-20 – for encasement in concrete (shall meet NEMA Standard TC-6)
  - EB-35 – for encasement in concrete (shall meet NEMA Standard TC-8)

- DB-100 – for direct burial or encasement in concrete
- DB-120 – for direct burial or encasement in concrete (shall meet NEMA Standard TC-8)
- Rigid Nonmetallic Conduit Schedule 40 – for direct burial or encasement in concrete (shall meet NEMA Standard TC-2)
- Rigid Nonmetallic Conduit Schedule 80 – for direct burial or encasement in concrete (shall meet NEMA Standard TC-2)
- Multiple Plastic Duct (MPD) – for direct burial or installation in conduit
- Rigid Metallic Conduit – for direct burial or encasement in concrete
- Intermediate Metallic Conduit – for direct burial or encasement in concrete
- Fiberglass Duct – for direct burial or encasement in concrete
- Innerduct PE – for direct burial or installation in conduit
- Innerduct PVC – for direct burial or installation in conduit
- High Density Polyethylene (HDPE) – for directional drilling

b. Nonmetallic conduits shall be encased in concrete of minimum 3,000 lb/in<sup>2</sup> (20,700 kPa) compressive strength where vehicular traffic (i.e., automotive, railway) is above the pathway or where a bend or sweep is placed.

c. Spacers shall be used to properly support ducts that are to be concrete-encased and shall be installed IAW the manufacturer's specifications. If the manufacturer's specifications are unknown, a spacer shall be installed a minimum of one spacer every 10 feet (3 m). Ducts supplied in 20-foot (6.1-m) lengths require spacers every 5 feet (1.5 m). The duct shall not be damaged, cracked, or crushed prior to or during installation. Conduit systems not encased in concrete shall be installed in layers with backfill installed around and between the ducts. To provide integrity of orientation, spacers shall be used where conduits are not encased in concrete. Construction vehicles shall not be driven over DB conduits.

d. Ensure the integrity of the orientation of the duct bank between maintenance holes. Do not allow the ducts to twist or tangle between maintenance holes.

e. Ducts that are classified as stub-outs shall be plugged inside the maintenance hole or building; tagged, identifying them as stub-outs; and capped on the far end to prevent soil and water from entering the duct. A locator ball may be placed at the stub-out location to facilitate future locating of the stub-out.

f. The duct system shall be concrete-encased in all main cantonment areas unless otherwise specified in the EDP/PWS. At a minimum, the duct system shall be encased where any bend/sweep exceeds 10 degrees in any direction; in any stream/drainage area subject to washing out; and in major construction zones. Ducts placed under paved road surfaces and certain heavy traffic, non-surfaced roads shall be protected by one of the following methods: Concrete-encased duct, galvanized RSC, steel pipe casings, or directional boring of HDPE ducts (when done IAW Paragraph 3.6.9).

#### **3.7.4.1 Ducts Installed in Trenches**

The type of duct for new installation shall be PVC, Schedule EB, Schedule DB, or Schedule 40. Schedule EB duct shall be used **only** if the duct is encased in concrete. Schedule DB or Schedule 40 duct shall be used for applications where the duct is DB or encased in concrete.

### 3.7.4.2 Joints and Connectors

Ducts shall be joined in such a manner as to be soil tight. Joints shall form a sufficiently smooth interior surface between joining sections so that cables shall not be damaged when pulled past the joint. Joints between dissimilar types of ducts (PVC, HDPE, galvanized steel pipe (GSP), EB, DB, etc.) shall use the appropriate connectors designed for the purpose of providing a seal between the ducts and preventing damage to cables pulled through these joints. All joint surfaces shall be prepared IAW the manufacturer's instructions, and, at a minimum, the mating surfaces shall be wiped clean before they are joined.

### 3.7.4.3 Bends and Sweeps

Accomplish changes in the direction of runs exceeding a total of 10 degrees, either vertically or horizontally, by long sweeping bends having a minimum radius of 20 feet (6.1 m). Long sweeps may be made up of one or more curved or straight sections and/or combinations thereof. Bends made manually shall not reduce the internal diameter of the conduit. There shall be no more than the equivalent of two 90-degree bends (180 degrees total) between pull points, including offsets and kicks with a curvature radius of less than 100 feet (30 m). Back-to-back 90-degree bends shall be avoided. The following definitions apply:

- a. 90-degree bend: Any radius bend in a piece of pipe that changes the direction of the pipe by 90 degrees.
- b. Kick: A bend in a piece of pipe, usually less than 45 degrees, made to change the direction of the pipe.
- c. Offset: Two bends usually having the same degree of bend, made to avoid an obstruction blocking the run of the pipe.
- d. 90-degree sweep: A bend that exceeds the manufacturer's standard size 90-degree bend (e.g., 24 inches (600 mm) is standard for 4-inch (100-mm) conduit).
- e. Back-to-back 90-degree bend: Any two 90-degree bends placed closer together than 10 feet (3 m) in a conduit run.

Utilize radius-manufactured bends to the maximum extent possible. Manufactured bends may be used on subsidiary/lateral conduits at the riser pole or building entrance. Manufactured bends shall have a minimum radius of 10 times the internal diameter of the conduit IAW Chapter 9 of the National Electrical Code and the ANSI/TIA/EIA-758 standard.

Bends and sweeps shall be concrete-encased to protect the duct from the pressures developed while pulling cables. Where a duct enters a building and sweeps up through a floor slab, galvanized RSC shall be used. For ducts transitioning from the lower duct window of a maintenance hole to the nominal trench depth, the transition shall be accomplished in no less than 30 linear feet (9.1 m) from the maintenance hole in order to reduce the radius of the bends. The duct shall be concrete-encased in the transition area.

### 3.7.4.4 Section Lengths

Without prior U.S. Government approval, the section length of conduit shall not exceed 600 feet (183 m) between pulling points in main conduit runs. The section length of duct is limited mainly by the size of the cable to be pulled into it and by the number of bends it shall contain. Table 3 lists the maximum section lengths.

**Table 3. Maximum Length of Conduit Containing Bends**

Cable Diameter mm (in)	Limited Lengths of Duct*		
	One 90-degree bend (m) (ft)	Two 90-degree bends (m) (ft)	Three 90-degree bends (m) (ft)
25.4 (1.0)	182 (600)	107 (350)	76.2 (250)
30.5 (1.2)	152 (500)	91.4 (300)	
35.6 (1.4)	122 (400)	83.8 (275)	
40.6 (1.6)	107 (350)	76.2 (250)	
45.7 (1.8)	91.4 (300)	61 (200)	
56 (2.2)	76.2 (250)	45.7 (150)	
66 (2.6) or greater	61 (200)	45.7 (150)	

\*Bends may be vertical or horizontal. Reverse curves and the use of three 90-degree bends shall be avoided.

### 3.7.4.5 Minimum Duct Bank Sizing

The minimum sizing for new duct banks is listed below. The total number of conduits required shall be determined, including existing conduits, conduits installed by this effort, and known future requirements, along with 50 percent of this total for spares.

a. Ducts between the cable vault and the first maintenance hole shall be based upon the size of the switch, the number of outside cable pairs served from the switch location, the FO requirements, and future growth.

b. A main duct run includes the maintenance holes and ducts from a DCO or node and provides the pathways for large feeder cables and/or core FOCs. New main duct runs shall consist of a minimum of 6-way, 4-inch duct banks. In Europe, ducts sized at a minimum of 125 mm shall be used. One of the ducts shall be equipped with four integrated 30-mm (1.19-inch) (minimum) sub-ducts or four 51-mm (2-inch) conduits connected into an assembly.

c. A lateral duct run is defined as a minor branch run from the main duct run between maintenance holes. New lateral duct runs shall be a minimum of four-way, 4-inch duct banks. In Europe, ducts sized at a minimum of 125 mm shall be used. One of the ducts shall be equipped with four integrated 30-mm (1.19-inch) (minimum) sub-ducts or four 51-mm (2-inch) conduits connected into an assembly.

d. Entrance ducts are defined as ducts from a maintenance hole or hand hole to an EUB. New EUB entrance ducts shall be a minimum of two-way, 4-inch duct banks. In Europe, ducts sized at a minimum of 125 mm shall be used. One of the ducts shall be equipped with four integrated 30-mm (1.19-inch) (minimum) sub-ducts or four 51-mm (2-inch) conduits connected into an assembly.

e. Entrance conduits in minor buildings, as listed in the design package, shall be a minimum of one-way, 4-inch (100-mm) ducts if the entrance cables are less than one inch (25-mm) in diameter and if less than 40 percent of the duct area shall be used.

f. The term “subsidiary duct” is commonly used to refer to any minor or spur conduit route branching off from the main duct run. Subsidiary ducts may serve the purpose of either lateral or entrance ducts as defined above and should be sized accordingly.

g. The lengths of ducts entering buildings or terminating at riser poles shall not be greater than the values specified in Table 3 without prior U.S. Government approval.



h. In accordance with the National Electrical Code, cables entering a building from the outside and not rated for inside plant use may not extend beyond 50 feet (15 m) from the cable’s point of entry into the building. The point of entry is defined as the point at which the cable penetrates the exterior wall or floor. The point of entry for metallic cables may be extended beyond the 50-foot (15-m) limitation by using either rigid metal conduit (RMC) or IMC, both of which shall be grounded. Electrical metallic tubing shall not be used for extending the point of entry of metallic cables (transmission media, shields, or strength members). The point of entry for non-metallic cables may be extended using EMT or PVC. Refer to the National Electrical Code, Sections 770.50 and 800.50.

**Table 4. Extending the Point of Entrance**

Cable Types		Extend Point of Entrance with:			
Non-Conductive	Indoor Listed	PVC	EMT	IMC	RMC
No	No	No	No	Yes	Yes
No	Yes	No	No	Yes	Yes
Yes	Yes	N/A	N/A	N/A	N/A
Yes	No	Yes	Yes	Yes	Yes

**3.7.4.6 Duct Installation Guidelines**

a. Depth of cover: At least 24 inches (600 mm) of cover are required above the top of the duct bank. At least 18 inches (457 mm) of cover are required under roads or sidewalks (if duct is concrete-encased). For ducts installed in solid rock, the cover shall consist of at least 150 mm (6 inches) of concrete. If rock is encountered below grade, the minimum cover above the concrete-encased duct shall be 12 inches (300 mm). Refer to Figure C-3 (Figure C-10 for Europe), Conduit Placement/Cut and Resurface, for details. The cover or fill shall be compacted IAW UFGS-02300.

b. Trench width: The installer shall engineer the trench width to the minimum width required to support the size of the duct bank being installed. When installing ducts, the trench width depends on the number of ducts, size of ducts, arrangement of ducts, and space around ducts (at least 2 inches [50 mm]). Additional width may be required to work in deep trenches or with large-count duct banks. Shoring of walls or sloping shall be performed as required by the OSHA and/or local requirements. The trench width for DB conduit shall be of sufficient width to permit tamping of dirt on the sides of the conduit formation. Refer to Figure C-3 (Figure C-10 for Europe), Conduit Placement/Cut and Resurface, for details.

c. Concrete encasement: In new construction (BRAC/MCA), the duct system shall be concrete-encased in all main cantonment areas. At a minimum, the duct system shall be encased under all traffic areas; where any bend/sweep exceeds 10 degrees in any direction; in any stream/drainage area subject to washing out; and in major construction zones. Concrete encasement of the ducts for a “core path” shall be required where no alternate paths are present. Concrete-encased duct, galvanized RSC, pipe casings, or HDPE duct placed by horizontal directional drilling (HDD) shall also be placed under all paved road surfaces and certain heavy traffic non-surfaced roads as documented in the design package. Concrete forms shall be utilized when encasing ducts into a maintenance hole to limit blockage of empty duct knock-outs or windows in the maintenance hole. The encasement/pipe shall be extended a minimum of 6 feet (1.8 m) beyond the roadbed for all

road crossings. The installer shall use only one brand of Portland cement that conforms to American Society for Testing and Materials (ASTM) C 150. The concrete shall be a wet type mix and shall be placed in such a manner as to ensure the concrete completely surrounds all ducts and that no air or voids are trapped in the mix. (A dry bag of ready-mix type cement that has not been mixed with water but has been dumped in the trench is not acceptable.) Prior to pouring any concrete over the duct, the installer shall obtain the signature of the on-site U.S. Government QC/QA representative to signify the acceptability of the duct placement and spacing. Concrete used to encase conduits shall be a minimum compressive strength of 20,700 kPa (3,000 PSI).

d. Duct placement: New ducts shall be swept down and installed in the lowest available duct positions within the lowest available duct window in the maintenance hole. Additional ducts required in the future shall be placed on top of the existing ducts. Ducts placed under this project shall not prevent placement of future ducts in the upper duct positions. Conduits shall terminate in bell ends or duct terminators at the point of entrance into the maintenance holes and buildings. Main conduits entering poured-in-place or precast maintenance holes shall be located in the lower portion of the end wall and centered between end walls. Conduits entering side walls shall be located a minimum of 4 inches (102 mm) from the end walls that are located farthest from the central office or serving node. Clearances of 12 inches (305 mm) should be maintained between main conduit formations and the roofs or floors of maintenance holes. Unless the construction drawings indicate otherwise, wall recesses shall be provided at conduit entrances. Subsidiary conduits entering maintenance holes shall be located to provide clearances of 4 inches (102 mm) from roofs and adjacent walls.

e. Rerouting of existing ducts: Existing ducts shall be joined to new maintenance holes (pre-cast or cast-in-place) by rerouting the designated ducts from the demolished or abandoned maintenance hole to the new maintenance hole. Rerouting shall begin a sufficient distance from the old maintenance hole, at least 30 feet, to allow for standard bending radius and pulling tension. Continuity of operations on the affected cables shall be maintained during the duct rerouting actions.

f. Reinforcement of existing ducts: New ducts installed to reinforce an existing duct bank shall be placed above the existing duct bank if the minimum top cover of 24 inches (600 mm) can be maintained. If sufficient top cover is not available, the new duct shall be placed beside the existing duct bank.

g. Pull string/rope/tape: After ducts are mandrelled to verify their integrity, a pull string, pull rope, or pull tape rated at not less than 200-lbs (890-newton (N)) tensile strength shall be installed in each new conduit and innerduct/sub-duct. A minimum of 5 feet (1.5 m) shall be provided at each end of the conduit. The string/rope/tape shall be coiled and secured at each end in such a manner as to prevent it from being accidentally pulled back into the duct.

h. Plugs: All ducts, sub-ducts, and, innerducts, whether main or subsidiary runs, shall be plugged using universal duct plugs in maintenance holes, hand holes, and building entrances. Foam sealant is not acceptable in a building. Outdoor-rated ducts (sub-ducts, etc) entering a building will be fire-stopped IAW the National Electrical Code, local codes, and the manufacturer's instructions.

i. Duct seals: The area between the entrance conduits and the penetrated floors and/or walls of a building or maintenance hole shall be sealed to be waterproof or shall be fire-stopped as appropriate. Use of hydraulic cement between the duct and wall is acceptable for waterproofing the duct entry point.

j. Toneable duct: In a new duct bank containing only FOC, one duct shall contain an imbedded or installed toneable metallic wire for duct locates.

k. Duct tie-downs: Duct systems to be concrete-encased shall be tied down to minimize, if not totally eliminate, movement of the duct system during the placement of concrete. All sections of conduit systems to be concrete-encased shall be tied down using an industry-recognized method such as metal rods (for stakes) and metal strapping (for securing the duct system). The metal strapping shall be wrapped completely around the conduit structure and securely attached to the metal rods. The metal rods shall be a minimum of ¼-inch thick. Rods will be driven into the ground a minimum depth of 12 inches depending on soil density. For example, clay would require the minimum depth; whereas, sandy soil shall be at an increased depth. The ducts shall be tied down every 10 feet or closer.

### **3.7.5 Galvanized RSC and Steel Casings**

Either RSC or steel pipe casings; or HDPE duct placed by HDD shall be used for road crossings not using the cut and restore method, as specified in the design package. The RSC and steel casings or HDPE duct shall be placed under the highway in such a manner that does not damage the conduit or casing.

#### **3.7.5.1 Size and Fill**

The installer shall use a steel casing, a minimum of 12 inches (300 mm) in diameter with a minimum wall thickness of 3/16-in (5 mm) for pushing under commercial railroad crossings and for multi-duct conduit runs under non-commercial railroad beds. The steel casing shall have an inner diameter a minimum of 4 inches (100 mm) wider than the outer diameter of the conduit formation (with spacers) that is to be placed within the casing. Spacers will be used to support ducts installed within the casing. A single, 4-inch (100-mm) diameter RSC can be installed under non-commercial railroad beds in single conduit applications. After the duct installation, the casing shall be filled with fine sand (blown in with air pressure) or with slurry and shall be sealed on both ends with at least a 3-inch (75-mm) thick concrete wall. Installation of the fill will be accomplished in such a manner as to not damage or deform the ducts. Refer to Figure C-3 (Figure C-10 for Europe), Conduit Placement/Cut and Restore, for details on railroad crossings.

#### **3.7.5.2 Materials**

Galvanized RSC used as telecommunications conduit shall be made from soft, weldable quality steel that is suitable for bending. The hot-dipped zinc coating (galvanization) placed on the interior of the conduit shall be smooth and free of blisters, projections, and other defects. The weight of the zinc coating on the interior and exterior surfaces shall not be less than 2 ounces per square foot (ft<sup>2</sup>) (61 grams per 1,000 square centimeters [cm<sup>2</sup>]) of the total coated surface. Steel pipe casings shall comply with ASTM A-139 Grade B or ASTM A-252. Pipe ramming shall be done IAW the Trenchless Technology Center (TTC)'s report for the USACE Engineering and Research Development Center (ERDC), No. 2001.04, *Guidelines for Pipe Ramming*, December 2001.

### 3.7.6 Split Duct

Pre-manufactured split ducts are designed to be placed around existing cable, such as when repairing conduit or capturing existing conduit. They can also be used in a long DB cable run where the cable is placed in the open duct while the duct and trench are still open. Pre-manufactured split duct shall be used for crossing roads in DB cable runs only after one-fifth of the cable reel length for cables greater than 1 inch (25 mm) in diameter and one-third of the cable reel length for cables less than 1 inch (25 mm) in diameter have been used in each unspliced span. The pre-manufactured split duct under road crossings shall be concrete-encased. When joining the split duct, duct glue shall be used to augment the clamps and to prevent concrete from seeping through the joints. Normal conduit shall be used in all other areas.

### 3.7.7 Rod/Mandrel/Slug/Clean Ducts or Conduits

#### 3.7.7.1 Rod Duct

Rodding a duct entails inserting or pushing a rod into the duct to:

- Determine the length of the duct.
- Locate the other end of the duct.
- Determine if the duct is usable or blocked.
- Insert a pull string in the duct.

#### 3.7.7.2 Mandrelling

Mandrelling a duct consists of pulling a test mandrel or slug through the duct to ensure that the duct diameter is intact and ready for the installation of cables. Mandrelling can also be used to clean any mud, sand, or dirt out of the duct. The mandrel's diameter, 1/2-inch (13-mm) less than the duct's inside diameter, depends on the type and size of the duct. New ducts in main and subsidiary duct runs shall be mandrelled with a test mandrel (non-flexible) or slug with an approximate length of 12 inches (300 mm) and a diameter that is 1/2 inch (13 mm) less than the duct's inside diameter. The test mandrel shall be used to verify the integrity of the duct joints, to test for out-of-round duct, and to verify that sweeps are not so severe as to preclude the placement of large-diameter cables. The 12-inch (300-mm) test mandrel shall not pass through ducts with 90-degree sweeps. A 6-inch (150-mm) length test mandrel may be used to test duct runs to buildings or riser poles. Flexible mandrels, wire brushes, rubber duct swabs, leather washer duct cleaners, etc., may be used to clean the ducts.

Sample mandrel sizes are as follows:

- DB120 = 3.75 in mandrel based on a 4.24 in ID
- SCH40 = 3.50 in mandrel based on a 3.99 in ID

#### 3.7.7.3 Existing Ducts

Existing vacant ducts that are to be used in new cable installations, as defined in the design package, shall be cleaned and tested with a test mandrel to detect any obstructions, collapsed ducts, or duct inconsistencies. The installer shall repair damaged ducts if such repair is approved by the U.S. Government. The duct shall not be mandrelled if existing cables are in the duct.

### **3.7.8 Sub-duct/Innerduct/Multi-duct/Fabric-mesh Innerduct**

Innerduct, sub-duct, multi-duct, or fabric-mesh innerduct is typically a nonmetallic pathway and may be placed within or in place of a duct to subdivide the space and facilitate initial and subsequent placement of multiple cables in a single duct space. All subdivided spaces shall have a pull rope or pull tape installed. The PVC sub-ducts that do not have cables installed shall be plugged with a duct plug. A minimum of one out of every four new ducts shall be subdivided with innerduct, sub-duct, multi-duct, or fabric-mesh innerduct. For projects with fiber optic cables only, a minimum of two out of every four new ducts shall be subdivided with innerduct, sub-duct, multi-duct, or fabric-mesh innerduct.

#### **3.7.8.1 Sub-duct**

Sub-duct shall provide the equivalent of four each 1¼-in (32-mm) diameter (minimum) conduits in the space that is normally occupied by a 4-inch (100-mm) conduit. The sub-ducts shall be held in relation to each other with spacers.

#### **3.7.8.2 Multi-duct**

Multi-ducts are pre-manufactured duct systems that are equipped with four, fully-integrated 1.19-inch (30-mm) (minimum) sub-ducts.

#### **3.7.8.3 Innerduct**

Innerducts are smaller diameter ducts, typically 1-inch (25-mm) diameter (minimum), that are placed inside existing ducts. The innerduct shall consist of a minimum of three each, 1-inch (25-mm) PE ducts installed inside a single, 4-inch (100-mm) duct. Innerducts shall be used in existing conduit systems, in RSCs, or in split RSCs. Rigid-type innerducts with pull strings shall be provided.

#### **3.7.8.4 Fabric-mesh Innerduct**

Fabric-mesh innerducts are made of a stiff, fabric-mesh cloth, folded and sewn in such a way as to create individual cells through which a cable may be installed without entangling cables in other cells. Fabric-mesh innerducts may be used as approved by the U.S. Government and shall be limited to a maximum of three cells per tape, unless otherwise approved by the U.S. Government. The preferred fabric-mesh size is 3-inch cells by three cells. Any deviation requires prior Government approval. Smaller-sized cells shall not be used in standard OSP designs. The size and number of cells shall not exceed the manufacturer's recommendation. The preferred configuration is two, three-cell tapes per conduit. The designer may specify up to three, three-cell tapes per conduit. Multi-cell fabric mesh shall have an uninterrupted, shared, sewn spine to prevent twisting. The multi-cell fabric mesh shall be cut off in each hole, leaving a minimum of 2 feet of slack in the material and a minimum of 5 feet of pull string that will be attached to a permanent part of the maintenance hole structure, such as tied to the pulling irons. Conduit formations shall not be undersized based on the increased modularity of the fabric-mesh innerduct. Fiber optic cables shall not be "home run" from buildings to serving nodes because of the increased modularity of fabric type innerducts. Fabric-mesh innerduct is available with tracer wire which eliminates the need to install locator wire in empty conduit banks or conduit banks containing dielectric cables only.

### **3.7.9 Conduit Rehabilitation**

The designer may consider rehabilitation of existing conduits as an alternative to installation of new concrete-encased conduit when the cost, location, or magnitude of the construction effort is prohibitive. The conduit rehabilitation shall be IAW standard practices of ASTM 1216, using ASTM-compliant products and processes. The rehabilitated conduit shall have an inner diameter sufficient to support the intended cable installation and minimal growth. The designer shall note that the inner diameter of existing conduits will be reduced by the application of resin-impregnated tubes for rehabilitation.

#### **3.7.9.1 Rehabilitation Survey Requirements**

Conduits intended as candidates shall be inspected to ensure that rehabilitation is feasible. The ASTM 1216 states that conduits shall be cleaned and inspected prior to the installation of the resin-impregnated tube. Therefore, the survey shall verify that cleaning is sufficient to prepare the conduit for rehabilitation. The survey shall include inspection from maintenance hole or building entrance end points, either visually or by a conduit video system, of both ends of the conduit. A record of the video inspection shall be maintained after the survey. Collapsed or crushed duct shall not be used for rehabilitation.

#### **3.7.9.2 Rehabilitation QA Inspection and Acceptance**

Restored conduits shall have a friction coefficient that meets the ASTM 1216. The conduit shall be inspected by a conduit video system to verify it was restored to a usable system that meets the minimum requirements outlined in the underground conduits section of this guide, with the exception of the inside diameter.

### **3.7.10 Directional Boring/Horizontal Directional Drilling**

Horizontal directional drilling, or HDD, is a trenchless method for installing ducts for underground cable. Ducts are installed by drilling or boring a path through the soil and placing the ducts within this path. The vertical profile of the bore alignment is typically in the shape of an inverted arc.

#### **3.7.10.1 Restrictions**

Ducts installed under roads by means of the HDD method shall be of sufficient depth to clear existing utilities and meet the H-20 load ratings. The ducts placed by HDD shall not directly enter a maintenance hole but shall be attached to conduit stub-outs that extend a minimum of 10 feet (3 m) from the maintenance hole. The HDD method may be used in areas approved by the U.S. Government or as stated in the design package. The maximum radius curvature of a bore is limited to the maximum conduit diameter multiplied by 100 feet per inch (30.5 m per 25 mm).

#### **3.7.10.2 Methodology**

Horizontal directional drilling is a multi-stage process consisting of drilling a pilot bore along a predetermined path and then pulling the desired product back through the drilled space. Back reaming shall be utilized when it is necessary to enlarge the pilot bore hole. In order to minimize friction and provide a soil-stabilizing agent, a drilling fluid is introduced into the annular space created during the boring operation. The rotation of the bit in the soil wetted by the drilling fluid creates slurry. This slurry acts to stabilize the surrounding soil and prevents collapse of the borehole and loss of lubrication.

### 3.7.10.3 Pits

In order to confine any free-flowing slurry at the ground surface during pull back or drilling, sump areas shall be created to contain any escaping slurry that might damage or be hazardous to the surrounding areas. All residual slurry shall be removed from the surface, and the site shall be restored to its pre-construction condition. Excavation for entry, recovery pits, slurry sump pits, or any other purpose shall be carried out as specified in UFGS-02300. Sump areas are required to contain drilling fluids.

### 3.7.10.4 Drilling Fluids

A mixture of bentonite clay (or other approved slurry) and potable water shall be used as the cutting and soil stabilization fluid. The viscosity shall vary to best fit the soil conditions encountered. Water used shall be clean and fresh, with a minimum of a 6-Phosphate (pH) level. No other chemicals or polymer surfactants (surface-active substances) are to be used in the drilling fluid without the written consent of the U.S. Government and after a determination is made that the chemicals to be added are environmentally safe and not harmful or corrosive to the facility. When drilling in suspected contaminated ground, the drilling fluid shall be tested for contamination and disposed of appropriately. Any excess material shall be removed upon the completion of the bore.

### 3.7.10.5 Tracking

The installer shall provide a method of locating and tracking the drill head during the pilot bore and shall ensure the proposed installation is installed as intended. All facilities shall be installed in such a manner that their location can be readily determined by electronic designation after installation. For non-conductive installations, this shall be accomplished by attaching a continuous conductive material externally, internally, or integrally with the product. A copper wire line or a coated conductive tape may be used for this conductive material.

### 3.7.10.6 Duct Installed by Directional Boring

Materials shall meet or exceed the standards listed in Table 5.

**Table 5. Duct Standards for Directional Boring**

Material Type	Standard
PE	ASTM D 2447
HDPE	ASTM D 2447
	ASTM D 3350
	ASTM D 2239

A PVC conduit with mechanical connectors made for the purpose of directional drilling may be used with U.S. Government approval.

### 3.7.10.7 Joints

An HDD conduit shall be placed with soil-tight joints. Joints between dissimilar types of ducts (PVC, HDPE, GSP, EB, DB, etc.) shall use the appropriate connectors to provide a seal between the ducts and to prevent damage to cables pulled through these joints.

### 3.7.10.8 Restoration

The site shall be restored after installation of the conduit is complete. The work site shall be cleaned of all excess slurry remaining on the ground. The installer performing the boring is

responsible for removal and final disposition of excess slurry or spoils as the conduit is introduced. Excavated areas shall be restored IAW UFGS-02300. The cost of restoring damage caused by heaving, settlement, escaping drilling fluid (fracout), or the directional drilling operation to roads, parking lots, pavements, curbs, sidewalks, driveways, lawns, storm drains, landscapes, and other facilities shall be borne by the installer. Fracout is environmental damage caused when the bentonite clay used seeps into the waterways or into the ground instead of reaching its intended destination, thus ruining the habitat.

### **3.8 Direct Buried Cable Installation**

The DB cable shall be engineered and installed IAW RUS Bulletins 1751F-640, 641, and 642.

#### **3.8.1 Cable Type**

Rodent-protected cable shall be used for all buried applications, unless otherwise specified in the design package.

#### **3.8.2 Warning Tape**

Refer to Paragraph 3.5.10.1 for the details on warning tape.

#### **3.8.3 Warning Signs**

Buried cable warning signs or route markers shall be provided at intervals no greater than every 250 feet (76 m) or at each change in route direction, on both sides of street crossings, on pipelines, and on buried power cables. Color-coded warning signs or markers shall be orange in color.

#### **3.8.4 Plowing**

Plowing shall be used in range environments or other areas where there are no significant obstacles and where cable runs typically exceed 1,000 feet (305 m) between splices. The design package shall identify areas in which plowing is deemed feasible.

#### **3.8.5 Trenching**

##### **3.8.5.1 Backhoe Trenching**

Trenching with a backhoe shall be done only for short distances (i.e., from maintenance hole to building). The installer shall hand dig at all existing maintenance hole locations, building entrance points, utility crossings, through tree roots, under curbs, etc.

##### **3.8.5.2 Trencher Trenching**

A maximum trench width of 12 inches (300 mm) shall be used in DB applications done by a trencher. The installer shall hand dig at all existing maintenance hole locations, building entrance points, utility crossings, through tree roots, under curbs, etc.

#### **3.8.6 Depth of Placement**

##### **3.8.6.1 Copper Cable**

The depth of placement for a DB copper cable shall provide a minimum top cover of 24 inches (600 mm) in soil, 36 inches (900 mm) at ditch crossings, and 6 inches (150 mm) in solid rock (RUS Bulletin 345-150/RUS Form 515A).

##### **3.8.6.2 FOC**

Direct-buried FOC shall be placed at a depth providing a minimum top cover of 42 inches (1070 mm). In solid rock, the minimum top cover shall be 6 inches (150 mm).



### **3.8.6.3 Frost Considerations**

In areas where frost heaving can be expected, the cable or wire shall be buried below the frost line. Movement of OSP housings due to frost heaving can cause damage to the insulated copper conductors, optical fibers, or may result in loss of shield and/or armor continuity. In areas where movement of OSP housings by frost heaving is encountered, the OSP housings shall be installed on stub poles. The stub poles shall be set below the frost line and IAW the requirements of RUS Form 515.

### **3.8.6.4 Other Considerations**

The NEC/DPW may stipulate special depth requirements for certain areas (i.e., tank tracks, ranges, etc.), which shall be provided in the design package.

### **3.8.7 DB Cable Splicing**

Buried splices shall be engineered and installed as identified in the design package. With U.S. Government approval, a buried splice may be used for the following conditions:

- Electrical or explosion hazard (i.e., ammunition areas).
- Vehicular hazard (i.e., motor pool areas).
- Security hazard (i.e., within a high security compound).

Only splice cases specifically designed for a buried application shall be used. All buried splices shall be encapsulated. All other splices in a DB run shall be placed in pedestals or maintenance holes. Encapsulation is not required in a pedestal.

## **3.9 Crossing Obstructions**

### **3.9.1 Pavement Crossing**

Cut and resurface is the preferred method to be used when crossing any paved area. Push/bore and/or horizontal directional drilling shall be used for special circumstances only as specified in the design package. The preferred method of cut and resurface is the “T” cut. That is, the outer edge of the cut of the road surface is to extend six inches beyond the edge of the trench on both sides. Refer to Figure C-3 (Figure C-10 for Europe), Conduit Placement/Cut and Resurface, for placement details.

### **3.9.2 Range Road Crossing**

For road crossings on ranges, concrete encasement shall be extended a minimum of 6 feet beyond the edges of the roadbed.

### **3.9.3 Railroad Crossing**

Push and bore with steel casings is the preferred method for railroad crossings. Where multiple conduit formations are placed, a minimum of a 12-inch (300-mm) diameter steel casing, with a minimum wall thickness of 3/16-inch (5-mm), shall be used. The casing shall extend no less than 12 feet (3.7 m) beyond the centerline of the track or the outermost track if multiple tracks are crossed. In accordance with the NESC, the casing shall be located no less than 50 in (1,270 mm) below the top of the rails. The casing shall be no less than 36 in (900 mm) below the bottom of any crossed drainage ditch.

Directional boring shall not be used to place conduits below commercial railroad beds. Directional boring is not the preferred method of placing conduits below U.S. Government railroad beds. When required by the U.S. Government, as stated in the design package, directionally-bored HDPE shall be placed a minimum of 15 feet (4.6 m) below the roadbed

in typical soil. The conduits shall be placed at such a depth so that standard E-80 live and impact loads 80,000-lb/ft (119,500-kg/m), i.e., axle loads spaced on 5-feet (1.5-m) centers, shall not produce more than five percent deflection in the proposed HDPE conduits.

#### **3.9.4 Rocky Soil Crossing**

Pushes shall not be engineered for sites with rocky soil conditions. Boring shall not be engineered for sites with rocky soil conditions without U.S. Government approval. Cut and resurface methods shall be used to the maximum extent possible.

#### **3.10 Aerial Cable**

Supporting documentation for aerial placement is available in RUS Bulletins 1751F-630 and 1751F-635. Aerial cable runs shall be used only with U.S. Government approval in extenuating circumstances or for long runs outside of the cantonment area, as specified in the design package.

##### **3.10.1 Messenger Strand**

The smallest messenger strand used for all new installations shall be 6.6 m. A 2.2-m strand shall be used only as an extension of existing 2.2-m strands. Fiber optic cable shall be installed on its own messenger. Copper and fiber cables shall not be lashed on the same messenger without U.S. Government approval. Figure 8 cable may be used; however, no additional cable shall be lashed to it.

##### **3.10.2 Guys and Anchors**

Place new guys and/or anchors for each new messenger strand at each applicable location (cable turns, wind loading, cable ends, etc.). The down guy shall be sized to the next larger strand.

##### **3.10.3 Aerial Splices and Terminals**

###### **3.10.3.1 Fiber**

Aerial fiber splices shall not be used without U.S. Government approval. Fiber optic splices shall be placed in a pedestal at the bottom of the pole. The cable alone shall not support the aerial splice case. Fiber splice locations shall include a sufficient amount of cable slack to allow the splice case to be moved into a splice trailer or tent for maintenance or service. The cable slack shall be coiled and secured in a maintenance hole so as not to entangle with other cables or be subject to damage while entering the maintenance hole. The cable slack for aerial applications shall be secured to the existing messenger. The cable slack in direct-buried applications shall be buried next to the pedestal.

###### **3.10.3.2 Copper**

Support all terminals and splices by direct attachment to a fixed object (pole, building, pedestal, etc.). The cable shall not support devices. Use pole-mounted and fixed-count terminals, and place them so that no single drop exceeds 152 m (500 feet) in length.

##### **3.10.4 Water Protection**

Weatherproof all outdoor connections by using weather boots or other approved methods. Form a rain-drip loop at all cable entrances into buildings at the point of ingress. Waterproof all building entrance points.

### 3.10.5 Horizontal Clearances for Poles/Aerial Cable

Adhere to the following horizontal clearance standards, as specified in the Lucent Technologies *Outside Plant Engineering Handbook*, Practice 918-117-090, unless the design package directs otherwise:

- Fire hydrants, signal pedestals: 4 feet (1.2 m).
- Curbs: 6 inches (150 mm).
- Railroad tracks: 15 feet (4.6 m).
- Power cables less than 750 volts (V): 5 feet (1.5 m) or more.

### 3.10.6 Vertical Clearances for Aerial Cable

Adhere to the following vertical clearance standards, as specified in the Lucent Technologies *Outside Plant Engineering Handbook*, Practices 627-070-015 through 017, and Practice 918-117-090, unless the design package directs otherwise:

- Streets or roads: 18 feet (5.5 m).
- Driveways to residences and garages: 10 feet (3 m).
- Alleyways: 5.2 m (17 feet).
- Pedestrian walkways: 8 feet (2.4 m).
- Railroad tracks (measured from top of rail): 27 feet (8.2 m).

### 3.10.7 Cable Placement on Bridges and Over Waterways

The designer shall specify bridge attachments that will not interfere with painting of the bridge structures. The designer shall also follow these recommendations:

a. When making attachments over waterways which are subject to flooding, the designer shall ensure that the lowest cable point is a sufficient height above the high water mark to prevent the cable from being entangled in flotsam.

b. When placing aerial cable on bridges, the designer shall use a messenger strand and shall lash the cable to it to prevent abrasion to the cable sheath. The use of cable rings is not recommended due to abrasion concerns.

c. When placing conduit for cable installation on a bridge, the designer shall specify that the bell end of the conduit be installed in the direction from which the cable is pulled to prevent pull line or cable snags on a non-belled end.

d. The designer shall specify expansion joints at the locations of existing bridge expansion joints to prevent cable from stretching and to facilitate all bridge members (the cable now being one) flexing at the points designated. Provision for expansion shall be made if the bridge has expansion joints.

e. The designer shall specify innerduct in the conduit for installation of small cable, allowing for future expansion. Innerduct, either corrugated or fabric mesh, does not in and of itself require expansion joints. However, allow the innerduct to “relax” or contract back to its original size and length after the pull is complete.

### 3.11 Free Space Optics

Free Space Optics (FSO) can provide an alternative to FO connectivity for the “last mile” to EUBs and small enclaves. Typical FSO implementations result from one of the following

factors that prohibit traditional infrastructure: rapid deployment, right-of-way permit issues, water, railroads, and rough terrain. The FSO is a line-of-sight (LOS), point-to-point, wireless optic technology that uses the transmission of modulated infrared beams through the atmosphere to obtain broadband communications. The FSO operates in the unlicensed near-infrared spectrum 750 nanometer (nm) to 1550 nm wavelength range. The FSO systems can function over distances of several kilometers (km), as long as there is a clear LOS between the source and the destination.

**Design Note:** For systems operating at 1.25 Gigabits per second (Gbps), the link distance shall be kept to approximately 1000 meters. If the FSO system is to operate in an environment of low visibility (fog), a backup system such as millimeter wave (MMW), symmetrical high-density digital subscriber line (SHDSL), or 802.11a shall be used.

A number of manufacturers are producing FSO equipment. The designer shall utilize an FSO device that has been tested, approved, and recommended by the USAISEC's Technology Integration Center (TIC). The FSO equipment shall be designed to prevent data loss due to temporary blockages, such as birds, smoke, dust, rain, and light fog. The FSO devices shall be FDA- and IEC 60825-1 Class 1M-approved to ensure safety. Operational test reports on individual equipment, such as the Technical Report (TR) No. AMSEL-IE-TI 04-009, *Free Space Optics (FSO) Comparison Report*, November 2003; and TR No. AMSEL-IE-TI 05-066, *Grafenwoehr Free Space Optics (FSO) Demonstration Report*, June 2005, are available from USAISEC-TIC.

### 3.11.1 FSO Technical Requirements

- a. The FSO will meet or exceed the following requirements and/or capabilities:
  - (1) Comply to or exceed industry standard emissions and eye safe considerations, e.g., certified eye safe as per IEC 60825 Class 1 or Class 1M.
  - (2) Support Simple Network Management Protocol (SNMP) management.
  - (3) Support remote configuration and management.
  - (4) Remote diagnostics capabilities.
  - (5) Environmental controls (heater, defrosters, etc.).
  - (6) Automated acquisition of link capabilities.
  - (7) Management channel.
  - (8) Support for GbE.
- b. The equipment shall be constructed so as to have sufficient protection against dust, sand, or birds. A hardened housing shall be used to provide a robust, waterproof environment.
- c. The system shall maintain its guaranteed performance when operating continuously or intermittently under any combination of the following conditions without readjustment and when maintained IAW the vendor's recommendation:
  - (1) Ambient temperature: 10° Celsius (C) to 40°C (indoor) 10°C to 50°C (outdoor).
  - (2) Relative humidity (rh) of up to 95 percent.
- d. The system shall be fully protected against voltage surges and lightning. It shall also be protected against damage from accidental reversals of polarity.

e. All test equipment, tools, accessories, and software necessary for Operations and Maintenance (O&M) support shall be submitted as part of the FSO System offer.

### **3.11.2 FSO Considerations**

The designer shall consider a number of different factors when deploying FSO. These include installation stability, beam alignment, mounting locations, atmospheric effects, impairments, required throughput, signal interfaces, security requirements, power requirements, and power availability.

#### **3.11.2.1 Installation Stability and Beam Alignment**

The FSO equipment is typically mounted on the outside edge of building rooftops, on towers, or inside building windows. These “solid” objects tilt, twist, vibrate, and sway due to heat, wind load, and seasonal changes. The FSO equipment used shall be able to compensate for minor movements and maintain beam alignment. There are generally two methods for keeping FSO laser transmitters and photo detection receivers aligned: active beam tracking, and beam divergence. Active beam tracking allows the FSO system to adjust end-to-end alignment a small number of degrees through beam strength tracking. Beam divergence is the intentional spreading of the laser beam to allow for FSO link head movement within both receivers’ fields of view.

#### **3.11.2.2 Mounting Locations, Atmospheric Effects, and Impairments**

The FSO transmitters and receivers shall be mounted as close to the building edge as possible. Placing the transmitters or receivers too far away could result in beam interference due to heat scintillation or refraction from the building roof. When placed within a building, FSO can transmit/receive through building windows with little or no attenuation. This capability allows the designer to avoid roof rights or premise cabling pathway issues. The designer shall consider actual glass losses in the overall link budget for through-window implementations. Additionally, the designer shall investigate to determine whether the newer windows were manufactured with an infrared (IR) reflecting coating or if older windows have a high lead content. Infrared coating or lead could severely impair an FSO link.

The designer shall consider the occurrence of rain, dust, snow, fog, or smog when implementing FSO. These weather conditions can add impairments to the transmission path. USAISEC-TIC testing has shown fog to cause severe, and sometimes total, signal loss. Signal penetration through prevailing weather conditions is a factor of beam strength, distance, and weather interference. The FSO device shall include gain control to accommodate distances and weather conditions. The gain control may be manual or automatic. However, beam power output is restricted by the eye safety requirements for this class of laser. The designer shall consider using a radio backup link, such as most MMW, microwave, 802.11 WLAN (wireless local area network), or 802.16 WiMAX (wireless interoperability for microwave access), in severe weather conditions. The FSO laser does not require municipal or host nation approval, but the backup radio link may require approval and frequency management. Additional security requirements may apply to the backup wireless link, as the radio frequency (RF) signal cannot be controlled as well as the FSO beam can.

### **3.11.2.3 FSO Security**

DOD Directive (DODD) 8100.bb requires Federal Information Processing Standard (FIPS) 140.2, Level 1 or 2, end-to-end encryption on all Army wireless implementations. Therefore, the designer shall incorporate required encryption of data passed through the FSO required to pass FIPS 140-2 and IA certification. The designer shall ensure that any encryption hardware is cable of supporting the throughput speeds and protocols.

### **3.11.2.4 FSO Throughput**

The FSO throughput is a factor of beam strength, distance between devices, and weather conditions. The designer shall consider the required bandwidth as it relates to the specific distance for each application. For systems operating at 1.25 Gbps, the link distance shall be kept to approximately 1000 meters.

### **3.11.2.5 FSO Signal Interfaces**

The FSO device shall be able to interface to the local data switch through standard FO connectors such as the SC type. The FSO device shall be able to transport the data stream transparently.

## **3.12 General Range Information Infrastructure Design**

The telecommunications sections of range construction projects shall follow the general provisions of this TC for new construction and renovations. There are several distinct types of information networks in a range environment: Administrative, Range Control (RC), and Tactical. The Administrative networks support telephone and data requirements to safety telephones and to the occupants of the range buildings. The special RC networks control down-range targets, sensors, and monitors, and transport this information to off-site locations. The Tactical networks support unit training requirements in a field environment. In addition, Security and Alarm networks may be present.

The following subparagraphs provide guidance for the design of the administrative use networks, with provisions for interfacing with the other networks. The following subparagraphs also provide specific design information for TRs and OSP telecommunication cables within range projects.

### **3.12.1 TRs**

In multi-story buildings, a minimum of one TR shall be located on each floor, with one TR acting as the aggregating TR or main cross-connect (MC) for the building. Small facilities, i.e., air traffic control towers, firing range towers, etc., may use one TR for the entire facility. The TRs on successive floors shall be vertically stacked wherever possible. A minimum of four, 4-inch trade size conduit sleeves shall be installed between stacked closets on successive floors, IAW ANSI/EIA/TIA-569-B, Paragraph 8.12.

### **3.12.2 Backbone Cabling**

The backbone cabling for range facilities shall be SM FOC IAW this TC. The IT designer shall also refer to this TC for the supporting infrastructure for distribution and riser cables.

### **3.12.3 Range Information Infrastructure Design**

Utilizing the RC building as a distribution node for all range telecommunications and as an intermediary between the ranges and the main cantonment area provides the ideal range information infrastructure architecture. The DB cable plant shall be used for range

telecommunications cables. If it is not feasible to use DB cable due to local mandates or rough terrain, aerial cable plant may be used. Pedestals or maintenance holes shall be placed at end-of-reel splice locations, where access to cable pairs or strands is required, and at future use points. In some range scenarios, a maintenance hole or a buried splice would be preferred over a pedestal due to the free-roaming abilities of heavy equipment, such as tanks and mowers. When pedestals are used, efforts shall be made to protect them from damage, such as using protective stub poles or locating the pedestals in tree lines or near steep banks. When using buried splices, above-ground warning signs and electronic locating devices, such as radio frequency ID or magnetic devices, shall be located with the splice.

### **3.12.3.1 Maintenance Hole and Duct Systems**

Normally, the IT designer shall not use the maintenance hole and duct system architecture in the range environment as it would incur too high a cost to the range project. At individual range complexes, a maintenance hole and duct infrastructure could be installed from the RC building to adjacent support buildings for growth and expansion. When a duct system is required, a minimum of two, 4-inch PVC ducts, one with four sub-ducts or nine-way (3 each, 3-way) textile mesh, shall be installed to each individual support building.

### **3.12.3.2 Direct Bury Depth of Placement**

The minimum depth of placement for a DB copper cable to ranges shall provide cover of 36 inches of soil, 48 inches at ditch crossings; and 6 inches of solid rock. To direct bury a fiber optic cable, the minimum depth shall provide a cover of 42 inches overall. In solid rock, the minimum depth is reduced to 6 inches for FOC. The NEC may stipulate special depth requirements for certain areas, such as tank trails, firing ranges, etc.

### **3.12.3.3 Concrete Encasement**

Concrete encasement or GSP shall be used in range projects under road crossings, heavy equipment (tank) crossings, or high-traffic areas. The IT designer shall plan for four, 4-inch PVC ducts; one with four sub-ducts or nine-way (3 each, 3-way) textile innerducts under road crossings, heavy equipment (tank) crossings, and high-traffic areas. The encasement/pipe shall be extended a minimum of 6 feet beyond the roadbed for all road crossings, heavy equipment (tank) crossings, and high traffic areas on ranges. In accordance with the referenced standards, PVC ducts shall also be encased in concrete at all sweeps or bends; at stream or drainage ditch crossings; or at other areas subject to washout. For consistency, the contractor shall use only one brand of cement that conforms to RUS Bulletin 1751F-644 ([http://www.usda.gov/rus/telecom/publications/pdf\\_files/1751f644-08-02.pdf](http://www.usda.gov/rus/telecom/publications/pdf_files/1751f644-08-02.pdf)).

### **3.12.3.4 OSP Cable**

The IT designer shall consider DB cables as the first choice for range telecommunications cables. If it is not feasible to use DB cables due to local mandates or rough terrain, aerial cables shall be used. The IT designer shall specify a minimum of 24 strands of SM FOC from either the DCO or nearest RSU to the RC building. Alternatives to FOC between the main cantonment area and the RC building may be considered on a case-by-case basis. The IT designer shall also specify a minimum of 12 strands of SM FOC from the RC building to the individual ranges or range buildings. The IT designer shall use SM FOC, as needed, to extend the data backbone, monitor circuits, sensors, cameras etc., from the RC building to all range buildings. Alternatives to FOC between the RC building and the individual ranges

or range buildings may be considered on a case-by-case basis. In addition to the usual administratively-required strands of FOC for voice and data networks to the ranges, the range cables shall be sized to support circuits for the RC and for the ever-changing training and tactical scenarios (minimum 25-percent spare strands). Cables homed to the RC facility would add flexibility to these systems.

### **3.13 General Airfield and Air Traffic Control (ATC) Information Infrastructure Design**

The telecommunications sections of airfields and ATC construction projects shall follow the general provisions of this TC for new construction and renovations. The two distinct types of information networks in an airfield environment are the post-wide administrative and the airfield-specific systems. The administrative networks support telephone and data requirements to safety telephones and to the occupants of the airfield buildings. The airfield-specific systems are not connected into the post-wide administrative network and include sensors, monitors, navigation systems, weather, radar, etc. In addition, security and alarm systems may be present. The following subparagraphs provide guidance for the design of the airfield-specific systems as well as specific design information for TRs and OSP telecommunication cables for airfield projects.

#### **3.13.1 Telecommunications Rooms**

In multi-story buildings, a minimum of one TR shall be located on each floor, with one TR acting as the aggregating TR for the building. Airfield facilities, i.e., air traffic control towers and approach control facilities, may use one TR for the entire facility. The TRs on successive floors shall be vertically stacked wherever possible. A minimum of four, 4-inch trade size conduits shall be installed between stacked closets on successive floors IAW ANSI/EIA/TIA-569-B, Paragraph 8.12.

#### **3.13.2 Outside Plant**

##### **3.13.2.1 Airfield Information Infrastructure Design**

Utilize the Approach Control facility as a distribution node for all airfield telecommunications and as an intermediary between the airfields and the main cantonment area, as this facility provides the ideal airfield information infrastructure architecture. If an approach control facility does not exist, utilize the Air Traffic Control Tower as the distribution node. The IT designer shall utilize the existing OSP infrastructure when passing remote site and tie cables through the cantonment area. Existing maintenance hole and duct systems shall be used for airfield telecommunications cables. Normally, the IT designer shall not use a concrete-encased underground maintenance hole and duct system outside the cantonment area leading to the airfield complexes, or between the airfield and remote airfield facilities (radar or radio towers, sensors, monitors, etc.). The direct-buried cable plant system is the preferred method for placement of cable in less congested areas. Pedestals or maintenance holes shall be placed at end-of-reel splice locations; where access to cable pairs or strands is required; and at future use points. In some airfield scenarios, a maintenance hole or a buried splice would be preferred over a pedestal due to the heavy equipment such as aircraft and support vehicles. When using pedestals, efforts shall be taken to protect it from damage, such as protective stub poles, locations in tree lines or close to steep banks. When buried splices are used, above-ground warning signs and electronic locating devices, such as radio frequency identification or magnetic devices, shall be located



with the splice. Refer to UFC 3-260-01, *Airfield and Heliport Planning and Design*, for additional airfield-specific requirements.

### **3.13.2.2 Maintenance Hole and Duct Systems**

For growth and expansion at individual airfield complexes, install a maintenance hole and duct infrastructure from the Approach Control building to adjacent support buildings and hangars. Follow the general guidelines in this TC for installing maintenance hole and duct systems.

### **3.13.2.3 Depth of Placement**

The minimum depth of placement for a direct-buried copper cable to an airfield shall provide cover of 36 inches in soil, 48 inches at ditch crossings, and 6 inches in solid rock. To direct bury a fiber optic cable, the minimum depth shall provide a cover of 42 inches overall. In solid rock, the minimum depth is reduced to 6 inches for fiber optic cable. The NEC or UFC 3-260-01 may stipulate special depth requirements for certain areas such as aircraft taxiways, aprons, etc.

### **3.13.2.4 Concrete Encasement**

Concrete encasement or galvanized steel pipe shall be used in airfield projects under road crossings, heavy equipment (aircraft) crossing, or high traffic areas. The IT designer shall plan for a minimum of four-four inch PVC ducts, one with four sub-ducts or nine way (3 each, 3-way) textile innerduct, under road crossings, heavy equipment (aircraft) crossings, and high traffic areas. The encasement/pipe shall be extended a minimum of 6 feet beyond the roadbed for all road crossings, heavy equipment (aircraft) crossings, and high traffic areas on airfields. In accordance with the referenced standards, PVC duct shall also be encased in concrete at all sweeps or bends; at stream or drainage ditch crossings, or in other areas subject to washout. For consistency, the contractor shall use only one brand of cement that conforms to Rural Utilities Service (RUS) Bulletin 1751F-644 ([http://www.usda.gov/rus/telecom/publications/pdf\\_files/1751f644-08-02.pdf](http://www.usda.gov/rus/telecom/publications/pdf_files/1751f644-08-02.pdf)).

### **3.13.2.5 OSP Plant Cable**

The IT designer shall specify a minimum of 24 strands of SM FOC from the DCO or the nearest RSU to the Airfield Control building. Alternatives to fiber optic cabling between the main cantonment area and the Airfield Control building may be considered on a case-by-case basis. The IT designer shall also specify a minimum of 12 strands of SM FOC from the Airfield Control building to the individual buildings and remote airfield facilities. The IT designer shall use SM FOC, as needed, to extend the data backbone, monitor circuits, sensors, cameras etc., from the Airfield Control building to all airfield buildings. In addition to the usual administratively-required strands of FOC for voice and data networks to airfields, the airfield cables shall be sized to support circuits and airfield control systems (minimum 25 percent spare strands). Cables homed to the Airfield Control facility would add flexibility to these systems.

## **3.14 Pier Installation**

Pier telecommunications shall be installed in a duct system, with pull boxes placed at critical points.

### 3.14.1 Pier Igloos

Pier igloos are structures where cable is terminated into terminal/plugs for shipboard use. Cable is generally run to igloos via a conduit system, raised into the igloos for termination and use, and is cross-connected to cable continuing to other igloos. Igloos can provide both copper and FO termination through a commercially-available combination fiber/copper cable type plug for shipboard use. This connectivity provides service to meet shipboard requirements. Inside the igloo, restricted from shipboard personnel, the FO and copper cross-connections may be changed to meet special requirements for special situations. Refer to Figure C-16 of Appendix C for igloo details.

### 3.14.2 General Pier Installation Guidance

Expansion joints are required at each pier expansion joint and in areas where the conduit enters an igloo. PVC-covered GIP or fiberglass conduit shall be used for the conduit and shall be installed in such a manner that docking vessels cannot scrape or crush it. For that reason, the designer shall place the cable on the underside of the pier and support it with approved PVC-covered or stainless steel hangers IAW UFGS-33 81 27, *Pier Telephone Distribution Systems*, April 2006. The designer shall place an innerduct into the conduit if only a small cable is to be installed. If spare ducting is to be placed, ensure that a pull line is installed and that the duct is plugged or capped at both ends of the run. If the spare duct enters or exits a pull box, plugging or capping is required inside the pull box. Expansion joints act like a slip joint, allowing the conduit to move (breathe), precluding separation or buckling. If the conduit is to be allowed to move, the cable and innerduct shall not be installed tautly or it shall break. Leave sufficient slack to allow for conduit movement, and also leave slack for expansion in pull boxes.

### 3.14.3 Pier Cable Types

Copper and FO cables for shipboard use shall be terminated in igloos located at the pier edge. These igloos may provide data, telephone, and video (cable TV, security cameras, etc.). All shipboard connectivity is accomplished via the front faceplate of the igloo. Only station/base personnel shall have access to the igloo's internal cabling, and only they shall be permitted to make physical wire or cable changes. Only filled cables such as PE-39 and filled FOC shall be installed on piers.

## 3.15 General Cable Specifications

### 3.15.1 General Installation

Cables shall be placed in such a manner as to avoid kinks and other sheath deformities. Cables shall be rated IAW the National Electrical Code (NFPA-70) for the environment in which they will be installed. When considering the use of indoor/outdoor rated cable, the economics of the design shall be factored into the decision. Typically, indoor/outdoor rated cable shall be limited to the link from the splice in the maintenance hole to the BET.

#### 3.15.1.1 Pulling Tension

When pulling cable into ducts, innerducts, or sub-ducts, do not exceed the manufacturer's specified pulling tension. Use a lubricant in the amount specified by the lubricant manufacturer. The lubricant shall be a pourable, water-based, slow-drying fluid that shall not stress-crack the low-density PE and shall not damage the cable jackets.

### 3.15.1.2 Evaluating Existing Cable/Testing New Cable

When the installation includes work on an existing cable, the installer shall test all affected pairs before completing any throws or splices. A list of the defective pairs shall be submitted to the Government POC before the work proceeds. After the cable work is completed, the installer shall test all affected cable pairs. The installer shall also clear trouble on any existing pairs that were not on the original list.

### 3.15.1.3 Bending Radius

During installation, the minimum bend radius for non-gopher-resistant OSP twisted-pair cable shall be no less than 10 times the cable diameter. After installation, it shall be no less than eight times the cable diameter, or as specified by the cable manufacturer. The minimum bend radius for gopher-resistant OSP twisted-pair cable during installation shall be no less than 15 times the cable diameter. After installation, it shall be no less than 10 times the cable diameter, or as specified by the cable manufacturer. (Refer to ANSI/TIA/EIA 758, Paragraph 6.1.4.4). During installation, the minimum bending radius for FOC shall be no less than 20 times the outside diameter of the FOC, or as specified by the cable manufacturer. After installation, it shall be no less than 15 times the cable diameter. (Refer to ANSI/TIA/EIA 758, Paragraph 6.3.6).

### 3.15.2 Cable ID/Cable Tags

Cable ID/cable tags shall be installed at all termination points (terminals) and splices, including house cables. In maintenance holes, all new and existing cables that are part of the project shall be tagged/retagged between the splice and the wall and on both sides of a splice loop or maintenance loop. When a cable is re-homed to a new node, DCO, cross-connect box, etc., all existing cable tags and terminal labels on the re-homed cable shall be re-tagged and re-labeled to reflect the new information. One tag is required for a copper cable pull-through, and two tags are required for an FOC pull-through. Labels in maintenance holes and hand holes shall be machine-produced on a durable material suitable for the environment. Handwritten labels are not acceptable.

#### 3.15.2.1 Cable Label Schemes

Typically, unless the SOW/PWS or site requirements direct otherwise, the unique identifier for each cable will include an indicator of the originating location of the cable. For a copper cable, it can be as simple as a local policy, e.g., Cables 1 through 15 originate from the node in Building xxx; Cables 16 through 25 originate from Building yyy. For fiber optic cable, the originating building number could be included as part of the identifier. The following cable label schemes shall be used unless the SOW/PWS or site requirements direct otherwise:

a. To identify a **copper cable**, size + type **and** cable ID+ count are needed. Cable sizes shall be identified with an abbreviation. For example, a 1,200-pair cable shall be identified as “P12-24PF.” The “24” represents the American Wire Gauge (AWG). All cables with fewer than 25 pairs shall include an “X.” (Refer to the examples.) **Note:** Only **existing** cable is identified with a “CA” prefix.

- 6-pair = P6X-24PF
- 12-pair = P12X-24PF
- 18-pair = P18X-24PF

- (1) To identify a 900-pair, 24AWG **copper cable**:
  - P9-24PF = size and type
  - 03, 1-900 = cable number and count
- (2) To identify two different **copper cables** under the same sheath:
  - P18-24PF
  - 07, 1-1,500 + T1, 1-300
- b. To identify **fiber optic cable**, use the cable ID + count **and then** size + type.
  - F 12, 1-72 = cable number and strand count
  - 12 SM = type of cable
- c. To identify a 10-pair, 0.6 mm **European copper cable**:
  - 10x2x0.6 = size and type
  - 01, 1-10 = cable number and count
- d. To identify an 800-pair, 0.6 mm **European copper cable**:
  - 800x2x0.6 = size and type
  - 05, 1-800 = cable number and count

### 3.15.2.2 Existing Cable Labeling

When an existing cable is rehomed to a new node, the new node identifier should apply to all of the rehomed cable, to include laterals. Therefore, all the existing cable tags, the labels on the building terminals, and associated cable records shall be changed to reflect the new information (new node). This requirement is not to be construed as a requirement to place labels on cables that do not have existing tags unless the identification of the cable is easy to determine with minimal or no impact on cost or schedule. An example of this is when there is only one cable in the maintenance hole, and the identifier and count were verified in the previous maintenance hole. Due to the potential labor required to verify the identifiers and counts on cables with no tags, this effort should be identified as a separate requirement or task in the SOW/PWS.

### 3.15.3 Copper Specifications

#### 3.15.3.1 Telephone Cable Requirements

The installer shall ensure that all cable used in North America is UL- listed and meets the specifications of Telcordia Document, GR-421-CORE, *Generic Requirements for Metallic Telecommunications*, December 1998. Cables specified for use in Europe may not meet UL or Telcordia specifications.

#### 3.15.3.2 European Telephone Cable Requirements

All multi-pair copper cable installed between buildings shall be waterproof, IAW DIN VDE 0815 and 0816, *Wiring Cables for Telecommunications and Data Processing Systems*, 1985-2009. The copper conductor size shall be 0.6-mm diameter. Commercially-available, industry-standard cables shall be type A-02YSOF(L)2Y...x2x0.6 ST III BD. The ellipsis mark (...) represents the pair count.

a. The conductors in the cable shall be color-coded. A basic color-coding scheme shall be used to provide different color combinations on the insulation for each pair. The North American standard is based on a 25-pair group IAW Telcordia documents:

- (1) Tip: white, red, black, yellow, violet
- (2) Ring: blue, orange, green, brown, slate.

b. The European standard is based on 10-pair groups.

(1) The basic colors of wires of five starquads in the sub-unit are red for the first quad, green for the second quad, grey for the third quad, yellow for the fourth quad, and white for the fifth quad.

- (2) Black rings code the individual wires.
- (3) The pilot unit bears a red helix.
- (4) All other units bear a white or transparent helix.

c. Minimum Guaranteed Pairs: One hundred percent (100%) of pairs in a cable prior to installation and 99 percent of pairs after installation (when it is not economical to recover the defective pairs) shall pass performance or acceptance tests. Defective pairs shall be identified by location and type of fault. Any splicing faults shall be corrected. (This applies to both the European and CONUS theaters of operation.)

### **3.15.3.3 Splices**

a. Copper and FOC splicing shall be performed IAW RUS Bulletin 1735F-401, *Standards for Splicing Copper and Fiber Optic Cable*, February 1995.

b. Cable shall be spliced into one continuous length. All copper splices shall be of the fold-back type to facilitate future work in the splice. Fiber optic cable shall contain splice loops in trays IAW the manufacturer's recommendations.

c. Completed splices shall meet similar performance and mechanical specifications of a single cable of the same overall length.

d. Self-piercing, electrical, filled connectors shall be used when plastic-insulated conductors are spliced. The installer shall place and install connectors using a tool specifically designed to place those particular connectors. In North America, a 25-pair splicing module, 3M-type MS2 or equal shall be used. The same modules shall be used throughout the project and shall be consistent with previously-installed connectors to preclude a requirement for a variety of installation tools. B-wire connectors shall not be used. In Europe, a 10-pair splicing module system is used.

e. Binder group integrity shall be maintained.

f. All dead pairs in a copper cable shall be spliced through if the size of the continuing cable shall allow a clear and cap at the end. Only UL-listed material shall be used for capping cable pairs.

g. All underground and buried splice cases shall use encapsulant-fillable closures and shall be filled with encapsulant upon completion of the splice IAW RUS Bulletin 345-72 (PE-74). To ensure sheath continuity, cable sheaths at all cable splices shall be bonded with bonding harnesses.

h. Splice cases shall not be installed in such a manner that their weight is supported by the cables on the cable hooks in the maintenance hole. The use of non-encapsulated, re-

enterable splice cases (for both copper and FOC) that are suitable for environmentally-sealed telephone splices in the aerial or underground non-pressurized network are acceptable for non-DB locations. The preferred method for installing splice cases is to hang them from an overhead support, such as a pipe supported by the set of cable hooks above the splice case.

#### **3.15.3.4 Cable Count Assignment**

When assigning cable counts, the center of the cable shall be the last pairs assigned on a cable route. The upper or higher cable pair counts shall be used first. Therefore, the highest pair count in a cable shall be located nearest to the switch location, and the lowest pair count shall be farthest away. Per the requirements of 6- and/or 12-pair terminals, Pair 13 (of a binder group) rather than Pair 1 shall be spared.

#### **3.15.3.5 Cable Gauge, Resistance Design**

The cable gauge shall be 24AWG (0.6 mm in Europe), unless otherwise specified in the design package.

#### **3.15.3.6 Loading**

a. Analog sets/circuits exceeding 18,000 feet (5.49 km) require U.S. Government approval. If approved, these sets/circuits shall be loaded.

b. When loading cables, H88 loading shall be used 3,000 feet (914 m) from the switch location/digital loop carrier for the first load (including calculations for tip cables, jumper wires, etc.) and every 6,000-sheath feet thereafter. End sections shall be greater than 3,000 feet (914 m) and less than 12,000 feet (3.66 km). End sections include all drops and station wire.

c. Build-out capacitors shall be designed on trunk circuits between switches for placement between load points for distances shorter than 6,000 feet (1.83 km) between loads or between loads and end sections.

d. Pairs for any data circuits shall not be loaded.

e. If digital or data sets are being used for the telephone system, these pairs shall not be loaded.

### **3.15.4 Fiber Specifications**

#### **3.15.4.1 FOC Requirements**

a. All specifications for FOC pertain to finished cable, not raw (uncabled) fiber. The FOC shall conform to the specifications contained in RUS Bulletin 1753F-601; EIA/TIA-472; and EIA 472D, ICEA S-83-596-2001, *ICEA Standard for Optical Fiber Premises Distribution Cable*; or ICEA S-87-640-2006, *ICEA Standard for Optical Fiber Outside Plant Communications Cable*. Refer to Table D-1 for the complete titles of these references.

b. The International Telecommunication Union-Telecommunication Standardization Sector (ITU-T) G.652 fiber is also known as standard, single-mode fiber and is the most commonly deployed fiber. It is the preferred FOC for the majority of the cable to be installed by this program. The non-zero dispersion shifted fiber (NZDSF) has been developed for optimized dispersion characteristics in high-capacity, long-distance networks. Compliant to ITU-T G.655 and G.656 recommendations, these fibers support Coarse Wavelength Division Multiplexing (CWDM), Dense Wavelength Division Multiplexing

(DWDM), Optical Carrier (OC)-192 and 10-Gb applications. The NZDSF is typically not required or used for applications of less than 40 km (25 miles).

### 3.15.4.2 Fiber Types

All new OSP fiber cable shall be single mode (SM). With U.S. Government approval, multimode (MM) fiber may be installed only in the following situations: those involving the extension of existing systems; those specified in the design package; or those that cannot be adapted to single-mode cable.

a. MM FOC: Fiber strands shall have a nominal core/cladding diameter of 50/125 microns. All cabled multimode fibers shall possess the following characteristics over the entire specified temperature range (Table 6).

**Table 6. Multimode Dual-windowed Fiber Cable Characteristics**

<b>Function</b>	<b>Parameters for 50 microns</b>	<b>Parameters for 62.5 microns</b>
Core/Cladding Diameter	50/125	62.5/125
Coating Diameter Microns	250	250
Core Eccentricity Maximum	6%	6%
Core Ovality	6%	6%
Refractive Index Delta	1%	2%
Core Diameter Microns	50 +/-3	62.5 +/-3
Cladding Diameter Microns	125 +/-3	125 +/-3
Numerical Aperture	0.20 +/-0.015	0.275+/-0.015
850 nm		
Maximum Attenuation dB/km	3.5	3.75
Minimum Bandwidth MHz-km	*500	160
1,300 nm		
Maximum Attenuation dB/km	1.5	1.0
Minimum Bandwidth MHz-km	*600	500
Cable Tensile Load Rating	**2,670 N (600 lb)	
Cable Minimum Bending Radius	15 x cable diameter under no load. **0-800 N (0-180 lb). 20 x cable diameter under load. **800-2,700 N (181-600 lb) (Note 2).	
*Building/Breakout Cables (Tight Buffer). Minimum bandwidths do not apply to tight buffered, or breakout-type cables. The minimum bandwidths for tight-buffered cable are 400 MHz-km at both 850 nm and 1,300 nm. The index of refraction profile of multimode fiber shall be near-parabolic graded index.		
**Building/Breakout Cables (Tight Buffer). Tensile load rating and minimum bending radius do not apply to tight-buffered breakout-type cables.		

dB=decibel; km=kilometer; MHz=megahertz; nm=nanometer

b. SM FOC: Fiber strands shall have a nominal core diameter of 8.3 microns. The cladding diameter shall be 125 microns (+/-2 microns). As shown in Table 6, all cabled single-mode fibers shall have a maximum attenuation value of 0.5 dB/km for high grade at 1,310 nm over the entire specified temperature range. The fibers described in Table 7 are glass with a protective coating and an outer buffer tube. These fibers are placed in a cable of up to 192 fibers and are further protected by various layers as described in Paragraph 3.10.4.3. Plastic fibers shall not be used.

**Table 7. Single-mode Dual-windowed Fiber Cable Characteristics**

Function	Parameters
Maximum Attenuation dB/km @ 1,310 nm	*0.5
Maximum Attenuation dB/km @ 1,550 nm	*0.5
Core Diameter Microns	8.3 (nominal)
Core Eccentricity	Less than or equal to 1.0 micron
Cladding Diameter Microns	125 +/-2
Coating Diameter Microns	250 +/-2
Mode Field Diameter Microns	8.8 +/-0.5
Zero Dispersion Range	1310 +/-010 nm
Maximum Dispersion Range	3.2 ps/nm - km (range 1,285 to 1330 nm) 19 ps/nm - km (range 1,550 nm)
Refractive Index	0.37%
Cable Tensile Load Rating	600 lb (Note 3)
Cable Minimum Bending Radius	**15 x cable diameter under no load. 0-800 N (0-180 lb) (Note 3). 20 x cable diameter under load. 800-2,700 N (181-600 lb).
*Building/Breakout Cables (Tight Buffer). Maximum attenuations do not apply to tight buffered, breakout-type cables. Maximum attenuation for tight buffered cable is 1.25 dB/km @ 1,310 nm and 1.0 dB/km @ 1,550 dB/km.	
**Building/Breakout Cables (Tight Buffer). Tensile load rating and minimum bending radius do not apply to tight buffered, breakout-type cables.	

ps=picosecond

c. NZDSF: Fiber optic cables installed to support DWDM, as identified in the design package, shall be NZDSF optic cable when the distance exceeds 25 miles. The NZDSF cable shall meet or exceed the recommendations of ITU-T Recommendation G.655 (03/2003), *Characteristics of a non-zero dispersion shifted single-mode optical fiber cable*, (Table 1/G.655-G.655A and Table 2/G.655-G.655B). Table 8 is an extraction of the ITU-T G.655 recommendation. If the use of standard fiber versus non-zero dispersion-shifted fiber for the distance is in question, an analysis shall be performed to determine which fiber will best support channel capacity for the distance at which the cable is to be installed.

**Table 8. Non-zero Dispersion-shifted Single-mode FOC Characteristics**

Fiber Attributes		
Attribute	Detail	Value
Mode Field Diameter	Wavelength	1,550 nm
	Range of nominal values	8-11 μm
	Tolerance	± 0.7 μm
Cladding Diameter	Nominal	125 μm
	Tolerance	± 1 μm
Core Concentricity Error	Maximum	0.8 μm
Cladding Noncircularity	Maximum	2.0 %
Cable Cut-off Wavelength	Maximum	1,450 nm
Macrobend Loss	Radius	30 mm
	Number of turns	100
	Maximum at 1,550 nm	0.50 dB



**Table 8. Non-zero Dispersion-shifted Single-mode FOC Characteristics (continued)**

Fiber Attributes		
Attribute	Detail	Value
Proof Stress	Minimum	0.69 GPa
Chromatic Dispersion Coefficient Wavelength Range: 1,530-1,565 nm	$\lambda_{min}$ and $\lambda_{max}$	1,530 and 1,565 nm
	Minimum value of $D_{min}$	0.1 ps/nm·km
	Maximum value of $D_{max}$	6.0 ps/nm·km 10.0 ps/nm·km*
	Sign	Positive or negative
	$D_{max} - D_{min}$ *	$\leq 5.0$ ps/nm·km*
Uncabled Fiber PMD Coefficient	Maximum	(See note.)
Attenuation Coefficient	Maximum at 1,550 nm	0.35 dB/km
PMD Coefficient	M	20 cables
	Q	0.01 %
	Maximum PMD <sub>Q</sub>	0.5 ps/ $\sqrt{\text{km}}$
<b>Note:</b> An optional maximum PMD coefficient on uncabled fiber may be specified by cablers to support the primary requirement on cable PMD link design value (PMD <sub>Q</sub> ), if it was demonstrated for a particular cable construction.		

\* Values that apply to systems with minimum channel spacing of 100 GHz or less.

$\lambda$ =wavelength;  $\mu\text{m}$ =micrometer; D=Chromatic Dispersion Coefficient; GHz=gigahertz; GPa=gigapascal; M=cable sections; PMD=polarization mode dispersion; Q=small probability level

### 3.15.4.3 Temperature Range

Outdoor cables shall have an operating and storage range of -40 to +70 degrees C. Indoor cables shall have an operating and storage range of -20 to +70 degrees C. Cables shall perform to their specified attenuation over the entire temperature range specified above. The attenuation shall not vary by more than 0.2 dB/km for single-mode fiber, 0.5 dB/km for multimode fiber, and shall never exceed the specified attenuation limits.

### 3.15.4.4 Fiber Cable Count Assignment

Fiber optic cable strand counts shall be assigned in a manner similar to copper counts. The high-number counts shall be dropped first, and the Strand 1 count shall be the farthest from the serving node. Fibers shall typically be split, handled, and/or terminated in groups or bundles of 12 strands. Groups that are designated as spares or for future growth (also called dark fibers) shall be dropped in the maintenance holes in an area stipulated by the SOW/SOR/PWS or the NEC to position them for future growth.

### 3.15.4.5 Fiber System Design Guideline

If there is no specific guidance in the project documents, use the following as a guideline for assigning fiber optic strands to buildings. A guiding principle is to eliminate single points of failure that would impact critical users or large groups of users.

a. General:

- Dual-homed = two connections over two physically diverse paths or over a single, concrete-encased path.
- Dual-uplinked = two (or more) connections over one physical path.
- Single-linked = one connection over one physical path.

- All core nodes shall, at a minimum, be dual-homed to each MCN (server farm, NMS, TLA).
- All distribution nodes shall, at a minimum, be dual-homed to at least two MCN core nodes.
- All distribution nodes shall be connected to two adjacent distribution nodes.
- All EUBs that support Special C2 users shall, at a minimum, be dual-homed to two distribution nodes (ADNs).
- All EUBs that support C2 users shall, at a minimum, be dual-uplinked to one distribution node (ADN).
- All EUBs that support C2 Routine users shall, at a minimum, be dual-uplinked to one distribution node (ADN).
- All EUBs that support non-C2 users shall, at a minimum, be single-linked to one distribution node (ADN).
- Designs for new fiber optic cable shall include at least 50 percent spare, unused strands, with cables designed in multiples of 12-strand groups.

b. New Cable Installation:

**Table 9. Fiber Sizing Between Buildings**

From	To	Strands	Notes
MCN	MCN	24	1.
Server Farm	MCN	24	1, 3
ADN	MCN	12	1, 3
ADN	ADN	12	1.
ADN	EUB	12	1, 2, 3, 4, 5

Note 1. The numbers listed are for the minimum required strands.

Note 2. Twelve (12) strands will support up to 300 users in an EUB. Four (4) additional strands are required for each group of 100 users above this threshold.

Note 3. Dual homing will require the same number of strands for both paths.

Note 4. Dual uplinks may require additional strands.

Note 5. Direct connections of multiple closets in a building to an ADN may require additional strands.

c. Existing Cable Guidelines:

Use of existing fiber optic cables is acceptable if the following conditions are met:

(1) The number of existing strands is adequate to support the required number of links (transmit and receive, multiple closet uplinks, dual uplinks, etc).

(2) The strands are tested to verify that they meet the requirements/specification of the proposed transport method (1-Gb, 10-Gb, DWDM, etc).

These determinations need to be accomplished during the survey and design phases of the project.

**3.15.4.6 Use of Innerduct/Subduct/Fabric Mesh**

For underground installation, each FOC shall be installed in innerduct, fabric mesh, or subduct. Fiber optic cable shall not be installed directly into a 4-inch (100-mm) duct.

#### 3.15.4.7 Splices and Power Budget

a. Splicing of FOC shall be accomplished using fusion splicing to weld the two fibers together. Fusion splices shall have insertion loss values of <0.05 dB and return loss values of >55 dB. Mechanical splices shall be used only with prior Government consent. Mechanical splices shall have insertion loss values of <0.15 dB with return loss values of >35 dB.

b. IAW RUS Bulletin 1751F-642 for buried FOC plant, the preferred method for splicing FOC plant is direct-buried, filled splice cases installed in maintenance holes or hand holes.

c. Loop-through splicing shall be used in lieu of homeruns/dedicated cables to the serving location. In loop-through splicing, only the fiber strands branching off from the main cable to enter a building are cut and spliced. The other fibers are not cut. The sheath is cut from the cable, exiting fibers are cut and spliced, and remaining fibers are folded back within the case (not cut) and then routed on.

#### 3.15.4.8 Manufactured Outside Plant Cable Assemblies

A manufactured OSP cable assembly will be an FOC that is manufactured with connection points that allow for the connection of smaller FOCs to be attached without splicing in the field. The manufactured OSP assembly will be constructed in such a matter that the assembly can be installed either in a conduit, DB, or aerial system and will not be adversely affected by its environment any more so than the traditional fiber cable products. Care shall be taken in the design, ordering, and installation phases so that excessive cable lengths are not disguised as maintenance loops. Maintenance loops on manufactured cable assemblies shall be IAW manufacturers' recommendations. In lieu of manufacturers' recommendations, a 20-foot maintenance loop is adequate.

The use of manufactured OSP cable assemblies is permitted in OSP designs. The connection points shall be selected to meet the overall design of the cable system.

#### 3.15.4.9 FOC Slack

a. The installed length of a FOC shall include additional amounts of cable for slack. This slack shall be distributed throughout the cable run to provide extra cable for cut repairs, path relocations, splice loops, maintenance, etc.

b. Slack in an underground system shall be secured in loops, typically with plastic cable ties, and placed so as to be out of harm's way and still be accessible if within a maintenance hole. Slack on aerial cables shall be neatly organized, using aerial fiber optic storage loops ("snowshoes"). The snowshoe's size shall be based on the cable bend radius.

c. Calculate the minimum amount of slack as follows:

- Splice locations: 50 feet on each cable sheath to allow splicing to take place in a splice trailer.
- Road crossings (aerial): 100 feet.
- Aerial per linear mile: three locations, each with 100 feet.
- Pull-through maintenance hole: 20 feet.

### **3.15.5 Transfers, Cuts, and Throws**

Cable transfers, cuts, and throws shall be performed to maximize existing resources. All cables and terminals affected by cable count transfers shall be retagged in the field to reflect the new changes.

### **3.16 Main Distribution Frame (MDF)**

The MDF is the interface between the OSP cable and the switch cables. The iron framework of the MDF supports the horizontal blocks and vertical connectors. The MDF shall be equipped with guard rails and end rails. The engineer shall provide new vertical sections to support all newly-installed cable if none are available. A minimum of 30 inches (760 mm) of clearance around the frame is required for safety.

#### **3.16.1 Horizontal Blocks**

The horizontal blocks terminate the cables between the switch and the MDF. Each connection corresponds to a telephone number on the switch. The switch engineer shall determine the number of horizontal blocks on the frame. All horizontal blocks shall be stenciled to show the termination IDs.

#### **3.16.2 Vertical Connectors**

The vertical connectors are mounted on the vertical side of the MDF. Each connector protects 100 or 200 pairs of the OSP cables. The connector is equipped with tip cables that are pre-terminated on the connector. The tip cables are routed either from the MDF through the floor to the cable vault, or over the MDF to the wall, where they are spliced to the OSP cable. The connectors for the tip cables shall be provided as either stub-up or stub-down as determined by the type of installation required. The vertical connectors protect the electronics in the DCO by providing lightning and surge protection. Each termination corresponds to a pair of the OSP cables. All OSP cable pairs shall be terminated on connectors. Each vertical connector shall be stenciled to show the cable number and the pair counts for all connectors on that particular vertical connector. All connectors shall show the count terminated. A schematic showing the vertical side of the MDF is shown in Figure C-7 (Figure C-15 for Europe), MDF and Cable Vault Schematic. Space-saver type MDF connectors shall be used, unless the U.S. Government directs otherwise.

#### **3.16.3 Cross-connects**

Cross-connects shall be installed between the OSP terminations on the vertical connectors and the switch terminations on the horizontal blocks. This process connects an OSP pair to a telephone number. Approximately 8 inches (200 mm) of slack shall be left in the cross-connect wire to allow re-termination for moves, additions, or changes.

#### **3.16.4 Special Circuits**

Since special circuits (such as data circuits, T-1s, or alarms) are non-switched, they shall be treated differently than voice and modem circuits. The protector modules shall be marked IAW the existing site procedure to indicate a special circuit. Various colors of protector modules are available to help in this differentiation. The special circuits shall be cross-connected to designated blocks on the horizontal side (not to the switch blocks).

### **3.17 Building Terminations**

#### **3.17.1 PETs**

All OSP copper cables shall be terminated on primary protector blocks equipped with 5-pin solid state or gas protector modules.

#### **3.17.2 Terminals and Hardware**

Terminals and hardware shall be UL-listed and shall be made of a flame-retardant construction and equipped with a built-in splice chamber; 5-pin gas protector modules; locking cover; and output on 110 blocks or RJ21 connectors. The PET for European projects will be equipped with protected, line-sharing adapter plus (LSA+) terminal blocks. All PETs shall be connected to the lightning protection grounding system for the building.

#### **3.17.3 Fiber Optic Patch Panels**

##### **3.17.3.1 Fiber Termination Device**

All strands of FOC, both OSP and inside plant (ISP), will be properly terminated on FOPPs. The OSP plant FOC will be extended IAW the National Electrical Code standards into the main data closet/location of the building and terminated there. If the main data closet/location cannot be determined, the OSP FOC will be terminated on a lockable patch panel collocated with the copper PET. Inside plant FO riser cables between the main data room/location and any satellite data room(s)/location(s) will be terminated at both locations on the FOPPs. All FOPPs will be stenciled with the panel number and the cable count.

##### **3.17.3.2 Fiber Terminations**

All terminations shall be made using subscriber connector (SC) or straight tip (ST) connectors (ST<sup>TM</sup>-compatible) or as defined in the SOR/PWS. Per the ANSI, duplex SC is the recommended connector for OSP cable terminations. Use of the Physical Contact (PC) family of connectors may be required based on the performance requirements of the network or system to be installed, the interface of the terminal electronics, or planned upgrades to the system or network. Physical Contact connectors are also referred to as Polished Connectors. The PC family of connectors includes Ultra PC (UPC), Super PC (SPC), and Angle PC (APC). These connectors shall typically be used to support systems with 10-Gb or higher connection rates. All OSP fibers shall be fusion-spliced to factory-produced pigtailed.

### **3.18 Grounding**

All unclassified TRs shall be connected to the building's earth electrode subsystem (EES) IAW MIL-STD-188-124-B. Information on grounding of classified facilities can be found in MIL-STD-188-124-B and MIL-HDBK-419-A. Figure C-17 of Appendix C provides detailed schematics for the signal grounding system. An acceptable grounding system encompasses fault protection grounds, lightning protection grounds, signal grounds, and DC power grounds (when applicable). Refer to NFPA 780 and MIL-HDBK-419-A for proper lightning protection and to NFPA 70 for proper fault protection grounding. The telecommunications designer shall review the applicable project drawing(s) to ensure that the lightning and fault protection grounds are addressed by the appropriate disciplines. The telecommunications designer shall ensure that the various grounding systems are not mixed within the building.

### **3.18.1 Building Ground**

The building EES forms the primary electrical, life-safety grounding system. Typically, a grounding electrode conductor connects the main building-grounding electrode to the main electrical entrance panel or cabinet. Article 250, Section III of NFPA 70 provides guidance on the grounding electrode system and conductor. The EUBs and ADNs shall have a resistance-to-earth of 10 ohms or less, following MIL-STD-188-124-B. The switch manufacturers may specify the resistance-to-earth as 5 ohms or less for a telephone switch or DCO. The designer shall be conscious of the proposed utilization of the facility and shall plan accordingly. Sites shall provide proper supporting documentation and specifications to the designer to support any resistance-to-ground requirements that are more stringent than those of NFPA 70 or MIL-STD-188-124-B for non-voice switch buildings. Proper documentation includes international, national, or local codes; DOD and DA standards; and/or manufacturers' equipment specifications.

### **3.18.2 Cable Entrance Grounding**

All metallic shields and strength members for OSP cable entering a building shall be connected to the lightning protection ground system. The designer shall ensure that the lightning protection is IAW MIL-STD-188-124-B and NFPA 780, *Standard for the Installation of Lightning Protection Systems*, most recent issue.

#### **3.18.2.1 Building Point of Entrance**

The NFPA 70 defines the point of entrance as the location where “the wire or cable emerges from an external wall, from a concrete floor-slab, or from a rigid metal conduit or an IMC grounded to an electrode IAW 800.400-B.” The Telecommunications Entrance Facility (TEF) is the space housing the point of entrance of the telecommunications service.

#### **3.18.2.2 Copper Cable Entrance**

The OSP copper cable shield, armor, and metallic strength member shall be bonded to the lightning protection ground as close to the building point of entrance as possible with a No. 6 AWG or larger ground wire. The designer shall use a non-bonded splice case for the transition from OSP-rated cable to interior-rated cable or shall indicate that the implementer shall not install the splice case carry-through bonding conductor. If the designer shall extend the OSP copper cable past 50 feet (15 m) IAW NFPA 70 Section 800.50, the metallic strength member shall be bonded to the lightning protection ground as close to the conduit egress point as possible with a No. 6 AWG or larger copper ground wire.

#### **3.18.2.3 Fiber Cable Entrance**

The OSP FOC armor and metallic strength member shall be bonded to the lightning protection ground as close to the building point of entrance as possible with a No. 6 AWG or larger ground wire. The designer shall use a non-bonded splice case for the transition from OSP-rated cable to interior-rated cable or shall indicate that the implementer shall not install the splice case carry-through bonding conductor. If the designer shall extend the OSP fiber cable past 50 feet IAW NFPA 70 Section 770.50, the metallic strength member shall be bonded to the lightning protection ground as close to the conduit egress point as possible with a No. 6 AWG or larger copper ground wire. If inside/outside cable is used, a cable shield isolation gap shall be incorporated.

#### **3.18.2.4 Copper Protector Block**

All OSP copper cables shall be terminated on primary protector blocks equipped with 5-pin solid state or gas protector modules. The protector blocks shall be bonded to the lightning protection ground with a No. 6 AWG or larger copper ground wire. Terminals and hardware shall be UL-listed, made of a flame-retardant construction, and equipped with a built-in splice chamber; 5-pin gas protector modules; locking cover; and output on 110 blocks, or RJ21 connectors. The PET for European projects will be equipped with protected, LSA+ terminal blocks. All PETs shall be connected to the lightning protection grounding system for the building. The protector block shall be placed as close to the lightning protection ground as possible.

### **3.19 Final Acceptance Test**

#### **3.19.1 Telecommunications Cable Plant**

Testing will consist of, but will not be limited to, the following cable tests:

- Insulation resistance.
- Shorts/crosses.
- Grounds.
- Opens.
- Reversals.
- Splits.
- Transpositions.
- Shield continuity.
- Loop resistance.
- Insertion loss (performed only when specified).
- Capacitance.

#### **3.19.2 FOC**

Testing will consist of Optical Time Domain Reflectometer (OTDR) measurements for one strand in each 12-strand bundle of fiber, and Power Source/Power Meter tests on every strand in all cables. Each strand of fiber cable not terminated at each end will be tested with the OTDR. While using the OTDR, measure the length of the strand and look for any circuit discontinuities and/or splice points. Run a strip chart for each fiber strand tested, and record the cable ID, strand ID, source location, meter location, and dB loss at each specified nm wavelength and fiber length, and note whether the strand passed or failed the test. The following tests will also be included as a minimum:

- Attenuation.
- Bandwidth.
- Power Source/Power Meter: This test will consist of bi-directional, dual-window (1,300/1,550 nm) testing of every fiber strand installed.

The standard cable reel lengths and diameters are listed in Table 10.

**Table 10. Standard Cable Reel Lengths and Diameters**

Cable Type	Number of Pairs	AWG	Standard Length (ft)	Nominal Diameter (in)
PE-22	6 x	19	5,000	0.53
Air Core	12 x	19	5,000	0.6
Alpeth	25	19	5,000	0.81
Sheath	50	19	2,500	1.08
	6 x	22	5,000	0.43
	12 x	22	5,000	0.53
	25	22	5,000	0.7
	50	22	5,000	0.85
	100	22	5,000	1.07
	200	22	5,000	1.48
	300	22	2,000	1.75
	400	22	2,000	1.96
	600	22	1,000	2.44
	900	22	1,000	2.88
	1,200	22	750	3.29
	6 x	24	10,000	0.41
	12 x	24	10,000	0.46
	25	24	10,000	0.55
	50	24	5,000	0.66
	100	24	5,000	0.87
	200	24	5,000	1.18
	300	24	2,500	1.38
	400	24	2,500	1.53
	600	24	2,500	1.85
	900	24	1,500	2.31
	1,200	24	1,000	2.69
	1,500	24	1,000	2.92
	1,800	24	750	3.01
	2,100	24	500	3.39
	25	26	10,000	0.49
	50	26	10,000	0.57
	100	26	10,000	0.71
	200	26	5,000	0.97
	300	26	5,000	1.14
	400	26	5,000	1.30
	600	26	2,500	1.54
	900	26	2,500	1.88
	1,200	26	1,500	2.10
	1,500	26	1,500	2.32
	1,800	26	1,000	2.48
	2,100	26	1,000	2.68
	2,400	26	1,000	2.90
	2,700	26	1,000	3.03



**Table 10. Standard Cable Reel Lengths and Diameters (continued)**

Cable Type	Number of Pairs	AWG	Standard Length (ft)	Nominal Diameter (in)
	3,000	26	750	3.20
Figure-8	6 x	22	9,930	0.96
Filled	12 x	22	9,930	1
Alpeth	25	22	9,810	1.16
Sheath	50	22	6,540	1.34
	6 x	24	11,340	0.88
	12 x	24	11,340	0.96
	25	24	11,340	1.02
	50	24	11,340	1.18
	50	26	13,320	1.08
	100	26	8,820	1.26
PE-89	6 x	19	5,000	0.52
Filled	12 x	19	5,000	0.62
Alpeth	25	19	5,000	0.86
Sheath	50	19	5,000	1.12
	100	19	2,500	1.51
	200	19	1,500	2.04
	6 x	22	5,000	0.48
	12 x	22	5,000	0.52
	25	22	5,000	0.66
	50	22	5,000	0.86
	75	22	5,000	0.96
	100	22	5,000	1.1
	150	22	5,000	1.32
	200	22	2,500	1.49
	300	22	2,000	1.72
	400	22	2,000	1.96
	600	22	1,000	2.4
	900	22	1,000	2.9
	1,200	22	750	3.28
	6 x	24	10,000	0.44
	12 x	24	10,000	0.48
	25	24	10,000	0.58
	50	24	10,000	0.7
	75	24	5,000	0.86
	100	24	5,000	0.94
	150	24	5,000	1.06
	200	24	5,000	1.2
	300	24	2,500	1.45
	400	24	2,000	1.59
	600	24	2,000	1.92
	900	24	1,000	2.32
	1,200	24	1,000	2.68
	1,500	24	1,000	2.92

**Table 10. Standard Cable Reel Lengths and Diameters (continued)**

Cable Type	Number of Pairs	AWG	Standard Length (ft)	Nominal Diameter (in)
	1,800	24	750	3.2
	2,100	24	600	3.44
	25	26	10,000	0.52
	50	26	10,000	0.58
	100	26	10,000	0.78
	200	26	5,000	1.02
	300	26	5,000	1.18
	400	26	5,000	1.33
	600	26	2,500	1.59
	900	26	2,000	1.92
	1,200	26	1,500	2.1
	1,500	26	1,000	2.34
	1,800	26	1,000	2.6
	2,100	26	1,000	2.78
	2,400	26	1,000	2.92
	2,700	26	750	3.14
	3,000	26	750	3.24
	6 x	19	5,000	0.58
PE-89	12 x	19	5,000	0.66
Filled	25	19	5,000	0.9
Rodent	50	19	2,500	1.18
Protected	6 x	22	5,000	0.54
Alpeth	12 x	22	5,000	0.58
Sheath	25	22	5,000	0.7
	50	22	5,000	0.9
	100	22	5,000	1.14
	200	22	2,500	1.51
	300	22	2,000	1.76
	400	22	2,000	2
	600	22	1,000	2.46
	900	22	1,000	2.94
	1,200	22	750	3.28
	6 x	24	10,000	0.5
	12 x	24	10,000	0.54
	25	24	10,000	0.58
	50	24	10,000	0.74
	100	24	5,000	0.98
	200	24	5,000	1.26
	300	24	2,500	1.49
	400	24	2,000	1.63
	600	24	2,000	1.96
	900	24	1,000	2.36
	1,200	24	1,000	2.68
	1,500	24	1,000	2.94

**Table 10. Standard Cable Reel Lengths and Diameters (continued)**

Cable Type	Number of Pairs	AWG	Standard Length (ft)	Nominal Diameter (in)
	1,800	24	750	3.22
	25	26	10,000	0.58
	50	26	10,000	0.66
	100	26	10,000	0.82
	200	26	5,000	1.08
	300	26	5,000	1.22
	400	26	5,000	1.38
	600	26	2,500	1.63
	900	26	2,000	1.92
	1,200	26	1,500	2.11
	1,500	26	1,000	2.36
	1,800	26	1,000	2.62
	2,100	26	1,000	2.78
	2,400	26	1,000	2.94
	2,700	26	750	3.18
	3,000	26	750	3.26
A-2YF(L)2Y	2	0.6	Special order only	9.0 (0.35)
PE insulation	4	0.6	Special order only	11.5 (0.45)
Jelly filled cable core	6	0.6	1,000	12.0 (0.47)
Laminated sheath	10	0.6	1,000	13.5 (0.53)
DIN VDE 0816	20	0.6	1,000	16.5 (0.65)
	30	0.6	1,000	19.5 (0.77)
	50	0.6	1,000	23.5 (0.93)
	100	0.6	1,000	31.5 (1.24)
	150	0.6	1,000	37.5 (1.48)
	200	0.6	1,000	42.5 (1.67)
	300	0.6	500	52.0 (2.05)
	500	0.6	300	67.0 (2.64)
	600	0.6	300	74.0 (2.91)
	800	0.6	300	85.0 (3.35)
A-2YF(L)2Y	6	0.8	1,000	13.0 (0.51)
PE insulation	10	0.8	1,000	15.0 (0.59)
Jelly filled cable core	20	0.8	1,000	18.0 (0.71)
Laminated sheath	30	0.8	1,000	21.0 (0.83)
DIN VDE 0816	50	0.8	1,000	26.0 (1.02)

Table 11 shows the European standard cable reel lengths and diameters.

**Table 11. European Standard Cable Reel Lengths and Diameters**

Cable Type	Number of Pairs	Conductor Size (mm)	Standard Reel Length (m)	Nominal Outside Diameter mm (in)
	100	0.8	1,000	34.0 (1.34)
	150	0.8	500	40.0 (1.57)
	200	0.8	500	47.0 (1.85)
	300	0.8	300	61.0 (2.40)
	500	0.8	300	78.0 (3.07)

Table 12 shows an example of a cable spreadsheet.

**Table 12. Cable Spreadsheet Sample**

Termination	Required Copper Pairs	Served From	Copper Cable & Count	Required Fiber Strands	Served From	Fiber Cable & Count	Priority	Remarks
MH 5	900	B 376	6, 1-900 C/C	N/A	N/A	N/A	Phase 1	
B 390	900	B 376	6, 901-1,800	192	B 376	FOC A, 1-192	Phase 1	Backbone fiber to ADN.
B 220	50	B 376	7, 1-50	12	B 376	FOC A-2, 25-36	Phase 2	
B 218	100	B 376	7, 51-150	12	B 376	FOC A-2, 37-48	Phase 2	
B 219	100	B 376	7, 151-250	12	B 376	FOC A-2, 49-60	Phase 2	
B 233	50	B 376	7, 251-300	12	B 376	FOC A-2, 61-72	Phase 2	
B 223	100	B 376	7, 301-400	12	B 376	FOC A-2, 73-84	Phase 2	
B 224	200	B 376	7, 401-600	12	B 376	FOC A-2, 85-96	Phase 2	
B 231	100	B 376	7, 601-700	12	B 376	FOC A-2, 97-108	Phase 2	
B 228	100	B 376	7, 701-800	12	B 376	FOC A-2, 109-120	Phase 2	
B 227	100	B 376	7, 801-900	12	B 376	FOC A-2, 121-132	Phase 2	
B 225	100	B 376	7, 901-1,000	12	B 376	FOC A-2, 133-144	Phase 2	
B 202	100	B 376	7, 1001-1,100	12	B 376	FOC A-1, 1-12	Phase 2	
B 203	100	B 376	7, 1101-1,200	12	B 376	FOC A-1, 13-24	Phase 2	
B 214	100	B 376	7, 1201-1,300	12	B 376	FOC A-1, 25-36	Phase 2	
B 204	100	B 376	7, 1501-1,600	12	B 376	FOC A-1, 37-48	Phase 2	
B 212	100	B 376	7, 1401-1,500	12	B 376	FOC A-1, 49-60	Phase 2	
B 206	100	B 376	7, 1301-1,400	12	B 376	FOC A-1, 61-72	Phase 2	

**Table 12. Cable Spreadsheet Sample (continued)**

Termination	Required Copper Pairs	Served From	Copper Cable & Count	Required Fiber Strands	Served From	Fiber Cable & Count	Priority	Remarks
B 192	100	B 376	7, 1601-1,700	12	B 376	FOC A-1, 73-84	Phase 2	
B 193	100	B 376	7, 1701-1,800	12	B 376	FOC A-1, 85-96	Phase 2	
B 399				12	B 376	FOC D1, 1-12	Phase 2	LAN C-DCO is B 376.

#### **4.0 VOICE SWITCHING, CENTRAL OFFICE/END OFFICE, AND CONVERGENCE**

Voice switching architecture and technology are addressed in USAISEC *TG for Telephone Switching*. The information previously provided in the section of this TC entitled “Dial Central Office/Remote Switching Unit” is also included in the *TG for Circuit Switching*. The circuit switching guide provides generic technical guidance for the design of telephone systems that support U.S. Army facilities. The document contains design guidance related to identifying system requirements, supporting engineering site surveys, performing new construction planning and systems designs, in support of procuring, engineering, installing, testing, and cutting over administrative telephone systems within the boundaries of U.S. Army installations. The document is currently under review for revisions and updates.

The convergence of voice, data, and video is addressed in the USAISEC *Voice over Internet Protocol Design Guidelines*, December 2005 (currently under revision). The document describes the design requirements that will be used to implement VoIP. It also incorporates regulatory policies and guidance as well as best business practices within industry. The document applies to both converged and non-converged networks, as defined within the *Department of Defense Unified Capabilities Requirements (UCR 2008)*, December 2008.

#### **5.0 NETWORK ARCHITECTURE**

The network architecture topology normally follows the existing telephone topology. Geographic dispersion, number of users in the area, available space for electronics equipment, existing cable and duct system, and identified areas of future growth are also considered when core node locations are selected. The converged architecture will provide a common IP-based transport for all Non-secure IP Router Network (NIPRNet), encrypted SIPRNet, non-authenticated users, Synchronous Optical Network (SONET), and Sensitive Information voice, data, and video services on the post, camp or station network. The converged architecture provides a core node backbone using carrier class switching to provide a high degree of scalability and availability to all required services as described in the U.S. Army Network Enterprise Technology Command (NETCOM) Horse Blanket LandWarNet LAN/CAN technical profile.

Data network architecture and technology are addressed in the USAISEC-TIC *Installation Information Infrastructure Modernization Program (I3MP) Data Performance Requirements, Version 1.2*, July 2004.

## **6.0 NETWORK AND SYSTEMS MANAGEMENT**

### **6.1 Introduction**

System and network management is becoming increasingly important in today's environment of distributed applications and heightened security and is addressed in the USAISEC *Technical Guide for Network and Systems Management (NSM)*. Network and system administrators rely heavily on automated NSM tools for tasks such as discovering, diagnosing, and correcting problems; updating software, and maintaining network/system operations. Managing networks and systems is a difficult and complicated task requiring extensive knowledge in numerous areas such as operating systems, networking devices and protocols, addressing, databases, applications, and others. The NSM systems are intended to ease the burden on resources associated with these tasks.

#### **6.1.1 NSM Objectives**

The objective of an NSM is to provide effective, responsive, and proactive management of networks and systems with minimal life-cycle support costs. This includes the integration of lower level management systems and subsystems to provide an enterprise view of the network and system assets. The primary uses of NSM are as follows:

- Provide backup and recovery services.
- Monitor, identify, track, and correct information system and network communication failures.
- Monitor, identify, and correct network and system security problems.
- Monitor, control, and fine tune network and systems performance.
- Identify communication and processing resource usage.
- Manage inventory and distribute software information assurance and security.

### **6.2 Purpose**

The USAISEC *Technical Guide for Security Engineering* defines the process for performing Information System Security (ISS) Engineering (ISSE) at the USAISEC. The National Security Agency (NSA) *Information Assurance Technical Framework (IATF), Version 3.1*, September 2002, defines ISSE as the process for addressing a user's information protection needs and is part of the systems engineering, systems acquisition, risk management, certification and accreditation (C&A) and the life cycle support processes. The USAISEC Security Engineering TG not only presents the IATF description for ISSE, but also defines how this process is implemented by USAISEC within the U.S. Army.

## **7.0 WIRELESS LOCAL AREA NETWORK**

The USAISEC *Design Guide for the Implementation of Wireless Technologies*, May 2007, provides detailed guidance on WLAN implementation for edge connectivity.

## APPENDIX A. TECHNICAL CRITERIA CHECKLIST FOR THE INSTALLATION INFORMATION INFRASTRUCTURE ARCHITECTURE

**Table A-1. TC Checklist**

Item	Compliance Y N N/A Not addressed	TC Paragraph	Standard and Section	Requirement	Comments
		2.0	TIA/EIA-568-B and TIA/EIA-569-B	Does this project include structured BCSs?	Continue through this checklist and TC for detailed information on BCS implementation.
		2.1		Does this project include a secure information systems infrastructure?	Refer to the USAISEC TG for the Integration of SIPRNET (August 2008)
		2.3	TIA/EIA-568-B and TIA/EIA-569-B	Design the workstation outlet configuration, locations and densities IAW sub-paragraphs 2.3.1 through 2.3.10	
		2.4	TIA/EIA-568-B	Specify standardized cabling types IAW paragraphs 2.4.1 through 2.4.3	
		2.4.4	TIA/EIA-569-B	Design the cabling infrastructure IAW paragraphs 2.4.4.1 through 2.4.4.7	
		2.5	TIA/EIA-568-B and TIA/EIA-569-B	Specify and provision the TRs IAW paragraphs 2.5.1 through 2.5.16	
		2.6	MIL-HNBK-419-A MIL-STD-188-124-B NFPA 70	Design the telecommunications grounding system IAW USAISEC TC and the specified standards.	The TG for USAISEC LPAGBS provides additional detail on overall grounding systems.
		2.7	TIA/EIA-606-A	Specify the labeling and identification of the telecommunications system IAW paragraphs 2.7.1 through 2.7.5	

Table A-1. TC Checklist (continued)

Item	Compliance Y N N/A Not addressed	TC Paragraph	Standard and Section	Requirement	Comments
		2.8	TIA/EIA-568-B and TIA/EIA-569-B, TIA/EIA- 758	Design the cable entrance IAW paragraphs 2.8.1 through 2.8.3	
		2.9	TIA/EIA-568-B	Specify the complete testing of all installed cabling IAW paragraphs 2.9.1 through 2.9.4	
		3.0		Does this project include structured OSP Cabling Systems?	Continue through this checklist and TC for detailed information on Outside Plant Cabling Systems implementation.
		3.1		Does this project include a secure information systems infrastructure?	Refer to the USAISEC TG the Integration of SIPRNET (August 2008)
		3.3		Design the OSP to support the U.S. Army architecture and meet the requirements of the user.	
		3.5		Consider and document all environmental and historical concerns.	
		3.6		Conform to all general considerations when designing and executing an OSP project, as specified in paragraphs 3.6.1 through 3.6.10	
		3.7		Select proper placement option for OSP location and application.	
		3.8		Conform to all underground construction considerations when designing and executing an underground OSP system.	The underground OSP system is the preferred method within the post, camp or station cantonment area.



**Table A-1. TC Checklist (continued)**

Item	Compliance Y N N/A Not addressed	TC Paragraph	Standard and Section	Requirement	Comments
		3.9		Conform to all DB construction considerations when designing and executing a direct-buried OSP system.	
		3.10		Conform to paragraphs 3.10.1 through 3.10.4 when crossing or passing through OSP obstructions	
		3.11		Conform to all aerial cable construction considerations when designing and executing an aerial cable OSP system.	Aerial cable runs shall be used only with U.S. Government approval in extenuating circumstances or for long runs outside of the cantonment area, as specified in the design package.
		3.12		Design any FSO links IAW section 3.12 and paragraphs 3.12.1 through 3.12.2	FSO can provide an alternative to FO connectivity, for the “last mile,” to EUBs and small enclaves, but shall closely follow the performance and security requirements specified.
		3.13		Does this project include ranges, or is the project located on a range?	Design any range project or connectivity IAW the guidance and directions provided in paragraphs 3.13.1 through 3.13.4.

**Table A-1. TC Checklist (continued)**

Item	Compliance Y N N/A Not addressed	TC Paragraph	Standard and Section	Requirement	Comments
		3.14		Does this project include piers, or is the project located on a pier?	Design any pier project or connectivity IAW the guidance and directions provided in paragraphs 3.14.1 through 3.14.3.
		3.15		Specify and install standardized cabling types in accordance with paragraphs 3.15.1 through 3.15.5	
		3.16		Is an MDF installation or upgrade required in this project? Specify and install the MDF IAW paragraphs 3.16.1 through 3.16.4.	
		3.17		Design and install building terminations IAW paragraphs 3.17.1 through 3.17.3.	
		3.18	MIL-HDBK-419-A MIL-STD-188-124-B NFPA 70	Design the telecommunications grounding system IAW USAISEC technical guidance and the specified standards.	The TG for USAISEC LPAGBS provides additional detail on overall grounding systems.
		3.19		Specify the complete testing of all installed OSP cabling IAW paragraphs 3.19.1 through 3.19.2.	
		4.0		Does this project include a voice switching system?	Voice switching architecture and technology is addressed in USAISEC TG for Circuit Switching.
		5.0		Does this project encompass the data backbone, or attach to the data core?	Data network architecture and technology is addressed in USAISEC TIC Installation Information Infrastructure Modernization Program (I3MP) Data Performance Requirements
		6.0		Does this project encompass the data backbone, or attach to the data core?	System and network management is addressed in USAISEC TC for NSM.

## APPENDIX B. BUILDING CABLING SYSTEM DIAGRAMS

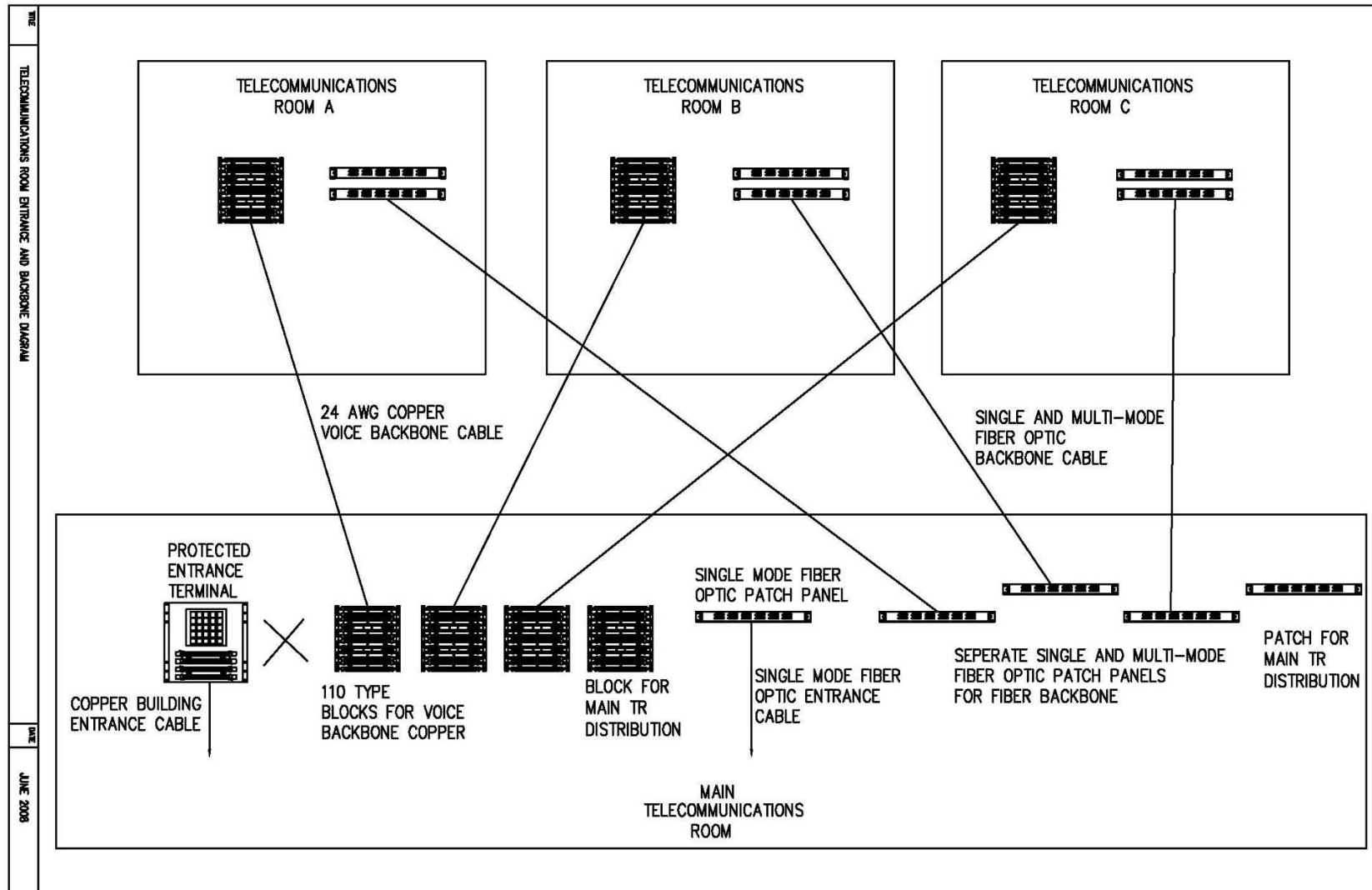

Figure B-1. Telecommunications Room Entrance and Backbone Diagram

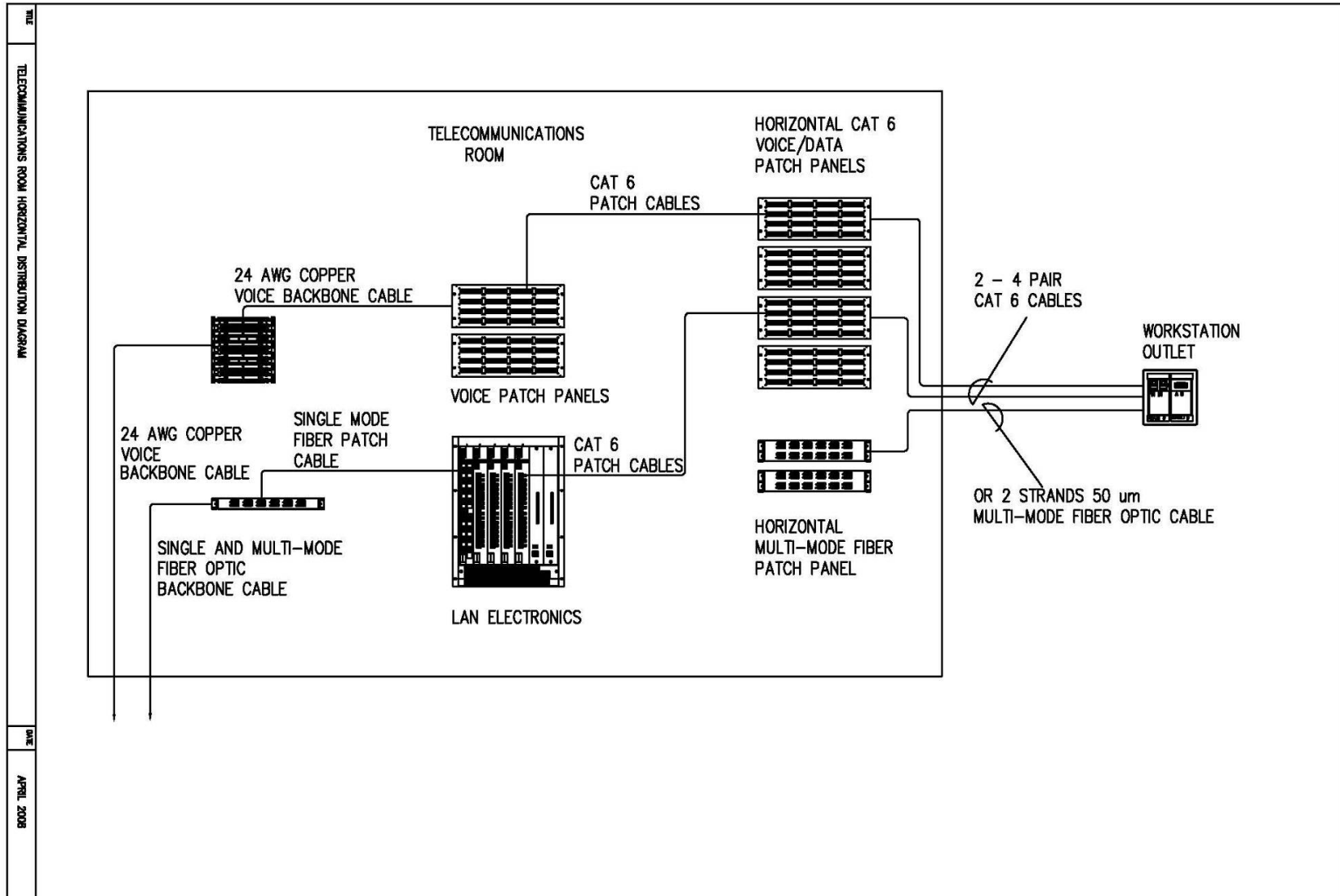

Figure B-2. Telecommunications Room Horizontal Distribution

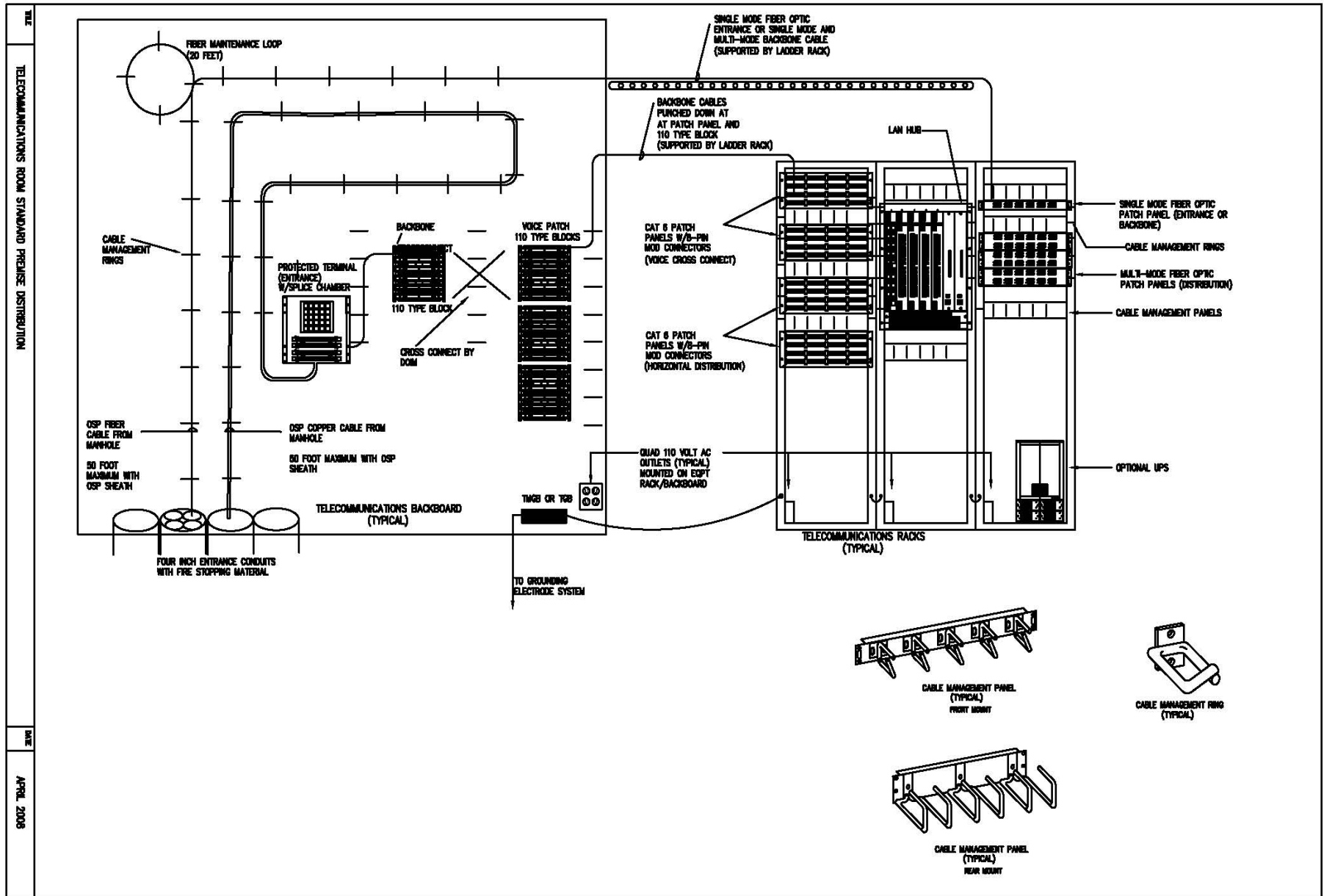

Figure B-3A. Telecommunications Room Standard Premise Distribution

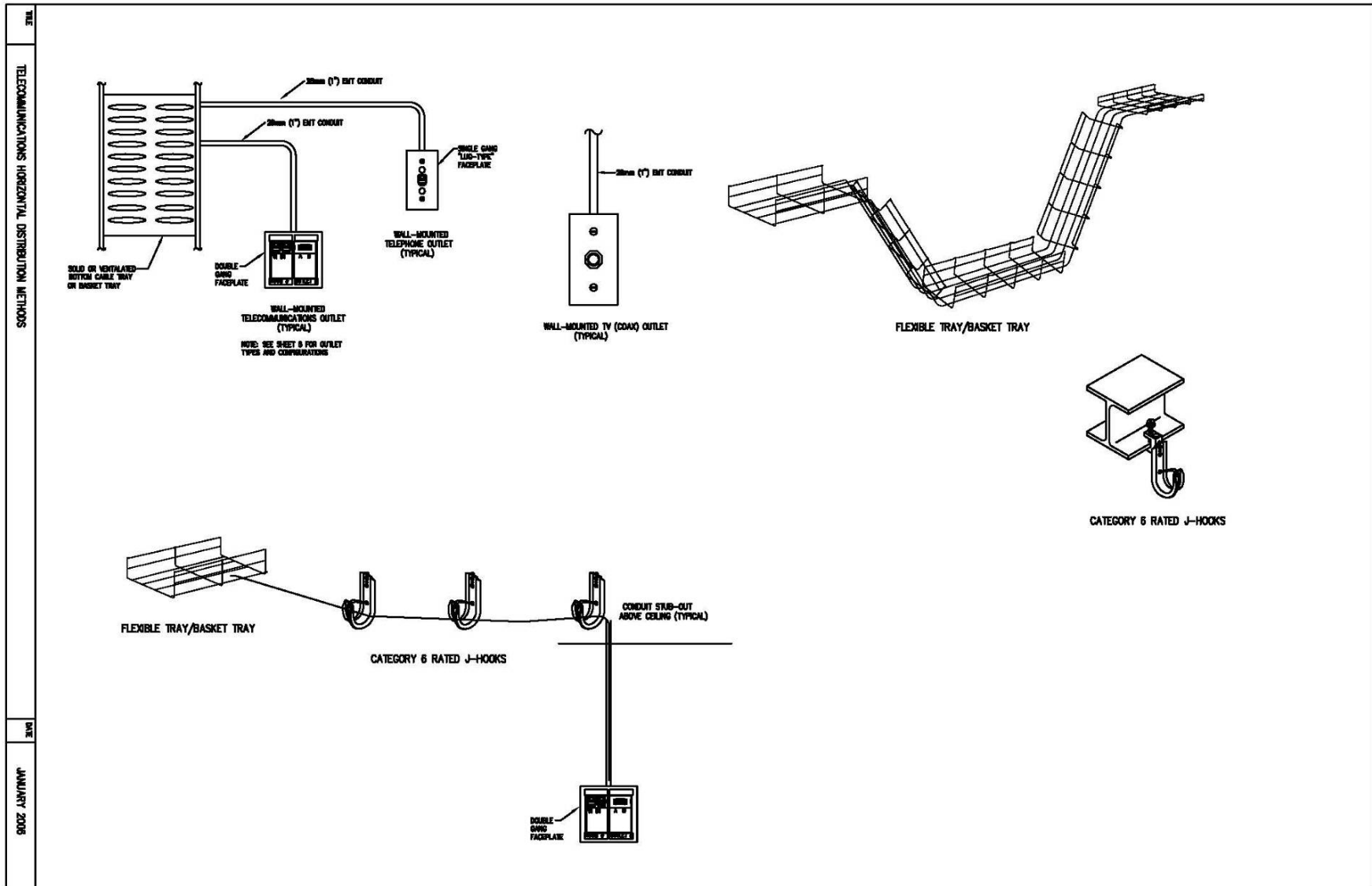

Figure B-3B. Standard Premise Distribution

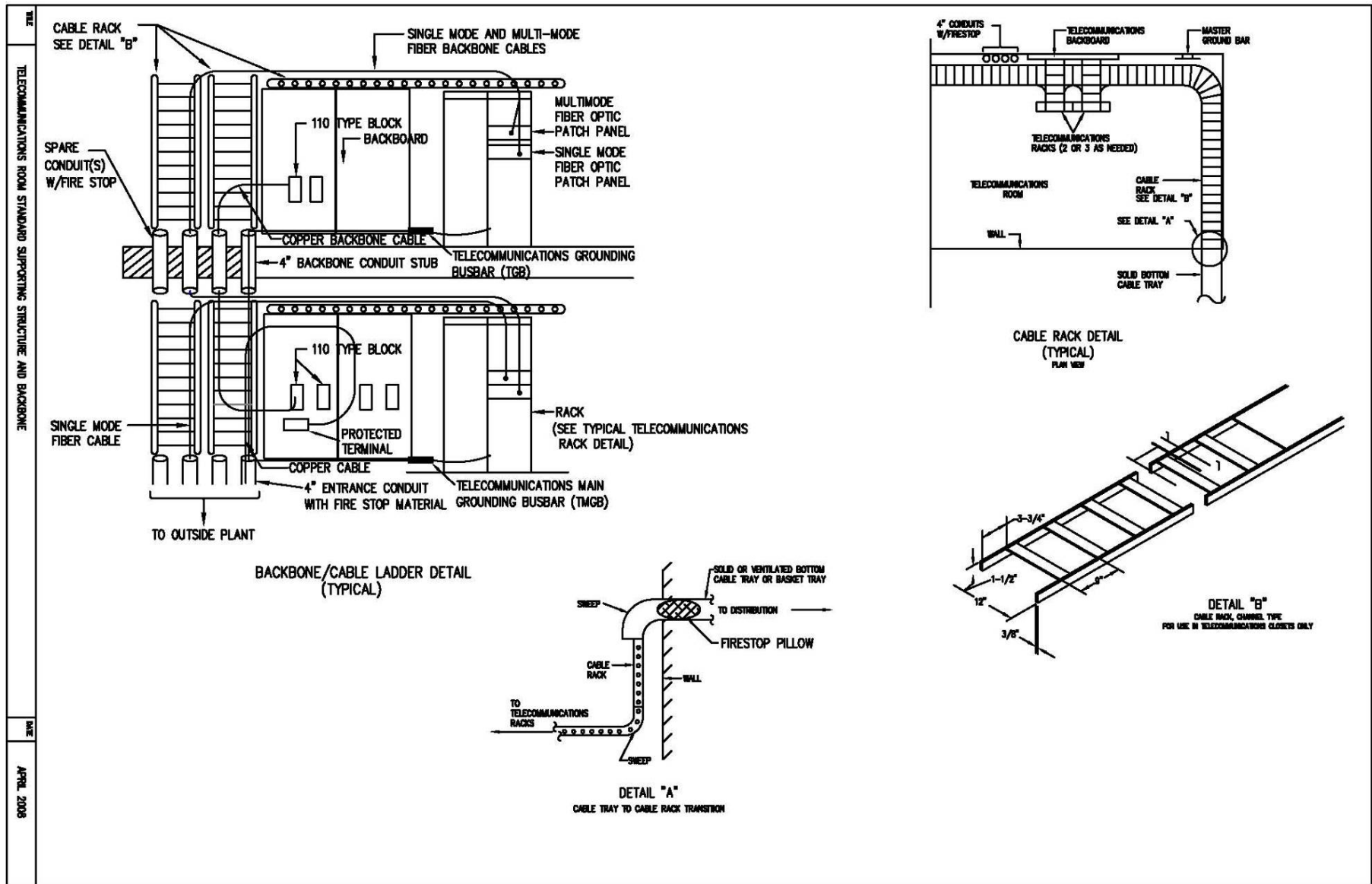

Figure B-4. Telecommunications Room Standard Supporting Structure and Riser

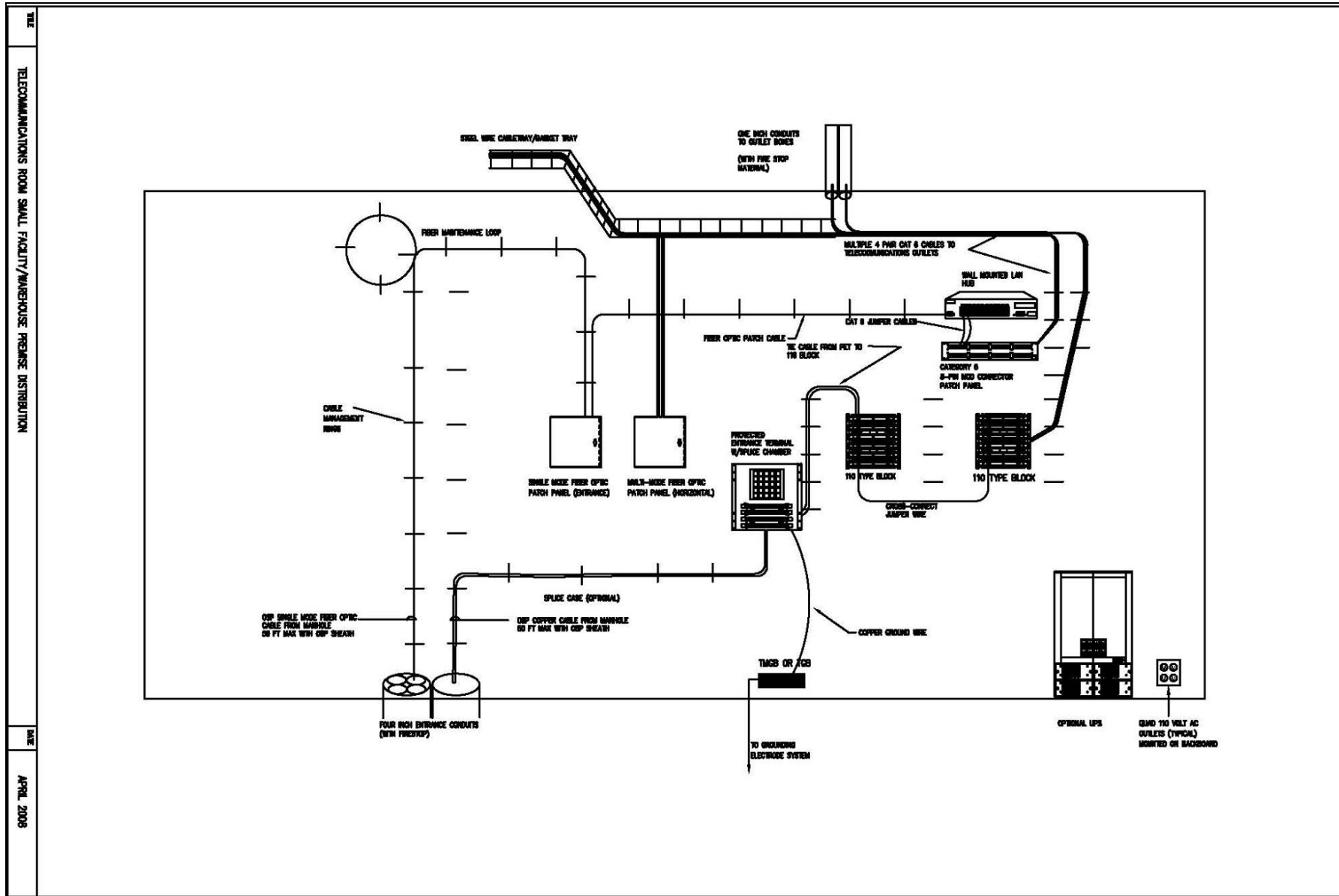

Figure B-5. Telecommunications Room Small Facility/Warehouse



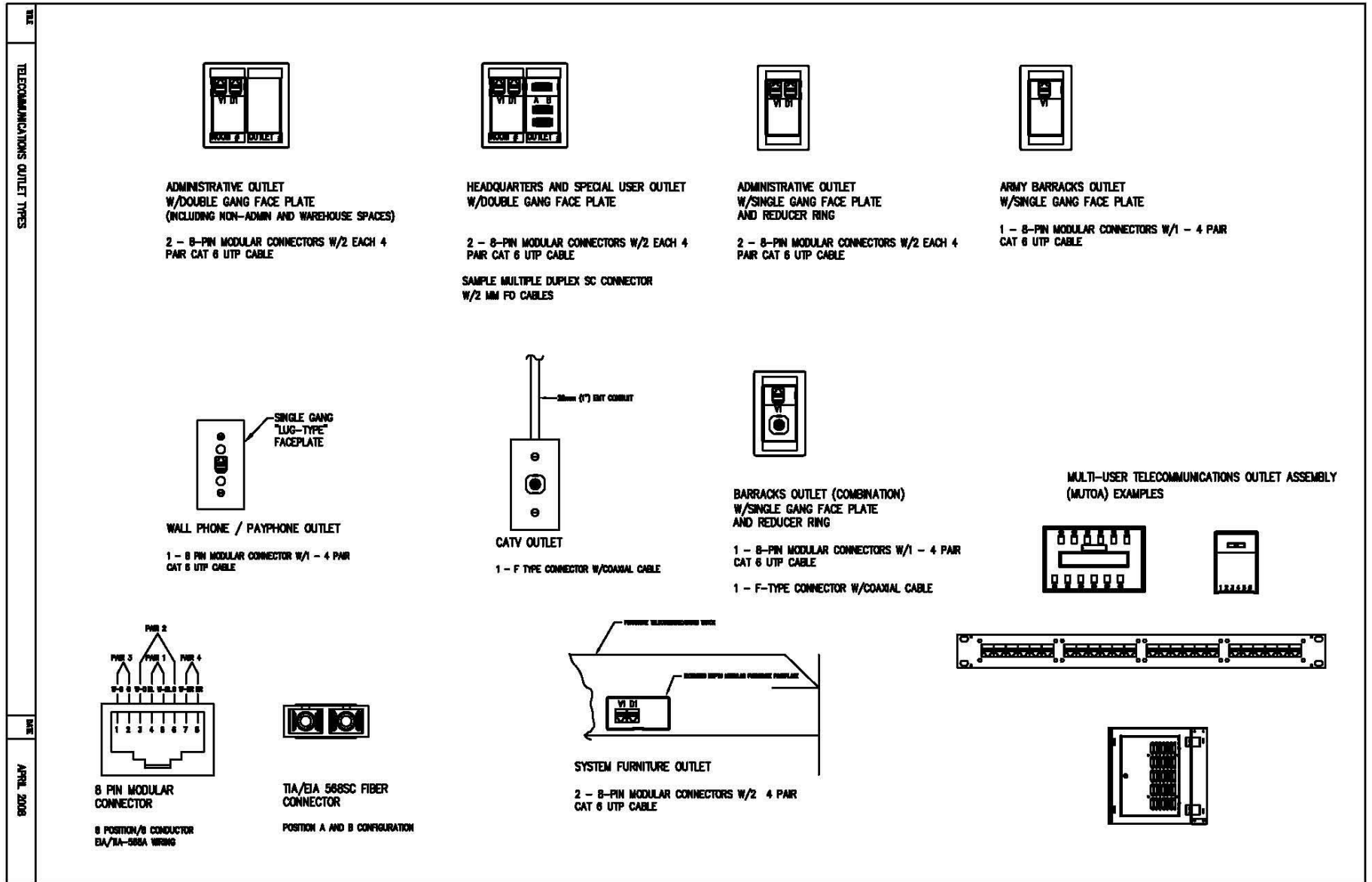

Figure B-6. Telecommunications Outlet Types

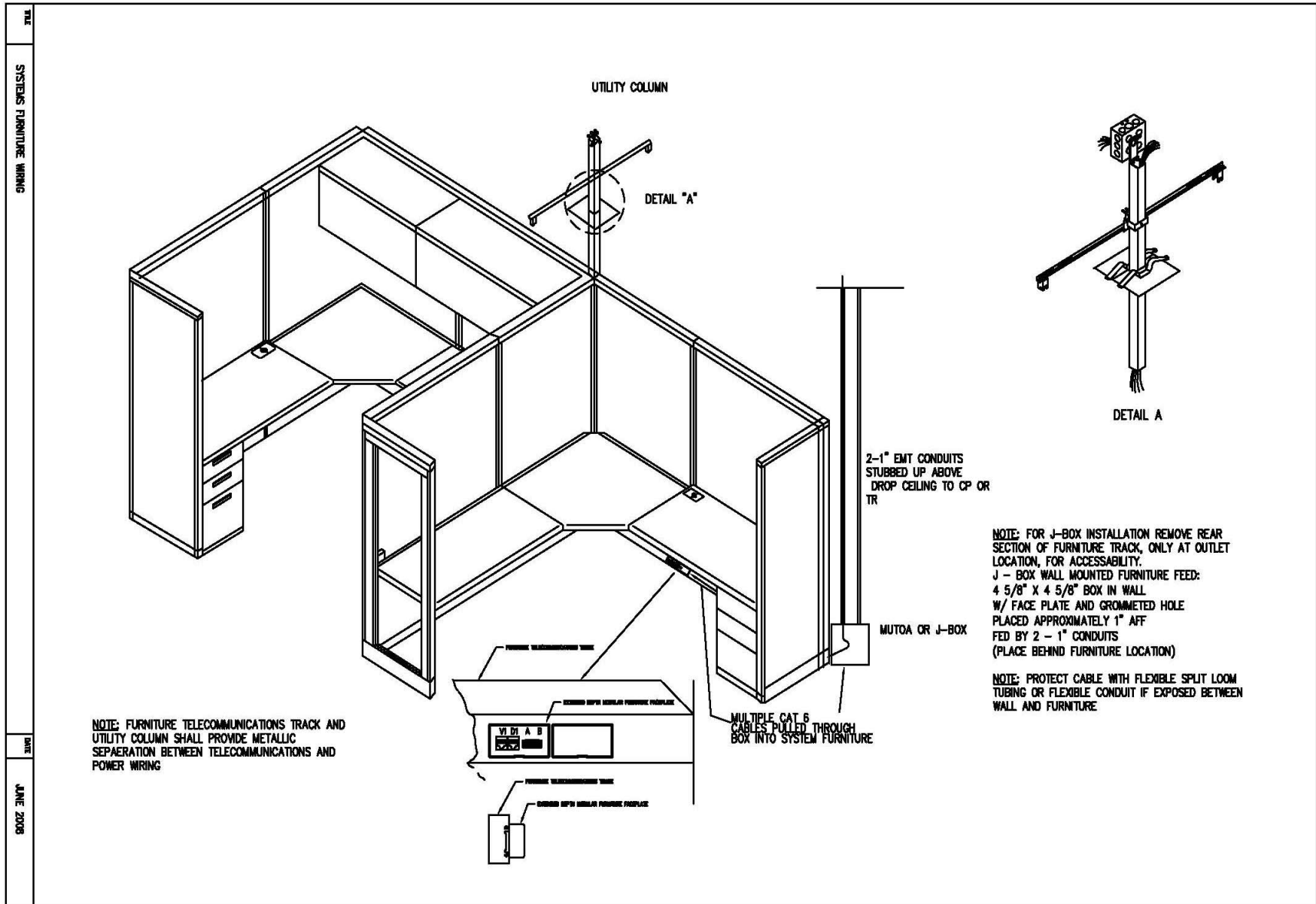

Figure B-7. Systems Furniture Wiring

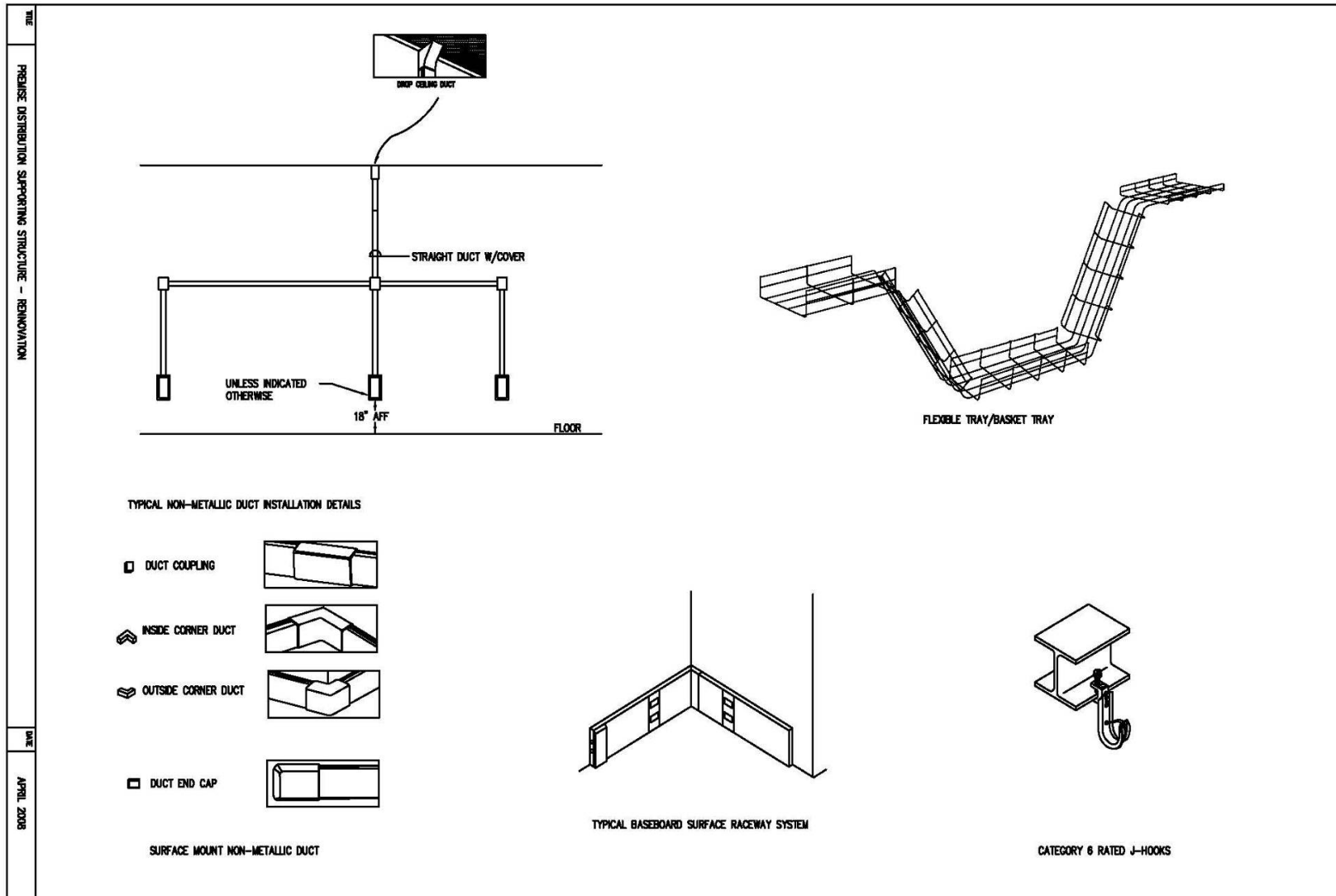

Figure B-8. Premise Distribution Supporting Structure - Renovations



**CLOSET CONFIGURATION– Total Ground Subsystems using a Signal Ground Bar for the SRGS**

**N<sup>1,2</sup> Lightning Protection Grounds** Lightning terminals, outside climbing ladders, cable, entrance plates, transient lightning protectors, structural steel, metal outside cable shields/sheaths (M.S 5.1.1.3.5), etc.

**NOTES:**

- N<sup>1</sup>: Different subsystem grounds should be connected, bonded to each other, if possible, only through the EES
- N<sup>2</sup>: M-S = MIL-STD-188-124B
- N<sup>3</sup>: Facility Entrance Plate or outside manhole ground point.
- N<sup>4</sup>: Engineering judgment required on selecting the lowest Z path to the EES Gnd.

**N<sup>1</sup> Signal (HF) Grounds**  
Higher freq circuits, frames, steel girders, equipment, chassis, racks, etc. See also MS 5.1.1.4.2

**N<sup>1,2</sup> Fault Protection Grounds** EGCs and DC Power Grounds)  
1) EGCs. EGCs (Equipment Grounding Conductors "Green" Ground wire run with AC power supply cables). Motor frames, generators, other rotating machinery (M-S 5.1.1.2.5.4).  
2) DC Power Grounds. One leg of each dc power system shall be grounded with a single connection directly to the EES (MS 5.1.1.2.5.5)

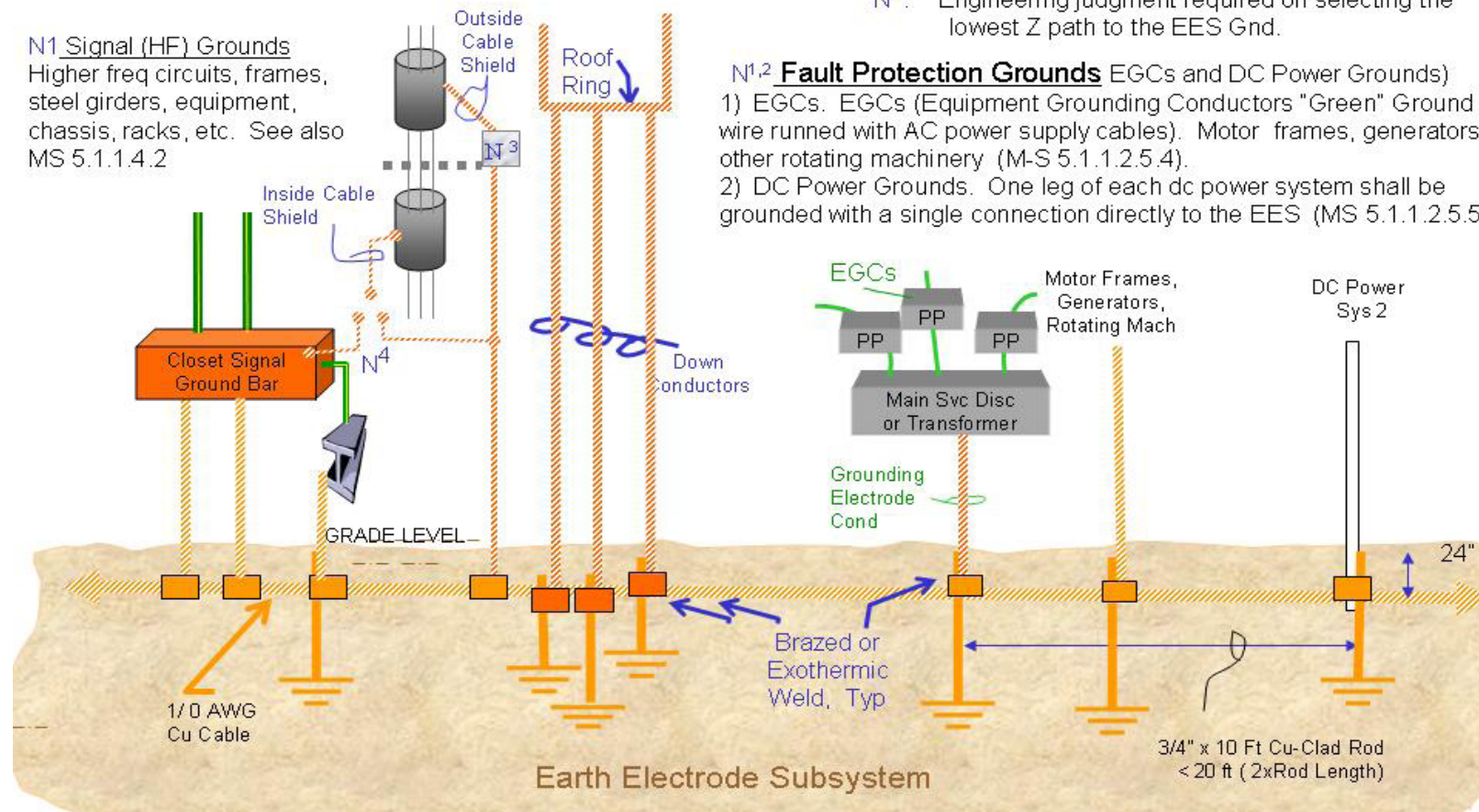

**Figure B-10. Grounding System**

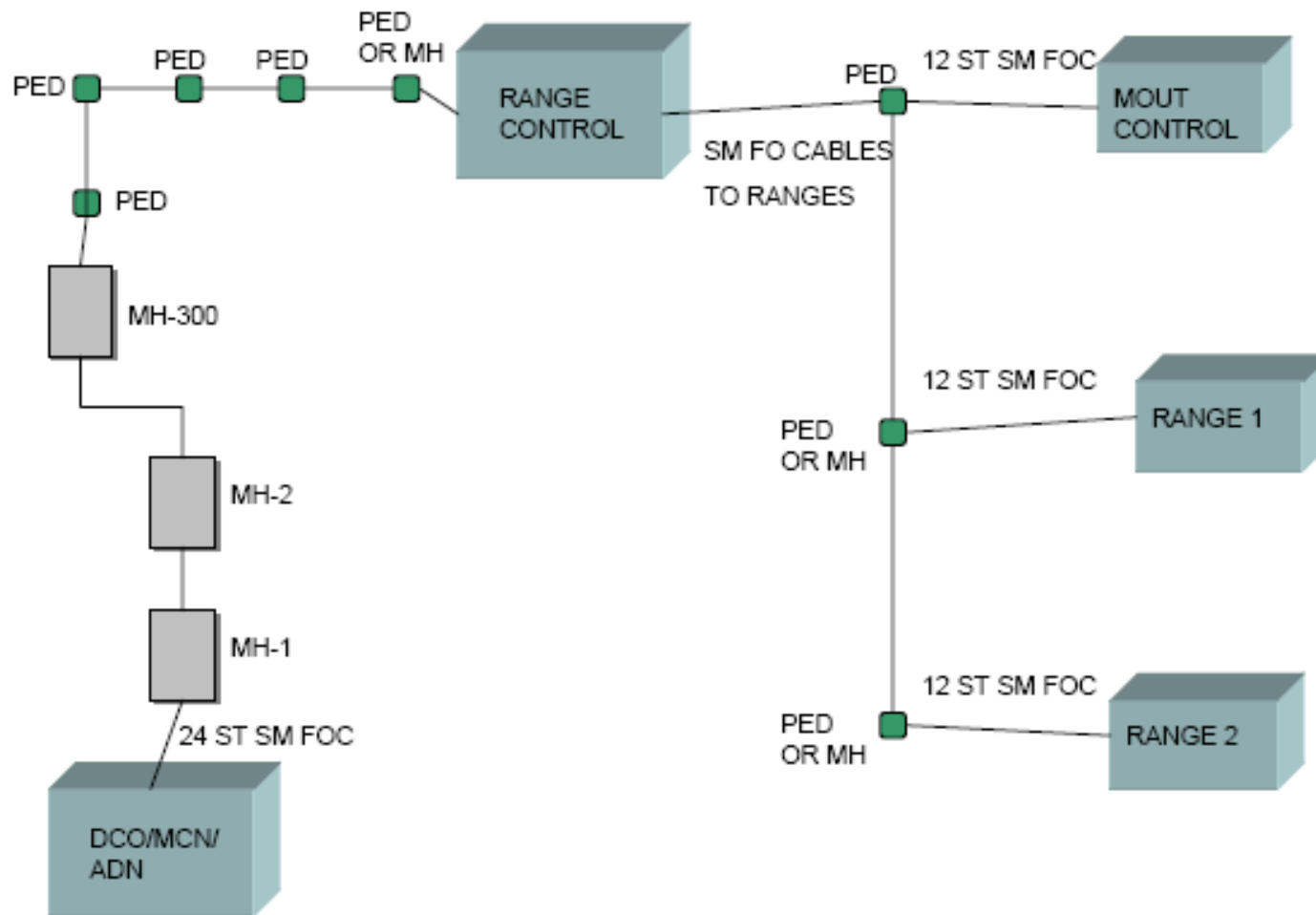

Figure B-11. Range Design

APPENDIX C. NORTH AMERICA AND EUROPE DRAWINGS

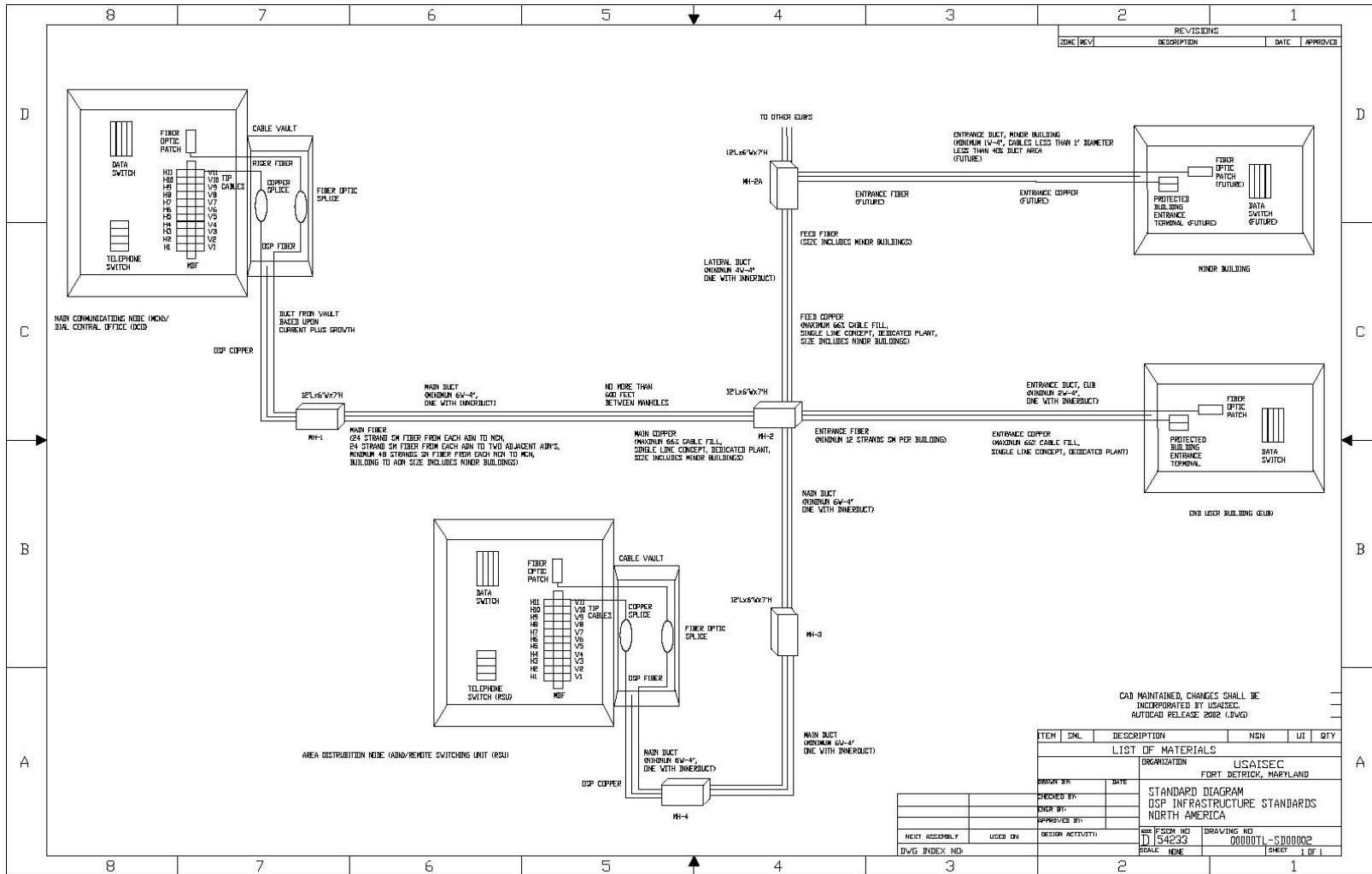

Figure C-1. OSP Infrastructure Standards – North America

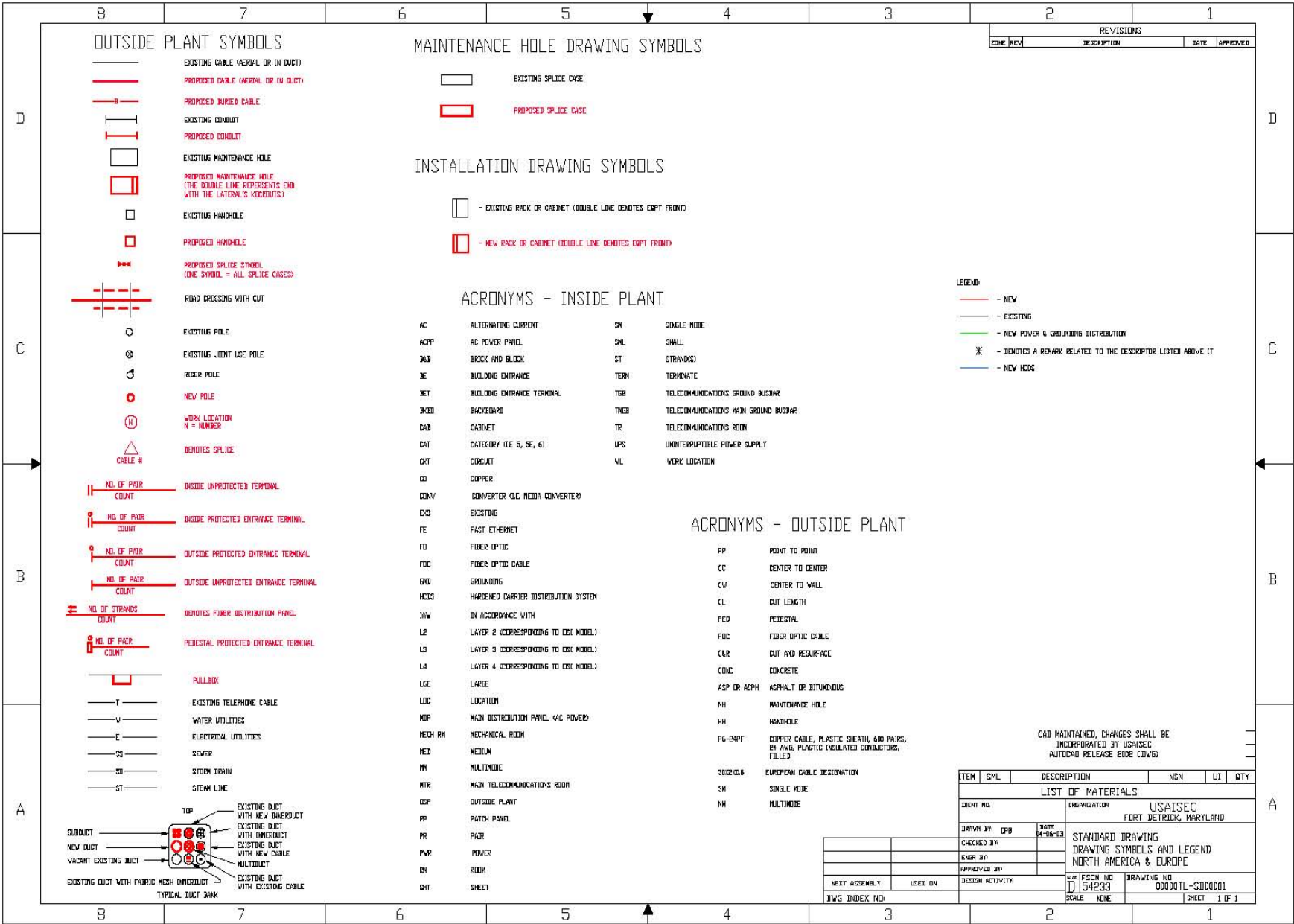

Figure C-2. Drawing Symbols – North America and Europe  
C-2



Technical Criteria for the Installation Information  
Infrastructure Architecture, February 2010

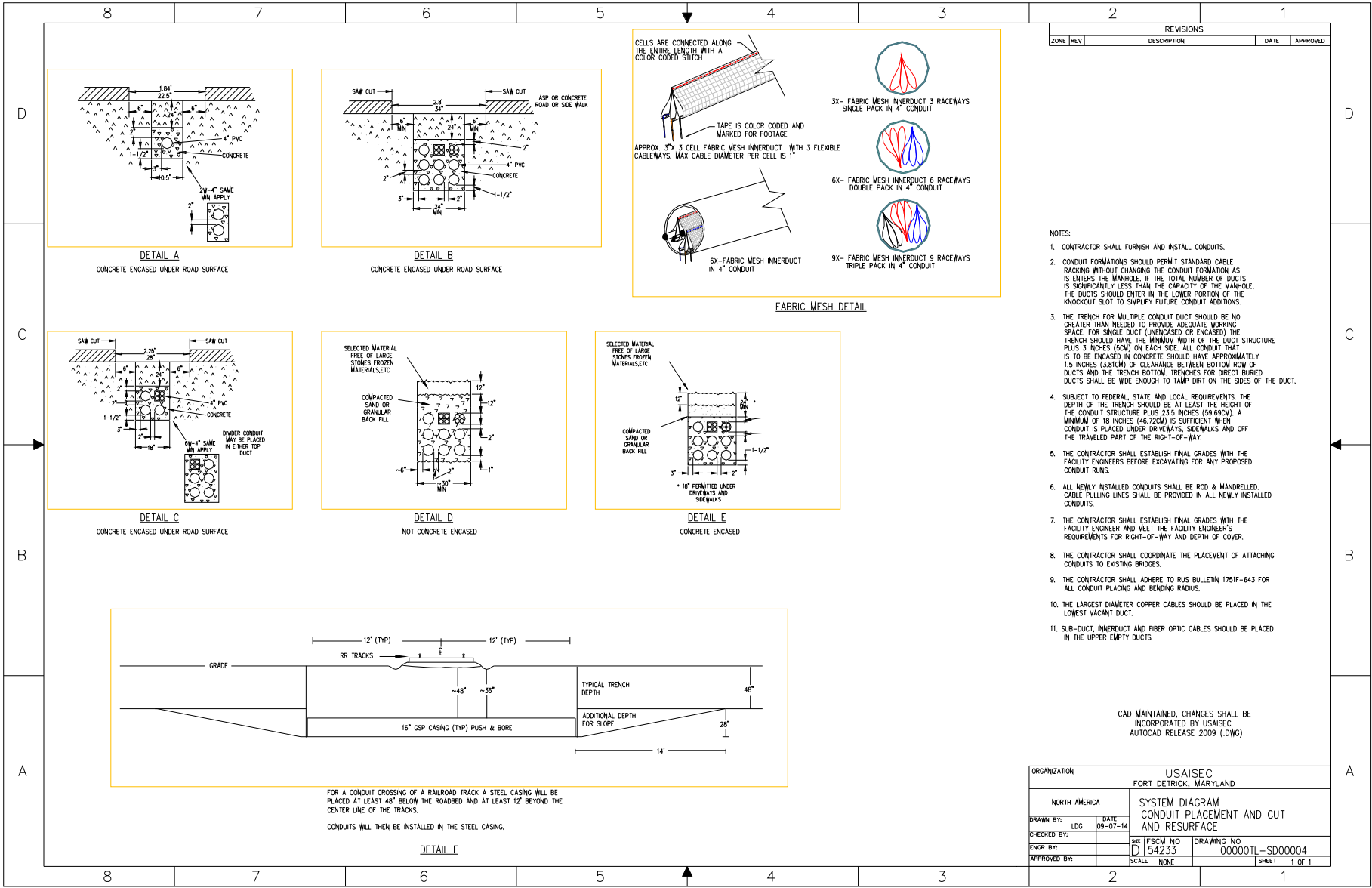

Figure C-3. Conduit Placement/Cut and Resurface – North America

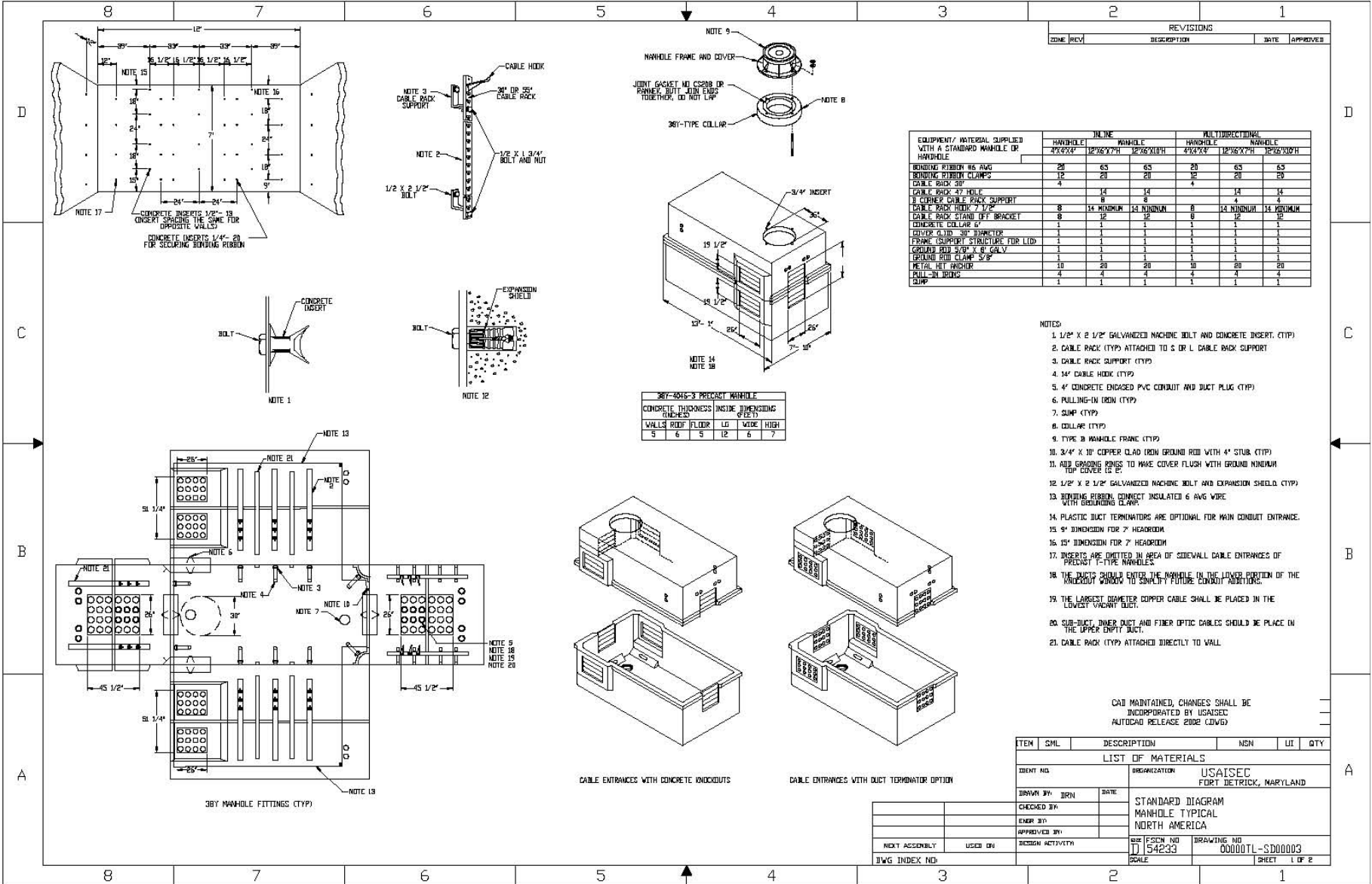

Figure C-4. Typical Maintenance Hole – North America (1 of 2)

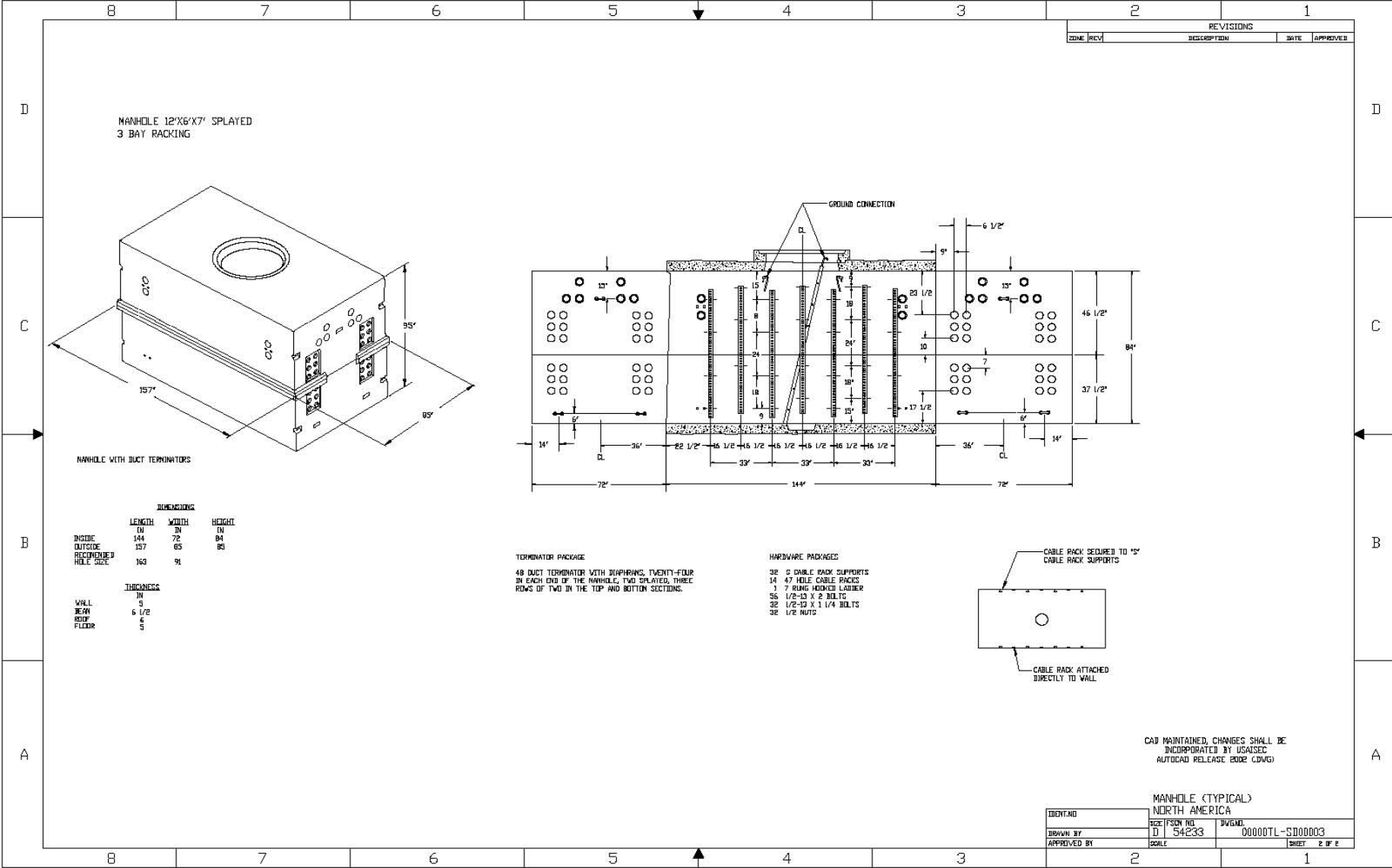

Figure C-5. Typical Maintenance Hole – North America (2 of 2)

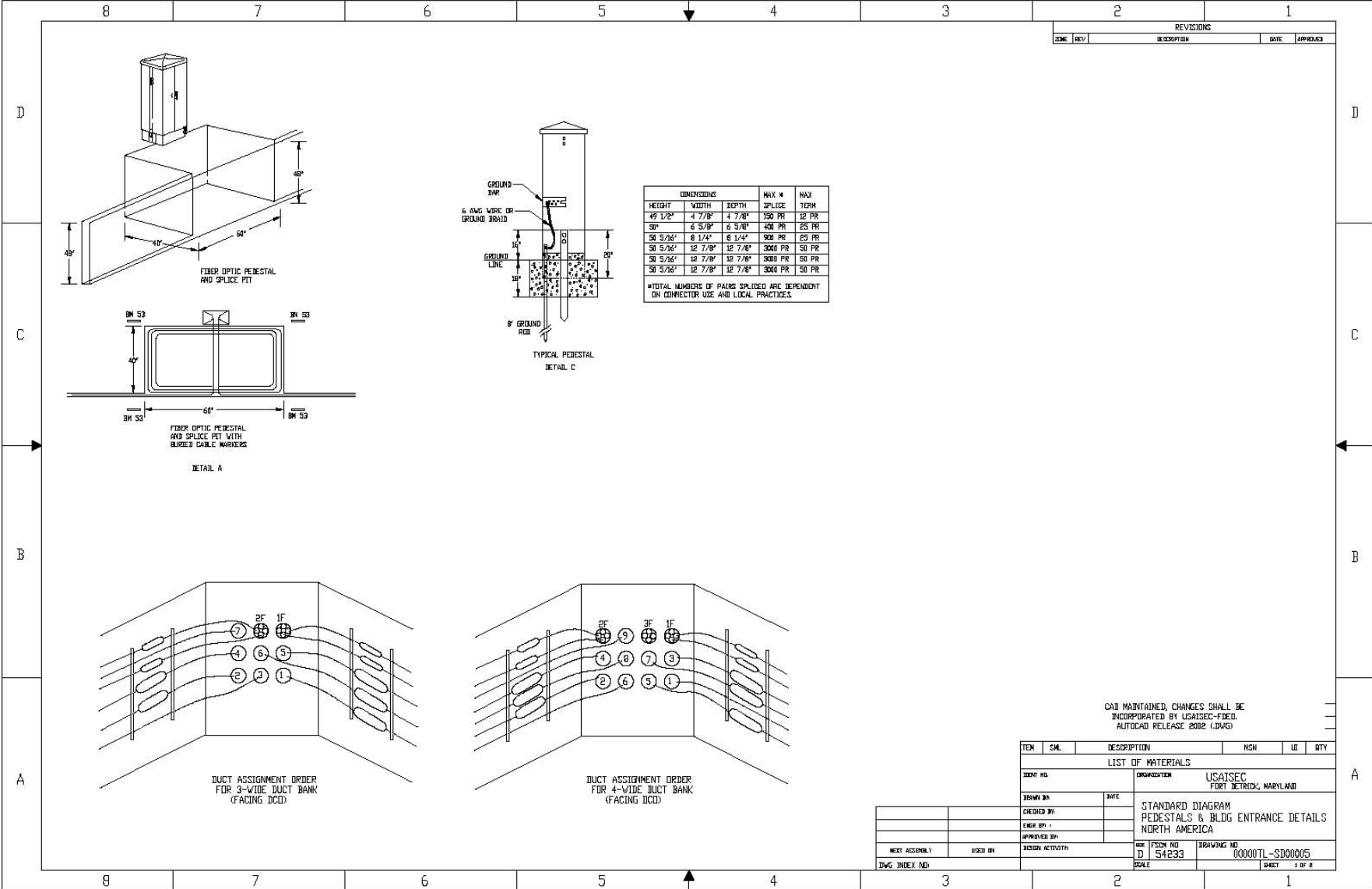

Figure C-6. Pedestals and Building Entrance Details – North America (1 of 2)

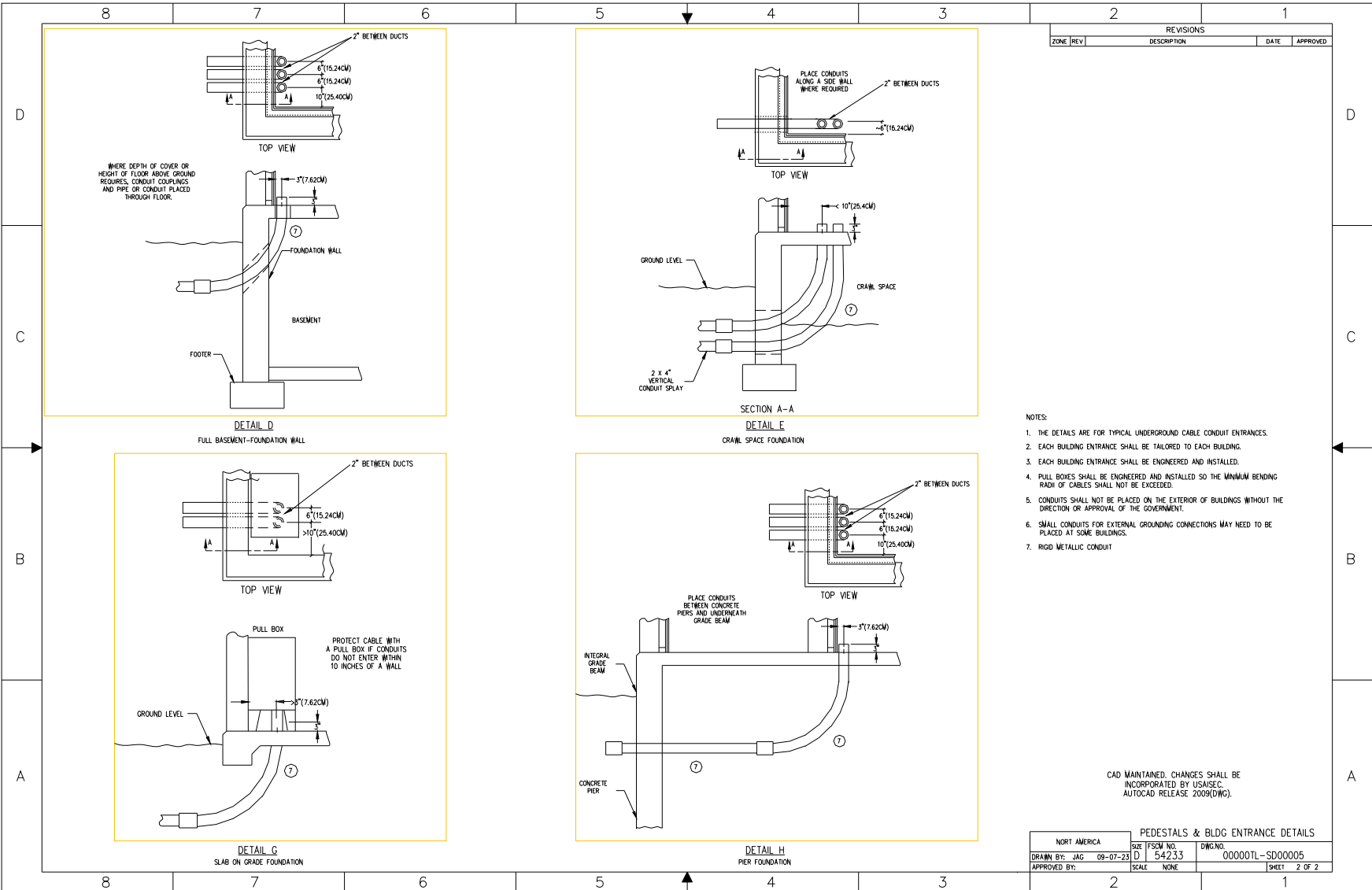

Figure C-7. Pedestals and Building Entrance Details – North America (2 of 2)

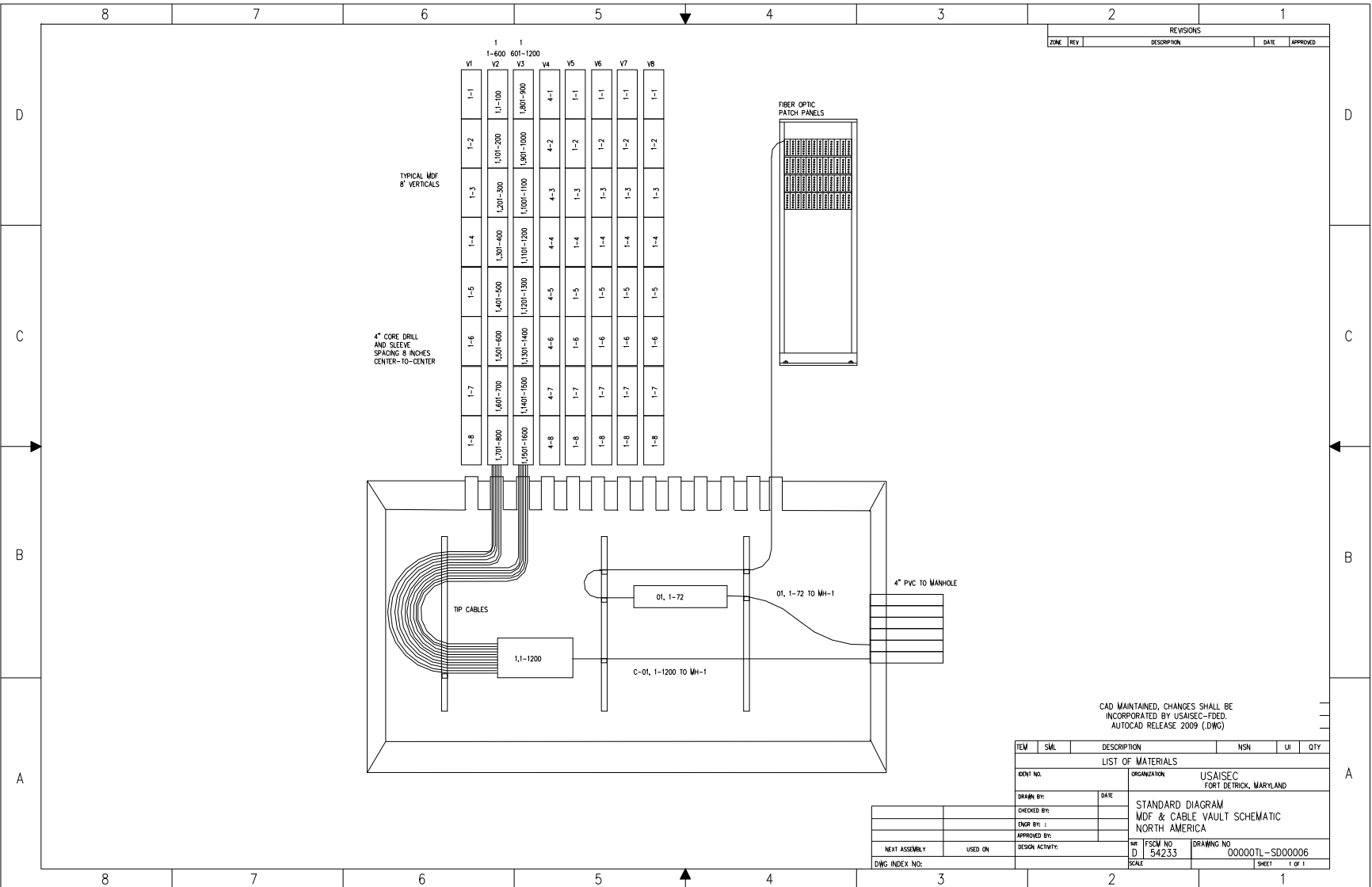

Figure C-8. MDF and Cable Vault Schematic – North America







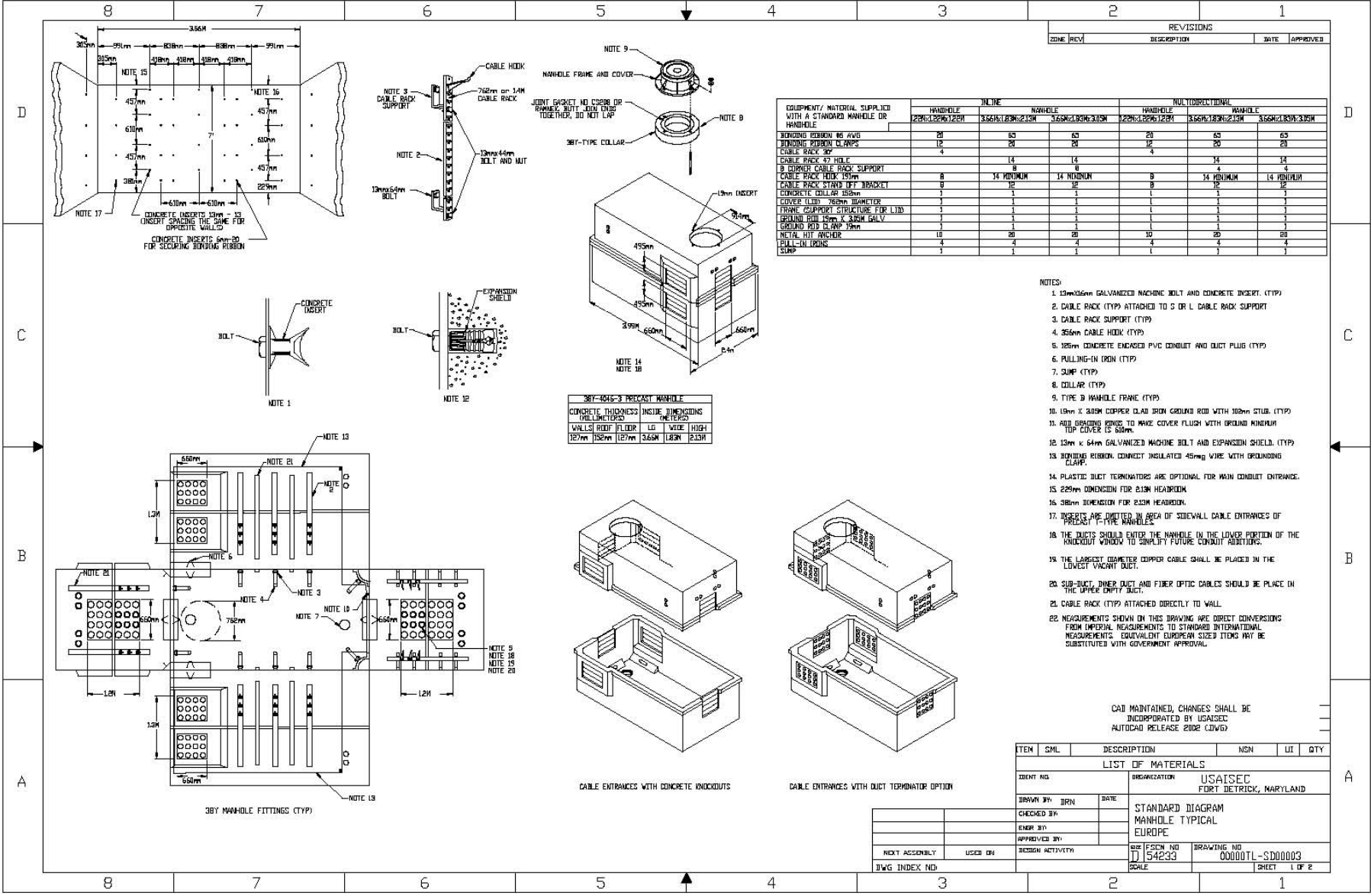

Figure C-11. Typical Maintenance Hole – Europe (1 of 2)

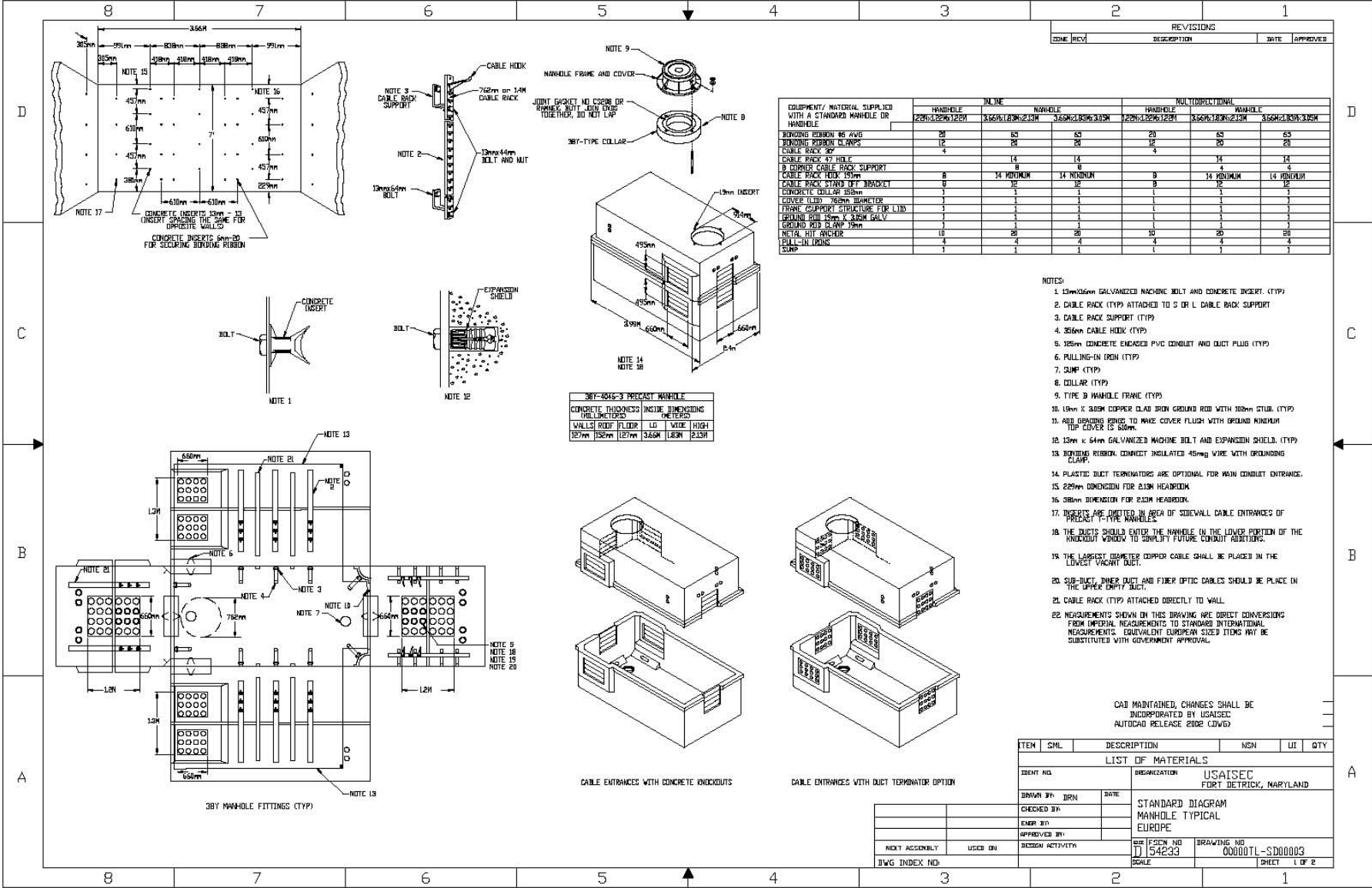

Figure C-12. Typical Maintenance Hole – Europe (2 of 2)

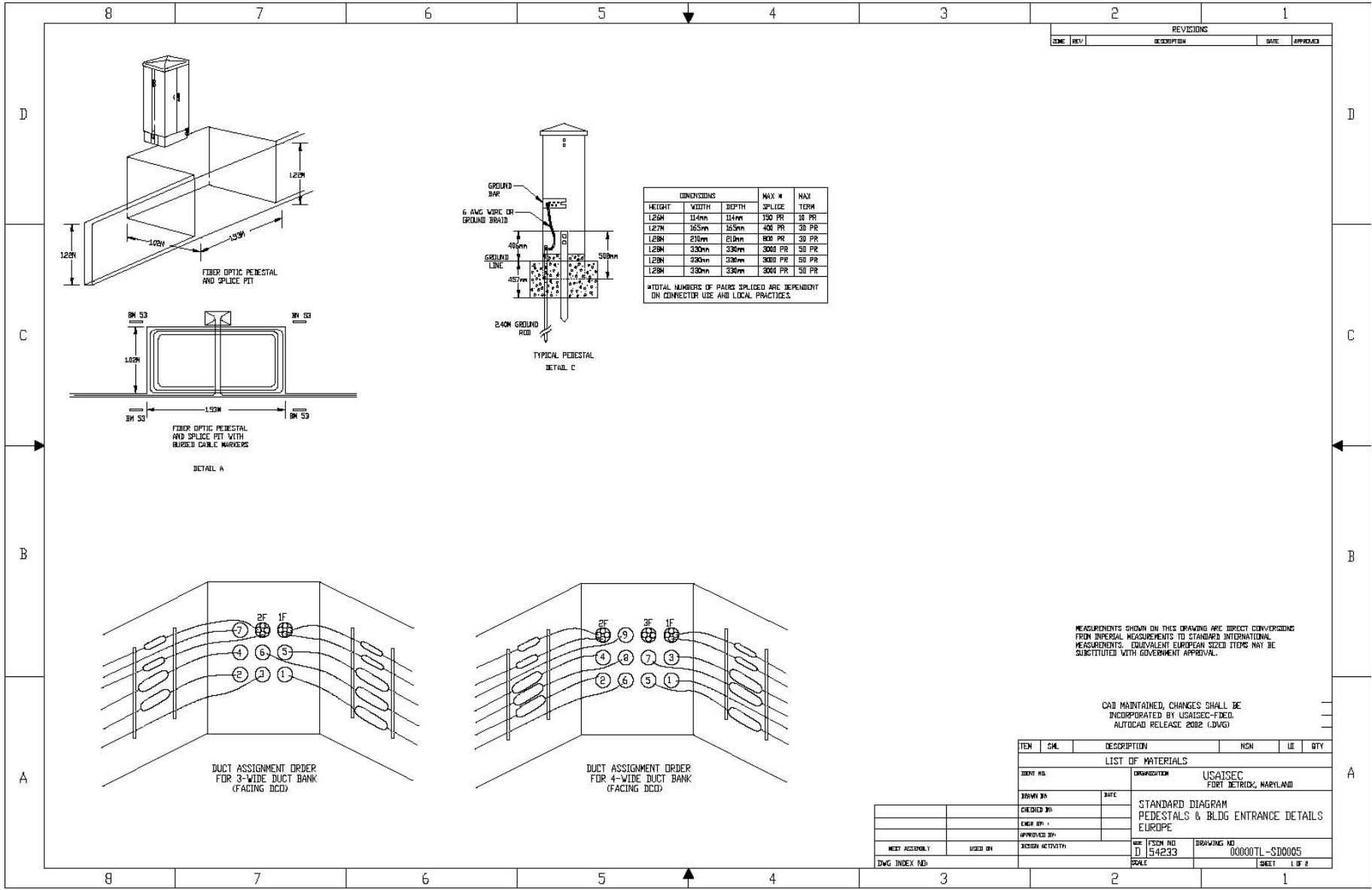

Figure C-13. Pedestals and Building Entrance Details – Europe (1 of 2)

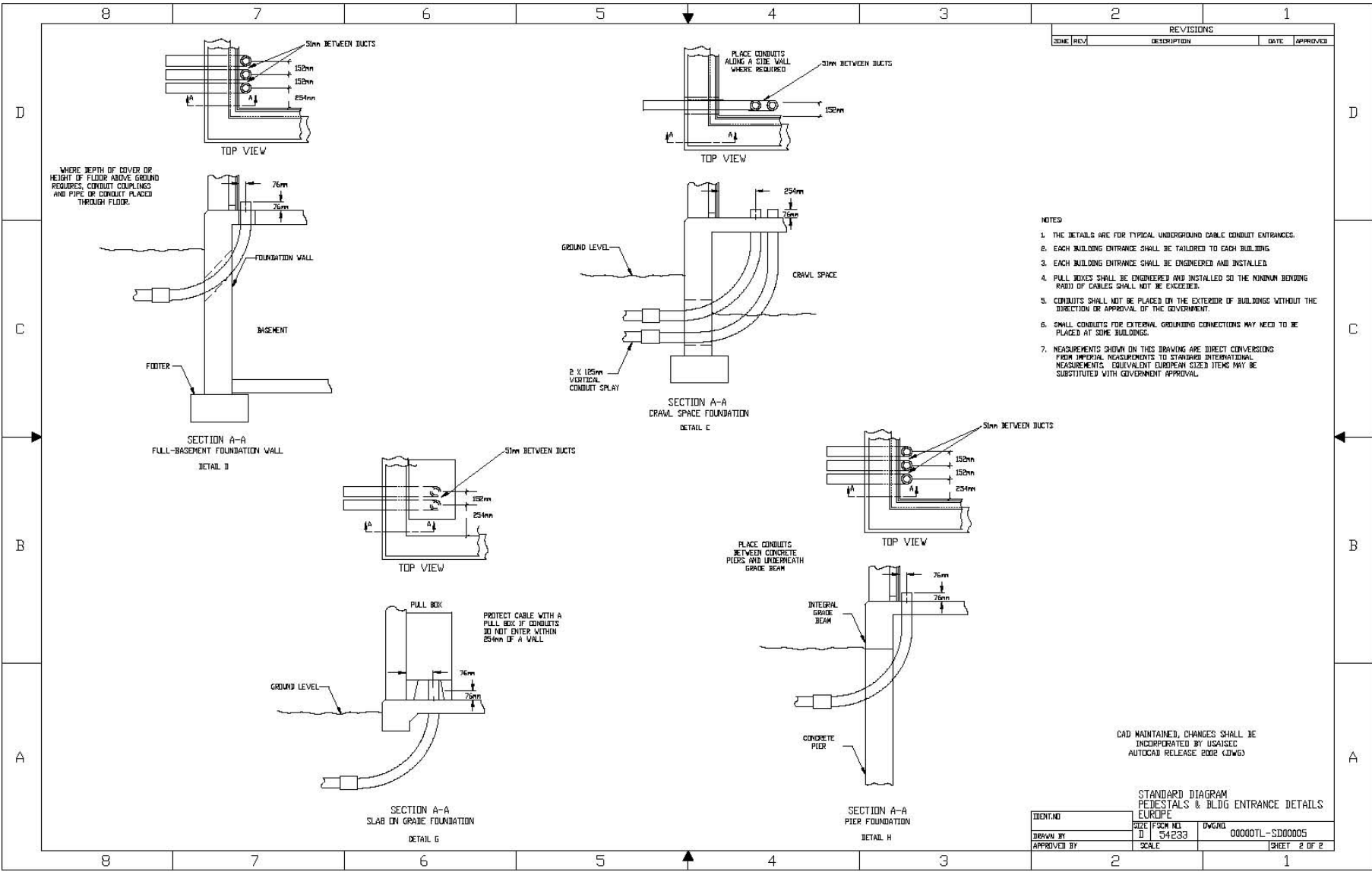

Figure C-14. Pedestals and Building Entrance Details – Europe (2 of 2)

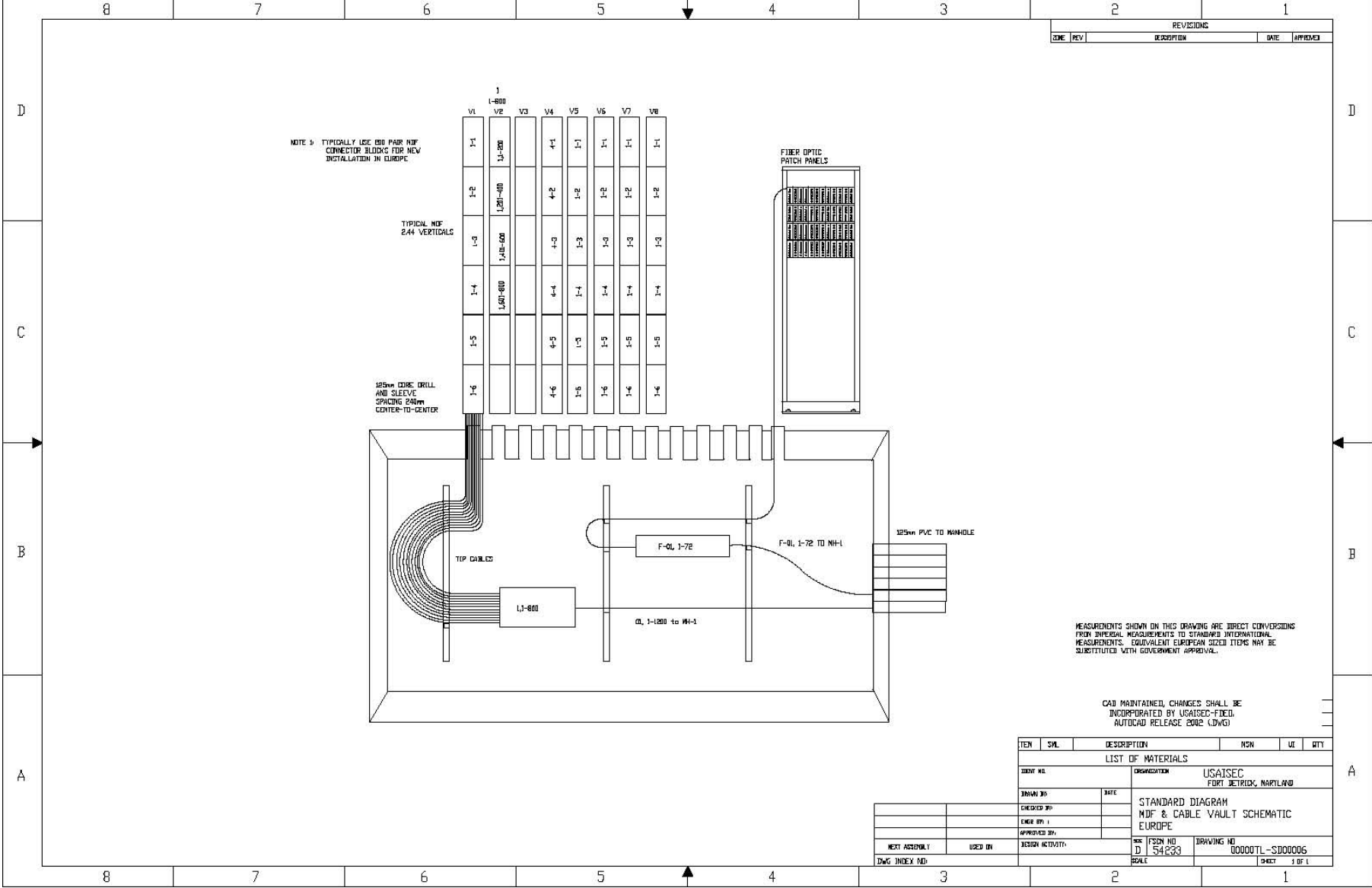

Figure C-15. MDF and Cable Vault Schematic – Europe

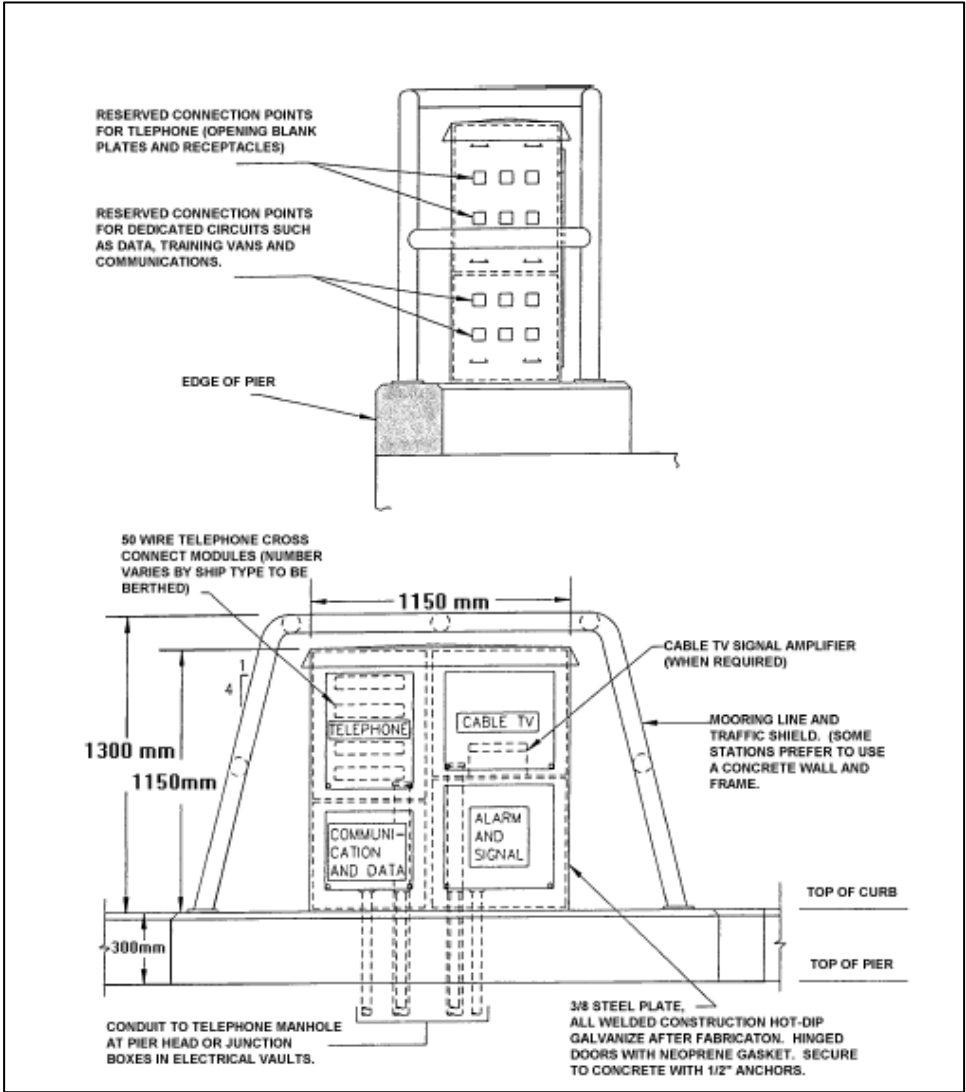

Figure C-16. Illustration of Pier Igloo Construction

**CLOSET CONFIGURATION– Total Ground Subsystems using a Signal Ground Bar for the SRGS**

**N<sup>1,2</sup> Lightning Protection Grounds** Lightning terminals, outside climbing ladders, cable, entrance plates, transient lightning protectors, structural steel, metal outside cable shields/sheaths (M.S 5.1.1.3.5), etc.

**NOTES:**  
 N<sup>1</sup>: Different subsystem grounds should be connected, bonded to each other, if possible, only through the EES  
 N<sup>2</sup>: M-S = MIL-STD-188-124B  
 N<sup>3</sup>: Facility Entrance Plate or outside manhole ground point.  
 N<sup>4</sup>: Engineering judgment required on selecting the lowest Z path to the EES Gnd.

**N<sup>1</sup> Signal (HF) Grounds**  
 Higher freq circuits, frames, steel girders, equipment, chassis, racks, etc. See also MS 5.1.1.4.2

**N<sup>1,2</sup> Fault Protection Grounds** EGCs and DC Power Grounds)  
 1) EGCs. EGCs (Equipment Grounding Conductors "Green" Ground wire runned with AC power supply cables). Motor frames, generators, other rotating machinery (M-S 5.1.1.2.5.4).  
 2) DC Power Grounds. One leg of each dc power system shall be grounded with a single connection directly to the EES (MS 5.1.1.2.5.5)

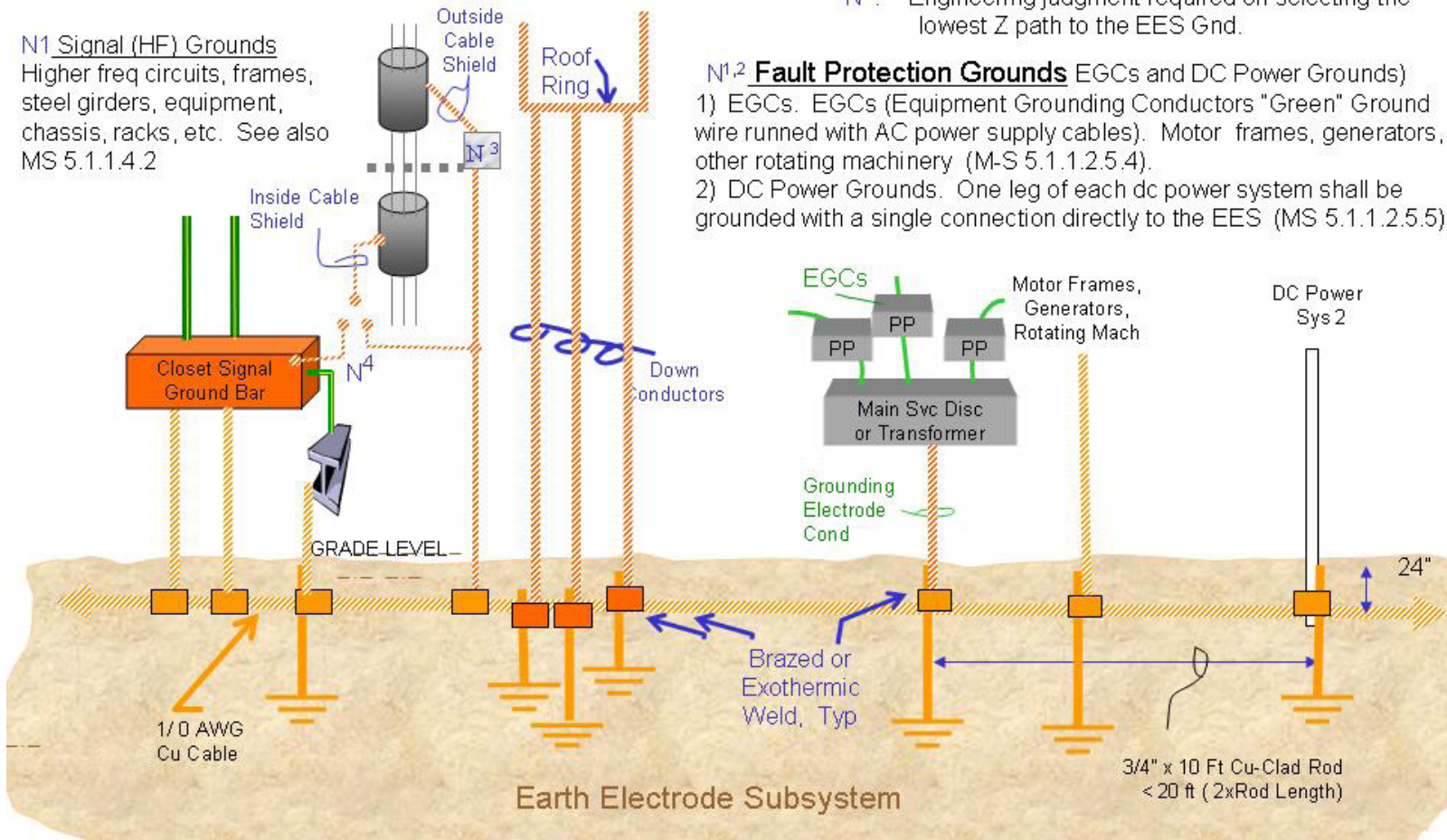

Figure C-17. Grounding System

**This page intentionally left blank.**



## APPENDIX D. REFERENCES

Refer to the current version of each publication cited.

### D-1.0 U.S. GOVERNMENT PUBLICATIONS

- a. NSA, *Information Assurance Technical Framework (IATF)*, Release 3.1.
- b. DOD, MIL-HDBK-419A, *Grounding, Bonding, and Shielding For Electronic Equipments and Facilities*.
- c. DOD, MIL-STD-188-124B, *Grounding, Bonding And Shielding for Common Long Haul/Tactical Communication Systems Including Ground Based Communications-Electronics Facilities and Equipments*.
- d. DOD, MIL-STD-3007-F, *Standard Practice for Unified Facilities Criteria and Unified Facilities Guide Specifications*. (Revision F)
- e. DOD, UFC 1-300-01, *Criteria Format Standard*.
- f. DOD, UFC 3-260-01, *Airfield and Heliport Planning and Design*.
- g. DOD, UFC 3-580-10 Design: *Navy And Marine Corps Intranet (NMCI) Standard Construction Practices Information System (IS)*.
- h. Headquarters, Department of the Army (HQDA), USACE, *Unified Facilities Guide Specification (UFGS)-02300, Earthwork*.
- i. HQDA, USACE, UFGS-33 81 27, *Pier Distribution Telephone Systems*.
- j. HQDA, USACE, UFGS-16710, *Premises Distribution System (Telephone System – Inside Plant)*.
- k. HQDA, USAISEC, *Technical Guide for Telephone Switching*.
- l. HQDA, USAISEC, *Technical Guide for the Integration of the Secret Internet Protocol Router Network (SIPRNET) Version 5.0*.
- m. HQDA, USAISEC, *Technical Guide for Lightning Protection, Power Quality Analysis, Grounding, Bonding, and Shielding (LPAGBS)*.
- n. HQDA, USAISEC, *Technical Guide for Network and Systems Management (NSM)*.
- o. HQDA, USAISEC, *Technical Guide for Security Engineering*.
- p. HQDA, USAISEC-TIC, TR No. AMSEL-IE-TI 04-054, *Installation Information Infrastructure Modernization Program (I3MP) Data Performance Requirements*, Version 1.2, July 2004.
- q. HQDA, USAISEC-TIC, TR No. AMSEL-IE-TI 06-001-1, *Voice over Internet Protocol (VoIP) Design Guidelines*, December 2005.
- r. HQDA, USAISEC, TIC, TR No. AMSEL-IE-TI 07-063, *Design Guide for the Implementation of Wireless Technologies*, May 2007.

### D-2.0 NON-U.S. GOVERNMENT PUBLICATIONS

#### D-2.1 American National Standards Institute (ANSI)/Telecommunications Industry Association (TIA)/Electronic Industries Alliance (EIA); Institute of Electrical and Electronics Engineers (IEEE); National Electrical Contractors Association (NECA)

- a. ANSI/IEEE C2-2007, *National Electrical Safety Code (NESC)*.

- b. ANSI-J-STD-607-A-2002, *Commercial Building Grounding (Earthing) and Bonding Requirements for Telecommunications.*
- c. ANSI/NECA/BICSI 568-2006, *Standard for Installing Commercial Building Telecommunications Cabling.*
- d. ANSI/TIA/EIA-526-7, *Measurement of Optical Power Loss of Installed Single-Mode Fiber Cable Plant.*
- e. ANSI/TIA/EIA-526-14A, *Measurement of Optical Power Loss of Installed Multimode Fiber Cable Plant.*
- f. ANSI/TIA/EIA-568-B.1, *Commercial Building Telecommunications Cabling Standard, Part 1: General Requirements.*
- g. ANSI/TIA/EIA-568-B.2, *Commercial Building Telecommunications Cabling Standard, Part 2: Balanced Twisted Pair Cabling Components.*
- h. ANSI/TIA/EIA-568-B.2 –1, Addendum 1, *Transmission Performance Specifications for 4-pair 100-ohm Category 6 Cabling.*
- i. ANSI/TIA/EIA-568-B.2–4, Addendum 4, *Solderless Connection Reliability Requirements for Copper Connecting Hardware.*
- j. ANSI/TIA/EIA-568-B.3 *Commercial Building Telecommunications Cabling Standard, Part 3: Optical Fiber Cabling Components.*
- k. ANSI/TIA/EIA-568-B.3-1, Addendum 1, *Additional Transmission Performance Specifications for 50/125 Optical Fiber Cables.*
- l. ANSI/TIA/EIA-569-B, *Commercial Building Standard for Telecommunications Pathways and Spaces.*
- m. ANSI/TIA/EIA-569-B-1, *Commercial Building Standard for Telecommunications Pathways and Spaces. Addendum 1- Temperature and Humidity Requirements for Telecommunications Spaces.*
- n. ANSI/TIA/EIA-606-A, *Administrative Standard for the Telecommunications Infrastructure of Commercial Buildings.*
- o. TIA Technical Committee TR-42, *Technical Service Bulletin (TSB)-162, Telecommunications Cabling Guidelines for Wireless Access Points.*

#### **D-2.2 Building Industry Consulting Services International (BICSI)**

- a. BICSI, *Telecommunications Distribution Design Methods Manual (TDMM).*
- b. BICSI, *Information Transport Systems Installation Methods Manual (ITSIMM).*

#### **D-2.3 German and European Standards (DIN VDE and EN)**

- a. DIN VDE 0815 and 0816, *Wiring Cables for Telecommunications and Data Processing Systems.*
- b. EN 50173:1996, *Information Technology – Generic Cabling Systems.*
- c. EN 50174-1:2001, *Information Technology – Cabling Installation, Part 1: Specification and Quality Assurance.*
- d. EN 50174-2:2001, *Information Technology – Cabling Installation, Part 2: Installation Planning and Practices Inside Buildings.*

e. EN 50174-3:2002, *DRAFT Information Technology – Cabling Installation, Part 3: Installation Planning and Practices Outside Buildings.*

**D-2.4 International Organization for Standardization/International Electrotechnical Commission (ISO/IEC)**

a. ISO/IEC 11801:2002, *Information Technology – Generic Cabling for Customer Premises.*

b. ISO/IEC 14763-1:1999, *Information Technology – Implementation and Operation of Customer Premises Cabling, Part 1: Administration.*

c. ISO/IEC 14763-2:2000, *Information Technology – Implementation and Operation of Customer Premises Cabling, Part 2: Planning and Installation.*

d. ISO/IEC 14763-3:2000, *Information Technology – Implementation and Operation of Customer Premises Cabling, Part 3: Testing of Optical Fiber Cabling.*

**D-2.5 National Fire Protection Association (NFPA)**

a. NFPA-70, *National Electrical Code.*

b. NFPA-780, *Standard for the Installation of Lightning Protection Systems.*

**D-2.6 National Security Telecommunications and Information Systems Security Instruction (NSTISSI)**

NSTISSI 7003, *Protected Distribution Systems (PDS).*

**D-3.0 OUTSIDE PLANT REFERENCES**

Table D-1 provides the Outside Plant references for the I3A.

**Table D-1. Outside Plant References**

Priority	Source	Identifier	Title	Source URL
1	Army	N/A	Site-specific EDP	N/A
2	Army	N/A	United States Army Information Systems Engineering Command (USAISEC) Worldwide Outside Plant Design and Performance Requirements (OSPDRM)	N/A
3	BICSI	OSPDRM	Outside Plant Design Reference Manual (OSPDRM).	<a href="http://www.bicsi.org">http://www.bicsi.org</a>
3	Army	N/A	Installation and Campus Area Network (ICAN) Design Guide	N/A
4	ASTM	ASTM A139	Standard Specification for Electric-Fusion (Arc)-Welded Steel Pipe (NPS 4 and Over)	<a href="http://www.astm.org">http://www.astm.org</a>
4	ASTM	ASTM A252	Standard Specification for Welded and Seamless Steel Pipe Piles	<a href="http://www.astm.org">http://www.astm.org</a>
4	ASTM	ASTM C150	Portland Cement	<a href="http://www.astm.org">http://www.astm.org</a>
4	ASTM	ASTM C857	Standard Practice for Minimum Structural Design Loading for Underground Precast Concrete Utility Structures	<a href="http://www.astm.org">http://www.astm.org</a>
4	ASTM	ASTM C858	Standard Specification for Underground Precast Concrete Utility Structures	<a href="http://www.astm.org">http://www.astm.org</a>
4	ASTM	ASTM C891	Standard Practice for Installation of Underground Precast Concrete Utility Structures	<a href="http://www.astm.org">http://www.astm.org</a>
4	ASTM	ASTM C1037	Standard Practice for Inspection of Underground Precast Concrete Utility Structures	<a href="http://www.astm.org">http://www.astm.org</a>
4	ASTM	ASTM D1556	Standard Test Method for Density and Unit Weight of Soil in Place by the Sand-Cone Method	<a href="http://www.astm.org">http://www.astm.org</a>
4	ASTM	ASTM D1557	Standard Test Methods for Laboratory Compaction Characteristics of Soil Using Modified Effort (56,000 ft-lbf/ft <sup>3</sup> (2,700 kN-m/m <sup>3</sup> ))	<a href="http://www.astm.org">http://www.astm.org</a>
4	ASTM	ASTM D2167	Standard Test Method for Density and Unit Weight of Soil in Place by the Rubber Balloon Method	<a href="http://www.astm.org">http://www.astm.org</a>
4	ASTM	ASTM D2239	Standard Specification for Polyethylene (PE) Plastic Pipe (SIDR-PR) Based On Controlled Inside Diameter	<a href="http://www.astm.org">http://www.astm.org</a>
4	ASTM	ASTM D2447	Specification for Polyethylene (PE) Plastic Pipe, Schedule 40 and Schedule 80 Based On Controlled Outside Diameter	<a href="http://www.astm.org">http://www.astm.org</a>
4	ASTM	ASTM D2487	Standard Practice for Classification of Soils for Engineering Purposes (Unified Soil Classification System)	<a href="http://www.astm.org">http://www.astm.org</a>
4	ASTM	ASTM D3350	Standard Specification for Polyethylene Plastic Pipe and Fittings Materials	<a href="http://www.astm.org">http://www.astm.org</a>

**Table D-1. Outside Plant References (continued)**

Priority	Source	Identifier	Title	Source URL
4	ASTM	ASTM F1216	Standard Practice for Rehabilitation of Existing Pipelines and Conduits by the Inversion and Curing of a Resin-Impregnated Tube	<a href="http://www.astm.org">http://www.astm.org</a>
4	ANSI	ANSI/TIA/EIA-568	Commercial Building Telecommunications Cabling Standards Set	<a href="http://global.ihs.com">http://global.ihs.com</a>
4	ANSI	ANSI/TIA/EIA-569	Addendum (ADD) 1 - Surface Raceways	<a href="http://global.ihs.com">http://global.ihs.com</a>
4	ANSI	J-STD-607	Commercial Building Grounding (Earthing) and Bonding Requirements for Telecommunications	<a href="http://global.ihs.com">http://global.ihs.com</a>
4	ANSI	ANSI/TIA/EIA-758	Customer-Owned Outside Plant Telecommunications Cabling Standard	<a href="http://global.ihs.com">http://global.ihs.com</a>
4	ANSI	NFPA-70	National Electrical Code	<a href="http://www.nfpa.org/catalog">http://www.nfpa.org/catalog</a>
4	ANSI	T1.105-2001	Synchronous Optical Network (SONET)-Basic Description including Multiplex Structure, Rates and Formats	<a href="http://webstore.ansi.org">http://webstore.ansi.org</a>
4	AASHTO	AASHTO HS-20 44	HS-20 44 Load Ratings	
5	ANSI	Y32.9-1972	Graphic Symbols for Electrical Wiring and Layout Diagrams used in Architectural and Building Construction (DOD adopted)	<a href="http://webstore.ansi.org">http://webstore.ansi.org</a>
4	TIA/EIA	TIA/EIA-422	Electrical Characteristics of Balanced Voltage Digital Interface Circuits	<a href="http://global.ihs.com">http://global.ihs.com</a>
4	TIA/EIA	TIA/EIA-423	Electrical Characteristics of Unbalanced Voltage Digital Interface Circuits	<a href="http://global.ihs.com">http://global.ihs.com</a>
4	TIA/EIA	TIA/EIA-472	Specifications for Fiber Optic Cables	<a href="http://global.ihs.com">http://global.ihs.com</a>
5	IEEE	IEEE-315	Graphic Symbols for Electrical and Electronic Diagrams	<a href="http://webstore.ansi.org">http://webstore.ansi.org</a>
5	TTC	Technical Report #2001.04	Guidelines for Pipe Ramming	<a href="http://www.latech.edu">http://www.latech.edu</a>
5	Federal	FED-STD-1037	Telecommunications: Glossary of Telecommunication Terms	<a href="http://www.its.bldrdoc.gov">http://www.its.bldrdoc.gov</a>
5	RUS	1751F-630	Design of Aerial Plant	<a href="http://www.usda.gov/rus/telecom/publications/bulletins.htm">www.usda.gov/rus/telecom/publications/bulletins.htm</a>
5	RUS	1751F-640	Design of Buried Plant - Physical Considerations	<a href="http://www.usda.gov/rus/telecom/publications/bulletins.htm">www.usda.gov/rus/telecom/publications/bulletins.htm</a>
5	RUS	1751F-641	Construction of Buried Plant	<a href="http://www.usda.gov/rus/telecom/publications/bulletins.htm">www.usda.gov/rus/telecom/publications/bulletins.htm</a>
5	RUS	1751F-642	Construction Route Planning of Buried Plant	<a href="http://www.usda.gov/rus/telecom/publications/bulletins.htm">www.usda.gov/rus/telecom/publications/bulletins.htm</a>
5	RUS	1751F-643	Underground Plant Design	<a href="http://www.usda.gov/rus/telecom/publications/bulletins.htm">www.usda.gov/rus/telecom/publications/bulletins.htm</a>
5	RUS	1751F-644	Underground Plant Construction	<a href="http://www.usda.gov/rus/telecom/publications/bulletins.htm">www.usda.gov/rus/telecom/publications/bulletins.htm</a>

**Technical Criteria for the Installation Information  
Infrastructure Architecture, February 2010**

**Table D-1. Outside Plant References (continued)**

Priority	Source	Identifier	Title	Source URL
5	RUS	1751F-802	Electrical Protection Grounding Fundamentals	<a href="http://www.usda.gov/rus/telecom/publications/bulletins.htm">www.usda.gov/rus/telecom/publications/bulletins.htm</a>
5	RUS	1753F-201	RUS Standard for Acceptance Tests and Measurements of Telecommunications Plant	<a href="http://www.usda.gov/rus/telecom/publications/bulletins.htm">www.usda.gov/rus/telecom/publications/bulletins.htm</a>
5	RUS	1753F-401	Standards for Splicing Copper and Fiber Optic Cable (PC-2)	<a href="http://www.usda.gov/rus/telecom/publications/bulletins.htm">www.usda.gov/rus/telecom/publications/bulletins.htm</a>
5	RUS	345-72	REA Specification for Filled Splice Closures, PE-74	<a href="http://www.usda.gov/rus/telecom/publications/bulletins.htm">www.usda.gov/rus/telecom/publications/bulletins.htm</a>
5	RUS	Form 515a	Specifications and Drawings for Construction of Buried Plant (RUS Bulletin 1753F-150)	<a href="http://www.usda.gov/rus/telecom/publications/bulletins.htm">www.usda.gov/rus/telecom/publications/bulletins.htm</a>
5	RUS	Form 515b	Specifications and Drawings for Underground Plant (RUS Bulletin 1753F-151)	<a href="http://www.usda.gov/rus/telecom/publications/bulletins.htm">www.usda.gov/rus/telecom/publications/bulletins.htm</a>
5	RUS	Form 515c	Specifications and Drawings for Construction of Aerial Plant (RUS Bulletin 1753F-152)	<a href="http://www.usda.gov/rus/telecom/publications/bulletins.htm">www.usda.gov/rus/telecom/publications/bulletins.htm</a>
5	RUS	Form 515d	Specifications and Drawings for Service Entrance Installations at Customer Access Locations (RUS Bulletin 1753F-153)	<a href="http://www.usda.gov/rus/telecom/publications/bulletins.htm">www.usda.gov/rus/telecom/publications/bulletins.htm</a>
4	Telcordia	FR-440	Transport Systems Generic Requirements	<a href="http://telecom-info.telcordia.com">http://telecom-info.telcordia.com</a>
4	Telcordia	FR-Fiber-1	Fiber Optic Cables and Connections	<a href="http://telecom-info.telcordia.com">http://telecom-info.telcordia.com</a>
4	Telcordia	FR-SONET-17	Broadband and Transport Network Generic Requirements: SONET and ATM Transport Technologies	<a href="http://telecom-info.telcordia.com">http://telecom-info.telcordia.com</a>
4	Telcordia	GR-111	Generic Requirements for Thermoplastic Insulated Riser Cable	<a href="http://telecom-info.telcordia.com">http://telecom-info.telcordia.com</a>
4	Telcordia	GR-1400	SONET Dual-Fed Unidirectional Path Switched Ring (UPSR) Equipment Generic Criteria	<a href="http://telecom-info.telcordia.com">http://telecom-info.telcordia.com</a>
4	Telcordia	GR-253	Synchronous Optical Network (SONET) Transport Systems: Common Generic Criteria	<a href="http://telecom-info.telcordia.com">http://telecom-info.telcordia.com</a>
4	Telcordia	GR-421	Generic Requirements for Metallic Telecommunications Cables	<a href="http://telecom-info.telcordia.com">http://telecom-info.telcordia.com</a>
4	Telcordia	GR-3151	Generic Requirements for Copper Splice Closures	<a href="http://telecom-info.telcordia.com">http://telecom-info.telcordia.com</a>
4	Telcordia	MDP-326-170	Pressure Tight Splice Closures	<a href="http://telecom-info.telcordia.com">http://telecom-info.telcordia.com</a>
6	Lucent	621-400-011	Guying Definitions	<a href="http://www.lucentdocs.com">http://www.lucentdocs.com</a>
6	Lucent	622-020-020	Conduit and Manhole Construction General	<a href="http://www.lucentdocs.com">http://www.lucentdocs.com</a>
6	Lucent	622-020-100	General Conduit and Conduit Couplings - Description	<a href="http://www.lucentdocs.com">http://www.lucentdocs.com</a>
6	Lucent	622-100-010	Conduit and Manholes Precautions	<a href="http://www.lucentdocs.com">http://www.lucentdocs.com</a>

**Table D-1. Outside Plant References (continued)**

<b>Priority</b>	<b>Source</b>	<b>Identifier</b>	<b>Title</b>	<b>Source URL</b>
6	Lucent	622-300-211	Main Conduit Reinforcing	<a href="http://www.lucentdocs.com">http://www.lucentdocs.com</a>
6	Lucent	622-500-011	Manholes - General	<a href="http://www.lucentdocs.com">http://www.lucentdocs.com</a>
6	Lucent	622-505-210	Concrete Maintenance Holes Cast-In-Place Construction	<a href="http://www.lucentdocs.com">http://www.lucentdocs.com</a>
6	Lucent	622-506-100	Precast Concrete Manholes, 38Y Types Description	<a href="http://www.lucentdocs.com">http://www.lucentdocs.com</a>
6	Lucent	622-506-200	Manholes, Precast Concrete 38Y-Type Installation 38Y-Type Installation	<a href="http://www.lucentdocs.com">http://www.lucentdocs.com</a>
6	Lucent	622-520-100	Conduit, Manholes And Cable Vaults Manholes Manhole, Hardware Manholes -- Equipping	<a href="http://www.lucentdocs.com">http://www.lucentdocs.com</a>
6	Lucent	622-520-100 ADD	Manholes-Equipping	<a href="http://www.lucentdocs.com">http://www.lucentdocs.com</a>
6	Lucent	626-107-006	AR-Series Riser Cables Description, Use Reel Lengths	<a href="http://www.lucentdocs.com">http://www.lucentdocs.com</a>
6	Lucent	627-610-225	Placing Metallic Riser and Building Cable	<a href="http://www.lucentdocs.com">http://www.lucentdocs.com</a>
6	Lucent	628-200-200	Underground Cable Placing, Rodding and Cleaning Ducts	<a href="http://www.lucentdocs.com">http://www.lucentdocs.com</a>
6	Lucent	628-200-206	Underground Cable, Pulling Cable Into Subsidiary Ducts	<a href="http://www.lucentdocs.com">http://www.lucentdocs.com</a>
6	Lucent	628-200-208	Underground Cable Placing	<a href="http://www.lucentdocs.com">http://www.lucentdocs.com</a>
6	Lucent	628-200-216	Fiber Optic Cable Placing in Innerduct and Direct Buried Duct	<a href="http://www.lucentdocs.com">http://www.lucentdocs.com</a>
6	Lucent	629-200-205	Guidelines for Trenching, Backfilling, and Ground Restoration of Buried Plant	<a href="http://www.lucentdocs.com">http://www.lucentdocs.com</a>
6	Lucent	629-200-206	Guidelines for Placing Buried Plant	<a href="http://www.lucentdocs.com">http://www.lucentdocs.com</a>
6	Lucent	629-200-215	Buried Plant Plowing	<a href="http://www.lucentdocs.com">http://www.lucentdocs.com</a>
6	Lucent	900-200-318	Outside Plant Engineering Handbook	<a href="http://www.lucentdocs.com">http://www.lucentdocs.com</a>
6	Lucent	901-350-300	Feeder Cable--Size	<a href="http://www.lucentdocs.com">http://www.lucentdocs.com</a>
6	Lucent	915-251-300	Outside Plant Design--Distribution Cable Design	<a href="http://www.lucentdocs.com">http://www.lucentdocs.com</a>
6	Lucent	917-152-200	Outside Plant Engineering -- Facility Design~Distribution Facilities General Information Distribution Cable Design -- Cable Sizing And Transmission	<a href="http://www.lucentdocs.com">http://www.lucentdocs.com</a>
6	Lucent	917-356-001	Outside Plant Engineering -- Facility Design~~~Distribution Facilities Engineering And Implementation Methods System For New Buried Distribution Facilities	<a href="http://www.lucentdocs.com">http://www.lucentdocs.com</a>
6	Lucent	917-356-100	Outside Plant Engineering -- Facility Design~~~Distribution Facilities Buried Urban Distribution Systems	<a href="http://www.lucentdocs.com">http://www.lucentdocs.com</a>
6	Lucent	917-356-100 ADD	Buried Urban Distribution Systems	<a href="http://www.lucentdocs.com">http://www.lucentdocs.com</a>

**Technical Criteria for the Installation Information  
Infrastructure Architecture, February 2010**

**Table D-1. Outside Plant References (continued)**

Priority	Source	Identifier	Title	Source URL
6	Lucent	917-356-201	Buried Non Urban Cable Systems	<a href="http://www.lucentdocs.com">http://www.lucentdocs.com</a>
6	Lucent	918-117-090	Clearances for Aerial Plant	<a href="http://www.lucentdocs.com">http://www.lucentdocs.com</a>
6	Lucent	918-117-090 ADD	Clearances for Aerial Plant	<a href="http://www.lucentdocs.com">http://www.lucentdocs.com</a>
6	Lucent	919-000-100	Design of Communication Lines Crossing Railroads	<a href="http://www.lucentdocs.com">http://www.lucentdocs.com</a>
6	Lucent	919-120-150	Pole Lines Numbering of Poles	<a href="http://www.lucentdocs.com">http://www.lucentdocs.com</a>
6	Lucent	919-120-200	Pole Lines Classification and Loading	<a href="http://www.lucentdocs.com">http://www.lucentdocs.com</a>
6	Lucent	919-120-200 ADD	Pole Lines Classification and Loading	<a href="http://www.lucentdocs.com">http://www.lucentdocs.com</a>
6	Lucent	919-120-600	Pole Lines Design Considerations	<a href="http://www.lucentdocs.com">http://www.lucentdocs.com</a>
6	Lucent	919-240-300	Underground Conduit Maintenance Holes	<a href="http://www.lucentdocs.com">http://www.lucentdocs.com</a>
6	Lucent	919-240-400	Underground Conduit Materials Types and Fields of Use	<a href="http://www.lucentdocs.com">http://www.lucentdocs.com</a>
6	Lucent	919-240-500	Underground Conduit Special Construction	<a href="http://www.lucentdocs.com">http://www.lucentdocs.com</a>
6	Lucent	919-240-520	Conduit Bridge Crossings	<a href="http://www.lucentdocs.com">http://www.lucentdocs.com</a>
6	Lucent	919-240-520 ADD	Conduit Bridge Crossings ADD	<a href="http://www.lucentdocs.com">http://www.lucentdocs.com</a>
5	ANSI/IEEE	C2-2007	National Electrical Safety Code (NESC) 2007	<a href="http://standards.ieee.org/nesc/">http://standards.ieee.org/nesc/</a>
N/A	Army	N/A	USAISEC-FDED, TG for I3A & I3MP Grounding and Bonding	N/A
4*	ISO	BS EN 50173- 1	Information Technology - Generic Cabling Systems - Part 1: General Requirements and Office Areas	<a href="http://global.ihs.com">http://global.ihs.com</a>
4*	ISO	BS EN 50173- 2	Information Technology - Generic Cabling Systems - Part 2: Office Premises	<a href="http://global.ihs.com">http://global.ihs.com</a>
4*	ISO	BS EN 50173- 3	Information Technology - Generic Cabling Systems - Part 5: Data Centres	<a href="http://global.ihs.com">http://global.ihs.com</a>
4*	ISO	BS EN 50174- 1	Information Technology – Cabling Installation - Part 1: Specification and Quality Assurance	<a href="http://global.ihs.com">http://global.ihs.com</a>
4*	ISO	BS EN 50174- 2	Information Technology – Cabling Installation - Part 2: Installation Planning and Practices Inside Buildings	<a href="http://global.ihs.com">http://global.ihs.com</a>
4*	ISO	BS EN 50174- 3	Information Technology – Cabling Installation - Part 2: Installation Planning and Practices Inside Buildings	<a href="http://global.ihs.com">http://global.ihs.com</a>

\*For projects in Europe only.

AASHTO=American Association of State Highway and Traffic Officials; ASTM=American Society for Testing and Materials; CD-ROM=compact disk-read only memory; DIN=Deutsches Institut für Normung e.V.; DOD=Department of Defense; GR=Generic Requirements; N/A=not applicable; TTC=Trenchless Technology Center; URL=Universal Resource Locator; VDE=Verband der Elektrotechnik Elektronik Informationstechnik



## GLOSSARY. ACRONYMS AND ABBREVIATIONS

AASHTO	American Association of State Highway and Traffic Officials
AC	alternating current
ADN	area distribution node
AFCESA	Air Force Civil Engineer Support Agency
AFH	Army Family Housing
AIS	automation information system
AKM	Army Knowledge Management
AKO	Army Knowledge Online
AMC	Army Materiel Command
ANSI	American National Standards Institute
ASTM	American Society for Testing and Materials
AT&L	Acquisition Technology and Logistics
ATC	Air Traffic Control
AWG	American Wire Gauge
BAS	Building Automation Systems
BCS	Building Cabling System
BICSI	Building Industry Consulting Service International
BOQ	Bachelor Officers' Quarters
C	Celsius
C&A	certification and accreditation
C/C	center-to-center
C2	command and control
CAT	category
CATV	cable television/community antenna television
CCB	Configuration Control Board
CCR	Criteria Change Request
CCTV	closed circuit television
CD-ROM	compact disk-read only memory
CECOM	Communications-Electronics Command
CIO	Chief Information Officer
cm <sup>3</sup>	cubic meter
CONUS	Continental United States
CP	Consolidation Point
CTTA	Certified TEMPEST Technical Authority
CWDM	Coarse Wavelength Division Multiplexing
D	Chromatic Dispersion Coefficient
DA	Department of the Army
DAA	Designated Accreditation Authority
dB	decibel
DB	direct buried
dBmV	decibel millivolts
DC	direct current

**Technical Criteria for the Installation Information  
Infrastructure Architecture, February 2010**

DCO	Dial Central Office
DDC	direct digital controller
DIN	Deutsches Institut für Normung, e.V.
DISA	Defense Information Systems Agency
DOD	Department of Defense
DODD	DOD Directive
DPW	Directorate of Public Works
DWDM	Dense Wavelength Division Multiplexing
EB	Encased Buried
EDP	Engineering Design Plan
EES	earth electrode subsystem
EIA	Electronics Industries Alliance
EMT	electrical metallic tubing
ESM	Enterprise Systems Management
EUB	end user building
FAX	facsimile
FDED	Fort Detrick Engineering Directorate
FIPS	Federal Information Processing Standards
FO	fiber optic
FOC	fiber optic cable
FOCIS	Fiber Optic Connector Intermateability Standard
FOPP	fiber optic patch panel
FOUO	For Official Use Only
FSO	Free Space Optics
ft	foot/feet
Gbps	gigabits per second
GHz	gigahertz
GIP	galvanized iron pipe
GPa	gigapascal
GR	Generic Requirements
GSA	General Services Administration
GSP	galvanized steel pipe
HCDS	Hardened Carrier Distribution System
HDPE	high-density polyethylene
HQ	headquarters
HQDA	Headquarters, Department of the Army
HVAC	heating, ventilation, and cooling
I3A	Installation Information Infrastructure Architecture
I3MP	Installation Information Infrastructure Modernization Program
IA	Information Assurance
IATF	Information Assurance Technical Framework

IAW	in accordance with
ICAN	Installation and Campus Area Network
ICEA	Insulated Cable Engineers Association
ID	identification
IEC	International Engineering Consortium
IMA	Information Mission Area
IMC	intermediate metal conduit
in	inch/inches
IS	information system
ISO	International Organization for Standardization
ISP	inside plant
ISS	Information Systems Security
ISSE	Information Systems Security Engineering
IT	information technology
ITU	International Telecommunication Union
ITU-T	International Telecommunication Union-Telecommunication Standardization Sector
km	kilometer
kPa	kilopascal
lb/in <sup>2</sup>	pounds per square inch
LOS	line of sight
LPAGBS	Lightning Protection, Power Quality Analysis, Grounding, Bonding, and Shielding
LSA	line sharing adapter
M	cable sections
m	meter
MC	main cross-connect
MCN	main communications node
MDF	main distribution frame
MHz	megahertz
MILCON	military construction
MIL-HDBK	Military Handbook
MIL-STD	Military Standard
MM	multimode
mm	millimeter
MMW	millimeter wave
MPa	Megapascal
MPD	multiple plastic duct
MUTOA	multi-user telecommunication outlet assembly
N	newton
N/A	not applicable
NAVFAC	Naval Facilities Engineering Command

**Technical Criteria for the Installation Information  
Infrastructure Architecture, February 2010**

NEC	Network Enterprise Center
NEMA	National Electrical Manufacturers' Association
NESC	National Electrical Safety Code
NETCOM	U.S. Army Network Enterprise Technology Command
NFPA	National Fire Protection Association
NIPRNet	Non-secure IP Router Network
nm	nanometer
NMCI	Navy and Marine Corps Intranet
NSA	National Security Agency
NZDSF	non-zero dispersion shifted fiber
O&M	Operations and Maintenance
OC	Optical Carrier
OCONUS	Outside the Continental United States
OSHA	Occupational Safety and Health Administration
OSP	Outside Plant
OSPDPR	Outside Plant Design and Performance Requirements
OTDR	optical time domain reflectometer
PC	physical contact
PE	polyethylene
PET	protected entrance terminal
PMD	polarization mode dispersion
PoE	Power over Ethernet
ps	picosecond
PSI	pounds per square inch
PVC	polyvinyl chloride
Q	small probability level
QA	Quality Assurance
QC	Quality Control
RC	Range Control
RCDD	Registered Communications Distribution Designer
RF	radio frequency
RMC	rigid metal conduit
RSC	rigid steel conduit
RSU	remote switching unit
RUS	Rural Utilities Service
SC	subscriber connector
SHDSL	symmetrical high-density digital subscriber line
SIPRNet	Secure Internet Protocol Router Network
SM	single mode
SONET	Synchronous Optical Network
SOW	Statement of Work

ST	smart terminal/straight tip
TC	technical criteria
TEF	Telecommunications Entrance Facility
TER	Telecommunications Equipment Room
TG	Technical Guide
TGB	telecommunications grounding busbar
TIA	Telecommunications Industry Association
TIC	Technology Integration Center
TMGB	telecommunications main grounding busbar
TR	telecommunications room
TSB	Technical Service Bulletin
TTC	Trenchless Technology Center
UFC	Unified Facilities Criteria
UFGS	Unified Facilities Guide Specification
UL	Underwriters' Laboratory
UPS	uninterruptible power supply
URL	Universal Resource Locator
USACE	U.S. Army Corps of Engineers
USAISEC	U.S. Army Information Systems Engineering Command
UTP	unshielded twisted pair
V	volt
VDE	Verband der Elektrotechnik Elektronik Informationstechnik
VoIP	Voice over Internet Protocol
WAP	wireless access point
WIDS	wireless intrusion detection system
WLAN	wireless local area network
$\lambda$	wavelength
$\mu\text{m}$	micrometer

**This page intentionally left blank.**