

# Field Artillery

A JOINT MAGAZINE FOR US FIELD ARTILLERY

OCTOBER 2006

## 1-87 Infantry's Split-Focus Fires and Effects Cell

Urban and  
Rural Iraq

### Inside:

**Why Some  
Field Artillerymen  
Will Make Excellent  
BCT Commanders**

**3-319 AFAR**  
*TF Gun Devils in Afghanistan*

**Joint Tactical Targeting for  
Base Security in Iraq**

# Field Artillery

A JOINT MAGAZINE FOR US FIELD ARTILLERYMEN • SINCE 1911

September-October 2006

HQDA PB6-06-5

## ARTICLES

- 3 1-87 Infantry's Split-Focus Fires and Effects Cell: Urban and Rural Iraq**  
*By Captain Nicholas J. Armstrong*
- 8 Combat Identification Training—Recognition of Combat Vehicles Program**  
*By Major (Retired) William M. Rierson and Colonel (Retired) David A. Ahrens*
- 9 Why Some Field Artillerymen Will Make Excellent BCT Commanders**  
*By Colonel Annie Baker*
- 14 The FA: Leading Joint Interdependency with JACI**  
*By Chief Warrant Officer Three (Retired) Christopher A. Saindon*
- 18 2nd IBCT, 2nd ID, Qualifies JFOs**  
*Major Christopher W. Wendland*
- 20 3-319 AFAR TF Gun Devils—Providing FA Fires for Afghanistan and Maneuvering on the Enemy**  
*By Lieutenant Colonel Bertrand A. Ges*
- 27 Leadership: Seeing What is Really in the Mirror**  
*By Captain Kevin K. Carlile*
- 28 ILARNG's 2-130 IN FSE as a Battalion-Level CMOC in Iraq**  
*By Captain Robert C. Davis and Sergeant First Class John L. Kullman*
- 33 The Deployed Commander's Information Band of Tolerance**  
*By Lieutenant Colonel Timothy J. Daugherty and Captain G. Damon Wells*
- 37 4th Fires Brigade in Iraq: Setting the Conditions for Safe Operations**  
*By Lieutenant Colonel Timothy J. Daugherty, Command Sergeant Major Gilbert L. Canuela and Captain Jared J. Sutton*
- 39 The New Precision-Guided Mortar Munition (PGMM)**  
*By Peter J. Burke and Travis R. Kundel*
- 40 Joint Tactical Targeting for Base Security in Iraq**  
*By Major Douglas W. Winton and Lieutenant Colonel Patrick M. Antonietti*
- 44 FOS with PSS Integrated—Nowhere for the Enemy to Hide**  
*By Milton B. Smith*

## DEPARTMENTS

- 1 Army's Joint Fires Coordinator (JFCOORD)—FA Branch: Transforming with Our Army**

**Front Cover:** An Iraqi soldier assigned to the 2nd Battalion, 1st Brigade, 6th Iraqi Army Division (2/1/6 Iraqi Army), pulls security during a joint patrol in Baghdad on 6 May. After the 15 December 2005 national elections, 1st Battalion, 87th Infantry (1-87 IN), 10th Mountain Division (Light Infantry), conducted a transfer of authority (TOA) of its area of operations (AO) in Baghdad to 2/1/6 Iraqi Army, primarily in the Al Shula, Ghazaliya and Amariya Districts.

**DISCLAIMER:** Field Artillery—is published bimonthly by Headquarters, Department of the Army, under the auspices of the US Army Field Artillery School (Building 758), Fort Sill, OK. The views expressed are those of the authors, not the Department of Defense or its elements. Field Artillery's content doesn't necessarily reflect the US Army's position and doesn't supersede information in other official Army publications. Use of news items constitutes neither affirmation of their accuracy nor product endorsements.

**PURPOSE:** (as stated in the first Field Artillery Journal in 1911): To publish a journal for disseminating professional knowledge and furnishing information as to the Field Artillery's progress, development and best use in campaign; to cultivate, with the other arms, a common understanding of the power and limitations of each; to foster a feeling of interdependence among the different arms and of hearty cooperation by all; and to promote understanding between the regular and militia forces by a closer bond; all of which objects are worthy and contribute to the good of our country.

**OFFICIAL DISTRIBUTION:** US Army and Marine Corps Active and Reserve Components FA units: seven copies to corps artillery, division artillery, FA fires brigade, brigade combat team (BCT), Stryker BCT, regimental combat team units and Marine regimental headquarters and battlefield coordination detachments (BCDs); 13 copies to FA fires battalions; and seven copies to fire support elements (FSEs), fires and effects cells (FECs), fire support cells (FSCs), fire support coordination centers (FSCCs), force fires coordination centers (FFCCs) and separate batteries or detachments. In addition, other US government agencies that work with FA or fire support personnel, issues, material, doctrine, training, organization or equipment may request a limited number of free copies. These include, but are not limited to, other branch or service units, training centers, schools, recruiting commands, readiness groups, libraries, education centers, project managers, arsenals, laboratories, state adjutant generals, liaison officers, military academies, ROTCs, major commands, military attaches and public affairs offices.

**PAID SUBSCRIPTIONS:** Those ineligible for Official Distribution may subscribe through the US Field Artillery Association, P.O. Box 33027, Fort Sill, OK 73503-0027 or [www.fieldartillery.org](http://www.fieldartillery.org). Telephone numbers are (580) 355-4677 or FAX (580) 355-8745 (no DSN). Dues are \$20 per year to US and APO addresses. The international rate is \$55 for a one-year subscription.

**SUBMISSIONS:** Mail to Editor, Field Artillery, P.O. Box 33311, Fort Sill, OK 73503-0311. Telephone numbers are DSN 639-5121/6806 or commercial (580) 442-5121/6806 or FAX 7773 with DSN or commercial prefixes. Email is [famag@sill.army.mil](mailto:famag@sill.army.mil). Material is subject to edit by the Field Artillery staff.

**REPRINTS:** Field Artillery is pleased to grant permission to reprint articles. Please credit the author and Field Artillery.

**POSTMASTER:** Field Artillery (ISSN 0899-2525) (USPS 309-010) is published bimonthly. Periodicals postage is paid by the Department of the Army at Lawton, OK 73501 and an additional mailing post office. Send address changes to Field Artillery, P.O. Box 33311, Fort Sill, OK 73503-0311.

**Redleg Hotline & Email**  
(Organization, Material, Doctrine and Training)  
DSN 639-4020 or (580) 442-2204 (24-Hours)  
[redleg@sill.army.mil](mailto:redleg@sill.army.mil)

**CounterStrike Task Force**  
<https://counterstrike.army.smil.mil>

**Field Artillery Home Page & Email**  
[sill-www.army.mil/famag](http://sill-www.army.mil/famag); [famag@sill.army.mil](mailto:famag@sill.army.mil)

By Order of the Secretary of the Army:

**Peter J. Schoomaker**  
General, United States Army  
Chief of Staff

Official:   
Joyce E. Morrow  
Administrative Assistant to the  
Secretary of the Army, 0612204

**David C. Ralston**  
Major General, United States Army  
Field Artillery School Commandant

**Editor:** Patrecia Slayden Hollis

**Art Director:** Fred W. Baker III

**Managing Editor:** Vacant

**Assistant Editor:** Tonya S. Goforth



# FA Branch: Transforming with Our Army

The Chief of Staff of the Army (CSA) General Peter J. Schoomaker recently decided that Field Artillerymen will be considered for Department of the Army (DA) selection to command all brigade combat teams (BCTs)—Infantry, Heavy and Stryker—beginning with the 2008 board. This is *great* news for the Field Artillery. It will further transform our branch. However, it also means we have some work to do.

This decision by the CSA recognizes the versatility of our branch. FA Soldiers around the world in the Global War on Terrorism (GWOT) have been performing *magnificently* in many non-FA tasks and missions. Many FA officers have commanded task forces with missions identical to those of our maneuver brethren. Indeed, some of our colonels have commanded brigades that had maneuver missions.

We performed the missions we were given, and we did them *well*. In a sense, every Soldier in our branch contributed to this CSA decision. Our branch continues to transform with our Army and to prosper.

Now that we've been given this opportunity, what are we going to do about it? Of course we'll immediately reevaluate our FA Officer Education System (OES). We'll examine our system to see if we need to make any changes to prepare our best officers for BCT commands, if selected. Furthermore, we'll institute a monitoring system to ensure the right officers are assigned to positions that enable them to compete and prepare them for these commands.

For those who have lamented the loss of the division artilleries (Div Artys), this should be a further sign that the Field Artillery is here to stay. We are a relevant, vital part of GWOT—recognized by the Army senior leadership. This opportunity to command BCTs will augment the current means for our best and brightest FA officers to become future senior leaders of our Army.

On that note, I'd like to point out some

of the senior FA officers in the Army and the unique jobs they have. Lieutenant General (LTG) James J. Lovelace is the Army's G3. LTG Michael D. Maples is the Director of the Defense Intelligence Agency (DIA). LTG David P. Valcourt is the Commanding General (CG) of Eighth US Army and the Chief of Staff of the United Nations Command/Combined Forces Command/US Forces in Korea. LTG Raymond T. Odierno is the III Corps CG. Finally, LTG Keith W. Dayton is the US Security Coordinator for the Israel-Palestinian Authority in Tel Aviv. This is quite an impressive list of Field Artillery officers of whom we all can be proud.

Our use and development of our precision-guided munitions (PGMs) continue to transform our branch as well. The guided multiple-launch rocket system unitary (GMRLS-U) is now the precision weapon of choice by ground commanders in GWOT. Army Artillery PGMs are a great complement to Air Force PGMs. The ground commander now has additional options from which to choose and, for the first time, a dedicated PGM at his disposal that he can employ quickly and efficiently 24/7 in all weather conditions. GMRLS-U is rapidly becoming the ground commander's primary precision munition.

MLRS and high-mobility artillery rocket system (HIMARS) units now train thoroughly on GMRLS-U before deploying, using the latest tactics, techniques and procedures (TTPs) from theater. We quickly have learned the best way to employ our "70-kilometer sniper rifle." Soon we'll have even greater employment flexibility as GMRLS-U testing continues. The commander soon will have a third fuze-mode option (proximity) plus the ability to attack targets vertically.

Excalibur unitary remains on track. Recently at Yuma Proving Ground, Arizona, we fired four XM982 Excalibur projectiles, two each under hot (approximately 145 degrees Fahrenheit) and cold (approximately -25 degrees Fahrenheit) at



a range of 22 kilometers. These projectiles engaged the targets successfully, landing between three and eight meters from each target's center.

For the test, full mission threads were executed using the advanced FA tactical data system (AFATDS) to send the fire missions to the portable Excalibur fire control system. This concludes the current phase of testing, and we continue on track for FY07 fielding.

The precision guidance kit (PGK) development continues as well. The PGK for both 155-mm and 105-mm conventional cannon munitions, such as the high-explosive (HE) or dual-purpose improved conventional munition (DPICM), will make these munitions' area fires more precise. In other words, this will allow our "dumb" rounds to be "smarter." PGK will guide rounds using the global positioning system (GPS) to an impact point within a 50-meter circular error probable (CEP).

BAE Systems and Alliant Techsystems were selected to compete for the PGK production contract. A shoot-off demonstration currently is scheduled for January 2007 at Yuma. After a successful shoot-off, the winner will be awarded the contract.

We continue to improve our branch everyday. We're developing Pentathletes constantly in our schools and adapting to be ever responsive to the ground commander in the GWOT fight. I commend all members of the Field Artillery for their support and commitment. A special thanks for demonstrating to our Army that the Field Artillery is vital and always will be the *King of Battle*!



Iraqi Soldiers from the 2nd Battalion, 1st Brigade, 6th Iraqi Army Division (2/1/6 Iraqi Army) conduct a combined cordon and knock with Soldiers of 1st Battalion, 87th Infantry (1-87 IN), 1st Brigade Combat Team (BCT), 10th Mountain Division, in the Baghdad neighborhood of Amariya as part of Operation Unified Front—a major operation targeting the local perception of security after the spike in sectarian violence sparked by the Samarra mosque bombing in March.



# 1-87 Infantry's Split-Focus Fires and Effects Cell

## Urban and Rural Iraq

By Captain Nicholas J. Armstrong

**R**eorganizing under the modular concept brought a tremendous increase in capabilities to both the brigade and battalion staffs, particularly in the new fires and effects cell (FEC) at both levels. [The Army recently renamed the FEC the fire support cell, or FSC.]

After transforming in less than a year and deploying in support of Operation Iraqi Freedom (OIF), Task Force (TF) Summit's or the 1st Battalion, 87th Infantry's (1-87 IN's) FEC quickly implemented this improved version of the fire support element (FSE) to conduct effects-based operations (EBO) in Baghdad.

**Test Driving the "New Car."** In August 2005, 1-87 IN deployed in support of OIF under the 1st Brigade Combat Team (BCT), 10th Mountain Division (Light), as the *first* fully transformed infantry BCT (IBCT) to deploy to a combat zone. TF Summit spent the majority of its deployment operating on the dense urban streets of western Baghdad, predominantly the districts of Al Shula, Ghazaliya and Amariya—all widely known for their high frequency of attacks on Coalition and Iraqi security forces as well as for Sunni/Shia sectarian violence.

After the successful national elections on 15 December 2005, 1-87

IN conducted a transfer of authority (TOA) of its area of operations (AO) to 2nd Battalion, 1st Brigade, 6th Iraqi Army Division (2/1/6 Iraqi Army)—a significant milestone along the path to the complete transfer of control of Iraq to its security forces.

Simultaneously, the battalion relieved the 1st Squadron, 11th Armored Cavalry Regiment (1-11 ACR) of the force protection mission for the Abu Ghraib Internment Facility and the area around it, better known to local Iraqi's as Khan Dari. Although less than 30 kilometers west of 1-87 IN's previous AO, this primarily rural and agrarian community presented a far different environment than the urban streets on which the battalion had been operating.

Three months later, in response to the upsurge in sectarian violence after the Samarra Mosque bombing in March, TF Summit was given the mission to surge its operations in Baghdad in conjunction with 2/1/6 Iraqi Army and the newly activated Iraqi National Police. At this point, TF 1-87 IN was back in the urban areas of western Baghdad while retaining its force protection mission at Forward Operating Base (FOB) Abu Ghraib.

This combination of urban and rural terrain created a complex mission set for the 1-87 IN FEC. In western Bagh-



D/1-87 IN Company Fire Support NCO SSG Robert Cortez advises Iraqi soldiers during search operations in the Baghdad neighborhood of Amariya.

dad, where the use of indirect fires is restricted due to the high risk of collateral damage and civilian casualties, attack aviation was the primary fire support asset, and it was integrated into every operation above the platoon level. 1-87 IN primarily used attack aviation for outer security and reconnaissance during raids and cordon and search operations and used it somewhat less often to support counter-improvised explosive device (IED) operations to supplement unmanned aerial vehicle (UAV) coverage.

The needs of the urban population differed greatly from the needs of the rural population. The city's primary concerns were security followed closely by essential services (sewage, water, electricity and trash, called SWEAT). These urban issues focus nonlethal operations on establishing and developing civil projects and local governance.

In contrast, FOB Abu Ghraib is mostly surrounded by farmland and small pockets of villages with little or no local government representation. In Khan Dari, we concentrated on integrating our mortars, Raven UAVs and attack aviation assets in support of the countermortar and counter-IED fights while focusing nonlethal operations on agricultural development and addressing the health care needs of the rural populace.

Because the enemy, terrain and population differed significantly between the urban and rural AOs, the commander's desired effects for each area did too, resulting in a split-focus for our FEC.

Nevertheless, the FEC's traditional role in the maneuver battalion has not changed. Initially, its reorganization created some uncertainty about its increased role and capabilities leading up to deployment. But the FEC retained its fundamental function and capabilities as the primary planning and integration cell for mortars, artillery, attack aviation and fixed-wing close air support (CAS). However, the FEC's new additional positions have increased its capability to plan, coordinate and integrate nonlethal operations for the battalion, such as civil-military operations (CMO), tactical information operations (IO) and psychological operations (PSYOP).

Despite the challenges of two different AOs, the 1-87 IN FEC's success during OIF can be attributed to the additional manning produced by the modular transformation, the additional staff embedded in the FEC and the systems and policies established within the FEC to create an effective and cohesive planning team. The latter included a reference document outlining expectations of the embedded staff members and the battalion's attachments, such as civil affairs (CA) and tactical PSYOP teams (TPTs), etc.

**FEC Manning and Operations.** Before transformation, the FSE consisted of the battalion fire support officer (FSO), a fire support NCO (FSNCO) and two enlisted Soldiers. In addition to integrating lethal fires, IO, CMO and PSYOP into battalion operations, this staff cell was responsible for training and employing a 34-Soldier

fire support platoon divided into four fire support teams (FISTs) and attached to the infantry companies throughout the battalion. This was a significant task for the FSE, particularly when operating in environments such as Iraq or Afghanistan where the focus is relatively balanced on both lethal and nonlethal operations. This old battalion fire support model was lacking in its capabilities to quickly integrate joint fires (Air Force and Navy CAS), coordinate CMO and PSYOP support and conduct offensive IO.

Changes to the FSE in the new infantry (combined arms) battalion table of organization and equipment (TO&E) include the duty title of "battalion FSO" changing to "effects coordinator (ECOORD)" and the creation of the assistant ECOORD (AECOORD), a targeting NCO, and an additional FSNCO. The transformed TO&E also includes a three-man Air Force tactical air control party (TACP) falling under the FEC's supervision for the terminal control and delivery of munitions from fixed-wing aircraft—a major step forward toward joint integration of fires. These manning additions allowed 1-87 IN's FEC to remain tied into current operations and future plans simultaneously.

The counterfire cell at FOB Abu Ghraib was comprised of the targeting NCO, advanced FA tactical data system (AFATDS) operator and Air Force TACP and was augmented by the company FSO and FSNCO executing the FOB's force protection mission. Operating 24/7, this cell was fully committed to managing counterfires and area denial fires and had the ability to employ joint fires, CAS, Army attack aviation, 105-mm artillery from 3-6 FA—our BCT's fires battalion—and 1-87's organic 120-mm and 81-mm mortars located on the FOB. FOB Abu Ghraib received frequent mortar and rocket attacks, and the counterfire fight was *very* complex due to Abu Ghraib's proximity to the Baghdad International Airport and the frequently urgent need to clear airspace.

To make the counterfire drill more responsive, the FEC's intelligence section conducted pattern analysis to determine most likely points of origin (POOs) and time windows for insurgent mortar and rocket attacks. Using this analysis, the FEC established pre-cleared, three-dimensional restrictive operating zones (ROZ) over the gun target lines (GTLs) for both the mortars on the FOB and the 105-mm "Hot" gun located close

to Baghdad International Airport supporting the greater divisional AO. This caused some initial difficulty in gaining approval for the artillery ROZ, as the area around FOB Abu Ghraib was barely within the maximum conventional range of the supporting howitzers and required shutting down a significant portion of the airspace between the firing point at the airport and the target area during these windows.

The FEC also used this pattern analysis to establish radar acquisition call-for-fire zones (CFFZs) over these historical enemy mortar/rocket POOs, allowing the AFATDS computer to receive fire missions directly from the acquiring radar system. By pre-clearing airspace, establishing radar CFFZs and maintaining a Hot tube during these windows, the FEC reduced the average counterfire response time by half to the doctrinal standard for effective counterfires.

**Effects Integration.** With part of the fires cell fighting the enemy indirect fire threat at FOB Abu Ghraib, the remaining members of the FEC had the flexibility to supervise the fires cell and still remain focused on the effects-based targeting process and coordination of lethal and nonlethal assets for operations within western Baghdad. While this relatively small manning increase has improved the FEC's overall capabilities significantly, it takes far more than simply adding Soldiers to achieve effects integration at the battalion level; effects integration also requires minor realignments in staff relationships and systems and a change in the organizational culture within the unit.

*Staff Reorganization and Cultural Change.* Within the first month of our deployment, the FEC evolved and grew into the central planning and targeting hub for all the battalion's operations. During the course of our tour, the nature of how our FEC operated can be best described as a scaled-down hybrid of an operational planning group and an intelligence fusion cell (staff sections found only at the brigade level and above).

We accomplished this by embedding our tactical intelligence officer and scout/sniper platoon leader into the FEC. Their traditional administrative and rating responsibilities remained unchanged, although they physically worked within the FEC alongside the AECOORD (who assumed the duties of the S5 civil affairs and S7 information operations planner) and the attached CA and PSYOP team leaders.

- Disrupt anti-Iraqi forces (AIF).
- Improve the capability of Iraqi security forces.
- Improve local governance.
- Improve essential services.
- Improve the local economy.
- Improve Iraqi support of their government.

**Six Effects Objectives to Focus Operations and Assess Mission Accomplishment**

These five FEC members along with the counterfire cell carried out their duties under the ECOORD's guidance who, in turn, received direct operational guidance from the battalion commander via the battalion S3 and executive officer (XO). Each member also had one or more staff counterparts within the brigade FEC who they "plugged" into the BCT's targeting process and provided bottom-up feedback to.

While this concept is slightly non-traditional, it helped integrate and synchronize every available asset for planning future operations and targeting. The FEC had the ability to integrate and apply any mix of assets to an operation quickly, whether it be leveraging UAV coverage and tactical human intelligence (HUMINT) teams to develop and action a time-sensitive target (TST) or using a CA or PSYOP team for consequence management and mitigation after a civil

disturbance. This concept significantly increased our ability to shift back and forth from kinetic (lethal) to non-kinetic (nonlethal) operations or apply a mix of the two, depending on the commander's desired effects.

While the framework for operations in Baghdad and Iraq was established two and three levels above the maneuver battalion, instilling a clear understanding within the FEC of how the division's BCTs' and battalions' operations are nested with the overall campaign plan was essential for success.

Compared to the high-intensity combat operations in March of 2003 when our ground forces had to achieve clearly defined objectives by lethal force, conducting full-spectrum combat operations in a maturing theater today presents more obscure objectives. These objectives include influencing the local population to support its newly elected and seated government, which is often difficult to measure to determine mission success. The operational framework provided a "way ahead" for combined efforts through clearly defined lines of operation (LOOs), each with a corresponding effects objective and supporting measures of performance.

Based on the LOOs in the operational framework, the battalion was tasked with six effects objectives as outlined in the figure. Considering that *four* of the six LOOs are *nonlethal* emphasizes the *strategic importance* of isolating the Iraqi population from the insurgency and



An Iraqi soldier assigned to 2/1/6 Iraqi Army Division distributes the latest edition of *Baghdad Now* during a joint patrol in Iraq on 6 May.

US Navy photo by Photographer's Mate 1st Class Samuel W. Shavers, Fleet Combat Camera, Atlantic



A 2/1/6 Iraqi Army soldier conducts security assessment surveys with local citizens in Amariya during Operation Unified Front.

influencing its support of its elected government through nonlethal means vice the *tactical importance* of disrupting the insurgency through kinetic operations.

The key ingredient to assessing progress along these effects objectives is regular, bottom-up input of the measures of performance (MOPs) and effectiveness (MOEs) for each objective from the company level. The contributions of our company FSOs—charged with the responsibility of collecting MOPs within their company areas of responsibility (AORs)—proved critical to driving the battalion’s weekly targeting process.

During the first month or so, most of the lethal targeting of insurgent groups and nonlethal targeting of government officials and civil-military projects were directed from higher. However, as the battalion began to familiarize itself with the environment and establish relationships on the ground, our Soldiers and leaders were able to develop actionable intelligence and get feedback relating to local Iraqi leaders, essential service issues and general attitudes of the local population. Within 30 to 45 days of assuming control of the AO, 1-87 IN’s targeting process had evolved from a top-down, directive system relying on intelligence and nonlethal guidance from higher to a collaborative planning system that integrated bottom-up, company-level effects assessments. These assessments were provided by the company FSOs with intelligence

gathered by patrol leaders and top-down intelligence collected by assets outside of the battalion.

The biggest lesson learned about effects-based targeting along multiple LOOs is that units—particularly maneuver units whose core competencies center on *kinetic, high-intensity combat operations*—must eliminate the mental distinction between a lethal operation (raid, air assault, cordon and search, etc.) and a nonlethal operation (PSYOP product distribution, IO, CMO projects, humanitarian assistance, etc.). All are means to achieve effects and should be applied together, in a combined and synchronized manner. This change in organizational culture contributed to our overall success in a very complex AO.

It is a *huge* combat multiplier to have platoon and squad leaders who have a solid understanding of how important IO is, how the media is tied into every mission conducted and how the leaders can leverage nonlethal assets through the company FSOs to develop intelligence and (or) influence popular support. Effective counterinsurgencies are fought at the company level and below, and every operation must be approached with the mindset of leveraging a combination of lethal and nonlethal assets to achieve its desired effects.

In March, Iraq experienced an upsurge in sectarian violence as the elected prime minister and representative parties of Iraq struggled to seat its government.

Bombing of a major Shi’ite mosque in Samarra and an upsurge in murders, kidnappings and intimidation in Sunni/Shia-mixed and predominantly Sunni neighborhoods created unease and fear within the population. Intense media coverage created an international misperception that Iraq was on the verge of civil war.

TF Summit’s AO experienced this initial wave of violence that gradually subsided as combined operations with 2/1/6 Iraqi Army increased and the Iraqi National Police came into the sector. Despite the increase in violence, the Iraqi perception of a lack of security and the possibility of civil war was not reality on the ground.

This was tactical IO at its core—a battle for information superiority and understanding of reality—to influence the local populace and bridge the gap between reality and their perception of reality. While TF Summit continued to actively target the cells responsible for the violence, the battalion’s number one high payoff target (HPT) was “local perception of security,” an *intangible* target as opposed to a definitive target, such as taking down an insurgent safe house or securing a weapons cache.

Influencing local perception is no easy task, and achieving this goal requires a combination of both lethal and nonlethal operations. This is where *effects coordination* becomes critical. An excellent example of this was Operation Unified Front, an operation inside of the Sunni neighborhood of Amariya, widely known at the time as a major source of sectarian violence.

This brigade-level operation included TF Summit operating in conjunction with 2/1/6 Iraqi Army and the 5th Brigade, 2nd National Police Division. It commenced with a massive cordon and search for multiple targeted individuals and weapons caches within the district. Iraqi Soldiers conducted the majority of the house-to-house searches alongside elements of TF Summit, and the Iraqi police provided outer cordon security.

In addition to the kinetic portion of the operation, the Iraqi Soldiers distributed pro-Iraqi leaflets and newspapers that helped inform the population of the recent successes of the new Iraqi government and its security forces. As the Iraqi army and National Police conducted the bulk of the operation, 1-87 IN used this as an opportunity to speak with the public, address their concerns and use CA and PSYOP teams to



identify possible areas within Amariya in which commander's emergency response program (CERP) projects could be leveraged toward improving local infrastructure and essential services.

By applying a mix of kinetic and non-kinetic actions with Iraqi security forces in the lead, the people of Amariya were shown visible proof that their indigenous forces are concerned with their safety and committed to ridding their neighborhoods of terrorists.

Iraqi and Coalition troops conducted security surveys during the operation and afterward, both of which revealed a drastic increase in the Iraqi's perception of security within Amariya as compared to previous weeks. Also as a result of speaking with the locals, the companies nominated many CERP projects, to include a trash clean up employing local workers and refurbishment projects in local elementary schools and on soccer fields.

This operation achieved multiple effects in that it disrupted terrorist cells in Amariya through the detention of several insurgents and the capture of IED-making materials. It also provided an opportunity for the Iraqi army and police to display their growing competence to the locals. The CERP project nominations helped to promote economic pluralism and improve local infrastructure within the community.

Operation Unified Front targeted five of our six LOOs *simultaneously*—a textbook example of how to execute EBO and how our battalion and BCT has embraced this methodology to achieve lasting effects over the course of our deployment.

**Clear Expectations.** The most helpful means for our FEC to integrate efforts during OIF was to establish clear expectations for enablers and the supporting staff throughout the battalion. This was done by creating a terms of reference document establishing standard policies and practices for those working within the FEC, such as direct support attachments, supporting staff sections and company-level representatives. Intended as an enduring document to encourage a collaborative and "non-stovepiped" mindset, it specifically outlines the expectations, duties and responsibilities of each position and those supporting staff members who provide essential input to the effects-based targeting process. It also served as an effective performance counseling tool.

The document provides manning

recommendations within the FEC for circumstances preventing certain positions from being filled. In TF Summit's case, the AECOORD assumed the duties of the S5 CA planner and S7 IO officer. While the S5's duties focused more on local Iraqi governance support, the CA team leader focused on essential service and infrastructure project assessments and management. However, the duties of these two positions often overlapped by operational necessity.

Another highlight mentioned earlier is that the tactical intelligence officer and the scout/sniper platoon leader were aligned together under the FEC to increase the integration of intelligence, surveillance and reconnaissance (ISR) for lethal targeting.

Naturally, this document helped integrate and transition enabler support as TF Summit experienced a great deal of attachment turnover (CA and PSYOP teams) throughout the deployment with little disruption in the battalion's operations. Often, these attachments do not train regularly with units at their home station. In addition, they rarely are attached to the unit they will support during a combat deployment in the unit's mission readiness exercise (MRE) at either the Joint Readiness Training Center (JRTC), Fort Polk, Louisiana, or the National Training Center (NTC), Fort Irwin, California.

The result is that these combat enablers don't meet up with the unit they will support until they arrive in theater. This creates a period in which the unit and the attached team must establish a working relationship with each other quickly—all while conducting combat operations.

The supporting attachments also often fall on a different deployment schedule than the unit they support, creating multiple periods of "attachment turnover" throughout the deployment. This initially creates potential risks for a unit and its new attachments during the integration period and hand-over from an outgoing attachment to an incoming attachment.

Throughout the deployment, TF Summit experienced three transitions of both the CA and PSYOP teams. While this issue is managed at echelons above the battalion, the FEC still must establish procedures to minimize tactical risk for its battalion and ensure a quick and efficient integration of their supporting assets. The terms of reference document helped to serve this purpose.

**The Big Picture.** Because the US is in a long war with threats to national security transcending well beyond the borders of Iraq and Afghanistan, there always will be a need for lethal fires during the course of the Global War on Terrorism (GWOT). Furthermore, today's increasing demand for balanced lethal and nonlethal effects integration is not changing the role of the Artillery; rather it is *expanding* the Artillery's role.

The US armed forces, government agencies and allies continue to work toward an increasingly joint and unified effort in GWOT. The need for effects integration and synchronization of activities is critical from the tactical to the strategic levels for the foreseeable future.

Tremendous efforts during recent years have gone into bridging the gaps between our armed services. The Army's transformation is providing a greater capacity for our BCT and battalion commanders to quickly and effectively leverage joint and interagency assets, in addition to their own, to shape the tactical fight. This requirement to leverage diverse assets coupled with the increasing demands for information superiority falls on the staff section that integrates and synchronizes these efforts in tactical maneuver operations—the FEC.

The battalion FEC must be a staff cell full of Pentathletes—a section that communicates and functions well from within, has a strong understanding of "two-levels up" and appropriately integrates every asset it can bring to the fight in a manner to best support its commander's intent. Today, these traits are critical as the operating environments in both Iraq and Afghanistan steadily improve where "working ourselves out of a job" becomes the true benchmark for mission success.

---

**Captain Nicholas J. Armstrong is the Effects Coordinator (ECOORD) for 1st Battalion, 87th Infantry (1-87 IN), 1st Brigade Combat Team (BCT), 10th Mountain Division in Iraq. Prior assignments include Speechwriter to the Commanding General and Deputy Secretary of the General Staff, Aide de Camp to Deputy Commanding General - Support, Battalion Fire Direction Officer (FDO), Battery Executive Officer (XO) and Platoon Leader, in 3-6 Field Artillery and the Company Fire Support Officer (FSO) for 2-22 IN, 1st BCT, all in the 10th Mountain Division. He is a graduate of Airborne and Ranger Schools at Fort Benning, Georgia, and Air Assault School at Fort Drum, New York.**

# Combat Identification Training

## Recognition of Combat Vehicles Program

As of 31 January 2006 in Operation Iraqi Freedom (OIF), the US Army has had 27 fratricides—friendly fire on friendly forces. Twenty-six of those were from direct fire and one from indirect fire (although not artillery indirect fire). Two of those incidents were ground-to-air engagements, and one was an air-to-ground strike—all others were surface-to-surface engagements. Fourteen incidents occurred during daylight hours and 13 at night. These fratricide incidents resulted in 11 US Soldiers killed and 10 other military fatalities. (*Countermeasure*, Vol 27, March 2006, published by the Army Combat Readiness Center at Fort Rucker, Alabama).

As these statistics verify, combat identification is still an unresolved problem on the modern battlefield, even during stability and support operations.

Combat identification has many considerations—situational awareness and target identification within specified rules of engagement (ROE) are the cornerstones. Individual and collective training are key to enabling Soldiers and leaders to identify friendly and enemy vehicles in multiple situations.

To prevent or reduce the potential for fratricide and simultaneously increase combat effectiveness, the Training and Doctrine Command (TRADOC) is implementing a five-tiered training model for combat identification. (See the figure.)

This model provides “trigger pullers” graduated and increasingly robust train-

ing to meet combat identification challenges. Regardless of all our advanced technology or the ability of the command and control architecture to provide near perfect situational awareness, once the vehicle commander or individual shooter confirms the target is hostile, the final decision to engage a target by direct fire is the shooter’s—the gunner with his finger on the trigger.

**Recognition of Combat Vehicles (ROC-V) Program.** The training software of choice is the ROC-V and training aids, devices, simulators and simulations (TADSS) with embedded imagery from the ROC-V program. ROC-V is thermal-sight training that runs on any computer with the Windows operating system.

With ROC-V, Soldiers learn to identify the thermal signatures of combat vehicles by using an interactive curriculum that teaches the unique patterns and shapes of vehicle “hot spots” and overall vehicle shapes. ROC-V also gives Soldiers practical experience in using their individual weapon thermal-sensor image controls. Using virtual sight controls, Soldiers learn to adjust their thermal optics to find targets and reveal thermal identification cues.

ROC-V includes training and testing to support the US Army Soldier’s Manual Common Task (SMCT) Skill Level I, Visual Vehicle Identification.

The training program includes paper trainer versions for reference without a computer. The instructor control module permits individual and collective train-

ing, testing and score tracking. ROC-V is the only training aid available for current joint combat identification marking system (JCIMS) devices.

ROC-V is the standard for ground combat vehicle identification training in the Army and Marine Corps. Users can download ROC-V from the website at <https://roc.v.army.mil>.

The Army Training Support Center (ATSC) at Fort Eustis, Virginia, is distributing compact discs of ROC-V through the Joint Visual Information Activity, Tobyhanna, Pennsylvania (<http://dodimagery.afis.osd.mil>). These CDs provide the ROC-V training program to Soldiers who cannot access the website.

**Future ROC-V Training.** Representatives from the four armed services are helping to produce the next generation of ROC-V to meet joint mission area applications. The ROC-V team already has produced a look-down aspect angle version for air-to-ground mission areas, such as fixed-wing close air support (CAS), attack and reconnaissance rotary-wing platforms, and AC-130 gunships. USMC light attack helicopter squadrons currently use this version. This same product improvement has a potential value for tactical unmanned aerial vehicle (TUAV) sensor analysts.

In the future, ROC-V imagery may be embedded in combat vehicle tactical trainers and other TADSS. Efforts also include developing a web-based course that conforms with the shared courseware object reference model (SCORM) that individual services can host.

Leaders must ensure they have a plan to reduce the risk of fratricide. Along with improving situational awareness during operations, the key is tough, realistic combat vehicle identification training before operations. ROC-V meets that training need. The bottom line—ROC-V training saves lives.

MAJ(R) William M. Rierson, FA  
Lead Analyst, Ground Combat Division of the Joint Fires Integration and Interoperability Team (JFIIT)  
Eglin AFB, FL  
COL(R) David A. Ahrens, FA  
Office of the Deputy Chief of Staff for Operations and Training, TRADOC, Fort Monroe, VA

Tier Level	Type Training
1. Individual	Combat Vehicle Identification with ROC-V
2. Individual & Team	AGTS, BATS, UCOFT &, CCTT
3. Team & Unit	Gunnery, Ranges & NGATS
4. Unit & Collective	Force-on-Force Training Exercises with JCIM at Home Station and the CTCs
5. Collective & Joint	Virtual Mission Rehearsals, Combined Arms Rehearsals & Rock Drills

<p><b>Legend:</b>  <b>AGTS</b> = Advanced Gunner Training Simulator  <b>BATS</b> = Bradley Advanced Training System  <b>CCTT</b> = Close Combat Tactical Trainer  <b>CTC</b> = Combat Training Center</p>	<p><b>JCIMS</b> = Joint Combat Identification Marking System  <b>NGATS</b> = New Generation Army Targetry System  <b>ROC-V</b> = Recognition of Combat Vehicles  <b>UCOFT</b> = Unit Conduct of Fire Trainers</p>
---	---

Combat Vehicle Identification Tiered Training Model

# Why Some Field Artillerymen Will Make Excellent BCT Commanders

The Chief of Staff of the Army (CSA) General Peter J. Schoomaker recently directed that Field Artillerymen and Engineers be considered for DA selection to command brigade combat teams (BCTs)—Stryker BCTs (SBCTs), Infantry BCTs (IBCTs) and Heavy BCTs (HBCTs)—along with Infantry and Armor officers, starting with the 2008 board.

As articles in this magazine have documented since the Global War on Terrorism (GWOT) began, Field Artillerymen have been commanding not only maneuver BCTs in the war, but also maneuver task forces very successfully alongside their maneuver brethren. In fact, the majority of FA battalion commanders in Central Command (CENTCOM) are commanding/have commanded maneuver task forces. Some of those task forces have been responsible for the most dangerous sections of their brigades' areas of operations (AOs).

*The Army must have an environment in which we develop leaders, all leaders, and take advantage of their capabilities and potential. It must be an environment of opportunities, one that leverages experiences and talents that is not constrained by narrowness of MOS or branch designation.*

LTG James J. Lovelace, Jr.  
Deputy Chief of Staff of the Army, G3  
"Today's Army in Change—And Exciting Place to Be"  
Interview, May-June 2006 *Field Artillery*

This article discusses the experiences and professional development of Field Artillerymen that prepare them to command BCTs successfully. I understand that many Engineers also have commanded motorized infantry units in GWOT—hence the CSA's directive. However, a discussion of the Engineers'

---

By Colonel Annie Baker

---

command experience in GWOT and professional development preparing them for BCT commands is out of my expertise and a subject for another article in another magazine.

The CSA's decision to expand the eligibility for BCT commands to FA and Engineer officers supports his philosophy of developing Pentathletes and giving them wider opportunities to use their skills and talents for the good of the Army.

There are a number of reasons why some Field Artillerymen will make excellent BCT commanders, not the least of which is, they *already have* made excellent BCT commanders.

**Field Artillerymen have commanded motorized infantry BCTs and task forces successfully in CENTCOM.** Four division artillery (Div Arty) commanders served successfully in recent

times as BCT commanders, one in Afghanistan and three in Iraq—BCTs in the 4th Infantry, 25th Infantry, 1st Infantry and 1st Cavalry Divisions.<sup>1</sup> In addition, the 82d Airborne Div Arty commander recently stood up and commanded the 4th BCT in the at Fort Bragg, North Carolina.<sup>2</sup>

I comfortably can say that the majority of FA and fires battalion commanders in CENTCOM in the past two years have commanded infantry task forces, one of the

most important qualifiers for selection to command BCTs. See Figure 1 on Page 6. The senior FA observer/controllers (O/Cs) at the National Training Center (NTC), Fort Irwin, California, and Joint Readiness Training Center (JRTC), Fort Polk, Louisiana, report that 100 percent of the FA units rotating through

their training centers are performing maneuver missions—most with dual responsibilities for their BCTs' fires and other missions.<sup>3</sup>

These are unusual times, and the Army is using unusual measures to execute today's challenging missions. The Army's leaders and Soldiers, once again, have demonstrated remarkable resourcefulness, adaptability and depth of combat arms skills to rise to the challenges in difficult times.

**The officer education system (OES) and FA assignments provide a sound foundation for Field Artillerymen to command BCTs.** Field Artillery officers are developed from lieutenant on up to operate in a maneuver environment at all levels. Understanding maneuver capabilities and limitations is the foundation of the Field Artilleryman's education and assignments. And the young Artilleryman's education and experience focus not only on combined arms operations, but also on joint fires and effects—the latter much earlier than most branches. This is an advantage in the contemporary operating environment (COE).

As fire supporters, Field Artillerymen are habitually associated with maneuver units, notably at the company, battalion task force and brigade levels. Their responsibilities and experiences as fire supporters integral to the maneuver units grow them as leaders and in the knowledge of the nuances, challenges and rewards of life in the combat arms unit. Being intimately involved in planning and executing combat operations provides them unique perspectives of both fires and maneuver.

Serving as fire support officers (FSOs) for the maneuver company, battalion and brigade commanders; as fire support coordinators (FSCOORDs) for brigade and division commanders; and as O/Cs at the combat training centers (CTCs) gives Field Artillerymen a thorough understanding of combined arms operations

on the battlefield. In counterinsurgency operations, such as those in GWOT, Field Artillerymen frequently are the ones planning, coordinating and synchronizing both lethal and nonlethal effects for the company, battalion, BCT, division or corps commander, often working with a deputy commanding officer (DCO) or

science of battle command. In short, they “get it.” And those around them know they get it—depend on their expertise and leadership to make things happen at the right time in the battlespace. Hence you get division commanders selecting Field Artillerymen to command BCTs.

In recent times, Field Artillerymen have

*We must pick the most capable, qualified person to command our troops—regardless of branch. Branch designations should not be inhibitors for BCT commands.*

MG William B. Caldwell IV

Former CG of the 82nd Airborne Division

“Pentathletes in the 82nd Airborne Division: Developing Critical Capabilities for the Army”  
Interview, July-August 2006 *Field Artillery*

chief of staff.

Field Artillerymen also are serving as S3s and executive officers (XOs) in FA or fires battalions, both in and out of the CENTCOM theater. Second only to serving in actual maneuver staff positions—as some Field Artillerymen are doing—all these jobs develop the Artillery officer’s scope and understanding of tactical operations across the spectrum of conflict.

The Artillery officer’s education and development parallel those of the Armor and Infantry officers. Figure 2 compares the macro skills of the maneuver officer to the Field Artillery officer as they develop in parallel through OES, promotions and assignments.

In the figure, note that they get the same instruction in the Basic Officer Leadership Course (BOLC) II, Intermediate-Level Education (ILE) and the Senior Service College/Army War College (SSC/AWC). In the Pre-Command Course (PCC), instruction on the art of command, combined arms tactics, the opposing force (OPFOR) in the COE—all skills and knowledge needed for commanding a tactical maneuver unit—are the same for both maneuver and Field Artillery officers.

In BOLC III and the Captain’s Career Courses (CCCs), maneuver and FA officers get similar instruction but on different systems. For both, the emphasis is on warfighting and incorporating lessons learned from GWOT.

Like the maneuver officer, the Field Artillery officer is considered for commands at all levels—platoon, battery and battalion/TF—preparing him for command at the brigade level.

FA officers have specific education, experience and skills that allow some to intuitively understand the art and

risen to the highest ranks, commanding divisions, corps, and an army—not to mention General (Retired) Tommy R. Franks who commanded all forces in combat operations in Operation Iraqi Freedom.<sup>4</sup> Although all these military leaders commanded Div Artys, without question, these senior military leaders would have made excellent BCT commanders.

Additionally, because several of our most senior Army and joint leaders have risen to their ranks through Div Arty commands, it is fair to assume that BCTs also will be a gateway for talented, capable FA leaders to continue through the ranks to serve the US military and the nation in the future as they have in

the past. These are four-star leaders who have held numerous high joint and national positions, including Chairman of the Joint Chiefs of Staff and advisors to US Presidents.<sup>5</sup>

Clearly, some Field Artillerymen fall into this “capabilities” zone. The key is to identify those with the potential for BCT command and ensure our most talented officers are fully prepared to command BCTs and truly competitive for selection.

Even at an early age, leaders with the potential for future commands stand out. Who are those guys? They are the Field Artillerymen chosen by their BCT commanders to serve in traditional maneuver positions, such as BCT XO in the 2nd BCT, 82 Airborne Division; 3rd BCT, 25th Infantry Division; 4th BCT, 1st Cavalry Division; 1st BCT, 10th Mountain Division; and others.<sup>6</sup> These young, talented Field Artillerymen could go on to command infantry TFs very successfully. Their serving as fires battalion S3s and brigade FSOs further develops their skills and leadership talent for command.











**Field Artillery, as a branch, fosters adaptable, flexible Pentathletes with traits that are ideal in BCT commanders.** Without question, all branches serving in GWOT are performing unique, nonstandard missions. But Field Artillerymen are performing more nonstandard missions in GWOT than any other branch—or certainly as many as any other branch.

Field Artillerymen have served and are serving in GWOT as military policemen, motorized infantrymen (patrols, raids, cordons and searches, convoy operations, quick-reaction forces, forward operating base security, etc.), transporters, coordinators/synchronizers of nonlethal effects (information operations, civil-military operations, civil affairs, etc.), and as infantry task force and BCT commanders and command sergeants major. That is not to mention their serving as Field Artillerymen, delivering lethal FA—thousands of FA rounds a year in Iraq and Afghanistan—and joint fires for their BCTs.<sup>7</sup>

So, what’s involved when a fires battalion becomes a motorized infantry task force? The battalion fire support element (FSE) also must be the fire direction center (FDC) for the TF. The FA battalion staff must transform into a maneuver TF staff. The maneuver TF commander must command subordinate maneuver units, remain the

- 1-17 FA, 75th FA Brigade, attached to the 4th Infantry Division, Operation Iraqi Freedom (OIF) I
- 2-82 FA, 1st Cavalry Division, OIF II
- 1-5 FA, 1-6 FA and 1-7 FA, 1st Infantry Division, OIF II
- 1-37 FA, 3rd Stryker Brigade Combat Team (SBCT), 2nd Infantry Division, OIF II
- 4-27 FA, 1st Armored Division, OIF II
- 1-9 FA and 1-10 FA, 3rd Infantry Division, OIF III
- 3-319 Airborne FA Regiment (AFAR), 82nd Airborne Division, Operation Enduring Freedom (OEF)
- 1-37 FA, 3/2SBCT, OIF III
- 3-29 FA, 1st Infantry Division, Currently in Iraq
- 4-11 FA, 172nd SBCT, Currently in Iraq

Figure 1: Sample FA Battalions as Maneuver Task Forces in the Global War on Terrorism (GWOT). This list is not comprehensive.

 <h2>Maneuver Officer</h2>	 <h3>Platoon (Plt)</h3> <ul style="list-style-type: none"> <li>Plt Leader</li> <li>Ranger Regiment</li> <li>Co Executive Officer (XO)</li> </ul>	 <h3>Company (Co)</h3> <ul style="list-style-type: none"> <li>Co Commander</li> <li>Battalion/Brigade (Bn/Bde) Staff</li> <li>CTC O/C</li> </ul>	 <h3>Bde/Division (Div) Staff</h3> <ul style="list-style-type: none"> <li>Bn XO/S3</li> <li>Bde/Div Staff</li> <li>MACOM/DA/Joint Staff</li> </ul>	 <h3>Commander (Cdr)</h3> <ul style="list-style-type: none"> <li>Bn Cdr</li> <li>Bde/Div XO</li> <li>CTC Senior O/C</li> </ul>	 <h3>Commander</h3> <ul style="list-style-type: none"> <li>BCT Cdr</li> <li>Corps/MA-COM Staff</li> <li>Div Chief of Staff</li> </ul>
<h3>BOLC II</h3> <ul style="list-style-type: none"> <li>Shoot: BRM, Target Engagement, Indirect Call-for-Fire</li> <li>Communicate: Tactical Radios, Visual Signals</li> <li>Advanced Land Nav: Map, GPS, One Point to Another (Mounted and Dismounted), Lead a Convoy</li> <li>Urban Ops: Enter/Clear a Room</li> <li>Medical: First Aid, Evacuation</li> <li>Physical Fitness: Combatives, Road Marches, Confidence Course, Battle Focus, Student Led</li> </ul>	<h3>BOLC III</h3> <ul style="list-style-type: none"> <li>Gunnery</li> <li>Offense/Defense</li> <li>Conduct Recon</li> <li>Urban Ops</li> <li>Stability/Reconstruction (SR) Ops</li> <li>Plt Fight</li> </ul>	<h3>CCC</h3> <ul style="list-style-type: none"> <li>Offense/Defense: Light Co/Team and Light Bn</li> <li>Offense/Defense: Mechanized Team, Mechanized TF</li> <li>SBCT Ops</li> <li>Combined Arms Bn in the Offense</li> <li>Recon, Surveillance/Target Acquisition</li> <li>HBCT Ops</li> <li>Security/Recon</li> <li>Urban Ops</li> </ul>	<h3>ILE</h3> <ul style="list-style-type: none"> <li>Full-Spectrum Ops</li> <li>Battlespace Appreciation</li> <li>Asymmetric Ops</li> <li>COE</li> <li>Urban Ops</li> <li>Problem Solving</li> <li>Performance-Oriented Training and Education</li> <li>Shaping, Decisive, Enabling Ops</li> <li>Effects Synchronization</li> <li>Component Roles and Responsibilities</li> </ul>	<h3>PCC</h3> <ul style="list-style-type: none"> <li>Art of Command</li> <li>Combined Arms Tactics</li> <li>Force Updates</li> <li>Institutional Training Updates</li> <li>OPFOR in the COE</li> <li>Doctrine Updates</li> <li>TTP Updates</li> </ul>	<h3>SSC/AWC</h3> <ul style="list-style-type: none"> <li>Joint, Interagency, Intergovernmental, Multinational Operations</li> </ul>
<p><i>Similar Instruction Different Systems</i></p>					
<h2>FA Officer</h2>	 <h3>Company</h3> <ul style="list-style-type: none"> <li>Delivery/Radar Plt Leader</li> <li>Co FSO</li> <li>Battery XO</li> </ul>	 <h3>Battalion</h3> <ul style="list-style-type: none"> <li>Battery Cdr</li> <li>Bn FSCOORD</li> <li>Bn Assistant S3</li> </ul>	 <h3>Bde/Div Staff</h3> <ul style="list-style-type: none"> <li>Bde FSO</li> <li>Bn XO/S3</li> <li>Bde Assistant S3</li> <li>CTC O/C</li> </ul>	 <h3>Commander</h3> <ul style="list-style-type: none"> <li>Div FSCOORD</li> <li>Fires Bn Cdr</li> <li>Deputy BCT Cdr</li> <li>BCT FSCOORD</li> <li>BCT DCO/S3</li> <li>CTC Senior O/C</li> </ul>	 <h3>Commander</h3> <ul style="list-style-type: none"> <li>Fires Bde/BCT Cdr</li> <li>BCD Cdr</li> <li>Corps/Army FSCOORD</li> </ul>

**Legend:**

**A<sup>2</sup>C<sup>2</sup>** = Army Airspace Command and Control  
**BCD** = Battlefield Coordination Detachment  
**BCT** = Brigade Combat Team  
**BOLC** = Basic Officer Leadership Course  
**BRM** = Basic Rifle Marksmanship  
**CCC** = Captain's Career Course  
**COE** = Contemporary Operating Environment  
**COIN** = Counterinsurgency  
**CTC** = Combat Training Center  
**D<sup>3</sup>A** = Decide, Detect, Deliver and Assess  
**DA** = Department of the Army  
**DCO** = Deputy Commanding Officer  
**FDC** = Fire Direction Center

**FDO** = Fire Direction Officer  
**FOB** = Forward Operating Base  
**FSCOORD** = Fire Support Coordinator  
**FSO** = Fire Support Officer  
**GPS** = Global Positioning System  
**HBCT** = Heavy Brigade Combat Team  
**HUMINT** = Human Intelligence  
**IPB** = Intelligence Preparation of the Battlefield  
**ILE** = Intermediate Level Education  
**JIIM** = Joint, Interagency/Intergovernmental Multinational  
**MACOM** = Major Command  
**O/C** = Observer/Controller

**OPFOR** = Opposing Force  
**Ops** = Operations  
**PCC** = Pre-Command Course  
**QRF** = Quick-Response Force  
**ROE** = Rules of Engagement  
**RSOP** = Reconnaissance, Selection and Occupation of Position  
**SBCT** = Stryker Brigade Combat Team  
**SSC/AWC** = Senior Service College/Army War College  
**SWEAT-MS** = Sewer, Water, Electricity, Academics, Trash, Medical and Security  
**TF** = Task Force  
**TTP** = Tactics, Techniques and Procedures

Figure 2: Comparison of Maneuver and Field Artillery Skills at the Macro Level. Note the early focus on joint warfighting in FA BOLC III and FA CCC.

FSCOORD for the BCT, remain responsible for the BCT's fires and the force FA headquarters and, all the while, control his own sizeable battlespace—many in very intense urban environments and most comparable to those controlled by brother maneuver TF commanders. And, the fires battalion commander must execute his maneuver task force mission with fewer assets than his combined arms task force counterpart.<sup>8</sup>

What that means is that from the top to bottom of the FA battalion, not just the

Read the articles written by senior leaders about merging branches and other articles discussing the number of military occupational specialties (MOS) to be combined across the Army. How about the Army's establishing centers of excellence (CoEs) to consolidate and enhance functional areas—such as the Fires CoE at Fort Sill, Oklahoma, consolidating the FA and Air Defense Artillery Schools, or the Maneuver CoE at Fort Benning, Georgia, consolidating the Infantry and Armor Schools. Then

current events, then look ahead at the impact of just one aspect of the FCS force on our future leaders: networked systems. Our networked systems will mean that the combined arms commander will have to be a leader and decision maker vice a Field Artilleryman, Infantryman, Tanker, Engineer, etc.

Although the BCT level demands leaders exercise both the art and science of command, it calls for more art than science. Art depends less on the BCT commander's mastery of technical branch-specific skills and more on his ability to make effective decisions. Battle command puts a premium on leader skills and actions that contribute to effective decisions.<sup>9</sup>

Our future networked systems will aid the BCT commander in the art of command. In the FCS force, he will have access to an advanced, networked command and control system that will allow him to have a common operational picture (COP) with superiors and subordinates and shared situational awareness of not only his battlespace, but also the battlespace of those around him, plus the big picture of the entire campaign. This advanced command and control system of systems also will allow him to communicate his commander's intent throughout his BCT with more fidelity, including to the lowest levels.

The network will enhance his tactical decision making and increase his tactical agility while reducing associated risks. The command and control information "hierarchy" will be flattened, and the BCT commander will spend less time

*Simply stated, these Field Artillerymen performed the same jobs [as infantry task force commanders in Iraq] as well as their fellow combat arms officers who wore Armor or Infantry brass.*

MG Martin E. Dempsey as CG of the 1st AD  
"Fires and Effects for the 1st Armored Division in Iraq"  
Interview, January-February 2005 *Field Artillery*

TF commander, Field Artillerymen have adapted, flexed and "done it."

Same-same with variations for the FA BCT commands.

They sound like Pentathletes to me.

**The future combat system (FCS) force will "flatten" branches for future commands—the Army is moving toward less emphasis on branch skills and capabilities to more emphasis on broader Pentathlete skills and capabilities.** As the Army continues transformation, clearly branches will become less important and capabilities more important. Witness the new uniforms with no branch insignia.

listen to the Chief of Staff of the Army outline his vision for Pentathletes to serve as multi-capable warriors and flex their talent and skills across the spectrum of conflict—Pentathletes who see service in the Army as a series of opportunities, not limitations.

The Army is making pervasive changes to meet the demands of the COE and the coming FCS force—all while at war—and breaking sacred "rice bowls" right and left as it makes those changes. The "handwriting is on the wall"—Pentathletes will command at all levels in the FCS force.

Now if I haven't convinced you with

#### Endnotes:

1. Colonel Kevin P. Stramara, 4th Infantry Division Artillery (Div Arty) Commander, commanded Task Force Gunner with an area of operations in northern Baghdad from April 2003 until March 2004 during Operation Iraqi Freedom (OIF) I (email from Colonel Stramara dated 3 May 06). Colonel Gary H. Cheek, Commander of the 25th Infantry Div Arty, commanded the Combined Task Force Thunder for 12 months in Operation Enduring Freedom (OEF) ("So You Want to Be a Maneuver Commander? CTF Thunder in Afghanistan," March-April 2005, *Field Artillery*); Colonel Richard C. Longo, 1st Infantry Div Arty Commander, commanded a coalition and combined arms brigade for six weeks in the hotly contested region of An Najaf, Iraq, to cover the gap between the 1st Armored Division's departure and the 11th Marine Expeditionary Force's (MEF's) arrival ("1st ID in Iraq: The FFA HQ Mission Endures," May-June 2005 *Field Artillery*); and Colonel Stephen R. Lanza, 1st Cavalry Div Arty Commander, commanded the 5th BCT in OIF II from January 2004 to March 2005 ("Red Team Goes Maneuver—1st Cav Div Arty as a Maneuver BCT," May-June 2005 *Field Artillery*.)

2. Colonel Victor Petrenko, former 82nd Div Arty Commander, stood up and, until June of this year, commanded the 4th BCT in the 82nd Airborne Division, Fort Bragg, North Carolina. He was selected for that mission and command by Major General William B. Caldwell IV, the Commanding General of the 82nd Airborne Division. Colonel Petrenko currently is the Chief of Staff of the 82nd Airborne Division.

3. Lieutenant Colonel David J. Brost, Chief of the FA Proponency Office, in phone conversations with Lieutenant Colonel James

L. Miller and Lieutenant Colonel Joseph R. Connell, Senior FA Observers/Controllers (O/Cs) at the National Training Center (NTC) Fort Irwin, California, and Joint Readiness Training Center (JRTC), Fort Polk, Louisiana, respectively. In his article "Observations from the Wolf's Den: Training to be a Maneuver (and Fires) Task Force," November-December 2005 *Field Artillery*, Page 30, Lieutenant Colonel Miller reports that in the past 18 months, all FA units rotating through the NTC have had maneuver and fires missions. Lieutenant Colonel Connell of the JRTC reports that 100 percent of FA units rotating through the JRTC have maneuver missions and 95 percent of the units have maneuver and fires missions.

4. Examples of recent senior commanders spawned by Field Artillery are Lieutenant General Raymond T. Odierno, who soon will command III Corps in Iraq and was the former CG of the 4th Infantry Division, deploying the division to Iraq; Major General Kenneth W. Hunzeker, CG of the 1st Infantry Division; and General Tommy R. Franks, Commander of Central Command (CENTCOM) and all forces in OIF and who also commanded Third Army.

5. These leaders include General (Deceased) Maxwell D. Taylor, Ambassador to Vietnam, Chairman of the Joint Chiefs of Staff and Chief of Staff of the Army; General (Retired) John W. (Jack) Vessey, Jr., Vice Chief of Staff of the Army and Commander-in-Chief of the Republic of Korea-US Combined Forces Command; General (Retired) John M.D. Shalikashvili, Chairman of the Joint Chiefs of Staff; General (Retired) Walter T. (Dutch) Kerwin, Jr., Vice Chief of Staff of the Army; General (Retired) Jack Merritt, Senior US Military Representative to NATO; Generals (Retired)

Carl E. Vuono and Dennis J. Reimer, Chiefs of Staff of the Army; and General (Retired) J.H. Binford Peay, Commander-in-Chief of Central Command and Vice Chief of Staff of the Army. Space limits me to naming only a few of these four-star leaders' most senior assignments.

6. Without having conducted a survey, these are the FA executive officers (XOs) of maneuver brigades who I am aware of: Major (Promotable) Jeffrey M. Sanborn, 2nd BCT, 82nd Airborne Division; Major Andrew A. Preston, slated to be the XO of the 3rd Brigade, 25th Infantry Division; Major Tony Hammes, slated to be the XO of the 4th Brigade, 1st Cavalry Division; and Major (Promotable) Glenn A. Waters, 1st Brigade, 10th Mountain Division.

7. In his column "Modularity Update: Transforming the FA" for the March-April edition of *Field Artillery*, the Chief of FA Major General David C. Ralston said, "Our incredible Field Artillerymen 'keep on keeping on,' firing literally thousands of rounds in Iraq and Afghanistan last year and continuing today." He went on to give several specific examples of units in Iraq and Afghanistan firing thousands of rounds each year.

8. See the article "Battlekings Return to Baghdad as a Maneuver Battalion: Doing More with Less" by Lieutenant Colonel Steven M. Merkel and Major John G. Clement in the July-August edition. The author deployed to Iraq with the 1st Battalion, 9th Field Artillery, the fires battalion organic to the 2nd Brigade, 3rd Infantry Division, and, with minimal additional assets, transformed the battalion into a maneuver battalion for operations in OIF III.

9. *Field Manual 3-0 Operations*, June 2001, Paragraph 5-2, Page 5-1.

directing information and more time using it.

In the networked FCS force, Pentathletes, not members of specific branches, will command BCTs, perhaps even combined arms battalions one day.

Field Artillerymen as proven maneuver commanders and Pentathletes will make excellent BCT commanders.

Now, having said all that, do I think *all* Field Artillery lieutenant colonels (promotable) and colonels are qualified and capable of commanding BCTs? Certainly *not*. But then, neither are all Armor, Infantry or Engineer lieutenant colonels (promotable) and colonels.

The point is *some* will make excellent BCT commanders. So our most capable Field Artillery officers who have related knowledge and experience and have demonstrated tactical combined arms and leadership skills will be eligible for DA selection to command BCTs, starting with the 2008 board. As a branch,

---

*Every one of my artillery battalions owned its own battlespace. My FA battalions were just like my maneuver battalions [with] Bradleys and tanks working for them.*

MG Raymond T. Odierno as CG of the 4th ID  
"Division Operations Across the Spectrum—Combat to SOSO in Iraq"  
Interview, March-June 2004 *Field Artillery*

---

our job is to ensure we identify these talented leaders and develop them via training, education and assignments to make them competitive for selection to command BCTs.

It's a win-win—for the Field Artillery and the Army.

---

**Colonel Annie Baker took command of the Field Artillery Training Center (FATC), Fort Sill, Oklahoma, on 17 May as the first woman to command the FATC. In her previous assignment, she was the Director of the Directorate of Training and Doctrine**

**(DOTD) and G3 for the Field Artillery Center and Fort Sill. In that capacity, she was the FA lead for designing the Fires Center of Excellence with the Air Defense Artillery's move to Fort Sill. She deployed to Iraq for six months in 2005 as the Senior Liaison Officer for the new Counter Rocket, Artillery and Mortar (C-RAM) multi-branch program. She was Commander of the 1st Battalion, 19th Field Artillery (1-19 FA) in the FATC where she also was the brigade's Deputy Commander Officer (DCO) and S3. She is a graduate of the Army War College, Carlisle Barracks, Pennsylvania, and holds an MA in Geography from Syracuse University in New York.**

## 6-52 ADA—First ADA Unit on Fort Sill

**O**n 14 July, the 6th Battalion, 52d Air Defense Artillery (6-52 ADA), the *Ironhorse Battalion*, part of the 31st ADA Brigade at Fort Bliss, Texas, uncased its guidon in ceremonies at its new home on Fort Sill, Oklahoma. The battalion came from Ansbach, Germany, where it had been assigned operationally to the 69th ADA Brigade, part of V Corps. It now has been reassigned to the 31st ADA Brigade, III Corps. The 31st ADA Brigade is scheduled to move to Fort Sill over the next several years as part of the Base Realignment and Closures (BRAC) directives for establishing the Fires Center of Excellence there.

6-52 ADA has 605 Soldiers, approximately 220 of whom were at the ceremony with the others to follow. The battalion's equipment includes Patriot missile launchers, radars and support equipment. 6-52 ADA will be housed in temporary facilities while renovations are being done for its permanent home on Fort Sill. The command team for the battalion is Lieutenant Colonel Artice Scott and Command Sergeant Major Michael Banes.

The battalion was first organized on 1 June 1917 with fixed fortifications at Fort Washington, Maryland, and traces

its origins to the days of the Coast Artillery. In World War I, it transformed into a mobile anti-aircraft artillery (AAA) battalion and served in Europe. As an AAA battalion in World War II, the unit fought in the Pacific Theater from 1941 to 1945. During the Cold War, it provided air and missile defense protection

in Germany 24/7. It then transformed into a Hawk battalion, deploying two batteries to Operations Desert Shield and Storm in the Gulf. It was the last forward-deployed Hawk battalion until its deactivation in 1993. Then in 1996, 6-52 ADA was reactivated as a Patriot battalion in Germany.



Photo by Fred W. Baker III

(Left) LTC Artice Scott, Commander of 6-52 ADA, and COL Jeffrey Oeser, at the time, Commander of the 31st ADA Brigade for Fort Bliss, Texas, uncasing the guidon at the battalion's new home, Fort Sill, during ceremonies on 14 July.

# The FA: Leading Joint Interdependency with JACI



An Air Force F-15E Strike Eagle over Afghanistan flies in support of Operation Mountain Lion on 12 April 2006. DoD photo by MSgt Lance Cheung

**A**merica is heavily engaged in a Global War on Terrorism (GWOT). We face an extended conflict against an irreconcilable and adaptive enemy. At the same time, we are changing how the US armed services conduct business.

This demands an unprecedented degree of joint cooperation. All services must move beyond joint interoperability (the

---

**By Chief Warrant Officer Three  
(Retired) Christopher A. Saindon**

---

assurance that service capabilities can work together smoothly), even beyond joint integration (collective efficiency and tempo). To gain the right force structure mix—one that is capable of

meeting the breadth, depth and longevity of the challenges throughout the range of military operations—the services and defense agencies must achieve *joint interdependence*.

This article describes the Joint and Combined Integration Directorate (JACI) at Fort Sill, Oklahoma, and what JACI has been doing to achieve joint



interdependency since it was founded two years ago.

**JACI's Charter, Programs and Organization.** With the current emphasis on joint operations and joint fires and effects, Fort Sill needed an office to synchronize activities to avoid duplication, generate cross-talk and ensure everyone is working on common goals.

JACI was established as part of the Training and Doctrine Command's (TRADOC's) reorganization. As TRADOC's training center for joint fires and effects, it was logical for Fort Sill to teach the command and staff skills required to integrate, coordinate and synchronize the application of the full range of joint fires and effects at Fort Sill. JACI serves as an Army hub for joint command and control (C<sup>2</sup>) developments and issues and is an active participant in joint doctrine development and materiel issues.

This new Fires Center of Excellence directorate is the commanding general's primary staff proponent for all joint fires and effects-related issues, including the development, integration and execution of all joint instruction, training and doctrine at the Field Artillery School and Fort Sill. See Figure 1.

JACI prepares, reviews and coordinates all joint issues with the joint staff; component commands; Headquarters, Department of the Army (HQDA); Forces Command (FORSCOM); TRADOC; and the installation staff. JACI also established, teaches and manages the Joint Operational Fires and Effects Course (JOFEC) and Joint Fires Observer Course (JFOC). The directorate provides Air Force participation for joint training exercises and coordinates live air support activities for Fort Sill.

In addition, JACI serves as the proponent for the battlefield coordination detachments (BCDs) and coordinates Fort Sill's foreign liaison officers (LNOs) activities. The LNOs at Fort Sill from France, Korea, Germany, Canada and United Kingdom share their expertise with the FA School.

JACI consists of key individuals from all the services and branches to help develop joint training, review joint doctrine and provide the instructor base for the joint training on Fort Sill. It continuously works warfighter issues with the Joint Fires Integration and Interoperability Team (JFIIT) at Eglin AFB, Florida, and the Joint Air-Ground Office (JAGO) at TRADOC. For joint issues, JFIIT is the main point of contact for Joint Forces Command (JFCOM), Norfolk, Virginia,

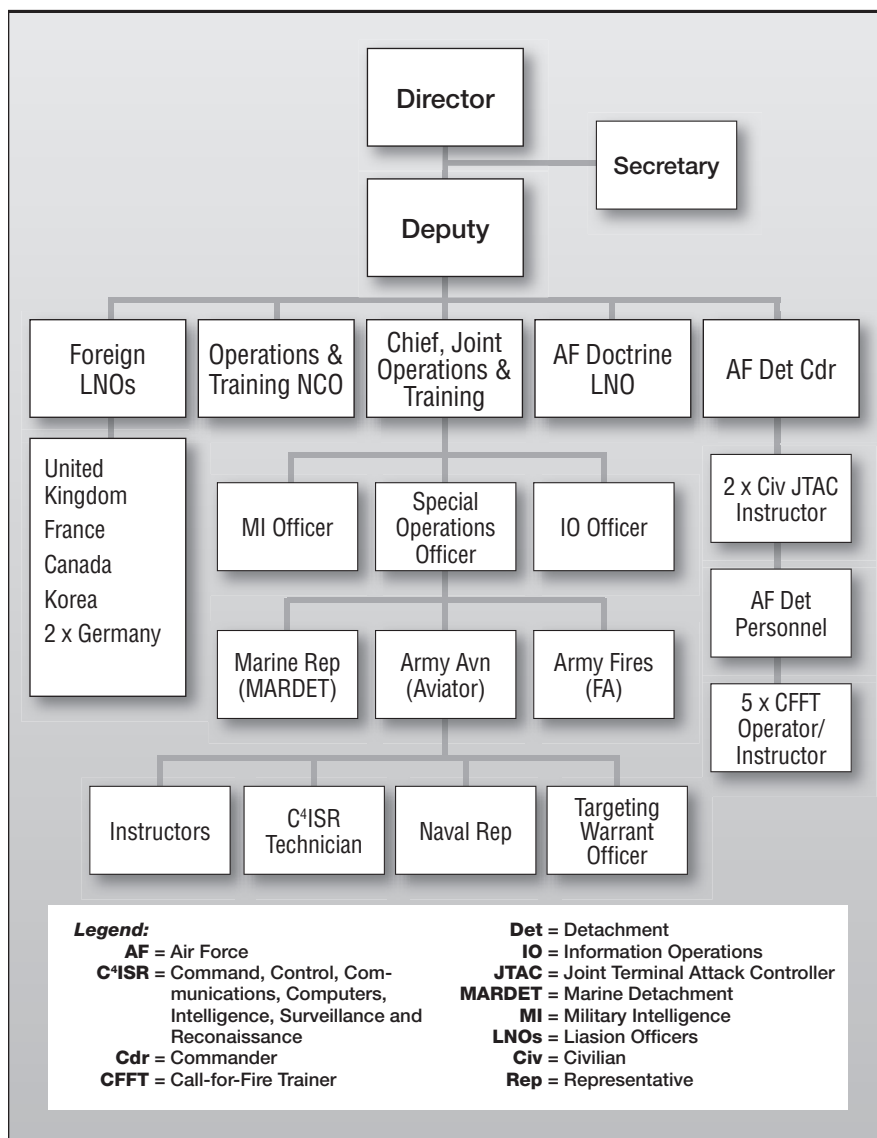

Figure 1: Joint and Combined Integration Directorate (JACI)

and JAGO is the main point of contact for TRADOC.

**JACI's Joint Training Programs.** JACI has instituted a number of training programs for not only Field Artillerymen training at Fort Sill, but also personnel from all four services and others who work with joint fires and effects.

**JOFEC.** This course provides instruction to joint fires and effects team members above the brigade level from all services, Coalition Forces and inter-agencies. The course covers the skills and processes to apply and integrate the full range of joint lethal and nonlethal fires and effects in current and modular formations. See Figure 2 on Page 12 for an outline of the course's content.

Each student gains baseline knowledge of joint and service sensors, capabilities, platforms and battlespace management; the joint targeting process; and joint fires

and effects system. JOFEC prepares students for the effects-based approach to warfighting. The students' knowledge is exercised and validated during a culminating exercise conducted in an immersive simulation environment where they apply and integrate joint lethal and nonlethal fires and effects.

Before JOFEC was initiated in September 2004, no single service school trained joint personnel on fires and effects above the brigade level. So Fort Sill developed JOFEC and has taught seven, two-week courses to date.

JOFEC focuses on operational-level fires and effects with emphasis on lethal and nonlethal fires and effects, information operations (IO) and space- and effects-based operations. Recent innovations include counterinsurgency (COIN) and coalition issues (foreign LNOs) as topics for current issues panel discussions.

Students from the Warrant Officer Advanced Course (WOAC) for 131A Targeting Officers attend the two-week JOFEC as part of their WOAC requirements. JOFEC helps prepare them to work as targeting officers at the operational level.

Human Resources Command (HRC) assigns the professional development skill identifier (PDSI) D9B to Army JOFEC graduates. The course is listed in the JFCOM joint schools catalog.

To date we have taught more than 190

students in JOFEC who are from all services, including from the Reserves and National Guard. In FY07, the number of JOFECs per year will increase from the current four classes to five per year with the number increasing to eight classes per year in FY08.

*JFOC.* The November 2005 memorandum of agreement (MOA) among the Army and Air Force and Special Operations Command (SOC) formalized the 2005 Joint CAS (JCAS) Action Plan developed by the Joint Close Air Support

(JCAS) Executive Steering Committee (ESC). The ESC was chartered by the Joint Review Oversight Council (JROC). The plan includes a recommendation for Issue 16 that states the requirements to standardize the title, responsibilities and qualifications of JFOs among the services. The recommendation provides training for forward observers (FOs), reconnaissance Marines and special operations personnel to better prepare them to execute terminal guidance operations (TGOs) as JFOs.

A JFO is a service member trained to request, adjust and control surface-to-surface fires, provide targeting information in support of Types 2 and 3 CAS terminal attack controls and perform autonomous TGOs. An Army JFO's surface-to-surface capability includes the ability to request, adjust and control naval surface fire support.

*Joint Publication (JP) 1-02 DoD Dictionary of Military and Associated Terms, JP 3-09 Doctrine for Joint Fire Support, JP 3-09.3 Joint Tactics, Techniques and Procedures (TTPs) for Close Air Support* and service publications will include the JFO definition, as updated.

The recommendation to resolve Issue 16 of the 2005 JCAS Action Plan includes four actions designed to standardize JFO training throughout the services: (1) Standardize the title and develop a joint definition for the position, (2) develop a joint individual standard and syllabus for training, (3) develop joint TTPs and update service manuals (as appropriate) and (4) establish a standard minimum equipment capability. Completing these actions will improve joint force interdependence and reduce the potential for mishaps and fratricides.

The November 2005 MOA established a JFO joint mission task list (JMTL) for services to develop initial and continuing JFO training programs. See Figure 3 for the JMTL.

The JFO training program emphasizes joint collaboration and the need for JFOs and JTACs to train together, as resources allow. Units are encouraged to send their JFOs with their respective JTACs to the course. The Army JFO requirement is one per maneuver platoon for a total of approximately 3,200 JFOs.

To date, JACI has trained more than 120 JFOs from all services. Seventeen classes are scheduled for FY07 and 20 for FY08 and beyond, each with 25 students per class. By the end of FY08, Fort Sill will have trained more than 900 JFOs. JFOs also are trained by the Army Joint

<b>Day 1</b>	<b>Day 7</b>
Joint Doctrine and Strategy	Joint Air Tasking Cycle
JOPES Intro (Joint Operations and Force Integration)	ASR and CAS Planning
JOPES Deliberate Planning	Airspace Command and Control
JOPES Crisis Action Planning	Joint Fires Element
Joint Targeting Cycle	Joint Fire Support
<b>Day 2</b>	Joint Targeting Coordination Board
Objectives Guidance and Intent	High-Value Individuals (Targeting)
Effects-Based Operations	Time-Sensitive Targeting
Objectives Guidance and Intent Practical Exercise (PE)	<b>Day 8</b>
<b>Day 3</b>	Counterinsurgency
TAGS	Combat Assessment
BCD Liaison	Joint Targeting Working Group PE
TAGS PE	<b>Day 9</b>
Joint IPB	JADOCs Overview and Lab
Law of Armed Conflict and ROE	<b>Day 10</b>
<b>Day 4</b>	Test/Test Review
Space-Based Operations	ATO Seminar
Information Operations	Current Issues (GARS)
National-Level Support to Targeting	<b>Day 11</b>
<b>Day 5</b>	Coalition Conference
C <sup>4</sup> I for Joint Operations	After-Action Review and Critique
Target Development, Vetting, Validation and Nomination	
Target Development, Vetting, Validation and Nomination PE	
<b>Day 6</b>	
Air-Ground Weaponing	
Air-Ground Fuzing Options	
Surface-to-Surface Systems and Munitions	
Precision versus Accuracy	
Collateral Damage	

<b>Legend:</b>
<b>ASR</b> = Air Support Request
<b>ATO</b> = Air Tasking Order
<b>BCD</b> = Battlefield Coordination Detachment
<b>CAS</b> = Close Air Support
<b>C<sup>4</sup>I</b> = Command, Control, Communications, Computers and Intelligence
<b>GARS</b> = Global Area Reference System
<b>IPB</b> = Information Preparation of the Battlefield
<b>JADOCs</b> = Joint Automated Deep Operations Coordination System
<b>JOPES</b> = Joint Operations Planning and Execution System
<b>ROE</b> = Rules of Engagement
<b>TAGS</b> = Theater Air-Ground System

Figure 2: Joint Operational Fires and Effects Course (JOFEC)

Support Team, 6th Combat Training Squadron, at Nellis AFB, Nevada, at a rate of about 100 JFOs per year.

Fort Sill has purchased two Rover III systems for JTACs to interface with their respective JFOs and the aircraft during training. Rover III provides a real-time, full-motion video feed from the aircraft for ground situational awareness, targeting, bomb damage assessment, surveillance, convoy operations and other situations where “eyes on target” are required. Rover III also provides enhanced air-to-ground coordination, which shortens “talk-ons” for targets in time-critical operations. Rover III is interoperable with data links in L-Band, C-Band and Ku-Band with Predator, Shadow, Dragon Eye, Litening Pod and other joint and coalition platforms.

The JFO course also includes a day of familiarization and hands-on training with Precision Strike Suite for Special Operation Forces (PSS-SOF) software. This software provides a three-dimensional “picture” of the target’s location that is accurate enough to employ precision-guided munitions (PGMs).

To help with the instruction and certification of the JFO course, JACI has the only two Department of the Army civilian JTAC instructors in the joint services.

*Air Force Detachment and Live CAS Training.* JACI has been working closely with the Air Force to assign an Air Warfare Center (AWFC) detachment and personnel from the 6th Combat Training Squadron at Nellis AFB to Fort Sill to coordinate for live CAS and provide air training. Currently, four active duty AF personnel are assigned. Additionally, there are five officers from the Oklahoma Air National Guard (OKANG) assigned, a number that may increase in the future due to the OKANG’s interest in the joint and combined programs to develop its officers and NCOs.

This past spring, Fort Sill reinstated live CAS and Air Force procedures familiarization and training for all officer, warrant officer and NCO courses. Live CAS training is now routine for the Basic Officer Leader’s Courses (BOLC) II and III and is expanding into all aspects of Fort Sill’s institutional training.

JACI also is working to integrate Army and Air Force training at the Air Force’s 13,000-acre Falcon Joint Precision Engagement Range on Fort Sill (part of Quanah Range). The Air Force developed the range for its aircraft to drop



A Soldier works through the Joint Fires Observer (JFO) Course at Fort Sill, Oklahoma, under the tutelage of an Air Force joint terminal attack controller (JTAC).

live ordnance. Integrated Army and Air Force training on this range will allow for a full-spectrum of target types and engagement options.

*Electronic Attack (EA) Training.* TRADOC is revitalizing the Army’s electronic warfare (EW) capabilities. As a core IO element, EW has three components: EW support (ES), EA and electronic protect (EP).

The Combined Arms Command (CAC) at Fort Leavenworth, Kansas, is the overall proponent for EW and is considering courses-of-action (COAs) to realign the EW components. As part of the reorganization, CAC has directed Fort Sill develop a course for EA and incorporate EA into instruction at the

1. Engage targets with ground surface-to-surface fires.
2. Engage targets with naval surface fires.
3. Engage targets with air-to-ground fires.
4. Conduct terminal guidance operations.

Figure 3: The 2005 memorandum of agreement (MOA) among the Army, Air Force and Special Operations Command established the joint forward observer’s (JFO’s) joint mission task list (JMTL).

FA School.

A deployed headquarters also will be able to request EA training for its Soldiers who must integrate and synchronize EW assets. These are Soldiers who will serve as subject matter experts (SMEs) on the combat ready early warning system (CREWS) family of systems for their brigade combat teams (BCTs) and higher units. Their skills will be critical in defeating the enemy’s improvised explosive devices (IEDs).

Currently the Navy is filling the EW capabilities gap. However, there is a mismatch between the Navy training and the skills the Army requires. The Army determined that the best COA would be to begin training Army personnel in the required skills.

Each EA class will consist of approximately 30 Army and 10 joint EW officers. Graduates will be tracked with a PDSI. The pilot EA course is projected to begin in October of this year.

Modularity force structure plays a key role in defining doctrine, organization, training, materiel, leadership and education, personnel and facilities (DOTMLPF) for EA. The Army now has requirements for EA at the corps level and below—new requirements per modularity.

If readers want more information on course dates and how to attend the courses, they can visit the JACI website at <http://sill-www.army.mil/jcid/>.

Joint is the way we fight. And joint fires and effects training, tactical IO operations and EA above the brigade align well with Fort Sill’s mission and vision as the Army’s joint fires and effects integration center—the Army’s branch leading joint interdependency.

**Chief Warrant Officer Three (CW3) (Retired) Christopher A. Saindon is the Deputy Director for the Joint and Combined Integration Directorate (JACI) and a charter member of JACI, which was established in 2004 at Fort Sill, Oklahoma. He is/has been a member of many joint working groups, including the Military Targeting Committee (MTC) and Joint Targeting Automation Steering Group (JTASG), sponsored by the J2 (Targeting) of the Joint Staff; Joint Unmanned Aerial Vehicle (JUAV) Working Group and Unmanned Aircraft Systems (UAS) Working Group, sponsored by the Office of the Secretary of Defense; and the Naval Afloat Targeting Integrated Process Team (NAT-IPT), sponsored by Navy Intelligence and Operations. He served 24 years in the Army.**

# 2nd IBCT, 2nd ID, Qualifies JFOs

The 2nd Infantry Brigade Combat Team (IBCT), 2nd Infantry Division (2nd ID), Fort Carson, Colorado, took advantage of the new Joint Fires Observer (JFO) Course at Fort Sill, Oklahoma, and other training and evaluation to qualify one company forward observer in each of the brigade's eleven maneuver companies and one in each of the brigade's four combat observation laser teams (COLTs) for a total of 15 qualified JFOs in the brigade.

After our first JFO candidate graduated from the Fort Sill course in February, we reviewed his packet, which revealed there were additional requirements for him to become a *qualified* JFO. A JFO Course graduate is defined as a *certified* JFO, but not qualified. The entire process is defined in a memorandum of agreement (MOA) among the Army, Air Force and Special Operations Command.

The MOA defines a certified JFO as one "who satisfactorily completes the appropriate service academic and practical training requirements of a core JFO training curriculum and completes a comprehensive evaluation." The Fort Sill JFO Course satisfies the first requirement.

**JFO Requirements to Be Qualified.** The process for a *certified* JFO to become a *qualified* JFO requires a considerable amount of home-station training concurrently with an Air Force joint terminal

attack controller (JTAC). A qualified JFO is "a certified JFO who has maintained currency by achieving the established minimum recurring training and evaluation requirements."

The JFO meets these requirements by performing the following six fixed- or rotary-wing events.

1. Perform two live or simulated laser-guided weapons system terminal guidance operations events.

2. Perform as a JFO in support of one live fixed-wing close air support (CAS) control. This control begins with the JFO acquiring the target and providing the JTAC targeting data for the JTAC's terminal attack control of Type 2 or 3 CAS.

3. Perform as a JFO during one live night target-marking event using marking devices (i.e., laser or infrared pointer). The event must be at night beyond the end of evening nautical twilight and prior to begin morning nautical twilight. This event, combined with requirement number one, satisfies both requirements.

4. Perform one simulated terminal attack control as a non-qualified JTAC individual using multi-service procedures for the joint application of firepower. Supervision by a JTAC is preferred but not required.

5. Perform one live or simulated abort, which may be accomplished with other

semi-annual events.

6. Perform one live or simulated AC-130 call-for-fire.

JFOs must requalify every six months with their qualifications recorded in a JFO evaluation folder maintained with the brigade fire support coordinator (FSCOORD). Both the JFO's maneuver battalion commander and brigade commander must verify the JFO's status as qualified. Units are responsible for creating and maintaining the evaluation folder in accordance with the guidance specified in the MOA and must ensure the folder accompanies the Soldier to his follow-on duty assignment.

The MOA also explains that after the JFO meets the requirements and becomes qualified, the qualified status lasts for six months unless the JFO deploys. The MOA says that "JFOs who deploy fully qualified do not have to maintain currency while deployed in support of combat/contingency operations." The JFO resumes normal training on his first duty day after deployment.

**Qualifying 2nd IBCT JFOs.** To qualify each of our newly graduated JFOs, the brigade worked with Fort Carson's 13th Air Support Operations Squadron (13 ASOS). The senior JTAC in support of 2nd IBCT was eager to help in the joint endeavor.

13 ASOS quickly helped us develop a training plan to support our new graduates. The program included three days in the classroom and one day in the simulator plus integrating CAS into the pre-National Training Center (NTC) mission rehearsal exercise (MRE) at Fort Irwin, California.

The 13 ASOS also helped identify a JFO-JTAC combination for each sortie flown in support of the exercise. We tried to maintain continuity with each unit's JFOs and the respective unit JTAC as much as possible to develop our joint fires team (JFT) within each of the maneuver battalions. The JFT is as described in the article "Building the Tactical Level Joint Fires Team (JFT)" by Colonel David R. Brown, et. al., in the May-June edition.

Each battalion or squadron JTAC developed a working relationship with his



2nd IBCT forward observers train at home station, Fort Carson, Colorado, to become *certified* joint fires observers (JFOs).

three to four maneuver company or troop JFOs, and the brigade JTAC developed a relationship with the four COLT JFOs. Interaction in the classroom focused on reinforcing what each JFO learned in the Fort Sill JFO Course. The most important benefit of the program was the three days for the JFOs to build a relationship with their respective JTACs.

The JTACs used mapping programs, such as Google Earth, and printed two aerial or urban setting views. The JTAC used the plain aerial view for classroom training while the JFO used the aerial view

with graphics. The JFO then attempted to “talk the JTAC onto the target.” This reinforced the dialogue and confidence between JFOs and JTACs. After the classroom portion, each JTAC mentored his JFO in the simulator for about an hour with multiple missions.

Finally, the JTAC and JFO were integrated into the company-level military operations in urban terrain (MOUT) live-fire exercises. The JTAC, collocated with the battalion’s assault command post (ACP), allowed the company or troop JFOs to be his eyes and help him with Type

2 controls for live-fire CAS. The JTAC and JFOs had rehearsed the process in the days prior with day and night dry-fire rehearsals leading up to the day and night company MOUT live-fire exercise.

2nd IBCT is the first Army brigade to have *qualified* JFOs throughout the BCT. This success is due to the strong cooperation between the 2nd IBCT and the 13th ASOS and the initial training in the Fort Sill JFO Course.

MAJ Christopher W. Wendland  
Fire Support Coordinator  
2nd IBCT, 2nd ID, Fort Carson, CO

# History of the USMC Artillery Detachment at Fort Sill

The first Marines to arrive on the hot and windy plains of Fort Sill, Oklahoma, were not Artillerymen but Infantrymen. In 1917, Marines initially reported to the School of Musketry at Fort Sill. It was 1925 when the first Marine Artillerymen entered the School of Artillery. And ever since the earliest days of the School of Fire in the 1920s, the Marine Corps has maintained a presence at Fort Sill. Initially providing instructors to augment the school, the Marines’ level of participation has steadily grown over the years.

The billet of Senior Marine Corps Representative was formally established in the early 1950s as the number of Marine instructors at Fort Sill continued to increase.

With the closing of the Marine Barracks at Naval Ammunition Depot, McAlester, Oklahoma, in 1977, the Marine Corps Administrative Detachment was established at Fort Sill and

the Marine Corps Representative was designated as the Commanding Officer of the Marine Corps personnel. The detachment assumed responsibility also for the Marines assigned to the Air Training Command at Sheppard Air Force Base, Wichita Falls, Texas, in 1978.

After the decision in 1978 to centralize all Marine Corps Artillery training at Fort Sill, the number of Marines assigned to the detachment more than doubled, and in 1989, in recognition of its true mission, the detachment was redesignated the “Marine Corps Artillery Detachment.” More recently, in 1997, the Marine Detachment was designated the fire support doctrinal proponent for the Marine Corps.

Today, there are approximately 115 Marines assigned to the Marine Corps Artillery Detachment in support of the Army Field Artillery School’s mission to train Soldiers and Marines to be the finest Field Artillerymen and fire supporters in

Colonel John S. Twitchell	Jul 1949–Jun 1952
Brigadier General Wilburt S. Brown	Jun 1952–Oct 1952
Colonel Frederick P. Henderson	Nov 1952–Jul 1955
Colonel Custis N. Burton, Jr.	Jul 1955–Sep 1958
Colonel William F. Kramer	Sep 1958–May 1961
Colonel Francis W. Benson	Jun 1961–Jun 1965
Colonel Francis R. Schlesinger	Jun 1965–Jul 1967
Colonel Mark A. Rainer, Jr.	Aug 1967–Aug 1970
Colonel William C. Patton	Aug 1970–Aug 1973
Colonel Karl N. Mueller	Aug 1973–Jun 1977
Colonel Robert W. Heesch	Jul 1977–Jul 1980
Colonel Martin D. Julian	Aug 1980–Jun 1983
Colonel Ernest B. Beall, Jr.	Jun 1983–Aug 1986
Colonel William C. Stroup	Sep 1986–Sep 1988
Colonel Kent O. W. Steen	Sep 1988–Aug 1991
Colonel Philip E. Hughes	Aug 1991–Jun 1993
Colonel Joseph F. Weber	Jun 1993–Sep 1995
Colonel Lynn A. Stuart	Sep 1995–Aug 1999
Colonel John M. Garner	Aug 1999–Aug 2001
Colonel Thomas R. Kelly	Aug 2001–Sep 2003
Colonel James A. Pace	Sep 2003–Jul 2006
Colonel Scott T. Campbell	Jul 2006–

Fort Sill Marine Artillery Detachment Commanding Officers

the world. More than 1400 Marines come through Fort Sill per year for training.

The Marine Corps Artillery Detachment is headquartered in Brown Hall on McNair Road. In 1992, the building was named after the late Brigadier General Wilburt Scott “Big Foot” Brown, who commanded the Marine Corps Detachment at Fort Sill in 1952. General Brown received a Silver Star for his actions in the Korean War. He earned the nickname “Big Foot” because he was a tall man with large feet.



# 3-319 AFAR TF *Gun Devils*

## Providing FA Fires for Afghanistan and Maneuvering on the Enemy

**T**ask Force (TF) *Gun Devils*' mission in one operation in Afghanistan was to defeat a known Taliban leader and approximately 40 of his men in a small village in the northern part of an isolated valley. The valley was bordered by a rugged ridge of mountains on the east and a mountain complex with a "bowl" to its west. Its floor was 10 kilometers long and four kilometers wide but narrowed into a 600-meter-wide chokepoint at the northern Taliban village.

The unique task force began combat operations in the valley when suddenly its B Company, 1st Battalion, 508th Parachute Infantry Regiment (B/1-508 PIR), *Legion Company*, was ambushed by a 10-man force. The task force with its Coalition partners suffered casualties in the ambush. It was time for the TF commander to change the plan.

After quickly consulting with his S2, S3, deputy S3, executive officer (XO) and command sergeant major, the task force commander announced the following.

*Attention in the TOC [tactical operations center]! We now are massing our combat power in the valley. This is where we are going to fight the enemy. Legion Company, with its Afghan element, is consolidating its combat forces to defeat*

---

By Lieutenant Colonel  
Bertrand A. Ges

---

*the enemy strongpoint in the valley.*

*We now are going to move Team Delta [D/2-504 PIR] west along the mobility corridor to establish blocking positions north of the valley to interdict possible enemy movement north from 3rd Platoon's [Legion Company] enemy contact location.*

*We are changing Team Alpha's [A/1-325 Airborne Infantry Regiment (AIR)] air insertion landing zone [LZ]. Team Alpha now will land on the LZ approximately five kilometers east of Legion's enemy contact location. But Team Alpha first will conduct a false insertion into the Sammy Hagar Bowl to the west. B/3-319 AFAR [Airborne Field Artillery Regiment] now is stopping its movement north and will occupy positions to execute pre-assault fires for Team Alpha's false insertion and provide fires throughout the valley.*

*I still will fly in the C<sup>2</sup> [command and control] aircraft for Team Alpha's false and actual air insertions. Once Team Alpha takes control of its objective, the aircraft will land as the ACP [assault command post] on CP Hilltop to linkup*

*with Legion Company. I have the French commander with me [French Special Forces lieutenant colonel].*

*The trigger for Gun Devils 5 [XO] to move the battalion TAC [tactical command post] with elements of 4-13 MP [Military Police] from our trains [Headquarters and Service Battery (HSB) 3-319 AFAR] and elements of the 151st [151st Infantry Battalion (Romania)] north toward the valley is when our ACP collocates with Legion Company and establishes communications from CP Hilltop.*

*Finally, as we isolate the enemy within the valley, I will decide whether Team Alpha is to occupy east of Legion Company or conduct another air insertion to the north NLT [not later than] H+5. H-hour is when Team Alpha's aircraft first touches down on the LZ. By H+5, Alpha 6 will give me his assessment as to whether or not he can exploit success in his initial LZ.*

*It is critical we deconflict Team Delta's movement south into blocking positions north of the valley while 1st Platoon [Legion Company] moves north to clear the northern most village.*

*Are we all tracking? What are your questions?*

This scenario is of an actual operation in which we cleared the valley of the Taliban. It is representative of the nine task force-level operations we conducted with varied US and allied units, which at times, were drawn from three different US Army brigades during our rotation in Operation Enduring Freedom (OEF) VI. It demonstrates the flexibility, innovativeness and willingness to take risks required of TF *Gun Devils* to defeat a smart enemy on his native terrain with maneuver and fires. Our successes in Afghanistan are a tribute to the US Army's band of excellence required in training and its emphasis on allied interoperability.

TF *Gun Devils*, 3-319 AFAR, is part of the 82d Airborne Division, deployed to Afghanistan for OEF VI from 2005 to 2006. 3-319 AFAR was responsible for not only all FA fires and radars in Afghanistan under the auspices of its 1st Brigade Combat Team (BCT) 504th PIR, 82d Division, known as TF *Devil*, but also for task force maneuver operations in the Kandahar Province under the 173rd Airborne Brigade, Combined TF (CTF) *Bayonet*, part of the US Army's Southern European TF (SETAF). SETAF, out of

Vicenza, Italy, was the Combined/Joint Task Force-76 (CJTF-76) headquarters in Afghanistan.

**3-319 AFAR Fires and Radar Mission.** Near the end of 2004, the 1st BCT was notified of its pending deployment for the Regional Command-East (RC-East) mission in Afghanistan. As a result, the 82nd Airborne Division changed 3-319 AFAR from a division artillery direct support (DS) asset and task organized it under the 1st BCT. Additionally, as the 82nd Airborne Division started its restructuring to become modular, A Battery, 3-319 AFAR, was task organized under another BCT and did not deploy for OEF VI. B and C Batteries remained in 3-319 AFAR as six-gun batteries for the deployment.

Under TF *Devil*, 3-319 AFAR was responsible for establishing two-gun platoons throughout Afghanistan for autonomous operations. These platoons provided DS FA fires under the tactical control (TACON) of various joint and combined assets. See the battalion's arming, manning and equipping for this CJTF-76 fire support mission in Figure 1.

TF *Gun Devils* had to provide DS

fires to Special Operating Forces (SOF) throughout Afghanistan. To achieve the desired effects in certain areas, C/3-319 AFAR was given the remarkable mission of converting from an M119A2 105-mm howitzer battery into an M198 155-mm howitzer battery—combat ready. C/3-319 AFAR was DS to TF *Devil* and collocated with the TF's 2-504 PIR.

In addition, the battalion was responsible for manning and equipping all radars in country, including oversight of and training units on the new lightweight countermortar radars (LCMRs).

The battalion moved the brigade fire support element (FSE) and weapons locating radar section to TF *Devil* in RC-East as well as C/3-319 and the 234th FA Detachment.

**TF Maneuver Mission and Threat.** About six months before the deployment, 3-319 AFAR received an additional mission: Serve as a maneuver TF (TF *Gun Devils*) assigned to the 173rd Airborne Brigade, Combined TF (CTF) *Bayonet*, in RC-South. (See the task organization in Figure 2 on Page 22.) Ironically, 3-319 AFAR had deployed to South Vietnam for combat with the 173rd Airborne Brigade (Separate) in 1965. The battalion's

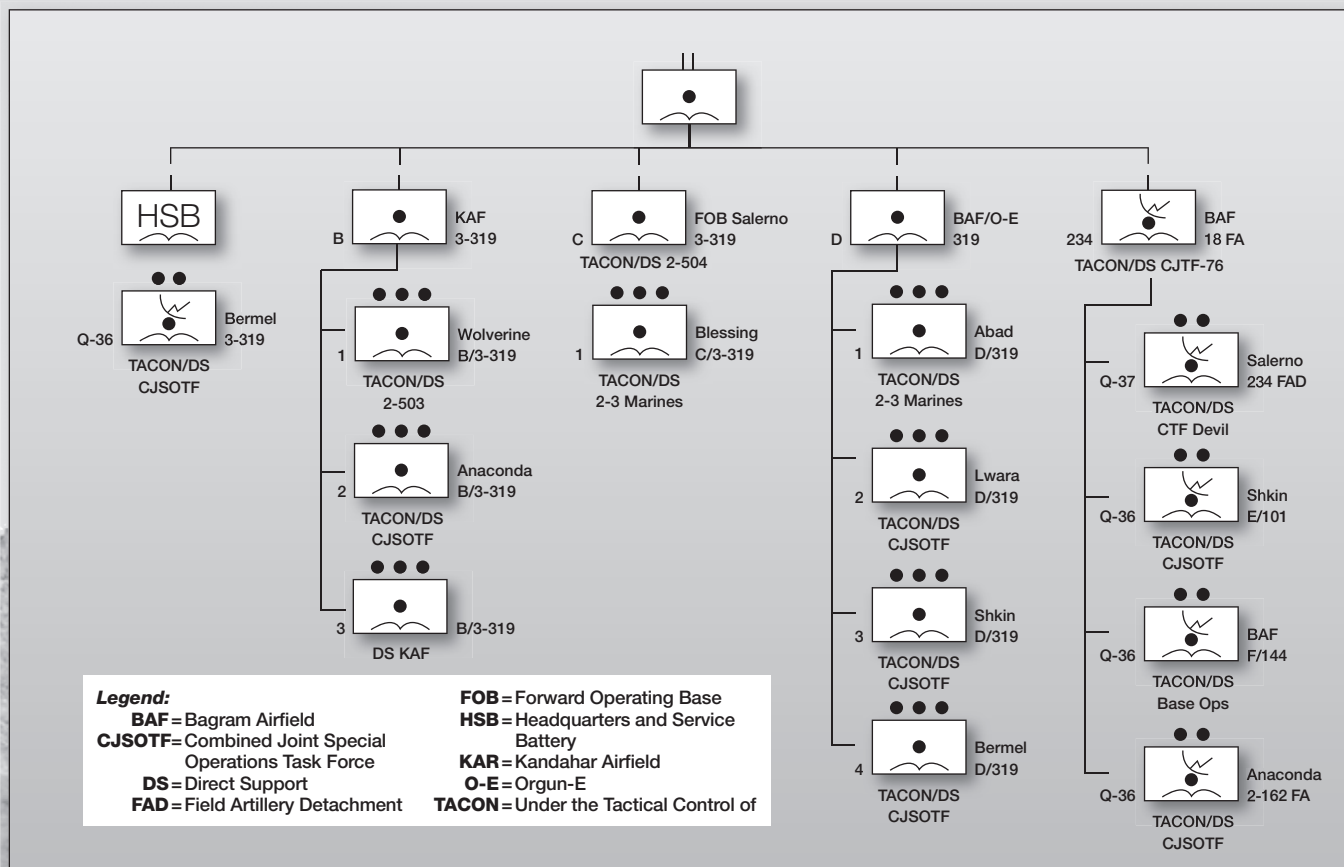

Figure 1: 3rd Battalion, 319th Airborne Field Artillery's (3-319 AFAR's) Arming, Manning and Equipping under the 1st Brigade Combat Team (BCT), 82nd Airborne Division, in Afghanistan. The battalion provided all FA fires and oversaw all radars in country.

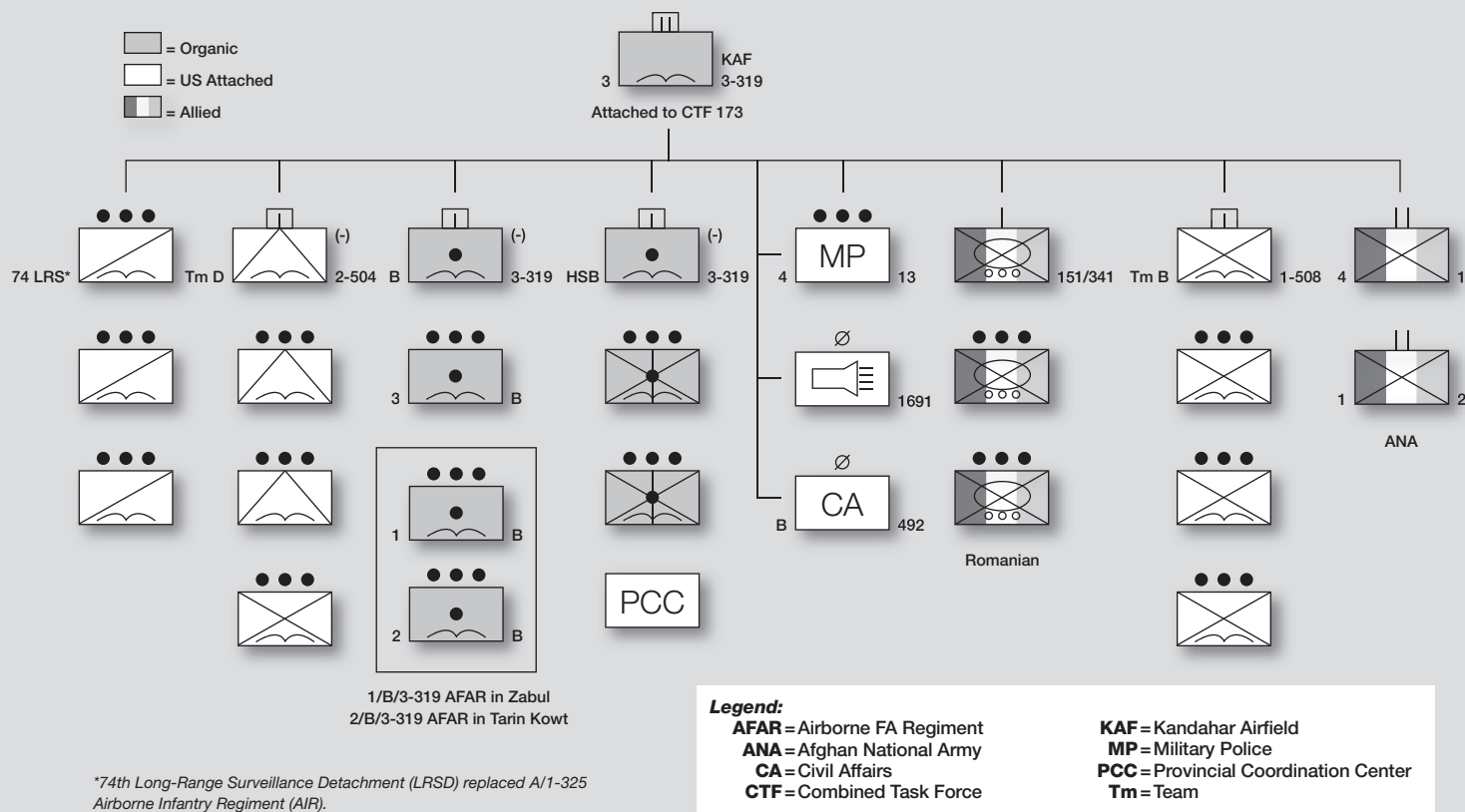

Figure 2: TF *Gun Devils*' Task Organization under the 173rd Airborne Brigade in Afghanistan

leadership was notified of this combat deployment task organization, literally, while receiving a leader professional development session from Colonel (Retired) Paul J. Raisig, Jr., the Honorary 319th AFAR Regimental Commander. During this session, Colonel Raisig was discussing his recently published book *Letters from a Distant War: Vietnam from a Soldier's Perspective* that covers his two combat tours in Vietnam, including his time as the 3-319 AFAR commander while fighting with the 173rd Airborne Brigade.

TF *Gun Devils*' mission in Afghanistan under CTF *Bayonet* was to defeat the anti-coalition militia (ACM) and conduct full-spectrum operations to set the conditions for reconstruction in the Kandahar Province. Through mission analysis, 3-319 AFAR identified specified and implied tasks along two lines of operations (LOOs). One LOO was population-focused: Extend the reach of the central government by building government capacity and empowering the Afghan National Security Forces (ANSF) through training and mentoring. The second LOO was enemy-focused: Find and destroy the enemy and their safe havens.

Kandahar is the most politically and culturally significant province in Southern Afghanistan or, as some would argue,

the entire country. It is the spiritual home of the Taliban. One estimate has at least 14 former senior Taliban government leaders originating from Kandahar.

**TF Organization.** 3-319 AFAR's task organization included US Army rifle and anti-tank infantry company teams, a long-range surveillance detachment (LRS), an MP platoon, a civil affairs team-A (CAT-A), and a tactical psychological team (TPT). The TF was partnered with Coalition Forces consisting of a Romanian infantry company and ANSF, a Canadian provincial reconstruction team (PRT) and embedded tactical training teams (ETTs) for the ANA from the both US Army National Guard/Reserve as well as French Special Forces units. TF *Gun Devils* retained B/3-319 (-) and HSB/3-319 (-) and a few individuals as liaison officers (LNOs) to CJTF-76.

The ability of this complex and disparate battalion TF to operate and fight against an enemy is a testament to the US Army's training standards and interoperability requirements with our allies.

**TF Operations.** Our goal was to interact positively with the local population's leadership in TF *Gun Devils*' 11 districts in the Kandahar Province. Our challenge was the weak local government organizations that allowed areas to become enemy safe havens and predisposition

of the populace as the province was the spiritual home of the Taliban. Another challenge was TF *Gun Devils*' large and rugged AO. The AO consisted of more than 18,000 square kilometers and contained extreme terrain, ranging from mountains at altitudes exceeding 9,000 feet to desert wastelands.

The size and ruggedness of the AO led to decentralized operations with sergeants, staff sergeants and lieutenants having enormous responsibilities with potentially strategic consequences while operating with ANSF, conversing with local leaders or fighting against the ACM. These talented junior leaders had to interact with Afghans at all levels—governmental officials, provincial council members and tribal, religious and village leaders—with the goal of establishing sincere relationships.

After TF *Gun Devils* took control of its districts in the Kandahar Province, it immediately established and enforced standards for how military operations would occur to mitigate risks associated with such decentralized operations. These standards ranged from individual Soldier discipline to conducting standardized battle drills during enemy contact.

Much of the input to establish these standards in military operations came from leaders of the various units task organized to the TF. This bottom-up



refinement was invaluable.

Additionally, the battalion headquarters monitored reports and the proximity of forces to the specific AO, issued five-paragraph operations orders (OPORDs) or gave at least clear tactical tasks and purposes. The battalion headquarters could serve as a TOC, tactical assault command post (TACP) or ACP, depending on which TF element was in control.

Before a unit moved, the senior tactical leader was trained to review accidental and tactical risk threats and identify the appropriate mitigation measures. One leadership challenge was negating this potentially mundane and tedious process through the use of physical or mental checklists.

Another technique to standardize decentralized operations over a large AO was the use of repetitive messages and acronyms. This technique was developed for Soldiers to use both internally and in their interactions with the local Afghan population. These techniques were not “gimmicks” but highly effective tools for enhancing force protection and improving relationships with the Afghans in the AO.

For instance, one of the TF leadership’s repetitive messages to Soldiers was, “The Afghan people are not the enemy.” This sincere phrase, adopted from the TF *Devil* commander during home-station training, captured a value for Soldiers as they encountered Afghans everyday.

The chain of command took care to eliminate the potential for poor judgment that could possibly lead to the Afghan’s perceiving Soldiers’ acts as malicious. The Soldiers’ values were clear as they quickly transitioned from fighting a lethal enemy that may have resulted in casualties and collateral damage to the surrounding areas to showing compassion toward the local population as the Afghans dealt with the horrors associated with the enemy.

To ensure maximum positive engagement with the populace, elements, such as the MP platoon, 3/B/3-319 or even an HSB/3-319 combat trains resupply convoy, had the specified task to interact with the local Afghans, either during a tactical halt or a three-day occupation.

On occasion, Soldiers made mistakes. When asked by Afghan leaders, the TF leadership was forthcoming, highlighting that no one was perfect, but that the leadership would take corrective measures to prevent the mistake from occurring again.

To properly synchronize and integrate

operations, TF *Gun Devils* conducted a weekly focus meeting using a basic synchronization matrix. The categories in the matrix served to focus the battalion’s planning for current and future operations. (See Figure 3.)

TF *Gun Devils* established subordinate unit AOs. To help communicate with the subordinate commanders, the TF came up with a classification system of different levels of operations or stages. (See Figure 4.)

TF *Gun Devils*’ units used aggressive actions during enemy contact. However, collateral damage considerations were paramount. Once enemy contact occurred, the commander on the scene provided the initial report. The superior leaders and battalion headquarters allowed the on-scene commander to develop the situation. Based on the initial report, the TF headquarters and on-scene commander could anticipate implementing standardized battle drills, such as those listed in Figure 5 on Page 24.

Technological tracking tools, to include the Blue Force Tracker (BFT), allowed key TF leaders to visualize the situation

and gain situational understanding and establish a common operational picture (COP) with the on-site leader. This led to informed decisions to support the on-site leader.

Based on conditions, including the use of multiple Coalition Forces or ANSF and an austere environment, TF *Gun Devils* developed a technique for pursuing an enemy force. This tactic was to delay air-to-ground fires until the element’s maneuver and surface indirect fires could more rapidly fix the enemy for destruction by airpower.

The level of intensity during enemy contact at times caused the TF to introduce aerial platforms (rotary- or fixed-wing) quickly into the fight. These aerial platforms rightfully require verification of positioning and the frontline trace of all Coalition Forces. At times, the air assets had to reposition to create standoff before the aerial platforms could fire their munitions.

This verification and repositioning were challenging and cumbersome, especially when operating with ANSF that require interpreters to transmit ra-

**1. Kinetic**—Enemy-focused and provided the direction for the S2 section to develop target packets and conduct analysis on potential operations.

**2. Civil-Military Operations (CMO)**—Population-focused and tied to the commander’s emergency response program (CERP). If a certain district or area had high instances of enemy activity or no enemy threat, CERP would be leveraged as an incentive for local leaders to counter the ACM’s influence and support Kandahar’s central government.

**3. Non-Kinetic**—Nonlethal targeting intended for interaction with influential powerbrokers or individuals with suspected ties to the ACM. Small reward program (SRP) payments also were tracked in this category.

**4. Focus**—Identify the TF commander’s priorities.

Figure 3: Categories for the Synchronization Matrix used to Focus the TF’s Weekly Meetings

**Class A** is a unit operating within its area of operations (AO) with internal or limited task-organized assets, e.g., a civil affairs team-A (CAT-A) or tactical psychological operations team (TPT).

**Class B** is a unit that is task-organized with up to a platoon from another unit to accomplish its mission.

**Class C** is two units operating within the same AO that require the TF tactical command post (TAC) or assault command post (ACP).

**Class D** is a battalion-led operation that is task-organized with various coalition and joint elements, to include national and foreign special operations forces, incorporating vast capabilities into mutually supportive missions with a reconstruction effort end state.

Figure 4: Classifications for Various Operations. These classifications facilitated communications for a unit conducting decentralized operations. TF *Gun Devils* conducted nine Class D operations during its deployment to Afghanistan (classification titles are fictitious for purposes of this article).

dio commands. Also, the battle drill to confirm the target location as it related to Coalition Forces stalled the pursuit of the enemy, causing Coalition Forces to lose momentum.

Therefore, TF commanders first considered employing observed indirect fires with mortars or artillery to interdict or block the enemy's movement as the commanders repositioned their maneuver forces to pursue the enemy. During this phase, through the battalion headquarters, the commanders asked the joint terminal attack controllers (JTACs), fire support officers (FSOs) or forward observers (FOs) to keep the aerial platforms clear of a specific terrain or map feature—for example, "Stay east of the 60 easting and the north-south easternmost ridge line in the valley." Using integrated communications security scanners to track enemy movements further enhanced the observed interdiction fires.

Once the enemy force was fixed or no longer could be pursued, then the commander cancelled the informal airspace coordination command and cleared the aircraft for attack on the visible and still hostile threat.

TF *Gun Devils* also established a provincial coordination center (PCC) as a fully functioning synchronization node, which enhanced the battalion's ability to incorporate ANSF into all operations. More impressively, ANSF leadership developed, planned and executed three

- Request close air support (CAS) or attack helicopter support.
- Request medical evacuation (MEDEVAC).
- Facilitate call-for-fire (CFF) missions for indirect fire assets.
- Reposition forces, using a code to call for a reaction force controlled by the task force or a code used to call for a reaction force approved by Combined Task Force *Bayonet* and Combined Joint Task Force 76 (CJTF-76).
- Request joint improvised explosive device (IED) defeat organization (JIEDDO) field team support (formerly known as TF IED).

Figure 5: TF *Gun Devils* Standardized Battle Drills

Afghan-led missions with minimal US tactical incorporation. The PCC also facilitated counterreconnaissance and counterstrike operations for the ANSF. The latter occurred after applying the principles outlined in the article "Counterstrike at the NTC: Reversing Negative Trends" by Lieutenant Colonel James L. Miller and Chief Warrant Officer Three Michael A. Harp in the September-October 2005 edition.

After the 74th LRSD conducted the

first counterstrike operation with its partnered ANSF, the Kandahar Airfield did not receive another indirect fire attack. The counterstrike mission was executed successfully by other units, to include the provisional mounted platoon. (This platoon was organized and trained as an infantry anti-armor unit from 3-319 AFAR's HSB personnel.)

Regardless of which nation's flag TF *Gun Devils*' Soldiers wore on their uniforms, all TF forces fought and supported each other continuously. Furthermore, during OEF VI, the Romanian *Black Wolf* battalion received its own TF AO and conducted the first Romanian tactical battalion operation since World War II. In addition, the Romanian TF's operations included Romania's first air assault mission partnered with US and ANSF elements—a truly historical accomplishment.

All elements of TF *Gun Devils*, regardless of original unit designation, epitomized the goals set forth for the Army's transformation. TF operations were a team effort by Soldiers and leaders at all levels who required nothing more than clear and concise orders.

Finally, the indigenous ANSF forces were an integral part of TF *Gun Devils*, proving themselves extremely capable of becoming a viable security element for their country. As the Global War on Terror (GWOT) continues, the intuitive insight provided by these ANSF will allow Af-

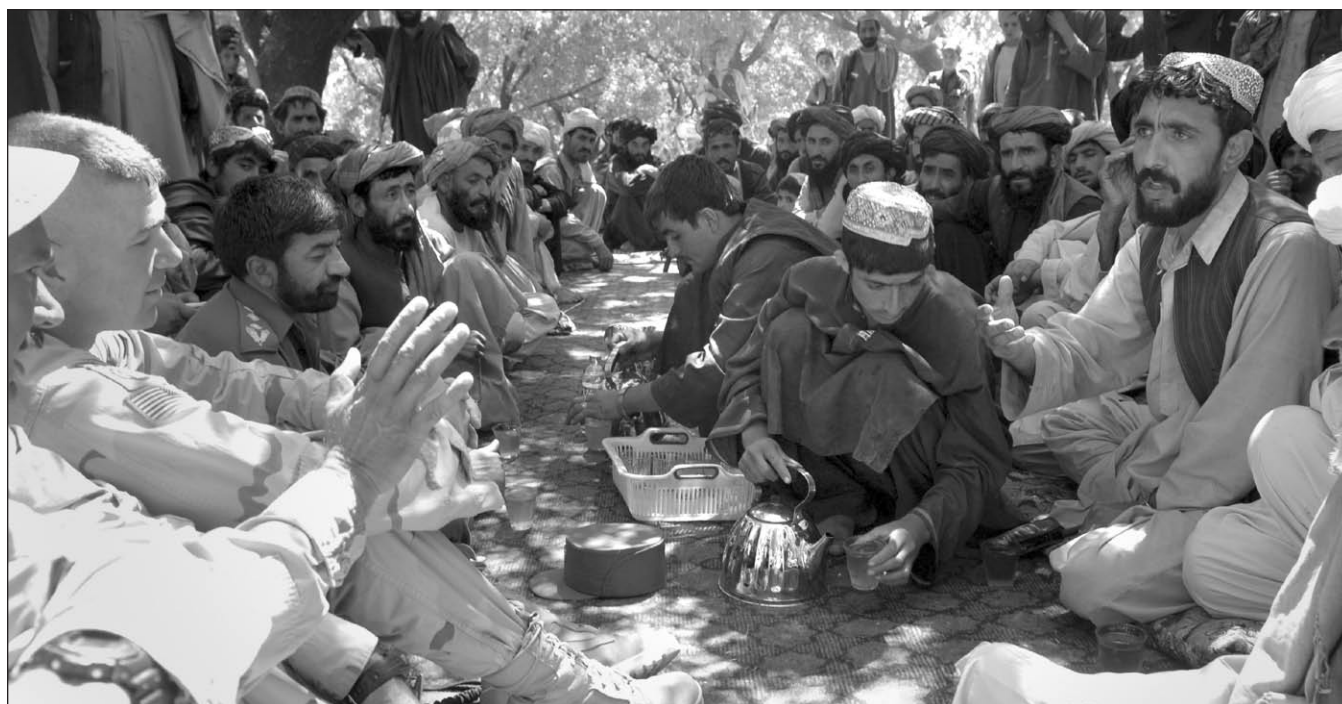

LTC Bertrand A. Ges, left, talks to the elders about providing help to the people of Mainasheen, Afghanistan, during the Shura meeting on 5 September 2005.

# 3-319 AFAR Preparing to Deploy as a Maneuver and Fires Task Force

**3**rd Battalion, 319th Airborne Field Artillery's (3-319 AFAR's) mission had several specified and implied tasks to accomplish to prepare the battalion to operate as the maneuver Task Force (TF) *Gun Devils* that was also responsible for all FA fires and radars in Afghanistan during Operation Enduring Freedom (OEF) VI. TF *Gun Devils* was assigned to the 173rd Airborne Brigade, Combined TF (CTF) *Bayonet*, which was part of the Southern European Task Force (SETAF) from Vicenza, Italy. SETAF served as the Headquarters for Combined Joint TF (CJTF) 76 in Afghanistan for OEF VI.

**Transition into a Maneuver TF.** In addition to individual- and unit-level training requirements, TF *Gun Devils* six-month transition into a maneuver TF started with two SETAF command post exercises (CPXs). The second CPX had the battalion operating with CTF *Bayonet*. Afterward, the battalion deployed as part of its 1st Brigade Combat Team (BCT), 82nd Airborne Division, TF *Devil*, to the National Training Center (NTC) at Fort Irwin, California, for a leader training program.

For both the CPX and NTC leader training program, TF *Gun Devils* was task-organized with appropriate units, had an AO and was issued maneuver-specific missions from the brigade commander. These training events led to the development of tactical operations standing operating procedures (TACSOP), to include incorporating a fellow battalion commander's internal review checklist (3-504 PIR), for all unit operations: infiltration; exfiltration; command and control; resupply; "reserve," which was defined as fire support, immediate and quick-reaction forces (QRFs); close air support (CAS); and casualty evacuation (CASEVAC). During moments of hasty decision making, this checklist proved to be extremely beneficial.

**Additional Personnel.** TF *Gun Devils* mission analysis to quickly transition into a maneuver battalion was greatly enhanced by its plans officer, an FA captain who had attended the Infantry Officer's Career Course at Fort Benning, Georgia. During the preparation for and throughout the OEF VI deployment, TF *Gun Devils*



Soldiers of the 151st Infantry *Black Wolf* Battalion (Romania) return to Kandahar Airfield (KAF) after completing the first Romanian tactical offensive operation since World War II and their first air insertion.

was resourced with additional personnel from both TF *Devil* and CTF *Bayonet*.

The battalion S3 section received an infantry captain and sergeant first class as the deputy operations officer and operations NCO, respectively.

To increase its operational intelligence effectiveness, TF *Gun Devils* received a military intelligence (MI) captain and two lieutenants. The MI captain became the S2 intelligence officer. One MI lieutenant acted as the assistant intelligence officer, responsible for coalescing all information sources and conducting several types of analyses. The other MI lieutenant acted as the tactical intelligence officer, overseeing the tasking and management of collection assets. The S2 and at least one of his lieutenants participated during the critical home-station and pre-deployment training events. These MI personnel additions alleviated S2 section staffing inadequacies suffered by all FA battalions.

TF *Gun Devils* also was resourced with a US Air Force (USAF) battalion air liaison NCO and several joint terminal attack controllers (JTACs).

Ironically, the *Gun Devils* received an additional FA captain to serve as the battalion fire support officer (FSO) and internally reassigned several 13F forward observers (FOs) to stand-up the TF's maneuver fire support element (FSE). TF *Gun Devils* could not draw personnel from the brigade FSE because it remained with TF *Devil* in Regional Command-East.

**Transform C Battery, 3-319 AFAR, into an M198 Battery.** C/3-319 accomplished

its conversion from an M119A2 105-mm battery into a M198 155-mm howitzer battery through an intense 15-day training period at Fort Bragg, North Carolina. This included dry-fire certifications and live-fire qualifications at the crew, platoon and battery levels before the battery deployed for OEF VI.

The battery's parent 82nd Airborne Division Artillery (Div Arty) and 1st Brigade Combat Team (BCT) coordinated for training and support from the 18th FA Brigade's 1-321 FAR (Airborne) 155-mm battalion and assigned former M198 13B Cannoneer howitzer section chiefs and sergeants to the 3-319th AFAR.

**Headquarters and Service Battery (HSB), 3-319 AFAR, as a Mounted Platoon.** HSB organized and trained a provisional mounted platoon comprised mainly of cooks from the dining facility (DFAC) section and other low-density military occupational specialty (MOS) positions.

The platoon's training plan and certification was a five-month process overseen by 1st BCT's headquarters and two of its infantry battalions. It was equipped with all infantry authorized individual gear and associated crew-served weapons.

To deploy, the provisional mounted platoon had to become fully mission capable to conduct operations as part of an infantry anti-armor company.

**Training with Interpreters.** For the CPX and leader training program, training included the use of interpreters. In retrospect, interpreter training should extend down to at least the platoon level



President Hamid Karzai is pictured with CPT Jeremy Turner, Commander, Team D, 2nd Battalion, 504th Parachute Infantry Regiment (Tm D/2-504 PIR), whose unit was responsible for security during the President of Afghanistan's visit to Kandahar City; 1LT Michael Adams (Executive Office, Tm D/2-504 PIR) and LTC Bert Ges (Commander, Task Force *Gun Devils*) are on the right.

and possibly to the squad leader. This covers a platoon's exposure to the local population and its actions with Afghan National Security Forces (ANSF), consisting of Afghan National Army (ANA); provincial and special purpose Afghan National Police (ANP) elements; National Directorate for Security (NDS), an intelligence agency; the Afghan Highway Patrol (AHP); and the Afghan Border Patrol (ABP), which did not operate within the TF *Gun Devils* AO.

*Validating the TF at Home Station.* The 82nd Airborne Division validated TF *Gun Devils* for OEF VI through a tactical certification exercise at Fort Bragg, North Carolina. All unit capabilities were physically present, e.g., civil affairs team-A (CAT-A)/B Company, 492 CA Brigade; or replicated, e.g., 3-73 Reconnaissance, Surveillance and Target Acquisition (RSTA) Squadron (-) as a Romanian infantry battalion (-); and A/3-4th Air Defense Artillery (ADA) Regiment as an ANA company.

**Provide FA Fires and Oversee Radar Operations for Afghanistan.** To achieve the theater-wide fires requirement, 3-319 AFAR increased its fire direction capability by establishing six autonomous fire control centers for 105-mm and 155-mm artillery systems throughout Afghanistan.

3-319 AFAR shut down its battalion fire direction center (FDC) and re-assigned the fire control and advanced FA tactical data system (AFATDS) Soldiers to the battery-level FDCs. This closure of the battalion FDC allowed the TF to establish an S5—civil-military operations

(CMO) capability—by redefining the fire direction officer's (FDO's) and chief fire control sergeant's duties to include reconstruction and capacity building responsibilities. The battalion master gunner also helped in CMO. However, regardless of their new responsibilities, the battalion FDO, chief fire control sergeant and master gunner still had critical FA responsibilities throughout OEF VI.

Once the firing batteries received the additional fire control sergeants and AFATDS specialists from the battalion FDC, each battery began the four-month training and battalion certification process to establish and operate in three two-gun platoon configurations.

*Platoon-Based Operations.* The number of two-gun platoon configurations allowed the many forward operating bases (FOBs) each to have a lethal firing capability.

A battery commander, executive officer (XO) or FDO, all operating independently from each other, oversaw and led the FDC and howitzer sections within these newly established two-gun platoons. This required the battery XO and FDO to cross train and certify for each assigned position.

The senior NCOs in the firing platoons were the first sergeant, chief of firing battery ("Smoke") and gunnery sergeant. For instance, 1/B/3-319 had the FDO and chief of firing battery; 2/B/3-319 had the XO and gunnery sergeant while 3/B/3-319 had the battery commander and first sergeant.

Another determining factor for battery key leader positioning was the first ser-

geant's military occupational skill (MOS) background. The first sergeant's subject matter expertise in either operations on the gun line, fire direction, forward observation, etc., impacted the final positioning of the battery fire control sergeant (E-6 position).

The leaders of these two-gun platoons were adaptive and agile. For example during an enemy attack against 2/B/3-319 AFAR's FOB, the battery XO called in fire missions from a tower, oversaw and approved fire direction commands and then observed the fire missions for further refinement.

These firing platoons were versatile. For example, they conducted several planned and hasty suppression of enemy air defenses (SEAD) missions for planned air insertions and aerial medical evacuations (MEDEVACs).

*Responsibility for the Lightweight Countermortar Radars (LCMRs).* Another specified fire support task was facilitating the manning, preparedness and functionality of all weapons-locating radars and LCMRs. The brigade fire support targeting officer, in conjunction with the task-organized 234th FA Detachment (234 FAD) from the XVIII Airborne Corps Artillery, also at Fort Bragg, ensured the operational effectiveness of all the radar personnel. Army National Guardsmen from five states and one territory provided the majority of personnel for the AN/TPQ-36 and AN/TPQ-37 Firefinder radars.

**Lieutenant Colonel Bertrand A. Ges, until recently, commanded the 3rd Battalion, 319th Airborne Field Artillery (3-319 AFAR), part of the 82nd Airborne Division, and deployed the battalion to Kandahar Province as Task Force *Gun Devils* for Operation Enduring Freedom VI. Currently, he is the Plans Chief of the Joint Improvised Explosive Device (IED) Defeat Organization (JIEDDO) in Virginia. Before taking command of his battalion, he was an Observer/Controller (O/C) for Fire Support S3 and then Deputy Fire Support O/C at the National Training Center, Fort Irwin, California; and did special duty as the Executive Officer to the Deputy Administrator of the Coalition Provisional Authority (CPA) in Baghdad, Iraq, for three months. He was also the S3 and Executive Officer for 2-320 FA, *Balls of Fire*, and Division Artillery Assistant S3, all in the 101st Airborne Division (Air Assault), Fort Campbell, Kentucky. While at Fort Bragg, North Carolina, also in the 82nd Division, he commanded A Battery, 2-319 AFAR, *Falcon's Fury* among other assignments.**

# Leadership:

## Seeing What Is *Really* in the Mirror

**A** true leader has seven essential qualities. He allows subordinates the latitude to make mistakes; follows through with good intentions; sets the example for subordinates; has a deeply ingrained professional love for his subordinates; can adapt to change; knows how to relate to subordinates; and knows what is important to the mission/organization, the individual and self. The following thoughts attempt to help leaders to forget about managing the problems of daily life and focus their attention on leading others to achieve common goals that will help make “life’s rockiest roads” seem smoother.

**1. The leader allows Soldiers and junior leaders to exercise their initiative.** Too often a “leader” is a micro-manager who tells others how to do their work to be more productive—after all, a micro-manager considers himself a subject matter expert (SME) in most areas. The true leader tells subordinates to exercise their own initiative, so those subordinates may grow into leaders themselves.

The leader is competent, but not too proud to accept advice, based on his subordinates’ experience.

**2. The leader has more than good intentions; he follows through with those intentions.** “The road to Hell is paved with good intentions.” Therefore, action must follow ideas to develop subordinates’ trust. The leader remains objective as much as possible to provide

a realistic view of the situation and take the correct actions to follow through on his good intentions.

**3. The leader sets the example in all that he does.** He strives to be impeccably moral and ethical. In all other areas, the leader does not have to be “the best” but must give his best. He must give 100

---

*As you review these essential leader qualities, honestly assess: where do you stand as a leader? After you have performed that assessment, challenge yourself to become the leader your subordinates deserve.*

---

percent at all times, so he can expect the same from his subordinates.

**4. The leader loves his subordinates and gives selflessly.** He acts as a parent to his subordinates. The leader listens to his subordinates and finds time to address their problems. He knows that subordinates can teach him lessons that his position does not allow him to see.

The leader has an overwhelming personal desire to make his subordinates successful. This attitude is contagious and allows subordinates to overlook his shortcomings. He sets goals for subordinates, helps them achieve the goals and then praises them for achieving the goals.

**5. The leader is adaptive.** If a leader does not have this quality, he risks the very existence of his organization.

The leader analyzes new situations and learns the changes in goals of the new organization. A true leader leaves his “comfort zone” and adapts to change before change is implemented without him, and his subordinates suffer.

At the same time, he does not try to “change the world in a day.”

**6. The leader relates to his subordinates.** He understands the demands on his subordinates on a daily basis. Periodically, he works alongside them, especially when they are performing complex or unpleasant tasks.

The leader keeps a firm “finger on the pulse” of those he leads. When a Soldier fails, the leader asks himself whether or not he failed the Soldier.

**7. The leader knows what is and what is not important.** The leader has vision and knows what his organization’s goals are, making sure these goals are nested with his higher headquarters’ goals. He understands that any task or event that takes away from achieving these goals is nonessential. An organization whose leaders take on too much becomes a “jack-of-all-trades and a master of none.”

So, do you have these qualities?

You may find you are lacking in some leader qualities. This does not mean you are ineffective. Everybody has his strengths and weaknesses, but all can overcome weaknesses with the right attitude and work.

If you are willing to sacrifice your personal agenda for the good of your subordinates and strive to develop these seven key qualities, you just might be surprised at your increased effectiveness in leading those around you.

CPT Kevin K. Carlile, FA  
Assistant Professor of  
Military Science, ROTC  
Central Missouri State University  
Warrensburg, MO



A squad leader gives instructions to one of his Soldiers in Iraq.

---

Iraqi soldiers participate in a school supply drop in Rodwynia near the Baghdad International Airport. The supplies were provided by the 2nd Battalion, 130th Infantry (IN), Fire Support Elements (2-130 IN FSE).

---



# ILARNG's 2-130 IN FSE as a Battalion-Level CMOC in Iraq

**W**hen the 2nd Battalion, 130th Infantry (2-130 IN), Illinois Army National Guard (ILARNG) *Blackhawks* deployed to Iraq in the spring of 2004, the staff paid particular attention to civil-military operations (CMO) that were the responsibility of the battalion's fire support element (FSE). The FSE had personnel from 1-118 FA GAARNG. As the fire supporters, staff and commander developed the CMO strategy, we decided that we were not going to "do good works" simply for

---

By Captain Robert C. Davis  
and Sergeant First Class  
John L. Kullman

---

"good works" sake." In other words, all CMO activities would create some benefit to the battalion, in particular, and Coalition Forces, in general.

Using that concept as the basis for CMO, we began our tour in Abu Ghraib East, an area of operations (AO) that included the rough neighborhoods around

Baghdad International Airport and a critical east-west highway. We ended our tour in the vicinity of Fallujah.

The battalion that we relieved had a building in a nearby Iraqi forward operating base (FOB) that it had used as its brigade CMO center (CMOC). 2-130 IN took control of the building, staffed it with fire supporters to work CMO who began to work through the maze of Army policies, tribal relationships and neighborhood jealousies.

While establishing our battle rhythm,

we initiated our targeting meetings, paying close attention to both lethal and nonlethal effects. As is always the case, tactics, techniques and procedures (TTPs) from the train-up exercises had to be adapted to the conditions in Abu Ghraib.

**CMO Assessments.** One product of our targeting meetings was a tightening up of the CMO assessment tool—sewage, water, electricity, academics, trash, medical and security (SWEAT-MS). At the direction of the battalion executive officer (XO), fire supporters designed a four-fold test for evaluating the conditions in the various AOs. When listening to the Iraqis and investigating the towns or neighborhoods, we asked questions about the SWEAT-MS elements listed in the figure to assess the importance of the potential project to the Iraqis and impact on the Coalition Forces.

Armed with these criteria, we judged the SWEAT-MS conditions objectively and began to form plans to address problems. The battalion commander added one critical stipulation to our brainstorming: all solutions had to be sustainable by the Iraqis after we were gone.

**CMOC Operations.** Through our initial planning sessions and experiences, one CMO fact became clear—namely, that a battalion CMOC was an extremely valuable asset that would contribute to all phases of the targeting cycle. It would serve as a link between the target population and the battalion. Also, to achieve a CMOC's full potential, the fire supporters were going to have to manage key aspects of the CMOC's operations aggressively, such as facilitating the access of local nationals to the CMOC, ensuring our infrastructure was secure and hospitable, establishing staffing responsibilities, motivating Iraqis to engage us and networking between locals and Coalition Forces.

Of all of these considerations, facilitating the Iraqis access to our CMOC was *by far* the most important—it was what all the others were designed to bring about.

*Iraqis Access for Engagements.* The CMOC's goal was to talk to everyone who visited, regardless of whether or not that person was a suspected insurgent, a person seeking to make a claim against the Coalition Forces, a contractor, an Iraqi official or a person "off the street." We met with a cross-section of the local community daily as we looked for the few people who could benefit us.

This "open door policy" was quite

1. What is the impact of the situation on the locals?
2. What is the impact on Coalition Forces?
3. What is the attitude of the locals toward the situation?
4. How does the situation compare to other places in Iraq?

#### Questions to Assess a Community's Civil-Military Operations (CMO) Needs

productive. Once the people in the community learned about it, they flocked to see us, and we reaped the benefits of those engagements.

In one instance, a self-confessed criminal and low-level insurgent walked into the CMOC to see the Americans. Rather than turn him away or hassle him because of his background, we sat him down in the air conditioned office and simply talked with him until he felt comfortable enough to follow through on the urges that had motivated him to enter in the first place.

During a series of conversations over several days, he revealed that he was angry with members of his family and one criminal circle for treating him disrespectfully and not sharing the monetary rewards in a way that he liked. He willingly disguised himself and traveled with the infantry company controlling the area to identify hidden weapons.

On another occasion, he traveled with the company to identify and capture members of a terrorist cell. One member of that cell was captured with improvised explosive device- (IED)-making materials while the others fled, eventually relocating outside of the *Blackhawks*' AO. Additionally, he exposed many of the criminal TTPs used to fund insurgent activities, giving us a better sense of the indicators to look for on the street.

The concept of access that allowed the *Blackhawks* to exploit his information involved more than our willingness to talk to all Iraqis. It also involved a willingness and ability on the Iraqis' part to come to us. It was nearly impossible for the average Iraqi to approach the Baghdad International Airport FOB complex and gain entry. Aside from the risk of being shot, arrested or just chased away by the Soldiers guarding the gates, the Iraqis were reluctant to attempt contact because they knew that insurgents and neighbors were watching the place.

That is why the CMOC location on an Iraqi FOB was so helpful. The Iraqis were able to approach their fellow Iraqis at the gate and gain entrance to the FOB and our building was only a few feet away. We cultivated a positive relationship with the guards at the gate who, in turn, were cooperative in admitting people to see us.

This particular access consideration was widespread in theater. Iraqis universally complained about the lack of discretion in coming to the Coalition Forces. We made every effort to build on their willingness to come to the Iraqi FOB by manning the facility 24/7. Iraqis could (and did) come and go under cover of darkness or during inconspicuous times.

We also worked with maneuver elements to bring in Iraqis under the pretense of an arrest or a simple rendezvous, allowing them to ride into the FOB in the back of a high-mobility multipurpose wheeled vehicle (HMMWV). The direct relationship between discretion and access manifested itself in every AO we occupied, and it was confirmed by overwhelming anecdotal evidence from other units.

*Infrastructure and Hospitality.* The physical CMOC plant was essential in enabling effective access. The opportunities or constraints we faced in our various AOs significantly impacted our degree of CMO success.

The dangers of a war zone necessitated a careful balance between easy access and physical security. CMOCs and the locals they attract are tempting targets for insurgent or terrorist activities. All of our CMOCs were shielded from direct fire and observation. One CMOC was on a compound surrounded by a 15-foot wall; one was in a building nestled between steep hills at the bottom of a ravine.

One of our first acts when we took over the building in Abu Ghraib was to enclose the building in tactical wire. Security layered with a series of searches was a requirement. To negate the threat of car bombs, we did not allow Iraqis to drive into any of our CMOC compounds. We had to bear in mind, though, that strict security policy discouraged the desired visitors as well as the insurgents.

Operational security was a prime concern as well. Beyond the obvious security measures, such as ensuring classified maps were covered or simply not used, we had to manage the documents that were produced. We took extensive notes, wrote reports and took many pictures. All

had the potential to compromise Iraqis who were desperate to keep their dealings with the Coalition Forces secret.

We removed paper files to the American FOB where we lived and burned all trash daily. More importantly, we maximized our use of computer files that were password protected.

The Iraqis also had to be safeguarded in the CMOC. They were often apprehensive about being in the waiting room because they did not want to be seen by other Iraqis. We addressed this by setting the CMOC up like a doctor's office. As much as possible Iraqis would be invited to wait in rooms with the doors closed.

All of our CMOCs were multiuse buildings, so certain days were set aside for specific activities. For example, contractors were paid on a certain day of the week, so our meetings with other Iraqis were scheduled for other days.

Contractor meetings were only one of the many uses of our building. We had rooms used for local governance meetings, sheik meetings with Coalition Forces, feasts, funerals, tactical questioning, formal interviews with the tactical human intelligence (HUMINT) teams (THT) and even lodging for people in need. At various times we housed informants who were hiding for their lives, people waiting to go with patrols to identify insurgents and even a stranded Somali truck driver who was trying to confirm his identity and rejoin his company on the main FOB.

Another consideration in the arrangement of the CMOC was hospitality. Hospitality is particularly important in Arab cultures, so a comfortable, welcoming environment went a long way toward encouraging cooperation and a degree of friendship.

Using the "scrounging" abilities of the

fire supporters and our FOB civilians' skill sets, we ensured that our buildings had electricity, air conditioning, water, food and toilets. These seemingly small things made a dramatic impression on the Iraqis, encouraging them to visit and talk often. The influence of the infrastructure went hand-in-hand with staffing to enable our success.

*Staffing.* A CMOC, just like the rest of the Army, is led by officers and run by NCOs. Every CMOC has its own staffing requirements based on whether it is a battalion- or brigade-level facility and (or) needed 24-hour operations and the amount of security needed in the AO.

Our ideal staffing for the day shift consisted of one senior NCO in-charge (NCOIC), two junior NCOs and four Soldiers.

The NCOIC ran the battalion CMOC and took on duties similar to those of a civilian officer manager. Besides managing the enlisted personnel, he was in charge of Iraqi interpreters, maintaining a building that usually was falling apart (air conditioning is a constant fight), provisioning the CMOC and ensuring that CMOC records were properly maintained.

In the officer's in-charge (OIC's) absence, he often found himself conducting meetings with Iraqis. Most Iraqi leaders wanted to speak only with the OIC. However, they sometimes arrived unexpectedly when the OIC was not there.

Frequently, an Iraqi leader brought someone who ensured that his bidding was done (the Iraqi civilian equivalent of an NCO). We had success when the NCOIC engaged these individuals.

Finally, sometimes it was the senior NCO who ran interference for the OIC. While we consciously pursued a strategy of engaging everyone, at times the OIC

did not want to meet with certain Iraqis for "political" reasons. It became the NCOIC's job to talk to them.

Our junior NCOs worked the CMOC. They made sure that no one was standing around. (Locals should not come to a CMOC to loiter but to conduct business and leave.)

They also isolated the Iraqis who needed to be segregated from the rest of the public, and, ideally, tried to solve routine problems that Iraqis brought to the CMOC. While doing that, they separated those we could help from those we couldn't. They then told the latter category where to find help.

One junior NCO was put in charge of tracking the days that the interpreters worked and ensuring the interpreters stayed on-task; the other junior NCO was tasked with maintenance on the building and vehicles.

The Soldiers manned the entrance to the CMOC, providing a final layer of security. They also spent time securing food for the CMOC, refueling generators, and in the event that a "wanted Iraqi" came in off the street, the Soldiers were prepared to become the detainee team.

We made extensive use of our Soldiers' civilian skills. Fortunately, we had two electricians with a background in air conditioning repair.

We found the Iraqi staffing at our CMOC worked best with five dedicated interpreters and a couple of cleaning people. Typically, we assigned one interpreter to the front door, one interpreter to claims (we needed more or less, depending on the volume of claims), one interpreter to the OIC and two interpreters as backups or extras. The two extras might sound frivolous, but interpreters were just like American workers—they fell ill, needed days off or sometimes just did not show up. The cleaning people also provided refreshments to Iraqi visitors, when appropriate.

When conducting leader engagements, we asked ourselves two things: could we trust the interpreter and was the interpreter suited to the guest? Some Iraqis only were comfortable with an interpreter having a similar background or with a specific individual they trusted.

It was best for us to start new interpreters at the front door where they could be observed. There was always the suspicion that some may have been working for or providing information to the insurgency. We relied on our S2 or a THT to interview and "vet" our interpreters.



A Qada, a local government group, meets at the Civil-Military Operations Center (CMOC).



To maintain order among the interpreters, it was best to be stern but factor in that they came from a different culture and had different considerations when it came to doing their jobs. For instance, arriving on time was not mandatory in the Iraqi mind. We initially put out that we wanted the work day to begin at an established time; however, interpreter safety was a serious concern because some interpreters and their families had been targeted by the insurgency. Therefore, a smart interpreter varied his routes and times, which caused some variance to his start time. In addition,

cars broke down, interpreters had to go through checkpoints, there might have been a curfew, and the interpreters might have had to avoid civil unrest, sandstorms or roadblocks.

Several interpreters were unproductive and abused these excuses, so we dismissed the worst offenders and downsized. This caused the others to “straighten up” and actually produced a happier working environment. The Iraqis call that practice, “kicking the dog to warn the lion.”

Another potential pitfall to watch for and end quickly was interpreters having private side-conversations with the Iraqis during our meetings. A large amount of time was spent in “small talk,” but the talk needed to be between the Coalition Force’s representative and the Iraqi leader—the interpreter was just a go-between. When side conversations happened, we stopped the interpreter and asked what the visitor was saying. After we did this a couple of times, they understood their role more accurately. The interpreters also were invaluable resources for understanding the Iraqi culture and background of the leaders being engaged.

There was a danger of our Soldiers becoming too friendly with the interpreters. Naturally people who work together become friends, but the Iraqis sometimes tried to have the Americans play favorites with the interpreters and even tried to play the Americans against each other. Normally the NCOIC talked to the Soldiers about once every two weeks concerning inappropriate behavior. The interpreters usually only received one warning before they were dismissed.

Ultimately, the job of the enlisted

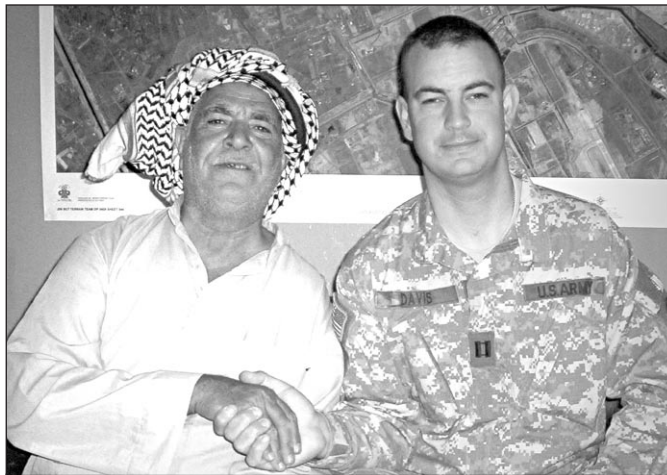

Captain Rob Davis meets with the father of an insurgent about a claim for damages to the father’s house caused when Coalition Forces blew up his son’s cache of explosives. The claim was denied.

Soldiers was to run the CMOC in such a way that problems were resolved before they ever reached the OIC. The OIC, with his dedicated interpreter, only needed to concern himself with engaging Iraqis to execute the battalion commander’s guidance for shaping the AO.

*Motivating Engagements.* In our quest to entice Iraqis into engaging us, we used what we called “carrots and sticks.” Upon arriving in Iraq, we quickly realized that events had overcome our stateside training scenarios. The tools and authority we anticipated having to help us resolve issues were things of the past.

Among the surprises, the battalion commander had no money to spend at his discretion and contracting authority was removed to higher levels. We, therefore, were forced to be creative in finding inducements to motivate the Iraqis to visit the CMOC and participate in CMO engagements.

The most powerful motivator for the Iraqis was money, whether the money came from a reconstruction contract or as a reward. The particulars of contracting varied from AO to AO and from headquarters to headquarters, but the trend of moving control of the contracts away from the battalion toward much higher echelons and, eventually, to the Iraqi ministries was evident from our first day.

Although projects were approved and managed at a higher level, we could advance project ideas through the Army bureaucracy. Some contactors were thieves or insurgent supporters, but some were an excellent source of actionable intelligence. Insurgents threatened the workers, the workers complained to

the project managers who, in turn, identified the insurgents for the Coalition Forces. We successfully suppressed several terrorist cells using this technique. The best contracts for this purpose were the smaller ones that could be given to cooperative people, for example trash pick up.

We drew the community in by using some of the other standard incentives as well. We received claims and helped people understand the claims process. Dealing patiently and courteously with claimants engendered tremendous goodwill and a stream of information into our office

regarding the local insurgents and the neighborhood social landscape. Filing claims, or at least coming to the CMOC under that pretense, was an excellent way for sympathetic locals to approach us while avoiding the anger and suspicion of their neighbors.

Additionally, we conducted our battalion’s reward programs through the CMOC and its staff. We also distributed donations to local organizations and people through the CMOC. Using supportive local figures to help with the distribution was an effective way to empower them in the community. Then they could aid us better in our efforts.

In one instance, we distributed frozen chickens to the community, using (in part) friendly sheiks and local government leaders to help select the recipients and make the actual deliveries. More often, we delivered school supplies to students. During those visits, we always tried to take Iraqi army leaders to advance positive relations between them and the community.

The most productive inducements that we had to offer, however, were ones we created. The CMOC became the prime conduit for returning seized property. In the course of operations, the maneuver units came into possession of cars, phones, guns, computers, money, etc. Understandably, Iraqis were eager to reclaim those items. Our work in locating and returning the property went a long way toward demonstrating the Coalition Forces’ honorable intentions and the beauty of the rule-of-law.

We also routinely used this as a follow-on opportunity to find out information from the claimants. In one particular instance, we matched a car claimant

with a maneuver patrol that wanted to know where he lived. The man was a recently released insurgent suspect. The patrol met him at the CMOC and escorted him with his car back to his house where (after a brief search) they discovered a weapons cache.

Badges were another extremely popular incentive that the CMOC could offer. Iraqis treasure badges and keep them long after they expire. When meeting new people, Iraqis commonly produced badges going back to their school days.

We tapped into this cultural value by issuing badges.

Where allowed by Army policy, we issued weapons-carrying cards, sheik cards and even “cultural advisor” cards. Obviously these badges were not given randomly. We carefully evaluated candidates before issuing the cards, but even the possibility of getting them drew the Iraqis.

The alternate method of bringing in the community using “sticks” was not effective. Essentially, we were limited to detaining people or withholding the “carrots.” Neither option proved to be effective, so we almost never took a negative approach to people.

*Networking.* Almost all of the benefits offered to the Iraqis at the CMOC and many of the benefits that we hoped to enjoy from the CMOC engagements required us to build connections between locals and various Coalition elements beyond the fire supporters who were staffing the building. Among the more obvious bridges to build were the ones between the locals, the brigade-level project management teams and the Iraqi contract seekers.

In some AOs, the battalion had an attached civil affairs team (CAT) that handled the technical details of writing contracts and proposals. Other AOs did not. We found ourselves having to assume that function in the FSE.

In all cases, however, we had to play matchmaker between the Iraqis wanting the work and the Coalition agency that authorized and paid for that work. Likewise, we formed the link between Iraqis wanting to file damage or loss claims and the government legal departments that actually adjudicated the claims and the finance offices that paid the claims.

We were not *required* to help in either of these two matchmaker categories.



(L-R) SSG Donald Menger, SPC Chris Davis, SGT Terry Brooks and SPC Conner from the 2-130 IN FSE sort through school supplies donated by US citizens.

These roles were not mandated, and we could have directed the community to other offices. But by making ourselves the middlemen, we gave the Iraqis a powerful reason to come to us.

When they did come to us, we were able to derive advantages, often through help from others. Information was the most desirable result of the visits. We at the CMOC had no resources for acting on what we learned; therefore, we had to connect the Iraqis with the proper members of the intelligence community or, at times, with the maneuver elements that would be the end users of the information.

In every AO and in each case, we were extremely careful to involve the battalion S2 section in the CMOC’s activities. Likewise we often introduced Iraqis to the THTs and invited those teams to use our facilities for interviews.

There are a number of Army policies and public laws prescribing who can perform intelligence tasks. We scrupulously observed those policies and laws and did not intrude on other agencies’ “lanes.” Carefully maintaining these relationships with the S2 and others allowed us to work quickly within the battalion to connect the people who wanted to share their knowledge about the AO and its people, good and bad, with the infantry companies who were responsible for those neighborhoods.

When a “promising” person walked into the building and displayed a willingness to work with us, we called the S2 and company or battalion commanders to meet that person. Sometimes they just talked to us, but other times they put on masks we kept ready and rode with the commanders to identify insurgents or safe houses.

Sadly the insurgents were not the only problems the people brought to

us. Several times local workers came to us to complain that they were being squeezed for bribes to work in certain areas or were being threatened away altogether. When they brought these cases to our attention, we worked through the battalion tactical operations center (TOC) to route infantry resources to investigate and resolve the problems.

It is a certainty that organizations on future deployments will learn, as we did, that all TTPs require refining or updating. However, by building a battalion CMOC operation based on the five concepts of access, infrastructure security and hospitality, staffing, engagement motivation and networking, they will have a tremendous opportunity to realize benefits mirroring those the *Blackhawks* experienced in all of our diverse AOs.

Furthermore, if a battalion is fortunate to remain in one area for an extended period, it will discover that when these concepts are matched with patient pursuit and longevity in an AO, the potential for success grows even greater.

---

**Captain Robert C. Davis is assigned to the 1st Battalion, 118th Field Artillery (1-118 FA) of the 48th Brigade, Georgia Army National Guard (GAARNG). He was deployed to Iraq from May 2005 to May 2006 as the Battalion Fire Support Officer for 2-130 IN, ILARNG. His collateral duties included managing the battalion’s Civil-Military Operations Center (CMOC). Captain Davis was commissioned in the active Army in 1995 as an FA officer and spent four years with the 10th Mountain Division at Fort Drum, New York, before joining the GAARNG. Among other jobs in the 10th Division, he served as a Battalion and Division Artillery S1. He has had two battery commands: Headquarters and Headquarters Battery (HHB), 1-118 FA, and B/1-118 FA. In civilian life, he is a high school English teacher.**

**Sergeant First Class John L. Kullman is assigned to the 1-118 FA. He was deployed to Iraq from May 2005 to May 2006 as the Senior Battalion Fire Support NCO for 2-130 IN, ILARNG. He has a total of almost 15 years of service in the Army, serving nine years as an Infantryman and the last six as an Artilleryman. His collateral duties during the deployment included building and managing the battalion’s CMOC. He deployed previously to Somalia with the 3rd Infantry Division and participated in Operation Iraqi Freedom (OIF) I as part of the 122nd Rear Operations Center (ROC), GAARNG.**

# The Deployed Commander's Information Band of Tolerance

The process of receiving, assimilating, filtering and conveying relevant information to an individual is a challenge that every Army leader will experience. Over the course of many combat deployments, it becomes evident that the concept of too much or too little information can cost commanders their ability to make sound decisions. Outlining information and determining for the commander where the critical decision must be made set the conditions for success.

The 4th Fires Brigade at Camp Liberty, Baghdad, Iraq, has taken information management to the next level. During pre-deployment training and the beginning phases of the 4th Infantry Division's (4th ID's) role in Operation Iraqi Freedom (OIF) 05-07, the fires brigade sought ways to improve and streamline the application of information management.

Based on the principle of an information

---

By Lieutenant Colonel  
Timothy J. Daugherty and  
Captain G. Damon Wells

---

band of tolerance (IBOT) that falls in a spectrum of all available information, the optimal amount of information conveyed is that required to make a viable decision. (See the IBOT model in the figure on Page 34.) The top line of the model is the theoretical state when all information flowing in for decision-making would be too overwhelming. Consequently, it does not support decision-making requirements. The bottom line represents minimal information flow and, again, does not lead to an effective decision.

The "garrison" or peacetime environment on the model encourages a wide IBOT. Leaders can accept and manage more information and discard irrelevant information in garrison. They also can accept less information because they can request more information later, if needed. In garrison, it is common for leaders to be presented

the same information many times before a decision is needed.

The IBOT model represents the change in information flow as a unit transitions from garrison to wartime operations.

Leaders in a deployed unit make far more critical decisions than garrison leaders on a daily basis. In fact, almost every decision a deployed leader makes has implications for accomplishing the mission and the well being of Soldiers.

In the high-stress deployment environment, the IBOT is much smaller and the information flow is more concise. The potential severe consequences of a poor decision force this IBOT into a tighter "band." Too much information wastes time and clutters the decision-making process. Too little information causes the leader to either make the wrong decision due to simple ignorance or requires a request for more information, which wastes time at a critical moment.

During a combat deployment, those key decisions that produce a measurable effect (positive or negative) on the commander's unit are greater in number and individual importance. This greater number of critical decisions is based on the principle that leaders are programmed to have certain levels of interest in decisions of varying severity made in their units.



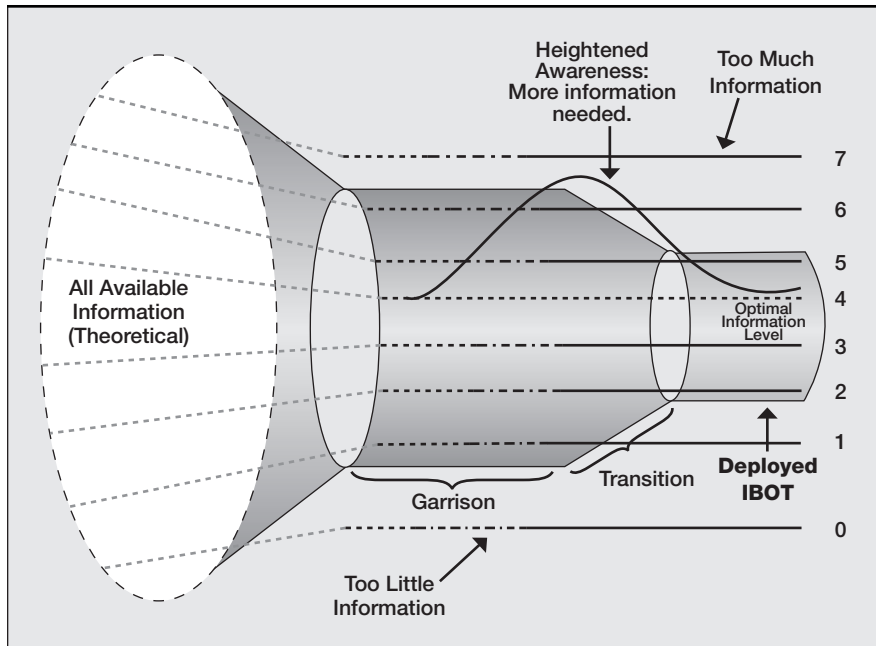

Information Band of Tolerance (IBOT) Model. When an incident occurs, the deployed commander may need more information on that specific event for a period of time, as shown as a “wavelength” through the IBOT model.

However, the leader who focuses on everything, focuses on nothing.

Limitations imposed on a leader’s schedule always have the same result: inefficient use of time leads to untimely or poor decisions. A staff that can effectively “manipulate” time by focusing on a narrow IBOT will create an environment that is conducive to decision making.

**IBOT Movement.** Think of the IBOT as a band of “wavelengths.” The total IBOT rarely fluctuates as a whole. A variety of different topics comprise the IBOT, and this represents the sum of the scope of interest for a particular command.

Each topic or potential topic has an individual wavelength. As these topics become more or less relevant, their corresponding wavelengths increase and decrease in magnitude.

The total number of wavelengths is infinite and is normally situationally dependent. The commander dictates to the staff the necessary topics, and the staff must anticipate any topics that require a decision in the near future.

The wavelength of a subject in the IBOT will increase or decrease as a result of specific events or lack of events. An increased IBOT wavelength will convey more information while a decreased wavelength conveys less. This shift in direction is the result of an action (or lack of action) that requires more (or less) information. The acceptable level of information prior to the event is no

longer applicable.

The increased IBOT is usually a result of a significant event (but can be due to the *anticipation* of one). For example, an indirect fire incident that kills local nationals requires more information for the commander (increase the IBOT). An effective staff must anticipate this need for information instead of waiting for guidance. Higher headquarters certainly will require more information. If a mosque is blown up, the staff will need additional information on the event and related topics. Too often the staff does not work to predict what additional information is required, and the 1900 battle update brief (BUB) goes as planned, no matter the situation.

The increased IBOT model applies to planned events also. It is obvious that more information is required for certain operations, but an effective staff can take information from commanders, staff and other units to anticipate and provide an increased IBOT.

For example, a trend in negligent weapons discharges across the division could increase the IBOT. Even if a commander did not experience such incidents, he can anticipate the possibility, given the trend, and avoid an incident with a properly focused IBOT. His staff should provide this information and encourage a course of action (COA) *before* the event.

A decrease in an IBOT wavelength is not necessarily due to a lack of interest. It also can be attributed to a staff that

can take control of that subject area and maintain adequate decision-making tools for its boss.

Eventually, as leaders begin to delegate less important missions to others and focus on “hot” topics, the IBOT on the remaining issues will move down. The commander’s focus is on topics he deems crucial at that time. As information on areas of lesser importance is stripped out of the IBOT, more time and resources can be dedicated to the commander’s priority areas.

The staff, however, must maintain visibility on all areas and topics. A focused IBOT does not negate the need for encompassing awareness; it just de-emphasizes the more stable topics. If a leader reaches a point on a topic where he is comfortable with the end state and there is no fluctuation, the IBOT decreases.

**Managing the Information: Filtering the IBOT.** There are a number of things that staffs and subordinate commanders can do to ensure the commander gets the information he needs to make good decisions.

- Design the garrison IBOT to reflect the deployment IBOT—create an information flow environment that works in garrison and during deployments. The staff and subordinate commanders must work to make information flow more concisely and efficiently (an acceptable reduction) in garrison. Although leaders can manage a wider, less efficient IBOT band in a less stressful environment, this requires the unit to revise its information flow techniques once deployed. This change causes an initial “shock” effect; once deployed, units waste valuable time re-learning information conveyance methods to make the information more concise.

For example, units should eradicate the “marathon” email traffic that has become rote and commonplace in garrison. Inept, long and cumbersome briefings have become a standard in many units as well. These bog down and clutter the decision-making process.

- Understand times and reasons for IBOT movement and plan accordingly. If a high-visibility event happens, the staff and commanders immediately can assume that the IBOT must respond, and the commander will need more information. Subordinate leaders must shift the IBOT in anticipation of the commander’s needs.

- Make a concerted effort to structure the information flow to the boss in a

concise manner. One of former III Corps Commander Lieutenant General Thomas Metz's remarks was "It takes a lot more talent and an efficient thinking process to write a functional one-page information paper on a topic than to develop a 20-page slide show."

Too many units have gotten into the habit of overwhelming leaders with information, beating them into submission with nonessential details.

The more difficult and complicated tasks should receive more attention in the process of "packaging" the important information for the commander. The information should clearly outline the topic, providing the commander the information he needs—not *all* the information on the topic, much of which is superfluous. The briefer/writer should examine the sequence and packaging of his information in terms of how the info will affect the commander's comprehension.

- Identify and examine those subjects the commander is getting too much information on and reduce the corresponding wavelengths or delete the topics altogether. The boss does not need information that does not affect his wartime mission—it is irrelevant information. This is a complicated but crucial issue. Subordinates can handle certain issues without dragging the boss "down into the rat hole" with them.

It is unavoidable that sometimes a staff member or a subordinate commander will "miss the mark" and withhold information from the commander that required his input or influence. But for the most part, the busy commander will appreciate the staff's keeping the less critical issues "off his plate."

- Give the commander a simple, functional means to gain the information he needs—develop methods that present data effectively in an information-rich manner. Too often, we see subordinates sending huge email files for leaders to try to print or read on the screen—printing the info or reading it on the screen are not efficient or clear ways for him to get the information. Subordinate commanders and staff should not send the commander slides on email but give him a hard copy so he can see and touch the information, quickly jot down a couple of notes on it and return the product with valuable input and guidance.

The "clipboard method" is a proven technique that reduces confusion and saves time. Instead of being hammered by questions that require some immedi-

ate research, staff and subordinate commanders can provide the boss a clipboard with five to 10 highlights, recent events, or answers to questions that he had the previous day. Standardized background information should be on the back of the clipboard for quick reference.

This technique is especially handy for meetings. During the meeting, the boss can write notes on it. The next day, the staff can have the answers to his questions on the clipboard. This method saves time for the boss and the subordinate.

**IBOT Dispersion.** There are certain aspects of today's Army that have become institutionalized and, unfortunately, cause a "dispersion" of the information in the IBOT instead of focusing on the right information. These are information flow "killers." Subordinates must negate these unhelpful habits and techniques. A few of these institutionalized bad habits are long emails, meetings the commander doesn't need to attend, unnecessary recurring meetings, too many commander's critical information requirements (CCIR), staff burn out, not factoring in the commander's experience level and not keeping the information (and action) at the lowest level possible.

*Long Emails.* Emails with "FYI" or "see below" and no summary are ineffective and cumbersome. Information conveyed via CDs, websites and internet portals are equally ineffective for leaders. Leaders should not be forced to search for the information they need—have to track it down in forums or search a table of contents on a CD.

If these tools are absolutely necessary, the subordinate should request permission to find the site, bookmark it and provide methods to help the boss collect information. Subordinates should be dedicated to assimilating valuable, actionable information.

*Non-Commander Meetings.* Subordinates should cover meetings for the boss, whenever possible. After the meeting, the subordinate composes a one-page summary of key events. Ideally this concise document is a "stand-alone" and does not require a briefing.

This process helps the commander in two ways: he saves time by not having to attend meetings and can read the summaries at his convenience. Counting preparation time, movement to and from the meeting and the meeting (most of which are more than an hour), this process saves the commander a considerable chunk of valuable time. Most meetings can be concisely summarized

in a functional one-page paper or briefed in about 15 minutes.

*Unnecessary Recurring Meetings.* The recurring meeting has become a "staple" in the Army. Many times, these meetings evolve into tortuous sessions of endurance with about 20 percent of the meeting applicable to any one attendee.

Each staff must take a hard look at these meetings and reevaluate the "take away" value. Was it worth 90 minutes of everyone's day? Could this information have been conveyed or distributed more effectively? Are you smarter or better equipped for having attended the meeting? Would a more streamlined one-on-one forum with key personnel have been more productive? Some of these recurring meetings are unavoidable due to the high visibility of the topic.

Maintenance meetings come to the forefront of many mechanized units. This is typically a forum to convey the maintenance status of all non-mission capable (NMC) vehicles to the senior maintenance officer (executive officer, or XO). However, if all units come to these meetings with the same information they leave with, what was the value added? If subordinate leaders are diligent in providing the right information to superiors, then these meetings become unnecessary.

*Too Many CCIRs.* Subordinates must evaluate the CCIRs progress aggressively in garrison and then plan the changes to those CCIRs in combat. Does the commander still want to be notified about issues that are in the realm of the rear detachment command? Does a CCIR require a decision by the commander? If so, clearly tell him where in the briefing he can expect to make that decision. Attempt to streamline this process so that subordinate leaders are empowered.

*Staff Burn Out.* A heightened level of the staff's mental and physical conditioning is imperative for a unit to be effective in combat operations. A common pitfall of a staff is to attempt to work itself to death. This can crush an otherwise effective staff during a deployment.

The staff effectiveness threshold for a continuous operational tempo (OPTEMPO) of more than 12-hour days is about six months. Most units still can produce acceptable products until then.

An attempt to work increased hours on a daily schedule for longer will prove disastrous for most personnel. Leaders must force each other to work no longer than eight to 10 hours a day, if at all possible. They also must establish a viable

physical training regimen for themselves as well as their Soldiers.

Units need a method to enforce personal time, social functions, staff interaction and rest and relaxation time. To the “Type A” personality, this seems like a waste of time, but the aggregate or composite dividend over the course of a year is higher, and the staff maintains a higher mental acuity. Leaders must plan for the long term.

*Not Considering the Experience of the Decision Maker.* Senior leaders are capable of making decisions with less input than junior leaders because they have detailed cognitive schemata based on years of experience. Junior leaders will require more information because of their lack of operational experience. That need for more information should not overflow into the information provided the more senior decision maker.

*Information (and Action) Not Kept at the Lowest Level.* Leaders must resist the temptation to “reach” down to a much lower level (team, section or platoon) for information digitally just because

they can. Currently, the Army has the ability to give general officers accurate, real-time information about section-level actions and allow them to communicate guidance to the sections directly, if they choose. The problem is that a more senior leader or staff member using this method “trumps” the junior leader and, in the long run, cripples the process by which the junior leader learns how to make important decisions. Senior leaders should foster the decision-making skills of subordinates.

Senior leaders should empower their subordinates with as much responsibility as they can handle.

A staff’s application of the IBOT model requires a level of diligence and a resistance to information overload. An initial effort is required at every engagement to streamline the flow of information. However, this process becomes faster and more effective over time. Eventually, the IBOT becomes the greatest contributor to the unit’s time management and the boss’s level of knowledge, ability to make decisions and personal efficacy.

**Lieutenant Colonel Timothy J. Daugherty is the Deputy Commanding Officer of the 4th Fires Brigade, 4th Infantry Division, at Camp Liberty in Baghdad, Iraq. In his previous assignments, he was the Executive Officer (XO) for 3d Battalion, 82 Field Artillery (3-82 FA), 1st Cavalry Division, at Fort Hood, Texas, and also the battalion’s S3 during Operation Desert Strike in 1996 in Iraq; Fire Support Officer (FSO) for 2nd Brigade, 1st Cavalry Division; a Battery Commander in 1-7 FA, 1st Infantry Division in Bosnia; and a Platoon Fire Direction Officer (FDO) for 2-3 FA, 1st Armored Division, in Germany and in the Gulf for Operation Desert Storm.**

**Captain G. Damon Wells commands Headquarters and Headquarters Battery, 4th Fires Brigade, at Camp Liberty. Previously, he commanded Headquarters, Headquarters and Service Battery, 2-20 FA, 4th Infantry Division, at Fort Hood. During Operation Iraqi Freedom (OIF) I, he was the FSO for 1-10 Cav, also in the 4th Infantry Division. Other assignments include his serving as a Company FSO for 3-325 IN, 82nd Airborne Division at Fort Bragg, North Carolina, and Battery Fire Direction Officer for 2-319 FA, also in the 82d Division.**

## FUBAR to Fobbit: War Influences Language

**H**istory shows that when the US armed forces go to war, they also give birth to new American language. Every war gives rise to cutting-edge terminology and unique slang terms.

What is war’s influence over words? Grant Barrett, author of *The Official Dictionary of Unofficial English*, notes that new military jargon and slang are an inevitable by-product of a tight-knit group with a focused purpose working together in tense situations requiring verbal shortcuts. Language is also one of the ways Soldiers can be creative.

From the first World Wars, terms such as “FUBAR,” (or the Vietnam-era FUBAB—which stands for F%#\$!\* up beyond all belief) “AWOL,” “think tank,” “Dear John” and “white knuckle” seeped into popular culture. Today, with the Global War on Terrorism (GWOT), new words are appearing that give insight into the daily lives of Coalition Soldiers fighting in the Middle East. Here are several terms that are fresh out of GWOT.

• **Angel**—n. Among military personnel in Iraq, a Soldier killed in combat is an angel.

• **Fobbit**—n. From FOB plus hobbit,

a Soldier or other person stationed at a secure forward operating base (FOB) is a fobbit, hence, someone who seeks the security and comfort of a well protected military base. Variations are “FOB mon-key” or “base camp commando.”

• **Ali Baba**—n. or v. An Ali Baba is a thief. After the government of Saddam Hussein was toppled, looting ravaged Iraq—most anything of value was stolen or destroyed. Iraqis call looters and thieves “Ali Baba” after the tale of “Ali Baba and the Forty Thieves” told by Scheherazade in the stories known in the West as *One Thousand and One Nights*.

American Soldiers serving in Iraq say they tend to use the term not as a noun but as a verb meaning “to steal”: “We’re going to Ali Baba some scrap metal from their junkyard.”

• **Hillbilly Armor**—n. Hillbilly armor is scavenged materials Soldiers use for improvised bulletproofing and vehicle hardening in Iraq. American Soldiers jerry-rigged vehicles in attempts to harden them against enemy weapons or explosives.

• **Mortaritaville or Mortarville**—n. Mortaritaville or Mortarville is a military base that is attacked regularly. It usually

refers to Logistic Support Area (LSA) Anaconda near Balad, Iraq, although an informant says that a multicolored “Welcome to Mortaritaville” sign was displayed at Log Base Seitz (also known as “Seitzkatraz” or “Impact Zone Seitz”) in late 2003. Mortaritaville is a play on the Jimmy Buffet song “Margaritaville.”

• **Backdoor Draft**—n. A backdoor draft is an extension of military enlistments through stop-loss orders that force personnel to extend their tours of duty.

• **Shako Mako**—n. An Arabic term that loosely is translated as “What’s up?” or more specifically, “What do and don’t you have?” or “What’s there and not there?” It is commonly one of the first Iraqi-Arabic expressions Coalition Forces learn. A common response is *kilshi mako* or “Nothing’s new.”

While it’s too soon to tell if these words will outlast Operation Iraqi Freedom (OIF), such words fill the niche created by Soldiers functioning under unique—and often extreme—circumstances.

*The Official Dictionary of Unofficial English* by Grant Barrett is published by McGraw-Hill Companies, ISBN 0-07-145804-2, and costs \$14.95 for the paperback.

# 4th Fires Brigade in Iraq: Setting the Conditions for Safe Operations

The 4th Fires Brigade is halfway through its rotation in Operation Iraqi Freedom (OIF) V, and we are pausing to identify areas where we have set the conditions for safety and where we can improve.

Our organization consists of three battalions and eight company-sized units for a total of 3,000-plus Soldiers and 700 pieces of equipment that are either organic to the brigade or under our operational control (OPCON). Within that framework, these units have hundreds of different missions, ranging from our organic target acquisition battery's (TAB's) mobile training team (MTT) mission to provide technical and tactical expertise on the employment of the Army's new lightweight countermortar radar (LCMR) to the headquarters and headquarters battery's (HHB's) mission to conduct convoys for the brigade commander's movement throughout Baghdad.

In the monthly review of our safety program, we have identified some key building blocks that have enabled us to conduct varied operations throughout our battlespace safely. During these operations, we've experienced minimal accidents and injuries to our Soldiers and equipment while still maintaining our focus on warfighting and accomplishing the mission.

Not all our success comes from actions typically thought of as "risk mitigation," although risk mitigation certainly is part of our routine planning process. The following elements have proven significant in keeping our Soldiers safe and successful.

**Brigade Safety Officer.** Our safety officer is a key member of the commander's safety program and is responsible for ensuring that safety is observed throughout the brigade. He consolidates all safety guidelines and standing operating procedures (SOPs) that are significant to every scenario and event Soldiers may encounter daily.

For example, we continuously train our Soldiers on convoy operations and evaluate their performance and actions before, during and after convoy operations. In response to the Soldiers' actions during simulated training scenarios, ad-

By Lieutenant Colonel Timothy J. Daugherty, Command Sergeant Major Gilbert L. Canuela and Captain Jared J. Sutton



Sergeant Major Kevin Jones, Operations Sergeant Major for the 4th Fires Brigade, conducts a pre-combat inspection of a convoy before it departs Camp Liberty in Baghdad.

ditional safety guidelines and procedures have been developed and added to the convoy SOP.

Daily risk assessments are the foundation of our risk management strategy. At the morning battle update brief (BUB), the brigade safety officer assesses the hazards for the day. He begins this process each Sunday when he updates a weekly composite risk assessment based on the projected weekly missions, other coalition operations, weather, the current enemy situation, and tactics, techniques and procedures (TTPs). Then each morning before the BUB, the safety officer ensures that the risk assessment is still valid and makes any adjustments.

During the briefing, he focuses the battalion, battery and company leadership on key hazards they may face that day. The BUB provides an opportunity for the commanders and safety officer to come together and discuss current safety issues.

**Command Relationships.** Another key building block of our safety program is the relationship between the commanders and the special staff. The commanders and staff have a mutual trust and understanding regarding the safety program. Every effort has been made to ensure that free dialog continues between the command teams and the safety subject matter expert (SME).

This policy has created an environment where subordinate units can meet and discuss the issues at the monthly safety meetings or incident review boards objectively without fear of the discussion turning into a "blame game." This special relationship also allows for positive safety reinforcement with weekly safety inspections.

At the Wednesday morning BUB, the safety officer announces the current inspection's focus. This focus is determined using input from the subordinate units. The safety officer conducts each inspection, providing the subordinate commander an additional set of objective eyes on the commander's safety programs. The inspection covers a wide variety of areas, such as fire extinguishers, documentation in the dispatch books and the type of protective eye wear worn by Soldiers.

The results of the previous week's inspection are displayed at the BUB, but care is taken to ensure only trends are displayed—not which units had the issues. This strategy preserves the open working environment between the subordinate units and the safety officer while highlighting areas that need additional focus.

**Safety Counsel Meetings.** Monthly safety counsel meetings are opened by the brigade commander or the deputy commanding officer (DCO) and conducted by the brigade command sergeant major (CSM). These meetings provide a forum for dialog on current trends and issues.

The safety officer always is present and helps capture the brigade's trends and TTPs for success. The CSM keeps the focus on what we have done, what we did well and where we can improve. This forum atmosphere keeps the focus on fixing an issue rather than simply providing time for a standard pitch by the safety officer.

**Safety Stand-Downs and Other Programs.** In the event of an incident occurring or a unit isn't following safety guidelines, the brigade adopts a "heightened awareness" posture at the unit level. The unit conducts a safety stand-down for 24 hours to provide corrective training and safety awareness.

Instead of the usual white flag, a red flag is flown over the headquarters building during this time. The red flag lets others know that the unit is conducting additional safety training or investigating an incident that occurred as a result of non-compliance with safety guidelines.

The brigade holds a regular weekly leadership development program that is mandatory for the separate company and batteries and optional for the battalions. These programs are taught by various staff sections and highlight critical components of combat operations for our leaders. Topics include changes to the convoy SOP, use of the improved first aid kit, the best way to incorporate the various electronic warfare (EW) systems to counter the radio-controlled improvised explosive devices (IEDs) into convoy operations, the latest enemy IED TTPs and composite risk management.

Other safety measures include training events and increasing our safety posture by providing a fresh look at areas where Soldiers might become complacent, such as when conducting repetitive missions in a combat environment.

**Weapons and Equipment Training.** Weapons ranges, such as the M2 .50 caliber, M240B and M249, feature prominently on unit training calendars. The ranges' focus is on more than simple qualification or familiarization with the weapons. An important part of the safe operation of crew-served weapons is how to mount and remove them from the turret of a vehicle, load and unload them, and properly clear the weapons.

Brigade training and competitions, such as the M1114 up-armored high-mobility multipurpose wheeled vehicle (HMMWV) lanes and competition, provide opportunities for Soldiers and leaders to broaden their combat training in

a controlled environment while demonstrating their proficiency in essential warfighter skills. The M1114 lanes focus on training the unit's convoy SOP and battle drills in a crawl-walk-run format. The M1114 competition reinforces that training by providing an opportunity for Soldiers to determine who the best is at what they do.

Events, such as the semi-annual combat logistics patrol lanes, provide an excellent opportunity for leaders to check unit safety factors and procedures and certify sections in the Soldiers' abilities to conduct the tasks. Soldier's caring programs help identify at-risk personnel and are an effective risk-reduction tool and key component of the unit's safety program.

**Individual Counseling.** Our units conduct individual counseling with Soldiers on a regular basis. The need for safety during day-to-day operations is reinforced during counseling. Our units counsel Soldiers who are getting ready to return home on leave, which ensures safety expectations are explained down to the Soldier level throughout the brigade. Every supervisor also maintains a leader's book to help implement the appropriate risk-reduction measures for the section and identify potential areas or personnel who pose an increased risk to themselves or the unit.

Risk-mitigation controls are a series of links in accident prevention, and it takes only one successful link to keep an accident from happening. Most accidents are not caused by a single error; rather, they're due to a series of failures in control measures. Any leader or Soldier can prevent an accident from happening, but only if they know the control measures.

Here's an example: A Soldier had a Class C incident when he lost his footing and fell while dismounting from the back of a family of tactical vehicles (FMTV) vehicle while carrying a heavy load. Attempting to break his fall, the Soldier pushed himself away from the vehicle. However, he landed on his side and fractured his elbow.

After a thorough investigation, the brigade leadership determined that the cause of the accident was simply a result of failure to observe the common safety measures. This incident could have been prevented if any one of the following controls had been observed: the Soldier should have been trained properly on the new vehicle, systems and operations; the Soldier should have used a ladder to

mount and dismount oversized vehicles such as the FMTVs; the Soldier should have maintained three-point contact to mount and dismount the vehicle; and the Soldier should have used designated loading docks to load and unload heavy cargos.

As our brigade continues its mission, our Soldiers likely will encounter significant changes in their surroundings that will require different approaches. As circumstances change, the existing courses-of-action (COAs) will become outdated and require changes. To maintain our units' competence and effectiveness, our brigade safety officer will continue to develop safety programs to tackle every situation. In addition, we will continue our other programs to ensure Soldiers are safe while accomplishing their missions. They deserve nothing less.

---

**Lieutenant Colonel Timothy J. Daugherty is the Deputy Commanding Officer of the 4th Fires Brigade, 4th Infantry Division, at Camp Liberty in Baghdad, Iraq. In his previous assignments, he was the Executive Officer (XO) for 3d Battalion, 82 Field Artillery (3-82 FA), 1st Cavalry Division, at Fort Hood, Texas, and also the battalion's S3 during Operation Desert Strike in 1996 in Iraq; Fire Support Officer (FSO) for 2nd Brigade, 1st Cavalry Division; a Battery Commander in 1-7 FA, 1st Infantry Division, in Bosnia; and a Platoon Fire Direction Officer (FDO) for 2-3 FA, 1st Armored Division, in Germany and in the Gulf for Operation Desert Storm.**

**Command Sergeant Major (CSM) Gilbert L. Canuela is the 4th Fires Brigade CSM in Iraq. Among other assignments, he has served as CSM of the 24th Infantry Division and Fort Riley, Kansas; the Army Test and Evaluation Command and White Sands Missile Range, New Mexico; the 1st Armored Division Artillery in Germany; and 1-41 FA, 3d Infantry Division, Fort Stewart, Georgia, deploying with the battalion to Kuwait during Operation Desert Thunder in 1998.**

**Captain Jared J. Sutton is the Brigade Liaison Officer for the 4th Fires Brigade in Iraq. He commanded B Battery, 2-20 FA, 4th Fires Brigade, at Fort Hood. He previously served as the S1 and S4 of 2-20 FA during Operation Iraqi Freedom (OIF) V. His other assignments include serving as an FSO for III Corps Headquarters at Fort Hood, FSO for 4th Squadron, 2nd Armored Cavalry Regiment (ACR) at Fort Polk, Louisiana, and as a Troop and Anti-Tank Company FSO for 1-2 ACR, also at Fort Polk.**



# The New Precision-Guided Mortar Munition (PGMM)

The Defense Science Board of 1996 said, "It is estimated by the year 2010, 75 percent of the world's population will live in urban areas. Urban areas are expected to be the future battlefield, and combat in urban areas cannot be avoided." The board's prophecy is proving to be accurate as our armed forces execute full-spectrum urban operations in Iraq, often with restrictive rules of engagement (ROE) that limit the amount of collateral damage. The need for responsive precision munitions that reduce collateral damage has yielded programs such as the XM395 precision-guided mortar munition (PGMM).

**What is the XM395 PGMM?** It is a multipurpose laser-guided 120-mm mortar cartridge capable of engaging high-payoff targets (HPTs) out to a maximum range of 7,200 meters. Its accuracy reduces collateral damage and decreases the logistics burden.

It is fired much like any standard mortar cartridge after programming the fuze with time-of-flight, target type and laser code of the day. It can be fired from all current and future smooth-bore 120-mm mortar weapons and flies ballistically to its search area. The laser sensor can acquire targets with an increased angle-T and requires minimum lasing times.

The PGMM's target set is enemy personnel protected by brick over block walls, lightly armored vehicles or earth and timber bunkers. The current PGMM (Increment 1) engages stationary targets, but future increments will include moving targets and a longer range (12 to 15 kilometers). The PGMM is the battalion or task force commander's hip-pocket precision munition.

**Capabilities Demonstration.** Although constructive simulation studies have shown the PGMM is a force multiplier, it was time to see how it would perform in realistic military operations in urban terrain (MOUT) with live Soldiers and equipment. Equipment included a mortar fire control system (MFCS), forward observer system (FOS), modified portable inductive artillery fuze setter (PIAFS) that mortars eventually will field as the mortar mission setter (MMS), M1064s (120-

mm mortar carriers) and a variety of multiple-integrated laser engagement system (MILES) equipment, to include a surrogate laser designator.

The XM395 120-mm PGMM Tactics, Techniques and Procedures (TTP) Demonstration was conducted 6 through 16 February at the McKenna MOUT site at Fort Benning, Georgia. This was a coordinated effort with the Infantry Center's Director of Combat Developments (DCD), the Soldier Battle Lab (SBL) and the Office of the Product Manager for Mortar Systems (OPM Mortars). Soldiers from 2nd Battalion, 29th Infantry (2-29 IN) from Fort Benning and 4-10 Cav out of Fort Polk, Louisiana, participated as well as a forward observer (FO) from 1-158 IN, Arizona Army National Guard. The maneuver element came from 3-124 IN, Florida Army National Guard.

Activities on the ground were as realistic as possible with a combination of friendly forces, opposing forces (OPFOR), inert PGMM rounds for loading and lights/pyrotechnics to simulate indirect fire effects. The PGMM was fired in simulation linked in real time to the live exercise on the ground. All buildings at the MOUT site were replicated in the simulation, to include the effects of building masking.

The TTP demonstration looked at the

operational impact of the PGMMs in an urban setting and at how a maneuver element supported by PGMM could conduct a deliberate attack in a village with an ROE restricted to precision munitions. We chose three enemy positions placed where PGMM would have to clear an intervening crest with respect to the mortar's gun-target line. The simulation showed the PGMM hit all three targets, each with one round.

FOs (13F Fire Supporters) had no problems learning how to use this new capability. The 13Fs were able to defeat protected targets using a few PGMM rounds versus firing many rounds to bracket targets.

PGMM currently is in system design and development overseen by OPM Mortars, Picatinny Arsenal, New Jersey. OPM Mortars has assembled a government-industry team to develop the munition and ensure that it will fit within today's fire support system. The PGMM will begin government developmental testing in late 2007 and production in late 2008.

Peter J. Burke, Chief  
Precision Effects Branch  
Travis R. Kundel, Contractor  
PGMM Platform Integration, Logistics  
and Training Team  
OPM Mortars  
Picatinny Arsenal, NJ



Soldiers train on the new XM395 precision-guided mortar munition (PGMM).

# Joint Tactical Targeting for Base Security in Iraq

**1**st Brigade Combat Team (BCT), 3rd Infantry Division, deployed to Iraq during Operation Iraqi Freedom (OIF) III in the Multinational Division-North Central (MND-NC). The BCT initially was attached to the 42nd Infantry Division, an Army National Guard (ARNG) division headquartered in New York, and, later, to the 101st Airborne Division (Air Assault). It conducted stability operations while transitioning responsibility for counterinsurgency (COIN) operations to Iraqi security forces and provincial and local governments throughout the Salah al Din Province. The province is north of Baghdad and covers most of what is known as the “Sunni Triangle.”

The brigade’s area of operations (AO) extended more than 150 miles along the corps’ Main Supply Route (MSR) Tampa (also known as Highway 1) and the Tigris River and included the population centers of Bayji, Tikrit, Samarra and Balad. The brigade’s 10 battalions (seven maneuver, one fires, one brigade troops and one forward support) con-

---

By Major Douglas W. Winton and  
Lieutenant Colonel Patrick M.  
Antonietti

---

ducted operations throughout the 17,250 square miles of the AO from 13 forward operating bases (FOBs) and two patrol bases in Samarra.

In addition to providing security for these FOBs, 1st BCT was responsible for security around Logistic Support Area (LSA) Anaconda (also known as Balad Air Base), a base for more than 20,000 Coalition Forces in the southern part of the brigade AO, 20 kilometers east of Balad.

The 1st BCT established a permanent tactical command post (TAC) at LSA Anaconda to provide command and control throughout the brigade AO and manage the unique requirements of security around LSA Anaconda.

This article describes the roles and functions of the 1st BCT TAC at LSA Anaconda and how it contributed to LSA security and offers suggestions

for improving future joint base defense operations.

**1st BCT TAC.** The TAC’s purpose was to help the brigade commander command and control his expansive AO and task organization. The 1st BCT TAC performed this support role across all battlefield operating systems (BOS) except combat service support. The TAC facilitated the execution of the brigade’s stability operations across all lines of operation (LOOs).

It augmented the brigade tactical operations center (TOC) in Tikrit with analysis of the southern AO and coordinated with the units on LSA Anaconda that oper-



B Battery, 1st Battalion, 41st Field Artillery, (B/1-41 FA), fires from Forward Operating Base (FOB) Brassfield-Mora, Samarra, Iraq. Photo by SSG Alfred Johnson, 55th Combat Camera

ated in the brigade's AO. The southern AO included Task Forces (TFs) 5th Battalion, 7th Cavalry (5-7 Cav), 1-128 IN and 1-442 IN.

Three TAC functions were critical to maintaining the security of LSA Anaconda: synchronizing and integrating intelligence, surveillance and reconnaissance (ISR) assets; running the LSA Anaconda counterstrike headquarters; and providing terminal attack control for close air support (CAS). The brigade manned this non-doctrinal permanent TAC with Soldiers from headquarters and headquarters company (HHC) and headquarters and headquarters battery (HHB), 1-41 FA, under the supervision of the brigade deputy commander.

1-41 FA's mission was to provide fires throughout the brigade AO, requiring that four firing platoons be positioned on four FOBs in direct support (DS) to the maneuver battalions based at the FOBs. The static, dispersed and decentralized nature of the battalion's DS mission created conditions that allowed 1-41 FA to provide Soldiers to the brigade's TAC with only minor disruption of its fires mission.

**LSA Anaconda Units (Role, Functions and Capabilities).** LSA Anaconda was the home of the 332nd Air Expeditionary Wing (AEW). This wing had two fighter squadrons that flew missions throughout Iraq and a Predator unmanned aerial vehicle (UAV) recovery squadron that launched and recovered Predator UAVs as directed by the combined air operations center (CAOC).

If the wing's aircraft had fuel remaining on board after being released from their air tasking order (ATO) missions, they contacted the joint terminal attack controller (JTAC) in the 1st BCT TAC and flew base defense missions as long as their fuel permitted. The brigade never relied on this "residual" capability to support deliberate operations. However, these aircraft provided additional ISR to observe enemy activities in the brigade's countermortar/rocket and counter-improvised explosive device (IED) named areas of interest (NAIs).

The 332nd AEW's security forces, the wing commander's base defense force, had capabilities that enhanced 1st BCT's operations in its AO. The security forces squadron controlled a force protection aerial surveillance system (FPASS) UAV. This battery-operated UAV flew up to 500 feet above ground level (AGL) for 45 minutes out to a range of 10 kilometers. It provided a limited reconnaissance and

surveillance capability in historic mortar and rocket points of origin (POOs).

The 332nd AEW's Office of Special Investigations (OSI) gathered intelligence about threats to the base and provided a "quasi" tactical human intelligence (HUMINT) function. These investigative capabilities provided the battalions operating around LSA Anaconda additional intelligence about the local anti-Iraqi force (AIF) cells attacking Coalition Forces with mortars, rockets and IEDs.

Multinational Corps-Iraq's (MNC-I's) general support (GS) aviation brigade was headquartered at LSA Anaconda along with its attack battalion, which had one company of AH-64 Longbows. Near the end of our deployment, it also had one OH-58 Kiowa troop based with it.

These attack and reconnaissance assets provided three air weapons teams to fly counter man-portable air-defense systems (MANPADS), mortars, and rocket interdiction (CM<sup>2</sup>RI) around LSA Anaconda for approximately seven and a half hours each day. This depended on the availability of aircraft due to maintenance, weather and commitments to higher priority missions. The aviation brigade also had a lift battalion based at LSA Anaconda that, as available, reconnoitered key infrastructure or air assault operations in the area.

The other joint asset operating from LSA Anaconda was the US Navy's Mako UAV project. This UAV flew in support of the 1st BCT for approximately nine months before it lost funding at the end of the FY. The Mako provided the TAC and the battalions operating around LSA Anaconda six hours of UAV support from 1,000 feet AGL out to a range of 50 kilometers from the LSA for six days each week.

The commander of the corps support command (COSCOM) was the senior Army commander on LSA Anaconda and responsible for base security. The 29th BCT, Hawaii ARNG, was attached to the COSCOM and provided the forces to execute the functions of the joint defense operations center (JDOC) and joint intelligence center (JIC), man the LSA's entry control points (ECPs), supervise the guard towers (manned by tenant units), provide a company quick-reaction force (QRF) and conduct routine patrolling throughout the 29th BCT AO. The BCT's AO extended 300 meters beyond the installation perimeter.

The JDOC maintained and controlled a wide array of sensors to help with LSA Anaconda security mission. These cam-

eras and radars had the ability to detect, observe and monitor activity well past the LSA perimeter that was the boundary of the 1st BCT and 29th BCT.

**Joint Tactical Targeting.** Each of the units on LSA Anaconda had assets that helped provide security. The preponderance of the brigade's COIN was fought at the battalion or company levels with few brigade-level combat operations to plan or control. Thus, the brigade's primary function was to resource its battalions with assets, based on the commander's assessment of likely enemy actions and his prioritized objectives for the AO.

The 1st BCT TAC coordinated the unique assets at LSA Anaconda to support the three battalions in the brigade's southern AO and ensure the task and purpose of these assets were nested with the brigade commander's priorities in the AO. The confluence of so many unique units with varied capabilities on LSA Anaconda coupled with the TAC's purpose created the need for a process to integrate assets and fires with the battalion ground maneuver plans.

The 1st BCT TAC relied on the *decide, detect, deliver* and *assess* (D<sup>3</sup>A) targeting methodology to synchronize ISR assets and fires with the ground maneuver plan and mobility support operations (route clearance). The TAC's targeting process was a weekly cycle with daily refinements. The TAC developed a weekly effects tasking order (ETO) that began each Friday.

*Intel Huddle.* Development of this ETO began each Saturday with an assessment of the effects achieved in the previous week. The Intel Huddle reviewed information requirements (IRs) that had been gathered in the previous ETO and focused on developing a common assessment of the enemy's actions in the previous week and a template of likely activity in the week that would begin that coming Friday.

The TAC S2 chaired this meeting that was attended by the battalion S2s, representatives from the JIC, the 332nd AEW Intelligence Officer, OSI commander and agents, S2s from various corps units on LSA Anaconda and the TAC staff. This forum established a collective judgment of the enemy's most likely actions and tactics, techniques and procedures (TTPs) for the upcoming week.

Based on the assessment, the TAC operations officer and S2 recommended specific targeting objectives to be achieved and IRs to be answered in the next week. The deputy commanding



Photo by SSG Matthew Acosta, 22nd Mobile Public Affairs Detachment (MPAD)

PFC Robert Waid, B/1-41 FA, secures water containers to the side of his M109A6 Paladin.

officer's (DCO's) approval of these recommended targeting objectives and IRs began the *decide* portion of the targeting cycle. The battalions used the collective assessment of the Intel Huddle and the DCO's approved targeting objectives to drive their mission analysis to develop the next week's patrol schedule.

*Targeting Board Meeting.* The next event in the TAC's weekly targeting process was the targeting board meeting each Tuesday. The purpose of this meeting was to consider requests from the battalions and allocate assets to achieve the approved targeting objectives and answer the approved IRs. The TAC operations officer chaired this meeting that was attended by JDOC operations officers; Predator recovery squadron, Mako, FPASS, OSI and corps GS attack battalion representatives; the 332nd AEW ground liaison officer (LNO) and weapons officer; the JIC collection manager; and the TAC staff.

Because these units provided assets to achieve desired effects or answer IRs in the 1st BCT AO but had no command relationship with 1st BCT, the operations officers only described their expected missions for the next ETO and projected when their assets likely would be available.

The targeting board meeting planned friendly force reactions to every templated enemy action, allocated all assets and listed asset, requests from the battalions that the TAC could not resource with LSA Anaconda assets. This information was forwarded to the TOC for consideration by the brigade staff.

On Wednesday, the brigade TAC con-

vened its weekly targeting meeting. It was attended by the battalion's S3s and commanders or the operations officers of the units providing assets in the 1st BCT AO and the TAC staff. The TAC operations officer briefed the tentative asset allocation plan for the next ETO and resulting battalion asset shortfalls to the DCO for approval. After the DCO's approval, the battalion S3s refined their patrol schedules, if required.

*Daily ISR Meeting.* The weekly targeting process provided a valuable framework for units to plan their missions for an upcoming week. New missions, enemy actions, maintenance status and weather all disrupted the prioritization or availability of assets allocated at the Tuesday targeting board meeting. Each day, liaisons from the battalions and units providing assets met with the TAC staff and resynchronized the plan for the following day.

This daily ISR meeting occurred in the morning at the TAC and was conducted like a wargame. The S2 presented an overview of recent enemy activities and a template of his expected activities for the next 24 hours. The S3 followed with an overview of planned operations.

The synchronization occurred by conducting four six-hour "turns" of enemy templated actions followed by friendly reactions. During each turn, the TAC S2 presented a "doctrinal template" of enemy actions based on a pattern analysis of enemy actions during that period the previous year and during the previous two weeks. Then each liaison briefed the task, purpose and location of his patrols or assets during the period.

Based on friendly actions and an assessment of the enemy, the TAC S2 presented an enemy reaction that became the "situational template" for that period. The operations officer led a wargame of any required counter actions and changes to the established plan.

This daily ISR meeting provided all the units operating in the area around LSA Anaconda a common assessment of recent enemy activities and an understanding of planned friendly actions for the next day.

The 1st BCT TAC recorded the results of the daily ISR synchronization meeting in the *Raider* TAC ISR synchronization matrix. The matrix was distributed to the brigade staff, subordinate battalions, all units that participated in the synchronization meeting and dozens of commanders and staff officers throughout LSA Anaconda.

*Targeting Success.* LSA Anaconda has gained notoriety as the Coalition Force base in Iraq that receives the most indirect fire attacks. Although these attacks never substantially impact the base's ability to command and control logistics or provide air support throughout the theater, they are a threat to Coalition Forces. Thus, 1st BCT had the objective of reducing the frequency and effectiveness of indirect fire attacks against the base.

Proactive targeting of known insurgent cells and templated firing positions was the most effective means of disrupting the indirect fire threat to LSA Anaconda. Based on a number of common factors, we assessed that two distinct cells conducted these attacks.

The 1st BCT made the neutralization of these cells a brigade targeting objective. Using pattern analysis of the cells' previous attacks, 1st BCT developed a plan to mass ground maneuver, attack aviation and fires in POOs to deny the terrain and force the insurgent mortar cells to attack at a time and place where the brigade could conduct persistent armed surveillance.

During August 2005, the 1st BCT TAC conducted a series of crawl-walk-run mission rehearsals to improve the coordination and synchronization of ground maneuver, attack aviation, CAS and Predator UAVs. These rehearsals focused on synchronizing the response of all assets to a mortar attack against LSA Anaconda and resulted in greatly improved communications and coordination across all units capable of delivering effects against insurgent mortar cells.

On 5 September 2005 just before sunrise, two insurgent mortar cells conducted two separate attacks with 82-mm mortars against LSA Anaconda from POOs on the east side of the Tigris River. The two attacks occurred approximately 1,500 meters and five minutes apart. As a result of the 1st BCT TAC targeting process, a Predator UAV and joint land-attack cruise missile elevated netted sensor (JLENS) camera controlled by the JDOC were scanning these POOs while ground maneuver and attack aviation assets conducted operations in nearby POOs.

The 1st BCT TAC received the POO of the attacks from the counterstrike radars on LSA Anaconda and cross-cued the Predator and JLENS to the exact POOs. The Predator UAV successfully engaged both crews with its two onboard Hellfire missiles, killing 11 insurgents.

**Recommendations.** We learned a number of lessons during our 12-month tour.

*Counterstrike Operations.* Ground patrols, air weapons team flights and interdiction fires all disrupted many planned attacks, but the disruptions merely forced the insurgent to change the time, location or method of his attack and did not have long-term effects. Reactive counterstrikes created conditions that forced insurgents to attack with low volumes of fire and inaccurate methods.

We always must improve the effectiveness of tactical units conducting counterstrike in COIN operations. The increase in the number and types of FA precision-guided munitions (PGMs) fielded in theater will help significantly.

*Joint Base Defense Doctrine/TTPs.* The

only common headquarters for all units based at LSA Anaconda was Central Command (CENTCOM). The common headquarters of all Army units based at LSA Anaconda was MNC-I. However, neither CENTCOM nor MNC-I had any staff representation at the base. All the units based at LSA Anaconda had to establish informal coordination mechanisms to synchronize the assets into consistent COIN operations.

There is no doctrine that addresses coordinating joint assets for base defense. The services must establish joint doctrine that makes one tactical commander responsible for base defense and security operations in an assigned AO around the base with a command or support relationship over all units conducting tactical operations in the AO. That operational headquarters must develop the AO via a thorough mission analysis and detailed intelligence preparation of the battlefield (IPB).

*Persistent Armed Surveillance for the Tactical Commander.* The armed Predator was very effective. However, despite flying many residual hours in the vicinity of LSA Anaconda, the Predator did not successfully engage mortar crews until conditions permitted the CAOC to temporarily assign a Predator DS to the 1st BCT. Current resourcing limitations keep all Predators under the control of operational commanders with infrequent tactical employment.

Enemy trends indicate that the requirement for tactical employment of persistent armed surveillance assets will increase. The services need to commit resources to provide tactical commanders routine access to persistent armed

surveillance.

*Signal Intelligence (SIGINT) and HUMINT.* Insurgents disperse and hide to ensure their survival. Despite the routine dispersion, they must communicate and occasionally assemble to plan and conduct attacks. This makes them vulnerable to attack but only if tactical commanders have access to the SIGINT and HUMINT assets necessary for exploitation.

The Army needs to commit resources to increase the amount and quality of SIGINT and HUMINT assets available to tactical commanders.

FOB or LSA security in Iraq is a challenge. Add a variety of units from multiple services stationed on the FOB or LSA with no common headquarters except at the theater level, and the challenges increase. A clear line of authority—and responsibility—and better resourcing of specific assets will diminish many of these challenges.

Major Douglas W. Winton currently is the Executive Officer (XO) of 1st Battalion, 41st Field Artillery (1-41 FA), 3rd Infantry Division, Fort Stewart, Georgia. He deployed as the S3 for 1-41 FA in Operation Iraqi Freedom (OIF) III with duty as the Operations Officer in the 1st Brigade Combat Team (BCT) Tactical Command Post (TAC) at Logistical Supply Area (LSA) Anaconda. In previous assignments, he was the Fires and Effects Planner for the 3rd Division; Battery Commander, Assistant S3 and S4 in 1-27 FA (Multiple-Launch Rocket System), V Corps Artillery, Germany; and XO and Company Fire Support Officer (FSO) in 3-320 FA, 101st Airborne Division (Air Assault), Fort Campbell, Kentucky.

Lieutenant Colonel Patrick M. Antonetti commanded 1-41 FA from July 2003 through June 2006, including deploying with his battalion for OIF III. Currently, he is the 3rd Infantry Division Fires and Effects Coordinator at Fort Stewart. In his assignment prior to command, he was a Political-Military Planner for Central Europe and Afghanistan in the Strategic Plans and Policy Directorate, J5, on the Joint Staff at the Pentagon. He was a Brigade FSO and Battalion XO in 1-6 FA and Assistant Fire Support Coordinator, all in the 1st Infantry Division Artillery in Germany. While serving as the XO, he deployed for Kosovo Force (KFOR) 1B. He commanded B Battery/2-8 FA and Headquarters and Headquarters Company, 7th Infantry Division (Light), at Fort Ord, California, and Fort Lewis, Washington. He is an Olmsted Scholar with a degree in Political Science from Comenius University in Bratislava, Slovakia.



PFC Andrew Ponton, B/1-41 FA, restocks his Paladin's powder storage container.

Photo by SSG Matthew Acosta, 22nd MPAD

# FOS with PSS Integrated

## Nowhere for the Enemy to Hide

**M**ajor General David P. Valcourt, then Chief of Field Artillery, said “Overcoming TLE [target location error], our bane for more than 30 years, will deliver the ‘keys to the joint effects kingdom’ to our observers.” (“Crossed Cannons on Your Collar: Change and Opportunity—*Steady* in the Harness,” March-June 2004). He was right.

With that charter and to respond to the warfighters’ needs, we integrated the mounted forward observer system (FOS) and precision-strike suite (PSS) application to overcome TLE. As a “joint reuse” effort, this allows the FO to use the joint PSS software on his hand-held digital device to locate targets precisely enough to execute them with preci-

By Milton B. Smith

sion-guided munitions (PGMs) or as close air support (CAS) missions. With PSS integrated into FOS, the FO at the tactical level can determine accurate coordinates in just seconds vice waiting much longer for target “mensuration” at much higher levels.

The FOS-PSS integration gives the FO the option of employing the integrated software when executing PGMs or employing the original FOS. The target area resolution of FOS (only) has been decreased significantly. FOS now provides a one-square-meter resolution vice its former 10-square-meter resolution.

Completely understanding what this

integration means to the joint warfighter requires revisiting the capabilities of each application.

**FOS.** This is a system developed by the Fire Support Software Engineering Division, Communications and Electronics Command (CECOM), located at Fort Sill, Oklahoma, to be the primary support for FOs, fire support teams (FISTs), FA commanders, fire support officers (FSOs) and survey teams in their mission areas. FOS provides automated capabilities in both mounted and in limited dismounted configurations. As a mounted integrated subsystem, it is a critical to the Bradley fire support team (BFIST), Knight, Stryker and combat observation lasing team (COLT) vehicles.

FOS interfaces with the advanced FA tactical data system (AFATDS) and weapon systems through a standardized signaling and messaging protocol set while maintaining compatibility with legacy systems via legacy signaling and messaging protocols. FOS also maintains a direct link with maneuver’s Force XXI battle command brigade and below (FBCB<sup>2</sup>) to clear fires in the fire support mission chain. FOS processes and translates this mix of data types and then sends it to the tactical operations center (TOC) and weapon platforms. This extensive interface network is shown in the figure.

FOS initially was developed during the late 1980s before the emergence of self-locating FA platforms or PGMs and before we had joint FOs (JFOs) helping joint terminal attack controllers (JTACs) control aircraft dropping precision ordnance in Types 2 and 3 CAS. In addition, our forces now operate in an urban environment with a high density of innocent civilians, calling for very accurate target locations—one round per target. These requirements exceed the accuracy and target resolution capabilities of previous observer devices.

Previous FO automated systems only could locate targets down to the nearest 10 meters on the X and Y axes, addressing only the requirements for open-area fires saturation and laser-guided munitions. This limitation, coupled with the inherent error in the observer’s location and sen-

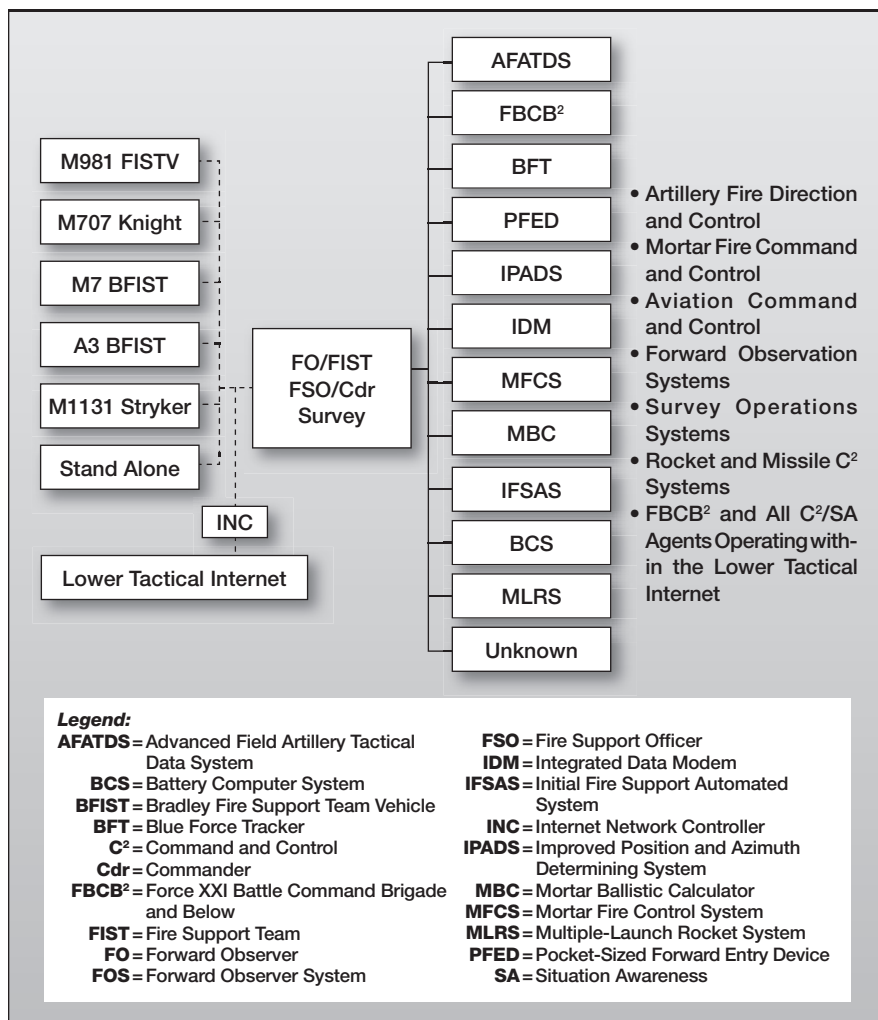

Forward Observer System (FOS) Key Interfaces

sors, caused a look for a way to achieve more precise battlefield accuracy. Enter the PSS software.

**PSS.** The Naval Weapons Center at China Lake, California, developed the PSS application. The National Geospatial Agency (NGA) at Bethesda, Maryland, has approved and validated PSS as a tool for determining precision geospatial coordinates. PSS prepares image datasets, called the digital point positioning database (DPPDB), to pull precise geospatial coordinates for target engagement. These classified image datasets are available to the unit from NGA on DVD and are ordered just as any other digital map data through Defense Logistics Agency (DLA), Fort Belvoir, Virginia.

For the last several years, PSS has enjoyed much success, primarily with Special Operations Forces (SOF) employing it in Operations Enduring Freedom (OEF) and Iraqi Freedom (OIF). The Joint Forces Command (JFCOM), headquartered at Norfolk, Virginia, sponsors PSS and has worked with the services to integrate the capability into each of the appropriate CAS suites used by SOF and conventional JTACs.

The PSS application gives extremely tight resolutions using stereoscopic images with a point-and-click target-location capability. NGA has preprocessed these images into three-dimensional resolutions. This allows the trained FO to see a static top-down omni-view of the target location that is accurate enough—in some cases more than accurate enough—to employ all current and planned precision fire-and-forget munitions.

PSS also augments FOS' capabilities with fragmentation rings definable by the user to determine the danger zones and potential for collateral damage before the munitions are fired. This allows the FO to conduct a collateral damage estimate (CDE) quickly.

**Integrated Capabilities.** As a result of prototyping FOS with PSS-SOF, the Fire Support Software Engineering Division contacted China Lake and JFCOM in June 2005 to enter into a joint reuse effort for the PSS software. The Fire Support Software Engineering Division's integration effort began on 1 November 2005. The integrated system completed qualification testing on 13 January 2006.

The integrated FOS-PSS software will be released to OIF and OEF rotational units in the Second Quarter of FY07, potentially coinciding with the fielding of the 155-mm Excalibur unitary PGM. (See

the article "FA PGMs—Revolutionizing Fires for the Ground Force Commander" in the May-June edition online at [sill-www.army.mil/famag/index.asp](http://sill-www.army.mil/famag/index.asp).)

FOS is already being incorporated into the JFO Course taught at Fort Sill. This facilitates Types 2 and 3 CAS. The JFO Course will certify the JFOs on PSS, based on NGA certification standards.

The FOS and PSS integration brings significantly reduced TLE and increased support for collateral damage assessment. This integration uses FOS' extensive interface, communications and messaging capabilities to provide a verified unbroken digital message chain from the observer through command and control systems to the weapons delivery platforms. The integration provides a resolution and accuracy more than sufficient to employ all PGMs with a standard of 90 percent circular error (CE) and lateral error (LE).

The integrated FOS checks each fire request against all fire support coordination measures (FSCM) and geometries plus, when connected, Blue Force Tracker information in the FO's immediate target area. This facilitates AFATDS' clearance of fires processing through all AFATDS nodes before the fire mission is sent to the delivery platform, which factors in additional information, the commander's pre-programmed guidance and battlefield and higher level insights.

With "hands-free" communications already established, the FO can use this system to send all artillery or mortar munitions down range onto the specified targets in 30 seconds or less after the mission is initiated. Because the FO can locate the target precisely in seconds, it decreases the time it takes to clear fires and execute air-dropped or FA precision munitions. This decrease in clearance time, in part, is due to the CDE's being passed by the FOS integrated system through AFATDS to the targeting cell.

Using FOS-PSS, the stationary FO can locate his own position as precisely as he can the target's position. The FO can determine a precise enough location to calibrate his laser.

The integrated FOS displays a static daylight image of the area of operations (AO) at night. It helps the survey teams with initial location accuracy and serves as a quick check point for survey calculations and procedures.

The integrated system operates on the ruggedized handheld computer (RHC) and the standalone computer unit (SCU). Due to the system's size and processing

demands, the integrated FOS and PSS won't work on the existing handheld terminal unit (HTU) and lightweight computer unit (LCU). PSS will not load on these platforms with FOS installed.

In the future, the integrated FOS user will have dynamic, highly accurate scene matching using near-real-time images from a variety of sources, such as commercial satellite images (recently validated by NGA). The scenes, without the associated error terms, have approximately the same accuracy as the static images currently used with PSS.

The improved FOS without PSS is very accurate for locating targets and the FO's position to employ conventional munitions. But when using PSS integrated into FOS, the FO can employ the fire-and-forget PGMs 24/7 in all weather conditions and respond very rapidly with the effects the ground force commander needs. FOS with PSS truly has delivered the keys to the joint effects kingdom to our FOs.

---

**Milton B. Smith is the Chief of the Systems and Software Engineering Branch within the Fire Support Software Engineering Division, Communications and Electronic Command, located at Fort Sill, Oklahoma. He has more than 32 years of service, 22 of which have been in the Fire Support Software Engineering Division where he worked on the Tactical Fire Direction System (TACFIRE), produced the first fielded FA system written entirely in Ada, and led the Fire Support Software Engineering Division to achieve the Carnegie Mellon University Software Engineering Institute's highest rating for Capability Maturity Model Integrated. He also has served as Branch Chief and Deputy Chief of the Fire Support Software Engineering Division and Acting Chief of the Fire Support Software Engineering Division. He enlisted with the last group of Army draftees in 1972, serving for more than nine years in the Army.**

*The author would like to acknowledge the contributions of the following in developing the Forward Observer System (FOS) integrated with the Precision Strike Suite (PSS) software: LTC James Chapman, Product Manager for Fire Support Command and Control, (FSC<sup>2</sup>), part of the Program Manager's Office for Battle Command, Communications and Electronic Command, Fort Monmouth, New Jersey; Christopher Boggs, Program Manager of PSS, Joint Forces Command (JFCOM), G6, Norfolk, Virginia; Michael Wirtz, Project Manager for PSS, Naval Weapons Center, China Lake, California; and COL John Haihcock, Training and Doctrine Command (TRADOC) Capabilities Manager (TCM) FSC<sup>2</sup>, Fort Sill, Oklahoma.*