

Field Artillery

A Professional Bulletin for Redlegs

March-April 2002

Science and Technology for the Field Artillery

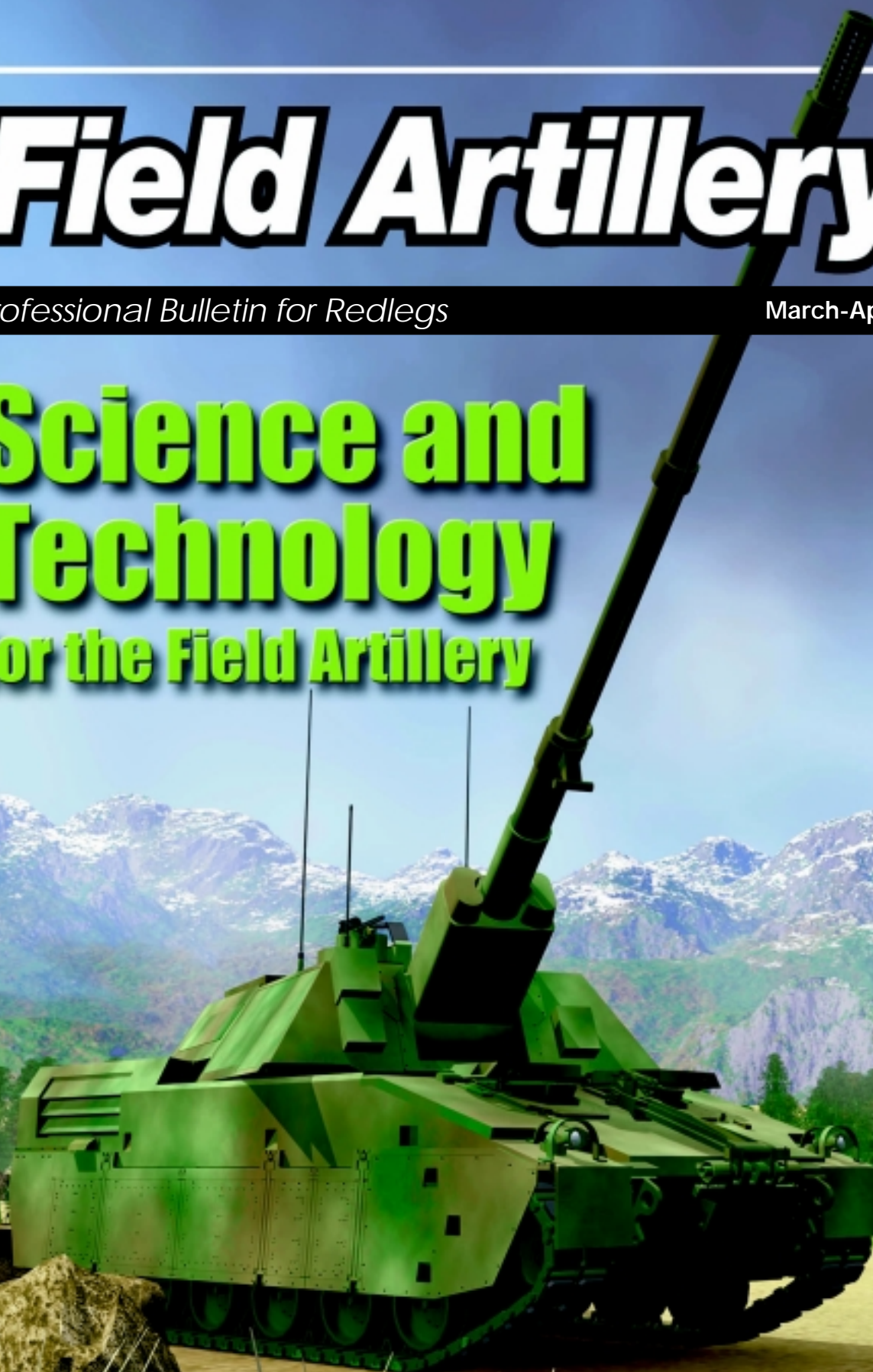

Field Artillery

A Professional Bulletin for Redlegs

March-April 2002

HQDA PB6-02-2

INTERVIEW

- 2 Digitizing the Army for the Objective Force**
Interview with Lieutenant General Benjamin S. Griffin, G8, and Former Commander of the 4th Infantry Division (Mechanized)

ARTICLES: Science & Technology

- 5 NetFires-Precision Effects for the Objective Force**
By Major (Retired) George A. Durham and Colonel (Retired) James E. Cunningham
-
- 10 The FCS-Based Force in Future Battle**
By Major (Retired) George A. Durham, Lieutenant Colonel (Retired) Frank T. Myers II and Lieutenant Colonel (Retired) Charles L. Hernandez
-
- 14 The Multi-Role Armament and Ammunition System (MRAAS) for the Multi-Mission FCS: Direct and Indirect Fire**
By Mark A. Ford and Colonel (Retired) John H. Northrop
-
- 19 4th ID DCX II: The Digitized Division Fights the COE OPFOR**
By Colonel Charles B. Allen
-
- 23 HIMARS for Rapidly Deployable Rocket and Missile Fires**
By Major Lawrence J. Abrams, AC
-
- 24 What the Commander Needs to Know About Guidance in AFATDS**
By Colonel James G. Boatner, Jr.
-
- 29 AFATDS Gunnery: Technical Fire Direction**
By Major Alford J. Williams, AC
-
- 40 M270A1: An MLRS Launcher with Leap-Ahead Lethality**
By Lieutenant Colonel Rocky G. Samek, AC
-
- 42 Crusader-Hammer for Today, Forge for the Future**
By Major Charles J. Emerson, Jr., AC

ARTICLES: Features

- 35 Field Artillery Institutional Transformation**
By Colonel Michael T. Madden
-
- 38 Fort Sill Telephone Directory**

DEPARTMENT

1 THE UPDATE POINT

Front Cover: The Crusader self-propelled howitzer, a combat multiplier—deployable firepower for the Legacy and Interim Forces and technology-carrier for the Objective Force. (Photo Courtesy of United Defense)

DISCLAIMER: *Field Artillery*—is published bimonthly by Headquarters, Department of the Army, under the auspices of the US Army Field Artillery School (Building 758), Fort Sill, OK. The views expressed are those of the authors, not the Department of Defense or its elements. *Field Artillery's* content doesn't necessarily reflect the US Army's position and doesn't supersede information in other official Army publications. Use of news items constitutes neither affirmation of their accuracy nor product endorsements.

PURPOSE: (as stated in the first *Field Artillery Journal* in 1911): To publish a journal for disseminating professional knowledge and furnishing information as to the Field Artillery's progress, development and best use in campaign; to cultivate, with the other arms, a common understanding of the power and limitations of each; to foster a feeling of interdependence among the different arms and of hearty cooperation by all; and to promote understanding between the regular and militia forces by a closer bond; all of which objects are worthy and contribute to the good of our country.

OFFICIAL DISTRIBUTION: Distribution (free) is to US Army and Marine Corps Active and Reserve Components FA units: seven copies to corps artillery, division artillery, regimental and brigade headquarters; 13 to battalions; and seven to separate batteries. In addition, readiness groups, recruiting commands, state adjutant generals, Army and Marine Corps libraries and schools, liaison officers and other Department of Defense agencies working with FA or fire support issues or material may request a free copy by writing to the Editor (see "Submissions").

PAID SUBSCRIPTIONS: Those ineligible for Official Distribution may subscribe through the US Field Artillery Association, P.O. Box 33027, Fort Sill, OK 73503-0027 or usfaa@sirinet.net. Telephone numbers are (580) 355-4677 or FAX (580) 355-8745 (no DSN). Dues are \$20 per year to US and APO addresses. The international rate is \$55 for a one-year subscription.

SUBMISSIONS: Mail to Editor, *Field Artillery*, P.O. Box 33311, Fort Sill, OK 73503-0311. Telephone numbers are DSN 639-5121/6806 or commercial (580) 442-5121/6806 or FAX 7773 with DSN or commercial prefixes. Email is famag@sill.army.mil. Material is subject to edit by the *Field Artillery* staff; footnotes and bibliographies may be deleted due to space.

REPRINTS: *Field Artillery* is pleased to grant permission to reprint articles. Please credit the author and *Field Artillery*.

ADDRESS CHANGES: *Field Artillery* (ISSN 0899-2525) (USPS 309-010) is published bimonthly. Periodicals postage is paid by the Department of the Army at Lawton, OK 73501 and an additional mailing post office. POSTMASTER: send address changes to *Field Artillery*, P.O. Box 33311, Fort Sill, OK 73503-0311.

Redleg Hotline

(Organization, Material, Doctrine and Training)
DSN 639-4020 or (580) 442-4020 (24-Hours)

Tactical Software Hotline

DSN 639-5607 or (580) 442-5607 (24-Hours)

Field Artillery Home Page

sill-www.army.mil/famag

FA Branch at PERSCOM

www.perscom.army.mil/opmd/fasitrep.htm
www.perscom.army.mil/epfa/fa_ltr.htm

By Order of the Secretary of the Army:

Eric K. Shinseki
General, United States Army
Chief of Staff

Official:

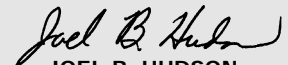
JOEL B. HUDSON

*Administrative Assistant to the
Secretary of the Army, 0201602*

Michael D. Maples
Major General, United States Army
Field Artillery School Commandant

Editor:
Patricia Slayden Hollis

Assistant Editor:
Donnis D. Blount

Art Director:
Bob T. Coleman

Looking Back 200 Years and Forward to Continue the Legacy

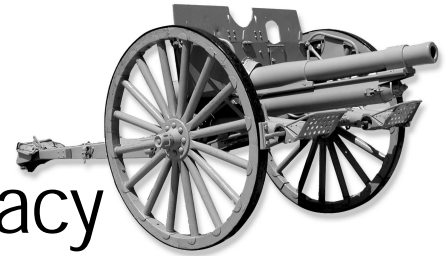

The United States Military Academy at West Point, New York, is celebrating its bicentennial. The Academy was founded in March 1802 largely due to the efforts of two distinguished Artillerymen: Henry Knox and Alexander Hamilton. West Point's purpose was to provide professional military leaders scientific and technical training in order to move the United States away from a dependence on a foreign officer cadre—particularly a reliance on foreign artillerists and engineers.

West Point and the Field Artillery have had a long, strong relationship. Even before the academy was founded, a Corps of Artillerists and Engineers was created in 1794 at West Point for our nation's young Army. The year the Military Academy was founded, this regiment was divided into the Corps of Artillery and the Corps of Engineers.

The FA Legacy. The history of the US Field Artillery began during the Revolutionary War when Colonel Richard Gridley's FA Regiment fought the British at Boston in 1775. But without a doubt, West Point's bicentennial also celebrates the importance of the technical branches to the Army, including its Corps of Artillerists.

It became apparent early on that West Point graduates would populate the Field Artillery. Of the 50 officers commissioned from West Point during Thomas Jefferson's eight years in office, 27 were commissioned in the Artillery, 14 became Engineers, eight found themselves in the Infantry and one poor soul was sent to the Dragoons.

Throughout the past 200 years, both the Field Artillery and the Military Academy have contributed immeasurably to the defense of our nation. Both have adapted through the years to the requirements dictated by changes in the world situation and advancements in science and technology. Significant changes in today's contemporary operating environment (COE) and tremendous developments in technological pos-

sibilities dictate that the Army and the Field Artillery transform for the future.

More to Come. As the Army transforms, Fort Sill is heavily engaged in developing Objective Force concepts for fires and effects. The Training and Doctrine Command (TRADOC) recently announced Boeing and the Science Applications International Corporation (Boeing SAIC), a consortium of corporations, as the lead systems integrator (LSI) for the future combat systems (FCS). TRADOC is in the process of establishing an organizational structure to support the detailed development of the maneuver unit of action (UA) FCS concepts, organizations and material requirements.

While the Mounted Maneuver Battle Lab at Fort Knox, Kentucky, has the TRADOC lead in this action, the Field Artillery Center is dispatching personnel to support the on-the-ground effort. We are linked closely with the process at every level, including through our Depth and Simultaneous Attack Battle Lab. Fort Sill continues as the Army's lead to develop fires and effects concepts for the maneuver UA and FCS.

The emerging concept calls for precision and speed to replace mass and momentum. Precision, as envisioned, includes both maneuver and fires, and the latter must include both land-based and joint capabilities.

While some may envision precision fires to imply a single round employed precisely against a single target, in the greater sense, precision fires means employing fires precisely where needed in the appropriate volume to achieve the desired outcomes. Thus, the Field Artillery must have systems for the precision engagement of both point and area targets.

Massing of effects still will be required on the future battlefield and, enabled by information dominance, can be achieved by massing effects rather than forces.

Given our anticipated method of conducting entry operations, the expected

size of the battlespace and the desire to conduct simultaneous operations from disparate locations, the close and deep aspects of the battlefield framework will merge. There will be more targets that are more widely dispersed over wider operational areas in a wider variety of terrain types, to include urban and complex environments. The enemy will present fleeting targets and seek greater use of terrain and weather to mask his movements, making engaging him more difficult.

Fires units will provide both tactical and operational fires at extended ranges. The FA must have robust fires capabilities with greater range, higher rates-of-fire, enhanced precision and devastating lethality. These capabilities will facilitate initial entry operations, counter anti-access threats, enable fires to shape engagements for the maneuver unit of action and proactively/reactively destroy an adversary's ability to counterstrike, and provide reach-back lethality for precision maneuver with fully integrated and synchronized precision fires.

The Objective Force increasingly will depend on land-based precision fires for its operations. Fires must be employed early to develop the situation while the Objective Force is out of contact with the enemy, thus enabling maneuver forces to engage the enemy at the time and place of their choosing. Fires must be available on demand in continuous support of successive engagements of multiple maneuver units of action throughout the area of operations. Precision fires combined with precision maneuver will provide operationally decisive land power.

Both the United States Military Academy and Field Artillery have a great legacy of service to our Army and nation. As we celebrate this bicentennial, we are leveraging science and technology and taking the actions required to ensure that our legacy will continue for another 200 years.

Lieutenant General Benjamin S. Griffin

Deputy Chief of Staff, G8, Army Staff, and Former Commander of the 4th Infantry Division (Mechanized)

Digitizing the Army for the Objective Force

By Patrecia Slayden Hollis

Q *As the former commander of the 4th Infantry Division [Fort Hood, Texas], you have had a unique opportunity to develop and observe digital systems for the Army Battle Command System (ABCS). What does ABCS do for our tactical warfighting units?*

A Our digital systems, coupled with UAVs [unmanned aerial vehicles], JSTARS [joint surveillance and target attack radar system] and other ground-based sensors, give us a much clearer picture of where the enemy is—a tremendous combat multiplier. Today, a soldier at the division, brigade or battalion levels—down in the company vehicles with an FCB² [Force XXI battle command brigade and below]—can see not only where his unit is, but also where other friendly units are in relationship to the enemy. That is a significant advantage in terms of direct and indirect fire. We refer to this as Blue Force Feed and “knowing” where we are.

The role of the Artillery in all this is to provide fires for deep and shaping operations and the close fight plus SEAD [suppression of enemy air defenses] and counterfire. The Artillery, with its AFATDS [advanced FA tactical data system] as part of ABCS, has been critical to the division’s success at the NTC [National Training Center, Fort Irwin, California] and in Warfighters [Battle Command Training Program, or BCTP, Warfighter exercises].

The Artillery has been at the forefront in the development of Army digital systems with AFATDS. But now the other systems have caught up: the MCS [maneuver control system], ASAS [all-source analysis system] and AMDWS [air missile defense warning system]. The challenge continues for the Army to develop and integrate these systems in tandem. Interoperability amongst systems is key; much progress has been made...but much still needs to be done.

I am a strong believer in the enhanced capabilities our digital systems bring to bear for the warfighter. But having those systems doesn’t change the requirements to move, shoot and communicate. Soldiers and leaders at all levels still must know the basics.

On the simulated battlefield, NTC, JRTC [Joint Readiness Training Center, Fort Polk, Louisiana] and home station training at night in high tempo operations while facing an enemy coming from three or four different directions, the leader’s and the individual soldier’s ability to be situationally aware is imperative. It is from this situational awareness that we develop situational understanding.

Q *In 2001, the 4th ID participated in Division Capstone Exercise I [DCX I at the NTC] and DCX II [a BCTP Warfighter]. What are some of the lessons you learned?*

A Let me first say the best ideas we get are from our young soldiers, officers and NCOs—soldiers and leaders at every level.

We were fortunate to have the M1A2 SEP [system enhancement program] tank, M2A3 Bradley [fighting vehicle], the M3 cavalry vehicle, the M109A6 Paladin howitzer and the tactical UAV [TUAV], which are great systems. But our success boils down to the quality and flexibility of our soldiers, NCOs and officers. I cannot say enough about the motivation and technical expertise of our young men and women today and their ability to work through difficult challenges to accomplish the mission.

We worked some traditional and non-traditional means of employing artillery. We had batteries DS [direct support] to maneuver battalions—dedicated batteries, if you will—as well as the FA battalion DS to the brigade, a more traditional role.

When a battery was in close support of a maneuver battalion, we used the M1A2 SEP tank’s long distance laser to acquire those targets, in addition to our FIST-Vs [fire support team vehicles], to create dedicated maneuver shooters. We also used TUAVs to confirm targets indicated by JSTARS; then, based on the TUAV grid, fired artillery at the target and adjusted fire, if we had to. Every maneuver brigade and the division had or will have its own TUAVs.

In DCX I at the NTC, we fought on a fluid battlespace that was about 60 by 70 kilometers in continuous operations, many times at night (our preferred option), against an enemy coming from more than one direction. Our brigade and battalion commanders were able to command and control their units in that battlespace with a very challenging scenario because they could “see” themselves and the enemy. The OPFOR [opposing force], as always, was outstanding and taught us many lessons.

For DCX II, the division had an expanded battlespace of 120 kilometers wide and 200 kilometers deep. With this larger battlespace, our forces tended to fight more decentralized. Our digital systems gave us the situational awareness to decentralize our artillery yet mass fires when and where we needed to at critical phases of the fight.

During the Warfighter, we had units spread all over the place. We had satellite communications shooting digital pictures between Forts McNair and Hood and Brownwood, Texas. Brownwood is about 115 miles from Fort Hood. Over extended distances, the SMAR-TT [secure, mobile, antijam remote tactical terminal] provided the division the ability to pass information over the horizon; this proved extremely effective during both DCX I and DCX II.

We fought a new threat scenario in DCX II as the first unit to do so. The Army has redefined the threat to make it more realistic for what our units could face today from potential adversaries across the full spectrum of conflict. [For more information on the contemporary operating environment (COE), see “4th ID DCX II: The Digitized Division Fights the COE OPFOR” by Colonel Ben Allen in this edition.]

But we fought the artillery pretty much the same. Based on the intelligence—JSTARS, ground reconnaissance and TUAV—the artillery again was key in setting the conditions for maneuver success on the battlefield. And with digitization, fire support officers at all levels are more critical; they can provide more timely and accurate fires, giving maneuver forces more capabilities and opportunities. This is true today and will expand greatly in the future in joint operations.

In terms of the Army's transformation, the lessons we've learned in the 4th ID will be refined and additional TTPs [tactics, techniques and procedures] will be developed as we place these new systems in the 1st Cavalry Division [Fort Hood], the IBCT [Initial Brigade Combat Team] at Fort Lewis, Washington, and, ultimately, develop them for the Objective Force. The C⁴I [command, control, communications, computers and intelligence] technology and software in the Legacy Force will grow in sophistication, but the C⁴I concept will remain, basically, the same for the Objective Force; our situational awareness, command and control on the

move and full integration of joint systems will increase for future conflicts.

In the not too distant future, a squad leader will be able to look at his FBCB² embedded in his IAV [interim armored vehicle] and see the battlefield, friendly and enemy forces' positions and fires. Eventually, as Land Warrior technology for the soldier progresses, the individual soldier will have that digital link away from his vehicle. This dismounted capability will provide a true assessment of the friendly situation. Great progress has been made in this area, but we cannot rest until we have the picture of mounted and dismounted forces.

Q Some have said the Field Artillery is failing to provide accurate, responsive close supporting fires at the CTCs. What are your thoughts?

A The digital systems in the division today can send and process information very quickly. It is critical that AFATDS keeps pace and stays integrated with those systems as we go down the road. We must carefully assess when humans *must* intervene to

determine whether or not to fire—have the proper checks and balances to avoid fratricide. At the same time, the Artillery must keep pace with our capabilities to rapidly acquire the enemy so we can rapidly fire on those targets.

One lesson we learned was that inaccurate fires were not always due to the artillery. Timely, accurate target location is still a problem. When the SEP tank acquired a target at longer distances [its max lasing range is eight kilometers] and called for fire, our maneuver soldiers had to adjust artillery fire instead of fire-for-effect. When the SEP lased at the longer distances, it wasn't accurate enough. Now when lasing closer in, the SEP could pinpoint the target for first-round fire-for-effect. We learned this at the NTC and refined our TTP at Fort Hood where we live-fire tested to pinpoint requirements.

We also learned that, sometimes when we fired the grid a TUAV displayed, the round did not hit the target. We learned certain depression angles of the TUAV to the target made the grid readings less accurate. So we came back from the NTC, figured out why we had inaccurate fires

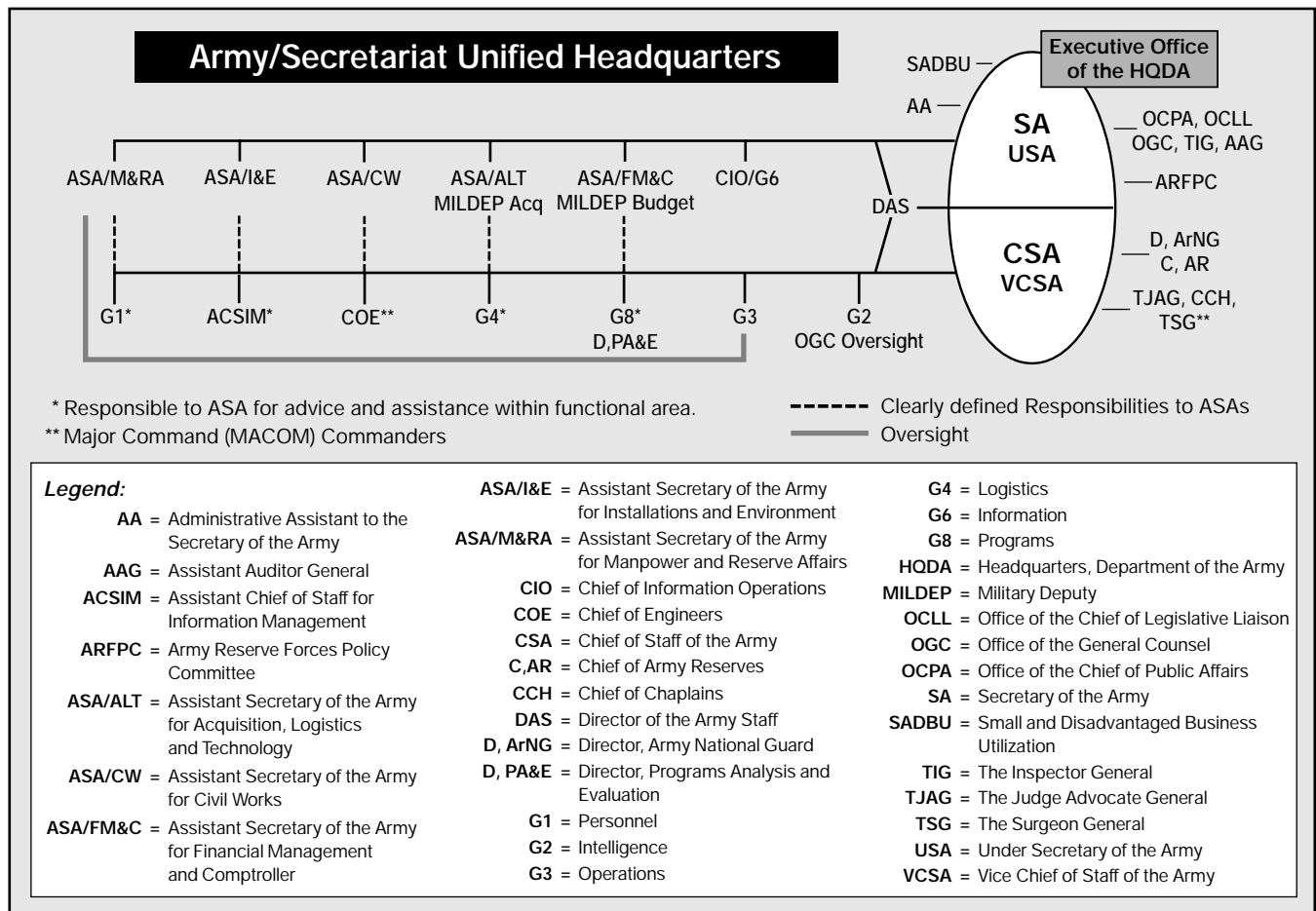

Reorganization of the Army Staff to Align with the Secretary of the Army Staff

and trained on adjusting fires off of the SEP tank and TUAV at home station.

To make fires more responsive, we dedicated a battery to a battalion. In some cases, that worked. For example, when a battalion task force had an independent mission, we gave that battalion a dedicated battery to move with it.

AFATDS needs to improve our ability to clear and process calls-for-fire more quickly. In the 4th ID, the standard for sensor-to-shooter operations is 59 seconds or less from target acquisition to the weapons platform's firing. Of course, at extended distances, this is much more achievable. But when firing close support (i.e., in close proximity to our soldiers), the times were extended—for obvious reasons. When we can track dismounted as well as mounted friendly soldiers, we will be able to reduce the sensor-to-shooter time for close support missions even more.

As technology progresses, we need to enhance AFATDS so it can process Apache (or UAV) calls-for-fire linked directly with the gun that will fire the target. The technology is out there; we just have to incorporate it while ensuring AFATDS remains integrated in ABCS—can talk to MCS, FBCB², etc.

Artillerymen in the field understand that. They are trying to get the capabilities to make these corrections. Until then, it boils down to training with AFATDS in peacetime, sorting through its limitations and developing TTP to make fires more responsive.

The challenge for responsive fires still exists in units with FBCB². As mentioned, our goal for sensor-to-shooter is less than one minute. These fires are traditionally forward of the CFL [coordinated fire line]. Short of the CFL is still a challenge. With the enhanced ability to fight over a large battlespace on a nonlinear battlefield, we are just now truly working the TTP to clear fires quickly and safely. As we continue to fight as maneuver shooters and get the systems in the hands of our soldiers, we will continue to become more responsive in clearing close fires in the future.

Now, having said all that, our indirect fires in both our Division Capstone Exercises were very impressive and made tremendous contributions to our fights. I am very excited about work being done to further integrate our indirect fires in the joint arena. This will involve both future sensors and platforms; we are seeing this today.

Q *The Army recently reorganized and unified the Army and Secretariat staffs (see the figure on Page 3). Why did the staffs reorganize?*

A The Army and the Secretary of the Army staffs realigned to improve efficiencies, both inside the Pentagon and for the support we provide to the Army in the field. We realigned and integrated the staffs and their missions, applying successful business practices to develop better products, and reduced the layers of review, resulting in a 15 percent staff reduction. The realignment will result in a leaner, more agile, adaptive staff that works faster with less bureaucracy.

An example of that unification would be that the G8 is aligned with the Assistant Secretary of the Army for Financial Management, so we can improve the interoperability between the POM [program objective memorandum] and budget. This is an improved process for following through with an Army program for formulation to budget execution. In the long run, we will provide better service to the field and, ultimately, the soldier on the ground.

Within the Army staff, for example, we moved FD [Force Development] from the G3 [formerly known as the Office of the Deputy Chief of Staff for Operations and Plans, or ODCSOPs] into the G8, so now we have FD, PA&E [Programs Analysis and Evaluation] and CAA [Combat Analysis Agency] in one organization. The G3 and G8 must work very closely together; we have a good system in place to do that. Our success directly impacts the combat readiness of the Army—our main focus.

Let's walk through the example of the IBCT. The IBCT was an Army priority. The requirement went from the G3 to the senior leadership for decision. Then the Army leadership made the decision to field six IBCTs. That came to the G8 for resourcing. We determined where the IBCTs are going to be within what time frame, what the fielding details are (number of systems, crew size, total soldiers, etc.) and work hand-in-hand with G3 to ensure we have the total package fielding at the right place and time—making this capability available to warfighters as quickly as possible.

If I can't resource a requirement, I go back to the Army leadership and say "this" constraint prevents me from resourcing "this" requirement. The decision is then for alternative resourcing and what risks to accept. This is a struc-

tured process, and it needs to be. Future capabilities must be weighed carefully against risks.

The realignment should be complete by September. It will maximize our operational capabilities—really the key.

Q *As the G8, can you give us an in-progress review on Crusader?*

A Crusader gives the Army a significant capability for the Objective, Interim and Legacy Forces. With its reduced weight, it will be transportable by C-17, and Crusader's higher rate-of-fire, maneuverability and speed will make it a significant combat multiplier.

Two Crusaders shoot as much as and faster than one battery of Paladin howitzers, have 33 percent increase in range and are three times more accurate than Paladin. Crusader will be able to engage targets of opportunity in less than one minute versus 10 to 12 minutes for the Paladin, and its sustained rate of fire is 10 times that of Paladin. Logistically, Crusader shares a common engine with the M1A2 tank, is totally robotic and reduces the howitzer crew by one-third.

The bottom line is that Crusader is a critical system for the Legacy Force as we transition into the Interim and then the Objective Forces. Clearly, the Army sees the Crusader and Comanche [helicopter] programs as essential in transformation. Crusader will be a tremendous combat multiplier for our Army and the joint force, complementing other means of direct and indirect fires.



Lieutenant General Benjamin S. Griffin is the G8 on the Army Staff at the Pentagon. In his previous assignment, he commanded the 4th Infantry Division (Mechanized), the Army's first digitized division, at Fort Hood, Texas. He served as the Director of Force Programs in the Office of the Deputy Chief of Staff for Operations and Plans, also at the Pentagon. In other assignments, he was the Assistant Division Commander (Support) in the 1st Cavalry Division, Fort Hood; the Commander of Joint Task Force Six at Fort Bliss, Texas; and Executive Officer to the Commanding General of Forces Command, Fort McPherson, Georgia. He commanded the 2d Brigade, 6th Infantry Division (Light) in Alaska; the 3d Battalion, 8th Infantry in the 8th Infantry Division (Mechanized) in Germany; and C Company, 3d Battalion, 325th Infantry in the 82d Airborne Division, Fort Bragg, North Carolina. He holds an MBA from Mercer University, Georgia.

Secretary of Defense Donald Rumsfeld is on a quest to change the military's culture and thinking about the nation's rapidly changing security environment. The recent actions in Afghanistan speak volumes on the reality of the changes in the Army's operational environment and the benefits of technology to our warfighting capability. Precision munitions have enabled the reduction of forces and logistics because of increased lethality.

The massive bombing raids of World War II involving hundreds of aircraft are now reduced by orders of magnitude in both the number of platforms and number of munitions to achieve even better effects on targets. Each smart bomb delivered on our enemy is more effective than 400 dumb bombs dropped in the past.

This enormous improvement in lethality and reduction in the number of platforms, supporting personnel and logistics is not just the domain of the United States Air Force and Navy. Our Army is moving rapidly on a course of unprecedented change—developing new equipment, revamping tactics and procedures, and revising training and leader development programs—to ensure we can provide the force necessary to support our nation's national defense policy. The Army is exploiting technology to develop the most advanced weaponry possible for the increased lethality, survivability and deployability of the future combat system (FCS)-equipped Objective Force.

The Objective Force may not be organized like the Army today. Basically, the vision for the future Army structure

consists of a "unit of employment" (roughly a corps or division) with FCS-equipped "units of action"—the smallest units that can be committed independently. A unit of action can be a combined arms brigade with subordinate combined arms battalions with a number of small units that fight as teams of teams.

The draft Unit of Action Objective Force Organizational and Operational (O&O) concept is of FCS-equipped units that are characterized by tactical speed and mobility, are focused on execution, are scaleable and rely on shaping effects to set the conditions for freedom of maneuver.

NetFires, an indirect fire capability and the focus of this article, will use advanced technologies to provide devastating, continuous close and shaping fires for the Objective Force at the tactical level.

Background. In the 1998 article "Fires: The Cutting Edge for the 21st Century" (May-June), the author, Brigadier General Toney Stricklin, outlined the Field Artillery School's vision for the branch out to 2020 and beyond to serve as a guide for the future. That vision has been updated several times, but the basics remain. Several of the tenets from that vision have enabled the FA to have continued relevance and be within the scope of achieving emerging Objective Force requirements.

NetFires

Precision Effects for the Objective Force

By Major (Retired) George A. Durham and
Colonel (Retired) James E. Cunningham

HMMWW/NetFires Launcher—Courtesy of Raytheon



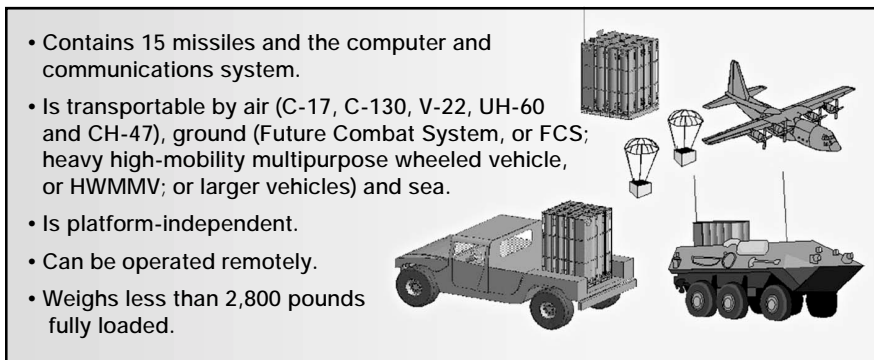

Figure 1: Container/Launch Unit (C/LU)

Among the many concepts proposed in the vision was that of an advanced fire support system that currently is being developed by the Defense Advanced Research Projects Agency (DARPA), Arlington, Virginia. The concept is that of a family of missiles that will be able to attack with precision or loiter over an area before attacking with precision, have a very small logistics footprint and not require a large, heavy, expensive and crew-intensive launch platform.

Lockheed-Martin, Raytheon and Boeing Corporations began to work on this concept in 1998, spending 10 months performing analyses of operational need and technology trade studies and establishing an initial concept definition for the system. The next phase began in 1999 and concluded with a detailed design.

The Depth and Simultaneous Attack (D&SA) Battle Lab at Fort Sill was designated the Training and Doctrine Command (TRADOC) proponent for the system to give DARPA and the contractor teams the information they needed to maintain an operational focus as they developed the critical design parameters and system characteristics.

In August 2000, Lockheed-Martin and Raytheon entered the system fabrication and test phase. They began to harness and integrate new technologies to produce a system with remarkable accuracy, range, lethality and reliability. These technologies include extremely accurate global positioning system (GPS)/inertial navigation system (INS) networked data links, advanced seekers with automatic target recognition (ATR), an advanced pintle motor and miniature turbojet engines.

NetFires System Description. The baseline NetFires system is being designed to attack a full range of stationary and moving targets. It will consist of a container/launch unit (C/LU), com-

puter and communications system (CCS), missile canister (MC), loiter attack missile (LAM), precision attack missile (PAM), NetFires shipping container (NSC) and mission planner computer (MPC).

Container/Launch Unit (C/LU). The C/LU will be the basic NetFires firing unit to serve as both the shipping container and launcher (see Figure 1). The C/LU will be reusable, reconfigurable and contain 15 missiles and the CCS. It will be tamper-resistant and capable of remote commands to conduct firing operations, self and on-command testing for reliability, and self and on-command disabling. A two-man crew will be able to reload and reconfigure the C/LU, to include various mixes of PAM and LAM.

NetFires will be a platform-independent system that does not require a specially designed launch vehicle. Missiles will be fired vertically from the C/LU, either mounted on the vehicle that transports it or from ground emplacement.

Vertical launch will be extremely valuable in built-up areas and forests and from defilade positions. It also will reduce the total mission time because it will eliminate traversing/elevation of the missiles—complicating the enemy’s counterfire radar detection of the missiles.

The C/LU will be mountable on robotic and manned ground vehicles or on compatible trailers for drive-on loading into C-130-like and all strategic lift aircraft. No data or electrical power connectors between the C/LU and transporting vehicle will be needed. The concept also envisions parachute or sling loads to deliver the C/LU.

Operators will be able to “ripple fire” both LAM and PAM from the C/LU, at least one missile per second, until all missiles are expended. The operator will be able to send each missile to a different target without physically re-aiming the system.

Computer and Communications System (CCS). The CCS will have the required communications and control functions for each NetFires C/LU (see Figure 2). It will consist of a battery power supply, a small ruggedized computer for control of all NetFires system functions, a wireless communications system that is compatible with current and future tactical radio systems, and self-deploying and retracting antenna(s). CCS will be able to provide self-location and orientation data and transfer this information to the missiles, as required. It also will be able to check the system’s status periodically or on-demand and perform technical fire direction functions.

The CCS will use standard fire control software to process fire commands originated by maneuver or fire support system sources, using the Army battle command system (ABCS)—the advanced FA tactical data system (AFATDS) and Force XXXI battle command brigade and below (FBCB²)—and future FCS command, control, communications and computer (C⁴) systems.

Missile Canister (MC). The MC will provide the missiles their primary protection against damage in storage, transportation and the tactical environment. The MC with missiles will weigh no more than about 150 pounds to facilitate quick two-man reloading of the C/LU. The MC will be capable of being stored or transported as part of the C/LU or as a separate unit.

Loiter Attack Missile (LAM). LAM will provide surveillance, targeting, battle damage assessment (BDA), airborne radio retransmission and attack of high-payoff targets (HPTs)—all with the same missile. (See Figure 3.) Using a solid propellant booster, LAM will be

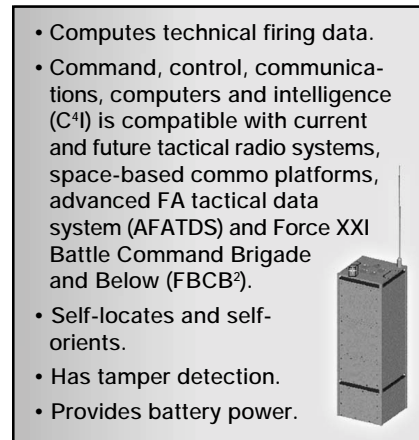

Figure 2: Computer and Communications System (CCS)

Common Munition Characteristics

- Weight: Approximately 100 Pounds
- Length: Approximately 55 Inches
- Diameter: Seven Inches
- Navigation: Global Positioning System/ Inertial Navigation System (GPS/INS)
- Data Link: Digital, Secure, Reliable and Two-Way

PAM-Precision Attack Missile

- Range: 5 to 50 Kilometers
- Warhead: Multicapable, Heavy Armor Defeating
- Seeker: Un-cooled Infrared Seeker/Semi-Active Laser (UCIR/SAL)
- Propulsion: Solid Fuel Rocket with Variable Thrust
- Command and Control (C²): Fire-and-Forget or Man-in-the-Loop Operations with In-Flight Target Updates

LAM-Loitering Attack Missile

- Loiter: 30 Minutes at Greater Than 50 Kilometers
- Warhead: Multicapable, Light Armor Defeating
- Seeker: Laser Radar (LADAR)
- Propulsion: Turbojet Engine
- C²: Fire-and-Forget or Man-in-Loop Operations with Imagery Transmission to Human Operator and Ability to Send Target Updates to Other Missiles



PAM will be launched out of a C/LU and powered by a pintle motor to provide variable thrust.
(Courtesy of Raytheon)

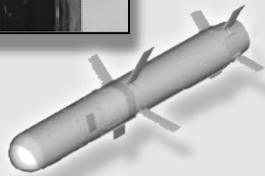

Figure 3: PAM and LAM Capabilities

launched vertically from the C/LU and, powered by a small turbojet engine, fly out to a range of more than 50 kilometers with a loitering time of 30 minutes.

The operator will be able to program mission data patterns into the missile or change the data in flight—to include the LAM's route, targeting priorities, mission tasks (targeting, BDA or attack), attack criteria and search. The missile will have a laser radar (LADAR) seeker with ATR that will be capable of transmitting near real-time information and imagery to a ground station. This control and imagery information will be transmitted over a digital, secure, reliable and networked data link that will support two-way communications between the missile in flight and the ground station. The accuracy with which LADAR will be able to find and identify targets promises affordable precision fires and the reduction of collateral damage.

As an example, if the mission is loiter-attack, LAM will be able to search for specific target types and attack in accordance with instructions that can be programmed into the missile or updated while it is in flight. LAM will have a multi-functional warhead to attack light armored and soft targets, such as BM-21

multiple-rocket launchers (MRLs), command and control (C²) vehicles, air defense targets, etc.

If the mission is to provide BDA, the LAM will have the "hang time" to transmit post-attack imagery to a ground station to help re-strike decisions.

Precision Attack Missile (PAM). PAM will be launched out of a C/LU and powered by a pintle motor to provide the missile variable thrust. PAM will be a guided missile with many flight profiles. These profiles are bounded by two types: a virtual direct fire trajectory for fast-attack at shorter ranges (0.5 to 20 kilometers) and a boost-glide trajectory for attack of targets at extended ranges (20 to 50 kilometers).

PAM will have a multi-capable warhead effective against armor and soft targets. It will receive target location and description data prior to launch and use a highly jam-resistant GPS/INS-aided internal navigation system to fly to the initial target location. Using the two-way data link, the operator will be able to send target location updates to the missile in flight—especially effective for attacking moving targets.

The uncooled infrared (UCIR) seeker will search the target area during the terminal portion of the flight and make

final corrections to ensure a high probability of kill. PAM also will have a semi-active laser (SAL) seeker to enable its precision attack. For a description of LAM and PAM capabilities, see Figure 4.

Mission Planner Computer (MPC). The MPC will be the FCS NetFires computer for planning and executing missions in support of the maneuver commander's concept of operations. The MPC will be able to plan and execute LAM and PAM missions simultaneously. In addition, MPC will provide the operator greatly enhanced overall situational awareness and an auto-

Planning Tools

- High-Payoff Target List (HPTL)
- Mission Type: Loiter or Targeting
- Battle Damage Assessment: BDA or Attack
- Weapon-Target Pairing
- Optimal Loiter Attack Missile (LAM) and Precision Attack Missile (PAM) Trajectories
- Flight Altitudes and Routes with Way Points
- Search Patterns
- Seeker and Warhead Selection
- Data Down-Link (Frequency and Secure Codes)
- The Status of Airspace Deconfliction
- Fire Support Coordination
- An ATR Confidence Threshold Report for Autonomous Attack and (or) Imagery Transmission
- Resolution of Terrain Interference Issues
- Recognition of "No-Strike Areas"
- Ability to Avoid Collateral Damage
- An Ability to Check on Communications Line-of-Sight (LOS) and Availability of Communications Relays
- A Method to Control Information Execution Tools
- An Artillery Target Recognition (ATR) Display for Target Selection and Prioritization
- Calls-for-Fire
- LAM Mission Management Display
- Ability to Re-Task a LAM in Flight
- Receive, Record and Show Missile Imagery with ATR Queues
- Allow for Human Interpretation of Missile Imagery
- An Interface with the Command and Control System—the Advanced FA Tactical Data System (AFATDS) or its Successor
- Ensure an Interface between a Forward Observer (FO) with a Semi-Active Laser (SAL) Seeker and the Missile

Figure 4: NetFires Mission Planner Computer (MPC) Automated Tools



LAM in Flight (Courtesy of Lockheed-Martin)

ated set of planning and execution tools as listed in Figure 4.

The MPC will be able to display icons over an electronic terrain map, showing the NetFires launch-box locations and, aided by the two-way link, the status of missiles in the air and targets located by LAM. It will allow the operator to select LAMs that are already in flight, interrogate their status and success in finding targets, re-task them onto new routes, and change target lists and ATR confidence thresholds.

The MPC will interface with ABCS, including the all-source analysis system (ASAS), maneuver control system (MCS), AFATDS, air missile defense warning system (AMDWS), tactical airspace integration system (TAIS) and global command and control system-Army (GCCS-A) plus the Air Force's theater battle management core system (TBMCS) and future systems existing at the time of fielding.

NetFires Shipping Container (NSC). NSC will hold up to 10 C/LUs for a total of 150 missiles in an international standards of operation (ISO) shipping container. (See Figure 5.) Its total weight will be less than 35,000 pounds, allowing it to be transported by the palletized loading system (PLS) and heavy expanded-mobility tactical truck (HEMTT). NSC also will be able to be transported by commercial or military wheeled, rail, air and sea systems.

Future Warfighting Concept. The primary mission for NetFires will be to provide the tactical commander ("division" level and below) immediately responsive precision effects on HPTs as well as near real-time target acquisition

and BDA. Using NetFires, the warfighter will have expanded capabilities across a broad range of operational situations: continuous close and shaping fires during all phases of early-entry as well as sustained operations.

NetFires' PAM and LAM munitions will attack and be highly lethal against the full spectrum of threat targets. NetFires will be mobile, able to support both contiguous and non-contiguous combat operations, flexible in organization and fully operable with the supported force as well as joint and coalition forces.

Command and Control. NetFires will operate within Objective Force command, control, communications, computers and intelligence (C⁴I) systems and architectures. It will operate primarily under the centralized control of an effects coordination cell (ECC) to respond to the needs of the force based on the mission and commander's intent.

NetFires also will be able to operate under decentralized control with combined arms FCS-platform commanders calling for effects. Sensors—such as counterfire radars, unmanned aerial vehicles (UAVs), attack aviation platforms or reconnaissance, surveillance and target acquisition (RSTA) plat-

forms—also will be able to initiate calls for fire.

The amount of centralization will vary based on the mission, enemy, terrain, troops and time available (METT-T) from completely centralized (the ECC planning and executing LAM missions) to totally decentralized (FCS maneuver platforms directly linked to NetFires C/LUs). Despite the degree of decentralization, basic fire support control and coordination procedures will be required to ensure NetFires missiles are delivered according to the commander's intent.

Communications. NetFires will be interoperable with other Army and joint systems. It will be compatible with Objective and Legacy Forces' digitized command, control and communication systems.

The communications to support operations involving NetFires will be a challenge that will demand careful planning and coordination. Each NetFires C/LU and missile will require reliable, uninterrupted and secure connectivity with GPS. NetFires C/LUs could be positioned at distances from the controlling ECC well beyond FM radio operating range, requiring the use of ground, airborne or space communications systems, depending on what is accessible and available.

Targeting. Targeting for the NetFires will follow the standard decide, detect, deliver and assess (D³A) methodology. The ECC will develop targets based on the high-payoff target list (HPTL) and intelligence collection plan. All available sensors and targeting information will be used to locate targets for scheduled, on-call or immediate attack.

The future AFATDS-like system will match the appropriate munitions with the target in accordance with the commander's guidance. If a NetFires munition is selected, then the system will send the fire mission to the appropriate C/LU.

LAM will provide targeting information in support of the intelligence collection plan or to meet the immediate needs of the commander. It will send

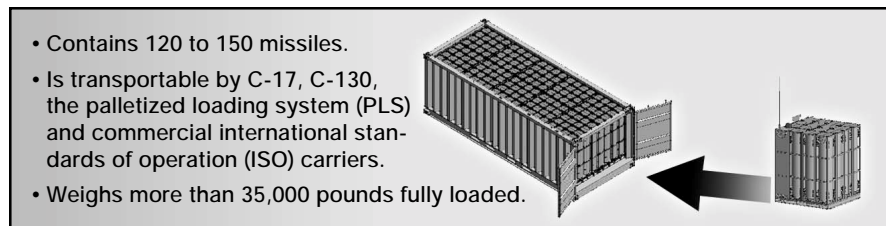

Figure 5: NetFires Shipping Container (NSC)

the targeting and other battlefield information in real time, information that all subscribers on the tactical information network will be able to share.

In most cases, requests for targeting and other LAM missions will be forwarded through fire support coordination channels to the controlling ECC. The ECC then will plan the mission, coordinate fire support and targeting, and execute the mission. Targeting data will be sent to the requester in the form of an artillery target coordinate report, intelligence summary or some other digital or video format. The form of the data will depend on the communications and processing devices at the receiving end.

Logistics. At the tactical level, the logistics system for NetFires units will follow the Objective Force logistics model. Resupply will be accomplished using standard procedures associated with the combined arms unit of action and unit of employment levels of support. When a C/LU has expended all missiles, the owning unit's ammunition section either will replace the expended CL/U or reload the CL/U with missiles, if time permits. The unit's ammunition resupply vehicles will travel to the desig-

nated ammunition transfer point (ATP) and draw additional NetFires ammo.

Employment. NetFires will provide precision line-of-sight (LOS), beyond-line-of-sight (BLOS) and non-line-of-sight (NLOS) fires plus target acquisition and BDA capabilities. Its primary purpose will be to support the tactical-level maneuver commander with immediately responsive effects to augment existing fire support systems. NetFires will be organic to the maneuver unit of action and supplement the systems in the supporting fires battalion, which will provide close and shaping fires.

The Way Ahead. NetFires has the potential for providing effects that will ensure an overwhelming overmatch to any threat against the FCS-equipped Objective Force. Its advanced technologies are being proven in the DARPA demonstration program. If NetFires' tests continue to be successful, it will be ready for fielding with the first FCS-equipped units in FY10.

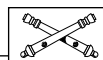

Major (Retired) George A. Durham is Deputy Director of the Depth and Simultaneous Attack (D&SA) Battle Lab at Fort Sill, Okla-

homa. He has been with Battle Lab since May 1992. In the Directorate of Combat Developments in the Field Artillery School, also at Fort Sill, he was the Director of the Soviet Artillery Effects Program. George Durham was the Executive Officer (XO) for a Department of the Army Special Action Team for Corps Support Weapons Systems, developing the Army Tactical Missile System (ATACMS). Before retiring from the Army, he served as the XO of the 4th Battalion, 4th Field Artillery, III Corps Artillery at Fort Sill and commanded two batteries. He's a graduate of the Command and General Staff College, Fort Leavenworth, Kansas.

Colonel (Retired) James E. Cunningham is a Senior Military Analyst under contract to support NetFires development with the D&SA Battle Lab at Fort Sill. Before retiring in 1996, he served as the Deputy Director of the D&SA Battle Lab. He also served as Chief of Staff of the 56th Field Artillery Command in Germany, and the Senior Analyst in the Operations Division of the Office of the Joint Chiefs of Staff, J3. He commanded the 17th Field Artillery Brigade, III Corps Artillery; the 3d Battalion, 9th Field Artillery (Pershing), part of the 214th Field Artillery Brigade, III Corps Artillery; and three batteries. He holds a Master of Engineering from Tulane University in New Orleans and is a graduate of the Air War College at Maxwell AFB, Alabama.



JWES: JMEM Weaponneering on CD

The Joint Munitions Effectiveness Manual (JMEM) Surface-to-Surface Weapon Effectiveness Systems (JWES) CD-ROM is a tri-service (Army, Navy and Marines) tool for weaponneering. The JWES CD-ROM, Version 2.0 to be released in April, is a multi-media product developed by the Surface-to-Surface Working Group of the Joint Technical Coordinating Group for Munitions Effectiveness (JTTCG/ME). JWES was developed at the Army Materiel Systems Analysis Activity (AMSAA), Aberdeen Proving Grounds, Maryland.

JWES generates weapons effectiveness estimates of fielded US and threat artillery and mortar systems, US naval gunfire systems and US and threat direct fire systems. It has three major components: the Browse and Weaponneer modules and an Effectiveness Guide. The Browse module provides data and graphics on indirect and direct fire weapons, munitions and targets. It also has information on mission planning, the com-

ponents of weapons effectiveness, effectiveness models and related JMEMs plus provides a glossary.

The Weaponneer module computes estimates of the effectiveness of indirect or direct fire weapons in various engagement conditions against personnel and material targets. The user can select a range of engagement parameters.

The JWES Effectiveness Guide provides indirect and direct fire effectiveness data in precalculated solutions. For indirect fire, the Effectiveness Guide is similar to standard graphical munitions effects tables (GMETs) and rank orders various selected weapon/shell/fuze combinations against a selected target.

Users can use JWES to compare the effectiveness of many US and threat weapon systems against a wide variety of target types. It is a suitable companion to fielded fire control computers for US FA, mortar and naval gunfire systems. Corps and division tactical operations centers (TOCs) can use JWES for

long-range fire planning of multiple assets against high-payoff targets (HPTs).

The 1st Battalion, 20th Field Artillery (1-206 FA), 30th Infantry Brigade (Separate), Arkansas Army National Guard, used JWES for staff planning in its 2000 Battle Command Training Program (BCTP) Warfighter exercise. The brigade fire support element (FSE) used JWES to determine which weapon system and shell-fuze combination would best achieve the effects described in the essential fire support tasks (EFSTs).

Distribution of JWES is restricted to US government organizations and authorized Department of Defense contractors. To obtain a copy of JWES, contact the JTTCG/ME Publications Office at Tinker Air Force Base, Oklahoma, by calling (405) 736-5468/2707 or DSN 336-5468/2707 or visit the JTTCG/ME home page at <https://jtcg.amsaa.army.mil>.

LTC(R) Steven J. Rawlick, FA
AMSAA Contractor
Aberdeen Proving Ground, MD

Major Keith A. Klemmer, FA
1-206 FA, Arkansas ARNG



Depth and Simultaneous Attack Battle Lab Test-Bed

The FCS-Based Force in Future Battle

By Major (Retired) George A. Durham,
Lieutenant Colonel (Retired) Frank T. Myers II
and Lieutenant Colonel (Retired) Charles L. Hernandez

The future is not as far away as we might think. During a recent experiment conducted at Fort Sill, Oklahoma, soldiers, combat and concept developers, “Graybeards” and contractors caught a glimpse of future warfare.

This article walks through the operational insights gained during the FY01 future combat systems (FCS) experiment conducted by the Depth and Simultaneous Attack (D&SA) Battle Lab in support of the Defense Advanced Research Projects Agency (DARPA) Independent Design, Experimentation, Analysis and Studies (IDEAS) supporting FCS.

Two stage-setting thoughts are worthy of note. First, at the time of this experiment’s conception, the Training and Doctrine Command (TRADOC) had not conducted experiments designed exclusively to examine warfighting with an FCS-based force. While this condition existed in the “Warfighting Requirements” community, there were four industry teams under contract to deliver

concepts for the FCS system-of-systems to DARPA in December 2001.

Secondly, at the time of the experiment, the TRADOC community was still in the midst of writing organizational and operational (O&O) concepts for the FCS. This fact essentially dictated the scope of the D&SA Battle Lab’s proposal to DARPA. The proposal was purposely broad with execution aimed at delivering insights that could inform the FCS concept evaluation and development process. Although insights do not readily translate into requirements, they do give an indication of the realm of possibilities.

Background. The Objective Force O&O describes units of action (U/As) as brigade-like and battalion-like warfighting organizations. The U/A brigade will integrate combinations of FCS-based and non-FCS-based organizations and capabilities.

The principal fighting force of the U/A brigade will be the FCS combined arms combat battalion. The U/A brigade will

employ four to six FCS combat battalions, which in turn will employ four to six subordinate combined arms companies (also referred to as teams of teams).

A fires battalion from a unit of employment (division or corps) will support U/A brigade operations. The fires battalion will consist of both FCS-based and non-FCS-based cannon, rocket and missile capabilities.

During the experiment, D&SA Battle Lab manned four FCS combat battalion cells; one was more robust with a six-man command and control cell. This “main effort” battalion controlled four subordinate company cells, each manned by two personnel. A five-person U/A brigade cell guided the tactical operations of the combat battalions and fires battalion.

The Objective Force networked fires environment was designed and validated with this experiment. It was established as a test-bed for examining the integration of Objective Force command, control, communications, computers, intelligence, surveillance and reconnaissance (C⁴ISR). (See Figure 1.)

The networked fires environment was stimulated by the FiresSim XXI distributed interactive simulation (DIS), which was enhanced to include replication and display of maneuver operations, and the multiple UAV [unmanned aerial vehicle] simulation environment (MUSE).

Experiment Design. The experiment was one week of training and two weeks of battle runs. In training, player staffs

were exposed to information about the Objective Force, the operational environment and the hypothetical “Road to War.” They also were introduced to a new computer system that emulated Objective Force command, control, communications, computers and intelligence (C⁴I) and the networked fires environment they would operate in.

Training was followed by a one-day rock drill for execution-focused battle planning and then six battle runs that placed great demands on the staffs’ professional and newly found skills. Through the battle runs, players were observed and surveyed as they performed the critical functions required of them.

Participants and contributors came from various Army agencies and research organizations to ensure the experiment remained non-parochial while retaining the ability to be informative to both the Army materiel developers and TRADOC combat developers. Senior consultants who served as the U/A brigade commander and the Red Force (REDFOR) commander were maneuver subject matter experts current in Army Transformation processes.

The TRADOC Analysis Command (TRAC) from Fort Leavenworth, Kansas, sent two observers to gain insights on how to model networked fires and effects in simulations. In its pre-analysis of Objective Force capabilities, TRAC recognizes that some network application of automated fires and effects will be essential to the FCS-based force and must be further defined and analyzed. The Army Research Lab (ARL), headquartered in Adelphi, Maryland, supported the experiment with human engineering and behavioral research personnel. Military personnel (Army and Air Force) and government contractors were the player/controllers.

The Battle Command Battle Lab at Fort Gordon, Georgia, linked the Dismounted Maneuver Battlespace Battle Lab at Fort Benning, Georgia, to Fort Sill’s Battle Lab and successfully extended the networked fires environment. The Force Projection Battle Lab Support Element from Fort Eustis, Virginia, sent an observer to examine the force design used and provide a deployability comparison and assessment.

Finally, the Office of the TRADOC Deputy Chief of Staff for Intelligence (DCSINT) provided the threat data (force structure and capabilities) that were simulated in this experiment. It was the first constructive experiment in

which a future threat used an “adaptive defense”—a threat outlined in TRADOC Objective Force seminars.

Road to War. The year is 2015. Objective US forces as part of a larger US and coalition force are deployed to support the defense of Azerbaijan. The Objective Force mission is to conduct offensive operations to repel Armenian forces that occupy the country.

The four FCS-based combat battalions of the U/A and its supporting fires battalion are strategically positioned along the exposed southern flank of the Armenian force. From there, the U/A brigade rapidly conducts offensive operations northward to secure a strategic airstrip at Agdam to be used to support the flow of follow-on forces. These additional forces will continue operations to force Armenian forces from Azerbaijan.

During the experiment, a total of six battle runs were performed. Battle Runs 5 and 5.1 comprised continuous operations over two days and yielded the most complete data for analysis. Other “targets of opportunity” in the first four battle runs included gaining insights about networked fires and effects; examining how battle staffs can exploit a robust situational awareness (SA) picture to achieve a higher level of understanding of the enemy and examining two tactical concepts for the employment of FCS-based capabilities.

Insights. By the start of Battle Run 5, player/controller staffs had achieved their highest levels of competence and cohesion. A more cohesive battle staff effort across the board allowed the

D&SA Battle Lab to gain the insights needed to meet experiment objectives.

Making Fires Automatic. The experiment showed that having fully automatic fires and effects is a very complex proposition. On the one hand, the force may be able to achieve maximum efficiency in processing fire missions, but on the other, the delivery of fires may not be as effective as the commander needs to achieve his intent or properly influence the battle.

Networked solutions may achieve their greatest effectiveness with semi-automatic solutions. Some parts may need to be fully automatic while others may need to be semi-automatic, having man-in-the-loop intervention and management.

The U/A brigade network and combat battalions networks both have sub-networks that compete for the right effects in the right amount and proportion all the time. The fires battalion from the unit of employment also brings its own network that must be seamlessly plugged in to answer the U/A brigade’s demands for reach-back and shared lethal effects.

In this experiment when fires were fully automatic, several issues arose. First, commanders did not like seeing their assets delivering fires and, possibly, putting at risk their own capability to deliver fires later in the operation. Second, commanders unexpectedly received accurate enemy counterfire, which immediately affected their plans. Last, commanders did not like being unable to stop the network from selecting their units to fire in mutual support of peer units.

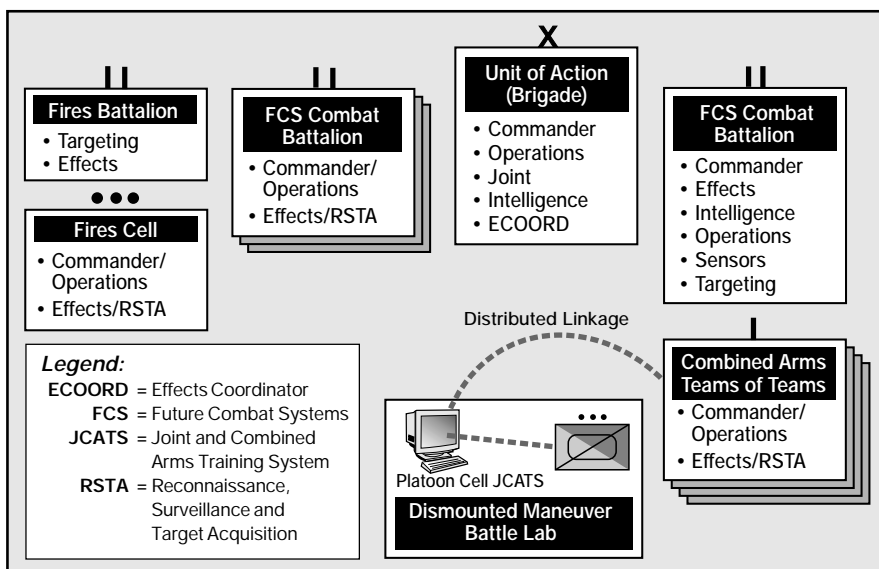

Figure 1: Test-Bed Networked Fires Environment for Objective Force Maneuver and Fires Simulation

Our first look at networked fires in experimentation showed it is an important component of network-centric and commander-centric operations. However, its components, conditions and rules of employment need further definition and validation.

Automating Targeting. In our experiment, all targets were always militarily significant, and therefore, battle staffs and organizations did not have to deal with noncombatants, urban areas and other non-military targets. We acknowledge that this was not representative of the complex operational and threat environments in which an Objective Force may find itself.

However, this was a deliberate and acceptable condition set in the experiment to allow the Battle Lab to gain insights about a level of targeting and engagements “approaching near perfection.” This capability is implied in emerging O&O concepts and requirements.

“Near perfection” means that targeting is on “automatic,” causing battle staffs to rely on smart sensors directly linked to smart computers that quickly adjudicate the location, identity and nomination of targets. Anything less implies man-in-the-loop intervention, delays and reduced operations tempo (OPTEMPO).

This experiment demonstrated that automated targeting should be combined with both automatic and non-automatic engagements. Why? Because we observed that network solutions to non-line-of sight (NLOS) fires may be efficient (reduce the response time), but not necessarily effective.

The degradations to the “effectiveness” span many aspects of the overall engagements. They included compromising a plan, putting friendly units at risk, failing to deliver the right effects on the enemy and, even, instilling high anxiety in the battle staffs who suddenly feel they’ve lost control of their organic assets.

Ultimately, the true measure of how effectively fires and effects are employed is whether or not the commander’s intent is achieved—including whether or not he is able to influence the battle when and where he needs to do so.

Swarming UAVs. Player/controllers unanimously recorded that the sensors being envisioned for the Objective Force provide excellent and necessary capabilities. The benefits are improved reconnaissance and surveillance at greater distances and without contact. (See Fig-

ure 2.) However, the FCS-based force had to learn how to work with these capabilities.

A 50 percent SA-intelligence picture of the REDFOR was provided to the U/A brigade and its subordinate battalions at the start of the experiment. This level of SA yielded a need for the force to further develop the situation out of contact, so the experimental force launched its UAVs.

The first actions taken by the FCS-based force were to launch all or almost all of its UAVs at, essentially, the same time. C⁴I screens immediately began displaying more of the enemy across the entire front. The numbers of acquisitions grew to hundreds and thousands, and the information processed from the sensors competed with target nominations, fire missions and other automated information exchanges by the player cells. The result was inevitable: information overload and network stoppages.

Later, the battle staffs improvised, and rather than swarm the UAVs at one time, deferred to the longer range and more capable UAVs for as long as they could before employing shorter range UAVs. This tactic had the impact of im-

proving survivability and future operational potential. Fewer UAVs being displayed in the staff’s C⁴I screens also gave battle staffs a greater sense of control.

Decision Making with Complete Information. All the battle staffs were challenged to make sense of the information being provided by their sensors. In the six-man FCS combat battalion staff, the “Threat/Operations Officer” was responsible for providing threat assessments based on the common operating picture. No such staff member existed in the others units. In the end, the staffs relied on the literal display of threat forces as they were acquired to decide what actions to take and how to proceed.

We observed that even at the company level, there may be a need for pattern recognition. But who is responsible for this? Should the combat battalion provide it based on being able to see the same tactical pictures on its computer screens that all the subordinate companies see and having a larger staff to work with? This experiment suggests that the burden may reside with the battalion as the battalion commander must determine where the profitable fight is or will be.

Other Decision-Making Factors. During the experiment, we determined other issues needing examination and resolution. For example, the decision-support (battle staffs) and decision-making (commander and the network) must match the tempo and demands of the operation.

Also, due to the number of UAVs employed nearly simultaneously, the acquisitions of militarily significant targets many times did not match the commander’s attack guidance. The targeting and engagement processes must adjudicate the differences.

Finally, the enemy will be adaptive and unpredictable. Unplanned demands for fires and effects will arise. Network solutions that do not fit battlefield requirements must be able to be interrupted without breaking network continuity.

Locating and Identifying the Enemy. Maneuver commanders had the luxury of near-perfect acquisition, providing complete information about the enemy it acquired. Such is the desired capability to successfully develop any situation out of contact.

Control of organic sensors must be embedded within the C⁴I display, and this direct linkage must give the company elements performing reconnaissance, surveillance and target acqui-

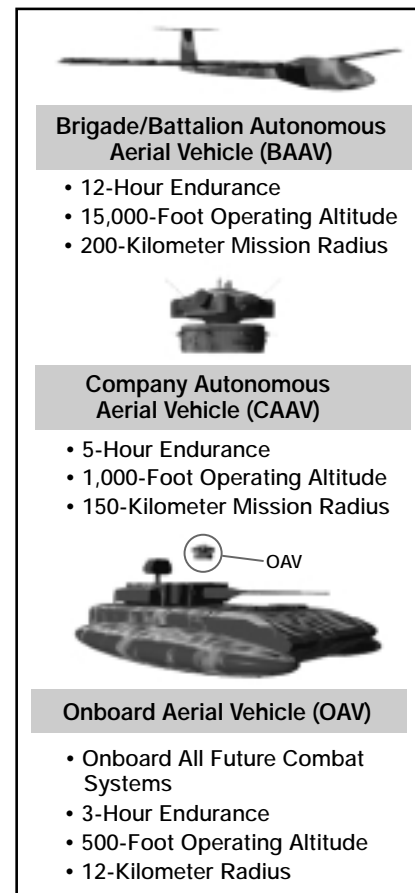

Figure 2: Objective Force Family of Unmanned Aerial Vehicles (UAVs)

tion (RSTA) operations and the company headquarters a clear sense of actually being within line-of-sight (LOS) of the enemy.

These maneuver companies that are in harms way and physically isolated (albeit linked electronically for mutual support) need near-perfect understanding of the enemy situation. The battlefield conditions place great demands on the company headquarters to know exactly what it is seeing and be able to decide what is and is not a relevant threat. Aided by his battalions' guidance toward the profitable fight, the company commander must not become misguided in his intentions and actions.

During the experiment, the operational plan became disjointed at times because company commanders took immediate action to eliminate the enemy it acquired at all ranges. We found that not all the enemy the company acquired was a target that needed immediate engagement.

The human instinct to eliminate what appears to be a more immediate threat shows that experience and tactical patience are skills that need emphasis in training. It should be noted that in some cases the engagements were performed automatically by the network, but in others, company commanders initiated the actions deliberately.

Developing the Situation Out of Contact. Developing the situation out of contact is an information-oriented operation. The Objective Force's FCS combined arms company, that has abundant UAV capabilities at its disposal, employs its organic sensors to gain information without making physical contact with the enemy and develops the situation based on what's displayed on C⁴I screens.

Our findings are that employing UAVs and unmanned ground sensors (UGS) that provide standoff reconnaissance and surveillance does not mean the force is invulnerable to enemy acquisition. As such, the force does not stay out of contact for very long. This resulted in high anxiety within the company headquarters where tactical patience was tried.

Acting First and Finishing Decisively. There were a number of close engagements but no assault at the main objective. Some close engagements were surprise engagements.

According to the FCS O&O, surprise engagements are not supposed to be the norm. We found that during surprise close engagements, the company generally did not fare well, suffering critical losses to anti-armor engagements.

The FCS-based force must be able to sense the enemy in greater detail and with assurance to keep from being surprised on the battlefield. This includes sensing the individual soldier threat armed with rocket-propelled grenades.

The company headquarters' ability to act first and finish decisively will be greatly assisted by C⁴I automation that is linked to smart sensors and is hyper-linked to available supporting and complementary fires and effects. The C⁴I also must intelligently balance the commander's guidance, priorities and endstate with every demand for integrated solutions for maneuver, fires and effects.

Emulating C⁴I Automation. Emulation of Objective Force C⁴I automation was accomplished through the use of a graphical user interface (GUI) to the FireSim XXI model. The GUI (pronounced "goeey") was a PC-based interface with the FireSim XXI model that allowed battle staffs to plan, coordinate, execute and manage combined arms battles on their screens.

Approximately 32 computers were configured in a network design that was intended to immerse battle staffs from the U/A brigade level down to the individual FCS combined arms company in a networked fires environment to produce high-tempo execution of combined arms fires and effects. (The GUI was not intended to replace any specific tactical C⁴I system but rather to serve as a stimulator for man-in-the-loop experimentation with FireSim XXI.)

More importantly, the GUI provided a broad emulation of critical battle command and effects management functions for a futuristic force organized with both FCS-based and non-FCS-based capabilities. With this experiment, the networked fires environment was validated to be a viable tool in man-in-the-loop DIS to examine Objective Force concepts and capabilities.

Conclusion. The experiment looked at future concepts and operational capabilities for an FCS-based force. It clearly has shown issues that need additional examination as we look to the future.

The D&SA Battle Lab took a bold step in FY01 to deliver *insights* that could *inform* the FCS concept evaluation and development process. In doing so, the networked fires environment was born, and the Battle Lab now is postured to support Objective Force experiments in the near future.

In this fiscal year, the D&SA Battle Lab is chartered to lead and execute a unit of

employment/unit of action (U/E-U/A) "Shaping the Battlespace and Shared Lethal Effects" experiment for TRADOC. Clearly, the road ahead spells opportunity for the Battle Lab to contribute to the Army's transformation to Objective Force capabilities.

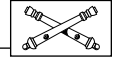

Major (Retired) George A. Durham is Deputy Director of the Depth and Simultaneous Attack (D&SA) Battle Lab at Fort Sill, Oklahoma, overseeing all experiments and projects in the lab. He has been with Battle Lab since 1992. In the Directorate of Combat Developments in the Field Artillery School, also at Fort Sill, he was the Director of the Soviet Artillery Effects Program. George Durham was the Executive Officer (XO) for a Department of the Army Special Action Team for Corps Support Weapons Systems, developing the Army Tactical Missile System (ATACMS). Before retiring from the Army, he served as the Executive Officer (XO) of the 4th Battalion, 4th Field Artillery, III Corps Artillery at Fort Sill and commanded two batteries.

Lieutenant Colonel (Retired) Frank T. Myers II is the Lead Data Analyst for Future Combat Systems (FCS) experimentation under contract with the D&SA Battle Lab at Fort Sill; he also worked on experiments for the Fires and Effects Coordination Cell (FECC) in the Initial Brigade Combat Team (IBCT) and the Effects Coordination Cell (ECC) in the Interim Division. Before he retired in 1992, he served as the 2d Infantry Division Artillery XO in Korea while simultaneously commanding a provisional battalion, consisting of the Headquarters and Headquarters Battery; E Battery, 25th Field Artillery (Target Acquisition); and B Battery, 6th Battalion, 32d Field Artillery (Lance/Multiple-Launch Rocket System). He also was the Deputy Director of the Gunnery Department in the Field Artillery School.

Lieutenant Colonel (Retired) Charles L. Hernandez is the Lead Project Officer under contract with the D&SA Battle Lab for experimentation based on FCS concepts and capabilities. Previously, he was under contract to develop tactics, techniques and procedures for the Army's first FECC in the IBCT at Fort Lewis, Washington. He retired in 1999 after spending his last six years in assignments at the Headquarters of the Training and Doctrine Command at Fort Monroe, Virginia, and the Field Artillery School working on the Army's Force XXI and Army-After-Next concepts. He served 23 years in the Field Artillery in heavy and light force troop and staff assignments, including as Assistant G3 of the III Armored Corps at Fort Hood, Texas.



MRAAS on Vehicle

The Multi-Role Armament and Ammunition System (MRAAS) for the Multi-Mission FCS: Direct and Indirect Fire

By Mark A. Ford and Colonel (Retired) John H. Northrop

The following article describes one of several possible scenarios for the design and operation of the future combat systems (FCS) for the Objective Force. The technologies described in this article are still under development and have not been tested on an FCS prototype. In FY03, the Army will make the decision as to the design of the FCS, including the type and calibers of the weapon systems and which technologies to incorporate. Ed.

In 1999, the Defense Advanced Research Projects Agency, (DARPA), Arlington, Virginia, in conjunction with the US Army Training and Doctrine Command (TRADOC) with its headquarters at Fort Monroe, Virginia, initiated the FCS Program for the Objective Force. This program will leverage advanced technologies in platforms,

sensors, communications, lethality and unmanned systems, including robotic ground vehicles and unmanned aerial vehicles (UAVs).

The FCS force has specific goals for strategic deployability, lethality and sustainability. For example, the FCS unit of action (brigade-sized) has a deployment goal of weighing only 25 per-

cent of today's heavy brigade. Additionally, this force must be more lethal, emphasize standoff precision engagement and be capable of closing with and destroying the enemy. FCS must be effective across the spectrum of conflict, including stability and support operations (SASO), and operate in all environments, including urban.

About this same time, the Assistant Secretary of the Army for Acquisition, Logistics and Technology approved an Advanced Technology Demonstration (ATD) to be run by the Tank-Automotive and Armament Command-Army Research, Development and Engineering Center (TACOM-ARDEC) at

Picatinny Arsenal, New Jersey. The ATD is designated the Multi-Role Armament and Ammunition System (MRAAS), the subject of this article, and includes developing an integrated direct and indirect firing capability on a common chassis.

MRAAS will be mounted on an FCS chassis to produce an advanced strike system to perform multiple functions on the battlefield of 100-by-100 kilometers. TRADOC provided initial guidance for MRAAS to be capable of providing lethality overmatch in the direct fire mission and full-spectrum lethality in both the red zone and shaping zone fights. (The red zone is the FCS-based force's standoff engagement area approximately 12 kilometers away from the enemy.)

TACOM-ARDEC began working with DARPA, TRADOC and industry to develop a high-technology armament system that will serve as one of the key FCS strike platforms and underpin the Objective Force's ability to dominate maneuver and fires throughout the battlespace.

Operational Concept. Developing an operational concept facilitated understanding the multi-role tactical requirements of the MRAAS system. The concept exploration scenario was one in which a joint task force (JTF) commander requested an FCS force for a rapid deployment mission. The force included MRAAS and other platforms consistent with emerging FCS concepts.

The scenario investigated the actions of a notional decisive operations unit (DOU) consisting of MRAASs, reconnaissance and surveillance (R&S) platforms, infantry fighting vehicles (IFVs) and responsive accurate munitions modules (RAMM). RAMM is another TACOM-ARDEC science and technology objective investigating a fully robotic indirect fire module that shoots conventional and special purpose 120-mm mortar munitions out to 15 kilometers.

In this operational concept, systems were inserted by parachute or immediate follow-on air transport landing on unimproved combat runways at a distance of about 75 kilometers from the threat force. The threat provided a robust baseline of battlefield targets, including tanks, light armored vehicles, cannons, rockets, missiles, trucks, helicopters, mortars and soldiers in the open and in fortified fighting positions.

Immediately after landing, the DOU dispersed. Due to limited airlift, the force did not bring UAVs. Instead, a

"[MRAAS] includes developing an integrated direct and indirect firing capability on a common chassis."



RAMM launched a limited-dwell UAV, called QuickLook, that flew to the threat area and provided a live feed for targeting purposes.

MRAAS oriented and commenced standoff engagements at ranges out to 50 kilometers. Each FCS system had a predetermined mixture of munitions that was weighted toward attacking the threat through long-range standoff fires while maintaining an air defense and direct fire capability.

MRAAS steadily moved toward the enemy, continuing to destroy enemy targets. Based on his systems' ammunition expenditure and movement rates, the DOU commander requested precision airdrop resupply between his force and the threat; MRAAS systems independently moved to dispersed pallets and resupplied.

The fight had unfolded rapidly, and MRAAS guns needed a quick ammo resupply. Resupplying ammunition at this point allowed systems to tailor the load for the last 25 kilometers of the fight when beyond-line-of-sight (BLOS) and direct fire engagements would prevail, but long-range engagements also might be needed. As a three-gun MRAAS platoon resupplied, the other platoon continued to rain lethal fires on the threat.

Soon all MRAAS systems had resupplied and moved to within 25 kilometers of the threat force. As FCS IFV systems repositioned to assault the flank of the enemy, RAMM systems robotically followed, providing what amounted to hip-pocket fire support to the infantry.

Quite predictably, the threat launched a helicopter counterattack. JTF assets detected this launch, and DOU assets were cued where to look.

When picked up by the R&S platform and MRAAS sensors, systems designated for the short-range air defense role immediately received the necessary targeting information. When the threat helicopters arrived within 12 kilometers of the flank MRAAS systems, the helicopter blips disappeared from the joint surveillance and target attack radar system (JSTARS) operator's screen. Soon, MRAAS closed with and executed direct fire engagements to destroy the enemy systems attempting to escape the RAMM and FCS IFV assault.

MRAAS Capabilities. The concept exploration highlighted a number of capabilities MRAAS should have. First, the scenario showed the special logistical implications of the fight. The wide range of targets suggested the need for MRAAS to have an ammunition suite both tailorable and multipurpose. C-130

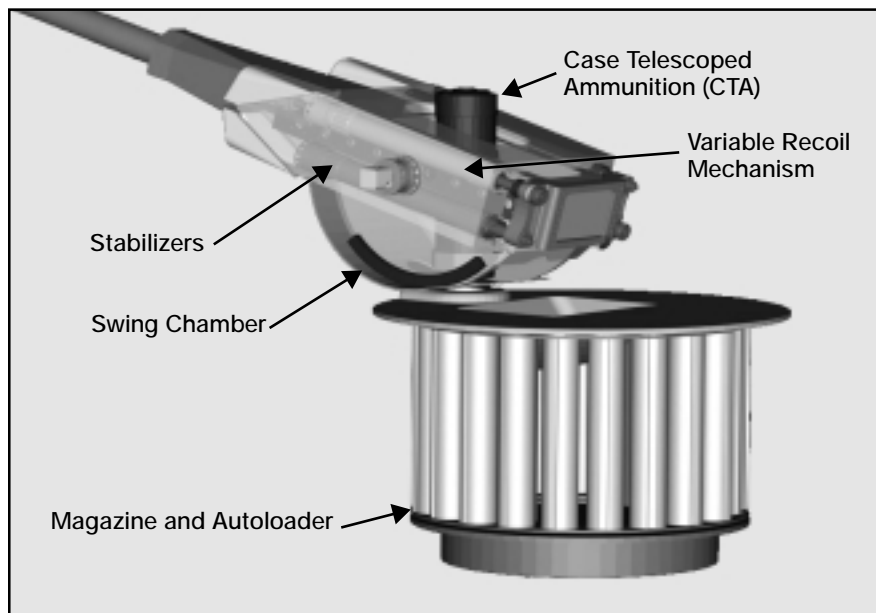

Close-Up of the MRAAS Turret

precision delivery and MRAAS' ability to self-upload ammunition was an underpinning capability. The log platform and the MRAAS platform should be designed to fully automate re-supply of ammunition, fuel and water.

But the overriding lesson from the scenario was the utility of a single platform's ability to provide fires across a full-spectrum of targets throughout the depths of the battlespace. But is this possible...a single platform that can serve as a direct fire, indirect fire and an air defense system?

Assessing this possibility lies in investigating the technologies of the armament and ammunition subsystems that underpin this vision.

MRAAS Subsystems. Trade studies conducted at TACOM-ARDEC selected a 105-mm cannon as the primary armament system for MRAAS because the cannon met future lethality requirements on the lightest platform. A 25-mm objective crew-served weapon is the secondary armament system.

MRAAS has five armament subsystems: ammo handling/resupply, weapon control, chassis integration, turret design and launcher.

Ammo-Handling/Resupply. Central to the MRAAS resupply vision are advances in resupply packaging, materials delivery and platform reloading. As described in the scenario, there should be a precision air-delivery capability to insert ammunition.

Work on precision parachute delivery is being done at Natick Labs in Massachusetts. Initial studies show a load equipped with a global positioning system (GPS) receiver likely could be delivered to within 10 meters of a specified location, thereby facilitating pinpoint and dispersed enroute resupply during MRAAS unit movement.

Under development today is the enhanced delivery system-air (EDS-A), a modular transportation platform to be used by air, land or airdrop delivery systems. Up to three MRAAS vehicle loads of water, fuel and ammo will fit on each modular platform. Analysis suggests this configuration will require 40

percent fewer aircraft sorties over the current 463L system configuration.

Ammunition will be prepackaged in five-round clips weighing less than 350 pounds or about half the weight of equivalent lethality in missiles.

Although the initial deployment weight of a gun platform may be slightly higher than a missile platform, that difference is more than made up with the first resupply. For equivalent stowed-kills, follow-on resupply loads of 105-mm munitions will weigh about one-half that of missile loads.

This suggests that, overall, MRAAS will be significantly less burdensome on the logistics system.

And resupply will be easier on the individual soldier, too. Advances in robotic technologies will allow the MRAAS chassis to have manipulators that will move ammunition clips from the modular platform into position to refill the platform's magazine. While TACOM-ARDEC engineers are investigating different concepts for this capability, initial modeling analysis suggests an ability to upload ammunition in about one-third of the time it takes now. The system also will be able to be re-loaded manually.

Weapon Control. Technical weapon fire control capabilities will be vastly superior to current systems—MRAAS will engage targets more accurately than ever before. The key to this will be the advanced stabilization of the tube and a closed-loop sensor system. A dynamic muzzle and tube reference sensor will provide information to computer controllers that will direct electric motors to dampen tube movement. Other sensors will monitor the entire system's status continuously, including mechanical problems, such as boresight alignment, tube wear and tube movement.

Embedded passive radio frequency sensor tags will provide ammunition identification and instantaneous propelling charge temperature to the fire control and inventory management systems. Environmental sensor tags inside the case telescoped ammunition (CTA) rounds will update the status of the

munition as it rests in the magazine as well as allow for total asset visibility and unprecedented inventory control.

Enhanced stabilization and continuously updated system status will allow predictable weapons performance and accurate firing computations and enable accurate direct and indirect fires while on the move.

Electro-thermal chemical (ETC) is an advanced technology that features the conversion of electrical energy to a high-temperature plasma that is used to augment ignition of the propellant bed. ETC will allow the precision ignition of the propulsion system.

The temperature of the propellant and projectile determines the amount of energy required to ensure a predictable, repeatable performance for every round fired across the operational temperature range. A new advanced propellant (Gen II) is being developed that features a high-energy formulation with a progressive burning configuration and decreased sensitivity.

Chassis Integration. TACOM-ARDEC's vision is that it will be possible for MRAAS to fit on the platform selected for FCS but also will integrate onto others. The MRAAS module will weigh five tons and comprise about one-third of the weight of the overall platform. Fully combat loaded with weapons systems' basic loads and fuel, the platform will weigh approximately 16 to 18 tons, be C-130 transportable and have platform mobility and agility equivalent to other FCS platforms.

Turret Design. The current FCS design calls for a compartment with a two-man crew to operate the vehicle and serve as a man-in-the-loop for the fully automated firing process but be totally separate from the firing event.

A second compartment will house the MRAAS. This arrangement facilitates future transitions to teleoperated and, ultimately, a fully robotic capability.

MRAAS Launcher. The launcher assemblies are some of the most interesting technological advances. Perhaps most challenging are those techniques to manage recoil.

The current MRAAS design envisions a variable recoil mechanism. Traditional recoil designs allow very rapid controlled rearward motion of the cannon assembly to absorb the energy of the fired munition.

Variable recoil will use advanced cylinder designs and valve switching technologies to control system hydraulics.

“Enhanced stabilization and continuously updated systems status will allow predictable weapons performance with accurate firing computations and enable accurate direct and indirect fires while on the move.”



Variable recoil will adjust and shorten the recoil stroke, accommodating the nature of the munition and the elevation fired.

Shortening recoil will mean less intrusion of the gun and chamber into the body of the vehicle. This will have three benefits. First, there will be more space for stowed rounds. The gun will be able to fire at higher elevations. And last, the gun will be smaller, more compact and lighter.

However, significant pressure and energy still will be transferred during firing. To move from the existing 40- to 60-ton systems of today to an 18-ton system of the future is no minor challenge. The gun mount and cradle still will undergo significant stress and, therefore, must be built of high strength/strong materials.

The tube must have consistent pointing performance. If too rigid, the tube is subject to structural failure during firing. If too flexible, the variable directional pointing of the tube throws inaccuracies into the firing computations.

New technologies and better engineering has resulted in the development of high-quality forged and rolled steel that is selectively wrapped and specially bonded with composites for increased strength, predictable rigidity and less weight.

Handling this stress also requires unique applications of many other advanced materials. But how does one achieve the strength of steel without incurring the weight? One technology of particular note is isogrid structures that have the high strength-to-weight characteristics of honeycomb structures.

These structures will offer the strength and hardness (stiffness) of steel plate at a fraction of the weight. By specifically designing the shape of the honeycomb structure, the material will be matched to the magnitude and direction of the force being applied. What results will be a very efficient structure, ultimately allowing tremendous overall weight reductions.

Within the launcher, an autoloader and swing-chamber mechanism will translate the projectile from the ammo magazine to the loader to the breech. The autoloader will work at any of MRAAS' firing elevations and permit loading on the move. A controlled velocity rammer will result in consistent ramming and also eject empty casings.

While swing-chamber mechanisms have been demonstrated in smaller caliber systems, the development of cased ammo capable of sealing the chamber to the gun tube in this dynamic environ-

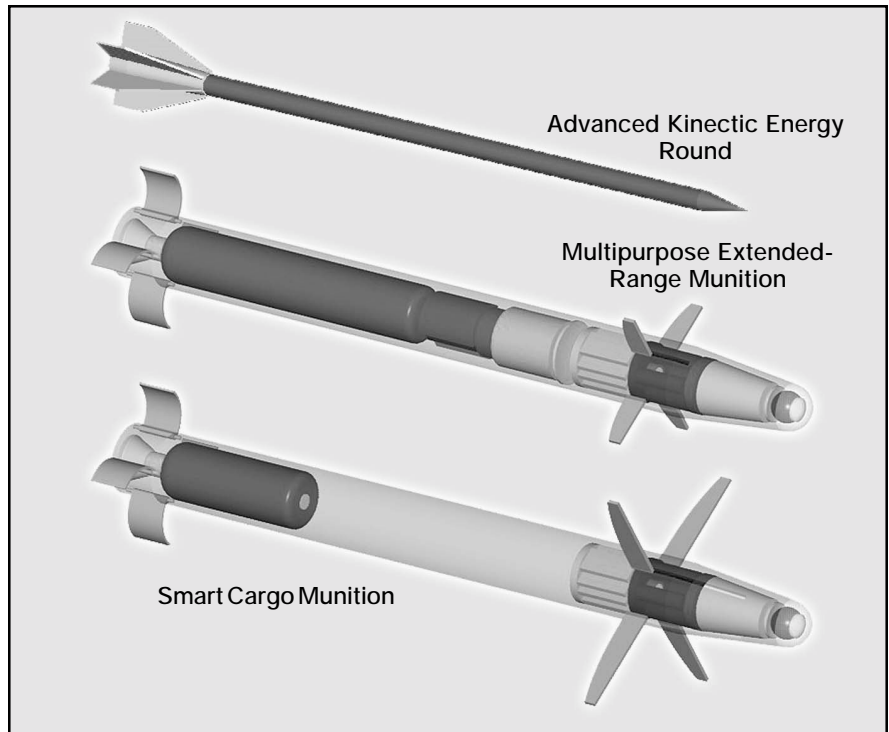

Precision Munitions Suite

ment is challenging. Nevertheless, the benefits of a swing-chamber mechanism make it an extremely desirable characteristic.

It will require smaller space than fixed chambers and associated autoloading mechanisms, resulting in more room available for ammunition storage. This also will contribute to achieving an operating elevating range of minus-10 to plus-55 degrees—not insignificant in urban operations. Swing-chamber mechanisms have demonstrated burst rates in excess of 20 rounds per minute.

MRAAS Ammunition Suite. The overall objective of the MRAAS munition suite program is to develop mature concepts and technologies for a small family of munitions capable of defeating the full spectrum of threat targets. TACOM-ARDEC established a baseline ammunition suite comprised of three fundamental types of rounds: an advanced kinetic energy (KE) precision round, a multipurpose extended-range munition (MP-ERM) and a smart cargo round. At the time of this writing, TACOM-ARDEC was in the process of selecting up to two industry teams to begin developing and demonstrating these rounds.

Precision munitions will be key to MRAAS as they improve both the probability of hit and probability of kill for each engagement. The capability to destroy targets beyond the effective

standoff of the enemy will be particularly important for the survivability of the MRAAS platform as aggressive weight goals limit the amount of platform armoring. Instead of a heavy armored outer shell, platform survivability will be enhanced by a combination of an active protection system (APS), reduced system signature and enhanced situational awareness that enables stand-off engagement.

Among precision munitions, there are common technological advances. First, all the projectiles are being designed to fit within the CTA cartridge case, thereby producing munitions that are self-contained and shorter than the current 105-mm munitions. Breech and chamber seals are an important element of the CTA system, so the cartridge case will incorporate composite casing with a self-sealing capability. After firing, the empty case simply will eject as part of the autoloader function.

Other common technologies include the ETC ignition and Gen II propellant previously discussed.

Advanced KE Round. For line-of-sight (LOS) defeat of heavy armor threats, MRAAS will fire an advanced KE round. The key technologies associated with the advanced KE munition will include composite sabot and a novel penetrator, which will be designed to defeat the current and future heavy armor threat.

MP-ERM Round. This round will offer an exciting capability to deliver short time-of-flight, multi-mode effects from two to 15 kilometers. This round will incorporate an on-board target acquisition capability enabling accurate engagement of LOS, BLOS and non-line-of-sight (NLOS) targets.

The projected target set goes beyond that mentioned in the scenario. Defeating a wide-range of targets with a single munition is a key challenge. To accomplish this, TACOM-ARDEC currently is developing two multipurpose warhead technologies. In one technology, explosively formed projectile (EFP), tactical fire commands inform the projectile to take on one of four selectable configurations: single-slug anti-armor; multiple-slug anti-armored personnel carrier; small-pellet anti-vehicle/UAV/helicopter; and anti-personnel fragmentation. In the other technology, an advanced shaped charge forms an explosive jet into either a single or multiple fragment effect.

In both of these technologies, the development priorities are to get the right level of armor penetration, add the multipurpose capability and then improve the round with more powerful explosives that occupy less volume.

Smart Cargo Round. This will be the final member of the ammunition suite. This munition will be used to attack armored systems, urban structures, bunkers and infantry formations and assembly areas.

The concept for the smart cargo round is to develop a lightweight round capable of carrying multiple payloads deep into the shaping zone. Possible payloads include unitary munitions, dual-purpose improved conventional munitions (DPICM), smart submunitions and nonlethal munitions, such as incapacitants.

To achieve the desired range, the smart cargo round will be fired to a given altitude and then glide to the target. In-flight updates on the target location are essential to modify the round's trajectory and achieve a high probability of target engagement at great distances. To accomplish this, the smart cargo program is leveraging technological advances involving novel applications of antennae to receive updates and advanced guidance systems coupled with GPS.

Challenges. Integrating a capability of MRAAS' significance has its challenges. There are many operational, technical and institutional issues to over-

come. Issues can be as simple as planning the proper ammunition mixes or as complicated as integrating a cooperative engagement capability within the MRAAS weapon control system in order to attack air defense targets.

Technological challenges include hardening sensitive electronics—such as those associated with guidance and control or electronic safe and arming—to withstand the high forces associated with a gun launch. Another challenge is miniaturization of munition guidance systems; one promising example is a micro-electromechanical system inertial measurement unit (MEMS IMU).

Maintaining 155-mm equivalent lethality in cargo rounds with a 105-mm projectile requires a number of these technologies to merge. As with any system, there will be significant software and hardware integration issues.

There also are considerations as to the technical, tactical management and leadership skills required in the young lieutenants and NCOs who will command the multi-role systems. Their skill sets will be subsets of those capabilities found in today's Infantry, Armor, Field Artillery and Air Defense leaders. The impact on the institutional training base and across doctrine, organizations, materiel, leader development, personnel and facilities will be enormous.

While MRAAS will contribute significantly to accomplishing the FCS goal of providing a rapid deployment and early access capability to Army forces, it also will have relevance in other areas. It will have particular utility in economy-of-force operations. Because of its multi-role capability, MRAAS will be able to serve as the central strike platform in a variety of missions, including reconnaissance and surveillance, force screening and rear area combat operations. MRAAS would be particularly useful to forces conducting deep raids or other special missions. Because MRAAS will be relatively light, resupply will be an enormous plus, especially when conducting distributed offensive operations.

This system will have no limitations across the full range of special environments in which Army forces will be asked to operate. Its multi-role capability will make it particularly relevant in military operations in urban terrain (MOUT) and SASO.

MRAAS will not only be key to FCS brigades, but also it likely will have immediate application to special capa-

bility forces—airborne, air assault, special operations forces (SOF) and Marine expeditionary forces (MEFs).

Yes—it's possible for a single platform to serve as a direct fire, indirect fire and air defense system. In terms of indirect fire, we will be able to achieve a range out to 50 kilometers using an 105-mm cannon mounted on a 18-ton common platform to provide effects throughout the 100-by-100 kilometer battlefield. If the Army selects MRAAS for its objective system, it could begin fielding by 2012.

With its baseline ammunition suite and its multi-role mission capability, MRAAS will underpin the FCS concept and provide the Objective Force the ability to dominate maneuver and fires.

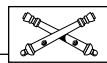

Mark A. Ford is the Project Manager for the Multi-Role Armament and Ammunition System (MRAAS) Advanced Technology Demonstration (ATD) at the Tank-Automotive and Armament Command-Army Research, Development and Engineering Command (TACOM-ARDEC) at Picatinny Arsenal, New Jersey. He has coordinated the design, modeling, analysis and demonstration of lethality concepts for Crusader, the Future Scout and Cavalry System (FSCS) and many other programs, several with robotic applications. He joined ARDEC in 1984, working first in the Fire Support Center on missile control systems. He holds a Master of Science in Electrical Engineering from Polytechnic University in Brooklyn. He was named the Distinguished Engineer of the Year 2000 by the North Jersey Section of the American Society of Mechanical Engineers and is a certified member of the Army Acquisition Corps.

Colonel (Retired) John H. Northrop, under contract with TACOM-ARDEC at Picatinny Arsenal, is responsible for identifying the relevance of MRAAS to future operational concepts and system requirements and MRAAS' relationship to the Future Combat Systems. Before he retired in 1998, he was the Chief of the Joint Requirements and Assessments Division of Force Development (FDJ) in the Office of the Deputy Chief of Staff for Operations and Plans at the Pentagon. He commanded the 3d Battalion, 7th Field Artillery, 25th Infantry Division (Light) at Schofield Barracks, Hawaii, and commanded a firing battery. He was the S3 and then Executive Officer in the 3d Battalion, 319th Field Artillery in the 82d Airborne Division, Fort Bragg, North Carolina. He is a graduate of the National War College, Washington, DC, and holds a Master of Science in Organic Chemistry from the Georgia Institute of Technology.

4th ID DCX II: The Digitized Division Fights the COE OPFOR

By Colonel Charles B. Allen



Ironhorse Six makes a call in the 4th ID Command Information Center.

The Secretary of the Army and Chief of Staff have articulated a clear vision for the future transformed Army, and we are pursuing that vision. On 1 January 2001, the 4th Infantry Division (Mechanized) (4th ID), Fort Hood, Texas, was designated the Army's First Digitized Division (FDD). The digitization path that we have been on for the past five years clearly complements the Army's priorities for Transformation. The Initial Brigade Combat Team (IBCT) at Fort Lewis, Washington, uses most of the same Army battle command system (ABCS) equipment the 4th ID has been developing.

The purpose of this article is twofold. First I discuss the conduct of the Division Capstone Exercise II (DCX II) and some of the lessons we learned while fighting the contemporary operational environment (COE) opposing force (OPFOR); I also update the Army and the fire support community on some of the fire support tactics, techniques and procedures (TTPs) we are employing in our division.

Historical Context. In 1996, the Army made the decision to take the force into the 21st century, and the mechanism that was chosen for that journey was the Force XXI to be followed by the Army After Next (AAN). The 4th ID was selected as the Force XXI unit and given a series of monikers, one of which was the Experimental Force (EXFOR).

Along the way, the unit participated in advanced warfighting experiments (AWEs) at the task force and division levels. The *Ironhorse Division's* journey as the Army's EXFOR culminated in 2001 when the division completed

the second of two successful training events: DCX I and II.

DCX I was the largest rotation ever conducted at the National Training Center (NTC), Fort Irwin, California. Almost half of the division, just under 8,000 soldiers—a ground maneuver brigade, the aviation brigade and the division tactical (DTAC) and division main (DMAIN) command posts—deployed to the NTC to demonstrate the 4th ID's capabilities. In October of 2001, the division participated in a Battle Command Training Program (BCTP) Warfighter exercise that was dubbed DCX II.

DCX II was a normal BCTP Warfighter exercise with a few noteworthy exceptions. Most importantly, the division fought with its assortment of ABCS "tools"—the advanced FA tactical data system (AFATDS), maneuver control system (MCS), all-source analysis system (ASAS), air and missile defense warning system (AMDWS), combat service support computer system (CSSCS) and the tactical airspace integration system (TAIS). Second, we fought over the extended battlespace the division is designed for, which is 120 kilometers wide by 200 kilometers deep. Third, the DMAIN and the division support element (DSE), formerly called the division rear (DREAR), were physically located in Brownwood, Texas, more than 100 miles from Fort Hood and the rest of the exercise participants. Finally, DCX II was the first time any unit fought a Warfighter against the newly designed COE OPFOR.

DCX II and the COE OPFOR. The international landscape has changed

over the years and with it our potential adversaries. After the break up of the Soviet Union in the early 1990s, the Army kept the Soviet "Threat" as our model enemy. We continued to train for and fight against Threat doctrine and capabilities at the Combat Training Centers (CTCs).

However, as we have seen in Bosnia, Kosovo and, most recently, in Afghanistan, this model does not provide the most realistic training approach for our leaders and soldiers. With this in mind, the Army's leadership approved the development of a contemporary opposing force for units to fight during their CTC rotations—our DCX II enemy.

As we studied the new OPFOR in preparation for the Warfighter, we came to understand that fighting this new force with its modern weapon systems and the ability to employ diverse, unpredictable tactics would be much like "fighting ourselves." With this in mind, we assembled a group to study the best methods to attack and destroy the OPFOR's ability to deliver effective fires against us.

This group determined that our high-payoff targets (HPTs) in the enemy's fire support structure would be his command, control and communications integrated fires command post (IFC); reconnaissance, surveillance and target acquisition (RSTA) capabilities; delivery systems/firing units; and logistical capabilities. During DCX II, we were successful against his delivery systems/firing units and special purpose forces (SPF)/RSTA capabilities.

OPFOR IFC. The IFC is clearly an HPT. It is a combination of a standing

command and control (C²) structure and a task organization of constituent and dedicated fire support and maneuver units. The IFC is designed to exploit the combat power inherent in carefully integrated ground and air operations with a desired effect being the rapid destruction of enemy formations or systems.

The OPFOR TTP of using one C² headquarters to control fires and maneuver creates a significant synchronization and integration capability. In short, the IFC can be described as having the characteristics and capabilities of a cross between our division targeting cell and the division artillery tactical operations center (TOC).

Although we acquired IFCs several times during the Warfighter—using signal intelligence (SIGINT) and electronic intelligence (ELINT)—and engaged them with Army tactical missile systems (ATACMS) and air attacks, we never felt the payoff we expected from neutralizing or destroying the enemy's ability to command and control his integrated fires. The enemy was in a defensive posture and had had several weeks to prepare his defenses, caching and digging in enough ammunition to support his forces for most of the campaign. For that reason, we had few, if any, reports of enemy logistics nodes we could engage.

OPFOR Fire Support. While the COE OPFOR does not have the tremendous number of artillery systems we had become familiar with, he now has systems that allow him to mass effects without massing actual weapons—like our multiple-launch rocket system (MLRS) and Paladin 155-mm howitzer.

He also has improved fire support systems, such as the 9A52 (Smerch) with its 70-kilometer range that placed us at a serious range disadvantage. During our BCTP Warfighter, approximately 10 percent of the 9A52 munitions were extended-range rockets that ranged out to 90 kilometers.

The OPFOR's fires are more precise due to close coordination and streamlined links between sensors and shooters. The COE OPFOR sensors include unmanned aerial vehicles (UAVs), SPF, commandos, RSTA, maneuver units with reconnaissance and surveillance missions, etc.

The OPFOR positions his long shooters in built-up areas and disperses them to a resolution of one to two systems per geographic location. This technique seriously challenges our ability to respond to the threat.

During our Warfighter, we had little problem acquiring the enemy's 9A52s with our extended-range (ER) Q-37 radars. However, the 9A52s fire across operational support command boundaries and their fires *are* mutually supporting. The problem was to determine how to destroy them once acquired.

In our train-up exercises, we attempted to attack the Smerches with ATACMS missiles. Due to the enemy's ability to displace the launchers after they fired and our inherently slow approval process for ATACMS launches, we had little or no success against the Smerches.

Our most successful TTP was to coordinate air attacks against them, preferably using aircraft that were already in the air when the ER Q-37 acquisition occurred. We passed the acquisition from the counterfire headquarters to our DTAC fire support element (FSE), and the request for uncommitted air interdiction sorties (XINT) to attack was processed from that command post.

We also had success doing predictive analysis of the locations (or "bands") from which we expected the enemy to initiate Smerch attacks and then established kill boxes that covered those bands.

OPFOR artillery commanders position a single howitzer/multiple rocket launcher (MRL) or up to battery-sized firing units on the battlefield while retaining the capability to mass the effects of multiple battalions at the decisive place and time. That's what we do. To fight the COE OPFOR, we had to prepare to "fight ourselves."

We did find, however, that the OPFOR seemed to be reluctant to employ their shorter-range cannon and MRL systems, opting instead to engage us with their Smerches at near max range. The enemy only employed his shorter range systems as part of IFC strikes—synchronizing his indirect fires with fixed- and rotary-wing air attacks—when he believed he had acquired our massed maneuver forces and the benefit of engaging the target outweighed the risks posed by the responsiveness of our reactive counterfire.

While the COE OPFOR disperses units and masses effects like we do, we differ in the locations in which we position our weapons systems. While we would never risk the lives of non-combatants or accept the potential collateral damage from positioning our cannons or MLRS launchers (or maneuver units, for that matter) in built-up areas or near protected sites, the COE OPFOR does

that by design. He does so and then challenges American units to engage his systems.

He believes he can defeat us by inflicting considerable casualties against us, causing us to lose our will to continue the fight. After DCX II, the OPFOR commander offered that his mission was to destroy one combat brigade from our division. He believed that accomplishing that mission would have met the standard for inflicting an unacceptably high number of casualties against an American unit.

He also thinks he can defeat us in the world of domestic or international public opinion by forcing us to cause unacceptably high levels of collateral damage and (or) civilian casualties.

To address the challenge posed by the OPFOR's positioning of fire support and maneuver units in built-up areas, we worked our rules of engagement (ROE) in great detail. The III Corps Commander delegated authority to engage targets in built-up areas to the division commanders. Our division commander further delegated that authority to the assistant division commanders, the division artillery commander and the maneuver brigade commanders.

The Balkan terrain we operated in during DCX II included many built-up areas and protected sites. In order to trigger the approval process for engaging targets in these areas, we established more than 400 no-fire areas (NFAs) and restricted fire areas (RFAs) around these locations. When AFATDS detected the initiation of a friendly fire mission inside one of these NFAs or RFAs, coordination was prompted. Then one of the approval authorities made the decision as to whether or not to attack the target.

To help make this decision, the affected commander enlisted the support and recommendations of the Staff Judge Advocate (SJA) and G5/S5. This team considered such information as the location and type of enemy unit or system involved, the effect it was having on friendly units and the mission, and the potential for causing collateral damage and civilian casualties.

When the commander made the decision to engage or not to engage the target, the SJA recorded the event, the circumstances and the commander's decision. This record was retained and passed to information operations (IO) and public affairs channels to proactively address possible collateral damage incidents before they were raised.

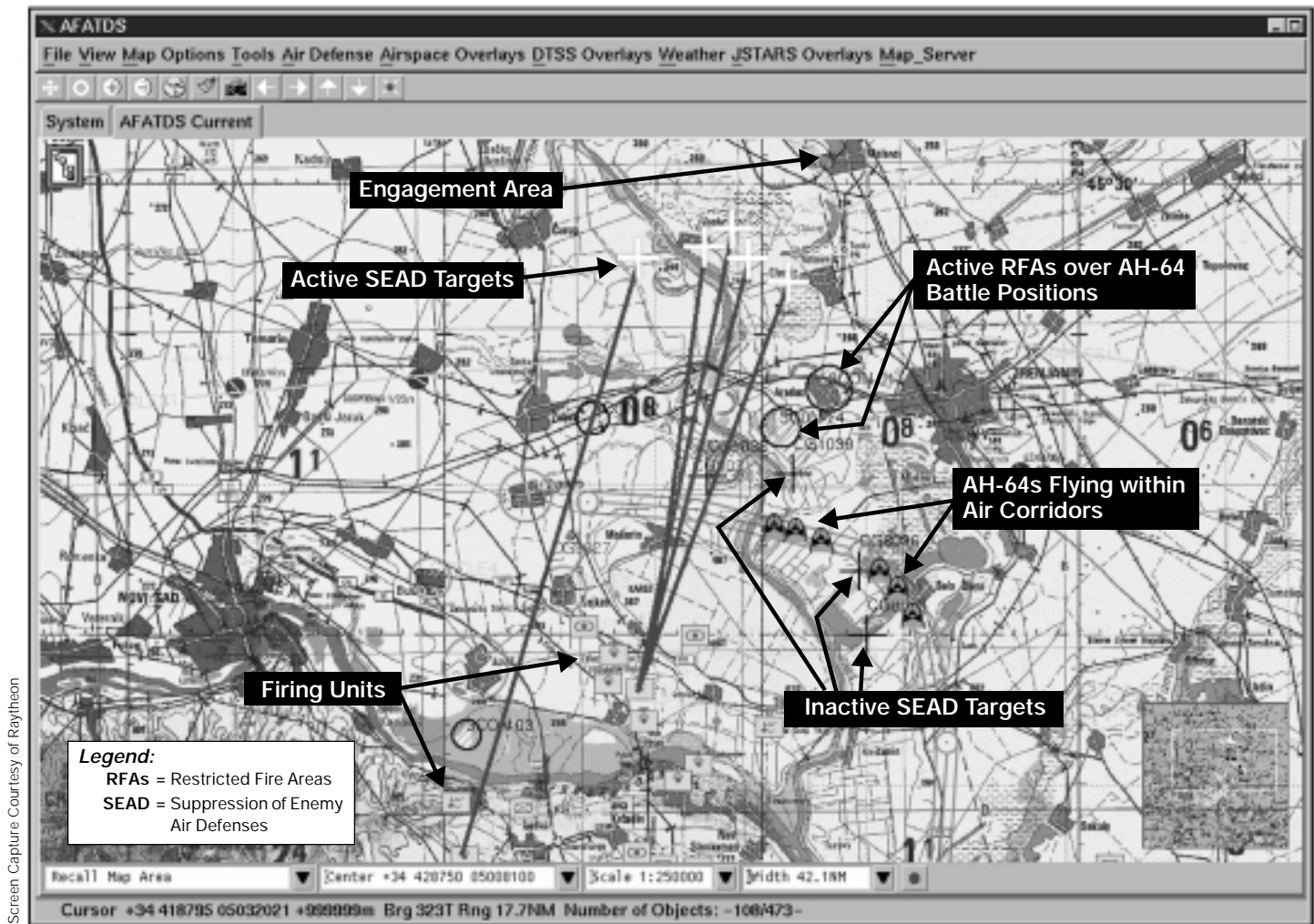

Screen Capture Courtesy of Raytheon

AFATDS Screen Capture. AFATDS is the only ABCS system that can display the entire picture as a deep attack is being conducted.

Those who do not support these procedures believe the number of NFAs and RFAs is too high and restricts our responsiveness at an unacceptable level. Their premise is that US forces always have the right of self-defense for individual soldiers and units.

During our training against the COE OPFOR in preparation for DCX II, we took this approach as well. However, responding with fires in self-defense must be proportionate and the decision-making process must be deliberate. To satisfy the requirement for a proportionate response, we used NFAs and RFAs as described.

The G5/S5 input in this process was particularly useful. On several occasions after consulting the G5/S5 representative, we discovered the built-up area in question was either no longer occupied or was occupied only by enemy forces. This information made the decision to engage the target much easier.

Our lesson learned was that we should have regular updates to our NFAs and

RFAs based on information from the G5/S5; this would have allowed us to avert some AFATDS coordination prompts.

In short, these ROE TTPs allowed leaders to be more comfortable making what normally would be very uncomfortable decisions.

Blue Force Tactics and Techniques. During our DCX II, we learned many tactical lessons, three of which I discuss in this article: artillery-based maneuver, the employment of the IBCT artillery and the retention of counterfire responsibility at the division level.

Artillery-Based Maneuver. In the past in our division, we have employed artillery-based maneuver to decrease our range disadvantage and secure terrain from which our indirect fire systems could set the conditions for our maneuver units to be successful. While we still have a considerable range disadvantage against the Smerch that we were unable to overcome with our artillery systems, we were not overmatched in overall

range or correlation of forces against the COE OPFOR.

During most phases of our DCX II fight, we had a one-to-one or better delivery system ratio vis-à-vis the COE OPFOR. Due to the expectation that the enemy would aggressively attempt to shape his battlespace with fires, our division commander declared the enemy's artillery and integrated fires capability as his center of gravity—at least in the initial phases of the fight. *Ironhorse Six* wanted to prevent the enemy from dictating the pace of the fight and using fires to delay, disrupt and attrit our attacking maneuver units. For that reason, we developed our concept of operations using an artillery-based scheme of maneuver.

The COE OPFOR is well trained at acquiring and attacking our high-value assets (HVAs). Our MLRS launchers and counterfire radars are at or near the top of the enemy's list of HPTs. He uses indirect fires requested by SPF teams to engage and destroy these HPTs.

However, his preferred method for attacking these targets is to hide small maneuver units, patrols or SPF teams in built-up areas, knowing our maneuver units will avoid that terrain. He then watches and waits for our maneuver units and the HVAs they are escorting/protecting to separate, so he can ambush and destroy the HVAs.

The solution is to ensure that in the execution of our artillery-based scheme of maneuver, our fires delivery systems, radars and other HVAs remain integrated into the movements of the maneuver units they are accompanying. The OPFOR will exploit the smallest gaps and separations between units.

The COE OPFOR also used indirect fire and fixed- and rotary-wing aircraft against our Paladins and MLRS launchers when we massed on the near side of rivers before executing the crossing. OPFOR UAVs cued these fires. Again, his capabilities are very comparable to ours.

Employment of the IBCT Artillery. During the DCX II, the 3d Brigade of the 2d Infantry Division, the IBCT at Fort Lewis, was attached to our division. It was a valuable experience for the *Ironhorse Division's* command team to train with the IBCT leaders and use the tremendous capabilities of that unique unit. From a fire support perspective, we found it challenging to use the IBCT's direct support (DS) artillery (12 M198 155-mm towed howitzers) during offensive operations.

The IBCT initially was given a mission to conduct stability and support operations (SASO) in a built-up area located in the southeastern corner of the division's zone. During that phase of the fight, we chose to leave the IBCT's FA battalion DS to its brigade.

However, when the IBCT completed its mission and transitioned to offensive operations in the center of the division's zone of attack, the M198 battalion would not have had the mobility to keep up and provide DS fires to the brigade. For that reason, we sub-assigned an M109A6 Paladin battalion from one of our two reinforcing FA brigades DS to the IBCT. This arrangement worked well, and the IBCT had immediately responsive DS FA fires in support of its attack.

As we transitioned from SASO to offensive operations, we assigned the IBCT's 12 M198s DS to the division's rear area.

Counterfire Mission at the Division Level. In the past, we regularly charged the maneuver brigade and its DS FA

battalion with responsibility for neutralizing regimental-sized artillery groups (RAGS) that could influence their battlespace. With the advent of the COE OPFOR, there are no longer RAGs, division artillery groups (DAGs) or any other artillery groups.

In the 4th ID, the responsibility for acquiring, engaging and neutralizing or destroying the enemy's cannon and rocket/missile units is at the division artillery/force FA headquarters.

Depending on the organization for combat and the reinforcing artillery available to the division and force FA commanders, the counterfire headquarters mission likely will be assigned to one of the reinforcing FA brigades. The maneuver brigade commander still will have an attached Q-36 radar and will have to respond to any mortar acquisitions that influence his battlespace.

Retaining the counterfire mission at the division frees up delivery units and DS or reinforcing artillery for the brigade commander to commit to his shaping operations or close fight.

Digital Capabilities. One of the highlights of our DCX II experience was the performance of AFATDS as a comprehensive tool for SA and battle tracking during deep shaping operations. Most of us understand the standard, analog approach for monitoring these operations. Multiple command posts—for example, the DMain, DTAC, division artillery TOC, aviation brigade TOC—are forced to maintain FM or mobile subscriber equipment (MSE) communications with each other throughout the conduct of the attack. The primary function of these command posts is to relay critical information, such as the progress and location of the attack helicopters and the timing of the suppression of enemy air defense (SEAD) fires.

However in the *Ironhorse Division* with the Army tactical command and control system (ATCCS) and the capabilities offered by the joint common data base (JCDB) that produces a common tactical picture (CTP), leaders at these command posts can track the entire attack using one screen: AFATDS. (See the figure of the AFATDS screen capture showing the entire attack on Page 21.) AFATDS is the only ATCCS system that can display the entire picture in real time as the attack is being conducted—fixed- and rotary-wing aircraft on their routes and in their attack positions (“air breather” function), locations of indirect fire delivery sys-

tems, SEAD targets, Blue Force vectors from delivery systems to those targets when SEAD fires are delivered, Blue vectors as targets of opportunity are engaged, enemy locations (or “Red picture”), engagement areas, maneuver graphics, air corridors and airspace coordination areas (ACAs).

The AFATDS PM, Training and Doctrine Command (TRADOC) System Manager for FA Tactical Data Systems (TSM FATDS) and the great military and civilian personnel who work for them should be commended for their super work in bringing this picture to life for our commanders, fire supporters and aviators.

Making the Transition. 2001 was an eventful year for the *Ironhorse Division*. We achieved FDD status, participated in a highly successful DCX I rotation at the National Training Center and “capped off” our Force XXI/EXFOR experience with an impressive performance during Division Capstone Exercise II. On 1 November 2001, we put Force XXI and the EXFOR behind us and assumed responsibilities as the Army's heavy Division Ready Brigade (DRB) unit.

All *Ironhorse* soldiers and leaders are proud of the contributions we have made to the digitization and transformation of our Army. Through enhanced situational awareness and situational understanding, we stand ready to respond and dominate any battlefield anywhere in the world at any time.

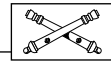

Colonel Charles B. (Ben) Allen commands the 4th Infantry Division (Mechanized) Artillery at Fort Hood, Texas. In his previous assignment, he was the Chief in the Balkans Branch of the Central and Eastern Europe Division of the Strategic Plans and Policy Directorate, J5, at the Pentagon. He commanded the 3d Battalion, 41st Field Artillery in the 24th Infantry Division (Mechanized) that, while he commanded, changed to the 1st Battalion, 9th Field Artillery in the 3d Infantry Division (Mechanized) at Fort Stewart, Georgia. He also commanded A Battery, 2d Battalion, 8th Field Artillery in the 7th Infantry Division (Light), Fort Ord, California, and A Battery, 4th Battalion, 9th Field Artillery (Pershing), 56th Field Artillery Command in Germany. Among other assignments, he spent two years as the Executive Officer of the 24th Division Artillery and was a Brigade Fire Support Officer and Executive Officer for the 3d Battalion, 320th Field Artillery, 101st Airborne Division (Air Assault) at Fort Campbell, Kentucky. During Operations Desert Shield and Storm in the Gulf, he was the Assistant Division Artillery S3 for the 101st Division.

In the early 1990s, the Army recognized a deficiency in supporting light and early entry forces with rocket and missile fires. The high-mobility artillery rocket system (HIMARS) was developed to meet the requirement for a lighter weight, more deployable rocket and missile system to provide the maneuver commander immediately responsive, long-range lethal fires.

HIMARS is strategically deployable and can be transported by C-130 aircraft for intra-theater deployment. It is based on the tracked M270A1 launcher system that is incorporated onto a family of tactical vehicles (FMTV) wheeled chassis.

HIMARS can fire all current and future rockets and missiles within the multiple-launch rocket system (MLRS) family of munitions (MFOM). MFOM gives commanders rocket fires ranging to 60 kilometers with the guided MLRS rocket (GMLRS) and missile fires up to 300 kilometers with the Army tactical missile system (ATACMS) Block IA. Unlike the tracked MLRS, HIMARS will fire one pod of either six rockets or one missile.

Supporting the launcher are two FMTV resupply vehicles (RSVs), each with a resupply trailer (RST). Both the launcher and the accompanying RSVs meet the requirements for C-130 transport.

History. In 1998, the Army launched the Rapid Force Projection Initiative Advanced Concept Technology Demonstration (RFPI-ACTD) that resulted in the delivery of four HIMARS prototype launchers. This program experiments with mature technologies that promise to add significant operational capabilities and, when successful, insert them into selected forces.

The 3d Battalion, 27th Field Artillery Regiment (3-27 FAR), part of the 18th Field Artillery Brigade, XVIII Airborne Corps, at Fort Bragg, North Carolina, has been employing three of the prototype launchers since September 1998. This unit has developed tactics, techniques and procedures (TTPs) for HIMARS and established and integrated a HIMARS platoon into its daily training plans. 3-27 FAR considers the platoon operationally deployable.

Additionally, 3-27 FAR has provided invaluable feedback on the system, influencing the production design. HIMARS prototypes' success and the significantly greater firepower the systems provide 3-27 FAR has convinced the Army leadership to retain the prototypes until HIMARS fielding in FY05.

In the next phase, six launchers will undergo complete operational testing. The actual launchers will resemble the prototypes only from the standpoint that both systems are based on a modified FMTV chassis. The launchers will be shorter than the prototypes and weigh almost 2,000 pounds less. They also will feature a new crew cab that incorporates design enhancements (25 separate changes) based on user input. During this phase, HIMARS will incorporate an improved fire control system (IFCS) that will enable the launcher to fire more MFOM missile variants.

Testing will include flight, road and cold region tests and culminate in an operational test with representative user soldiers at Fort Sill, Oklahoma, in 2004.

In FY06, the Marine Corps will field HIMARS in its 14th Marine Regiment (US Marine Corps Reserve) headquartered in Fort Worth, Texas. HIMARS will give the Marine FA a robust general support (GS) artillery capability.

HIMARS and Transformation. In October 1999, the Chief of Staff of the Army announced HIMARS is clearly in line with his vision for Army transformation. HIMARS, as part of the Legacy Force, will serve as a bridge to and, ultimately, as part of the Objective Force, with developing technologies incorporated into future platforms.

As the Army continues to explore and develop technologies for the future combat systems (FCS), those technologies will be migrated into future HIMARS platforms. Also, the addition of sensor-to-shooter and shooter-to-shooter linkages will significantly improve the system's responsiveness.

HIMARS is a key component of FA modernization, ensuring Army and Marine forces can rapidly deploy over-matching rocket and missile fires as the *King of Battle*.

MAJ Lawrence J. Abrams, AC
Assistant TSM RAMS, Fort Sill, OK

HIMARS

for Rapidly Deployable Rocket and Missile Fires

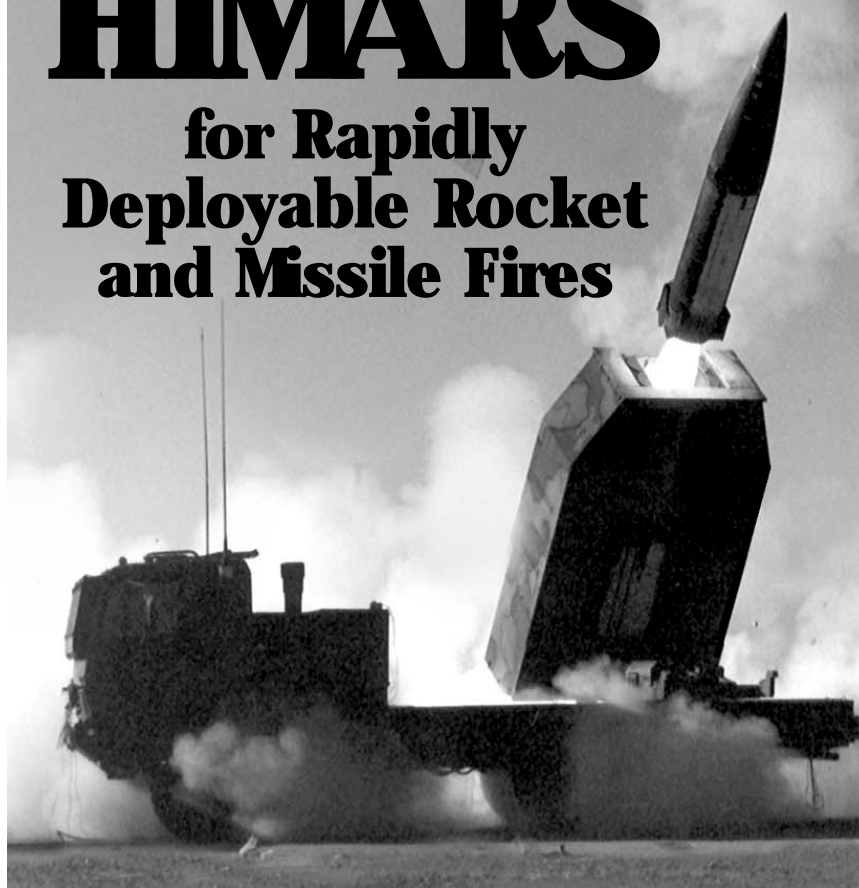

ATACMS Launch from HIMARS (Photo by T. Gaskins White Sands Missile Range)

What the Commander Needs to Know About Guidance in AFATDS

By Colonel James G. Boatner, Jr.

Fielding of the Advanced FA Tactical Data System (AFATDS) began in 1997 and has continued throughout much of the Active Component (AC) and into the Reserve Component (RC). (See the article “ARNG [Army National Guard] Fielding AFATDS” by Major Richard H. Owens III in the January-February edition.)

The newest software version of AFATDS, Version 6 (formerly called A99), includes technical fire direction capabilities and will begin fielding in April and go through the summer of

2003. Ultimately, Version 6 will displace legacy digital systems, such as the battery computer system (BCS) in cannon units and the fire direction system (FDS) in rocket and missile units. (See the article “AFATDS Gunnery: Technical Fire Direction” by Major A. J. Williams in this edition.)

As units train to build proficiency with a new, more capable fire support digital system, one consistent challenge for leaders has been the ability to manipulate AFATDS guidance settings—often called “guidances”—to most effectively

support the maneuver commander’s intent and concept of the operation.

This article suggests specific areas within AFATDS guidance that are important enough to require the maneuver commander’s or fire support coordinator’s (FSCOORD’s) approval—“Commander’s Criteria,” to use an old tactical fire direction system (TACFIRE) term. The TACFIRE “Commander’s Criteria” referred to a six-message set that allowed specific criteria to be established for attacking a target, including volume of fire and the selection of fire units and shell/fuze combinations. The implication was that the commander personally approved the criteria set in these messages.

Guidance in AFATDS is key to exploiting automated capabilities to plan, clear and execute fires to accomplish the commander’s intent. AFATDS guidance components fall primarily into the two broad areas of target management and attack analysis. The guidance affects all AFATDS operations but none more than fire mission processing.

Properly using the guidance settings allows for increased automation and consistently predictable results. This predictability will bring a degree of confidence in AFATDS’ ability to as-

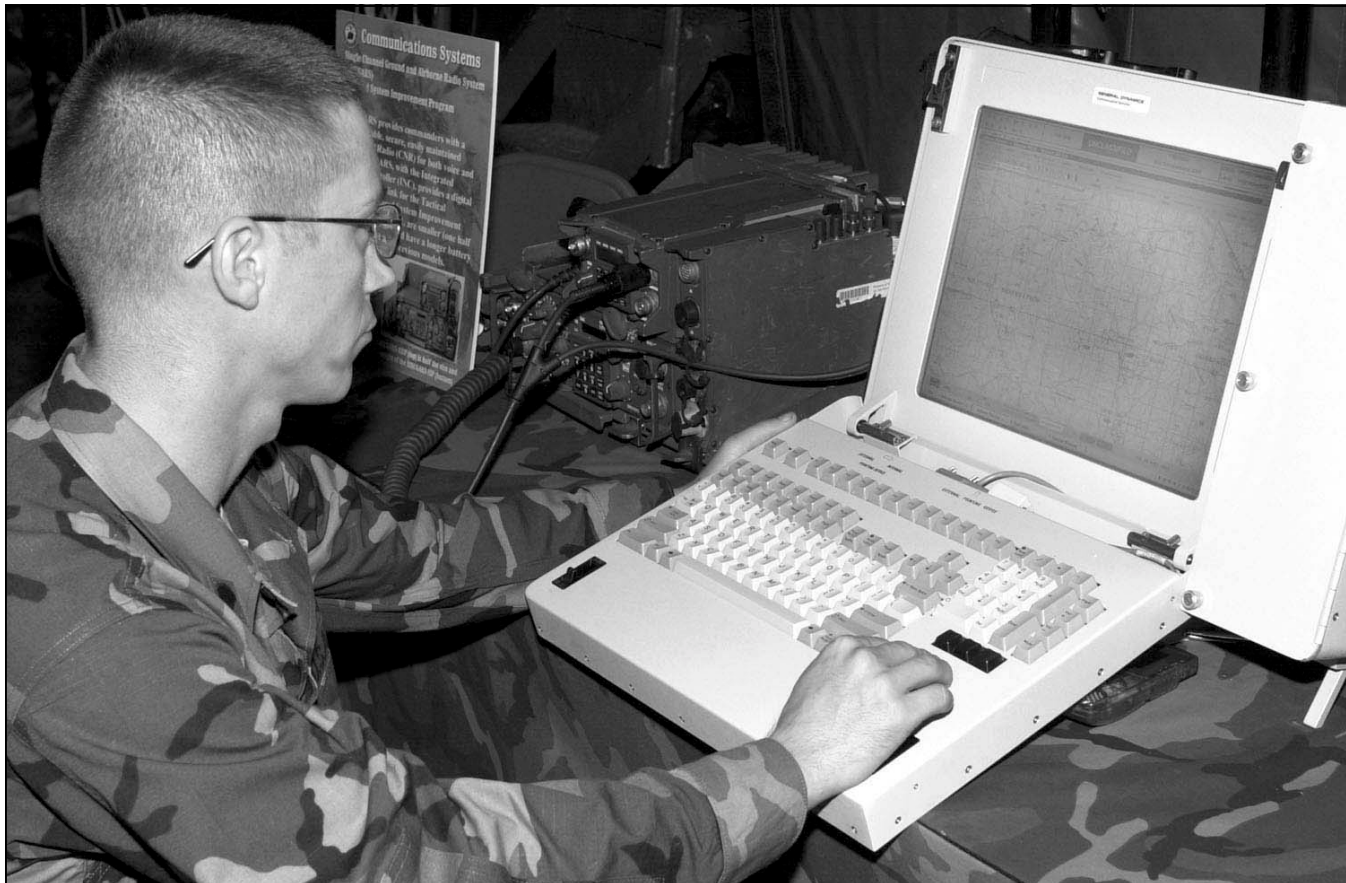

Photo by PVT. Travis Burnham

sume some of the routine processing jobs that soldiers have accomplished in the past. This confidence also should encourage commanders to process fire missions with less human intervention.

It is critical to our digital fire support systems that the AFATDS guidance settings are uniformly established and disseminated throughout a unit. Once loaded in AFATDS, the guidance settings can be distributed digitally via AFATDS or transferred using an optical disk or other archival device.

In the 4th Infantry Division (Mechanized) at Fort Hood, Texas, the Army's first "Digitized Division," the division fire support element (FSE), in concert with the division artillery fire control element (FCE), publishes and disseminates a digital attack guidance matrix (DAGM). The DAGM is part of the division's fire support annex and augments or modifies AFATDS guidance as determined in the 4th Division's tactical standing operating procedures (TACSOP). This DAGM includes detailed information related to the AFATDS guidance settings and was discussed in the article "Reactive Targeting: Firefinder and AFATDS in the Digitized Division" by Chief Warrant Officer Two Eric J. Moran and Lieutenant Colonel Dominic D. Swayne in the May-June 2001 edition.

During AFATDS fielding, it is critical units develop a AFATDS or digital annex for their TACSOPs. The commander should be involved in developing this annex. It serves as the play book for digital operations and builds expertise and continuity within a unit—including the guidance settings. See Figure 1 for a sample AFATDS annex for a unit TACSOP.

Commanders need to influence other specific components of AFATDS guidance, including mission prioritization, the target management matrix (TMM), fire support buffer distances, FA restrictions and attack methods. Also, commanders should approve AFATDS mission intervention rules. Mission prioritization and the TMM are probably the two most important components of AFATDS guidance that a commander must review and approve.

Mission Prioritization. The settings in this window determine how AFATDS prioritizes incoming missions. See Figure 2 for an AFATDS screen capture of a sample "Mission Prioritization" window.

AFATDS does not simply process missions first-in, first-out. It ranks the

ST 6-3-1 AFATDS Digital Leader's Guide, dated February 2001, includes a sample AFATDS TACSOP and detailed sections on digital operations with AFATDS: fire mission processing, fire mission planning and guidance. An appendix on advanced AFATDS tasks provides additional information and a discussion on the use and management of the AFATDS guidance settings.

ST 6-3-1 is a good reference for mid-grade officers or NCOs with limited experience with AFATDS. It is available on line at the Training and Doctrine Command (TRADOC) System Manager for FA Tactical Data Systems (TSM FATDS) home page at www.army.mil/tsm_fatds in the "Documents Library" portion of the menu.

Figure 1: *Special Text (ST) 6-3-1 Advanced Field Artillery Tactical Data System (AFATDS) Digital Leader's Guide* with a Sample of an AFATDS Annex for Unit Tactical Standing Operating Procedures (TACSOP)

missions and determines an overall mission value based on four parameters: target type, on-call targets, priority of fires and targeted areas of interest (TAIs). These four parameters can be ranked from one through four in importance or be assigned relative weights using slip scales next to each parameter. The "Reactive Targeting" article already mentioned includes a section called "AFATDS Primer" that gives a concise description of AFATDS' mission prioritization.

Essentially, a mission value is calculated for each mission on a 0 to 100 scale. This allows an AFATDS operator at an FSE or fire direction center (FDC) to select the most important mission or target in queue (a high-value mission) to be processed next.

Figure 2 shows an example of a weighted mission prioritization scheme where the "Target Type" is weighted heaviest at 70 percent, "Priority of

Rank	Parameter	Weight
1	Target Type	70
2	On-Call Tgts	0
3	Priority of Fires	20
4	TAIs	10

Assign Value by: Rank Weight

On-Call Targets have higher priority

Rank	Unit ID
1	FSE TF 1-10M 3BDE 23CVD
2	FSE TF 5-85AR 3BDE 23CVD
3	FSE TF 8-28AR 3BDE 23CVD

Rank	TAI
1	SILVER
2	GOLD

Fire Mission Cutoff Values:

- FA Cannon: 20
- Rocket/Missile: 30
- Mortar: 10
- Air: 35
- Aviation: 35
- NSFS: 35

Figure 2: Mission Prioritization Window. The top left section of the screen shows the "Target Type" weighted 70 percent, "Priority of Fires" weighted 20 percent and "TAIs" (targeted areas of interest) weighted 10 percent for a total of 100 percent.

Fires” second at 20 percent and fires in planned “TAIs” as third at 10 percent. These weights are used to calculate an overall mission value that is a weighted average of the relative values of each parameter associated with that mission. In this example, if a target is a high-payoff target (HPT) from a unit with priority of fires (as established in the “Priority of Fires” box) or is in a key TAI (as established in the “Targeted Area of Interest” box), it will receive a relatively high mission value and be fired before other lower priority missions.

If mission prioritization parameters are ranked, then mission prioritization by AFATDS is straightforward. For example, if “Priority of Fires” is ranked one and “Target Type” two, then AFATDS will process missions sent by observers supporting the units listed in the “Priority of Fires” box first—i.e., Task Force (TF) 1-10 (Mechanized), 3d Brigade, as shown in Figure 2. This may be appropriate when one TF in a brigade is leading an attack or movement-to-contact. In general, HPTs sent by other units would be fired next.

If “On-Call Tgts” were ranked first, then specific targets from the on-call target list could be designated as having the highest priority.

The “Mission Prioritization” window also can set a minimum mission value that a fire request must meet before AFATDS will consider using a specified attack system. Mission values are set in the “Fire Mission Cutoff Values” box. Generally, cutoff values are lower for mortars, cannons or rockets and higher for more valuable or scarce attack assets, such as missiles and air or naval fire support. Setting fire mission cutoff values can prevent a high-value asset from being considered for a lower priority (or value) mission or target.

Clearly, the commander must understand how AFATDS prioritizes fire missions and the use of attack systems. He must be involved in making decisions about how AFATDS will be used to set his priorities for fires.

Target Management Matrix. This window allows the maneuver commander or FSCoord to specify those HPTs (from the high-value target list, or HVTL) that are the fire support priorities for a particular operation. See Figure 3 for a sample TMM screen capture.

“Target Types” are designated in the “High Payoff Targets” box with each assigned a mission precedence (when the target will be attacked) and the ef-

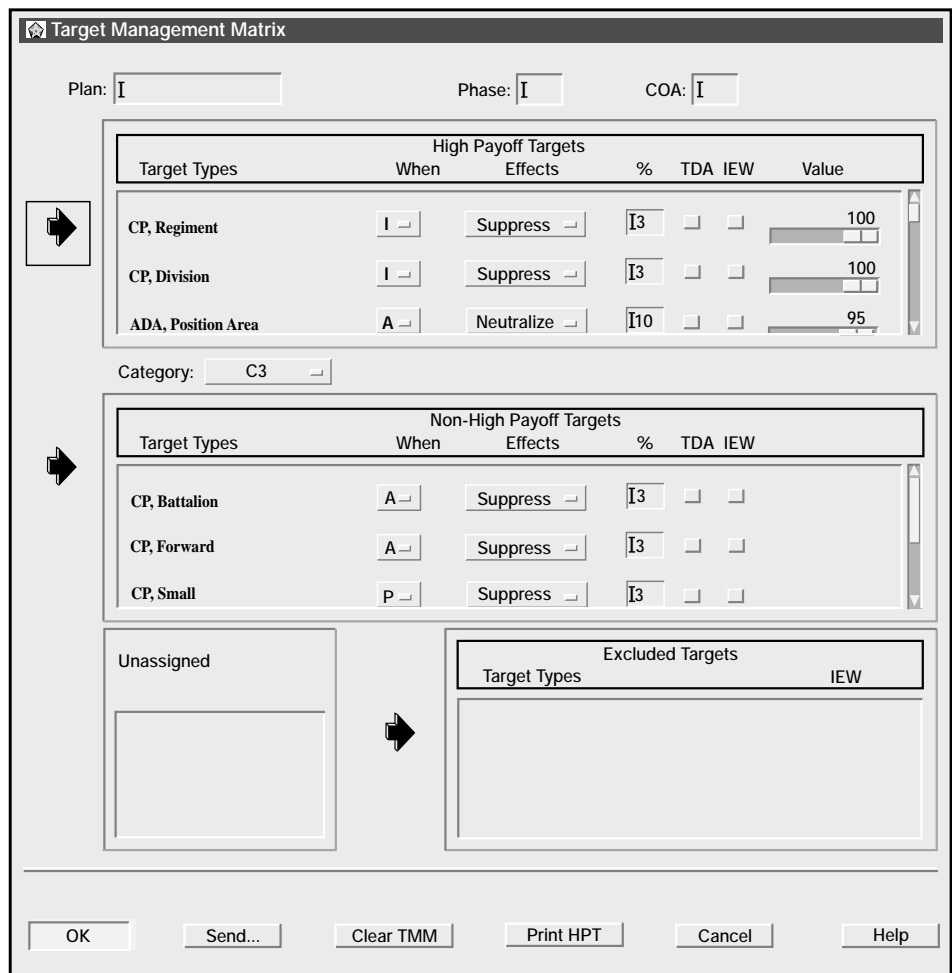

Figure 3: Target Management Matrix. The attack precedence for “Target Types” is “I” for Immediate, “A” for As Acquired (fired after “I” targets) or “P” for Planned.

fects desired against the target. Again, a slip scale is available to establish the relative weight of each target.

The most important HPTs should be assigned an “I” for Immediate precedence—only priority targets (final protective fires and Copperhead) will be fired before “I” targets. “A” or As Acquired targets are fired after Immediate targets in accordance with their calculated mission values. This HPT list (HPTL) also should reflect which targets require coordination for target damage assessment (TDA) or intelligence and electronic warfare (IEW).

The TMM also has an “Excluded Targets” box that the commander needs to approve. Adding targets to the HPTL or excluded list is done using point and click functionality.

The targets in the “Non-High Payoff Targets” box automatically include all target types from the HVTL that are not placed in the “High Payoff Targets” box.

Fire Support Buffer Distances. A buffer distance is the effects distance added to the target aim point in AFATDS

to determine if a fire support coordinating measure (FSCM) violation has occurred. Buffer distances are established in the initial setup of AFATDS and can have a significant impact on clearance of fires.

AFATDS performs a doctrinal clearance of fires check of each mission by comparing the target location to current FSCMs. If an observer is calling for fires into his unit’s zone, then it is implied that he has cleared the mission or has “eyes on” the enemy target.

Fires called into another unit’s zone, across a restrictive FSCM or short of a permissive FSCM will generate a yellow gumball in the mission intervention window and a digital clearance request to the unit that established the FSCM that has been violated.

In digital systems, it is important to realize that a zone of responsibility (ZOR) defines the area that represents the sector or zone that a maneuver unit owns. Boundaries, forward-lines-of-own troops (FLOTs) and friendly unit symbols do not cause coordination requests. As the live feed of friendly force

locations generated by the Force XXI brigade and below battle command (FBCB²) system in digitized units matures and improves, a friendly unit check will be implemented in a future update of AFATDS.

Commanders should establish and approve effects buffer distances in AFATDS. *ST 6-3-1 AFATDS Digital Leader's Guide* recommends 300 meters for a cannon/rocket buffer and 500 meters for air.

During the 4th Division's recent Division Capstone Exercise II at Fort Hood, the 4th Division Artillery commander used minimum safe distance (MSD) buffer distances of 600 meters for cannon missions and 2,000 meters for multiple-launch rocket system (MLRS) missions due to very restrictive rules of engagement (ROE) for a populated urban environment. Although this generated many more clearances of fires requests, civilian casualties were minimized throughout the fight and the maneuver brigade commanders felt they had responsive fires with adequate controls in place.

FA Restrictions. This window is used to prevent specific units from firing certain shell/fuze combinations. There are also maximum fire units and maximum volley restrictions that impact massing fire solutions in AFATDS.

Maximum fire units should be equal to the number of firing units controlled by the unit listed (i.e., six firing platoons for an FA cannon battalion). If high maximum volleys are inputted, then fewer fire units will be required to achieve the effects on a target. Therefore, to achieve massed fire solutions in AFATDS, maximum volleys are set relatively low (i.e., six volleys) and maximum fire units are set high.

Attack Methods. Commanders may have strong preferences as to how to attack particular HPTs. AFATDS includes attack method tables for all possible available fire support attack systems, including cannons, rockets/misiles, mortars, air and naval surface fire support. The commander can specify guidance settings for the shell/fuze and volume of fire for a particular weapon system for any target, called a "volley" target.

"Effects" targets should have the desired effects specified in the "Target Management Matrix" window as percentages in the "High Payoff Targets" or "Non-High Payoff Targets" boxes (see Figure 3) and no entry in the attack methods table. AFATDS will use its

joint munitions effectiveness manual (JMEM) tables in its data base to determine an attack solution that achieves the desired effects.

AFATDS also has an effects calculator in the "Mission Processing" window. This is used during planning to determine what effects percent can be achieved by a given number of volleys from a weapon system (or munition) against a specific target type.

Mission Intervention. Although technically outside the realm of guidance settings, the use of intervention rules and intervention points (IPs) in AFATDS is another area that deserves the commander's close scrutiny. The streamlined use of IPs in FSEs and FDCs is essential to efficient fire mission processing.

Simply put, responsive fires cannot be provided if IPs are allowed to default to "All" at every fire support node. AFATDS will allow the operator to view and make decisions on any mission received at an FSE or FDC; however, management by exception should be the goal for mission intervention.

Commanders should strive to tailor IPs to stop specific types of missions (or targets) for operator or leader review at intermediate fire support nodes while allowing other missions to automatically process through the fire support system to a firing unit for rapid response.

When an "Intervention" window is opened in AFATDS, the operator will be given a recommended attack option that quickly can be accepted, rejected or modified. All other attack options also are displayed. (See the article "AFATDS Gunnery: Technical Fire Direction" for screen captures of "Intervention" windows.)

Figure 4 shows the categories for establishing IPs within AFATDS. An intervention rule can include criteria from any or all of these categories. For example, an intervention rule could be established for all missions with a precedence of "A" (As Acquired) and an AFATDS mission value of less than 50. This will allow "P" (Planned) and "I" (Immediate) missions plus "A" missions with high mission values (above 50) to process automatically, but it would require an operator to review and approve low value "A" missions.

The 4th Infantry Division uses four standard IPs and adjusts them based on the tactical situation and dry fire AFATDS mission values generated

during planning and wargaming. The four IPs are targets requiring coordination, targets with an AFATDS "Deny" recommendation, "I" (Immediate) precedent missions of a specified value (based on DAGM-calculated dry fire mission) and "A" (As Acquired) precedent missions of a specified value (based on DAGM-calculated dry fire mission).

Mission Precedence
Priority
Immediate
As Acquired
All
Munition Category
By Type
All
Filters
Target Selection Standards (TSS)
Duplication
Exclusion
Intelligence and Electronic Warfare (IEW) Routing
Target Buildup Areas
Coordination Required
All
Mission Type
Immediate Smoke
Immediate Suppression
Adjust
Fire for Effect
Assign Final Protective Fires
Assign Priority Target (Copperhead)
Continuous Illumination
Coordinated Illumination
All
Analysis Results
Send Fire Request
Send Order to Fire
Deny
All
Battle Areas
Close
Deep
Rear
All
Target Type
By Category
By Type
All
Attack Option
Mortar
FA Cannon
Rocket/Missile
Army Aviation
Air Force Air
Naval Surface Fire Support
All

Figure 4: AFATDS Intervention Points (IPs) Criteria

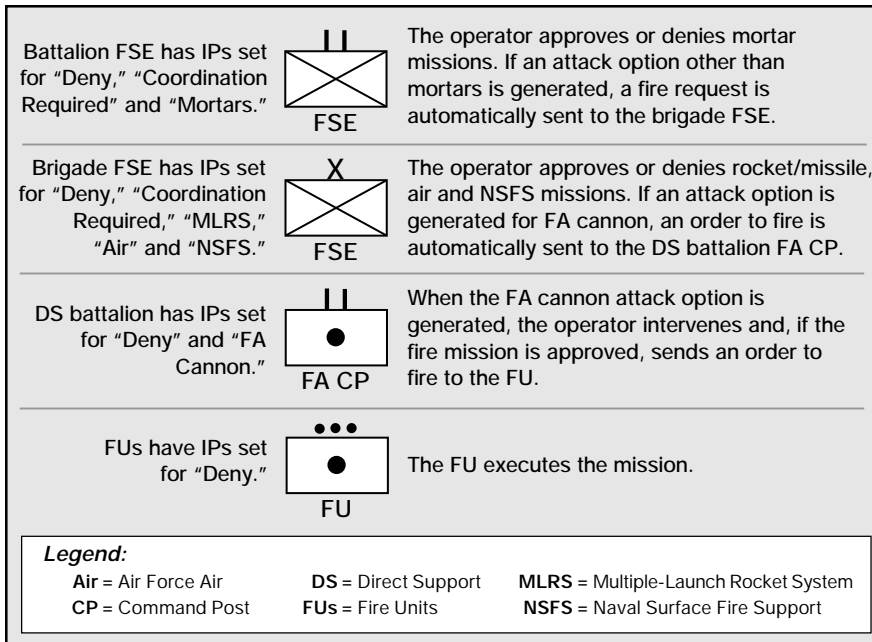

Figure 5: IPs—Management by Exception. The figure shows the IPs after the forward observer sends a call-for-fire to the battalion fire support element (FSE).

Figure 5 shows an example of how IPs could be established within a brigade to facilitate mission processing. Note that the attack systems generally are managed at one fire support node. One exception to this may be FA cannon systems that may require intervention at the brigade FSE (i.e., to approve a mission for a unit without priority of fires) and the FA battalion (i.e., to approve a dual-purpose improved conventional munition, or DPICM, mission when supply availability is low).

Generally, each FSE or FDC should review missions AFATDS recommends for denial; FSEs also should establish IPs for missions requiring clearance of fires. This will prevent losing visibility of missions pending coordination.

Conclusion. The AFATDS guidance settings discussed in this article are certainly not everything a maneuver commander or FSCOORD needs to understand about how AFATDS operates. (See Figure 6.) Trigger events and more sophisticated rule sets to control processing and attacking targets (called fire support system task lists) also can be loaded into AFATDS guidance. The 4th Infantry Division's use of a DAGM is one example of a unit tool to help build guidance in sufficient detail for the operator to enter the data.

Of course, many other variables affect the performance of the total digital fire support system; the effective use of guidance in AFATDS alone will not provide optimum results. For example,

- Digital Annex in the Unit TACSOP
- Mission Prioritization
- Target Management Matrix (TMM)
- Fire Support Buffer Distances
- FA Restrictions
- Attack Methods
- Mission Intervention

Figure 6: "Commander's Criteria" for AFATDS—These are the specific areas in which the maneuver commander should be involved in developing.

sustainment training and leader and operator tactical and technical proficiency remain basic requirements.

Our understanding and use of ever-changing communications protocols and networks is fundamental to digital op-

erations. Communications capabilities in AFATDS allow units to streamline digital quick-fire channels to support specific, high-tempo operations.

Establishing command and support relationships in AFATDS during setup and initialization also impacts mission processing, automated clearance of fires and data distribution. The entire targeting team—G2, FSE and G3—also has to be on the same "sheet of music" with respect to how specific HVTs/HPTs are mapped to AFATDS target categories and types.

Commanders must understand and influence all these aspects of digital operations. Hopefully this article provides information to allow the commander to focus his efforts and fight more effectively with fires as part of the ever-increasing digitized Army.

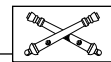

Colonel James G. Boatner, Jr., is the Training and Doctrine Command (TRADOC) System Manager for Field Artillery Tactical Data Systems (TSM FATDS) in the Futures Development Integration Center (FCIC) at Fort Sill, Oklahoma. His previous assignments include serving as the Fire Support Program Integrator for the Program Analysis and Evaluation Directorate in the Office of the Chief of Staff of the Army, both at the Pentagon. He also commanded the 6th Battalion, 27th Field Artillery in the 75th Field Artillery Brigade, III Corps Artillery at Fort Sill, and B Battery, 3d Battalion, 29th Field Artillery and C Battery, 1st Battalion, 27th Field Artillery, both in the 4th Infantry Division (Mechanized) at Fort Carson, Colorado. He is a graduate of the National War College in Washington, DC, and holds a Master of Science in Operations Research/Systems Analysis from the Georgia Institute of Technology.

2002 Senior Fire Support Conference

Planning is underway for the next Senior Fire Support Conference at the Field Artillery School, Fort Sill, Oklahoma. The conference dates are 30 September through 4 October 2002. The conference will focus on current, future and joint fires.

Senior Fire Support Conference invitees include Army Corps and Marine expeditionary force (MEF) commanders; Reserve Component (RC) and Active Component (AC) Army and Marine division commanders; Training and Doctrine Command (TRADOC) school commandants;

AC and RC Army corps artillery, FA brigade, division artillery and Marine regimental commanders and their command sergeants major (CSMs); and US Field Artillery Association corporate members

More details on the conference will appear in the next edition of *Field Artillery*. If readers have questions about the conference, contact Colonel Gary Swartz, Director of the Fire Support and Combined Arms Operations Department at swartzl@sill.army.mil or Captain Stacy Gerber, Project Officer, at gerbers@sill.army.mil.

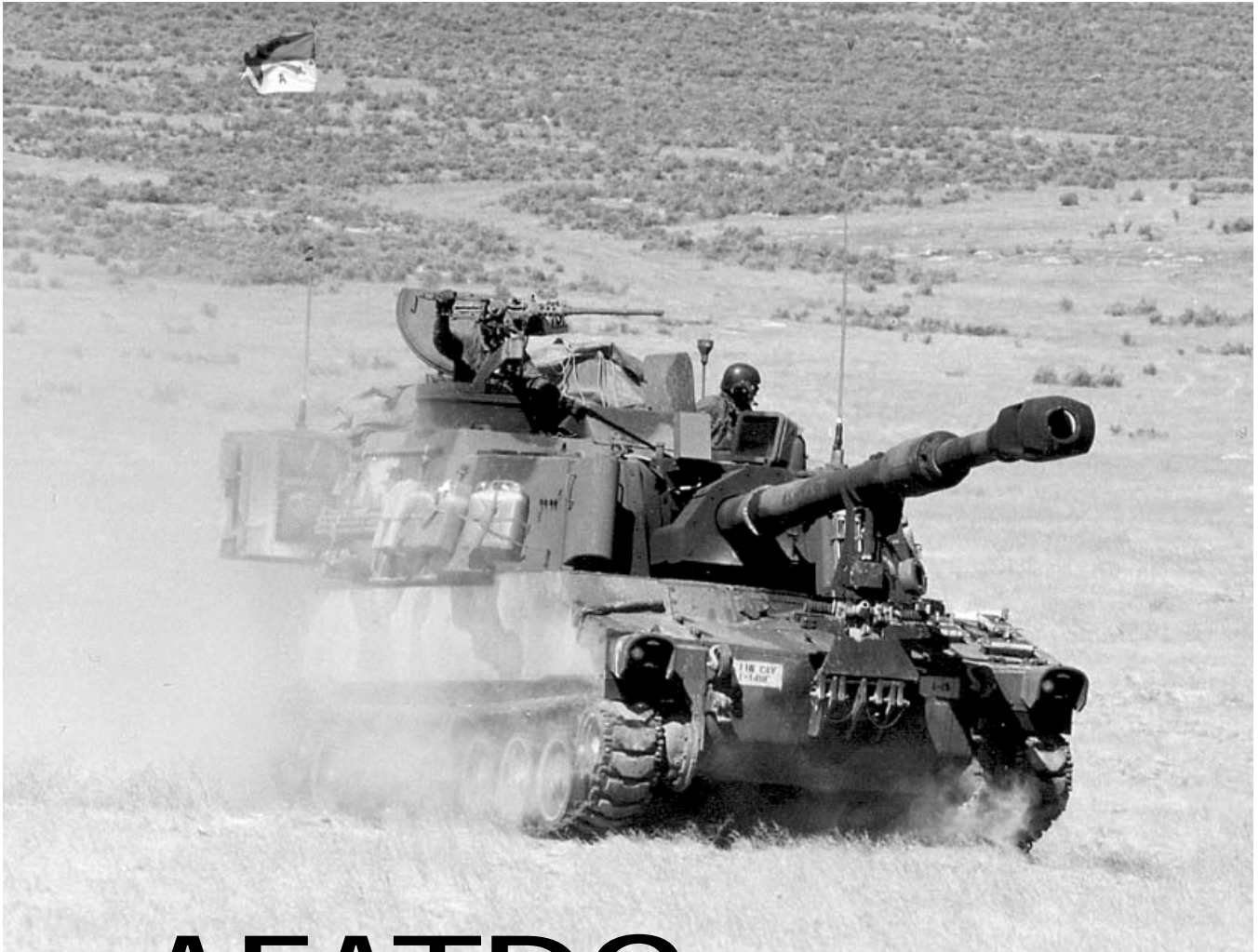

AFATDS Gunnery Technical Fire Direction

Major Alford J. Williams, AC

“The mission of the Field Artillery is to destroy, neutralize or suppress the enemy by cannon, rocket and missile fires and to help integrate all fire support assets into combined arms operations....The gunnery problem is an indirect fire problem. Solving the problem requires weapon and ammunition settings that, when applied to the weapon and ammunition, will cause the projectile to achieve the desired effects on the target.”

*FM 6-40 Tactics, Techniques and Procedures (TTP)
for Field Artillery Manual Cannon Gunnery*

Gunnery is an age-old tradition for Field Artillerymen. It can be divided into two parts: tactical and technical fire direction.

Legacy Force fire direction systems operate differently for Field Artillery cannon and rocket systems. Earlier software versions of the Advanced FA Tactical Data System (AFATDS), one of the Army battle command system (ABCS) digital systems, concentrated on tactical fire direction. Version 6 (V6) software, for the first time, will integrate technical fire direction with AFATDS' tactical fire direction capabilities and calculate solutions for both cannon and rocket systems.

V6, formerly called A99, is scheduled for release in April and will be fielded through the summer of 2003. The naming convention for software versions of AFATDS recently has been modified to align with the releases of ABCS software versions and the Army's unit set fielding plan. The current version of ABCS is 6.3 with Version 7 slated for release in FY04.

This article outlines what soldiers and Marines can expect in AFATDS Version 6 with technical fire direction.

Historical Background. The tactical fire direction system (TACFIRE) provided the initial tactical fire direction for cannon battalions, FA brigades, division artilleries and corps artilleries. The initial fire support automation system (IFSAS) replaced TACFIRE and provided the Army National Guard its first tactical automation capability. AFATDS was developed as a replacement for IFSAS and as the fire support component of the Army tactical command and control system (ATTCS), now referred to as ABCS.

AFATDS has been providing integrated, automated support for planning, coordinating and controlling all fire support assets: FA cannons, rockets and missiles plus mortars, air support, naval surface fire support (NSFS) and attack helicopters. As a tactical fire direction system, AFATDS automatically processes fire requests; generates multiple tactical fire solutions for missions; monitors mission execution; supports the creation and distribution of fire plans (fire planning); automates artillery target intelligence; accounts for the fire unit status, ballistics and ammunition; and processes meteorological and geometry data. AFATDS fundamentally changes tactical fire support by decentralizing the decision-making process, moving it from the fire direction center (FDC) to the fire support element (FSE).

For well over two decades, soldiers and Marines have depended on the battery computer system (BCS) to provide cannon technical fire direction and the multiple-launch rocket system (MLRS) fire direction system (FDS) to provide rocket and missile technical fire direction. Technical fire direction applies the correct weapon and ammunition settings to achieve the desired effects on the target at the desired time.

BCS computes firing data based on each gun's location, muzzle velocity, target location, observer location, aiming point and the effects of meteorological data on the trajectory. BCS also provides fire commands to the cannon artillery delivery systems in the battery. In Paladin units, BCS sends target information to the Paladin's automated fire control system (AFCS) for it to compute the ballistic solution.

FDS, on the other hand, does not send fire commands to the launchers. In fire mission processing, FDS determines

which launcher(s) will shoot from which firing point(s) and only sends target information for on-board calculations. FDS checks for violations of battlefield geometry, fire support coordinating measures (FSCMs), air corridors and down-range mask violations. It also applies commander's criteria and manages communications.

AFATDS Technical Fire Direction. Ultimately, AFATDS software V6 will replace BCS and FDS in the firing units. It provides essential BCS and FDS capabilities while improving situational awareness, communications and operational flexibility. However, AFATDS does not perform all tasks in precisely the same manner as BCS and FDS do.

AFATDS V6 gives users some of the look and feel of both BCS/FDS and Microsoft Windows. In the currently fielded BCS and FDS software versions, soldiers and Marines use the upper, middle and lower displays. AFATDS V6 shows the same data in its "Fire Control Status" and "Weapon Status" windows.

In the window, operators will find many of the same symbols as in BCS and FDS. This will help reduce training time. The upper display shows the mission and the phases of that mission. The middle display shows which guns were selected and which responded to the mission. The lower display shows what type of mission the guns are executing.

AFATDS allows the operator to review the recommended fire solution. If necessary, the operator can modify the technical solution and have AFATDS recalculate the mission data before it is sent to the cannons or launchers.

AFATDS allows operators to manage muzzle velocity/muzzle velocity variations, masks and registration data and track the status of Paladin and non-Paladin howitzers. V6 uses the NATO Ballistic Kernel (NABK) to calculate the ballistic solutions for cannon projectiles.

In interfacing with Paladin, AFATDS can send "Fire Orders" that contain the tactical fire control solution but leaves technical computations to the howitzer or AFATDS can send howitzer commands that include a complete ballistic solution. In M198, M109A5 or M119 units, AFATDS interfaces with the gun display units (GDUs), just as BCS does, and provides the complete firing solution.

AFATDS allows MLRS units to track the status of individual launchers, man-

age ammunition, process mission selection and reassignment, conduct rocket flight path predictions and manage both the M270 and M270A1 launchers. AFATDS uses the MLRS flight path algorithm to compute the rocket flight path predictions and checks airspace control measures three dimensionally.

Just like FDS or any other tactical system, AFATDS requires training to become familiar with certain tasks. Soldiers and Marines will learn procedures during new equipment training (NET) or new software training (NST) and through courses at the Field Artillery School, Fort Sill, Oklahoma.

Intervention Points (IPs) at the Battery and Platoon Levels. In processing missions, firing units should use IPs selectively. AFATDS automatically will process missions based on the commander's guidance. (See the article "What the Commander Needs to Know About Guidance in AFATDS" by Colonel James G. Boatner in this edition.) However, if IPs are used, most missions are not auto-processed.

The fire support officer (FSO), fire support NCO (FSNCO), fire direction officer (FDO) or the fire direction NCO (FDNCO) always should use the "Deny Mission" and "Coordination Required" IPs. During training events, at the commander's discretion, units may want to establish additional IPs.

It should be noted that tactical IPs used by the FSE should not be set at the battery level if the battalion FDC is in the fire mission chain. The battalion FDC already should have made the tactical fire direction decisions. An IP for tactical fire direction should never be set at the battery or platoon levels except when the platoon is taking calls-for-fire directly from sensors, such as forward observers (FOs), radars, etc.

During mission processing with an IP on, the mission will appear in the "Intervention" window shown in Figure 1. This window is where the FDO first will see the AFATDS recommendation. Before the FDO can accept the recommendation, he must view the attack options shown in Figure 2 and the cannon or rocket/missile technical solution shown in Figures 3 or 4 on Page 32.

In cannon units, if the FDO doesn't accept the AFATDS recommendation, he can select a platoon to send the mission to. At the platoon level, if the FDO doesn't accept the AFATDS recommended solution, he can select the howitzer to send the mission to. AFATDS

Intervention

Intervention | Attack Options | Cannon Tech Soln | Missile Information | Rkt/Msl Soln

Tgt Number: NLT:

Tgt Type: Msn Value:

Msn Type: Precedence:

Filter	Result
Duplication	Pass
BuildUp	Pass
Tss	Pass
Exclusion	Pass
Route to IEW	Pass

Attack Options

- FA Cannon
- Rocket/Missile
- Mortar
- Air
- Aviation
- Naval Gun
- Naval Land Atk MSL
- Naval Cruise MSL
- Mass All Systems

Opt	Tgt #	Unit ID	Munitions	Qty	Go/NoGo	%	Crd

Recommendation

Figure 1: IP for Mission Processing Turned On. This window shows the fire direction officer (FDO) the AFATDS recommendation for the first time.

Intervention

Intervention | Attack Options | Cannon Tech Soln | Missile Information | Rkt/Msl Soln

Meets Mission Cutoff: Number of Active Missions:

Number of Missions with Lower Priority:

- FA Cannon
- Rocket/Missile
- Mortar
- Air
- Aviation
- Naval Gun
- Naval Land Atk MSL
- Naval Cruise MSL

Opt	Seg?	Unit ID	Caliber										
1	No	2 C 1-37FA	23CVDA	155MM	Y						Y	Y	Y
2	No	1 C 1-37FA	23CVDA	155MM	Y						Y	Y	Y
3	No	1 B 1-37FA	23CVDA	155MM	Y						Y	Y	Y
4	No	2 B 1-37FA	23CVDA	155MM	Y						Y	Y	Y
5	No	1 A 1-37FA	23CVDA	155MM	Y						Y	Y	Y
6	No	2 A 1-37FA	23CVDA	155MM	Y						Y	Y	Y

Munitions

Shell	Model	Lot	Rounds	Volleys	Fuze	Model	Lot
Adjust:	<input type="text"/>	<input type="text"/>	<input type="text"/>	<input type="text"/>	<input type="text"/>	<input type="text"/>	<input type="text"/>
FFE#1:	<input type="text"/>	<input type="text"/>	<input type="text"/>	<input type="text"/>	<input type="text"/>	<input type="text"/>	<input type="text"/>
FFE#2:	<input type="text"/>	<input type="text"/>	<input type="text"/>	<input type="text"/>	<input type="text"/>	<input type="text"/>	<input type="text"/>

Unit Data

Range (m):

Reaction Time (sec):

Angle T (mils):

Operational Status:

Recommendation

Deny Mission, No Capable Units/Systems

Figure 2: Attack Options

Intervention

Intervention Attack Options Cannon Tech Soln Missile Information Rkt/Msl Soln

TOF: 31

FFE 1

Wpn	Cap	MOC	# Rnds	Shell Category	Shell Model	Shell Lot	Prop Color	Prop Lot	Prop Charge	Fuze Category	Fuze Model	Fuze Lot	Fuze Time	DF	QE
1	Y	DNL	1	HE	M107 DC	A	WB	W	Four	PD	M557	P	0.0	2495	483
2	Y	WR	1	HE	M107 DC	A	WB	W	Four	PD	M557	P	0.0	2495	483
3	Y	DNL	1	HE	M107 DC	A	WB	W	Four	PD	M557	P	0.0	2495	483
4	Y	DNL	1	HE	M107 DC	A	WB	W	Four	PD	M557	P	0.0	2495	483
5	Y	DNL	1	HE	M107 DC	A	WB	W	Four	PD	M557	P	0.0	2495	483
6	Y	DNL	1	HE	M107 DC	A	WB	W	Four	PD	M557	P	0.0	2495	483

FFE 2

Wpn	Cap	MOC	# Rnds	Shell Category	Shell Model	Shell Lot	Prop Color	Prop Lot	Prop Charge	Fuze Category	Fuze Model	Fuze Lot	Fuze Time	DF	QE
-----	-----	-----	--------	----------------	-------------	-----------	------------	----------	-------------	---------------	------------	----------	-----------	----	----

Recommendation

Send FO to GDU GUN 1, GDU GUN 2, GDU GUN 3, GDU GUN 4 GDU GUN 5, GDU GUN 6

Accept Recommendation Recalculate Deny Unsupportable Cancel Help

Figure 3: Attack Options with Cannon Technical Solution

Intervention

Intervention Attack Options Cannon Tech Soln Missile Information Rkt/Msl Soln

Tgt Number: AA1004 Location: 5 65716 038 58053 200 11

Unit ID	Attack Option	Aimpoint	Munition Model	Munition Type	Qty	MOC	DP	NET/TOT	NLT	Firing Point	Next Point Type	Next I
2/3/A	1	5 65716 038	M30	JEG	6	When Ready						

Aimpoint # Easting Shift Northing Shift Altitude # Rounds

Send

Recommendation

Send FO to 1 2 A 3-27FA 18FABXVIIIICORPS

Accept Recommendation Recalculate Deny Unsupportable Cancel Help

Figure 4: Attack Options with Rocket and Missile Solution

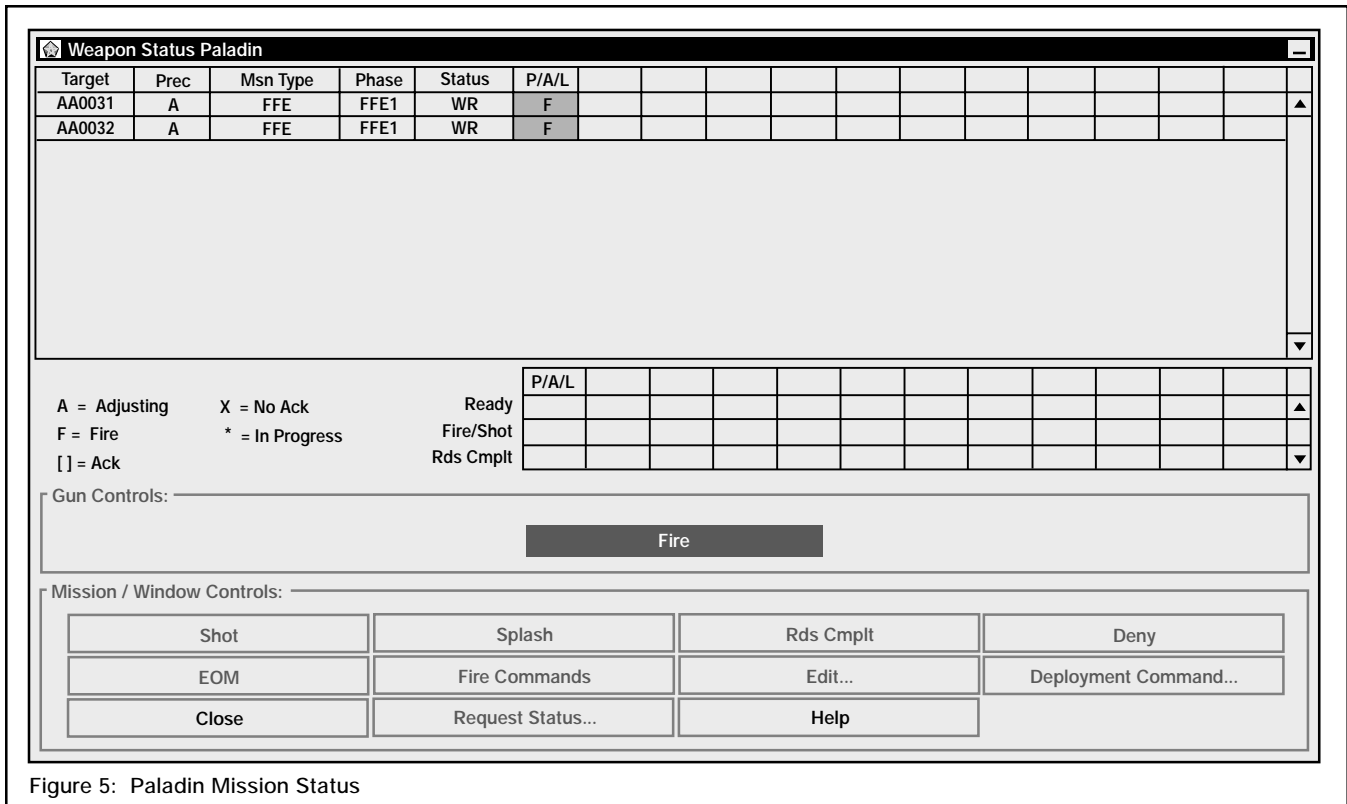

Figure 5: Paladin Mission Status

will recalculate the firing data when the operator overrides the recommended solution.

In MLRS batteries, the FDO can select the launcher to send the mission to. If the mission should fail at the launcher, he can reassign the mission or relay it through the platoon operations center (POC).

The cannon and rocket/missile FDO also can monitor the status of the mission at all times. Figure 5 shows the status of Paladin missions, Figure 6 the status of MLRS missions and Figure 7 on Page 34 the status of M109A5 and towed artillery missions.

Even though AFATDS will be fielded from echelons above corps (EAC) down to the firing platoon, technical fire direction is only available to those units that have delivery systems in subordinate units in their database. For example, a corps FSE can't select a Paladin or MLRS launcher to fire if the weapon isn't in one of its subordinate units.

Testing and Fielding. Each version of AFATDS software goes through operational and user tests to ensure it can accomplish its critical tasks. This test integrates AFATDS and other systems and platforms that must interface with AFATDS to ensure the "total system" can perform its critical tasks.

V6 software was tested extensively in 2001 and results indicated that AFATDS

was capable but still required some software corrections. The software was corrected, and AFATDS passed a government confidence test in December 2001 at Fort Sill. This confidence test allowed the government to ensure that all corrections were properly applied and that V6 functioned as required, including accomplishing all critical tasks of BCS and FDS.

Headquarters, Department of the Army (DA) determines the priority of the fielding plan and can and does change the plan as needed. There is a fielding plan

for units receiving AFATDS as new equipment and a plan for fielding units with software upgrades. Units scheduled for an AFATDS equipment fielding will undergo a different process than units already fielded with Version A98 software.

New Software Training (NST). Units with A98 will undergo V6 NST that covers all improvements and changes to AFATDS and concentrates on technical fire direction. Some units may need an equipment upgrade before the V6 NST because the ultra computer

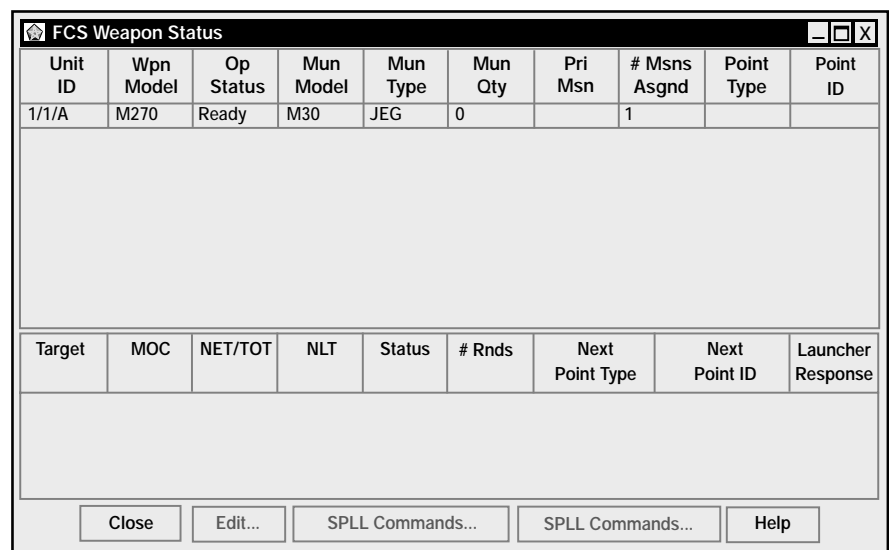

Figure 6: MLRS Mission Status

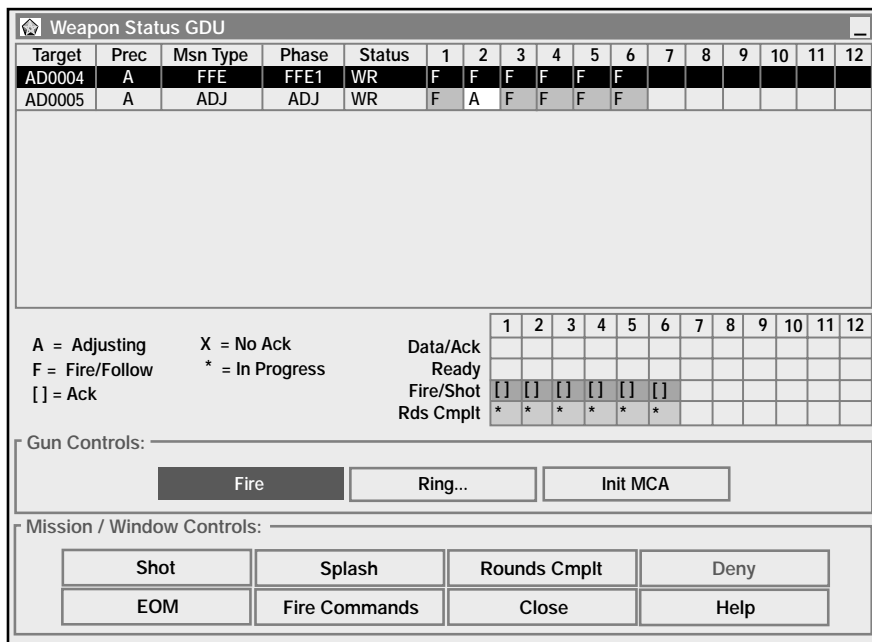

Figure 7: M198, M119 and M109A5 Mission Status

units (UCUs) and the earlier issued compact computer units (CCUs) used for A98 will not support the processing required for the common Army software components of V6.

The US Army Communications and Electronics Command (CECOM) NET team (NETT), based at Fort Sill, trains units for 120 hours (about three weeks) in a school-approved program of instruction (POI). NETT will contact brigade, division artillery and separate battalion points of contact (POCs) to coordinate their V6 upgrade training. Soldiers may get information on where their units are in the V6 upgrade plan at <https://akocomm.us.army.mil/afatds/>. An Army Knowledge Online (AKO) password is required. To obtain an AKO password, visit the AKO web site at <http://www.us.army.mil> and log in as a new user.

New Equipment Training (NET). A unit receiving AFATDS as new equipment receives a new material in-briefing at least 12 months before fielding (active units) or 18 months before fielding (National Guard units). This briefing covers all the logistics issues associated with the fielding. It also gives the unit instructions on what to expect of the new equipment, how the unit will support NET and what to do with its old equipment. In some cases, the old tracked vehicles are upgraded with installation kits to support the new equipment.

During NET, the unit learns AFATDS from top to bottom: tactical and techni-

cal fire direction. For active units, the training is six weeks, including a one-day Executive Leader Briefing, two weeks of installation and setup, three weeks of lecture/hands-on and one week of validation. For National Guard units, NET is a three-week process (consolidated lecture/hands-on and validation).

Once the unit is fielded and trained, the NETT normally will support requests for follow-up visits to provide assistance. The embedded simulation/stimulation training device (SISTIM) will simulate unavailable tactical units and stimulate live FA unit training on AFATDS. SISTIM will focus the unit training and provide repeatable scenarios to enhance team and other collective training.

USMC Training. For the current software version of AFATDS, all Marine units that have needed those capabilities already have fielded the system. After V6 with technical fire direction begins fielding, Marine batteries will receive AFATDS with V6, completing the Marine FA fielding.

Marine NET is different than Army NET. Marine NET is three weeks: one week of AFATDS basic operations, one week of technical fire direction and one of AFATDS changes and improvements. Fielded units may request additional blocks of instructions, including the AFATDS Supervisors Course, AFATDS Air Support Class and a Fire Support Coordination Cell (FSCC) Class.

Future AFATDS Improvements. Soldiers and Marines can expect to see

continuing improvements in future versions of AFATDS. In addition to the V6 upgrades, other improvements planned include an update to the NABK and the addition of the new LW 155 howitzer (M777), aimpoint offset calculation for the Army tactical missile system (ATACMS) brilliant antitank (BAT) munitions, the modular artillery charge system (MACS), automated generation of range fans for command posts, a countdown timer for Paladins and MLRS launchers, an active "Fire Control Status" window (a platoon monitor window for MLRS), improvements to MLRS safety and improvements to the target area hazard (TAH) geometry processing.

Once a unit has AFATDS V6 and trains with it, the unit can write or call the Training and Doctrine Command (TRADOC) System Manager for Field Artillery Tactical Data Systems (TSM FATDS) about capabilities or critical tasks needed to improve technical fire direction in AFATDS. Units should include a POC with a telephone number or email address so TSM FATDS may contact him for clarification. POCs can call either the FATDS Software Hotline at 580-442-5607 (DSN 639) or the FATDS Training Hotline at 580-442-3390 (DSN 639) or fax the suggestions to (580) 442-2915 (DSN 639).

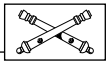

Major Alford J. (A. J.) Williams, Acquisition Corps (AC), is the Assistant Training and Doctrine Command (TRADOC) Systems Manager for Field Artillery Tactical Data Systems (TSM FATDS), part of the Futures Development Integration Center (FDIC) at Fort Sill, Oklahoma. In TSM FATDS, he is responsible for determining the software requirements of the Advanced FA Tactical Data System (AFATDS) and ensuring the interoperability of AFATDS with Air Force and Navy command and controls systems. Prior to this assignment, he participated in the Training with Industry program at Raytheon Systems Company, Fort Wayne, Indiana; Raytheon designs AFATDS software. Among other assignments, he was the Targeting Officer and Assistant G3, Plans, for the XVII Airborne Corps Artillery, Fort Bragg, North Carolina, and Division Artillery Counterfire Officer in the 3d Infantry Division (Mechanized), Germany. He commanded Service Battery, 3d Battalion, 321st Field Artillery in the 18th Field Artillery Brigade at Fort Bragg.

The strategic landscape has changed, and our Army is on an aggressive path of transformation to reshape how we train and fight. The emphasis is on the development of technologies that will enhance our forces' deployability, lethality, mobility, agility, responsiveness, survivability and sustainability. As in past periods of significant change, how the Army integrates new technologies into its doctrine, training, leader development, organizations, material and soldier development (DTLOMS) will determine the success or failure of the transformation efforts.

The Army is transforming pervasively, including its operational, institutional and sustainment base—starting at the top with the realignment of the Army staff with the Secretariat. The Army staff realigned with the Secretary of the Army staff to gain efficiencies aimed at increased flexibility and to reduce bureaucratic processes that stymie change.

In the same light, the FA School is transforming to improve staff efficiencies and integrate the development of branch capabilities to ensure the FA will contribute most effectively to the future Objective Force. The school's initial trans-

formation is part of the Training and Doctrine Command's (TRADOC's) Institutional Transformation Initiative that several branch schools are in the process of implementing, called the interim institutional model.

The TRADOC initiative creates a Futures Development Integration Center (FDIC) for each branch to integrate doctrine, training and combat developments. The recent creation of the FDIC at Fort Sill eliminated the Field Artillery School's Warfighting Integration and Development Directorate (WIDD). (See the figure on Page 36.) Many of the Field Artillery School functions affected by the initiative had been fragmented over the past decade due to military and civilian personnel reductions and force structure initiatives.

The FDIC is designed to integrate matrix-managed functions to maximize the development of FA systems, not only within the FA branch, but also across battlefield functional areas (BFAs) and our sister services. Matrix-

managed functions make the most of the organization's available expertise; the experts (such as systems analysts or training developers) work on an "as needed" basis across multiple projects as opposed to working fulltime on one project.

TRADOC's long-term goal is to establish centers under which related groups of FDICs would operate as one organization per center, helping to eliminate "stovepipe" doctrine, training and combat developments. Although the number and types of centers are yet to be determined, they could include effects integration, maneuver, maneuver support and sustainment centers plus an overarching battle command center, the latter perhaps at Fort Leavenworth.

The implementation of TRADOC's objective institutional model in the long term may move FDIC assets to the various centers and create Leader Training Centers in place of the more traditional branch schools. To that end, the new FA FDIC is separate from the Field Artil-



Field Artillery Institutional Transformation

By Colonel Michael T. Madden



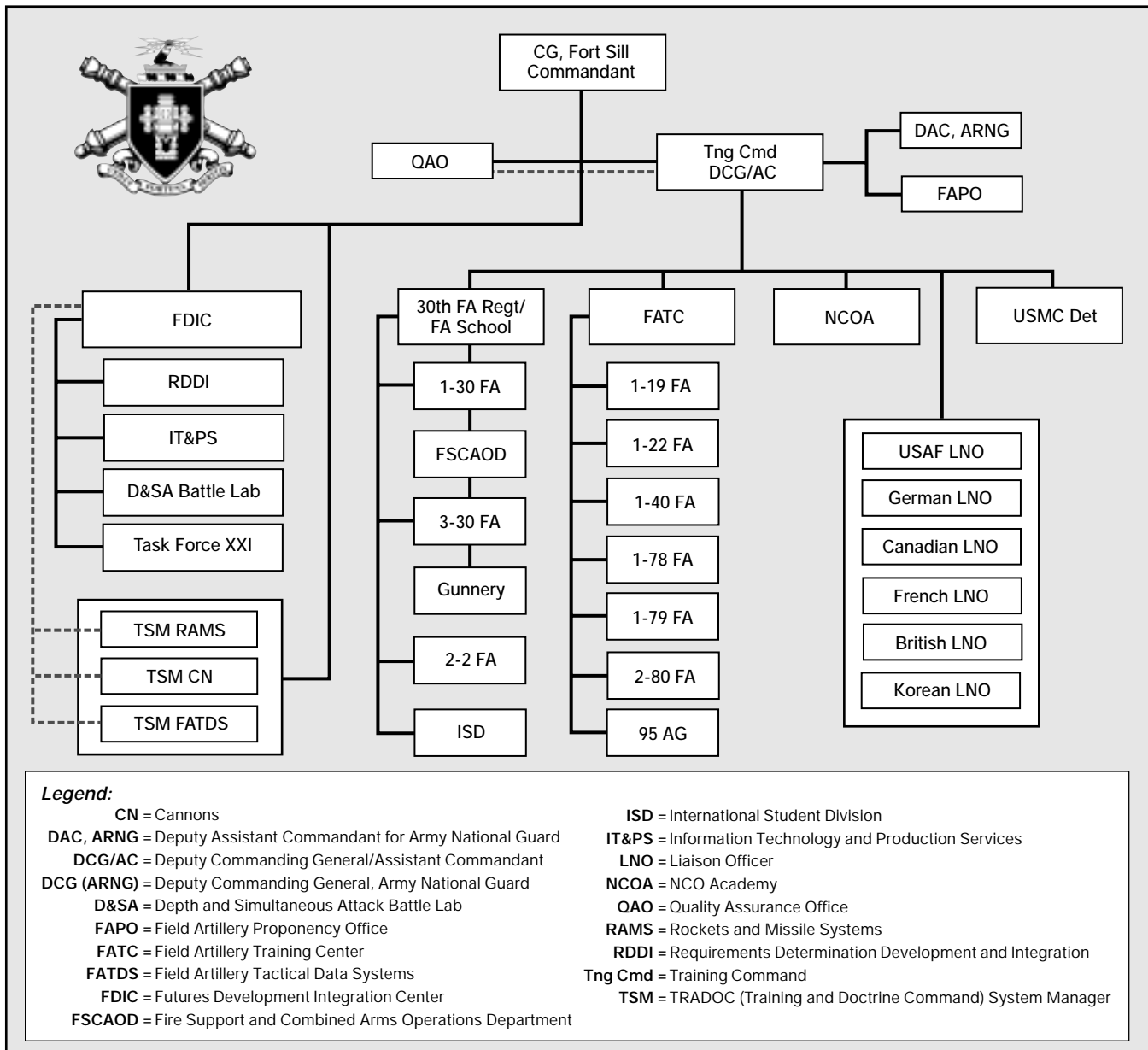

Training Command—Reflecting the Reorganization of the Field Artillery School

lery School, and its director reports to the Commanding General/Chief of Field Artillery while keeping the Deputy Commanding General/Assistant Commandant (DCG/AC) informed. The Field Artillery School, with the remaining traditional schoolhouse functions, still reports to the Commandant/Chief of Field Artillery via the DCG/AC.

This article discusses how the Field Artillery School has reorganized under TRADOC's interim model—establishing doctrinal, training and combat development functions within the FDIC and the first steps of reorganizing the Field Artillery School under the 30th FA Regimental structure. The latter restructuring will facilitate the development of an FA Leader Training Center in the long term.

Futures Development Integration Center. FDIC stood up on 1 October 2001. It is responsible for the “cradle to grave” development of new and legacy organizations and systems, to include their training and doctrine developments, that impacts across the DTLOMS and BFAs. The result will be a more efficient process that captures all the requirements in a timely manner during this period of rapid transformation.

Given FDIC's charter, it understandably incorporates the combat developments of the TRADOC System Managers (TSMs) for FA Tactical Data Systems (TSM FATDS), Cannons (TSM CN) and Rocket and Missile Systems (TSM RAMS) as indicated in the figure. The FDIC also understandably in-

corporates the experimentation and science and technology demonstrations of the Depth and Simultaneous Attack Battle Lab and the Objective Force project office of Task Force XXI. However, the Requirements Determination Development and Integration (RDDI) and Information Technology and Production Services (IT&PS) Divisions call for further explanation.

Basically, RDDI incorporates into the FDIC the development of force structure and all non-TSM combat systems—the material for the fire support team (FIST), radars, meteorological, etc. It also integrates the FA doctrine and individual and collective training functions of WIDD into FDIC, including developing products such as training aids,

devices, simulators and simulations (TADSS); unit training support packages (TSPs); mission training plans (MTPs); programs of instruction (POIs); etc. It also maintains and integrates intelligence and threat functions.

RDDI provides intensive, centralized, total systems management of the development and integration of the DTLOMS products across the affected TRADOC service schools.

One of the enhancements TRADOC is looking for in the interim model design is increased production services—thus IT&PS was created. IT&PS manages Classroom XXI and the distance learning network, develops multimedia training products for distance learning, maintains the online learning management system (LMS) and the digital library archives, and processes training products for submission to TRADOC. In addition, IT&PS trains the Field Artillery School instructors.

FDIC streamlines FA development processes using matrix-managed functions and integrates FA doctrine, training and combat developments, enabling the functions to be more flexible and effective in support of the Army's transformation and joint warfighting.

Field Artillery School and the 30th Regiment. The reorganization of the 30th FA Regiment and the FA School complements the TRADOC interim model. For many years the FA School had been organized with a separate Student Battalion and a Staff and Faculty Battalion. Since the establishment of the 30th Field Artillery Regiment in 1995, the 1st Battalion, 30th Field Artillery (1-30 FA) has been responsible for the staff and faculty of the school, and 3-30 FA has been home for thousands of students passing through Fort Sill.

Over the years, leaders have tried several initiatives to reorganize the regiment to align students with their instructors in the academic departments responsible for the students' courses of instruction—the Fire Support and Combined Arms Operations Department (FSCAOD) or the Gunnery Department. These initiatives were unsuccessful. Within TRADOC, the Armor School at Fort Knox, Kentucky, and Infantry School at Fort Benning, Georgia, are organized with students aligned with their instructors in the battalions of their respective "school brigades."

In March 2002, the 30th Regiment was reorganized to align a battalion of students and instructors with each de-

partment. The benefits of this move are that both battalions have students and instructors and a more balanced distribution of responsibilities. This will enhance coordination and cohesiveness as the battalions develop habitual relationships with the departments and promote the regimental battalion leaders' playing a more active role in the leader development process of the Officer Basic Course (OBC), Captains Career Course (CCC) and the Warrant Officer Basic and Advanced Courses (WOBC and WOAC).

Under the new organization, 1-30 FA is responsible for FSCAOD with its CCC students, WOBC and WOAC students, and advanced FA tactical data system (AFATDS) and initial FA automation system (IFSAS) students. Additionally, the FDIC receives its administrative and logistics support from 1-30 FA.

In a similar vein, 3-30 FA is responsible for the Gunnery Department with its OBC students. Additionally, the battalion is responsible for the International Student Division and has Uniform Code of Military Justice (UCMJ) authority over the NCO Academy.

This alignment streamlines planning, scheduling and coordination, providing a unity of command in training leaders that did not previously exist. The FDIC and 30th FA Regiment realignment will improve operations and posture the school to support the branch transformation in the coming years.

Ultimately, in the objective institutional model, the respective 30th Regiment battalion commanders may wear "dual hats"—one as the battalion commander and one as the department director. This would further streamline and integrate functions in the FA Leader Training Center.

In the interim model, the commander of the 30th FA Regiment continues to serve as Chief of Staff of the Training Command that still encompasses the FA School, NCO Academy and the FA Training Center (FATC). Eventually, he will become Director of Training in the Leader Training Center and Commander of the 30th Regiment when the departments are integrated into the regiment.

Other Changes to Training Command. Although most of the rest of Training Command remains intact—NCO Academy and FATC—some additional changes were necessary to implement the interim model. For example, the Army training requirements

and resources system (ATTRS) and academic records functions that used to be part of WIDD now fall under the G3, Training Command.

Perhaps the most significant additional change is the creation of the Quality Assurance Office (QAO). This office ensures the quality and effectiveness of FA training, a function that also used to be part of WIDD. QAO evaluates and validates training and training products, maintaining the standard. It conducts strategic analyses, evaluates performance deficiencies and ensures combat development and other requirements are integrated into training. QAO also is responsible for institutional self-evaluation and the Army school system (TASS) accreditation.

In all, the interim model redesign of the Field Artillery School streamlines the organization and uses resources more effectively. It integrates critical functions and ensures training quality and relevance to the field.

The FA School is transforming with the Army, leveraging existing structures to improve operations. With this interim institutional transformation, we are committed to producing the best soldiers and leaders, systems, organizations and doctrine for the FA branch—and doing it better.

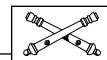

Colonel Michael T. Madden commands the 30th Field Artillery Regiment and is Chief of Staff of Training Command at Fort Sill, Oklahoma. In his previous assignment, he was Chief of the Plans Division in the J5 Plans and Policy Directorate and Chief of the Major Theater War Branch, among other assignments, at Central Command at MacDill AFB in Florida. He commanded the 1st Battalion, 31st Field Artillery in the Field Artillery Training Center, Fort Sill; a firing battery and headquarters and headquarters battery in the 25th Infantry Division (Light), Schofield Barracks, Hawaii; a Lance battery in the 210th Field Artillery Brigade, part of VII Corps in Germany; and the Metro Recruiting Company in Pittsburgh. He was the Executive Officer of the 1st Infantry Division (Mechanized) Artillery at Fort Riley, Kansas, having deployed as an Operations Officer with the division to the Gulf for Operations Desert Shield and Storm. Colonel Madden holds a master's degree in Management from Webster University, St. Louis, Missouri, and a master's degree in National Security Strategy from the National War College, Washington, DC.



Fort Sill Telephone Directory

As directed by the Assistant Secretary of Defense in a memorandum dated 28 December 2001, all "personally identifying information regarding DoD personnel.[such as] name, rank, email address.." will not be published or posted on a web site in a list or roster that the public has access to, with the exception of general officers and senior enlisted at the highest levels and other selected individuals with whom the public will have frequent contact. *Ed.*

(580) 442-XXXX
or DSN 639-XXXX

Command Group

Cmdt, FA School/CG, Fort Sill (ATZR-C)

MG Michael D. Maples
3006/3709/FAX 4700
Email: michael.maples@sill.army.mil

Asst Cmdt, FA School

DCG/AC (ATSF-A)

BG David C. Ralston
6604/3622/FAX 7191
Email: david.ralston@sill.army.mil

DCG, (ARNG) (ATZR-CB)

BG David E. Greer
3058/FAX 7134
Email: david.greer@sill.army.mil

CSM, Field Artillery (ATZR-CSM)

CSM Rodney L. Beck
3205/FAX 7134
rodney.beck@sill.army.mil

Training Command

C/S, Tng Cmd (ATSF-AD)

2301/3022/FAX 7191

CSM, Tng Cmd (ATSF-B)

6935/FAX 2304/7191

Executive Officer (ATSF-AX)

3022/2301/FAX 7191

G3, Tng Cmd (ATSF-ADO)

2520/5460/5771/FAX 7494

ATRRS

Academic Records

Special Actions Office (ATSF-ADO-S)

3323/4509/FAX 6800

Field Artillery School

DAC, ARNG (ATSF-ARC)

4587/FAX 7118

FA Proponency Office (ATSF-ADF)

4970/6365/FAX 7118
Email: fapo@sill.army.mil

Command Historian (ATZR-ADM)

3804/FAX 7300

Morris Swett Library (ATSF-ADL)

4525/4477/FAX 7300

Senior Force Rep (ATSF-LAF)

2300/3261/FAX 7629

British Liaison Officer

4309/FAX 7305
Email: britlno@sill.army.mil

Canadian Liaison Officer

4217/FAX 7254
Email: canlno@sill.army.mil

French Liaison Officer

4806/FAX 7412
Email: frelno@sill.army.mil

German Liaison Officer

4003/FAX 5109
Email: gerlno1@sill.army.mil

Korean Liaison Officer

4816/FAX 7191
Email: korlno@sill.army.mil

30th FA-30th Field Artillery Regiment

Commander, 30th FA (ATSF-B)

2301/3022/FAX 7191

Executive Officer, 30th FA
3022/2301/FAX 7191

CSM, 30th FA
6935/FAX 7191

Adjutant/Personnel 5330/3394

International Student Division (ATSF-BS)

4600/4726/FAX 5142

2-2 FA (ATSF-BG)

2803/3265/FAX 4744

1-30 FA (CCC) (ATST-BF)

5088/2009/FAX 7613

3-30 FA (BOLC) (ATSF-BO)

6194/6415/FAX 3124

FSCAOD-Fire Support and Combined Arms Operations Department

Director, FSCAOD (ATSF-T)

4704/3995/FAX 6003

Deputy, FSCAOD
6424/3995/FAX 6003

Sergeant Major
6424/3995/FAX 6003

PreCommand Course 5194

Fire Support 5819/4557

Combined Arms 4653/6808

Fire Support Automation 3811/6385/
FAX 6526

Communications and Electronics
3115/5107/FAX 2602

Target Acquisition 6207/3867/FAX 4202

- Warrant Officer 4925/2971/FAX 7861
- Radar 2408/6111/FAX 7861
- Meteorology 2406/5014/FAX 4202

GD-Gunnery Department

Director, GD (ATSF-G)

2400/2014/FAX 5616

Deputy Director, GD
2014/2400/FAX 5616

Sergeant Major, GD
2014/2400/FAX 5616

Master Gunner
2204/2447

Paladin (M109A6) NET 4418/5301/FAX 3901

Paladin Cadre Course 2708/3994

PM-Paladin/FAASV Field Office 6215/
FAX 7008

Cannon Division 2761/3103

M119/M198 Maintenance (ASI U6) 6318

OBC Revision 6224/5409

Manual/Automated Gunnery 6224/5409

Unit-Level Logistics System (ULLS) 6829

New Systems 4418/5301/FAX 3901

MOS 13E Instruction 6803/5345

MLRS Instruction Branch 5151/4743

MLRS Fire Direction Branch 6121/2606

MLRS NET 2431

USMC-Marine Corps Detachment

Commander (ATSF-MCR)

6311/6498/FAX 5127

Operations Officer
6498/4204/FAX 5127

Sergeant Major
3873/2307/FAX 5127

Training/Education (Info for all Courses)
2307

Marine Personnel Locator 6188/6192

Marine Btry Cdr/1stSgt 5615/2467

GD-Senior Marine 6224/2622

- Enlisted Instructor Branch (MOS 0844 and 0848) 5084
- OIC/NCOIC, Marine Cannon Crewman Course (MOS 0811) 5595/6811
- OIC/NCOIC, Survey Branch 6616/FAX 3216

FSCAOD-Senior Marine 5819

- Advanced Fire Support Branch 4809
- Basic Fire Support Branch (MOS 0861) 5343/3085
- Radar/Met (MOS 0842/0847) 6111

RDDI-Marine Corps Warfighting
Liaison Officer, MCCDC 4927

NCOA- NCO Academy

Commandant, NCOA (ATSF-W)
4272/3141/FAX 8290

Asst Cmnt, NCOA
2417/3141/FAX 8290

Adjutant/PAC/S1 5606/3466

Staff Duty NCO 2417/3141

BSNCOC (DL) 1740

PLDC 4241

BNCOC 6127/2097

ANCOC 2619/6970

Camp Eagle: PLDC Operations 3648

FATC- Field Artillery Training Center

Commander, FATC (ATSF-K)
1261/1262/FAX 1279

Deputy, FATC
1261/1262/FAX 1279

CSM, FATC
1262/1261/FAX 1279

S3 2011/6198/FAX 6118

Sr ARNG Liaison NCO 1146/1147/FAX 6118

Sr USAR NCO 4168/6107/FAX 3525

1-19 FA (BCT) (ATSF-KF)
1401/1402/FAX 7601

1-22 FA (BCT/OSUT) (ATSF-KN)
2345/2541/FAX 7117

1-40 FA (OSUT) (ATSF-KI)
200/1203/FAX 7120

1-78 FA (Training Committee) (ATSF-KT)
2611/5022/FAX 7907

1-79 FA (BCT) (ATSF-KG)
1301/1302/FAX 7121

2-80 FA (AIT) (ATSF-KL)
5818/6272/FAX 7600

95th AG Battalion (Reception) (ATSF-KR)
3606/4576/FAX 7974

FDIC-Futures Development Integration Center

Chief, FDIC (ATSF-F)
2604/6980/FAX 7216

Deputy, FDIC
2604/6980/FAX 7216

CA-Concepts and Analysis

Director, CA
2604/6980/FAX 7216

Analysis (ATSF-FA) 4715

Task Force XXI (ATSF-FT) 4511/5206

RDDI-Requirements Determination Development and Integration

Director, RDDI
3814/2045/FAX 4300

Deputy, RDDI
2045/3814/FAX 4300

FA Weapons/Munitions

FIST Equipment

Radars

Meteorological Equipment

Force Structure/TAA 2578

Documentation 2726

Doctrine and Training Div (ATSF-FR)
5644/3300/FAX 5724

- Doctrine
- Individual/Collective Tng
- ARTEPS MTPs/TADSS/Unit TSPs
- CATS/SATs
- STRAC
- New Systems Integration

IT&PS-Information Technology & Production Services

Director, IT&PS (ATSF-FP)
5903/3427/FAX 7764

Deputy, IT&PS
3611/5903/FAX 7764

TRAMOD Systems 5103

Production Services 3611

Distance Learning/Classroom XXI 5903

Staff & Faculty 3427

D&SA- Depth and Simultaneous Attack Battle Lab

Director, D&SA Battle Lab (ATSF-FB)
3706/6954/FAX 5028
Toll Free 1-800-284-1559

Deputy, D&SA Battle Lab
5647/3636/FAX 5028

- Simulations 3649/3834
- FireSim XXI Model
 - Simulation Support
 - Simulation in Classroom
 - Janus/JCATS/BBS
 - Digital Training

Experiments and Demonstrations 3139

- ACTDs (TPSO)
- TMD Attack Operations
- Army Joint Targeting Requirements

Science & Technology 2928

- S&T
- STOW
- CEPs
- NetFires

ARDEC LNO 2936

ARL Field Office 5051

TSM CN-TRADOC System Manager for Cannons

TSM CN (ATSF-FMC)
6902/4451/FAX 5902

Deputy, TSM CN
4451/6000/FAX 5902

Crusader 3716

Excalibur 3803

Lightweight 155-mm Howitzer/TAD 6178

Training 3454

TSM RAMS-TRADOC System Manager for Rocket and Missile Systems

TSM RAMS (ATSF-FMR)
6701/5205/FAX 6126

Deputy, TSM RAMS
6701/5205/FAX 6126

M270A1 MLRS Launcher 5205

HIMARS 5205

Rockets 6701

ATACMS 6607

TSM FATDS-TRADOC System Manager for FA Tactical Data Systems

TSM FATDS (ATSF-MA)
6836/6837/FAX 2915

Deputy, TSM FATDS
6836/6837/FAX 2915

Software
6418/5607/6067/FAX 2915

- AFATDS/IFSAS/LTACFIRE 5607
- Communications 6418
- FDS/BCS 6067
- Firefinder 6067
- FED/HTU 5607
- Fire Support Interoperability 6418
- C⁴I Architecture 2233
- User Interface Requirements 6067

Plans/Operations/Training 6838/6839/
FAX 2915

24 Hour Hotline 5607

AFATDS NETT (CECOM) 6362/4754/
FAX 5612

QAO- Quality Assurance Office

Director, QAO (ATZR-CQ)
2002/2005/FAX 5724

Quality Assurance

- Training Product Validation
- CD Requirements Integration
- Performance Evaluation Deficiencies
- Strategy Analysis
- Process Integration

Accreditations 4902/2835/FAX 7799

- TASS/Accreditation
- Institution Self-Evaluation

Satellite Organization

**PEO-GCSS-Program Executive Officer-
Ground Combat and Support Systems
Field Office**

PEO Field Officer (SFAE-GCSS-FS)
2028/FAX 7008

In mid-February, the FA began fielding the multiple-launch rocket system (MLRS) M270A1 launcher. The basic M270 launcher, first fielded in 1983, provided a quantum leap in the ability to ripple-fire 12 M26 rockets and (in 1990) two Block I Army tactical missile systems (ATACMS). The M270 established itself as the premier long-range (seven to 165 kilometers), all-weather, indirect fire weapon in the division and corps commanders' arsenals.

However, Operation Desert Storm after-action reports (AARs) indicated a need for faster response times, global positioning system- (GPS)-aided munitions and improvements to both the fire control system (FCS) and the launcher drive system. In 1992, we began efforts to improve the M270 launcher.

Why upgrade the M270?

The new launcher is expected to extend the service of MLRS by 20 years and enhance its performance. It incorporates technologies that allow for continued MLRS family of munitions (MFOM) growth. The upgrade is comprised of three systems: the improved FCS (IFCS), improved launcher mechanical system (ILMS) and M993A1 carrier enhancements.

IFCS. The need for the IFCS evolved from a growing obsolescence of electronic components and additional requirements generated by the development of new munitions. IFCS replaces the existing MLRS FCS. It consists of the line replaceable units (LRUs) listed in the figure plus GPS, a boom controller (BC) and new redundant cabling between LRUs.

IFCS mitigates obsolescence, reduces the operational and sustainment burden, enhances system reliability, reduces system start-up times and accommodates the growth of MFOM. Of note, IFCS eliminates the launcher's calibration requirement.

M269A1 ILMS. This materiel change dramatically improves responsiveness. ILMS allows the launcher to move simultaneously in both azimuth and elevation. It reduces the stow-to-aim point

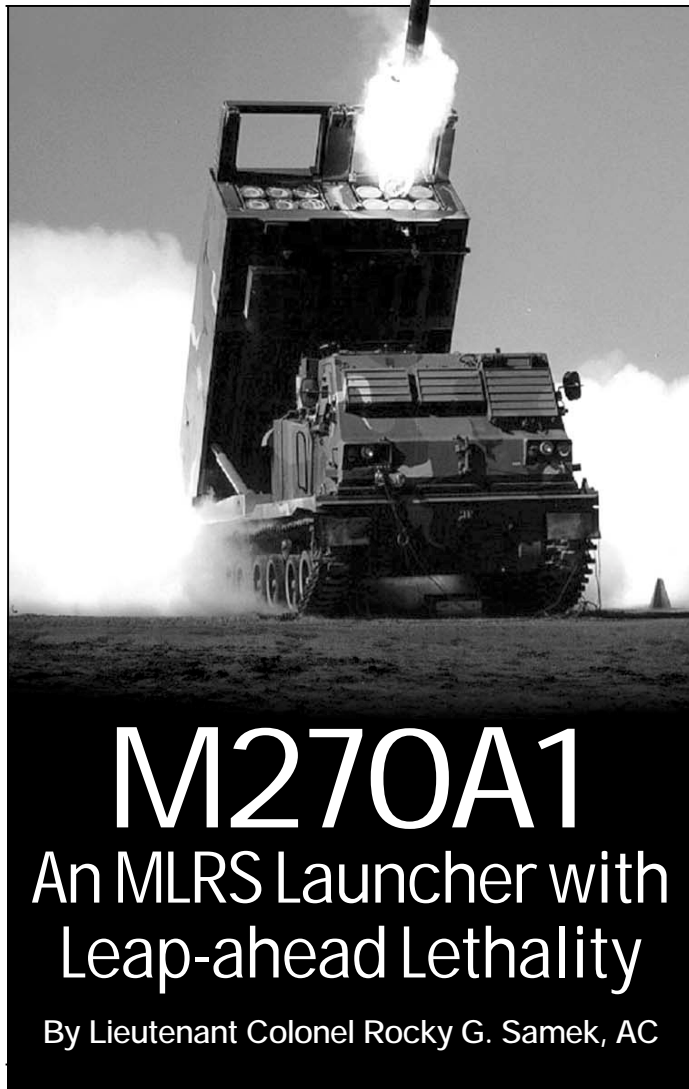

M270A1

An MLRS Launcher with Leap-ahead Lethality

By Lieutenant Colonel Rocky G. Samek, AC

time of 93 seconds (worst case) to just 16 seconds—a reduction of 83 percent. Additionally, reload times improve nearly 38 percent, decreasing from 260 seconds to approximately 160 seconds.

ILMS also reduces the number of parts, lowering operational and sustainment costs. It supports all MFOM and can be operated, maintained, repaired, trained and supported in all environments.

M993A1 Carrier. The M270A1 carrier is a basic M993 (Bradley variant) that has been brought back to zero miles and zero hours. Enhancements include the addition of the power take off (PTO) pump to maintain hydraulic pressure and the Centry system that maintains precise, constant engine revolutions per minute plus improvements to the electrical system. The latter includes the addition of the improved electric distribution box (IEDB).

The M993A1 can be operated, maintained, repaired, trained, and supported in all environments.

Who will get the new M270A1? Fielding began with the 2d Battalion, 20th Field Artillery (2-20 FA), 4th Infantry Division (Mechanized) at Fort Hood, Texas. M270A1 battalions each will receive 18 launchers. Additionally, one operational readiness float (ORF) will be allocated per battalion.

A combination of active and National Guard units will receive the M270A1 launchers. Currently, 15 battalions, prepositioned stocks and institutional training and testing centers will receive the 327 launchers that are funded. Fielding will be completed in 2009.

New Equipment Training (NET). The M270A1 NET focuses on the operational and maintenance skills to perform tasks critical to accomplishing the mission. The basic MLRS tactics, techniques and procedures (TTPs) do not change with the fielding of the M270A1.

MLRS crewmen receive the additional skill identifier (ASI) of A1 after completing two weeks of M270A1 training. The A1 ASI can be awarded three ways: after Military Occupational Specialty (MOS) 13M MLRS Crewman

Advanced Individual Training (AIT); after a transition course at the Field Artillery School, Fort Sill, Oklahoma; or by completing NET.

Safety Features. The M270A1 has several new safety features. Two of particular note are the jury strut safety switch and rocket pod hold-down safety switch. When activated, these switches dramatically reduce the possibility of personnel injury or equipment damage.

Maintenance Concept. The M270A1 operates under a three-level maintenance concept: operator/unit, direct support (DS) and depot. The five MOS that support this concept are 13M, 27M MLRS Repairer, 63Y Track Vehicle Mechanic, 63H Track Vehicle Repairer, and 63G Fuel and Electrical Systems Repairer. These MOS do not require additional qualifications to work with the M270A1.

The M270A1's unique launcher loader module (LLM) is being supported by





interim contractor support (ICS) through September 2003. Each battalion will have a contractor field technician (CFT) to maintain a database that tracks demands, returns, issues and other data; supports training activities; and repairs the M270A1 LLM LRUs. During the ICS period, Lockheed-Martin Missile and Fire Control (LMMFC) will supply M270A1-unique repair parts at no cost to the unit. Then parts will be requisitioned by either national stock number (NSN) or Army part number (APN).

Operational Testing. The M270A1 began operational testing in July 2001. The tests consisted of both ground and flight phases where soldiers from 1-12 FA, 17th Field Artillery Brigade, III Corps Artillery at Fort Sill demonstrated the capabilities of the M270A1 alongside the basic M270 launcher. The ground phase at Fort Sill consisted of three, 96-hours field exercises firing 108 reduced-range practice rockets (RRPRs). The flight phase at White Sands Missile Range, New Mexico, consisted of firing many pods of M26 and M26A2 rockets as well as one M39A1 ATACMS missile out to a range of 171 kilometers. The Operational Test Command evaluated the tests, which included the full range of mission profiles of the MLRS launcher and its MFOM.

The M270A1 performed magnificently—in many cases, exceeding expectations. It demonstrated it can load, hide, move, aim, shoot, and reload in an unprecedented manner. When compared to the M270, the M270A1 reduced nearly every time standard, to include total mission cycle time, launcher lay to completion of fire, reload and last round fired to first movement. The shorter times improved effects on target and increased soldier survivability. The M270A1 demonstrated it can receive, process, service the target and move long before the crew is susceptible to counterfire.

The M270A1 easily met or exceeded its mean time between operational missions and failure. At the system level, the time it took for the system to fail was nearly double the time required in the test. This indicates a unit's personnel and funding will not be excessively taxed to maintain operational readiness.

When a repair was necessary, the M270A1's built-in-test functionality proved its value. In many cases, faults were isolated to a specific group—saving time, reducing maintenance man-hours, eliminating human errors and improving operational readiness rates.

IFCS LRU	Replaces the...	Function Provides...
Fire Control Panel (FCP) 	Old FCP and Electronics Unit (EU)	A man-machine interface with internal and external systems with a high-resolution display, full-text keyboard, audio-visual alarms and 350 megabyte storage with bit status.
Power Switching Unit (PSU) 	Electronics Box (EB)	A vehicle power source interface and high-current power distribution; operates under LIU control.
Launcher Interface Unit (LIU) 	EU, Fire Control Unit (FCU) and Communications Processor	An interface with the boom controller (BC) that incorporates a "Kill Switch"; aims and controls the launcher loader module (LLM); and has system power management and communications processing functions.
Weapon Interface Unit (WIU) 	FCU, Short/No-Voltage Tester (SNVT), Payload Interface Unit (PIU) and EU	SNVT functions, ballistics calculation processing and weapon interfaces.
Position Navigation Unit (PNU) 	Stabilization Reference Package/Position Determining System (SRP/PDS)	Launcher position and navigation data and an embedded global positioning system (GPS) with an interface to the guided missile launch assembly (GMLA).

Improved Fire Control System (IFCS) Line Replaceable Unit (LRU) Capabilities Summary

What are the future improvements to the system? Several improvements are being planned, including environmental conditioning and the addition of an auxiliary power unit, a low-cost fire control panel (LCFCP) and the Force XXI battle command brigade and below (FBCB²) system.

Environmental Conditioning. The temperature of the M270A1 cab can approach 130 degrees, adversely affecting both soldiers and the electronic equipment. Plans include possible temperature conditioning for the M270A1.

Auxiliary Power Unit. An MLRS crew spends significant time in the hide position. Ideally, the engine should be off (communications equipment operational) the majority of this time. The demand for electrical power increases as more electronic units are placed in the vehicle. These demands may affect silent running time to the point an auxiliary power supply may be necessary.

LCFCP. This panel will replace the FCP and include a new display, mass storage unit and ancillary equipment. The LCFCP will improve functionality and ease of use. Fielding will begin in FY03.

FBCB². Current plans call for incorporating FBCB² into M270A1 launchers in FY04. The launcher chief will use

the FBCB² to display digital maps and other situational awareness information.

These enhancements to the venerable M270 launcher increase combat effectiveness, improve soldier survivability and reduce operations and sustainment costs. The M270A1 launcher ensures that FA rocket and missile fires will be an integral part of the future combat force.

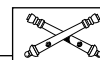

Lieutenant Colonel Rocky G. Samek, Acquisition Corps (AC), is the Assistant Training and Doctrine Command (TRADOC) System Manager for Rocket and Missile Systems (TSM RAMS) for Crusader, part of the Futures Development and Integration Center, Fort Sill, Oklahoma. He began his AC assignments in 1994 and, since then, has served as the Assistant Project Manager (PM) for Crusader Logistics and MANPRINT and Test Officer at Yuma Proving Ground, Arizona, firing direct and indirect fire weapons ranging from 60-mm mortars to the 203-mm 8-Inch howitzer. He was the Commander of B Battery, 2d Battalion, 80th Field Artillery in the FA Training Center (FATC) at Fort Sill and the G3 Mobilization Officer, also in the FATC. He holds a Master of Science in Materiel Acquisition from Florida Institute of Technology.



Crusader: Hammer for Today, Forge for the Future

By Major Charles J. Emerson, Jr., AC

Crusader is critical to transformation. The Army's new FA system contributes directly to the Chief of Staff of the Army's vision of an Objective Force that's responsive, deployable, agile, versatile, lethal, survivable and sustainable.

The US military is the undisputed master of the battlefield. Our prowess has been demonstrated against the full range of operations. We have outstanding equipment and the best-trained forces in the world. We have been able to dominate all threats, including attacks on our homeland.

However, there is a glaring exception to our total battlefield superiority. There exists today (and has existed for several years) a deficiency in artillery fires.

This deficiency has manifested itself in many ways. US cannon artillery is out-gunned by many of the platforms proliferating across the world (Russian 2S19, South African G6, German PzH2000 and others). Cannon fires provide insufficient volume to satisfy the close battle fires, while the fire support architecture lacks the responsiveness to attack targets of opportunity. Today's cannon platforms hinder the advance of forces by lagging behind their supported maneuver counterparts. Despite the dissimilarity of these deficiencies, they all include a common shortfall: the declining utility of our primary self-propelled cannon platform, the M109-series howitzer.

The challenge we face is to continue our battlefield superiority while the 30-

year process of transformation takes place. Crusader, fielding in 2008, answers the call. As the Army's new cannon system, Crusader will enable transformation as a significant contributor to the Legacy, Interim and Objective Forces. See Figure 1.

***Legacy Force:** The Army has a non-negotiable contract with the American people to fight and win our nation's wars. The Legacy Force is our guarantee that we will be able to fulfill our contract as the primary force through 2016. At that point, the Legacy Force will supplement the Objective Force until it's integrated in 2032. Consisting primarily of systems found in today's heavy divisions, the Legacy Force will be modernized with equipment already programmed and recapitalized until it's integrated into the Objective Force.*

Some believe the Legacy Force will look and act just like the force that fought in Desert Storm. But this simplified view fails to take into account the sea change in operational concepts and organizational structure that already has occurred.

In 1996, the Army reduced the firepower of maneuver and artillery battalions by 25 percent. Cannon battalions that previously had three batteries of

eight guns were reduced to three batteries of six guns. The typical heavy division experienced a loss of 18 cannon artillery systems with a commensurate loss of personnel.

This decrease in force structure was based upon the expectation of increasing combat power—enabled, in large part, by the expected future fielding of Crusader and smart munitions. The Army took a strategic risk.

At the same time, however, the geographical operating area of the mechanized division has more than doubled. Today, tactical units are expected to travel faster and farther and accomplish a greater range of objectives than ever before.

Mobility. Paladin, the Army's current fielded artillery system, cannot keep up with its supported maneuver force in this environment. Because of the shortfall in mobility, it is common practice to "echelon" artillery assets to ensure that supported units are in range. This technique ensures that fires are readily available, but it often robs the force commander of the ability to mass fires or attack targets of opportunity.

To make up for this mobility shortfall, Crusader will use a turbine engine that will be common with the M1A2 system enhancement program (SEP) tank (Abrams/Crusader common engine). This potent engine will enable Crusader to achieve the required highway speed of 67 kilometers per hour, but tests indicate it most likely will achieve a higher speed. Likewise, the potent engine will allow Crusader to surpass the required cross-country speed of 39 kilometers per hour, most likely 48 kilometers per hour. Its speed and cruising range of 405 kilometers will allow it to efficiently "nest" within maneuver forces and enable "maneuvering" of fires.

Its mobility, autonomy and responsiveness will ensure that fires always will be available and integral to the supported force. Crusader vastly opens up tactical possibilities for the force commander.

Lethality and Responsiveness. The Crusader self-propelled howitzer's (SPH's) responsiveness, accuracy, range and high rate-of-fire will combine to create an extraordinarily lethal howitzer. An emplaced SPH will respond to a fire mission with the first round fired within 20 seconds (45 seconds from on the move). Its liquid-cooled 56-caliber cannon will shoot the vast majority of fire missions at the rate of at least 10

rounds per minute. Its robotic ammunition handling system will allow each howitzer to shoot its own time-on-target (TOT) by delivering four to eight rounds that all will land within four seconds on the target. The advanced fire control and gun pointing system will make the SPH roughly three times more accurate than the Paladin.

Using its on-board projectile tracking system, the SPH will be able to track its own projectiles to apogee. The fire control system will use this data to perform "should hit, did hit" calculations and automatically apply those corrections to subsequent rounds or missions, enabling greater effects on target. In effect, the SPH will register every mission, and continually refine that data in real-time.

The Crusader battalion will have two versions of the resupply vehicle (RSV): a tracked version, RSV(T), and wheeled version, RSV(W). The RSV(W) will be a light, highly mobile version that consists of a standard palletized loading system (PLS) truck that will carry a Crusader resupply module with flatrack-like connections. Optimized for use where roads exist, the RSV(W) will leverage the advantages of wheeled vehicles to quickly resupply the SPH or another RSV.

The RSV(T), on the other hand, will be an armored tracked resupply vehicle. A majority of its components will be common with the SPH and able to withstand the most hazardous threat environment.

Each resupply vehicle will contain more than two complete SPH ammunition loads and supply the SPH through an extendable boom. The fully automated ammunition handling system will be able to resupply the SPH with a full load of ammunition, fuel and data in less than 11 minutes without any physical effort required of the crew. These capabilities will yield an ammunition throughput that is more than twice that of any other comparable howitzer (PzH2000, AS90, Paladin, etc.).

Survivability. The SPH and RSV(T) will have a number of features that combine to make Crusader crewmen among the most survivable in battle. The two tracked vehicles will have ballistic and nonballistic protection that greatly improves on Paladin armor. Ammunition will be compartmentalized to protect the crew in case of hull penetration or fire. There will be a defensive weapon (machinegun or grenade launcher) on top of both tracked vehicles that will be aimed and fired remotely by the crew under armor.

Crusader will have the ability to dash 750 meters in 90 seconds after conducting a fire mission. Thus, even if targeted, it will be able to avoid being hit. When these features are combined with optimal tactics, techniques and procedures (TTPs), Crusader will have unprecedented survivability.

Analysis and Report Results. The most recent analytical study of Crusader ("Crusader and the Army Transformation: A Report to the Congressional Defense Committees," December 2000) demonstrated the significant benefits of the system. While the actual results depended on the nature of the scenario, Crusader-supported forces inflicted substantially more personnel and equipment losses on the opposing force (27 percent to 35 percent), while sustaining far fewer losses (16 percent to 34 percent) than forces equipped with Paladin. Additionally, the benefit of Crusader's high force effectiveness extended to the supported maneuver force: more tanks and personnel carriers survived the conflict.

Forces equipped with Crusader were found more capable for a number of reasons. The combination of the SPH's lethality, the ammunition throughput enabled by the RSVs and the mobility of the platforms provided the ability to engage units with intense pulses of fire-power. The pulses created devastating effects and denied the enemy an ability to react to the engagement. The secondary effects were also significant, allow-

- Designated as a Legacy-To-Objective Force system in November 2001.
- The first Crusader self-propelled howitzer (SPH) prototype fired more than 3,700 rounds in developmental testing at Yuma Proving Ground, Arizona, in December 2001.
- A limited user evaluation is scheduled for this summer; additional operational testing on full prototypes will start in 2006.
- Crusader is fully funded, on schedule and within budget; it will start fielding to the Counterattack Corps in 2008.



Figure 1: Crusader Program Highlights

ing the maneuver force greater opportunities to engage the enemy.

When the close battle was initiated, it occurred more frequently on friendly force's terms against an enemy that had been attrited by relentless deep fires.

Crusader's mobility, lethality, responsiveness and survivability will provide the ability to execute decisive action.

Interim Force. *The Army is responding to existing shortfalls in the operational spectrum by introducing the Interim Force into the force structure. Designed to be a strategically deployable force, it will have significantly more combat power than today's light divisions. By procuring today's state-of-the-art equipment and optimizing operations and our organizational structure, the Army will equip the Interim Force with as many of the characteristics of the Objective force as feasible. The Interim Force is being created today and will consist of six brigade combat teams (IBCTs) that will remain in the Army's structure until 2032.*

The Interim Force must be strategically deployable. In practical terms, that means being able to quickly deploy by air to theaters anywhere in the world.

Deployability and Lethality. As a result of the recent redesign efforts to reduce Crusader's weight, the SPH or RSV(T) will have a curb weight of 38 to 42 tons. At that weight, one C-17 aircraft can transport two Crusader vehicles (tracked or wheeled) worldwide that will be combat-capable "off the ramp."

Crusader will be able to plug into the joint command and control (C²) network and immediately expand the battlespace controlled by friendly forces. Crusader will give the supported warfighting commander far greater capability for the same amount of strategic airlift assets than any other artillery system.

During a small-scale contingency map exercise (MAPEX) conducted during the latest analytical study, the addition of Crusader was deemed invaluable. Neither the Paladin nor the Crusader was believed to be critical for initial operations, but the accuracy of Crusader made it an attractive firepower option in areas where collateral damage could not be tolerated.

In fact, the MAPEX participants (not analysts, but warfighting subject matter experts) concluded that the overwhelming firepower Crusader offers the sup-

ported commander more than justifies any overhead associated with deploying, employing and sustaining the system.

The organic artillery platform for the Interim Force will be the lightweight 155-mm towed howitzer (LW 155), projected for fielding in 2006. It will fill a significant capability gap. While Crusader is strategically deployable and clearly a significant fire support augmentation option for this force, it lacks an important feature of the Interim Force: it cannot be transported within theater on a C-130 payload. The LW 155 will be transportable by C-130.

The distinction is an important one because the Interim Force is more than just a stopgap measure. It will be developing the doctrine and TTP of the Objective Force. The intra-theater transport of "C-130-like" payloads will be critical to that development.

State-of-the-Art Connectivity. Crusader has been designed from its inception to operate on the digitized battlefield of the future and will incorporate a great number of the Objective Force features sought by the Interim Force.

Operations will be conducted by a section that is a one-third smaller than today's Paladin section. Crewmen will control the system from a state-of-the-art, software-driven crew cockpit that will provide a "shirt sleeve"-protected environment from enemy nuclear, biological and chemical (NBC) effects.

The three-man crew will be freed from the labor- and attention-intensive tasks of previous systems. As needed, the crew will be able to access decision aids, practice training scenarios, inven-

tory on-board ammunition and perform perimeter surveillance.

The crew also will be able to access the common operating picture (COP) on demand. The Crusader crew will have a level of situational awareness and flow of information that is unprecedented in artillery.

Equipment failure will be prevented with the system prognostics, and repairs will be facilitated with the diagnostic tools embedded in the platform. The crew will be able to "fight the system" rather than "service the piece."

Through the power of its fully integrated cockpit and its digital architecture, Crusader will be able to establish rapid links with sensors and eliminate much of the latency of today's hierarchical fire support C² system. Just as there always will be a need to mass fires at a battalion level, there also will be a need to quickly and efficiently force-tailor shooters to deal with the proliferation of engagements or focus on targets of opportunity. The dispersed nature of the Interim Force means long-range fires frequently will be called upon for close support missions. Thus, the artillery community must be able to execute simultaneous missions and respond to changing missions quickly and efficiently.

Employment Flexibility. Today, the maneuver commander says he wants fires, and the fire support team initiates a call-for-fire through the brigade fire support officer (FSO) to the battalion fire direction center (FDC) on to a battery FDC then down to platoon operations center (POC) and, ultimately, to the guns... and all for only one target at a time.



The Crusader crew will have a level of situational awareness and flow of information that is unprecedented in artillery.

Courtesy of United Defense

We have techniques today that can flatten that hierarchy. But they typically are workarounds that either revolve around a single firing platform or require a dedicated C² node to coordinate a rapid response. They cannot be implemented rapidly and, therefore, have limitations.

Crusader will allow greater flexibility in force tailoring. If the situation dictates, Crusader will be able to link directly with a Comanche helicopter, an unmanned aerial vehicle (UAV) ground station, an M1A2 SEP or other target acquisition source and immediately initiate effective fires. With minimal pre-coordination, one sensor will be able to directly control the fires of up to a battery of howitzers. Crusader will be able to respond with a battery of fires within 60 to 90 seconds of target detection.

Crusader will enable this flattened structure by conducting its own tactical fire direction and coordinating the fires of up to five subordinate howitzers. When these capabilities are combined with Crusader's mobility and survivability, true opportunities exist to greatly increase responsive fires.

Crusader, with its strategic deployability and lethality, exceptional connectivity and employment flexibility will augment the Interim Force capability to conduct decisive action.

Objective Force. *This force will be more responsive, deployable, agile, versatile, lethal, survivable and sustainable. Although many details of the Objective Force are unclear, we do know some characteristics. It will be able to operate on a large, nonlinear battlefield where the enemy will be able to challenge friendly forces, regardless of their locations. Success on this battlefield means having overmatch on every point on the operational spectrum. The first objective brigade combat team (OBCT) is scheduled to be fielded in 2010. From 2012 on, the Army will convert three brigades a year to OBCTs until fielding is completed in 2032.*

The Objective Force is expected to be a full-spectrum system-of-systems force capable of direct fire or line-of-sight (LOS), mortar-like fires or non-line of sight (NLOS) and indirect fires or beyond line of sight (BLOS). The most recent technology assessments indicate the Block 1 future combat system (FCS) may have limited or no indirect fire capability. By providing massive lethal

- Fielding Quantities: 480 SPHs and 240 Each of the RSV(T)s and RSV(W)s
- Payload: 48 Rounds on the SPH and 100 Rounds on the RSV(T) or RSV(W)
- Maximum Rate-of-Fire: 10 to 12 Rounds per Minute
- Sustained Rate-of-Fire: 3 to 10 Rounds per Minute
- Maximum Range: 40 Kilometers with M549A1 Rocket-Assisted Projectile (RAP)
- Response Time: 20 Seconds (Emplaced) and 45 Seconds (From the Move)
- One-Gun Time-on-Target: 4 to 8 Rounds Impacting within 4 Seconds of Each Other
- Emergency Displacement: 750 Meters in 90 Seconds
- Road Speed: 67 Kilometers per Hour
- Cross-Country Speed: 39 Kilometers per Hour
- Ammunition Handling/Gun Pointing: Fully Automated
- Ammunition Transfer: Fully Automated (Ammo, Fuel and Data)
- Maintenance Aids: Embedded Diagnostics and Prognostics and an Electronic Technical Manual
- Crew Size per Vehicle: 3
- Weight: SPH Curb Weight of 42 Tons or Less and Combat-Loaded Weight of 50 Tons or Less



Figure 2: Crusader Capabilities. The Crusader system includes three different vehicles: the tracked self-propelled howitzer, or SPH; the tracked resupply vehicle, or RSV(T); and the wheeled resupply vehicle, or RSV(W).

indirect fires, Crusader will make the FCS vision work.

While it is true that Crusader will not fit on a C-130, the aircraft used for strategic airlift are the C-17 and the C-5 transports. Despite the Objective Force requirement to be transportable on a C-130, the strategic aircraft are the ones most likely to be used in an initial strategic deployment. Either aircraft can deploy two Crusader vehicles worldwide without requiring in-flight refueling, making Crusader a firepower combat multiplier for follow-on to early entry forces.

Crusader's technologies will be used by FCS. It is breaking new ground in a number of areas related to sustainability, survivability and versatility. Examples include laser ignition, robotics, electronic spray cooling, and electric drive motors for breech, turret movement and ammunition handling.

Through embedded prognostics and diagnostics, Crusader will "know" more about its operational readiness than any other ground combat vehicle. In addition to knowing its operating capability, the Crusader will be able to diagnose its problems, order and track replacement parts, reconfigure after a fault to achieve its best capability and assist the crew in servicing the platform.

A robust interactive electronic technical manual (IETM), the first of its kind, will guide the crew in all aspects of repairs, from crew-level to depot-level repairs. This will include assisting in

battlefield damage assessment and repair (BDAR) procedures.

Crusader represents a generational leap in fire support. Its contribution to the future force will rely on its ability to plug into the firepower "system-of-systems," be strategically deployable, be ready to fight upon arrival and maintain its devastating lethality throughout the fight. See Figure 2.

Today, Crusader promises to fulfill an urgent warfighting need and provide a technical bridge to the Objective Force. Its mission, functions and viability will remain critical throughout the Army's Transformation.

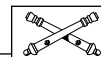

Major Charles J. (Jack) Emerson, Jr., Acquisition Corps (AC), is a Crusader Combat Developer Staff Officer in the Training and Doctrine Command Systems Manager for Cannons (TSM Cannon), part of the Futures Development Integration Center, Fort Sill, Oklahoma. In his previous assignment, he was the Combat Developer In-Plant Representative to the prime contractor for Crusader, United Defense Limited Partnership, Minneapolis, Minnesota. Among other assignments, he served as Commander of Service Battery in the 1st Battalion, 82d Field Artillery, 1st Cavalry Division, Fort Hood, Texas; Division Assistant Fire Support Coordinator, also in the 1st Cavalry Division; and Platoon Leader in 5th Battalion, 17th Field Artillery, 210th Field Artillery Brigade, VIII Corps, Germany. He also has served as a Test Officer for the US Army Operational Test Command at Fort Hood.