

Field Artillery

A Professional Bulletin for Redlegs

September-October 2001

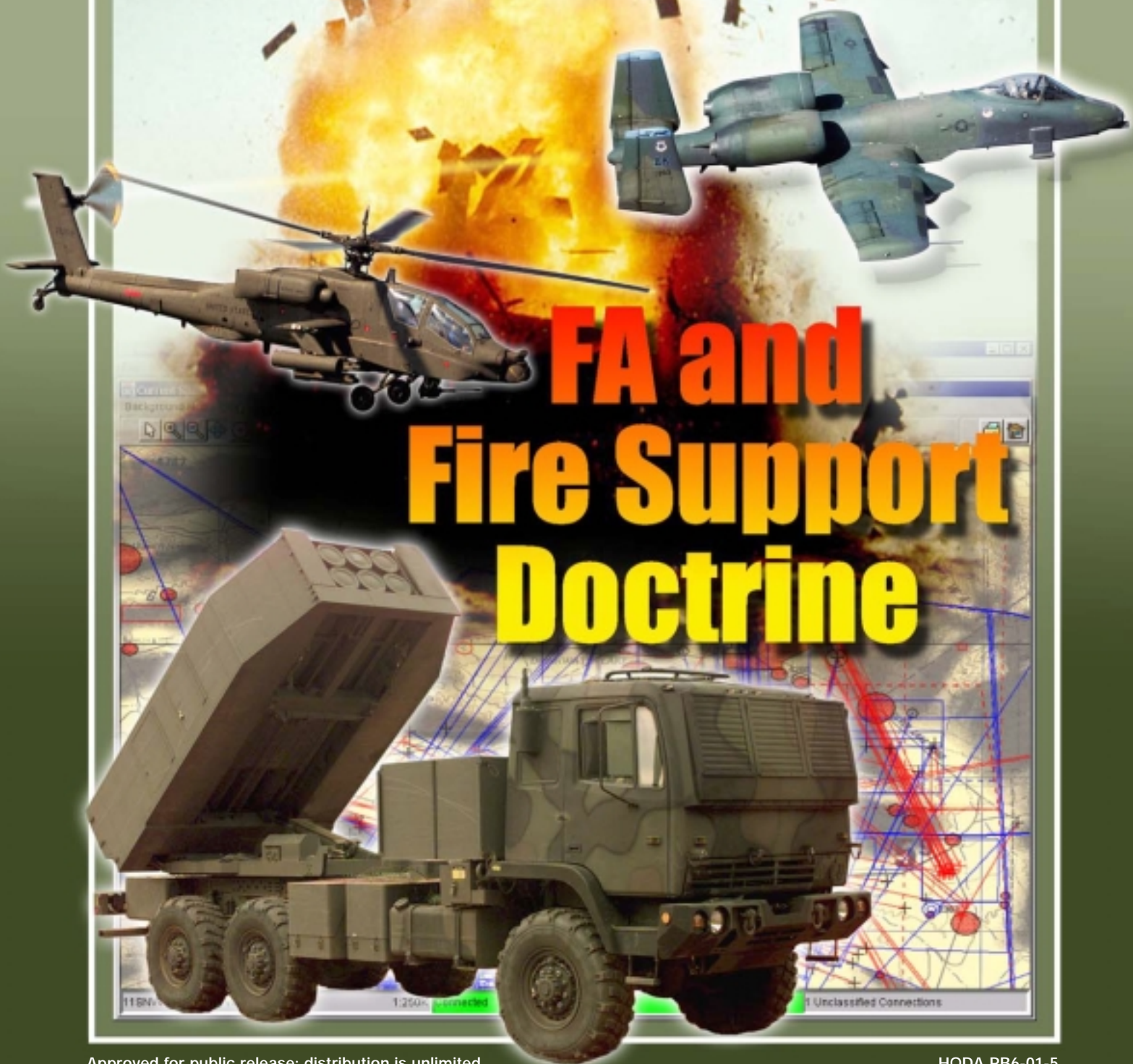

Field Artillery

A Professional Bulletin for Redlegs

September-October 2001

HQDA PB6-01-5

INTERVIEWS

- 5 Accurate, Responsive Enemy-Focused Fires**
An Interview with Lieutenant General Leon J. LaPorte, Commanding General of III Corps and Fort Hood, Texas
- 8 XVIII Airborne Corps Fires: Fast, Flexible and Effective**
An Interview with Lieutenant General Dan K. McNeill, Commanding General of the XVIII Airborne Corps and Fort Bragg, North Carolina

ARTICLES: FA and Fire Support Doctrine

- 11 MAGTF Fires XXI**
By Major Brian D. Kerl, USMC, and Major Thomas O. Mayberry, USMC
- 15 V Corps FECC**
By Lieutenant Colonel Roy E. Perkins
- 21 Fighting With and Against Fires: The Transformation Continues**
By Colonel Kenneth W. Hunzeker and Lieutenant Colonel Dominic D. Swayne
- 25 CAS Battle Drill**
By Major David G. Smith, USAF, and Major Jonathan E. Bachman, USAF
- 29 Task Force Fire Support Evolution: FIST Employment Concepts**
By Captain R. Reed Anderson
- 32 Advice to Field Artillerymen: Making Fires Key to Objective Force Success**
By Lieutenant General William J. Lennox, Jr.
- 36 Joint Targeting Doctrine**
By Lieutenant Colonel Thomas J. Murphy and Lieutenant Colonel (Retired) Bernd L. Ingram
- 39 From the Gun Line 2002 Author's Guide**
- 40 Doctrine for Fire Support: What Comes After AirLand Battle?**
By Lieutenant Colonel Peter J. Zielinski
- 43 The MEF's Force Artillery**
By Chief Warrant Officer Three Quint D. Avenetti, USMC

DEPARTMENTS

- 1 THE UPDATE POINT**
- 2 FROM THE GUN LINE**
- 3 INCOMING**
- 34 REDLEG REVIEW**

DISCLAIMER: *Field Artillery*—is published bimonthly by Headquarters, Department of the Army, under the auspices of the US Army Field Artillery School (Building 758), Fort Sill, OK. The views expressed are those of the authors, not the Department of Defense or its elements. *Field Artillery's* content doesn't necessarily reflect the US Army's position and doesn't supersede information in other official Army publications. Use of news items constitutes neither affirmation of their accuracy nor product endorsements.

PURPOSE: (as stated in the first *Field Artillery Journal* in 1911): *To publish a journal for disseminating professional knowledge and furnishing information as to the Field Artillery's progress, development and best use in campaign; to cultivate, with the other arms, a common understanding of the power and limitations of each; to foster a feeling of interdependence among the different arms and of hearty cooperation by all; and to promote understanding between the regular and militia forces by a closer bond; all of which objects are worthy and contribute to the good of our country.*

OFFICIAL DISTRIBUTION: Distribution (free) is to US Army and Marine Corps Active and Reserve Components FA units: seven copies to corps artillery, division artillery and brigade headquarters; 13 to battalions; and seven to separate batteries. In addition, readiness groups, recruiting commands, state adjutant generals, Army and Marine Corps libraries and schools, liaison officers and other Department of Defense agencies working with FA or fire support issues or material may request a free copy by writing to the Editor (see "Submissions").

PAID SUBSCRIPTIONS: May be obtained through the US Field Artillery Association, P.O. Box 33027, Fort Sill, OK 73503-0027 or usfaa@sirinet.net. Telephone numbers are (580) 355-4677 or FAX (580) 355-8745 (no DSN). Dues are \$20 per year (\$38 for two years and \$56 for three years) to US and APO addresses. The international rate is \$55 for a one-year subscription.

SUBMISSIONS: Mail to Editor, *Field Artillery*, P.O. Box 33311, Fort Sill, OK 73503-0311. Telephone numbers are DSN 639-5121/6806 or commercial (580) 442-5121/6806 or FAX 7773 with DSN or commercial prefixes. Email is famag@sill.army.mil. Material is subject to edit by the *Field Artillery* staff; footnotes and bibliographies may be deleted due to space.

REPRINTS: *Field Artillery* is pleased to grant permission to reprint articles. Please credit the author and *Field Artillery*.

ADDRESS CHANGES: *Field Artillery* (ISSN 0899-2525) (USPS 309-010) is published bimonthly. Periodicals postage is paid by the Department of the Army at Lawton, OK 73501 and an additional mailing post office. POSTMASTER: send address changes to *Field Artillery*, P.O. Box 33311, Fort Sill, OK 73503-0311.

Redleg Hotline

(Organization, Material, Doctrine and Training)
DSN 639-4020 or (580) 442-4020 (24-Hours)

Tactical Software Hotline

DSN 639-5607 or (580) 442-5607 (24-Hours)

Field Artillery Home Page

sill-www.army.mil/famag

FA Branch at PERSCOM

www.perscom.army.mil/opmd/fasitrep.htm
www.perscom.army.mil/epfa/fa_ltr.htm

By Order of the Secretary of the Army:

Eric K. Shinseki
General, United States Army
Chief of Staff

Official:

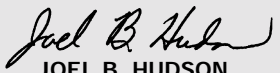
JOEL B. HUDSON

Administrative Assistant to the Secretary of the Army, 0120714

Michael D. Maples
Major General, United States Army
Field Artillery School Commandant

Editor:
Patricia Slayden Hollis

Assistant Editor:
Donnis D. Blount

Art Director:
Bob T. Coleman

Strategy for the Future

It is my great privilege to assume responsibilities as the Chief of Field Artillery for our Army and follow many distinguished Chiefs who so ably have led the Field Artillery. I realize the importance of sustaining the proud traditions of our branch and ensuring Field Artillerymen are trained to succeed in their units, are ready to deploy and win decisively, have modernized weapons and fire support systems, and have new concepts and capabilities to enable fires and effects as key components of our transformed Army.

The Field Artillery has a tremendous history. Its legacy to the nation and Army in conflict is remarkable. The nation and our fellow soldiers have relied on our gunners' competencies and our weapons' capabilities to deliver decisive effects throughout the Army's history. Those combat-experienced soldiers who know firsthand the devastating physical and psychological effects achieved with fires realize the tactical and operational advantage that our firepower provides. They are among the Field Artillery's greatest advocates.

The Challenges. But the FA's historical accomplishments are insufficient to persuade many of our continued responsiveness and relevance. This is particularly true in our current training and operational environments—largely the Combat Training Centers (CTCs) for high-intensity conflict training and small-scale contingencies (SSCs) for engagements. Equally significant is the view that we are too focused on the *process* of delivering fires rather than on the *effects* our fires must deliver.

I agree with my predecessor Major General Toney Stricklin who wrote in his final column, "We, the branch, as well as the Army as a whole do have a problem providing responsive and accurate close supporting fires" ("Field Artillery Relevant, Trained and Ready...Two Years Later," July-August). He laid out a strategy for improving home-station training, conducting quality training for our observers, restricting the execution of unobserved fires,

establishing true sensor-to-shooter linkages and better digital fires, achieving better effects replication, enhancing our simulations and decentralizing execution.

This strategy addresses concerns of our Army's senior maneuver commanders who frequently cite problems with lack of precision in target location, lack of sensor-to-shooter linkages, too many intervention points in the advanced FA tactical data system (AFATDS), lack of integrated combined arms training at home station, the production of products rather than results and inadequate replication of indirect fire effects during training. It is imperative that we, the current FA leaders, develop and implement solutions to train our soldiers and produce results in our training centers and warfighting exercises.

My Commitment. *FM 1 The Army*, published this summer, establishes the Army's doctrine for employing land power in support of our National Military Strategy. It establishes the core competencies of our Army, including being capable of "sustained land dominance." Our doctrine states, "The Army is capable of attacking an enemy directly or indirectly with lethal and non-lethal means through the synergistic application of precision fires and maneuver...the goal of future operations will be to simultaneously attack critical targets throughout the area of operations by rapid maneuver and precision fires."

The Field Artillery is now and will continue to be an integral part of that nonnegotiable contract with the American people to fight and win our nation's wars.

Our Army has embarked on a process of transformation in which the Field Artillery must participate. This does not mean we'll disregard our tremendous legacy or competencies that in the past enabled us to be an integral part of the combined arms team. It does mean we must seek new technologies to enable tactical standoff and massing of effects and new capabilities and operating meth-

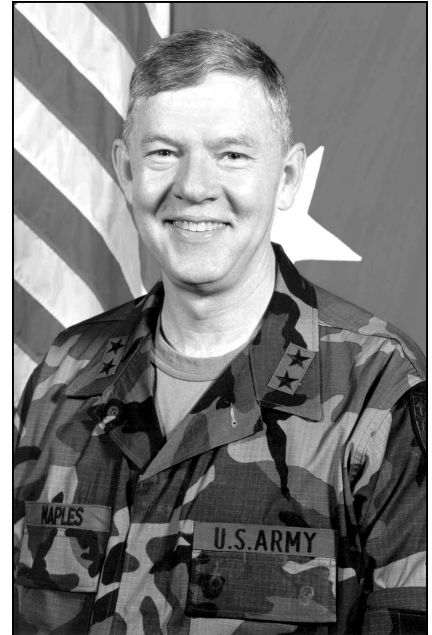

odologies to enhance the quality and precision of our fires.

The qualities sought in the Objective Force are those that always have described the Field Artillery: lethal, agile, survivable and versatile—but we must again prove our responsiveness and develop both deployability and sustainability through increased precision and bold innovation—qualities that will be critical on the future battlefield.

We must attract, train, retain and grow adaptive leaders; continue to provide our operating forces competent deployable soldiers, maintain full partnership with our Reserve Component Field Artillerymen; enhance our training methodologies, devices and simulations significantly; and advance our proficiencies in joint fire support. It is imperative we operate seamlessly as an integral part of the combined arms team.

Our challenge is to prove the relevance of our branch by demonstrating our abilities to provide our maneuver brethren timely, accurate fires; simultaneously we must take advantage of the opportunity to shape the composition and capabilities of the Field Artillery in the Objective Force by transforming fires.

I look forward to serving with you as we take this branch forward. *Cedat Fortuna Peritis*—Let Fortune Yield to Experience. Skill is better than luck.



Stay Focused on the Basics

Command Sergeant Major Rodney L. Beck
CSM of the Field Artillery

The soldiers of the Army are leaning forward in their foxholes, taking aim at the changes in the Army—changes such as controlled access onto Army installations, new technologies and, for some, fewer personnel. That means some of you are working through change while doing the same job with fewer people. In this time of change, I ask that we remain positive and stay focused on the mission.

Now is the time to focus on basic soldiering skills. You must know, *cold*, the proper wear of the uniform, drill and ceremonies, manual gunnery, gunnery theory or solution (learn them again, if you've forgotten), procedures on the gun line...and the list goes on. As soldiers in the Army, when we are directed to change our way of life, we must snap sharp, proper salutes; practice all military courtesy; and be in the proper uniform looking smart.

Now, I'm not saying we don't do these well already. But what I am saying is that when challenging times come—and we have had some challenges and will see some more—too often the basics slip. Important things like standards slip.

I mentioned manual gunnery and understanding the gunnery solution and theory as a basic. When I came into the Army, manual gunnery was the primary means of computing and determining firing data for the cannon artillery in the fire direction centers (FDCs). Yes, times have changed, and we have to be flexible. We have the advanced Field Artillery tactical data system (AFATDS). Its new software will compute the firing data. But a well-trained NCO understands the basics of gunnery—understands his trade.

The knowledge of basic skills also pertains to the Cannoneers on the howitzers. They need to know how to lay the howitzer without the help of a ground positioning system. The same basic knowledge applies to the forward observers. They need to know how to



accurately identify targets and send an accurate location of the target without using computerized equipment.

New technologies, the computers, are fast, convenient and reliable pieces of equipment, and we all must know how to operate them to take advantage of their capabilities and speed. Such luxuries are great to have, but they have the tendency to cause the human to stop practicing and understanding the basics. And, some day, God forbid, you or the soldiers you trained may need those basic skills to accomplish a critical combat mission in degraded operations.

The basics for the NCO have never changed. The NCO trains and takes care of soldiers *every* day. Training and caring for soldiers is a part of continually enforcing the basic standards. Enforcing the standards could be something as simple as making on-the-spot corrections in the wear of the Army uniform or as difficult as ensuring the gun crews can fire their howitzers to time and accuracy standards as they go into a combat zone to fight a powerful adversary.

You and your soldiers must *know* your trade. You won't have time to hook up a computer, get on the Internet and find

out how to give first aid, and you won't be able to pick up your cell phone to call someone to find out what to do next. When the time comes, you and your soldiers already must know first aid and what to do next.

There is no excuse for not training to the standard. Never just train to the amount of time allotted for training—train to standard. I agree with and fully support the article written by CSM Thomas J. Donohue, 1st Infantry Division (Mechanized) Artillery, Germany, in his May-June 2001 article, "Are You on the Train or Still on the Platform?" He wrote, "We must train soldiers using hands-on repetitive, realistic training until they meet the standard."

We must practice what the Army Chief of Staff stated, "Ensure that our soldiers are physically and mentally prepared to dominate the next battlefield—that no soldier goes into harm's way untrained." Yes, he means training in the new technologies, but he also means being mentally and physically prepared. For example, soldiers must be prepared to compute the gunnery solution or conduct land navigation when computers fail or vehicles break down.

Training in all aspects, to include the basics, is the *duty* of the noncommissioned officer. *Fire Support, King of Battle, Field Artillery!*

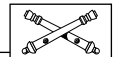

Command Sergeant Major Rodney L. Beck became the CSM of the Field Artillery in May 2001. His previous position was as the CSM of the 10th Mountain Division (Light Infantry) Artillery at Fort Drum, New York. He has served in every combat leadership position from Section Chief of a Field Artillery Battery Fire Direction Center to Command Sergeant Major. He served as a Battery Nuclear, Biological and Chemical NCO, Drill Sergeant, Gunnery Instructor, Field Artillery Battalion Operations NCO, Operations Sergeant for the Commander-in-Chief of Europe Airborne Command Post and has more than six years as a First Sergeant and two and one-half years as a Battalion CSM. He is a certified Computer Repair Technician.

Response to Major General Stricklin's Farewell Article

I enjoyed [Chief of Field Artillery] Major Toney Stricklin's article ["Field Artillery—Relevant, Trained and Ready—Two Years Later," July-August] as he reflects on a long career as an artilleryman and offers us a "status of the Field Artillery." However, I was dismayed by his statement about the condition of our delivery systems.

He said on Page 3: "Our medium and light towed systems are worn out... Only one is capable of supporting offensive operations—the M119...but it is mechanically unreliable. Paladin and the M198...are cumbersome, labor intensive and unable to support fast-moving, offensive-oriented maneuver operations."

If this is true, we need replacement systems as soon as possible. The problem is the long delay before any of these systems are replaced. For example, the M198 will not be replaced until FY06 at the earliest [by the lightweight 155-mm

howitzer], Paladin in FY08 [by Crusader] and the M119 FY14 [assuming there will be a fire support variant of the future combat system, or FCS]. This means that for the next six to eight years or even longer, Field Artilleryman must train and go to war, if necessary, with systems that are "worn out, mechanically unreliable and unable to support offensive maneuver operations." Knowing this, if I were a young soldier or prospective Field Artilleryman, I might chose a different combat arm.

My point is, the systems we have are still the best in the world, and with good support, training and the dedication of the individual crewmen and their leaders, all these systems will serve the artillery well.

Since World War II, we have maintained a high state of readiness and also participated in several conflicts with seemingly old, worn-out systems. I com-

manded a battery of World War II vintage howitzers in both Germany and Vietnam, and they never failed to do the job.

Another chapter in this story can be written about why it is taking so long to field new systems. The lightweight 155-mm howitzer (LW 155) and Crusader have been under development for many years, and both have experienced major delays. Crusader's problems are all not just because the transformation of the Army required a major reduction in weight. The LW 155 has been delayed about three years, and with the major weight reduction achieved with the extensive use of titanium, many challenges remain related to welding and manufacturing. There is no program started yet to replace the M119.

COL(R) James B. Lincoln, FA
Annandale, VA

45th FA Bde 1st to Field AFATDS

The 45th FA Brigade, Oklahoma Army National Guard (ARNG), is the first ARNG brigade to field the advanced FA tactical data system (AFATDS). AFATDS is replacing the initial fire support automation system (IFSAS) used by FA ARNG units.

The 45th Brigade Headquarters in Enid and its Oklahoma battalions completed the intensive three-week AFATDS Version 99 fielding process at Camp Gruber, Oklahoma, in June. The brigade has two multiple-launch rocket system (MLRS) battalions in Oklahoma—1st

Battalion, 158th Field Artillery in Lawton and 1st Battalion, 171st FA in Altus. The brigade's 2d Battalion, 222d FA, an M109 Paladin unit in Cedar City, Utah, completed its AFATDS fielding in July. The next challenge is for the brigade to conduct routine training to sustain its digital fire support skills.

The fielding of AFATDS to the 45th is not the brigade's only "first." Ten years ago, the brigade was the first ARNG unit to field MLRS.

ILT Scarlet Tyler
Public Affairs Officer
45th FA Brigade, OKARNG



SFC William Wilkins, B/1-158 FA

No Red Book Annual Report in 2001

The 2001 November-December *Field Artillery* will not be a Red Book but a routine magazine with the theme "Transforming the FA." The November-December 2002 edition will be a Red Book annual report as will the November-December editions every other year after that.

Editor

Correction to "TLP for Light Company Fire Support Planning for the Defense"

The figure on Page 35 in the March-April article "TLP for Light Company Fire Support Planning for the Defense" [by Sergeant First Class Jeffrey A.

Mubarak] has an error. The figure limits the registration corrections for mortars to 800-mm short of and 800-mm beyond the registration point. However,

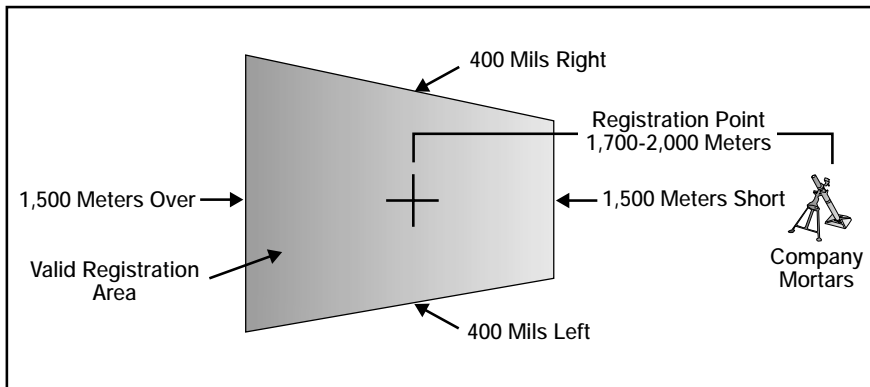

Corrected Figure 3: Targets outside the valid registration area require additional registration points, which adjusts the ammunition requests, tasks for mortars and time line.

Figure 14-4 on Page 14-4 of *FM 23-91 Mortar Gunnery* illustrates that registration corrections may be applied 1500-mm short of and 1500-mm beyond the registration point along the gun-target line. [The figure is shown corrected with this letter.]

The difference is significant and must be understood by fire supporters. It should be noted that the 1500-mm transfer limit is the same regardless of the size of the mortar.

More information about registering mortars can be found in CALL [Center for Army Lessons Learned] Bulletin 99-3 at http://call.army.mil/products/ctc_bull/99-3/chap4.htm. Figure 14-4 of *FM 23-91* can be viewed online <http://www.adtdl.army.mil/cgi-bin/atdl.dll/fm/23-91/ch14.htm#pl>.

SFC Sean Harris, FA
C Battery, 319th AFAR
82d Airborne Div, Fort Bragg, NC

FSO Handbook On Line

Every good fire support officer (FSO) will have a "Smart Book" that includes maximum ranges for various projectile-powder combinations, maximum effective ranges of friendly and enemy direct fire systems, smoke planning factors and other such information to help him do his job. He gathers this information in one location and commits the majority of it to memory for immediate recall. When riding in a truck or walking in total darkness, he won't have time to fumble with his Smart Book and find basic planning data.

Now there is an "FSO Handbook" on line to help the FSO. *ST 6-20-20 FSO Handbook* provides some considerations for the type of material that should be in an FSO's Smart Book. *ST 6-20-20*

was written by the Fire Support Division of the Fire Support and Combined Arms Operations Department of the Field Artillery School, Fort Sill, Oklahoma. The handbook is on line at <http://sill-www.army.mil/faccc/> and is a student text for the Field Artillery Captains Career Course.

The FSO handbook does not replace doctrinal manuals or a unit's standing operating procedures (SOPs). However, it fills a how-to gap. Doctrine does not explain the "how" of the task force FSO's job. *ST 6-20-20* also is not a book of checklists. Finally, this book of tactics, techniques and procedures (TTPs) is not intended as a "how to fight at the Combat Training Centers (CTCs)" handbook.



ST 6-20-20's best use is as a foundation of knowledge for FSOs to draw upon to accomplish their jobs. If a unit does not have a fire support SOP, then the handbook can be used as a basis for establishing that SOP.

Maj Alvin W. Peterson, USMC
Small Group Instructor, FSCAOD
FA School, Fort Sill, OK

Field Artillery Magazines On Line

Copies of previous editions of *Field Artillery* are now on line at the *Field Artillery* Bulletin home page for download: sill-www.army.mil/famag.

If interested, you can go to "Previous Editions" on the home page menu to read specific articles or download entire editions from the July-August 2001 edition back to the December 1987 edition.

The 2000 and 2001 editions are in PDF format. Next to the "Selection" bar is the choice to download free Adobe Acrobat PDF Reader software, as necessary.

The editions 1999 back through 1987 are in zip format. Be prepared to download from 52 to 110 MB per magazine.

Other services on the home page include the current "Author's Guide," with submission information, themes for 2002 and copy deadlines; the "Digital Photo Shooter's Guide"; "2002 Annual History Writing Contest Rules"; subscription information; how to change your address; and links to other military magazine and US Field Artillery Association home pages.

Editor

Lieutenant General Leon J. LaPorte
Commanding General of III Corps, Fort Hood, Texas

Accurate, Responsive Enemy-Focused Fires

Interview by Patrecia Slayden Hollis, Editor

Q Some people have said the Field Artillery is failing to provide responsive, accurate close supporting fires to the CTCs [Combat Training Centers]. Based on your experiences as a brigade, division and now corp commander, what are your thoughts on this? What do the FA and Army need to do to improve our responsiveness and accuracy?

A The process of providing close supporting fires is complex, involving training, leader development, equipment and the commander's intent. Executing fires in the CTC environment is challenging. Precision, timing and focus of fires are critical factors in determining success.

In analyzing ineffective fire missions at the CTCs, many times they are due to a lack of precision in target location. So without an accurate target location, we begin the fires process with faulty information.

We must have better target location equipment in terms of fielding technologies that enable soldiers calling for fires to determine and transmit target grid coordinates accurately and rapidly. We need lightweight, highly mobile target locator-designators for all our observers.

And those soldier-sensors need to transmit the data directly to the shooting battery, sensor to shooter. Our current system is rigid and somewhat cumbersome—AFATDS [advanced FA tactical data system] has too many intervention points that delay fires and make them less responsive. We need to address the issues with AFATDS as we streamline and simplify the sensor-to-shooter process significantly.

We also need to train soldiers to identify and locate targets better. That's a challenge at Fort Polk [Louisiana] be-



cause of the close proximity of the enemy to friendly forces and the fact that the close, complex terrain is sometimes difficult to read. Target location at the National Training Center [NTC, Fort Irwin, California] is difficult because of the vastness of the training area. At the NTC, what appears to be two kilometers away is actually four or five kilometers.

We need to train units in integrated combined arms operations before they get to the CTCs. Synchronizing the maneuver plan and fire support plan is demanding and requires the focus of the commander and his entire staff to make it happen. Most often units work in a compressed time period, and if they are not careful, they can get caught up in the process—caught up in producing products that may or may not be relevant to

the fight. Units have to stay focused on fighting the enemy, not on the *process* of fighting the enemy. At the CTCs, we may have become too process- rather than results-oriented when it comes to fire support. *Effects* on target is the only outcome that matters in war.

In III Corps we have three warfighting rules. First, "Focus on the enemy." Second, "Fight the enemy, not the plan." Third, "See Rule Number One."

Last, we need to improve the replication of indirect fire effects in force-on-force battles at the CTCs. It's easier to replicate direct fire effects than indirect fire effects. We need to explore and develop technologies to truly replicate indirect fires at the CTCs at the level we would see in combat.

Because we do not replicate realistic indirect fire effects at the CTCs, we have defaulted to "negative training"—units fire-for-effect instead of conducting adjust fire missions, which are the "bread and butter" of artillery effectiveness. The time pressure is such that commanders are not following our doctrine. They fire artillery and go on to the next mission rather than shoot a round, adjust the fire in on the target and then fire-for-effect. That's a recipe for ineffective fires. Current simulations reinforce the incorrect notion that all fires will be effective from the first round of impact.

The CTCs give leaders and soldiers a tremendous opportunity to learn at every level repeatedly. We need to make the most of that opportunity in hard, demanding training that replicates combat conditions as closely as possible.

Q As the 1st Cavalry Division commander [Fort Hood], you were the architect of artillery-based maneuver as outlined in your September-October 1996 article "Massing Combat Effects: 1st Cav Fire Support TTP" [tactics, techniques and procedures]. Please briefly explain the concept and why you implemented it in the 1st Cavalry Division. Is artillery-based maneuver still a valid approach and under what circumstances?

A As we went through the military decision-making process in the 1st Cav, we devised artillery-based maneuver as a mechanism to defeat an enemy's center of gravity in a particular area of the world. We developed a scheme of maneuver and fires to keep the enemy from capitalizing on his strengths.

The enemy's center of gravity was his artillery that out ranged our artillery significantly, and the theater of operations had very rugged terrain with a lot of choke points. The many choke points did not allow for rapid maneuver, so our choice was to fight with fires—a combination of cannon- and rocket-delivered fires coupled with close air support and attack helicopters.

We developed TTP to get our artillery closer to the enemy to range him with our systems without allowing him time to maximize his artillery range advantage. Our maneuver forces rapidly seized terrain from which our artillery could range the enemy and quickly brought up FA battalions to occupy that terrain. The artillery then fired and moved out to fire on another piece of terrain maneuver forces had seized. We used maneuver to extend our killing mechanism, which was fires.

Is artillery-based program still valid today? Yes—against a similar enemy in

similar terrain. Would I use that TTP fighting a different enemy in wide open desert terrain? No.

Commanders must focus on the enemy and determine the method of dealing with his capabilities on a given piece of terrain.

Q *Do you envision the IBCT [interim brigade combat team] employing artillery-based maneuver TTP?*

A I can envision several situations in which artillery-based maneuver would be very effective. In these situations, the lightweight, highly mobile IBCT would want to maximize its intelligence-gathering and fire-delivery capabilities without confronting enemy forces in a direct fire fight.

Under other conditions, such as in MOUT [military operations in urban terrain], the TTP would be less applicable. In those situations, the IBCT would want to rely more heavily on its infantry to accomplish the mission.

Q *With the IBCT projected to be deployable in FY03 and the Objective Force transformed as early as FY10, what significant challenges do you see in integrating the IBCT in mechanized forces, as necessary, through about 2020?*

A From the perspective of the Counterattack Corps [III Corps], we need to ensure the legacy forces are interoperable with the transformed forces in terms of training, leader development, doctrine and equipment so we can fight in the same battlespace. As the Army gets new equipment with leap-ahead technologies, it must interface with legacy technology equipment and we must mediate any significant differences in doctrine.

That gets to the importance of Crusader to the Counterattack Corps. We need Crusader for its increased range and firepower to fight future adversaries and serve as a technology carrier for the Objective Force. Crusader brings significant advantages to Army formations—it is agile enough on the battlefield to stay up with maneuver forces, and one battery of Crusaders will give the formation the equivalent fires of an entire battalion of Paladins. Crusader will provide our maneuver forces responsive, accurate close supporting fires, among other missions.

In terms of interoperability, throughout our history, the Army has been a "hybrid" force. We never have had the entire force at the same level of modernization at the same time. For example, just because the 4th Infantry is a digitized division does not mean it can't fight side-by-side with the 1st Cav, which is still an analog force, or fight with a less modernized coalition force.

We still can rely on basic command and control measures, such as maps, boundaries, phase lines, fire support coordination measures, etc., to allow us to fight effectively with forces at different stages of modernization in the next 15 or so years.

Q *Please contrast how corps and divisions are prosecuting the deep fight today with how Force XXI will fight deep with its new digital tools.*

A In so many ways, the digitized 4th Division, with its new technologies and connectivity with joint systems, is more capable than a traditional corps is in getting information on targets and prosecuting the deep fight. In the past, units had some form of deep battle handover of intelligence between the division and corps. Today, the 4th Division's enhanced capabilities allow



After a Fort Hood run, Lieutenant General LaPorte and 17-year-old Private Cheyne Young (A Cannoneer in A/2-82 FA, 1st Cav Division) cut the Army's 226th birthday cake. It is a tradition for the CG to cut the cake with the youngest soldier on Fort Hood.



"Crusader will provide our maneuver forces responsive, accurate close supporting fires, among other missions."

it to attack throughout a typical corps battlespace.

I think in the future we will have more division assets supporting the close fight. The battalion or brigade in the close fight that knows where the friendly and enemy forces are has the distinct advantage and can make the most of its firepower.

The 4th Infantry Division has tremendous capabilities. Its situational awareness has taken it to the next level of situational understanding—that is, understanding the interrelationships of entities in the battlespace. This allows the commander to begin to "see" the enemy's intent and make tactical decisions in terms of fires, both close and deep.

The division also has the technology to allow it to prosecute the close and deep fights simultaneously from one location—which the corps does not. The corps still has the deep operations coordination cell [DOCC] for the deep fight while the tactical command post focuses on the close fight.

In the near term, FBCB² [Force XXI battle command brigade and below] will be one of the most significant digital tools for situational awareness for the Army. [FBCB² is a ruggedized computer mounted on vehicles or in tactical operations centers that provides consistent real-time visualization of friendly forces on a moving map display.]

During DCX I [Division Capstone Exercise I for the digitized 4th Division at the NTC], FBCB² proved its worth. As the brigade fought major battles at night over extended distances—50 to 60 kilometers—while countering flank threats, the FBCB² helped provide the commander the situational awareness that allowed him to make effective tactical decisions.

When a commander can look at a digital map on the computer display and see every vehicle in his brigade to 10-digit grid resolution, that's significant. When he can transmit operations overlays with the push of a button instead of making copies and having LNOs [liaison offic-

ers] drive throughout the battlespace delivering those products hours later, that's significant.

Systems such as FBCB² are allowing commanders and their staffs the freedom to focus on warfighting versus mundane tasks to make the intelligence, command and control, communications and fires processes work.

Q *As the new information and high-technology systems become fielded, what do you see as the most significant training and leadership challenges the mechanized forces face?*

A We face training and leadership challenges at different levels. At the individual level, we must train the soldier to operate the new equipment, but with the added challenge of ensuring he fully understands how his digital device interfaces with other ATCCS [Army tactical command and control system] systems—for example, how the intelligence BOS' [battlefield operating system's] ASAS [all-source analysis system] operates with the artillery BOS' AFATDS. In the past, that level of understanding was required of battle captains and field grade officers. But our young leaders will have to integrate ATCCS systems' information and display it—an entirely new challenge.

The commander of a digital unit will have to focus on his CCIR [commander's critical information requirements]. He will have access to a tremendous amount of information and must define the critical information he and his staff need.

One challenge is to train the commander how not to be overwhelmed with the volume of information he will have coming at him and how to determine the information he needs to accomplish his intent selectively and precisely and then access it. He will have to coach his staff on how to extract the information he needs out of the ATCCS systems and then display it so he can make good tactical decisions. He will need "thinking" staffers to support him.

It all goes back to integrating all the BOS on the battlefield. Integration is tough to train. It requires experience and an understanding of the interrelationships between systems and entities in battlespace.

In the next 20 years, I believe the principles of war will remain constant—integrated combined arms warfare still will be key. Every element of the force will have requirements it must fulfill for the force to be successful.

The essence of warfare might change slightly to emphasize information operations and combat in complex terrain, such as in MOU. But we still are going to have to train our officers, NCOs and soldiers to be combined arms warriors.

Q *What message would you like to send Army and Marine Field Artilleryman stationed around the world?*

A As the King of Battle, continue to focus on the basics, those building blocks that allow you to deliver responsive, effective fires. Massing the effects of all fires on the enemy is still the primary focus of the artilleryman.

Those of us who have been in combat and have endured mortar and artillery attacks understand how truly devastating indirect fires can be—not only their physical destruction, but equally their emotional and mental effects.

As a Cavalryman—and Cavalrymen are true combined arms warriors—I understand how critical indirect fires are to the fight.



Lieutenant General Leon J. LaPorte commanded III Corps at Fort Hood, Texas, at the time of this interview. He currently is the Deputy Commanding General and Chief of Staff of Forces Command headquartered at Fort McPherson, Georgia. He also served as Assistant Deputy Chief of Staff for Operations and Plans at the Pentagon. In other tours at Fort Hood with the 1st Cavalry Division, he commanded the division; commanded the 3d *Greywolf* Brigade; was the division G3; and in the Gulf during Operations Desert Shield and Storm, was the Chief of Staff of the 1st Cavalry Division. General LaPorte commanded the National Training Center, Fort Irwin, California. He is a Vietnam veteran and holds a Master of Science in Administration from the University of California.

Lieutenant General Dan K. McNeill
 Commanding General of the XVIII Airborne Corps and Fort Bragg, North Carolina

XVIII Airborne Corps Fires: Fast, Flexible and Effective

Interview by Patrecia Slayden Hollis

Q *Although lightfighters tend to do a good job of training close supporting fires integrated with maneuver at home station, they sometimes experience challenges with responsiveness and accuracy at the CTCs [Combat Training Centers]. Based on your experiences as a brigade, division and now a corps commander, what are your thoughts on these challenges? What do the Army and FA need to do to improve our responsiveness and accuracy?*

A The context of my responses to your questions will be based on what I know best in the artillery—that is the artillery of the units of the XVIII Airborne Corps. We are a multi-component, mixed-caliber and varied propulsion artillery force in this Corps. And while the XVIII Airborne Corps is often mistakenly called a lightfighter formation, we are anything but lightfighters.

If you use the analogy of prizefighting, the XVIII Airborne Corps would qualify at least as a middleweight force. With the M109A6 Paladins of the 3d Infantry Division (Mechanized) [Fort Stewart, Georgia] and the launchers of both the 3d Division and the Corps Artillery MLRS [multiple-launch rocket system] battalions, we have the reach to “hang in there” with the heavyweights. Nevertheless, the preponderance of the 303 tubes and launchers belonging to the XVIII Airborne Corps are towed pieces—three of the four divisions of this Corps are dependent on towed 105-mm howitzers for DS [direct support] artillery. Most of my comments in this interview will be oriented toward those towed artillery pieces.

We are not doing as well as we ought to do at melding fires with maneuver and the other BOS [battlefield operating systems] to achieve synergy—and



that includes during home-station training. We all profess to be doing the greatest home-station training, but, somehow, it doesn't always result in responsive, effective fires at the CTCs.

First, I want to make clear that the lash up between fires and maneuver is not all “broken.” Performance varies from unit to unit rotating through our CTCs. We do well in the deep fight, as we measure it in simulations. Our challenge is to consistently integrate fires and maneuver in the close fight to gain that synergy that's decisive.

I certainly don't take issue with our professional education system or the qualifications of those coming out of Fort Sill, from the junior NCOs to the senior commanders. As a matter of fact, the Field Artillery NCOs in the XVIII Airborne Corps, which I consider a microcosm of the entire Army, are the finest I've seen in my 32-plus years in the Army.

The Corps FSCOORDs [fire support coordinators] and FSOs [fire support officers] know how to advise their commanders and remain within arm's length from them during combat training. We have extraordinary training and certification programs for our gun crews and the big three: the battery XO [executive officer], chief of smoke and FDO [fire direction officer]. We have the right doctrine and TTP [tactics, techniques and procedures]. But, somehow, our firing units can't consistently move, shoot and communicate and go “tit for tat” with the maneuver units they support.

So the question is, “Why?” But, I'm not sure I know why. Fully integrated and effective fires is simple in theory but complex in execution. And it is not just a challenge for the Field Artillery, but for the entire Army as well.

For example, the Army needs to do a better job of replicating indirect fires at our CTCs. We do a better job of replicating these effects at the JRTC [Joint Readiness Training Center, Fort Polk, Louisiana] than at the NTC [National Training Center, Fort Irwin, California], but MILES [multiple integrated laser engagement system] does not create the effects we realistically can expect under live-fire conditions.

We need a computerized instrumentation system that automatically creates casualties down to the individual vehicle and soldier level in near real-time. Our antiquated MILES and fire marking systems—with delays that range from three to eight minutes—does not allow for realistic effects and can result in “negative” training.

One part of the responsiveness challenge is our inability to locate the target accurately and pass the information rapidly to the fire support asset for attack—

not just our observers, but anyone who might call-for-fires. We need to shorten the sensor-to-shooter link.

I'm not sure we're taking advantage of new technology that could improve responsiveness. I see Palm Pilots and hand-held computers on the market that have tremendous capabilities. We could use such capabilities to locate a target accurately and send call-for-fire data through the clearance of fire process to the guns in near real-time. The soldier the longest distance away could "point and click" the small device at a target and, using GPS [global positioning system]-type capabilities, could accurately locate the target and, with the push of a button, pass the targeting data to a fire support asset for precision attack in a nano second—even use the device to laser the target for attack, as necessary.

Such a device would give our fire support system a quantum leap forward, affecting the training of the crews, the lash up of doctrine and TTP—just about every aspect of fire support. This digital target locator/rangefinder/laser device would be the stepping off point for greater technology in the future.

I believe the technology is already out there and will only improve in the next few years.

I also believe every caliber indirect fire weapons system should have precision munitions: mortars, 155s, 105s, missiles and rockets. The technology is available, and we must be willing to expend the resources to develop precision munitions.

And, our indirect fire systems must weigh less. For example, it now takes 10 strong men to manhandle an M198 on the battlefield. Today, we can lighten our howitzers—it might mean, say, the tube has a shorter life span before it needs to be overhauled or replaced, but it would be worth it. We can use composite materials to lighten the base plate, trails and frame of the howitzers.

The logical follow on is that artillery rounds must retain maximum lethality yet weigh less. And our rounds need to shoot farther. When a main battle tank can direct fire nearly as far as some of our mortars and low-end howitzer munitions, then something is wrong with "this picture."

As the XVIII Airborne Corps Commander, I don't care what caliber of howitzer our Field Artillerymen have,

as long as it is lethal, the lightest practical weight and agile—can be deployed by C-130 or equivalent, air-lifted by Black Hawk helicopter and easily manhandled on the battlefield and can fire light, versatile munitions, including precision munitions. If we go to one towed howitzer and it is a 155-mm howitzer—fine, as long as the new 155 and its munitions come in at the cube and weight to do the job for the dismounted formations.

To ensure our fires are flexible and fast in the near term, we need to secure funding for the TAD [towed artillery digital system] for the M119 howitzer that will allow the howitzer to self-lay. We experimented with two M119s with TAD during the JCF-AWE [Joint Contingency Force-Advanced Warfighting Experiment] at the JRTC last September, and it improved the gun line's speed and accuracy dramatically.

In terms of fire support processes, I have one caution: fire supporters must not become so involved in their FA battalion commander's intent and tasks that they lose track of what drives fire support—the brigade commander's intent. They must not become a separate team within a team.

Q *In the XVIII Airborne Corps' most recent BCTP [Battle Command Training Program] Warfighter exercise, the Corps won. To what do you attribute your victory?*

A We had a successful training event in our recent Warfighter. Lots of actions contributed to our success, but probably two of the most significant are our abilities to focus our assets on achieving specific objectives and to visualize the battlefield and share one common picture to make decisions.

Early on, we decided the enemy's center of gravity was his long-range artillery. So we established his artillery as our priority target and first objective. Our DOCC [deep operations coordination cell] then focused a lot of battlefield functions to kill those targets. We focused all our sensors on finding the enemy artillery and continued to track the targets until we could attack them. We focused all shooters—the artillery, attack helicopters, Air Force and Navy aircraft, the ATO [air tasking order] cycle, the kill boxes—everything—on killing the priority targets to achieve our objective.

Once we achieved an objective, we shifted to systematically track and kill the enemy's maneuver or engineer assets—other corps objectives. For example, we didn't divide up the sensors and give one division a couple of hours of a UAV [unmanned aerial vehicle] if we needed the UAV to look for a corps target array. During the offensive phase, we would allow the divisions to have more CAS [close air support], but during the defensive phase, we would mass all the CAS we needed to achieve an objective. We did not deviate from our focus.

At the corps—the joint task force level—it is a very involved process, and at least part of our success was due to the DOCC's ability to fuse joint BOS functions and integrate the deep fight. The corps, more so than its divisions, is going to be in the business of deep operations. We had to take the DOCC, our deep operations fusion center, "out of hide," which was painful—everyone in the DOCC had another full-time job. So we need to resource the DOCC. The DOCC gives the corps near real-time sensing and the ability to rapidly order or reorder sensors and shooters to achieve objectives.

As part of the JCF-AWE last year, we gained software called Information Work Station. [IWS is a collaborative planning tool that assists in parallel staff planning (horizontal and vertical), allowing the real-time sharing of infor-



Lieutenant General McNeill observes troop training at Fort Stewart, Georgia.

PV2 Katherine Robinson, Fort Stewart, GA

mation via slides/briefings, message boards and conference calls.] We applied this remarkable software to command and control the Corps in this Warfighter exercise.

This software allowed commanders to see the same updates on the display screens of the computers and hear the same audio through little headsets in their CPs [command posts] at different locations—at the Corps, Corps Artillery, divisions, wherever. Now, granted, all the CPs were positioned to accommodate the BCTP simulations, so on an actual battlefield with greater distances between the CPs, command and control with this software would be more difficult.

During the exercise, we all could sit in our CPs and see the same B-52 strikes down the same corridor on our displays. We could send Predator to a NAI [named area of interest] and watch the UAV feeds. We could watch the JSTARS [joint surveillance and target attack radar system], the graphics in AFATDS [advanced fire support tactical data system] Fire Support Client software and other feeds.

With Fire Support Client, we could see the blue vectors of the gun-target lines of the enemy artillery firing as acquired by the Firefinder radar focused in on NAIs. We had a visual of where the enemy was firing and could begin to see what he was trying to do.

With this kind of information, you can become active vice reactive. For example, every night before our aviation deep strikes, we determined where the enemy would be and the best areas in which to engage him. Right before we launched the aircraft, we got last minute intelligence updates for electronic signatures of where the enemy's air defenses were, suppressed the air defenses and launched the aircraft through selected air corridors.

We used the corridors very efficiently. For example, we coordinated an air corridor with a division in its deep attack and used one SEAD [suppression of enemy air defenses] package. The We used nonlethal jamming SEAD, and the Corps piggybacked on the division's corridor with the aircraft divided by time and space.

We used all these sources of near real-time information to strike the enemy before he struck us. As we all looked at

the same screen on our individual displays, I could point my arrow at something and say, "What's going on here?" and get feedback from my commanders in real time.

We had a picture of the battlefield. We knew the terrain and had analyzed the enemy's courses of actions—had a decision matrix. So we could track and monitor the enemy and then extrapolate his intent.

We read the enemy and projected that he would be on "such and such" terrain under "such and such" conditions at "such and such" time—projected his tactical disposition in the future. We then repositioned assets to kill the projected target array, but not without accepting some risks.

At one point, we took MLRS and some tubes away from the divisions, their GSR [general support reinforcing] artillery, at a time when the divisions needed their artillery—had a pretty good fight going. Then we moved the systems forward to mass on the enemy in anticipation of where the enemy was going to be.

We even considered taking some of the divisions' DS artillery and sending it forward. But my division commanders, who already had fought the loss of their other artillery, fought even harder to retain their DS artillery—just exactly what I would have done when I was the 82d Airborne Division commander.

It was a calculated risk. We "jerry-rigged" a number of battlefield functions and reordered and rearranged some of our military intelligence assets to focus in on where we extrapolated from our battlefield information that we needed to focus. Then we sent shooters forward to kill the enemy in a future location.

Now, would I take away my divisions' artillery during battle as a routine matter of course? No. I owe it to the divisions to give them the resources to fight. But an opportunity presented itself at one point in time, and I took the chance. It worked.

Q *What role do you see the air assault and airborne forces playing in the Objective Force?*

A Clearly our air assault and airborne divisions will be part of the legacy force. But I also believe they have roles to play in the Objective Force.

The value of the vertical envelopment capabilities they provide is irrefutable. And that vertical envelopment can come in two ways: parachute assault or helicopter assault.

So, as we move down the road toward the Objective Force, in the next year or two, we need to go through the intellectual process of looking at these two unique forces and how they need to change. We need to glean all the information we can from Fort Lewis [Washington], which is leading the transformation process, and export some of their concepts into these divisions to make them more capable, flexible forces for the new operating environment.

I think that in seven or eight years hence, our air assault and airborne divisions will look more like the Objective Force than the legacy force.

Q *What message would you like to send Army and Marine Field Artillerymen stationed around the world?*

A The business you are in is incredibly complex. You battery and company commanders and your first sergeants are carrying a far greater load than I had to carry as a company commander in the late 1970s—and you do it well. Thank you.

The combined arms live-fire exercises we routinely conduct at our installations are invaluable. They allow soldiers to understand the impact of artillery and learn to trust rounds flying over their heads and landing very close. Once in a while, we need to be reminded how awesome live fire is.



Lieutenant General Dan K. McNeill commands the XVIII Airborne Corps and Fort Bragg in North Carolina. He also served as the Chief of Staff and G3 of the XVIII Airborne Corps. He commanded the 82d Airborne Division, Fort Bragg, the same division in which he served as the 3d Brigade Commander, G3 and as a Battalion Commander. He was the Assistant Division Commander for Maneuver of the 2d Infantry Division in Korea. He is a combat veteran of Vietnam and Operations Just Cause in Panama, Desert Shield and Storm in the Gulf and Uphold Democracy in Haiti. Lieutenant General McNeill is a graduate of the Army War College at Carlisle Barracks, Pennsylvania.

The proposed concept of Marine air ground task force (MAGTF) fire support under development at the Marine Corps Combat Development Command (MCCDC), Quantico, Virginia, is based on current, planned and desired capabilities. By design, it is a broad concept that is adaptive to changes in technology, capitalizes on innovation and experimentation, and helps to enhance joint capabilities. The MAGTF fire support concept will enable the Marine Corps to build fire support principles and operational concepts to succeed in future battles out to 2015.

This article describes the MAGTF Fires XXI concept, starting with the overarching expeditionary maneuver warfare (EMW) warfighting strategy under which it falls, and developments in progress to make the fires concept a reality.

Expeditionary Maneuver Warfare. EMW is the Marine Corps' capstone concept that focuses on the arrange-

ment of air, land, sea and information into a seamless battlespace for action across the full range of military operations. Unlike traditional operations, EMW focuses on maximizing the effects of specific actions, rather than on merely destroying an adversary's military forces.

Exploiting the advantage gained through the application of maneuver warfare principles requires Marines to have an unprecedented understanding of the situation, specific mission, desired end state and the effects necessary to achieve that end state. This requires a fire support package tailored for force projection to be as lean as possible yet retain the firepower to dominate an enemy force, allowing freedom of action for its own maneuver elements.

Fires for future MAGTF will be characterized by enhancements in strategic agility, operational reach and tactical flexibility.

Strategic Agility. Supporting arms systems must be ready to deploy to a

theater of operations through any combination of lift (sea, air or land) and be prepared to employ immediately without an "operational pause."

Operational Reach. Fires employed by the MAGTF will support Marine forces from expeditionary bases to objectives within a theater of operations. Coordinated sets of effects enabled through expanded information operations (IO) and produced by all-weather, combined arms expeditionary fires will require the force to employ a single, integrated command, control, communications, computers, intelligence, surveillance and reconnaissance (C⁴ISR) capability. All systems will be linked by a flexible command and control (C²) architecture capable of supporting naval surface fire support (NSFS), Marine air and surface fire support as part of joint, multinational and interagency operations.

Tactical Flexibility. MAGTF fire support systems must be able to adapt to rapidly changing circumstances and support the force with its ability to sequence rapidly from one mission to another without needing to reorganize, re-equip or retrain. All available facets of fire support (air- ground- and sea-based) must be able to support an overwhelming tempo of operations.

Effects-Focused Fires. Marine Corps warfighting is effects-focused operations. These operations center on the notion that all actions undertaken by a joint task force (JTF) are linked to the commander's guidance and desired end state. Effects are the means to achieve that end state. Therefore, within the

MAGTF Fires XXI

By Major Brian D. Kerl, USMC, and
Major Thomas O. Mayberry, USMC



LW 155 Howitzer

arena of fires, we can define the ends (purpose) in the following categories: disrupt, limit, delay and divert. Similarly, the means (how) can be categorized as destroy, neutralize, suppress and react (see the figure).

Effects-focused targeting synchronizes all lethal and nonlethal “fires” at the decisive time and place to achieve the commander’s intent. The integrated use of informational activities and fires, both lethal and nonlethal, to achieve a common purpose is essential. We recognize that the targeting means is secondary to achieving the desired targeting effects as targets no longer reside strictly in the physical domain but include the perceptions, actions and reactions of civilians, military leaders and military forces.

The MAGTF supports achieving the JTF commander’s end state through the application of effects enabled by information superiority. The full range of effects can set conditions for success and crisis termination. For example, the focus of joint fires, although lethal in nature, frequently is to create psychological shock, breaking an enemy’s confidence, creating apprehension and confusion, shattering cohesion and causing him to react from a position of disadvantage or quit.

Accurately assessing the operational effects of MAGTF fires requires the early integration of intelligence and operational planning. We can measure physical effects through traditional observation. However, measuring psychological effects is more difficult and requires closely integrated intelligence methods, such as human intelligence (HUMINT), signal intelligence (SIGINT), counterintelligence (CI), enemy prisoners of war (EPW) reports, etc.

MAGTF Fire Support Development. Lethal MAGTF fire support must retain the strengths of its current design and leverage new technologies to enhance its continuous availability; responsiveness; sufficiency in numbers and volume; ability to provide shaping fires; ability to acquire, track and identify targets; expeditionary nature; joint interoperability; and mutual support-ability and survivability.

Continuously Available. Sufficient, accurate, proportional fires must be available in all weather conditions and in periods of reduced visibility. This fire support capability must be prepared for immediate employment without operational pause.

Ends (Purpose)

Disrupt—Fires to preclude the interaction or cohesion of enemy combat and combat support systems.

Limit—Fires to reduce the options or courses-of-action (COAs) available to the enemy commander.

Delay—Fires to alter the time of arrival of forces at a point on the battlefield or the ability of the enemy to project combat power from a point on the battlefield.

Divert—Fires delivered as an interdiction objective to tie up critical enemy resources.

Means (How)

Destroy—Fires to destroy the target’s combat effectiveness. A unit, weapon system or other battlefield operating system (BOS) is destroyed when it can’t accomplish its combat mission until reorganized, regrouped or replaced.

Neutralize—Fires to render a target temporarily ineffective or unusable. A unit, weapon system or other BOS is neutralized when it can’t accomplish its combat mission for a period of time.

Suppress—Fires on or about a weapons system (a combination of one or more weapons with all related equipment, materials, services, personnel and means of delivery and deployment required for self-sufficiency) or some other BOS to degrade the system’s performance below the level needed to fulfill its mission objectives during the conduct of the fire mission.

React—Fires to cause a given effect (inform, influence, warn, gain cooperation, disorganize, isolate or deny) on an opposing force other than destroy, neutralize or suppress. Reactionary effects include lethal and nonlethal fires and information operations (IO) designed to influence the adversary.

Effects-Focused Marine Corps Warfighting Philosophy

Responsive. Responsiveness is defined as the time lag between fires requested and the desired effects. The time from the request to the attack must provide the desired effects on the target in a timely manner.

The future targeting system will support and automate the decision cycle, providing reliable links from sensor-to-commander-to-shooter. Expeditionary fire support coordination systems will integrate the types of fires available to the MAGTF, allocate those fires, deconflict them and ensure that friendly units and noncombatants are protected. Leveraging revolutions in connectivity, redundancy and security will contribute to the realization of the next level of fires allocation and adjudication.

Sufficient In Numbers and Volume. Fire support assets will be available in sufficient numbers to allow the MAGTF commander to simultaneously shape the battlespace, weight the main effort or reallocate resources rapidly to support decisive maneuver. Fires also will be available in sufficient numbers to address a continuously emerging variety of targets throughout the course of the operation.

Able to Provide Shaping Fires. This will require the MAGTF have sustained, organic indirect fire support assets. Fire support assets must have extended ranges.

Able to Acquire, Track and Identify Targets. MAGTF target acquisition (TA) must locate high-payoff targets (HPTs), quickly share the targeting information, assess the information’s accuracy and reliability, make engagement decisions and deliver the targeting data to the fire support asset available that can provide the best effects on target. This vital part of the MAGTF fire support system is often the most difficult.

Expeditionary. The MAGTF fire support system of 2015 will be as quickly deployable, sustainable and maneuverable as the elements of the MAGTF it supports. For first-entry maneuver forces, organic fire support (i.e., the firing system; prime mover, if required; TA systems; and ammunition) must be compatible with available lift assets. This will provide the minimum adequate direct support (DS) ground-based fires to committed maneuver forces.

Prosecuting deep operations requires a mobile long-range fire support system

that can provide continuous, all-weather surface fires.

Interoperable with Other Services. Expeditionary fire support will require some systems unique to the Marine Corps. However, the Marine Corps will ensure its systems are fully interoperable with those of other services. This includes maximum possible ammunition, C² and hardware/software application compatibility.

Complementary, Mutually Supporting and Survivable. No one system can provide all capabilities. Systems must be mutually supporting, allowing them to cover deficiencies or capability gaps of other systems. Furthermore, no single system should be so vital and so unique that the loss of that system would cripple the entire fire support effort.

Future Systems. The following are some systems being developed to support MAGTF Fires XXI.

Target Acquisition. Operational forces will require a system that can track both friendly and enemy maneuver elements and fire support systems. MAGTF organic weapons-locating capabilities must be interoperable with all planned fire support communications systems operated by the Marine Corps and other services. It must be transportable by sea, air or land without special preparation and able to operate in any environment.

Marine forces will require an enhanced TA capability to support the EMW force. A proactive TA system will maximize the impact of MAGTF fires by seeking out HPTs or high-value targets (HVTs), allowing the MAGTF to maintain the initiative.

TA assets must provide the commander and fire support personnel the information to make rapid, accurate decisions. In order to do so, the system must verify the reliability of the targets and reduce the time required to transmit the target data into the decision-making/delivery system.

TA will come in many forms of active and passive capabilities, such as special operations forces, ground weapons-locating radars (GWLRS), space-based (satellites), unmanned ground vehicles (UGVs)/unmanned aerial vehicles (UAVs) and forward observers (FOs). Rather than have a variety of observers, each specializing in one supporting arm, future fire support teams will feature "universal spotter" expertise, allowing them to coordinate and control all MAGTF supporting arms within the team.

Command and Control. Marine Corps doctrine emphasizes decentralized execution with subordinate commanders exercising the maximum possible latitude in accomplishing their missions. Future warfare, with its increased ranges and lethality, will force military formations to disperse to survive, stretching the limits of C².

The MAGTF fires C² system will have shared situational awareness through a common picture of the battlespace. Links to national, theater and tactical reconnaissance, surveillance, and intelligence systems will continuously update the tactical picture and provide TA support to the MAGTF.

Automation will streamline fire support procedures and support all aspects of fire support planning and execution. Future capabilities will capture the potentially overwhelming amount of data, manage that volume of information and, as empowered, provide knowledge to support decisions.

Information is valuable only insofar as it contributes to knowledge, understanding and decision-making. It is not the amount of information that is critical, but rather key elements of intelligence (when available as needed and in a useful form) that is critical to improving the commander's knowledge and understanding of the situation.

The fire support C² system will recognize information entered once at any location, update it across the system or provide it to selected users at any location. Commanders will have timely, accurate knowledge of friendly unit locations, activities and status. This improved friendly unit situational aware-

ness will enhance the fire support system's ability to clear fires, significantly reducing the danger of fratricide, while providing more responsive fires.

MAGTF fire support C² will enable rapid analysis, course-of-action (COA) development and decision. The C² system will be survivable, have individual voice recognition, have simple power requirements and be flexible enough to react to task organizing into small, light packages. The C² system will be re-programmable on site, self-integrating with other systems, (joint, combined or interagency) and extendable to any tactical echelon.

Another key aspect under C² relative to fires is IO, which are actions taken to affect adversary information and information systems while defending one's own information and information systems. Historically, fires have been employed in the initial phases of operations to achieve air superiority. Future MAGTF fires will witness a shift in initial priority from obtaining air superiority to achieving information dominance—denying an adversary's ability to collect, process and disseminate information.

The MAGTF will integrate IO planning and execution into its concept of fires in order to disrupt or deny the enemy critical information and information systems necessary for him to operate effectively.

Weapons Systems. Future fire support weapons will have the responsiveness, accuracy, lethality, range and flexibility in terms of effects on targets to support the MAGTF commander throughout the full spectrum of operations. A balance of aviation, naval sur-



The high-mobility artillery rocket system (HIMARS) will provide the MAGTF's initial rocket system as part of its ground-based fire support.

face and ground-based capabilities will ensure the force commander will have the support he needs at all times and under all conditions.

- Aviation systems support the MAGTF commander's scheme of maneuver by dramatically expanding his ability to see throughout his battlespace plus assess and influence his battlespace. Aviation fires will provide local air superiority; escort vertical assault forces; provide deep air support, screening and close air support (CAS) for MAGTF maneuver elements; and strike HPTs. As the operational reach and tempo of the MAGTF increases under EMW, the importance of aviation as an integrated element will increase dramatically.

Aviation will continue to improve and may eventually overcome most weather limitations. But in the joint environment, the MAGTF commander must retain sufficient aviation assets to weight the main effort, shape the battlespace or support the JTF commander. MAGTF aviation must focus on developing a true all-weather capability.

The air combat element (ACE) supports the MAGTF commander's scheme of maneuver by dramatically expanding his ability to see, assess, influence and engage throughout his battlespace. Future airlift capabilities will improve the ACE's ability to exploit time and distance factors significantly while reducing today's current limitations on tactical lift.

- NSFS will remain a supporting arm critical to the success of the MAGTF, but the realities of magazine capacity, variety of munitions, terrain and weather, and continuous availability of NSFS will preclude it from filling all surface-to-surface fire support requirements. Further, even with the increased

range and precision of new munitions, fire support is time-sensitive and long times of flight may not be acceptable for the ground combat element (GCE) commander with immediate fire support requirements.

- Future ground fire support will provide the MAGTF commander a combination of ground-based organic surface fires, to include a mobile rocket capability, medium artillery and an expeditionary fire support system (EFSS). The high-mobility artillery rocket system (HIMARS) will provide the initial rocket weapon; the lightweight 155-mm howitzer (LW155) under development will provide the near-term medium artillery and the EFSS has yet to be designed. Each system will provide unique capabilities and fill deficiencies or gaps in other systems.

This triad of ground-based fire support systems will increase the MAGTF commander's firepower significantly, especially in the GCE. They will provide shaping fires, long-range counterfires and immediately responsive direct support firepower for the close battle. The EFSS will be a very lightweight expeditionary system able to penetrate deep with maneuver units.

If an adversary is in a position to threaten current or future operations, the MAGTF will be able to locate and engage him early enough to prevent him from inhibiting operations—will be able to execute proactive counterfire. These requirements affect weapons, but also apply to associated capabilities, such as TA, intelligence, communications and the transport necessary to reposition weapons and ammunition.

Infantry mortars will continue to provide very close, continuous fire support

to MAGTF units. Mortars will have advanced fire control systems for faster response, greater first-round accuracy and integration into the fire support coordination network. Increased lethality for mortar projectiles is also desirable.

Conclusion. To support the MAGTF and the dynamic nature of future conflict, MAGTF fires will be expeditionary in nature, naval in character, flexible, adaptable and sustainable. Improvements in expeditionary fire support in concert with dramatic improvements in the operational and tactical mobility of the landing force will enable the MAGTF commander to generate overwhelming combat power, tempo and momentum.

Combined arms doctrine will remain valid in the future. The synergistic effects of the MAGTF's warfighting functions will enable the commander to shape his battlespace and exploit the enemy's critical vulnerabilities to achieve the decisive action envisioned in EMW.

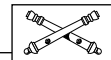

Major Brian D. Kerl, US Marine Corps (USMC), is the Fire Support and Amphibious Doctrine Officer in the Doctrine Division of the Marine Corps Combat Development Command (MCCDC), Quantico, Virginia. Among other billets, he also has served as the Artillery Representative as part of the Tactical Training, Exercise Control Group (TTECG) at Twentynine Palms, California, and Executive Officer for the Marine garrison at Camp Fuji, Japan. He commanded A Battery, 1st Battalion, 12th Marines in Hawaii and Headquarters Company, 3d Marines, also in Hawaii. He is a graduate of the Marine Corps Command and Staff College and holds a master's degree in Management from Webster University, St. Louis, Missouri.

Major Thomas O. Mayberry, USMC, until recently, was a Naval Surface Fire Support Requirements Officer in the Warfighting Requirements Division of MCCDC. Currently, he is a Program Coordinator in the Program and Resources Division at Headquarters Marine Corps in Washington, DC. Among other billets, he was the Commander of Headquarters Battery, 2d Battalion, 11th Marines at Camp Pendleton, California, where he also served as the Regimental Assistant Operations Officer. He served with the 2d Air Ground Liaison Company, Camp Lejeune, North Carolina, deploying to Somalia as a Firepower Control Team Officer and to Haiti as a Supporting Arms Liaison Team Officer. He holds a Master of Business Administration from Averett College, Danville, Virginia.



The Joint Strike Fighter will be the cornerstone of future MAGTF close air support.



V Corps FECC

By Lieutenant Colonel Roy E. Perkins



"Eagle 3, this is Apache 6. There's nothing but SAMs [surface to air missiles] out here. We can't find the target. We're going 'Winchester' on cannon and 2.75-inch rockets doing self-SEAD [suppression of enemy air defenses] and near Bingo [out] on fuel. I've hit my abort criteria.

"We just lost a helicopter due to enemy ADA [air defense artillery] in addition to the one we lost to friendly fire as we crossed the FLOT [forward line of own troops]. You're coming in very weak and broken at this range. I sure hope you can hear me because we couldn't recover the helicopter crew.

AI [air interdiction] never hit the target, and the CAS [close air support] never showed. I don't think the leaflets got through because these guys still want to fight.

"Where are those EA-6B [Marine Prowler] jammers you promised? I never heard from the AWACS [Air Force airborne warning and control system] or ABCCC [Air Force airborne battlespace command and control center].

"Apache troop is SP [starting] on egress route Condor and hopes we can get 'wheels down' without anything else going wrong. Apache 6, out."

Although Apache 6 is not part of a real attack helicopter troop, this radio call shows how rapidly a combat mission can go from bad to worse—giving examples of the range of lethal and nonlethal effects that can be employed in an Army aviation attack. If Apache 6 had had an agency to manage and integrate all effects, he may not have encountered all these problems.

Such an organization exists, and its purpose is to manage all lethal and non-

lethal effects for decisive shaping operations in the corps fight. One of the newest of these organizations is the European Command (EUCOM)-based V Corps Fires and Effects Coordination Cell (FECC).

The V Corps FECC combines the traditional members of the deep operations coordination cell (DOCC) and other non-standard battlefield operating system (BOS) representatives under one roof and one leader. The traditional DOCC includes the corps main

fire support element (FSE), G3 air, air defense element (ADE), airspace command and control (A²C²), rescue coordination center (RCC) liaison, air liaison officer (ALO) along with the V Corps Artillery tactical operations center (TOC).

This article explains why V Corps implemented an FECC, what it looks like and how it functions, and what challenges we encountered transitioning from a DOCC to an FECC.

What was wrong with the DOCC?

After all, we finally got our maneuver brethren to accept it. The FECC is the next evolution of this concept of integrating assets, but the FECC is *not* just a bigger DOCC.

A DOCC focuses primarily on planning and executing deep fires. In a linear corps fight, this could extend from a division's forward boundary out to the corps' forward boundary. Historically, this range could be more than 150 kilometers.

What the maneuver commander needs—from brigade to corps or even above—is one central clearinghouse for planning, developing and executing effects-based targets wherever they are in his expanded battlespace. He must be able to visualize, synchronize and coordinate all aspects of his lethal and nonlethal actions. An FECC is charged with that responsibility.

In recent years, conflict has changed. Brigades fight in areas larger than Vietnam-era divisions. Divisions currently conduct operations that corps executed during Operation Desert Storm. The counterfire fight is no longer fought at the corps level. With the extended range of most indirect systems, the burden of counterfire has shifted to the division artillery or the reinforcing brigade TOC.

The corps fight has transitioned into employing long-range artillery fires, primarily the Army tactical missile system (ATACMS), as well as Army attack helicopters and joint fires: AI, Navy Tomahawk land-attack missiles (TLAMs), electronic warfare (EW) and CAS. Additionally, the corps plans and executes nonlethal effects, such as operational security (OPSEC), military deception, psychological operations (PSYOPS), special information operations (IO), information assurance, physical security, counterdeception, counter-PSYOPS, and counterintelligence. Public affairs and civil affairs also can help attain IO objectives. Finally, the corps fight includes providing logistic sup-

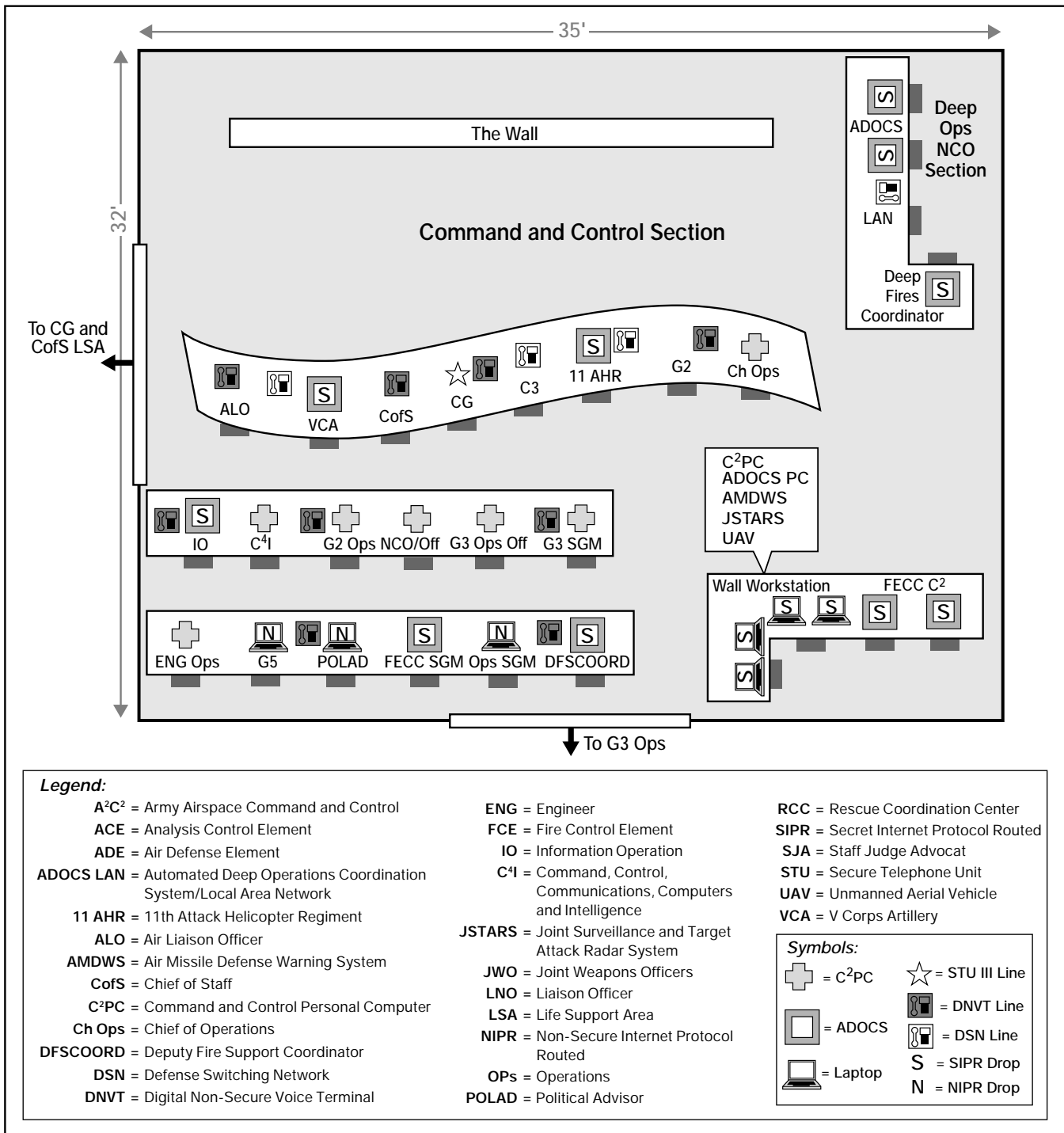

Figure 1: V Corps Integrated Main Command Post. This includes the Battle Command Center (BCC), Operations and the Fires and Effects Coordination Cell Command and Control (FECC C²).

port for additional artillery in the area of operations (AO).

The corps now focuses more on bridging the tactical and operational levels of war, a role once reserved for numbered Armies and Army service component commands. An FECC recognizes this change and provides the organizational structure to support it.

Why do we need an FECC in V Corps? After all, the interim brigade

combat team (IBCT) is testing the concept at Fort Lewis, Washington. The IBCT FECC is focused on brigade operations and integrating new systems while V Corps is a tank-heavy unit that will fight primarily with legacy equipment and older doctrine. So what gives?

After Operation Allied Force (Kosovo Air Campaign), V Corps undertook a formidable challenge. It reshaped itself into a lighter, more deployable and syn-

chronized command post (CP) with a rapid strike capability in line with the Chief of Staff of the Army's (CSA's) vision of transformation.

We examined emerging doctrine from the Field Artillery School at Fort Sill, Oklahoma, and evolving examples from the XVIII Airborne Corps at Fort Bragg, North Carolina; Eighth Army DOCC in Korea; and III Corps at Fort Hood, Texas. Then the V Corps Artillery

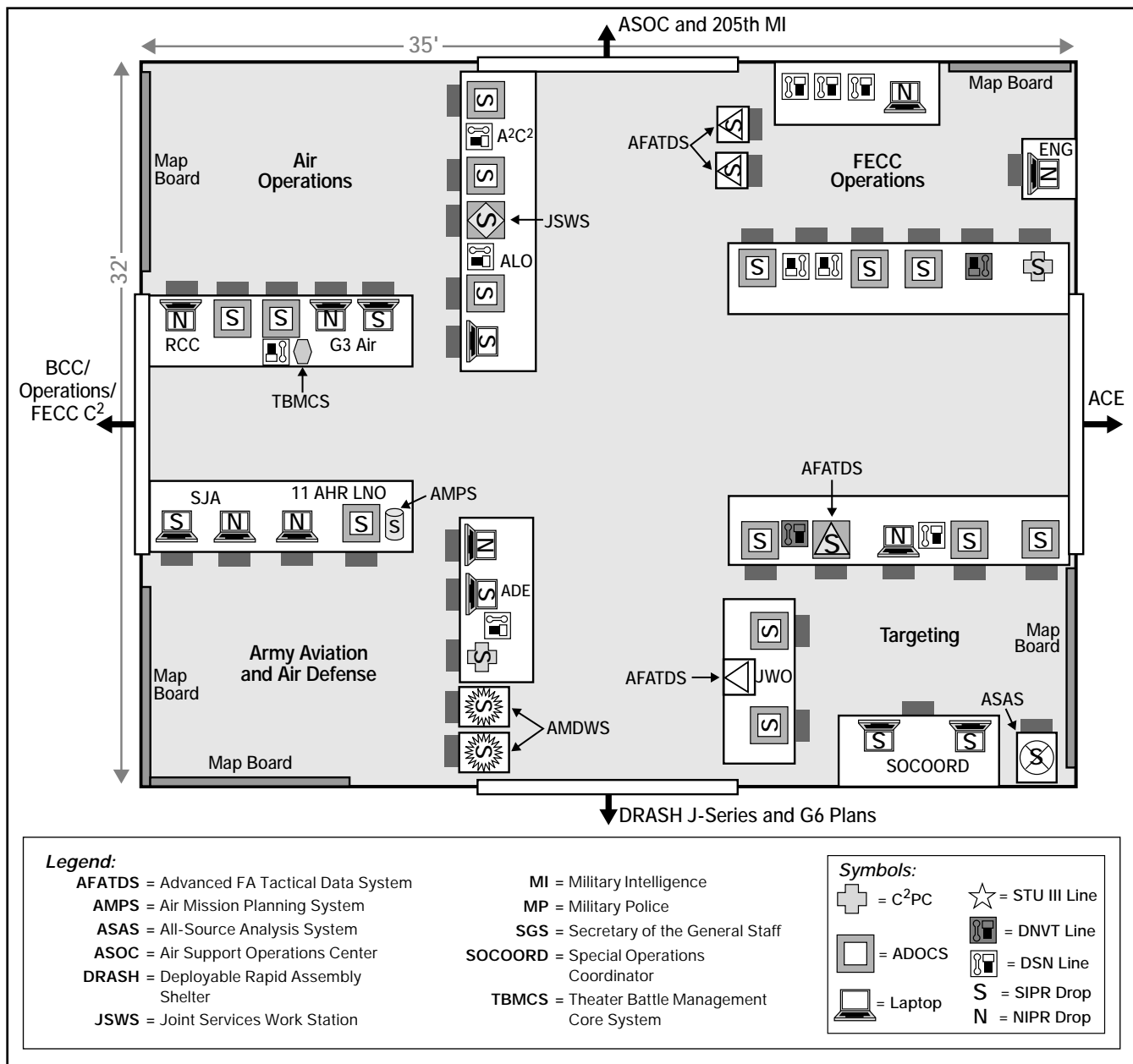

Figure 2: Fires and Effects Coordination Cell (FECC)

(VCA) commander made some tough decisions to transition from a DOCC into a FECC.

The ideas in this article were extracted from our research. What is new is the timing and integration of this concept to a redesigned V Corps CP that has been commended by Army and joint organizations worldwide.

Because of limited manning and, therefore, skill sets, the corps artillery commander consolidated the V Corps TOC with his main CP, in effect built an FECC. V Corps Artillery, like most other non-divisional units, is manned at significantly reduced levels. The headquarters is filled to 60 percent strength for artillery field grade officers and less

than 50 percent strength for company grade officers.

More importantly, inbound personnel have very limited or no experience with integrating multi-branch, multi-service and national-level targeting and weapons systems. This type of targeting applies only to corps, numbered Armies and joint staffs. Those officers and NCOs trained at the division level or below have little knowledge of how to plan and use many of these systems. Because of these deficiencies, the V Corps Artillery commander integrated his TOC with the corps main CP, which built a *fires* (VCA TOC) and *effects* (V Corps main CP and DOCC) *coordination cell*—an FECC. (See Figure 1.)

This improved situational awareness for the VCA TOC. With a separate TOC, the VCA staff knew little more than its part of the mission and could not understand how the lethal effects of fires integrated into the complete corps fight.

So, what does the V Corps FECC look like? It includes the following sections: command and control (C²), operations, targeting, joint weapons officer (JWO), G3 air, automated deep operations coordination system (ADOCS) local area network (LAN) and 11th Attack Helicopter Regiment (AHR) S3 plans. (See Figure 2.)

C² Section. This used to be the corps main CP FSE and is the primary coordi-

nator of effects operations. It is in this section that the VCA commander and corps chief of staff develop the corps targeting guidance and objectives. This cell is the primary integrator of battlefield visualization that gives the corps main CP an unprecedented ability to see the current effects-based execution of targets as it applies to friendly units, enemy forces and the terrain.

Operations Section. This section came from the old VCA G3 and fire control element (FCE). It is the artillery backbone of the FECC. The operations section manages the effects and delivery of rocket and missile-based lethal fires. It develops fire plans; executes the high-payoff target list (HPTL), attack guidance matrix (AGM) and target selection standards (TSS); prosecutes targets; and deconflicts and manages artillery airspace.

The operations section also manages artillery resources with the VCA administrative logistics center (ALOC) and coordinates fire support coordination measures (FSCM). The corps tactical CP (TAC) FSE and main CP current operations FSE report to this section. This operations section also is the main point of contact for subordinate fire support organizations.

Targeting Section. The old VCA G2, counterfire cell and the corps targeting officer comprise this section. Its primary purpose is to synchronize the corps targeting effort between the V Corps G2 and executing agencies. The section is a primary planning center for enemy

artillery target development. The targeting section focuses the employment of lethal and nonlethal assets in conjunction with the corps G2. It builds the HPTL and AGM and, with the corps G2, determines the TSS.

The Field Artillery intelligence officer (FAIO) reports to the targeting section but works inside the corps analysis and collection element (ACE) and provides real-time target information to the operations section for prosecution.

The targeting section includes engineer, IO, staff judge advocate (SJA) and other BOS representatives to help develop targets.

JWO Section. This is a new section designed to manage air support requests (ASR) and air tasking order (ATO) distribution and management. The JWO section is responsible for target updates and target validations and leads the corps target prioritization process for ATO nominations.

The JWO section is both a planning and executing agency and works in conjunction with the targeting section. It manages all joint effects requests, both lethal and nonlethal.

G3 Air Section. In addition to G3 air, this section includes the A²C², air defense element (ADE), air liaison officer (ALO) and other unit liaison officers who perform their traditional DOCC roles but in close coordination with other BOS reps.

The additional impact that a corps FECC brings is the close proximity of

the air support operations center (ASOC) and military intelligence brigade TOC. These elements are adjacent to the FECC and work closely with the G3 air section, providing rapid access for CAS integration as well as Guard Rail source feeds and long-range surveillance (LRS) target information.

This section also provides Army input into joint personnel recovery (JPRG) and combat search and rescue (CSAR) operations through the RCC liaison officer from the corps general support (GS) aviation brigade.

ADOCs LAN Manager. V Corps Artillery uses ADOCs to manage its battlefield functional systems. The ADOCs LAN manager, who is the deep operations NCO, also serves as a fire support NCO in the FECC C² (Figure 1) when required.

11th AHR S3 Plans Section. This section is inside the FECC and provides route-planning, mission-processing and battle-tracking functions.

How does the V Corps FECC function? Making the V Corps FECC work is more than just putting these agencies together in one tent. By working closely, the FECC agencies can conduct target development, target prosecution or airspace management and implement tactics, techniques and procedures (TTPs) that provide a more rapid and cohesive engagement of target sets.

The consolidated layout facilitates coordinating and engaging the right target with the appropriate effects desired,

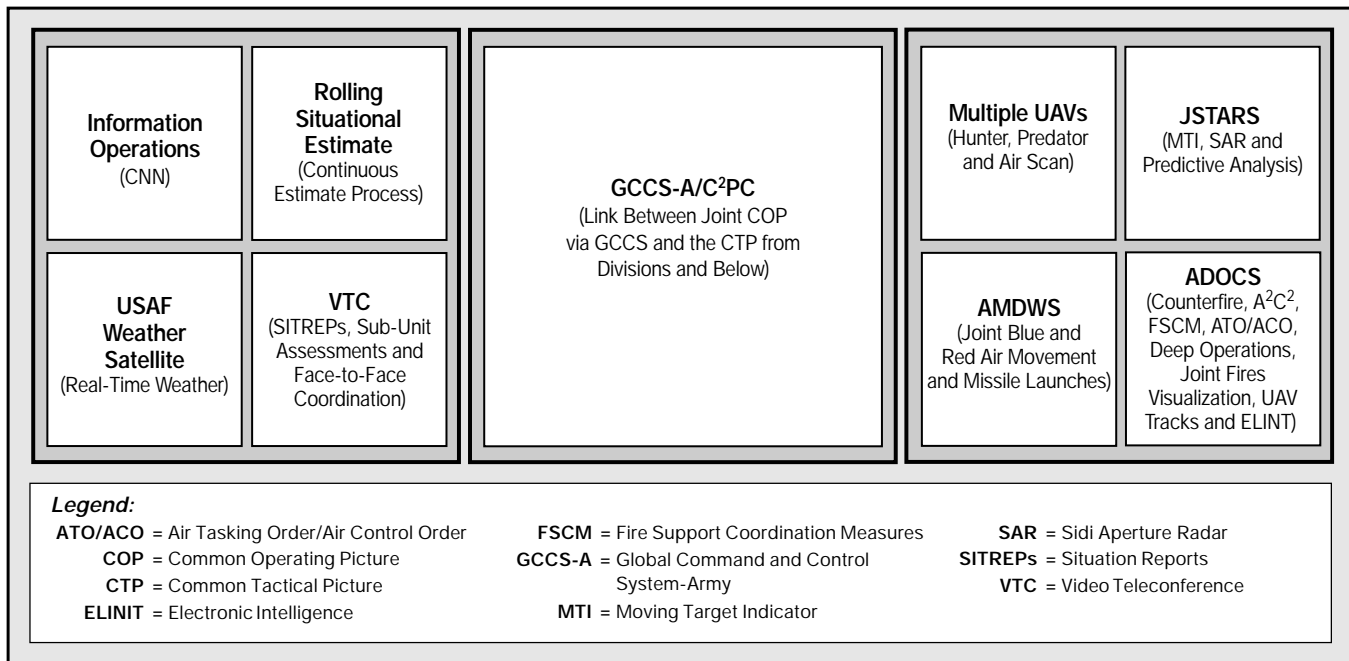

Figure 3: Joint Fires Visualization Screens

lethal or nonlethal. This is particularly important for airspace management and deconfliction. This also helps to link stove-piped staff organizations together to focus on common objectives.

Effects Coordinator (ECOORD). The FECC functions as one organization under one leadership for unity of effort. Because the VCA commander was already the corps fire support coordinator (FSCOORD), moving these agencies under one roof connected to the corps main CP naturally led to his role as the effects coordinator (ECOORD). All the cells inside the FECC report through the ECOORD.

The ECOORD chairs the targeting meetings, which address not only lethal requirements, but also nonlethal and IO. During the targeting meeting, all issues are surfaced and cross-walked to develop a cohesive application of the spectrum of effects. This guidance is then formalized and approved by the V Corps Chief of Staff during the targeting board. This process allows the corps to have a common view of visualizing and applying effects onto targets.

Common Operating Picture (COP). Today's buzzword for CPs is COP. A layman's definition of COP is the full situational awareness of all information sources integrated into one complete picture of the battlefield.

The FECC's COP connectivity is achieved in many ways. V Corps uses a combination of computer-based visualization tools to provide the corps CP a near real-time picture. (See Figure 3.)

Additionally, today's warfighter requires the ability to overlay multiple pictures and feeds into one common frame of reference. Specifically, the V Corps FECC uses ADOCS to horizontally integrate many automated Army battle command system (ABCS) feeds. These include the advanced FA data system (AFATDS), initial fire support automation system (IFSAS), all-source analysis system (ASAS), air missile defense warning system (AMDWS), air mission planning system (AMPS), global command and control system-Army (GCCS-A) as well as joint service feeds, such as the Air Force's theater battle management core system (TBMCS), joint surveillance and target attack radar system (JSTARS) and unmanned aerial vehicles (UAVs).

However, the most important connectivity has nothing to do with computers or message formats or even maps with acetate. Instead, maps and message

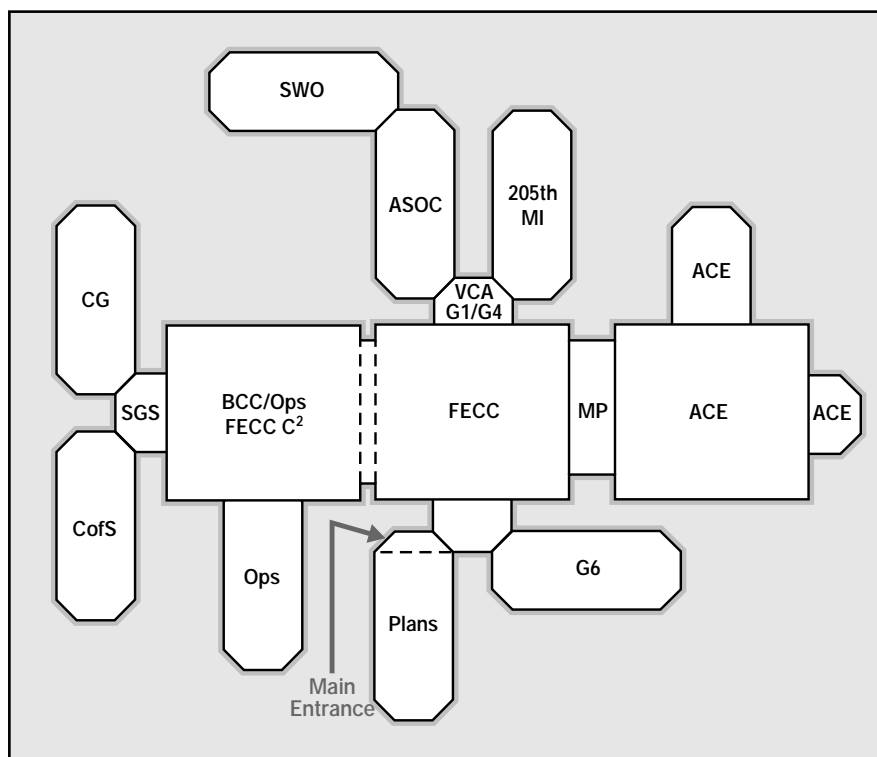

Figure 4: V Corps Strike Command Post

boards are placed against the outside walls of the FECC. Operators sit facing out from the wall looking at the other sections. All sections can cross talk with each other, significantly improving coordination. This set up allows all sections access to the HPTL/AGM/TSS matrix and empowers them to execute many decisions at much lower levels than previously required.

Corps Strike CP. The FECC is the logical cornerstone of any contingency deployment. It is not only a major component of the newly designed corps main CP, but also forms the basis of the corps Strike CP, which provides limited combat operations support. (See Figure 4.) From the FECC, officers and NCOs have rapid access to the corps ACE, ASOC, military intelligence brigade TOC, current operations cell and battle command center (BCC) where the corps commanding general fights. Being "under one roof" allows for better cross talk among sections inside and outside the FECC.

This concept works strictly because of new tent products on the market that use large, modular systems with cavernous main tents and smaller connecting tents.

The organization also provides a highly improved link with corps plans. The plans battle staff actively participates in the targeting process, integrating the extended, joint planning requirements

with contingency plans being developed.

Finally, because the FECC uses the existing corps CP LAN and communications backbone, its sections maintain high visibility of all fragmentary orders (FRAGOs) and changes. It also experiences minimal system down time due to the rapid responses of both the corps and VCA G6 sections.

What were the challenges of transitioning from a DOCC to FECC? As rosy as this picture sounds, we had problems transitioning to an FECC organization. Most challenging was the mismatch of the personnel and equipment in our modified table of organization and equipment (MTOE) and our doctrine and training with the newly identified joint requirements.

Organizational Changes. These are needed to sustain the FECC concept. Critical positions must be coded via an additional skill identifier (ASI) to reflect the required joint weapons training, and the NCOs who have gained the skills must be managed for appropriate assignment.

Because the ACE is the central agency for collecting and processing targeting information, critical billets and military occupational specialties (MOS) must adapt. We must continue to develop our warrant officers, 131A Targeting Technicians, in the grades of WO3 or higher

to ensure they are trained and developed to serve as targeting officers at the corps level. Their duties require they work closely with G2 ACE personnel. We also should process 131As automatically for Top Secret clearances upon selection for the MOS.

Traditional DOCC operations use only one or two FAIOs, primarily to relay target information. As the ACE targeting team generates target cards from either single-source or all-source data, the target cards are passed to the FAIO, who only validates them, and then passes these targets to the DOCC for execution. It is in the DOCC that the target is finally analyzed for relevance and then integrated into targeting objectives.

However, the V Corps FECC uses a more robust FAIO section with NCOs and soldiers processing target cards, thereby freeing the FAIO to use his targeting training for visualizing targeting priorities and prosecution.

An organizational change should reflect this increased presence inside the ACE, and positions should be coded for Top Secret clearances.

Equipment Changes. In addition to organizational changes, equipping corps-level FECCs demands changes. V Corps deployed its MTOE-based TOC of five-ton expandable vans to Hungary in 1996 as the Implementation Force (IFOR) and to Albania in 1999 for Operation Allied Force. Because of size restrictions, these vehicles must move by strategic assets only (rail, ship or strategic airlift). These deployments were deliberate, slow processes—not in line with the CSA's transformation initiative.

Similar to initiatives in III Corps and the XVIII Airborne Corps, V Corps has developed new corps main and Strike CPs that are fully deployable via EUCOM-based C-130 aircraft. The MTOE does not reflect these changes.

Headquarters and Headquarters Battery of V Corps Artillery still maintains a fleet of vans. While never used, these vans require maintenance, drivers and supply operations. The base TOE for corps should remove these vans and replace them with lighter, C-130-deployable vehicles.

V Corps has a greater ability to see, understand and operate on today's battlefield, but situational awareness is not the only automation requirement for the decision-maker. Commanders and staffs now want rapid prototyping; graphic user interfaces (GUI); web-

based, easy instructions; and responsive support staffs.

The business world demands its software adapt to the changing user requirements at a more rapid pace and the US Army should be no different. As with all modern CPs, the V Corps FECC is developing new TTP to handle a variety of new missions. Software must be able to handle a more varied set of missions and target identifications.

Today's missions no longer fit into the traditional counterfire against a target described by the old tactical fire direction system (TACFIRE) as "HEAVY RKT/MSL" (heavy force rocket/mis- sile). Instead, commanders want software that identifies a specific unit ("Republican Guards Division") with a specific AGM applied to that unit ("counterfire against 2S-19s but not D-30s").

Program managers, advanced concept development teams (ACDTs), battle labs, Training and Doctrine Command (TRADOC) system managers (TSMs), branch proponent schools and contractors must recognize this need and continue to promulgate this increasing situational awareness capability to all units. This is especially important for those units that will deploy first in near-term contingency operations—those units that quickly will be on the front line.

Doctrine and Training Revised. In addition to organization and equipment changes, doctrine and institutional training should be revised. The current *FM 100-15 Corps Operations* does not reflect the missions or orientation most corps currently are executing. More discussions of joint targeting, joint fires execution, joint planning, battle rhythm development and information operations should be included in the new manual.

The definitions of AO and area of responsibility (AOR) should reflect the larger vision of battlespace and not be limited to a geographical area. Internet attacks by Serbian sympathizers against continental US (CONUS)-based defense computers during Operation Allied Force proved that conflicts no longer remain regional. These attacks and the defense mounted against them must be integrated as part of corps IO and are a version of nonlethal targeting.

Doctrine and institutional training also must reflect that corps operations are joint and that even the most "green" corps training exercises must include joint operations and joint training audiences. An example might be to reexam-

ine using the Battle Command Training Program (BCTP) Operations Groups A and B for corps-level Warfighter exercises. Most corps Warfighters are conducted in the "purple-halo" of other joint exercises, as opposed to as a true joint exercise. An expansion of Operations Group D into this joint role or including Operations Group-D-type expertise is required for Operations Groups A and B.

V Corps and V Corps Artillery serve as the US Army Europe and Seventh Army component for fires within EUCOM. The V Corps FECC is the primary user of services provided by the 4th Battlefield Coordination Detachment (BCD) located with United States Air Force, Europe (USAFE) at Ramstein AFB, Germany. It also was the principal author for the joint TTPs being staffed and executed in draft form in EUCOM.

The face of corps operations has changed. V Corps realized it was time to move to an effects-based CP organization and structure. We did that by dissolving the V Corps Artillery TOC as a separate entity and reorganizing its functionality inside the corps main CP. Although challenges remain, this move paid dividends in both efficiency and improved communications.

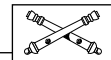

Lieutenant Colonel Roy E. Perkins is the V Corps Deputy Fire Support Coordinator (DFSCOORD) in Germany. In his previous assignment, he was S3, helping to activate the 1st Infantry Division (Mechanized) multiple-launch rocket system (MLRS) and target acquisition (TA) battalion, the 1st Battalion, 33d Field Artillery, Germany, and then, during Operation Allied Force, trained and deployed the TA battery as the first company-sized unit into Kosovo. Also in Germany, he was the Fire Support Officer for the 4th Aviation Brigade, 1st Armored Division. He was an Operations Research Systems Analyst at Headquarters, Training and Doctrine Command, Fort Monroe, Virginia, when he deployed to Bosnia in Operation Joint Endeavor. He commanded B Battery, 5th Battalion, 29th Field Artillery, and the Division Artillery Headquarters and Headquarters Battery, both part of the 4th Infantry Division (Mechanized) at Fort Carson, Colorado. He is a graduate of the Command and General Staff College, Fort Leavenworth, Kansas.

Fighting With and Against FIRES.

The Transformation Continues

By Colonel Kenneth W. Hunzeker and
Lieutenant Colonel Dominic D. Swayne

The phrase “fighting with fires” has become commonplace in the fire support community. But the integration of new technology is not only improving how we fight with fires, but making it possible to fight better against fires as well. We now are using our advanced Field Artillery tactical data system (AFATDS) not only to plan and execute fires, but also as an *analysis* tool against the opposing force’s (OPFOR’s) fires to help the commander shape his battlespace more effectively than ever before.

At the division level, the commander often tasks fire support to shape the fight for the maneuver brigades, neutralize or destroy the enemy’s artillery and, finally, neutralize or destroy air defenses and radars, providing suppression of enemy air defenses (SEAD) for deep attacks with Army aviation. Using the latest technology available, the 4th Infantry Division (Mechanized), Fort Hood, Texas, developed dynamic and adaptive tactics, techniques and procedures (TTPs) to accomplish these missions. During our April digitized Division Capstone Exercise (DCX) at the National Training Center (NTC), Fort Irwin California, we executed the TTPs

and tracked our progress to a fidelity never before possible.

What follows is a narrative of battles with a live OPFOR combined with the actual screen shots of the fight as depicted on the prototype fire support coordinator’s (FSCoord’s) synchronization tool—currently known as the AFATDS Fire Support Client. Throughout the battle, the information provided through our systems greatly improved our situational awareness and execution of fires.

Fire support Client Software. AFATDS offers some powerful new processing and analysis tools that caused us to re-evaluate two fundamental TTPs: radar zones and planned targets.

First, we decided to use the Firefinder radars as we do most of our other technology-based acquisition platforms; we had them report all acquisitions as fast as possible to the fire support element (FSE) and used AFATDS to analyze and “weight” the criticality of the targets based on the commander’s guidance. This saved time and avoided the “best-guess” zones built into the radar and AFATDS that are established before the fight begins.

We found that by using *no* radar zones, acquisition reports came from the radar

with both a point of origin and point of impact. This enabled AFATDS to display the enemy gun-target line as red vectors on the AFATDS screen. (For a more detailed explanation, see the article “Reactive Targeting: Firefinder and AFATDS in the Digitized Division” by Chief Warrant Officer Two Eric J. Moran and Lieutenant Colonel Dominic D. Swayne in the May-June edition.)

The unintended consequence of showing the red vectors was that suddenly we could visualize the enemy’s intent for fires and translate that into real-time intelligence. This capability proved to be one of the key enablers for achieving situational dominance.

With default radar targets loaded into the AFATDS high-payoff target list (HPTL), AFATDS automatically converts each acquisition into a call-for-fire. We consider this interim TTP and anticipate that target areas of interest (TAIs) will replace Firefinder call-for-fire zones (CFFZs). Future changes to AFATDS will factor critical friendly zones (CFZs) into its mission value analysis (the basis of priority of targets), and the Firefinder radar will allow all zones to generate red vectors in AFATDS. The FA Tactical Data Systems (FATDS) Version 7 software for AFATDS and Firefinder radar is scheduled to be fielded in FY03 and will include these capabilities.

The second breakthrough TTP was to harness the power of the TAI in AFATDS. In the traditional sense, a target should have an intent, an observer and something to apply effects to the target (a shooter). In much the same way, AFATDS provides its TAI as a potent tool that makes top-down, bottom-up fire planning flexible and easy to execute, and allows us to associate areas with both *observers* and *shooters*.

The benefits of the TAI are that they can contribute to mission value in AFATDS, and several can be entered and rank ordered. Also, we can associate them with observers and shooters independently. With the radar reporting every acquisition, we used TAIs in AFATDS (rather than CFFZs and CFZs in the radar) to focus fires.

Death by Fires. Using the Fire Support Client, the fire support officer (FSO) or targeting officer in the FSE can quickly and dynamically establish (draw) TAIs over the enemy artillery. By analyzing and targeting the source of the red vectors, the enemy fires’ origin, the FSO and counterfire cell can

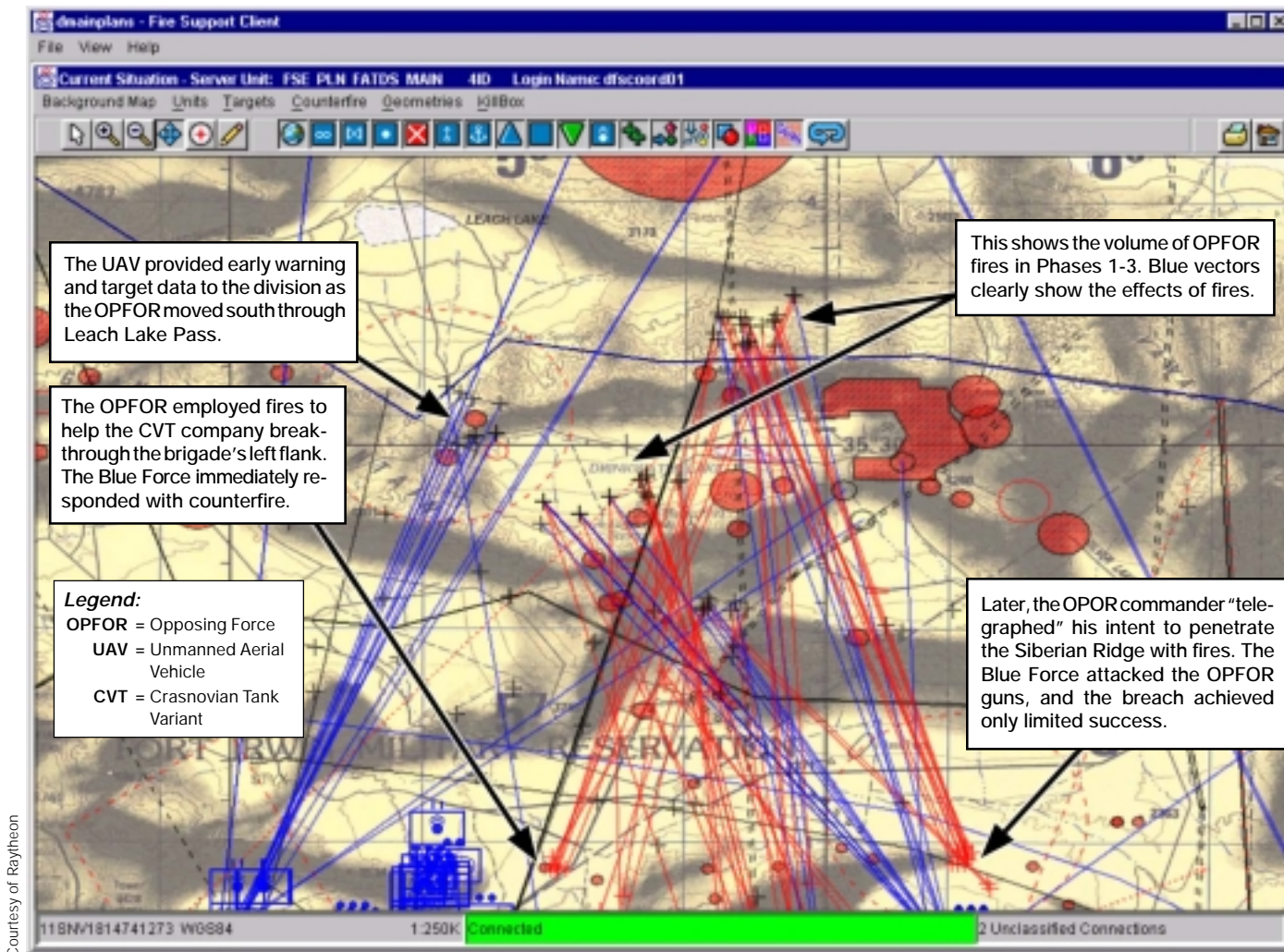

Courtesy of Raytheon

Figure 1: DCX Fire Support Client Screen Capture. This advanced FA tactical data system (AFATDS) screen capture illustrates the Blue Force's canalization of the OPFOR in Leach Lake Pass and how the Blue Force prevented the OPFOR from flanking it during the Blue Force's hasty defense near Siberian Ridge. (The red vectors are the OPFOR's gun-target lines, and the blue vectors are the Blue Force's gun-target lines.)

take advantage of the TAI's power in AFATDS and truly influence the fight.

The TAI increases the mission value of acquisitions, much like a CFFZ increases message priority in legacy systems. The FSO or targeting officer can selectively prioritize each TAI, so the FSCOORD can focus the counterfire fight. This is a much more rapid and dynamic process than creating and adjusting CFFZs. The process also allows us to "see" the enemy's fires in the current version of software.

A second effective use of the TAI was to attach them to friendly firing units. If there was a need to focus a particular unit's fires in one area, the FSCOORD could create a TAI associated with only one fire unit. In this way, only calls-for-fire originating in that TAI would go to the associated unit.

The AFATDS screen captures show the friendly units' "gun-target" lines as

blue vectors from missions that were executed, as documented in AFATDS. Although passing vectors from AFA-TDS to AFATDS has some communications and update challenges, the process gave us reliable vectors on the battalion-level unit firing the mission.

Additionally, AFATDS TAIs are much more flexible than radar zones as they can overlap with or be inside of another TAI. This gives the FSCOORD a number of automated decision-making tools with a large number of fine-tuning options.

As we explored AFATDS' potential, we examined how AFATDS could link with other battlefield operating systems (BOS). We then linked the power of AFATDS and the Fire Support Client to our existing technology, in this case the joint surveillance and target attack radar system (JSTARS) and unmanned and aerial vehicles (UAVs). These systems helped improve our *Decide, De-*

tect, Deliver and *Assess* targeting methodology.

Canalizing the OPFOR at Leach Lake Pass. JSTARS proved to be an effective tool for both analysis and targeting. Using JSTARS and the division's UAV, we tracked the OPFOR's movement into Leach Lake Pass at the NTC. (See Figure 1.)

In anticipation, we built four target groups along the two severely restricted passes and timed the fires to attack the columns when they were still tightly grouped. The first column entered the northern pass with 27 vehicles. After firing the group, they were observed exiting the pass with 12. The next column chose the southern route but suffered a similar fate.

Hitting moving targets always has been difficult. But in this situation, we used a natural obstacle, Leach Lake Pass, to canalize the enemy's forces. This allowed us

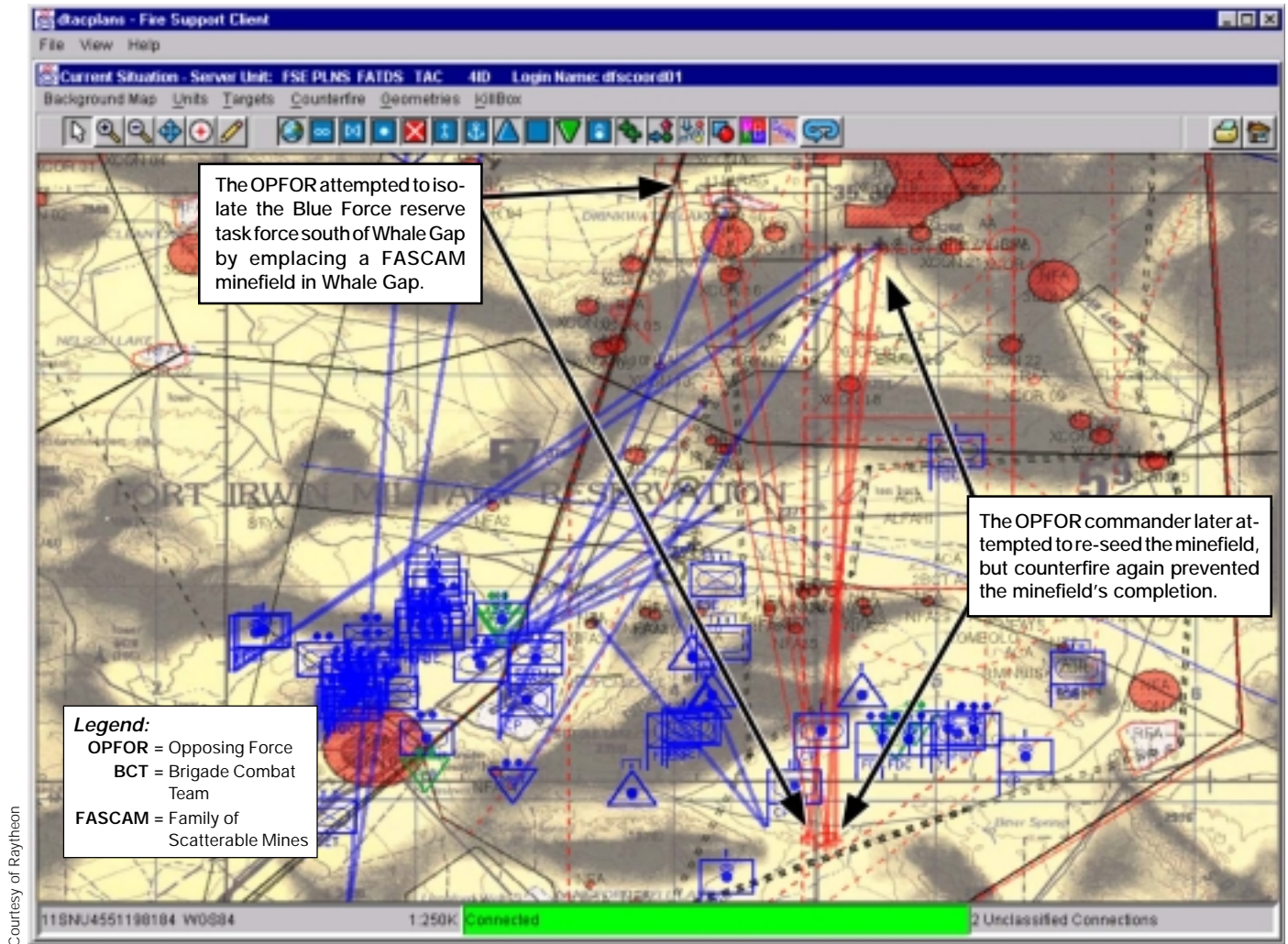

Courtesy of Raytheon

Figure 2: Fire Support Client Screen Capture. The OPFOR fired into Whale Gap, an area in which there were no Blue Forces. By deduction, the Blue Force determined the fires were most likely laying FASCAM with the intent of isolating the Blue Force reserve task force south of Whale Gap from the rest of the Blue Force. The Blue Force fired counterfire to stop the OPFOR from firing the minefield and then had the brigade engineers breach the obstacle.

to execute on-call groups of targets as JSTARS and the UAV tracked the opposing forces moving through the pass.

Securing the Hasty Defense. In a subsequent fight with Blue Forces in a hasty defense, the G2 assessed that the OPFOR would press both flanks of the brigade, but his main effort would be center at the crest of the Siberian Ridge. We used JSTARS to monitor battlefield movement, much like a television camera provides slow-motion replay.

On the AFATDS' display of the Fire Support Client, we watched as the OPFOR "telegraphed" his intent to press our left flank with a high volume of fires. Rapid, effective counterfire prevented Blue Force attrition, and a quick "heads up" to the maneuver commander confirmed the enemy's intended point of penetration.

JSTARS moving target indicators again confirmed the G2's read as tracked

vehicles moved in coordination with their Phase 3 fires. Next came a high volume of fires at the crest of the Siberian Ridge. The OPFOR commander followed his Phase 3 fires with a well-coordinated movement of tracked vehicles—valuable, real-time information provided by the stalking JSTARS platform and displayed in AFATDS as red vectors.

The raw information provided by multiple sensors and automated systems combined with staff analysis gave the high-ground advantage to the assistant division commander for maneuver [ADC (M)]—in effect enabled him to achieve situational dominance. Situational dominance and the ability to synchronize dominant maneuver at the decisive point are powerful combat multipliers.

Spoiling the OPFOR Defense. JSTARS was also an effective stand-alone analy-

sis tool when other systems were not available. Before our deliberate attack, the G2 assessed that the OPFOR was taking advantage of limited visibility to build a battalion-level defense. The brigade combat team (BCT) was rebuilding combat power and preparing to continue the offense the next day. The brigade's UAV had been employed to its maximum time limits during the previous fight and was not available to target the enemy as they prepared their defense.

The FA intelligence officer (FAIO) noted that JSTARS was tracking multiple vehicles moving into the areas where the G2 predicted the OPFOR would be digging in his defensive positions. JSTARS tracked three to 14 vehicles into discrete areas near the templated defensive positions. The vehicles then stopped and began making short back-and-forth movements, the

same type of movements you would expect from bulldozers digging in a trench line.

Because the vehicles tended to stay in pretty tight areas (300-meter radius), we decided to target them and, at least, reduce the enemy's ability to dig in. This made it easier for the Blue Forces to assault through the obstacles and defeat the strongpoints.

Although using JSTARS as a primary acquisition platform for targeting is not common, in this scenario we already knew the area was clear of civilians and neutral forces and the OPFOR was preparing a defense. Also, no other viable acquisition platforms were available. Over the course of the evening, this TTP proved exceptionally effective.

Reading the OPFOR's Intent for Fires. Another effect of our analysis benefited our interaction with our engineers and maneuver elements. The OPFOR artillery initiated a high volume of fires into Whale Gap. (See Figure 2 on Page 23.) Assuming the OPFOR was employing observed fires, these volleys initially didn't make sense as our situational awareness provided by Force XXI battle command brigade and below (FBCB²) showed no Blue Forces nearby.

The brigade commander back-briefed the ADC (M) over the video teleconference (VTC) display screen so everyone in the division tactical operations center (DTAC) knew the brigade's plan. The plan assumed the OPFOR had achieved some success in infiltrating reconnaissance and probably had a fair assessment of the disposition of Blue Forces. The Blue Force reserve task force was positioned south of Whale Gap, terrain that was a likely location for an obstacle—such as a family of scatterable mines (FASCAM) minefield fired by the OPFOR FA.

The FSE in the DTAC quickly consulted the division engineers who concurred with the plan. Counterfire prevented the OPFOR from firing multiple volleys, and within minutes, BCT engineers were dispatched to the site and quickly breached the immature minefield before any Blue Forces were damaged significantly.

A short time later, the OPFOR attempted to re-seed the minefield. Again, we analyzed his fires vectors and dispatched BCT engineers to the site. Simultaneously, the NTC fire markers arrived to mark the minefield as reseeded, which the engineers then breached without additional Blue Force losses. In other

words, we “read” the enemy's intent and sent engineers to counter his intent as the fire markers arrived to mark the simulated minefield.

The same methodology could be used for dealing with artillery-delivered chemical strikes.

Locating the OPFOR Observers. One final tool we developed proved useful in focusing counterreconnaissance efforts in the rear. Again, based on the knowledge that the OPFOR usually employs observed fires, we used our engineer's digital topographic support system (DSST) to help locate enemy observers. Because our AFATDS TTP allowed us to track impacts of enemy fires in our rear area, we were able to analyze several of these targets. It appeared likely that one observer was responsible for many of the fires in our rear area.

We gave the impact grids to the division engineer support element and asked the element to do a common line-of-site analysis from the points of impact to see if there were limited areas from which one observer could see all three targets. Using the DSST, the engineers not only determined that one observer probably was responsible for the three targets, but also provided eight-digit grids to the three likely observer locations. This enabled the brigade to focus its division reconnaissance team (DRT) sweeps more effectively.

Conclusion. As the DCX clearly demonstrated, digital systems give the commander greater flexibility in employing joint and combined arms teams deeper and over a significantly larger battlespace. Our digital systems allow us to get “inside” the enemy's decision cycle. The Blue Force was able to defeat substantial enemy forces well before we made contact with enemy ground maneuver.

Although the 4th Infantry Division's new digitized tools have increased our warfighting capabilities significantly, such technology is not a panacea. During the DCX in the same NTC scenario, the low-tech OPFOR still achieved some successes. One example follows.

Having halted the OPFOR attack, the brigade prepared to attack into the enemy's prepared defensive positions to the north in Echo Valley. The BCT launched a company-sized demonstration designed to make the enemy react and divert his attention away from our scout insertion.

Even without high-technology tools, the OPFOR hit these moving targets

and halted the demonstration well before the company could make contact with the OPFOR defense. The OPFOR's well-trained observers, 80 percent illumination and primitive optics allowed him to engage moving vehicles and destroy several. Regardless of our superior technology, we must never underestimate an enemy.

As a digitized force, we must capitalize on the strengths of the fire support BOS: our ability to focus effects, expedite sensor-to-shooter links, allow the commander to visualize blue and red fires, and contribute to situational dominance. Our strengths enable the commander to fight more effectively with and against fires.

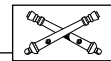

Colonel (Promotable) Kenneth W. Hunzeker, until recently, was the Assistant Division Commander (Maneuver) of the 4th Infantry Division (Mechanized) at Fort Hood, Texas. Currently, he is the Deputy Director of Program Analysis and Evaluation in the Office of the Deputy Chief of Staff for Programs at the Pentagon. Also at Fort Hood, he served as the Chief of Staff of the 1st Cavalry Division. He commanded the 1st Infantry Division (Mechanized) Artillery in Germany; the 2d Battalion, 18th Field Artillery, 212th Field Artillery Brigade in III Corps at Fort Sill, Oklahoma; and a firing battery and headquarters and headquarters battery, both in the 25th Infantry Division (Light), Schofield Barracks, Hawaii. Colonel Hunzeker holds an MS in Systems Technology from the Naval Postgraduate School at Monterey, California, and an MS in National Security and Strategic Studies from the National Defense University in Washington, DC.

Lieutenant Colonel Dominic (Nick) D. Swayne, until recently, was the Deputy Fire Support Coordinator (DFSCOORD) for the 4th Infantry Division. Currently, he is the Professor of Military Science at James Madison University at Harrisonburg, Virginia. Also at Fort Hood, he served as the Division Artillery Executive Officer and S3 of the 2d Battalion, 20th Field Artillery, both in the 4th Division. He commanded two batteries: Headquarters and Headquarters Battery of the 212th Field Artillery Brigade, III Corps Artillery, and A Battery, 1st Battalion, 19th Field Artillery in the Field Artillery Training Center, both at Fort Sill. Lieutenant Colonel Swayne is a graduate of the Command and General Staff College, Fort Leavenworth, Kansas, and holds a Master of Public Administration from Northeastern University in Boston, Massachusetts.



CAS Battle Drill

By Major David G. Smith, USAF,
and Major Jonathan E. Bachman, USAF

At the National Training Center (NTC), Fort Irwin, California, we have a unique opportunity. We can train and execute in near real-world combat scenarios, providing quantifiable effects to the combat teams and identifying performance trends requiring attention.

One area needing attention is close air support (CAS). Routinely, we see aircraft dedicated to CAS departing the area of operations (AO) with devastating combat effects still hanging from their wings or loaded in their guns. For example, two battle-laden A-10 aircraft dedicated to CAS may carry a variety of munitions, but a fairly standard load would be AGM-65 Maverick attack guided munitions, CBU-87 cluster bomb munitions and gun passes with the 30-mm cannon. Why allow this combat capability to depart the AO without expending ordnance on the enemy?

The core cause of ineffective employment of CAS assets: Lack of prompt execution of this fleeting (fuel- and time-limited) asset. At the NTC, we identified areas for improving CAS integration into the ground fight as shown in Figure 1 on Page 26. Although Figure 1 is not all-encompassing, it addresses many areas that even units that execute

CAS promptly and efficiently could draw potential benefit from.

This article outlines TTP for executing CAS that is timely and effective in massing fires to achieve the supported unit commander's intent.

Communicating the Mission. The ground commander has an air liaison

officer (ALO) located with his staff. The ALO is a rated Air Force officer (flyer) with tactical experience and expertise in fixed-wing employment. The ALO leads the tactical air control party (TACP) that "...provides the interface between the Army unit it supports and the combat Air Force unit that provides combat air support" [*Joint Pub 3-09.3 Joint Tactics, Techniques and Procedures [TTP] for Close Air Support (J-CAS)*]. The TACP also includes the airborne forward air controller (FAC-A) and the enlisted terminal attack controller (ETAC) who control the aircraft in the final attack of the CAS missions.

The ground commander owes the ALO guidance and intent for his CAS assets. This guidance should be clear and tied to battlefield effects and outcomes.

For example, we often hear guidance such as, "Send the CAS deep and destroy the enemy."

Instead, we should hear, "Employ CAS against enemy reserves and repositioning forces to prevent a counterattack and preserve favorable ratios for the close fight. Desired destruction is six combat vehicles from the CAR [combined arms reserve]. Then shift CAS to

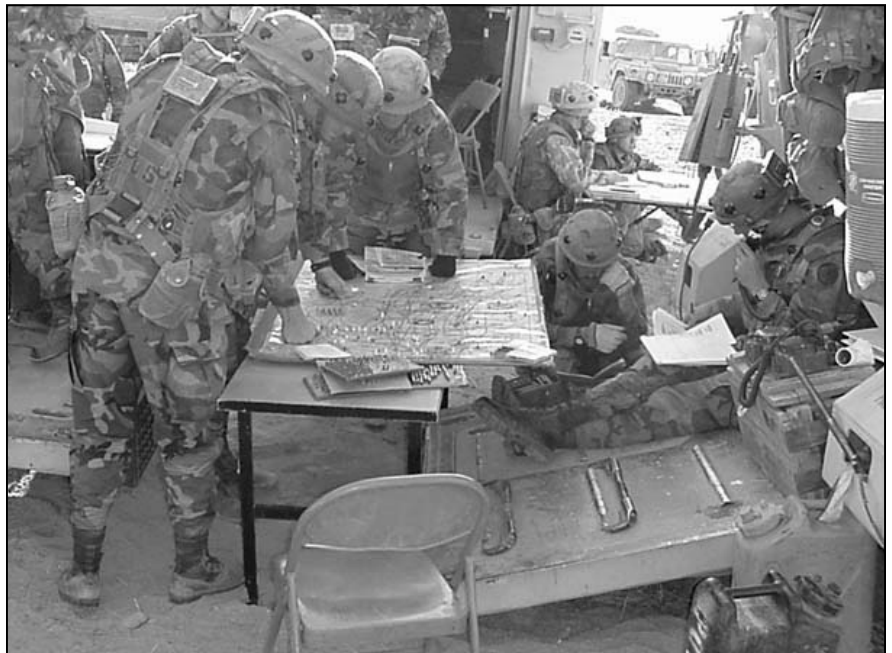

The brigade tactical operations center (TOC) conducts a targeting meeting.



- Commander's guidance for CAS is not specific.
- Fire support officer (FSO)/air liaison officer (ALO) are not prepared to wargame CAS.
- Airspace coordination areas (ACAs) are not developed in detail.
- Suppression of enemy air defenses (SEAD) is not planned in detail.
- Combined arms and fire support rehearsals are not addressing CAS.
- Excessive time taken briefing aircrews.
- CAS conflicts with indirect fires.
- CAS departs without executing the essential fire support tasks (EFSTs).

Figure 1: National Training Center (NTC) Trends. These areas need improving to more effectively integrate close air support (CAS) into ground operations.

direct support of the close fight under the main effort's task force control."

The ALO owes the commander advice and counsel on the correct and exploitive use of air power. The ALO is the commander's expert on air power and works hand-in-hand with the commander and his staff to integrate CAS into ground operations. He must be part of the military decision-making process (MDMP) and integrate air power into the wargaming process and into the entire scheme of maneuver. For the ALO to accomplish this, he needs the support of the commander.

Too often, we hear, "ALO, when will we get air?"

When we should hear, "ALO, the S-2 believes we'll identify the position of the enemy forces in the defense at 0630 and have the conditions set for our offensive. We will need the air on station at 0620 to support destruction of those enemy forces as they move from their hide sites to battle positions as we begin to smoke the objective."

"Roger, Sir. We will request air on station at 0615 so the aircraft are briefed and ready to employ on time. We'll request Maverick and gun to facilitate use in the close fight vicinity the POP [point of penetration]. I will have an ETAC in position to over-watch the POP [to provide final control and prevent fratricide]. When the task force breaches, I will shift CAS to EA [engagement area] Cobra to prevent enemy repositioning and reinforcing."

Airspace Coordination Areas (ACAs). To ensure we can mass fires instead of just deconflicting fires, we need to plan and implement ACAs to integrate all fires. Joint Pub 3.09.3 discusses TTPs for several ACA techniques: formal, informal and artillery-CAS joint attacks by separating fires laterally, by altitude and by time. Figure 2 lists some considerations for developing ACAs.



An enlisted terminal attack controller (ETAC) executes CAS.

An integral part of planning an air corridor for CAS is to provide for suppression of enemy air defenses (SEAD). One of the most difficult CAS missions to support is when the artillery provides SEAD for CAS and also fires on the target simultaneously with CAS aircraft. See Figure 3 for the CAS-artillery attack battle drill. We must use all the tools at our disposal to integrate and mass fires.

An important point to remember is that SEAD must be based on the threat and the tactics the CAS aircraft will employ to defeat the threat—not simply provide suppression in the attack area. For example, Maverick launch may take place several kilometers from the target. Another example: If we can employ air power above the low-altitude threats, SEAD only needs to deny the enemy employment of his mid- to high-altitude threat systems to be effective.

If we plan SEAD for every target area and a mark to expedite target identification for the aircraft, we will be prepared to execute that mission if needed and may obtain the added benefit of massed fires. The TTP in Figure 3 serves as a template for planning and integrating CAS to deconflict and mass fires—a template the ALO, ground commander and his key staff easily can understand and execute.

Targeting. As stated in *FM 6-71 Fire Support Handbook for the Maneuver Commander*, the purpose of the targeting meeting is to update and revalidate targets, coordinate target acquisition (TA) assets and update the HPTL and attack guidance matrix (AGM). In terms of CAS, the key personnel who must attend the targeting meeting include, but are not limited to those shown in Figure 4 on Page 28.

Throughout this process, the targeting methodology of *decide, detect, deliver, and assess* (D³A) should be stressed. An unclear targeting process can delay the execution of air power to the extent that we lose it all together. The staff needs to keep in mind the lethality of CAS, but equally important, it must remember its fleeting nature. Sooner or later, the air-



- Where is the target area (when CAS is available)?
- What is artillery shooting and from where?
 - Where is the direct support artillery, reinforcing artillery and mortars?
 - Have we considered the fire and maneuver plans?
- What is the air defense threat?
- What are our sector boundaries?
- How much maneuver airspace do our fighters need? *
- Have we considered weapons employment?
- What ACA type (or combination) will complement all our fires (lateral, time or altitude separations)?
- Will we need suppression of enemy air defenses (SEAD) for this mission, and if so, can we range the targets?

*A-10s require less than F-16s or F/A-18s, but all require at least six to eight kilometers with at least four kilometers maneuvering space around the target.

Figure 2: Questions to Answer to Develop Airspace Coordination Areas (ACAs)

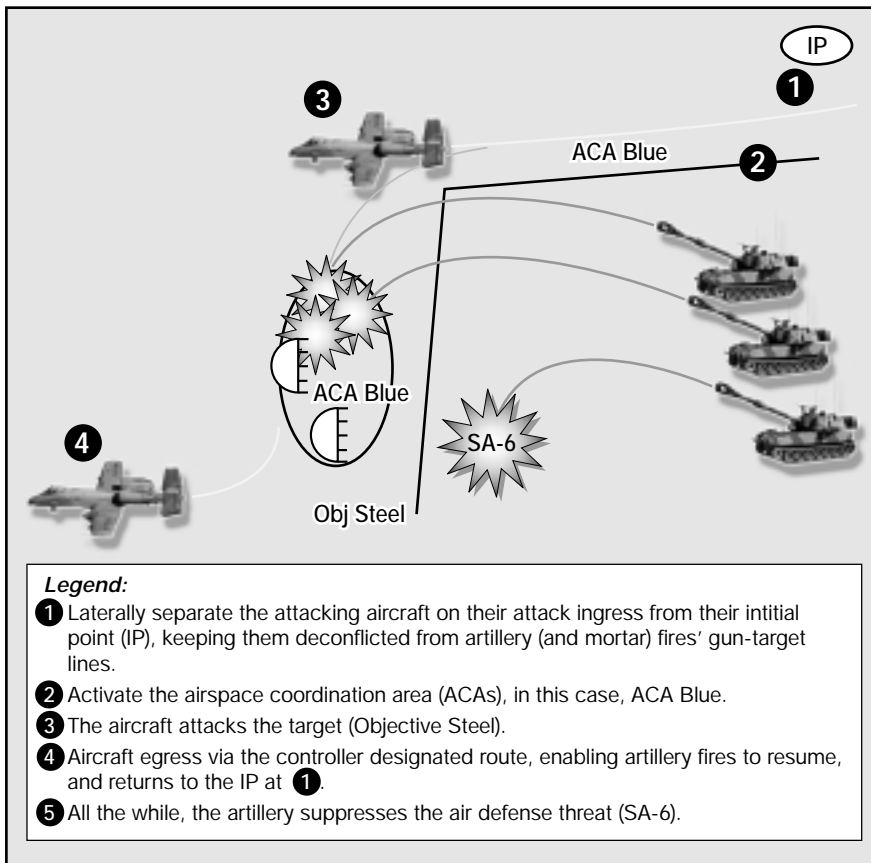

Figure 3: Close Air Support (CAS) and Artillery Attacking the Same Target

craft will run out of fuel and need to return to base.

CAS Drill. As soon as the ALO (or any TACP member) receives word of aircraft launch or tasking to their AO, he communicates this to the supported unit's executive officer (XO). Essential information is first the projected time on station. Other information includes weapons load, loiter time, airspace requirements and system capabilities. This information also needs to be communicated to the air defense artillery (ADA) cell to ensure everyone understands that friendly aircraft are arriving on station.

At this point, the target needs to be verified or selected. A running CAS focus expedites this process and simply requires the staff validate the target for the TACP. This process must be expeditious and completed before the aircraft checks in on-station. The earlier the target is available, the better.

The air support operations center (ASOC) can pass target updates to fighters while still enroute to the AO (as recommended in Joint Pub 3-09.3). In this case, when the CAS checks in, the pilots already will have gotten their target data, to include a nine-line CAS briefing, and are nearly ready to attack

the target with minimal additional coordination with the TACP.

Assuming our target is selected for CAS, we then plan for SEAD. These may be tactically located in the same target area (suppressing the man-pad, small arms and light anti-aircraft artillery threat) or in an adjacent area with a significant threat (SA-6/8, etc.). When planning SEAD, don't forget holding, ingress and egress threats.

As the aircraft check in, any information not passed to them by the ASOC needs to be transmitted. By now, the pilots need to know the nine-line briefing (or updates), threats, commander's intent, location of the forward-line-of-own-troops (FLOT), location of fire support coordination measures (FSCM), final controller information, any specific instructions and any other information deemed applicable.

At this point, we are ready to coordinate the attack. This may be by time-hack or time-over-target. In a very low-threat environment, we may clear the fighter pilots directly to their target or final controller. The pilots need a realistic and rehearsed process driving they're timing—for example, if the coordination process demands a seven-

minute hack, don't attempt a five-minute hack.

The next several events happen in rapid sequence or simultaneously. The FSO calls the fire direction center (FDC) to fire SEAD; the air defense officer (ADO) changes weapons control status. The targeting cell selects secondary or "back-up" CAS targets. The FDC calls with SEAD "Splash." The FSO then calls all fire support elements (FSEs) and activates ACAs as required.

The ALO/TACP announces fighters departing the initial point (IP). The fighters engage the target and egress per their briefed instructions. Now the ALO/TACP announces the fighters are clear of the ACAs and unencumbered fires can resume. ACAs are closed (if required), and the ADO changes weapons control status.

An important culmination to this process is the transmitting of battle damage assessment (BDA) and battlefield intelligence from the fighters/FAC-A to the brigade combat team (BCT). Often this may be the best and most timely source of battlefield reconnaissance data.

So, as we look at our earlier scenario, an example of a possible CAS battle drill might be:

ALO: "CAS airborne, expect on time at 0615."

Staff: "CAS airborne."

XO (After Targeting Meeting): "Focus of CAS, enemy armor west of the POP [point of penetration] vicinity 4215; closest friendlies east of the obstacle, east of the 40."

ALO: "Roger, Sir. Armor vicinity 4215; I have an ETAC with eyes on."

FSO: "Understand CAS focus 4215; preparing SEAD mission."

ALO: "Roger, we'll need target area SEAD and as soon as splash, no fires west of the 46 above 9,000 feet MSL [minimum sea level]...CAS on station."

Staff: "CAS on station."

ADO: "Weapons control status yellow tight." (While this is going on, the fighters are getting their nine-line briefing, if not previously relayed, and target area coordination and description.)

FSO: "SEAD mission ready; ready for five-minute hack."

ALO: "Five minute hack ready; ready, hack."

FSO: "Good hack."

Pilots: "Good hack."

ALO: "Fighters departing the IP."

FSO: "SEAD shot, out....SEAD splash."

ALO: "I need no fires west of the 46 above 9,000 feet."



- Brigade executive officer conducts the targeting meeting.
- Brigade FSO and targeting officer ensure fire support asset allocation, validates the high-payoff target list (HPTL) and updates the high-value targets (HVTs)/HPTL.
- Brigade S2 provides target updates and retasks collection assets.
- Combat observation lasing team (COLT) platoon leader provides target updates.
- Air liaison officer (ALO) ensures sortie allocation to the targets and provides target updates.

Figure 4: In terms of CAS, these are the key personnel who must attend the targeting meeting and their responsibilities.

FSO: “Roger, no fires west of the 46 above 9.”

ALO: “Fighters inbound.”

ADO: “Visual with friendly fixed wing.”

XO: “Secondary CAS target EA [engagement area] Cobra.”

ALO: “Fighters engaging armor... Fighters off target, cancel ACA.”

FSO: “ACA canceled.”

ADO: Weapons control status red tight.”

ALO: “Fighters report three tanks destroyed, four to five armored vehicles observed at 4015 moving northeast.”

XO: “Roger, can the fighters engage that target?”

Barriers to Execution. The following are some of the most common barriers to executing CAS effectively as observed at the NTC.

Lack of Clear Guidance. Without knowing where to plan for CAS, it’s difficult to prepare to execute.

Lack of Willingness to Use CAS Close. Although a great tool in shaping the battlefield, CAS also can produce devastating effects in the “knife-fight.” Imagine the shock of an enemy hammered with indirect fires, direct fires, electronic countermeasures and CAS.

Lack of Willingness to Shut-Down or Shift Fires. CAS is a very lethal but fuel-limited asset. The BCT needs to think carefully about employing all its fires. However, based on the mission and lethality, a shift or “check fire” of the brigade’s ground fires may be warranted. If this is the case, the ALO/TACP needs to ensure CAS is executed promptly so ground fires can resume.

Lack of Effective Observation. ETACs need to be considered a critical asset and put in position to control the air power. This should be in concert with the scheme of maneuver and commander’s intent. Additionally, the BCT should be prepared to employ positive indirect CAS using data from scouts and combat observation lasing teams (COLTs).

Slow or Ineffective SEAD. When SEAD is needed, it is needed *now*. The lack of timely, effective SEAD results in the loss of irreplaceable aircraft—they cannot be returned to the fight.

Lack of Complete Battlefield Calculus. CAS can be employed very close to friendlies and with devastating effects if the lay of the battlespace is fully understood. Terrain features and obstacles can create CAS employment areas and targeting opportunities of sizeable significance. A visually significant tank ditch can clearly be communicated as well as the delineation of friend and foe. Something as simple as, “Enemy north of the ditch” can create a clear opportunity for CAS to support a penetration.

CAS Not Synchronized with Fires. Massing is the key. At all opportunities, we should bring joint and combined arms to bear on the enemy. The artillery can force the enemy to move, making him visually significant to CAS. When struck with CAS, if the enemy goes to ground, he becomes an ideal artillery target. This complementary effort creates an untenable situation for our foe.

CAS Not Synchronized with Maneuver. The effects of CAS can be maximized by using channelizing terrain and obstacles to force the enemy into concentrations. This creates an ideal opportunity for CAS aircraft to reap the full effects of their munitions. Additionally, CAS can be integrated with smoke as a trigger to catch repositioning forces in support of an objective. Coordinating the availability of CAS in this role can significantly influence the outcome of an attack.

Conclusion. Joint Pub 3-09.3 lists the conditions for effective CAS as “air superiority, suppression of enemy air defenses, target marking, favorable weather, prompt response, aircrew and terminal controller skill, appropriate ordnance, communications, and com-

mand and control.” The brigade staff, in concert with the TACP, controls or, at least, influences the great majority of the items on this list.

CAS can be integrated into and synchronized with the ground fight with devastating effectiveness. The key is the ground unit must have a tactical standing operating procedures (TAC-SOP)-driven CAS process that maximizes the lethality of CAS while minimizing its limitations and that is rehearsed and understood across the BCT staff.

CAS, as an additional weapon in the commander’s arsenal, is significant. CAS, as an integrated and synchronized element of the BCT’s fighting force, becomes a force multiplier, a battlefield shaper and a key contributor to a victorious consequence.



Major David G. Smith, USAF, until recently, was Raven 02, the Air Liaison Officer (ALO) attached to the 11th Armored Cavalry Regiment at the National Training Center (NTC), Fort Irwin, California. His duties included training and evaluating the close air support (CAS) mission and personnel in joint operations with the Army. He is a Master Navigator with 2,700 hours rated in B-52 bombers. He currently is serving as the Experimental Test Flight Radar Navigator for B-52s assigned to the 419th Flight Test Squadron at Edwards AFB, California. Major Smith is a graduate of the Air Command and Staff College at the Air University, Maxwell AFB, Alabama. He holds a Master of Aeronautical Science (Management) from Embry-Riddle Aeronautical University, Daytona Beach, Florida.

Major Jonathan E. Bachman, USAF, Raven 03, is Director of Operations in Detachment 2, USAF Air Ground Operations School at the NTC, Fort Irwin; among other duties, he is responsible for training and evaluating CAS missions and USAF personnel supporting the Army at the NTC. He is a Command Pilot with more than 2,900 hours in the F-111 Aardvark, F-117 Stealth and T/AT-38 Talon. In his previous assignment, he was the Operations Officer of the F-117A Operational Test and Evaluation Squadron, 53d Wing, on Holloman AFB, New Mexico. Also at Holloman, he won Top Gun during the 1995 Gunsmoke worldwide gunnery competition for the best precision-guided weapons delivery and 8th Fighter Squadron Instructor Pilot of the Year. He is a graduate of the Air Command and Staff College and holds a Master of Aeronautical Science from Embry-Riddle Aeronautical University.

Task Force Fire Support Evolution: FIST Employment Concepts

By Captain R. Reed Anderson

Time and time again brigade combat teams (BCTs) at the Combat Maneuver Training Center (CMTC) in Hohenfels, Germany, learn the cruel reality that the fire support team vehicle (FIST-V) is an outdated target acquisition (TA) platform. The reason for this is twofold. First, the vehicle is unable to keep up with maneuver; it lacks survivability and maneuverability; it has a high silhouette; and it uses older, slower technologies, for example, its north-seeking gyro (NSG) alignment times. Second is the vehicle's lack of flexibility, both from the company commander's perspective and from the FIST's ability to execute essential fire support tasks (EFSTs).

This article addresses solutions to mitigate FIST-V limitations using the Bradley fire support team vehicle (BFIST) and the Striker high-mobility multipurpose wheeled vehicle (HMMWV). It then suggests employment tactics, techniques and procedures (TTPs) for the proposed solutions.

Equipment and Manning. To mitigate the failings of the FIST-V as quickly as possible and then for the long term, I propose two FIST employment concepts—one using the Striker HMMWV and one using the BFIST—as outlined initially by its equipment and manning requirements.

Striker HMMWV Concept. The Striker HMMWV concept is similar to that of the Interim Brigade Combat Team's (IBCT's) use of wheeled vehicles as the primary platform. The Striker HMMWV combines proven components of the BFIST mission equipment package (MEP), the technical TA and processing brains of the system, with the mobility, flexibility and the stealth of the HMMWV. Engineered Support Systems, Inc., the manufacturer of the Striker HMMWV, announced in November 2000 it had received final approval for full-rate production of the Striker HMMWV with the Army planning to purchase more than 800 systems during the next 10 years.¹

There are two versions of the Striker HMMWV. Striker II adds a remote controlled multi-sensor suite to the Striker advanced fire support package.² This suite, although useful for the combat observation lasing team (COLT) mission, would not be necessary for a FIST Striker

HMMWV. All the other components of the MEP planned for Striker II are applicable.

The Striker HMMWV is a viable solution to replace the FIST-V for several reasons. First, it provides the same capabilities as the FIST-V plus uses more advanced technology for self-location and has interfaced mission-processing software. Second, the stealth of the HMMWV is significantly increased—not only over the FIST-V's stealth, but also BFIST's. The HMMWV has a lower silhouette, drives quieter, idles quieter when required to run the engine for power production and is easier to hide and dig-in. Granted, it does not have the self-defense platform that comes with the BFIST, but the FIST vehicle was never intended to be a direct fire platform.

In recent experiences at the CMTC, HMMWVs were used when FIST-Vs were not operational; the HMMWVs gave the FIST a greater ability to infiltrate to planned observation posts (OPs) and is a more survivable platform. Therefore, the HMMWVs will give the task force (TF) commander greater flexibility in positioning his fire support acquisition assets in the battle where and when he needs them.

Manning under the Striker HMMWV concept would remain unchanged from the FIST-V: fire support officer (FSO), the fire support NCO (FSNCO), a radio/telephone operator (RTO) and driver. Their responsibilities would mirror their responsibilities in the FIST-V.

The advanced technology and increased abilities of the Striker HMMWV over the FIST-V make this concept a viable one for integration in the near



Striker HMMWV



Instead of manning the BFIST with a four-man crew, it should be manned with a six-man crew. This would allow a two-man team to dismount at a strategic location and observe the enemy.

future. With 800 systems potentially available within the next 10 years, the Army could easily refit the six heavy divisions with Striker HMMWVs fairly quickly: nine FISTs and six COLTs per maneuver brigade for a total of 15 Striker HMMWVs required per brigade times three brigades for a total of 45 for a division and 270 to refit the six heavy divisions. For those units still resourced with the FIST-V, we could field the Striker HMMWV to them first and get the older, more ineffective technology out of the fight first; this would enhance our ability to find and kill the enemy—provide timely and accurate fire support for our maneuver commanders.

BFIST Concept. The fielding of the BFIST² is already mitigating the lack of survivability and maneuverability of the FIST-V. However, not all heavy divisions have or are scheduled to field the BFIST.

Additionally, it is doubtful that company commanders will be any less reluctant to allow the BFIST the flexibility to maneuver freely to execute FIST EFSTs. The company commander often relies on the company FSO for execution of the fire support plan and uses the FIST-V as a communications and intelligence platform. This impedes the FIST from completing its dual mission of TA and fires integration.

The best solution to completing the dual mission is to operate under a split-based system. The BFIST stays with the company commander, giving him immediate access to his company FSO, yet frees elements of the FIST to accom-

plish the mission. This also gives the TF commander flexibility in planning fires.

Instead of manning the BFIST with a four-man team, it should be manned with a six-man team. The company FSNCO would serve as track commander (TC), the FSO as the gunner (only uses the 25-mm gun to disengage from the enemy) and 13F10 Fire Support Specialists as the RTO and driver. These four would man the primary fire support platform.

The remaining two soldiers would be a 13F20 or senior 13F10 and an additional 13F10. They would allow the FIST to operate in a manner similar to that of the infantry forward observer (FO) teams in some mechanized infantry fire support elements (FSEs), dismounting a team of two from the BFIST at a strategic location to observe the enemy. These positions are scheduled to fall off the modified table of organization and equipment (MTOE).

The BFIST would retain its primary purpose to acquire targets, and the FIST would retain its primary duties and responsibilities.

Employment TTPs. The HMMWV and BFIST concepts have different TTPs.

Striker HMMWV TTP. FIST control options for the Striker HMMWV remain the same as with the FIST-V: centralized or decentralized, although execution of the mission in each control option is slightly varied.

Under centralized control, the TF commander and FSO develop an observation plan to position the FISTs where the TF commander needs them to execute his scheme of fires. In this option,

the FISTs could be integrated into the reconnaissance and surveillance (R&S) plan and deployed in conjunction with the TF scouts.

Under decentralized control, the company commander and company FSO develop an observation plan synchronized with the company scheme of maneuver that allows the FIST to execute its EFSTs. The company commander has two options under decentralized control for FIST employment. First, to enable the FIST to position itself on the battlefield in the right place and still provide fire support integration for the company commander, the FIST would use its stealth and infiltration capability with the HMMWV to position two members of its team forward in a dismounted OP. The FIST HMMWV might need a small security force provided by the company commander (e.g., section of Bradley fighting vehicles), as dictated by mission, enemy, terrain, troops and time available (METT-T).

The FSNCO and RTO would man the dismounted OP and would take all necessary equipment to carry out the mission, to include the lightweight laser designator rangefinder (LLDR). The HMMWV and security force then would return, and the HMMWV would move to a position from which it could provide fire support integration for the company commander and still process missions from the dismounted OP. The FSO and driver, who is now acting as an RTO as well, would man what would be a fires integration and communications platform for the company commander.

The second option is to release the entire FIST with the HMMWV to execute its observation plan using its stealth and infiltration ability to get to the right place at the right time. Use of a security force to get the team safely into position would be METT-T dependent. In this option, the commander loses his “hip pocket” FSO, but he does not lose his fires integration capability as long as the FIST remains in communications range—a necessity so it can talk to the TF FSE. The advantages of this option over the dismounted option is that it allows more flexibility for the FIST to reposition to execute its EFSTs and to meet the needs of the fluid battlefield and any changes to the TF commander’s scheme of fires.

Either option provides the TF commander and FSO the flexibility to put the TA assets in the right place on the battlefield at the right time.

BFIST TTP. Under centralized control, the BFIST concept is similar to the Striker HMMWV concept except the TF commander and FSO have the option of infiltrating the FO teams with TF scouts or assigning infiltration responsibilities to one of the FISTs. If the FO teams infiltrate with the TF scouts, then the FO observation plan must be fully integrated into the R&S plan as well as the fire support plan.

Under decentralized control, the BFIST would be used as the primary fire support vehicle at the company level. The company FSO would make an aggressive observation plan that positions the FIST to execute EFSTs and integrate fires for the company commander. Likewise, the company commander must be willing to allow the FIST to execute its observation plan and provide security, when METT-T dictates.

The company FSO also must develop an FO team observation plan from which the FO team can execute its EFSTs, provide early warning and (or) target engagement, as well as target hand-off from COLT or TF scouts. Once the company commander approves the observation plan, the company FSO uses the BFIST to deploy the FO team to a determined location from which the FO team then would infiltrate dismounted to its OP. The FO team would go light, carrying with them the basic resources required to survive and acquire and engage targets: mini eye-safe laser infrared observation set (MELIOS), precision lightweight global positioning system receiver (PLGR), forward-entry device (FED) and radio. The BFIST still would retain responsibility for target designation.

The end state using this concept is twofold: the company commander has fire support resources to execute EFSTs and integrate fires, and the use of the FO teams (three per TF) gives the TF commander greater flexibility in his observation planning to position observers to execute EFSTs.

A Common Caveat to all Concepts. A potential key aspect for all these concepts is the integrated training of the TF fire support assets with the maneuver unit. Simply stated, all three FISTs and the TF FSE would need to be organic assets assigned to the headquarters and headquarters company (HHC) of the maneuver battalion as they are in the new IBCT. Similar to medics and maintenance sections, the fire support platoon would maintain a habitual rela-

tionship with maneuver companies, thus giving the company commander ownership of his FIST.

The TF FSNCO and TF FSO would retain responsibility for fire support training for the FISTs and integrate their training plan with that of the company commanders and the maneuver battalion. This would allow the TF FSO to fully integrate fire support training into the company commander's training plan, helping to develop the idea of ownership of fires, and still provide the 13Fs their essential fire support training. In addition, the TF FSO would be an integral part of the battalion staff.

An additional and vital element to this is the integration of the fire supporters with the direct support (DS) artillery battalion. This can be accomplished through weekly brigade FSE meetings to synchronize all fire support training. During these meetings, the brigade FSO and DS artillery battalion S3 would integrate gunnery and other related training events with the TF FSOs. In addition, to facilitate maintenance of today's digital battlefield skills, weekly digital sustainment with all FISTs, FSEs and firing unit elements would be a must.

The result would be well-trained and -integrated fire support teams, which in turn would facilitate synchronization of fires on the battlefield.

A Proposed Near- and Long-Term Plan. There is no one right way to solve the challenges created by the FIST-V. A proposed immediate and, perhaps, long-term solution follows.

First, units with the BFIST or programmed to field the BFIST (i.e., funds have already been allocated) would continue to field and use the BFIST. However, personnel authorizations would be adjusted to provide a two-man FO team to each FIST.

All other units, minus the IBCT that would continue with its plans, would field the Striker HMMWV. With the number of Striker HMMWVs scheduled for production in the next 10 years, all heavy divisions could be fielded either the BFIST or Striker HMMWV in the next four years, thus negating the combat ineffectiveness of the antiquated FIST-V.

A key aspect here is that no matter what platform a unit uses, the MEP is the same, thus providing a common technical TA platform requiring common training for all heavy units.

Conclusion. The proposed plan strives to solve our FIST-V challenges by providing a modern, survivable, maneu-

verable and practical platform for TA and fires integration. In addition, organic relationships with maneuver units will facilitate integrated training and make the most effective use of our time to learn how to maneuver with our combat arms brethren and integrate fires. Anyone can learn the technical skills of fire support in a classroom, in a fires simulator or sitting on an OP. To learn how to maneuver and infiltrate our new fire support platforms, the FIST must maneuver on a regular basis with its unit.

Based on lessons learned over and over again at the CMTC and other CTCs, the current fire support resources (minus those units with the BFIST) and configuration of mechanized task forces are essentially ineffective. We must be creative and adaptive to find better ways to accomplish our mission of TA and fires integration. The possibilities discussed using new assets and adapting employment TTPs to facilitate execution of fires, would provide greater flexibility and adaptability and would also save in operations tempo (OPTEMPO) dollars (the HMMWV costs much less to maintain than a FIST-V or BFIST). By configuring FISTs to provide eyes in depth and giving them proper resources, they will better influence and shape today's battlefield and that of the future.

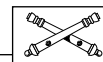

Captain R. Reed Anderson is the Assistant S3 of the 1st Battalion, 6th Field Artillery, which is direct support to the 3d Brigade of the 1st Infantry Division (Mechanized) in Germany; the article's contents are based on lessons learned during Combat Maneuver Center (CMTC) rotations with the 3d Brigade at Hohenfels, Germany. Also in Germany, he was a Battalion Fire Support Officer (FSO) in the 1st Battalion, 63d Armor, part of the 3d Brigade in the 1st Division, and Training Officer in G3, V Corps. He served as a Company FSO in D Company, 1st Battalion, 34th Armor, and Fire Direction Officer, Firing Platoon Leader and Battalion S4 in the 1st Battalion, 5th Field Artillery, all in the 1st Infantry Division at Fort Riley, Kansas. He is a graduate of the Field Artillery Captains Career Course at the Field Artillery School, Fort Sill, Oklahoma.

Endnotes:

1. Engineered Support Systems, Inc., Press Release, dated 20 November 2000, located at the Systems and Electronics, Inc., web site at www.seistl.com.
2. Systems & Electronics, Inc., web site contains product information on the Striker series and the BFIST at www.seistl.com.

Our “dirt” Combat Training Centers (CTCs) have been the greatest boosts to training our Army has seen in the last two decades. Although CTC “lessons learned” are focused on the close fight and the CTCs do not replicate artillery well in many circumstances, artillerymen have learned from CTC rotations that responsiveness is key to artillery effectiveness in *all* circumstances.

As we look forward to transformation, responsive, long-range fires will be the

key to success for both the Interim and the Objective Forces. Artillerymen must continue to increase that responsiveness.

Here are a few thoughts gleaned from my 30 years in the Army, most of which were spent working with Field Artillery and fire support.

There are simple things we can do to cut fire mission processing times. We must cut slow, complicated processes. Illumination and smoke missions come immediately to mind. In former days, we could afford long adjustment times

for coordinated illumination. No longer. Nowadays, especially with the night-vision devices we have, we no longer have to conduct the finesse adjustments that were required earlier.

First rounds should be two- or four-gun illumination. Adjustments should be made to the guns only as required by the mission and as time allows. Most of the time, with the modern night-vision devices and target location equipment, two or four illumination rounds in the vicinity of the target provide sufficient visibility to attack the target.

The same is true with smoke. You can begin shooting your battery smoke immediately and adjust off of the initial mark. We no longer can afford the time to adjust high-explosive (HE) and then fire smoke.

Furthermore, our maneuver commanders must be trained to be flexible and agile enough to use the smoke as it is delivered (location and density) to breach the obstacle and attack the objective. Fort Sil, in consultation with the Infantry and Armor Centers, has to update mission training plan (MTP) standards to reflect the required responsiveness.

Advice to Field Artillerymen:

Making Fires Key to Objective Force Success

By Lieutenant General William J. Lennox, Jr.



We've come a long way with computers and digitization—we must use them. Field artillerymen have to know ballistics, and they have to know their software. Only by knowing ballistics and the intricacies of the software can we be responsive.

This statement has several corollaries. There is not enough time to train (in schools or in field units) using both computers and old manual methods. We must have a computer backup for our main system, and if that goes down, we should deadline the system and fix it expediently.

Working manual backups slows us down—first, because we cannot train to the level of expertise we need, and second, because these methods are inherently slower.

This is controversial, but we have to step into the 21st century and learn our ballistics well and the systems that give us computer and digital advantages. We must learn to trust in and rely on our digital systems and capabilities.

We must use distance learning in ways we are just beginning to understand. Distance learning gets the expertise of the schoolhouse out into units. We must set up Fort Sill classes on firing techniques, software and ballistics for unit training via distance learning. We can tie Fort Sill expertise to unit training.

We need to simplify our ammunition. Multiple munitions, propellants and fuzes pose an unacceptable challenge for our operations officers and logisticians. For example, 155-mm howitzer section chiefs have 20 projectiles, 14 fuzes and six propellants to juggle. We have to demand simpler systems.

As we simplify ammunition, we should study the munitions of other nations. Some allied munitions give one gun the power of many. Fuel air explosives, for example, can provide the simple, single-

gun shock action that is the equivalent of several of today's battalions.

In the future, we also have to emphasize our sensors. Our fire support teams (FISTs) must remain capable of being the "eyes" of the force, and as such, they should have the best target acquisition tools we can develop. In the past, FIST equipment has been a second thought. Now, as we upgrade our reconnaissance forces, our FISTs and Strikers should be armed with, at least, the same level of capabilities.

Our lightweight laser designator rangefinder (LLDR) that will be fielded to the 82d Airborne Division, Fort Bragg, North Carolina, and Interim Brigade Combat Team (IBCT) at Fort Lewis, Washington, within the year was a long time in coming. It will accurately locate targets at 10 kilometers and designate the target for smart munitions. We need to keep the funding coming for fielding to the entire force and continue to develop follow-on technologies for our FISTers.

The deep fight is critical to shaping the battlefield. Unmanned aerial vehicles (UAVs) will be key and should provide immediate digital feeds to our new effects coordination centers (ECCs). Advanced warfighting experiment (AWE) lessons learned demonstrate that teaming UAVs with delivery systems pays immediate dividends against high-pay-off targets (HPTs).

Currently the Hunter UAV does not provide a direct digital link through the all-source analysis system (ASAS) to the advanced Field Artillery tactical data system (AFATDS). However, the Shadow tactical UAV (TUAV) will have this critically important capability.

Engaging moving targets has always been tough—let's get it right. The Army tactical missile system (ATACMS) with its BAT submunitions will enhance our

ability to attack moving targets greatly. Also, adding rounds that provide surveillance and automatic target recognition (ATR) place the targeting burden where it should be: on the down-range sensor (in this case the round), rather than on computers, gun chiefs and FISTs. Both BAT and ATR rounds have the added benefit of cutting logistics tails and simplifying ammunition management.

Responsiveness is key to the Artillery's future. We, as Artillerymen, must increase our knowledge of our craft, exploit modern systems for all they're worth and just make it happen. The effectiveness of the Objective Force will depend on our responsive fires.



Lieutenant General William J. Lennox, Jr., is the Superintendent of the US Military Academy at West Point. In his previous position, he served as Chief of Congressional and Legislative Liaison in the Office of the Secretary of the Army. He also has served as the Deputy Commanding General of the Eighth US Army and Assistant Chief of Staff, CJ3, of the Combined Forces Korea; Chief of Staff of III Corps and Fort Hood, Texas; and Deputy Commanding General of Fort Sill and Assistant Commandant of the Field Artillery School, Fort Sill, Oklahoma. He commanded the 24th Infantry Division (Mechanized) Artillery at Fort Stewart, Georgia, and the 5th Battalion, 29th Field Artillery in the 4th Infantry Division (Mechanized), Fort Hood, the same division in which he commanded a firing battery. Among other positions, he was a Forward Observer, Battery Executive Officer, Company Fire Support Officer, Battalion Operations Office and Battalion Executive Officer. He holds a Master of Arts and Doctorate in Literature from Princeton University and was a Senior Service College Fellow at Harvard University.

ARNG On-Line College Degrees

Capella University, Minneapolis, Minnesota, has signed an agreement with the Army National Guard Institute and Coast Guard Institute to provide on-line college degree programs. As part of the agreements, Capella University will offer Army National Guard soldiers and Coast Guardsmen, their families and civilian employees discounts on tuition.

Capella is an accredited university with more than 3,000 students in 40 countries enrolled through its on-line campus. The university offers courses, certificates and degree programs in business, human services, education, psychology

and technology. The two institutes have expressed particular interest in Capella's MBA program and bachelor's degree in information technology.

Military research shows that due to busy schedules and work lives, it takes the average military member seven years to earn a bachelor's degree from a traditional university. On-line programs provide the flexibility for the service member to continue his education no matter where his tour of duty takes him.

For more information, contact www.capellauniversity.edu or call 1-888-227-3552.

Doctrine Under Trial: American Artillery Employment in World War I

Mark E. Grotelueschen, Westport,
Connecticut & London: Greenwood
Press, 2001, 174 Pages, \$62.50

Our Army is currently struggling through a period of change as we enter the 21st century. Many of the questions of organization and doctrine are not unlike those that a previous generation of artillery officers faced. At the dawn of the 20th century, armies worldwide were in a state of upheaval as their leaders struggled with the challenge of how to harness overwhelming firepower at a time when logistics, transportation and communications capabilities lagged behind.

Mark E. Grotelueschen provides a glimpse of how the US Army's antiquated pre-World War I doctrine evolved on the battlefield to overcome the challenges of combat. Further, the author introduces the reader to the conflict that arose among post-war leaders over what our warfighting doctrine would look like in the wake of the world war.

This book is a thought-provoking account of challenges to consider and a "must-read" for Field Artillerymen grappling with finding solutions to similarly vexing problems today.

Documenting Artillery Developments. The purpose of Grotelueschen's book is to fill a glaring gap in the historiography of artillery development in World War I. Much is written about the experiences of the European powers in terms of the evolution of artillery tactics. In addition, there is a great body of work concerning the birth, training, deployment and the combat experience of the American Expeditionary Force (AEF). However, no one has chronicled the interesting and important development of the AEF artillery in the war.

Because there are a great number of official documents from the various Field Artillery units from the war with widely varying experiences, Grotelueschen chose to focus his work by exploring the record of a single division artillery, the 2d Infantry Division Artillery. The 2d Division's set organizational structure combined with its combat experience from various sectors on the Western Front made it an excellent case study through which to gauge the Field artillery branch as a whole.

State of the Branch before the World War. Grotelueschen begins by providing an overview of the Field Artillery at the outbreak of World War I and its role within the larger US Army doctrine. Using many contemporary doctrinal sources and professional literature, such as field manuals and *Field Artillery Journals*, the author succinctly traces the status of the branch in reference to training, organization and doctrine. Grotelueschen introduces the reader to a Field Artillery branch that is "professionally dormant, unprepared" and organizationally "obsolete."

The experience of the Allies in the Great War forced them to reconsider their infantry, offensive-oriented doctrine in the

face of the dominance of firepower. As stated by the AEF commander, General John J. Pershing, US doctrine still retained the Allies pre-war conceptions of combat. The author concludes that, "[I]n short, when America joined the war, the whole of its army, and especially its field artillery branch, was too small, devoid of any applicable combat experience, insufficiently trained, and in possession of a doctrine that did not appear in any way suited to the daunting military operations that lay in its future in Europe."

As the author notes in succeeding chapters, unfortunately for the soldiers of the AEF, the horrific combat characteristics of the Western Front forced a change in the thinking of our leaders. Pershing arrived in France wedded to the concept that the infantryman with rifle and bayonet dominated the battlefield. He believed the Allies had lost their aggressiveness and become "overreliant [sic] on artillery support."

One American observer noted that Allied infantry officers "do not hesitate to say that infantry should not leave its trenches until artillery has smashed all targets" and further "can advance only so far as their artillery can escort them with fire." Pershing felt this attitude bred timidity in the infantry, and he sought to show the Allies what the American Army could do. The 2d Infantry Division's baptism by fire in Belleau Wood began the slow, evolutionary change to this mentality and tactics and techniques, based on the reality of modern combat.

Slow Changes. In June 1918, the 2d Division deployed to the front after a period of training under the tutelage of French officers. In spite of French efforts to impress the need to use artillery as an integral part of any offensive action, their suppositions went largely ignored as the division entered the fray to stop the massive German Spring Offensives. The soldiers and Marines of the division deployed opposite a thin stretch of timber known as the Belleau Wood.

The French corps commander ordered a limited counteroffensive to halt the German advance. The 2d Infantry Division received the mission to take Belleau Wood and planned to take it using the doctrinal concept of "self-reliant infantry." The result was a tragedy as the brigades attacked devoid of any artillery support. The fight convinced one brigade commander that it was "impossible to attack hostile machine gun positions without artillery."

As a result of this grim lesson, the division planned a subsequent attack that began with a massive artillery preparation followed by a rolling barrage and concluded with a standing barrage upon objective consolidation, the latter similar to a final protective fires (FPFs). The division staff planned a well-synchronized fire plan for this assault, and it succeeded in marked contrast to the infantry-only attack.

The author continues to breakdown how the fledgling AEF artillery came into its own at the battles of Vaux, St. Mihiel, and Mont Blanc. However, some in the AEF still attempted ill-conceived self-reliant infantry assaults, such as at Soissons.

By late 1918 these officers—at least at the divisional level—were in the minority as most realized that a combined arms approach complete with copious numbers of artillery weapons proved the best way to mount an offensive. The AEF did not take the final step in its doctrinal evolution in World War

I. This took continued efforts to evolve the doctrine during the inter-war years.

Grotelueshen demonstrates in the closing chapters that although the AEF had perfected the set-piece battles, as at Meuse-Argonne, it still had not solved the challenge of making and exploiting a breakthrough. In the closing days of the war, the Allies made their greatest advances, but as they neared the point of making the long-sought-after breakthrough, the offensives petered out.

Why? The author alludes to the fact that the problem lay in a lag in the technological development of transportation, logistics and tactical communications systems. Although by the end of the war, use of motor tractors, transport vehicles and wireless communications had begun to catch up to firepower on the battlefield, tactics, techniques and equipment availability were inadequate at best.

A particular problem that he points out is in the realm of liaison between artillery and infantry units. The AEF had not developed a standard doctrine for the duties and responsibilities of artillery liaison officers. Moreover, such officers needed cumbersome field telephones to carry out their vital duties. This required time to set up the equipment and lay wire all while the battle situation changed.

Although commanders took strides to codify duties, responsibilities and tactics during the Great War, much remained unresolved at the termination of fighting in November 1918.

Conclusion. The author concludes by identifying the beginnings of a power struggle for the soul of the US Army in the post-war years. While there were those who advocated a more conservative style of warfare as a result of their experiences on the Western Front, the infantry, offensive-centered devotees still abounded, particularly among officers who served at echelons above division.

Because our involvement in the war only lasted a few months, all of our officers did not succumb to the more conservative line. A good many, including Pershing, still believed in the nebulous concept of "open warfare" using self-reliant infantry rather than a combined arms approach. The

conservative approach lost in the inter-war years as technological advances in transport, logistics, communications and, most notably, the tank overcame the long lead firepower had over mobility in World War I.

Groteleschen's book is an excellent read that explores a heretofore-ignored area of the history of the AEF. Although the author does an excellent job of exploring the evolutionary changes forced on our antiquated doctrine, I believe he needed to discuss the reasons why the AEF failed to solve its problems with making and sustaining breakthroughs in more detail. Firepower had outstripped mobility on the battlefield by the early 20th century by a wide margin. While he alludes to the shortcomings of transportation, logistics and communications, he fails to drive home the point that these shortcomings forced the AEF into set-piece attacks and conspired to prevent the transition to open warfare. His wrap-up leaves open the possibility of another book to chronicle our doctrine in the inter-war years—a good contribution to our knowledge.

This is an easy-to-read, must-have book for every artillery officer as the branch struggles with our transformation into the 21st century. The Information Age is forcing upon us changes in force structure, organization and doctrine.

Are the Interim Brigade Combat Team (IBCT), advanced Field Artillery tactical data system (AFATDS) and Force XXI battle command brigade and below (FBCB²) digital terminals, fires and effects coordination cell (FECC) and our training model the solutions to fighting and winning future conflicts? Or, do we need to jump ahead to a new generation of technology and organization to maintain our edge in the future?

This book makes the reader realize we must perfect our solutions in peacetime so we won't lose soldiers in the process of perfecting them in war. This is the value of this book for officers of all branches. I highly recommend it for a place in every officer's professional library.

MAJ Michael J. Forsyth, FA
Student, Command and General Staff College
Fort Leavenworth, KS

New Fort Sill DCG-ARNG Honored

Colonel (Promotable) David E. Greer, Tennessee Army National Guard and former Commander of the 196th Field Artillery Brigade, is the new Deputy Commanding General for ARNG (DCG-ARNG) at Fort Sill, Oklahoma. A retreat ceremony hosted by the Chief of FA was held at Fort Sill on 31 July in his honor.

Colonel Greer is the second DCG-ARNG. The position was established in 1998 with Brigadier General Daryl K. McCall, Oklahoma National Guard, as the first DCG-ARNG. The position recognizes the importance of the ARNG to the FA and Army. Fully two-thirds of the total FA is in the National Guard.

The DCG-ARNG works under the Chief of FA in support of FA ARNG

units. He serves 139 days on active duty each year, starting on 1 August. His responsibilities include advising the Chief of FA on training, doctrine and combat developments for FA ARNG units and visiting both active and ARNG FA units to identify issues and solve problems. In addition, he advises the Chief of FA on the future of the FA ARNG.

Colonel Greer is a native of Memphis, Tennessee. Prior to commanding the 196th FA Brigade, he was the Deputy Chief of Staff for Logistics, Tennessee National Guard State Area Command. He also commanded two battalions, including the 3d Battalion, 115th Field Artillery, the same battalion in which he served as S2, S3 and Battery Commander.

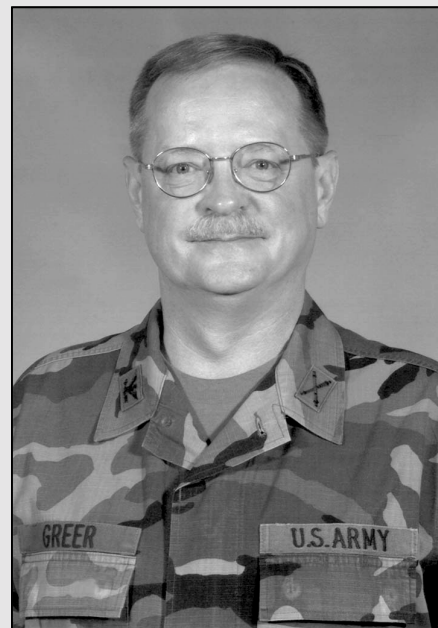

Joint Targeting DOCTRINE

By Lieutenant Colonel Thomas J. Murphy
and Lieutenant Colonel (Retired) Bernd L. Ingram

Joint fire support includes those fires that assist land and amphibious forces to maneuver and control territory, populations, and key waters.

Joint Pub 3-0 Doctrine for Joint Operations

The US Army is undergoing many changes based on the Army Chief of Staff's transformation initiative. The Army's Training and Doctrine Command (TRADOC) ensures these changes are reflected in Army doctrine and tactics, techniques and procedures (TTPs), and, through the Department of the Army's Strategic Plans and Policies Division, integrates them into joint doctrine. One significant challenge for Army fire supporters is adapt-

ing to the many doctrinal manuals that provide detailed approaches to joint operations.

This article discusses the most significant aspects of two bedrock joint doctrine manuals: *Joint Publication 3-09 Doctrine for Joint Fire Support* (12 May 1998) and *Joint Pub 3-60 Joint Doctrine for Targeting* (Final Coordinating Draft, 5 April 2001).

Joint Fire Support. The purpose of Joint Pub 3-09 is to provide fundamen-

tal principles and doctrine for the command and control (C²) of joint fire support for US forces throughout the range of military operations. It accomplishes this first by defining "fires," "joint fires," "fire support" and "joint fire support." It then explains the joint fire support system and its intended effects; describing guidelines for planning and coordinating joint fire support operations and the responsibilities and considerations for executing joint fire support.

Key aspects of the manual include the integration of effects and nonlethal terminology in joint fires doctrine, the introduction of the joint fires element (JFE), and the presentation of the Air Force's targeting cycle phases fused with the Army's and Marine's *decide, detect, deliver and assess* (D³A) targeting methodology.

Effects-Based Fires. The transformation of the Army is introducing effects-based fires that encompass lethal and nonlethal fires (means). The concept was first introduced in the "Field Artillery Vision" presented at the 1998 Senior Fire Support Conference, Fort Sill, Oklahoma. It was further defined in article "Effects-Based Fires—The Future of Fire Support Coordination and Execution," by Colonel Jerry C. Hill



USS John S. McCain DDG 56 fires a five-inch round during Exercise Tandem Thrust 2001, May 2001.

and Major Carl R. Trout in the November-December 2000 edition.

A discussion of nonlethal fires appears in Joint Pub 3-09 under “Nonlethal Means” in Chapter I, “Overview,” and is defined in Chapter II, “Joint Fire Support System” under “Attack Resources.” Nonlethal fires include fires from electronic warfare (EW), psychological operations (PSYOP) (e.g., leaflet drops), information operations (e.g., disrupting the enemy’s information networks) and nonlethal weapons. Nonlethal weapons are those designed and employed to incapacitate personnel or material while minimizing fatalities, permanent injury to personnel and undesired damage to property and the environment (Page II-16).

Joint Pub 3-09 addresses nonlethal fires in only a few paragraphs. However, we believe the concurrent development of effects-based fires concepts in the Air Force and Navy that also encompass nonlethal fires is the beginning of more detailed doctrine and TTPs for joint effects-based operations.

An area that deserves more consideration and could become part of a future revision of Joint Pub 3-09 is examples of nonlethal means supporting operations. An example of nonlethal means supporting operations would be the employment of PSYOPS and information operations (IO) during Operation Joint Endeavor in Bosnia. Elements of this included civil affairs teams living and operating with the local populace in selected areas, distribution of local language pamphlets and leaflets discussing the dangers of unexploded ordnance and mines, and implementation force (IFOR) radio broadcasts, which included interviews with IFOR commanders at various levels. The purpose of these nonlethal approaches was to create effects to positively influence the populace, thereby enhancing peace enforcement operations.

Joint Fires Element. Currently, the JFE is an optional staff element that provides recommendations to the J3 to accomplish fires planning and synchronization. However, future coordinating and executing effects-based (lethal and nonlethal) fires in support of the commander’s intent require close planning, execution and analysis cycles supported by a permanent, integrated joint element or cell. Any “stovepipe” organizational walls that currently exist must be broken down to facilitate joint operations.

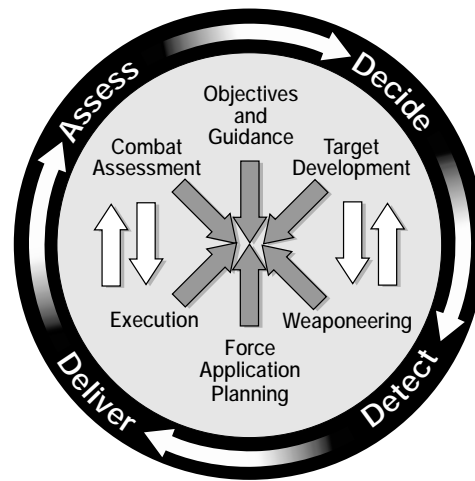

Joint Targeting Process

The development of a joint effects coordination cell (JECC), linking lethal, nonlethal, targeting and intelligence elements, would meet those needs and help the joint force commander dominate any future adversaries in full-spectrum operations.

Joint Planning and Coordination. Similar to brigade-level fire support, a key aspect of joint fire support is continuously including fire support in the planning process and thorough coordination to deconflict attacks, avoid fratricide, reduce duplication and shape the battlespace. Here, Joint Pub 3-09 introduces the fusion of the D³A methodology, commonly used by the Army and Marine Corps, with the targeting cycle phases used by the Air Force. The fusion is shown in the figure as a complementary process to achieve joint targeting. Although the two targeting processes overlap, the steps are aligned as depicted in the figure.

The alignment not only reflects the application of joint targeting to fire support, but also the conceptual elements of effects-based fires. This means coordinating and executing fires that focus on the terminal effects of lethal and nonlethal capabilities against high-payoff targets (HPTs) to achieve a joint and combined arms purpose supporting the commander’s intent.

Joint Pub 3-60. In the manual *Doctrine for Joint Targeting*, a reader will see more detail on how the targeting process outlined in the Joint Pub 3-09 is executed. JP-3-60 is an effort to separate targeting as a distinct function at the joint level and give it its own doctrinal reference. This publication also seeks to incorporate elements of the previous Air Land Sea Application Center’s *FM*

90-36 *The Joint Targeting Process and Procedures for Targeting Time-Critical Targets* (July 1997). Time-critical target attack operations are addressed in more detail in the article “Joint Targeting for Time-Sensitive Targets—To Boldly Go Where No Army Has Gone Before,” May-June.

Joint Pub 3-60 is in final coordinating draft and is expected to be published as this magazine is published. The FA School submitted its comments on the final review of Joint Pub 3-60 in June of this year.

The manual has three major points. First, it is clear that the doctrine writers are transitioning to effects-based fires. Second, it shifts the centralization of the joint targeting effort away from the joint force air component commander (JFACC) to the JFC and his J3. And finally, time-sensitive targets are significantly unique to warrant special attention and unique TTP. Last, we discuss shortcomings of Joint Pub 3-60.

Effects. Beginning with the “Fundamentals of Targeting” in the “Executive Summary” and in Chapter 1, “Creating Effects,” the effects-based approach is reflected in most references to the purpose of targeting and to translation of the JFC’s objectives and guidance. The key link to effects-based operations and targeting is found in Section 6 of Chapter 1: “Effects-Based Targeting” (Pages I-11 through I-16). Effects are not defined in this section as much as they are described. Based on this description, attacking targets serves no purpose unless attacking the targets alone or in concert with other targets achieve a specifically planned effect on the enemy.

Our conversations with joint doctrine writers and Army Staff action officers indicate this publication may be getting ahead of efforts to define and codify effects at the joint levels. Although the days of true attrition-based targeting are gone—where we just defined the targets and destroyed them as quickly as we could without regard to greater impact—no real joint definitions of effects-based operations and procedures have been decided to date.

Joint Targeting Responsibilities. Evident in reading the manual is a shift of responsibility for executing targeting to the JFC staff level (Page III-2). Aided by the joint targeting coordination board (JTCCB) and the JFE, the JFC J3 now “...conduct[s] execution planning, coordination, and deconfliction associated with targeting” (Page III-2). Section 6

of Chapter 3 identifies the J3 as the primary developer of the joint integrated priority target list (JIPTL), which shifts the responsibility away from the JFACC's automatically serving as the primary developer.

An even more subtle indicator of a reduction of the JFACC's primacy in targeting is the revision of "Service and Functional Commander Responsibilities," Chapter 3, Section 7. Here, separate functional component sections were integrated into one, and previous guidance that each would submit emerging or immediate target nominations to the JIPTL via component liaison organizations to the JFACC's joint air operations center (JAOC) was modified.

As a final indicator, under "Target Nomination Procedures," Section 8 of Chapter 3, the service or functional component submissions of target nominations to form the JIPTL are now directed toward the "...joint force staff or component to whom the JFC delegated joint target execution planning..." (Page III-14). The JFC can designate the JFACC as the component lead for his targeting, but the JFACC is no longer the defacto lead for theater targeting.

In the past, the USAF generally had both the acquisition and strike assets to locate and engage the widest range of targets and, frequently, was or could have been the first on the scene. Increasingly, JFCs have multi-service visibility on target acquisition and national asset reach-back capabilities that present the most coherent picture of the enemy.

Each service also is adding to its weapons suites, extending their abilities to attack deeper and with more precision, giving the JFC more options. For example, the Army tactical missile system (ATACMS) already can achieve ranges out to 300 kilometers, and the Navy has the land attack standard missile (LASM) that ranges to 100 kilometers and the tactical tomahawk (TACTOM) which, depending on length of loiter, can range to 1,000 kilometers, among other weapons. Based on weapons and acquisition capabilities and enhanced C² automation, it appears "centralized control, decentralized execution" may become standing operating procedures (SOP) at joint commands like it exists at lower level commands today.

Time-Critical Targets. It is significant the doctrine writers believe this subset of HPTs are valuable enough to address separately in this publication. Because these targets are of such high interest to

theater commanders-in-chief (CINCs) around the globe, integrating this unique aspect of joint targeting into this manual is a timely action.

Shortcomings. Joint Pub 3-60 has two main shortcomings: lack of detail on the JFE and no solid cross walk of D³A targeting methodology with other methods.

The manual includes no details of the JFE's composition and responsibilities. The JFE would include much of the JFC staff as well as matrix-aligned members from components and other organizations as tasked by the JFC. This organization would essentially become the JFC's fire support element (FSE) or, based on the direction of the future fires organization, the JFC's effects coordination cell (ECC). It would, in fact, conduct most of the continuous daily targeting work and support the efforts of the JTCB, which likely would meet daily as required, but not necessarily be a standing organization.

Joint Pub 3-09 cross walks the D³A methodology with the established six-step targeting methodology of other services, which usually is referred to as the joint process. It is clear that the D³A fits within this joint process and includes the same six basic steps. Writers for Joint Pub 3-60 may have believed including a crosswalk in this manual would have been a duplication of Joint Pub 3-09. However, ensuring the service targeting procedures are meshed into a commonly accepted joint construct should be one of the prime objectives of the publication as the overarching joint reference for the targeting process.

Integrating different service targeting approaches is vital to joint success, and it is most appropriate to put the crosswalk in this publication. In various sister service white papers and concepts, many different processes are being proffered—observe, orient, decide and act (OODA); find, fix, track, target, engage and assess; or even assess, plan, find, fix, track, target, engage and assess. The doctrine needs to address these developmental methods, in terms of future operations, and specify the one joint targeting process to be accepted by all. When it does so, it must also come to grips with the definitions of effects-based operations and how they impact this targeting process, providing guidance.

Joint Doctrine—A Must Read. Commands and units around the globe must read, incorporate into training and op-

erations, and sustain a dialogue on evolving joint doctrine and TTPs. Corps, and even division and brigade staff officers must become versed in joint doctrine that will buttress the joint and multinational operations we most likely will conduct in the future.

The review of these two publications shows both common issues as well as variances in focus and direction. Obviously, any disparities must be resolved and common ground found as both manuals define basic doctrine used in joint targeting and attack operations.

One thing that is obvious from recent operations in war and in peacekeeping is that future operations will continue to be joint and coalition, and we must remain ready to interact with other services and national forces to be successful. We predict that as the targeting effort in the past has been key to tactical successes, understanding and executing joint targeting will be key to future successes in complex multinational operations.

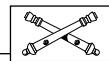

Lieutenant Colonel Thomas J. Murphy, until recently, was the Chief of Experiments and Demonstrations at the Depth and Simultaneous Attack Battle Lab, Fort Sill, Oklahoma. He is now the Commander of 1st Battalion, 77th Field Artillery, 75th Field Artillery Brigade, part of III Corps Artillery, Fort Sill, Oklahoma. His previous assignments include serving as the S3 of the Division Artillery and S3 of the 4th Battalion, 27th Field Artillery, both in the 1st Armored Division in Germany, and Commander of C Battery, 3d Battalion, 11th Field Artillery, 9th Infantry Division (Motorized) at Fort Lewis, Washington. He is a graduate of the Australian Army Command and Staff College, Fort Queens Cliff, Australia.

Lieutenant Colonel (Retired) Bernd L. Ingram is an Action Officer in the Depth and Simultaneous Attack Battle Lab for the Theater Precision Strike Operations (TPSO) Advanced Concept Technology Demonstration (ACTD) and Joint Fires and Targeting. He retired as the Chief of NATO Enlargement at the Headquarters of the European Command in 2000. His previous assignments include service as a Tactics and Fires Author/Instructor at the Command and General Staff College, Fort Leavenworth, Kansas; and Executive Officer of 1st Battalion, 82d Field Artillery, 1st Cavalry Division, Fort Hood, Texas. He commanded A Battery, 1st Battalion, 94th Field Artillery, 1st Armored Division. He holds a master's degree in Management from Webster University of Kansas City, Missouri.

From the Gun Line

2002 Author's Guide

From the Gun Line (FGL) is a one magazine page column featured in *Field Artillery* written by an Army Command Sergeant Major (CSM) or Marine Sergeant Major (SgtMaj) sharing his expertise or point of view with our readers. The purpose of the column is to encourage or validate a positive trend; solve problems; inspire; explain a new program, system, procedure or concept; or outline training and leadership techniques. Your column's contents are not limited to Field Artillery- or fire support-related topics. Although the magazine has a theme for each edition, your column's contents do not have to relate to the theme.



Since its founding in 1911, one of *Field Artillery's* objectives has been to serve as a forum for professional discussions. Therefore, your viewpoint, explanations, recommended techniques and procedures, or discussions of concepts do not have to agree with those of the branch, Army, Marine Corps or the Department of Defense. However, your column's contents must be logical, accurate, complete, address disadvantages as well as advantages (as applicable), promote only safe procedures and include no classified information.

Magazine Readership. A bimonthly magazine, *Field Artillery* is the professional journal for US Army and Marine Corps Field Artillerymen stationed around the world. Approximately 40 percent of our readership is company grade—officer and enlisted. The remaining 60 percent are more senior Army and Marine personnel, members of other branches and services, DoD and other civilians, military retirees, allies, defense contractors, ROTC and USMA cadets, and our political leaders. Our readership includes active duty, Army National Guard and Marine Reserve personnel.

Writing Style. Write clearly and concisely and put your column's thesis statement (bottom line) up front in the first couple of paragraphs. The body of your column should systematically contribute to your thesis. One way to check your column's organization is add a subhead for each of your main points and check to see if each contributes to your bottom line; if not, then either rewrite your point or bottom line.

Don't discuss only general concepts, such as training and leadership; give our NCO readers practical information on how to implement the concepts—tell them what to do to improve. Be specific about your points, giving examples whenever possible.

When writing, always keep in mind your readers, many of who are not in the Army or Marines or even in the military. When you use an acronym, spell it out the first time. When mentioning a new or rare concept, system or technique, briefly explain it, even if it isn't the point of the paragraph.

Submissions. Please send or email the following—

- A clean three and one-half page, double-spaced typed column. *Please do not send a column to Field Artillery while it is being considered for publication elsewhere.*

- A comprehensive biography outlining your experience, training, and military and civilian education. Please include any information that credentials you as the author of your column. Include your full name, job, military address, telephone and fax numbers, and email and home addresses. Please keep this information current as long as we are considering your column.

- A graphic to illustrate your column. The column can be a photograph, chart, military crest, slide, map, etc. If the graphic is a photo, include a caption. Please go to our web site and read the "Digital Photo Shooter's Guide" before you shoot or send us a

digital photo: sill-www.army.mil/famag.

Send your column, bio and graphic to—

Field Artillery

P.O. Box 33311

Fort Sill, Oklahoma 73503-0311

Email: famag@sill.army.mil

The *Field Artillery* staff will edit your column and put it in our style and format. You'll receive a "Check Copy" of the edited version for review before we publish it. Feel free to access copies of the magazine back to 1979 on line: sill-www.army.mil/famag. If you have questions, call us at DSN 639-5121/6806 or (580) 442-5121/6806. Our fax is 7773 and works with both prefixes.

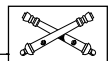

2002 *Field Artillery* Themes and Deadlines

Edition	Theme	Deadline
Jan-Feb	Training XXI	1 Oct 01
Mar-Apr	FA Science and Technology	1 Dec
May-Jun	The FA NCO	1 Feb 02
Jul-Aug	History	1 Feb: Contest* 1 Apr: Other
Sep-Oct	Close Support	1 Jun
Nov-Dec	Red Book-	1 Aug

* History Contest submissions are due; all other articles are due 1 April.

Doctrine for Fire Support: What Comes After AirLand Battle?

If you only look at the title of this article and read no further, you will probably think this article got lost about 10 years ago, and the Editor, having just found it, printed it. After all, AirLand Battle was the Army's operational doctrine in the mid-1980s.

AirLand Battle was how the Army was supposed to beat the USSR in central Europe and how it beat the Iraqis as part of a joint and combined task force in Operation Desert Storm.

In 1993, *FM 100-5 Operations* was published, replacing AirLand Battle doctrine. The trouble was, our 13-year-old *FM 6-20 Fire Support for AirLand Battle* capstone doctrine was never revised.

This article discusses what is happening in fire support and FA doctrine development. Within the past three years, the FA School has begun revisions on almost one-half of its FMs: 12 of 25.

Accordingly, I share three key pieces of information in this article: a brief summary of the most significant principles and tactics, techniques and procedures (TTP) today's doctrine espouses; the process by which doctrinal manuals are developed; and the status of our various field manuals under revision.

For our doctrine to be effective, the FA School needs input from the field about changes that could trigger revisions to manuals and input from the field during the manual's development process. The most critical point at which the FA School needs field input is during the first staffing of the initial draft—the field's first look at potential new doctrine. Our branch manuals are only as good and useful as we make them.

What Comes After AirLand Battle?

Our doctrine has changed significantly in five areas. Changes are due to revisions to *FM 3-0 (100-5) Operations*; the establishment of the essential fire support task (EFST) methodology per a 1998 FA School White Paper; requirements for common terminology; mak-

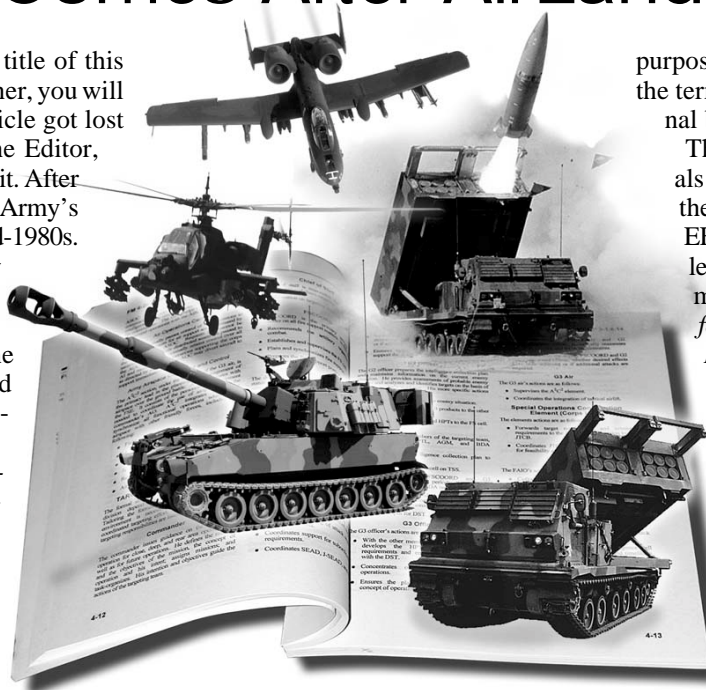

By Lieutenant Colonel Peter J. Zielinski

ing fire planning, targeting and the military decision-making process (MDMP) seamless; and the FA-focused approach to the MDMP for FA staffs.

FM 3-0 Operations. This manual changes our doctrine quite substantially in certain respects. The manual emphasizes full-spectrum operations in war and military operations-other-than-war.

In terms of a battlefield framework, *FM 3-0* introduces “decisive,” “shaping” and “sustaining” operations as the more common approach when framing an operational concept. It still retains “deep,” “close” and “rear” terminology for a spatial arrangement of actions, but these terms are not emphasized. Our emerging fire support doctrine, therefore, delineates principles and TTP for fires in support of decisive, shaping and sustaining operations almost exclusively.

1998 White Paper “Fire Support Planning for the Brigade and Below.” A landmark change in fire support planning and execution methodology was captured in this white paper. All emerging field manuals are incorporating the EFST and essential FA task (EFAT) approach to fire support planning. *FM 3-09* will slightly redefine EFST (task,

purpose, method and effects) to clarify the term “task” and provide the doctrinal basis for this methodology.

The other fire support TTP manuals address EFST development at their respective levels as well—thus EFSTs now work above the brigade-level. The two FA headquarters TTP manuals (*FM 3-09.21 (6-20-1) TTP for the Field Artillery Battalion* and *FM 3-09.22 (6-20-2) TTP for Corps Artillery, Division Artillery and Field Artillery Brigade Headquarters*) address developing EFATs from EFSTs.

Common Terminology. The manuals also clarify fire support terminology. “Destroy” doctrinally should not mean one thing to the maneuver commander (“render an enemy force combat ineffective until it is reconstituted”) and another to his fire support coordinator (FSCOORD) (“render

a target so damaged that it cannot function as intended nor be restored to a usable condition without being entirely rebuilt”). “Destroy” means “30 percent incapacitation or destruction of the enemy force” to the artilleryman and “70 percent destruction” to his aviation liaison officer (LNO).

FA doctrine is being written so fire supporters use the exact terms and definitions as maneuver and combined arms manuals—not the old FA 6-series of manuals. We no longer will have to differentiate among the definitions of effects, targeting objectives, attack guidance, etc. The maneuver commander will give us a task and purpose, and we will determine how to execute the task based on common terminology.

The FSCOORD still will have clarify guidance or intent with the maneuver commander to ensure he understands what has to be accomplished. But their terminology start point will be identical.

There will be only one set of doctrinal terms that our TTP manuals will reference—those in *FM 101-5-1 Operational Terms and Symbols*, *FM 3-100.40 (100-40) Tactics* and *FM 3-13 (100-6) Information Operations*.

Seamless Fires-MDMP. Another long-standing chasm our emerging doctrine will bridge is defining the relationship among fire planning, targeting and the MDMP. *FM 3.09 Doctrine for Fire Support* defines the overarching principles of fire support planning and depicts how the larger process of fire planning has sub-processes; it also shows that, at different times, these sub-processes both support and are supported by fire planning. These sub-processes are the MDMP and the targeting actions within it. The manual also shows targeting supporting fire planning outside of the MDMP.

Other fire support TTP manuals address targeting within the MDMP at that particular organizational level. As with doctrinal terms, we will have to trigger changes to combined arms doctrinal manuals to ensure these initiatives are not just “by fire supporters for fire supporters.”

Similarly, we have made strides in the past 10 years in taking the MDMP and “artillerizing” it. That is, we have learned a lot about FA-focused intelligence preparation of the battlefield (IPB) and FA-specific course-of-action (COA) development and analysis.

MDMP Tailored for the FA Staff. Our key TTP manuals for FA headquarters, FM 3-09.21 (6-20-1) and FM 3-09.22 (6-20-2), have expanded chapters on how to conduct fire planning using an MDMP tailored for an FA organization. This offers FA staffs TTP to produce the best possible FA support plan (FASP) in the shortest time, regardless of the unit’s tactical mission: direct support, (DS), reinforcing (R), general support reinforcing (GSR), general support (GS). Additionally, we have brought back the concept of the dedicated battery (see FM 3-09.21 (6-20-1) for the specifics) to present units with various TTP to improve responsiveness.

Manual Development Process. Of the 25 FMs for which the FA School is the proponent, we have two “doctrine” manuals that focus primarily on principles: FM 6-20 and *FM 100-13 The Battlefield Coordination Detachment*. The majority (18) are “TTP” manuals that focus on section functions, key-individual responsibilities and the TTP of FA and fire support organizations across all operations. The remaining field manuals are “reference” FMs that contain relatively unchanging tabular data concerning meteorology and celestial bodies.

During the initial step in doctrine development, we assess the validity of a

manual’s contents when new information triggers the possible need for revision—such as a new National Military Strategy, results of training exercises, deployment lessons, higher level doctrinal changes (also for us, any changes in maneuver doctrine), senior leader guidance, force changes, organizational modernization, etc.

Once the decision is made to revise or develop an FM, the assessment phase is complete and the process continues with development, preparation, production and distribution, implementation and eventually, back to assessment. (See Figure 1 for milestones in manual development.)

Once we receive all the review comments, we assemble the working group and review each comment. Time permitting, we notify any reviewer if his comments were rejected. The author then is given the accepted comments and prepares the next draft of the manual. The remaining drafts are prepared and staffed

in the same manner as the initial draft. Therefore, although many FM revisions are contracted out, most of the contents are decided by the FA School and field “green-suiters.”

Upon approval of the manual, the preparation phase is accomplished. During this phase, the final approved draft is edited and a “camera-ready copy” is produced.

In the production and distribution phase, the Training and Doctrine Command (TRADOC) prints and forwards the publication to central distribution sites, and it is posted electronically with the Reimer Digital Library and on the WIDD home page.

During implementation and evaluation, proponents integrate the new doctrine into lesson plans, field units implement the changes and provide feedback and recommended changes to the proponent (by emailing to the point of contact or submitting DA Form 2028

1. Event(s) triggers the need to revise the manual (change in Army doctrine, FA equipment, etc.).
2. Write program directive justifying the need for revisions for Training and Doctrine Command (TRADOC) review and funding.
3. Develop the statement of work (SOW) in conjunction with the contracting office (if the work is to be contracted out).
4. Review the contractor’s detailed management plan and time line (if contracted out).
5. Working group reviews the manual’s topic outline. [Each working group is unique and usually gets field input from additional subject matter experts (SMEs).]
6. Council of Colonels from the FA School reviews and approves the topic outline.
7. Develop the initial draft and staff it to the field electronically by posting it on the WIDD home page for 90 days.
8. Working group reviews and approves the comments on the initial draft.
9. Develop the final draft and staff it to the field electronically on the WIDD home page for 90 days.
10. Working group reviews and approves comments on the final draft.
11. Develop the approved final draft to present to the FA School Council of Colonels for approval.
12. Assistant Commandant and Commandant of the FA School approve the approved final draft.
13. As required, convene a doctrinal review and approval group (DRAG) to approve the final draft before it goes to print. (The DRAG’s composition varies with the subject. DRAGs approve all fire support manuals while the Commandant of the FA School approves FA manuals. DRAGs must resolve nonconcurrences with drafts.)
14. The final approved draft is edited, and the manual is laid out electronically in print format, posted on the WIDD home page (<http://155.219.39.98/>) and transferred to the Reimer Digital Library.
15. The TRADOC Army Training Support Center (ATSC) at Fort Eustis, Virginia, prints hard copies of the manual and forwards them to central distribution sites.

Figure 1: Typical Milestones for Developing Doctrinal Manuals. The process takes from 18 to 24 months. Unless otherwise stated, the work is done by the Warfighting Integration and Development Directorate (WIDD) in the FA School, Fort Sill, Oklahoma, or by the directorate’s contractors.

Manual	Comments
Manual Revisions Ongoing	
<i>FM 3-09 (6-20) Doctrine for Fire Support</i>	Final draft currently being staffed with the field.
<i>FM 3-09.4 (6-20-40) Tactics, Techniques and Procedures [TTP] for Fire Support for Brigade Operations</i>	Final draft completed and staffed May 2000. Developing approved final draft.
<i>FM 3-09.5 (6-20-30) TTP for Fire Support for Division Operations</i>	Draft prepared for the doctrinal review and approval group (DRAG), November 1999. Coordinating for DRAG.
<i>FM 3-09.6 (6-20-60) TTP for Fire Support for Corps Operations</i>	Final draft currently being staffed with the field.
<i>FM 3-09.12 (6-121) TTP for Field Artillery Target Acquisition</i>	Final draft currently being staffed with the field.
<i>FM 3-09.21 (6-20-1) TTP for the Field Artillery Battalion</i>	Development phase completed April 2001. As of June 01, being prepared for printing.
<i>FM 3-09.22 (6-20-2) TTP for Corps Artillery, Division Artillery and Field Artillery Brigade Headquarters</i>	Development phase completed April 2001. As of June 01, being prepared for printing.
<i>FM 3-09.30 (6-30) TTP for Observed Fire and Fire Support at Battalion Task Force and Below</i>	Final draft comments currently being worked into the approved final draft.
<i>FM 3-09.31 (6-71) TTP for Fire Support for the Combined Arms Commander</i>	Approved final draft completed July 2001. Coordinating for DRAG.
<i>FM 3-09.60 (6-60) TTP for Multiple-Launch Rocket System (MLRS) Operations</i>	Developing approved final draft.
<i>FM 3-09.70 (6-70) TTP for M109A6 Howitzer (Paladin) Operations</i>	Produced and distributed 1 August 2000.
<i>FM 6-300 Army Ephemeris</i>	Produced and distributed electronically 1 January 2001. The data will be updated each calendar year.
Future Manual Revisions (Starting in FY02)	
<i>FM 3-60 (FM 6-20-10) TTP for the Targeting Process</i>	Triggers: Lessons from digitized unit exercises, deployments, trends at Combat Training Centers (CTCs), need for common terminology, etc.
<i>FM 6-2 Field Artillery Survey</i>	Assess for possible revision.
<i>FM 100-13 The Battlefield Coordination Detachment (BCD)</i>	Assess for possible revision.
<i>FM 100-13-1 TTP for the BCD</i>	Assess for possible revision.

Figure 2: Field Artillery Manuals Being Revised, Now and in the Future

Recommended Changes to Publications and Blank Forms). The Combat Training Centers (CTCs), Center for Army Lessons Learned (CALL) and other Army-wide observers also provide evaluations of doctrine implementation.

Figure 2 gives the current status of our doctrinal publications under revision and those to be assessed or revised in FY02. Note the new numbering system used to align Army publications with the joint numbering system.

Conclusion. Doctrine development is the business of providing a body of thought on how the military fights in the present to near-term with current force structure and material. Doctrinal principles provide an authoritative guide for leaders and soldiers but still provide freedom to adapt to circumstances. Moreover, doctrine provides a com-

mon understanding of how to think about conducting operations and a common language for discussion and warfighting.

The sheer scope of FA doctrine developments should serve as a warning order (WARNO) to other schoolhouses and the field that a “new” way of doing business is about to be promulgated. Some have already begun using the draft doctrine, some are not even aware our doctrine is changing. This article briefly discusses the general topics of the changes—you can go to the WIDD home page to see the specifics of the changes for yourself: <http://155.219.39.98/>.

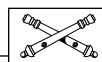

Lieutenant Colonel (P) Peter J. Zielinski, until recently, was the Chief of Training and Doctrine Development, Warfighting Inte-

gration and Development Directorate in the Field Artillery School at Fort Sill, Oklahoma. Currently, he is the Director of the Joint and Army Concepts Directorate in the Office of the Deputy Chief of Staff for Doctrine, Headquarters, Training and Doctrine Command, Fort Monroe, Virginia. He commanded a 3-174 (FA) Training Support Battalion at Fort Drum, New York; taught tactics to Command and General Staff College students at Fort. Leavenworth, Kansas; fought in three rotations at the National Training Center, Fort Irwin, California, as a Battalion S3 with 1st Battalion, 5th Field Artillery, part of the 1st Infantry Division (Mechanized), Fort Riley, Kansas; and served as the division main command post Assistant Fire Support Coordinator for the 2d Infantry Division in Korea. He holds a Master of Arts in International Relations from the University of Akron in Ohio and is a graduate of the Army War College at Carlisle Barracks, Pennsylvania.

The MEF's Force Artillery

By Chief Warrant Officer Three Quint D. Avenetti, USMC

The Commandant of the Marine Corps directed we develop lethal, flexible and potent fire support capable of supporting today's style of modern maneuver warfare. We reviewed our force structure and equipment and identified capabilities and shortfalls with respect to the Force Artillery. USMC Force Artillery is similar to the Army's corps-level artillery; however, it does not control assets other than those that are organic or attached.

This article outlines the doctrinal changes being implemented to provide a Force Artillery to complement the fire support needs of the marine expeditionary force (MEF) in a major theatre war (MTW). The 14th Marine Regiment (Reserves), Fort Worth, Texas, will fulfill that role.

Background. History and the Gulf War, in particular, have proved the continued need for long-range fire support capable of providing dedicated counterfire assets to engage high pay-off targets (HPTs). The-MEF-sized element, such as the one employed in the Gulf War, assumes a vast area of responsibility, and supporting fires must be positioned to provide either general support (GS) or reinforcing (R) fires to the ground combat element's (GCE's) organic artillery force structure. Cuts in the 1970s and 1980s eliminated the FA group, leaving the MEF commander with no organic GS artillery.

During the Gulf War, the 14th Marine Regiment had no more capability with respect to range than her active duty sister regiments; this relegated the 14th Marines to augmenting the active artillery with firing batteries. There was no dedicated counterfire headquarters nor was there a ground-based fires liaison to the MEF to resolve fires-related conflicts between the close and deep battle areas.

The Force Artillery Mission. The quick response study along with les-



sons learned from many MEF-level exercises were influential in modifying the Force Artillery mission statement to read as follows: "Upon activation, Force Artillery provides an artillery capability and a MEF-level artillery headquarters to command and control all cannon/rocket artillery units not assigned to the Ground Combat Element in order to provide the MAGTF commander all weather, surface-to-surface deep fires in support of MEF deep battle space fire support requirements; fires to reinforce the MEF close battle; and an effective MEF-level counterfire capability." (This mission statement is from Chapter 5, "Force Artillery" of *Marine Corps Warfighting Publication 3-16.1 Marine Corps Artillery Operations*, March 01 Coordinating Draft.) The studies began identifying the details of the Force Artillery mission, personnel and equipment, which are still evolving.

Rocket Artillery. Key, here, was the Marine Corps' decision to add a rocket delivery system to its inventory. The first of two battalions designated as high-mobility artillery rocket system (HIMARS) battalions is currently being configured for this mission and will be fielded to the 14th Marines in FY06.

Upon full integration of HIMARS, the 14th Marines will be composed of three cannon battalions and two rocket battalions (HIMARS). The ability to prosecute targets beyond cannon artillery ranges is one of the main advantages of the Force Artillery, enabling it to provide the MEF commander the support listed in Figure 1.

Liaison Element. The integration of the Force Artillery in the MEF fight cannot be accomplished without the addition of a liaison element to the MEF force fires control center (FFCC). The

1. Deep Fires in Support of Marine Expeditionary Force (MEF) Shaping Operations
2. Fires to Reinforce the MEF Close Battle
3. Capability to Weight the Main Effort in a Timely Manner without Impacting Ground Combat Element (GCE) Artillery Assets
4. An effective MEF-Level Counterfire Attack Capability with Force Artillery Organic Weapons
5. Counterbattery Radar (CBR) Target Acquisition Capability
6. Command and Control of all Non-GCE Artillery Assets

Figure 1: Force Artillery Responsibilities

principal artillery functions of the FFCC are to integrate and control deep artillery fires, coordinate and deconflict the employment of surface and air-delivered weapons and munitions inside the MEF battlespace and monitor the conduct of MEF artillery operations and the status of artillery assets. The MEF liaison team helps develop the counterfire plan, which includes the documents listed in Figure 2.

Force Artillery Challenges.

The Force Artillery faces some unique challenges as shown by the application of fire support coordinating measures (FSCM) on the MEF battlefield in Figure 3. The figure shows what could be a typical MEF battlespace with applicable FSCMs.

Deconflicting Surface and Aviation Fires. Note the battlefield coordination line (BCL) was created in response to scenarios where placement of the fire support coordination lines (FSCLs) was directed by a higher headquarters, usually a commander-in-chief (CINC). This resulted in the placement of the FSCL well beyond the range of the MEF's organic artillery (non-rocket assisted).

By definition, the BCL is a supplementary FSCM established based on the mission, enemy, terrain, troops and time available (METT-T) that facilitates the expeditious attack of surface targets of opportunity between the BCL and the FSCL. Primarily, this is to allow Marine aviation to attack surface targets without approval of a GCE commander in whose area the targets may be located.

1. Organization for Combat
2. Counterfire Policy
3. Radar Plan
4. Sensor/Shooter Concept
5. Target Attack Matrix
6. Target Confirmation Standards
7. Counterfire Priorities
8. Target Attack Standards
9. Attack Target Information and Execution Matrix
10. Fires Coordination Process
11. MEF Liaison Plan

Figure 2: Documents to Support the Force Artillery Counterfire Plan

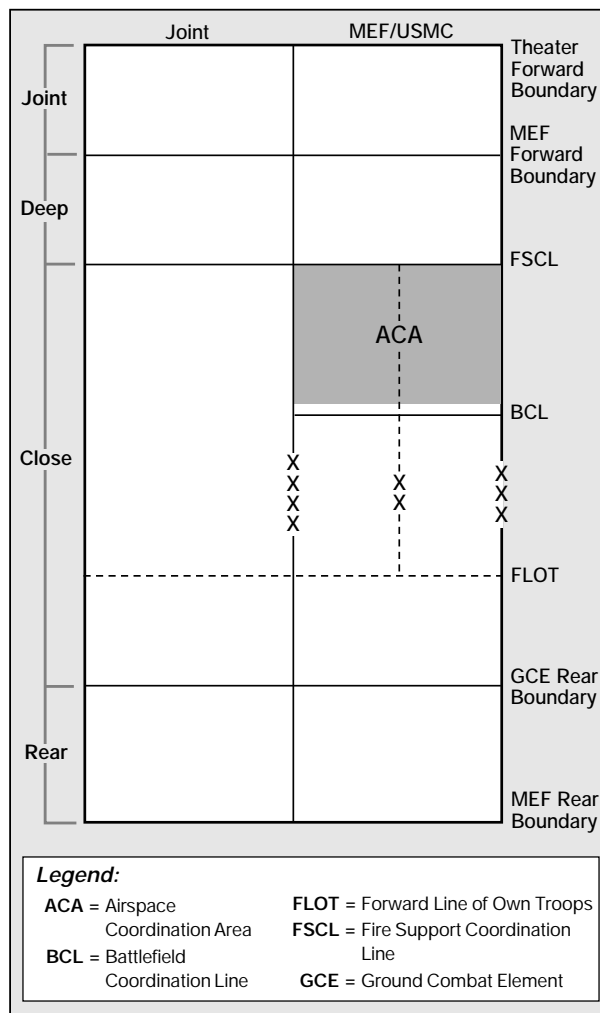

Figure 3: Battlespace Geometry Comparison. This depicts a Marine Expeditionary Force (MEF) battlespace with applicable fire support coordinating measures (FSCM).

To deconflict air and surface fires, an airspace coordination area (ACA) always will overlie the area between the BCL and the FSCL. Additionally, ground commanders may strike any targets beyond the BCL and short of the FSCL as long as those fires do not violate the established BCL ACA.

As you can see, the BCL plays a key role in the Force Artillery's ability to quickly engage targets beyond the range of organic artillery. It should be noted that, ideally, a FSCL would be positioned to facilitate maximum integration of air and surface fires, thereby, negating the requirement for a BCL.

The Force Artillery will play a critical role not only in counterfire, but also in shaping the battlefield for the MEF, specifically with ground-based fires between the BCL and FSCL. Counterfires must be examined more closely to define the Force Artillery's responsibilities.

Counterfire. The Force Artillery will provide liaison to the MEF force fires coordinator (FFC) to help plan, coordinate and execute the counterfire effort. The counterfire liaison officer (CFLNO) is located in the MEF combat operations center (COC). The CFLNO monitors counterfire operations at the MEF level and liaisons with the Force Artillery. He coordinates the counterfire efforts between the theater counterfire headquarters, the division FSCCs, the MEF current fires cell, the reactive targeting cell and the Force Artillery COC.

The CFLNO works closely with the MEF FFC to maximize proactive counterfires with respect to the MEF commander's guidance. He ensures the FSCLs and BCLs are placed so that counterfire targets are primarily attacked as deep fires, thereby, synchronizing maneuver fires and counterfire operations.

The Force Artillery then implements a counterfire radar plan that maximizes coverage and minimizes interference and duplication of sensors. The Force Artillery does not control radars organic to the divisions; however, the Force Artillery and divisions coordinate a radar MEF cueing plan and report the radar locations and orientation to the MEF

FFCC via the advanced Field Artillery tactical data system (AFATDS).

Integrating Multiple Battlefield Radars. The multiple sensors on the battlefields must be closely managed. The use of common sensor boundaries (CSBs) is essential to effective radar management. Figure 4 shows a scaled-down scenario of multiple radars deployed by the GCE and a ground weapons-locating radar (GWLRL) deployed by the Force Artillery.

The Force Artillery helps coordinate the MEF surface counterfire operations, to include managing the radars. By coordinating the radar plans for acquisition of all indirect fires (mortar, cannon, rocket and missile), the Force Artillery conserves valuable cueing time, maximizes the probability of acquisitions and ensures timely reactive counterfires and the survivability of the critical asset.

As the Force Artillery does not control the GCE radar assets, the GCE executes

counterfire within its zone and submits mission fired reports (MFRs) via AFATDS to the Force Artillery. All artillery units configure their AFATDS to reflect MEF-designated CSBs. These CSBs, in essence, could be effective at the BCL (as depicted in Figure 4), routing all counterfire acquisitions below the BCL to the GCE for prosecution by organic assets.

All acquisitions beyond the BCL would be ignored by the GCE radars, picked up by the Force Artillery radar and then sent to the Force Artillery target-processing center (TPC) for prosecution. The Force Artillery TPC collects and processes all counterfire targets within the MEF area of operations (AO). The TPC then submits MFRs to the MEF. This integrates all radar assets, maximizes coverage and improves responsiveness of counterfire systems.

Quickfire Air Support. One important point to consider is the likelihood that a target will plot beyond the range capabilities of the GCE's organic artillery as well as the Force Artillery's rockets. Counterfire by air is the next logical step and responsiveness is just as critical for that target as for ground-based counterfire targets. To rapidly prosecute these targets, the Force Artillery implements a procedure known as "quickfire."

At the first sign of a counterfire mission, a quickfire coordinator (QFC) determines the most effective method of neutralizing the firing element. The QFC immediately contacts the tactical air control party (airborne), called a TAC (A), working the deep battlespace and determines if any aircraft are already attacking the target. If so, the counterfire mission is being processed.

If not, the QFC and TAC (A) determine how best to engage the target by air or whether or not the counterfire mission should wait due to a higher priority air mission in progress, based on the commander's attack guidance matrix.

Target Execution Responsibilities. The coordination of counterfires depends on whose battlespace the target is in—whether it is cross boundary, adjacent, rear, deep—as well as what weapon platform will be the "shooter." This article does not address each one spe-

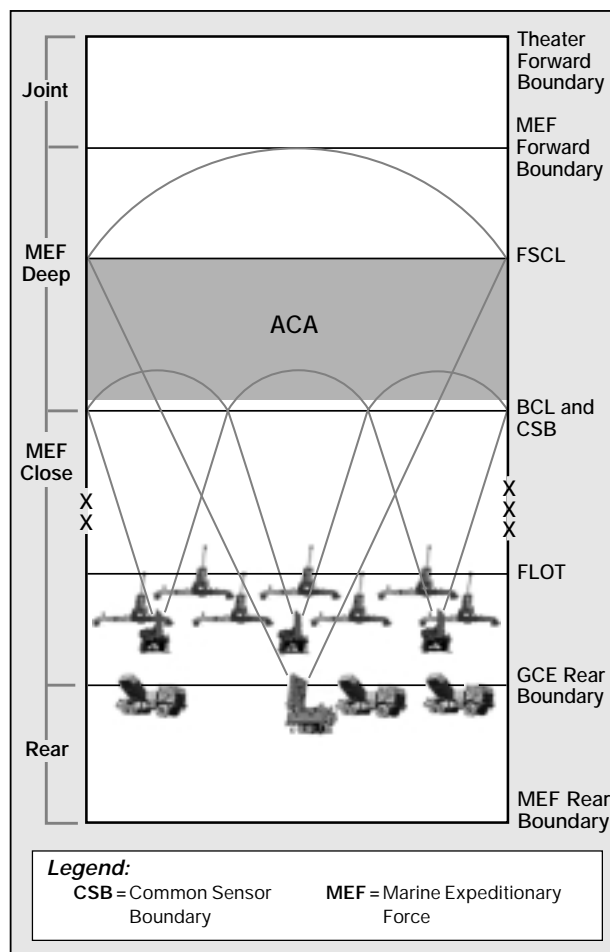

Figure 4: The Force Artillery deploys its ground weapons-locating radar (GWLR) and integrates the MEF radars.

cifically, as they are covered by standard doctrine; however, suffice it to say that the addition of rockets to Marine artillery brings a new facet to Marine fire support. No longer is Marine air considered the only option when prosecuting targets beyond organic cannon artillery range.

One of the following counterfire options will occur, as depicted in simplified scenarios.

- If division assets locate a counterfire target and it is within the division's zone, the target is the division's responsibility and its assets attack the target. Reinforcing fires may be requested.

- If the Force Artillery assets locate a counterfire target and plots the target within a division zone, the Force Artillery passes the target to the division for disposition.

- If either division or the Force Artillery assets locate a counterfire target and it plots in an adjacent ground force zone, the target is passed to the responsible ground force FSCC through the MEF FFCC.

- If division assets in the MEF zone locate a counterfire target, the division passes the target to the Force Artillery for disposition.

- If Force Artillery assets in a MEF zone locate a counterfire target and the Force Artillery can engage the target, the Force Artillery notifies the air combat element (ACE) to clear the airspace, informs the FFCC and attacks the target.

- If Force Artillery assets in the MEF zone locate a counterfire target and the Force Artillery can't engage it, the Force Artillery passes the target to the ACE via the QFC and notifies the FFCC.

Reinforcing Fires. The Force artillery also is responsible for reinforcing fires within the GCE commander's close fight. These fires fall between the GCE rear boundary and the FSCL (or BCL, if in use).

When assigned a reinforcing mission, the Force Artillery provides a liaison team to the reinforced unit. In this case, the Force Artillery staff assumes standard liaison and coordination responsibilities.

The 14th Marine Regiment, indeed, will bring the decisive arm of combat to tomorrow's fight. In the role of Force Artillery, the 14th Marines is the MEF's all-weather, 24-hour general support weapon of choice. *At the Ready!*

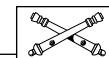

Chief Warrant Officer Three Quint D. Avenetti, US Marine Corps, is the Chief of the Meteorology Branch in the Fire Support and Combined Arms Operations Department of the Field Artillery School, Fort Sill, Oklahoma. He is the Field Artillery School Project Officer working with the 14th Marine Regiment to redesign the regiment to take on Force Artillery responsibilities. His previous billets include serving as the Survey/Meteorological Officer for the 1st Battalion, 11th Marines; Survey/Met Officer for the 3d Battalion, 11th Marines; and Regimental Met Officer for the 11th Marines, all at Camp Pendleton, California. He also served as Assistant Battalion Operations Chief for the 1st Battalion, 12th Marines during Operation Desert Storm and Battery Operations Chief for Battery F, 2d Battalion, 12th Marines during Operation Desert Shield, both in the Persian Gulf.