

# ***Field Artillery***

*A Professional Bulletin for Redlegs*

May-June 1998



Approved for public release; distribution is unlimited.

HQDA PB6-98-3

# Field Artillery

A Professional Bulletin for Redlegs

May-June 1998

HQDA PB6-98-3

## ARTICLES-21st Century Fire Support

### 3 Challenges for Army Leaders in the Age of Rapid Change

by Lieutenant General Montgomery C. Meigs

### 7 The Army and Space

by Lieutenant General Edward G. Anderson III

### 11 Force XXI Victory- More Than Just Gizmos and Digits

by Colonel David P. Valcourt

### 18 Fighting with Force XXI Fires: A Brigade FSCoord's Perspective

by Lieutenant Colonels Thomas J Roth II and Richard G. Cardillo, Jr.

### 22 Fires: The Cutting Edge for the 21st Century

by Brigadier General Toney Stricklin

### 28 The Counterfire Battle in the DAWÉ

by Colonel Bruce A. Brant

### 33 HIMARS- Deployable "Heavyweight" Fire Support

by Captain Jason W. Robbins, AC

### 34 Leading the National Guard into the 21st Century-The 138th FA Brigade and the DAWÉ

by Colonel Jasper Carpenter and Major Freddie R. Waggoner

### 38 The DAWÉ Divisional MLRS Battalion

by Lieutenant Colonel Richard R. McPhee

### 42 AC/ARNG Integrated Division for the 21st Century

by Major Douglas B. Earhart

## DEPARTMENTS

1 FROM THE FIREBASE

2 INCOMING

17 AFATDS UPDATE

41 CRUSADER UPDATE

45 VIEW FROM THE BLOCKHOUSE

**Cover:** 21st Century Fire Support—The Crusader self-propelled howitzer is the Army's premiere weapons platform of the future and will take full advantage of information dominance when fielded in 2005. (Artist's rendition of Crusader is courtesy of United Defense Team Crusader.)

**DISCLAIMER:** *Field Artillery*—is published bimonthly by Headquarters, Department of the Army, under the auspices of the US Army Field Artillery School (Building 746), Fort Sill, OK. The views expressed are those of the authors, not the Department of Defense or its elements. *Field Artillery's* content doesn't necessarily reflect the US Army's position and doesn't supersede information in other official Army publications. Use of news items constitutes neither affirmation of their accuracy nor product endorsements.

**PURPOSE:** (as stated in the first *Field Artillery Journal* in 1911): To publish a journal for disseminating professional knowledge and furnishing information as to the Field Artillery's progress, development and best use in campaign; to cultivate, with the other arms, a common understanding of the power and limitations of each; to foster a feeling of interdependence among the different arms and of hearty cooperation by all; and to promote understanding between the regular and militia forces by a closer bond; all of which objects are worthy and contribute to the good of our country.

**OFFICIAL DISTRIBUTION:** Distribution (free) is to US Army and Marine Corps Active and Reserve Components FA units: seven copies to corps artillery, division artillery and brigade headquarters; 13 to battalions; and seven to separate batteries. In addition, readiness groups, recruiting commands, state adjutant generals, Army and Marine Corps libraries and schools, liaison officers and other Department of Defense agencies working with FA or fire support issues or materiel may request a free copy by writing to the Editor (see "Submissions").

**PAID SUBSCRIPTIONS:** May be obtained through the US Field Artillery Association, P.O. Box 33027, Fort Sill, OK 73503-0027. Telephone numbers are (580) 355-4677 or FAX (580) 355-8745 (no DSN). Dues are \$20.00 per year (\$38.00 for two years and \$56.00 for three years) to US and APO addresses. All others add \$13.00 per subscription year for postage.

**SUBMISSIONS:** Mail to Editor, *Field Artillery*, P.O. Box 33311, Fort Sill, OK 73503-0311. Telephone numbers are DSN 639-5121/6806 or commercial (580) 442-5121/6806 or FAX 7773 with DSN or commercial prefixes. Email is famag@usafas.army.mil. Material is subject to edit by the *Field Artillery* staff; footnotes and bibliographies may be deleted due to space limitations.

**REPRINTS:** *Field Artillery* is pleased to grant permission to reprint articles. Please credit the author and *Field Artillery*.

**ADDRESS CHANGES:** *Field Artillery* (ISSN 0899-2525) (USPS 309-010) is published bimonthly. Periodicals postage is paid by the Department of the Army at Lawton, OK 73501 and an additional mailing post office. POSTMASTER: send address changes to *Field Artillery*, P.O. Box 33311, Fort Sill, OK 73503-0311.

#### Redleg Hotline

(Organization, Materiel, Doctrine and Training)  
DSN 639-4020 or (580) 442-4020 (24-Hour)

#### Tactical Software Hotline

DSN 639-5607 or (580) 442-5607 (24-Hour)

#### Fort Sill Home Page

<http://sill-www.army.mil/index.htm>

#### FA Branch at PERSCOM

<http://www-perscom.army.mil/opmd/fasitrep.htm>  
[http://www-perscom.army.mil/enlisted/fa\\_itr.htm](http://www-perscom.army.mil/enlisted/fa_itr.htm)

By Order of the Secretary of the Army:

**DENNIS J. REIMER**  
General, United States Army  
Chief of Staff

Official:



**JOEL B. HUDSON**  
Administrative Assistant to the  
Secretary of the Army, 04442

**Leo J. Baxter**  
Major General, United States Army  
Field Artillery School Commandant

**Editor:**  
Patricia Slayden Hollis

**Art Director:**  
Bob T. Coleman

**Assistant Editor:**  
Joanne Alexander Brown



## Nothing to Fear

advantage. They merely set the conditions for developing the 1939 Blitzkrieg. Mechanization altered the battlefield, but the Germans achieved dominance by redesigning their doctrine, leadership, organization and training to exploit these cutting edge technologies—the essence of any revolution in warfare.

Most of the American Army was not as bold in embracing the changing conditions and the corresponding opportunities ... but some Field Artillerymen were different. Some Redleg leaders of the 20s and 30s saw the need for change and boldly faced challenges, as we should today. In 1929, Lieutenant Colonel Lesley J. McNair, Assistant Commandant of the (Field) Artillery School, and officers from the Gunnery Department recognized that the techniques for massing fires during the Great War could not keep pace with the fluid battlefield that motorization had produced.

These forward thinkers developed new fire direction techniques and established a fire direction center (FDC) at the battalion level. Combined with the expanding network of wireless communications, the FDC techniques allowed frontline forces to quickly mass and adjust fires on this more mobile battlefield. Many officers opposed these changes—not for being unsound, but for merely being different. Such opposition is the resistance that accompanies any change and is normal. But during periods of significant transition, failure to identify opportunities and implement corresponding changes can cost lives.

**The Comfort of Complacency.** During the recent Senior Fire Support Conference, the CG of the Training and Doctrine Command (TRADOC) discussed the human difficulty in embracing change. He discussed the traditionally conservative nature of developing change through brainstorming, concept development and evaluation.

By our very nature, we, the Army, strive to be bold and audacious. Our initial discussions are resolute, and we freely talk about "thinking outside the box"—some even do. But we warriors are human beings who often distrust the transition from ancestral wisdom to the

relative unknown, so we migrate toward more conventional concepts. During evaluation, we tend to apply our new concepts in a self-limiting manner due to parochial or deep-seated biases. An outcome that could have been a bold, important initiative is reduced to a minor adjustment in the status quo. Many times minor adjustments are all we need. We should never change for the sake of change. But when called for, we must draw a deep breath and take that bold step.

**Cutting Edge Transition.** Tomorrow's battlefield will be considerably different than today's. The conventional view of breadth and depth of battlespace, sequential operations and extensive staff synchronization are becoming obsolete. Simultaneous and distributed operations will abound. Widely dispersed formations, near-perfect battlefield awareness, instantaneous effects and concise and complete battle damage assessment could make our current processes archaic—a tremendous challenge for thinking "out of the box." The Field Artillery has the people, technology and tradition for it.

So as we boldly look forward, we must be cautious, yet brave. Ideas such as distributive fires, effects management and force tailoring may initially make us uncomfortable. We aren't entirely used to them. We must not blindly accept these new ideas; and we won't. We will try them, test them, discover what's best and drive on while remaining just one member of the combined arms team working for the force commander.

Today, we face information-age opportunities that could revolutionize the 21st century battlefield. We must seize these opportunities and maximize the potential they promise. We must aggressively examine our doctrine, organization and procedures to determine what changes will give us the asymmetrical advantage in tomorrow's wars. Asymmetrical success tomorrow requires cutting edge thinking today. We, truly, have nothing to fear but fear itself.



**E**merging information age technologies seem to be leading to near-perfect situational awareness on our battlefields of the future. This, coupled with smart and brilliant munitions delivered by extended-range cannons and missiles, makes 21st century warfare a new ball game. As we prepare for and experience these technological changes, we must capitalize on the opportunities they present.

History is marked by periods of transition when technological advancements substantially change the conditions of warfare. In each transition, the army that recognized the significance and capitalized on the opportunities secured a marked advantage in the next war. We face such a period today. So the question is, will we be observers or players? Shouldn't we prepare intellectually to capture the opportunities presented?

**Seizing the Moment.** The last period of transition occurred during the interwar years of the 1920s and 1930s. The internal combustion engine and wireless communications facilitated a revolution in warfare. These technological advancements and the resulting high mobility and ability to command and control large forces set unprecedented conditions for the battlefields of World War II.

The Germans exploited the opportunities created by changing conditions during the inter-war years and gained early dominance at the outbreak of hostilities. The technological improvements did not, by themselves, give the Germans an asymmetrical

### Response to "The Scud Battery"

We are writing in response to the short article "The Scud Battery—An Inside Look at the Threat" contributed by Second Lieutenant David E. Kinnamon in the January-February edition. First, we would like to thank the 1st Battalion, 12th Field Artillery [17th Field Artillery Brigade, Fort Sill, Oklahoma], again, for the superb job throughout the Roving Sands 97 exercise, in spite of unpredictable weather and other unforeseen obstacles. Without the superior leadership and professionalism of the battalion's officers and NCOs and the dedication and attention to detail of its soldiers, Roving Sands would not have been as successful as it was.

The purpose of this joint test is to redefine how we go about attack operations against mobile ballistic and cruise missile systems. The Scud assets are our hands-on training devices.

The Scud battery that Lieutenant Kinnamon refers to was part of a Scud battalion acquired and maintained by the Joint Theater Missile Defense-Attack Operations [JTMD—Attack Ops] of the Joint Test Force [Kirtland AFB, New Mexico]. Although other organizations possess similar assets, none have the ability to field as many Scuds using accurate real-world tactics, techniques and procedures (TTP).

The assets used by the Lieutenant's battery arrived shortly before the exercise began and, for the most part, the learning curve for operating and maintaining these vehicles was extremely steep throughout Roving Sands. We don't question that the Lieutenant accurately presented in his article his experiences with his Scud battery during the exercise; however, some of what he says is not representative of the systems' overall capabilities and could be misleading. It is important to remember that while the Scud and its ZIL-131 [support truck] are "low tech," they should not be underestimated.

**Firing Times.** The Scud firing sequence typically requires from 30 to 45 minutes to launch a missile, depending on the crew proficiency and accuracy desired. (During the Roving Sands' launch sequence, we provided a visual cue to SOF [special operations forces] and other sensors by raising the missile. Prior to the

simulated launch, the missile was lowered to ensure that realistic timelines were employed after the simulated liftoff. These were "artificial" requirements in the launch sequence.)

After launch, the missile crew needs only to roll up the remote launch cable and the TEL [transporter-erector launcher] is on its way to a new hide position. The time to leave the firing point is typically two to three minutes. In all cases, effective use of camouflage creates an extremely difficult target.

This ability to quickly scoot and hide makes this target practically impossible to kill when based solely on a satellite launch warning. In Desert Storm, not a single TEL was found or destroyed.

This was not the first time theater missiles caused problems for the theater commander-in-chief. In World War II, the V1s and V2s caused many critical assets to be diverted to attempt to find and kill the fixed launchers. America's score in attack operation missions for all wars is somewhere around 10,000 sorties/missions with *zero* success.

**Maintenance.** Our TELs were built in the mid-1970s. They are powered by V-12 diesels and, although they are not exactly state-of-the-art, they are extremely dependable when properly maintained. On the main roads, the TELs can travel at 65 kilometers per hour vice the 40 kilometers per hour Lieutenant Kinnamon's battery experienced.

The ZILs are slower and less mobile, and that is part of the target set's weakness. The many breakdowns referred to in the article primarily were due to bad fuel filters and the use of incorrect fuel. Since the Roving Sands exercise, we changed the fuel filters and instituted a routine maintenance program that has enhanced performance considerably.

**Know Your Enemy.** The Lieutenant's most important observation was "know your enemy." This is why we possess these assets. Scuds continue to pose a serious threat throughout the world. We must work hard to learn how to properly prosecute the attack operations mission.

We cannot just say, "Well that's too hard," or become complacent in the effort and depend on active defense assets. Doing so concedes an important part of

our battlespace to the enemy and constitutes a serious flaw in judgment, especially considering that Scuds can be used as weapons of mass destruction.

The joint test continues to exercise our "Scud Battalion" at the Tonopah Test Range in Nevada. We had the good fortune of getting soldiers from the 2d Battalion, 4th Field Artillery [214th Field Artillery Brigade, Fort Sill] for a joint test exercise in April. They played the role of the enemy Scud missileers and tried their best to "shoot at us," scoot and survive to fire another day. We used our various sensors and attack assets to try to "even the score." Our sincere thanks to III Corps Artillery for its continued outstanding support.

COL Eugene A. McKenzie, USA  
Army Deputy Test Director

LCDR Jeffrey S. Brownsweiger, USN  
Director of Field Testing

CW5 Five Michael R. Lukes, USA  
Missile Technician

JTMD—Attack Ops, Joint Test Force  
Kirtland AFB, NM

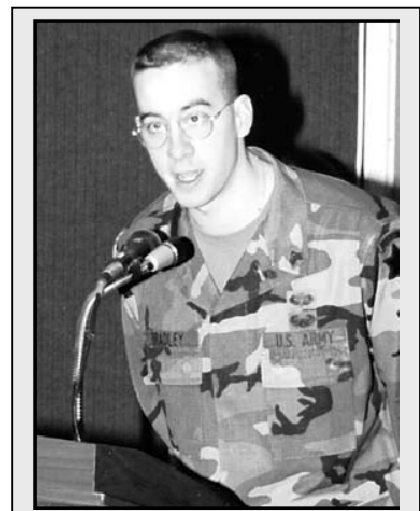

**NCO of the Year.** Sergeant John Bradley, a Forward Observer with C Battery, 4th Battalion, 11th Field Artillery at Fort Richardson recently was named the US Army Alaska NCO of the Year for 1997. This 21-year-old outstanding Redleg from Sacramento, California, was named US Army Pacific Soldier of the Year in 1996.

# Challenges for Army Leaders in an Age of Rapid Change

by Lieutenant General Montgomery C. Meigs

**Editor's Note:** This article was taken from a portion of Lieutenant General Meigs' presentation at the Senior Fire Support Conference at Fort Sill, Oklahoma, in March.

The recent Division Advanced Warfighting Experiment (DAWE) at Fort Hood, Texas, provided many insights into operations of Army XXI—not the least of which was how future leaders will make decisions. The Training and Doctrine Command (TRADOC) and Forces Command (FORSCOM), with the assistance of the Army Materiel Command (AMC) conducted the DAWE in November 1997 using soldiers of the 4th Infantry Division (Mechanized), the experimental force (EXFOR).

The soldiers employed prototypes of gear approximating the capabilities of future systems, including the Army battle command system (ABCS) scheduled for fielding in FY 2000. They fought in a constructive environment supported by the corps battle simulation (CBS) for two weeks, allowing operators, developers and engineers alike to gain insights into the directions our new command and control capabilities will take the Army as it moves through Force XXI to the Army After Next.

As we analyze these insights, we can begin to template new directions and determine their impact on how we'll make operational decisions in the digital age and to chart the path ahead. One thing is apparent: how we execute the decision-making process will be different.

This article discusses some of the factors compelling changes to how we execute our military decision-making process and examines the impact of these changes on future leaders. The challenge for today's leaders is to move the Army through these changes to realize the potential of the future.

## An Age of Rapid Change

We're operating in a fundamentally new environment: the information age. Gordon Moore, a co-founder of the Intel Corporation, observed a "law" that expresses the speed at which leap-ahead technology is moving and the capabilities that technology feeds into the information



EXFOR Division Tactical Command Post (DTAC), November 1997



age. Moore's Law states that the calculating power or speed of the chip doubles about every 18 months while the costs per unit fall by half.<sup>1</sup> In short, the information processing industry doubles its capabilities roughly every year and one-half, providing more information faster at half the price.

Andy Grove, Corporate Executive Officer (CEO) at Intel, discusses how industry deals with such rapid change in his book *Only the Paranoid Survive*. He notes that technology continually changes the rules in the marketplace, and to survive, corporations must acquire new sets of skills to replace the old ones.<sup>2</sup>

He argues that at certain points in the business cycle, companies reach an inflection point, a time when change is so powerful that it fundamentally alters the way business is done. Technology can alter the basic parameters of the market or customers can demand new products or combinations of services.

Good corporations understand inflections are occurring, react and change the nature of their business. Some do not recognize inflection points; for these corporations, new market forces make them unprofitable, and they disappear.

The Army faces a strategic inflection point. Digital technology is changing the art of command and control and our abilities to link sensors and surveillance capabilities with killing systems. We must adapt.

---

## Army XXI-How We'll Fight

How we'll fight is changing. Force reductions and technological advances have contributed significantly to this change. They have helped define the requirements for and capabilities of the future: force projection and distributed operations in a multi-dimensional, integrated battlespace. Within the context of this future battle concept, three aspects require further discussion to begin to fully understand the impact of change on the Army: asymmetrical warfare, information operations and distributed operations.

**Asymmetrical Warfare.** This concept is defined in the upcoming edition of *FM 100-5 Operations* as "...a way of striking that forces an opponent to shield against things for which he has no immediate understanding, design or capability."<sup>3</sup> In other words, an opponent is attacked with a weapon he does not understand or even

perceive as a weapon and, at least for a while, has no means or idea how to counter it.

The use of centimeter wave radar and the acoustic torpedo against U-boats in the Battle of the Atlantic during World War II provides a classic example of asymmetrical warfare. In March of 1943, German U-boats began disappearing in the Atlantic at a shocking rate, and the Germans didn't know how or why as the losses continued to accelerate. The Allies, who had broken the German Navy's code, were sending aircraft from escort carriers to U-boat locations highlighted by the codes. The aircrafts' centimeter wave radar pinpointed the boats on the surface searching for convoys. The aircraft then attacked the submarines with acoustic torpedoes and other weapons the Germans didn't realize the Allies possessed.

We must be prepared to counter or react to asymmetrical warfare as well as conduct it. Events in Mogadishu, Somalia, on 3 October 1993 represent a form of asymmetrical operation against US troops.

In Mogadishu, we faced an enemy who used women and children as shields for attacks from every quarter of a labyrinth of blind alleys in this third world city. The enemy's ability to mass fighters and combatant civilians constituted an approach to warfare not often encountered by our soldiers. In the intense battles in the streets of Mogadishu, our troops were initially caught in an asymmetrical situation, and although they acquitted themselves valiantly, they found themselves at a disadvantage.

Our future operational plans must factor in that our enemies probably won't attack our points of strength. An opponent will seek our blind spots. As in Tet '68 in

Vietnam and Mogadishu, he will seek to exploit sensitivities with weapons, military and political tactics, and combinations of capabilities designed to throw us off balance. His goal will be to inflict great military and, equally important, political damage before we can counter his attack or method. Therefore, we must become adept at anticipating and preempting these types of attacks and at orchestrating asymmetry ourselves, using the tremendous technical capabilities we'll be able to bring to bear.

**Information Operations.** This second new aspect of modern conflict significantly impacts the decision making of future leaders. Conducting information operations is an increasingly important part of the way we'll fight.

Although we've always conducted some form of information operations, we haven't operated on the scope and with the fidelity required today—nor have we perfected the staff process that can take full advantage of the volume of information becoming available to commanders and staffs. We also must develop measures in our command and control architecture to protect the vulnerabilities of our information systems to intrusion, manipulation and deception.

In Bosnia, units are involved in information operations daily, operations that integrate the effects of psychological operations (PSYOP) teams and radio stations, public affairs officers, political advisors, civil affairs teams and the efforts of unit soldiers and commanders in the area. Seen as a multi-dimensional capability that integrates a group of different functions to create an effect, such operations link integrated information and actions to the commander's specific operational objectives.<sup>4</sup>



Asymmetry-in Mogadishu, the enemy used women and children as shields for attacks.

*FM 100-6 Information Operations* defines information operations as those "...that enable, enhance and protect the friendly force's ability to collect, process, and act on information to achieve an advantage across the full range of military operations....and exploiting or denying an adversary's information and decision capabilities."<sup>5</sup>

Obviously, the G2 plays an important role in information operations by providing critical intelligence about the adversary's susceptibilities and the overall situation. But fundamentally, information operations start with the commander and his intent. Having set his objectives and desired end state, the commander regulates and orchestrates the activities of all his players in the campaign. The public affairs officer interacts with his counterparts and reinforces the information objectives, but his efforts remain in parallel to the information operation.

Under the system set up by the Dayton Peace Accord, NATO commanders in Bosnia have authority over former warring faction commanders. NATO commanders can order the former warring faction commanders to be present at meetings, restrain their training and cease inappropriate actions or turn over equipment. So in a peace enforcement operations such as Joint Guard, NATO commanders responsible for joint military commissions (JMCs) use their authority over the Bosnian faction leaders to help achieve information objectives—both those objectives to gain or to promulgate information.

Civil affairs soldiers operate across the countryside interacting with local figures. As the unit political advisors talk to village and county leaders, they also reinforce the information campaign through the thrust of their work in local communities and in their interaction with key officials.

Across the board, a wide range of actors aggressively work issues in a coordinated way to push events closer to the commander's desired end state. The efforts are supported by, but are in fact much broader in scope and effect than, the contributions of the G2.

To focus information operations efforts, units must have a staff process that answers three questions. What is the commander's intent? What end state is the unit is trying to achieve? How does the staff influence leaders or information providers onto those objectives in a rigorous way over time and space?

**Distributed Operations.** This third new doctrinal term will emerge in the next *FM 100-5 Operations*. In distributed operations, commanders simultaneously attack forces, functions, locations and facilities to develop a total effect throughout the depth, width and height of the area of operations.

Distributed operations rely on a new way of thinking about campaigning and operating. Current doctrine posits a finite, limited area of operations with a left boundary, right boundary and deep, close and rear areas of endeavor. Distributed operations provide a framework that moves beyond geographical references. Shaping battlespace, conducting decisive operations and sustaining the force will replace the current linear framework of conducting operations deep, close and rear. In distributed operations, the force attacks in multiple ways simultaneously throughout the battlespace to make the enemy system collapse.

Operation Just Cause is an example of distributed operations. Throughout the area of operations, US forces simultaneously neutralized or destroyed targets and attacked units. The campaign brought different effects to bear with Special Operations Forces (SOF), Marines and Army forces all converging on the area of operations from home bases inside Panama and the continental US (CONUS) at the same time.

All actions were coordinated with an information campaign that induced enemy units to turn themselves in rather than fight. As part of distributed operations, the coordinated players in an information campaign worked to destroy the confidence of the enemy and his supporters and policymakers, a campaign that was very successful.

---

## DAWE Insights Affecting Decision Making

The Army's recent DAWE previewed the new command and control process, indicating some additional new techniques and procedures. In the DAWE, a capable, well-trained division headquarters used ABCS technology in a Battle Command Training Program (BCTP) Warfighter environment. Then we watched and learned from them.

One thing we took away is that the linear, sequential military decision-making process is no longer valid. To take advantage of the situational awareness the information age can yield,

we must move to a nonlinear, non-sequential, more parallel and more integrated process of decision making. While the jury is still out on exactly how this new process will work, some of its patterns are strongly evident.

Although we've always advocated parallel decision making, it has been difficult to achieve in practice. Currently, the process starts with the corps commander's analysis: his intelligence preparation of the battlefield (IPB), estimate of the situation and determination of courses of action (COAs), which result in his issuing warning orders and initial guidance to the divisions.

After receiving the corps warning order or planning guidance, a division then estimates its situation, begins to develop its IPB for its part of the corps battle and division COAs and issues warning orders to its brigades, all in sequence.

In the DAWE as soon as the tactical situation changed, all echelons of command perceived it. The warning order from division actually occurred in a video teleconference with a detailed, collaborative discussion of the new mission and COAs. This collaborative session kicked off parallel planning at all three levels: division, brigade and battalion.

ABCS will make it possible to meld analyses, action plans and assignments of responsibilities into one continuous, collaborative planning session. On receipt of a change in the situation, planners at successive levels will be able to sort out phase lines, boundaries and objectives immediately and work their unique plans in parallel. Orders could be issued immediately in the collaborative session and based on a more thorough and common understanding of the situation.

In our current command and control method, each echelon derives its own picture of the battle, creating a set of layered intelligence pictures, one for each echelon. Each echelon derives its own situational awareness from the resources, systems and analytical capability available to it. In Army XXI, all units at all echelons—corps, division, brigade—will have a view of the battle based on the same situational awareness derived from concurrent access to one database.

Our current linear decision-making process is sequential, centered on the planning procedure and reliant on a hierarchical situational awareness. It is dependent on preliminary analysis and sequential planning by each echelon. We're moving to parallel decision making

that focuses on execution—a collaborative process with real-time, common situational awareness.

While the new decision-making process offers incredible opportunities, it likewise increases the pressure on commanders and staffs to fully understand and use these new capabilities. They must have the vision to understand what the technology can provide, the knowledge of how it aggregates the operational picture and how best to exploit that picture.

What else did we learn in the DAWG? The pace of operations is much greater. The tempo of decision making and the complexity of decision inputs greatly increase in digitized operations. Our leaders will have decision cycles that are much faster than what they experience with analog systems.

Now, that's not to say that past decision-making processes have been easy; in fact, they often have been grinding and very tough to carry out properly in the tactical situations we have seen and modeled in the past decade. But we haven't had to deal with the information components becoming available to commanders as rapidly as they do with ABCS. The leaders' powers of induction will have to be much greater under the kind of load that ABCS will generate, and they will have to understand and trust the picture they will see electronically. To understand how to use and improve our understanding as we build the new system, commanders and key staff will have to be fluent in how the software compiles and manages data.

## The Challenges Ahead

The rules are changing. How we will fight is changing. Future leaders must continue to be creative, flexible experts in combined arms and joint warfare, but they also must become fluent in the new technology of command and control as it relates to decision making. In addition, in spite of the significant changes in how we'll make decisions on the battlefield, leaders must never forget that the role of soldiers in battle remains constant. Former Chief of Staff of the Army General Creighton Abrams once said, "The Army is not made up of people...the

Army is people..."<sup>6</sup>

Given all the leap-ahead technologies and the most technologically "sweet" equipment and concepts, we must never lose sight of the contribution of the soldier. Our Army is a values-based organization. As we adapt to a new military decision-making process in the information age, we must remember the human dimension—the constant role of physical and ethical strength, character, self-discipline and teamwork in combat.

The need for teamwork will never change, only the conditions under which the team must operate. In the future, we could see command posts with vehicles 300 meters apart, working together via a wireless local area net (LAN). This may create its own new challenges.

For example, soldiers in the S2 track may not see soldiers in the S3 track for a day or more. A dispersed but digitally connected team will feel the stresses of 24-hour operations in combat of being shot at and, perhaps, under the threat of chemical attack with the added dimension of physical isolation. Each new capability will bring with it unintended consequences that commanders and soldiers will have to sort through.

We also are examining how 21st century leaders' tactical, technical and interpersonal skills must change, along with the demand for increased conceptual abilities. The tempo and complexity of leader activities that naturally hamper critical and creative thinking will increase. If leaders don't understand the logic of future information systems, they won't make the most of them. Similarly, leaders who are highly competent in the new command and control technologies also must be able to build high-performing teams that will thrive in the pace of future operations.

So our challenge in this new era of cybernetics in military affairs is twofold. First, we must be insightful enough to understand the new operational capabilities the advanced technologies offer and to incorporate concepts such as asymmetry, information operations and distributed operations into our doctrine and techniques. Can our Army take advantage of the new ways of fighting enabled by digital technology? Can we

adapt in a creative, exploitative way?

Our second challenge is to ensure we maintain the human dimension, the role of the soldier, in exploiting this new command and control technology. As we accelerate our adaptation of our decision-making process, can we protect those human elements of soldiering that are immutable? Can we develop the skills of leaders and units and prepare them to absorb the new rates of operation while maintaining the qualities of self-discipline and teamwork that have always been part of our success as an Army?

There's no substitution for leaders who have strength and values to go along with their creativity, curiosity and willingness to adapt the institution to make the promises of Army XXI a reality. But successful adaptation means gaining fluency in the nontraditional functions of digital systems while sustaining the soldier-oriented leadership that has always been a hallmark of great units in our Army.



**Lieutenant General Montgomery C. Meigs commands the Combined Arms Center and Fort Leavenworth, Kansas. In his previous assignment, he was the Commanding General of the 3d Infantry Division (Mechanized) in Germany then the redesignated 1st Infantry Division (Mechanized). As a Division Commander, he was the senior US military representative in Bosnia-Herzegovina and Commander of Task Force Eagle, NATO's Multi-National Division (North), during Operations Joint Endeavor and Guard. His other commands include the 7th Army Training Center; 2d Brigade, 1st Armored Division, during Operation Desert Storm and the brigade's subordination to the 3d Infantry Division; and the 1st Squadron, 1st Cavalry, 1st Armored Division, all in Germany. He served as Chief of Staff of V Corps, Germany; Deputy Chief of Staff for Operations in US Army Europe (USAREUR); and as a Strategic Planner on the Joint Staff at the Pentagon. Lieutenant General Meigs holds a Ph.D. in history from the University of Wisconsin and taught Military History at the US Military Academy at West Point.**

### Notes:

1. Joshua Cooper Ramo, "A Survivor's Tale: Andrew Grove," *TIME* (December 29, 1997-January 5, 1998), 66.

2. Andrew S. Grove, *Only the Paranoid Survive* (New York: Doubleday, 1996), 20-23.

3. *US Army Field Manual 100-5 Operations* (Fort Monroe, VA: Training and Doctrine Command, Revised Final Draft, 23 March 1998), 2-17.

4. "Operation Joint Guard, B/H CAAT 9 Initial Impressions Report," March 1998 (Fort Leavenworth, KS: Center for Army Lessons Learned), Chapter 2.

5. *US Army Field Manual 100-6 Information Operations* (Fort Monroe, VA: Training and Doctrine Command, August 1996), Glossary-7.

6. *US Army Field Manual 22-100 Army Leadership* (Fort Monroe, VA: Training and Doctrine Command, Revised Initial Draft, 1997), 3-2.



# The Army and Space

by Lieutenant General Edward G. Anderson III

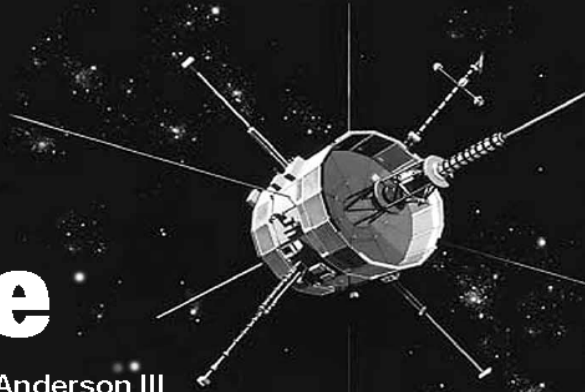

**Editor's Note:** This article was taken from part of Lieutenant General Anderson's presentation at the Senior Fire Support Conference at Fort Sill, Oklahoma, in March.

Space systems and space-based applications are rapidly expanding the potential for warfighters to do a multitude of combat functions across the depth and breadth of the battlespace. There is a growing linkage between land warfare, high-quality information and space-based assets.

Now, that is not to say that space is a panacea for the multitude of challenges the warfighter faces—far from it. But warfighting concepts are changing, and space plays a critical role in enabling these new concepts for the 21st century.

In Army Vision 2010, the Chief of Staff of the Army talks about *dominant maneuver* as a vital Army modernization objective. This is not, however, "your father's concept of maneuver." Instead, Army Vision 2010 defines dominant maneuver as "...massing effects...not forces."

As a concept, this notion of "maneuver" is a stunning break from our military past. It foreshadows a major shift away from our old artillery paradigm of providing supporting fires as distinct from maneuver. It also hints at a day when indirect fires will no longer be classified as merely a supporting capability but rather a pivotal maneuver force.

This concept suggests the significant role that space and space-based products will play in the transformation of our old notions of fire and maneuver. Space will help the Army of 2010 maneuver fires for massed effects.

This article examines the concept of "maneuver of effects, not forces" within the context of the contributions of space. I address three topics: the evolution of space as a combat multiplier, the Army's space support organization and the concept of enabling "effects-based fires." Each topic highlights the growing interdependence of space and land warfare.

## Evolution of Space as a Combat Multiplier

Long before the 1990-91 Gulf War, space played an important role in our national military strategy. Space-based satellites and sensors provided our magnificent Cold War Army of the 1980s much of its strategic intelligence and essential positional knowledge about where the enemy was, what he appeared capable of and where he might be headed.

Artillerymen in Europe relied on the strategic value of force tracking to plan the crucial counterfire phase of any NATO-versus-Warsaw Pact war. However, land warriors during the Cold War saw space as an intelligence community and (or) Air Force domain. We were generally ignorant about how space might help the operational and tactical fights.

The Gulf War vaulted us out of this benign ignorance. Desert Shield and Desert Storm amplified the importance of space as a combat multiplier in maneuver warfare at both the tactical and operational levels. In the desert, soldiers and commanders saw and understood space's relevance to their efforts every day. Corps and separate division commanders began to receive targetable imagery and intelligence feeds from space regarding the location and

activities of Iraqi forces arrayed to their front and in depth. While these feeds were not "real time" in any true sense, they were timely enough to allow the ground commanders to visualize the deep fight. With augmentation from air-breathing systems, such as the joint surveillance and target attack radar system (JSTARS) and unmanned aerial vehicles (UAVs), satellite images helped commanders visualize and rehearse their close battles.

More importantly, our military satellite constellation provided most coalition soldiers in the Gulf critical positional, weather and topographic information. Small, lightweight global positioning system receivers (SLGRs) and, later, precision lightweight global positioning system receivers (PLGRs) became the coalition force multiplier of absolute value.

These space-based navigational systems assured our soldiers knew where they were and where they were going in good weather and bad. This, in turn, allowed for a high operational tempo without fear of disorientation or dislocation. These capabilities are in contrast to the Iraqis' inability to figure out where they were, where they were going or what hit them.

Since the Gulf War, there has been a virtual explosion of warfighter interest in gaining and maintaining control of this new "military high ground"—space. Military applications of space support to land warfare have expanded into the operational realm and driven even deeper into the tactical realms of military operations.

Space is now an integral component of each of the Army's critical mission areas. Space-based assets are vital to our ability to project the force and protect it from threats once it arrives in theater.

Satellites are vital to the land component commander's ability to visualize and shape his battlespace to conduct decisive combat and (or) peacekeeping operations. Finally, space-based navigational assets are becoming increasingly important in logistical efforts to sustain the force across the globe on extended deployments and during complex training exercises.

Space is a combat multiplier for the ground warrior to gain and maintain information dominance against the enemy. Space platforms help the commander's ability to answer three basic questions: Where am I? Where is the enemy? Where are my buddies? Simultaneously, space assets allow the ground commander to thwart enemy efforts to answer the same questions.

Commercial exploitation of space has progressed more rapidly than military exploitation since the end of the Gulf War. Many nations and countless corporations now have sensory and communications satellites in space.

US firms continue to lead the way in the commercial exploitation of space for communications, positional, navigational, imagery and geo-sensory applications. But, many foreign countries are represented.

India, for example, operates its INDOSAT satellite imaging system. For a price, INDOSAT will sell its imaging on the commercial market. Just recently, the US Army purchased some INDOSAT digital sensory images of a maneuver box in which our experimental force (EXFOR) was operating. INDOSAT's imagery was reasonably up-to-date, accurate and available at an affordable price. This and other commercial applications that contribute directly to military operations and exercises are now a fact of life in space. INDOSAT's next sale *could have been* to a rogue nation-state or disgruntled political group. The US military must factor in the potential for the enemy to use commercial space capabilities.

Space systems are of considerable national, strategic and military interest. The United States must maintain a robust and highly capable space force, protect that force from rogue interference and deny would-be enemies access to critical information from space. If we can do these things, then we can build upon space-based platforms to revolutionize our notions of decisive maneuver and lead our future Army into an effects-based force.

As the global constellation of satellites

grows and becomes more capable and is combined with UAVs and manned aircraft, the ground commander's ability to collect, process and disseminate space-based intelligence and information will grow dramatically at the tactical and the operational levels. The challenge to military professionals is to visualize that future—to think about the opportunities space can offer—and plan to realize the potential of space.

---

## Army Space Support

To meet the challenges of future land warfare in the digital age, the Army has focused on warfighting experiments and wargames. Integral to this process has been a requirement to form a unique Army organization to champion the future Army's needs in space.

The US Army Space and Missile Defense Command (SMDC) was chartered by the Chief of Staff of the Army more than two years ago and became a reality 1 October of 1997. (See the figure.) The old Army Strategic Space Command (SSDC) reorganized and transformed itself into the SMDC to meet the challenges of supporting the future Army from space. The SMDC in Arlington, Virginia, is the Army's proponent for space and national missile defense and, in coordination with the Training and Doctrine Command (TRADOC) at Fort Monroe, Virginia, serves as the overarching integrator of theater missile defense (TMD).

**ARSPACE.** The Army Space Command (ARSPACE) in Colorado Springs, Colorado, is near the US Space Command (USSPACECOM) Headquarters. It provides commanders-in-chief (CINCs) and their ground warfighters consolidated operational space planning and direct space support for contingency operations and training exercises. This includes coordinating the use of space-based sensor and communications assets as well as access to commercial space-based imagery and information products.

ARSPACE's principal deployment packages are the Army space support teams (ARSSTs). For training exercises or unit deployments, ARSSTs help field commanders access the array of space resources to help them visualize the battlefield and command and control from space.

**SMDC Acquisition Center.** This agency is in Huntsville, Alabama, and coordinates a growing pool of space and

missile defense resources and facilities. The Acquisition Center enables the Army to leverage emerging technologies as they become available from other national agencies and commercial applications.

Under the Center is the Army Space Program Office (ASPO). ASPO develops, fields and sustains the Army's tactical exploitation of national capabilities (TENCAP) systems. TENCAP technologies with other systems allow the Army to tap national and strategic intelligence capabilities.

TENCAP linkages have been vital to ground component intelligence processing on recent mission deployments from the Gulf to Somalia and Bosnia. With new technologies and commercial developments continuously emerging, ASPO's job is to identify capabilities for tactical national intelligence efforts and make that equipment available.

The Acquisition Center also oversees the Army's High-Energy Laser Test Facility (HELSTF) at White Sands, New Mexico. HELSTF is the Army agency involved in the Defense Department's high-energy ground component laser experimentation and testing activities to learn how to protect space-based assets from inadvertent blinding and direct attack from lasers.

In addition, the SMDC acquisition center manages the US Army's Kwajalein Missile Range (USAKMR), part of the Marshall Islands in the central Pacific. USAKMR serves as a missile "catcher's mitt" during testing of theater and national missile defense systems and operates a sophisticated suite of sensors to conduct space surveillance operations.

Finally, the SMDC Acquisition Center oversees two joint program offices (JPOs) at Huntsville. The joint land attack cruise missile defense elevated netted sensor system (JLENS) is a major element of cruise missile defense. JLENS will enable a ground commander to detect, identify and track enemy land-attack cruise missiles before they threaten friendly battlespace and engage them with joint weapons systems, such as the Army Patriot missile, the Navy standard missile and Air Force fighters. The second program is the Army missile targets program office (Targets) to develop the array of ballistic missile targets necessary to test our emerging interceptor technologies against missile threats.

**Space and Missile Defense Battle Lab (SMDBL).** This new organization with

offices at Huntsville and Colorado Springs will provide the Army modeling and simulation, concepts and initiatives, and training devices and experiments to integrate emerging space and missile defense capabilities into warfighter exercises and deployments.

**Missile Defense and Space Technology Center (MDSTC).** This agency continues its long-standing mission of interfacing with industry and academia to leverage emerging technologies and basic science in the space and missile defense fields. The center focuses on collaborative research to reduce the cost and time for the Army to stay on the cutting edge of space and missile defense technology.

**Force Development and Integration Center (FDIC).** The FDIC supports TRADOC, Army Headquarters and Joint

Staff efforts to develop space and missile defense doctrine, training and other requirements for the US armed forces. The SMDC focuses space support on those efforts to provide full-spectrum dominance for our digitizing Army. As SMDC matures, it will concentrate on developing the resources, materiel, personnel and organizations to integrate space capabilities into land warfare for the Army of the 21st century.

## Space Enabling Future Fires

In collaboration with the Depth and Simultaneous Attack Battle Laboratory (DSABL) at Fort Sill, SMDBL is working to exploit emerging space technologies to enable the "effects-based

fires" outlined in "Fires: the Cutting Edge for the 21st Century" in this edition by Brigadier General Toney Stricklin. The Field Artillery is correct in asserting that the concept of managing effects is the key to unlocking the Army's potential for dominant maneuver in the 21st century. Space-based means are becoming available now and in the future for the artillery community and Army to exploit deep precision fires and, eventually, maneuver effects.

The Army of the future must—based on the commander's intent—be able to simultaneously mass and maneuver multiple weapons effects throughout the battlefield. This will require a paradigm shift, a shift in thinking about how we target and deliver effects on the enemy.

**Deep Operations Coordination Cell (DOCC).** Changing the paradigm begins

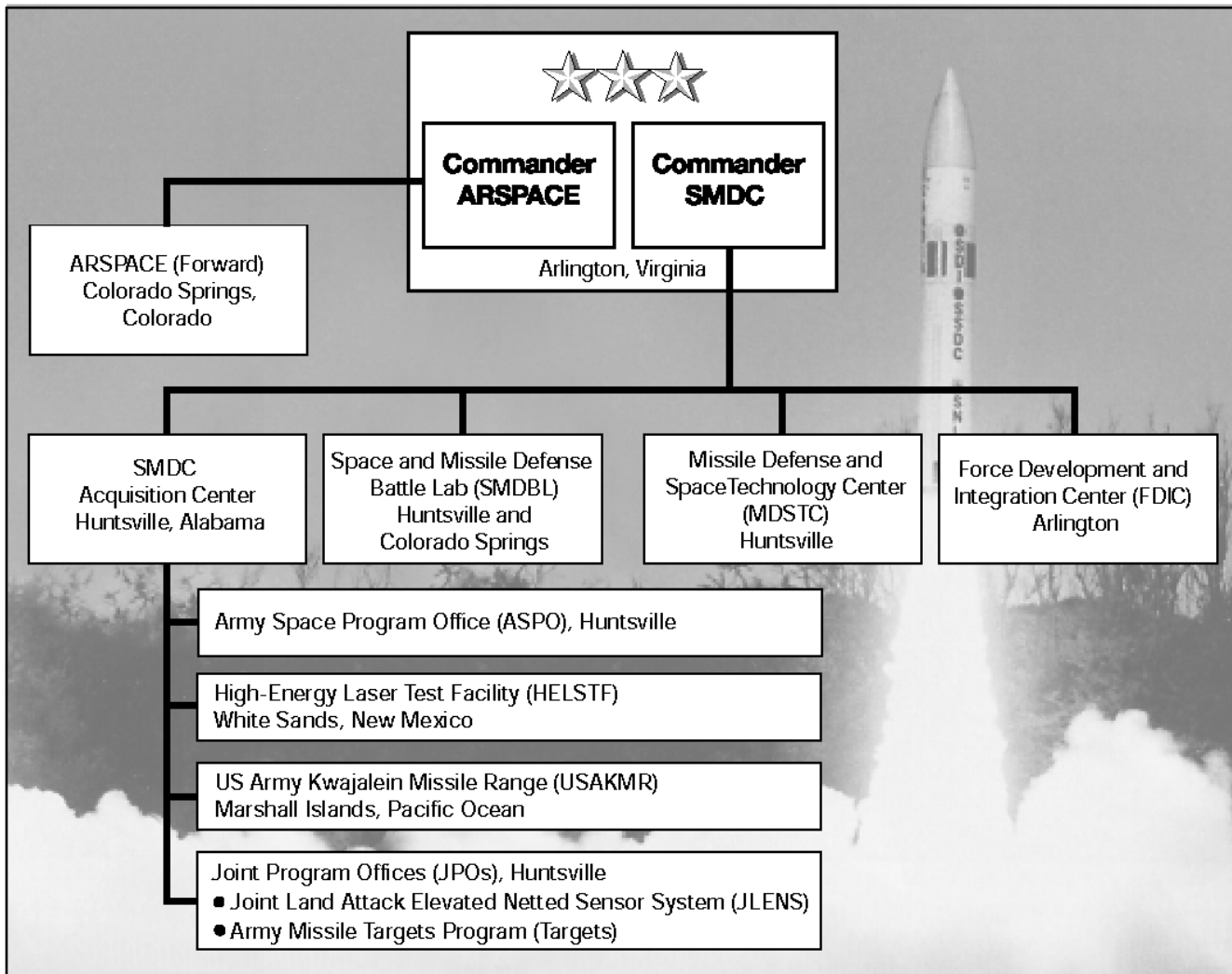

The US Army Space and Missile Defense Command (SMDC) is the proponent for Army space programs and the overall integrator for national missile defense efforts. In addition, the Commander of the SMDC serves as the Commander of Army Space (ARSPACE), part of the US Space Command (USSPACECOM). ARSPACE helps establish joint space requirements and programs in direct support of land force warfighters.

with the Field Artillery vision of a DOCC where target effects are coordinated and massed in accordance with the commander's intent. To be effective, the DOCC must have direct access to near real-time imagery, information and intelligence—the type of information that only space can provide. Space is critical for the DOCC to leap ahead into coordinating revolutionary deep operational effects.

Today, the Army and its sister services are developing the potential for airbreathing systems to enhance the ground commander's view of his battlespace and facilitate targeting for massed effects. Indeed, JSTARS, the airborne warning and control system (AWACS) and UAVs all help provide the DOCC the information it needs to mass effects.

However, these systems have limitations. JSTARS, for example, may require a mission standoff range of about 120 to 130 kilometers behind the forward line of own troops (FLOT). This means that, relying on JSTARS, the commander's scope of his battlespace will be dictated by the line-of-sight limitations of JSTARS. Furthermore, the line-of-sight nature of JSTARS leaves "dead space" in the commander's battlespace forward of the FLOT. UAVs can fill some, but not all, of these gaps.

Space-based sensors, however, introduce a vertical component into battlefield visualization that's indispensable. Satellites can extend the commander's battlespace beyond the horizon—deep into the enemy's rear.

Today, our satellites can provide this imagery and information in near-real-time to help the commander plan and wargame. In fact, satellite sensory and direct downlink technologies are advancing so rapidly that imagery soon may be timely enough to help the tactical commander execute his fight. In this manner, systems in space are becoming a key enabler of effects-based fires and DOCC operations.

**Effects Control Center (ECC).** Emerging military and commercial satellite systems are anchoring our efforts to develop a deep effects control center (ECC) for our future Army. First, the tactical exploitation system (TES) provides the Army direct downlinks from national and theater satellite sensors. The speed and resolution of TES products continues to improve as new technologies are fielded.

Another satellite program with great potential—one that will be demonstrated over the next few years—is Starlite.

Sponsored by the Defense Advanced Research Projects Agency (DARPA), Starlite promises to enable a corps commander to task a 24-hour-a-day, all-weather synthetic aperture radar and moving target indicator radar to execute tactical missions. Starlite will be the first space system designed for the operator and holds great potential as a DOCC resource.

In conjunction with other national and defense agencies as well as the Field Artillery School, MDSTC is working on the battlefield ordnance awareness (BOA) system. BOA will allow the warfighter to mass deep effects via near-real-time battlespace characterization, with practical application for targeting artillery and missile launchers.

The Air Force has the Defense Department lead in launching the space-based infrared system (SBIRS) that will facilitate fire effects control. SBIRS is a constellation of satellites to be launched over the next five years in varying earth orbits with significantly enhanced infrared surveillance capabilities—providing about 75 percent better battlefield resolution than current satellites.

Efforts also continue in the exploitation of commercial satellite imagery for military applications. The National Reconnaissance Office (NRO) has designated the Army as the executive agent for the defense-wide program, Eagle Vision II. Eagle Vision II will allow the warfighting commander to directly task commercial imagery satellites and process unclassified imagery products to help visualize the battlefield and develop precise terrain and geographic data.

Finally, the Air Force is overseeing a cooperative defense and industry effort to develop a hyper-spectral imagery system—Warfighter I. This sensor will be able to penetrate camouflage and concealment, detect deception initiatives and even determine the location of military minefields. Warfighter I is merely the "tip of the iceberg" of futuristic space ventures in hyper-spectral, multispectral and even "change-pass" technologies. SMDC is working with the Air Force on this initiative.

The Army is taking steps to protect its valuable military space assets. HELSTF recently completed a data collection exercise (DCE) using lasers at White Sands. For the first time, lasers tracked and then illuminated an Air Force satellite that had a decaying orbit. This effort will help the Defense Department establish satellite vulnerability criteria and provide data to make satellites less vulnerable to

rogue interests.

**Effects and the Future.** Today's DOCC focuses on delivering weapons effects against land- and air-based targets. A future ECC might leverage our accelerating space-based capabilities to determine which weapons system from among a wide variety is best suited to engage a specific target. It's conceivable that the ECC of 2020 or 2025 would be the corps or joint task force commander's means to control target effects from an enormous variety of weapons and other platforms onto a wide array of enemy targets in support of the ground commander.

For example, with a robust ECC, the commander could control effects from land-based weapons onto enemy space targets, from air-based weapons onto enemy land targets, from seabased weapons onto enemy land or air targets, and even from space-based weapons onto land-based targets. The ECC may become the integrator of near-instantaneous effects from a wide-variety of land, air, sea and space platforms.

Space is the new military high ground. The Army and artillery community must become engaged in securing this high ground to give the ground warfighter what he needs to attain dominant maneuver and mass effects.

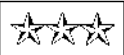

**Lieutenant General Edward G. Anderson III is the Commanding General of the US Army Space and Missile Defense Command, Arlington, Virginia, a command he established and stood up, effective 1 October 1997. In his previous assignment, he was the Assistant Deputy Chief of Staff for Operations and Plans for Force Development at the Pentagon. Among other assignments, he served as Deputy Commanding General for Combat Developments at the Combined Arms Center, Fort Leavenworth, Kansas; Assistant Division Commander for Support of the 3d Infantry Division (Mechanized) in Germany; and Assistant Division Commander of the 1st Armored Division, also in Germany. General Anderson commanded the 17th Field Artillery Brigade, VII Corps, Germany, and two batteries, one in the 2d Infantry Division, Korea, and one in the 23d Field Artillery Group, Vietnam. He holds a Master of Science in Aeronautical Engineering from Georgia Institute of Technology and a Master of Science in National Security and Strategic Studies from the Naval War College.**

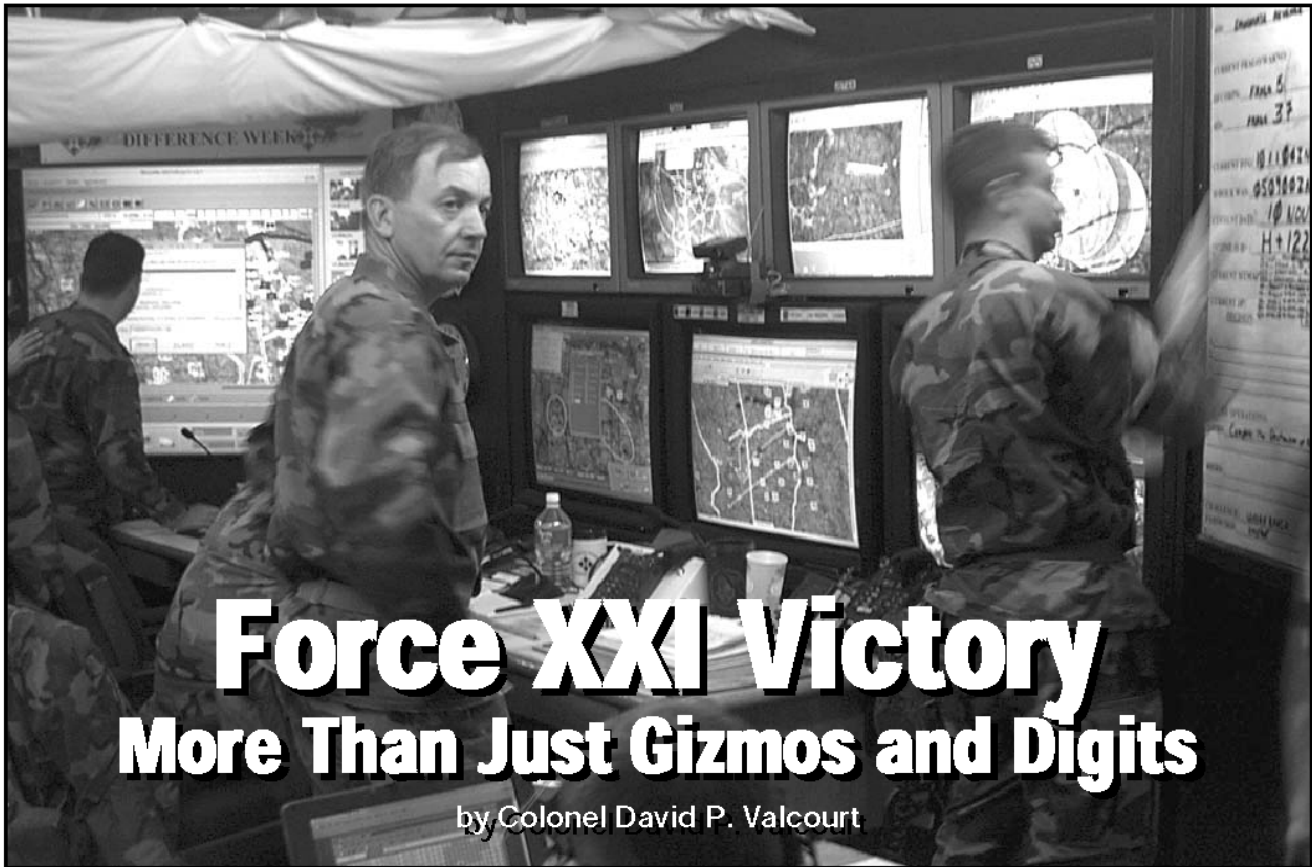

# Force XXI Victory More Than Just Gizmos and Digits

by Colonel David P. Valcourt

If you were looking for an epitaph for the four Bisdonian Armies, the opposing force (OPFOR), that was defeated by the Experimental Force (EXFOR) during the recent Division Advanced Warfighting Experiment (DAWE) at Fort Hood, Texas, it might read:

*Here lies the OPFOR, killed by an EXFOR that was less than half its size in half the time fighting in battlespace three times the norm with 25 percent fewer combat platforms using information age technology. Long Live the EXFOR!*

The post-fight Battle Command Training Program (BCTP) wrap-up of the combat systems killed by the EXFOR versus the OPFOR during the DAWE are clearly impressive. (See Figure 1.) Unquestionably, the EXFOR fires played a central role in the annihilation of the four OPFOR armies. EXFOR fires frustrated the OPFOR's fires complex by never allowing it to mass, maneuver or seriously threaten the EXFOR commander's battle rhythm or combined arms combat power. By every measure of comparison, the EXFOR fires out-killed those of the enemy and did so with significantly fewer rounds downrange—a result of a vastly improved

ability to find the enemy and reach out to kill him.

However, because this was an experiment, the real success isn't measured solely by battle damage assessment (BDA) statistics. What is more important

than the details of the victory is *how* the EXFOR achieved victory during the DAWE. This article examines how the 4th Infantry Division (Mechanized) as the EXFOR found, killed and finished the Bisdonian OPFOR during the DAWE.

Rounds Fired				
EXFOR			OPFOR	
Cannon	70,313		Cannon	98,767
MLRS	38,212		MRL	85,677
ATACMS	88		SSM	398
Battle Damage Assessment				
	EXFOR Arty	OPFOR Arty	EXFOR Overall	OPFOR Overall
Tubes	1,514	32	3,031	145
MLRS	486	17	728	104
Tanks	1,482	167	3,675	1,515
ADA	394	25	2,999	206
Veh/Equip	6,202	6,414	25,897	7,251
Personnel	31,101	8,016	120,524	2,356

Figure 1: DAWE Battle Statistics. The top portion of this figure compares the number of rounds fired by the Experimental Force (EXFOR) and its opposing force (OPFOR) by their respective artillery systems. The bottom portion compares the EXFOR and OPFOR artilleries' battle damage assessed by category and as compared to the overall BDA incurred for each force.

---

## What was the DAWE?

The DAWE was a nine-day Warfighter-like BCTP exercise conducted at Fort Hood from 5 to 14 November 1997. It was a simulation-driven Warfighter incorporating new and evolving technologies, the Army battle command system (ABCS) and various training simulations. The corps battle simulation (CBS) served as the exercise driver enhanced by the addition of Firestorm and the fire support simulation support model (SSM). In simple terms, Firestorm replicated intelligence acquisitions, such as electronic intelligence (ELINT), while the SSM provided near-real-time linkage between our tactical systems and CBS.

The Firestorm and SSM enhancements significantly improved our ability to conduct devastating proactive and reactive counterfire. Together, they demonstrated the impact of linking near instantaneous ELINT hits or Firefinder radar acquisitions simulated in CBS with our counterfire cell. This eliminated the "swivel chair" operations experienced in previous warfighters.

Embedded within the III Corps framework, the division employed equipment, weapons and the Army tactical command and control system (ATCCS), which is part of ABCS, expected to be fielded by 2003. In all, the EXFOR came to battle with some 70-plus new "Gizmos." Each is an article in itself—but not this article.

Many of the tools used during the DAWE were not new. Unmanned aerial vehicles (UAVs), joint surveillance and target attack radar system (JSTARS) downlinks, improved ATCCS subsystem capabilities for each of the battlefield operating systems (BOS), tactical video teleconferencing and many of the weapons have been used in previous division-level Warfighters. However, some were new entrees: a faster and farther shooting howitzer, the Crusader; an improved 60-kilometer-capable multiple-launch rocket system (MLRS); a Firefinder radar with increased acquisition range; a tremendously capable Comanche reconnaissance and attack helicopter; engineer Raptor mines; and smart munitions. These are a few of the new tools of the Army 2003 arsenal used in the DAWE.

The objective of the DAWE included evaluating the performance of these tools and systems as organized around information and determining the impact

of emergent tactics, techniques and procedures (TTP) and smaller, different organizations and technological enhancements on soldiers and leaders in a future heavy division. The DAWE's Force XXI division and its operations were designed to determine if information dominance and enhanced battle command would produce a force with significantly increased lethality, survivability and sustainability—one that could operate at a much higher tempo. The results of the DAWE will have a tremendous impact on the design of the future heavy division and the Army.

---

## What Did We Learn About the Divisional Design?

The DAWE reaffirmed that to continue the strength of the US Army, it must remain combined arms-based. What probably will change are the traditional roles and relationships in that combined arms division. The EXFOR Commanding General (CG), Major General William S. Wallace, explained it best:

*There is an evolving relationship among reconnaissance, fires and maneuver that amplifies the effects and benefits of each. Reconnaissance is electronic (JSTARS), human-assisted (UAV) and human (scouts)—each cued by the other—with our knowledge of the enemy improving in granularity from electronic to human. Maneuver systems protect and position fires forward extending their tactical reach. Maneuver systems also perform the necessary task of fixing enemy formations through positioning and direct fires so that indirect fires and attack aviation can destroy the enemy using ambush techniques that are becoming the defeat mechanisms of choice.*

Figure 2 shows the EXFOR division. Organizational changes to the division cavalry squadron, military intelligence battalion, signal battalion and maneuver brigade reconnaissance troops significantly improved the reconnaissance capability of the division.

Our ability to kill the enemy early and in depth was tremendously improved by the addition of the divisional 2x9 MLRS battalion with a target acquisition battery and headquarters, headquarters and service battery added. (In previous articles, this battalion has been called the command and attack battalion, or CAB.) With the divisional MLRS battalion, the division could provide our aviation

brigade habitually associated fire support assets for the first time.

In the DAWE, the divisional MLRS battalion was assigned direct support (DS) to the aviation brigade, making the divisional MLRS battalion commander the fire support coordinator (FSCOORD) to *Eagle 6*, the aviation brigade commander. (See the article in this edition by Lieutenant Colonel Rich McPhee, commander of the divisional MLRS battalion during the DAWE.)

Senior observers of the DAWE remarked they never had witnessed such a close working relationship between the division artillery and the aviation brigade in a division. The marriage of the aviation brigade and divisional MLRS battalion became the most lethal sensor-to-shooter combination in the division. The "eyes" of the Comanche helicopter and the extended killing power of MLRS—launchers positioned forward under the protection of the division cavalry's ground troops—formed the killing team that found and killed the enemy before all others.

The extended battlespace over which the division cavalry and aviation brigade operated could not have been supported by just one MLRS battery. The battlespace called for *at least* two MLRS batteries, and a strong case can be made for a third.

In addition to its organic fire support assets, the division was reinforced by two Field Artillery brigades, each organized with two MLRS battalions (3x9) and one Crusader battalion (3x6). Neither brigade was fully digitized with the 4th Infantry Division ATCCS BOS systems. This presented challenges we overcame with aggressive liaison officers (LNOs) and frequent battle updates on the division FM fire support radio net.

Noteworthy was that one reinforcing FA brigade was from the Active Component (AC) and one from the Reserve Component (RC), a winning combination. The 214th *Leader Brigade* from III Corps Artillery at Fort Sill, Oklahoma, and the 138th *Kentucky Thunder*, Kentucky Army National Guard from Lexington, combined their firepower to reinforce the EXFOR *Ivy Redleg Gunners*. (See the articles in this edition by both commanders: Colonel Bruce Brant, 214th FA Brigade, and Colonel Jasper Carpenter, 138th FA Brigade.) In all, the division's indirect fire support arsenal included 90 Crusader howitzers and 126 M270AI MLRS launchers.



The package of conventional, smart and brilliant munitions proved devastating to the enemy. The sense and destroy armor munition (SADARM) fired by the DS and reinforcing Crusader battalions provided the brigade combat teams (BCTs) a lethal knockdown punch in support of decisive operations. Although capable of firing 45-kilometer extended-range dual-purpose improved conventional munitions (ERDPICM), Crusader also fired SADARM that forced the enemy to fight through a 27-kilometer "Red Zone" gauntlet forward of the BCTs. The MLRS smart tactical rocket (MSTAR) allowed

the division commander to create a divisional Red Zone out to 60 kilometers.

Throughout the DAWE, our munitions frustrated the OPFOR's ability to mass his artillery and made his large maneuver formations vulnerable to our fires. In fact, although planned continuously, the division never launched its helicopters in the traditional deep attack because the enemy formations targeted were so heavily attrited by launch H-hour that they no longer constituted suitable targets.

The EXFOR division fought across a battlespace that required maneuver brigade commanders to fight nearly autonomously

over brigade frontages frequently extending to 70 kilometers. The division commander's intent was to use reconnaissance and intelligence linked to fires and aviation to set the conditions that would allow the BCTs to execute decisive maneuver to complete the destruction of a heavily attrited enemy force.

BCTs were given the mission to protect critical fires and intelligence assets, which included the FA brigade's MLRS battalions and Q-37 Firefinder radars. The force protection assets included maneuver ground elements, engineers and air defense artillery (ADA). Balancing

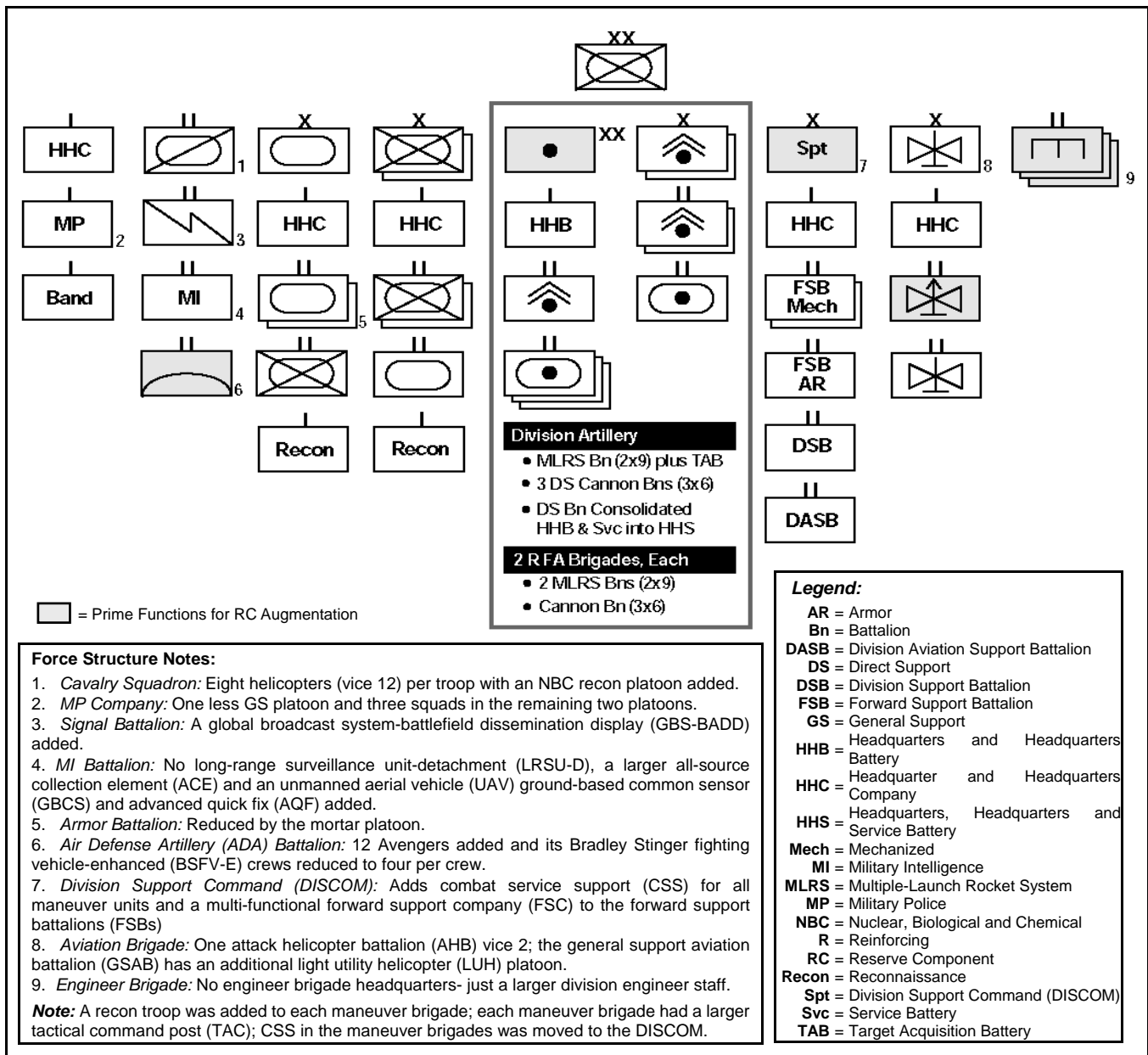

Figure 2: The DAWE Heavy Division Design

the BCT's combat power to simultaneously protect our high-value assets and execute the Red Zone maneuver fight remained a challenge for all leaders.

## How Were the DAWE CPs Organized Around Information?

The division command posts (CPs) included a main CP (DMAIN), tactical CP (DTAC) and rear CP (DREAR). Perhaps the most significant changes occurred in the DMAIN and DTAC. The changes were due to the division's information-based organization and emergent TTP and technological enhancements.

Traditionally, the DMAIN plans the fight and executes deliberate deep attacks. The DTAC is normally the domain of current division operations, fighting the DMAIN's plan while monitoring brigade operations.

During the DAWE, we organized and functioned much differently. (See Figure 3.) Both the DMAIN and DTAC pattern of operations included a "plan" and a "direct" function while each was responsible for seeing and assessing the

current *relevant common picture* (RCP). RCP is the ability to see both friendly forces and the enemy in near-real-time and space, relevant to the fight and commonly shared throughout the division. The RCP concept is central to understanding how the EXFOR division fought and how this shared *situational awareness* geometrically improved its decision making and performance.

The EXFOR's situational awareness of friendly forces was dynamic as the location of our unit icons were automatically updated by CBS, which functioned as a surrogate for the future battle command and control brigade and below (FBCB<sup>2</sup>) system. Near-real-time EXFOR situational awareness of friendly forces was achieved by the maneuver control system/Phoenix's (MCS/P's) horizontal distribution of unit locations to the other ATCCS devices.

EXFOR situational awareness of the enemy proved to be more of a challenge. The intelligence community greatly improved the timeliness and accuracy of the OPFOR picture by using real-time simulated sensor feeds resident in each of the maneuver brigade analysis and control teams (ACTs). Our intelligence community also distributed analytical functions geographically by BCT area of

responsibility to build the enemy picture. The division created a *virtual* analysis control element (ACE) by using the shared analysis of each of these nodes to maintain the enemy picture. All-source analysis system-remote work stations (ASAS-RWS) provided video and audio links among all divisional intelligence analysts to resolve differences.

The division's collective assessment of the enemy situation was then distributed vertically from the ACE-forward (ACE-Fwd) to the brigades' ACTs via ASAS. At the brigade level, distribution of enemy situational awareness was horizontal from ASAS to other ATCCS devices. Our goal was to maintain the most relevant picture of the enemy for each node—DMAIN, DTAC and every major subordinate command (MSC) and BOS staff section—based on an identical database.

**DMAIN.** This CP developed plans and executed synchronization at the macro level, primarily by asset allocation. Division operations orders (OPORDs) and operations plans (OPLANs) from the DMAIN focused division combat power in intent and purpose.

The division plans team (DPT) operated as part of the DMAIN and worked

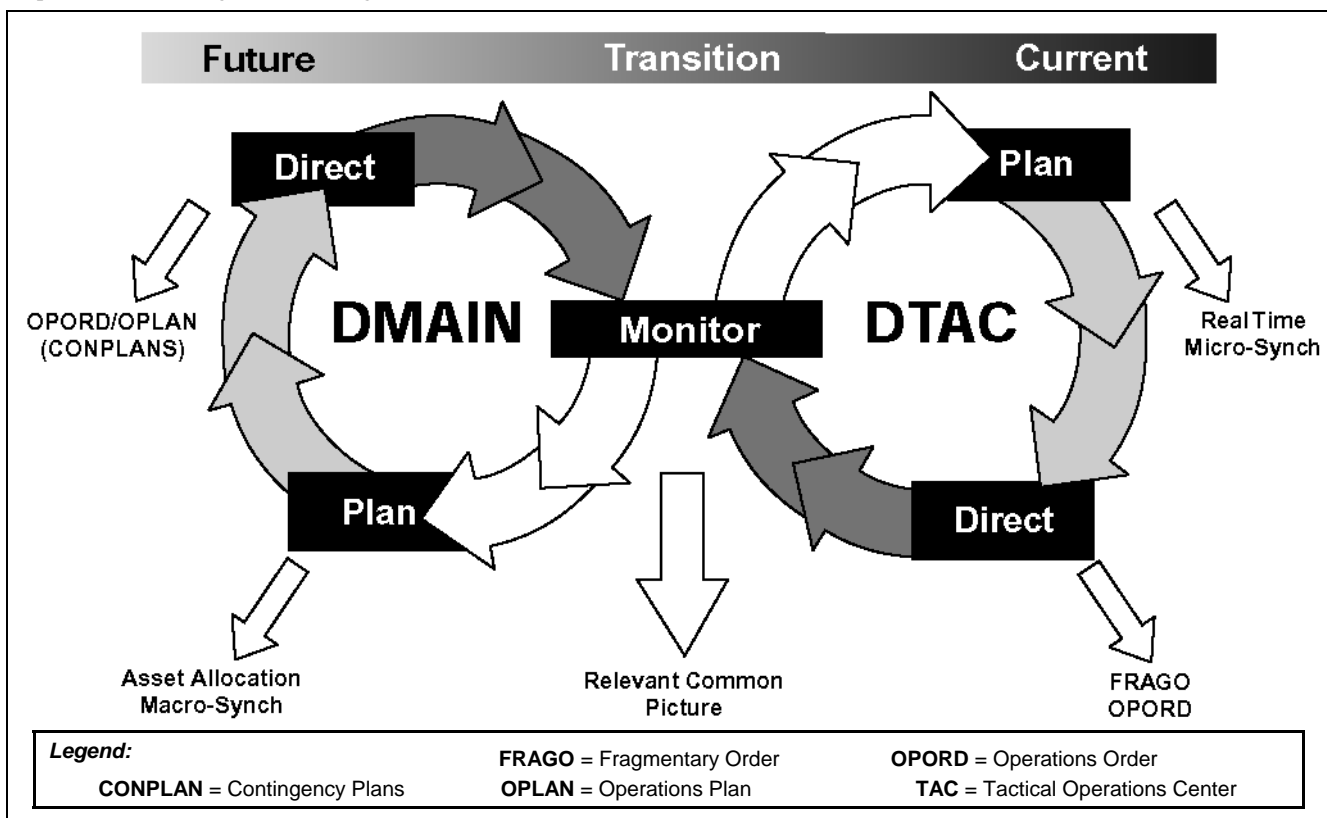

Figure 3: Division Main and TAC Command Posts- How We Fight

for the Chief of Staff. This team planned and wargamed courses of action (COAs) and branches and sequels.

So far, none of the DMAIN operations described were out of the ordinary. What was extraordinary, however, was the capabilities the battlefield planning and visualization (BPV) tool gave the DMAIN. The BPV provided a dynamic computer-constructed situation depicting both EXFOR and OPFOR unit icons and graphics overlaid on a digitized map. Animated movement routes and icon speeds were selected in BPV for each COA. This enabled commanders and planners to visualize the fight in time and space while adjusting icon movement over terrain. During the DAWE, the Division Commander and DPT routinely used the BPV to evaluate future COAs in the decision-making process.

BPV also could wargame the movement and positioning of fires assets by associating range arcs with fire support icons. FSCOORDs advised maneuver commanders and wargamed the movement-to-contact of indirect fires to show where and when EXFOR or OPFOR fires might influence the fight. That information was also important for commanders to know when and where their forces would be inside the enemy's indirect fire Red Zone.

As our CG frequently used maneuver to position fires forward and extend their tactical reach, the BPV helped planners visualize his intent; select COAs, rates and orders of march; focus intelligence collection; and plan for force protection. The animated information in the BPV plan developed at the DMAIN and sent electronically to the DTAC enabled the executing commander to compare "should-hit" to "did-hit" in the middle of the fight.

The division targeting team (DTT) met daily at the DMAIN and focused the division's decisions in the familiar decide-detect-deliver-assess targeting process. Chaired by the Chief of Staff, the team included representatives of the G2, G3, weather, Air Force, electronic warfare (EW), engineers, the assistant FSCOORD (AFSCOORD), aviation and ADA. DTT products were MS Word documents sent over MCS/P to all elements. DTT efforts were synchronized with those of the corps targeting cell.

Uniquely, the EXFOR had the Paradise "whiteboard" for posting information that was viewed on a monitor in each MSC tactical operations center (TOC) and linked by computers to the division CPs.

Using the whiteboard, DMAIN DDT meetings were video teleconferenced with the DTAC fire support element (FSE), potentially hundreds of miles away, and targeting information was shared in real-time. This not only provided the DTAC immediate access to products and decisions, but the DMAIN and DTT also benefited from the DTAC's participation and the linkage between current and future operations. From the FSCOORD's view, the ability of the DMAIN and DTAC FSEs to coordinate the collection and attack effort in a collaborative, realtime environment was pivotal to the lethality and agility of the division's attack in depth.

**DTAC.** This CP fought the battle by micro-synchronizing, issuing fragmentary and other orders, and monitoring the RCP as the DMAIN did. The DTAC command information console (CIC) was the nerve center for division execution. The CIC was geographically centered among standard integrated CP system (SICPS) extensions of each BOS and framed by a perimeter of battle captain work stations interconnected on an internal local area network (LAN) of laptop computers. Of particular significance, the DTAC organization included the ACE-Fwd, which gave the DTAC a collection and analysis capability.

The deep operations coordination cell (DOCC), normally located at the DMAIN, was also in the DTAC. To eliminate confusion, we simply called the DOCC in the DTAC the "Deep Cell."

The photographs at the beginning of this article and Page 3 are of the DTAC's CIC. The large screen at the far left of each photograph takes the place of the old operations map and provides the Assistant Division Commander for Maneuver (ADC-M), G3, deputy G2 and FSCOORD the same RCP available to the CG in the DMAIN and the maneuver brigade commanders in their TOCs. Using their CICs, the brigade TOCs can appear as small insert screens vertically along the right edge of the DTAC CIC's large screen monitor.

This capability linked the CG, ADC, G3, FSCOORD and brigade commanders in real-time, viewing the same RCP. Each could provide his view of the current situation and future plans verbally or graphically via color-coding. This green tab link enabled the division leaders to staff and coordinate information; make a decision; and execute completely synchronized, "turn-on-a-dime" joint and combined arms operations with

unprecedented speed and effectiveness.

In addition to the big screen monitor, DTAC's CIC had a bank of seven screens, each with a split-screen capability. From these screens, DTAC could monitor BOS ATCCS information. The seven screens shown at any one time were packaged (after trial and error) to enable commanders to quickly access the information they needed for decision making.

For example, the bank could include screens showing the ASAS enemy-only picture, MCS/P friendly and enemy tactical picture providing the RCP, the air defense picture via the air missile defense work station (AMDWS), JSTARS moving target indicators, MCS/P depicting friendly and enemy artillery capabilities (colored arcs superimposed on the RCP) and UAV videos (simultaneously of Hunter and the three brigade-level Outriders). The console instantly could bring up the advanced FA tactical data system (AFATDS) screen; a video teleconference with the brigades, DMAIN and corps; or the Ironhorse News Network (INN). INN was a continuously updated bubble-chart presentation by each BOS cell and DTAC battle captain that was broadcast on the DTAC LAN to provide traditional combat power data and significant events.

The Deep Cell functioned continuously throughout the fight. It was in this cell that the "find," "kill," and "finish" business for the division happened in spades. The Deep Cell had a smaller CIC to access the real-time battlefield information it needed to execute decide-detect-deliver-assess. Normally controlled by the deputy FSCOORD (DFSCOORD), the Deep Cell was adjacent to the main DTAC CIC, just an arm's length from the ADC-M and FSCOORD.

The Cell included the DTACFSE with both plans and operations AFATDS boxes linked digitally to the DMAIN, maneuver brigade FSEs, division artillery and the FA brigades. It also included a G2 intelligence/targeting officer with an ASAS, the aviation LNO, a video teleconference whiteboard, Air Force representatives and an MCS/P.

The Deep Cell communicated digitally and by internal LAN, voice FM nets, mobile subscriber element (MSE) and lightweight headsets the soldiers called "Burger Kings." (The headsets were nicknamed after those worn by

personnel at the Burger King drive-through window.) The multiple means of communicating allowed the Deep Cell to share and coordinate information among the DTAC's key staff and system operators at an incredible speed. This capability kept the noise level remarkably low—despite the DTAC's large size. The Burger Kings were especially effective linking the DFSCOORD with the targeting warrant officer to fine tune UAV targeting; the warrant officer was in the DTAC but located a distance away from the Deep Cell.

In one memorable event, a young engineer ATCCS operator (private first class) called an FSE AFATDS operator (13B, Specialist 4) to report he was detecting enemy vehicles in an engineer Raptor minefield. Using their Burger Kings, the two soldiers created an ad hoc sensor-to-shooter link, and then using AFATDS, the FSE specialist initiated fires that destroyed several OPFOR vehicles. That's Force XXI power and our best "computer" at work—the well-trained soldier with initiative.

The ability to correlate and cross-cue the "time-now" sensor feeds into the Deep Cell created a powerful synergy. The horizontal connectivity among the ATCCS systems constantly improved as soldier-operator confidence grew and creative ideas flourished.

One example involved ASAS and AFATDS connectivity for ELINT detections of hostile air defense radars. ASAS has the collection potential to overwhelm the FSE with ELINT targets. Often, many of these potential targets are irrelevant and do not meet engagement criteria. To narrow the ASAS collection focus, we used logic similar to that used when we create Firefinder radar call-for-fire zones. By defining a geographical collection zone for ELINT acquisitions, the division could telescope in on the areas designated for the counterair defense effort and avoid target gridlock.

The air defenders' AMDWS provided a tremendous amount of useful information and, linked digitally to AFATDS, automatically called for fires. When hostile aircraft, drones or missiles were detected, alerts and countermeasures were initiated immediately. These reactive survivability measures included calling for air defense, employing smoke and, when a drone overflowed an MLRS position, displacing. The AMDWS also enabled leaders to quickly spot check if critical high-value assets were under air defense



The DTAC's Deep Cell. From the Top, Left to Right: the Advanced Field Artillery Tactical Data System (AFATDS), friendly picture in the Maneuver Control System/Phoenix (MCS/P), enemy picture in the All-Source Analysis System (ASAS), the sensory picture of an unmanned aerial vehicle (UAV), a monitor with a video teleconference and one with another UAV picture.

coverage. The AMDWS could monitor the locations of our own UAVs and aircraft.

JSTARS and situational awareness enabled the DTAC FSE to vector in UAV, Comanches or Firefinder radars to find enemy formations rapidly and transmit targeting information to the division's direct and indirect fire killing systems to ambush and destroy his formations before he could use his combat power. In some situations when weather degraded our ability to cross-cue sensors, we attacked large enemy formations with MSTAR fires based solely on JSTARS or Raptor target locations. The advantage of smart munitions with terminal guidance, such as MSTAR, allowed us to strike first "with the heaviest of hands."

## So, How Did the EXFOR Win?

EXFOR technologies are important. The ability of the EXFOR division to see itself and see the enemy, although not perfect, was unprecedented in both fidelity and speed. Information age technology, collaborative decision making tools and future weaponry empowered commanders. It gave them the abilities to react at an unprecedented operational tempo to battlefield opportunities to find, kill and finish the enemy simultaneously close and at depth.

But it was our soldiers who clearly demonstrated the advantages all those new technologies can give the future Army. They quickly learned how to operate and take full advantage of our high-tech information and fighting systems, demonstrating their creativity and initiative and giving the EXFOR its victory.

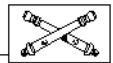

**Colonel David P. Valcourt has commanded the 4th Infantry Division (Mechanized) Artillery, Fort Hood, Texas, since June 1996 and was the Commander of the Experimental Force (EXFOR) Division Artillery in the November 1997 Division Advanced Warfighting Experiment (DAWE). He also commanded the first battalion in the Army to be fielded the Paladin M109A6 howitzer, the 2d Battalion, 17th Field Artillery, III Corps Artillery, Fort Sill, Oklahoma. He served as Chief of the Field Artillery Branch at the Total Army Personnel Command, Alexandria, Virginia; G3 of III Corps Artillery; S3 of the 212th Field Artillery Brigade, also in III Corps Artillery; and Executive Officer of the 2d Battalion, 17th Field Artillery at Camp Pelham as part of the 2d Infantry Division in Korea. He's a graduate of the Naval War College, Newport, Rhode Island, and holds a master's degree from Springfield College in Massachusetts.**



# AFATDS Update

This update briefly describes the recently released advanced Field Artillery tactical data system (AFATDS) software package (A97), which provides additional fire support functions for the corps and echelons above corps (EAC) and several enhancements identified in last year's Division Advanced Warfighting Experiment (DAWE). Among the significant enhancements are the tactical air support module (TASM), "Trigger Events," the capability to support multiple-launch rocket system (MLRS) family of munitions (MFOM), digital mapping and deep fire coordination.

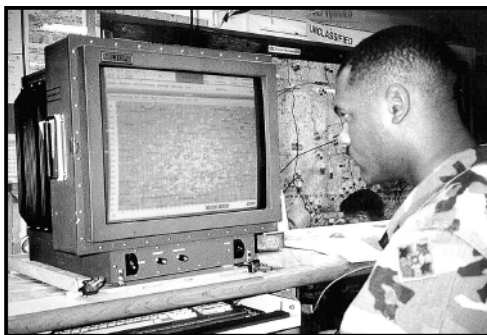

**TASM.** This category of enhancements provides an initial interoperability capability for the Army, Marine Corps and an air component services (Air Force, Navy and Marine). The air component services use the contingency theater automated planning system (CTAPS) to perform mission planning. With the release of A97, CTAPS will interface directly with AFATDS.

TASM provides the ability to plan and coordinate preplanned and immediate close air support (CAS), air interdiction (AI) as well as several non-fire missions, such as "reconnaissance request," at the AFATDS operational facility (OPFAC).

**Trigger Events.** Another facet of A97 is the management and monitoring of trigger events. These events help the commander synchronize fire support operations within the tactical situation and allow the fire support coordinator (FSCoord) or commander to specify criteria (e.g., "enemy ADA [air defense artillery] unit reported in NAI [named area of interest] Foxtrot") against which incoming data is compared.

Once a trigger event has been created in the OPFAC's current situation, AFATDS will monitor any changes (unit, geometry and targets) and alert the operator when the trigger event has been violated. These "tripped" trigger events are then presented to the operator so further actions may be taken (e.g., shift priority of fires).

**MFOM.** A97 also can support the MFOM in monitoring the unit status and attack analysis. This utility allows AFATDS to add new or update existing

MLRS munitions. Upon receipt or entry of new munitions data, AFATDS conducts an internal validation to ensure sufficient data is present to use the new munitions. The operator then is alerted that new munitions have been received and are ready for use.

**Other Enhancements.** Additional enhancements address higher echelon operational considerations such as vector mapping, deep fires coordination and "all available" massing. The vector map is an overlay that displays a geographical area to include cities, towns, roadways, terrain elevation and terrain features (rivers, lakes, etc.). The operator can choose from 16 different features and categories for his display.

The deep fires coordination function provides the capability to automatically conduct clearance of fires with selected battlefield agencies, such as the special operations forces (SOF). The procedure automatically conducts unit coordination when a mission meets clearance criteria.

The "all available" massing enhancement allows the commander to mass all capable artillery or rockets/missiles on a single target using subordinate and supporting fire support assets. Previous versions of AFATDS software would not allow massing of a mix of fire support systems.

**Conclusion.** A97 software was approved for material release to Army AFATDS-equipped units in April 1998. It will be used on both AFATDS common hardware systems (CHS)—both CHS 1 (a 125 MHz processor with a two-gigabyte hard drive) and CHS 2 (the new Ultra Sparc 200 MHz, nine-gigabyte computer). CHS 2 began fielding this year.

The Communication Electronics Command (CECOM) new equipment training team (NETT) will conduct training on the specific A97 enhancements ("Delta" training) for each unit fielded A97 and provide the new software package, technical manuals and technical bulletins. For further information, AFATDS units may contact the Training and Doctrine Command (TRADOC) System Manager-AFATDS (TSM-AFATDS) at Fort Sill, Oklahoma: DSN 639-6836/6837 or Commercial (580) 442-6836/6837 or E-mail: [afatds@usafas.army.mil](mailto:afatds@usafas.army.mil). The AFATDS Fire Support Information Center web page is <http://www.hughes-defense-comm.com/fsic/webpage.nsf>. (Correction to "AFATDS Update" in the March-April edition: the 2d Infantry Division in Korea was not fielded AFATDS. The division is scheduled for fielding in FY01.)

## Corps and EA

### 1. Mission Support

- Multiple-Launch Rocket System (MLRS) Family of Munitions (MFOM)

### 2. Mission Processing

- "All Available" Massing
- Rule Set for Clearance of Fires Coordination
- Coordination Status Monitoring

### 3. Situational Awareness

- Trigger Events (Situation Monitoring)
- Defense Mapping Agency (DMA) Vector Map

### 4. Air Support

- Air Mission List (AML)
- Tactical Air Support Module (Preplanned and Immediate Air Support)
- Air Tasking Order (ATO) and Airspace Coordination Order (ACO) Parsing and Processing

### 5. Interoperability

- USAF Contingency Theater Automated Planning System (CTAPS)

AFATDS 97 Enhancements. Focusing on fire support for the corps and echelons-above-corps (EAC), the AFATDS 97 software version will provide the capabilities listed in this figure.

MAJ Richard Z. Miles, AC  
Combat Development Manager, AFATDS  
TSM-AFATDS, Fort Sill, OK

# Fighting with Force XXI Fires

## A Brigade FSCOORD's Perspective at the DAWE

by Lieutenant Colonel Thomas J. Roth II and  
Lieutenant Colonel Richard G. Cardillo, Jr.



Courtesy of United Defense Team Crusader

**W**e leveraged intelligence assets, such as the brigade's UAV [unmanned aerial vehicle], Strikers and Raptor minefields, to find the enemy's 10th Motorized Rifle Division and then simultaneously attacked the division with mortars, artillery, attack helicopters and close air support. SADARM [sense and destroy armor] killer ambushes alone resulted in the destruction of an entire MRB [motorized rifle battalion]. These losses forced the enemy off his plan, disrupted his movement and enabled our task forces to complete his destruction.

One of the highlights for this attack was the destruction of the 9th IMRB [Independent Motorized Rifle Brigade]. A classic sensor-to-shooter lash-up between the "eyes" of our 1-10 Cavalry Comanche aircraft—OPCON [under the operational control] to our brigade—and the deadly reach of an MLRS [multiple-launch rocket system] battalion from the reinforcing 138th FA Brigade.

Such was the report of one of the

Experimental Force (EXFOR) Brigade Combat Team [BCT] commanders during the recent Division Advanced Warfighting Experiment (DAWE).

In the nine-day DAWE in November at Fort Hood, Texas, the 4th Infantry Division (Mechanized) Artillery, as the EXFOR artillery, experimented with Force XXI systems and munitions. (See the figure.) The new tools in the DAWE allowed us to explore fire support tactics, techniques and procedures (TTP) for the brigade fight.

This article discusses the fire support organization for combat in a BCT structured to make the most of information dominance, some TTP emerging for fires in the brigade fight and some insights about the FA and its future.

### Brigade Organization for Fire Support

Our future howitzer and munitions were replicated and employed in the exercise: Crusader firing the extended-range

dual-purpose improved conventional munition (DPICM) with a range of 47 kilometers and SADARM with a range of 27 kilometers. Crusader's significantly improved rate-of-fire, increased range and special munitions capabilities allowed the BCT commander to increase his Red Zone fight to 47 kilometers. This very capable howitzer could emplace a 400x400 medium-density family of scatterable mines (FASCAM) minefield in only seven minutes.

The BCT's artillery organization for combat consisted of its direct support (DS) 3x6 Crusader battalion and a reinforcing 3x6 Crusader battalion provided from a reinforcing FA brigade the BCT usually had under its tactical control (TACON). The BCT was responsible for providing security for the reinforcing FA brigade.

The Field Artillery brigade provided a savvy liaison officer (LNO) to the BCT headquarters, enabling close, effective coordination between himself and the division artillery (Div Arty) S3, who positioned the reinforcing brigade. The



capabilities of the LNO in this particular position paid huge dividends.

The EXFOR division commander shaped his battlespace with fires using limited quantities of the Army tactical missile system (ATACMS) Blocks IA and IIA that had a range of up to 300 kilometers. He also employed the MLRS smart tactical rocket (MSTAR)—his smart munition of choice beyond 22 kilometers.

The BCT tactical operations center (TOC) was organized around information dominance. The intent was to enable the commander and his fire support coordinator (FSCOOD) to leverage that dominance to focus combat power and destroy the enemy on their terms.

The TOC was designed to provide near-real-time electronic feeds from all acquisition assets on its command information console (CIC). A CIC was resident in all the EXFOR brigade-level subordinate commands, the division main command post (DMAN) and the division tactical command post (DTAC). During the DAWE, the FSCOOD and engineer battalion commander flanked the BCT commander at the CIC throughout the fight.

Displayed on the CIC monitors were downlinks from the joint surveillance and target attack radar system (JSTARS) and UAVs. Additional displays showed the maneuver control system/Phoenix (MCS/P), locations of the engineer's Raptor minefields and data from information from the advanced Field Artillery tactical data system (AFATDS) and other battlefield operating system (BOS) devices. These devices included the combat service support control system (CSSCS); all-source analysis system (ASAS); forward area air defense command, control, communications and intelligence system (FAADC<sup>3</sup>I); and a digital map showing situational awareness of both friendly and enemy forces.

Our goal was to destroy enemy forces in depth and shape the battlefield to set the most advantageous conditions before becoming decisively engaged with ground maneuver forces. This was done routinely and with great success.

---

## Tactics, Techniques and Procedures

TTP emerged over the course of the brigade and division level AWEs. The brigade-level experiment took place at the National Training Center, Fort Irwin,

California, in March 1997 with the DAWE following in November. Both exercises provided tremendous insights into the future of our Army and the Field Artillery.

One recurring insight is that the capabilities of a system were greatly enhanced when combined with the strengths of others. Seldom was one system used as a stand-alone device, including the following systems highlighted with their fire support TTP.

**JSTARS.** The downlink JSTARS provided the maneuver brigade TOC was invaluable. It enabled the BCT commander to track enemy movement and formations at distances well beyond our engagement abilities—oftentimes in excess of 100 kilometers. This information allowed enough time for the BCT commander to mass dispersed forces and destroy the enemy at the commander's place of choosing.

Once we identified an enemy formation, we initially tracked and monitored its movement with JSTARS. Next, the BCT commander and FSCOOD vectored the UAV to confirm the target's type, location and movement status. The UAV provided targeting data in enough detail to engage formations. Occasionally, we used JSTARS information on movement directions and rates and correlated them with an engineer obstacle plan at a predetermined location to trigger fires planned to support the obstacle. Coupled with other systems, JSTARS became a very valuable tool for the BCT commander and his FSCOOD.

**UAV.** A true success story, the UAV provided accurate targeting data and served as an intelligence asset. As information feeds from JSTARS were downlinked into the BCT TOC, the commander and FSCOOD decided when and where to focus the eyes of the UAV.

Hitting a moving target with indirect fire remains difficult, but smart munitions improved our success rate considerably. Employing JSTARS and UAVs, we could follow a high-payoff target (HPT) a great distance until it stopped or became engaged in a dynamic obstacle. It was during these critical times that the fire support community provided lethal fires to destroy these HPTs.

Another advantage to the UAV was its ability to support proactive counterfire. Often the UAV located enemy artillery within range of our weapons systems before the enemy artillery had begun to fire on our forces. By taking advantage of

the UAV's acquisition capabilities and Crusader's extended range, the FSCOOD could destroy the enemy artillery—at the least, keep the enemy artillery moving.

**Firefinder Radar.** The enhanced capabilities of the Q-36 and Q-37 radars allowed the FSCOOD to locate the enemy artillery accurately at extended ranges. Linked with MLRS assets of the reinforcing artillery brigade and (or) the divisional MLRS battalion (previously called the command and attack battalion, or CAB), we delivered high volumes of fire on the enemy, quickly and routinely silencing his guns.

**Striker.** While not a new organization, the effectiveness of these "combat observation lasing teams (COLTs) in high-mobility, multipurpose wheeled vehicles (HMMWVs)" on the battlefield could not be beat. Controlled at the brigade level, six three-man Striker teams were in each BCT with up to four of them employed at any time. This left two teams to prepare for the next mission and (or) replace teams that had been compromised.

The BCT reconnaissance troop enhanced the Strikers' effectiveness by providing security while the Strikers were getting into their positions to observe critical target areas of interest (TAIs). Routinely, Strikers knew about approaching enemy formations from JSTARS and (or) UAV feeds via the BCT TOC. Information was passed forward digitally by the enhanced position location reporting system (EPLRS) or by

### Systems:

- Crusader
- M270A1 Multiple-Launch Rocket System (MLRS) Launcher
- Q-36 Firefinder Radar Version 8
- Q-37 Firefinder Radar Block II
- Advanced Field Artillery Tactical Data System (AFATDS)

### Munitions:

- Extended-Range Dual-Purpose Improved Conventional Munition (ER DPICM)
- ER MLRS
- ER (Guided) MLRS
- MLRS Smart Tactical Rocket (MSTAR)
- Army Tactical Missile System (ATACMS) Blocks I and II

New Field Artillery Systems and Munitions Experimented with in the DAWE

voice on the single-channel ground and airborne radio system (SINCGARS) improvement program/integrated network controller (SIP/INC) radios. Enemy formations were handed off from one acquisition asset to the next until the Strikers had positive "eyes-on" and could call for accurate and lethal indirect fires.

**Crusader.** A 21st century system of systems, Crusader consists of a 155-mm self-propelled howitzer and its armored resupply vehicle. The howitzer has fully automated ammunition handling and firing that allows it to fire its 60 rounds onboard at rates of up to 10 rounds per minute and out to ranges in excess of 45 kilometers. Moreover, Crusader can fire multiple rounds to achieve simultaneous impact on a target (MRSI). It can fire eight rounds to hit one target simultaneously for a one-howitzer massing at 20 kilometers.

The BCT routinely was responsible for frontages of up to 70 kilometers wide. Depending on the movement of enemy formations, we repositioned the artillery to meet the threat, which was facilitated by Crusader's mobility equivalent to the Abrams tank.

Crusader's extended range; increased on-board ammunition haul capability, rate-of-fire and lethality; and improved mobility gave the BCT commander a significantly more flexible weapon. Using Crusader, he could attack more targets faster and deeper while simultaneously providing improved lateral support.

**AFATDS.** The strength of AFATDS lies in its ability to incorporate the commander's intent into the fire support plan. It uses the commander's guidance to prioritize incoming fire missions instead of firing first-in, first-out targets. AFATDS also exchanges information digitally with other Army tactical command and control system (ATCCS) subsystems: MCS, CSSCS, ASAS and FAADC<sup>3</sup>I.

Through a combination of inputting the commander's guidance and manipulating AFATDS intervention points (IPs), the FSCOORD could tailor each fire mission. For example, fire mission processing could be tailored for automatic sensor-to-shooter routing with minimum (if any) human intervention. While IPs can enhance the responsiveness of fire mission processing, they must be used



The brigade's Strikers- combat observation lasing teams (COLTS) in enhanced high- mobility multipurpose wheeled vehicles (HMMWVs)- were very effective on the DAWE battlefield. An enemy formation was handed off from one acquisition asset to another until the Strikers had "eyes on" and executed the target. *Photo courtesy of SEI*

cautiously and always in conjunction with the commander's intent.

AFATDS is a superb planning tool, but it calls for one significant caution: it will fight the plan—not necessarily the enemy. The brigade fire support officer (FSO) and FSCOORD must recognize when the plan changes and correct the guidance in AFATDS digitally or know when to change from digital to voice processing of fire missions.

**Raptor.** A recent arrival for the future battlefield, the engineer's Raptor is a hand-emplaced, wide-area minefield. The beauty of this system is its ability to detect and report moving vehicles (wheeled or tracked). Once a sensor identifies a lucrative target, we can remotely change the minefield from a "sensing" mode to an "acquisition and destroy" mode. A Raptor minefield can be placed on a likely enemy avenue of approach and serve as an additional set of eyes, providing highly responsive and very accurate target locations.

Depending on the target array (the type and numbers), the BCT commander and his FSCOORD and engineer could engage enemy vehicles based solely on Raptor's input.

Near-real-time communications between the minefield and the BCT TOC enabled the engineer to transfer accurate target locations to the brigade FSO for engagement. Improvements planned for the computer supporting Raptor will allow the computer to send digital

information to AFATDS directly, a quantum improvement in ATCCS connectivity.

**Force Protection Measures.** With near-real-time information and the ability to see deeper, the BCT dispersed its forces greater distances for survivability and then repositioned them at the appropriate time and place to defeat the enemy. Tomorrow's brigades won't fight on today's doctrinal frontages. In some cases, the DAWE brigades fought on fronts that were in excess 70 kilometers—per today's doctrine, almost a division-sized front.

This extended battlefield left "holes" in the BCT sectors, holes in which the enemy could insert small reconnaissance forces undetected.

Their mission was to locate our long-range enemy artillery (MLRS) and disrupt our logistical operations. In fact, MLRS became the enemy's priority HPT because MLRS was so effective against his artillery.

A small reconnaissance force equipped with anti-tank weapon systems can reek havoc on an MLRS battery. One solution was to attach a mechanized platoon to the artillery battalion for local security. We also used air defense artillery (ADA), smoke and engineer assets in many cases to augment force protection.

These force protection measures were directed at the division level and implemented



MLRS became the enemy's priority HPT because it was so effective against his artillery.

at the brigade level. Units that adhered to the directive achieved great success in providing security for the division commander's high-value MLRS assets. Oftentimes the allocation of warfighting assets to MLRS security caused concern among BCT commanders because it took away some of their combat power. A proposed alternative security solution is to equip MLRS units with hard-topped HMMWVs with M-19 grenade launchers. Also, MLRS rocket or Army tactical missile system (ATACMS) launchers could be equipped with ring-mounted M60/M2 machineguns.

**Engagement Areas.** Munition-unique engagement areas were developed based on the extended range of our acquisition assets and weapons and the dynamic obstacles emplaced by the engineers. By handing off targets from one platform to the next—JSTARS to UAV to Striker—the BCT commander and FSCOORD tracked and engaged the enemy using close air support, attack aviation or artillery-delivered SADARM and (or) the extended-range DPICM (ERDPICM). Requests for additional fires were routinely sent to the Div Arty via AFATDS, and targets were engaged with MSTAR. These procedures created very effective high-density "killing zones." The enemy was knocked completely off balance by the brigade's ability to acquire, engage and destroy him at great range.

**Minimum Safe Distances in the Red Zone.** Smart munitions can search for, detect, acquire and engage targets, but they can't discriminate among target classes or target types—for example, distinguish between friendly or enemy vehicles in the target area. They are not for use close to friendly forces. Smart munitions are designed for the "many-on-many" battle where many munitions are directed into an area known to contain many enemy targets.

For force protection, FSCOORDs must be familiar with lethality and employment considerations of smart munitions—dispersal patterns, probabilities of acquisition and kills, and the number of munitions available to engage specific target types. They also must know battlefield countermeasures, such as signature alteration and deception, obscurants, armor enhancements, jammers and others.

In an effort to lessen the probability of fratricide, we applied the following minimum safe distances. For BAT, the antiarmor submunition in ATACMS, the minimum safe distance we applied was four kilometers. For both MSTAR and

SADARM, the minimum safe distance applied was two kilometers.

**Digital Proficiency.** With the plethora of digital systems from company through brigade and the relative ease of accessing and altering guidance, the man-machine interface is becoming critical. The old days of only the battalion fire direction officer (FDO) knowing the digital business are gone. All soldiers, NCOs and officers must be proficient in digitized operations.

Sustainment training is key. FSOs at every level must understand the impact of their decisions on their company or brigade and the impact that it will have in AFATDS for the overall operations.

During the DAWE, officers and NCOs found themselves gravitating toward being AFATDS proficient. This does not mean being AFATDS operators but, rather, knowing what information is available and how to access it.

---

## Insights about the Future FA

As we experimented with new systems in the DAWE, we realized that commanders and leaders must understand how to use the information they gained and tools these unique systems provide.

**The Basics.** But we also learned that many of Field Artillery fundamentals won't change. To succeed on the battlefield, we must meld the new TTP and maintain the basics, such as some FA fundamentals that follow.

- From the beginning, the fire supporter must clearly understand the commander's intent and his guidance on how he envisions using fires.

- The fire support plan must be simple and executable.

- The fire supporter must fight the enemy—not the plan. The fire supporters must know when the plan must change due to the enemy's actions or reactions and be flexible.

- There will be a Red Zone fight; it just will occur at extended ranges (60 kilometers for MSTAR and 45 kilometers with ERDPICM).

- Fire supporters will have to clear fires. The high tempo of operations and the commander's easy access to realtime information will allow him to alter his plan often, increasing the requirements for positive clearance of fires.

- The five requirements for accurate predicted fire are still requirements.

**The Shift.** One of the major changes we saw during the DAWE was a shift in

the Field Artillery's focal point for mission processing. The focus shifted from the battalion fire direction center (FDC) to the brigade commander and his FSCOORD.

In the DAWE, the brigade commander, his FSCOORD and the brigade fire support element (FSE) routinely made the engagement decisions. With the tremendous amount of information coming into the brigade TOC, the commander and his FSCOORD had near-real-time situational awareness to make timely and more effective decisions about how to destroy the enemy long before our maneuver forces were committed.

Despite the vast improvements in technology, some things will never change. Fire support is and always will be an art. It demands ingenuity and innovative training techniques to optimize every tool of the future battlefield to focus fires for cohesive, decisive Army XXI operations.

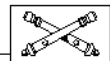

**Lieutenant Colonel Thomas J. (Chip) Roth II commands the 3d Battalion, 16th Field Artillery of the 4th Infantry Division (Mechanized), Fort Hood, Texas, and served as the Experimental Force (EXFOR) Fire Support Coordinator (FSCOORD) for the 2d Brigade Combat Team (BCT) during the recent Division Advanced Warfighting Experiment (DAWE). He also commanded B Battery, 1st Battalion, 40th Field Artillery in the 3d Armored Division in Germany. In other assignments, he served as Executive Officer for the Director of Officer Personnel Management at the Total Army Personnel Center in Alexandria, Virginia; and S3 and Executive Officer for the 5th Battalion, 41st Field Artillery in the 3d Infantry Division (Mechanized) in Germany.**

**Lieutenant Colonel Richard G. Cardillo, Jr., commands the 4th Battalion, 42d Field Artillery of the 4th Infantry Division at Fort Hood and served as the FSCOORD for the EXFOR's 1st BCT during both the Task Force XXI rotation at the National Training Center (NTC), Fort Irwin, California, in March 1997 and the DAWE in November of the same year. He also commanded A Battery, 92d Field Artillery, part of the 2d Armored Division at Fort Hood. In other assignments, he served as G3 of V Corps Artillery and S3 of the 2d Battalion, 32d Field Artillery of the 41st Field Artillery Brigade, both in Germany, and five years as an Observer/Controller at the NTC.**



# FIRES: *The Cutting*

by Brigadier General Toney Stricklin

**T**oday, many believe we are at the threshold of change that will transform the nature of war. This transformation is being brought about by lightning advances in information technologies and space exploitation, geopolitical shifts, and demographic trends with revolutionary implications for the future of fire support and the Field Artillery.

Several years ago, our Army leaders positioned themselves on an intellectual mountaintop in an attempt to visualize the future. As a result, Army planners looked to the year 2010 and translated what they saw into Army XXI, which has been the focus of great experimentation and is now being designed. The Field Artillery has been at the forefront of this effort and has proven to be as valuable as ever to our Army XXI warfighting force.

But the world will continue to change significantly, and our Army is looking out even further to visualize how war might be waged in 25 or even 50 years. Predicting the future is always risky but necessary if we are to be prepared for tomorrow.

We, at the Center for Fires, Fort Sill, Oklahoma, have carefully examined the emerging predictions for warfare in 2025 and beyond. We believe that no arm may be more profoundly affected than the Field Artillery, beckoning a revolution in approaches to providing fires. Although we can never know with certainty what the future will bring, we do know we must begin now to adjust our thinking if we are to ensure highly responsive, versatile and overwhelmingly lethal fires on this future battlefield.

Our vision presented at the 1998 Senior Fire Support Conference here at Fort Sill in February carries the same title as this article. It is intended to stimulate thought—to energize our efforts to

recognize potential avenues for change today to meet the challenges of tomorrow.

Our vision is of a more technologically advanced, potent, and agile Field Artillery force, relying as always on well-trained, dedicated and motivated leaders and soldiers to ensure success. This vision identifies certain trends and outlines new concepts, such as a gradual movement to munitions centrality and effects management as well as changes in how we distribute fires and organize and tailor our forces.

It lays the foundation for a future effects-based FA force and outlines the capabilities such a force might produce. It exploits information dominance and leverages the full spectrum of fires and effects from any source to meet the commander's intent and beat an unpredictable threat. These effects range from the crush of massed fires, to suppressive fires, to surgical precision strikes, to non-lethal munitions that simply stun the enemy.

As the Field Artillery changes to meet the future, one thing will remain certain: we will *never* weaken our commitment to the infantryman or the tanker on the ground. But, most assuredly, there is a revolution in fire effects occurring that may make the terms "direct and indirect," and "close and deep" and the use of standard tactical missions less meaningful.

For example by 2025, a soldier on foot or at a console in a command center might acquire a target and just pull a trigger or push a button to deliver the effects desired by the commander. The source of these effects could be transparent to the soldier, delivered by future cannon systems, Marine Corps aircraft, electronic warfare (EW) devices, precision munitions from unmanned

aerial vehicles (UAVs) or even unseen satellites in low earth orbit. These "cutting edge fires" would be the near-instantaneous delivery of a wide variety of effects anywhere in the battlespace.

---

## The World and Army of 2025

As we see the world of 2025, we're confident the Army will be largely continental United States (CONUS)-based, relying heavily on power projection forces for deterrence and defense. We may face potential adversaries ranging from those with military-technical capabilities roughly equivalent to ours to those who are vastly inferior but seek clever alternatives to offset aspects of our dominance. For example, by 2025, more than 60 percent of the world's population is projected to be urbanized. A future enemy likely will exploit urban terrain in an attempt to nullify our technological superiority.

**Transformation in Warfare.** Many military leaders believe we're at the threshold of a dramatic transformation in the nature of warfare. The signs are the explosion of information technologies, the emergence of instantaneous global media coverage, rapid expansion in the use of space and deep rooted intolerance of the human and material cost of war. Failure to recognize and be prepared to adapt to this transformation could spell defeat on some future battlefield. But if we abandon proven approaches that still apply, the result could be just as costly.

Our future Army must be dominant across the entire spectrum of conflict—prepared to win from the high to the low ends of the spectrum. Future battlefields are likely to be characterized by distributed operations with non-linear, noncontiguous

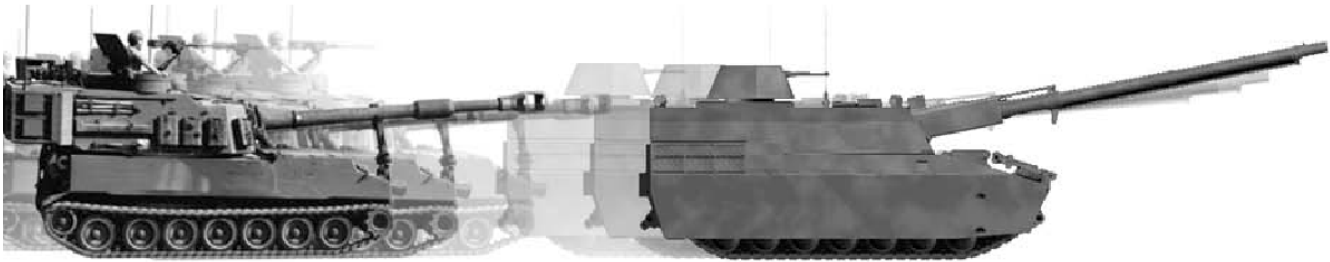

# Edge for the 21st Century

and well-dispersed forces, which will present new and unique challenges.

**Hybrid Forces.** The future Army and its Field Artillery must possess a wide array of capabilities. It will be a hybrid force, as our Army always has been, composed of units with varying levels of modernization.

Rapidly deployable strike forces will be the tip of a very formidable spear, providing early paralyzing effects on the enemy. Our campaign forces that follow will exploit improved Army XXI Abrams tanks, Bradley fighting vehicles, Apache and Comanche helicopters, multiple-launch rocket systems (MLRS), and Crusader howitzers to provide the heft and sustaining combat power to prosecute and defeat a determined foe. It is within the context of maximizing the combat power of the hybrid force and fulfilling likely requirements that we must examine Field Artillery contributions.

---

## Revolution in Fires

Conceptualizing future fires is complex. It requires dissection in non-traditional ways. A revolution in fires must occur if we are to be ready to fight and win America's wars in these future years. We've identified several significant implications of this revolution in progress: distributing fires, effects management, packaging effects, force tailoring and protection, munitions centrality and organizational transformation.

**Distributing Fires.** It should come as no surprise to artillerymen that the joint force or combined arms commander in 2025 will expect effects from fires to be delivered at the right place and time on the battlefield. However, the commander shouldn't have to be concerned with the origin of fires, just that their effects are delivered on time and on target.

The implication for the Field Artillery is that we must provide the force commander robust support from Field Artillery and other fires platforms that are not necessarily "tucked in his back pocket" but can best deliver the required effects. With the technologically advanced battle command and combat systems on future battlefields, selecting effects will depend less on the relative position of the firing platforms to the acquiring sensors or targets and truly be based on the most desirable effects.

Given that premise, we can revolutionize how we distribute fires, bringing about an era of profound doctrinal change. For example, Field Artillery doctrine has long emphasized centralized control of fires as the most efficient means of matching effects to requirements. But limitations in battle command and in the range, mobility and versatility of our shooting systems required us to position them close to supported maneuver units and establish special command and support relationships.

On the fluid and dispersed battlefields of 2025, such relationships between fires platforms may be unnecessary or impractical, and these limitations may disappear. Fires effects are critical; the physical location of platforms may be less so. Fires platforms can be positioned to optimize the ability of the total artillery system to apply overmatching effects quickly and decisively when and where needed.

This revolution in how we distribute fires will happen *only* when we are certain that the needs of our maneuver brethren will be better served than they are today.

**Effects Management.** Changing the way we distribute fires also implies our evolution to effects-based fires as a basis for a new and bold warfighting capability. In 2025, we must go well beyond the

sensor-to-shooter links we're working so hard to perfect today. Twenty-first century fires will have sensor linkages to a much broader range of on-demand effects. Centralized effects management can be realized with the development of an enhanced capability—an effects control center (ECC)—linked to a multitude of sensors and effects providers, including space-based systems. (See Figure 1 on Page 24.)

Envision an adaptive ECC initially capable of exercising early battle command from land, sea or air. While the exact echelon and number of ECCs for early entry and continued operations must be determined through experimentation, it's clear that effects management requires visibility over all potential sensors and fires assets to maximize seamless responsiveness to users. An ECC at the brigade, division and corps levels seems likely.

What we need is an ECC capable of establishing, altering and terminating direct sensor-to-effects links in seconds without lengthy coordination and reconfiguration. It must be capable of adaptive effects management, ready to meet rapidly changing battlefield requirements. For example, the ECC must manage effects to defeat a high-payoff, time-sensitive target for the corps commander one minute and then shift to manage totally different effects in support of a Special Operations Forces A-Team the next.

**Packaging Effects.** Commanders will need tactically meaningful options through dynamically packaged effects. We may have to broaden how we "allocate fires" to provide combined arms commanders effects they can count on for specified periods of time.

Allocating fires to achieve time-sensitive effects is not new. We allocate smoke effects and family of scatterable mines

(FASCAM) in this manner today. What would be new is tapping into delivery assets throughout the force—from other branches and our sister services in joint operations—to package the full spectrum of terminal effects and allocate them for delivery on demand.

**Force Tailoring and Force Protection.** We also must advance our capability to tailor our forces to meet future challenges. Providing versatile and flexible effects calls for more dynamic force tailoring.

Our future artillery force may not be organized around a finite number of weapons systems as it is today. We need to be more flexible—able to perform effects-based tailoring. One hypothetical future scenario might call for employing the effects of five Crusaders, four high-mobility artillery rocket systems (HIMARS) and seven sets of a futuristic advanced fire support system. We are certainly not that versatile today.

Another aspect of force tailoring relates to force protection. We know future maneuver formations will move with greater speed across operational distances; we witnessed this in the Division XXI Advanced Warfighting Experiment (DAWE) at Fort Hood, Texas, in November 1997. We also know that supporting ground-based fires systems will operate autonomously—dispersed to enhance survivability from indirect fires but, perhaps, at increased risk for self-defense.

Because Field Artillery forces are capable of only limited self-protection, we might consider a form of force tailoring that offers protection where fires systems operate in an envelope of dedicated defensive and sustainment capabilities. Vigorous protection will be even more critical in distributed operations.

**Munitions Centrality.** From the invention of the cannon more than 600 years ago, the effectiveness of artillery has been largely a function of the caliber, range, accuracy and precision of the shooting platform. Most artillery platforms today are area fire weapons, dependent on volume of fire for lethality.

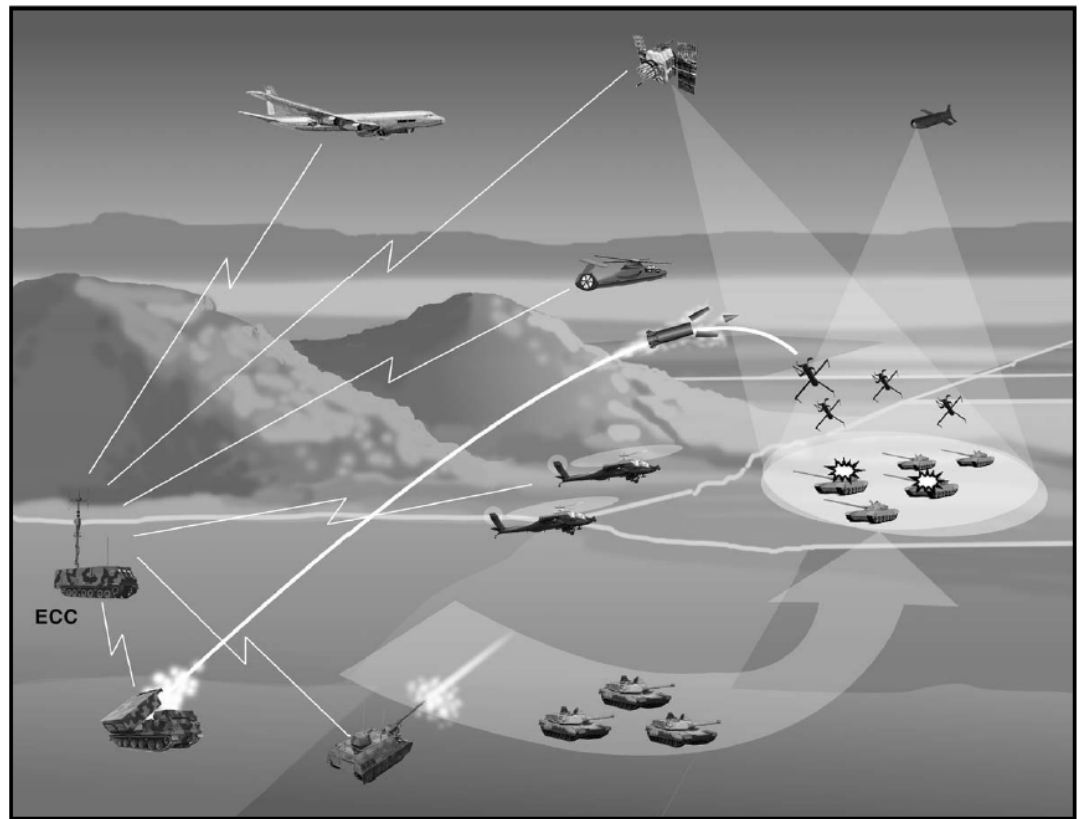

Figure 1: Effects Control Center (ECC). The futuristic ECC will be linked to a multitude of sensors and effects providers, including space-based systems, to manage fires effects for the combined arms commander.

But evolving self-propulsion, guidance and warhead technologies are edging us from our current platform centrality to munitions centrality.

While still in its infancy, munitions centrality demands our attention. As we realize the rates of fire and extended ranges being achieved by present and emerging Army XXI systems, the burden of effectiveness is beginning to shift to the munition.

Guidance capabilities in the munitions will reduce the requirement for firing platform location and target location accuracy. Combined with self propulsion, these munitions will have increased range and loitering time. Emerging munition technologies promise greater lethality, more versatile terminal effects and, eventually, the ability to perform in-progress battle damage assessment (BDA).

Precision munitions make every round count. Just as important, their tremendous killing power reduces the burden of ammunition deployment and resupply. They help to give us the greater strategic, operational and tactical speeds required on tomorrow's battlefield.

Additionally, non-lethal munitions will help us avoid collateral damage and

reduce casualties—effects valuable in urban combat and peacekeeping missions. Clearly, munitions technologies are introducing endless possibilities for increasing the effectiveness of future fires.

These munitions will be enabled by such revolutionary warfighting systems as Crusader. As the Army's 21st century combat system, Crusader will increase total force effectiveness by an unprecedented 52 percent and force survivability by 36 percent while reducing crewmembers by 30 percent and decreasing the logistical tail. Crusader and other future state-of-the-art delivery platforms will ensure we can deliver these remarkable munitions with pinpoint accuracy as well as mass fires decisively when required.

**Transforming Organizationally.** The revolution in fires may require some radical organizational changes. Future systems and capabilities such as Crusader and the ECC offer the flexibility to flatten and functionally segregate delivery system and effects control organizations.

Our adaptive delivery system units would be dynamically tailored for operations



before deploying or during mission staging. These organizations will be shooter heavy and, perhaps, manned with soldiers having greater rank and experience. Commanders would be responsible for moving, positioning, shooting and resupplying the platforms but, possibly, not for coordinating and employing their effects. The effects control organizations, separate and distinct from those doing the moving and shooting, would provide dedicated full-time fire support coordination and management of effects.

## Bridge to the Future

These revolution in fires ideas require we assess just how well we're postured for the future. Most of Army XXI materiel programs and technology enablers are expected to enter the force

between 2000 and 2010. Our intuition tells us that many of them will work well with the emerging revolution of fires concepts just described. We also believe that these materiel programs and enablers will be supported by solid training, leader and soldier development programs that are closely tied to evolving Army-wide initiatives.

Many senior leaders believe that a few key systems will serve as a bridge between today and 2025. These systems provide the lethality, mobility and information dominance essential to future warfighting requirements. Crusader, Javelin, Comanche and UAVs are such systems.

**Crusader.** Crusader is our premiere fire support system—the most devastating combat system ever advanced for fielding. It will be an integral part of Army XXI and will provide fires for the forces of

2025. For the first time in a combat system, Crusader is being designed to marry the advantages of information dominance with the speed and lethality of an advanced warfighting platform to provide full spectrum, overwhelming and overmatching effects.

Crusader is the Army's first ground combat system built to fully exploit information dominance. Its revolutionary cockpit, fully automated ammunition resupply and other systems enable the crew to concentrate on making the most of battlefield information. Additionally, its improved firepower, increased accuracy, better survivability, reduced logistics and corresponding reduction in manning will make our artillery force more lethal and versatile than ever.

Employing composite armor and state-of-the-art mobility subsystems, its advanced robotics and laser ignition will speed the delivery of highly responsive long-range effects. With Crusader, the maneuver commander can quickly shape his fight. The ability of future sensors to "pull the Crusader trigger" in rapid succession will shock and devastate the enemy.

**Additional Transition Systems.** Other platforms, munitions, sensors and battle command systems also will make outstanding contributions to our future hybrid force. The M270A1 improved MLRS launcher; an improved light towed howitzer; HIMARS; sense and destroy armor (SADARM); BAT, a brilliant submunition for moving armored vehicles; MLRS smart tactical rocket (MSTAR); and Firefinder Block II will be in our "kit bags" soon. The advanced Field Artillery tactical data system (AFATDS), a great leap forward in fire support battle command, is being fielded today.

These are relevant capabilities, but we must do more. We must broaden our spectrum of effects, exploit technologies that give our munitions a real loitering capability and examine non-lethal munitions as well. We must achieve effective targeting throughout the depth of the battlespace by fully exploiting other Army, joint and national sensors—not just develop more of our own.



Figure 2: Next-Generation Fire Support Battle Command Automation. The next system must provide the real-time status of all fires and filter information to enable the timely production and prioritization of high-payoff targets (HPTs). It also must optimize matching effects-to-target and present this information for fast and easy deconfliction at all levels of command.

We must begin now to envision the next generation of fire support battle command automation for a vastly improved Army battle command system (ABCS). (See Figure 2 on Page 25.) This system must provide the real-time status of all fires and automated information that's filtered to enable the timely production and prioritization of high-pay-off targets. Our new fire support battle command system also must optimize matching effects-to-target and present this information for fast and easy deconfliction at all levels of command.

**Leader and Soldier Development.** While today's programs are ensuring our leaders and soldiers are very comfortable with digitization, we must take them to another level of skill and confidence. Dispersed and autonomous operations in 2025 will require our junior leaders and crews to be more self-reliant. They must be prepared to exercise initiative and make decisions that were formerly reserved for more senior commanders.

Embedded training, such as we'll see in Crusader, combined with vastly enhanced simulations are key enablers to meeting these challenges. Future battle command training must realistically induce the stress, tempo, speed of decisions and unprecedented amount of information available at all levels.

We must leverage combined arms home-station training in an enhanced synthetic training environment to maximize the experience in the dirt at the combat training centers. This training environment must be virtually indistinguishable from combat.

We also must do more to leverage links with joint training opportunities. As we integrate effects management across the joint force spectrum, routine training with all service components providing sensors and fires will be more critical than ever.

---

## Moving Out to Meet the Future

While we continuously analyze existing programs to bridge to the future and remain vigilant for emerging possibilities, we must "cross the line of departure" and move forward. We can begin now to refine the broad implications of becoming an effects-based force and make adjustments to transform organizationally, doctrinally and in other ways. If new materiel solutions are required, the acquisition process must begin in the next

few years.

With that mindset, we've identified some initial opportunities to prepare for the future—opportunities that afford us minimum risk today for maximum payoff tomorrow.

**Transitioning to Effects Management.** We must shift our thinking and processes as we begin transitioning to effects management. In fact, the deep operations coordination cell (DOCC) employed by the 4th Infantry Division (Mechanized) and III Corps shows we are beginning to do just that. The DOCC provides a unified organization to plan, prepare and execute deep operations throughout the relevant battlespace. The 4th Division's DOCC employed during the DAWE offered an initial glimpse into effects control.

However, for today's force to become effects-based, two things must occur. First, we must have significantly improved, longer range communications. Second, ABCS horizontal connectivity and functionality must be enhanced and expanded.

With the advent of these key initiatives, we could move quickly to effects management and revolutionize fire support.

In an effects-based force, all artillery systems could become fires assets integral to the combined arms force, not necessarily using the command and support relationships we have today. Field Artillery fires and other Army effects could be managed, controlled and directed from highly automated ECCs. Additionally, ECCs would have visibility over all relevant joint fires and sensor capabilities, enabling the fastest possible coordination and delivery of effects when needed to achieve the commander's intent.

We envision being able to reduce our layers of fire support and fire direction nodes dramatically. We could consolidate these organizations and functions into fewer and more capable ECCs. We would locate them at those levels that could best plan, coordinate, prioritize, deconflict and execute the scheme of fires.

For example, we could eliminate battery and battalion fire direction centers (FDCs), integrating tactical fire direction into an ECC within the brigade commander's tactical operations center (TOC). We see possibilities for similar restructuring of fire support elements (FSEs) and fire control elements (FCEs) at the division level. Savings in our force

structure could be substantial.

We must experiment with these concepts and determine their value and viability for implementation.

**Reconfiguring Delivery Assets.** We must look at configuring delivery assets very differently. They may or may not be collocated with supported maneuver formations to provide the most effective fires. Our delivery assets might be positioned most often as shared platforms centrally located among the supported formations but maneuvered independently. (Such a configuration will not happen until it's clearly the best option.)

Organizationally pooled for command and control at the highest level of tactical command, delivery assets would be configured as mission-tailored strike packages to provide subordinate commanders tactically meaningful options for fires. The delivery assets in these strike packages should, perhaps, be treated as high-value assets and have their own security and sustainment, just as a naval carrier group is screened, given air and sub-surface defense and replenished on the move. In effect, these mission-tailored assets would become "mobile firebases."

**Expanding Delivery Options.** We are investigating opportunities to expand delivery options even though future warfighting requirements are only loosely defined. The light towed howitzer and HIMARS are two funded developmental systems that will provide responsiveness and speed in both inter- and intra-theater operations.

Another delivery option is the concept being developed by the Defense Advanced Research Projects Agency (DARPA), Roslyn, Virginia—a crew-less, remotely operated and containerized advanced fire support system. (See Figure 3.) We view this radically different concept as a "wide area support weapon" and call it WASP for its operational potential to repeatedly sting the enemy. We're working with DARPA to develop an operational concept through simulations and intend to follow up with major experimentation.

**Delivering Versatile Effects.** We must expand our capabilities to provide even more versatile effects for our future force. While today's Army delivers the widest range of effects of any modern army, we see further growth in two technologies giving us the ability to greatly broaden our range of effects.

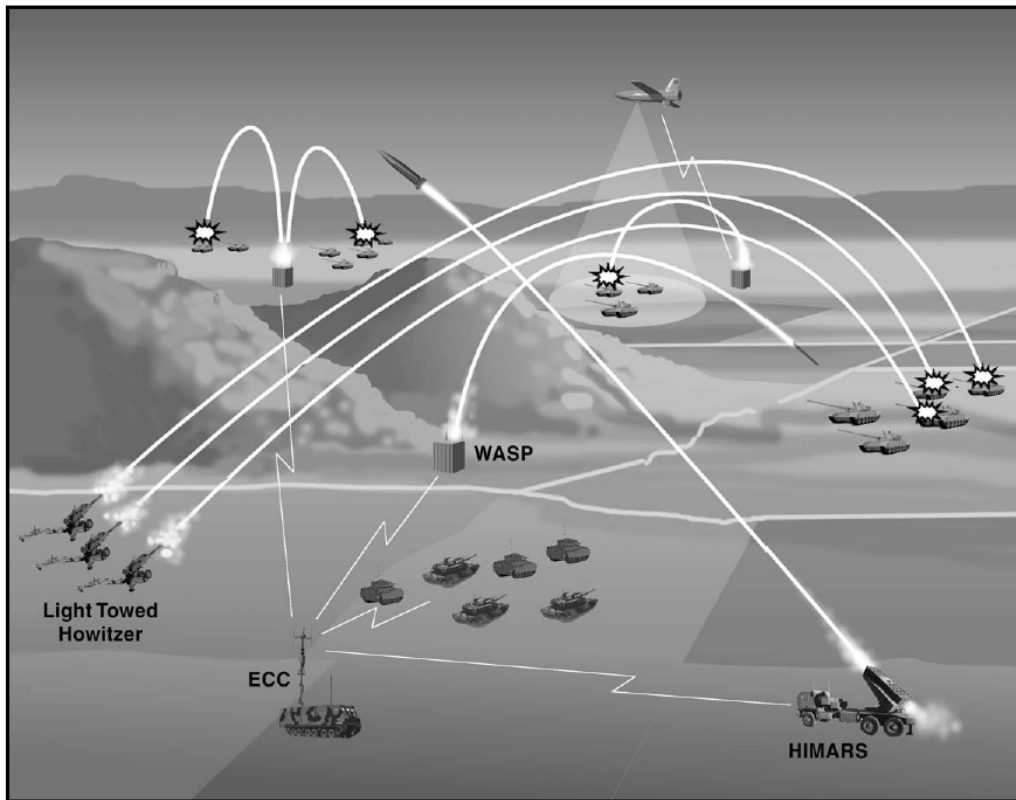

Figure 3: Expanding Delivery Options. One new option is the WASP, a "wide-area support platform" being developed by the Defense Advanced Research Projects Agency (DARPA). WASP would be a crew-less, remotely operated, containerized advanced fire support system.

First, the development of non-lethal munitions will provide us capabilities we've never had before. They offer tremendous potential in situations where we must minimize collateral damage. Non-lethal munitions could provide incapacitating effects, such as stunning the opponent, inhibiting his foot and platform movement, interrupting his communications or neutralizing his optical, thermal and electronic sensors.

Second, we need to capitalize on emerging loitering munition technologies that provide battlefield "hang-time" and lethality. We must improve our current efforts by embedding in the munitions the capability to avoid fratricide, so that in flight without other sensor or information support, they can determine if potential targets are friend or foe. They must be able to identify and attack the enemy or self-destruct if only friendly forces are in the search area.

**Leveraging Space.** Space is, indeed, the new high ground—an exceptional area of opportunity. (See the article "The Army and Space" by Lieutenant General Edward G. Anderson III in this edition.) Today, we depend on space-based

systems for target acquisition, communications and navigation. By 2025, we foresee this dependence increasing exponentially.

In coordination with the Space and Missile Defense Command (SMDC), with its headquarters in Arlington, Virginia, we're establishing an office at Fort Sill to define fire support requirements for space-based systems. Initially, we'll work on two important fires issues: making re-tasking of space assets more dynamic and ensuring fire support requirements are factored into the design of future space-based systems.

## Remaining on the Cutting Edge

While there is not wide consensus on the characteristics of warfare in 2025, we believe we're on the threshold of a transformation in the nature of war. Our teacher has been the Force XXI AWE process. Insights the DAWE provided compel us to start now to develop revolutionary fires concepts that will maximize the combat power of our future forces, beginning with the Field Artillery.

We believe we are on the right path as our Army moves boldly into the 21st century.

This vision charts our course to the future. It provides a starting point for victory on future fields of battle. It predicts an era of enormous, yet necessary, change that will challenge us as a branch.

Our vision is also about building solid credentials for an Army-level focus to realize full-spectrum warfighting dominance in Army, joint and combined fires. Unavoidably, it touches on many areas beyond our branch. To achieve synergy of effort, our vision must be nested with other Army and joint visions and concepts.

Our vision for the future FA challenges us, as a branch, to be innovative, bold and yet thoughtful. It calls for us to manage risks while experimenting with non-traditional ideas. It demands razor-sharp thinking from our best and brightest to look beyond today's horizons to the 21st century and keep us on the cutting edge.



**Brigadier General Toney Stricklin** until recently was the Assistant Commandant of the Field Artillery School and Deputy Commanding General for Training at Fort Sill, Oklahoma. In early May, he became the Director of Requirements in the Office of the Deputy Chief of Staff for Operations and Plans (ODCSOPS) at the Pentagon. He also was Assistant Deputy Chief of Staff for Combat Developments for the Training and Doctrine Command (TRADOC) at Fort Monroe, Virginia, and on the Joint Staff as the Chief of the Conventional Arms Division, J-5. He commanded the 210th Field Artillery Brigade at Fort Lewis, Washington; the 3d Battalion, 3d Field Artillery, 2d Armored Division, Fort Hood, Texas; and A Battery, 1st Battalion, 3d Field Artillery in Korea. Among other assignments, he was the Senior Fire Support Combat Trainer at the National Training Center, Fort Irwin, California; S3 for the 1st Cavalry Division Artillery, Fort Hood; and Assistant Deputy Chief of Staff for Force Development, also in ODCSOPS.

The Division Advanced Warfighting Experiment (DAWE) started like most Battle Command Training Program (BCTP) Warfighter exercises. The artillery of the opposing force (OPFOR), the "Red God of War," not only vastly outnumbered the friendly artillery, it out-ranged, out-supplied and, with centralized command and control procedures, outmaneuvered the friendly artillery. However, by the end of the exercise, the OPFOR's center of gravity—his artillery—lay smoldering in ruins.

The November 1997 DAWE at Fort Hood, Texas, involved the 4th Infantry Division (Mechanized) as well as some III Armored Corps, Army Reserve and National Guard units serving as the Experimental Force (EXFOR). There were several train-up exercises with the actual DAWE consisting of four consecutive battles lasting nine days. The EXFOR's Force XXI fought these battles in large areas of operations (AOs) with frontages of up to three times larger than current doctrinal division fronts.

Critical to the EXFOR's victory was the success of the counterfire battle that eliminated the OPFOR artillery as a major player. This article examines the DAWE counterfire fight, the adjustments each side made as the various battles progressed and doctrinal possibilities for

future counterfire.

## OPFOR Artillery

The DAWE counterfire battle was a challenge because the threat forces had more artillery systems, many of which fired longer ranges at higher rates of fire. (See Figure 1.) In addition, the OPFOR protected its artillery with robust air defense coverage.

Just as the DAWE units modernized for the exercise, so did the OPFOR. Its longest range multiple rocket launchers (MRLs) were the 280-mm WM-80s, which fired out to 80 kilometers, and its 300-mm 9A52 that could reach out to 70 kilometers. The OPFOR also had the 220-mm BM-22 that ranged to 40 kilometers. The enemy's gun-howitzers included the 152-mm 2S19 with a rocket-assisted projectile (RAP) range of 40 kilometers and the 203-mm 2S7 that could range out to 50 kilometers with RAP.

The 9A52 and BM-22 units had a fire mission processing system that provided capabilities similar to those of the advanced Field Artillery tactical data system (AFATDS). Placed at the battery level, this system allowed the OPFOR to mass the effects of fires without positioning his assets together.

The OPFOR artillery fielded an impressive array of countermortar and counterfire radars. In addition to sound and flash units, the OPFOR employed ARK-1, SNAR-10 and the Type 704 counterfire radars. The OPFOR also employed many aircraft and unmanned aerial vehicles (UAVs) and drones with photo, communications intelligence (COMINT) and electronic intelligence (ELINT) capabilities to find the DAWE artillery. As in similar exercises, many special operations reconnaissance teams infiltrated

<b>EXFOR - 116 Tubes and MLRS</b>
Iran-1,000 Tubes and MRLs
Germany-1,350 Tubes and MRLs
Israel-1,400 Tubes and MRLs
<b>OPFOR - 3,170 Tubes and MRLs</b>
North Korea-5,500 Tubes and MRLs

Figure 1: The OPFOR artillery in the DAWE consisted of 2,616 artillery tubes and 554 multiple rocket launchers (MRLs)—a lot of artillery as shown in the comparison to the artillery of other nations. The EXFOR artillery was considerably smaller with 90 Crusader howitzer tubes and 126 multiple-launch rocket systems (MLRS). (The OPFOR and EXFOR artillery numbers represent the total systems in the four battles over a nine-day period.)



behind the forward line of own troops (FLOT) seeking friendly radars and artillery to destroy.

## DAWE Artillery

For the counterfire battle, the EXFOR division artillery (Div Arty) commander had significant assets. His three direct support (DS) battalions were Crusader-equipped (3x6) and each had a Q-36 radar. Their primary counterfire mission was against mortars and regimental artillery groups (RAGS). The Div Arty also commanded and controlled the divisional multiple-launch rocket system (MLRS) 2x9 battalion that includes a target acquisition battery (TAB) and a headquarters, headquarters and services battery. (In previous articles, this unit has been referred to as the command and attack battalion, or CAB.)

Supporting the division was the 214th FA Brigade, III Armored Corps Artillery, from Fort Sill, Oklahoma, and the 138th FA Brigade from the Kentucky Army National Guard in Lexington. The Div Arty commander attached his target production section (TPS) and Q-37 radars from the divisional MLRS battalion to the 214th FA Brigade, which he designated the counterfire headquarters. The 214th FA Brigade controlled two other Q-37

TA detachments, one of which was a decoy detachment. Each brigade was assigned two MLRS battalions and a Crusader battalion.

These units gave the EXFOR artillery a total tube strength of 90 Crusaders and 126 MLRS launchers.

During the DAWE, the 214th FA Brigade used three automated systems to enhance fire mission processing and situational awareness. The advanced FA tactical data system (AFATDS) planned and executed targets, targets lists and fire support coordinating measures (FSCM) and provided unit status reports and radar information. The maneuver control system/Phoenix (MCS/P) gave the friendly and enemy unit situational awareness and graphics plus relayed operations plans (OPLANs), operations orders (OPORDs) and situation reports (SITREPs). The all-source analysis system (ASAS) provided essential enemy information from multiple sources as well as analysis and intelligence reports.

One device that facilitated command and control was a video teleconference (VTC) whiteboard that allowed commanders to talk face-to-face with and collaboratively draw graphics on a digitized map. Using this device, the division commander could discuss new intelligence, wargame courses of action and formulate orders directly with his commanders in the Div Arty, brigade combat team (BCT), and aviation brigade tactical operations centers (TOCs) or his staff in the division command posts (CPs). The entire planning process often took minutes instead of hours.

During whiteboard commanders' sessions, the 214th FA Brigade commander displaced to the forward division CP (DTAC) where the Div Arty commander fought the battle. At the DTAC, he coordinated any changes to the commander's intent, missions, priorities and organization with the Div Arty commander. He then synchronized the changes with the 138th FA Brigade.

The DAWE offered the opportunity to work with future weapons, acquisition systems and munitions. Crusader fires 155-mm projectiles almost 50 kilometers at a rate of up to 12 rounds a minute. It can displace 750 meters in only 90 seconds, greatly improving survivability. A single howitzer can fire up to eight rounds out to 20 kilometers on a time-on-target mission. The system includes

self-laying, computing and locating technology.

The improved MLRS M270AI launcher was the standard. In addition to its new array of rocket and missile munitions, the launcher's improved ability to stow, displace, elevate and slew has reduced its exposure by 75 percent.

Firefinder Q-36 Version 8 can acquire 20 targets a minute with increased range and accuracy. The Block II Firefinder Q-37 increases range and accuracy to 60 kilometers in the mode for conventional artillery or acquires up to 250-plus kilometers in the mode for theater ballistic missiles.

Clearly, one DAWE success was the enhanced munitions. Crusader fired the extended-range dual-purpose improved conventional munition (DPICM) with 85 bomblets to 47 kilometers and sense and destroy armor (SADARM) with two submunitions to 27 kilometers. The millimeter wave and infrared sensors of the submunitions have a 130-meter radius search footprint.

MLRS fired the extended-range rocket (ER-MLRS) to 45 kilometers and the guided MLRS (GMLRS) out to 60 kilometers. The star of the rocket munitions was the MLRS smart tactical rocket (MSTAR). It carries fire-and-forget munitions to a range of 60 kilometers. MSTAR submunitions have a four-kilometer search area and are deadly against enemy armor.

The Army tactical missile system (ATACMS) also had new munitions. The Block IA carries an anti-personnel anti-materiel (APAM) missile to 300 kilometers. The Block II carries 13 fire-and-forget antiarmor submunitions, called BATs, to 140 kilometers while the Block IIA took six improved BATs 300 kilometers.

These munitions proved devastating against not only doctrinally templated artillery units that had been confirmed and counterfire units, but also moving artillery formations.

## Counterfire Fight

The Div Arty commander's intent for the counterfire battle was to leverage all intelligence sources "to proactively attack and kill the enemy's fire support systems to deny him the capability to influence the battle while providing reactive counterfire with a near instantaneous sensor-to-shooter trigger that is agile and paralyzes enemy fires to protect friendly forces." The counterfire battle was divided into proactive and reactive.



The EXFOR Div Arty controlled proactive counterfire while the 214th FA Brigade controlled the reactive counterfire fight. Initially, the goal was for 75 percent of the counterfire effort to be proactive. While this goal was not met, more than 50 percent of enemy artillery was destroyed by proactive means. The ability to prosecute proactive counter-fires was a quantum leap forward as compared to past BCTP Warfighter exercises.

The Div Arty commander was surrounded by real-time intelligence systems at the DTAC. Sitting next to the Assistant Division Commander (Maneuver), he quickly determined the latest division priorities and focus, confirmed intelligence collection and then targeted the enemy's artillery. He then sent fire missions via the DTAC fire support element (FSE) AFATDS through the Div Arty TOC to the FA brigades to fire.

The FA brigades could not receive intelligence reporting on their all-source analysis system (ASAS) fast enough to meet targeting criteria. However, the DTAC monitored joint surveillance and target attack radar system (JSTARS) and UAV real-time feeds, showing the enemy's actual movement on the battlefield. This real-time intelligence and situational awareness allowed the Div Arty commander to immediately employ his reinforcing brigades against high-priority targets within their range limits.

Normally, the UAVs were attached to the maneuver brigades instead of being controlled by the division fire support coordinator (FSCoord). Although the Div Arty and FA brigades had no ground control station to fly the UAVs directly, the DTAC FSE did have this capability. At times, fire supporters had direct control of the divisional UAV through the DTAC FSE. Usually when JSTARS observed artillery movement while focusing on a named area of interest (NAI), a UAV was sent to confirm the target. The enemy units were then monitored moving into a target area of interest (TAI) and attacked.

Critical to the reactive counterfire battle was the use of FSCM and radar zones. The coordinated fire line (CFL) had to be kept as close to the FLOT as possible to facilitate rapid clearance of fires. This proved incredibly difficult in the DAWE with the increased agility of the attack aviation and division cavalry squadron.

Huge covering force operations areas created large gaps in Q-36 coverage.

While Q-37 radars could fill the gaps, a common sensor boundary was difficult to maintain. Radar acquisitions short of the CFL were sent to the Div Arty to coordinate with the brigade and task force fire support officers (FSOs) for clearance. This often took 30 minutes—much too long to fire on a fleeting OPFOR artillery target.

Even with AFATDS and MCS/P, the Div Arty had to continuously update situation reports from the FSOs because the battle moved faster than the digital process. TPS and the Div Arty and brigade S2s continuously worked intelligence preparation of the battlefield (IPB) to template enemy formations. They overlaid the locations with call-for-fire zones (CFFZ) to confirm templates and attack rapidly. CFFZs short of or near the CFL were sometimes "pre-cleared" of maneuver units to facilitate the speed of the attack.

Each acquisition was plotted on a map by color relating to a time of fire. This greatly aided targeting, reading enemy order of battle and calculating battle damage assessment (BDA).

Often, large enemy artillery formations were plotted and sent to the Div Arty and corps for nightly aviation deep attacks. (As it turned out, the traditional aviation deep attack was never executed during the DAWE because the enemy formations were so damaged by artillery by H-hour that they no longer constituted targets suitable for aviation attack.)

Critical friendly zones (CFZ) shortened the response times and protected high-value targets and critical terrain. The rapid mobility of the division demanded continual maintenance of CFZ plans.

**Counterfire Battle Drill.** The counterfire battle drill used by the 214th FA Brigade took advantage of digital systems, accommodated the work-arounds between AFATDS and the initial fire support automated system (IFSAS) and ensured a "man in the loop" to visually check data and target plots before missions were fired. (See Figure 2.)

An important part of the DAWE for artillerymen was linking the FA brigades equipped with IFSAS and the Div Arty equipped with AFATDS. In the future, different versions of systems must work together, so the DAWE provided an excellent opportunity to try linking two generations of technology. The FA brigades, Div Arty and Field Artillery School at Fort Sill worked together to develop tactics, techniques and procedures (TTP) and work-arounds to accommodate both systems. These fell

into three main categories: mission processing, sensor-to-shooter interface and message interoperability.

*Mission Processing.* AFATDS' ability to process missions quickly would over-whelm IFSAS. In addition, changes made by IFSAS to an AFATDS-generated fire order only could be communicated back to the AFATDS via the mission-fired report (MFR)—after the mission was executed. To accommodate the differences in the systems, soldiers had to interface at MLRS command posts for work-arounds, increasing firing times.

*Sensor-to-Shooter Interface.* The interface between Firefinder and AFATDS caused several problems. AFATDS does not prioritize radar acquisitions in terms of radar zones. IFSAS was used to process these missions. When AFATDS received a radar acquisition, it determined if it violated a CFZ, CFFZ or artillery targeting intelligence (ATI). When acquisitions were received at the 214th Brigade IFSAS, the determination was made to attack the target. If the target was short of the CFL, the fire mission was passed to the Div Arty via AFATDS where the Div Arty used AFATDS digital coordination requests to clear the target. Once cleared, the Div Arty counterfire officer then sent the target back to the brigade IFSAS to process. Targets beyond the CFL were simply attacked via IFSAS.

*Message Interoperability.* Perhaps the greatest IFSAS-AFATDS challenge was in message interoperability. Some of these problems were—

- The AFATDS' mission message had to be displayed in IFSAS to ensure the format was correct before the mission was entered into IFSAS. Because IFSAS only accepts geometry names of up to seven characters, AFATDS geometry names often caused the IFSAS operator to have to correct the message for IFSAS and manually input it. The AFATDS database also allows far more target types than IFSAS recognizes. The IFSAS operator had to re-input the message using IFSAS terms, which were not as descriptive as AFATDS and did not always precisely meet Div Arty targeting criteria.

- Although AFATDS could pass fire plans, the IFSAS operator had to build a separate fire plan file so IFSAS could accept the AFATDS fire plan.

- If the AFATDS operator altered the database during a battle, the IFSAS fire

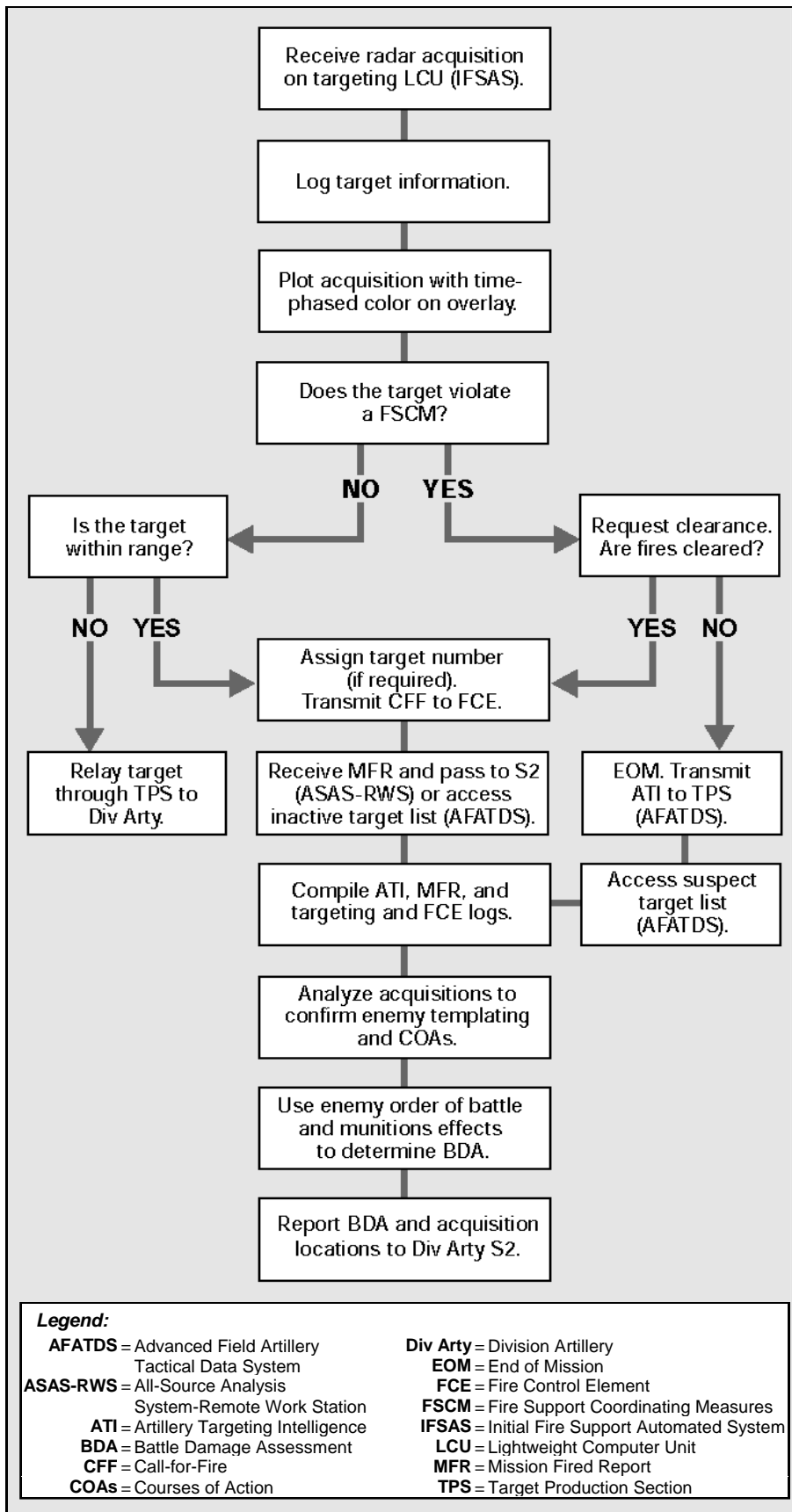

Figure 2: Counterfire Battle Drill

control element (FCE) had to revert to accepting missions by voice until the database was corrected. If the databases were the same, IFSAS fire missions were processed automatically.

Work-arounds performed at the operator level reduced the impact of unrecognizable geometry, target types and fire plans, but they also reduced responsiveness.

The week after the DAWE, the AFATDS Project Manager, Training and Doctrine Command (TRADOC) System Manager for AFATDS (TSM-AFATDS) and representatives of developers, contractors, the 4th Infantry Div Arty, 214th FA Brigade and the FA Center's Project 2000 met. Their purpose was to take advantage of what was learned about AFATDS during the DAWE and develop a course of action to adjust for easier AFATDS-IFSAS interoperability and correct the deficiencies found in AFATDS.

**Half-Time Changes.** During a train-up exercise for the DAWE, the OPFOR was unsuccessful in meeting his objectives, so he modified his TTP and doctrine significantly. For the final exercise, the OPFOR employed new TTP against the EXFOR. The changes included the following:

- Doubling the number of special forces reconnaissance teams operating deep in the division rear area.
- Shifting his reconnaissance team priority from aviation to MLRS units and his UAV priority to MLRS units.
- Moving his target acquisition radars forward with his division reconnaissance assets and changing his fires priority to MLRS and radar units.
- Creating TTP to counter Crusader and MLRS by first firing family of scatterable mine (FASCAM) minefields to hold them in place while he fired a rolling barrage.
- Committing army and army artillery groups (AAGs) farther forward behind the most forward detachments.
- Orienting first-echelon forces on the EXFOR's fires complex instead of the maneuver brigades.
- Adding regimental indirect fires to barrages designed to suppress and destroy forward MLRS launchers.
- Varying his speed of movement to throw off the timing of the attack between an NAI and TAI.

It was obvious from these changes that the counterfire battle during the train-up exercises had forced the OPFOR into major adjustments. Clearly, his priority



was to defeat the EXFOR counterfire capability.

**Keys to Success.** Although some of the OPFOR's new TTP worked initially, the EXFOR division quickly adjusted.

The EXFOR developed several TTP that set the conditions for success in counterfire. All the TTP listed also apply during routine BCTP exercises.

- The Assistant Division Commander (Support) ran rear operations just as if he were on the FLOT. He used every available asset to find, fix and destroy the "eyes" of the OPFOR before they attacked or called for air strikes on critical command and control nodes, aviation assets, main supply routes and support units. This kept the OPFOR from attacking counterfire assets and ensured timely ammunition resupply.

- Extensive force protection was attached to the Q-37 radars. The radar was provided maneuver forces, air defense, engineers and smoke capability. Several OPFOR UAVs were shot down while trying to confirm locations and came too close to the radars. (Although this TTP was employed by the EXFOR from the beginning of the DAWE, it really began to show its value as the OPFOR focused on killing the EXFOR artillery.)

- MLRS and Crusaders stayed behind hills, whenever possible, to minimize sighting and attack time by enemy aviation assets. Crew drills included immediate smoke and movement when the air defense early warning system announced inbound attack helicopters.

- Although maneuver assets were often used to protect MLRS, the best technique was to stay right behind lead maneuver task forces as they cleared enemy forces in front of them. This gave the launchers added range and ensured "stay-behind" forces did not attack them from the rear.

- Although FA brigade liaison officers (LNOs) normally are sent to the Div Arty or unit headquarters they are reinforcing, LNOs were sent from the Div Arty to the FA counterfire brigade headquarters during the DAWE. The FA brigades sent LNOs to the maneuver brigade TOCs. This greatly helped coordination with the maneuver units for force protection, unit locations, movement of the CFL and Q-36 radar coverage.

- The FA brigades closely monitored the movement and placement of their forward logistics elements (FLEs). They anticipated logistical needs and coordinated with maneuver forces for

protection of the FLEs and, at times, collocating or exchanging FLE stockages.

---

## Lessons Learned

There were, of course, thousands of doctrinal, tactical and technical lessons from the DAWE. These are but a few from the counterfire headquarters perspective.

- During the days of the "active defense" doctrine, there was a saying about killing tanks: "If I can see you, I can hit you—If I can hit you, I can kill you." During the DAWE, the same could be said about enemy artillery as well as armor. The combination of the eyes of JSTARS, Comanches, UAVs and Q-37 radars left no place for enemy formations to hide. The EXFOR identified, categorized, prioritized, attacked and destroyed the enemy's formations before his combat power was brought to bear on the battlefield.

- Enemy doctrinal artillery templates, such as DAGs and RAGs were rapidly confirmed and attacked. This forced the OPFOR away from his doctrine and OPLANs. His artillery groups had to disperse among his maneuver forces, decreasing command and control and his ability to rapidly mass fires.

- Smart munitions not only killed the enemy, they also provided greater friendly force survivability because of their reduced signature as well as their drastically reduced logistics requirements.

- At the same time, smart munitions raise the probability of fratricide—they can't distinguish friend from foe in a target area. Firing smart munitions call for complete discipline to clearance procedures and minimum safe distances and for fire supporters to understand the munitions' capabilities and limitations in detail.

- The increased size of the division AO demands two reinforcing artillery brigades for full coverage and rapid response.

- Automation decreases the fog of war, but it also increases the friction of war.

- There is no end date for automation experimentation. Artillerymen have used digital automation for many years. We grew up with the Field Artillery digital analog computer (FADAC), tactical fire direction system (TACFIRE), TI-59, backup computer system (BUCS), light TACFIRE, the battery computer system (BCS), IFSAS and now AFATDS. Every piece of hardware has several versions of software. Artillerymen working outside their own brigade or Div Arty have had to

develop work-around procedures for different hardware-software configurations.

That is the future. All US forces—active and reserve components—will never have the same version of software and hardware—much less our coalition forces. A critical skill for soldiers in the future is the ability to assimilate various automation systems to meet commander's needs and ensure interoperability.

DAWE was successful at almost every level. Future automation, intelligence, information and weapons systems used make it is easy to credit technology with the victory—to minimize the effort of soldiers and leaders. Just the opposite is true.

The DAWE environment stretched soldiers' capabilities to think and solve problems for themselves. They often had to decide what information was important and what wasn't, when to act on their own and when to request help. They combined their independence with their abilities to manipulate databases to fit commanders' needs.

The EXFOR won because it acted inside the OPFOR's decision cycle and created opportunities that it quickly exploited. The division commander and his subordinate commanders changed plans "on the fly" (often using the video teleconference whiteboard) to mass when necessary or take advantage of an enemy vulnerability. Automation provides insight, but the leaders provided the determination, the creativity, the agility to win. Training must continue to develop leaders and warriors—not digital soldiers.

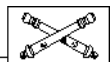

---

**Colonel Bruce A. Brant commands the 214th Field Artillery Brigade, III Armored Corps Artillery at Fort Sill, Oklahoma, the brigade that served as Counterfire Headquarters during the recent Division Advanced Warfighting Experiment (DAWE) at Fort Hood, Texas. In his previous assignment, he commanded the Combined Battlefield Coordination Detachment (BCD) in Osan, Korea. He also commanded the 1st Battalion, 319th Airborne Field Artillery Regiment in the 82d Airborne Division at Fort Bragg, North Carolina, and a firing battery in the 41st Field Artillery Brigade at V Corps in Germany. His other assignments include serving as Senior Fire Support Observer/Controller at the Joint Readiness Training Center (JRTC), Fort Polk, Louisiana, and S3 of the 25th Infantry Division (Light) Artillery, Schofield Barracks, Hawaii.**

# HIMARS

## for Deployable "Heavyweight" Fires

Since the early 1980s, some Army leaders envisioned the need for a lightweight multiple-launch rocket system (MLRS). Although the M270 MLRS system was being fielded, it lacked the strategic sortie efficiencies and tactical air mobility the C-130 aircraft fleet could afford the Army.

In addition to MLRS, the Army needed a lightweight multiple rocket system to satisfy a multitude of requirements for contingency forces—provide interdiction and counterfire fires, engage deep targets and be C-130 transportable. A new start was necessary to meet all of these requirements.

Approximately 16 years have passed, and the need for such a firing platform has grown. The number of deployed US forces to widely dispersed geographical areas have increased during the past several years. This increased number of deployments supports the need to maximize lethality while minimizing strategic transportability requirements. The high-mobility multipurpose artillery rocket system (HIMARS) will provide that lethality and transportability.

**System Requirements.** HIMARS will be a C-130 transportable, wheeled, indirect launch system capable of firing all rockets and missiles in the current and future MLRS family of munitions

(MFOM). Each HIMARS unit will mirror current MLRS unit functionally and operationally. The HIMARS unit will be assigned to Field Artillery brigades in support of light force operations.

HIMARS will be fully interoperable with and will use the existing and future command and control and support systems the M270 launcher uses. It will have on-board navigation and positioning systems and technical fire control capabilities. It also will be able to on-and off-load munitions autonomously. The system will operate in the same climatic conditions as the M270 and, to the maximum extent possible, share components with the M270.

**HIMARS Demonstration.** The transition of US national military strategy from forward-basing to force projection coupled with the changing geopolitical environment in the post-Cold War era has influenced the Army's acquisition decisions to design a capabilities-based force. The Rapid Force Projection Initiative-Advanced Concepts Technology Demonstration (RFPI-ACTD) will help in that design. Its goal is to transition mature technological solutions into significant operational capabilities to fill the gap created by aging forward-based equipment and the new power projection strategy of forced or

early entry operations. HIMARS will play in the RFPI-ACTD for two weeks this summer at Fort Benning, Georgia, in an exercise that is a building block for the Joint Contingency Force/Light Army Warfighting Experiment (JCF-AWE). The JCF-AWE tentatively is scheduled for the Fourth Quarter of FY 2000.

For the RFPI-ACTD field training exercise, Fort Sill developed four HIMARS go-to-war prototypes—three were fielded to the XVIII Airborne Corps' 3d Battalion, 27th Field Artillery at Fort Bragg, North Carolina, the exercise participants. Incorporating HIMARS into the ACTD and JCF/Light AWE will give the forced or early entry commander the range, precision and lethality of MFOM to project fires and protect the force while using little strategic airlift.

The battalion will keep three of the prototypes in a HIMARS platoon for two years after the RFPI-ACTD exercise to evaluate the system's capabilities and provide input to engineers designing the system. This should shorten the HIMARS development cycle significantly. (The fourth prototype system will remain at the contractor's site.)

**System Fielding.** In 1997, HIMARS was funded for fielding in 2007. We are currently exploring options to accelerate the program and field HIMARS sooner—perhaps a battalion as early as 2005. Emerging force structure studies for HIMARS call for the two Field Artillery brigades in support of the light division, each having two HIMARS battalions and one towed artillery battalion.

HIMARS will give the commander flexibility, go anywhere quickly and allow the FA to do its job with increased firepower. HIMARS will provide highly deployable, heavyweight fires for forced or early entry forces—any contingency mission—and serve as a bridge for fires in the Army After Next.

CPT Jason W. Robbins, AC  
HIMARS Action Officer  
TRADOC Systems Manager-ATACMS  
Fort Sill, OK



HIMARS Prototype

# Leading the National Guard into the 21st Century

## *The 138th FA Brigade and the DAWE*

by Colonel Jasper Carpenter and Major Freddie R. Waggoner



Photo by SSG Dave Altum, PA, KY/ARNG

**T**he 138th Field Artillery Brigade, Kentucky Army National Guard, was one of two FA brigades reinforcing the Experimental Force (EXFOR) during the Division Advanced Warfighting Experiment (DAWE) at Fort Hood, Texas, late last year. In addition, the 138th was the only brigade-level unit from the Army National Guard to participate in this experiment designed to fight a future heavy division. In April of 1997, our brigade began the first of many train-up events for the DAWE, culminating in a nine-day war in November of the same year.

This article discusses the 138th Brigade's role and mission in this important exercise—one that will shape the design and operations of the Total Army well into the 21st century. We detail the unique challenges our citizen-soldiers faced when participating in the DAWE and train-up exercises and several emerging issues the fire support

community and Army must address.

### **DAWE Background**

The Army's purpose in conducting the DAWE was to determine the payoff associated with the advanced information technologies of the Army tactical command and control system (ATCCS) and test new doctrine, force structure, weapons, munitions and training for our future Army. The 138th FA Brigade participated in the experiment and revalidated the requirement for two FA brigades to support the Army's future heavy division. The exercise determined whether a "non-digitized" FA brigade (the 138th) could be integrated successfully into a digitized division and (or) corps operation while assessing the Guard's ability to learn and fight with the new doctrine and tactics, techniques and procedures (TTP) associated with these new systems. Although the 138th Brigade

had the digital initial fire support automated system (IFSAS), the brigade was not fully digitized with access to the digital subsystems of ATCCS.

The 138th FA Brigade participated in a one-week Warfighter seminar in April, two simulated exercises (SIMEXs) of 15 days each and four staff exercises involving the brigade S3 for a total of three more weeks that culminated with the November DAWE. During this period, the brigade also attended its normal 15-day annual training at Fort Stewart, Georgia, in July.

Early on in the DAWE preparations, we learned our participation would require tremendous commitment and sacrifice by our citizen-soldiers who have fulltime civilian careers—particularly the primary staff.

As the FA brigade that wasn't fully digitized, we had IFSAS while the EXFOR's 4th Infantry Division (Mechanized) Artillery had the advanced Field Artillery tactical data system (AFATDS), all-source analysis system (ASAS), the maneuver control system/Phoenix (MCS/P) and combat service support control system (CSSCS). (See Figure 1.) This necessitated many work-arounds, often demanding extraordinary means for us to maintain our situational awareness. The EXFOR artillery provided our tactical operations center (TOC) an AFATDS and MCS/P with operators for 24-hour operations. Additionally, we learned new tactics and procedures for processing fire missions for the Crusader howitzer and M270A1 multiple-launch rocket system (MLRS) launcher and employing the new extended-range and smart and brilliant cannon, rocket and missile munitions. With these new systems and munitions, the MLRS battalions of the FA brigades, along with the Comanche helicopters of the aviation brigade, became the greatest "killers" on the DAWE battlefield.

### **National Guard Challenges**

The biggest challenge we faced was ensuring we had enough personnel to accomplish our mission of reinforcing the EXFOR division artillery (Div Arty). We had to operate the brigade TOC in 24-hour, continuous operations; provide two liaison officer (LNO) teams; and operate a battalion player cell to

138th FA Brigade	214th FA Brigade	4th IN Div Arty
IFSAS	IFSAS	AFATDS
AFATDS*	AFATDS*	MCS/P
MCS/P*	MCS/P*	ASAS
	ASAS**	CSSCS

\*Provided and operated by the 4th IN Div Arty.  
\*\*ASAS provided for only one FA brigade as an experiment to compare the impact of one FA brigade having and one brigade not having direct access to ASAS.

**Legend:**

**AFATDS** = Advanced Field Artillery Tactical Data System    **Div Arty** = Division Artillery  
**ASAS** = All-Source Analysis System    **IFSAS** = Initial Fire Support Automated System  
**CSSCS** = Combat Service Support Control System    **IN** = Infantry  
**MCS/P** = Maneuver Control System/Phoenix

Figure 1: Comparison of Digital Command and Control Systems

replicate a 155-mm Crusader battalion and two MLRS battalions. This amounted to 74 soldiers. Our brigade headquarters and headquarters battery provided 15 officers and 33 enlisted soldiers, while the 2d Battalion, 138th FA (155-mm M109A5) and 1st Battalion, 623d FA (MLRS), our subordinate in-state battalions, provided eight officers and 14 soldiers. In addition, 3d Battalion, 13th FA (MLRS) from the 214th FA Brigade, provided two officers and two soldiers.

Before we undertook the DAWE opportunity, we informed our staff and senior NCOs of the time required and asked them to make a commitment. Where possible, we agreed to work with employers by staggering travel days and bringing certain key people only for the actual exercise days. Fifty-five Guard soldiers and 15 full-time active Guard/Reserve (AGR) soldiers participated in the DAWE; more than 100 soldiers participated in all or part of the experiment and train-up exercises.

Several of our soldiers could volunteer for only one or two of the exercises because of employment or college conflicts. Although we used some different soldiers during each exercise, we maintained proficiency by having key officers and NCOs participate in every exercise and conducting an intensive train-up during the week before each event. In particular, we used our digital systems test and training simulator (DSTATS) to conduct a TOC and fire control element (FCE) mini-exercise before each SIMEX and the DAWE. To illustrate the commitment required, all members of our primary staff spent eight weeks in support of the DAWE and two weeks at annual training, for a total of 10 weeks of active duty between 27 April

and 14 November 1997.

A significant challenge we had to overcome was the lack of knowledge our key leaders, both officer and NCOs, had of AFATDS and MCS/P. None had received formal training on either system before the DAWE. With assistance provided by the operators from the EXFOR Div Arty, the 214th FA Brigade and contractor support, we met this challenge. The more we worked with the systems, the more we became proficient at maximizing their capabilities.

Maintaining a relevant common picture (RCP) of the battlefield was a significant challenge, especially in the area of intelligence. Except for our brigade, the division's brigade-level assets had ASAS. In coordination with the 214th FA Brigade, we had to develop different

procedures to receive intelligence information. The "old" method of submitting intelligence spot reports by FM radio (which allowed us to eavesdrop on the division and Div Arty intelligence nets) was replaced by a digitized system that we did not have. We could use the MCS/P and the tactical local area network (TACLAN) to get periodic intelligence summaries (INTSUMs) and the locations of enemy units. We constantly monitored the division, aviation brigade and 1st Brigade Combat Team (BCT) voice command nets to receive more current spot reports and the locations and status of friendly units, thereby maintaining situation awareness. (See Figure 2.)

The ability to transfer critical fire support information and data between AFATDS and IFSAS posed an additional training opportunity. Most message types can be exchanged between AFATDS and IFSAS. However, several problems required detailed and timely work-arounds. IFSAS equipped units cannot receive the AFATDS automatic data distribution of battlefield geometry. This required our AFATDS operator (provided by the Div Arty) to constantly monitor his messages for any received geometry updates, then select those specific geometries that might have changed and individually transmit them to IFSAS. This is a time-consuming process that requires operations officer and NCO time and supervisory attention.

AFATDS can't build and directly transmit fire plans to IFSAS. The AFATDS

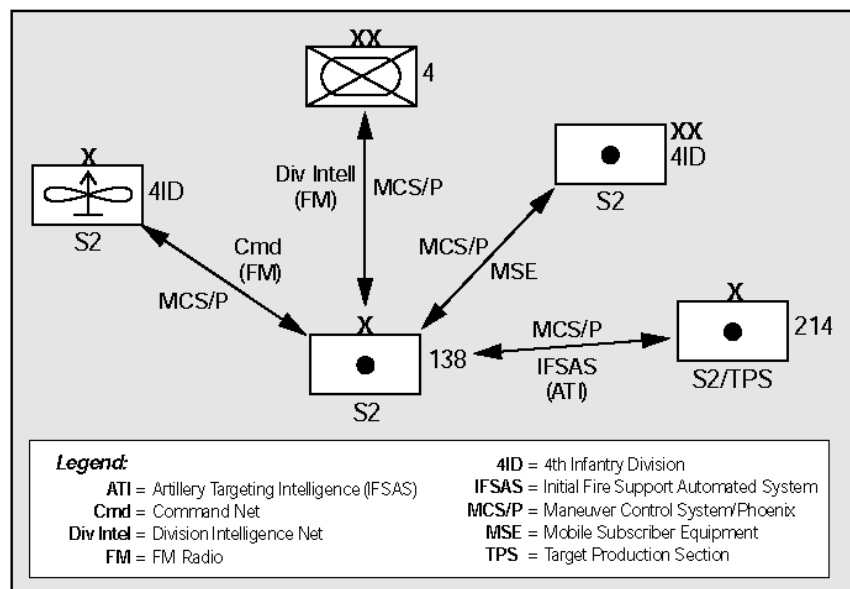

Figure 2: Intelligence Links

operator can send his target list to an IFSAS operator, who then must build the fire plan and transmit it to subordinate units for execution. With the assistance of the EXFOR Div Arty fire control officer, we developed work-around procedures for processing fire missions. (See Figure 3.)

With the mission of reinforcing, we primarily provided our guns on call for proactive counterfire directed by the Div Arty. The 214th FA Brigade provided the counterfire (reactive) headquarters. We received targets identified by unmanned aerial vehicles (UAVs), the joint surveillance and target attack radar system (JSTARS), electronic intelligence (ELINT) and attack aviation assets.

Combined with those of the 214th FA Brigade, our fires supported the division's deep operations, shaping the division's battlespace and setting the conditions for decisive maneuver. By having two reinforcing FA brigades, the Div Arty commander had the flexibility he needed to provide both proactive and reactive

counterfire and suppression of enemy air defenses (SEAD) in support of aviation deep attacks while simultaneously providing reinforcing fires in support of the close fight.

The soldiers of the 138th FA Brigade met every challenge and, during the DAWE, earned the nickname "Kentucky Killers."

## Issues for the Future

During the DAWE and its train-up, several issues emerged that fire supporters and other Army leaders will have to resolve as we draw closer to implementing a division design similar to the one we experimented with.

**Extended Battlespace.** The DAWE reinforced the requirement for two FA brigades to support one heavy division. The enhanced capabilities of the Force XXI division allow it to expand its battlespace significantly. During the DAWE, the division sector was, at times, more than 100 kilometers wide, with

brigade sectors having a width of up to 70 kilometers. A single FA brigade could not have positioned its battalions and communicated with all elements to service such a large division sector that had a significantly increased operational tempo and volume of precision and massed fires.

**FA Direct Support (DS) to Attack Aviation.** The DAWE proved that the FA, particularly MLRS, and attack aviation will be the killers on the battlefield of the future. During several covering force battles, our brigade was well forward into the security zone DS to the aviation brigade and divisional cavalry squadron to destroy the approaching forward detachments and lead regiments of attacking enemy divisions. MLRS DS to aviation breaks a mold and calls for more examination and TTP testing.

**Changing Role of the FA Brigade.** The future mission of the FA brigades may not "fit" into the traditional reinforcing (R) or general-support reinforcing (GSR) missions. Because of the

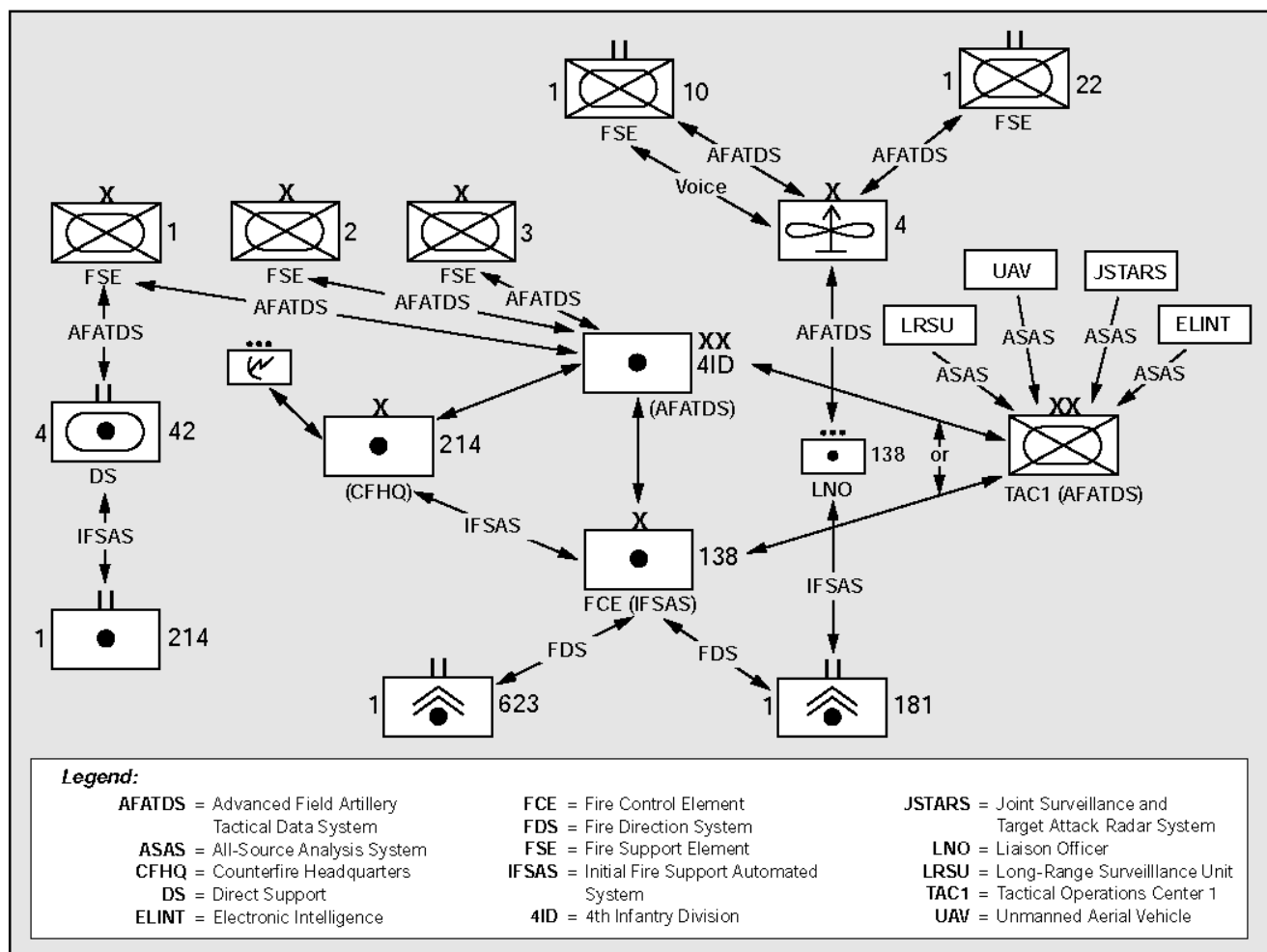

Figure 3: 138th FA Brigade Fire Mission Processing



Redlegs of the 138th FA Brigade met every challenge and, during the DAWE, earned the nickname "Kentucky Killers."

division's extended battlespace and our reliance on the maneuver brigades for force protection, we had to place an LNO team in the 1st BCT TOC to coordinate security for and the movement and positioning of our units.

With the BCT's access to intelligence and targeting systems such as JSTARS and its UAV, the BCT can now "see" out to more than kilometers but doesn't have the assets to attack the enemy at that range. We need to develop TTP for employing fire support assets to maximize their range. We worked through this problem (when allowed to do so) by establishing a quick-fire channel, both digital and voice, from the BCT fire support element (FSE) through our LNO to our brigade FCE.

**Doctrine for Counterfire Fight.** Doctrine and TTP need to be developed for employing two FA brigades for both proactive and reactive counterfire missions. Specifically, we need to relook our doctrine on how we conduct the counterfire fight.

Traditionally, the Div Arty assigned the counterfire mission to one FA brigade. But with a division operating in such a large sector, two FA brigades are required to support the division. Using current communications systems, one FA brigade could not maintain communications with all target acquisition systems.

We recommend the two FA brigades each have two Q-37 radars and be tasked by the Div Arty to provide target acquisition coverage and reactive counterfire for a specific area of the battlefield. This would allow more timely attacks of targets the radars acquire. It also would necessitate a change in how we employ the division's target production section (TPS) and in the table of organization and equipment (TOE) to increase the number of soldiers in the FA brigade targeting section.

**UAV for the Division Artillery.** The

target acquisition systems and extended-range cannon and rocket munitions now available to the division allow us to truly conduct proactive counterfire. To maximize these capabilities, the Div Arty needs a dedicated UAV.

The Force XXI division had four Outrider UAVs authorized. During the DAWE, two were allocated to the committed maneuver brigades and one to the aviation brigade, when committed. The remaining UAV was used for intelligence

gathering, targeting, tracking and battle damage assessment (BDA). The use of these four UAVs constituted far too many missions and requirements for too few assets.

**Force Protection.** The increased lethality and effectiveness of our smart and brilliant munitions against the opposing forces (OPFOR) made the FA brigades' MLRS battalions the enemy's number-one priority target. Force protection became our greatest operational challenge during the DAWE.

The OPFOR, literally, threw everything he had at us in an attempt to find and destroy our units. Through our battalions' proactive self-reconnaissance that gave early warning and their aggressive coordination with the BCTs for movement, positioning and security, they were able to severely limit the enemy's ability to attack our units.

The issue of force protection becomes more difficult with an extended battlespace. We soon will have less maneuver units defending and securing more terrain than ever before. MLRS battalions need organic self-protection assets, such as reconnaissance teams in armored high-mobility multipurpose wheeled vehicles (HMMWVs) with Mark 19s and (or) .50-caliber machineguns.

FA doctrinal manuals must do a better job of addressing force protection. This includes employing battery reconnaissance teams, artillery S2s conducting reconnaissance and surveillance planning, coordinating security with maneuver and employing M1 tank and Bradley fighting platoons in the force protection role. Additionally, our doctrine should specify that dedicated maneuver force protection assets are an absolute requirement for artillery strike force operations and (or) artillery raids.

**Interoperability of Digitized and Non-Digitized Units.** To maintain situation awareness and a RCP,

non-divisional FA brigades must have the same capabilities as the supported division. This not only includes AFATDS, but also MCS/P, ASAS, CSSCS and having a video teleconferencing capability. As future divisions are fielded ATCCS systems, the habitually associated FA brigades also should be fielded those systems. This would eliminate the problems of AFATDS-IFSAS interoperability and improve FA brigade situation awareness.

On all counts, the DAWE was a success. The EXFOR soundly defeated the OPFOR and the artillery, with great intel and aviation, shone like the shining fires they provided.

But remembering that many of the wonderful new capabilities we experimented with in the DAWE are still under development, we must refine them to be most effective for our future Army and prepare ourselves for that future. The Army deserves nothing less than our most effective, killing fires.

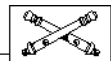

**Colonel Jasper Carpenter** until recently Commanded the 138th Field Artillery Brigade, Kentucky Army National Guard in Lexington. Currently, he is the full-time Director of Plans, Operations and Training for the Kentucky Army National Guard. He has served in various staff and command positions with the 138th FA Brigade, 103d Forward Support Battalion, 149th Armor Brigade, and Headquarters and the State Area Command, all in Kentucky. Colonel Carpenter also commanded the 103d Forward Support Battalion. He's a graduate of the Field Artillery Officer Basic Course, Fort Sill, Oklahoma; Quartermaster Advanced Course, Fort Lee, Virginia; and the Command and General Staff College, Fort Leavenworth, Kansas.

**Major Freddie R. Waggoner** is the S3 and full-time Administrative and Training Officer for the 138th Field Artillery Brigade in Lexington. His previous assignments include Recruiting and Retention Manager for Headquarters and the State Area Command, Battalion S3, Brigade Fire Support Officer, Battalion Fire Direction Officer and Assistant S3 (Plans) for the 2d Battalion, 138th Field Artillery at Lexington. He commanded A Battery, 2d Battalion, 138th Field Artillery at Carrollton, part of the 35th Infantry Division (Mechanized). He's a graduate of the Field Artillery Officer Basic and Advanced Courses, Fort Sill, and the Combined Arms Staff and Services School and Command and General Staff College, Fort Leavenworth.

# The Divisional MLRS Battalion in the DAWE

by Lieutenant Colonel Richard R. McPhee

The Army fielded its first divisional multiple-launch rocket system (MLRS) 2x9 battalion in September 1997—1st Battalion, 21st Field Artillery—in the 1st Cavalry Division, Fort Hood, Texas. (In a previous article, the divisional MLRS battalion was called the command and attack battalion, or CAB.) This fielding significantly increased the division commander's ability to shape his battle-space with organic fires. He now has access to faster, more flexible fires provided by more organic MLRS combat power than ever before.

In the Division Advanced Warfighting Experiment (DAWE) at Fort Hood in November 1997, the divisional MLRS battalion for the 4th Infantry Division (Mechanized) Experimental Force (EXFOR) was the "2d Battalion, 20th Field Artillery" (2-20 FA) played by the 5-3 FA of the 17th FA Brigade, Fort Sill, Oklahoma. This new divisional MLRS battalion's lethality and command and

control structure allowed it to focus fires rapidly from the squadron to the division levels. (See the figure.)

**Flexibility.** By comparison, the separate divisional MLRS battery either was commanded and controlled by the division artillery (Div Arty) or the battery was attached to a non-divisional battalion. In either case, the battery was not a flexible organization.

With its own staff and a more senior commander, the divisional MLRS battalion has the same structural capabilities as a non-divisional MLRS battalion.

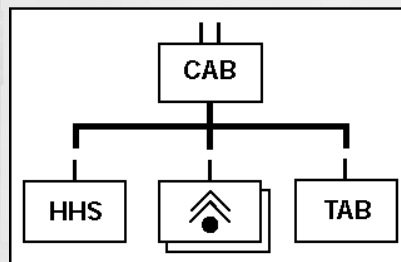

Divisional MLRS Battalion

The true strength of the organization is revealed when this structure is part of a tight-knit division team, which is exactly what happened during the DAWE.

The Div Arty commander had an MLRS battalion commander and staff who were fully integrated into the division. They understood the division commander's personality and how the team fought and, therefore, could move from mission to mission rapidly. This flexibility is the greatest benefit the divisional MLRS battalion brought to the EXFOR division.

During the DAWE, 2-20 FA fought employing four tactical missions: general support (GS) to the division, direct support (DS) to the aviation brigade, general support reinforcing (GSR) to DS Crusader battalions supporting the 2d and 3d Brigade Combat Teams (BCTs)



5-3 FA (MLRS)



and GS with a quick-fire net to the divisional cavalry squadron. Rapid-fire change of missions was possible because of the relationships built within the division through the course of several exercises.

A caution is in order. With all its capabilities, the divisional MLRS battalion cannot replace an FA brigade reinforcing the division. The divisional MLRS battalion staff is not robust enough to be the divisional counterfire headquarters in a mid- to high-intensity conflict—nor does it have enough MLRS combat power for the division's mid- to high-intensity counterbattery fight.

**Employment.** Although there are no "approved solutions" for employing the divisional MLRS battalion, it's ideally suited to accomplish rapid, high-payoff missions in support of the division.

For example, the EXFOR's 2-20 FA was DS to the aviation brigade. Positioning was a challenge for the brigade fire support officer (FSO) and battalion commander to work through. The DS mission easily was changed to GS based on whether the aviation brigade conducted close or deep operations. The intent of the DS mission was not only to shoot suppression of enemy air defenses (SEADs), but also to take advantage of aviation "eyes" for MLRS fires. The flexibility of the battalion allowed it to rapidly transition from a DS mission to a GS mission when the aviation brigade was idle.

This concept proved invaluable during the DAWE. The aviation brigade twice fought as the covering force for the division. The brigade fought as a combined arms team with a force-oriented mission to destroy the lead regiments of a combined arms army (CAA). The capabilities of the joint surveillance and target attack radar system (JSTARS), unmanned aerial vehicles (UAVs) and aviation eyes combined with MLRS, Crusader, Apache Longbows, Apaches and Comanches were devastating.

Another caution: the battalion does not have a robust logistical capability. Like the non-divisional MLRS battalions, it needs to be fully integrated into the division's logistical system to survive for extended periods. Resupply was a constant concern in the DAWE as the battalion moved throughout the battlefield. Close coordination with the aviation brigade commander, Div Arty commander and the division staff made the resupply of Class V possible.

At the beginning of the fight, the battalion was DS to the aviation brigade using the aviation support battalion's forward logistic element (FLE) as a resupply point. For the remainder of the fight, the aviation brigade FLE was used. While difficult at times, the process worked because it was a priority for the aviation brigade and Div Arty commanders. Logistical procedures for the divisional MLRS battalion will take time to fully develop.

A portion of the maneuver force was used to protect the division commander's high-value targets (HVTs), such as MLRS—at times, up to 15 percent of the maneuver force. While providing protection forces was a drain on the BCT's combat power, these forces ensured the artillery and attack helicopters were survivable.

Rather than using specific target grids for orientation, larger target areas of interest (TAIs) were used to orient targeting and killing systems. The abilities of the M270A1 improved MLRS launcher, Comanches and Apaches to



rapidly shift fires made this concept highly successful. The aviation brigade commander and his FSO orchestrated this combination of aerial maneuver and fires from their tactical operations center (TOC) using the many Force XXI information and intelligence systems afforded to them.

Another example of a focused mission for the battalion is GS designated to attack specific HPTs. Given this mission, the battalion employed its radars against artillery in a call-for-fire zone (CFFZ) using stay-hot, shoot-fast tactics, techniques and procedures (TTP). Another option would be to establish a direct link between the division tactical command post (DTAC) and the FA for HPTs, such as 9A52 multiple rocket launchers (MRLs) or mobile air defense artillery (ADA) launchers. By placing 2-20 FA liaison officers (LNOs) in the DTAC, the battalion was linked directly with the division, improving acquisition-to-firing times significantly.

A final example is of the battalion as part of a raid force pushed forward. The divisional MLRS battalion could rapidly join maneuver, ADA, engineer and combat service support (CSS) forces to form a task force ideal for this mission. An additional combat multiplier in a raid scenario is the commander-to-commander interface achieved in units that habitually work together as part of a brigade or division.

In the DAWE, the divisional cavalry squadron linked with the divisional MLRS battalion as a raid force and pushed forward to attack lead regiments

of an approaching enemy division. Ground troops provided protection along with designated Comanches flying air cover and reconnoitering. Cavalry engineers conducted both mobility and survivability operations, and 2-20 FA had ADA assets attached.

The divisional MLRS battalion tapped into the cav squadron's intelligence and information feeds in the cavalry's TOC and used the targeting capabilities of the Comanches. Command and control for the operation was provided from the division cavalry TOC where the squadron and 2-20 FA commanders fought. Just as the aviation brigade commander orchestrated multiple intelligence and killing systems during the covering force fight, the cavalry squadron commander fought multiple systems during the raid, achieving superb results with minimal casualties.

**Positioning the Battalion Commander.** Questions have been raised concerning how to best use the divisional MLRS battalion commander. Where does he fight his unit so the division can take full advantage of his expertise? There are several options, based on the battalion's mission.

If the battalion is DS to the aviation brigade, the commander might best be positioned with the aviation brigade commander. With a raid mission, his place probably would be in his TOC or with the maneuver force designated to conduct the operation. Given a mission to attack a specific HPT, his place could be either in the division main command post

(DMAIN) or DTAC, depending on which had the best intelligence feeds to accomplish the battalion's mission.

Just as the battalion provides a flexible tool to the division, the battalion commander provides a flexible resource to the Div Arty commander.

**Conclusion.** The more we learn about the newest battalion in the Army, the more questions will be raised. One thing we do know is that the battalion is a new resource for the division, one that can provide deadly fires. It's up to us to come up with innovative TTP to provide the division commander the most effective fires well into the 21st century.

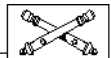

**Lieutenant Colonel Richard R. McPhee commands the 5th Battalion, 3d Field Artillery (Multiple-Launch Rocket System, or MLRS), part of the 17th Field Artillery Brigade, III Armored Corps Artillery, Fort Sill, Oklahoma. During the November 1997 Division Advanced War-fighting Experiment (DAWE) at Fort Hood, Texas, he served as the Commander of the fictitious 2d Battalion, 20th Field Artillery Divisional MLRS Battalion for the Experimental Force. He also commanded a firing battery in the 6th Battalion, 80th Field Artillery, 7th Infantry Division (Light), Fort Ord, California. He served as the Executive Officer for the 3d Infantry Division (Mechanized) Artillery at Fort Stewart, Georgia. During Operations Desert Shield and Storm, he was the Corps Deep Operations Officer for the VII Corps Fire Support Element.**

## Brigade-Level Fire Support Conference in June

The Fire Support and Combined Arms Operations Department (FSCAOD) of the Field Artillery School, Fort Sill, Oklahoma, will host its quarterly Fire Support Conference on June 24 and 25. The purpose of the conference is to discuss tactics, techniques and procedures (TTP) for selected fire support topics. Attendees will be representatives from active and National Guard division artilleries and FA brigades plus reps from the combat training centers (CTCs) and interested branch schools. Topics for the June conference are-

- *Suppress, Obscure, Secure, Reduce (SOSR) TTP.* This will include presentations by the CTCs and information from a conference at the Engineer School, Fort Leonard Wood, Missouri.

- *Distance Learning Update.* The update will cover digital training conducted between Fort Sill-Fort Knox, Kentucky, and Fort Sill-Fort Hood, Texas.

- *CTC Lessons Learned.* This will update fire support lessons from the Combat Maneuver Training Center, Hohenfels, Germany; Joint Readiness Training Center, Fort Polk, Louisiana; and National Training Center, Fort Irwin, California.

- *Striker TTP.* This will include the effectiveness of observation plans and the use of combat observation lasing teams (COLTs), scouts, strikers and other observers.

- *Close Air Support (CAS) and Joint Targeting.*

- *Clearance of Fires.*

- *Technical and FA Battalion Rehearsals.*

These quarterly conferences allow the fire support community to discuss TTP and what works at the CTCs in varying environments. For more information or to make a reservation at the conference, call Major Dave Lee at FSCAOD: DSN 639-4809 or commercial (580) 442-4809; Email: leed@usafas.army.mil. Reservations must be made by 17 June. (The next quarterly conference will be in September.)





# CRUSADER UPDATE

A warning to tactical operation centers (TOCs): *Lead, follow or get out of the way!* Crusader is about to become hard steel with the first prototype to be delivered in April 1999. On 12 March 1998, the Chief of Field Artillery and Program Executive Officer (PEO) for Ground Combat and Support Systems approved the Crusader design and authorized fabrication of four prototypes. The decision means we jump from the virtual to the real world. Why the warning to TOCs? Crusader unprecedently will tax a present day TOC's ability to command and control.

**Revolutionary Cockpit.** Crusader has potential that we've not begun to fully understand. The self-propelled howitzer's (SPH's) digitized cockpit alone ensures Crusader will become an all-encompassing fighting platform and revolutionize the way we'll fight in the 21st century. Manned by three soldiers, the cockpit will conduct tactical as well as technical fire control.

The SPH will be its own fire direction center (FDC), fully integrated in the tactical internet. It will receive, process, analyze and attack targets with devastating mass and surprise. The SPH will store multiple fire missions and compute ballistic solutions based on the commander's guidance, fire support coordinating measures (FSCM), systems status and intermediate crests. Once the round is fired, the SPH will determine muzzle velocities and the "did-fly" trajectory, ensuring every round is "steel on target."

Employing fully automated fighting and robotic reloading operations from the digitized cockpit, the Crusader crew will be able to make the most of information dominance. It will be free to use technical and tactical skills to strike rapidly, decide quickly and finish a fight cleanly with minimal loss of life to all sides.

Crusader will be integral to our ability to eliminate platoon, battery and battalion FDCs—which will pave the way for the dynamic effects control centers (ECCs) in 2025. (See Brigadier General Toney Stricklin's article "Fires: The Cutting Edge for the 21st Century" in this edition.)

**Rate of Fire and Survivability.** Crusader will provide the 21st century soldier a robust cannon that won't overheat, thus producing a sustained rate of fire unmatched by any other weapon system. With a 10-round-per-minute rate of fire, Crusader will place an 60 rounds on a target in six minutes.

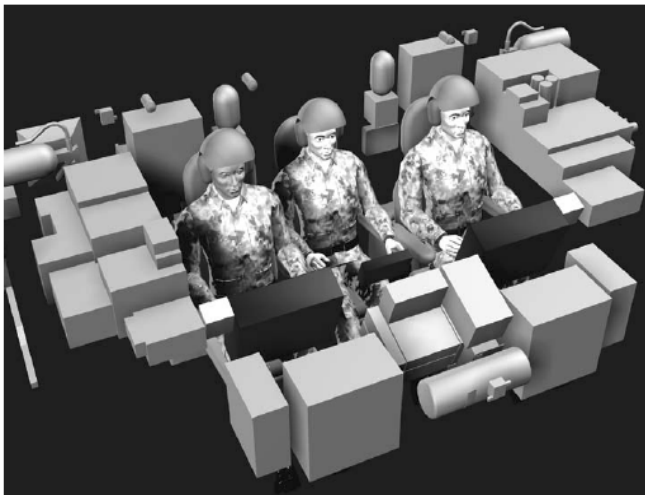

Crusader Cockpit

Crusader will be able to achieve mass and surprise with multiple round simultaneous impact (MRSI)—its ability to place four to six rounds out to 30 kilometers on an area,

linear, stationary or moving target. Because it will fire an MRSI in less than a minute and then dash 750 meters out of the counterfire footprint in 90 seconds, our young Crusader cannoneers will live to become old veterans.

Crusader's 1,500-horsepower engine will allow it to keep pace with an M1 Abrams-equipped force and is critical for survivability. The survivability suite of nuclear, biological, chemical (NBC) sensors and overpressure system, susceptibility reduction measures, remotely controlled crew-served weaponry and additional vulnerability reduction measures will make Crusader a sanctuary in the chaos of battle.

**Crew Skills.** Crusader "raises the bar" for the traditional 13B crew by moving FDC and tactical decision-making functions to the weapon. The November-December 1997 edition's article "TTP for the Crusader Battalion-A Beginning" by Major Warren N. O'Donnell and Lieutenant Colonel (Retired) William A. Ross discusses Crusader operations that will dramatically alter the future. Consequently, we must approach Crusader crew training very differently.

Crews must develop an intuitive system-level, future-planning regimen to fight Crusader; the howitzer will have embedded devices to facilitate, train and sustain that regimen. Crusader will require a soldier who knows shell-fuze combinations, can troubleshoot a fire control console, can review firing data for five different missions and can execute a defensive plan.

Crusader crew training must include skills and knowledge associated with tactical internet operations and tactical fire direction readouts as well as mechanical and electronic diagnostic and prognostic readouts. Crusader cannoneers must be able to verify the FA support plan (FASP) as it initializes the tactical database and interpret maneuver graphics as routes are planned for routine tactical and hasty survivability moves. They must be able to analyze intelligence data and assess anticipated threats to survivability measures. Digital and voice communications are vital to our possible decentralized operations, so the crew must have a firm grasp of electronic counter-countermeasures (ECCM) to ensure uninterrupted communications.

**Crusader Commander.** The Crusader soldier must be a leader, someone who can make tough decisions based on an abundance of information—someone who can attack and destroy targets while ensuring his team's survivability.

The Crusader "senior to subordinate" capability will allow one SPH to do limited tactical control for up to five other SPHs. This will require Crusader commanders to possess an ability to command and control several dispersed weapon platforms, like our Armor brethren do.

On 12 March, we took one more step toward ensuring that today's second lieutenants and privates will, indeed, have a world-class weapon system with which to win quickly and decisively in any conflict of the next century. Crusader, the Army's premiere weapons platform for the 21st century, is becoming a reality.

MAJ Reginald Brown, AC  
Crusader Project Officer  
TSM-Cannon, Fort Sill, OK

# AC/ARNG Integrated Division for the 21st Century

by Major Douglas B. Earhart



The modernization and digitization of the Total Field Artillery will be realized in the 21st century. By FY99, 63 percent of the Total FA—70 percent of the FA at echelons above division (EAD)—will be in the Army National Guard (ARNG). It's imperative the ARNG FA remains integrated with the same level of experience, equipment and technology as the Active Component (AC) FA.

ARNG FA units have been deployed in support of Operations Joint Endeavor and Guard in Bosnia-Herzegovina. These ARNG units arrive in country ready for their assigned missions to augment the AC FA units. Such deployments only will

continue, and the spirit of cooperation and integration that characterizes them is only the beginning of what's to come...the AC/ARNG Integrated Division.

This article outlines the plan to design and stand up one light and one heavy AC/ARNG division in three phases, starting with the activation date of 1 October 1999. (The light division will be configured more like an air assault division but without air assets.) In the first two phases, each division's maneuver brigades will be the ARNG enhanced separate brigades (ESBs).

**Background.** On 23 May 1996, the Secretary of the Army approved the results of the Army National Guard

Division Redesign Study. An integral part of the results called for standing up the two new AC/ARNG Integrated Divisions.

The Secretary directed the Army study and test the concept that would further integrate the active Army with the Army National Guard. Specifically, each division would consist of an AC division headquarters and three ESBs.

Currently, the ESB has three maneuver battalions, an engineer battalion, FA battalion, air defense battery, a forward support battalion (FSB), cavalry troop, military intelligence company, chemical platoon, military police platoon and a signal platoon. The FA battalion features an organic meteorological (Met) team, a cavalry troop fire support team (FIST), Firefinder radars and, in the heavy brigade, the Paladin M109A6—the latter starting in FY00 when the modernization for the ESBs comes on par with the AC divisions. With this organization, the brigade is capable of autonomous operations in a theater with the support of the corps.

The Training and Doctrine Command (TRADOC) conducted the study of the AC/ARNG Integrated Division concept. Three alternatives were developed to meet the requirements established by the Secretary of the Army. The alternatives can be viewed as a phase-in process for the integrated division.

**Phase I.** As approved by the Secretary, Phase I is the starting point for the AC/ARNG organization, which has an AC division headquarters and headquarters company (HHC). Its primary mission is to provide training and readiness oversight for the division's three ESBs as shown in Figure 1. (Note the figure is of an armored brigade in the example heavy)

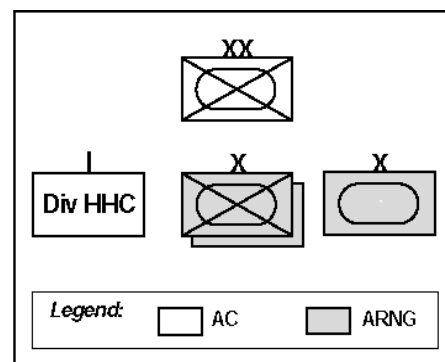

Figure 1: Phase I of the AC/ARNG Integrated Division. This is an example of a heavy division in Phase I. The divisional structure consists only of the active component (AC) headquarters and headquarters company (HHC) and three National Guard enhanced separate brigades (ESBs).

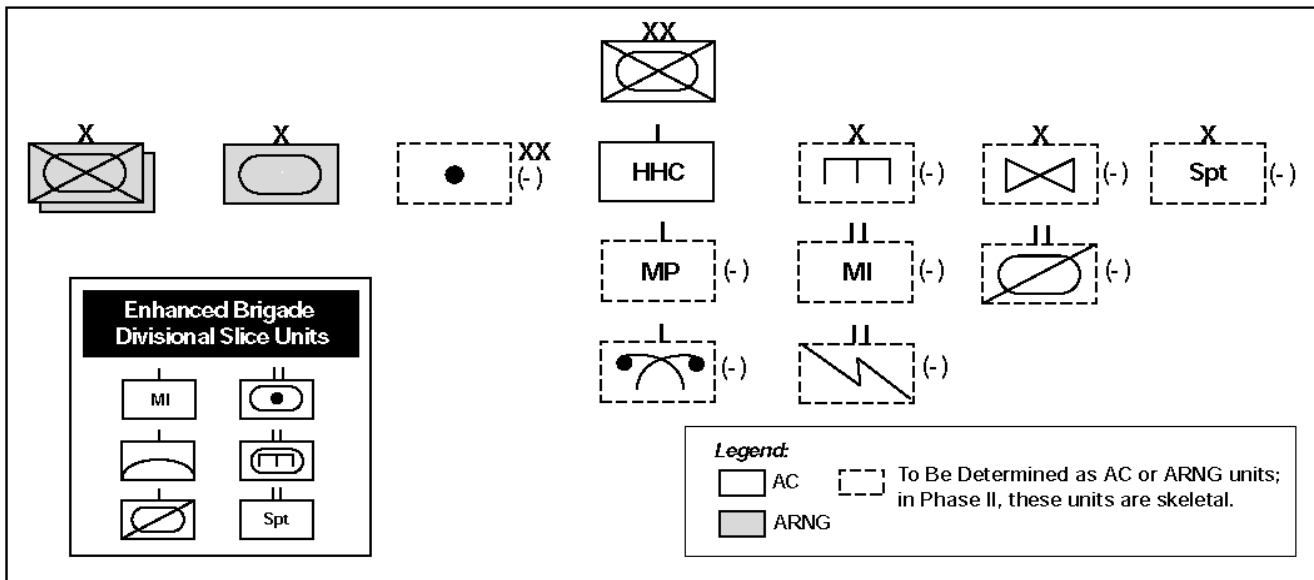

Figure 2: Phase II of the AC/ARNG Integrated Division. In this phase, the division initially has a full strength headquarters and headquarters company (HHC) and three enhanced separate brigades with the rest of the divisional organization skeletal. The division has the flexibility to deploy by enhanced brigades or strip out the brigade slice assets that make them separate (see boxed insert in the figure) and deploy as an Army of Excellence (AOE) division. The division artillery commander acts as the training advisor and coordinator for the FA battalions under the command and control of the brigades, assuming command and control of the direct support artillery assets only when the organization deploys as an AOE division.

division design. Currently, all ESBs are mechanized; eventually some may convert to armored brigades when the Army XXI heavy division design is implemented.) In peacetime or pre-mobilization training, the Phase I design allows each ESB to have dedicated training support via the division headquarters.

The division in the first phase would mobilize and deploy as ESBs, reporting to the theater corps commander. Upon mobilization for war, the active duty heavy and light division commanders and their HHCs would run the National Training Center (NTC) at Fort Irwin, California, and Joint Readiness Training Center (JRTC) at Fort Polk, Louisiana, respectively.

Phase I has the least impact on the status quo. Brigades stay trained and organized as ESBs, and a division artillery (Div Arty) is not formed.

**Phase II.** As the AC/ARNG Integrated Division progresses from Phase I to Phase II, the changes in its design allow for the formation of a division base with a skeletal staff. (See Figure 2.) This includes the Div Arty, division support command (DISCOM), aviation and engineer brigades and other supporting units of a standard division base.

The main feature of this second phase is that the unit can mobilize as individual ESBs or as a division. Before the unit mobilizes, the division base is

decremented to avoid redundant capabilities organic to the brigades. This enables the ESBs to continue to train in peacetime with their organic units. In pre-mobilization, the Div Arty commander acts as the training advisor and coordinator for the direct support (DS) FA battalions, which are under the command and control of the brigades.

If the AC/ARNG Integrated Division mobilizes, the ESB divisional slice units shown in the box in Figure 2 move to the division base and the maneuver brigades deploy as part of an Army of Excellence (AOE) division design. Upon mobilization, the DS FA battalions would report to the Div Arty commander, thus forming the Div Arty. The scenario of the FA moving from the ESBs to the division would be followed for the engineers, FSB and remaining support entities. Phase II enables the ESBs to train as they do now in peacetime with all organic assets and, then upon mobilization, train as a division.

In this phase, the Div Arty commander is responsible for developing a training strategy with built-in flexibility to allow the DS FA battalions to function both within the Div Arty or as separate DS battalions assigned to their ESBs. The vision for the Div Arty's skeletal manning is a mix of AC, Active/Guard-Reserve (AGR) and traditional or Mobilization-Day (M-Day) soldiers who can train and deploy together under the

same command.

The intent of Phase II is to have a ready-made task organization that allows the ESBs or integrated division to deploy—the most flexible deployment packaging options of all the phases.

**Phase III.** The last phase in the development of the AC/ARNG Integrated Division is the potential long-term end state. (See Figure 3 on Page 44.) Under the Phase III organization, the ESBs would convert to divisional brigades while the Div Arty and other supporting elements would function as they do in a division today.

**Implementation.** The TRADOC study was released on 6 August 1997 when the Secretary of the Army approved it. The Secretary selected Forces Command (FORSCOM) to form and lead an implementation process action team (IPAT) to complete the details of the project before the proposed activation of Phase I by 1 October 1999.

On 3 December 1997, the Secretary selected the six ESBs and the locations for the two division headquarters. (See Figure 4 on Page 44.) The heavy AC/ARNG Integrated Division headquarters will be at Fort Riley, Kansas, with a forward headquarters at Fort Jackson, South Carolina. The light division headquarters will be at Fort Carson, Colorado, and its forward headquarters at Fort Polk.

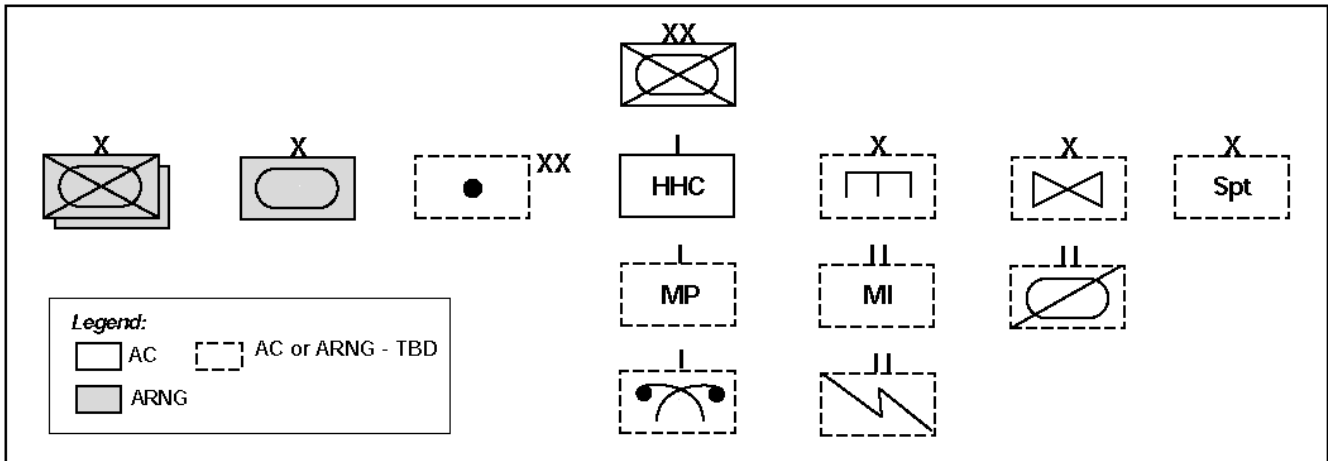

Figure 3: Phase III of the AC/ARNG Integrated Division. In this final, long-term potential phase of integration, the ARNG brigades are divisional with all units full strength.

While the Secretary made unit-stationing decisions, the reflagging decisions are awaiting final approval by the Chief of Staff of the Army. The 7th, 9th and 24th Infantry Divisions are among those flags under consideration for the two AC/ARNG Integrated Divisions.

AC soldiers assigned to this division will be integral parts of the Army National Guard units they support. This integrated division training concept will go well beyond the old "roundout/roundup" relationships of pre-Desert Storm. While the concept of roundout/roundup had merit, it never matured to the intended end state as evidenced by the fact that the 48th Infantry Brigade (Mechanized) of the Georgia National Guard never deployed to the Gulf with the 24th Infantry Division (Mechanized)

of Fort Stewart, Georgia. The 48th Brigade went to the NTC. The war ended as the 48th successfully completed its NTC rotation. The AC/ARNG Integrated Division will ensure all units associated with the deploying division are trained and ready at the same time.

The AC/ARNG Integrated Division concept, through each phase, is intended to provide additional combat power to America's Army in a timely manner. As the former Chief of Staff of the Army General Gordon R. Sullivan testified before Congress, the previous deployment standard for ESBs was "about 90 days." With the intensive oversight of a dedicated AC division commander and staff, the ESBs and, in later phases, the division as a whole, should be ready in considerably less time.

While the final details are not yet complete, the integration of AC, AGR and M-Day soldiers in the Div Arty will be a major stepping stone to improved training relationships. The expected result will be a ARNG combat force that can be maintained at a high level of readiness and modernization at relatively low cost.

The future of fire support in the Total Army will change as this integrated division progresses from its organizational start point. The training relationships between the Army's AC and ARNG will become much stronger as a result of this initiative. The Total FA is *now*.

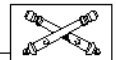

Enhanced Separate Brigades	Direct Support FA Battalions
<b>Heavy Division</b>	
30th Infantry Brigade (Mechanized) North Carolina ARNG	1st Battalion, 113th Field Artillery (155 SP)
48th Infantry Brigade (Mechanized) Georgia ARNG	1st Battalion, 118th Field Artillery (155 SP)
218th Infantry Brigade (Mechanized) South Carolina ARNG	1st Battalion, 178th Field Artillery (155 SP)
<b>Light (Air Assault) Division</b>	
39th Infantry Brigade Arkansas ARNG	1st Battalion, 206th Field Artillery (105)
41st Infantry Brigade Oregon ARNG	2d Battalion, 218th Field Artillery (105)
45th Infantry Brigade Oklahoma ARNG	1st Battalion, 160th Field Artillery (105)

Figure 4: Enhanced Separate Brigades Designated for the AC/ARNG Integrated Divisions. These six Army National Guard brigades listed with their direct support FA battalions will comprise the integrated heavy and light (air assault configuration) divisions.

Major Douglas B. Earhart, Virginia Army National Guard, is the Division Force Integrator in the Force Management Directorate of the Army National Guard Readiness Center, Arlington, Virginia. In his previous assignment he was a Field Artillery Organizational Integrator in the same directorate. Major Earhart also was the Force Development Officer, G3, Forces Command (FORSCOM), Fort McPherson, Georgia, and Executive Officer to the Deputy Commanding General- Reserve Component at FORSCOM. Among other assignments, he served as Battery Executive Officer and Battery Fire Direction Officer in the 2d Battalion, 111th Field Artillery, 29th Infantry Division (Light), Virginia Army National Guard. He is a graduate of the Command and General Staff College, Fort Leavenworth, Kansas; Airborne and Ranger Schools at Fort Benning, Georgia; and Air Assault School at Fort Campbell, Kentucky. He holds a Master of Arts in Education from Appalachian State University in North Carolina.

## Teletraining- Knox and Sill Develop OPORD

*Mission: 52ID (-) [52d Infantry Division-minus] defends in sector BMNT [beginning morning nautical twilight] 20 March 19XX along PL [Phase Line] Expos FEBA [forward edge of the battle area] to defeat the 11th Motorized Rifle Division in order to deny enemy access to uranium resources vicinity NK6419 and protect the corps staging area from direct and indirect fires.*

The situation is that the direct support (DS) FA battalion fire support officer (FSO) is at the aviation brigade's tactical operations center (TOC) coordinating for the battle handover. It's 0700, and the brigade combat team (BCT) staff is preparing an operations order (OPORD) to defend against the motorized rifle division. It has 48 hours until the attack.

During the digitally conducted course of action (COA) briefing, the brigade commander asks the brigade FSO on the computer monitor to explain how he plans to support Phase II of the brigade's operation. The FSO keys his microphone and describes his essential fire support tasks (EFSTs). The commander provides some additional guidance, and the staff continues with the COA brief.

Does this sound like a scenario out of the future? The future is now. Students from the FA Officer Advanced Course (FAOAC) Class 7-97 at Fort Sill, Oklahoma, conducted an exercise using this scenario with students from the Armor Officer Advanced Course (AOAC) at Fort Knox, Kentucky. They used Teletraining Network (TNET) sites at Forts Sill and Knox to conduct this exercise from 4 to 10 February 1998. The AOAC brigade staff at Fort Knox developed a brigade OPORD while working with its brigade fire support element (FSE) at Fort Sill.

The key is the technology used to develop the OPORD during training replicated the technology the Experimental Force (EXFOR) used during the Division Advanced Warfighting Experiment (DAWE) at Fort Hood, Texas, last November. This or a similar Teletraining scenario is ideally suited for training our Army National Guard.

**Purpose, Methodology and End State.** The TNET training was to use advanced technologies to improve parallel planning with a brigade staff while developing the FA support plan (FASP) for the brigade OPORD.

Fort Knox provided the brigade staff members with a Colonel at the Armor School playing the role of the brigade commander. Fort Sill provided the brigade FSE—consisting of a fire support coordinator (FSCoord), FSO, assistant FSO, targeting officer and fire support NCO—four maneuver battalion staffs, a DS battalion staff and a reinforcing battalion staff.

Critical to this exercise was our ability to communicate live via the TNET, Internet and voice communications, allowing the military decision-making process (MDMP) to continue uninterrupted in the planning phase. The end state for this exercise was a well-written brigade OPORD, which allowed the students to develop battalion/task force (TF) plans executed in Janus.

As the brigade staff developed its OPORD, the students at Fort Sill replicating the battalion TF staffs became frustrated by the delays in parallel planning. The frustration the students felt was no different than that of battalion TF staffs in rotations at the National Training Center (NTC), Fort Irwin, California. One unexpected benefit of the exercise was that the FA and Armor students observed the high level of expertise of their counterparts.

**Exercise Observations.** The following are some observations noted during the exercise.

First, the schools used different tactics, techniques and procedures (TTP). The difference in TTP is probably due to the time it takes to revise and publish field manuals (FMs). For example, the FA School is teaching a new method of writing the fires paragraph (task, purpose, method, effects), that is also being coached at the combat training centers (CTCs) but is not reflected in any FM. The Armor School was teaching the older method (purpose, priority, allocation, restriction) found in the 1997 *FM 101-5 Staff Organization and Operations*.

The Army is no longer a paper-based army. All schools must use home pages to post changes to doctrine as an interim information means before the FM changes can be published.

Second, the targeting process is addressed only in the FA series of FMs. This became an issue when we wanted to conduct a targeting meeting as part of the MDMP with Fort Knox. FM 101-5 must be updated to include the targeting process as part of the MDMP because it requires the participation of brigade and TF staffs.

Finally, FM 101-5 must be updated to include the FSO in briefings to the commander during the MDMP.

The next step in "knocking down the classroom walls" of the Field Artillery is to resolve three problems.

1. All schools must use a common OPORD scenario.
2. All OACs must be on a common schedule. For example, the Armor School at Fort Knox and Infantry School at Fort Benning, Georgia, conduct four OACs per year. The Field Artillery School at Fort Sill conducts seven.
3. Certain classes must be common to all OACs. For example, the FA School should be the proponent for developing a class on the OPORD fires paragraph to be taught at the other OACs. This ensures TTP will be updated across the Training and Doctrine Command (TRADOC) in a timely manner.

The potential for Teletraining is tremendous. For example, a division OPORD written by students at the Command and General Staff College at Fort Leavenworth, Kansas, could be used by OAC students in the Armor brigade TF at Fort Knox; mechanized brigade TF or air assault TF at Fort Benning; the aviation brigade at Fort Rucker, Alabama; and the division artillery at Fort Sill. Each proponent OAC students could coordinate with the others via TNET and, once the plans were developed, fight their piece in a computer simulation from their school.

MAJ David A. Lee, FA  
MAJ Shawn Ball, FA  
FAOAC Small Group Instructors  
FSCAOD, FA School, Fort Sill, OK