

Field Artillery

A Professional Bulletin for Redlegs

July-August 1998



Field Artillery

A Professional Bulletin for Redlegs

July-August 1998

HQDA PB6-98-4

INTERVIEW

- 2 History- The Context for Change in the Army**
An interview with Brigadier General John W. Mountcastle, Chief of Military History

ARTICLES: History

- 5 Staying on the Cutting Edge: Military Professionalism and the Mexican War**
by Major R. Powl Smith, Jr.
- 11 1999 History Writing Contest Rules and 1999 *Field Artillery* Themes**
- 12 From the Parade Ground to the Battlefield: Henry Knox and the Battle of Monmouth**
by Captain Michael D. Carter, USAR
- 17 Steel Curtain- The Guns on the Ia Drang**
by Captain Steven M. Leonard, OD
- 21 Deep Battle 1914-1941: The Birth of the Modern Style of Warfare**
by Brigadier Jonathan B.A. Bailey, MBE
- 38 Thunder in the Ozarks: The Battles of Wilson's Creek and Pea Ridge**
by Majors William S. Bland and William M. Raymond, Jr.
- 44 Big Gun Vignettes: Fun and Games in WW II**
by Colonel (Retired) Robert B. Partridge

ARTICLES: Other

- 28 Fire Support in Bosnia-Herzegovina: An Overview**
by Colonel Mark T. Kimmitt
- 31 Integrating Targeting and Information Operations in Bosnia**
by Lieutenant Colonel Steven Curtis, IN; Captain Robert A.B. Curris; and Major (Retired) Marc J. Romanych, ADA

FEATURES

- 1 FROM THE FIREBASE**
- 37 VIEW FROM THE BLOCKHOUSE**

DISCLAIMER: *Field Artillery* is published bimonthly by Headquarters, Department of the Army, under the auspices of the US Army Field Artillery School (Building 746), Fort Sill, OK. The views expressed are those of the authors, not the Department of Defense or its elements. *Field Artillery's* content doesn't necessarily reflect the US Army's position and doesn't supersede information in other official Army publications. Use of news items constitutes neither affirmation of their accuracy nor product endorsements.

PURPOSE: (as stated in the first *Field Artillery Journal* in 1911): *To publish a journal for disseminating professional knowledge and furnishing information as to the Field Artillery's progress, development and best use in campaign; to cultivate, with the other arms, a common understanding of the power and limitations of each; to foster a feeling of interdependence among the different arms and of hearty cooperation by all; and to promote understanding between the regular and militia forces by a closer bond; all of which objects are worthy and contribute to the good of our country.*

OFFICIAL DISTRIBUTION: Distribution (free) is to US Army and Marine Corps Active and Reserve Components FA units: seven copies to corps artillery, division artillery and brigade headquarters; 13 to battalions; and seven to separate batteries. In addition, readiness groups, recruiting commands, state adjutant generals, Army and Marine Corps libraries and schools, liaison officers and other Department of Defense agencies working with FA or fire support issues or material may request a free copy by writing to the Editor (see "Submissions").

PAID SUBSCRIPTIONS: May be obtained through the US Field Artillery Association, P.O. Box 33027, Fort Sill, OK 73503-0027. Telephone numbers are (580) 355-4677 or FAX (580) 355-8745 (no DSN). Dues are \$20.00 per year (\$38.00 for two years and \$56.00 for three years) to US and APO addresses. All others add \$13.00 per subscription year for postage.

SUBMISSIONS: Mail to Editor, *Field Artillery*, P.O. Box 33311, Fort Sill, OK 73503-0311. Telephone numbers are DSN 639-5121/6806 or commercial (580) 442-5121/6806 or FAX 7773 with DSN or commercial prefixes. Email is famag@usafas.army.mil. Material is subject to edit by the *Field Artillery* staff; footnotes and bibliographies may be deleted due to space limitations.

REPRINTS: *Field Artillery* is pleased to grant permission to reprint articles. Please credit the author and *Field Artillery*.

ADDRESS CHANGES: *Field Artillery* (ISSN 0899-2525) (USPS 309-010) is published bimonthly. Periodicals postage is paid by the Department of the Army at Lawton, OK 73501 and an additional mailing post office. POSTMASTER: send address changes to *Field Artillery*, P.O. Box 33311, Fort Sill, OK 73503-0311.

Redleg Hotline

(Organization, Materiel, Doctrine and Training)
DSN 639-4020 or (580) 442-4020 (24-Hour)

Tactical Software Hotline

DSN 639-5607 or (580) 442-5607 (24-Hour)

Fort Sill Home Page

<http://sill-www.army.mil/index.htm>

FA Branch at PERSCOM

<http://www-perscom.army.mil/opmd/fasitrep.htm>

http://www-perscom.army.mil/enlisted/fa_itr.htm

By Order of the Secretary of the Army:

DENNIS J. REIMER

General, United States Army
Chief of Staff

Official:



JOEL B. HUDSON

Administrative Assistant to the
Secretary of the Army, 04680

Leo J. Baxter

Major General, United States Army
Field Artillery School Commandant

Editor:

Patricia Slayden Hollis

Art Director:

Bob T. Coleman

Assistant Editor:

Joanne Alexander Brown



Looking Through History to the Future

the lessons learned. How might the commander have done things differently? Would better preparation have saved the plan? Using this analysis method—instead of trying to commit dates and events to memory—will improve the critical thinking skills military leaders need to succeed.

New Technology Demands Doctrinal Change. Throughout history, military hardware has undergone many technological changes, some of them so radical we've had to alter the basics of how-to-fight. At the turn of the last century, improved gunpowder and breech-loading cannons transformed the Field Artillery from a direct fire to an indirect fire system. Mid-century saw the advent of the data processor, and the FA community was quick to see its potential.

One of the earliest computers, the electronic numerical integrator and computer (ENIAC), computed FA firing tables. We continued using automation in systems such as the FA digital automatic computer (FADAC) and the tactical fire control system (TACFIRE). The advanced FA tactical data system (AFATDS) continues to exploit the automated capabilities that aid warfighters with battlefield awareness and fire control.

During the Gulf War, the Abrams tank exploited a one- to two-kilometer range advantage over the Iraqi armored vehicles it faced. Our sense and destroy armor (SADARM) rounds enjoy a range of more than 22 kilometers. The multiple-launch rocket system (MLRS) will boost its reach to 45 kilometers, redefining the division "deep attack." BATs, anti-armor submunitions that are brilliant, will range out to 140 kilometers, finding and killing armored vehicles on the move. MLRS smart tactical rockets, the MSTAR that proved so valuable during the November 1997 Force XXI Division Advanced Warfighting Experiment (DAWE), will all but guarantee the destruction of moving armored vehicles that dare enter its 60-kilometer range.

The appearance of our new 155-mm self-propelled howitzer, Crusader, is just over the horizon. It will keep up with the

fastest maneuver formations, have a 10 to 12-round-per-minute rate of fire—tripling that of Paladin's—and fire multiple-round simultaneous impact (MRSI) missions, giving a single Crusader howitzer the ability to mass fires. Combining these assets into a unified fire support plan will require creative combat leaders with sharp, analytical minds.

History Shapes Future Doctrine. These quantum leaps forward in fire support capabilities will be useless unless we change the manner in which we fight. No longer tied to a maneuver commander for positioning, protection and support, Field Artillery will maneuver and fire independently.

Our rate of fire will no longer be limited by our weapon's physical constraints—only by how fast we can acquire high-payoff targets. Combined arms ambushes and raids could become our standard battle drills, replacing deliberate attacks and movements-to-contact. Our target set may no longer be comprised mainly of counterfire targets but encompass every possible ground threat with a weapon and munition designed to destroy those threats long before they can affect our troops.

Combat leaders with agile minds conditioned by their analytical studies of military history must create new fighting doctrine—sometimes on the spot.

No one can accurately predict the future, so how can we plan for it? Revolutionary War patriot Patrick Henry once remarked, "I have but one lamp by which my feet are guided, and that is the lamp of experience. I know of no way of judging the future but by the past." If there is one thing we experience from reading military history, it is that we live in an ever-changing geopolitical world with ever-changing technological capabilities.

Today's technological wonders will be tomorrow's museum pieces. But a combat leader who has honed his critical thinking skills through analytical study of military history will always be in demand.

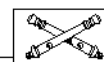

The philosopher George Santayana once said, "Those who cannot remember the past are condemned to repeat it." We often hear comparisons being made about today's reduced-force Army and the armies of the past. It may seem to some that we are, indeed, repeating the errors of the past—especially the error of allowing tactics to lag behind technology.

In the next century, just two short years away, technology will advance exponentially, giving our weapon systems and munitions fantastic capabilities. These advances will demand new tactics to maximize the systems' effects, creating a huge challenge for leaders in all branches and services. How can we develop tactics that will fully utilize the advanced capabilities of our future weapons? We can start by looking at history.

A Better Way to Look at Military History. I'm not suggesting we carry copies of *Caesar's Gallic Wars* or Clausewitz's *On War* into battle for use as field manuals. But there's tremendous value in reading such military classics.

Lieutenant Colonel James J. Carafano, a Redleg and historian, recommends we use history as an after-action review and suggests a three-step method to analyze military history. First, determine what was supposed to happen—what the commander intended his troops to do. Second, examine exactly what did transpire in that particular event. As we all know, the fog of war and the imperfect world in which we fight often creates chaos out of order. Third, determine

Brigadier General John W. Mountcastle, Chief of Military History

History—The Context for Change in the Army

Interview by Patricia Slayden Hollis, Editor

Q *There has been a long-standing debate between advocates of attrition and maneuver warfare. Historically, how has firepower contributed to attrition and maneuver warfare? What do you see as the future of fires in the 21st century Information Age?*

A If we look at attrition warfare as killing as many of the enemy as you can until he can't fight any more or uses up all his war supplies, I don't think many warfighters would describe themselves as proponents of attrition warfare. Most would prefer to maneuver their forces—position them to bring a telling amount of firepower to bear on the enemy.

In the Civil War, some people regarded General Ulysses Grant as a proponent of attrition warfare, of wearing the enemy down. In fact, once he became General-in-Chief of all the Armies, he was very much a proponent of maneuver. It's just that he wasn't always successful at maneuvering into a position of advantage over the Confederate forces. Toward the end of the conflict, the full impact of his larger battle plan, his strategy of maneuver, came to bear.

In maneuver and attrition warfare, there's a very important balance. If you can maneuver to a point that you convince your enemy you can deliver overwhelming fires, then you can accomplish what Sun Tzu, the Chinese philosopher, would applaud: a bloodless victory. Through maneuver, you can convince the enemy that it's in his best interest to stop fighting.

As far as the future is concerned, we're already in the Information Age. We now have a more complete view of battlespace in all of its dimensions, making a big difference in the way we employ accurate, rapid, telling fires throughout the spectrum of the battle area. In the 21st century, the Field Artillery has a tremendous future along with the other combat arms that depend so heavily upon Field Artillery to give them the freedom to maneuver.

Q *Some say the advent of the Information Age and digitization of the Army are revolutionizing warfare. What is the historical perspective?*

A The Information Age and digitization are bringing about changes in the volume and detail of information available to us and the speed with which we process that information. It's critical for us to look for opportunities to leverage information technology to dominate future operations.

But too frequently we see such changes as occurring suddenly—to use the business term—in a "paradigm shift." In fact, military history tells us change is more evolutionary in content. Warfare is episodic; we go from periods of fairly low levels of military operations to intense peaks. The peaks highlight changes that have been ongoing and show which forces have not taken advantage of those changes.

Today, we're not just talking about technical innovation, but also changes to our operating concept from bipolar military confrontation that's centered on the central region of Europe between unified alliances to a world situation with many threats to our national interests. We're seeing a general shift to conflict along "fracture lines" instead of East versus West. The threats are those states that are either in severe economical or political straits or both—failed states.

These states will look for ways to confront us asymmetrically—employ material, doctrinal or emotional means that we aren't prepared to respond to. For instance, an enemy can use our reluctance to inflict casualties on innocent civilians to his advantage and assault our interests while surrounding himself with civilian personnel. We saw this in Somalia in October 1993. In the recent Army After Next wargame simulation at the Army War College, the fictional enemy shielded his activities behind masses of innocent civilians.



We must recognize that major changes are based on a collection of events within the context of history. Our military structure is complex; our changes occur over time and are highlighted by confrontation points. The period between World War I and World War II had a number of changes that became apparent in the second war. The development of the aircraft carrier; submarine warfare; the long-range, even strategic bomber; and others. These were theoretical changes developed when there was no way to demonstrate their necessity. World War II highlighted those changes.

Q *After wars, America reduces the size of her Army significantly. We were ill prepared for World War II, the Korean Conflict and some even dubbed the Army after Vietnam as "hollow." In 1991 after Operation Desert Storm, the active Army had 15 divisions and five corps; now we have 10 divisions and we're talking about going to eight, and we have four corps and we're talking about going to three. What's the difference between the cuts today and those that made us ill-prepared for World War II? What are the risks?*

A It is normal for America to decrease her standing force in a period of decreased threat, and that's what we've done subsequent to the demise of the Soviet Union. Our national leadership looks for opportunities to support the nation's welfare and do the best for the most people.

What is unique about the recent reductions is we're operating at a tempo that far exceeds the tempo of other inter-war periods when the active force structure was reduced. In each of those periods, our operating tempo did not approach what it has been for the past five years.

So, within this historical context, it is unique in our military experience to reduce the Army when our commitments have greatly increased around the world. The active Army has gone from almost 800,000 to less than 500,000 and moved from a largely deployed force to one that essentially is based in CONUS [continental United States].

In 1920, the Congress passed the National Defense Act which authorized an army that, had it been resourced, would have been far better prepared for World War II than the Army we had on the eve of the war in 1940. But the forces authorized by this law were not resourced. In the 20s and into the 30s, our equipment was out-of-date—almost as old as the soldiers using it.

Today, once again, the Army is operating equipment, such as the UH-1 helicopter, M113 personnel carrier and M109 howitzer, that's so old we're rapidly approaching a point where we can no longer sustain it. We must replace it with equipment that's more capable of accomplishing the short-notice, rapid deployment and aggressively executed missions we see now and into the future.

One risk is not having enough funding—not only for research, development and acquisition of the modern equipment we need, but also for opportunities to train on the new equipment both at home station and our Combat Training Centers.

Another risk is in reducing our force structure too far to do the job the nation wants done. An old saying purports that quantity has a quality all of its own. In application, regardless of how good an organization is, if it is too small to meet its commitments, then it eventually will fail—because there aren't enough assets to go around.

Accomplishing the missions delineated

in our National Military Strategy will stretch the Army at this point. If America reduces her land forces further, I would be very concerned about our ability to execute the National Military Strategy.

Q *During World War II, the German military opted for fewer weapons of superior technology over larger quantities of more primitive technology. Yet in the end, the larger volume of equipment fielded by the Soviet Union, US and other allies overwhelmed the Germans. Realizing that global conflict is unlikely, what are the challenges we face on the high-technology path we are pursuing?*

A It's always important to look at equipment in terms of what's available at the time it's needed. In that regard, we found ourselves fielding combat systems in World War II that were not perfect, but the systems were about what we could do in the time we had.

Frequently people talk about the exceptional weapon systems developed by the Germans, and they did develop some extraordinary systems. Unfortunately for them and fortunately for us, their ability to field and sustain them was much less than their research and development techniques. So, the old story of "for want of a nail, the shoe was lost; for want of a shoe, the horse was lost" and so forth was what happened

to the German forces. They insisted on fielding as many new tank models and aircraft as possible without the spare parts needed to sustain them. So the Germans would roll out a beautiful new Tiger tank, and frequently if it broke down, its crew had to walk away from it.

What we did well in World War II and must do today with our high-tech equipment is support ourselves away from our standard sustaining base and keep our systems operating, even under difficult circumstances. We're taking a new, global approach with pre-positioned stockpiles of equipment for our troops to fall in on in many different locations around the world. It's also very important to embed training technology in the equipment and to continue to improve our logistical and maintenance techniques.

So, the challenges of developing high-tech equipment are getting the most out of the technology and keeping the equipment working.

Q *Fire support played a key role in defending NATO. Explain the role of fire support during your assignments in Germany as a tank company commander from 1971 to 1973, as a tank battalion commander from 1983 to 1984 and then as an armored brigade commander from 1988 to 1990. How did our capabilities change and why?*

Short List of Redleg Readings

Brigadier General Mountcastle recommends young Redlegs read the following books to enhance their critical thinking skills to lead in the 21st century.

1. Robert H. Scales, Jr., *Firepower in Limited War*, Revised Edition (Novato, CA: Presidio Press, 1997). How fire supporters have had to adapt to dynamic situations where, with little notice, they were thrust into operations that tested their abilities to think on the move and use non-traditional means of mobility.

2. David T. Zabecki, *Steel Wind: Colonel Georg Bruchmuller and the Birth of Modern Artillery* (Westport, CT: Praeger, 1994). How fire support developed in the first half of this century.

3. Williamson Murray and Allan R. Millett, eds., *Military Innovations in the Interwar Period* (New York, NY: Cambridge University Press, 1996). Case studies on the complexity of the innovation process and why one country succeeded while another did not.

4. Edward Tenner, *Why Things Bite Back: Technology and the Revenge of the Unintended Consequences* (New York, NY: Alfred A. Knopf, Inc., 1996). Entertaining look at how our expectations of new technology don't mesh with reality and how we don't conceive of some consequences.

5. Martin van Creveld, *Technology and War: From 2000 BC to the Present* (New York, NY: Free Press, 1989). Discussion of the relationship between technology and war.

New History and Esprit Manual for Trainers:

The American Military Heritage (Fort Monroe, VA: Training and Doctrine Command, due for release in September 1998). A source book that puts a human face on the Army's 223-year history, telling the story of the Army's core values and contributions to the nation.

A Fire support for NATO changed tremendously. In my early experience, we looked for ways to use artillery in covering force operations designed to delay a Soviet attack into the central region of NATO. It was standard in our war plans of the early 70s to position representative calibers—175-mm, 8-inch and 155-mm howitzers—forward. We had to move artillery forward into predetermined positions and then rapidly displace it as we expected an overwhelming armor-heavy force to approach our major defense zones. We still had the Honest John rocket in the corps artillery.

When I was a battalion commander in Germany in the early 1980s, the general effect of the introduction of TACFIRE [tactical fire direction system] and the improved range of the 155-mm howitzer was significant. At the same time, we had moved through several doctrinal changes from the Active Defense in the late 1970s to AirLand Battle, calling for aggressive maneuver and for fires applied throughout the depth of the battle area. These changes played a major role in establishing a highly responsive, more rapidly deployable Field Artillery.

By the time I went back to Germany on my third tour as a brigade commander, 1988 to 1990, we had MLRS [multiple-launch rocket system]. Our target acquisition batteries had much better equipment. Within the division, we were more closely tied with our direct support and general support artillery. The corps artilleries, V and VII Corps, were more integrated into our general maneuver plan.

Over time, I saw the partnership of fires and maneuver develop.

Q *After Operation Desert Storm, many units did not retire their operational records. What have been the consequences?*

A We have grappled with the issues surrounding the maintenance of operational records during Desert Storm for the past five years. Units at the division level and higher from the Persian Gulf generally complied with the Army regulation requiring them to retire their records. But many gaps exist in the brigade, battalion and separate unit records, and we've been trying to fill them with oral histories.

The records are important to maintain the history of the Army and its operations,

but also to maintain soldiers' record of service to the nation. For example, records of Army units in Vietnam have been very important to the government's response to the illnesses associated with the use of Agent Orange.

The approach the US Army Europe has taken in its operations in Bosnia is an excellent model for deployments of this sort. Since December 1995, an annex in each operations order covers unit responsibilities for historical activities. In Bosnia, we are collecting unit operational records monthly and retiring them to a special holding area in Germany.

The Army has 22 military history detachments to help deployed commanders record the history of their operations—all but one of which is in the Reserve Components. Each detachment has an officer with a history degree, a senior NCO trained in conducting oral history interviews and a junior NCO who transcribes the interviews and makes copies of and files the pertinent documents—operational logs, orders, etc. They come with their own tactical vehicle, a HMMWV [high-mobility multipurpose wheeled vehicle], and equipment. So you see, these detachments have soldiers useful to the commander—not tourists.

The commander can turn to his military history detachment to request examples of previous operations similar to the one he's conducting, to record the circumstances surrounding a particular operation being conducted or to research unit honors and lineage for changes of command and other ceremonies. The detachment also can pull together historic information on host nation military and cultural activities.

The major thing we can learn from our experience with operational records is just how important they can be for a host of people during the operation and for years afterwards.

Q *What message would you like to send Army and Marine Redlegs stationed worldwide?*

A Field Artillerymen are flexible, fast, accurate and deadly. Again and again, Redlegs have demonstrated their valor and teamwork. From Lieutenant Alonzo Cushing, Battery A, 4th US Artillery, holding his battle position and firing his last round at Gettysburg to Sergeant Jack Vessey in Italy during World War II to Lieutenant Colonel Charlie Rogers who won the Medal of Honor in

Vietnam to the great Active and Reserve Component gunners and rocketeers in Desert Storm—all worked for victory. You must take great pride in the fact that your contributions to the Army's history have been significant.

Center of Military History Home Page

<http://www.army.mil/cmh-pg>

The CMH Home Page provides Army historical information for soldiers, scholars and the general public, including:

- Unit Lineage and Honors
- American Military History
- Gulf War Key Personnel List
- Military Biographies
- Citations of Medal of Honor Winners
- Books and Documents
- CMH New Publications List
- Digitized Unpublished Studies
- Art, Photos and Images
- Records and Research Locations
- Research Inquiries, Finding Aids and How-To Sections
- Timely Features: Centennial of the War with Spain and Normandy Invasion
- Links to other Military Websites
- Other Historical Services



Brigadier General John W. Mountcastle has been the Chief of Military History and Commander of the US Army Center of Military History in Washington, DC, since October 1994. In his previous tour at Fort Leavenworth, Kansas, he served as Chief of Staff of the Combined Arms Center and then Director of Strategic Studies at the Command and General Staff College. He commanded a tank company in the 1st Armored Division; the 3d Battalion, 63d Armor in the 3d Infantry Division (Mechanized); and the 2d Brigade, 1st Armored Division, all in Germany. He taught Military History at the US Military Academy at West Point. Brigadier General Mountcastle is a graduate of the Virginia Military Institute and holds a Ph.D. in History from Duke University.

July-August 1998  **Field Artillery**

Staying on the Cutting Edge: Military Professionalism and the Mexican War

by Major R. Powl Smith, Jr.

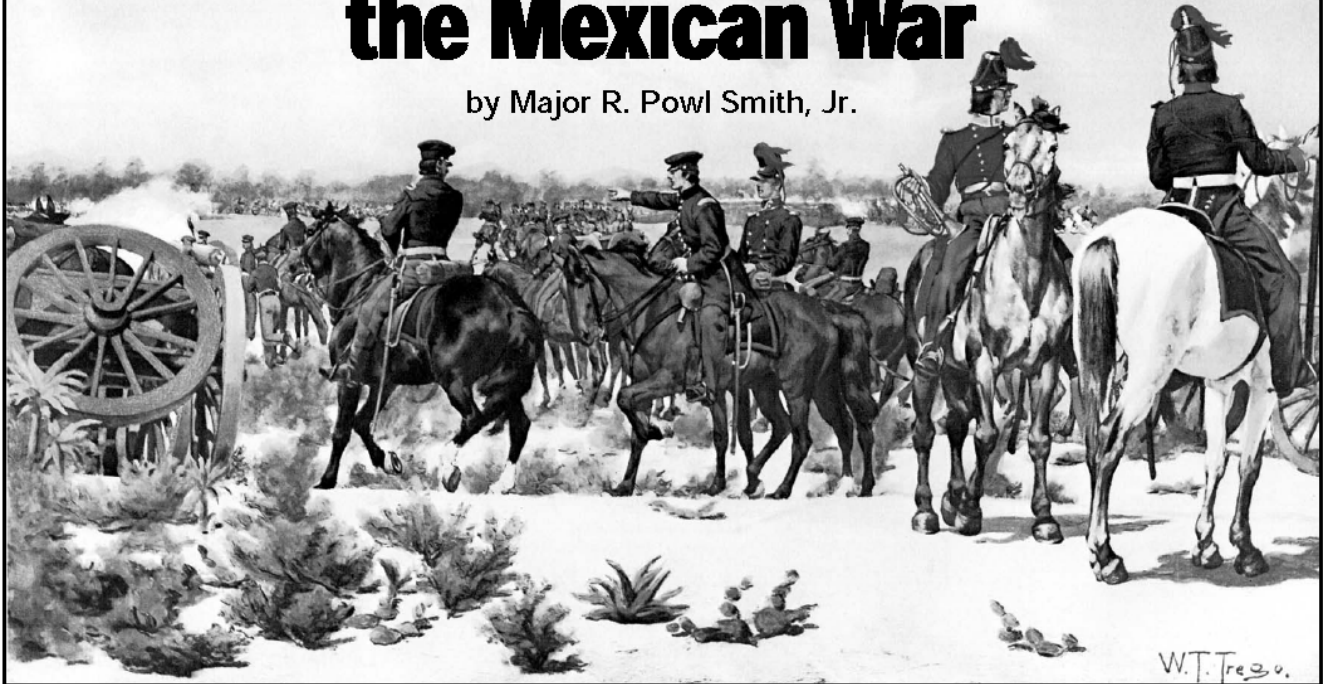

One could cite many instances throughout history in which army leaders efforts to stay "on the cutting edge" of their profession by studying military organizational design, equipment, tactics and techniques were pivotal to the success of their units. However, one outstanding example of the effect of such studied professionalism is that of the Redlegs of America's "Flying Batteries" during the Mexican War, particularly in the first battle of the war, the Battle of Palo Alto.

On 4 May 1846, 3,270 men of Mexico's best army, the Army of the North, crossed the Rio Grande River into Texas. They surrounded a 500-man US Army outpost named Fort Texas and began to bombard it with mortar and cannon fire. The Mexican force was led by General Mariano Arista, one of his country's most capable commanders. Three days later, Brigadier General Zachary Taylor started an army of 2,300 US Regulars marching to relieve Fort Texas.¹

At noon on May 8, Taylor learned from his scouts that Arista and his army were waiting at a place called Palo Alto (map on Page 6). The Mexican general had placed his army astride the road in order to force

1st Place



Taylor's smaller American Army to attack and fight through the Mexicans to reach Fort Texas. Arista had chosen a battle site that was an island of open, treeless prairie in the vast expanse of thick chaparral that covered the coastal plain of south Texas.

At Palo Alto, Arista's best arm, his veteran cavalry, could be used with greatest effect against the untried American infantry. He placed his cavalry on the extreme left and right of his line to envelop the American forces in their anticipated attack. In the center, he placed his infantry and 12 cannons. When the Americans arrived and began forming into their battle line only three-quarters of a mile away, the Mexicans already had been in position for hours—they were rested and ready.²

Taylor was affectionately known to his troops as "Old Rough and Ready" for his disdain for military ceremony and his unsophisticated, down-to-earth ways. Unfortunately, his view of tactics was equally unsophisticated. When the Army marched to relieve Fort Texas, Taylor advised his men to rely primarily on the bayonet. In his 34 years of service, Taylor had campaigned only against the eastern Indians. His experience indicated that cavalry and artillery had little utility; a straight-forward infantry attack was the best and simplest means of removing the Mexican forces barring his path.³

But Taylor's subordinate commanders had other ideas, especially his two artillery battery commanders, Brevet Major Samuel Ringgold and Captain James Duncan. As the infantry regiments formed the battle line, Ringgold and Duncan raced their light (or field) artillery batteries out in front of the infantry. With speed and precision, the men and horses moved as if choreographed, bringing the four guns of each unit into battery. Within minutes they began firing, and soon they found the range. The eight American guns—each firing a round a minute—began battering and shredding the proud Mexican infantry.⁴

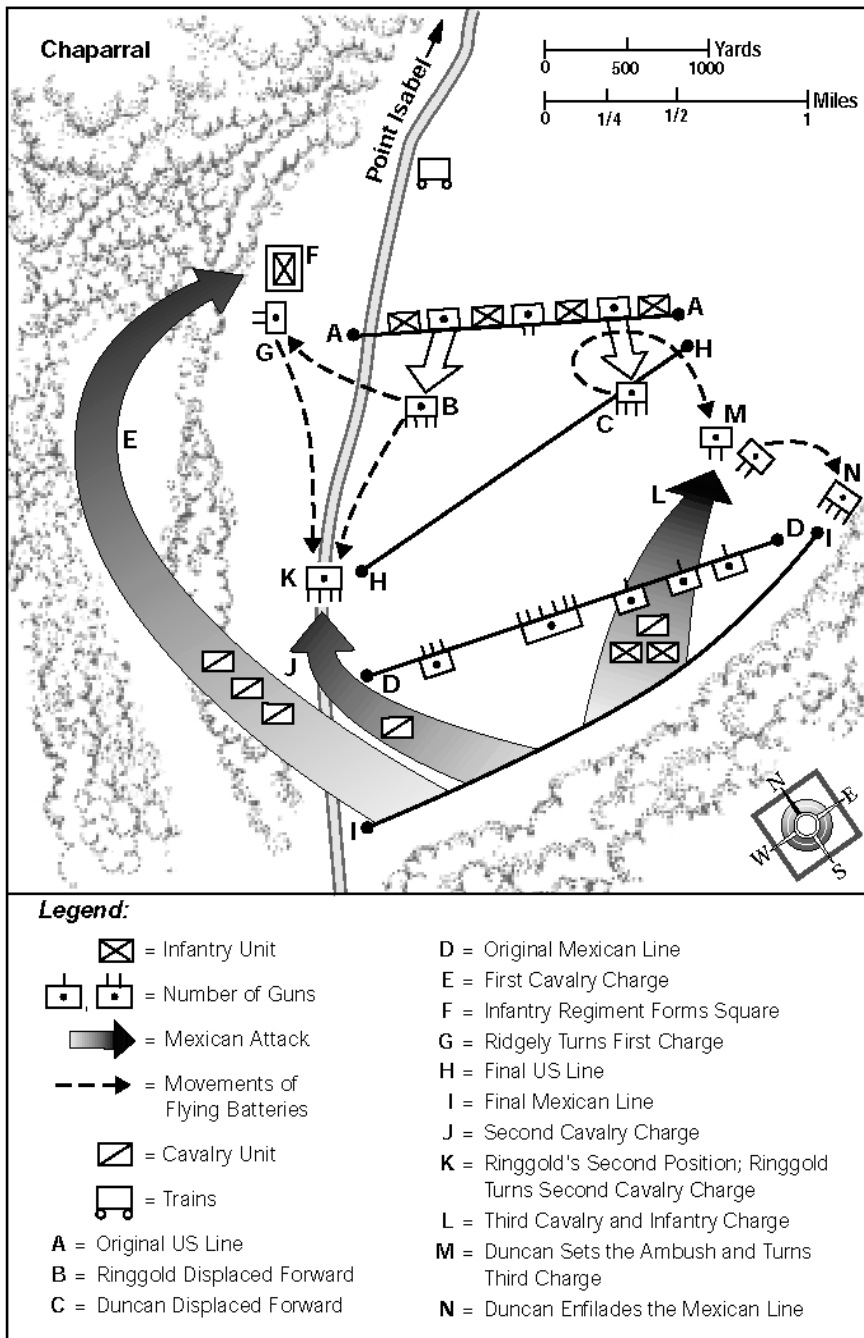

Battle of Palo Alto

The older, less capable Mexican guns returned fire, but with little results. The *yanquis* were just out of range of their longest range munition, solid shot (cannon balls). In fact, the Mexican rounds hit the ground so far in front of the American lines that the blue-clad infantry simply parted ranks like mobile bowling pins to let the bouncing missiles pass through.⁵

After half an hour of relentless bombardment, Arista's infantry was still bravely standing up to the ravaging fire, but not for long. Many of them were

barely trained conscripts. If Arista waited much longer, his men would be completely broken by the American guns. The US Field Artillery had forced him to change his plan; he could no longer afford to stand and wait for Taylor's attack. Arista ordered his most effective force, his cavalry, to break the US line.⁶

The cavalry were to circle around through the thick chaparral, attack the American right flank and roll it up. Unprepared, inexperienced infantry could rarely stand up to the thundering charge of

cavalry, and the Mexican cavalry was some of the world's best. Three regiments, 1,000 lancers in all, circled left, using the thick chaparral to conceal their movements.⁷

Again General Arista's plan was foiled. As his cavalry fought through the entangling chaparral and soft bogs, the 5th US Infantry Regiment spotted them. Realizing the threat, the unit fell back off the line and, like a well-oiled drill team, reformed into an infantry square, a formation ideal for repelling cavalry attacks. As the Mexican lancers descended upon the infantry square, Lieutenant Randolph Ridgely's section (two guns) from Ringgold's battery limbered up and raced to the aid of the threatened infantrymen. The Redlegs, as the US Field Artillerymen were called, quickly unhitched the teams and placed the guns into battery, delivering "a destructive fire of grape and cannister on the enemy," who had closed to within 50 yards of the infantry square. The lancers retreated, reorganized and charged again. Once more, grapeshot, cannister and a hail of musket balls tore into the men and horses, throwing them back. After the second bloody repulse, the lancers limped back to the safety of their own lines.⁸

In the meantime, the fighting on the main battlefield had subsided as smoke from a prairie fire caused by the American guns blanketed the field. Both sides used the smokescreen to adjust their positions. Arista repositioned counter-clockwise, trying to edge his line, especially his guns, closer to the Americans. Taylor adjusted his line in the same direction but more aggressively. As the smoke cleared, Ringgold's battery (once again a four-gun battery with Ridgely's section rejoined) moved forward with the American right, closing the distance to the Mexican left.⁹

Arista's guns were in range at last and began vengeful fire on the American right, especially Ringgold's guns. At the shortened range, the Mexican guns were finally having an effect. The exposed American battery was hit as were its supporting infantry. The infantry wavered under the fire and began an orderly withdrawal. But the Redlegs held on and returned fire.¹⁰

With the US infantry pulling back, Arista ordered his battered lancers forward once again. They were to take the guns, now unsupported and vulnerable. But even as the aide rode off with the orders, more American infantry and dragoons began moving quickly to the isolated battery's defense.¹¹

At last Arista's lancers launched the second attack of the day, but not with the vigor or resolve of the first. They had had enough of the American guns. They were turned easily and returned to the Mexican lines dispirited and tired. The battle on the American right was over.¹²

Arista was no longer executing his plan; he had lost the initiative due to the American Field Artillery. The Redlegs had provoked him into attacking and then rapidly moved to and defeated each of his assaults. General Arista studied the smoky battlefield, carefully trying to divine from the movements of the blue-clad enemy the best moment to strike to regain the initiative and destroy the upstart little army.

Finally, he saw an opportunity. From the far left side of the American line, Duncan's battery had limbered up and was galloping toward the American right. The American left was still screened by smoke and had been idle for an hour. With the movement of Duncan's battery, no artillery remained on that flank to stop an attack. Arista ordered his fresh troops on his right, a regiment of light cavalry, his best infantry regiment, the 2d Light Infantry, and the Tampico Battalion, to attack and crush the weakened American left under the cover of smoke.¹³

If the Mexican infantry could get to the American infantry, the Mexicans could give as good as they got, and their greater numbers would carry the field. As his right wing lurched forward across the smoky, smoldering grass, Arista must have felt a surge of excitement—at last victory would be *his*.

But what General Arista had not counted on was that the Redlegs' new flying battery could turn and dash back as fast as it had raced away.

Evolution of the Flying Battery. The commander of that flying battery, Captain James Duncan, was part of a new breed of Redlegs. Duncan had fielded and trained one of the Army's first Field Artillery batteries, Company A, 2d Artillery, as a flying battery. "Flying battery" was the flamboyant name applied to any light battery trained and equipped with the newest, most technologically advanced, horse-drawn Field Artillery guns and limbers. They were developed to attain greater tactical mobility and greater speed of emplacement and displacement—as well as a higher rate of fire.¹⁴

The US Army had only begun fielding these batteries a few years before against significant opposition from both the

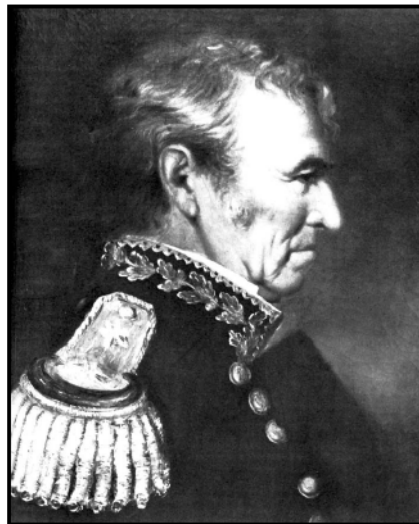

General Zackery Taylor

military and government. The fielding was the culmination of a 30-year evolution of the US Field Artillery from virtual nonexistence to being regarded as the equal of any other nation's Field Artillery.¹⁵

The evolution began after the War of 1812 with post-war reorganizations in 1815 and 1821 that created America's first light artillery companies. In the Act of 1821, four artillery regiments were created, each composed of eight coast artillery companies and one light artillery company. However, the light artillery companies were missing two essential elements of an effective military unit: equipment and training.¹⁶

Plans to equip the new light artillery companies ran into two problems: first, deciding which types of artillery pieces, caissons, limbers and other accoutrements to buy and, second, obtaining funding from the Congress and War Department. Then, as now, authorization did not equate to realization.¹⁷

Several Ordnance Department surveys were conducted in the 1820s and 1830s to determine how to modernize the hopelessly obsolete US arsenal of artillery. Many new designs, some revolutionary, competed with older, reliable ones (some Revolutionary War) for selection as the American standard design. However, the greatest problem was funding.¹⁸

Even though the light artillery had been authorized, critics in the military and the government argued that there was little need for it in the American Army. It had not affected the last war with a conventional foe in 1812, and it was nearly useless in frontier operations against

Indian opponents. Worse, light artillery was very expensive due to the need to purchase, train and maintain horse teams for the guns and ammunition wagons.¹⁹

Against such arguments, both the selection of suitable designs and the decision to purchase languished. Meanwhile, the artillerymen assigned to those companies served more frequently than not as "Redleg infantry," augmenting the regular infantry at the frontier outposts and never gaining artillery experience or expertise.²⁰

However, in 1824, John C. Calhoun, the most visionary of the early Secretaries of War (1817-1825), recognized the lack of technical and tactical skills of the American artillerymen and established the "Artillery School of Practice" at Fort Monroe, Virginia. Here he gathered a corps of artillery instructors—specialists in mathematics, engineering and chemistry—drawn from both the artillery regiments and academia to school newly commissioned officers in both the theoretical and practical aspects of gunnery. This first "Field Artillery Officer Basic Course" also conducted collective training through which every artillery company rotated periodically, spending several months refreshing its tactical and technical artillery skills.²¹

Unfortunately, the school never achieved its full promise due to a lack of Congressional and War Department support, distracting Indian wars and, most significantly, a lack of funds to acquire the necessary horses, textbooks and new equipment. Poor funding plagued the training system and equipment modernization programs equally.²²



Brevet Major Samuel Ringgold

Finally, in 1838, the Field Artillery found its greatest ally in Secretary of War Joel Poinsett (1837-1841). Poinsett redoubled the Ordnance Department's efforts to select suitable weapons to replace the entire arsenal of US artillery: field, siege and coast artillery pieces alike. From the department's studies emerged the Model 1840 family of bronze, smoothbore artillery pieces. Two of these became the Field Artillery's standard pieces: the six-pounder gun and 12-pounder howitzer. Also from the Ordnance Department's study came the adoption of the new French-designed carriages, limbers and caissons—sturdy, lightweight equipment designed for mobility and durability.²³

Poinsett approved these designs and directed that one test-bed light artillery company be mounted and equipped, at long last. In 1838, Brevet Major Samuel Ringgold, one of the Army's premier gunners, received orders from the War Department to form and train a light, mounted Field Artillery battery at Carlisle Barracks, Pennsylvania, from artillerymen in the 1st and 2d Artillery Regiments. The lack of American experience with light, horse-drawn artillery did not deter Ringgold—he was a professional, a student of warfare as well as a practitioner. He knew where to find the information he needed to execute his mission.²⁴

Military Professionalism and Innovation. Fortunately for Poinsett and the Army, Ringgold was one of a core of professional Army officers who adhered to the fledgling philosophy of military professionalism espoused by West Point's Dennis Hart Mahan. Mahan held that an officer could become truly proficient at his trade only if he acquired a broad historical knowledge of war. He wrote, "It is to military history that we are to look for the source of all military science. In it we shall find those exemplifications of failure and success by which alone the truth and value of the rules of strategy can be tested."²⁵

Upon commissioning, Ringgold and men like him embarked on personal study programs of both military history and recent technical and tactical developments to keep themselves current in military developments of many kinds, including those of the artillery. After he researched and found no suitable American examples, Samuel Ringgold relied on an English horse artillery system as the foundation for developing the tactics and techniques of his mounted Field Artillery battery.²⁶

Such research was in spite of the potential ridicule of fellow officers. The study of military history and military affairs was scorned by many, including the Army's second-most senior officer, Brigadier General Edmund P. Gaines.

General Gaines believed the European armies' technical lessons and tactical combat experiences had nothing worthwhile to offer Americans. Likewise, future Mexican War General Zachary Taylor, a self-taught tactician, was openly disdainful of the study of military history and related military subjects and those who pursued them.²⁷

Many junior officers also scorned book-learned professional studies. After the Mexican War, two veterans had the following exchange: Captain Henry J. Hunt, a Field Artillery battery commander, was ridiculed by dragoon expedition commander Major Charles May, who was trying to lighten the expedition's wagon loads and found Hunt's battery library.

"Books!" May exclaimed in astonishment. "You say books! Who ever heard of books being hauled over the plains? What in hell are you going to do with them?" At that moment Captain Campbell of the Dragoons came up and asked permission to carry a barrel of whiskey.

"Yes, anything within reason, Captain. You can take along the whiskey, but damned if these books shall go."²⁸

Hunt went on to become George B. McClellan's and George Meade's artillery commander, orchestrating the massed Union artillery at Malvern Hill and Cemetery Hill (Gettysburg) and other battles.²⁹

Enough officers studied their profession to support several military periodicals, including the *Military and Naval Magazine* (1833-1836), the *Army and Navy Chronicle* (1835-1844) and the *Military Magazine* (1839-1842). Using these forums, officers in far-flung outposts could remain current by exchanging views and experiences on American and foreign weapons developments and tactics.³⁰

Among these professionals was another man who, together with Major Ringgold, could rightfully be called a father of the US Field Artillery: Major Robert Anderson. Anderson was an 1825 graduate of West Point and a veteran of the Black Hawk and Seminole Indian Wars. Like Ringgold, Anderson was one of the nation's foremost artillerymen.³¹

But while Ringgold looked to the English example, Anderson studied the French Field Artillery system. In 1839 he translated the key French publications and training manuals and melded their concepts with Ringgold's practical work with the guns and teams at

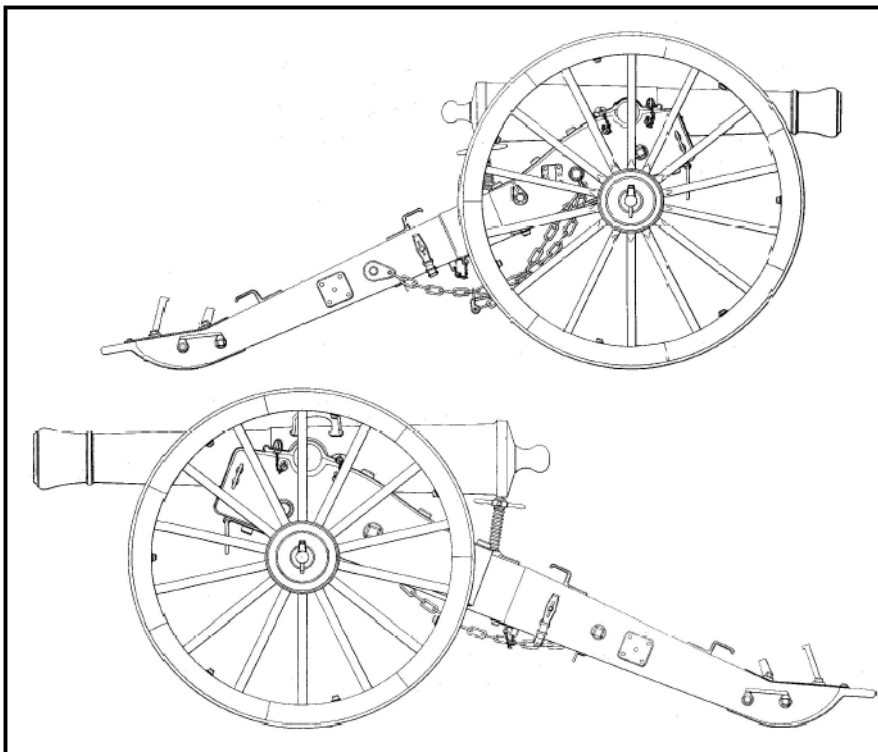

Six-Pounder Gun (Top) and 12-Pounder Howitzer

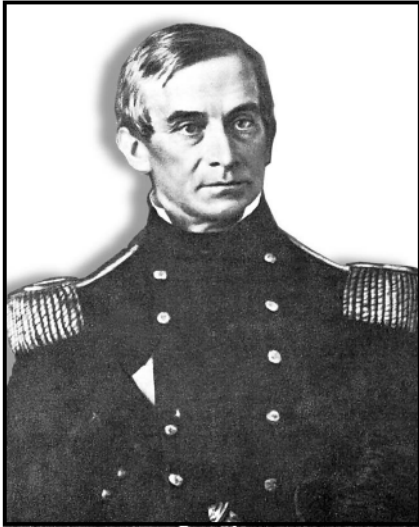

Major Robert Anderson

Carlisle Barracks. In 1839, Anderson published the first American Field Artillery manual detailing the US Army's version of flying battery tactics: *Instruction for Field Artillery Horse and Foot*. Two years later, the War Department adopted this publication as the official manual of Field Artillery tactics.³²

Major Ringgold's command, Company C, 3d Artillery, was the first to be fielded the new American artillery pieces. In 1839, the company received four of the new six-pounder field guns. (Four guns per battery was the peacetime authorization that was designed to be expanded to six or even eight guns in wartime.)³³

With his new equipment and many months of training under his belt, Poinsett had Ringgold's battery put on a synchronized demonstration with maneuvering infantry and dragoons for a group of dignitaries, including several influential members of Congress. The success of the demonstration earned Secretary Poinsett the dollars with which to equip the last three authorized field batteries: Company K, 1st Artillery (commanded by Captain Francis Taylor); Company B, 4th Artillery (commanded by Captain John M. Washington); and Company A, 2d Artillery (commanded by Captain Duncan). Lieutenant Braxton Bragg's Company E, 3d Artillery, was the last battery to be fielded before the war and the first to be equipped with a mixture of six-pounder guns and 12-pounder howitzers. These units were ordered to New Jersey where they trained to perfection under Major Ringgold's watchful eye before returning to their posts to establish their own Field Artillery training schools.³⁴

Secretary Poinsett's decision to modernize the Field Artillery batteries could not have been better timed. His choice of the well-read Samuel Ringgold to create the flying battery was as prophetic. In a few years, the new flying batteries demonstrated their utility against an enemy with conventional infantry, cavalry and artillery of its own—the Mexican Army.³⁵

Victory at Palo Alto. Just three years after Captain Duncan's battery was created, he led it across the smoke-shrouded battlefield at Palo Alto to the aid of his mentor, Major Ringgold. As his battery moved to support the embattled American right, Duncan saw through a break in the smoke that the Mexican infantry and cavalry had surged forward toward the American left, the very flank he had just left unsupported and unprepared.³⁶

Duncan and his men had been schooled and trained not only in speed and precision, but also in personal initiative and daring action—the hallmarks of flying battery tactics. Seeing the Mexican attack forming, he turned his guns and, under the cover of the smoke, put them back into battery in a new position. Duncan set up an L-shaped ambush and waited to give the unsuspecting Mexican attackers a hot reception.³⁷

Minutes later, his battery staggered the Mexicans with canister and grape, driving them back with tremendous casualties. Not yet satisfied, the fast-moving Duncan then used the smoke and confusion of the retreating Mexican cavalry and infantry to limber up and advance his guns farther, reaching a position from which his fire could enfilade the entire Mexican line.³⁸

The surprised and confused enemy had had enough of the American artillery for one day and broke under the pressure. General Arista staved off a complete rout, but the field belonged to the Americans.³⁹

US losses were ten killed, 43 wounded and two missing. Sadly, the only officer killed was Major Samuel Ringgold, who had both thighs ripped apart by a Mexican cannonball. Mexican losses were 92 killed, 116 wounded and 26 missing, almost all of whom were lost to the fast-firing, fast-moving artillery. The Battle of Palo Alto was the first of many times in the Mexican War that the American artillery would, quite literally, win the battle.⁴⁰

The Mexican Campaign Concluded. Although General Zachary Taylor had not been a believer in the potency of artillery before Palo Alto, he most certainly became one. The remainder of his campaign into the Mexican interior was based on the

single road capable of supporting his artillery and its ammunition. At the end of this campaign trail nine months after Palo Alto, Old Rough and Ready faced his greatest combat test. Just south of a small hacienda named Buena Vista, his artillery, once again, demonstrated its worth.⁴¹

By 23 February 1847, Taylor's Army of Occupation had been reduced from 14,000 to 4,750 men to support Major General Winfield Scott's coming Vera Cruz-Mexico City Campaign. Of those Taylor had left, only about 700 had been in combat before. Most of these veterans were in his three Field Artillery batteries. His infantry was made up almost entirely of green volunteers.⁴²

The Mexicans, thought to be all but defeated, achieved strategic surprise by marching an army across the northern desert to face Taylor's men. That army was led by Mexico's best leader and most experienced commander, General Antonio Lopez de Santa Anna. Although severely short of artillery, the self-styled "Napoleon of the West" had more than 15,000 soldiers under his command.⁴³

At the Battle of Buena Vista, Old Rough and Ready Taylor barely held a narrow pass against Santa Anna's determined legions. Throughout the day,



A Dragoon During the Mexican War with Carbine and Saber. The Indian-style leggings were worn only in the Southwest.

the battle seesawed with the Mexicans threatening and, in some cases, penetrating the American line—always to be driven back by the timely arrival of a flying battery. Almost 80 percent of Taylor's volunteers broke and ran, but the veteran regulars of his Field Artillery batteries held Santa Anna's army at bay.⁴⁴

At 1700, the Mexicans launched one final, all-or-nothing attack on the untested American center. It caught Taylor by surprise, smashing through three fresh volunteer regiments and surging on toward the US rear. Only the arrival of Braxton Bragg's flying battery saved the entire Army from defeat and destruction. Bragg's battery poured three volleys of cannister into the advancing Mexican line, tearing huge, bloody gaps in it, staggering it, and finally stopping it. The Mexican infantry, truly "cannon fodder" at Buena Vista, retreated from the American guns and battlefield.⁴⁵

Santa Anna retired south over the next few days, never to return. American losses were heavy: 272 killed and 387 wounded—roughly 16 percent of Taylor's force. But Mexican losses were twice that: 594 killed, 1,039 wounded and more than 1,800 missing—20 percent of Santa Anna's force. The American Field Artillery "saved the day" at Buena Vista. Without them, the American Army could not have held even

its strong defensive position "for a moment."⁴⁶

Many young American officers of the Mexican War would see these flying battery tactics again as colonels and generals. They would better understand why the Mexican infantry so rapidly crumbled in the face of the fast-firing cannon when they used the same tactics on each other at Malvern Hill, Shiloh and Gettysburg.

Military Professionalism and Today's Redleg. Military professionals like Robert Anderson and Samuel Ringgold stayed abreast of the latest in equipment, tactics and techniques of their day by studying military history and military affairs. Their personal studies enabled them to place the US Field Artillery at the cutting edge of fire support in 1840. By 1846, with the help of the flying batteries, the American Army was able to defeat the numerically superior (and only marginally inferior technologically) Mexican Army that was defending its homeland.

The significant lesson for today's Redlegs is that while history doesn't repeat itself, it does "paraphrase" itself. Those who do not learn the lessons of history are doomed to repeat mistakes of the past.

Are you keeping up with the latest thoughts and lessons learned in fire

support? How about developments in the advanced FA tactical data system (AFATDS), Crusader, the Army tactical missile system (ATACMS), Firefinder and the targeting and warfighting implications of the Information Age? Are you reading *Field Artillery* regularly? Are you staying On the Cutting Edge?

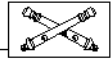

Major R. Powl Smith, Jr., won First Place in the US Field Artillery Association's 1998 History Writing Contest with this article. He is the Secretary of the General Staff at the Field Artillery Center and Fort Sill, Oklahoma. His previous assignment was as the S3 of the 3d Battalion, 13th Field Artillery, part of the 214th Field Artillery Brigade, III Armored Corps Artillery, Fort Sill. Major Smith also served as a Fire Support Observer/Controller for the Battle Command Training Program (BCTP), Fort Leavenworth, Kansas, and the Deep Battle Coordinator for V Corps Artillery in Germany. He commanded A Battery, 2d Battalion, 32d Field Artillery in the 41st Field Artillery Brigade, part of V Corps. Major Smith is a graduate of the Command and General Staff College at Fort Leavenworth and holds a Master of Arts in History from the University of Missouri.

Notes:

1. John S.D. Eisenhower, *So Far from God: The US War with Mexico, 1846-1848* (New York: Random House, 1989), 65, 73-74, 76; and Charles E. Heller and William A. Stofft, eds, *America's First Battles, 1776-1965* (Lawrence, KS: University of Kansas Press, 1986), 64-67, 69.
2. Heller and Stofft, 67-70; and US Congress, Senate, *Presidential Message Relative to the Operations and Recent Engagements on the Mexican Frontier* (29th Congress, 1st Session, June 12, 1846. Senate Document 388, Serial 477), 2. This contains the official reports of Zachary Taylor and his commanders at the Battle of Palo Alto.
3. K. Jack Bauer, *Zachary Taylor: Soldier, Planter, Statesmen of the Old Southwest* (Baton Rouge and London: Louisiana State University Press, 1985), 80, 128, 162-163; Heller and Stofft, 67, 69; Justin H. Smith, *The War with Mexico, Vol. I* (New York: Macmillan, 1919, Reprint, Gloucester, MA: Peter Smith, 1963), 140-141, 374; and Russell F. Weigley, *History of the United States Army* (New York: Macmillan, 1967), 177, 181.
4. Boyd L. Dastrup, *King of Battle: A Branch History of the US Army's Field Artillery* (Fort Monroe, VA: Office of the Command Historian, US Army Training and Doctrine Command, 1992), 71; Eisenhower, 77; and Heller and Stofft, 70.
5. Bauer, 154-155; Dastrup, 73; Eisenhower, 77; Heller and Stofft, 63-71; and Smith, 156, 462.
6. Bauer, 154-155; Heller and Stofft, 70; and US Congress, 2-3.
7. Ibid.
8. Bauer, 155; Heller and Stofft, 70; and US Congress, 2-3, 14, 19-20. It is difficult to determine precisely when and where the various attacks occurred because even the official reports by participants in the battle made a few days after the event conflict with one another.
9. Bauer, 155-156; Heller and Stofft, 71; and US Congress, 2-3, 20.
10. Bauer, 156; Heller and Stofft, 71; and US Congress, 3, 14.
11. Ibid.
12. Ibid.
13. Bauer, 156; Heller and Stofft, 69, 71; and US Congress, 23, 25.
14. Dastrup, 69-70; Eisenhower, 379; and William B. Skelton, *An American Profession of Arms: The Army Officer Corps, 1784-1861* (Lawrence, KS: University of Kansas Press, 1992), 252.
15. Eisenhower, xxiii, 379.
16. Dastrup, 63-64; Lester R. Dillon, *American Artillery in the Mexican War, 1846-1847* (Austin: Presidial Press, 1975), 63-64; and Weigley, 171-172.
17. Dastrup, 63-68.

18. Ibid.
19. Skelton, 252; and Weigley, 171.
20. Dastrup, 66; and Weigley, 171-172.
21. Dastrup, 66-67; and Skelton, 249-250.
22. Ibid.
23. Dastrup, 68-69; and Weigley, 172.
24. Dastrup, 69-70; Skelton, 252; and Weigley, 172.
25. Eisenhower, 35; Weigley, 150-151, quoted from Dennis Hart Mahan, *An Elementary Treatise on Advanced Guard, Out-Post, and Detachment Service of Troops* (Rev. Ed., New York: Wiley, 1864, first published in 1847).
26. Dastrup, 69-71; Dillon, 17-20; and Skelton, 239-240, 254-257.
27. Skelton, 238-240; and Smith, 140-141.
28. Skelton, 238, quoted from Page 112 of the Armistead L. Long, "Recollections of a Lieutenant, USA" (typewritten manuscript), Armistead L. Long Papers, Southern Historical Collection, University of North Carolina Library, Chapel Hill.
29. Dillon, 71.
30. Skelton, 255-257; and Weigley, 152.
31. Dillon, 63.
32. Dastrup, 70; and Dillon, 17-20.
33. Dastrup, 69.
34. Dastrup, 69-70; Skelton, 252; and Weigley, 172.
35. Smith, 156-158, 461-462.
36. Bauer, 156; Heller and Stofft, 71; and US Congress, 23, 25.
37. Ibid.
38. Ibid.
39. Bauer, 157.
40. Bauer, 157; and US Congress, 4-5.
41. Heller and Stofft, 69.
42. Eisenhower, 172-173, 183.
43. Taylor and Santa Anna were probably equals in their abilities to inspire and lead troops. However, Santa Anna demonstrated strategic and tactical skill that far exceeded Taylor's. Eisenhower, 8-15, 29, 175, 373; and Smith, 140-141, 374.
44. Bauer, 212-216; Eisenhower, 183-190; and Smith, 393-394. In fact, the only units of Taylor's that did not break under the Mexican attacks were the 3d Indiana Infantry, Jefferson Davis' Mississippi Rifles and the Regulars—1st and 2d Dragoons and his three flying batteries.
45. Bauer, 204-205; and Smith, 393-394.
46. Bauer, 204-206.

1998 History Writing Contest Winners

First Place- "Staying on the Cutting Edge: Military Professionalism and the Mexican War" by Major R. Powl Smith, Jr.

Second Place- "From the Parade Ground to the Battlefield: Henry Knox and the Battle of Monmouth" by Captain Michael D. Carter, USAR

Third Place- "Steel Curtain: The Guns on the Ia Drang" by Captain Steven M. Leonard, OD

Honorable Mention- "National Guard FA in the Chinese Spring Offensives, Korea 1951" by Captain William M. Donnelly, USAR

Judges of the 1998 History Writing Contest

Colonel Jerry D. Morelock has been the Director of the Combat Studies Institute at the Command and General Staff College, Fort Leavenworth, Kansas, since May 1994. In his previous assignment, he was the Chief of the first Russia and Republics Branch in the Strategic Plans and Policy Division, J5, at the Pentagon. He commanded two batteries, one at Fort Sill, Oklahoma, and one in Vietnam, and the 570th Artillery Group in Germany. He holds two master's degrees and a Ph.D. in History from the University of Kansas. Colonel Morelock has published four books on military history and strategy and numerous papers and articles, including the 1986 Field Artillery Association History Writing Contest winning article.

Colonel Bruce A. Brant commands the 214th Field Artillery Brigade of the III Armored Corps Artillery at Fort Sill. In his previous assignment, he commanded the Combined Battlefield Coordination Detachment in Osan, Korea. He also commanded the 1st Battalion, 319th Airborne Field Artillery Regiment in the 82d Airborne Division at Fort Bragg, North Carolina, and a firing battery in the 41st Field Artillery Brigade, V Corps, Germany. He holds three master's degrees, including the Master of Military Arts and Science from the School of Advanced Military Studies at Fort Leavenworth, Kansas. Colonel Brant has written many articles and papers, including three articles for *Field Artillery* in the past year.

Lieutenant Colonel Russell E. Quirici is assigned to the Congressional Activities Division in the Office of the Chief of Staff of the Army at the Pentagon. In his previous assignment, he commanded the 2d Battalion, 80th Field Artillery at the Field Artillery Training Center, Fort Sill. He also served as Chief of the Field Artillery Proponency Office, part of the Field Artillery School at Fort Sill. He commanded the Headquarters and Headquarters Detachment of the 528th Artillery Group in Turkey and C Battery, 2d Battalion, 4th Field Artillery in the 9th Infantry Division (Motorized) at Fort Lewis, Washington. Lieutenant Colonel Quirici holds a Master of Arts in History from Penn State University and has been published several times in *Field Artillery*.

Field Artillery Themes for 1999

Edition	Theme	Copy Deadline
Jan-Feb	Lightfighter Fires	1 Oct 98
Mar-Apr	Initial Entry Training	1 Dec 98
May-Jun	Leadership	1 Feb 99
Jul-Aug	History	1 Feb: History Contest 1 Apr: Other
Sep-Oct	RC Redlegs	1 Jun
Nov-Dec	Red Book	1 Aug

1999 History Writing Contest Rules

The US Field Artillery Association is sponsoring its 14th annual History Writing Contest with the winners' articles to be published in *Field Artillery* and the Association subscribers' version of the magazine, *FA Journal*. To compete, submit an original, unpublished manuscript on any historical perspective of Field Artillery or fire support by 1 February 1999.

The Association will award \$300 for the First Place article, \$150 for Second and \$50 for Third. Selected Honorable Mention articles also may appear in *Field artillery*.

Civilians or military of all branches and services, including allies, are eligible to compete. You don't have to be a member of the Association. Your submission should include (1) a double-spaced, typed manuscript of no more than 5,000 words with footnotes, (2) bibliography, (3) your comprehensive biography and (4) graphics (black and white or color photographs, maps, charts, etc.) to support your article.

The article should include an analysis of lessons or concepts that apply to today's Redlegs—it should not just record history or document the details of an operation. Authors may draw from any historical period they choose.

A panel of three historians will judge the manuscripts without the authors' names. The panel will determine the winners based on the following criteria:

- Writing clarity (40%)
- Usefulness to Today's Redlegs (30%)
- Historical Accuracy (20%)
- Originality (10%)

By 1 February 1999, send the manuscript to the US Field Artillery Association, ATTN: History Contest, P.O. Box 33027, Fort Sill, Oklahoma 73503-0027. For more information, call DSN 639-5121/6806 or commercial (580) 442-5121/6806.

From the Parade Ground to the Battlefield: Henry Knox and the Battle of Monmouth

By Captain Michael D. Carter, USAR

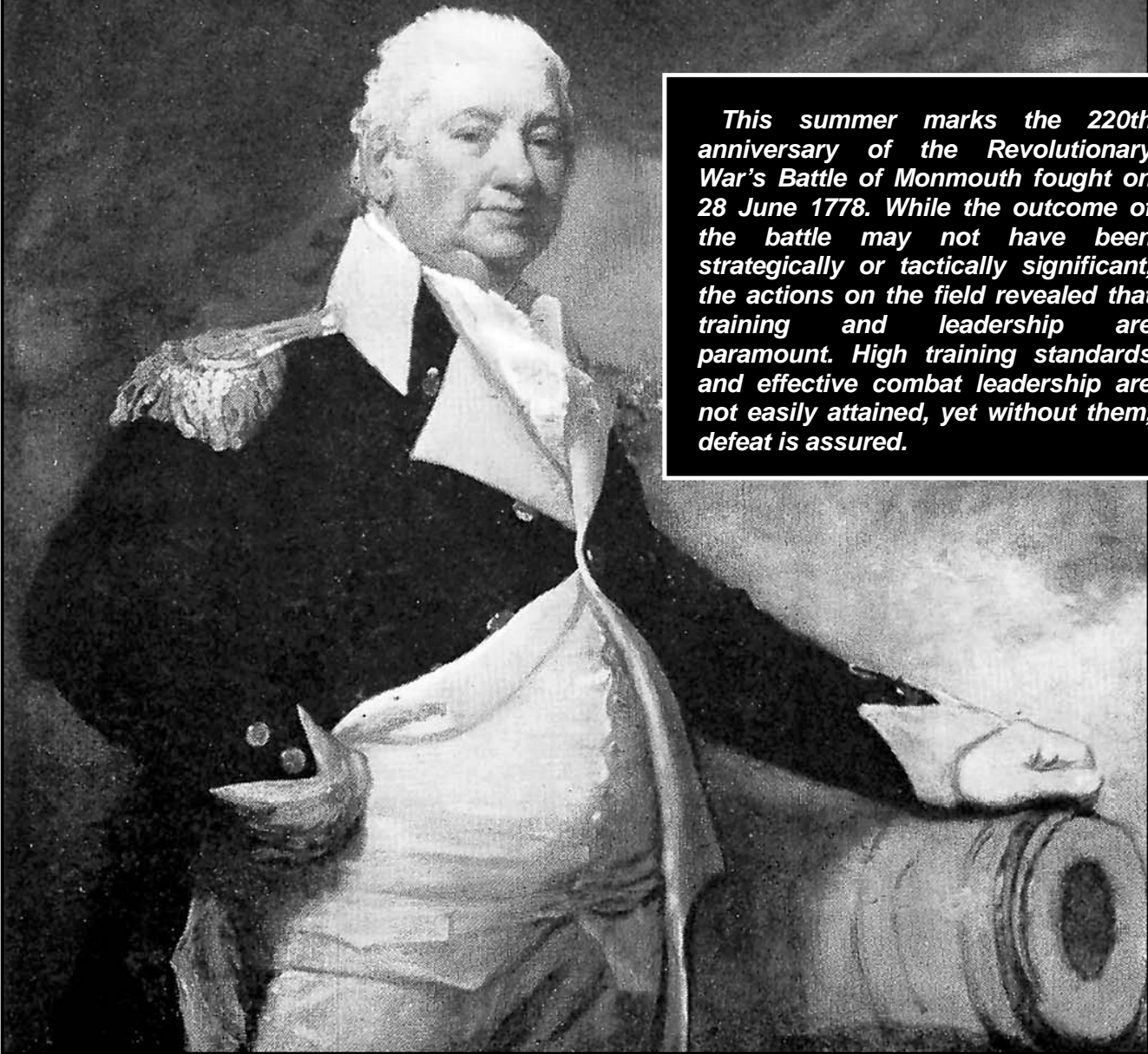
A black and white portrait of Henry Knox, an elderly man with white hair, wearing a dark military coat with a white collar and epaulettes. He is holding a rolled-up document or map in his left hand.

This summer marks the 220th anniversary of the Revolutionary War's Battle of Monmouth fought on 28 June 1778. While the outcome of the battle may not have been strategically or tactically significant, the actions on the field revealed that training and leadership are paramount. High training standards and effective combat leadership are not easily attained, yet without them, defeat is assured.

Henry Knox was a young book seller from Boston turned Continental artillery commander. He pursued the dual goals of training to the highest standard and leading American cannons boldly throughout the War for Independence and demonstrated their effectiveness during the Battle of Monmouth.

Training and Leading the Force. The military triumphs in the 1776 Trenton-Princeton operation were critical events for Brigadier General Henry Knox, commander of the Continental Artillery, and the young American Army as they learned the realities of war and matured as soldiers. The up-and-down campaign year of 1776 ominously had indicated the long road Knox would have to travel before the contest was decided.

With a little breathing room after Princeton, Knox and his commander, General George Washington, concentrated on rebuilding the Army. The main problem, which persisted throughout the war, was a lack of regular troops. Despite the winter victories, the *rage militaire* of 1776 was a thing of the past by 1777. Most enlistments had run out at the end of the year, and the small bounties being offered by the individual states did little to entice new recruits. Therefore, the continued training of troops, which Knox knew was crucial to the future success of the Army, could not take place. As he reported in a letter dated 10 May 1777 to his friend and political patron, Continental Congressman John Adams, "I sincerely wish that the spirit of the enterprize [a training program] may animate our army; but you well know, my dear sir, during the winter past and the most part of the spring we have had no army to be animated."¹

Eventually enough recruits with three-year terms of enlistment were assembled to give Knox a corps of artillerymen to train. Throughout the spring and summer of 1777, Knox put his gunners through their paces in a series of rigorous battle drills.

With Washington's encouragement, Knox also continued to reform and reorganize the Continental Artillery. He organized more artillery regiments along the lines of the First Regiment of Continental Artillery and built up separate artificer companies whose mission was to maintain and construct artillery materiel.² His regiments were composite, consisting of different sizes of cannons, howitzers and mortars. Some were primarily heavy

2nd Place



siege weapons, but each regiment contained direct support (DS) companies that consisted of light field pieces. Knox made an effort to outfit his DS artillery companies exclusively with six-pounder guns, but he never could achieve total uniformity.

By the time the campaign season of 1777 began, the 27-year-old brigadier general commanded four artillery regiments. This changed Knox's function, and he spent less time personally supervising the deployment of artillery around the Morristown encampment and dispatching security patrols—instead he delegated the responsibilities to his four full colonels commanding his regiments.³

Since he could not always be with his artillery, Knox developed standing operating procedures (SOPs) for his regimental commanders in the Continental Artillery. As was consistent with his attention to detail, these standards included traveling formations for the artillery with and without infantry, training schedules, and personnel and ammunition-reporting procedures.⁴ Standing operating procedures allowed Knox to delegate duties and empower his colonels while ensuring uniformity of discipline and training.

Knox got his first chance to test his training efforts in September 1777 at the Battle of Brandywine in southeastern Pennsylvania. Unfortunately, the British, under the command of General William Howe, had managed to outflank the American line, and by the time Knox, Washington and division commander Major General Nathanael Greene reached the scene, the American right of the line was in flight. Continental Generals John Sullivan, William Alexander, Lord Stirling and Adam Stephen had been unable to stem the tide of a joint British-Hessian assault, and many of the troops were already in headlong retreat by the time Washington, Greene and Knox arrived. Washington threw Greene's newly arrived division into the fight. Greene's men

performed remarkably well, opening ranks and allowing the beleaguered troops to pass through and regroup. Knox immediately put the guns assigned to Greene's division into action, and the enemy attack finally slowed.

Reports that Washington himself had been sighted on the field caused Howe to commit his reserve in an effort to achieve the crushing blow he had sought for so long. The sheer numbers of their opponents were too much for the Continentals, and Knox and Greene were forced to perform a fighting withdrawal to prevent being surrounded. Through brave personal leadership and force of will, Washington's two lieutenants managed to keep control over their men and successfully fought backward until darkness fell and they could escape.⁵ As Knox later wrote to his wife Lucy, "It was no deficiency in bravery that lost us the day."⁶

This gave much needed experience to the "new" army of 1777 and increased the confidence of the officers. Washington singled out Knox and his gunners for praise, and reported the Field Artillery delivered well-aimed fire and the cannons stood by their guns until "they had been shot down or forced to flee"—proof that Knox's hard work on high training standards and his command leadership were beginning to pay dividends.⁷

After a disappointing failure to successfully execute Washington's four-pronged offensive plan at the Battle of Germantown, Henry Knox remained determined to achieve the elusive victory that would prove decisive for the American Revolution. The chance to strike a deciding blow against the British, however, evaporated like the smoke from Knox's guns as a stand-off developed in the aftermath of the Battle of Germantown. A frustrated Knox was forced to wait for the enemy to expose himself again.

The constant turnover of Continental infantry commanders left Washington with a paucity of experienced combat leaders, and he shared the frustration of his young artillery commander who had served by his side since the siege of Boston in 1776. The commander-in-chief knew that Knox's Continental Artillery, which the young artillery commander had honed to perfection on the parade ground and had been baptized under fire in many engagements, had often proven to be the only factor separating

victory from defeat or, more recently, defeat from destruction.

The persistent problem of insufficient training continued to plague the bulk of the Continental Army. What good was dependable and accurate fire support if the infantry failed to execute its maneuvers or, as was often the case with the militia, broke and ran at the first shot? The Army needed experienced trainers of infantry.

Into the picture stepped a short, stocky Prussian, Frederick von Steuben, who claimed to be of aristocratic class and a baron by title. Being well-drilled in Prussian infantry tactics, Steuben volunteered his services to the Army at Valley Forge and served without rank or salary. Knox, who continued to drill and organize his Redlegs, admired the Prussian's brashness and immediately put him to work.⁸

As Knox had done with the artillery, Steuben singled out the most proficient soldiers and recommended them to be NCOs to serve as constant trainers and enforce the highest of standards. Steuben's hard work drilling the American troops was rewarded when Washington recommended and Congress approved his appointment as Inspector General with the rank of major general. Finally, the training problem in the Continental Army had been addressed.

Under the watchful eyes of Knox and Steuben, the Continental artillery and infantry were brought up to snuff as first individual arms and then the two trainers cooperated to emphasize combined arms maneuvers. Knox, Steuben and the rest of Washington's staff hoped soon to meet the awesome strength of their British opponents with some degree of parity and excitedly began to plan for the 1778 campaign.

The winter at Valley Forge had been a trying time for Knox and his fellows, but a lot had been accomplished. Washington's inner circle had grown with the addition of Steuben and a young French noble, the Marquis de Lafayette.

On the other side of the lines, an even more significant change in personnel had occurred. British commander Lord Howe, similar to his American counterpart, had come under serious criticism in the fall of 1777. After complaining for so long that he could not get Washington to commit his army, Howe, although victorious, had been unable to destroy the American rebels at Brandywine or Germantown. The inability to catch the Continental Army in Pennsylvania and the stinging defeat and surrender of British General "Gentleman Johnny" Burgoyne at Saratoga provided the writing on the wall for Howe.

Frustrated after chasing Washington

and Knox unsuccessfully for three years in America, Howe spent the rest of the winter of 1777-1778 without incident in Philadelphia. Knowing he would be blamed for Burgoyne's failure, he resigned his command to return to London and face his critics. Howe left America for good on 25 May 1778 and was replaced by his second-in-command, Sir Henry Clinton.⁹

The Battle of Monmouth. Knox and the Continental high command finally got their chance when Howe's successor, Sir Henry Clinton, vacated Philadelphia without firing a shot.¹⁰ Clinton then began a long and arduous overland march through New Jersey back to New York in an effort to consolidate his forces. Here was the opportunity Washington and Knox had long anticipated. Washington ordered Major General Charles Lee, who had recently been exchanged as a prisoner, to take a large advance force of approximately 5,000 men and attack Clinton's rear guard at Monmouth Courthouse (present-day Freehold, New Jersey).¹¹ (See the map.) Lee delayed, and when he finally closed with the enemy, he had no plan of attack. The moment of decision had passed by the time Lee's force launched its lackluster assault against the British on the morning of 28 June 1778.¹²

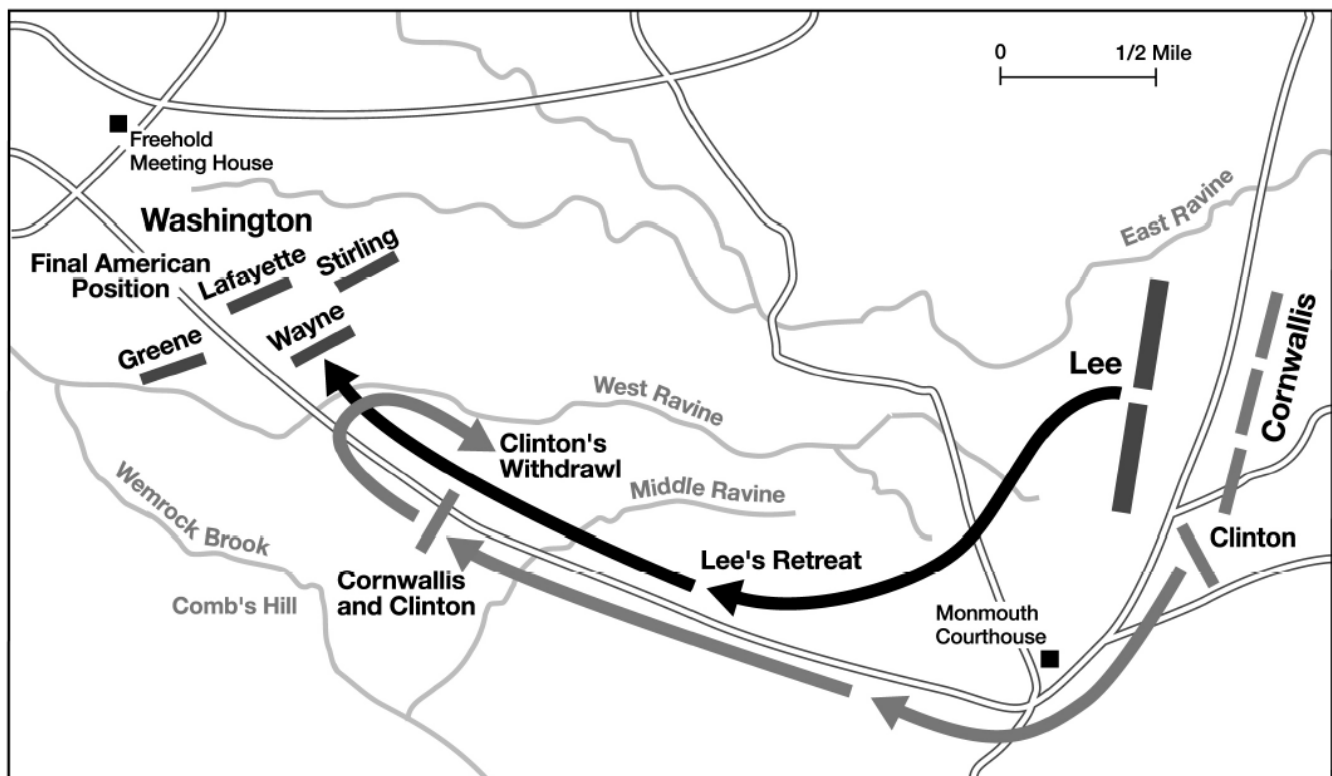

Battle of Monmouth Courthouse, 28 June 1778

Knox and Washington expected promising reports as they brought the rest of the main body forward to join Lee in the battle. When word reached them that Lee had ordered a general retreat, Knox watched his commander erupt with fury. Spitting invectives at Lee, Washington personally rode to the front, exposing himself to enemy fire, and rallied Lee's troops.¹³

The bizarre result was that the Americans, who had been pursuing the British and had opened an offensive against their rear guard, found themselves forced to organize a defense. A defensive posture, however, had long been a strength of the Continental Army.

Realizing the severity of the situation, Knox and Greene quickly ordered their units to take up forward

positions against the oncoming British as they had done at Brandywine. The Pennsylvanian infantry, commanded by Anthony Wayne, was attached to Greene's force, and Washington sent him well forward to a hedgerow directly in the path of the British assault. The maneuvers under fire by the American infantry and artillery were a credit to Steuben's and Knox's long hours of training.¹⁴

With Washington's having rallied Lee's troops that were joined by the remainder of the Army, Clinton could not continue his drive against the Americans. He chose to strike at the Continental right flank where Greene, Wayne and Knox had taken up positions. Clinton ordered the seasoned General Charles Earl of Cornwallis to lead the "flower of the British Army in North America" against the American defense: the British 37th and 44th Regiments, the elite Coldstream Guards, along with another Guards battalion, light infantry, and British and Hessian Grenadiers.¹⁵

Knox's artillery was ready. As Cornwallis' troops deployed into battle formation, they came under enfilading fire from one of Knox's batteries. The fire from this six-gun battery commanded by Knox's brigade adjutant, Chevalier de Mauduit du Plessis, was so accurate and devastating that it almost repulsed the first British thrust by itself. During this deadly crossfire between Knox's guns and



General Washington rallies his men near Monmouth Courthouse. Note Knox's artillery riding into action in the background. This painting by Emanuel Leutze is printed courtesy of the University of California, Berkeley Art Museum and was a gift to the university by Mrs. Mark Hopkins.

Greene's muskets, a single cannonball shot down the front of a British platoon knocked the muskets out of the hands of an entire squad.¹⁶

Clinton directed several units of dragoons against Wayne's forward-deployed force, but Wayne was able to repel the first attack. Washington then sent General James Varnum's brigade along with a six-gun battery under Lieutenant Colonel Eleazer Oswald to reinforce Wayne's and Greene's units.¹⁷

When the British launched another wave against Wayne, Knox could no longer stand by and watch. Bringing four guns with him, Knox personally took command of the artillery, which was situated on Comb's Hill, well forward of the American main line and abreast of Wayne's men.¹⁸ The elevation and positioning of the artillery allowed Knox to fire straight into the enemy flanks as the enemy attempted a third attack against Wayne's position.

Wayne, who realized he was receiving the brunt of the enemy attack and was steadily depleting his ammunition, ordered his force to "Wait for the word, and then pick out the king birds!" He steadied his men and then called for them to fire when the British infantry and cavalry were only 40 yards away. A barrage of grape and round shot from Knox's guns devastated the enemy ranks, and those lucky enough to survive were crumpled under Wayne's

brutal close volley. The British were driven off for a third time.¹⁹

Outnumbered and almost out of ammunition, Wayne finally had to withdraw under the pressure of a fourth British assault. This action left Knox and his cannoners on Comb's Hill as the most forward of the American units, exposed to the entire British force. Once Wayne was safely within the protection of Washington's main force, Knox gave the order for his gunners to withdraw. Cool and calm despite his extremely exposed and unsupported position, Knox maintained control of the situation, and his men reacted according to their training and regained the American lines without losing a cannon.²⁰

Washington could take nothing but pride in the exemplary actions of Knox, Greene, Wayne and their men who had so valiantly fought the British to a standstill. Still, he yearned for a victory, and to get one, he needed to regain the offensive.

Washington ordered his reserve to form into two columns for simultaneous attacks on the British flanks. By the time he could assemble his men, however, darkness was beginning to envelope the field.²¹ The attack was postponed until morning. A brief artillery duel between Knox's batteries and the British concluded the fighting on the 28th.²²

As the artillery duel settled down into brief harassment fire during the night,

Knox ordered his crews to sleep by their guns and be ready to resume the fight in the morning. When dawn broke, however, the British were gone. Washington had been deceived by Clinton and Cornwallis just as he had deceived Cornwallis the year before prior to the battle of Princeton.²³

The Battle of Monmouth was over. The day-long battle had been a bloody affair. Eight American officers and 61 enlisted men were killed, 19 officers and 142 enlisted men were wounded, and 130 were reported missing. The British reported their losses as four officers and 61 enlisted killed, 15 officers and 155 enlisted wounded, and 64 missing.²⁴ Washington claimed that British losses exceeded those officially reported and estimated them at approximately 2,000 killed, wounded, missing or captured. This would have been more than 15 percent of the total British force—a devastating loss for Clinton in an age of warfare in which 10 percent losses were considered disastrous.²⁵

Despite the varying claims of losses, scholars are generally in agreement over the ultimate outcome of the Battle of Monmouth: essentially, it was a draw. Both the Americans and the British held the field technically at the end of the fighting. The British, however, succeeded in their ultimate goal of moving to New York. Despite the valiant efforts of his best officers, Washington was denied a decisive victory as the British slipped away.²⁶

Still, the Americans, particularly Knox's artillerymen, proved once again that they

were capable of standing toe-to-toe with some of the best professional soldiers that Europe had to offer. The ability of the Continental line to withstand four assaults by the British was evidence that Washington had been able to assemble a team of competent division, regiment and brigade commanders. The combined arms had worked for the Americans. The integration of infantry and artillery fire was a testament to the fact that the united efforts of Washington, Knox, Steuben, Greene, Wayne and the other unit commanders had successfully forged an army of regulars.

Knox, again, had demonstrated his own personal bravery and leadership in the heat of battle. As Dr. James Thacher, an eyewitness to the battle, recorded, "In the hard-fought contest of Monmouth, no officer was more distinguished than General Knox. In the front of the battle, he was seen animating the soldiers and directing the thunder of their cannon. His skill and bravery were so conspicuous that he received the particular approbation of the commander-in-chief in general orders issued on the day succeeding the battle, in which he says that 'the enemy have done us the honor to acknowledge that no artillery could be better served than ours.'"²⁷ As was characteristic of Knox, he gave full credit to his men in his letter to Lucy, "My brave lads behaved with their usual intrepidity, and the army gave the corps of artillery their full proportion of the glory of the day."²⁸

Knox's actions at the Battle of Monmouth are an excellent example of dedication to the highest standards of training combined with strong personal command leadership. His perseverance in adhering to these principles proved to be critical for the young American Army, which eventually triumphed three years later at the 1781 Battle of York-town.



Captain Michael D. Carter, US Army Reserves, won Second Place in the US Field Artillery Association's History Writing Contest with this article. He served three years on active duty as a multiple-launch rocket system (MLRS) Platoon Leader for A Battery, 13th Field Artillery, and Executive Officer for Headquarters and Headquarters Battery in the 24th Infantry Division (Mechanized) Artillery, both at Fort Stewart, Georgia. He is a graduate of the Field Artillery Officer Basic Course and Multiple-Launch Rocket System Cadre Course, Fort Sill, Oklahoma, and Airborne School, Fort Benning, Georgia. A Distinguished Military Graduate (ROTC) of Washington and Lee University, he also holds a master's degree from the University of Maryland, Baltimore, and a doctorate from West Virginia University. His doctoral dissertation, which he recently completed while a Fellow of the Naval Historical Center, is a biographical study of the life and career of Secretary of War Henry Knox. Captain Carter lives in Madison, Connecticut.

Notes:

1. Robert J. Taylor, ed., *The Papers of John Adams* (Cambridge, Massachusetts: Harvard University Press, 1979), 5:191.
2. Boyd L. Dastrup, *King of Battle: A Branch History of the US Army Field Artillery* (Fort Monroe, Virginia: US Army Training and Doctrine Command, 1992), 18.
3. *Ibid.*, 20.
4. "Revolutionary War Orderly Books. Volume I. A. Crane's Continental Artillery Regiment, 25 March-7 September 1777," (kept anonymously), containing Generals Knox's and Greene's orders to Captain Benjamin of Frothingham's company of the Knox's Continental Artillery Regiment commanded by Crane, 22 March to 7 September 1777, (Boston: Massachusetts Historical Society).
5. John C. Fitzpatrick, ed., "The Writings of George Washington" from the *Original Manuscript Sources 1745-1799, George Washington Bicentennial Edition* (Washington, DC: US Government Printing Office, 1938), 9:206-2098; and Robert Leckie, *George Washington's War: The Saga of the American Revolution* (New York: Harper Collins, 1992), 350-351.
6. Henry Knox to Lucy Knox, 24 September 1777, from Francis S. Drake, ed., "Life and Correspondences of Major General Henry Knox" from *Memorials of the Society of the Cincinnati of Massachusetts* (Boston: Press of John Wilson and Son, 1873), 50-51.
7. Dastrup, 23. See also Christopher Ward, *The War of the Revolution* (New York: The MacMillan Company, 1952), 1:352-53; John Richard Alden, *The American Revolution, 1775-1783* (New York: Harper & Row Publishers, Inc., 1954), 23-24; and Don Higginbotham, *The War of American Independence: Military Attitudes, Policies, and Practice, 1763-1789* (Boston: Northeastern University Press, 1983), 185-186.
8. John E. Ferling, *The First of Men: A Life of George Washington* (Knoxville, Tennessee: The University of Tennessee Press, 1988), 232. Steuben wasn't actually a baron, but the Continental Congress was so used to accepting European nobility that it accepted him with all his pretensions.
9. George Athan Billias, ed., "George Washington's Opponents: British Generals and Admirals in the American Revolution," *George Washington's Generals and Opponents: Their Exploits and Leadership* (New York: Da Capo Press, 1994), 61-62.

10. *Ibid.*, 83.
11. Leckie, 475.
12. *Ibid.*, 484-486.
13. R. Ernest Dupuy and Trevor N. Dupuy, *The Compact History of the Revolutionary War* (New York: Hawthorn Books, Inc.), 285-286.
14. Leckie, 484-486.
15. Ward, II:584.
16. Leckie, 485; and Ward, II:583-584.
17. Ward, II:583-584.
18. Dupuy and Dupuy, 284.
19. *Ibid.* See also Joseph B. Mitchell, *Decisive Battles of the American Revolution* (New York: G.P. Putnam's Sons, 1962), 146.
20. Dupuy and Dupuy, 284; and Ward, II:584-585.
21. Ward, II: 585; and Leckie, 485.
22. Mitchell, 146.
23. Ward, II:585.
24. William S. Stryker, *The Battle of Monmouth* (Boston), 293-294. See also Ward, II:585; and Leckie, 486.
25. Leckie, 486.
26. Ward, 585. One aspect of the battle that robbed Knox and the rest of the Army leadership of a victory was the performance of Charles Lee. A court-martial board of general officers found that Lee had disobeyed Washington's orders, conducted himself in an unbecoming manner by ordering a withdrawal in the face of the enemy and, in the aftermath of the battle, was disrespectful to the commander-in-chief. The board's recommendation, which was approved by Congress, was a one-year suspension from command. Dupuy and Dupuy, 285-286. For a discourse on Lee's failure and speculation on his possible mental illness, see Leckie, 487-489.
27. *James Thacher's Military Journal During the American Revolutionary War* (Boston: Richardson and Lord, 1823).
28. Knox to Lucy Knox, 29 June 1778, "Knox Papers," (Boston: Massachusetts Historical Society).

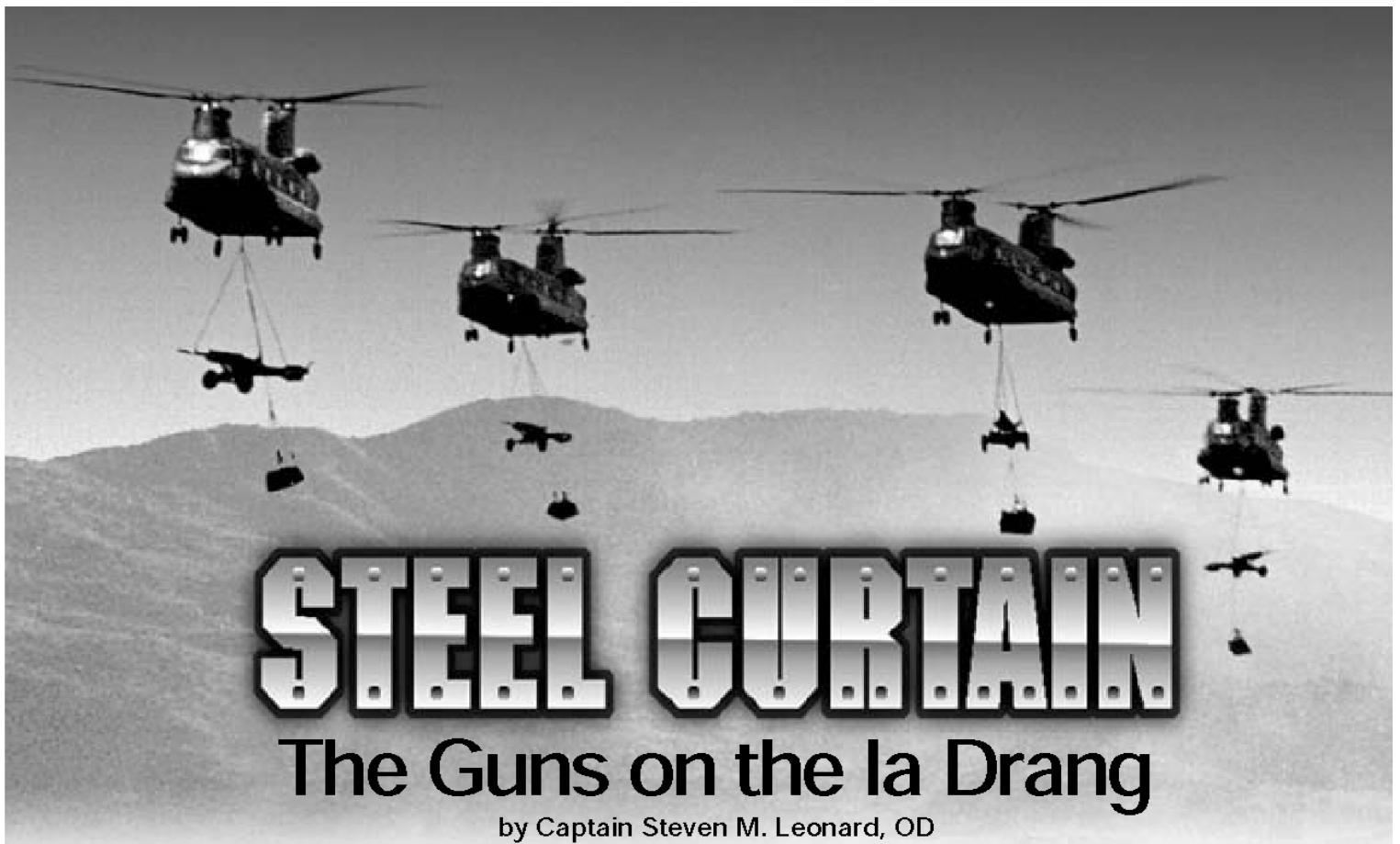

In the stifling heat of the midday sun, forward elements of the 7th Cavalry Regiment crossed over the dry creek bed, searching for an adversary unseen yet nonetheless present. The regiment was at a distinct disadvantage. On unfamiliar terrain, the regiment was already under observation by an enemy notorious for his use of unconventional tactics. The lead battalion faced imminent disaster and would make initial contact outnumbered ten to one.

On this day, the regiment engaged in a historic battle—not on the plains of southern Montana in the valley of the Little Big Horn River, but far from our own shores in the central highlands of South Vietnam. In 1965, nearly 90 years after the annihilation of the 7th Cavalry at the Battle of Little Big Horn, the regiment fought a battle that would forever change the course of the war in southeast Asia: the Battle of the Ia (River) Drang Valley. But unlike Lieutenant Colonel George Armstrong Custer on that fateful day in 1876, the modern-day regiment, the 3d Brigade of the 1st Cavalry Division, brought along a vital asset that would turn the tide of battle in favor of the Americans. This asset was airmobile fire support.

Field Artillery  July-August 1998

3rd Place



Setting the Stage. When President Lyndon B. Johnson announced the deployment of the "Airmobile Division" to Vietnam on 28 July 1965, the 1st Cavalry Division brought with it a vision of mobility and lethality still in its infancy. General James M. Gavin, the legendary World War II paratroop commander, first described this revolutionary concept in his 1957 article "Cavalry—and I Don't Mean Horses." General Gavin, the Army Chief of Operations, had ordered a series of staff studies in 1954 to design a hypothetical helicopter-based cavalry organization. The airmobile vision evolved around the notion of the helicopter freeing combat forces from the limitations of terrain and significantly accelerating the pace of battle. Employing airmobility, Gavin

believed, would transform the battlefield into a three-dimensional nightmare that would overwhelm enemy commanders.¹

On 15 February 1963, the Army organized the 11th Air Assault Division (Test) at Fort Benning, Georgia, to explore the feasibility of the airmobile concept on the conventional field of battle. Under the command of Brigadier General Harry W.O. Kinnard, the division established a large contingent of aviation assets for mobility and a wide array of artillery to provide a lethal umbrella of fire support. The division artillery consisted of three battalions of M102 towed 105-mm howitzers in direct support (DS), a battalion of Little John rocket launchers in general support (GS) and an aerial artillery battalion. (The Little John launchers were later eliminated from the authorized structure.)²

Arguably one the most significant innovations of the decade, aerial artillery changed the face of modern combat. An aerial artillery battalion had two batteries of six modified UH-1 Huey helicopters that added a degree of mobile lethality never before seen in combat. Free of the restrictions of terrain, aerial artillery

maneuvered virtually at will on the battlefield, engaging multiple targets simultaneously and providing direct or indirect fire support.

From the outset, Kinnard's division artillery was a revolutionary concept. Free of ground transport, the artillery could be airlifted into position by helicopters, extending the radius of fire support available to ground units. Both the lightweight M102s and Little John launchers were new to the Army inventory as were the airframes around which Kinnard built the division: the Huey and the CH-47 Chinook. (The M102 was the first howitzer sling loaded beneath a Huey.)

Through many months of intense training, preparation and growing pains, the 11th Air Assault Division thoroughly tested and experimented with Gavin's airmobile vision. On 16 June 1965, Defense Secretary Robert S. McNamara formally announced the authorization of an airmobile division in the Army's force structure and declared the 1st Cavalry Division would carry the airmobile concept beyond the test stage.³ Colonel Timothy (Tim) W. Brown, who commanded the 3d Brigade during the airmobile test phase, would lead this modern-day descendant of the famed 7th Cavalry Regiment into combat when the division deployed to Vietnam.

On 16 August, the 1st Cavalry Division (Airmobile) set sail from Charleston, South Carolina. That same day, the last elements of the 66th Regiment of the People's Army of Vietnam departed from their base camp along the Ho Chi Minh Trail in Thanh Hoa Province in North Vietnam.⁴ For the Americans, the journey through the Panama Canal and across the Pacific Ocean would last almost a month; the 800-kilometer foot march through Laos and Cambodia into the central highlands of South Vietnam would take the North Vietnamese regulars two months. Destiny would bring them together in the valley of the Ia Drang.

Brown's 3d Brigade, aboard the USNS *Maurice Rose* docked in the coastal enclave of Qui Nhon in mid-September. (See Figure 1.) The division cleared a huge expanse of scrub jungle and established a base camp just north of the village of An Khe, 68 kilometers west of Qui Nhon on Colonial Route 19. As Chinooks transported the troops and equipment into An Khe, Lieutenant Colonel Harold G. "Hal" Moore, commanding the 1st

Battalion, 7th Cavalry, recognized the area as the departure point for the French *Groupement Mobile 100* on its historic march into the Viet Minh ambush that signaled the end of French colonial rule in Indochina in 1954. Moore understood that "death is the price you pay for underestimating this tenacious enemy."⁵

On 1 November as lead elements of the 66th Regiment crossed into South Vietnam using trails that followed the Ia Drang River, the US divisional cavalry squadron captured the 33d Regiment's field hospital eight miles west of Plei Me. A fierce North Vietnamese counterattack ensued, and within days, Colonel Brown's 3d Brigade began patrolling in Pleiku Province on a search and destroy mission. Moore's battalion was assigned to "find and kill the enemy" east of Plei Me but found nothing but peaceful mountain villagers.

On 12 November, Brigadier General Richard T. Knowles, the Assistant Division Commander, ordered Brown to conduct an air assault operation near the heart of a suspected enemy base camp on the Chu Pong massif above the Ia Drang Valley. (See Figure 2.) Knowles later said he issued that order "based on strong instincts and flimsy intelligence."⁶

Into the Fire. The Chu Pong massif dominates the serene valley of the Ia Drang, rising 500 meters above the valley floor and stretching westward into Cambodia. At the base of the Chu Pong, a large natural clearing in the surrounding jungle formed a landing zone (LZ) ideal for Moore's assault into the Ia Drang and was named "X-Ray." The clearing was flat, relatively free of trees and had sufficient area to land eight helicopters in formation. Unknown to Moore, the North Vietnamese were nearby—very nearby. The 9th Battalion, 66th Regiment occupied a position less than 500 meters southwest of the clearing; the 7th Battalion was on a ridge line above the clearing; and the 8th Battalion was just across the Ia Drang to the northeast. In addition, the remnants of the 33d Regiment occupied positions along the eastern face of the Chu Pong overlooking the clearing below.⁷

In the early morning hours of 14 November, as Colonel Moore prepared his battalion for the air assault into LZ X-Ray, CH-47s positioned Alpha and Charlie Batteries, 1st Battalion, 21st Field Artillery, on a plateau eight kilometers to the northeast, which was designated LZ Falcon. As part of a deception plan, the 12 105-mm howitzers would fire for eight

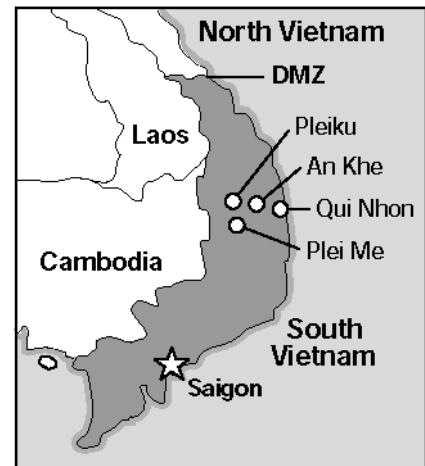

Figure 1: In early November 1965, the 1st Cavalry Division (Airmobile) landed at Qui Nhon and established a base camp just north of An Khe.

minutes on two alternate LZs before shifting fire and laying a steel curtain around LZ X-Ray and the adjacent area. Following the 20-minute preparatory fire on X-Ray, the guns would lift fire, and Charlie Battery, 2d Battalion, 20th Artillery (Aerial Rocket Artillery) would bathe the perimeter with 30 seconds of rocket and grenade fire followed by another 30 seconds of helicopter gunship fire.⁸ Virtually impenetrable, this umbrella of steel would be the difference between life and death for the soldiers of Moore's battalion.

After a 13-minute flight from Plei Me, the initial eight Hueys dropped their tails to reduce speed and touched down into LZ X-Ray, the door gunners firing into the trees around the clearing. It was just 1048 on a clear, quiet morning when Lieutenant Colonel Hal Moore became the first American to set foot in X-Ray. Within seconds, the next eight helicopters touched down with a second wave of troops. The whine of the turbine engines and the deafening sound of rotor blades pounding against the dense jungle air signaled the departure of the helicopters as they banked sharply to the east and disappeared over the trees.⁹

At 1120, Bravo Company reported it captured a prisoner just as the second lift returned from Plei Me with additional troops. Moore's interrogation of the prisoner—reportedly a North Vietnamese deserter—was simple: provide the location and size of the enemy forces in the area. The prisoner replied through the battalion interpreter that three battalions

were on the mountain, and they were all very eager to kill Americans.

Three battalions of the enemy equated to more than 1,600 men. Moore had only 160 troops on LZ X-Ray.¹⁰

Outnumbered ten to one, what began as a search-and-destroy mission quickly evolved into a fight for survival. Bravo Company made contact with the enemy at 1245, running straight into a North Vietnamese assault force after crossing the dry creek bed northwest of the landing zone. While maneuvering to support the 1st Platoon flank, Second Lieutenant Henry Herrick's 2d Platoon broke off from the main body of the company in pursuit of an enemy squad. Within minutes, the North Vietnamese pinned down and surrounded Herrick's platoon with a fierce, relentless volley of fire.¹¹

As the third lift arrived on X-Ray at 1330, the enemy assault intensified and North Vietnamese scouts began to breach the LZ perimeter through the high elephant grass.¹¹ Moore quickly maneuvered his troops (most of his three companies were on the ground, at that point) to secure his tenuous hold on the perimeter, but he desperately needed to slow the assault. Moore ordered his operations officer and artillery liaison officer (LNO) orbiting overhead in the command chopper to coordinate supporting fire, concentrating on the lower slopes of the Chu Pong before ringing the landing zone.¹³

Sometimes, the fog of war favors the underdog. With the battlefield shrouded in smoke and dust, forward observers (FOs) found it difficult to accurately direct artillery fire or identify terrain features, so they "walked" in the rounds.

Moving progressively down the mountainside, the torrential storm of steel rain closed in around X-Ray like a hangman's noose. For the next five hours, the batteries on LZ Falcon fired for effect. By day's end, the howitzers had fired more than 4,000 high-explosive (HE) rounds, exhausting the gun crews and leaving stacks of shell casings up to three meters deep scattered about the firebase.¹⁴

While the artillery—combined with a hail of aerial rocket artillery, Air Force and helicopter gunship fire—did not halt the North Vietnamese assault on the LZ X-Ray, it crippled the flow of enemy reinforcements into the battle. Soldiers making their way down the intertwining trails along the slopes of the Chu Pong massif had to pass through a "seething inferno of exploding artillery shells, 2.75-inch rockets, napalm canisters, 250- and 500-pound bombs and 20-mm cannon fire."¹⁵

Meanwhile, efforts to rescue Herrick's "lost platoon" continued with little success. Sergeant Ernie Savage, now leading the platoon after the deaths of Herrick and Platoon Sergeant Carl Palmer, fought for his life along with a handful of other survivors. With the enemy literally in and around his precariously held position, Savage called in and held artillery fire as close to his perimeter as possible. Throughout the day and into the night, the enemy attacks on the Lost Platoon continued unabated—but so did fire support. The first light of the new day revealed scores of North Vietnamese dead in the tall grass around Savage's position.¹⁶

At 0640 on 15 November, as Moore and his staff began preparations for

rescuing the Lost Platoon, the 7th Battalion of the 66th Regiment launched a massive attack along the southern sector of LZ X-Ray. Again, superior fire support proved the difference. The 21st Artillery LNO to the 3d Brigade coordinated fire from Brown's command helicopter circling above the landing zone and directed artillery so close to the perimeter that individual FOs on the ground had to shout warnings as the howitzers fired each successive volley. Seconds later, the troops in X-Ray would hear the rounds split the air overhead and the distinctive crack of the detonating HE immediately followed by the disturbingly familiar sound of shrapnel tearing through the vegetation around them.¹⁷

By 0900, the attack was repulsed and the first lift of reinforcements touched down on the eastern edge of LZ X-Ray. At the same time, Brown established a second firebase on LZ Columbus, five kilometers northeast of X-Ray, adding two additional batteries of howitzers to the steel curtain protecting Moore's battalion. Shortly after noon, Lieutenant Colonel Robert Tully's 2d Battalion, 5th Cavalry arrived to reinforce Moore's beleaguered troops after marching overland from LZ Victor, 3.5 kilometers to the southeast.¹⁸

Moore and Tully immediately assembled a relief column and by 1500, the survivors of the Lost Platoon were inside the relative safety of X-Ray. Amazingly, once Savage had taken charge the previous afternoon, the platoon had avoided any additional fatalities. Savage's precise placement of artillery throughout the siege enabled the platoon to survive the long ordeal. For his gallantry under relentless enemy fire on an otherwise insignificant knoll in the valley of the Ia Drang, Ernie Savage received the Distinguished Service Cross.¹⁹

Despite their horrible losses, however, the North Vietnamese were not yet ready to give up the fight. The calm beauty of the cloudless, moonlit night of 15 November went unnoticed as all four batteries of artillery rained a ceaseless barrage of hot steel around the perimeter of LZ X-Ray. Nevertheless, a series of whistles signaled a renewal of the assault at 0400 16 November. The FO for Tully's Bravo Company, First Lieutenant William Lund, ordered the batteries to mix point-detonating and time-fused HE shells with white phosphorous rounds, saturating the enemy with a veritable shower of death.²⁰

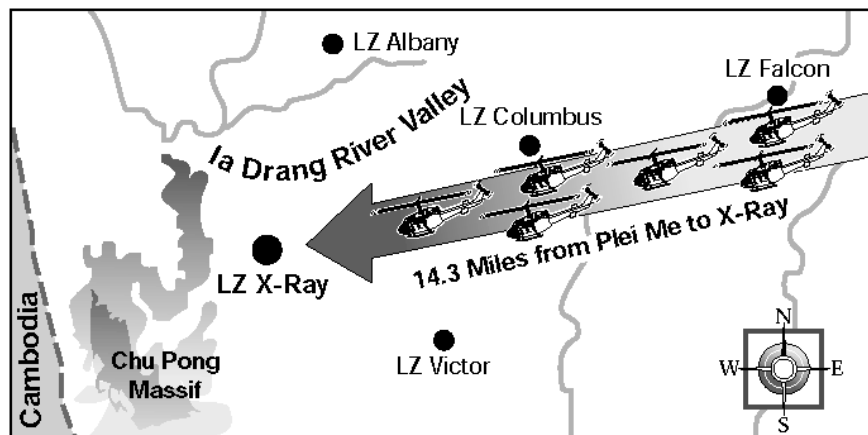

Figure 2: Battle of Ia Drang, 14-17 November. The 1st Cavalry Division's 1st Battalion, 7th Cavalry air assaulted into Landing Zone (LZ) X-Ray and, outnumbered ten to one, called in a deadly curtain of fire support and survived. The 2d Battalion, 7th Cavalry took over and, refusing to call in fires, was decimated in a North Vietnamese ambush.

By 1000, the siege on LZ X-Ray was broken. Within half an hour, the lead elements of Lieutenant Colonel Robert McDade's 2d Battalion, 7th Cavalry closed on the landing zone after an overland march from Columbus. A flurry of Hueys and Chinooks carried the men of the 1st Battalion away from X-Ray that day for a much-deserved rest. Two days after his arrival in the Ia Drang, Hal Moore climbed aboard his command chopper, the last man of his battalion to depart the battlefield.²¹

Aftermath. The following day, a North Vietnamese ambush decimated McDade's battalion as it completed a sweep of the area leading into LZ Albany, 5.5 kilometers north of X-Ray. While other battalions sweeping the valley elected to use the supporting artillery fire to clear their march routes, McDade declined, a decision that doomed the men of the 2d Battalion.²² The battalion arrived at LZ Albany and the 8th Battalion, 66th Regiment caught the Americans in a textbook L-shaped ambush, inflicting 279 casualties in the ensuing melee.²³ Inevitably, some compared the ambush to Custer's 7th Cavalry at the Little Big Horn.

In the aftermath of X-Ray, Moore flew directly into LZ Falcon to give thanks to the brave artillerymen who relentlessly stood by his battalion through the heat of battle. For 53 continuous hours, these men—stripped to the waist and covered with a greasy mixture of sweat and dirt—fired more than 18,000 rounds in defense of X-Ray. Surrounded by mountains of empty brass shell casings, Moore extended his gratitude to the cannoners with heartfelt emotion.²⁴ In the Battle of the Ia Drang Valley, the artillery was the difference—not just between victory and defeat, but between life and death itself.

Proving Ground. In November 1965, General Jim Gavin's airmobile concept

received a baptism of fire in the Ia Drang Valley. Under direct, intense enemy fire in the central highlands of South Vietnam, the troopers of the 1st Cavalry Division proved the validity of the concept, much of which has endured the test of time.

Operations in the Ia Drang also redefined the use of fire support in a war fought without definable front lines. It was the indomitable human spirit of the cannoners on LZs Falcon and Columbus that kept the soldiers of the 1st Battalion, 7th Cavalry alive under an impenetrable steel curtain of protective fires.

Versatile as well as mobile, artillery was positioned virtually anywhere in the midst of dense jungle, far from roads or other means of access. The guns displaced just as quickly, closely following the tide of battle while providing that critical edge of superiority.²⁵

Artillerymen eventually designed a double sling system that enabled a complete firing section (both howitzer and ammunition) to be transported by a single helicopter. This maintained fire support mobility with that of maneuver elements.

In response to the enemy's ability to attack from any point on the compass at any time, gun crews developed procedures to hasten reaction time and rapidly deliver artillery fire in a full circle.²⁶

While airmobility extended the umbrella of fire support during battle, a lone position could not defend itself in the face of guerilla tactics in a dense jungle. Fire support operations in Falcon and Columbus highlighted the necessity of establishing mutually supporting artillery firebases.

Much of what is common practice today has roots in the 11th Air Assault Division (Test) and a large clearing at the base of the Chu Pong massif in the Pleiku Province of South Vietnam. The artillerymen who called themselves the "Big Voice of Garry Owen" paved the way

for future generations in that fateful November battle in 1965.

Exactly 25 years later, former United Press International reporter Joe Galloway—who fought alongside Moore at X-Ray—discovered one of the batteries from Falcon in the northern desert of Saudi Arabia, still supporting the 1st Cavalry Division. An officer, who obviously was familiar with the battery's history and the role Galloway played in it, saluted Galloway and said proudly, "Sir, we call ourselves the Falcons, and I expect you know why better than anyone else."²⁷

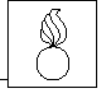

Captain Steven M. Leonard, Ordnance Corps, won Third Place in the US Field Artillery Association's 1998 History Writing Contest with this article. Currently, he is Assistant Professor of Military Science at the University of Montana. His previous assignments include service as the Adjutant of the Combat Equipment Group-Europe in Kerkrade, The Netherlands; Company Commander of the 16th Combat Equipment Company in Zutendaal, Belgium; Battalion S4 and Materiel Officer for the 561st Corps Support Battalion, Fort Campbell, Kentucky; and Shop Officer and Platoon Leader of the 584th Maintenance Company, also at Fort Campbell. He's a graduate of the University of Idaho and holds a master's degree from Murray State University, Kentucky. Captain Leonard is a distinguished graduate of the Ordnance Officer Advanced Course, Aberdeen Proving Ground, Maryland, and a graduate of the Combined Arms and Services Staff School, Fort Leavenworth, Kansas, and the Air Assault School at Fort Campbell. He previously has published articles in *Army Logistician*, *Ordnance* and several civilian publications.

Notes:

1. Lieutenant General Harold G. Moore and Joseph L. Galloway, *We Were Soldiers Once...and Young* (New York, NY: Random House, 1992), 10.
2. J.D. Coleman, *Pleiku: The Dawn of Helicopter Warfare in Vietnam* (New York, NY: St. Martin's Press, 1989), 33.
3. Boyd L. Dastrup, *King of Battle: A Branch History of the US Army's Field Artillery* (Washington, DC: US Army Center of Military History, 1993), 277.
4. Moore and Galloway, 29.
5. *Ibid.*, 29, 49 and 368; and Coleman, 202.
6. *Ibid.*, 38; and Coleman, 196.
7. Colonel Harry G. Summers, Jr., "The Bitter Triumph of the Ia Drang," *American Heritage* (February/March 1984), 53. Also see Moore and Galloway, 196.
8. Moore and Galloway, 67; and Coleman, 207.
9. *Ibid.*, 69.
10. *Ibid.*, 72-73; and Coleman, 210.
11. Coleman, 211.
12. *Ibid.*, 214.

13. *Ibid.*
14. Moore and Galloway, 122-123.
15. *Ibid.*, 123.
16. *Ibid.*, 166-167, 201.
17. Coleman, 235.
18. *Ibid.*, 237.
19. Personal correspondence with Joseph L. Galloway, 8 January 1998.
20. Coleman, 241.
21. *Ibid.*, 245.
22. *Ibid.*, 249.
23. Moore and Galloway, 268.
24. *Ibid.*, 237-239.
25. Dastrup, 283.
26. *Ibid.*
27. Moore and Galloway, 280.

Deep Battle 1914-1941: The Birth of the Modern Style of Warfare

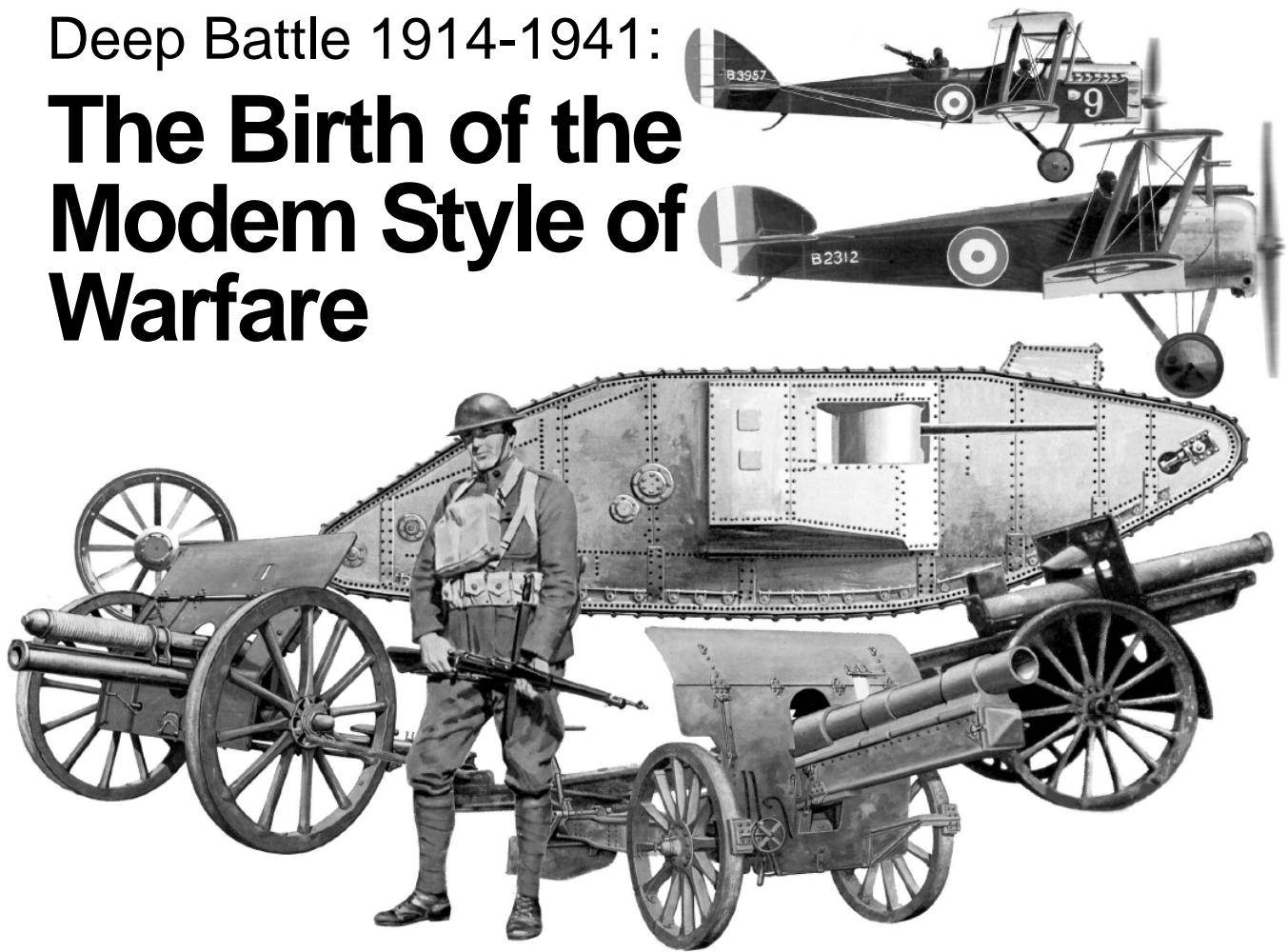

by Brigadier Jonathan B.A. Bailey, MBE

Editor's Note. This article is the first of two exploring the concept that the First World War was the most significant revolution in military affairs (RMA) in history. In this first article, Brigadier Bailey discusses the significance of the birth of deep battle in the First World War and shows that all developments that have followed only complement this model. In the second article, he will discuss the persistent underestimation of firepower in the 20th century and how armies can learn from the patterns of technological developments that have enhanced the deep battle concept since the First World War. For more comprehensive information and references on the RMA and its impact, read the Strategic and Combat Studies Institute's Occasional Paper Number 22: "The First World War and the Birth of Modern Warfare" written by Brigadier Bailey. The 1996 pamphlet is available in several US military libraries or can be obtained from the Editor, Strategic and Combat Studies Institute, British Staff College, Camberley, Surrey, GU15 4NP, United Kingdom.

There is a misguided tendency in military cultures to assume that the more recent military history is, the more "relevant" it is. The familiar from our recent past may be reassuring because of technical trappings and the availability of data when, in fact, older and less familiar

periods may be more relevant conceptually.

The focus on the recent past also may tend to encourage the flawed view that history can tell us what to do next rather than, as Clausewitz recommended, develop our "educated judgement." The

military needs to make up its current deficit in historical study, particularly of the First World War. Conceptually, the First World War gave birth to the deep battle, a model for the Modern Style of Warfare, and by studying that war, military professionals can help develop educated judgement for the future.

The Contention

My contention is that the most significant RMA in the history of warfare took place between 1917 and 1918. It amounted to the birth of modern warfare with the advent of artillery indirect fire as the foundation of planning at the tactical, operational and strategic levels of war—the invention of deep battle.

This phenomenon was so revolutionary that the burgeoning of armor and airpower and the arrival of the Information Age since then have been no more than complements to it—incremental technical improvements to the efficiency of the conceptual model of the Modern

Style of Warfare. They are its products, not its peers.

I contend that this RMA had technological and tactical but, most crucially, conceptual components. While elements of the first two existed before the First World War, it took the shock of war to act as a catalyst for change. From the solution to pressing tactical problems emerged the unforeseen possibility that the new techniques of deep attack might create a new operational paradigm.

Equally, as the means of prosecuting deep battle have become ever more sophisticated, so the logic of the Modern Style of Warfare has encroached upon and now dominates the strategic level.

Modern Style of Warfare. Let me paint a picture of what we understand by the Modern Style of Warfare, using offensive operations as an example:

- It takes place over an extended area and is three-dimensional.
- The importance of time is critical in terms of tempo and simultaneity.
- Information about enemy dispositions is gathered by aerial, electronic and optical means. This is transformed into intelligence about enemy intentions and potential targets throughout the depth of the enemy positions.
- The capability exists to hit high-payoff targets accurately throughout the enemy's space; the targets can be attacked separately or in synchronization with the contact battle.
- A plan is developed for maneuver forces to achieve a rapid penetration or breakthrough.
- The fire plan creates shock and maximum dislocation. It's synchronized with air operations and the scheme of maneuver to achieve a synergy of effects. The weight of fire is carefully measured according to the neutralizing or destructive effects required. The fire plan attacks enemy headquarters, communications systems, artillery, logistical operations, bridges and depots. It blinds enemy observers and destroys strongpoints and field defenses. It attacks enemy positions in depth—especially the enemy reserve before it can join the contact battle—sealing off the battlefield and harrying any who flee.
- Command, control and communications (C³) systems and styles of command that can fuse the capabilities of these systems can break the enemy's cohesion and will with catastrophic consequences.
- The plan includes ruses and deceptions, including a complete dummy fire plan, if necessary.



Mules Hauling Ammunition at St. Baussant, 1918

• Planning for this operation is conducted at a high level under centralized command, but measures are taken to make the plan responsive to the unexpected that will inevitably occur.

This generic model is readily recognizable in the doctrine of NATO and Warsaw Pact armies of the Cold War, in the operations for the Egyptian crossing of the Suez Canal in 1973 and, more recently, in the minds of Gulf War planners. At the tactical level, many of the components are integral to a contemporary attack helicopter cross-FLOT (for-ward-line-of-own-troops) operation. It is also the precise blueprint for battle as tested by the British Army at Cambrai in November 1917, but seen in more complete form in the German offensives of spring 1918, the "*Kaiserschlacht*," and the Allied offensives later that year.

Warfare in 1914. More than 80 years later, we know this model of 1917 as our own style of warfare; but in 1914, just three years earlier, it would have seemed entirely unfamiliar.

- Warfare in 1914 was linear with prevailing doctrines emphasizing flanks, envelopments and annihilations. It was based on the contact battle of physical encounter where maneuver forces were supported by artillery firing directly, generally at short range.
- While the few aircraft could conduct reconnaissance, they had no means of locating targets in depth; relatively few howitzers in service were capable of engaging targets in "dead" ground—ground that can't be observed because of terrain features. Techniques to adjust fires were primitive and generally involved an estimate on the gun position itself. Communication with observers was by a limited number of telephones, semaphore or megaphone.

• In the case of the British field army, all artillery ammunition was shrapnel. There was no means of supplying large quantities of artillery ammunition to maneuver forces in the field, and partly in recognition of this fact, there was very little ammunition.

• Artillery planning did not exist at the operational level, except in siege warfare. Indeed, given the purely tactical operations envisaged, centralized, high-level command of artillery would have been irrelevant.

Clearly between 1914 and 1917 something extraordinary of enduring military significance happened: the indirect fire revolution and birth of modern warfare.

Tactical and Technical Deficiencies of 1914

The revolution was technical, tactical and conceptual, but many of the components that contributed to the indirect fire revolution were not new. The importance of being able to engage unseen targets had been clear even in antiquity. Indirect fire was common in siege warfare, but observers generally were not in a position to adjust the fall of shot and precision was relatively unimportant.

The earliest use of indirect fire on the battlefield was probably at Paltsig in July 1759 by the Russian Army firing over the tops of trees. By 1840 the British had given the howitzer the task of firing from cover at enemy artillery, but this was literally a hit-or-miss business with no calculation. Primitive indirect systems relied upon a line of markers from the gun to the point at which the target could be observed. This made them relatively immobile and, therefore, generally unusable, given the tactics of the day.

The Germans advocated the use of indirect fire as a means of protecting gunners from machineguns based on their experience in the Franco-Prussian War. In 1882, the Russian Karl Guk wrote a seminal book *Indirect Fire for Field Artillery* that described the essentials of aiming points, crest clearance and observer corrections to fire.

The Germans followed these developments and produced a device to facilitate indirect fire called the *Richtflaeche*. By 1904, the Russian artillery had an indirect fire sight used on a large scale at Liao-Yang in August; thereafter in that war, indirect fire became the norm. The US Army noted the value of indirect fire in the Russo-Japanese War as reflected in its artillery "Drill Regulation" of 1907.

The British experimented with indirect fire during the Boer War and concluded that in mobile warfare it was not practical. It was a neglected art, and the Royal Field Artillery did not have an effective indirect fire sight until 1913.

Indirect fire also had been practiced in siege warfare and by garrison and coastal artilleries where the problems of accurate survey were less severe. It was in these branches of the artillery, far removed from the battlefield, that the most progress was made.

Despite the existence of so many components that would ultimately be melded to create the indirect fire revolution, armies failed, or chose not to realize their potential for a number of reasons.

- *No Apparent Tactical Necessity.* All armies of the day planned to conduct fast-moving operations in which it was quite possible that artillery would be unable to keep up.

- *No Apparent Operational Necessity.* There was no concept of artillery being used at the operational level to break through enemy lines; such an eventuality was not contemplated. The exception to this would be the reduction of fortifications, such as those at Liege.

- *No Action to Supply the Means: Guns and Ammunition.* Because fire was generally to be direct, guns had a relatively short range and would not have been able to make the most of an indirect fire concept. Longer range guns would have been heavier, even less mobile and, thus, even less relevant to the prevailing concept. Shortly before the First World War, British designers of a new gun carriage chose to sacrifice range for mobility. Because the primary role of

artillery was not counterbattery fire (CB) and because most CB would be direct fire, howitzers were relatively few in number.

Ammunition was of limited utility and did not exist in sufficient quantity to prosecute the sort of concept so familiar three years later. Pre-war doctrine had not envisaged that such a catastrophe could occur. The British war establishment of 1913 allotted each 18-pounder howitzer 1,000 rounds with 300 in the United Kingdom (UK) and an additional 500 to be provided from factories within six months. Of the 1,000 rounds, only 176 were held at the battery level, and they could sustain firing for just 44 minutes at Rate 4. Six such periods would consume the ammunition of the force, with 75 minutes worth in the UK and another 60 minutes worth arriving within six months. In comparison, by 1918 most light guns of both sides expected to fire about 600 rounds per day at the start of an offensive.

While many of the means to fire indirectly existed in some form, there remained substantial technical deficiencies in accuracy. The means of locating targets in depth were wanting, as were the means of predicting fire.

The issue was, however, not merely technical. The prime reason for the failure

to exploit indirect fire—given that so many of its means could have been made available—was lack of imagination and doctrinal laziness. Once the brutal necessity presented itself, the technical and tactical problems soon were overcome. The problem also went beyond laziness; in part, it was sheer miscalculation by the conservative military cultures of the day.

As early as 1890, Moltke had expressed concern at the diminishing prospects of avoiding a long war. In 1900, the Polish financier Jan Bloch had foreseen that the overwhelming lethality of defensive firepower would slaughter attacking infantry, and Lord Kitchener predicted the war would last for years. But their views were dismissed because of the unacceptable conclusions that flowed from them.

Artillery was held in the highest social and professional esteem in the Russian Army, which had pioneered indirect fire; but even in the Russian Army, some were deeply suspicious of officers with technical ability. During the Russo-Japanese War, one Russian general, on seeing a battery take up position behind cover, ordered it out into the open; he refused to believe it could engage an enemy it couldn't see.

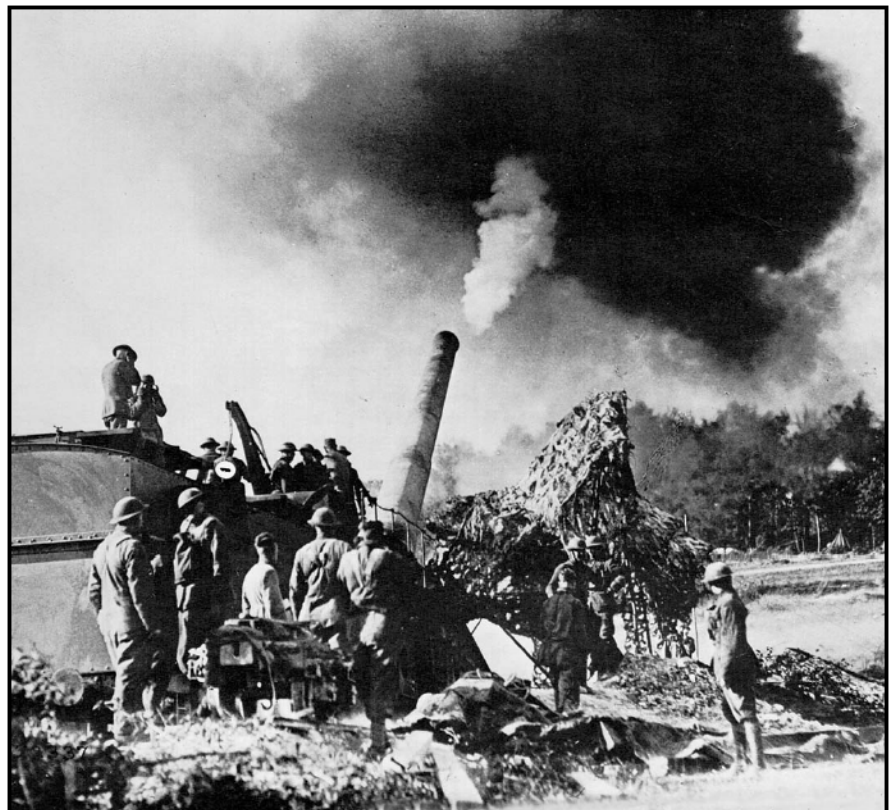

Meuse-Argonne Offensive, 1918. A Coastal Artillery 14-inch railway gun fires on German targets 20 miles away.

In the British Army, artillery officers' use of maps to fix targets was considered to be ungentlemanly, devaluing the skills of estimating range by eye. The introduction of high explosive (HE) ammunition had been suggested but was dismissed partly on the grounds that it was rumored to give off noxious fumes that would not have been a proper way to wage war. The more probable reasons for not introducing HE was to avoid complicating logistics and the unlikelihood of its ever being required. The elan of horse artillery summed up the ethos of the gunner: survey, mathematical calculations and static operations were the unspeakable diet of the garrison and coastal artillery.

In May 1914, Captain Hill of the Royal Garrison Artillery addressed the Royal Artillery Institute on the subject of indirect fire. He was greeted with hoots of laughter when he asserted that within two months of the outbreak of war, Field Artillery would be making corrections for meteorological variations.

The French and Germans were no better. Artillery was not widely esteemed in the German Army. It is worth noting that the designer of the German blueprint for the Modern Style of Warfare, Colonel Georg Bruchmueller, was only on temporary active duty and, despite the award of the *Pour le Merite*, was never promoted above colonel. He retired on a lieutenant colonel's pay.

In spite of the 1907 US artillery manual's emphasis on indirect fire, Lieutenant Colonel E. McGlachin noted as late as 1916 that some of the most experienced graduates of the US Army's School of Fire could not conduct indirect fire missions. Although the US Army had the equipment and theory to apply indirect fire, it lacked the qualified personnel and, presumably, the will to do so.

Problem Assessed: 1915

The battles of summer 1914 were typified by artillery deploying in the open, rapidly expending its ammunition and being destroyed. The power of machine-guns and rapid rifle fire in the defense brought maneuver to a grinding halt, and there was insufficient artillery firepower to break the stalemate in the offense.

It soon became clear that an entirely new approach would be required, and the problem had to be examined from the first

principles. The solution, albeit an imperfect one, took four years to evolve, and is still with us today.

Tactical Problem. The tactical problem was clear. The force had to breach obstacles, destroy or neutralize as many troops manning them as possible, conduct CB fire to protect assaulting troops and be able to fire at unseen targets in the enemy's depth to protect troops exploiting success before the enemy's accompanying artillery could come forward. In 1914 and 1915, artillery could do none of these adequately and, in most cases, not at all.

In the battles of 1915 at Neuve Chappelle, Festubert and Loos, British planners came to understand the new fundamentals of firepower and battlefield geometry by trial and error. At Neuve Chappelle, 10 to 12 March 1915, the British Army deployed 354 pieces against 60 German pieces on a sector of 1,200 meters. This was a density not matched until 1917, yet the British only could fire 200 to 400 rounds per gun. In addition, targeting was defective, although aerial photography was available at the time. At Festubert on 15 May 1915, the attack was preceded by a fire plan lasting 48 hours rather than the 35 minutes of Neuve Chappelle. However, the destructive effect was still inadequate, and surprise was lost.

At Loos on 15 September 1915, the attack sector was eight times longer and the density of guns only one-fifth that at Neuve Chappelle. To achieve the weight of fire required, the guns had to fire for a longer period, again compromising surprise.

The issues were:

- Was it necessary to destroy the enemy obstacles and trenches or rather to neutralize the men defending them?
- How much fire was required for how long to achieve the desired result?
- Could the amount of fire required be calculated through some universal mathematical formula? If so,
 - Was this to be expressed in terms of guns-per-yard-of-front or the rounds they could deliver on a given front over a given period, and of what calibers the guns should be?
 - Was the rate of fire of the appropriate calibers of ammunition or the availability of ammunition per day the key?
 - If an adequate, high rate of fire could be achieved over a critical period, did it matter that this could not be sustained?
 - How long should fire be applied before the maneuver phase began?

- How long did a battle last—one week or nine months?

The Operational Problem. Tactical successes were mere attritional encounters if they lacked an operational dimension. The operational conundrum for both sides was how to achieve the breach and breakout.

The Germans defied Allied tactical successes, such as they were, by constructing and withdrawing to ever more formidable fortifications, culminating in the Hindenburg Line. These withdrawals were ever deeper and to denser fortifications and their defense ever more "elastic."

In the defense, the key was to hold a line so far in depth that if the enemy reached it, he couldn't bring his artillery forward fast enough to support his gains, subjecting him to massive defensive fire and counterattack. A "rule of thumb" developed that reserves should be held nine kilometers to the rear, capable of counterattacking within two hours of the start of an attack. The shape of the battlefield, thus, came to be determined by the range of artillery. The ability of artillery to locate and engage targets in depth and to move guns forward rapidly came to have operational significance.

The Conceptual Solution: 1916-18

It became clear that indirect fire would be the key to answering these tactical and operational problems. The starting point was the availability of artillery ammunition and gun barrels. From this a solution might be crafted.



1918 "BC Scope." A Redleg observes the next target from the ruins of war.



Aerial photography permitted precise targeting throughout the theatre and up-to-date mapping of ever-changing trenches. Here an observer operates the Graflex camera from an observaton plane.

Vast attritional experiments were conducted at Verdun and on the Somme. By 1917, it was accepted that, given the concentration of resources, the guns could advance two to three kilometers virtually anywhere. But this tactical achievement could only be bought at the expense of forfeiting any hope of operational surprise and success. Other approaches to the application of firepower would be needed to achieve operational success. By 1918, these approaches were established.

Technical Means. In an astonishingly short time hitherto, conservative military establishments identified the technical obstacles and devised a series of techniques to overcome them. These have stood the test of time and are, essentially, the basis of gunnery today: the conceptual model of three-dimensional firepower. Such a model applies equally to airpower.

Air observers and aerial photography permitted precise targeting throughout the theatre and up-to-date mapping of ever-changing trenches. But not until 1917 were the problems of image distortion overcome to achieve adequate accuracy.

Advances in military survey enabled a gun to fix its own position exactly, an achievement made easier by the static nature of the war. But even when the exact locations of the target and the gun are known, inaccuracies still occurred. The means were devised to minimize these. Meteorological data were gathered and calculations made to compensate. Allowance was made for the wear on each

gun barrel, called calibration. The displacement of each gun from the point of survey was taken into account—also the effects of temperature on the propelling charge and variations in ammunition manufacture by batch. By 1918, an 18-pounder could be assumed to fire with an accuracy of 80 mils over a range of four kilometers, a similar standard expected of today's field gun at that range.

Communications to send corrections to the fall of shot remained a problem as they were based on vulnerable telephone lines or primitive radios. At the same time, techniques of electronic warfare were developed to intercept wireless and telephone communications. Pigeons, semaphore and runners also were used. Aerial observers developed elaborate signaling systems to communicate directly with gun positions.

A series of heavier guns and howitzers were produced along with a variety of HE and gas shells and fuzes, the most important of which were the instant and delay fuzes. The instant fuze gave HE effects similar to those of shrapnel without requiring the same skill in firing it. In its way, it was as significant as the introduction of radar fuzes in 1944.

Organizational Means. A new artillery command, intelligence and planning organization was created for the operational and tactical levels. By 1916 in the British Army, the artillery commander at the corps level commanded all the divisional artilleries. He set the times of

fire plans, and he allocated observers to batteries throughout the formation. By 1918, artillery planning in the British Army was conducted at the army level and decentralized to the divisions for execution once the offensive was launched.

The Germans did not have a corps artillery until February 1916, and even then it was merely a reserve pool of ordnance. There was no coordination between divisional and corps artillery; the former could not call for the support of the latter. By spring 1918, all German artillery was task organized into seven functional groups divided into sub-groups—a revolutionary departure from traditional command hierarchies.

The distinction between the close and deep battles was fully recognized as was the need to coordinate the two. By 1918, German artillery received times, tasks and areas of fire from the army-level command, but targets were selected by the group and sub-group. As important, the emphasis in training and planning was on all-arms coordination and making fire plans flexible enough to match the new infantry tactics.

An enormous new logistical organization was created to service the unprecedented demands of artillery. The armies of 1914 were the armies of the Industrial Revolution but mere shadows of what the Great Artillery War was to bring forth. The Royal Artillery became larger than the Royal Navy. In the case of the British and German armies, the ratio of gunners to infantrymen doubled between 1914 and 1918 and the French ratio trebled. Whereas in April 1917, the US Army had nine field regiments, by the Armistice it had 234. Gigantic new arms and munitions industries were created with huge social consequences—not the least of which was the emancipation of women.

Experiment and Practice. These technical, tactical and conceptual advances came to fruition in November 1917 in the British Offensive at Cambrai. The firing of the first predicted (as opposed to registered) fire plan was arguably more significant than the first mass deployment of tanks. It was to be the model for the successful offensives of the summer of 1918 on the Marne and at Amiens.

The Germans demonstrated the application of fire in novel tactical and operational ways without armor in their *Kaiserschlacht* of spring 1918 as masterminded by Bruchmueller. Interestingly, in the battles of the last few months of the war, tanks featured less prominently and artillery became even more

dominant. By 1918, artillery had restored maneuver and exploitation to the battlefield, capabilities that had been snuffed out in 1914.

The First World War as an RMA

So how do the events of 1917 to 1918 rate as an RMA? The revolution in the First World War changed the face of 20th century warfare in many ways. Above all, warfare became dominated by artillery—became an ascendancy of fire and artillery by indirect fire.

The Schlieffen Plan and the German offensive of 1914 from which it was derived had been the epitome of a style of warfare: two-dimensional linearity—a style perhaps as old as warfare itself.

The revolution of 1917 to 1918 occurred because prevailing ideas firmly rooted in the establishments of the day were out of step and unyielding to the multiple pressures of change. The tectonic plates of firepower and maneuver shifted and could not be restrained by social and technical conservatism, the perceived

lessons of previous wars or convenient general staff theory.

The secondary shock from this military earthquake occurred in the following autumn and winter when the imbalance was further magnified by the reinforcement of defense and immobility by the power of the newly developed trench lines. The result was a suppurating stalemate and the gestation of a new concept that would generate sufficient firepower in the offense to make maneuver possible once more.

By 1918, the new paradigm employed three dimensions. Its object was a break-through with simultaneous fire into the enemy's rear areas leading to paralysis and collapse rather than mere envelopment. Indirect firepower was the key.

Based on this indirect fire model, the execution of the concepts of 1917 and 1918 was wanting in two primary respects. First, there was a lack of transport to move forward and supply guns over rough terrain in the offensive and, second, both armies lacked the communications to maintain decentralized control over a fire



Communications to send corrections to the fall of shot remained a problem as they were based on vulnerable telephone lines or primitive radios.

plan once an offensive had begun.

After the war, the model's implementation was improved by mechanized transport, close air support (CAS) and wireless communications. The absence of these had not prevented the birth of modern warfare; they were the natural consequences of the desire to improve its efficiency. They were technical "fixes" and not, in themselves, conceptually revolutionary.

Modern Style of Warfare after 1918.

After 1918, the Germans sought to achieve a paralyzing operational breakthrough using armor supported, not by artillery, but by airpower. Some have described the difference between the Schlieffen Plan and the airpower approach of Manstein's *Sichelschnitt* as revolutionary, given the concept of the breakthrough in the latter. I would argue that the last four years of the First World War had been precisely about creating a breakthrough, and that *Sichelschnitt* was merely a replay of the *Kaiserschlacht* with updated technology and tactics.

Therefore, the most instructive comparison isn't between the Schlieffen Plan and *Sichelschnitt*, but between the Schlieffen Plan and the *Kaiserschlacht* and between the *Kaiserschlacht* and *Sichelschnitt*. The difference between the first two was conceptually revolutionary and between the latter merely technical and tactical.

From their miraculous victory in France in 1940, the Germans proceeded to learn disastrous lessons, believing that the tactics and technology demonstrated in France constituted an RMA. They missed the point that the critical element in the Modern Style of Warfare is three-dimensional firepower throughout the area of operations. This was a difficult lesson to relearn a few years

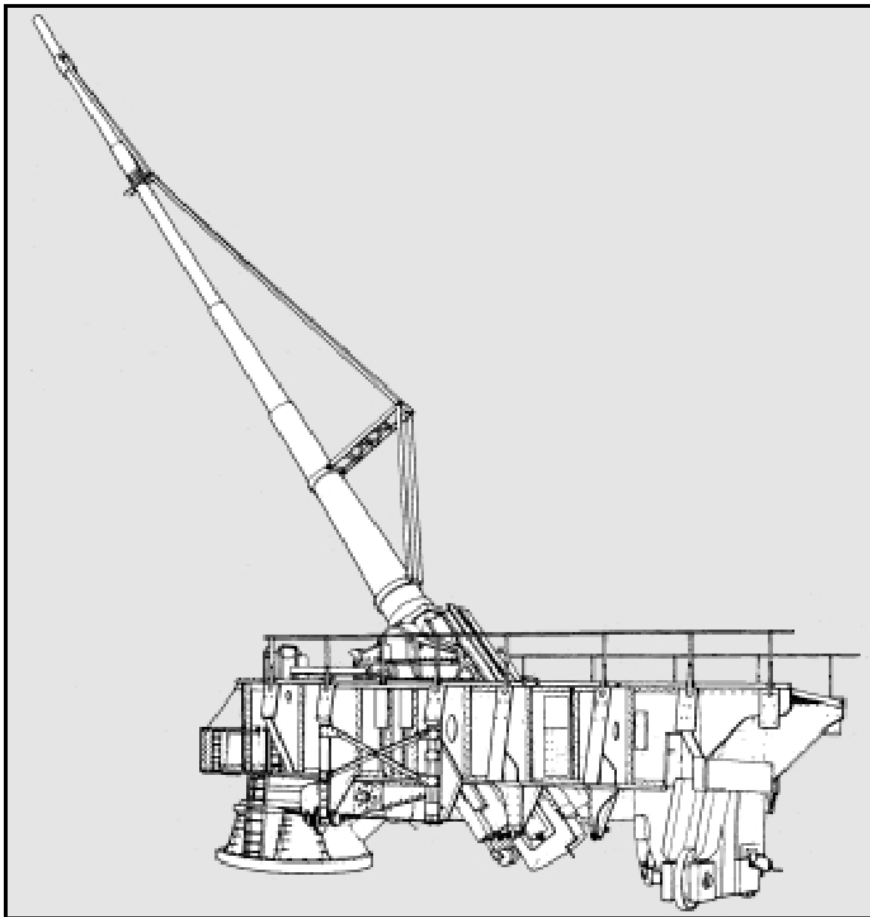

The Paris Gun fired a 264-pound shell more than 60 miles to bombard Paris.

later in the USSR when the Luftwaffe could not deliver this and artillery was often not available to compensate. Operations became rooted in the style of flanks, envelopments and attempted annihilations. The rapid strategic breakthrough and paralysis achieved in France was not repeated.

As a result, the Germans were mired in another *materialschlacht* (a battle of relative logistic strength) with the Eastern Front degenerating into a prolonged four-year agony analogous to the final months of 1918. This was a historical model their planning had specifically intended to avoid. Thus the *Kaiserschlacht* and Operation Barbarossa in July 1941 followed a similar pattern.

Strategic Perspective. In 1918, the Germans fired on Paris with their "Paris Gun," an attack in keeping with the emerging Modern Style of Warfare. This attack was the first long-range strategic attack using surface-to-surface systems—a revolutionary conceptual and technical event. Its immediate effect was minimal, but it proved the immature first step along a path that would lead to the V1 and V2 rockets in World War II and the Scud intercontinental ballistic missiles (ICBMs) and cruise missiles of today. The logic of the Modern Style of Warfare is that as technology allows, it has expanded ever outward from its tactical origins to its current dominance at all levels of warfare.

In the 20th century, developments in firepower have outstripped those in maneuver. From 1914 onward, the challenge was to convert a tactical breakthrough into an operational breakthrough, and firepower was the means. Increasingly, the challenge is to make tactical and operational breakthroughs simultaneously strategic—firepower, again, will be the key. This strategic breakthrough may entail operations that are not merely deep in the traditional geographical sense, but also integrated and non-linear wherever and whenever needed to create that effect. This is the enduring dynamic of the Modern Style of Warfare.

Today, some say we're experiencing an RMA. But the fundamentals look similar to those of the First World War and hardly revolutionary by comparison. The new factors generally cited are precise, standoff strikes; improved command, control, communications and intelligence; information warfare; and non-lethality. In First World War parlance, these would be termed accurate indirect fire;



US Army Tactical Missile System (ATACMS). By 2005, ATACMS Block IIA will be able to prosecute the deep attack out to 300 kilometers.

improvements in command and control, intelligence and the means of acting upon it; and the munitions and techniques of neutralization and suppression.

The Information Age does not herald a new RMA, rather it adds technical impetus to the conceptual dynamic of the Modern Style of Warfare. The effects of the microchip are no more profound than was the technical apparatus of the *Blitzkrieg* in 1940—both should be seen as scientific attempts to make an older conceptual model operate more effectively. Thus, the joint surveillance and target attack radar system (JSTARS) and similar systems are merely technical developments along the conceptual path pioneered by aerial photography. Likewise, the global positioning system (GPS) is a technical evolution arising from the conceptual revolution that first required firing platforms to survey their positions and make their fire more precise when standing off from targets. Such additions make the prosecution of deep battle more efficient.

Many will naturally be impressed by the enormous technical achievements of their day and insist that the scale of this achievement must warrant the term "revolution," even if conceptually it is not. Without a conceptual perspective, such an analysis latches onto the conspicuous and the material and is impoverished and, probably, unsustainable. At the same time, we are clearly witnessing a period of astonishing change and imaginative innovation in warfare.

The RMA of 1917 and 1918 does not diminish the significance of developments

since; but the two are not comparable. For such a comparison, we must await the arrival of four-dimensional warfare—cyberwar or whatever else that may be.

Future wars involving developed nations are unlikely to look anything like the World Wars—we all hope they do not. But the developments in fires between 1914 and 1941 do inform us and confirm how we might best shape our efforts in changed circumstances. The more we study the future, the more remarkable the RMA of 1917 and 1918 is.

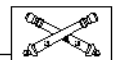

Brigadier Jonathan B. A. Bailey, Member of the British Empire (MBE), is the Chief of Fire Coordination for the Allied Command Europe Rapid Reaction Corps in Germany. He commanded the 40th Field Regiment in Germany and a battery in the 4th Field Regiment, Royal Artillery. He also served as a Tactics Instructor and member of the Directing Staff at the Staff College in England, from which he was a graduate, and as the Artillery Operations Officer for the 4th Armoured Division in Germany. Other highlights of his service in the British Army include commanding a Zipra guerrilla Assembly Place in Rhodesia as part of the Commonwealth Cease-Fire Monitoring and serving as an Operations Officer and Battery Commander during the Falklands land campaign. Brigadier Bailey is a graduate of the Higher Command and Staff Course in England and holds a Bachelor of Arts in Medieval History and Philosophy from the University of Sussex. He has written a number of articles and books on the subject of artillery and military history.

Fire Support in Bosnia-Herzegovina: An Overview

by Colonel Mark T. Kimmitt

Fire support operations in peacekeeping and peace enforcement, virtually unknown a few years ago, are undergoing a great deal of analysis due to operations in Bosnia-Herzegovina. Bosnia has proven to be a doctrinal greenhouse for the development of tactics, techniques and procedures (TTP) for military operations in what some call the "New World Disorder."

The 1st Armored Division Artillery in

Germany began this thought process in early 1993 when first given the mission to prepare to deploy to the former Yugoslavia. At that time, the plan was to embed artillery, radars and command and control capabilities into a force inserted onto the Sarajevo Airport. The mission was simple: Acquire hostile artillery shelling the city of Sarajevo and respond in accordance with the rules of engagement (ROE). This vanguard force would be followed by the remainder of the



Glanoc Firing Range

division, which would occupy key positions within the country to enforce the peace plan.

The 1st Armored Division actually entered Bosnia in 1995, crossing the Sava River in the dead of winter to enforce the provisions of the Dayton Peace Accord. Field Artillery M109 howitzers rolled across the Sava side-by-side with the M1 tanks, M2 Bradleys and the Apache helicopters of the 1st Armored Division's Task Force Eagle in Operation Joint Endeavor. This force made history in executing the tough Implementation Force (IFOR) mission in 1995 and 1996.

The 1st Armored Division Artillery—joined by an ad hoc group of 2d Armored Cavalry separate batteries and National Guard radars, fire supporters and meteorological sections—returned to Bosnia in late 1997 to relieve elements of the 1st Infantry Division (Mechanized) then serving as Task Force Eagle. The 1st Armored Division returned to Bosnia to conduct stability operations under the Stability Force 2 (SFOR-2) mandate as part of Operation Joint Guard.

The fire support lessons learned continue, and the articles in the series to be published over the next several editions of *Field Artillery* are an attempt by experienced forces to add to the evolving body of doctrine for fire support in peacekeeping or stability operations.

Fire Support doctrine and TTP are taught and refined every day in Bosnia. Leaders at all levels learn through a comprehensive "Right-Seat Ride" program with their subordinates in the field, by reading existing literature and by participating in operations. As an overview of the articles in the series, let me offer a few observations about providing fire support for Task Force Eagle.

Heavy Artillery Presence. Heavy artillery provides the maneuver commander the ability to demonstrate a tangible presence of significant, far-reaching firepower to the former warring factions. Short of the (infrequent) use of M1 tanks and M2 Bradleys, there is no

better weapon system to demonstrate the potential penalty for any belligerent considering violating treaty provisions.

Artillery is a respected and valued weapon system in the countries of the former Warsaw Pact. Four-gun raids, two-gun raids and two-gun presence missions are flexible tools for the maneuver commander to extend his footprint and influence throughout his sector—well beyond the base camp or gun position occupied. Such missions are visible reminders to the former belligerents as to Task Force Eagle's determination and capability to enforce the peace accord.

These missions also provide a great deal of ambiguity in the minds of the potential belligerents. The artillery is flexible enough to shoot powders, low-impact training rounds (LITR), smoke, illumination, Copperhead, family of scatterable mines (FASCAM), high explosive (HE) or dual-purpose improved conventional munitions (DPICM). Such flexibility keeps potential aggressors "on their toes" as they are unable to pinpoint the "intentions" of an M109 rolling through the countryside on a raid, a presence mission or a potential live-fire mission.

Firefinder Force Protection. Firefinder radars have taken on a new importance in Bosnia—perhaps generating unreasonable expectations. The radars in Task Force Eagle and Sarajevo radiate continuously (less maintenance periods), providing the capability to acquire and document the firing of small arms, mortars, artillery and rockets within known parameters. The radars have received a lot of press remarking on their capabilities.

Firefinders radiate over most US base camps and significant hot spots in Bosnia, but they are not positioned to orient on potential origin of fire grids, which are virtually infinite in number. This inability to predict origin of fire zones and the few radar sites in country mean that the radars can't acquire or "tell all" about every round fired in country.

Unfortunately, some non-artillery commanders overestimate the capability of Firefinders and see the continuous radiation as a virtual guarantee that they will acquire any rounds fired. To many base camp commanders, the hum of the Firefinder generators promotes a false sense of security. They think the radars will deter any potential aggressor and are a fail-safe means of documenting the source and type of any round if one is fired. The

artillery community must ensure the commanders understand what Firefinder can do for them, which is a lot, but without overselling or overstating its capabilities.

Active-National Guard Integration. We've come a long way in our integration process since 1990. The Guard has been a critical force provider to Operation Joint Endeavor and Guard—including artillery. These units have demonstrated their ability to arrive in country at a high-level of combat readiness. This is a credit to their home-station training and Forces Command's (FORSCOM's) train-up program.

The Guard has provided fire support elements (FSEs), fire support teams (FISTs), target acquisition batteries (TABs) and meteorological sections to the 1st Armored and 1st Infantry Divisions. The units have distinguished themselves by matching—often exceeding—the performance of active duty units.

Training. The use of *FM 25-100 Training the Force* and *FM 25-101 Training the Force: Battle Focused Training* and FM 6-series (Field Artillery) doctrine doesn't stop at the Sava River. The Army training management system and artillery doctrine for conventional operations has significant value in Bosnia. In fact, these systems are the glue that binds the ad hoc Active-Guard organizations together.

Bosnia is a tough mission that's made tougher if there is no goal beyond the next day's weapons storage site inspection. Unit commanders must aggressively develop a training vision that extends through and beyond the deployment to retain some measure of conventional combat readiness.

The 1st Armored Division Artillery runs a strong training program alongside ongoing operations in Bosnia, programs designed specifically around the cannon artillery firing tables and fire direction center (FDC) and FIST operations. Our common doctrinal foundation and training management systems enable us to integrate new units—an ongoing requirement—in a relatively routine process.

Fire Support. Fire support coordination in peacekeeping and peace enforcement operations is fundamentally identical to



Q-36 Firefinder in Bosnia

To many base camp commanders, the hum of the Firefinder generators promotes a false sense of security.

conventional operations with some additional requirements.

Fire Support Planning and Coordination. Planning and coordinating fire support in Bosnia within a multinational context using significantly restrictive ROE is a manual in itself. But the fire support fundamentals and principles hold true, although following the justifiably cautious ROE often makes the process seem more like nuclear than conventional fire planning. The decision to "go lethal," not completely unlike the decision to "go nuclear" in a conventional context, is one fraught with high-level clearance, significant implications and a clear understanding that the context of the mission from the original peace support or enforcement operation has changed dramatically.

Therefore, fire support planning and coordination in Bosnia requires far more steps, involves a "graduated response matrix" of available options and authorizations and has far more checks and rechecks than one encounters in a conventional operation. These steps are similar to those used by our light forces in conventional operations to avoid fratricide.

Fire Support and Information Operations. A second area of interest in fire support is targeting for peace enforcement operations. Decide, detect, deliver and assess (D³A), the functions of the targeting process, still apply. But one must recognize that the "hard,"



The 1st Armored Division has frequent exchange opportunities with colleagues in Bosnia.

typically materiel-oriented conventional targets such as the army group of rocket artillery (AGRA), multiple rocket launchers (MRLs), air defense artillery (ADA) sites and motorized rifle divisions (MRDs) are not the high-payoff targets (HPTs) and high-value targets (HVTs) of the peace enforcement commander. Rather, he targets the "soft" intentions and behaviors of the former belligerents. D³A, then, includes targeting behaviors, not systems.

In peace enforcement, the goal is not to defeat, destroy or delay things (except *in extremis*). The goal is to persuade, compel or moderate behaviors. While this may be hard for targeting teams to grasp initially, the information operations (IO) community understands this. The fire support community must join the IO community in active dialogue regarding emerging IO doctrine and the part the targeting process plays in identifying and integrating the "attack" of IO targets into all operations.

Multinational Fire Support. A third area of note is fire support in a multinational environment. Simply stated, relationships (and rank) mean more than position or task organization. I am often reminded of former Commander of Task Force Eagle and the 1st Armored Division Major General William L. Nash's response when asked why the unique US-Russian task organization worked. His answer was simple: "We are paid to make it work."

The same can be said of the artillery

organization for combat in Bosnia. If one were to examine the direct support (DS), tactical control (TACON), national and logistical arrangements, one might misinterpret the organizational structure as exhibiting the worst aspects of coalition warfare—and, at some level, the criticism might be valid.

Such a structure imposes on all commanders, especially artillery commanders, the need to build professional and personal relationships with fellow coalition cohorts to overcome the inherent weaknesses of the arrangements. Many multinational problems of the past few months—some of substance, some of form, some of pettiness—have been solved in person or with a phone call between artillery colleagues.

For example, one can only wonder how the generator problem at Camp Valhalla, the radar coverage in Bijelina or the survey problem in Teslaj would have been solved if leaders had not built relationships during the Nordic-Polish Saint Barbara's Day festival, or at the Turkish National Day ceremony or at the Russian-US exchange. These activities built friendships that neither want to risk or see suffer. Building personal relationships is one of the most critical—and certainly the most enjoyable—fire support tasks that commanders must undertake in combined operations.

Despite appearances to the contrary, successful fire support coordination doesn't dramatically change in the peace

support and enforcing environment. The artillery community should take great pride in its ability to provide quality fire support for NATO's Multinational Division (North). The frequent exchange opportunities with our Russian, Turkish, Nordic and Polish colleagues reinforces the primacy of our equipment, the professionalism of our NCOs and the quality of our individual soldiers.

The future force structure in Bosnia is sure to include less and less artillery. With that in mind, several officers of the 1st Armored Division Artillery have taken on a project to record their experiences and document their observations in what could be the waning months of DS artillery support in Bosnia-Herzegovina. The articles in this series reflect the great accomplishments of our

Redlegs in Bosnia since that fateful day America crossed the Sava and augment the growing body of doctrinal literature in peace enforcement operations. The hope is that each article will serve as a "job aid" for those who will follow in Bosnia or other peace support or enforcement operations in the future. *Steel Forward!*



Colonel Mark T. Kimmitt commands the 1st Armored Division Artillery and "Steel Forward," the artillery component of Task Force Eagle in Bosnia-Herzegovina. Among other elements, Steel Forward includes 22 Fire Support Teams, 15 Fire Support Elements (division, brigades and battalions), eight radar sections and three firing batteries from eight active and Guard units. It provides fire support coverage for NATO's Multinational Division (North) and radar coverage for Sarajevo. Colonel Kimmitt also commanded the 2d Battalion, 320th Field Artillery in the 101st Airborne Division (Air Assault), Fort Campbell, Kentucky, and a 105-mm battery in the 9th Infantry Division (Motorized), Fort Lewis, Washington. Also in the 1st Armored Division, he served as Executive Officer for the Division Artillery. Prior to taking his current command, Colonel Kimmitt was Special Assistant to the Director for Strategy, Plans and Policy, J5 on the Joint Staff at the Pentagon. He holds three master's degrees, including one from Harvard University.

One of the major outgrowths of the US participation in the NATO mission to enforce the peace in Bosnia-Herzegovina is the ongoing "sea trials" for information operations (IO). A concept somewhat understood by most commanders, IO's full implementation is still well into the future.

Many articles and organizations have described various cells, processes and techniques for leveraging the vast potential of IO, but most describe ad hoc methods that rely to some extent on the operational environment, the level of command support and the amount of command involvement. For IO to be embraced fully at the tactical level, it first must become an integral part of corps and division battle rhythms

Integrating Targeting and Information Operations in BOSNIA

by Lieutenant Colonel Steven Curtis, IN; Captain Robert A. B. Curris; and Major (Retired) Marc J. Romanych, ADA

and planning cycles and be compatible with doctrine. One cannot expect a division planning staff to speak in one language for conventional operations

and transition to another for the sake of information operations.

In recent operations in Bosnia, a group of 1st Armored Division Task Force Eagle planners bridged the tactical IO gap. By using conventional targeting processes to merge IO into the decision-making process, the division staff was able to incorporate lethal and non-lethal attack options into a synchronized plan for the commander. The experience proved valuable because it broke down what appeared to be a wall between tactical IO and conventional military operations. In the process, planners significantly enhanced the attractiveness of information operations as another tool for tactical commanders.



This article explains how the division conducted IO in support of the peace enforcement mission Operation Joint Guard in Bosnia-Herzegovina and integrated IO into tactical operations by merging it into the targeting process. More work needs to be done to fully align the two processes, but the progress made by Task Force Eagle promises a future of IO as a responsive option for the tactical commander.

Targeting in Bosnia. Targeting in peace enforcement operations is fundamentally identical to that used in high-intensity operations. It is a logical process that decides what must be attacked, how and when it will be attacked, and then matches the best attack asset to the target. The tasks facing the division targeting team are no different in Bosnia, although the conditions and standards differ somewhat.

Perhaps the major difference in peace operations is the broad definition of "adversary," which can be interpreted to mean anyone, military or civilian, who can prevent the friendly force from accomplishing the mission. Although this definition generally applies to all operations, the potential for civilian "enemies" is significantly greater in peace operations. This changes the targeting objectives by expanding target sets to include non-military entities and

nondestructive options and changes many "attack" effects from lethal to non-lethal.

Instead of well-defined military targets, such as multiple rocket launchers (MRLs), air defense artillery (ADA) sites and motorized rifle divisions (MRDs), the high-value targets (HVTs) and high-payoff targets (HPTs) facing the peace enforcement commander are not as well-defined. His "targets" may be the intentions of government leaders, attitudes of the local populace and influence over various social and political groups. In this environment, targeting takes on a dimension that, up to now, has been considered by many to be the singular domain of information operations. However, in recent Joint Guard operations, the unique capabilities of IO were integrated into the targeting process to expand the maneuver commander's range of attack options.

IO in Peace Operations. Information operations is an element of combat power that attacks adversary information and information systems while defending the friendly forces' own. In its applied form, IO synchronizes seven elements—psychological operations (PSYOP), electronic warfare (EW), operations security (OPSEC), military deception, physical destruction, civil affairs (CA) and public affairs (PA)—into offensive and defensive information

operations. The mix of IO elements depends on the level of war (strategic, operational or tactical) and the range of military operations (peacetime, conflict and war) as well as the factors of mission, enemy, terrain, time and troops available (METT-T).

FM 100-6 Information Operations states IO in operations other than war (OOTW) may be one of the most critical and acceptable means of achieving the assigned objectives because rules of engagement (ROE) may severely restrict the use of conventional military weapons (see Figure 1). It recognizes that IO consists of both lethal and non-lethal attack options. Yet, as IO doctrine has emerged over the last several years, the use of IO at the tactical level of war, especially at the low-intensity end of the spectrum of military operation, has received relatively minor attention. During Operation Joint Guard, the need for non-lethal attack options revealed the void in existing tactics, techniques and procedures (TTP).

Recent experience in Bosnia demonstrates IO activities can be integrated into the conventional targeting process and tactical operations. The principles espoused in *FM 6-20-10 Targeting* and *FM 100-6* provide the commander the doctrine for using lethal and non-lethal means to achieve his mission. Conventional targeting describes both lethal and non-lethal attack options (fires, maneuver, EW and PSYOP) while IO usually describes non-lethal attack options to strike at the adversary's personnel, equipment, communications and facilities in an effort to disrupt or shape command and control. (To cover every eventuality, lethal attack options always are planned as part of military peacekeeping operations.) In contrast to lethal fires that habitually target military systems, non-lethal IO can attack attitudes, behavior and intentions.

Typical non-lethal IO targets are civil, political and military leaders who control or influence the local population or assets these leaders use to achieve their objectives. For example, if adversary leaders seek to turn a legal civilian political rally into a violent, hostile demonstration, the target set may be those capabilities and personnel needed to form or transform a crowd into a mob (inflammatory radio broadcasts, loudspeaker vans, handheld communication systems or crowd leaders). Critical information nodes—for example, a radio station broadcasting messages instructing hostile crowds to assemble—are

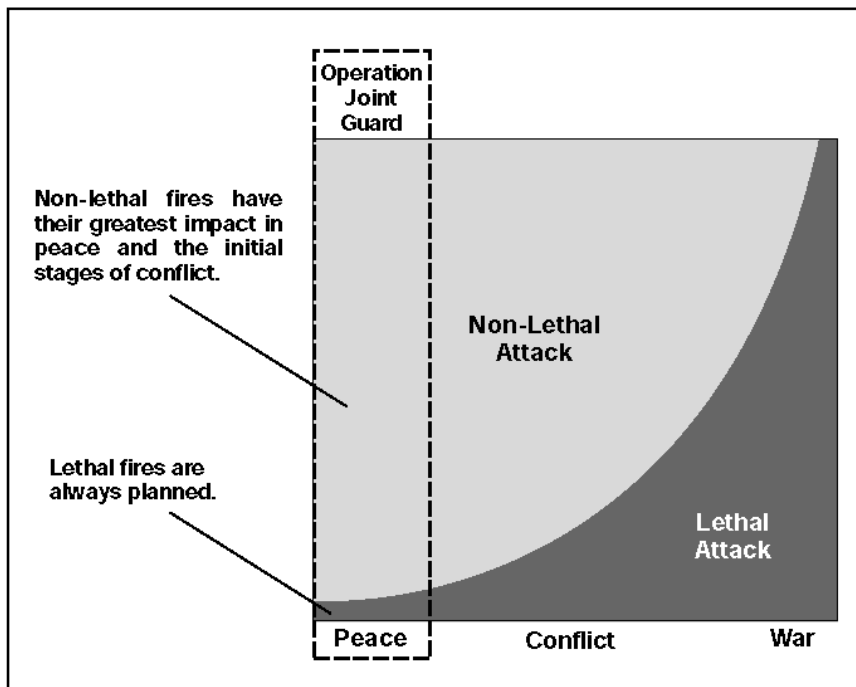

Figure 1: Targeting Emphasis. Information operations (non-lethal fires) may be the most effective means of achieving objectives because the rules of engagement (ROE) may severely restrict the use of conventional military weapons.

Attack Effects	Traditional Operations	Information Operations
Limit	Reduce available options or courses of action (COAs).	Minimize influence.
Disrupt	Preclude effective combat system cohesion.	Reduce ability or effectiveness.
Delay	Alter time of arrival.	Hinder decision making.
Divert	Tie up critical resources.	Gain cooperation or assistance.
Destroy	Ruin the target's structure.	Destroy something physically.
Damage	Undefined/Subjective	Undefined/Subjective

Figure 2: Targeting Objectives. This figure compares the description of effects desired against traditional military as compared to information operation targets.

candidates for non-lethal attack target by EW assets. In some cases, complementary systems may work to attack an IO target, as often is done with conventional attack options against military targets. Thus, if buses are needed to transport people to the demonstration, the owner of the bus company could be targeted to discourage his vehicular support of the demonstration. Also, traffic control points could be placed on likely avenues of approach to delay or stop buses carrying passengers to the

demonstration.

IO and Targeting. The targeting process—*decide, detect, deliver, assess* (D³A)—can be used without modification to conduct offensive IO. Integrating lethal and non-lethal IO into the targeting process starts by acknowledging the compatibility of conventional and IO targeting objectives.

FM 6-20-10 describes targeting objectives that "limit, disrupt, delay, divert, destroy or damage" the enemy. These same

terms are applicable to IO targeting, although the descriptions must be refined from both the conventional and IO perspectives to reflect the focus of IO targeting (e.g., adversary decisionmakers, information structures and decision-making processes). (See Figure 2.)

Because targeting and IO share the same end state (enemy capabilities altered to a level specified by the commander and friendly capabilities protected), it logically follows that the processes to achieve that outcome should be similar. Using parallel, non-integrated planning processes is an inefficient use of limited planning time and produces sub-optimal results.

Decide. The decide function begins with the HVT list (HVTL) developed by the G2 during the intelligence preparation of the battlefield (IPB). The HVTL identifies the people or things (capabilities) critical to the enemy's success as shown in Figure 3. (The example HVTL and other matrices referred to in this article are found in Annex C, of *FM 6-20-10* and can

	Limit	Disrupt	Delay	Divert	Destroy	Target Set	HVT	HVT1	HVT2	
						Entity A Gov't				
				X		City Gov't	X	Mayor	Deputy Mayor	
				X		Police	X	Reg CoP	City CoP	
						Entity B Gov't				
				X		Mayors	X	Mayor X	Mayor Z	
				X		Community Leaders	X	Leader A	Leader B	
						Media				
	X					Radio Stations	X	Radio R	Radio S	
						Remote Site Military				
					X	WSS	X	Site 1	Site 2	
		X				ADA				
						FA				
				X		Unit Cdrs	X	Corps Cdr	Brigade Cdr	
	X					Other				
	X					Crowds		Serb	Federation	
						Buses				
						Loudspeaker Vehicles				
						Barrier Material				

IO targets are:

- Civil and political command and control structures.
- Crowd-forming capabilities.

Key Civil, Political and Military Leaders

Legend:

ADA = Air Defense Artillery	HVT = High-Value Target	WSS = Weapons Storage Site
FA = Field Artillery	Reg CoP = Regional Chief of Police	

Figure 3: Information Operations (IO) High-Value Target List (HVTL). This matrix shows the HVTs- targets that are critical to the enemy's operations. Non-lethal and lethal targeting use the same HVTL.

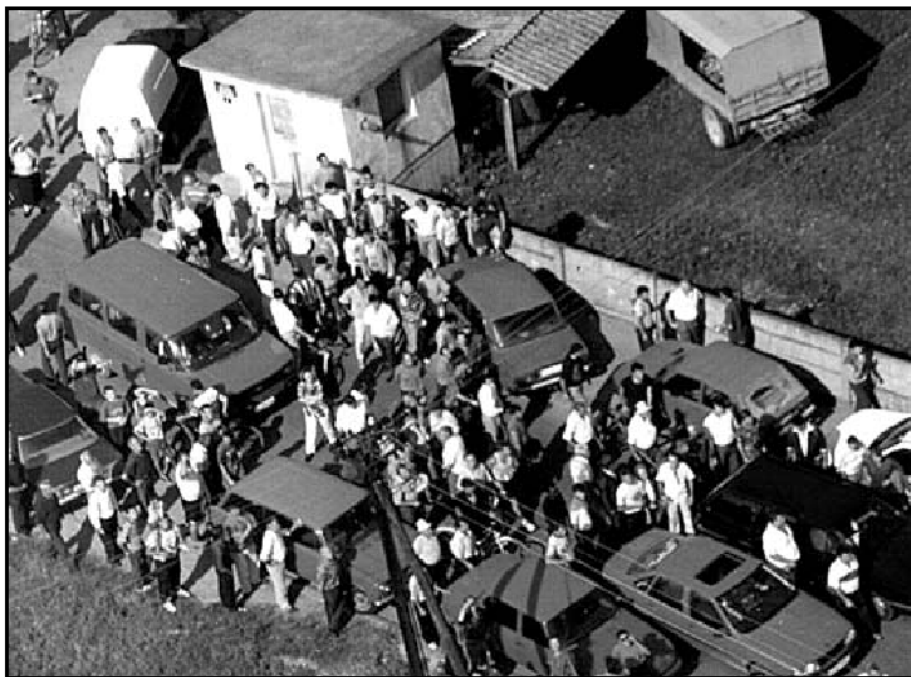

If adversary leaders seek to turn a legal civilian political rally into a violent, hostile demonstration, the target set may be those capabilities and personnel needed to form or transform a crowd into a mob

be applied to both traditional and IO targeting without modification.)

The HVTL includes all targets, by target category (i.e., government leaders, media, weapons storage sites, etc.) that are critical to the adversary's successful completion of its mission paired against the targeting objectives (limit, disrupt, delay, etc.). Note that in the example HVTL shown in Figure 3, traditional targeting terms are applied to non-traditional targets, such as buses and government officials.

Targeting objectives are derived from the commander's guidance. These objectives focus all division systems (maneuver, fires, IO) on a few key tasks. To reflect the focus of IO, it is necessary to include both lethal and non-lethal attack in the targeting objectives.

Traditionally, targeting decisions have focused on the "what" (physical targets), while IO focuses on the "who" (leaders and decision makers). In most military operations, the commander's intent will include both target sets. By expanding the attack options to include non-lethal means, planners develop a truly integrated and comprehensive target set for the operation that will fulfill the commander's intent.

Development of the HPTL is the primary objective of the decide function of targeting. Built during the military decision-making process (MDMP) course-of-action

(COA) development, the HPTL identifies those targets critical to the success of the friendly mission (see Figure 4). Targets are selected from the HVTL and re-grouped into target categories

on the HPTL. The target categories are adversary capabilities and functions. Within each category, individual targets are rank-ordered by sequence of appearance, importance or other criteria that satisfy the targeting objectives. In this way, the targeting process ensures the selected targets support the commander's intent.

Targets on the HPTL are confirmed and refined in the war-gaming process. Prioritization of the high-priority targets may differ between phases of an operation, but the target list should remain the same and include all critical targets—from people to tanks. Once the entire target list is finalized, the assignment of delivery means follows the traditional targeting process.

Detect. The detect function begins with the intelligence collection plan. Although collectors for traditional and IO targets are frequently the same, the number and type of collection assets are expanded beyond those normally used for traditional targeting in order to identify IO targets for non-lethal attack.

Additionally, descriptive target selection standards (TSS) frequently are required to identify IO targets. Unlike traditional target selection where the enemy is known to possess specific types of equipment (e.g., T-54 tanks,

Priority	Category	Target
Phases 1 & 2: 1	Entity A Crowd Formation	Town Mayor Radio Stations R & S Sirens (3 Locations) Loudspeaker Vehicles Populace
Phases 1 & 2: 2	Entity B Crowd Formation	Area Mayors X & Z Community Ldrs A & B Buses Populace
Phase 1 & 2: 3 Phase 3: 1	Military Mobilization	ADA Site WSS 1 WSS 2 WSS 3 Corps Cdrs
All Phases: 4	Other Targets	Blockade Vehicles Barrier Material

Figure 4: High-Payoff Target List (HPTL). These targets are critical to the friendly force's course of action (COA) success. Non-lethal and lethal targeting use the same HPTL.

Category	HPTL	When	How	Effect	Rmks*
Traditional Attack					
Military Mobilization	ADA Site	P3	FA, Atk Avn	S	
	WSS 1	P3	FA, Atk Avn	N	
	WSS 2	P3	FA, Atk Avn	N	
	WSS 2	P3	FA, CAS	N	
IO Attack					
Crowd	Mayor	P1, 2	BILAT - Unit, CA	I	ERG
			MSG: CA, CB**	C	
	Radio Station	P1	BILAT - PSYOP	W	
	Loudspeaker Veh	P2	Unit Patrol FPT	H	
Military Mobilization	Corps Cdrs	P1, 2	BILAT - JMC	D	
			MSG: MA, MB**	H	
Other	Blockade Veh	P2	Unit Patrol		

*Rmks (Remarks) column is the space for additional guidance. For IO targets, the remarks clarify the desired effect.
**MSG (message) is two-letter designator that refers to a specific IO message.

Effects:	Legend:	ERG = Emergency Reaction Team
Traditional Attacks- S = Suppress and N= Neutralize	ADA = Air Defense Artillery	FPT = Force Protection Team
IO Attacks- I = Influence, C = Co-Opt, W = Warn and H = Hinder	Atk Avn = Attack Aviation	HPTL = High-Payoff Target List
	BILAT = Bilateral	JMC = Joint Military Commission
	CAS = Close Air Support	PSYOP = Psychological Operations
	CA = Combined Arms	WSS = Weapons Storage Site

Figure 5: Attack Guidance Matrix (AGM). This matrix combines the HPTL and AGM and is used for lethal and non-lethal targeting. Note the "Effects" for the "Traditional Attack" are different than those for the "IO Attack." (Matrix is in accordance with Appendix C of *FM 6-20-10 Tactics, Techniques and Procedures for the Targeting Process*.)

BMPs, etc.), in peacekeeping IO, target identification is often unclear. For example, not everyone carrying a cellular telephone in a hostile crowd is an agitator and not all buses in the area of responsibility (AOR) are transporting reinforcements to a

demonstration. Thus, descriptive criteria are required to help the attacking systems (e.g., patrols and traffic control points) determine valid targets.

Deliver. Once detection assets are assigned against the HPTs and appropriate

named areas of interest (NAIs) and target areas of interest (TAIs) are established, delivery assets are determined for each target. A prioritized list of this information is developed by building an attack guidance matrix (AGM), the primary tool for executing all attacks, both lethal and non-lethal. (See Figure 5.) The AGM provides the target (who/what) and when and how to attack it with the effect desired for each target.

If employed creatively, virtually all lethal attack systems can have a non-lethal role. For example, positioning howitzers (lethal delivery means) in range of selected weapons storage sites could influence disgruntled faction leaders (the targets) whose weapons are stored at that site to agree to comply with the provisions of the peace accord (desired effect). In Operation Joint Guard, non-lethal delivery systems include Task Force Eagle commanders and staff conducting face-to-face bilateral discussions with entity leaders and target groups; PSYOP print, radio and television media products; CA contacts with the local populace; and PA press releases and conferences.



Descriptive criteria are required to help the attacking systems- in this case, a traffic control point- determine valid targets.

Traditional Attack (Quantifiable)		IO Attack (Descriptive)	
Effect	Criteria	Effect	Explanation
Harass	Disturb, Curtail	Inform	Provide information to counter misinformation.
		Warn	Provide notice of intent in order to prevent a specific action.
		Influence	Curtail or cause a specific action.
Suppress	Degrade Performance (For Specified Time)	Disorganize	Reduce effectiveness/abilities.
		Isolate	Minimize power/influence.
Neutralize	Render Ineffective (10-29% Destruction)	Co-Opt	Gain cooperation.
Destroy	Physically Render Combat Ineffective (30% or Greater Destruction)	Deceive	Mislead to induce a reaction.

Figure 6: Targeting Effects (Non-Doctrinal). The different types of attacks call for different effects.

Assess. Targeting assessment is a continuous process to determine if targeting objectives have been achieved and if re-attack is required. The assessment process for traditional and IO targeting is the same, except that while the traditional assessment is objective, IO assessment is often subjective. Overcoming this difference requires a clear understanding of the desired end state as well as the capability to interpretively measure the effectiveness of the attack.

In traditional targeting, desired effects are precisely and quantifiably measured in terms of "harass, suppress, neutralize and destroy." Because *FM 100-6* does not include such definable effects for IO attack, Task Force Eagle planners developed equivalent targeting effects with descriptive assessment criteria for IO (see Figure 6).



IO is another vital tool available to the tactical commander. Clearly, offensive IO can be integrated into the maneuver commander's operation using the targeting process.

Lessons Learned. In the process of integrating IO into the targeting process, we have learned a number of lessons—three of the most important of which we discuss here.

1. IO is another vital tool available to the tactical commander. Clearly, offensive IO can be integrated into the maneuver commander's operation using the targeting process.

2. IO is not a stovepipe process. Few divisions and corps can afford another two-to three-hour meeting injected into an already tight battle rhythm. Integrating IO into the existing targeting process is a sensible and efficient way to bring IO "under the tent."

3. IO brings additional and unique capabilities to the maneuver commander. In peace operations where lethal fire support and maneuver options are often limited by restrictive ROE, IO has proven to be an effective and efficient method for executing the commander's intent.

The next challenge is to apply these lessons learned to a traditional warfighting operation.

This is an exciting time for the development of IO. Field Support Teams (FSTs) from the Land Information Warfare Activity (LIWA) out of Fort Belvoir, Virginia, and the 1st Armored Division staff have made significant advances in employing IO at the tactical level.

Incorporating IO into D³A

methodology allows planners to use simple processes executed by existing organizations within the military decision-making process. The way ahead for incorporating IO into tactical operations is clearly marked. The same process for IO must be applied to high-intensity conflict. We must identify those significant aspects of the IPB that should be fine-tuned to answer specific information operations requirements.

The efforts of Task Force Eagle planners to integrate IO into the targeting process portends a bright future for the full adoption of IO in tactical operations for peace missions, conflict and war.

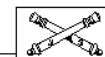

Lieutenant Colonel Steven Curtis, Infantry, is the Field Support Team (FST) Chief for the Land Information Warfare Activity (LIWA) out of Fort Belvoir, Virginia. In January 1998, he returned to the 1st Armored Division to coordinate Information Operations for Task Force Eagle in Bosnia-Herzegovina; previously he had served as a Battalion Executive Officer in the division. He completed a tour on the Joint Staff, J39 (Information Operations). He also commanded a mechanized infantry company and a tank company in the 1st Cavalry Division at Fort Hood, Texas.

Captain Robert A.B. Curriss is an Assistant Fire Support Coordinator (AFSCOORD) for Plans with the 1st Armored Division Artillery in Bosnia-Herzegovina. He has served as a Company Fire Support Officer (FSO), Reconnaissance and Survey Officer, Support Platoon Leader, Battalion S4 and Battalion FSO, all for the 1st Battalion, 327th Infantry, 101st Airborne Division (Air Assault), Fort Campbell, Kentucky, and participated in five Combat Training Center rotations. He has been the Division Fire Support Planner in Bosnia since February.

Major (Retired) Marc J. Romanych, Air Defense Artillery, is an IO Specialist with JB Systems Engineering Support Company, out of Fort Belvoir serving on the LIWA FST in Bosnia since February. His last active duty assignment was as a Strategic Planner in a Department of the Army Information Operations/Information Warfare Program. Major Romanych served in five ADA battalions in various leadership and operations positions, to include as Commander of C Battery, 3d Battalion, 8th ADA (Hawk) at Fort Bragg, North Carolina, and Commander of Headquarters and Headquarters Battery, 2d Battalion 2d ADA (Chaparral) at Fort Hood.

New USMC Towed Howitzer in 2001

With so much attention focused on the Army's Paladin and Crusader howitzers, it's understandable that few artillerymen know of the newest howitzer about to enter the US inventory: the XM777. In 1997, Textron Marine and Land Systems was awarded an engineering and manufacturing development (EMD) contract to transform Vickers Shipbuilding and Engineering Limited's (VSEL's) ultralightweight field howitzer (UFH) into a suitable replacement for the Marine Corps' aging M198 towed 155-mm howitzers. The XM777 will give the Marine Corps a Paladin capability in a towed howitzer.

The UFH was selected as the developmental baseline after more than a year of competition among four competitor systems and involving user unit trials, selection boards and senior leader evaluations. A nine-month-long competitive shoot-off involved the four prototype weapons and both Army and Marine personnel. Testing included six months of technical work at Yuma Proving Ground, Arizona, where items such as weight, range, accuracy, precision, strength of design, extreme climatic operations, stability and mobility were scrutinized. Only two of the four competitors advanced from this phase.

Then for three months, units from the Army (B Battery, 3d Battalion, 321 FA, part of the 18th FA Brigade from Fort Bragg, North Carolina) and Marine Corps (L Battery, 3d Battalion, 11th Marine Regiment from Twenty-Nine Palms, California) conducted operational testing. The units ran the howitzers through their paces at the Marine Corps Air-Ground Combat Center, Camp Pendleton and San Diego Naval Station, all in California. Testing included emplacement, displacement, speed shift, live-fire, tactical mobility, helicopter lift and amphibious operations, which stressed both the weapons and the crews.

A source selection evaluation board (SSEB) comprised of Marine and Army technical experts conducted an extensive review of the test data and other pertinent information and

presented its findings to a source selection advisory council (SSAC). The SSAC was made up of senior Army and Marine officers and government officials. The SSAC identified the UFH design as the best weapon in the competition to continue development.

The UFH that completed the testing and selection process is not the weapon that will be fielded. Over a three-year period, eight more prototypes will be built and continuously tested, improved and retested to ensure the final design will meet the requirements stated in the joint operational requirements document. Key requirements include a weight of 9,000 pounds or less, 30-kilometer assisted range, maximum rate of fire of five to eight rounds per minute, emplacement time of three minutes or less and displacement time of two minutes or less.

The Marines will field the M777 starting in early 2001. First unit equipped (FUE) is scheduled for the middle of FY 02. Paladin-like electronics for towed artillery is being developed by the Army (see "Digitizing the Joint LW 155-mm Howitzer," by John K. Yager, September-October 1996) and will be added to the basic weapon. The digital capabilities will be added as a preplanned product improvement (P³I) to the already fielded howitzers or, if the technology proves mature enough, cut into the production line. This technology will improve the future howitzer's tactical flexibility while its new medium tactical vehicle replacement (MTVR) prime mover will give it greater logistical supportability.

The XM777 with prime mover and ammunition programs such as the XM982 extended-range guided projectile and sense and destroy armor (SADARM) will provide the Marine Corps a responsive, all-weather fire support system for the 21st century.

John K. Yager

Lightweight 155-mm Project Officer TRADOC Systems
Manager (TSM)-Cannon
Maj Kevin C. Rogers, USMC
USMC Battle Lab Liaison Officer
Directorate of Combat Developments
Field Artillery School, Fort Sill, OK

1999 Senior Fire Support Conference Set for April

Planning already has begun for the next Senior Fire Support Conference at the Field Artillery School, Fort Sill, Oklahoma. The conference will be the week of 12 April. General information on the days and theme of the conference will follow in fall editions of *Field Artillery* with the details of registration and the speakers and sessions available in early 1999.

As in past years, Senior Fire Support Conference attendees include Army

Corps and Marine expeditionary force (MEF) commanders; Reserve Component (RC) and Active Component (AC) Army and Marine division commanders; selected retired general officers; Training and Doctrine Command school commandants; AC and RC Army corps artillery, FA brigade, division artillery and Marine regimental commanders and their command sergeants major; and US Field Artillery Association corporate members.

Watch for more information in future editions of the magazine.





Thunder in the Ozarks

The Battles of Wilson's Creek and Pea Ridge

by Majors William S. Bland and William M. Raymond, Jr.

Most studies of the Civil War focus on the seesaw battles of the eastern theater, the struggle for Vicksburg and the Mississippi River, the cataclysmic clash at Gettysburg or Sherman's devastating drive through Georgia. In fact, it was the early fighting in the western theater to gain control of Missouri that laid the groundwork for the eventual Union victory.

Twenty-five years after the guns fell silent, Sherman, the famed general himself, wrote: "Somehow, few men realized the full value of the victories of Pea Ridge, Donelson and Shiloh....The more you study the Civil War, the more you will discover that the Northwestern states 'saved the Union.'"¹

Control of Missouri was the reason the Battle of Wilson's Creek was fought near Springfield, Missouri, in August 1861 and one of the reasons for the clash at Pea Ridge, commonly referred to as the "Gettysburg of the West," in March 1862. (See Figure 1.) In both key battles, the King of Battle played dominant and decisive roles.

For example, the most intense sustained artillery barrage ever to

take place on the North American continent up to that time—a two-hour cannonade with more than 40 cannons firing—occurred on the second day of fighting at the Battle of Pea Ridge. The 4th Ohio Battery, with only six

guns, fired an amazing 566 rounds during the cannonade. One Iowan soldier present described the experience, "It was a continual thunder, and a fellow might have believed that the day of judgement had come."²

Border Politics. Missouri entered the Union in 1820 as a slave state, more to preserve the balance in the US Senate than for any other reason. Politically, geographically and emotionally, Missouri was a border state, perched uncomfortably on the political fence. The majority of the populace considered itself conditional unionists, opposed to secession, but believed the Federal government had no right to coerce states to remain in the Union. While they may have preferred staying neutral, the military and political imperatives of geography would not allow Missourians the luxury of sitting on the sidelines.³

In 1860, Missouri was important to both the North and South because of its wealth, population and geographic position. The state had a vast industrial and agricultural capacity, producing large quantities of tobacco, hemp, wool, rye, corn, wheat, oats, coal, lead, horses, pigs and cattle. The state was an abundant source of manpower

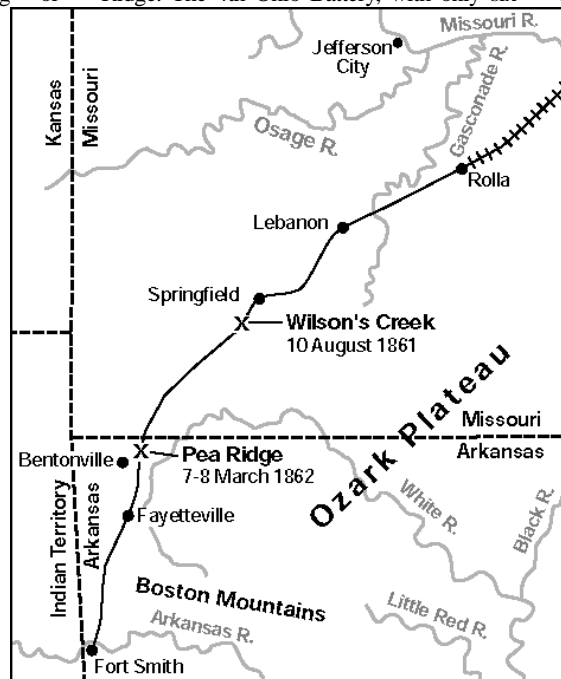

Figure 1: Battles of Wilson's Creek and Pea Ridge—Control of Missouri

with more than 60 percent of its 236,000 military-aged men eventually serving during the war.⁴ Missouri also contained or bordered the confluence of the Missouri, Mississippi and Ohio Rivers, waterways that facilitated transport and trade in all directions.

Once South Carolina seceded from the Union in 1861, the unionists and secessionists in Missouri began posturing to gain control of the state. In response to this, Governor Claiborne F. Jackson called out the state militia to begin preparations for the defense of the state against both sides. The unionists, fearing an attack from the militia, surrounded and captured the militia forces at Camp Jackson. During the march back to the arsenal with the captured militia, a boisterous crowd got out of hand and shots were fired. Twenty-eight people were killed or wounded, civilians and soldiers alike. This incident pushed many of the "fence sitters" in Missouri toward the southern cause and led the state legislature to pass a bill creating the pro-Confederate Missouri State Guard.⁵ The political battle lines were drawn.

Battle of Wilson's Creek. In June 1861, the Missouri State Guard under the command of Brigadier General Sterling Price moved to Springfield. The Union forces under the command of Brigadier General Nathaniel Lyon pushed west from Saint Louis to capture the State Capitol at Jefferson City and then drove southwest to seek out Price. By 13 July, Lyon's 6,000 Federal troops were encamped in Springfield with Price's 5,000 Guardsmen about 75 miles southwest.

In late July, Confederate forces under Brigadier General Benjamin McCulloch drove north from Arkansas to rendezvous with Price, bringing the total Confederate force to more than 12,000 men. Intent on defeating the Federals and regaining control of the state, the combined Confederate forces marched northeast to attack Lyon.

Hoping to surprise the Confederates, Lyon set out from Springfield on 1 August. Realizing he was outnumbered, Lyon withdrew back to Springfield. McCulloch ordered the Confederates to follow, and by 6 August, they were encamped near Wilson's Creek.⁶ (See Figure 2.) The Battle of Wilson's Creek, or Oak Hills as the Confederates called it, was about to begin.

The Confederates planned a surprise attack on the Federals for the night of 9 August, but rain forced McCulloch to

cancel the operation. Meanwhile, Lyon decided to seize the initiative and attack the larger Confederate force that same night. He sent 1,200 men under the command of Brigadier General Franz Sigel around the Confederate right flank and his remaining 4,200-man main body south to attack the Confederates head on.⁷

On the morning of 10 August, Lyon's attack caught the Confederates completely off guard. Contributing to his success was the fact that the Confederate pickets had been withdrawn and never replaced. Federal forces drove the Confederates back, overrunning several camps and occupying the crest of a ridge subsequently called "Bloody Hill." Pulaski's Arkansas Battery fired into the Federals, checking their advance and allowing Price's infantry time to set up hasty defensive positions.⁸ The fighting for Bloody Hill lasted more than five hours with the tide turning after each charge and countercharge.

Sigel, undetected on the Confederate flank, used his artillery to bombard the Confederate cavalry camp. Disoriented and confused, the Confederates fled from the relentless artillery fire. Sigel's infantry and cavalry forces swept through the camp but failed to prepare for the inevitable Confederate counterattack. As the Confederates charged his position, Sigel's forces mistook them for part of Lyon's forces because of the color of their uniforms. The Federals held their fire until the Confederates had closed to within 30 yards. Realizing their mistake, the surprised Federals panicked in the face of the close-quarters attack and fled the battlefield.

As the battle for Bloody Hill raged back and forth, the outnumbered Federals began to waver. With the defeat of Sigel's flanking movement, Lyon's decision to split his forces proved costly. While rallying his troops yet one more time, Lyon was struck and killed.

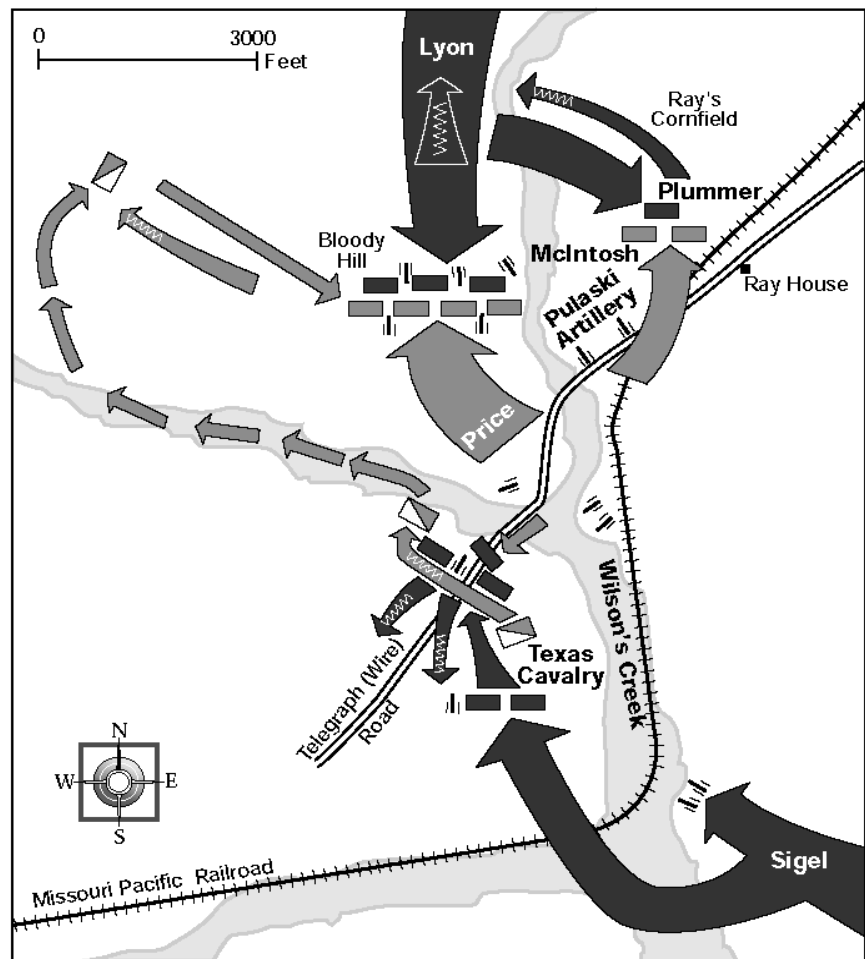

Figure 2: Wilson's Creek, 10 August 1861. The Union combat strength was 6,000 while the Confederates had more than 12,000 soldiers. Casualties were high; the Union lost 1,131 soldiers, and the Confederates lost 1,222 soldiers.

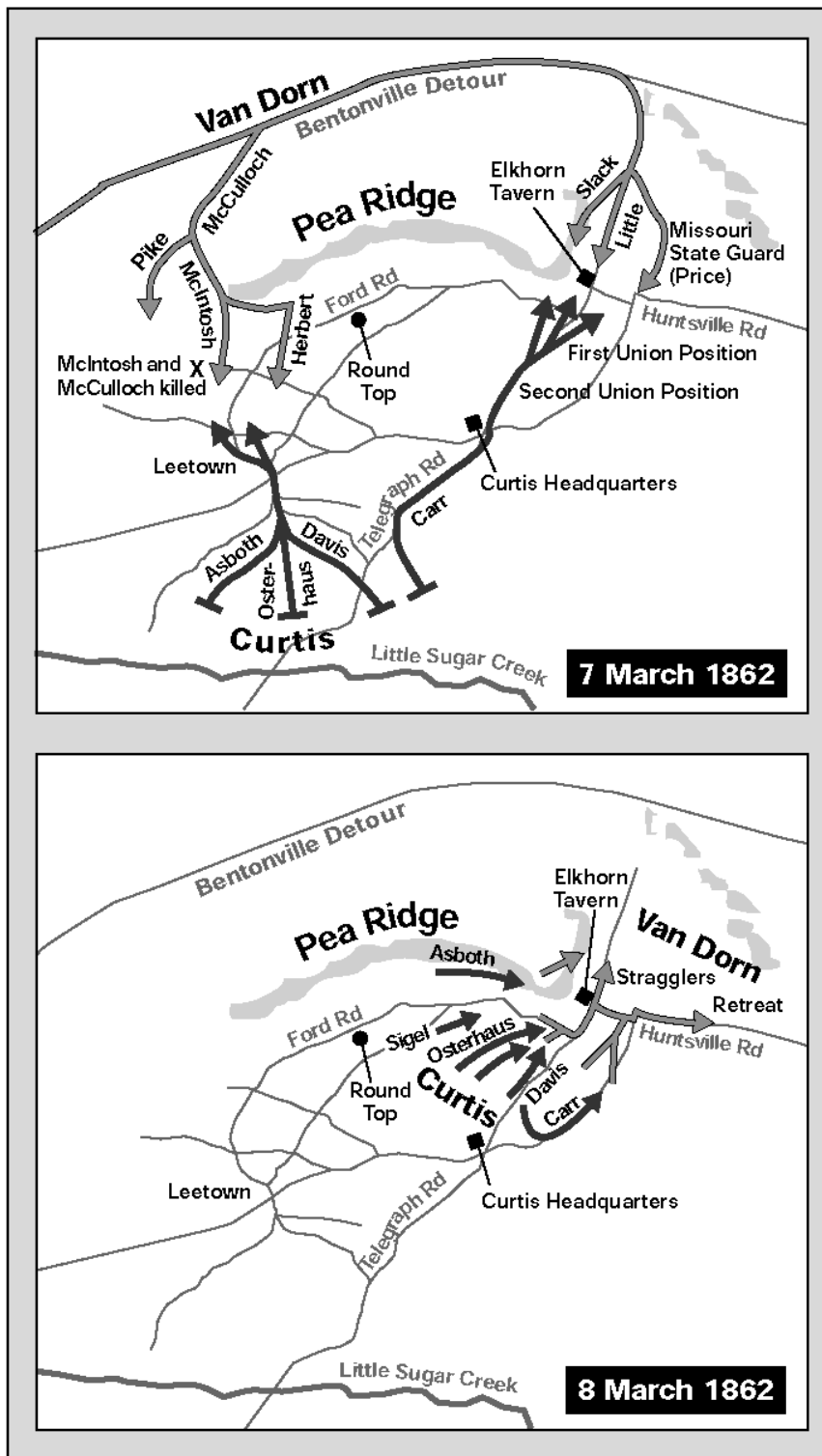

Figure 3: Engagements at Pea Ridge, 7-8 March 1862

Demoralized, nearly out of ammunition and severely outnumbered, the Federals decided to withdraw. Using a rear guard and covering artillery fire, they broke contact and withdrew to Springfield. The Confederates followed them to Springfield but did not pursue any farther as the

Federals continued on to Rolla.

Losses were heavy and nearly equal for both sides—1,222 for the Confederates and 1,131 for the Federals.⁹ On the heels of this Confederate victory, Price marched his State Guard northward and won a moral victory at Lexington on 20

September. These two Confederate victories required President Lincoln to devote more resources to this theater and set the stage for future Union operations to control the state of Missouri.

Battle of Pea Ridge. Seven months after Wilson's Creek on 7-8 March 1862, many of the same leaders met again at the battle of Pea Ridge, or Elkhorn Tavern, as the Confederates named it. (See Figure 3.)

Confederate President Jefferson Davis sent Major General Earl Van Dorn, a West Pointer and flamboyant veteran of the Mexican War, to take command of all Confederate forces in the area and heal a rift between the very capable McCulloch and the more senior Price who was a Brigadier General in the Mexican War. Van Dorn named his new command the Army of the West and immediately began his march north from Fayetteville, Arkansas, intent on striking into Missouri and capturing Saint Louis.

Dug in and blocking his path in prepared breastworks on the bluffs overlooking Little Sugar Creek was Brigadier General Samuel R. Curtis, commander of the Army of the Southwest. Little Sugar Creek is three miles south of Pea Ridge and the nearby hostelry called Elkhorn Tavern.

Van Dorn intended to conduct a double envelopment, similar to Lyon's attempt at Wilson's Creek; however this time, the attacker would outnumber the defenders: 16,500 men and 64 guns to 10,500 men and 49 guns.¹⁰ Van Dorn ordered campfires set on the opposite side of Little Sugar Creek as a simulated encampment to allow him to maneuver undetected to Curtis' rear. Using the Bentonville Detour, Van Dorn sent Price and his Missouri State Guard on a night march around the north side of Pea Ridge and then down the road past Elkhorn Tavern for a dawn attack on Curtis' unsuspecting rear.

The other half of Van Dorn's army under the command of McCulloch used the same detour to attack through Leetown and strike Curtis' right rear. The Confederate soldiers were hungry, cold and weary from the difficult three-day march of more than 55 miles into a snowstorm the entire way.¹¹

At approximately 0500 on 7 March, Curtis realized that Van Dorn had tricked him, thanks to a private in the 3d Illinois Cavalry who, while a prisoner, witnessed the Confederate night movement and then escaped and warned his superiors.¹² Curtis then acted with incredible boldness when he turned his

army to face north and the road that the enemy was still moving on. This rapid shift was one of the most extraordinary changes of front in the Civil War.¹³

Due to the slow marching of the tired Confederate troops, who were hindered further by hastily constructed Union

obstacles on the detour, Van Dorn was unable to complete his movement by dawn. He decided to conduct his attack by dividing his army. Thus, the battle of Pea Ridge consisted of two engagements, one at Leetown and the other at Elkhorn Tavern.

At Leetown, Curtis responded quickly to McCulloch's attack, first with Colonel Cyrus Bussey's Flying Column composed of cavalry and artillery and then with Sigel's First and Second Divisions. The battle raged in the cornfields north of Leetown until the death of key Confederate

Staff Ride to Wilson's Creek and Pea Ridge

The officers of 2d Battalion, 2d Field Artillery, 30th FA Regiment of the Training Command at Fort Sill envisioned a staff ride as an opportunity to obtain important insights into military operations, concepts of leadership and how men have fought and endured in battles. We also saw it as a team-building event.

The proximity of the Wilson's Creek and Pea Ridge battlefields to Fort Sill and wealth of artillery lessons they could provide made them particularly attractive. We planned a three-day trip, leaving Thursday afternoon and returning Sunday night (5-7 March) and staying the two nights at a National Guard Armory (1-142 FA). The only government expenses were for transportation and gas while the individual only had to pay for food. We turned our staff ride vision into reality at an extremely low cost.

To get the most out of the staff ride, we followed the Center of Military History recipe for a staff ride: systematic preliminary study of a selected campaign, an extensive visit to the actual sites associated with that campaign and an opportunity to integrate the lessons derived from each. (Information taken from Page 5 of "The Staff Ride" by William G. Robertson that was printed by the Center of Military History, Washington, DC.)

We scheduled two officer professional development (OPD) sessions, one for each battle, and had assigned readings. During the OPDs, we broke into teams and played Jeopardy, asking questions about the readings for each battle. This was a fun team-building exercise that helped "cross-level" information throughout the attendees. We then showed videos from each battlefield's visitor center and held an in-progress review (IPR) on the upcoming staff ride. Finally, we assigned each officer a Civil War leader to research the role that leader played in the

battles and prepare a biographical sketch of him.

We coordinated with the Combat Studies Institute (CSI) at Fort Leavenworth, Kansas, for Dr. Jerry Brown and Lieutenant Colonel David Chuber to accompany us on the staff ride. Among other missions, CSI conducts battlefield staff rides in support of the Command and General Staff College and other organizations throughout the Army.

These two individuals proved invaluable. Their knowledge of the subject matter was extensive, and they brought several museum artifacts and detailed blown-up maps to support the staff ride.

Upon arriving at the Armory Thursday night, the CSI personnel presented classes on Civil War tactics, weaponry, uniforms and the political situation in Missouri in 1861. Friday morning, we watched a short film at the Pea Ridge National Military Park and then headed to the Wilson's Creek National Battlefield. We saw, perhaps, one of the best historical dioramas in the US at the visitor's center and then began our walk through the battlefield. At each key site, we paused to discuss the flow of the battle, the role of each character in the fighting and the applicability of what we were learning to present-day operations.

The next morning, we arrived at the Pea Ridge National Military Park and, because of the rain, decided to drive rather than walk through the battlefield. We repeated the previous day's activities, conducting detailed discussions at each key site. Our staff ride coincided with the 136th anniversary of the original battle, and we had the good fortune to arrive in the middle of a Civil War reenactment. We witnessed the firing of a Civil War howitzer section, a typical encampment and various other activities. In mid-afternoon, we wrapped up the staff ride with a CSI-led after-action review (AAR) and then began the trip back to Fort Sill.

The staff ride was a complete success, exposing the *Big Deuce* officers to the dynamics of battle, especially those factors that interact to produce victory and defeat. It provided a case study in unit cohesion, the application of the principles of war and combined arms operations. It demonstrated the impact of logistics and terrain upon plans and their implementation. Finally, the officers returned from the trip a much more cohesive and bonded group. The staff ride was an excellent tool to develop our officers into better leaders, and we highly encourage other battalions to conduct staff rides.



Officers of 2-2 FA during their March 1998 Staff Ride to Pea Ridge pose with Civil War reenactors.

federate leaders Brigadier Generals McCulloch and James McIntosh and the capture of Colonel Louis Hebert. The loss of these Confederate leaders and the devastating effectiveness of Union artillery with canister and grapeshot were instrumental in breaking up the Confederate attack.

Meanwhile at Elkhorn Tavern, Price's Missouri Confederates fared better as they attacked Curtis east of Pea Ridge. The most intense fighting occurred around Elkhorn Tavern. Colonel Eugene A. Carr, the Fourth Division commander, was wounded three times in two hours as he supervised the emplacement of the 3d Iowa Battery. His distinguished gallantry earned him the Medal of Honor, one of four at Pea Ridge.¹⁴

Van Dorn used massed artillery to overpower the Union batteries defending along Telegraph Road. Once the Federal guns were silenced, the Confederate guns fired unimpeded into the Union infantry, greatly facilitating Price's attack. Because of the Union commitment at Leetown, the Federals were forced to slowly give ground. The Confederates held Elkhorn Tavern and the crucial Telegraph and Huntsville Roads by nightfall.

During the cold night, both sides concentrated their forces around Elkhorn Tavern for the decisive clash in the morning. At about 0700 on 8 March, the Confederates opened the fighting with a cannon blast. The Federals responded with Sigel massing his 20 guns south of the ridge with his infantry 250 yards behind the guns.¹⁵ This artillery duel that lasted about two hours was the largest of its kind west of the Mississippi River—the thunder of artillery was heard for 50 miles across the Ozark Plateau. An Illinois soldier said that "the constant roar of artillery seemed to shake the ground like an earthquake" and another soldier wrote his brother that "no recital of the scene can give you any idea of the terrible grandeur of this period of the battle....It beggars all my powers of description."¹⁶

Massing the Union guns provided effective preparatory and suppressive fires that disabled the Confederate batteries and forced their withdrawal. To the Confederates arrayed on Pea Ridge, the effect of shot and shell in the rocks was devastating as the rock fragments created an early form of improved conventional munitions (ICM).

After this two-hour preparation, nearly 10,000 Federal infantrymen rose to their

feet and dressed their ranks. In what may have been the only time in the Civil War, Curtis deployed his entire Army (First, Second, Third and Fourth Divisions) on line and in numerical order from left to right facing north. In their book, *Pea Ridge*, William Shea and Earl Hess describe it as "a scene of martial grandeur right out of a picture book on the Napoleonic Wars."¹⁷

Sigel directed the First and Second Divisions west of Telegraph Road, and Curtis directed the remaining two divisions east of the road while retaining overall command. At approximately 1000, Van Dorn knew he was beaten. All morning he had waited for his ordnance trains that never showed up due to a mix-up in orders. As a result, his own gunners were left to use stones as ammunition when their shot ran out.¹⁸ The tremendous success of the Union artillery and the Confederates' lack of ammunition allowed Curtis and Sigel to maintain the momentum of their counterattack and forced Van Dorn and his army to retreat.

The Federals suffered 1,384 casualties (203 killed, 980 wounded and 201 missing or captured). Confederate casualty estimates ranged from Van Dorn's low estimate of 800 (600 killed and wounded and 200 captured), a medium of 1,300 (1,000 killed or wounded and 300 captured) and a high of 2,000.¹⁹

The Federal victory, the first clear and decisive one gained by the North west of the Mississippi, ensured that Missouri remained in the Union. It marked the end of the struggle for control of Missouri (notwithstanding Price's futile invasion north again in 1864) and opened up Arkansas for eventual Federal occupation.

Lessons Learned. Field Artillerymen can learn many lessons from these battles for Missouri, several of which we discuss here.

Military Studies. Moltke, "The Elder," once said that history is "...the most effective means of teaching war during peace."²⁰ McCulloch, who had no formal military training, spent his free time reading books on the history and strategy of war. His favorite readings were those of the great military captains as he compared the views and actions of both ancient and modern military leaders. Clearly, the study of our profession of arms is important to one's development.

Principles of War: Maneuver/Surprise. Sigel's flanking movement into the Confederate rear at Wilson's Creek and

Van Dorn's march along the Bentonville Detour into Curtis' rear at Pea Ridge are great examples of these principles. Both were bold, unexpected maneuvers that turned the element of surprise into a combat multiplier.

Principle of War: Unity of Command. At Pea Ridge, the Federals had a clear chain of command with Curtis only having to deal with three immediate subordinates. The Confederates, on the other hand, had a fragmented chain of command; Price, for example, had up to nine immediate subordinates.²¹ When McCulloch and then McIntosh were killed in quick succession on 7 March, the Confederate force at Leetown collapsed and no one took charge. Without unity of command, it is difficult to direct the efforts of a force to achieve a unified purpose.

Logistics. Logistics had a tremendous impact on when and where these two battles were fought. The large Confederate force moving north to join Price had to find food, forage and water. It found all these plentiful at Wilson's Creek and settled there in late July to prepare for operations against the Federals, setting the stage for that battle. Curtis chose the commanding bluffs overlooking Little Sugar Creek to set up his defensive position because his supply lines would not support a location any farther south.

Ammunition in the Civil War was always a problem in terms of both quality and quantity. A corrupt procurement system pumped out substandard ammunition while lining the pockets of company stockholders.²² Scarce resources and the inability of supply trains to keep the front lines supplied led the soldiers to improvise and increased day-to-day hardships. Logistics remain an important consideration for today's planning and execution.

Leadership. The key leaders in these battles demonstrate different leadership styles. Lyon was headstrong and quick to take the initiative. By driving the secessionists out of Jefferson City, he forced them to operate without a base, money or legal footing and he bought time for the unionists to establish an interim state government. Conversely, he also destroyed any chance of a peaceful settlement by forcing everyone to take sides.

His aggressiveness explains Lyon's attacking a much larger Confederate force at Wilson's Creek on 10 August, hoping the surprise would offset the

advantage of the superior Confederate numbers.²³ In this case, he was mistaken. Taking the initiative is indeed important when trying to shape the battlefield, but good leaders must have a plan to accommodate an enemy who does not cooperate.

Curtis was the central figure of the campaign. He understood his commander's intent and accomplished the mission. His administrative ability allowed him to operate in the field for six months far from his supply base and under trying conditions.

Curtis was cool under pressure and displayed tactical boldness when necessary, such as when he reversed his front on 7 March. He also held much of his force in reserve until he knew the true nature of the rebel threat. This act required considerable moral courage when he received competing requests for immediate help from his subordinate commanders at Leetown and Elkhorn Tavern. Once Curtis realized that Leetown was the critical point on the battlefield, he sent his reserves there despite the desperate state of affairs at Elkhorn Tavern. As a result, the Medal of Honor winner Carr and his Fourth Division incurred half of all Federal casualties on 7 March when he bore the brunt of Price's repeated attacks at Elkhorn Tavern.²⁴

On the other hand, Van Dorn was "an irresponsible general who was continually in overdrive...his lack of logistical preparation was almost criminal, and his obsession with speed and surprise wore down his troops and led to the division of his army in the presence of the enemy."²⁵ Van Dorn marched his soldiers 55 miles in three days during a snowstorm while he rode in an ambulance. His failure to empower his subordinates to keep track of his ordnance trains was a mistake his army could not recover from.

The Pea Ridge Battle

*An' with that dread confusion
We was forced to leave the
ground. The rollin' stones of
iron balls Was cuttin'
thousands down. To see our
friends a-fallin' It did us so
provoke, The sun was dim, the
sky was hid With clouds of
rollin' smoke.*

Figure 4: This song was popular at the time and captured the important role the artillery played at the Battle of Pea Ridge.

There is no substitute for quality leadership while under fire and in the command of soldiers.

Importance of Artillery. According to Shea and Hess in their book *Pea Ridge: Civil War Campaign in the West*, "Firepower, not shock, dominated the battlefield at Pea Ridge."²⁶ While the sheer number of tubes and rounds fired during the battles was impressive, the integration of artillery fires with maneuver was what most often made the difference between success and failure.

At Wilson's Creek, both the Federals and Confederates employed artillery fires very effectively. Both sides coordinated artillery fires to support attacks and thwart counterattacks. According to Captain Joseph Plummer of the 1st US Infantry Battalion, "We were materially aided in extricating ourselves by the timely aid of Du Bois' battery, which beat back the advance of the enemy with much slaughter."²⁷

During the first day of the Pea Ridge battle, leaders employed their artillery piecemeal and often without support from the infantry. Each commander wanted his

own cannon or battery to support his formation rather than massing artillery. On the second day, Sigel massed his artillery with much greater effect.

A popular song of the time, "The Pea Ridge Battle," emphasized the importance of artillery.²⁸ (See Figure 4.)

Integration of fire support with maneuver always has been difficult and continues to remain a challenge today. While the tools to accomplish this task change over the years, the basic premise remains the same—"combined arms warfare produces effects that are greater than the sum of the individual parts."²⁹

Crucial to the outcome of both battles was the King of Battle's timely, accurate fires—the Thunder in the Ozarks.³⁰

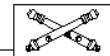

Major William S. Bland is the S3 of the 2d Battalion, 2d Field Artillery, 30th Regiment, part of the Training Command at Fort Sill, Oklahoma. Among other assignments, he commanded Headquarters and Headquarters Battery in the 1st Armored Division Artillery and Service Battery of 2-5 FA in the 1st Infantry Division (Forward), both in Germany. He holds a Master of Science in Operations Research from Florida Institute of Technology.

Major William M. Raymond, Jr., is the Executive Officer for the 2d Battalion, 2d Field Artillery, the battalion in which he also served as S3. In the 1st Armored Division Artillery in Germany, he was the S1 and Assistant S3 and Commander of Headquarters and Headquarters Battery for 6-1 FA. He holds a Master of Arts and Ph.D. in Politics from the University of Michigan.

Officers of 2-2 FA conducted a Staff Ride to the battlefields at Wilson's Creek in Missouri and Pea Ridge in Arkansas in March.

Notes:

1. William L. Shea and Earl J. Hess, *Pea Ridge: Civil War Campaign in the West* (Chapel Hill, NC: University of North Carolina Press, 1992), 317.
2. *Ibid.*, 236.
3. John H. Donovan, "Guidance for Conducting the FAOAC Staff Ride to Pea Ridge, Arkansas," US Army Field Artillery School, Fort Sill, OK, 21 August 1992, Tab A.
4. *Ibid.*, Tab A.
5. George E. Knapp, *The Wilson's Creek Staff Ride and Battlefield Tour* (Fort Leavenworth, KS: Combat Studies Institute, 1993), 6.
6. *Ibid.*, 9.
7. Frances H. Kennedy, ed., *The Civil War Battlefield Guide* (Boston: Houghton Mifflin Company, 1990), 11.
8. *Ibid.*, 13.
9. Donovan, Tab A.
10. *Ibid.*, Tabs B and C.
11. *Ibid.*, Tab F.
12. D. Alexander Brown, "Pea Ridge," *Battle of Pea Ridge Staff Ride* (Fort Leavenworth, KS: Combat Studies Institute, 9 August 1997), 8.
13. Kennedy, 22.
14. Shea and Hess, 171.

15. Donovan, Tab F.
16. Shea and Hess, 236.
17. *Ibid.*, 239.
18. Brown, 13.
19. Shea and Hess, 271; and "The Battle of Pea Ridge Handout," Fire Support and Combined Arms Operations Department of the US Army Field Artillery School, Fort Sill, OK, TVOIAS, HO-1, December 1988, 32.
20. Donovan, Tab F.
21. *Ibid.*, 3, Tabs B and C.
22. *Ibid.*, Tab F.
23. Knapp, 11.
24. Shea and Hess, 270 and 309-311.
25. *Ibid.*, 311.
26. *Ibid.*, 315.
27. Knapp, 44.
28. Shea and Hess, 321.
29. *FM 100-5 Operations* (Washington, DC: Department of the Army, June 1993), 2-3.
30. The idea for the title of this article came from Chapter 12 of the Shea and Hess book.

Editor's Note: The author of these vignettes, Colonel (Retired) Partridge, graduated from West Point in the Class of 1936 and served with the 179th Field Artillery Group, First Army, in World War II. He retired from the Army in 1965.

Cat and Mouse with Big Bertha. I was assigned to the 179th Field Artillery Group just as our forces came to a halt near the German border, at the end of our rat race across northern France. Our group was part of Seventh Corps Artillery and had some heavy artillery units attached, including 240-mm and 8-inch howitzer battalions. Our positions were generally just south of Aachen, Germany, and for a time, a good portion of our fire was directed on that city.

At this point, one of our forward observers (FOs) looking down on the city

from a position on a high ridge was having trouble locating targets in the midst of the huddled city. But then in a new twist in target acquisition techniques, he noticed that as occasional German soldiers scurried past a certain large building, they slowed and rendered the conventional "Heil Hitler" salute.

The building was a massive one and, with all the saluting, undoubtedly a headquarters of some importance, so the FO called for fire from an 8-inch howitzer, got a bracket and went into fire-for-effect.

The battle-weary 8-inch howitzer, "Molly," lived up to her widely recognized reputation for accuracy (despite worn slides and other aches and pains) and soon rounds were falling on the building almost room by room. At one point, one fire command was, "Just lean a little on the breech block to the left." This modest artillery action may not have brought about the capture of Aachen, but it surely dampened German enthusiasm for saluting.

Our fire apparently got the enemy's attention, for we soon began to pick up

counterbattery fire from a heavy artillery gun, something on the order of a 10-inch caliber. Many of the incoming rounds were quite accurate, so making shelling reports (SHELREPS) was a simple matter of stepping out the front door of the command post (CP).

Fortunately for us, the enemy apparently was using old (or sabotaged) ammunition that only broke into a few big chunks on impact. Each made a lot of noise and threw up a lot of mud, but otherwise the rounds were not very effective.

As for the SHELREPS, they all intersected on a railroad track to the east toward Cologne. What's more, the rays pointed directly to a railroad tunnel. We then were sure the gun was on a railway mount and, hiding in the tunnel, would come out to fire only for 10 minutes or so and then duck back into the tunnel. How then to take out "Big Bertha?"

Like good cats, we waited until the mice came out to play. When they did and incoming rounds began to catch our attention, we went after them with our 240-mm howitzer that had been waiting patiently, more or less cocked and ready.

Big Gun Vignettes

Fun and Games in WW II



We returned fire in short order—in fact, put rounds in the air even as Big Bertha's was coming our way.

A 240-mm round equipped with a variable time (VT) fuze can make an impression, a big impression. Apparently it did, for the German gun crew ceased firing and headed for that blessed tunnel. Thereafter, whenever the German crew ventured out again and started firing, we quickly ran them back into their hole.

The uneven duel continued for about seven days until the weary German cannoners suddenly remembered there was another, better end to the tunnel. We no longer heard the distant thudding noise that meant Big Bertha was firing at us, foretelling her incoming round would arrive in about 23 seconds. The cat and mouse game was over.

Betsy in Direct Fire. When our front lines moved forward and approached the German city of Duren, our GIs up front were stopped by the small but difficult Roer River. The entire First Army stopped to catch its breath and gather for a massive attack Army-wide.

At the onset of the attack, infantry units directly opposite Duren faced a severe problem. As they crossed the river, they would have to storm ashore right into a long red brick wall at the river's edge. As part of a huge factory complex, the wall was high and well built—a formidable obstacle. Could the artillery lend a helping hand? Yes, *indeed*.

We moved "Betsy," an 8-inch howitzer, well forward, emplaced her on the forward slope of a ridge and dug in her carriage to bring the muzzle down into direct fire position. At the right moment, we sent 8-inch shells thundering just over the heads of the hapless GIs and slamming into the wall in front of them.

It was duck soup. With some 15 rounds, we opened large holes along the wall, maybe 30 feet apart. The infantrymen were ecstatic. What promised to be a bloody attack against the wall turned out to be a Sunday picnic—relatively speaking.

Having completed our mission, we then sat and watched as the First Army front erupted into a stupendous time-on-target (TOT) barrage. Awesome, it was. The night was lit up as the guns began to fire, and we could see the flashes for miles on either side and hear

the increasing growl of hundreds of guns. Then, at the specified TOT moment,

the world shattered into bright yellow explosions across the enemy lines. No wonder the constant refrain found in letters of captured German soldiers was, more or less, "The American artillery is dreadful!"

When the sun came up, our infantry was doing well, but our FO reported two German soldiers had climbed to the top of a 150-foot-high brick industrial smokestack located in the factory yard. Could we discourage such unwanted observation? *Indeed*.

We unleashed Betsy once again, firing directly at the stack. The first round grazed the stack and the second round hit it squarely. We did not topple the stack but did put a big hole through it about halfway up.

Shortly, two German soldiers were seen making their way frantically down through the gaping hole. Being a softhearted fellow with a particular soft spot for forward observers (even enemy), I was secretly happy to see them reach safety before the tower was reduced to a pile of red bricks.

At the Artillery School, I don't recall learning about employing an 8-inch howitzer in the direct fire role. But as I watched that monumental artillery barrage earlier, I recalled my years at Fort Sill and thought pensively of the extraordinary display I was witnessing—a display of fearsome power, of old-fashioned tactics and techniques that had developed and germinated at Fort Sill over the years. As our troops clawed their way into Germany, Fort Sill know-how was in action, 5,000 grinding, begrudging miles away from Signal Mountain and Dodge Hill.

The Queen Monarch. A little later, after the Battle of the Bulge was won, our infantry and tankers raced forward toward the Rhine. The Third Armored Division was heavily engaged with German panzer divisions and was beginning to take them apart. Army headquarters feared that the remnants would escape across the Rhine over a bridge near the famous Cologne Cathedral.

Headquarters directed us to take the bridge under fire, but *not* to destroy it—just interdict the German troops and tanks and keep them from crossing it. The aim was to trap them on the west side of the Rhine where they could be surrounded. We were told also that we must not, repeat *not*, damage the

cathedral that was about 200 yards short of our target.

We cranked up a 240-mm howitzer and positioned it well forward—so far forward that a general officer stormed at us that we were in the way of his tank advance. That night we started firing, disturbing the sleep of the weary infantry who were not accustomed to the bellowing of such a big gun or to its enormous muzzle flashes across the dark sky. On into the morning, we put fire down on the bridge at brief but irregular intervals so the enemy would never be sure when it was safe to cross.

As it turned out, we accomplished our mission, keeping the German units from escaping across the bridge and saving it for our use while preserving the historical cathedral. Our 240-mm shells armed with VT fuzes ruined the Germans' whole day.

Finally, after crossing the Rhine, we turned north into the southern flank of the Ruhr Pocket. We knew that the morale of the surrounded Germans was low and set out to further demoralize them. We reasoned that the Germans would be huddled in and around the many German towns and villages in the pocket, so we put periodic air bursts using VT fuzes over every town or village our guns could reach. After two nights of such, we had reason to believe that our firing dismayed enemy civilians and soldiers alike and played a considerable part in the subsequent quick collapse of the German troops in the pocket.

There is a 240-mm gun squatting at the Artillery Museum at Fort Sill on the brow of the hill overlooking so many of the school buildings. In modern terms, it is ugly and ponderous. But for all that, the gun did what was asked of her—and more.

One wonders if, as she sits there, the old queen monarch nostalgically remembers the days when she was top gun. In those days, every time she spoke, the enemy listened. In those days when the enemy artillery went silent, her crew proudly painted yet another small symbol on her breech. Does she remember the young artillerymen who pampered her, pushed, shoved and nursed her across distant battlefields?

COL(R) Robert B. Partridge, FA
San Antonio, TX