

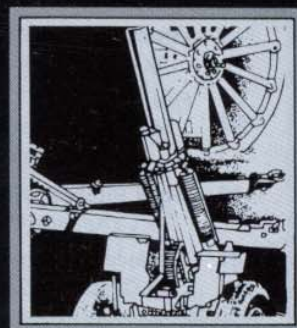

# Field Artillery

A Professional Bulletin for Redlegs

August 1990

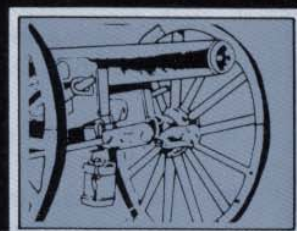
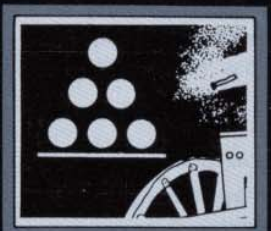
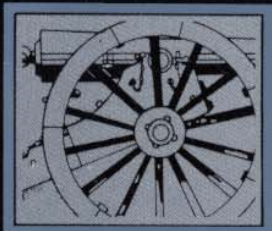
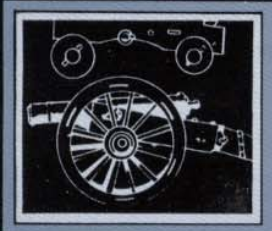

## Making History

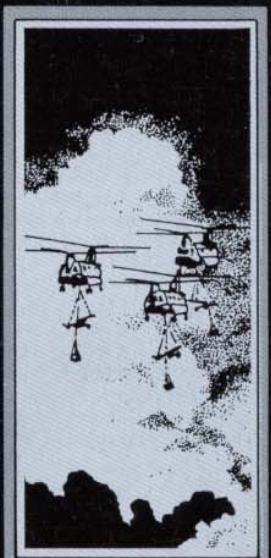
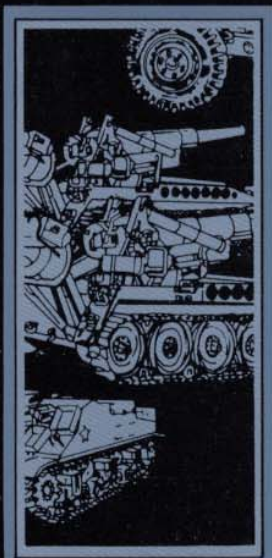
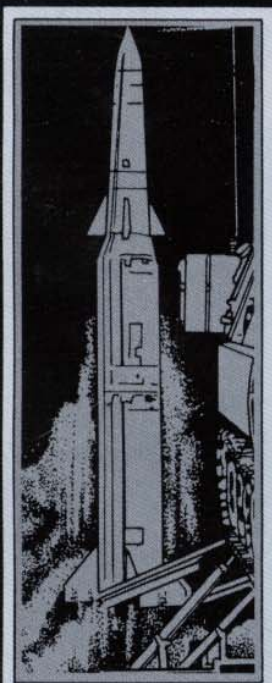



# Field Artillery

A Professional Bulletin for Redlegs

August 1990

HQDA PB6-90-4

## Articles

- 6 The Challenges of our Changing Times**  
Interview with General John W. Foss, Commanding General of the Training and Doctrine Command
- 9 The Evolving AirLand Battle-Future Concept**  
Summary of General Foss' New Airland Battle-Future Doctrine
- 12 *Der Durchbruchmueller***  
*by Major David T. Zabecki, USAR*
- 20 The Origins of Indirect Fire: Technology versus Tactics**  
*by Captain Joseph P. Nizolak, Jr.*
- 24 Battle in the Streets—Manila 1945**  
*by Major John Gordon IV*
- 30 Fire Support and Maneuver at Dien Bien Phu: Tragedy and Triumph**  
*by Captain Stephen L. Curtis*
- Fire for Effect***
- 36 Hope as a Motivator**  
*by Lieutenant General (Retired) Gordon Sumner, Jr.*
- 38 Molly Pitcher: Who Was She?**  
*by Constance M. McDonald*
- 41 Artillery Ammunition Resupply and Storage**  
*by Captain S.D. Thompson, Royal Canadian Artillery*

## Features

- 2 On the Move**
- 3 Incoming**
- 45 Redleg Review**

**DISCLAIMER:** *Field Artillery*—a bimonthly professional bulletin for Redlegs (ISSN 0899-2525)—is published by Headquarters, Department of the Army under the auspices of the US Army Field Artillery School, Fort Sill, OK. The views expressed are those of the authors, not the Department of Defense or its elements. *Field Artillery's* content doesn't necessarily reflect the US Army's position and doesn't supersede information in other official Army publications. Use of news items constitutes neither affirmation of their accuracy nor product endorsement.

**PURPOSE** (as stated in the first *Field Artillery Journal* in 1911): *To publish a journal for disseminating professional knowledge and furnishing information as to the Field Artillery's progress, development and best use in campaign; to cultivate, with the other arms, a common understanding of the power and limitations of each; to foster a feeling of interdependence among the different arms and of hearty cooperation by all; and to promote understanding between the regular and militia forces by a closer bond; all of which objects are worthy and contribute to the good of our country.*

**SUBSCRIPTIONS:** May be obtained through the US Field Artillery Association, P.O. Box 33027, Fort Sill, OK 73503-0027. Telephone numbers are AUTOVON 639-5121/6806 or commercial (405) 355-4677 or 355-8745. Dues are \$16.00 per year (\$31.00 for two years and \$46.00 for three years) to US and APO addresses. All others add \$9.00 per subscription year for postage.

**SUBMISSIONS:** Mail to Editor, *Field Artillery*, P.O. Box 33311, Fort Sill, OK 73503-0311. Telephone numbers are AUTOVON 639-5121/6806 or commercial (405) 351-5121/6806. Material submitted for publication is subject to edit by the *Field Artillery* staff; footnotes and bibliographies may be deleted due to space limitations.

**REPRINTS:** *Field Artillery* is pleased to grant permission to reprint articles. Please credit the author and *Field Artillery*.

**POSTMASTERS:** Second-class official mail postage is paid by the Department of the Army at Lawton, OK 73501. Send address changes to *Field Artillery*, P.O. Box 33311, Fort Sill, OK 73503-0311.

## Field Artillery Hotlines

- Unit Training Hotline—AV 639-5004 or (405) 351-5004; ARTEP, AMTP, SQT, MQS, TEC and ACCP.
- Redleg Hotline—AV 639-4020 or (405) 351-4020: NTC, JRTC and Other Artillery Subjects.

## Corrections to the April 1990 *Field Artillery*

- On Page 10 of the article "What Role for Artillery in LIC or MIC?" the photograph is not an M1946 152-mm howitzer as stated in the caption; it's a picture of a Soviet M46 130-mm gun.
- On Page 29 of the article "The Battle for Jafna: Artillery Lessons Learned," the picture is of Pakistani M109A2 howitzers instead of Indian 130-mm self-propelled guns as the caption states.

By Order of the Secretary of the Army:

**CARL E. VUONO**

General, United States Army  
Chief of Staff  
Official:

**William J. Meehan II**

Brigadier General, United States Army  
The Adjutant General

**Raphael J. Hallada**

Major General, United States Army  
Field Artillery School Commandant

## Staff

### Editor:

Major Charles W. Pope, Jr.

### Managing Editor

Patrecia Slayden Hollis

### Art Director:

Donna Jeanne Covert

### Assistant Editor:

Joanne Alexander Brown

*Field Artillery*



## Forging Military Realities

If you take nothing else from this edition of *Field Artillery*, you have to see the need to shift trails rapidly—to isolate the critical issues associated with today's crises and apply innovation, the lessons of history and personal experience to forge a new military reality. Our truly great leaders have always done just that, as the articles that won the US Field Artillery Association's 1990 History Writing Contest amply demonstrate. Unfortunately, we have not always considered what history clearly indicates. Frequently, we run to what is familiar and comfortable instead.

If we had learned the lessons of Manila in 1945, we might have made certain our soldiers had concrete-piercing fuzes to take with them to Panama. Had we the passion for excellence and tactical and technical competence of Lieutenant Colonel Georg Bruchmueller, some of our units wouldn't be rediscovering the need to get back to the basics of fire planning and direction at our Combat Training Centers. And if we don't apply the sum of our current knowledge and innovative thinking to the shaping of AirLand Battle-Future, we'll fail to capitalize on the technological advances being made today.

The Field Artillery community is indebted to the fine writers and distinguished judges who participated in the History Writing Contest, to the US Field Artillery Association for making it possible and to General John W. Foss, Commander, Training and Doctrine Command, for putting his emerging AirLand Battle-Future concept under the scrutiny of our open forum in his interview with us. This edition allows you, the reader, the unusual opportunity to apply the lessons of history directly to our Army's concept of future warfare.

Editor

### Judges of the 1990 History Contest

The US Field Artillery Association thanks the following expert historians for judging this year's submissions:

- **Lieutenant General (Retired) David E. Ott**, author of articles for various publications and the book *Field Artillery, 1954-1973*, part of the Department of the Army Vietnam Studies Series. General Ott fought in three wars and was the Commanding General of Fort Sill, Oklahoma, and VII Corps, West Germany. He holds a master's degree in International Affairs from George Washington University, Washington, D.C., and is a graduate of the Advanced Management Program, Harvard University, Boston, Massachusetts.

- **Colonel Robert H. Scales, Jr.**, author of several historical articles and the book *Firepower in Limited Wars*, released in May. Colonel Scales is Chief of Staff of Fort Sill; he gave up command of the Field Artillery Training Center, Fort Sill, in June. He holds a doctorate in history from Duke University, Durham, North Carolina.

- **Colonel Richard M. Swain II** is the author of several historical articles and Director of the Combat Studies Institute, Command and General Staff College, Fort Leavenworth, Kansas. Colonel Swain commanded the 2d Battalion, 28th Field Artillery, 210th Field Artillery Brigade, West Germany. He earned his doctorate in history from Duke University.



### Contest Winners

**First Place:** "*Der Durchbruchmueller*" by Major David T. Zabecki, USAR

**Second Place:** "The Origins of Indirect Fire: Technology versus Tactics" by Captain Joseph P. Nizolak, Jr.

**Third Place:** "Battle in the Streets—Manila 1945" by Major John Gordon IV

**Honorable Mention:** "Fire Support and the Maneuver Commander at Dien Bien Phu: Tragedy and Triumph" by Captain Stephen L. Curtis

### Upcoming *Field Artillery* 1991 Themes

Month	Theme	Copy Deadline
February	Artillery in Heavy-Light and Light-Heavy Operations	1 October
April	Light Fighters and Low-Intensity Conflict	3 December
June	Molding the Modern Field Artillery*	4 February
August	History: Fire Support in Combined-Arms Operations	Contest: 4 February** Regular: 2 April

\* The theme will cover new force design, unit deactivations, movement of units and equipment, redefined threat, etc.

\*\* See the History Writing Contest rules on Page 29.



# On the Move

MAJOR GENERAL RAPHAEL J. HALLADA

*The only thing new  
in the world is the  
history you don't know.*

Harry S. Truman  
1884-1972

## Setting the Stage for the Future

It's easy to see the tremendous changes in Eastern Europe but hard to remember the particular contributions leading to them. So many mundane events of the past have led to the extraordinary future. Even today, the political alignment of a unified Germany is under consideration when a year ago the concept was unthinkable. These and other events are all making history.

Unfortunately, some of us ignore that which has gone before. Some of us might even say history isn't important. There are those who would say our world is too complex today to follow antiquated rules devised in forgotten times. However, in the context of today's rapidly changing world, the insight provided by an appreciation of history is more important than ever before.

## History's Challenge

The reexamination of history is a challenge. And for military professionals, studying history is essential. Only the terrible defeats and great triumphs of history will illuminate the reasons behind failure and success. If we don't use history as a valuable tool, we can't benefit from the experiences of great warriors who have established our legacy.

*Human history becomes  
more and more a race  
between education and  
catastrophe.*  
H.G. Wells



MAJ Charles W. Pope, Jr.

## History for Today

The tenets of modern warfare and the concepts of joint and combined operations, massing fires and others are all based on important lessons from the past. But at places such as Chancellorsville, the Little Big Horn, and twice in the Ardennes, we forgot those lessons and the fact that deception was a combat multiplier and could even be the key element in victory or defeat.

At Gettysburg and Omaha Beach, we witnessed the need for flexible fire support. Yet we failed to apply several of these lessons in the hills of Korea and the paddies of Vietnam.

We no longer can afford to ignore our past. We must apply the principles it teaches us and its hard-learned lessons to focus and fine-tune our efforts, or we'll again pay dearly for our actions.

The study of history, military or otherwise, can help us understand the courses of action we should take. History may not repeat itself totally, but it should be a guide for today's decisions.

## History for Tomorrow

In this era of emerging world peace, we must be mindful of the conditions of change. The recent changes in Eastern Europe require us to look again at our direction and verify our azimuth.

The future battlefield promises to be unlike anything we've ever known.

We must embark on a path reflecting the lessons of history, one that makes sense doctrinally, and then train accordingly. To do that, we must invest time in study now to make wise decisions for the future.

## Tomorrow's Stage

Today, the US Army is more focused on worldwide contingencies and better prepared to accomplish its mission anywhere. We've applied technology and trained and led our forces well in a world with rapidly changing politics. But the requirement to study the past and prepare for the future has never been greater, and we must take advantage of every opportunity available. Staff rides, battle studies, reenactments and history discussions all enhance our understanding.

Just as many a lonely soldier has questioned his purpose as he stood watch over the Fulda Gap, we must evaluate ours. More importantly, our actions, like his, set a chain of events in motion. However insignificant some may seem, they set the stage for tomorrow. Our survival and future demand our attention to the past.

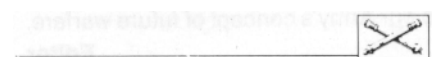



# Incoming

LETTERS TO THE EDITOR

## M113 Platoons to Have Mixed Weapons

It might be of interest to the self-propelled Field Artillery units in the Army that, according to the May-June 1990 "Infantry Notes" in *Infantry* magazine, the Infantry is planning to convert the armament of its armored personnel carrier M113-equipped platoons from four .50

caliber heavy-barrel machineguns, or HBMGs, (one per M113) to two .50 caliber HBMGs and two Mk-19 40-mm high-velocity grenade launchers.

This is similar to what I recommended in my article "Defending the Battery," published in the May-June 1979 *Field Artillery Journal*.

I wonder if the Artillery will ever see such a mix of weapons for platoon or section defense?

MAJ Larry A. Altersitz, FA  
NJARNG  
New Jersey Military Academy

## Artillerymen, Seize the Moment

Two events, *Glasnost* and the Gramm-Rudman Act, will cause history to repeat itself during the last decade of the 20th century. That is, the Army will be reduced in size. Imminent budget cuts and arms control treaties, the fruit of such events, will shrink the number of Army personnel and programs. Prudence and frugality will be future watchwords of professional artillerymen. The optimist can seize this moment to suggest healthy change. The cynic will dry on the vine.

One change certain to save money and improve fire direction involves the battalion fire direction officer (FDO). Currently, this position requires a first lieutenant or captain from the battalion. He receives training on temporary duty (TDY) at the Tactical Fire Direction

System (TACFIRE) Course at Fort Sill, Oklahoma. Travel, lodging and school expenses are high. Upon completion, he serves as an FDO for an average of six to 10 months. At most, the commissioned officer has time to learn the job and establish a TACFIRE training program. Then, the inefficient cycle starts again.

A more cost-effective solution is to assign a warrant officer as the battalion FDO. After initial schooling, he could serve for three years as an FDO in one battalion before changing station. Fewer expensive TDY trips will have to be made to the TACFIRE Course. Also, tactical and technical competence would rise to new levels. Battalion TACFIRE training would be more continuous and effective. I submit the above as one example of prudent and

frugal change in artillery.

We all can make the impending "shrinking process" less painful with similar suggestions. Deleting the ineffective SQT [skill qualification test] system, re-establishing mess hall KP duty, returning a large portion of personnel services to the battery level and changing the "up or out" policy for career enlisted are other examples.

The dollars saved from such changes could enlarge Army procurement, research and, most important, personnel accounts. Let's put on our thinking caps and seize the moment.

1LT John Knier, FA  
C/3-29 FA  
Fort Carson, CO

## Standardized Gunnery Training

Field Artillery units approach artillery gunnery similarly to the way many units approach small-arms marksmanship. The standard approach is to ensure crews or individual firers know how to operate their weapons safely, then put them on the range to qualify. If soldiers do not qualify on their individual weapons, the unit's response is often to return soldiers to the range and let them try again without any specific training to correct shooting problems. This approach is taken for several reasons: first is the relative abundance of small-arms ammunition, and second is the time constraints on ranges, which in many cases allows only time for firing, prohibiting any of the training outlined in *Field Circular (FC) 23-11 Unit Rifle Marksmanship Training Guide*.

Unfortunately, in the case of Field Artillery gunnery, the same technique is

used too often to train cannon crews. Conditions are different and would indicate a different approach is necessary. Range time is somewhat more available while there's less training ammunition available. Cannon artillery weapon systems are allocated a number of per-tube rounds in the strategy outlined in *DA Pam 350-38 Training Standards in Weapons Training* to meet artillery requirements. Armor and Bradley units also are allocated rounds systematically. But, the number of rounds is related to specific gunnery events and tables that are tied to crew, section and platoon specifications. There is no comparable qualification system for cannon artillery.

### Qualification Gates

Current section qualification procedures for artillery units differ greatly from section or crew

qualifications for armor and infantry units. Maneuver units must pass through various gates before moving to qualification at crew, section and platoon levels.

Examples are Tank Table (TT) IV for basic crew gunnery skills with machinegun tables and preliminary gunnery tables V-VII for tank units. The basic qualification table is Tank Table VIII (TT VIII). TT VIII is the first gate soldiers must pass through before moving to section and platoon gunnery skills in the higher tables. Tank Table XII is the basic qualification table for platoons. Bradley units have similar tables.

Tank Table VIII outlines the tasks, conditions and situations under which a target would be engaged and standards for the engagements in terms of time and accuracy. This is a first key gate for tank and Bradley

units' live-fire gunnery program followed by the platoon gunnery Tank Table XII, the second gate prior to participating in the combined-arms, live-fire exercise (CALFEX). This process is outlined in USAREUR [US Army Europe] Regulation 350-1 for units in USAREUR. This training strategy is a total-gunnery program that runs from tank-crew qualifications through a CALFEX. In addition, the FC contains tests for the crew that are similar to those found for cannon units in *FM 6-30 Observed Fire Procedures*.

Artillery units, on the other hand, have no gates they must pass through before firing at the platoon or battery level. In comparing the artillery qualification to armor and infantry tables, artillery units begin their training at the Tank Table XII level. There is no real live-fire qualification at the section level; the qualification is, at best, at the platoon and battery levels. This current process allows units to "qualify" and demonstrate proficiency at the higher levels but leaves out a measure of proficiency at the section level.

Many commands, such as VII Corps, require a certification of sections using the qualification test in *FM 6-50 Field Artillery Cannon Battery*, but this is done usually in a non-firing environment. Since the basic firing element for the artillery is the platoon, it is possible for artillery to require similar gates to be passed through before firing.

## Artillery Gunnery Program

It is time for the artillery to develop a live-fire gunnery program that begins with gates at the section level before firing at the platoon and battery levels. This series of qualification tables would include all weapon systems available to the cannon section, including both the howitzer and the ammunition carrier.

Initial gunnery tables for artillery would include the requirement for individual sections to pass a qualification test as part of the firing requirements at the major training areas (MTAs). The impact of this would be that sections could go as much as six months with an unqualified section until they get to the MTA to conduct section qualification.

In USAREUR; for example, the three-week density at the MTA would have to

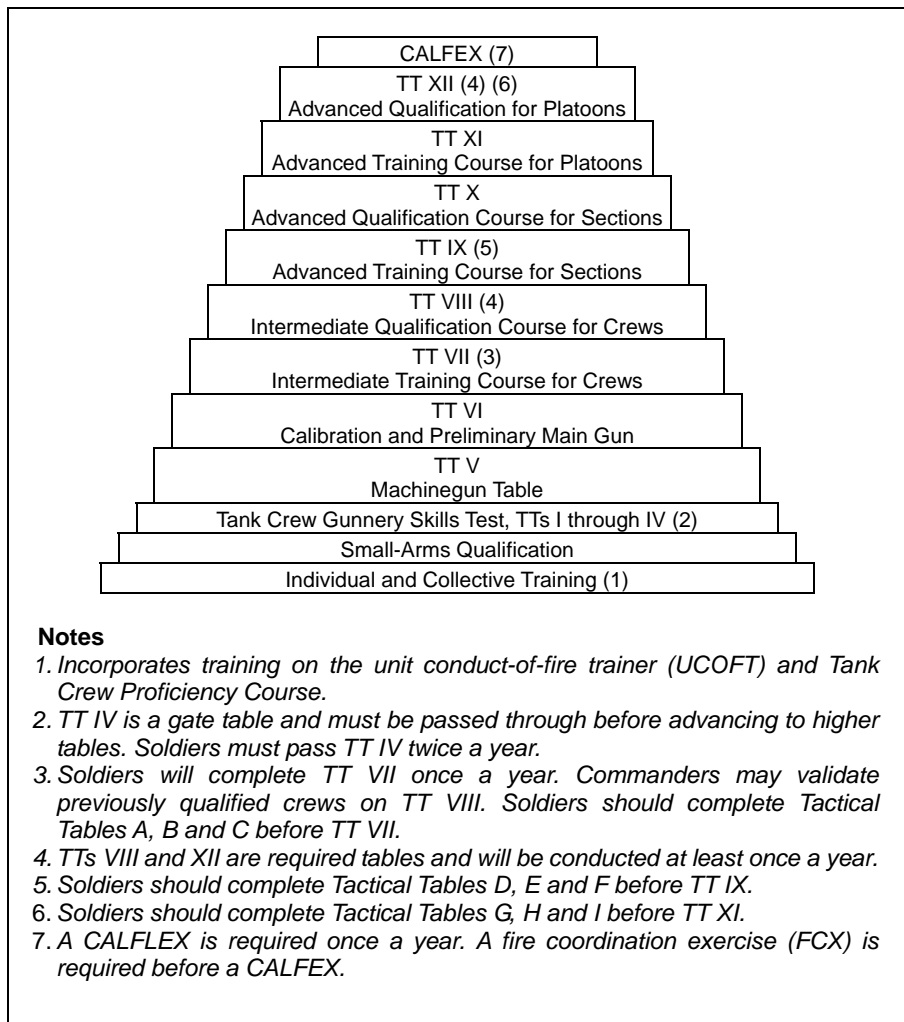

Tank Gunnery Training Program, USAREUR Regulation 350-1

be conducted similarly to those of maneuver units. Crews would have to qualify during the first week of the density and proceed to platoon-level exercises the second week with the ARTEP [Army training and evaluation program] either at the battery or battalion level the last week.

As with tank gunnery, a point system could be developed and, to some degree, already exists in *FM 6-50*—specifically those indirect-fire and direct-fire tasks required in the cannon section evaluation. Specific requirements include 20 rounds of ammunition (four missions at five rounds each) with at least one TI [time], one VT [variable-time] and two PD [point-detonating] fuzes. The direct-fire tasks would require four rounds. In Europe, possible locations exist at the Grafenwoehr Training Area (GTA) to conduct both indirect and direct firing at current ranges and firing positions.

As an additional task requirement, machinegun qualification could be conducted similarly to the tank and Bradley machinegun tables on ranges. This would include howitzers and ammunition carriers as part of the crew qualification. The crew qualification at home station still would take place at local training areas, but actual certification would be conducted at the MTA.

Additional standardization of the certification process will require some modifications on ranges normally used to conduct direct fire. These would include adding moving targets to the ranges. This may require additional ammunition for training, but careful use of ammunition may, in fact, reduce the number of rounds required during platoon, battery and battalion training because the gun sections will demonstrate some proficiency during section qualification. The FDCs [fire direction centers] will benefit from and

could qualify through this process because of the requirement to process 16 missions (4 guns x 4 missions).

Platoon qualification would be conducted as a part of the battery or battalion ARTEP/SEE [standardized external evaluation]. This qualification process would emphasize crew training and serve as a definite gate for firing as is currently done at the MTA.

### Actions Required

For this qualification of cannon sections to take place, action would be required of the Field Artillery School Fort Sill, Oklahoma!. It must—

- Prepare a series of howitzer tables for machinegun ranges and a table for indirect-fire and direct-fire tasks at the section level.
- Identify ammunition requirements for caliber .50 machinegun and main gun rounds and compare them with the current STRAC [standards in training committee] training strategy.
- Identify targeting requirements, to include range design for moving targets. The design could be incorporated into a standard range design for all units. Scoring for this event could be arranged as it is

for tank and Bradley gunnery. Some units have used such a process to identify their best section or have base-piece shoot-offs in competition at an MTA. This implies that to really determine the effectiveness of a gun section, it must be looked at under firing conditions rather than by qualification through written tests.

### Qualification Program Benefits

The reason to change our current method of doing business is twofold. First, it gives leaders a method to measure section performance. While leaders have many methods to examine section performance, the true method of evaluating performance is through firing.

Second, it provides an indicator of overall section capability and a minimum level of performance required of sections before they can meet platoon performance requirements. Current mission training plans focus on time and actions. Accuracy issues, for the most part, are oriented at the platoon, battery and battalion levels. The missing element from evaluations is a standard, measurable firing event for all howitzers Army-wide.

This method, if adopted, could result in

changes in ARTEP/SEE administration and also holds the section chief responsible for section performance. The ARTEP/SEE would focus on the battery or battalion to provide fires and support maneuver.

### By Design, Not by Chance

Our current gunnery program at the section level is still conducted similarly to the small-arms qualification program mentioned earlier. Our sections are successful, but it appears to be by chance rather than by design. Our gunnery training strategy should be developed down to the howitzer section level.

The Armor and Infantry Schools' training strategies focus on an individual tank or Bradley to kill enemy tanks and vehicles, and the requirement for accuracy is no less important for artillerymen. We must achieve the appropriate training benefit from each training round fired in terms of providing qualified gun sections, batteries and battalions.

MAJ Stephen P. Walsh, FA  
210 FA Bde  
West Germany

## Murphy's Laws of Combat

1. If you're short of everything except targets, you're in combat.
2. Anything you do can get you shot, including doing nothing.
3. Incoming fire has the right of way.
4. Don't look conspicuous, it draws fire. Corollary: If you look conspicuous, try to look unimportant because the bad guys may be low on ammo.
5. No plan survives the first contact intact.
6. If the attack is going really well, it's an ambush.
7. The enemy diversion you're ignoring is the main attack.
8. The important things are always simple—the simple things always hard.
9. If the enemy is in range, so are you.
10. Never forget your weapons were made by the lowest bidder.

*Anonymous*





General John W. Foss, Commanding General of the Training and Doctrine Command

# The Challenges of Our *Changing Times*

Interview by Major Charles W. Pope, Jr., Editor

*With our reduced force structure, how do we make the AirLand Battle-Future concept work? [See the article "The Evolving AirLand Battle-Future Concept" on Page 9.]*

Well, we have to know where the enemy is. Otherwise, we'll be out there flailing around and dispersing forces to fight an enemy that may not be there. That's the key—knowing where the enemy is. You want to gain and maintain the initiative, which is absolutely critical in battle. You don't want to sit and wait for him to come to you.

You want to use technology to find and attack your enemy. If you do that, you'll have the capability of pulling back and reconstituting. Otherwise, you'll end up committing yourself to a piece of ground that may or may not be important and not focusing on the enemy force, which obviously is going to be important. It won't be easy.

*What are fire supporters' most serious challenges on the non-linear battlefield in AirLand Battle-Future?*

The most serious challenge always is being on-time and accurate with fires. And part of that challenge today is determining how we move from a very structured battlefield [linear] to an essentially unstructured battlefield [non-linear] and how your relationship with others changes.

At times, you may be forced into a linear battle, and then, of course, the battlefield will be structured much as it is today. Others will end up fighting the non-linear part of it—another corps. But you prefer not to get locked into a long attrition battle. You prefer to fight the enemy on his flanks and rear, and then you won't lose.

In the past, you've trained for a linear battlefield; your fires were requested by

---

***What we're going to see . . . is the corps commanders initiating and controlling much of fire support.***

---

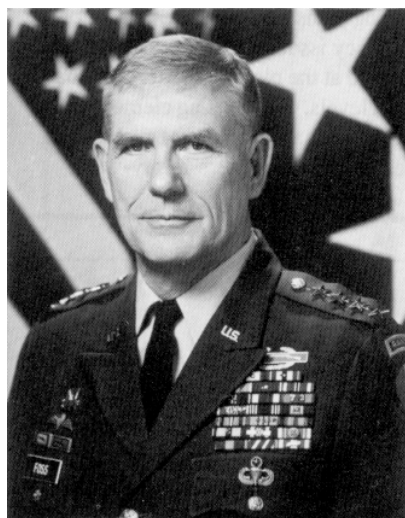

the forward forces from the division artillery and reinforced or weighted by the corps artillery. What we're going to see, especially with the long-range capabilities coming into the artillery, is the corps commander's initiating and controlling much of fire support. He now has the intelligence and the long-range systems to do that. Those relationships will change a bit. So, I think the mindset about those relationships has to change.

*With much of the logistical support to reside at the corps level and knowing that Field Artillery consumes about 80 percent of the Army's ammunition, how do*

*we resupply our units smoothly, given longer lines of transport and communications?*

You see, we've always had a cumbersome logistical system. By cumbersome I mean non-participatory and unmanaged. We stack up supplies, and soldiers with their own vehicles go back and pick them up. Everyone has to have his own vehicle. What we have is a lot of redundancy in the operation. When you have very expensive munitions and fewer of them, you can't afford that kind of redundancy.

We've put a lot of money into automation and communications. We now have a touch-tone dial capability to call back to the corps support command. We've invested in automated fire control systems that allow the corps artillery commander to know who's shooting where. He can have the round-count fast.

We now also have the opportunity to invest in a logistical system that will do the same thing without putting Field Artillerymen on the road. And we're not talking about great distances. We're talking about the distance from the corps to the brigade—internal distribution.

So the artillery—which tells Infantry and Armor, "Not to worry, I'll give you fires when you ask for them, just ask for them"—should have the same confidence in logisticians. If nobody trusted anyone, you'd find the artillery still up front as an organic part of Infantry and Armor units. There used to be a cannon company in the infantry regiment in World War II.

I saw units in Vietnam where they didn't have confidence in Field Artillery and, therefore, didn't use fire support. And when they were in a tough spot, they fought a tough infantry battle without fire support and took a *lot* of casualties.

***It's going to be a less orderly battlefield for the battery commander. . . . [with] a lot of the "messiness" of the maneuver commander.***

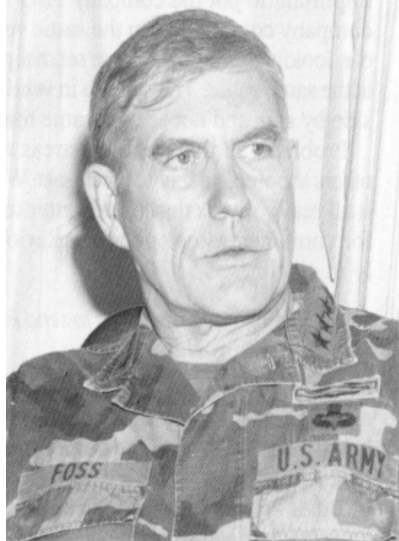

Sam Orr

Some artillerymen aren't comfortable with this new resupply concept. You talk to infantrymen about giving up some of their mortars, and they are uncomfortable about that. All of us need to look beyond our comfort zones.

*As you see it, will there be new roles for the battery-grade Field Artilleryman?*

Everything's going to get tougher. When you open up the playing field and you open up the game, the individual and leadership demands are going to be greater. It's going to be a less orderly battlefield for the battery commander. He's going to find he has a lot of the "messiness" of the maneuver commander. And he's going to find he has plenty of challenges requiring a lot of initiative. This is all the result of the changes on the battlefield over which we have no control [the changing threat and diminishing resources].

*Programmed modernization is critical, and we're looking at long-range instead of short-range systems. What's the most critical element of our modernization plan in your estimation?*

What is critical is our understanding of the threats we face worldwide—not just the Soviet threat, which has certainly lessened but not gone away. That has to be clear to the Department of the Army,

the Secretary of Defense and the Congress. Then we'll take fewer but more important steps in modernization.

You see, for years we've had a program in which every system had a little fix-up after it got going, the product improvement program or PIP. We can't afford that anymore, unless it's a significant improvement. If you go from an M109 howitzer to a HIP, an improved howitzer, you get that kind of significant effect. We have to wait until we can have that same kind of effect on the battlefield. But we want to stay ahead in technology.

We'll have fewer system starts and finishes. But I hope we'll put our money on the right systems, so we'll have much greater capabilities.

*Are there any systems that are pivotal?*

In the debate about the HIP versus the future advanced Field Artillery system-cannon [AFAS-C], the issue is which one to buy, in what quantities and when. Such decisions have always been threat-driven. Now we have to make sure that as we do our R&D [research and development], we know and understand the threat and are fairly confident we aren't going to drop behind.

*Will the threat scenarios for the Combat Training Centers, simulation training, etc., change?*

Yes. The scenarios are based on the real world, and the real world is changing. Right now, units train for their current wartime missions because negotiations with the Warsaw Pact have not yet been completed. But I think we'll see them change very soon.

We face many dangerous areas. We're going to have some people focusing on a less dangerous Europe but still a Europe with a lot of problems. Others will focus more on contingency operations, such as those that might be necessary in either Latin America or the Middle East. We still have soldiers on peacekeeping duties in the Middle East—not many people know that we have an active-duty battalion in the Sinai Desert with support units. We still have soldiers in the Persian Gulf and Syria, along with some Navy elements. The Mid East is a dangerous area with many challenges.

There are problem areas around the world affecting our country as a world power that could call for us to do a variety of things. What we have to do is make sure we're trained to accomplish all sorts

of tasks. We'll go through a process in which the CINCs [commanders-in-chief] will define their threats, based on the changes taking place, and all else will evolve from their analyses.

One thing we've already started to do at TRADOC [Training and Doctrine Command] is change the way we look at combat. We've changed from close combat light and close combat heavy—an artificial break, and not the way people will go to war—to combined-arms low-intensity and

***. . . the CINCs will define their threats, based on the changes taking place, and all else will evolve from their analyses.***



Sam Orr

combined-arms mid- to high-intensity. As we saw in Panama, we had heavy forces in an essentially low-intensity situation. We had Sheridans [armored reconnaissance vehicles] out of the 82d [Airborne Division, Fort Bragg, North Carolina], we had a mech battalion out of the 5th Mech [Mechanized Infantry Division, Fort Polk, Louisiana], and we mixed those forces very well with light and special operations forces. So, we're going to be looking at intensities of war, not the weight of the combat vehicle in which one fights or rides.

*What kind of role do you see for Field Artillery in low-intensity conflict (LIC)?*

Operation Just Cause [Panama, December 1989] after the short initial battles the first night was essentially a fight against a relatively smaller force in a heavily populated area. We didn't have the opportunity to use the fire support we could

use in a more open area. We had constraints on the artillery, and that could possibly happen again if we have to go into built-up areas such as Beirut or the Dominican Republic as we've had to in the past.

But there are many places we'll want the command and control aspects of fire support in LIC, not only for artillery howitzers, but also for the other kinds of firepower it can bring to bear. We'll need precise weapons that can hit one building without hitting other things, whether they're attack helicopters, tactical air or other assets.

Or, if we are in a more open area facing a relatively low-level threat that has great mobility, then of course, we'll want to be able to use Field Artillery very discretely too. But the fire support network is always going to be there.

---

***... there are many places we'll want the command and control aspects of fire support in LIC, not only for artillery howitzers, but also for other kinds of firepower it can bring to bear.***

---

In many cases, the contingency forces won't take the entire battery with them. We took four-gun batteries down to Honduras in 1988, and that worked very well. We took a small number of batteries down to Panama, though they fired very little. But we had them there if we needed them, and we made maximum use of the fire support channels.

The 82d Div Arty [division artillery] trains all the time with the Marines' ANGLICOs [air and naval gunfire liaison companies], Naval gunfire and with the Air Force and Navy air. The Div Arty knows its light contingency forces depend on its expertise and efficiency in calling in the firepower available.

*As we reduce our force structure but still have to be prepared to accomplish low-, mid- and high-intensity missions, what training should Field Artillery units focus on?*

First, the artillery already does many things very well. But what we're finding at the Combat Training Centers is we haven't invested enough time in training on the fundamentals, and that shows up right away, just as it would in combat. It's absolutely critical we invest in the

---

***If the FSO and maneuver commander aren't totally in tune, they'll fight two different battles at two different rates . . . which is why it's so important to put [them] in the same vehicle.***

---

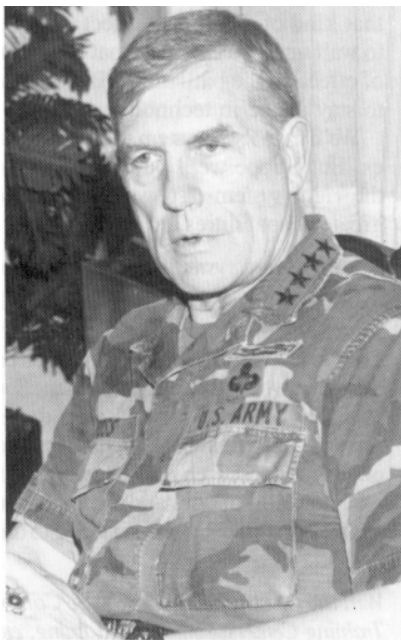

Sam Orr

fundamentals by training the crews on the guns, the fire direction people and so forth, so they know their jobs very well.

The other thing that shows up very quickly is whether you trained by yourself or with the maneuver element forces that're going to use you. If you don't train with maneuver elements, it's like putting all the quarterbacks together throwing passes to each other and all the ends together throwing passes to each other. Then you wonder when they get in the game, why it doesn't work out very well.

---

***More artillery commanders need to get the maneuver forces involved in setting the pace of their fires.***

---

More artillery commanders need to get maneuver forces involved in setting the pace of their fires. Because when you go to a Combat Training Center or war, the pace of fires will be set by somebody else. It's a mental agility thing. It's always training to the highest standard along with those with whom you're going to fight.

Another area critical to our success is being sure we're all fighting the *same* battle. If the fire support officer [FSO] and the maneuver commander aren't totally in-tune, they'll fight two different battles at two different rates. We won't be able to mass on target—which is why it's so important to put the company FSO and company commander in the same vehicle, looking through the same set of sights at the same battle. They can be in vehicles side by side and not see the same thing.

Problems in these critical areas and others show up quickly in rehearsals. What it all really says is that you'd better train for combined-arms operations seriously at all times.

*What message would you like to send Field Artillerymen worldwide?*

The Field Artillery has great challenges and a great future. The Field Artillery has always been one of the best branches in the US Army. You've been admired by other armies for your capabilities on the battlefield and your vision of what you can do. You've also been admired for your Field Artillery traditions. As we move toward the more demanding challenges on the horizon, you need to balance your vision and traditions and not get the two mixed up.



**General John W. Foss, commands the US Army Training and Doctrine Command (TRADOC) that has its Headquarters at Fort Monroe, Virginia. In his more than 40 years of service, he has commanded eight units, including the 3d Infantry Brigade, 1st Cavalry Division, Fort Hood, Texas; the Infantry School and Fort Benning, Georgia; and the 82d Airborne Division and, then, XVIII Airborne Corps, both at Fort Bragg, North Carolina. General Foss served two tours in Vietnam and tours as Chief of the Joint US Military Command in the Philippines; and Deputy Chief of Staff for Operations, Department of the Army, and simultaneously as the Senior Member of the Military Staff Committee of the United Nations, both in Washington, D.C. He has served in various positions with the 4th, 7th and 24th Infantry Divisions and for three and one-half years in combat developments at Headquarters, TRADOC. General Foss earned the Master US Parachutist Badge and was awarded the British, Philippine, Honduran and Egyptian Parachute Badges while completing more than 300 military jumps.**



# The Evolving AirLand Battle-Future Concept

The following information is a summary of General John W. Foss' "AirLand Battle-Future: An Evolving Concept," 28 February 1990, and his briefing "Challenges for the Field Artillery," given 26 April 1990 at Fort Sill, Oklahoma. General Foss is the Commanding General of the Training and Doctrine Command (TRADOC), Headquartered at Fort Monroe, Virginia.

## Threat Trends

- **Old.** The Soviet force is growing smaller but is continuing to modernize and is still a highly capable threat.
- **New.** Terrorism and narcotics continue to emerge as significant threats. Chemical weapons are proliferating in many countries.
- **Sophistication.** Technology has improved worldwide. Virtually every country will have relatively sophisticated equipment.

## Operational Trends

- **Regional Conflict and LIC.** The probability of a major conventional war is low, and the probability of regional conflict and low-intensity conflict (LIC) with some mid-intensity conflict is high.
- **Much Lower Density of Forces on the Battlefield.** We have fewer military-age personnel available in the US and Western Europe. The cost of maintaining a large modern Army is prohibitive. In addition, Arms Control Talks appear to be headed toward eliminating the great asymmetries that exist in conventional arms between the Alliances. If the Conventional Forces in Europe (CFE) agreement is approved and implemented, the US Army there will shrink to about 150,000 troops, equating to a robust corps.
- **Fewer Number of Systems Entering the Inventory.** The technology is available, but the complexity and cost of new systems will rise. Therefore, we must develop selected systems.

## Short-Term Certainties (1990-1994)

### We'll see more—

- Heavy-light and light-heavy (as opposed to separate heavy and light) operations and training.
- Emphasis on contingency operations and training.
- Emphasis on conventional warfare with special operations integration.
- Counternarcotics operations and taskings.
- Nation assistance support.

- Environmental pressures.
- Short-term modernization that has achievable results.
- Device-based training to protect the environment and save money.

### We'll continue to see—

- Combat Training Centers (CTCs) as the centerpiece of unit training.
- Leader development.

## Operational Conclusions

- **Non-Linear Warfare.** Even on the densest battlefield, concentrations of forces to reach operational objectives in one area will create gaps in another sector—a non-linear battlefield. Warfare will be rapid, fluid and tactically offensive. It will be more difficult to execute with greater inherent risk. Non-linear warfare doesn't exclude linear battles, when necessary.
- **Near-Revolutionary Knowledge of the Enemy.** Technological advances in intelligence sensors and processing are beginning to allow us to know where significant elements of the

enemy are and where he's going almost all the time.

- **Long-Range Lethality.** Technological improvements in weapons and target acquisition systems will allow us to engage the enemy at ranges in excess of 100 kilometers very accurately and lethally.

## Evolving Ideas

- **Sensors.** We'll use them instead of forces to locate, track and acquire the enemy.
- **Attack at Depth.** We'll attack the enemy at long range (100 kilometers) with air and surface assets.
- **Short, Intense Battles.** We'll disperse our maneuver forces out of the battle zone and quickly mass them and move them forward, when necessary. We'll force the pace of action with long-range fires or maneuver forces with supporting fires to fight short, intense, highly synchronized battles.
- **Organizational Flexibility.** We'll tailor our forces rapidly with the right mix for diverse missions.

## The Potential Future Force New Systems (Emphasis On)

- Reliable, accurate intelligence and target acquisition systems and reconnaissance capabilities.

## The Depth Array

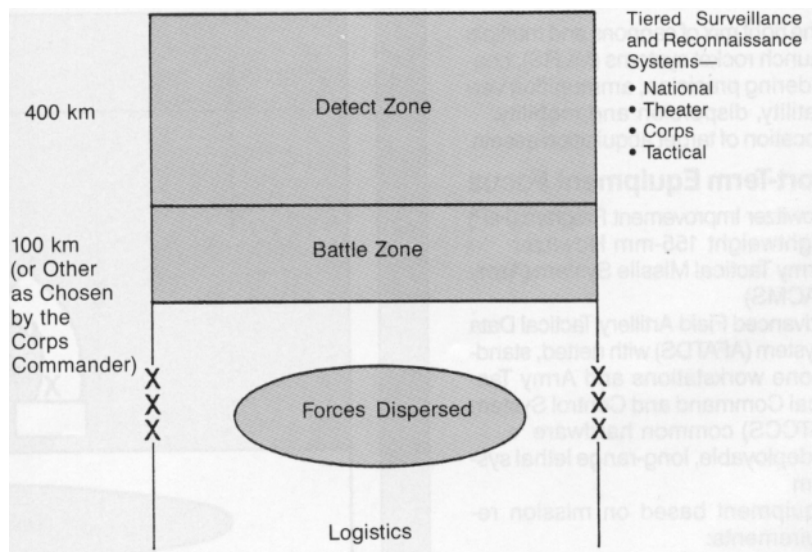

AirLand Battle-Future forces will disperse, mass, fight (highly synchronized, avoiding the grinding attrition battle), redisperse and reconstitute.

# Field Artillery Challenges in AirLand Battle-Future

## Operational Issues

- Increased Role of Corps Artillery.
- Increased Role of Field Artillery Brigade.
- Increasing importance of some roles for example:
  - Long-range fires can destroy enemy forces.
  - Field Artillery role in suppression of enemy air defense (SEAD) is key to exploiting aviation capabilities.
  - We still must win the counterfire battle.

## Combat Training Center Issues

- Synchronization of the battle—fire support planning.
- Massing all available fires.
- Timely fires—fire support execution by improving:
  - Control of the length of target lists.
  - Designation of a "shooter" for key targets.
  - Maneuver of fire support assets to ensure continuous fires on the enemy.
  - Update of the target list continually.
  - Synchronization of direct and indirect fires.
- Training on the *basics*—fundamentals and standards.

## Force-Structure Issues

- The right mix of cannons and multiple launch rocket systems (MLRS), considering precision, ammunition versatility, dispersion and mobility.
- Location of target acquisition assets.

## Short-Term Equipment Focus

- Howitzer Improvement Program (HIP)
- Lightweight 155-mm Howitzer
- Army Tactical Missile System (Army TACMS)
- Advanced Field Artillery Tactical Data System (AFATDS) with netted, standalone workstations and Army Tactical Command and Control System (ATCCS) common hardware
- A deployable, long-range lethal system
- Equipment based on mission requirements:
  - Long-range fires for more than Follow-on Forces Attack (FOFA).
  - Determine the role of nuclear weapons.

- Effective, efficient command and control systems.
- Highly lethal, long-range fire capabilities.
- Agile, lethal close-combat maneuver systems.

## New Tasks and Organizations

- **Corps.** Have the Corps find and engage the enemy at long ranges and task organize fire support and air assets to the divisions and their maneuver elements for the close

## Corps Range of Options

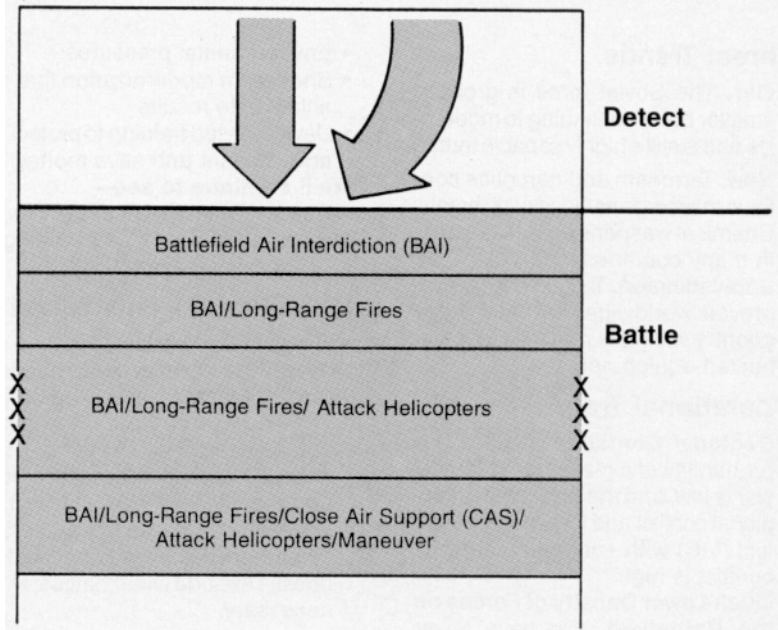

Intelligence and surveillance systems will allow us to know where significant elements of the enemy are and initially attack them with highly lethal, long-range fire support systems followed by an attack by the combined-arms maneuver forces.

## The Maneuver Fight

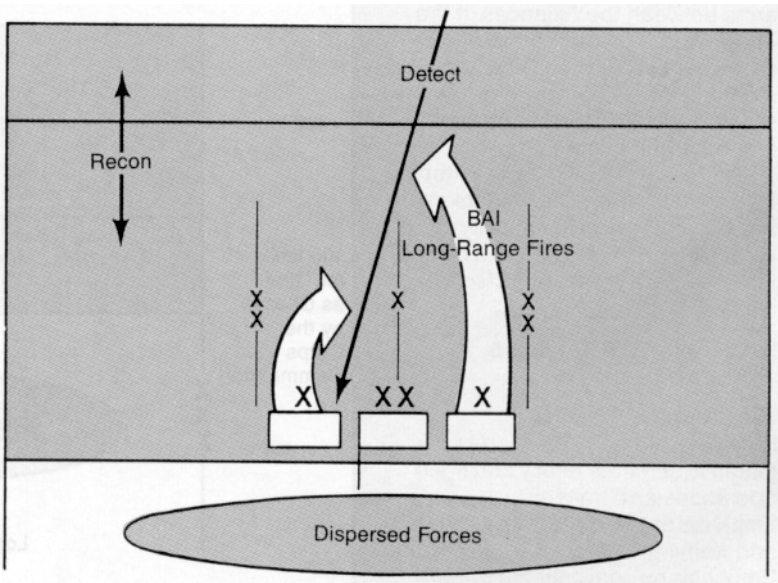

The combined-arms brigade will avoid "head-to-head" confrontation and will attack the enemy on his flanks and rear.

fight. For greater flexibility, we'd move some of the combat support and combat service support elements from the divisions to the corps.

- **Division.** Have the division focus on control and synchronization, requiring increased agility. Most logistics and combat service support functions will move back to corps or forward to the brigade. A reconnaissance capability is necessary to

verify sensor information about the enemy and the positioning of the friendly maneuver forces.

- **Combined-Arms Brigade.** Have a new combined-arms brigade be the maneuver element and focus on the close fight. The brigade will avoid "head-to-head" confrontation and attack the enemy's flanks and rear.
- **Logistics.** The division support command, though reduced in size, will synchronize support between the

corps support command and the forward brigade. Automation and communications technology must replace redundancies in support operations.

This is an *evolving* concept for future warfare, needing much refinement. But we must start now to design the Army for 1995 and beyond. The greatest mistake we could make is to take our Army of the 70s and 80s into the 21st century.



## *Historical Vignette:* British Observed Fire

During World War I, Field Artillerymen experienced the first real opportunity to employ indirect fire extensively. Too dependent on good communications and forward observers' (FOs') seeing the target, observed indirect fire quickly fell out of favor. The smoke and dust on the battlefield made detecting targets difficult, while shelling cut telephone wires and hampered communications between the observer and battery.

### Observed versus Unobserved

To overcome these problems, combatants developed unobserved or map firing. This type of fire depended on sound- and flash-ranging and aerial observation to find targets that could be located on a map. The guns then could adjust on them without depending on FOs and good communications.

Field Artillerymen also designed rolling barrages of high-explosive rounds and shrapnel to furnish close support for the infantry and standing barrages of various kinds to neutralize enemy batteries or other targets. These minimized the need for observed fire.

For the most part, a rolling barrage moved faster than the infantrymen could because of the shell-pocked ground and obstacles that hampered their movement. This left them without adequate close support, allowing the enemy to wait in trenches until the barrage passed and then pop up to cut them down with small-arms and machinegun fires.

### British Successes

Despite the problems with observed fire, some Field Artillerymen persisted in using it and had some success. Neil Fraser-Tytler, a British battery commander of 18-pounders, was one of those. Bored with unobserved fire, he enjoyed creeping at night into "no-man's land" to find a crater from which he could adjust fire on enemy targets.

During the Battle of the Somme in 1916 as a lieutenant, he recalled he relieved another forward observer on 18 July. Because his unit's wire wasn't severed during a German artillery bombardment, he was able to direct fire from British batteries onto German targets. After experiencing an hour of concentrated shelling from his battery, some Germans bolted from their isolated trench for a wheat field. In response, Fraser-Tytler called for fire from three 18-pounder batteries that hit the Germans with shrapnel.

Fraser-Tytler recounted another experience with observed fire that occurred in October 1916. On the 20th of the month, he adjusted fire on various German positions and then returned to his battery. The following day, he went back to his observation station. As he was moving forward, he noticed a "fresh collection" of Germans dug into the banks of a sunken road that ran up the hill from the British lines. The only way for the Germans to escape was to bolt across open ground. As they fled to safety, Fraser-Tytler adjusted fire on them, while the rest of the British guns shelled the road to catch those still hiding there.

### Conclusion

Although Fraser-Tytler was one of the few observers who had success with observed indirect fire in World War I, he demonstrated this type of fire could be effective and could be shifted around the battlefield as needed to neutralize targets and furnish close support. His method of observed fire later influenced the US Army to change its techniques during the 1920s and 1930s, which provided the foundation for American fire support in World War II.

Dr. Boyd L. Dastrup  
*Command Historian*  
Fort Sill, OK





# Der Durchbruchmueller

by Major David T. Zabecki, USAR

*I considered him an artillery genius. He had the gift, which I found in no other artilleryman, of instinctively knowing how much of which type of munition to throw at a position in order to soften it up. The troops realized very quickly that under an artilleryman of Bruchmueller's capability, artillery preparations for the attack were more reliable; and they went forward with a fuller sense of confidence when Bruchmueller and his staff were in charge.*

General Max von Hoffman  
Chief of Staff, Eastern Front  
From *Hoffman's Der Krieg der  
Versaumten Gelegenheiten*

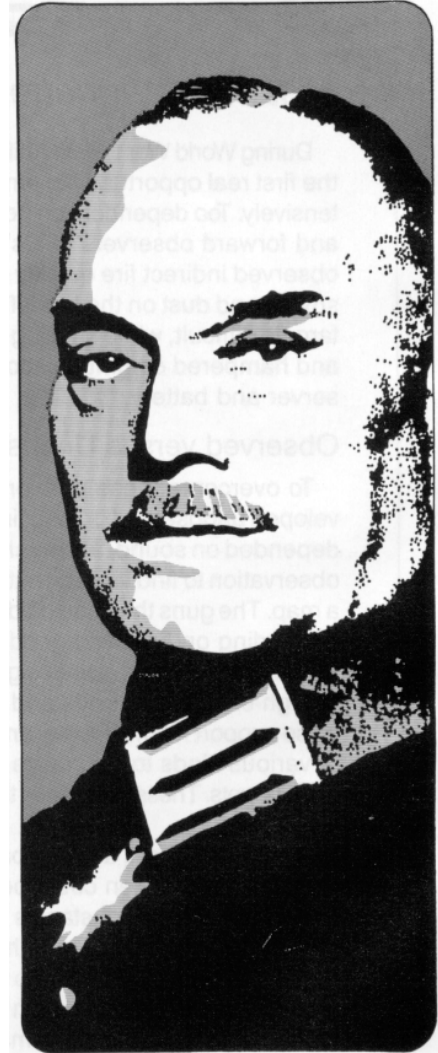

If a modern artilleryman were to journey back to the world of August 1914 at the start of the First World War, he would find very little familiar to him. The guns would be recognizable enough, but the artillery tactics and techniques would be more familiar to an artilleryman of Grant and Lee's day.

If our modern artilleryman were to move ahead a scant four years to early 1918, he instantly would recognize the key elements of the fire support systems of today. The principles of indirect fire, counterbattery, meteorology plus velocity error (Met+VE) and combined-arms operations were known in 1914, but they were seldom practiced or applied. By the start of 1918, these techniques were rapidly becoming standard on both sides.

Moreover, on the German side of the line, our modern artilleryman would be surprised to find firepower employed in a manner amazingly consistent with today's AirLand Battle principles. The driving force behind this revolution in German artillery tactics was an obscure retired lieutenant colonel named Georg Bruchmueller. The German infantrymen he supported had a nickname for him that was a combination pun on his name and the German word for breakthrough, *durchbruch*. They called him "Der Durchbruchmueller."

## The Great War— The Great Paralysis

*The war of 1914-1918 became an artillery duel of vast proportions.*

Ian V. Hogg, *The Guns: 1914-1918* Ballentine Books, 1971

When World War I started, neither side envisioned the almost four years of fighting from fixed positions that would follow. Both sides advocated highly mobile and offensively oriented operations and had trained and organized accordingly. The French Army, in particular, clung to the romantic notion that its gallant infantry, imbued with the spirit of *elan*, was irresistible in the attack.

Field Artillery on both sides focused on mobility to the exclusion of almost all else. Horse-drawn batteries trained to gallop into action at some critical moment, pop off a few rounds of direct fire and then rush off for an encore at some other point on the battlefield. And despite the lessons of the recent Russo-Japanese and Balkan Wars, infantrymen and artillerymen still seemed determined to fight separate battles.

But things didn't work quite the way they were planned. The troops on the line encountered devastating firepower on a scale previously unimaginable—not only

artillery, but also infantry fire, particularly from machineguns. Tactics had failed to keep pace with firepower technology, and military leaders seemed incapable of adapting doctrine accordingly. The linear mass attack formations used since Napoleon's day could not stand up against the withering fire. Unable to survive on the surface of the earth, the troops started digging.

*Field Artillery*

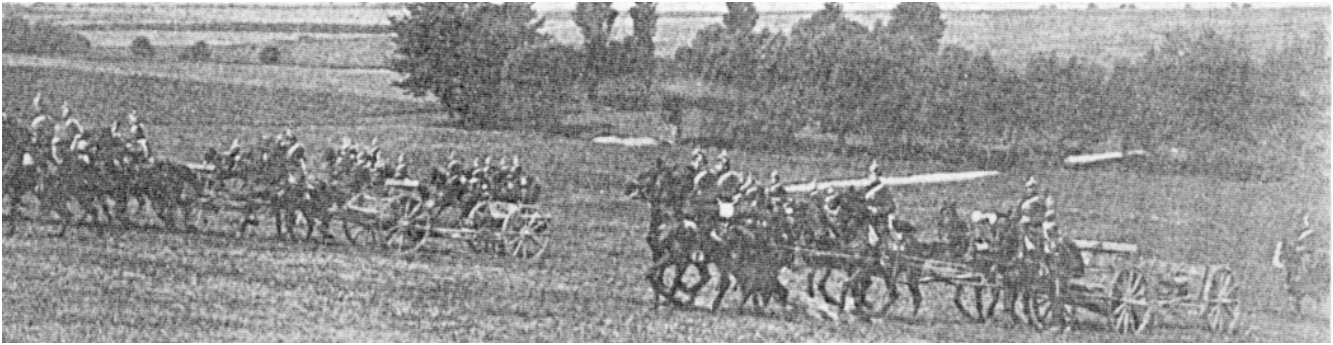

In 1914, both sides advocated highly mobile, offensively oriented operations. Neither envisioned the four years of fighting from fixed positions that would follow.



Observation in the Front-Line German Infantry Trenches

## Trench Warfare

By the start of 1915, the war in the west had degenerated into two sets of opposing trench lines running from the Swiss border to the Belgian coast. Firepower had gained the upper hand over maneuver, and the result was trench warfare.

With two huge armies burrowed into the mud and glowering at each other across the barbed-wire-laced strip of no-man's land, artillery quickly became the primary means of prosecuting the War. Its main functions shifted to destruction and annihilation: destroy the attacking enemy before he reached friendly lines and destroy the defending enemy before attacking friendly troops reached the hostile positions. Special emphasis was placed on obliterating the enemy's fortifications with artillery even expected to cut his barbed wire. The prevailing philosophy became "The Artillery conquers, the Infantry occupies."

## Artillery Prep

The key technique in this new form of warfare was the artillery preparation. Military leaders convinced themselves that the more high explosives (HE) they dumped on the objective, the easier the

infantry's job would be. As the War progressed, the preparations grew longer and longer.

In truth, however, the long preparations accomplished very little and actually caused more problems for the attacker. In the first place, a long prep sacrificed surprise; it told the defender exactly where the attack was coming. The longer the prep, the longer the defender had to take his countermeasures. Quite often the defender was able to withdraw his front-line infantry from the area being shelled, reinforce it and re-insert it when the fire lifted.

Also, the long prep did a poor job of cutting the defender's wire, but it did a great job of tearing up the terrain the attacker had to cross. In other words, it created more obstacles for the attacker than it cleared.

Finally, the massive preps were an enormous logistical drain that slowly bled the national economies of the belligerents. The apocalyptic battles of 1916 and 1917 finally exposed the bankruptcy of the destruction-by-artillery doctrine.

## Artillery Destruction Bankruptcy

The British started their attack at the Somme in 1916 with a seven-day preparation during which 1,537 guns fired more than 2,000,000 rounds. When the British infantry jumped off on 1 July, they advanced in the traditional linear formations. Their leaders believed nothing could have survived the shelling.

The German infantrymen apparently didn't get that word. They swarmed out of the rubble of their bunkers, set up their machineguns in the convenient new shell holes the British had just provided and proceeded to massacre the attackers.

The British Army had more than 57,000 casualties that day, including 20,000 killed. It was the largest single-day loss in British history.

British troops tried the same thing at Passchendale in 1917. This time a 13-day prep threw 4,300,000 rounds at the German positions. The results were no better, and British losses for that three-month campaign ran to 400,000. German losses were high too, but the point is that method of attack was a dismal failure.

## Movement Returns to the Battlefield

The pattern of stagnation finally broke on the Eastern Front when the Germans executed the War's first successful large-scale penetration against Russian prepared defenses and followed up by exploiting it. On 1 September 1917, the numerically inferior German 8th Army under General Oskar von Hutier forced a crossing of the Dvina River, drove three divisions through the entrenchments of the Russian 12th Army and captured the Baltic port of Riga. The 12th Army broke and fled three hours into the assault, and the fall of Riga effectively knocked Russia out of the War. This German success resulted from the aggressive application of new tactical concepts for both infantry and artillery.

Von Hutier's infantry abandoned the old linear tactics and advanced leapfrog fashion, similar to our current fire and move or "shoot and scoot" technique. They infiltrated in small groups, probed for weak spots and bypassed enemy strongpoints, leaving them for the heavier follow-on forces to reduce. Reserves were committed to reinforce success rather than being thrown in where the attack had stalled. These were radical tactics by World War I standards.

When the Allies later encountered these tactics on a large scale on the Western Front, they somewhat erroneously labeled them "Hutier tactics." Actually, various elements of these tactics had been slowly

developed and tested on a small scale during the previous three years on the Western Front by tacticians on both sides. Von Hutier was the first commander to bring them all together and use them successfully in a major operation.



General Oskar von Hutier, the Victor of Riga

### The Chemical Prep

*The first skillful use of gas to effect a penetration was made in General von Hutier's attack on the Riga Front.*

Major General J.F.C. Fuller  
*The Conduct of War: 1789-1961*  
Rutgers University Press, 1961

Von Hutier's artillery played by an entirely new set of rules. Rather than firing a preparation for days or even weeks, the prep lasted just five hours. It may not have been long, but it was incredibly violent.

At 0400 hours on 1 September, 750 German guns and 500 trench mortars opened up with a preparation that, for the first time in the War, used a high percentage of chemical rounds. And rather than being thrown downrange indiscriminately, the rounds were used against carefully selected targets. During the five hours of the prep, German guns dumped an average of 388 gas rounds per minute on the key targets in a 3,000-meter-wide penetration zone. This diabolical firestorm was the

brain child of von Hutier's Artillery Chief, Lieutenant Colonel Georg Bruchmueller.

### The Man Who Synchronized Fire with Maneuver

*His great knowledge and capacity, his devotion to his profession and his arm, and his warrior spirit marked [Bruchmueller] out as one of the most prominent soldiers of the war.*

General Erich Ludendorff  
*Meine Kriegserinnerungen 1914-1918*  
Berlin, 1919

Georg Bruchmueller was a most unlikely innovator in a war infamous for its lack of innovation. Born in Berlin in 1863, he started his military career in 1886 as a lieutenant in the 8th Regiment of Foot Artillery.

Through the end of World War I, German artillery was organized into two different branches. The Field Artillery was mounted and directly supported the maneuver units, primarily using light guns. The Foot Artillery manned fixed fortifications, didn't have organic mobility and used heavy howitzers and siege mortars.

The two branches were barely on speaking terms. Field Artillerymen looked down on the foot gunners as "dugout artillerymen."



Lieutenant Colonel Georg Bruchmueller, wearing the *Pour le Merite*

With this background, Bruchmueller should have fit right in with the mentality of blindly blasting away with more and more artillery—but he didn't.

### A Leader by Default

Bruchmueller had a thoroughly undistinguished pre-war career. He spent almost all of it in the Foot Artillery and took 25 years to make major. In 1913, he fell from a horse, suffered a nervous

Standard Chemical Rounds Used by the German Artillery in World War I			
Shell Marking*	Effect	Chemical	Duration & Lethality
White Cross	Lachrimator (Tear)	Tear Gas	Nonpersistent Nonlethal
Blue Cross**	Sternator (Vomiting)	Arsine	Nonpersistent Nonlethal
Yellow Cross	Vesicant (Blistering)	Mustard	Persistent Lethal
Green Cross	Asphyxiant (Choking)	Phosgene Chlorine Lewisite	Nonpersistent Lethal
<p>* <i>The German marking system for chemical rounds was adopted by the Allies, to a large extent.</i></p> <p>** <i>Most Allied masks were ineffective against Blue Cross. Bruchmueller's technique was to fire mixed Blue and Green Cross (Buntkreuz). Blue Cross made it almost impossible to keep a mask on in the presence of the lethal Green Cross.</i></p>			

Figure 1: Bruchmueller used gas to neutralize the enemy, eliminating the mobility impediments of destruction fire.

breakdown and was medically retired as a lieutenant colonel that October.

He was recalled to temporary active duty when the War started and put in charge of the guns of Fortress Kulm. Shortly after that, he took command of a Foot Artillery battalion of the Landwehr (similar to our National Guard). Because of attrition and the shortage of experienced officers in the rapidly expanded German Army, Bruchmueller eventually became the commander of the 86th Field Artillery Regiment on the Eastern Front.

### The Rising Star

Bruchmueller's star began to rise when he commanded 30 German batteries in the repulse of the Russian attack at Lake Narotch in March 1916. The Russians suffered an estimated 90,000 casualties, due in large part to Bruchmueller's guns. In April 1917, he commanded the artillery in the German counterattack at Toboly Bridgehead.

His performance in both of these battles earned him the coveted *Pour le Merite* (the Blue Max), Prussia's highest military decoration. It also brought him to the attention of General Max von Hoffman, Chief of Staff of the Eastern Front, who put Bruchmueller in charge of the artillery of the 8th Army even though he was still only a retired lieutenant colonel on temporary active duty.

### Bruchmueller Tactics

*We desired only to break the morale of the enemy, pin him to his position, and then overcome him with an overwhelming assault.*

Colonel Georg Bruchmueller  
*Die Deutsche Artillerie in den Durchbruchschlachten des Weltkriegs*  
Berlin, 1921

Bruchmueller was one of the first great practitioners of neutralization. Realizing the counterproductive nature of the long preparations, he understood that duration of fire mattered less than strength and intensity. The shock effect of a barrage is greatest during its first few hours. After that, the impact tends to wear off, and the troops being shelled develop a mental resistance to its psychological effects.

Bruchmueller saw no sense in continuing to throw shells after that point. He also understood the problems heavy use of HE created for the attacker.

### Gas Neutralization

Gas, on the other hand, was the perfect neutralization weapon, and the German

Army had a well-developed array of chemical rounds for Bruchmueller to draw from. (See Figure 1.) Persistent gas used against enemy artillery positions eliminated the gun crews and contaminated the position and equipment, making it difficult, if not impossible, for replacement crews to put the guns back into action. Nonpersistent gas used against the enemy's front-line positions and timed to dissipate as attacking units arrived could neutralize the enemy without the mobility impediments of destruction fire.

Bruchmueller didn't even try to use artillery to cut barbed wire. Sappers accompanying

the infantry handled those obstacles.

### Task Organization

One of Bruchmueller's greatest innovations was a system of task-tailoring artillery to support specific operations. To the irritation of the hard-line traditionalists, he completely ignored the distinctions between Foot and Field Artillery and built his task groups and subgroups with whichever batteries he needed to accomplish the mission.

He organized the majority of the artillery-controlled assets into counterinfantry

Bruchmuller's Organization of Artillery for the Attack			
Functional* Group	Mission	Controlling Echelon	Comment
Artillery Assets IKA ( <i>Infantriebekaempfungs-artillerie</i> )	Close Support	Attacking Division	75% of Arty Assets – 1 Group per Div – Subgroups Organized by Task
AKA ( <i>Artillerie bekaempfungs artillerie</i> )	Counter-battery	Corps	20% of Arty Assets – 1 Group per Corps
FEKA ( <i>Fernkampf-artillerie</i> )	Deep Battle	Corps	Long-Range Guns – Command, Control and Communication Targets – Flank Targets – Rear Lines of Communications – Reserves
SCHWEFLA ( <i>Schwereste Flachfeuer-artillerie</i> )	Special Destruction	Army	Heavy Guns – Hard Targets – Bridges – Command Bunkers
Infantry Assets MW ( <i>Minenwerfern</i> )	Close Support	Div Arty During the Prep Infantry Bns During the Assault	Trench Mortars – Enemy Front Trench Line – Machinegun Emplacements
IBB ( <i>Infantriebegleitbatterien</i> )	Accompanying Artillery	Attacking Division	Light Field Guns – Didn't Fire in Prep – One Bn per Div, if Available
* Groups were not fixed organizations. Each group and subgroup was configured from varying numbers of batteries to accomplish specific missions for each operation.			

Figure 2: Bruchmueller task organized units for specific operations.

(IKA) and counterartillery (AKA) groups. About five percent of his guns went into special long-range groups (FEKA) for deep targets or heavy groups (SCHWEFLA) for special missions. The infantry-controlled assets included trench mortars (*Minenwerfern*) and specially designated batteries of accompanying artillery (*Infantriebegleitbatterien*).

During the preparation, the artillery controlled the trench mortars, which fired exclusively on the enemy's leading positions. During the assault, the trench mortars reverted to infantry control. (See Figure 2.) In the Riga attack, for example, Bruchmueller allocated 116 of his 170 batteries to three IKA groups and 36 batteries to one AKA group. (See Figures 3 and 4.)

### Use of Technology

Bruchmueller seized every opportunity to use emerging technology to his advantage. He quickly recognized the potential of the airplane and used air observers for long-range adjustments and the acquisition of deep targets. He also viewed the need for the guns to register as a major handicap.



Major A. D. Pulkowski

Organization and Missions of German Artillery								
Group	Sub-Group	Mission	Batteries					
			Field Guns	Hvy Guns	Lt Field How	Hvy Field How	Hvy Arty Mortars	
AKA	A1	Neutralize the enemy artillery.	5	5	–	2	–	
	A2		6	–	–	1	–	
	A3		7	1	–	–	–	
	A4		7	1	–	1	–	
IKA	B1	Lay fire on the first-line positions to prepare for assault in the 19th Reserve Division's attack zone.	4	–	8	6	3	
	B2	Lay heavy fire on the second-line positions to prepare for the assault in the 19th Reserve Division's attack zone.	–	–	3	3	–	
	B3	Lay down a fire barrier to the east.	9	2	–	–	–	
	C1	Lay heavy fire on the first-line positions to prepare for the assault in the 14th Bavarian Jaeger Division's attack zone.	6	2	7	10	5	
	C2	Lay heavy fire on the second-line positions to prepare for assault in the 14th Bavarian Jaeger Division's attack zone.	2	2	3	3	–	
	D1	Lay heavy fire on the first-line positions to prepare for assault in the 2d Guards Jaeger Division's attack zone.	5	–	7	7	2	
	D2	Lay heavy fire on the second-line positions to prepare for assault in the 2d Guards Jaeger Division's attack zone.	1	–	5	3	–	
	D3	Lay down a fire barrier to the west and provide fire support for the 1st Reserve Division in case of a Russian attack.	6	2	–	–	–	
	<b>Total</b>			58	15	33	36	10
				152				

Figure 3: Bruchmueller's Task Organization for the Riga Attack

Registration, of course, compromised surprise and gave away a battery's position, making it an instant counterbattery target. Fire direction and survey techniques at the start of the War were just too primitive for indirect fire without registration.

But Bruchmueller had the habit of getting intelligent and aggressive officers

and NCOs for his staff. One of them, Captain Erich Pulkowski, eventually worked out a Met+VE technique based on the same concepts we use today. The old hardliners bitterly fought against adopting the Pulkowski Method, but by the start of 1918, Bruchmueller (still only a lieutenant colonel) forced the German Army into using it.

### OPSEC and Maneuver Coordination

Bruchmueller was a fanatic on two things: what we today call operational security (OPSEC) and coordination with the infantry before the start of the battle. His batteries moved only at night. Quite

**Field Artillery**



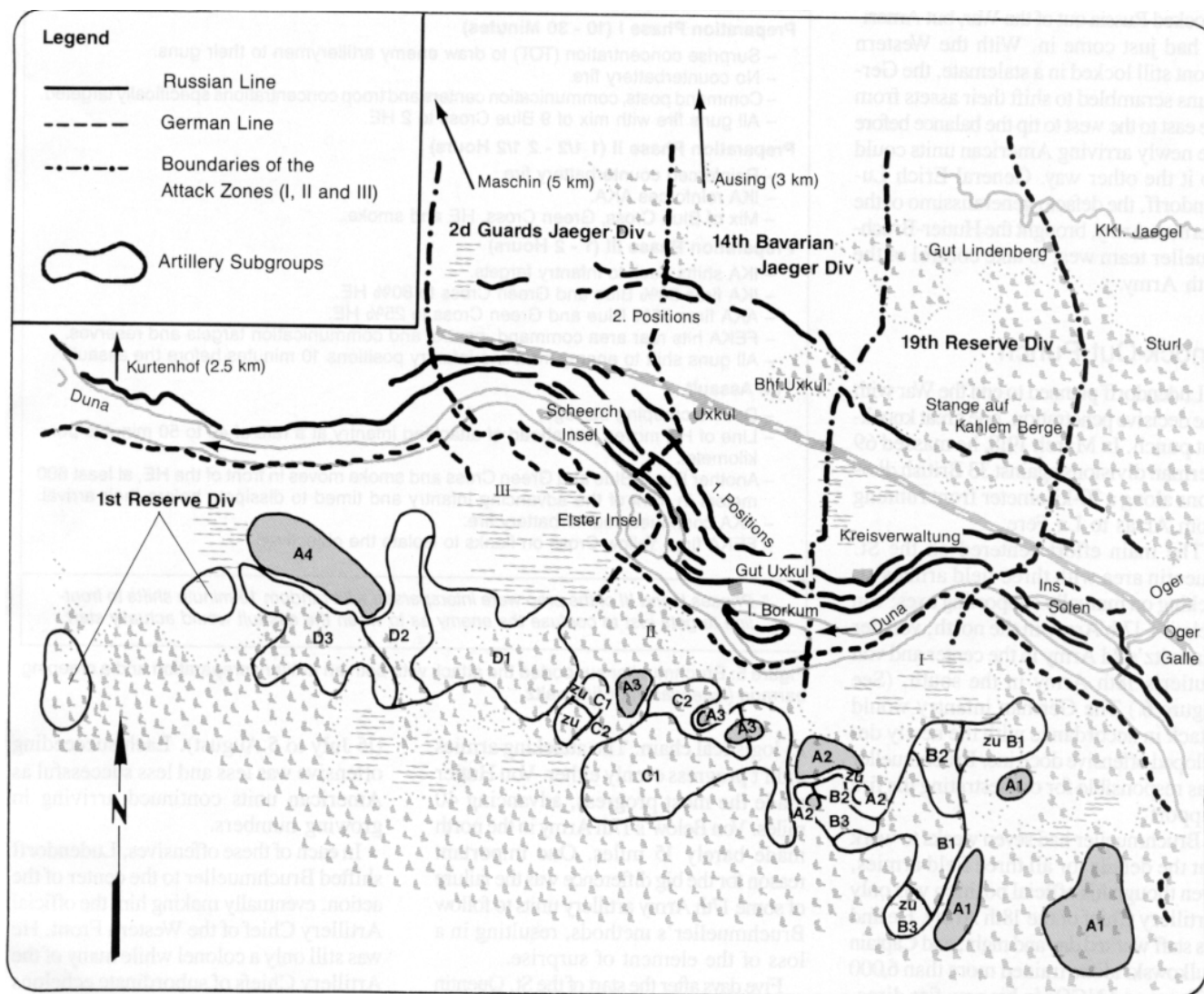

Figure 4: Bruchmuller's Positioning of Fire Units near Riga to Support the Attack on 1 September 1917. He allocated 116 of his 170 batteries to one AKA group. Note the even distribution of AKA units (counterbattery "A" subgroups in blue).

often they occupied presurveyed and prestocked positions within just a few hours of the start of a preparation. He used his own aerial observers to check the camouflage and track plans of his units. His staff devised and executed elaborate deception plans.

Before starting an operation, Bruchmuller personally briefed the commanders and staffs of the supported units on the fire support plan. As his responsibilities grew and the task became more than one man could handle, he sent all his group and subgroup commanders out to brief the infantry.

Bruchmuller expressed his philosophy on this point: "The thanks of the infantry must be treasured more by every artilleryman than all decorations and citations." For Bruchmuller, supporting the maneuver commander was the

only game in town.

### Psychological Prep

*It seems impossible that firing began without adjustments. But in not one of the great [1918] offensives did the German Artillery reveal its presence by preliminary adjustments.*

*"Measures Taken by the German Artillery to Carry Out Preparations for Attack Without Betraying the Intentions of the Command,"* Field Artillery Journal, Oct-Dec 1919

Bruchmuller supported the attack with both a preparation and a creeping barrage (which the Germans called the *feuerwalze*) during the assault. Neither type of fire was new, but the way Bruchmuller used these techniques kept his enemy constantly off balance. He stressed short, three-phase preparations with minimal registration. As

the War moved through 1918, he eliminated registrations altogether, and the length of the preps progressively decreased from five hours to just slightly more than two. (See Figure 5.)

Phase Three of each prep ended with all guns shifting to the enemy's leading positions for a 10-minute saturation. It didn't take the Allies long to figure out this was the signal for the start of the assault.

Bruchmuller countered by inserting varying numbers of 10-minute shifts to the front targets in random spots in Phases Two and Three of the prep. He understood the psychological effects of artillery fire.

### Ludendorff's Offensives in the West

By the end of 1917, Germany had

knocked Russia out of the War, but America had just come in. With the Western Front still locked in a stalemate, the Germans scrambled to shift their assets from the east to the west to tip the balance before the newly arriving American units could tip it the other way. General Erich Ludendorff, the defacto generalissimo of the German Army, brought the Hutier-Bruchmueller team west to take control of the 18th Army.

## Knock-Out Punch

Ludendorff planned to end the War with one decisive penetration, one great knockout punch. In March 1918, he massed 69 German divisions against 33 British divisions along a 70-kilometer front running from Arras to La Fere.

The main effort centered on the St. Quentin area with three field armies attacking on mutually supporting axes: von Below's 17th Army in the north, von der Marwitz's 2d Army in the center and von Hutier's 18th Army in the south. (See Figure 6.) The German infantry would attack in accordance with the newly developed offensive doctrine. Bruchmueller was responsible for orchestrating the fire support.

Bruchmueller had seven weeks to work out the details for all three field armies, even though his official position was only Artillery Chief of the 18th Army. He and his staff worked day and night, and Captain Pulkowski alone trained more than 6,000 officers and NCOs in his new fire direction center (FDC) techniques.

At 0440 hours on 21 March, the Germans opened with 6,473 guns and 3,532 trench mortars against approximately 2,500 British guns. During the five-hour prep, the German guns fired more than 2,000,000 gas rounds. At 0940 hours, the German infantry surged forward. The initial results were overwhelming. By the end of the first day, eight battalions from the British XVIII Corps counted a total of only 50 survivors.

It almost worked. By the end of the ninth day, the Germans had gained more ground than the Allies had in the previous three years combined. They took more than 1,200 square miles as compared to the 125 square miles the British had fought almost five months to gain in their Somme offensive. But by 30 March, Ludendorff's great offensive ran out of steam short of its strategic objectives.

It failed for several reasons. Perhaps the most important was that the German Army advanced too far, too fast and outran

### Bruchmueller's Fire Plan to Support the Attack

#### Preparation Phase I (10 - 30 Minutes)

- Surprise concentration (TOT) to draw enemy artillerymen to their guns.
- No counterbattery fire.
- Command posts, communication centers and troop concentrations specifically targeted.
- All guns fire with mix of 9 Blue Cross to 2 HE.

#### Preparation Phase II (1 1/2 - 2 1/2 Hours)

- Reinforced counterbattery fire.
- IKA reinforces AKA.
- Mix of Blue Cross, Green Cross, HE and smoke.

#### Preparation Phase III (1 - 2 Hours)

- IKA shifts back to infantry targets.
- IKA fires 20% Blue and Green Cross to 80% HE.
- AKA fires 75% Blue and Green Cross to 25% HE.
- FEKA hits rear area command, control and communication targets and reserves.
- All guns shift to enemy front-line infantry positions 10 minutes before the assault.\*

#### The Assault

- Double creeping barrage.
- Line of HE moves just ahead of attacking infantry at a rate of 40 to 50 minutes per kilometer.
- Another line of Blue and Green Cross and smoke moves in front of the HE, at least 600 meters in front of the advancing infantry and timed to dissipate before their arrival.
- AKA continues counterbattery fire.
- FEKA fires Yellow Cross on flanks to isolate the objectives.

\* Phases II and III of the prep were interspersed with random 10-minute shifts to front-line targets just to confuse the enemy as to when the assault would actually start.

Figure 5: Bruchmueller supported the attack with both an artillery preparation and a creeping barrage (*feuerwalze*) or fire waltz.

its logistical chain. The attacking armies didn't progress evenly either. Von Hutier made the most progress, advancing 40 miles. Von Below's 17th Army in the north made barely 15 miles. One important reason for the big difference was the failure of some 17th Army artillery units to follow Bruchmueller's methods, resulting in a loss of the element of surprise.

Five days after the start of the St. Quentin offensive, Georg Bruchmueller received the rare oak leaves to his *Pour le Merite*—an unprecedented award for even a higher-echelon artillery officer. Early the following month, the German Army finally restored him to the active list and promoted him to colonel. Ludendorff then put him back to work planning the fire support for a second great offensive.

## Successive Punches

This time the attack would be conducted by the 6th Army near Lys, farther to the north. Ludendorff didn't take any chances. He seconded Bruchmueller to the 6th Army to make sure the artillery did what it was supposed to. The Lys Offensive started on 9 April 1918, but it failed too. After almost four years of a two-front war, the Germany Army was spent.

But Ludendorff wasn't through. He tried it again—three more times: Chemin des Dames (27 May to 2 June), Noyon (9 to 13 June) and the second battle of the Marne

(15 July to 5 August). Each succeeding offensive was less and less successful as American units continued arriving in growing numbers.

In each of these offensives, Ludendorff shifted Bruchmueller to the center of the action, eventually making him the official Artillery Chief of the Western Front. He was still only a colonel while many of the Artillery Chiefs of subordinate echelons were general officers.

## Bruchmueller's Legacy

*The significance of the new thinking of 1917-18 lay not so much in how it determined the outcome of the First World War, but in how it formed the seed-bed for the new techniques of fire and manoeuvre developed in the 1920s and 1930s and practised in the Second World War.*

Lieutenant Colonel J.B.A. Bailey, MBE, RA  
Field Artillery and Firepower  
The Military Press, Oxford, 1989

Georg Bruchmueller didn't necessarily invent all the tactical concepts he so effectively employed, but he was the first to bring them all together and make them work in large-scale operations. He turned fire support into an art.

He had a profound impact on the way artillery has been used on the battlefield

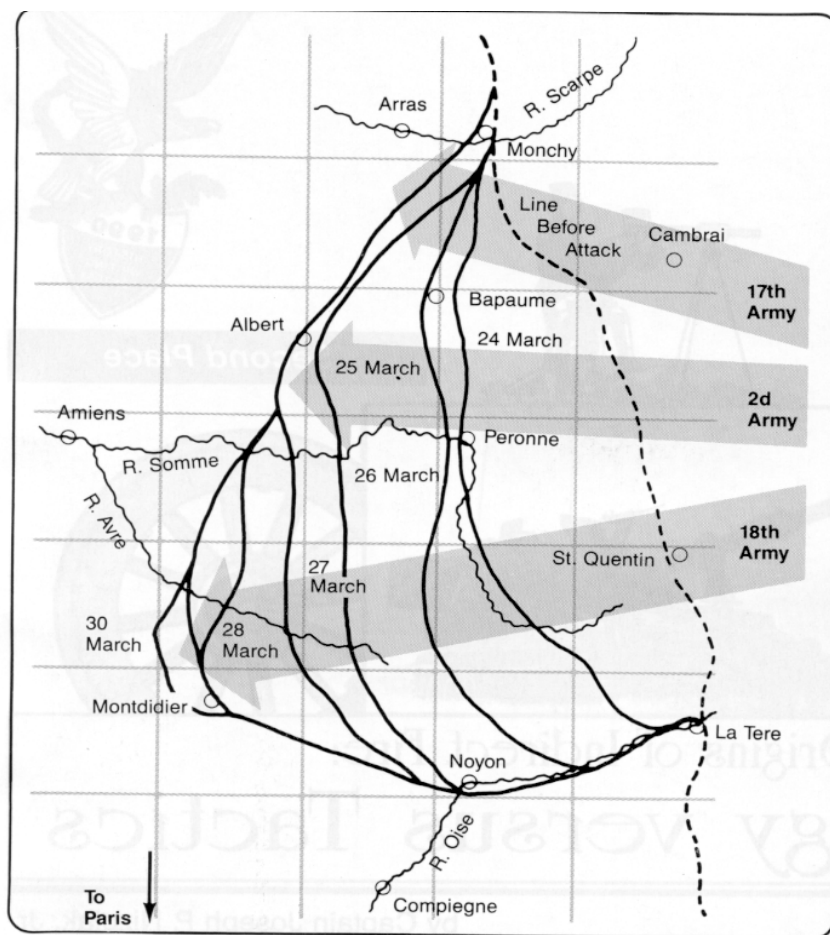

Figure 6: Ludendorff's St. Quentin Offensive—The German Offensive on the Somme, 21 to 30 March 1918

ever since. Even before the last round of World War I was fired, his methods were being dissected feverishly in the artillery journals of the Allies. The Russians too learned from the bloody lessons they received at Lake Narotch and attempted to copy Bruchmueller's techniques for Bursilov's ill-fated offensive in the summer of 1916.

After every major war, old soldiers write books. And while Bruchmueller was no exception, his book was exceptional. His 1921 *Die Deutsche Artillerie in den Durchbruchschlachten des Weltkriegs* (The German Artillery in the Breakthrough Battles of the World War) sparked another round of analysis in the Allied artillery journals, and the US Army Field Artillery School translated the book's 2d edition.

Bruchmueller's book actually caused a fair amount of controversy and finger pointing in German military circles. That bickering came to an abrupt halt when Lieutenant General Heinrich Rohne, the patriarch of German Artillery, flatly declared, "I believe the book...is the most

important piece of artillery literature in recent years. Every artilleryman should study it carefully, not just read it."

As late as 1939, Bruchmueller's concepts were still being discussed in German military journals. In September of that year, the German Army belatedly promoted him to major general on the retired list.

### Soviet Artillery Doctrine

There's much to suggest that Bruchmueller had a major influence on Soviet artillery thinking. In his book *Red God of War*, Chris Bellamy noted, "Ex-imperial officers working for the Soviets certainly studied Bruchmueller's methods after 1918." When the 1st Ukrainian Front made its attack during the Vistula-Oder Offensive in January 1945, its artillery prep was almost an exact copy of the Bruchmueller model, except for the use of gas.

The similarities between Bruchmueller's methods and Soviet doctrine even today are striking: the overwhelming massing

of artillery in the area of penetration, task-tailored artillery groups for specific operations, accompanying artillery under infantry control and the selective use of chemicals to accomplish specific tasks. The similarities are too many and too close for mere coincidence.

### US Artillery Doctrine

Georg Bruchmueller would be right at home in today's AirLand Battle environment. He had "all the bases covered." Synchronization: he was among the first to synchronize fire with maneuver and to integrate air assets into the overall fire support plan. Depth: he always allocated a portion of his units (FEKA and SCHWEFLA) to the deep battle and paid close attention to coordinating the deep and close battles. Initiative: his almost fanatic attention to OPSEC measures and surprise ensured his enemy was always reacting to his moves rather than the other way around. Agility: This is perhaps the area in which we have the most to learn from him. When doctrine failed and most of those around him were locked in a state of paralysis, the 53-year-old medically retired lieutenant colonel had the mental agility to scrap the old and find new doctrine that worked.

*FM 100-5 Operations* states, "Maximum effective firepower against the enemy requires that many functions be coordinated and performed well." Colonel Georg Bruchmueller was one of the 20th century's first artillery commanders to understand that concept and all of its complexities—and he made it work.



**Major David T. Zabecki, US Army Reserve (USAR), won the US Field Artillery Association's 1990 History Writing Contest with this article. He's a Field Artilleryman in West Germany assigned as the S3 of the USAR Military Intelligence Group-Europe, supporting NATO's Theater and Army Group headquarters. A frequent contributor of historical articles for *Field Artillery* and six other magazines, Major Zabecki is Contributing Editor of *Military History* and *World War II* magazines and Editor of the *Encyclopedia of World War II in Europe*, currently in preparation for publication. His articles have placed in every Field Artillery Association history contest entered, and his "The Guns of Manchuria" (April 1988) won the 1987 contest. Major Zabecki expresses his appreciation to the *Bundeswehr's Militaergeschichtliches Forschungsamt*, the Imperial War Museum and the Royal Artillery Institution for generously making their library resources available to him.**



**Second Place**

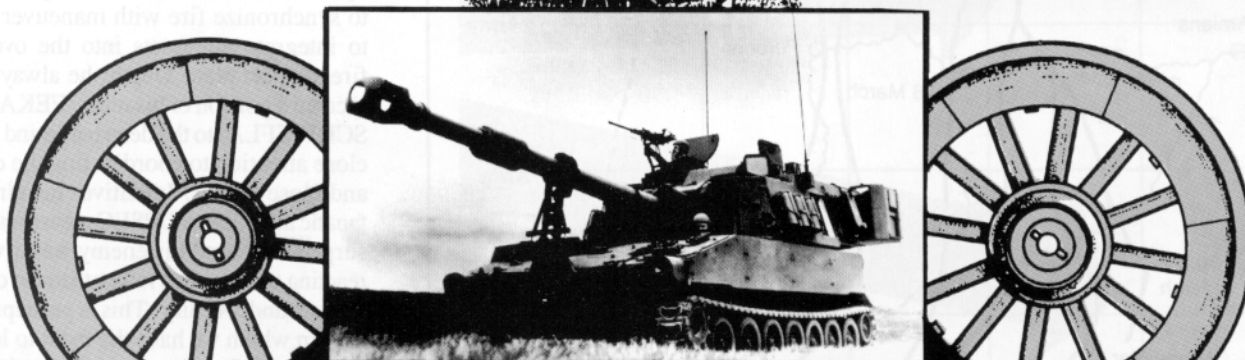

# The Origins of Indirect Fire: Technology versus Tactics

by Captain Joseph P. Nizolak, Jr.

**A**s modern Redlegs, we generally think of artillery battles as being fought over great distances. Fellow artillerymen who are well forward adjust our lethal fires. Our batteries fire from behind the forward line of own troops (FLOT), seldom, if ever, seeing the destruction they cause. However, it wasn't always this way. For most of artillery's existence, it was a direct-fire asset.

Acceptance of indirect fire as the preferred artillery technique was the classic clash of new technology and old tactics. It took several advances in technology and the hard school of war to convince commanders to accept massed, indirect fire. This is the story of how technology triumphed over tactics and indirect fire became the preferred method of fire support.

## Forward the Guns

The first use of artillery on a battlefield took place about 1000 B.C. From that moment until just recently, great (and not so great) captains used artillery principally in a direct-fire role. They massed their fires by the physical

positioning of the cannons in front of or alongside their infantry and not by technical methods of fire direction. These commanders considered artillery an auxiliary, primarily defensive weapon and not a principal arm of the battlefield.

For a long time, these methods of forward positioning and massing facilitated both the destruction of the enemy and the preservation of the gunners. Early cannons had a range advantage over infantry weapons. Forward positioning and fragmentary rounds (e.g., grape shot, shrapnel, etc.) allowed the gunners to engage the enemy safely. Physical grouping improved the gunners' ability to mass fires and survive. As long as the defenders could keep the enemy infantry from closing to effective musket or bayonet range, the cannons could continue to provide fires. If this failed, commanders expected their cannoneers to go down with their guns, which many heroically did.

Unfortunately for many cannoneers, these positioning techniques remained while the range and accuracy of the infantry weapons improved. During the second half of the 19th century, the rifle

and early machineguns began obliterating the forwardly placed gunners.

Compounding the new hazards of manning the guns was the Prussian development of cordite or "smokeless powder" as a propellant. Cordite eliminated the obscuring effect that firing the cannon once provided. Then artillerymen desperately needed a means to fire accurately from a covered position to survive.

## Limited Early Experiments

Several factors limited early experimentation with indirect fire. Before the improvements in infantry weapons, direct-fire artillery outranged and outgunned the enemy infantry. Artillerymen felt there was no need to fire from covered positions and made no effort to do so.

Also, scientists and engineers had yet to develop the technology for indirect fire. Improvements such as recoil mechanisms, sights and electronic communications

wouldn't appear until the latter part of the 19th century. Thus, early artillerymen limited their direct-fire experimentation to siege tactics.

## Technology to the Rescue

Advancements in technology during the latter decades of the 19th century made indirect fire both possible and necessary. Cordite not only was smokeless, but it also was a powerful propellant that significantly increased the range of artillery pieces. Quick-fire weapons, such as the French 75, had a range of approximately 6,000 meters; heavier weapons had ranges of more than 10,000 meters. Using direct fire, artillerymen couldn't take advantage of this increased range as the distance to the target was farther than they could see. Gunners needed a method to exploit this greater range.

Recoil mechanisms were another improvement to the howitzers that facilitated indirect-fire methods. Without recoil mechanisms, the gunners would have to reposition and re-aim their guns after each round because of the large displacement—the distance the guns shifted their positions during firing. While this required a bit of physical effort, it wasn't a major problem in a direct-fire role. The gunners could see their targets and could quickly reorient their guns.

The large displacement, however, presented significant problems for maintaining battery orientation with indirect fire. The addition of recoil mechanisms allowed the gun carriages to become stable and maintain their proper orientation. This allowed indirect fire and higher rates of fire.

Improvements in electronic communications technology were another important prerequisite to indirect fire. Attempts at visual signaling, such as flags and lights, proved unsatisfactory because they required line of sight. This meant signaling at short ranges, and the signaler had to expose himself to the enemy while transmitting. Telephones and, later, radios provided the safe means to link a forward observer with his guns at a great distance.

## Convincing Indirect Fire Lessons

The synergistic effect of these advancements satisfied the requirements for an effective system of accurate, massed, indirect fire. Technology provided the means, but armies needed the lessons of war to

become convinced of the need. Those convincing lessons began with the Franco-Prussian War.

### Lesson 1: The Franco-Prussian War, 1870-1871

The Franco-Prussian War was the first one on the European continent to use the new infantry weapon technology fully. Armies of both sides equipped their soldiers with breech-loading rifles, accurate to about 1,200 yards. The French also fielded the *Mitrailleuse* that had 37 rifled barrels, similar to a Gatling gun's. These weapons proved especially deadly for artillerymen. Though artillery weapons had a range of approximately four miles, both sides used direct fire.



German Observations. The Germans used indirect fire after the Franco-Prussian War.

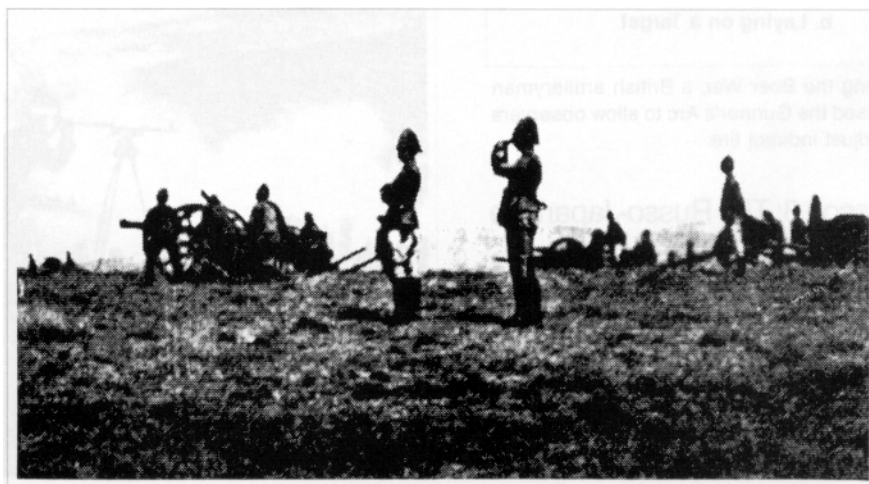

The Royal Horse Artillery in action in the Battle of Alleman's Nek. During the Boer War, the British usually had their artillery up front.

The improvements in infantry weapons made the exposed artillerymen easy targets.

The Germans, victors in this War, took home several lessons. The first was the importance of medium and heavy artillery to attack enemy trenches. Second, they learned the effectiveness of breech-loading rifles and artillery pieces. Third, the Germans learned they needed to develop a system of indirect fire to take advantage of the increased range of the artillery and improve its survivability.

German artillerists immediately began developing a system to direct the fires of their batteries from behind cover. They became the first army to produce a gun-mounted sight, the *Richtflache*, that they used to orient the battery and lay the guns. Combining this sight with standardized correction procedures, telephone links and maps, the Germans soon had an accurate system of indirect fire. By 1896, indirect fire was the accepted means of attacking targets in the German artillery.

### Lesson 2: The Boer War, 1899-1902

Either ignoring or disbelieving the lessons of the Franco-Prussian War, the British began the Boer War using the traditional forward emplacement of artillery. Once again, accurate long-range fires of infantry in covered and concealed positions took a heavy toll on the British gunners. There were many instances of the enemy's wiping out entire batteries before the British tried to change procedures.

Improvisation by a British artilleryman resulted in the Gunner's Arc. This simple sight was a board mounted on the gun. It had a center hole and several other holes drilled at the end of lines that radiated out at half-degree intervals. The gunner



would place a match stick in the center hole, select an aiming point on a far crest and align another match in a hole between the center match and the aiming point. After firing, the observer would give a correction, left or right, in degrees and range in yards. The gunner would move the match stick the specified number of degrees, realign the piece and fire. The Gunner's Arc was a simple but effective system.

Unfortunately, the British didn't take the artillery lessons of the Boer War to heart. They incorrectly assumed that the Boer War was atypical of future wars and, except for the Royal Garrison Artillery, abandoned indirect fire after the War. The British would relearn this lesson of technology and tactics.

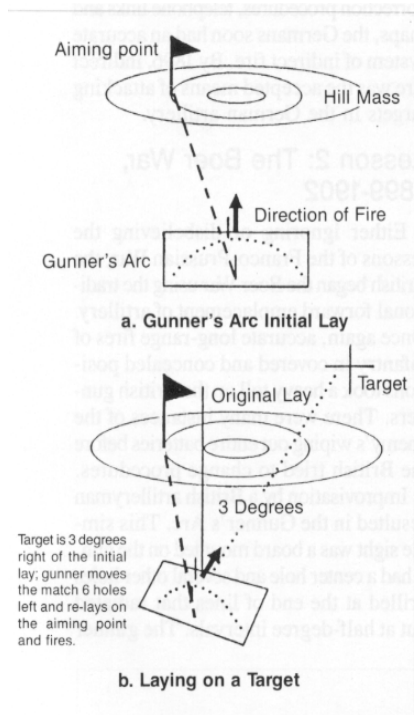

During the Boer War, a British artilleryman devised the Gunner's Arc to allow observers to adjust indirect fire.

### Lesson 3: The Russo-Japanese War, 1904-1905

Impressed by the capabilities that technology was offering to war-fighting, a Russian artilleryman named G. Guk foresaw and wrote about the advantages of indirect fire in 1882. His work impressed many Russian artillerists who subsequently became interested in the German model. They quickly adopted and improved the German artillery sight into their own version

called the *Uglomer* (pronounced ouglamare). Armed with ideas and a basic sight, they began to experiment with indirect fire at their schools of artillery.

Russian artillery officers soon became very proficient at methods of indirect laying, even practicing on moving targets. They developed a method to lay and orient their guns with all guns on line, using one aiming point. This method was fast, simple and automatically resulted in parallel lines of fire. It's also interesting to note the Soviets use this same method to this day.

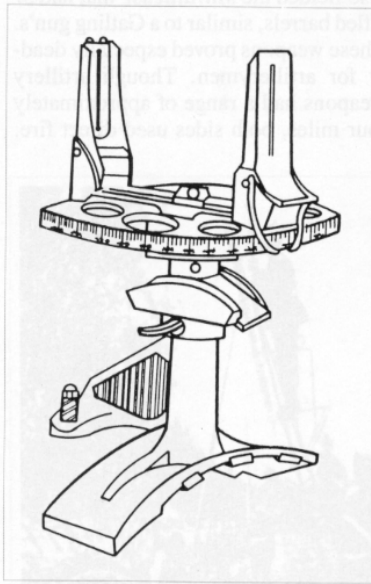

This Russian *Uglomer* is an artillery sight for indirect fire used in the Russo-Japanese War, the first one in which both sides engaged in indirect artillery duels.



The Japanese entered the Russo-Japanese War with an indirect-fire system.

Despite this training, the Russians entered the Russo-Japanese War lacking the confidence to use indirect fire in combat. They weren't convinced of its feasibility until the Japanese effectively used it against them during the first battle of the War. German officers had trained the Japanese artillery and given them the equipment necessary for indirect fire.

The Japanese used gun sights, angle-measuring aiming circles and aiming stakes to orient their guns. Japanese forward observers used a bracketing technique of adjusting with one gun, then firing for effect with the battery. The effectiveness of the Japanese artillery taught the Russians a costly lesson.

Fortunately, the Russians were quick to see the error of their ways. They began using indirect fire in the next battle and because of their peacetime training, showed a high degree of proficiency. Indirect fire became the preferred method for the rest of the War. Thus, the Russo-Japanese War became the first in which both sides engaged in indirect artillery duels.

### Why the Reluctance?

After lessons in three wars on the advantages of indirect fire, it's surprising to note the continued reluctance to accept it as the standard method of fire. This resistance originated from several sources. The first is the classic distrust of any *new* technique. Artillery and maneuver commanders felt it would take away both their control and fire support. Artillerymen, enthralled by the romantic vision of artillery up front, felt indirect fire

placed them in inglorious positions.

Another major source of reluctance came from senior officers too stubborn to admit that advances in technology demanded changes in doctrine. So, despite clear examples from recent combat, most nations entered World War I with a doctrine of forward emplacement.

## World War I: School Starts Again

The British and French artillery entered the War ill-prepared. Convinced that it would be a war of mobility, most of their weapons were light artillery, such as the French 75-mm gun. While these light pieces had high rates of fire, their terminal effects were inadequate. Compounding this was the pitifully small supply of ammunition, which the rate of fire quickly exhausted.

The idea of high mobility called for forward emplacement. This made artillery units easy targets for the heavier German artillery and machineguns. Allied artillery had a hard time providing support; the enemy was taking advantage of his greater range and cover by using indirect fire. Except for the few German light artillery units, the Allies couldn't see him and, therefore, couldn't engage him. The mobile war never materialized in the West, and because of their tactics, the Allies paid for it in blood.

Both the French and the British knew about indirect fire, but neither entered the War with an established system to lay the guns or call for fire. Their light artillery proved inadequate, and both had to add heavier guns to support the front. Because their weapons and techniques had to be modified under fire, it cost many lives.



The Russians began returning indirect fire during the Russo-Japanese War. Note the ogler on the howitzer in the forefront.

By the time the United States saw action in October of 1917, indirect fire was the standard on the Western Front. All but about 100 of 2,250 pieces of artillery the American Expeditionary Force (AEF) used during the War were French. As a consequence, the French artillerymen trained the AEF in French indirect-fire techniques. The AEF was fortunate not to have had to learn this lesson of war on the battlefield.

The situation was only slightly better on the Eastern Front. There, greater mobility occasionally allowed the artillery to fall back on its old direct-fire habits. Even so, the Russians primarily used the indirect fire techniques of the Russo-Japanese War. The experience reinforced the advantage of indirect fire, even though the Russians achieved limited success due to the low quality of their artillery. By the time the Russians left the War late in 1917, they had indirect fire firmly established as their primary means of fire support.

While most of the German artillery took to heart lessons from the previous wars, World War I reinforced its conviction. The majority of German artillery was heavy and medium batteries that used forward observers to adjust its fires. This technique proved very successful against Allied artillery and trenches, especially during the initial stages of the War. Surprisingly, the Germans employed their light artillery in the same manner as the French with the same unfortunate results.

At the end of the First World War, The War to End All Wars, all participants were well-schooled in the advantages of indirect fire. They had learned methods to orient, mass and control fire and the devastating effects of indirect fire on their soldiers. More importantly, they experienced the

clash of technology and tactics with its inevitable result: modification of current tactics.

## Conclusion

This article briefly explores the long journey artillerymen took to learn (and relearn) the benefits of indirect fire and what it finally took for them to accept it. It's a story of several armies working on a similar idea and taking different views about its functionality. It's also a story of how new technology can change doctrine.

Technology provided new capabilities that commanders should have capitalized on before armed conflict. Lack of foresight by these military leaders, despite several examples, prevented changes to doctrine during peace. As often happens in history, this lack of foresight forced armies to learn the benefits of indirect fire in the school of war. They paid a high price to learn to change tactics and techniques.

There's one critical lesson to learn from this historical example. Tactics and techniques must fully exploit the technical capabilities of new systems, or we should modify our tactics and techniques. Doctrinal research, war gaming and modeling must go hand-in-hand with new system development. We have the capability to figure out if our current doctrine is appropriate for the new system or if there's a better way.

If we do this, we'll stop endangering our soldiers' lives and limiting our capabilities. In the face of new technology, we must not let doctrine become dogma or let soldiers die for lack of foresight.



**Captain (P) Joseph P. Nizolak, Jr., won Second Place in the US Field Artillery Association's 1990 History Writing Contest with this article. Currently, he's an Assistant Fire Support Coordinator (AFSCOORD), 25th Infantry Division (Light) Artillery, Hawaii. He holds a master's degree in Computer Science from the Naval Post Graduate School, Monterey, California, and a master's of Military Art and Science from the Command and General Staff College, Fort Leavenworth, Kansas, and is an Honor Graduate of the Field Artillery Officer Advanced and Basic Courses, Fort Sill, Oklahoma. Captain Nizolak commanded A Battery, 1st Battalion, 10th Field Artillery, and A Battery (Target Acquisition), 25th Artillery, and served as S3 of the 1st Battalion, 76th Field Artillery, all in the 3d Infantry Division (Mechanized) in West Germany.**

# Battle in the Streets—Manila 1945



Third Place

**F**rom 4 February until 3 March 1945, the US XIV Corps fought a savage house-to-house battle against some 17,000 Japanese troops who had dug themselves into Manila. It was the only battle during the Pacific Campaign that saw large-scale urban fighting. The battle was a great strain for the infantrymen who had to dig the Japanese out. It was also a unique challenge for the Field Artillery battalions that supported them.

Events were to show that the artillery's role was vital in the American victory. The study of this battle has many lessons for today's gunners who must consider the proper use of artillery in urban combat.

## The Battlefield

Manila was, and is, one of the largest cities in the Orient. In early 1945, Manila covered roughly 14.5 square miles and had a population of some 800,000.

The city was of greatly varied composition. From the shanties of the densely populated Tondo slums to the massive, modern stone and concrete public buildings to the 400-year-old Spanish-built walled city, the Intramuros, Manila was an urban area that presented challenges and opportunities to defender and attacker alike. Bisecting the city was the east-west flowing Pasig River. To the east lay the



by Major John Gordon IV

*February 1945 . . . A month earlier, American forces had returned to the main Philippine Island of Luzon. After a cautious initial advance southward from the beachhead at Lingayen Gulf, the American forces picked up speed and raced south toward Manila. By the evening of 3 February, the "flying column" of the 1st Cavalry Division had reached the northern outskirts of the city. The lack of opposition the cavalymen had encountered during their approach to the city was to prove misleading. A month of bitter street fighting lay ahead. The Battle of Manila was about to begin.*

Sierra Madre Mountains where the Japanese Army had established a strong defense.

## The Japanese Defenders

Wanting no part of a fight for Manila, the commander of the 14th Area Army, General Tomoyuki Yamashita, had ordered the withdrawal of Japanese Army troops

from the city. However, due to the lack of unity of command that was typical of Japanese operations in World War II, Yamashita had minimal control over Rear Admiral Sanji Iwabuchi's Manila Naval Defense Force. As Japanese Army units evacuated the city, naval troops dug themselves in, preparing for the US Army to arrive.



Manila, one of the largest cities in the Orient, is divided east and west by the Pasig River. Note Provisor Island on the lower left center.

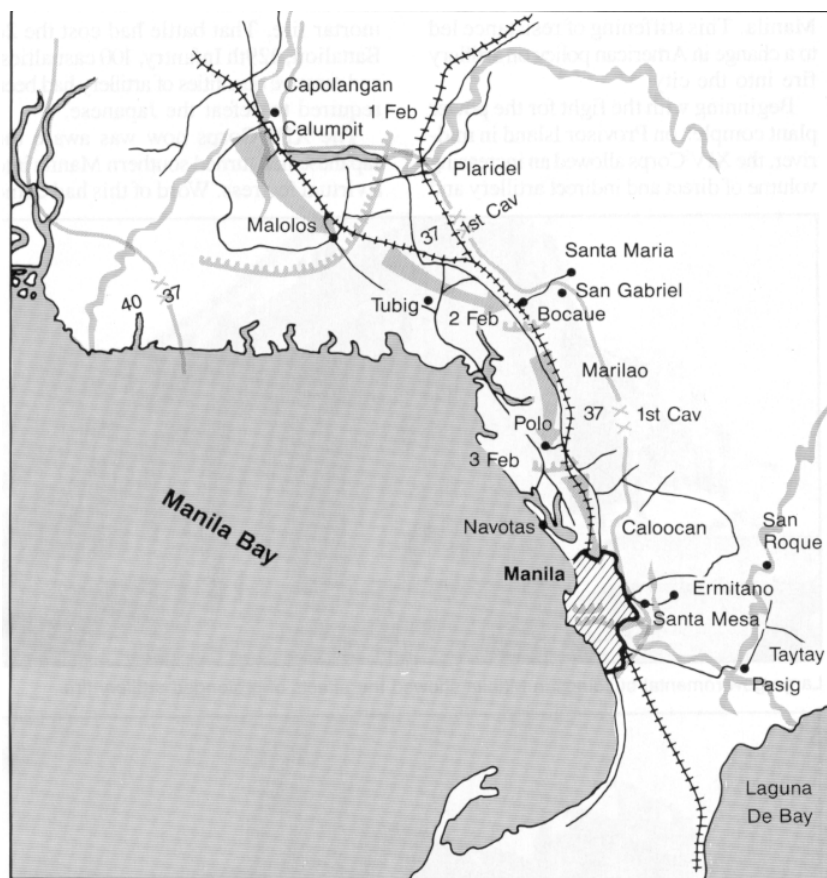

The Advance on Manila, February 1945



Soldiers of the 37th Division plunged directly into the heart of Manila.

Though the vast majority of Admiral Iwabuchi's men were not trained ground troops, the Japanese sailors turned most of Manila into a fortress. Using large governmental buildings as the main centers of resistance, the Japanese reinforced walls with sand bags, mined roads and bridges, dug trenches and tunnels between buildings and sited hundreds of automatic weapons, many of them removed from wrecked aircraft at nearby airfields and from half-sunk ships in Manila Bay.

Although the enemy was short of conventional Field Artillery, he had a very large complement of machineguns, 20-mm automatic cannons, mortars and more than 60 120-mm naval dual-purpose anti-aircraft

guns. The Japanese also had a fair number of fixed rocket launchers, some as large as 450-mm. Covering the southern approaches to Manila, the direction from which the Japanese expected the main American attack, was a large number of concrete pillboxes and bunkers.

Including some Army units that were unable to evacuate in time, there were some 17,000 Japanese in the Manila area as the 1st Cavalry and 37th Infantry Divisions arrived on the city's northern edge. Needless to say, the Japanese were prepared to fight it out to the last man.

Unfortunately in what was to prove a terrible tragedy, the civilian population of Manila had been unable to evacuate before the XIV Corps began its encirclement of the city. Hundreds of thousands of Filipinos were to be caught in the cross-fire.

### The US Attackers

Lieutenant General Oscar W. Griswold's XIV Corps initially was composed of the 1st Cavalry and 37th Infantry Divisions that had landed at Lingayen Gulf and had

advanced south to the city. On 10 February, the XIV Corps gained control of the 11th Airborne Division on the south side of Manila. But the brunt of the fighting was to fall on the 1st Cavalry and 37th Divisions.

Both divisions arrived on Manila's northern outskirts following fighting in central Luzon and were somewhat understrength in infantry. And the 1st Cavalry was ill-configured for infantry-intensive street fighting. Its four cavalry regiments each numbered 1,750 men as opposed to the 3,000-plus in the regiments of a regular infantry division. Not all its maneuver units would be available to fight in the city since there was a need to throw a screen to the east in the direction of the Japanese in the mountains. Moreover, the 1st Cavalry Division's regiments began the Luzon campaign understrength from the Leyte Island campaign in October and November. As the divisions began to push into northern Manila, their infantry needed large amounts of fire support.

Supporting the infantrymen and cavalrymen were five battalions of 105-mm, three of 155-mm, more than a battalion of 4.2-inch mortars and several batteries of 8-inch and 240-mm howitzers. With the addition of the self-propelled 105-mm weapons in the infantry regimental cannon companies, there were well over 140 cannons and heavy mortars.

However, because of concern for the large number of civilians in the city and the desire to retake it as intact as possible. General Douglas MacArthur imposed restrictions on the use of artillery fire. Only positively identified enemy targets would be engaged by Field Artillery. In addition, there would be no close air support (CAS) within the city. On the morning of 4 February, the XIV Corps began to push into northern Manila.

### North of the Pasig

Partly because XIV Corps arrived suddenly in Manila's northern suburbs and also because the Japanese defenses in the north were less developed, the 37th Division made good progress clearing the area north of the Pasig River. Meanwhile, the 1st Cavalry Brigade of the 1st Cavalry Division swung to the east to encircle the city and link up with the 11th Airborne coming up from the south.

### Clearing the North

During the fighting north of the Pasig, the 37th Division quickly discovered the

need to bring much of its artillery up to the front line to engage the Japanese strongpoints with direct fire. The bitterest fighting north of the Pasig was in the Tondo slum area along the Manila Bay. Here 105-mm fire from the M-7 self-propelled "Priests" of the regimental cannon companies (organic to the infantry regiments) proved very effective against the poorly built tenements. Further inland, the 1st Cavalry Brigade also attacked with good artillery support, mostly in the conventional indirect-fire role.

On 8 February, the 8th Cavalry Regiment fought its way through the New Manila and San Juan del Monte suburbs in the northeast, supported by more than 1,300 rounds of 105-mm and 350 of 155-mm. Artillery fire knocked out many Japanese strongpoints, allowing the cavalrymen to overcome the remaining enemy.

By 10 February, XIV Corps had cleared Manila north of the Pasig. Roughly 1,500 Japanese had been killed, the vast majority by American artillery fire. Thus far, the restrictions on the use of artillery and mortars had helped minimize the damage to the city north of the river. Unfortunately, the bitterest part of the battle lay ahead. This had already become evident to the 37th Division during the first crossings of the river on 7 February.

### Stiffening Resistance

Three days of fighting south of the river from 7 to 10 February cost the 148th Infantry Regiment more casualties than both divisions had suffered in the fighting north of the Pasig. The battle north of the river had been, in effect, a Japanese delaying action that allowed the enemy to redistribute troops and prepare to meet the two-division drive coming through northern

Manila. This stiffening of resistance led to a change in American policy on artillery fire into the city.

Beginning with the fight for the power plant complex on Provisor Island in mid-river, the XIV Corps allowed an increasing volume of direct and indirect artillery and

mortar fire. That battle had cost the 2d Battalion, 129th Infantry, 100 casualties, and massive quantities of artillery had been required to defeat the Japanese.

The XIV Corps now was aware the Japanese had turned southern Manila into a virtual fortress. Word of this had come



Large governmental buildings in Manila showed the effects of prolonged artillery fire.



This building in Manila was totally devastated by direct and indirect fire in 1945.



An American 105-mm artillery battery deploys in a public park in downtown Manila in 1945.



from escaping civilians, patrols and Filipino guerillas who were active within the city. And by this time, the infantry regiments of the 37th Division were feeling the strain of street fighting.

On 10 February, the 148th Infantry, for example, was 600 men understrength. This combination of the obvious strength of the enemy positions south of the river and weakening US infantry led to a general relaxation of artillery restrictions. The prohibition against bombing, however, remained in effect.

## The Fight in the South

As the 37th Division continued to push south across the Pasig, the 1st Cavalry

Division overran the Japanese positions in eastern Manila and turned west toward Manila Bay. By 12 February, the 1st Cavalry Division had reached the bay shore and made contact with the 11th Airborne Division. The remaining Japanese garrison in Manila was now trapped.

From 12 February on, the troops of XIV Corps were forced into a street-by-street, house-by-house battle through the city. The cohesiveness of the Japanese defense gradually fell apart, but groups of enemy, ranging from handfuls to several hundred, fought savagely for blocks and single buildings.

As the infantry pushed deeper into the city, the artillery was called on to provide more and more fire. Most of the larger

buildings of the city were in the area south of the Pasig, and these proved tremendous obstacles. Often the battle for a single building could go on for days.

## Urban Direct Fire

US forces quickly discovered that 105-mm fire against well-constructed structures was ineffective. Usually 155-mm howitzers had to be brought up to within 200 to 400 yards of the building to pound the target. Often unfuzed 155-mm shells were initially fired against large buildings to open cracks in the structure since such rounds dug deeper before exploding. Next, 155-mm rounds with delay fuzes would be fired into the weakened part of the target to widen the breach.

Depending on whether a building was to be stormed or simply destroyed would dictate whether the cannoneers aimed for the top or bottom floor. If a building was to be cleared, fire initially would directed at the top floor to drive out the enemy. Next, assault troops heavily armed with flamethrowers and grenades would move into the top floor, often from an adjacent building. They would then fight their way down, room by room. If a building was to be destroyed, artillery and tank fire would be directed at the bottom floors to cause the structure to collapse.

**Police Station.** Large public buildings proved incredibly resistant to artillery fire. The 37th Division experienced great difficulty in taking the massively constructed new Police Station. More than 680 155-mm rounds were fired in support, and the assault still cost 25 dead and 80 wounded, plus three tanks.

**University.** Clearing the Phillipine University campus took 10 days, and more than 3,400 105-mm and 155-mm rounds were fired in support. There were more than 500 US casualties.

**City Hall.** Another massive public building was City Hall, which Japanese sailors had turned into a huge strongpoint. Mortars, tank destroyers and tanks supplemented the Field Artillery in reducing the building. On 22 February, two 155-mm howitzers of the 136th Field Artillery were brought up to within 250 yards to place direct fire on the structure. It required 145 rounds to collapse the east wall, allowing the infantry to rush the building.

**Senate Building.** The most difficult task fell, of course, to the infantry—it suffered roughly 90 percent of the casualties. But the artillery suffered, too. The requirement to bring guns forward for direct fire

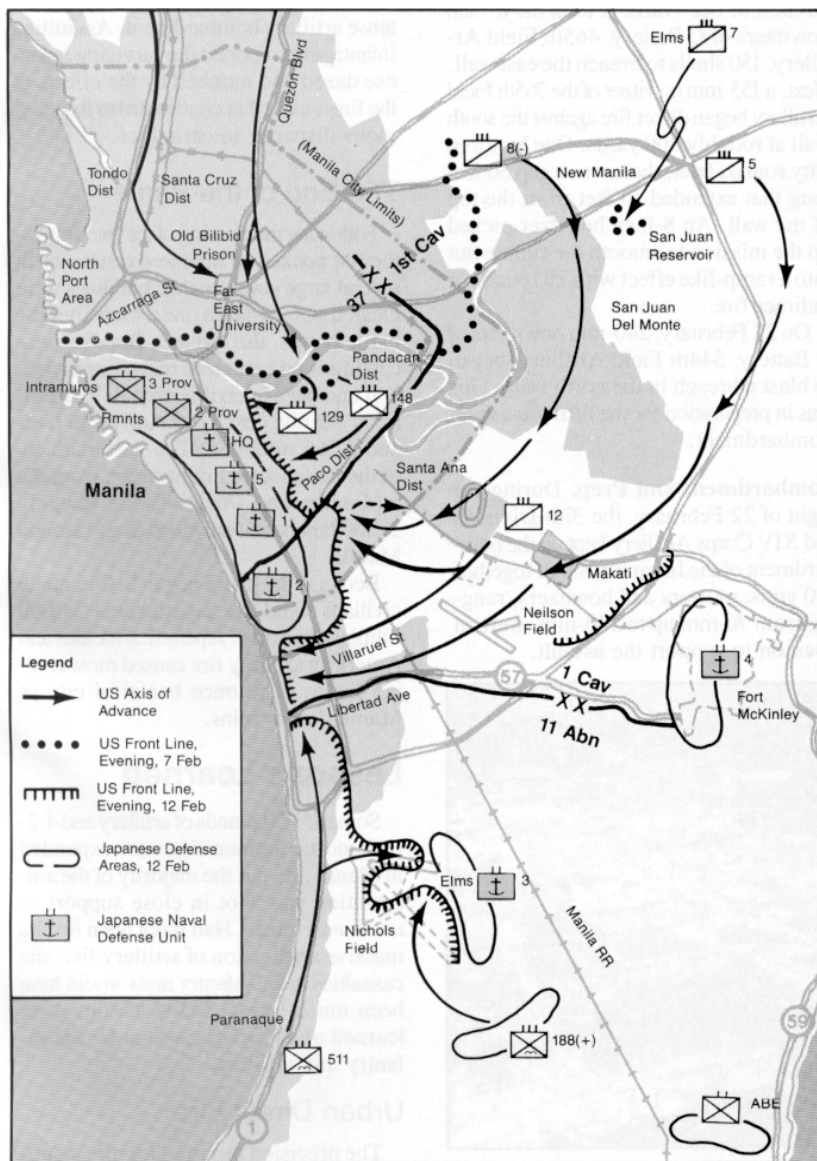

The Encirclement of Manila, 3-12 February 1945

at very close range meant gun crews were exposed to fire from their target or from enemy in nearby buildings. The 136th Field Artillery, in support of the assault on the Senate Building on 24 February, brought most of its 155-mm howitzers to within 250 to 800 yards of the building. Five gun crewmen were killed and 54 wounded from Japanese fire. The 155-mm howitzers had only small, thin gun shields to protect the crews. Unfortunately, the 105-mm armed M-7 Priests, which were well-armored being based on Sherman tank chassis, were ineffective.

### Urban Indirect Fire

In addition to the close support mission, the artillery had to fire interdiction to prevent the Japanese from moving troops around in the city. These missions probably weren't very effective because of the protection provided by the buildings and the tunnels and trenches the Japanese had constructed.

Counterbattery fire also was needed. Although the Japanese had few howitzers, their mortars and rockets could and did produce many casualties. Numerous accounts speak of the terrific morale effect of the Japanese rockets, ranging from 200 to 450-mm. Artillery Cub spotter planes circled over the city to spot enemy indirect-fire weapons firing from open areas.

### The Intramuros

By the evening of 22 February, the surviving Japanese had been pushed into an area roughly 1,000 by 2,000 yards south of the Pasig River. The key terrain feature still in enemy hands was the oldest section of Manila—the Intramuros.

Built by the Spanish in the 1500s, the Intramuros was enclosed by stone walls

up to 40 feet thick at the base and 20 feet at the top. The wall was some 25 feet high. The 37th Division, tasked with the mission of taking the Intramuros, concluded that any attempt to storm the few gates would result in heavy casualties. Consequently, the artillery was called on to blast new openings in the walls.

As early as 17 February, 8-inch and 240-mm indirect fire had been directed against sections of the Intramuros' north and east walls. On 16 February, the Sixth Army Commander, General Walter Krueger, had requested permission for bombers to attack the Intramuros. Once again, General MacArthur had said "No" on the grounds of potential massive civilian casualties.

**Breach of the Walls.** It took the 8-inch howitzers of C Battery, 465th Field Artillery, 150 shells to breach the east wall. Next, a 155-mm howitzer of the 765th Field Artillery began direct fire against the south wall at roughly 800 yards. One hundred fifty rounds later, there was a gap 50 feet long that extended 10 feet from the top of the wall. An 8-inch howitzer picked up the mission to smooth the rubble out into a ramp-like effect with 29 rounds of indirect fire.

On 22 February, 240-mm howitzers of C Battery, 544th Field Artillery, began to blast a breach in the north wall. This was in preparation for the final pre-assault bombardment.

**Bombardment and Prep.** During the night of 22 February, the 37th Division and XIV Corps Artillery kept up the bombardment of the Intramuros. All together 120 guns, mortars and howitzers, ranging from 76-mm up to 240-mm, were in position to support the assault.

At 0730 on 23 February, the artillery preparation on the Intramuros began. The entire area inside the old walled city was raked with fire. From 0730 to 0830, 11,237 rounds were fired into the Intramuros. At 0830, infantrymen of the 37th Division stormed through the gaps blasted in the walls. The artillery began firing minutes later to create a 100-yard wide wall of fire to seal off the southern portion of the Intramuros while the infantry swept through the north.

**Artillery Effects.** By all accounts, the artillery prep had proved extremely successful. All organized resistance had collapsed by mid-day on 24 February. Total American casualties were 25 dead and 265 wounded. Perhaps 2,000 Japanese had died, the majority killed by the intense artillery bombardment. Assaulting infantrymen reported the surviving Japanese dazed and numbed by the effects of the fire—a fact that contributed to the enormous disparity in casualties.

### The End of the Battle

Following the clearing of the Intramuros, the last pockets of Japanese resistance in several large governmental buildings were cleared. On 3 March one month after the battle began, the Finance Building was captured and organized resistance ended.

It had been a terrible ordeal. The Battle of Manila cost 1,010 American lives and 5,565 wounded. The vast majority of the losses were infantrymen from the 1st Cavalry and 37th Divisions. Roughly 16,000 Japanese were killed in and around Manila.

Because the battle began before many civilians could flee, an estimated 100,000 Filipinos had died. Japanese atrocities and American artillery fire caused most civilian losses. The once beautiful city of Manila lay in ruins.

### Lessons Learned

Some 45,000 rounds of artillery and 4.2-inch mortar ammunition were expended in Manila. By far, the majority of the ammunition was shot in close support of maneuver forces. Had it not been for the massive application of artillery fire, the casualties in the infantry units would have been much worse. Many lessons were learned about urban combat by the infantry and artillery.

### Urban Direct Fire

The precision required for direct support in a street battle forced the artillery

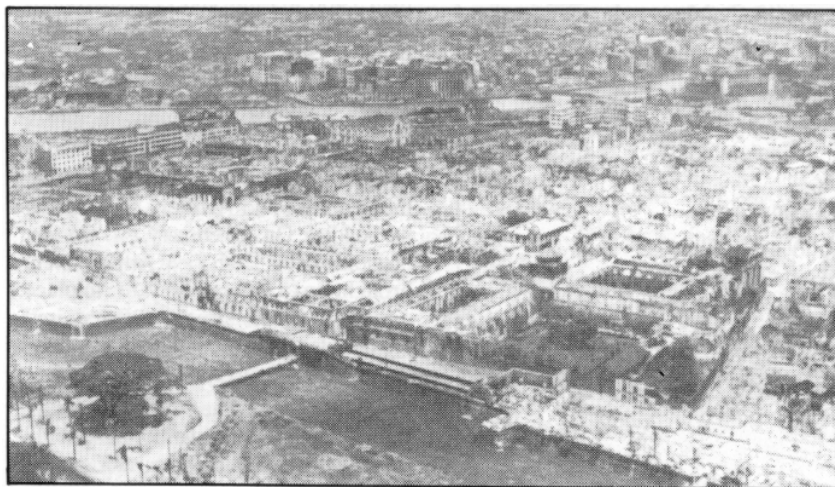

The Intramuros After the Battle of Manila

to send direct-fire weapons in fairly large numbers to the forward edge of battle (FEBA). Large, well-built buildings proved virtually immune to tank fire or even 105-mm artillery fire. The power of the 155-mm and 8-inch weapons was needed.

Simply pounding the top floor of some buildings with indirect fire often proved counterproductive because defenders would capitalize on the mounds of rubble that would heap up from the battered upper floors. Precision direct fire, often aimed at individual windows, was needed. This, as has been shown, exposed artillery gun crews to heavy casualties.

### Urban Indirect Fire

In the indirect-fire role, Field Artillery battalions moved about the city looking for public parks or other relatively open areas to set up battalion positions. The limited range of World War II-era 105-mm howitzers didn't allow the artillery battalions to stand off outside the city. The vast majority of the ammunition expended was still for the indirect fire, accounting for more than 90 percent of the ammunition fired.

Observers were often close enough to their guns and the battle was sufficiently immobile to lay wire from the observers to the gun positions. As was already mentioned, artillery spotter planes circled above the city, looking for targets.

### 1990 Urban Artillery

There is some interesting food for thought for artillerymen as a result of the Manila fighting. With urban sprawl being what it is today throughout the world, the likelihood of urban combat is increasing,

so the lessons of the Battle of Manila are worth studying.

Field Artillerymen in Manila had to employ direct fire to support the infantry in close combat deep within a large urban area. Adjacent buildings proved such a problem for trajectories that there was no alternative to direct fire.

In addition, the 75 and 76-mm guns on tanks and tank destroyers simply didn't have the power to seriously damage large buildings. Keep in mind that those World War II vehicles carried high-explosive rounds, whereas the current generation of tanks don't; our tanks today carry high-explosive anti-tank rounds, which would be marginally effective against concrete buildings. Thus the likelihood the infantry will need artillery to come forward to help is probably even greater today.

The massive quantity of ammunition needed to seriously damage a large concrete or stone building was a surprise for the artillerymen of 1945. Literally hundreds of rounds were needed against individual buildings.

The quality of World War II concrete-piercing fuzes left much to be desired, forcing gunners to pound away for hours or days to attain the required effect. This also should give today's artillerymen something to think about.

World War II artillery battalions carried, for the most part, high-explosive ammunition. This proved to be the right type needed for urban fighting. Today, however, much of our artillery basic load is dual-purpose improved conventional munitions (DPICM). This type of ammunition would have been nearly useless in Manila in 1945. All DPICM would have

done would be to put a lot of tiny holes in the roof of the top floor of well-constructed buildings. Artillery planners should keep this in mind should an urban fight be likely.

### Hard-Learned Lessons

The Battle of Manila was unique in the Pacific Campaign. It was a hard urban fight with heavy losses. Without question, the role of the artillery was critical, and the accounts of the participating infantry units don't hesitate to praise the work of the cannoners who, quite literally, opened the breach for the infantry.

Many of the lessons of this month-long battle are as relevant today as they were 1945. It's up to today's artillerymen to profit from such lessons that were learned at such great cost 45 years ago.



Major John Gordon IV, a frequent contributor to *Field Artillery*, won third place with this article in the US Field Artillery Association 1990 History Writing Contest. He's a Training and Doctrine Command (TRADOC) Systems Staff Officer in the Firepower Directorate, Combat Developments, Headquarters, TRADOC, Fort Monroe, Virginia. Major Gordon recently completed his second tour in South Korea, where he was the Fire Support Officer for the 1st Brigade, 2d Infantry Division. He also served in the 82d Airborne Division, Fort Bragg, North Carolina, and the 5th Recruiting Brigade, San Antonio, Texas, and as gunnery instructor at the Field Artillery School, Fort Sill, Oklahoma. Major Gordon holds a master's in International Relations from Saint Mary's University, San Antonio. He also has published in *Army*, *Naval Institute Proceedings* and *Military Review* magazines.

## 1991 History Writing Contest

The United States Field Artillery Association is sponsoring its sixth annual History Writing Contest with the winners' articles to be published in the August 1991 edition of *Field Artillery*. Submit an original, unpublished manuscript on the theme **Fire Support in Combined-Arms Operations** by 4 February to compete.

The Association will award \$300 for the First Place article, \$150 for Second Place and \$50 for Third. Selected Honorable Mention articles also may appear in the August *Field Artillery*.

Civilians of any nationality or military of all branches and services, including Allies, are eligible. You don't have to be a member of the Association to compete. Your submission should include your (1) double-spaced manuscript of no more than 2,500 words, (2) biography and (3) graphics (black and white or color photographs, slides, charts, graphs, etc.) to support your article. Be sure to include footnotes and a bibliography with your manuscript.

The article should include specific lessons or concepts that apply to today's Redlegs in combined-arms operations. The article should not just record history or document the details of an operation. Authors may draw from any historical period they choose.

A panel of three expert historians

will judge the manuscripts, which will be sent to them without the authors' names. The panel will determine the winners based on the following criteria:

- Relevance to Fire Support in Combined-Arms Operations (20%)
- Usefulness to Today's Redlegs (30%)
- Historical Accuracy (20%)
- Originality (10%)
- Writing

Effectiveness—Organization, Construction and Style (20%)

By 4 February, send the submission to The United States Field Artillery Association, ATTN: History Contest, P.O. Box 33027, Fort Sill, Oklahoma 73503-0027. For more information, call the Editor or Managing Editor of *Field Artillery* at AUTOVON 639-5121 or 6806 or commercial (405) 351-5121 or 6806.

# Fire Support and the Maneuver Commander at Dien Bien Phu: Tragedy and Triumph

by Captain Stephen L. Curtis

## Honorable Mention

*You must take care to choose an elevated position in order to fall upon the enemy with greater advantage. But the most important point is not to gather your army on a plain situated at the foot of a mountain which the enemy might be able to occupy unimpeded; for with his artillery he would crush you from the neighboring heights; in vain would you try to prevent his batteries from hitting you ceaselessly and without impediment. Embarrassed by your own troops, you would find it impossible to harm him.*

Niccolo Machiavelli  
1469-1527

A maneuver commander in a rapid-deployment force fighting a come-as-you-are battle far from his logistical base depends on both land-and air-based fire support. In most cases, the maneuver unit's survival depends on the successful application of fire support. Operation Urgent Fury in Grenada (25 October to 2 November 1983) showed that our current doctrine needed more work to address joint fire support planning. It also showed how critical time and information shortages can be.

The operation was an overall success, due in part to our massive superiority in arms and men against a relatively unorganized band of Cuban Marxists. However, there's one clear and tragic example of how vital fire support is and how vulnerable it is to failure in the face of a truly determined guerrilla force. It was the ordeal faced by two French artillery groups 36 years ago, 13 March to 7 May 1954, at a place called Dien Bien Phu.

## Background

It was into this valley, three miles wide by 11 miles long, that the French parachuted five infantry battalions and supporting artillery in November of 1953. They had been fighting the Vietminh to maintain control of North Vietnam since 1946. Vietminh offensives in 1950 had



resulted in the capture of the French outposts near the Chinese border, giving the Vietminh control of the Highlands and backing the French into the Red River Delta behind the De Lattre Line.

In 1951, the French were attacked by the Vietminh in a succession of battles in the Red River Delta, culminating in the battle of Hoa Binh. At this battle, the French had occupied a position deep in enemy territory, attempting to draw the Vietminh into a set-piece battle. The Vietminh surrounded the French, then destroyed their planes, ambushed their supply convoys and narrowly missed annihilating them. The French retaliated in 1952 with Operation Lorraine, a series of battles that achieved a stalemate at best.

Then in November of 1953, again they were looking for the decisive battle that would bring the Vietminh to its knees. It was to be called Operation Castor, and the French Commander-in-Chief, General Henri Navarre, chose a site in the Thai highlands, again deep in the heart of Vietminh territory.

## The Plan

The Vietminh had controlled the highlands because the cross-country mobility of their soldiers and artillery

effectively neutralized the French superiority in artillery and air support. The only other difference between this upcoming battle and the one at Hoa Binh was that the French supply line was 200 miles longer and the Vietminh firepower 300 percent greater.

The French maneuver commander at Dien Bien Phu, General Christian de Castries, expected to wage a battle of annihilation. His plan, he said, hinged on three operations:

(1) *On an ensemble of five centers of resistance which form the infrastructure of the static defense and which shall define on the terrain the area of the desirable battlefield;*

(2) *On the ability to concentrate on every point of the battlefield at least four fifths of all the firepower available to me; and*

(3) *On a full scale of counterattacks . . . (Hell in a Very Small Place by Bernard B. Fall, Lipincott, 1967).*

## French Artillery

To support this plan, the artillery commander, Colonel Charles Piroth, had employed six batteries of 105-mm howitzers, four 155-mm howitzers and three 120-mm mortar companies (see Figure 1). He also employed observers on outlying hills and six spotter planes to observe rounds. He boasted to General de Castries that "No

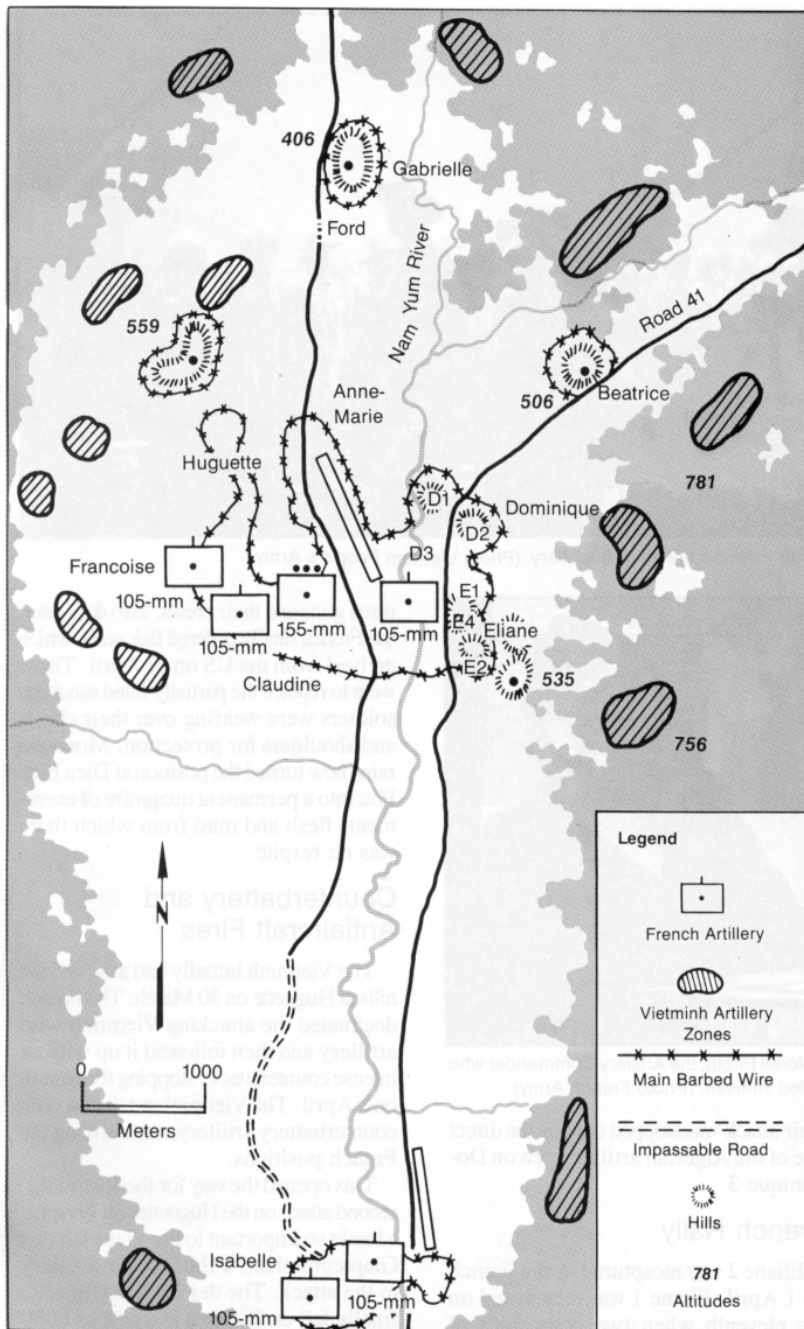

Figure 1: The Battle of Dien Bien Phu, 13 March 1954.

Vietminh cannon will be able to fire three rounds before being destroyed by my artillery" and that they would be "unable to supply their pieces" in that terrain (Fall, 1967).

Colonel Piroth emplaced his guns on hills so they were mutually supporting. The guns at Isabelle couldn't reach Gabrielle and Beatrice, so these two outposts were covered by 120-mm mortars to compensate for the difference and to provide

local support. The French positions at Dien Bien Phu were uncamouflaged and in the open to allow them to fire in all directions. Soldiers had shoddily built bunkers and no flak vests.

Complacency abounded because historically the Vietminh used artillery sparingly, and when they did, it was never with guns larger than 75-mm. In addition, the French figured the Vietminh artillery couldn't reach them with the trajectory



The Vietminh had a 500-mile supply route.



Photo French Army

The shell casings piled up after an artillery barrage.

they would need to clear the crests of the surrounding hills. Surely, they thought, the Vietminh would not fire from the forward slopes, which nobody had tried since Napoleon and which would expose them to merciless French fire.

### Vietminh Artillery

The Vietminh commander, General Vo Nguyen Giap, had indeed decided to attack the French, but not until he had overwhelming firepower. He first had his army stealthily hack out a 500-mile road back to the Chinese border at Mu Nam Quan, large enough for their bicycles and 800 Molotova trucks. He then succeeded in infiltrating, via this supply line into the valley, at least 36 105-mm howitzers, as well as 48 75-mm pack howitzers and 104 other field guns of 57-mm caliber or greater. He also was able to supply at least 103,000 rounds of artillery ammunition during the battle. Thus before the battle began, the Vietminh had a three-to-one superiority in numbers of artillery pieces with no shortage of resupply.

Once the guns arrived on the battlefield, the Vietminh dug them into the hillsides in bombproof dugouts, complete with camouflaged portholes that hid their flashes when they fired. The guns were



dug at least six feet into the ground with covers that closed before and after firing. Collocated with them were massed antiaircraft artillery camouflaged in the same manner. These positions on the hills also made the guns impervious to the monsoon floods. This was the situation when the first rounds slammed into the French positions at 1700 hours on 13 March 1954.

## The Battle

*It is known that an army can pass wherever a goat has passed; it is possible to hoist cannon with ropes onto the highest mountains . . . and to lay waste an enemy camp which did not expect to see a hail of cannonballs fall from the clouds.*

Prince Charles Joseph de Ligne  
Austrian General and Writer  
1735-1814

The Vietminh destroyed the French observation posts and six spotter planes within 48 hours. They then neutralized the main French artillery at Claudine and Dominique, leaving Beatrice and Gabrielle without artillery support. The mortars on the two outposts couldn't hope to survive this pounding, and the two outposts fell to the Vietminh by the second day of the battle.

## French Fold

It soon became evident that all the artillery Colonel Piroth had wouldn't be enough to destroy the Vietminh in their trenches or their guns that were hidden from detection. He was unable to put together a fire plan as his batteries were decisively engaged and never could have executed it. The French infantry tried a counterattack without artillery, losing two entire companies before it was stopped cold.

Colonel Piroth felt directly responsible for the cemeteries that used to be Beatrice and Gabrielle. Despondent and full of guilt, he committed suicide on 15 March by blowing himself up with a grenade. On that day, a monsoon hit, caving in most of the French bunkers and filling them with water. The Vietminh swarmed toward Anne-Marie and began constricting the French with trench works.

The Vietminh then proceeded to assault the "five hills" complex of positions at Dominique 1 and 2 and Eliane 1, 2 and 4 after an artillery barrage destroyed the mortars on the positions. Even though the Vietminh were too close to the French for their own artillery to support them,



Fall, Hell in a Very Small Place

Giap inspects antiaircraft artillery. (Photo Vietnam People's Army)



Fall, Hell in a Very Small Place

Colonel Piroth, the Artillery Commander who Killed Himself. (Photo French Army)

their attack was stopped only by the direct fire of the Algerian artillerymen on Dominique 3.

## French Rally

Eliane 2 was recaptured by the French on 1 April. Eliane 1 was recaptured on the eleventh when two companies of Foreign Legion troops under the cover of artillery fire defeated a Vietminh battalion. The French held these positions until the end of the battle, by which time soldiers were stacking corpses for protection from the Vietminh artillery. Only then did the French begin digging trench works between their gun positions and strongpoints.

On 16 April, the French had one of their few lucky strikes against the enemy when its 155-mm battery scored a direct hit on a Vietminh 75-mm gun battery, destroying

three guns and their crews. Two days later, the French finally ordered flak vests, which arrived from the US on 27 April. These were to replace the partially filled sandbags soldiers were wearing over their chests and shoulders for protection. Monsoon rains now turned the position at Dien Bien Phu into a permanent quagmire of excrement, flesh and mud from which there was no respite.

## Counterbattery and Antiaircraft Fires

The Vietminh initially had attacked the hills at Huguette on 30 March. The French decimated the attacking Vietminh with artillery and then followed it up with an intense counterattack, stopping the assault on 3 April. The Vietminh retaliated with counterbattery artillery, neutralizing the French positions.

This opened the way for the Vietminh's second attack on the Huguettes on 19 April, a battle so important to the Vietminh that Giap committed a third of his artillery to the attack. The defenses at Huguette finally fell on 21 April at a cost of 1,080 Vietminh and 500 French lives.

By then, French air support had all but stopped because of the accuracy of the Vietminh antiaircraft fire. As thick as any in World War II, it had so far shot 48 planes out of the sky.

## Defeat

By 16 April after repeated Vietminh assaults, the French were down to only one 155-mm howitzer and 300 rounds of ammunition for it with little chance of resupply. Fifty-six days of operating in

**Field Artillery**

waist-deep mud under constant fear of death had taken its toll on combatants on both sides as each wondered how much the other could endure.

The question was answered by the Vietminh. They hit the French with a new and devastating weapon in the form of Russian-made Katyusha rockets, which broke the back as well as the resolve of the French. The barrage destroyed most of the remaining bunkers and all but one of the remaining 105-mm howitzers. For those who were not part of the 30,084 dead and wounded of both sides strewn about the battlefield, the misery ended the next day.

## Battle Analysis

The success or failure of each of the maneuver commander's fire support at this battle was decided in three areas: tactics at every level, logistics and intelligence estimates of enemy capabilities and actions.

**Vietminh Tactics.** The Vietminh fire support was successful partly because of superior tactics. The gun crews emplaced their howitzers and covered and concealed them in places thought impossible by the French. In addition, the Vietminh crews would dismantle and move their howitzers under fire to support their maneuver commanders. This undoubtedly required enormous effort and cost many lives.

The Vietminh artillerymen also were masters of camouflage; the French didn't recognize their positions in spite of the fact that most were on forward slopes and close to the main French positions.

The Vietminh held their attack until they had an overwhelming ability to mass fires. They held their attack in spite of the fact that every day they waited, the French grew stronger.

**Vietminh Logistics.** Giap's forces were able to demonstrate a logistical capability unmatched by the French. Considering they had no planes, they should have been at a disadvantage.

The Vietminh used the limitations of the jungle as an ally in affecting the perceptions of the French regarding its supply capabilities. This, combined with the Vietminh's hidden air-defense capability, was enough to lure the French into an unwinnable logistical situation.

**Vietminh Intelligence.** The Vietminh artillery was successful because it knew the enemy. The French soldiers were out of their element in jungle terrain, and their doctrine reflected this inexperience.

Giap knew the French would try to apply the lessons from the delta flatlands to the

Photo US Navy



A French medical evacuation helicopter comes under heavy fire at Dien Bien Phu.



The Vietminh artillery forced the French to surrender at Dien Bien Phu.

jungle highlands (such as tank warfare, static defense and aerial resupply). He purposely didn't fire his 105-mm howitzers before the start of the battle because he wanted the French to continue unaware of them in his preparations. As a result of the above factors, not only was the Vietminh artillery able to support its maneuver element, but it also accounted for 75 percent of all French casualties.

**French Tactics.** The French artillery positions lacked both survivability and mobility because they were on low, muddy ground with no cover or concealment. The positions also lacked decent bunkers for their personnel who were without flak vests for most of the battle.

The key to the success of the French position lay in the occupation of the hills at Beatrice and Gabrielle. If the Vietminh could take them, they would have a commanding view of the entire French position. By placing one-third of his artillery at Isabelle out of range of these positions, Colonel Piroth couldn't support General de Castries' plan to "concentrate on every point of the battlefield at least four-fifths of all the firepower available." The importance of this tactical omission can't be overstated.

**French Logistics.** The French logistical capability was shut down totally by Vietminh anti-aircraft artillery. This was due in part to inadequate suppression of enemy air defense (SEAD) as well as an overreliance on airpower they didn't have. The French basically overestimated their own logistical ability and underestimated the ability of the Vietminh to neutralize it.

**French Intelligence.** Poor preparation for the battle on the part of the French fire supporters was largely the result of a condescending and overconfident attitude toward the Vietminh. Colonel Piroth failed to heed accurate intelligence reports on enemy artillery strengths and unorthodox gun emplacements and actually refused an offer of additional artillery from Hanoi before the battle.

## Conclusion

This battle shows how vitally important fire support is to the maneuver commander. Its importance is graphically evident if we view the battle through a modified target value matrix (see Figure 2).

Fire support always must be synchronized with the maneuver commander's in-intent and thoroughly planned by competent

fire support coordinators (FSCOORDs) at all levels. Highly proficient SEAD and target acquisition as well as survivability measures and mobility can mean the difference between victory and defeat. These factors, not surprisingly, determine success or failure at the National Training Center (NTC), Fort Irwin, California. We also must know the enemy and the environment.

Field Artillerymen must be prepared for a battlefield calling for "individual stamina and fortitude, for the understanding and acceptance of battlefield conditions almost unimaginable in their demands on human endurance, for recognition in doctrine that these requirements exist and that they may very well have to be met" (*Street Without Joy*, Fall, Schocken Books, 1961). Our fire support, especially for a rapid-deployment or light force, must be prepared to accomplish what the French didn't at Dien Bien Phu.



**Captain Stephen L. Curtis won Honorable Mention with this article in the US Field Artillery Association's 1990 History Writing Contest. He's a Division Target Analyst in the Fire Support Element of the 10th Mountain Division (Light Infantry) Artillery, Fort Drum, New York. Captain Curtis has served as the Company Fire Support Officer for A Troop, 4th Squadron, 7th Armored Cavalry Regiment, South Korea; Executive Officer for B Battery, 2d Battalion, and a Platoon Leader for E Battery, both in the 7th Field Artillery at Fort Drum. He's a graduate of the US Military Academy at West Point; his other schools include the Field Artillery Officer Basic Course, Fort Sill, Oklahoma; Airborne and Ranger Schools, Fort Benning, Georgia; Air Assault School, Fort Campbell, Kentucky; and Northern Warfare School, Fort Greely, Alaska.**

French Fire Support Effects on Vietnam				Vietminh Fire Support Effects on French		
D I S R U P T	D E L A Y	L I M I T	Target Set	L I M I T	D E L A Y	D I S R U P T
			Command, Control and Communications	X		
		X	Fire Support	X	X	X
		X	Maneuver	X	X	
		X	Air Defense Artillery	N/A	N/A	N/A
		X	Engineer	X	X	
			Reconnaissance, Survey and Target Acquisition	X	X	X
N/A	N/A	N/A	Radio-Electronic Combat	N/A	N/A	N/A
N/A	N/A	N/A	Nuclear/Chemical	N/A	N/A	N/A
			Class III (Petroleum Oil and Lubricants)	X	X	X
			Class V (Ammunition)	X	X	X
			Class IX (Maintenance)	X	X	X
N/A	N/A	N/A	Airlift	X	X	X
			Lines of Communications (Logistical Routes)	X		

Figure 2: This Fire Support Assessment Matrix, a modified target value matrix, clearly shows the importance of fire support for the maneuver commanders in the Battle of Dien Bien Phu.



The Vietminh hoist their flag over de Castries' bunker.

### Historical Vignette:

## Field Artillery Tactics in the Spanish-American War

Although the importance of massing fires was one of the most significant lessons of the American Civil War, time erased the importance of this tactic. Rocked by the explosion of the *USS Maine* and other events, the United States went to war against Spain over Cuba in 1898. The American artillery's use of outdated tactics and obsolete guns caused it to play only a minor role in the Spanish-American War. Our inability to mass fires caused the Americans

to lose the advantage of firepower as a combat multiplier.

### Organization

As finally organized, our V Corps included two divisions of infantry and one division of dismounted cavalry. Each infantry division had three brigades of three regiments each, while the cavalry division consisted of two, three-regiment brigades. Shortly

before embarkation at Tampa, Florida, getting ready to sail to Cuba, an independent brigade of two regular infantry regiments and a cavalry squadron joined V Corps.

In addition to the infantry and cavalry units, V Corps had a provisional Field Artillery battalion of four batteries under Major John Dillenback. The battalion had two batteries of siege artillery, a provisional battery of four Gatling guns under First Lieutenant John H. Parker, two engineer companies and a Signal Corps detachment with an observation balloon.

Aside from the three volunteer regiments—the 71st New York, the 2d Massachusetts and the Rough Riders—V Corps was essentially a standing army of long service. Even though the Corps was composed of veterans, none had seen any combat except for the Indian campaigns, which certainly didn't prepare the soldiers for combat against a European Army.

### Equipment

For fire support, V Corps had M1885 and M1890 3.2-inch field guns that had been introduced during the previous 13 years. That direct-fire, breech-loading gun used black powder that emitted a white puff of smoke when fired, lacked a recoil system and had a range of 6,600 yards. Although the 3.2-inch piece was the Army's most modern, it was obsolete. European armies had smokeless powder, steel, rapid-fire breechloaders.

Equally importantly, American Field Artillerymen still relied upon direct fire, and the 3.2-inch gun's range allowed them to advance their guns right up to the infantry skirmish line.

### The War

After completing a poor reconnaissance of Spanish positions around Santiago, Major General William R. Shafter, Commanding General of V Corps, moved his force into position. He dispatched Brigadier General Henry Lawton's division to assault El Caney, a hill on the American right, and directed the rest of his force to attack San Juan Hill.

With support from Captain Allyn Capron's battery of 3.2-inch field guns, Lawton's division climbed El Caney. Artillery fire had little effect on the Spanish on El Caney because Lawton, who was acting as his own chief of artillery, failed to mass fire on any particular target. In fact, his battery opened fire with shrapnel at what appeared to be a column of cavalry moving along the road from El Caney toward Santiago, fired a few shots at the blockhouse perched atop El Caney, hit a hedge with a few shots where enemy infantry appeared to be and then fired into the village on El Caney.

As Lawton struggled, the rest of the Americans

advanced against San Juan Hill. With Captain George S. Grimes's battery of four 3.2-inch guns providing close support and Captains Charles D. Parkhurst's and Clermont L. Best's batteries of 3.2-inch guns in reserve at the Corps Headquarters, the Americans attacked.

Grimes opened fire on a blockhouse and entrenchments on San Juan Hill at 2,500 yards, which was too far for effective fire. At the same time, white smoke from his guns marked his battery's position.

The Spanish had two smokeless-powder, 3-inch Krupp rapid-fire breechloaders to complement their obsolete muzzleloaders they converted to breechloaders. These Spanish rapid-fire guns went unspotted and mercilessly pounded the American battery. After 40 minutes of heavy artillery fire, which the Americans had difficulty returning, the Spanish drove the Americans from their guns. Two hours later, Grimes opened fire again to cover the infantry advance that was beginning to unfold.

Despite the inability of the American artillery to provide close support, American infantry and dismounted cavalry forced the Spanish to start retreating from San Juan Hill to their main line of defense. Encouraged by this, Dillenback moved Best's and Parkhurst's batteries forward to help. Before the two batteries could open fire, the infantry and dismounted cavalry had pushed the Spanish off San Juan Hill.

Subsequently, Dillenback advanced Best's battery to the top of the hill to within small-arms range. However, a Spanish counterattack drove the battery off the hill. Finally after tough fighting, the Americans held the hill and placed their three batteries on line with the infantry on 1 July 1897.

The following day, the American batteries opened fire with canister and shrapnel at a range of 500 yards. Once again, intense small-arms fire caused the Americans to withdraw their field guns. Although American Field Artillery played a minor role at San Juan Hill, the United States eventually compelled the Spanish to surrender.

### Conclusion

As combat action indicated, the Americans never massed artillery fire. They employed their batteries piecemeal and failed to take advantage of the firepower of their field guns.

Equally importantly, the Americans employed tactics suited to smoothbore Field Artillery, not the rifled technology both sides were using, by positioning their guns on line with the infantry. This further precluded our massing fire. Obsolete guns and tactics restricted the role of the Field Artillery in Cuba.

Dr. Boyd L. Dastrup  
*Command Historian*  
*Fort Sill, OK*

# *Fire for Effect*

SENIOR LEADERS SPEAK OUT

## Hope as a Motivator

by Lieutenant General (Retired)  
Gordon Sumner, Jr.

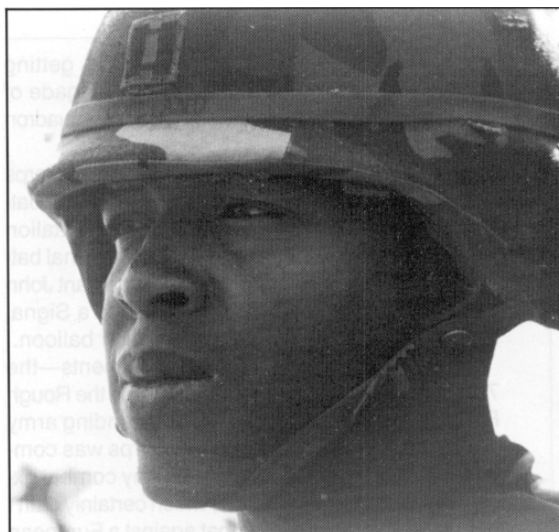

**T**here's probably nothing more difficult or complex in the field of human endeavors than military leadership. For this reason, it holds continuing fascination for everyone from philosophers to politicians. Though the subject has many facets such as ability, vision and integrity, *hope* is an important one that's too often overlooked. Military leaders' maintaining hope, their own and that of their subordinates, is an integral part of our Army's esprit de corps and, ultimately, its success on the battlefield.

I came on active duty in 1944 and spent my first 14 years as a battery-grade officer. It was a time of great turmoil in the Army, just as it is today. But that time provided wonderful opportunities for me to study human nature and the magic of military leadership under many different leaders in a variety of circumstances.

It wasn't all roses. But upon reflection, it was probably the failures and disasters that gave me the most insights into motivating others. And part of motivating others is maintaining hope. Today's Army personnel system fails to recognize the importance of hope as a motivator.

### Hope Defined

Hope is defined in Webster's Dictionary New World Edition as "a feeling that what is wanted will happen; desire accompanied by anticipation or expectation." Every leader should "carry" hope in his knapsack. I believe Napoleon said that in every corporal's knapsack is a field marshal's

baton. In other words, the battlefield leader is out there—we just have to find, recognize and promote him. We must give him the hope that his performance, brilliance, initiative and innovativeness will result in his rising to the top where, in fact, he'll be most effective for the Army. But this nebulous term hope has implications far beyond leadership on the battlefield, although that's certainly the ultimate dimension.

### A Daily Ingredient

We sometimes fail to recognize that hope is a day-to-day ingredient. Every leader, be he a general or a corporal, must weave it into the task of motivating and leading the people entrusted to him to accomplish his mission. And hope is a motivator at several different levels.

The first is the troop level. Here the junior officers and battery commanders identify what the troops hope for, individually and collectively. They, together with the senior NCOs, select those "hope fors" that contribute to the mission and work out a program where these hopes can be realized through performance.

These "hope fors" may be very obvious and simple, such as promotion, leave, better work schedules, etc., or they may be more complicated, such as better food or housing, less administrative harassment, etc. Some of these "hope fors" may be things over which the battery commander and his lieutenants have very little influence.

After World War II and Korea, I was fortunate enough to be assigned to the 11th Airborne Division Artillery working with

one of the most outstanding groups of NCOs and junior officers I have ever seen collected in one division. These junior leaders with many years of troop experience, combat and peacetime, faced all kinds of bizarre changes going on at the division and higher levels of the Army. I was privileged to observe the battalion and battery commanders use their meager resources to ameliorate the Army's lack of funding and facilities, keeping morale high and combat readiness to the maximum.

Charlie Hall (Lieutenant General, Retired), Vernon B. Lewis (Major General, Retired) and Max Thurman, (a four-star now Commanding General of the Southern Command) were just some of these leaders who later made their mark on the Army. Despite the many obstacles, hope and optimism were the hallmarks of their positive leadership.

### The Right Chemistry

But what of hope when you move to the higher echelons of the Army? This is where the problem becomes much more difficult and is an area where the Army has forgotten what it learned at the troop level.

First, the Army, as an institution, must clearly understand human nature. The people in the Army, male and female, don't fit into a single mold. An individual who may perform brilliantly in one situation under one commander may be simply mediocre or inadequate in another situation under another commander. To use the popular expression, the chemistry must be right.

As one moves up the Army's personnel system and matures, this becomes crystal clear. It's so clear, indeed, that every officer and NCO hopes and prays that he'll be able to work with his commanders and be in situations where the chemistry will work—where he'll be appreciated and contribute.

At the battalion and battery levels, the commander has the flexibility to move people around to find the best mix of chemistries. As one moves to the brigade, division and higher levels, this flexibility and the hope that goes with it has been replaced by a system that has Washington dictating who the battalion and higher commanders and the Command Sergeants Majors will be. Boards that look at paper files fill these key positions, and the validity of those papers is probably no more than 80 to 90 percent.

But the depressing aspect is that the system destroys hope for the majority of officers and senior NCOs who aren't selected by these boards. Unfortunately, it's the greater number for whom hope has been destroyed who carry the major responsibility for the Army's day-to-day functions.

## Flexible Development

The conventional wisdom is the Army must have centralized boards for promotions and selections. (But then one remembers World War II, a war we won, when this was not so.) As the Army has become more computerized, the access to information has been a "siren" calling for the Department of the Army to reach down further in its control, which reinforces "ticket punching." (Notice I do *not* use the term manage.) This control infringes on the commander's ability to shift human assets to optimize the abilities of his command and staff.

## The Right Leader

The current system never would have tolerated "Wild Bill" Harris (Major General, Retired), a Field Artilleryman selected by his Division Commander to command the 7th Cavalry Regiment in 1950 during a very critical phase of the fighting in Korea. Or "Bud" Mearns (Lieutenant General, Retired), another distinguished Field Artilleryman, selected by the senior commanders on the ground to command an infantry battalion in World War II during intense combat. Or "Dutch" Kerwin (General, Retired), who commanded

both infantry and armor units without once attending schools at Fort Benning, Georgia, or Fort Knox, Kentucky. In my case, when selected to command the 25th Infantry Division Artillery in Vietnam in 1968, I went to the Field Artillery branch and selected my battalion commanders, officers I had served with and whose chemistry I knew would ensure a winning combat team.

Certainly at the general-officer level, it's a personal selection system where the Chief of Staff ensures the chemistry is optimized. General Creighton Abrams once growled, "There is no career development for general officers"—not entirely true, but close to the mark.

## The Right Time

As Chief of the Field Artillery branch in the Office of Personnel Operations (OPO), it was quite obvious to me that people develop at different rates. Some are fast starters but "burn out" at the field-grade level. Others start slow but "catch fire" after 15 or 20 years. Indeed some are passed over repeatedly but kick into "after burner" after 20 years and go on to achieve three- or four-star responsibility.

Hope does indeed "spring eternal," and the Army must be careful not to slam the door on the Troy Middletons (Lieutenant General, Retired) or the Don Bennetts (General, Retired) of the future.

## Restoring Hope

As the Army shrinks in the years ahead, we must re-examine our current ways of doing business and reintegrate hope into the personnel system. Critical to this is the concept of giving all the commanders more flexibility in selecting, assigning and developing the most important asset of an Army—people.

One way of putting hope back into the system would be for the senior commanders to select their commanders from a list of officers qualified to be battalion and brigade commanders. Also, a senior commander should be able to reach down on a secondary list of officers not as qualified (for one reason or another) and pick others to be part of his command team.

## Eternal Hope

Currently, there's considerable discussion about the dashed hopes of many officers and NCOs as the result of the force

structure reductions looming on the horizon. This won't be the first time for such reductions. In the history of the United States Army, it's a common phenomenon, one that soldiers must expect as possible when they choose a military career.

On the other hand, when the Army experiences a massive retrenchment, there are always opportunities for professional innovativeness and time to do some of the things lost in the patterns that develop during the periods of expansion and drives to meet immediate threats. These drawdowns even might be called periods of enrichment.

Seeing the changes our Army faces today as opportunities for enrichment as opposed to setbacks leading to our inevitable demise is the job of our military leaders at all levels, a most difficult one. But if we're to realize the potential of our forces, those leaders must have hope and pass it along to those they lead.

Further, the Army must build mechanisms into our personnel system, starting at the top, to allow more flexibility in the development and assignments of soldiers and officers. The mechanisms must consider the needs of the commanders and those of their subordinates to establish the right chemistry in units—to allow soldiers to succeed as the right man in the right place at the right time. The Army must take advantage of the opportunity to promulgate hope as a motivator.

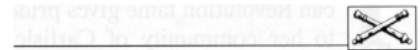

**Lieutenant General (Retired) Gordon Sumner, Jr., who retired in 1978 after 34 years of service, moved steadily through the Army from commanding small units in World War II and the Korean Conflict to serving as Chairman of the Inter-American Defense Board, Washington, D.C. After serving as Military Assistant to the Secretary of Defense, he directed the Middle East Task Group during the 1973 Arab-Israeli War. After retiring from the Army, General Sumner founded and has served as chairman of the board of two international consulting corporations. In 1981, President Reagan appointed him Ambassador at Large for Latin America. Recently, General Sumner was the National Security Advisor for the President's BiPartisan Commission on Central America.**



# Molly Pitcher:

## Who Was She?

by Constance M. McDonald



*This article is an abbreviated version of a larger, carefully documented college research paper on the same subject. Based on Mrs. McDonald's and others' research, the US Field Artillery Association plans to change the name of "Molly Pitcher," now listed as Mary Ludwig Hays, to Mary Hays McCauly in the next printing of its various publications referring to Molly Pitcher if no evidence to the contrary surfaces as a result of this article.*

The story of Molly Pitcher of American Revolution fame gives pride to her community of Carlisle, Pennsylvania, and the United States Field Artillery that claim her as its heroine. Her battleground in New Jersey boasts of a Molly Pitcher Well and a monument dedicated to her contributions during the Battle of Monmouth. The flesh and blood woman who fought at Monmouth, Mary Hays McCauly, served her country well.

Because her tale has been retold many times, details conflict in different versions. In addition, assumptions in a few historical documents have led to controversy over whether the famed Molly Pitcher's real name was Mary Hays McCauly or Mary Ludwig Hays. Though many disagree, I only can conclude from research and historical documentation that the heroine Molly Pitcher was Mary Hays McCauly.

### The Battle of Monmouth

Molly Pitcher's fame began two years after the signing of the Declaration of Independence

by the American Colonies. The fight for independence had yet to take a favorable turn toward the Colonials. As the war continued, 28 June 1778 proved to be another day of fighting with stories of b r a v e r y .

Monmouth rocked with musket and gun fire. The Colonial cannon line under General Stirling aimed the barrels of its guns straight down on the British Redcoats as they attempted to cross a causeway. Stirling's left-wing cannons bought time for General Washington to take command and regroup General Lee's scattered forces. The gun line met the demands of its mission.

The heat of June 1778 soared to 96 degrees as the guns barked at the British. The cannon barrels smoked, and men fell from heatstroke. In the heat, a woman walked back and forth from a well (or possibly a nearby creek) carrying water to the hot men and smoldering guns. Her husband manned one of the valuable cannons. They were making a difference by holding the causeway.

As American men fell from wounds and heat, the woman's bucket of water (or "pitcher") became more precious. The men among the cannons began to call her Molly Pitcher. A large woman, she reportedly carried wounded men away from the line to shade trees as she made her trip back to the well.

During one of her many returns to the line, she saw her husband fall. A Colonial officer ordered his gun moved to the rear to make room on the line; he had no one left to man it. But Molly Pitcher stepped

forward to keep her husband's gun roaring—every cannon was important.

As if she had been trained for the task, Molly kept the cannon booming. The artillerymen around her noticed her swift, accurate action in keeping the gun firing. No longer were they asking for water from her; she had become one of them—a gunner. The tale of her efforts passed among the men that evening, and as each gunner spoke, the story's details changed.

### Memories of Molly

Carlisle holds the memories and remains of Molly Pitcher. The "Old Graveyard" in Carlisle is where she was laid to rest with a military parade but with no stone marker for her grave. All that was left of her story lived in the memories of those who had known her and a few diaries describing the Battle of Monmouth.

The citizens of Carlisle knew their heroine as Molly Pitcher, a woman who could neither read nor write. Therefore, the written accounts of Molly's contributions at Monmouth weren't by her. The written story depended on the people of Carlisle.

One such citizen recorded some of his memories of Molly Pitcher six weeks before the centennial of the Declaration of Independence. Wesley Miles recounted his time as the charge of Molly Pitcher in an article that appeared in *The Carlisle Herald*.

Miles' mother died when he was small. Molly had nursed his ailing mother and

helped raise him after her death. He wrote, "The heroine of Monmouth, Molly Pitcher, otherwise known to us when a boy, as Molly McCauly, her real name...." He was the first to put the real name of Molly Pitcher in print. Miles continued, "The remains of this Irish woman rest in the Old Graveyard of Carlisle...Perhaps, not even a rude limestone marks her grave."

A stonecutter from town, Peter Spahr, remembered Molly McCauly. After reading Wesley Miles' article, he pursued the idea of a gravestone suggested by Miles. The community raised \$100 to mark her grave, and Spahr cut the stone to mark the spot. He carved:

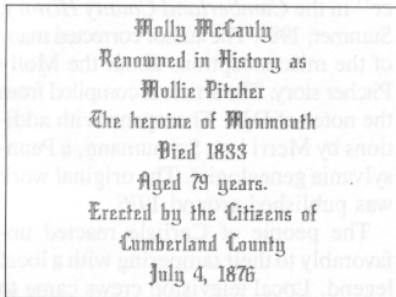

Research later would prove that some numbers on the stone were wrong. Her death notice in the local paper was dated 1832. A stonecutter later corrected the date as requested by the city leaders. Tax records also showed her age of death wasn't 79. The obituary in the *The Carlisle Herald* dated 26 January 1832 revealed her age to be 90 at her death. The stone marker did show, however, the citizens of Carlisle were not willing to let her story die.

The people of Carlisle returned to the grave of Molly McCauly to erect yet another marker. On 28 June 1916, 138 years after the Battle of Monmouth, the



Commonwealth of Pennsylvania unveiled a monument to stand near Molly McCauly's grave.

A life-size statue of Molly holding a rammer staff stands atop a marker containing legendary information about Molly's life. The face of the statue was modeled after a composite picture of five of her great-grandchildren.

A local legend states, "If a little girl stands in front of Molly's buxom statue... looks up into her face, makes a wish, closes her eyes then walks around the statue three times...and looks up at Molly's face again, the wish will come true." The Patriotic Order of the Sons of America added a cannon, flagstaff and bronze relief to depict the heroic deeds of Molly Pitcher.

## Making of a Legend

During the aftermath of the Battle of Monmouth, the tired and hot men retold the story many times—the story about acts of bravery by one of the gunner's wives. Because the events happened during the confusion of battle, many details went unnoticed by different witnesses. After the day's skirmish, the story's life was dependent on its being retold, and each witness added to or subtracted from the details. Many conflicts with a few inconsistencies put the Molly Pitcher tale into the category of legend and folklore.

## Folklore versus Fact

But a legend she was not. The memory of those who marked her grave proved correct when the search for another unmarked grave in the area began in 1892. Mrs. Patton of Carlisle, searching for the graves of her infant brother and sister, requested digging in the area. She felt certain the grave then marked as Molly McCauly's was the grave she sought.

Mr. Frederick Hays, Molly's great-grandson, agreed to allow Mrs. Patton to dig up Molly's grave. He and Mrs. Patton's attorney stood near as the remains of an adult woman were uncovered at the spot marked as the grave of Molly McCauly. Molly Pitcher had been flesh and blood.

## Ludwig Hays versus Hays McCauly

Accounts of the Battle of Monmouth reveal differing details of Molly Pitcher. Many are based on an assumption that Molly's husband was John Hays.

While preparing the bicentennial celebrations at Monmouth, Samuel Steele Smith searched for documented information about Molly Pitcher. Digging into the local archives of Carlisle, Smith found evidence that Molly's husband's last name was Hays but that his first wasn't John.

**Ludwig Hays.** An eyewitness account from the battle revealed that Molly's husband was "a man of the artillery." Historians had found a marriage certificate for Mary Ludwig and Casper Hays. Next, the historians examined the listing of men at the Battle of Monmouth in artillery units. A John Hays surfaced as an infantryman who had been there.

Initially, John was the only Hays identified as present at the Battle. The historians inferred that Casper had a second name, John. From this came the assumption that Molly Hays' full name was Mary Ludwig (or Ludwick) Hays.

**Hays McCauly.** A later search by Samuel Smith found tax records in Carlisle showing William Hays, a returning Revolutionary soldier. After his death, property was listed in 1788 to "Mary Hays administrator of the estate of William Hays...." Continuing tax records show her as Mary and Polly. Since Mary couldn't write, this left the recording of her name to Carlisle officials.

Mary Hays remarried a John McCauly. Spelling variations of McCauly show that her second husband, John, couldn't write either. The records show that McCauly was assessed for the holdings of the widow of William Hays. (But no marriage certificate has been found for William Hays and Mary.)

The search then went back to the listings of the men at the Battle of Monmouth who would have manned the artillery guns. Smith found a William Hays in the Pennsylvania State Regiment of Artillery. The unit became the 4th Continental Artillery Regiment that served "notably at Monmouth...." Hays' service record states, "Gunner: William Hays, Place of birth, Ireland, Date of Commission May 10, 1777." A later document shows, "Hayes, William, discharged January 24, 1781, re-enlisted July 27, 1781."

Researchers initially had overlooked the Pennsylvania unit at the Battle because of its name change, and prior to their discovering it, they only had been able to determine one Hays (John, an infantryman) had fought at the Battle. Some erroneously inferred that Casper Hays to whom Mary Ludwig was married also carried the name John. But finding William

in the Pennsylvania unit introduced a second Hays at the Battle of Monmouth—an artillery gunner.

If the man whom Molly Pitcher followed to war was not John Hays, then she was not Mary Ludwig Hays. Therefore, the name of Ludwig shouldn't be a part of Molly Pitcher's fame. Should researchers find a marriage certificate for William Hays and Mary, if one still exists, it would reveal Mary's correct full name.

## German versus Irish

Based on whether Molly was Mary Ludwig Hays or Mary Hays McCauly, the controversy extends to whether she was of German or Irish descent.

**German.** A second monument placed at Molly's grave bears the name Ludwig. The book *The Germans in Colonial Times* lists her as a heroine with "Teutonic blood." Fairfax Downey wrote in *Sound of the Guns*, "Mary Ludwig Hays was a plain, ruddy-faced farm girl, as Pennsylvania Dutch as sauerkraut."

The first to try to connect Mary Hays to the Mary Ludwig found on the marriage certificate was William Stryker, the author of *The Battle of Monmouth*. Stryker claimed he even knew the name of her father, "John George Ludwig, who came to this country with the Palatinates."

Indeed, Mary Ludwig Hays' father may have been John George Ludwig of Germany. However, Mary Ludwig Hays wasn't married to William Hays, the artilleryman of the Battle of Monmouth—Mary Hays (and later McCauly) was.

Many secondary sources on Molly Pitcher relied on Stryker's use of the marriage certificate. Mary Ludwig Hays' parentage has been well-researched, whoever she was.

As interest grew during the centennial celebrations, publications of Revolutionary journals surfaced. Diaries and journals that previously had been published without accounts of Molly Pitcher appeared later with accounts added in. Dr. Thacker's *Military Journal*, 4th Edition, has a story of Molly Pitcher that the first, second and third editions did not have. Stryker's reliance on the marriage certificate of Mary Ludwig and Casper (assumed also to be John) Hays gave birth to more publications erroneously printing Mary Ludwig's name as Molly Pitcher's real one.

**Irish.** The majority of Carlisle was populated by Irish and Scottish immigrants during the Revolutionary days. Captain John B. Landis wrote "Investigation into the

American Tradition of a Woman Known as Molly Pitcher" in 1905, which appeared in the *Journal of American History* in 1911. Landis wrote, "The real Molly, then, was a young woman of German parentage, living among the Scotch-Irish...." But locals described Molly Pitcher as an Irish woman. The people of Carlisle who knew Molly didn't use the word German to describe her; "Irish" appeared in every local account where nationality was mentioned.

Among those who remembered Molly was Harriet Foukle, daughter of Dr. George M. Foukle of Carlisle. Molly had worked for Dr. Foukle as domestic help. Harriet described her: "She wore a short gown, white or calico, a linsey striped skirt, very short and full, woolen stockings, heavy brogans, and a broad white cap with wide flaring ruffles." Brogans are coarse, heavy shoes made in Ireland.

Molly's former charge, Wesley Miles, in his article for *The Carlisle Herald*, described Molly and used the word Irish three times in his article: "...an aged Irish woman.... The Irish woman was employed by my father...." and "The remains of this Irish woman rest...."

## Molly's Consistencies

Among all of the conflicts in and confusion about the story of Molly Pitcher, some detailed consistencies persist. Regardless of her name or national heritage, Molly was a buxom, plain woman who used rough language.

**Buxom.** The physical descriptions were similar. Harriet Foukle remembered, "She was homely in appearance...average height, muscular, strong and heavy-set." Wesley Miles described her as "...an aged Irish woman, past sixty, healthy, active and strong, fleshy and short of stature...." Fairfax Downey stated that Molly Pitcher was a "plain, stocky, ruddy girl, with a tuft of hair on her nose." In his poem, Downey describes her:

*A sturdy lass, a buxom lass, Good Pennsylvania Dutch.*

*On Molly Pitcher's ruddy face, No trace of beauty's touch.*

**Common Language.** Molly's choice of coarse language often appeared in descriptions of her character. Stryker, in an explanatory note, quoted a Miss Ege, who knew Molly: "Molly was a rough, common woman who swore like a trooper."

An eyewitness to Molly's deeds at Monmouth, Joseph Plumb Martin, recounted her reactions during the Battle. While

reaching for a cartridge to load her cannon, a British shot came "directly between her legs without doing any other damage than carrying away all the lower part of her petticoat. Looking at it with apparent unconcern, she observed that it was lucky it did not pass a little higher, for in that case it might have carried away something else...." Wesley Miles remembered, "to go beyond her presence, and to street to play, childlike, with other boys, would excite her passion to profanity."

## Controversy Continues

The Carlisle Historical Society published an article, "Goodbye, Molly Pitcher" in the *Cumberland County History*, Summer, 1989. The author corrected many of the misconceptions about the Molly Pitcher story. The article is compiled from the notes of D.W. Thompson with additions by Merri Lou Schaumann, a Pennsylvania genealogist. The original work was published around 1976.

The people of Carlisle reacted unfavorably to their tampering with a local legend. Local television crews came to the Society to interview the author. The public of Carlisle resented the implications that what was literally engraved in stone was wrong.

## Conclusion

Carlisle benefits from the Molly Pitcher story. The town boasts of "Molly Pitcher Clubs." If her deeds of bravery and valor cause these groups to use her as a model, then she deserves to have her life properly documented.

Mary Hays McCauly was not just a figure of folklore; she lived. Molly Pitcher stories always will be retold with errors, but Mary Hays McCauly, as a historical figure, deserves the truth to be told.



**Constance M. McDonald, the wife of a Field Artilleryman stationed at Fort Sill, Oklahoma, wrote this article as a brief of a college research paper. She attends Cameron University, Lawton, Oklahoma, majoring in History and has previously attended the University of Tennessee at Chattanooga. To document her research, Mrs. McDonald has copies of several of the original Carlisle records on Molly Pitcher and of articles and accounts that have appeared in various publications. As an Army wife, she has lived in Oromocto, New Brunswick, Canada; Fort Bragg, North Carolina; and Vicenza, Italy.**



# Artillery Ammunition Resupply and Storage

by Captain S. D. Thompson, Royal Canadian Artillery

*Until December 1989, the Canadian Army had independent maneuver groups (brigade size), each with an organic close-support artillery battalion. Now the 1st Canadian Division has a separate artillery brigade that's the operational equivalent of a US division artillery and controls all the artillery assets of the Division, including Air Defense Artillery.*

*In this article, Captain Thompson proposes two methods to facilitate artillery ammunition resupply in the new organization. His second and preferred method calls for centralized control at the "corps" level with a route as direct as possible to the user units. There are similarities between his recommended method of resupply and those being considered for ammunition resupply under AirLand Battle-Future, a concept being refined and considered for adoption.*

**D**uring the past several years, a great deal of thought has been given to the storage and movement of artillery ammunition in the forward and rear areas. A recent study by the Operational Research and Analysis Establishment (ORAE), titled "*The Evaluation of Artillery Ammunition Holding Concepts: Sensitivity Analysis Results*," and the work of the Directorate of Land Requirements as part of the Corp 96 Combat Development Study have tried to identify where to hold artillery ammunition stocks. Both agencies are in the National Defence Headquarters in Ottawa.

With the advent of the Artillery Brigade on 1 December 1989, we must seriously consider the practical application of resupply theories at the divisional level. This practical execution of the artillery resupply is the subject of this article.

## Current Methods of Resupply

The current methods of moving artillery ammunition forward are to resupply the first line (the artillery battalion) from nightly delivery points (DPs). Our current methods include delivery points at the first and second lines that have truck-to-truck transfers of ammunition. (The second line is the Division Support Group or DISGP, the

equivalent to the US Division Support Command or DISCOM.) The second method is to deliver ammunition directly to the gun platform or ammunition point (AP) from the second line.

## Pros and Cons

The first solution is generally unacceptable as it's too decentralized and inherently inefficient. As will be discussed later, however, it does have a logical place in the resupply of the Artillery Brigade.

The second method is more efficient, although it isn't refined enough. It leaves the division without a mobile reserve of artillery ammunition for significant parts of the day as the second-line transport is busy resupplying itself from the replenishment point (RP) at the third line—the Canadian Support Group (CSG). The CSG is roughly equivalent to the US Corps Support Command (COSCOM), without the accompanying resources. The drawbacks to establishing forward ammunition points at the first line to provide for this reserve will be discussed later.

## Ammunition in Reserve

Although the current doctrinal basic load of three days of ammunition is designed to provide this reserve, two important factors must be taken into account. First, the basic load is

doctrinally being held at the first line and is subject to the same dangers as the weapon systems. Because a reserve should be held in a secure area before it's committed, it's arguable whether part of the basic load constitutes a reserve at all.

Second, we currently don't have enough trucks to carry three days of ammunition for the Artillery Brigade at the first line. Therefore, we must find alternatives to providing the commander an artillery ammunition reserve.

The contention that the artillery never is held in reserve is nonsense. The weapon of the artillery is the projectile. If all our weapons are placed forward with their delivery systems and a dedicated reserve isn't held at the second line, then we're violating an important principle. What if a gun position is overrun? What if counterbattery fire renders a battery and its ammunition useless?

One of the reasons the artillery is flexible is that any number of similar delivery systems can deliver its weapon (projectile). If G Battery is destroyed, its reserve ammunition is simply dispersed between J and A Batteries, and the "weapon" still gets downrange. That's why we must hold a dedicated reserve of ammunition at the second line.

The ideal situation would be to have a maintenance load (one day) of ammunition held permanently on wheels in the relative safety of the second line. Unfortunately,

not enough transport exists to do this under the current lift distribution.

## Proposed Methods of Resupply

The ORAE analysis recommends the adoption of the Corps 96 proposal of having a two-day supply at the first line, a two-day supply at the second line and three-days' worth at the third line. One of the maintenance loads at the third line would be on wheels.

This recommendation is logical, *less* the idea that the third day of ammunition supply at the third line be held on wheels. There should be no requirement to hold ammunition on wheels that far away from the front. Any flexibility gained in keeping the resource mobile would be lost in its distance from the battery positions.

A balance would exist if the three-day supply of basic load at the first line was rightfully compromised in exchange for dedicating enough transport to the second line to permanently hold two maintenance loads: one for first-line resupply and one held permanently in reserve.

### Multi-Chain System

Depending on the tactical situation and the needs of the commander, I propose two systems of forward movement of artillery ammunition. The Multi-Chain System (Figure 1) would require each echelon of lift to carry its ammunition forward to the delivery points to transfer it to the next echelon's transport.

We'd use this system when command of transportation assets remained decentralized. But we'd use it rarely because it's inherently inefficient. Under conditions where formations are on independent countermove or pursuit operations, the commander may be forced to separate his lift in this way to protect his third- and second-line resources from unnecessary risk.

### Multi-Channel System

We'd use the Multi-Channel System (Figure 2) when our lift resources are, more preferably, commanded at the highest level. We'd gain optimum efficiency if a transfer of ammunition didn't take place (i.e., delivering ammunition directly from the replenishment point to the gun position) negating the time and energy loss involved in transferring loads. Similarly, salvage (empty pallets, etc.) could be returned directly to the third-line for further rearward movement or repackaging,

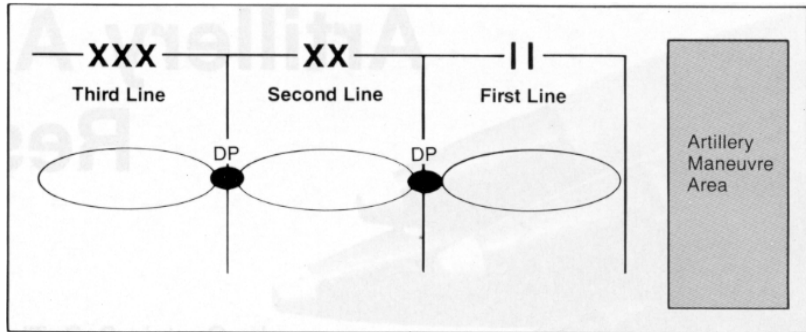

Figure 1: The Multi-Chain System of Artillery Resupply. Note that under this system, all levels of the chain must have equal amounts of lift if we're to achieve tailgate-to-tailgate movement.

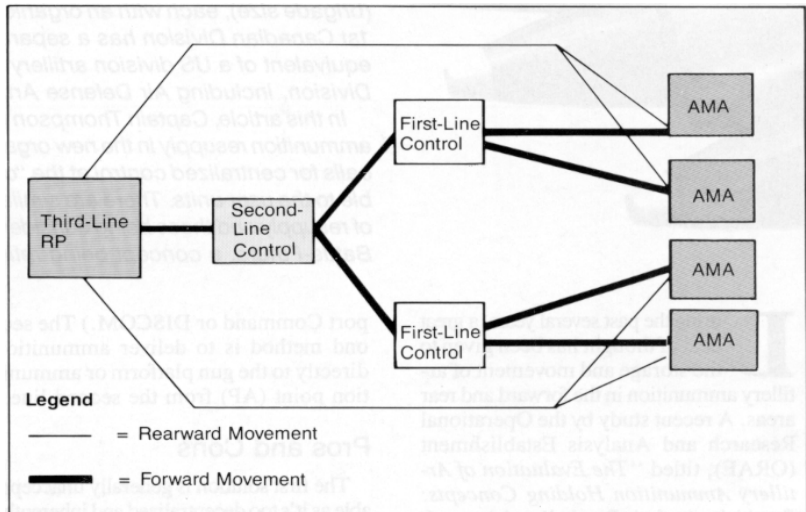

Figure 2: The Multi-Channel System of Artillery Ammunition Resupply. Second-line control would be exercised by the DISGP transport company under the direction of the division artillery rear headquarters. The second-line control element would have a communications link with the third and first lines. Drivers leaving the third line would be given a second-line rendezvous point. Upon arrival, the second-line control element would redirect them to the appropriate first-line control element that would, in turn, redirect the ammunition to the battery requiring it most.

as necessary. Such a system also would allow us to hold the Artillery Brigade's ammunition to reserve permanently at the second line.

The problem with this concept is one of time and control. The distance from the third to first lines could be as much as 100 kilometers or a minimum of an eight-hour round-trip under optimum conditions with crew rest, vehicle maintenance and turnaround time. Given the possible changes in the tactical situation as well as the need to manage these assets effectively, second- and first-line control stations are necessary to ensure we maintain enough control over the trucks.

The Multi-Channel System of forward movement allows the divisional headquarters

to command our transportation resources while maintaining effective control over them at the lowest level. With its first- and second-line control stations, the system would direct ammunition to those firing units that need it most, providing a flexible response to rapidly changing conditions on the battlefield. In such a system, second-line transport would increase (at the expense of first-line resources) to ensure it had the capability to continuously carry two days of artillery ammunition supplies for the Artillery Brigade. While one day was being delivered to the first line, one day's worth of lift would be returning to the third line to reload and carry back salvage. Meanwhile, a maintenance load would



be constantly held at the second line as the artillery reserve.

## Standardized Systems

The Multi-Chain and Multi-Channel Systems of ammunition resupply offer standardized solutions for resupplying the first line from the forward maintenance support unit (FMSU), which is an ad hoc unit formed from CSG resources to support units in combat. For these systems to work, enough lift resources have to be transferred from the first and third lines to the second-line transportation units.

In addition, both the Multi-Chain and Multi-Channel Systems allow us to hold a reserve at the second line equal to the Artillery Brigade's maintenance load. This reserve would be released only on the authority of the commander, divisional artillery (CDA), under the direction of the divisional commander when the third-line supplies are depleted or the supply chain is interrupted.

A situation is, therefore, envisioned where three days of artillery ammunition is held in close proximity (10 to 15 kilometers) to the forward edge of the battle area (FEBA), two-days' worth held by the unit and one-day's supply held by the DISGP on wheels.

## Coordination and Control

The artillery G4 staff at the divisional rear headquarters would be in direct contact with both the DISGP staff and those individuals at the regimental (battalion) level charged with ammunition planning and resupply. This dual task at the regimental level would probably be shared by the regimental sergeant major and the operations officer, as decided by the commanding officer. The artillery G4 staff would coordinate the second- and first-line rendezvous points for ammunition moving forward from the replenishment point and also would coordinate the delivery points and select ammunition point locations, as necessary.

The proposed systems are for use within a Canadian divisional structure where resupply is a national responsibility. Command and coordination of artillery ammunition resupply would be vested at the corps rear headquarters, if one existed.

## Ammunition Points

Of course, there will be situations where the dumping of ammunition is unavoidable. But we must establish a downloaded ammunition point as a last resort. Ammunition

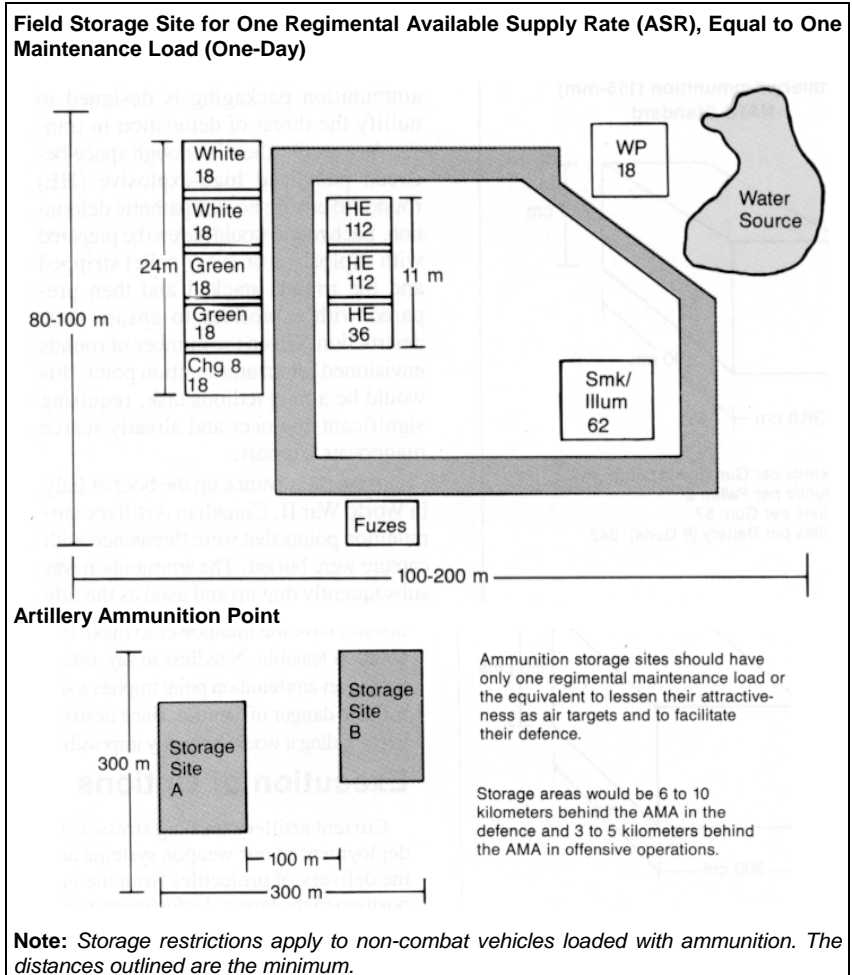

Figure 3: At the storage site, white phosphorous (WP), fuzes and hexachlorophene smoke and illumination must be stored separately from HE. The physical separation required is a fire break of not less than 25 meters. The WP should be stored near a water source. The numbers beside or underneath the commodity in this diagram indicate the number of pallets per storage module.

points are far too vulnerable from air attack, and our very limited air defence resources won't always be available for their protection.

The only situation where establishing an ammunition point may be acceptable would be in the defence where large amounts of ammunition would be prepositioned for the covering force, main defensive and countermove battles. Even then, however, we should only establish them when our lift capabilities won't allow us to hold three days of ammunition within 15 kilometers of the FEBA, as earlier discussed.

**Storage.** Figure 3 illustrates a properly laid out ammunition point containing one

close-support regiment's maintenance load, based on a basic load of 453 rounds per gun. An ammunition point consists of a group of ammunition storage sites, which in turn have a number of artillery ammunition field storage modules. The size of these modules is illustrated in Figures 4 and 5.

The dimensions were established by assuming NATO standard pallet dimensions for the projectiles and pallet dimensions obtained from the Office of the Director General, Ammunition (DG Ammo) for the propellant. These dimensions will fluctuate, depending on the source of the ammunition; however, for ammunition-point planning, they're accurate enough.

**Location.** When an ammunition point is established, it must be in an area where

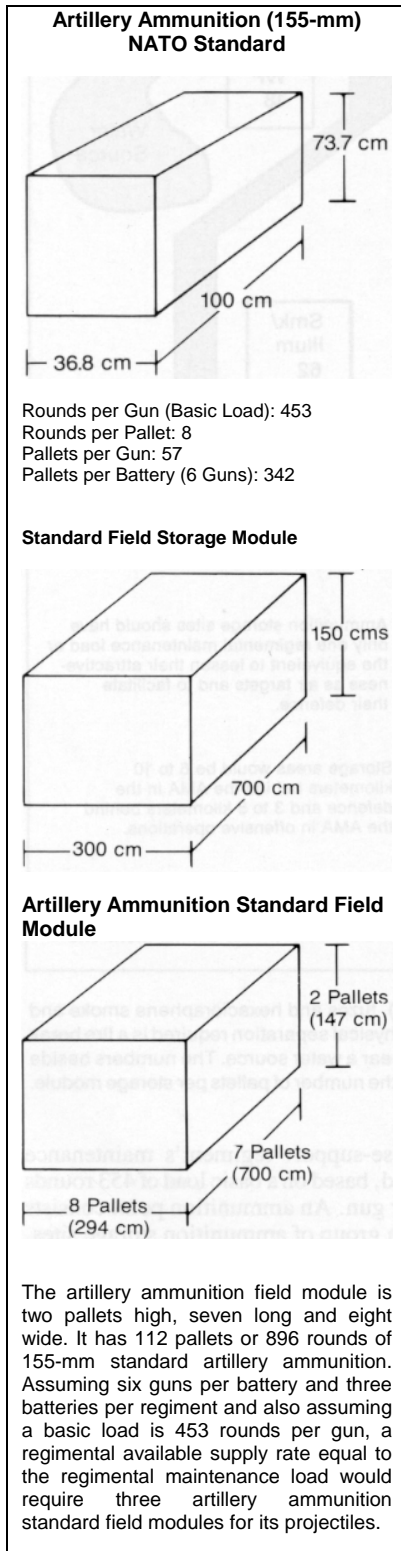

Figure 4: Standard Field Storage Modules—Artillery Projectiles, B-GL-312-009/FP-001 *Combat Service Support Volume 9—Ammunition in the Field, Draft 1.*

the possibility of its capture is remote. Self-destruction of an ammunition point is virtually an impossible task. Modern ammunition packaging is designed to nullify the threat of detonation in transit. As a result, there's enough space between palletized high-explosive (HE) rounds to ensure no sympathetic detonation. Each round would have to be prepared with explosives or every pallet stripped and the rounds stacked and then prepared with explosives to ensure their destruction. Given the number of rounds envisioned for an ammunition point, this would be a long tedious task, requiring significant engineer and already scarce manpower support.

During the advance up the boot of Italy in World War II, Canadian Artillery ammunition points that were threatened with capture were buried. The ammunition was subsequently dug up and used as the tide of battle changed back in our favor. The modern Artillery Brigade, however, doesn't have the manpower to make this solution feasible. Needless to say, establishing an ammunition point implies a significant danger of capture, since destroying or hiding it would be nearly impossible.

## Execution of Options

Current artillery training stresses the deployment of our weapon systems and the delivery of projectiles from the gun position to the target. Unfortunately, too often the combat service support (CSS) requirements on the high-intensity battlefield aren't appreciated. This is all too evident in our command post and field training exercises (CPXs, FTXs). As a result, many artillery units, especially

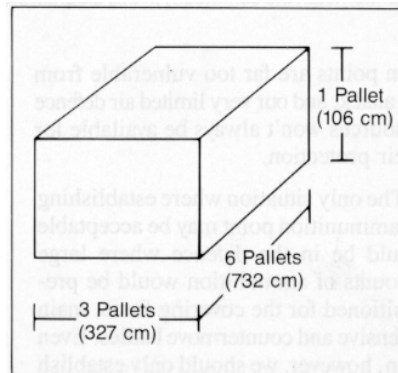

Figure 5: Standard Field Module—Propellant. This module contains 18 pallets. The regimental maintenance load requires five storage field modules of propellants, which would be broken down into two modules of green, two of white and one of M119 propellant.

Canadian-based units, have become complacent in administrative training.

The Artillery Brigade Headquarters should develop a standard exercise for one close-support medium battery with all of its ammunition and lift requirements in a three-day counterattack operation. The purpose of the exercise would be to demonstrate the administrative support requirements and identify the administrative command and control procedures necessary to support the battery deployed with its guns dispersed in several artillery manoeuvre areas (AMAs) during countermove operations. (An AMA is approximately five-to-six grid squares designated for a regiment's batteries to deploy in. But the artillery batteries don't have exclusive rights to the AMA; other units will deploy in the area, including US artillery units.) The exercise then could be expanded to include a trial of artillery ammunition resupply procedures throughout the Artillery Brigade's area.

The administrative planning requirements for sustaining the Artillery Brigade with ammunition are known factors. What's lacking is practical experience in the execution of these plans.

Given the new capabilities of the Brigade with the new heavy logistical vehicle, wheeled (HLVW) and the requirement to execute previously theoretical dumping (delivery of large quantities of ammunition to selected firing positions) and other plans at the brigade level, the Artillery Brigade Headquarters must share responsibility for providing ammunition to the artillery delivery systems. Overall responsibility for artillery ammunition resupply within the divisional boundaries rests with the Chief of Staff Administration. The CDA must be responsible to the commander for ensuring that enough ammunition has been demanded for upcoming operations. The control of artillery ammunition, however, must rest with the DISGP staff in concert with the artillery G4 staff at the divisional rear headquarters.

## Conclusion

This article has tried to present practical solutions for executing administrative plans as they pertain to ammunition resupply in the Artillery Brigade. Staffs are too quick to establish ammunition points and don't fully appreciate their size, composition or siting requirements. Realistic administrative training is not exercised in Canadian-based units, and we need a training plan to address this shortcoming.

The theoretical groundwork for ammunition resupply has been completed. It's time for practical solutions to ensure its smooth implementation.

**Captain S. D. Thompson, Royal Canadian Artillery, is a Staff Officer in G4 Operations for the 1st Canadian Division Artillery Brigade in Kingston, Ontario. He was commissioned in The Royal Canadian Artillery in 1984 and served three years in the Royal Canadian Horse Artillery, an M109 howitzer close-support regiment, in Shilo, Manitoba.**

**In 1987, Captain Thompson was posted to E Battery Parachute where he served as a forward observer for the Canadian Airborne Regiment, Canadian Forces Base, Petawawa, Ontario. He has been selected to attend the Instructor of Gunnery Course at the Combat Training Centre, Gagetown, New Brunswick.**



## Redleg Review

### BOOK REVIEWS

#### ***The Running Wounded***

William W. Day IV. Riverton, Wyoming: Big Bend Press, 1989, 272 pages. \$19.35

The book relates the personal memories of the Korean War as told by Mr. Day, a veteran of the 300th Armored Field Artillery (AFA) Battalion, Wyoming Army National Guard. Written from the viewpoint of a citizen-soldier, Mr. Day's work recounts his experiences from being launched from a peaceful life in Northern Wyoming to the intense fighting of the Korean War and his post-war feelings.

He moves up through the ranks and serves as cannoneer, surveyor, gunner, chief of section and chief of firing battery. The command reports, personal letters and memories combine to give the reader a better understanding of the Korean War from the soldier's perspective.

The book is a soldier's account of the 300th AFA, which was subjected to very intense combat operations. The Battalion fought at the Battle of Soyang, Bloody Ridge, Punch Bowl and

others. Mr. Day discusses his combat experiences and personal feelings throughout his tour of duty in Korea.

He continues the discussion during his transition back to civilian life. Upon his return to Wyoming, he served as a commissioned officer in the National Guard. Mr. Day's family began to grow and his career as an educator blossomed. The experiences of combat had weighed heavily on his mind since the War, and Mr. Day confronted those feelings by returning to Korea in 1985.

This book is of special interest to Redlegs. Mr. Day describes the actions of an artillery battalion in combat and the emotions of a soldier who fought with that battalion.

***The Running Wounded*** can be ordered from Rambeck, 4019 Prestwick Place, Riverton, Wyoming 82501. A hardbound copy costs \$19.35, and soft cover is \$12.85; add \$3.00 for shipping and handling (three percent sales tax for Wyoming residents only).

MAJ Larry D. Bartelbort, FA  
115 FA Bde, WYARNG  
Cheyenne, WY

#### ***Strategy: The Logic of War and Peace***

Edward N. Luttwak. Cambridge, Massachusetts: Harvard University Press, 1987. 248 pages. \$10.95.

As a Senior Fellow at the Center for Strategic and International Studies in Washington, D.C., Mr. Luttwak is well-known to the American military community. His book, *The Pentagon and the Art of War*, helped spark much of the interest in military reform during the early 1980s. His previous books on the Grand Strategy of Ancient Rome and the Soviet Union prompted discussions about how military forces shaped policy in those societies. In this, his most recent work, Luttwak has examined the concept of strategy in a more abstract sense to "uncover the universal logic" that shapes the "adversarial dealings of nations."

While reading this book, my first impression was that Luttwak has attempted to out-Clausewitz the Prussian strategist himself. In fact, the book reads much like the original *On War*. Although the author presents some interesting ideas worthy of discussion, the book is a chore to read. The reader must sift through layers of abstract prose to follow Luttwak's ideas. While strategy is, by definition, an abstract concept, the author's text adds to the complexity of the subject rather than clarifies it.

Luttwak's thesis places strategy into two dimensions. In the vertical dimension, he examines the interplay of technical, tactical,

operational and theater levels that reach a confluence at the level of Grand Strategy. His consideration of the horizontal dimension looks at the interaction of two or more adversaries at each level. This discussion of the horizontal dimension is the most thought-provoking aspect of the book.

Luttwak contends that the traditional perception of strategy follows a linear progression toward a fixed goal. He argues that strategy, instead, must be viewed as a series of action-response-counteraction, with each side's reconsidering its position based upon the opponent's response. This discussion of strategy as a dynamic and interactive process is innovative and worthy of discussion.

The author's earlier works introduced some controversial ideas, but he defended them clearly. In *Strategy*, Luttwak has raised some interesting points, but his arguments lack their usual clarity of expression. He has tackled a difficult subject, and the book is worth reading. Unfortunately, many readers will be discouraged by the complexity of the text long before the logic of the arguments begins to emerge.

MAJ Donald A. Carter, FA  
Military History Instructor  
Field Artillery School