



# Field Artillery

*A Professional Bulletin for Redlegs*

June 1988

## Supporting the Maneuver Commander

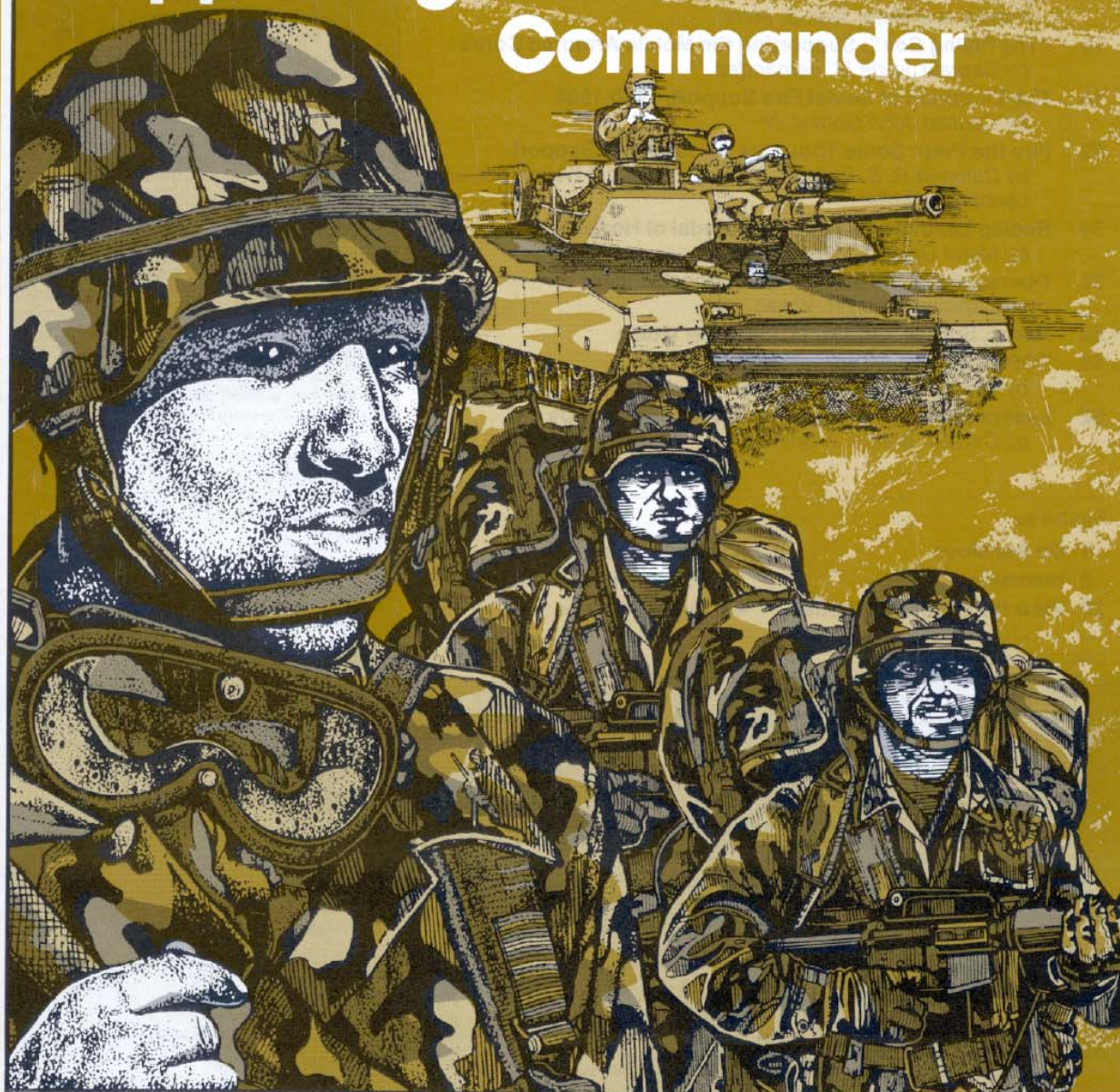



# Field Artillery

A Professional Bulletin for Redlegs

June 1988

## Articles

- 7 Multi-Dimensional Concept: The Force Multiplier for Future Battlefields**  
*by Brigadier General John C. Bahnsen and Colonels Gordon M. Hunt, IN, and Robert C. Stack, IN, all USA Retired*
- 12 Fire Support in Mobile Armored Warfare**  
*by Lieutenant General Crosbie E. Saint, Colonel Tommy R. Franks and Major Alan B. Moon*
- 15 "The Flying Box": Supporting the Mobile Armored Corps**  
*by Captain Jorge M. Fernandez*
- 18 The Evolution of Soviet Fire Support, 1940-1988**  
*by Captain John Gordon IV*
- 22 Fire the Prep: Some Thoughts About Direct Support**  
*by Colonels R. S. Ballagh, Jr., Floyd J. (Buck) Walters, IN, and Leonard D. Miller*
- 34 Redleg Leathernecks and The Medal of Honor**  
*by Major David T. Zabecki, USAR*
- 38 Operations at the JRTC: Fire Support Issues**  
*by Captain Robert H. Vokac*
- 42 Radar, Survey and Met MOS Career Guide**
- 49 TOPFORM: 3 x 8 Tactical Operations**  
*by Captain Gary M. Stallings*
- 52 Lasers: Direct-Fire Weapons For and Against Us**  
*by Captain William J. Spencer*

## Features

- |                                    |                          |
|------------------------------------|--------------------------|
| <b>1 On the Move</b>               | <b>43 Redleg News</b>    |
| <b>2 Incoming</b>                  | <b>45 Fragments</b>      |
| <b>28 View from the Blockhouse</b> | <b>48 Right by Piece</b> |

Cover illustration by Bobby Hill

**Field Artillery**—A Professional Bulletin for Redlegs—(ISSN 0191-975x). Unless otherwise stated, material does not represent official policy or endorsement by any agency of the US Army. Approved for public release; distribution is unlimited.

**PURPOSE** (as stated in the first *Field Artillery Journal* in 1911): "To publish a journal for disseminating professional knowledge and furnishing information as to the *Field Artillery's* progress, development, and best use in campaign; to cultivate, with the other arms, a common understanding of the power and limitations of each; to foster a feeling of interdependence among the different arms and of hearty cooperation by all; and to promote understanding between the regular and militia forces by a closer bond; all of which objects are worthy and contribute to the good of our country."

**SUBSCRIPTIONS:** May be obtained through the US Field Artillery Association, PO Box 33027, Fort Sill, OK 73503-0027. Telephone numbers are AUTOVON 639-5121/6806 or commercial (405) 355-4677. Dues are \$16.00 per year (\$31.00 for 2 years and \$46.00 for 3 years) to US and APO addresses. All other addresses should add \$9.00 per subscription year for postage.

**SUBMISSIONS:** All letters and articles should be addressed to Editor, *Field Artillery*, PO Box 33311, Fort Sill, OK 73503-0311. Telephone numbers are AUTOVON 639-5121/6806 or commercial (405) 351-5121/6806. Material submitted for publication is subject to edit by the *Field Artillery* staff, footnotes and bibliographies may be deleted due to limitation of space.

**REPRINTS:** *Field Artillery* is pleased to grant permission to reprint articles. Please credit the author and *Field Artillery*.

**POSTMASTERS:** Second-class official mail postage is paid by the Department of the Army, DOD 314, at Lawton, OK 73501. Send address changes to *Field Artillery*, PO Box 33311, Fort Sill, OK 73503-0311.

## Fire and Maneuver

Initiative, agility, depth and synchronization—these tenets of AirLand Battle doctrine call for an aggressive team approach to fighting and winning the battles of the future. The approach is sound, but many professionals disagree as to degree. Just how much agility and initiative must we have? What systems accomplish the deep, close-in and rear battle missions most effectively now, and what should they be able to do in 20 years? How do you synchronize the efforts of maneuver and fire support to achieve maximum training readiness in spite of severe budget limitations and competing branch-particular priorities? Just how do Field Artillerymen support the maneuver commander best?

This issue helps you come to grips with some of the thornier issues facing the maneuver and fire support communities. Three of the articles feature unique and important perspectives. Lieutenant General Crosbie E. Saint's "**Fire Support in Mobile Armored Warfare**" presents a view of Field Artillery's role in the attack as seen by the current commander of III Corps. Brigadier General (Retired) John C. Bahnsen offers a yet unadopted **Multi-Dimensional Concept** for the use of robotic forces in the 21st Century. His approach may solve many of the maneuver commanders' current and future problems. Colonels Ballagh, Walters and Miller offer a primer for the direct support battalion commander called "**Fire the Prep.**" Their analysis of the maneuver and fire support relationships and priorities provides practical guidance for operations in these large, complex and pivotal organizations—a must reading for officers and NCOs now or soon to be assigned to a direct support unit.

Our mission is to provide timely and accurate fire support to the maneuver commander. The more Field Artillerymen and our maneuver brothers know about each other's capabilities and limitations, the better we'll work together with initiative, agility, depth and synchronization balanced to meet the specific threat. We hope this issue helps you do it better.

Editor

By Order of the Secretary of the Army:  
**CARL E. VUONO**  
General, United States Army  
Chief of Staff

Official:  
**R. L. DILWORTH**  
Brigadier General, United States Army  
The Adjutant General

**RAPHAEL J. HALLADA**  
Major General, United States Army  
Field Artillery School Commandant

## Staff

**Editor:**  
Major Charles W. Pope, Jr.

**Managing Editor:**  
Patricia S. Hollis

**Art Director:**  
Donna Jeanne Covert

**Assistant Editor:**  
Joanne Alexander Brown

*Field Artillery*

# On the Move

MAJOR GENERAL RAPHAEL J. HALLADA

The pivotal AirLand Battle tenet for fire supporters is synchronization. *FM 100-5 Operations* defines synchronization as "the arrangement of battlefield activities in time, space and purpose to produce maximum relative combat power at the decisive point." This definition may seem simple, but the task is extremely complex. The Manual further reveals the intricacies of the process and its outcome when it says ". . . the product of effective synchronization is maximum economy of force, with every resource used where and when it will make the greatest contribution to success and nothing wasted or overlooked." These words capture the essence of synchronization for AirLand Battle doctrine, and our mission as fire supporters is clear—provide "custom-tailored" fire support to the maneuver commander.

The need for synchronization is absolute. It's not "light-" or "heavy-dependent" nor an issue of Active versus Reserve Components. When the moment arrives for us to fight, we must be ready to deal with any type of conflict.

## A Process and a Result

Synchronization is a process as well as an essential result. It requires anticipation, intuitive command of time-space relationships and a complete grasp of friendly and enemy interactions. The ultimate responsibility for this process and the final outcome rest with the maneuver commander; however, we are the key orchestrators of fire support.

Synchronization of fire support is not an easy process and goes far beyond ensuring the artillery firing batteries are technically and tactically proficient. It includes orchestrating *all* aspects of cannon, rocket and missile artillery, mortars, aviation, (Army, Air Force, Navy) naval gunfire and electronic warfare. History points out that the failure to orchestrate total fire support is always costly.

## Synchronization at the Maneuver Brigade

Certainly a key echelon where fire

---

*The need for synchronization is absolute. It's not "light-" or "heavy-dependent" nor an issue of Active versus Reserve Components.*

---

support is integrated is at the maneuver brigade. The job of the fire support coordinator (FSCOORD) is unquestionably the most challenging one in the artillery. As the maneuver brigade FSCOORD, the direct support (DS) battalion commander must be both an artilleryman and maneuver tactician. But he is not alone. His brigade, battalion or task-force and company fire support officers (FSOs) are an extension of the FSCOORD. They have as much to do with the success of fire support as anyone in the DS battalion. They must anticipate fire support requirements and articulate fire support capabilities and limitations to the maneuver commander.

Fire supporters must be knowledgeable of maneuver operations. On the other hand, we all must help educate maneuver commanders as to the capabilities, roles and mission of fire support. Currently, the Field Artillery School is distributing a draft of *FM 6-71 Fire Support for the Maneuver Commander* that will help him better understand how to get the most from his supporting fires. Units can expect to receive the manual in early FY 89.

To synchronize fire support, fire planning must be done from the top down and not in isolation. We don't have the time for the planning system to work any other way. The brigade FSCOORD must be a primary planner from mission receipt through the war gaming process to issuance of the commander's intent and the operations order (OPORD). Additionally, he must work actively with the maneuver commander's staff to develop the optimum fire support plan.

After coordinating with the DS battalion and developing the Field Artillery support plan, the brigade FSCOORD is an essential leader during the battle. He should position himself where he and the maneuver commander feel he best can influence fire support and the final battle outcome.

## Home Station Team Building

If we are going to be successful synchronizing fires for maneuver commanders in battle, we must prepare for it at our home station. First, we must strive to keep as much continuity and stability as possible in our key fire support slots. Most commanders are now filling FSO positions with the "strong horses," putting experienced, senior artillerymen in these jobs. Maneuver commanders deserve nothing less!

We also must make maximum use of the limited resources available. We'll never have all the training ammunition, time, devices or facilities we would like. So we must use what we have wisely.

Many commanders have discovered innovative training ideas. Some of the excellent training events include fire support conferences with maneuver and the use of the training set, fire observation (TSFO) by many units to rehearse upcoming training or war-plan scenarios with maneuver leaders.

Streamlined and innovative internal practices help, too. Tactical standing operating procedures (SOPs) need to be mutually supportive with those of the maneuver unit. Our training centers clearly have shown there is no substitute for a "practiced" SOP that provides coordinated operations and requires short OPORDs.

## Conclusion

The combined-arms team-building efforts at home station, local training centers and at the Field Artillery Center are resulting in better-trained FSOs and a closer relationship with maneuver commanders who now better understand the application of fire support. Our ability and need to support maneuver have never been greater. We must always remember the vital element to successful support of maneuver is synchronization. Only then can we appropriately orchestrate fires with maneuver to cause the death, destruction and confusion we need to win on the battlefield. 

# Incoming

## LETTERS TO THE EDITOR

### Fire Coordination Exercises

With the many excellent first-hand accounts of company-level infantry combat in the 20th Century, Field Artillerymen can't fail to notice a recurring theme: employing multiple indirect-fire systems close to friendly troops as the decisive element of an engagement.

Clearly, artillerymen who coordinate this daring use of less-than-precise weapons require a high degree of proficiency in observed fire procedures, fire support planning and fire support coordination under pressure. While forward observer (FO) simulation training, fire planning exercises, command post exercises



and observed fire missions from a fixed observation post are valuable procedural drills, they are only the first steps in developing an effective fire support specialist. To develop his confidence and decisiveness, units regularly must conduct innovative and aggressive training that closely simulates combat conditions.

The most effective combined-arms training for the company fire support team (FIST) is the fire coordination exercise (FCX). An FCX involves the company commander, his platoon leaders and their FISTs, who plan and execute a scheme of fire and maneuver involving danger-close indirect fires. From receiving the battalion's operations order to hitting the objective, speed in planning and execution is paramount.

During the advance, platoon leaders and FOs must work closely to engage targets of opportunity rapidly with the appropriate systems. Simultaneously, the maneuver platoons, the battalion tactical operations center (TOC) and other elements inundate the company commander and his fire support officer (FSO) with reports in a simulation of a battalion task-force operation. Each participant must make quick, correct decisions in an environment of danger-close artillery and mortar fire. Ideally, the maneuver element should be astride the artillery gun-target line.

Creative target construction further enhances the exercise; machine guns

concealed in armored vehicles, pop-up silhouettes and remotely triggered smoke grenades are just a few of the possibilities. For a light infantry unit, the exercise can begin with an H-hour preparation for an airmobile assault, supported by a combination of helicopter gunships and tactical air. Anything that increases the required level of coordination should be encouraged.

Safety is a major consideration, of course. The battalion FSO must control every facet of the operation, down to the surveyed location of maneuvering elements. Properly managed, however, the training distractions of detailed safety considerations need not interfere with the exercise. The result is an exceptionally challenging exercise that builds trust among the maneuver companies and their FISTs and yields realistic, live-fire training in a fast-paced, combined-arms exercise.

As he reflects upon the history of Field Artillery in combined-arms operations, the Field Artilleryman fortunate to be assigned as a fire support officer or NCO must recognize the challenge to provide timely, accurate and coordinated fire support on an increasingly complex battlefield. The FCX is the best means to prepare for this, and as such, it should be the culmination of our fire support training.

Steven A. Stebbins  
CPT, FA

1-319 Abn FA Regt  
Fort Bragg, NC

### Response to "Fire Coordination Exercises"

In Captain Steven A. Stebbins' letter to the editor "Fire Coordination Exercises" (FCXs), he brings out interesting points about realistic training for company-level officers. Using a danger-close, live-fire tactical exercise without troops (TEWT) to train the company commander, platoon leaders, fire support officer and fire support team is beneficial.

Captain Stebbins offers the FCX as a vehicle to train the company command structure in a fast-paced environment

simulating combat. The emphasis is on the company commander and fire support officer's (FSO's) controlling the platoon actions and coordinating target engagement.

Currently, most units use the combined-arms, live-fire exercise (CALFEX), controlled at brigade, to integrate maneuver and fire support. Maneuver units, usually no lower than battalion or company level, use the TEWT before field training exercises (FTXs), ARTEPs and terrain walks.

The FCX, as envisioned by Captain Stebbins, is applicable to light infantry, airborne and air assault units. With modifications, a mechanized infantry or armor unit could use this as an effective training tool. In all cases, we should use it as a train-up for CALFEXs and integrate it into ARTEP training.

Before adopting the concept, we should look at both a manpower analysis for support and a training management accounting control system

(TMACS) cost analysis. We also must consider ammunition requirements for mortar, artillery and maneuver organic weapon systems to give a clearer picture of additional costs.

In conclusion, any training scenario that enhances a leader's ability to act under pressure is important. However,

the cost of conducting the FCX with mechanized versus light units may preclude its adoption and implementation.

Karl R. Stumpff  
CPT, FA

*Fire Support and Combined Arms  
Operations Department  
Field Artillery School*

---

## Response to "Coordinated Illumination"

Captain Tim Samorajski's letter to the editor ("Coordinated Illumination," April 1988) uses a situation similar to the example given in *FM 6-30 Observed Fire Procedures* (page 6-11). His example and the one in *FM 6-30*, could lead one to believe that once the target is identified, an extra illumination round is always fired to make final illumination corrections (if necessary) and to determine a "mark" before high explosive (HE) adjustment. This is not necessarily true. The author attempts to save an illumination shell and reduce the corresponding delay in HE adjustment, which he perceives occurs on every coordinated illumination mission.

Proper fire direction center (FDC) procedures dictate that when illumination is fired at a suspected target, a stopwatch is started. Thus, the observer

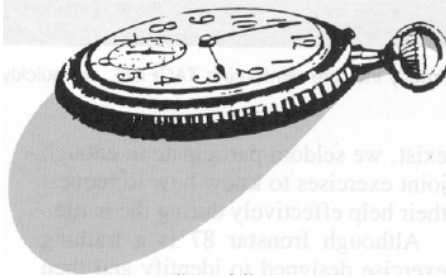

can "mark" any illumination round (even if he gives corrections for that round) when appropriate. Ideally, the illumination round that allowed the target location to be determined is "marked." This would eliminate the "extra" illumination round fired in the *FM 6-30* example. However, there may be occasions when a situation similar to this example occurs. The tactical situation, target description, terrain, weather and observer experience are factors affecting the technique and procedures the observer and FDC use.

The author's procedures would work in some situations. But there are also

occasions when HE time-of-flight would exceed the illumination burn-time remaining when the FDC receives "illumination mark." The result would be an HE round's bursting in darkness—a wasted round.

Coordinated illumination missions are so situation dependent (ammunition type, terrain, trajectory, weather, observer or FDC control, observer skill, etc.) that no one procedure can be endorsed as *the solution*. The keys to effective missions of this type are a well-trained gunnery team, flexibility, initiative (as demonstrated in the author's article) and common sense. The new *FM 6-30* will give several coordinated illumination examples that should clear up any further confusion about these missions.

Steven M. Hanscom  
Capt, USMC  
Gunnery Department  
Field Artillery School

---

## Response to "The Counterfire Battle—the Missing Element in Today's Training"

I found the article "The Counterfire Battle—the Missing Element in Today's Training" [April 1988] by Lieutenant Colonel [Eric C.] Deets to be extremely interesting and thought-provoking. His discussion of the innovative, computerized procedures used in the 1st Armored Division Artillery (Div Arty) to demonstrate the destructive capability of Soviet artillery is excellent. He aptly describes how fire supporters must be able to deal with those effects on the modern battlefield.

Lieutenant Colonel Deets reiterates the premise that if the friendly fire support system is able to neutralize (at

least temporarily) the enemy artillery, our maneuver direct-fire weapons should be able to destroy the enemy ground forces. Few would argue that this is an inaccurate statement, but the theory really holds true only after (and if) we survive initial hostilities.

Should the Soviets adhere to their current doctrine, they will begin offensive action with a massive preparation against our frontline defenses (particularly targeting nuclear-capable weapons) that easily could last an hour and land 23,500 rounds on each battalion position. Closing down the enemy artillery without being able to fire the

first round will be difficult. Therefore, we must practice other methods of surviving the massive artillery onslaught at the outbreak of war.

Certainly, being in defensive positions and using camouflage, hardening and wire communications along with deceptive measures are but a few of the many ways. Even if we do dig in properly and are able to remain an effective combat multiplier, we still must be even more proactive in preventing the enemy artillery from totally dominating the battlefield. And it is in this scenario, as outlined by the 1st Armored Div Arty, that we can fight and win. To



By having the AN-TPQ-36 radar report targets directly into the reinforcing TACFIRE, we quickly can destroy the counterfire targets affecting brigade operations.

be proficient with these procedures in wartime, we must train to standard in peacetime. Simply stated, we must train as we're going to fight.

Lieutenant Colonel Deets clearly outlines the reality of attempting to survive against opposing forces (OPFOR) artillery with his vivid description of what happened to the 2-78 FA and the 1-30 FA during the Hohenfels exercise. This is a realistic assessment of what could happen to any unit in a future conflict. He points out that the attached Q-36 radar must be used to the maximum in locating enemy weapons to ensure timely and accurate engagement. To do this, our radars must be positioned properly for survivability and logistical support. Cueing must be done with the utmost respect for our "brethren across the fence." Since the Soviets do have radar direction finders and are able to locate the Firefinder, we should have a cueing schedule that accurately takes into account the enemy situation. On-call cueing is likely to be the most effective method and the best bet for radar survivability. Since radars are extremely scarce and especially vulnerable, they are our most valuable asset in the counterfire battle.

Although radar is the major counter-fire target acquisition device, it is not the only one. Aerial observers, ground observers and other acquisition assets from sister branches and services are also available. These assets require special consideration when applying mission, enemy, terrain, troops available and time (METT-T) to the battlefield situation. The key point is that even though these other resources exist, we

seldom participate in enough joint exercises to know how to request their help effectively during the battle.

Although Ironstar 87 is a training exercise designed to identify and then train to strengthen unit weaknesses, I got the impression that counterfire was treated as a separate operation. Counterfire is but one of the three roles of Field Artillery. It isn't a "separate" battle, but an ongoing and continually interactive component of all phases of the operation, which include the rear, deep and close-in areas of the battlefield. Even though the player-unit system of dividing up the missions appears to be the best solution to the counterfire problem, I would caution that this solution may not always be viable, based on METT-T.

The direct support (DS) battalion can't afford to divorce itself totally from the counterfire effort. DS units may need to fire strictly counterfire missions when the enemy artillery is "breaking the back" of the maneuver commander (e.g., initial preparation fires). That the DS battalion often was overwhelmed when it tried single-handedly to manage counterfire is not surprising. I know from experience as a DS battalion S3 that it's extremely difficult to keep up with the close support missions the maneuver commander requires (mainly those that directly counter enemy maneuver actions). Augmenting this enormous task with total responsibility for the equally important counterfire effort is probably more than the DS battalion can handle.

But the DS unit should not shirk its

doctrinal control of the brigade battle. As the article indicates, the reinforcing unit can share the counterfire responsibility. The working relationship, based on the seven inherent responsibilities for tactical missions, clearly indicates that the reinforcing battalion commander will be totally responsive to the DS unit.

By having the Q-36 report targets directly into the reinforcing unit's tactical fire direction computer system (TACFIRE), we quickly can destroy the counterfire targets affecting brigade operations. Knowing the critical friendly zones (CFZ) and the brigade commander's attack guidance helps the reinforcing battalion commander assist the DS battalion most effectively.

If all counterfire missions are sent directly to the reinforcing battalion, the DS battalion should at least "set up" (message of interest) for all requests for additional fire (RFAFs) generated by the radar. With these controls, we have proper procedures to provide a cohesive and efficient fire support system. We may have a slight loss in responsiveness for normal close-support missions when calling the reinforcing unit to augment DS fires. But the trade-off is we gain an effective counterfire program that benefits all players in the brigade zone.

Surprisingly, Lieutenant Colonel Deets doesn't mention the possibility that general support or general support reinforcing assets provided by the Div Arty or attached Field Artillery brigade (if there is one) would be available to help in the counterfire effort. Other

fire support means (e.g., close air support or naval gunfire) also may aid in the counterfire fight. The fact that outside help is available becomes an important factor should the reinforcing battalion have to shoot only close-support fires, based on the maneuver commander's mission and guidance.

In summary, I found the article timely

and well-written. It is obvious that much thought coupled with emphasis on previous lessons learned went into planning Ironstar 87. As the 1st Armored Div Arty discovered during the exercise, there is no substitute for well-defined training objectives realized in hands-on execution. My compliments to the planners and players of Ironstar 87 for a rather enlightened look at how to

succeed in training to accomplish an extremely difficult task. Their efforts will be well-rewarded in any future conflict.

H. G. Malone  
CPT(P), FA  
*Fire Support and Combined Arms  
Operations Department  
Field Artillery School*

---

## Response to "Artillery Logistics—The Other Side of the Battle"

"Artillery Logistics—The Other Side of the Battle" [April 1988] by Major [Thomas B.L.] Stanford is a very good article on how one battalion managed its logistics at the National Training Center (NTC).

The overall logistical operation as presented in the article is basically the same as that presented in *FM 6-20-1J Field Artillery Battalion* with the exceptions of the unit maintenance collection point (UMCP), the casualty collection point (CCP) and the logistics resupply point (LRP). These points are developed and incorporated into the battalion standing operating procedures

(SOP) to implement the doctrinal solution found in FM 6-20-1J. However, neither the potential problems of command and control in the use of these points nor the question of security is addressed.

One alternative to eliminate the problems with information flow, command and control and security of the combat trains is to collocate the combat trains with the battalion tactical operations center (TOC). This location, then, could be used also as the LRP.

The problem of ammunition resupply is continuous with no easy solution. However, designating ammunition for

immediate consumption and prepositioning ammunition for preparations and counterpreparations are alternative solutions.

I agree the problem of logistics requires continuous thought by all. It's one of the Field Artillery's greatest challenges in AirLand Battle.

Bruce R. Berry  
MAJ, FA  
*Fire Support and Combined Arms  
Operations Department  
Field Artillery School*

---

## NTC Trends

It seems everyone is jumping on the National Training Center (NTC) bandwagon these days. Several articles and various memoranda about the NTC have circulated in the Field Artillery community. These papers, for the most part, are written by people who rotate infrequently through the Army's finest training facility or just spend a few days observing.

Recently, units have come with the attitude of "How can I beat the NTC?" When asked how they train at home, some battery commanders include only Army training and evaluation program (ARTEP) and ARTEP-based qualification test (ABQT) performances in their response. Unfortunately, the way we conduct our annual firing evaluations doesn't always incorporate supporting the maneuver arms. The result? We often anticipate set scenarios. And most units that train to beat a scenario fail.



Field Artillery is an extension of a maneuvering force with a very complex system to kill the enemy.

Units do well when they train in a combined-arms environment before fighting at the NTC. In the rotations where Field Artillery battalions do well, maneuver forces also are successful.

Our doctrine changes based on the technological advances of opposing forces. It also changes when smart people introduce better ways to operate.

Two key words in delivery of fires are timeliness and accuracy. Unfortunately, we are concentrating more on the timely delivery of fires. Speed results from training and practice when following correct doctrinal procedures.

On the line of steel, first-echelon supervisors generally know procedures to prepare and deliver munitions. Many section chiefs, however, are not following procedures set to support the combined-arms team. Section chiefs do not record firing commands properly. Many do not require the gunner, assistant gunner and the number-one man to execute in accordance with published technical manuals. Watch a crew during a fire mission. Does the section chief require the assistant gunner to announce "quadrant set" or the gunner

"deflection ready"? Does the number-one man verify the charge, announce closing and stand out of the recoil path when priming? Is the tube swabbed and sight picture realigned during subsequent volleys?

In the fire direction center (FDC), fire direction officers (FDOs) sometimes just "play" radio-telephone operator and fail to pay attention to internal operations, forget to verify their data base and neglect to update their tactical situation maps. As a result, voice fire commands are often poor, the FDCs can't accurately depict the forward line of own troops (FLOT) and FDC maintenance deteriorates. FDC personnel must know their specific duties and then master them.

Often, company fire support officers (FSOs) are lieutenants with minimal experience on a fluid battlefield. They don't yet know the capabilities of their unit to deliver timely fires. They have not yet mastered map reading techniques while moving across rough terrain at 30 miles per hour in the highest level of mission oriented protective posture (MOPP 4). We must choose our FSOs

carefully.

As Field Artillerymen, we deliver and maneuver our fires with adjustments. We are an extension of a maneuvering force with a very complex system to kill the enemy. But training to compute and deliver a particular mission within a certain time doesn't guarantee us success in a combined-arms environment. Continuous combined-arms training helps us synchronize and execute fire support planning throughout the Field Artillery system.

If we follow doctrinal procedures, speed will come with accuracy. We also must enforce discipline standards and take care of our weapons systems. Finally, with our complex systems, we must eliminate non-performers after remedial training has failed. Training ruthlessly to doctrinal standards in a combined-arms environment is the only way to ensure success.

Marcellus Hay Jagoe IV  
CPT, FA  
Fire Support Trainers, NTC  
Fort Irwin, CA

---

## Response to Kuila-I Ka-Nuu

In reading "Kuila-I Ka-Nuu," a history of the 9th Field Artillery Battalion, [by Second Lieutenant Richard W. Wilde, August 1987], I noted that some of the dates pertaining to it and the 3rd Infantry Division are incorrect.

Upon graduation from the Field Artillery Officers Advanced Course (FAOAC) in June 1949, I was assigned as the executive officer to the 9th Field Artillery Battalion (155-mm towed) at Fort Benning, Georgia. Major Tom Arnold commanded the Battalion, which was an organic artillery unit of the 3d Infantry Division Artillery (Div Arty). During July 1950, the Battalion was relieved from assignment to the Division, sent to Korea as a separate unit and assigned to corps artillery in the theater. Having been assigned as the Div Arty S3 in May 1950, I didn't accompany the Battalion to Korea.

The 3d Division did not arrive in Korea in September 1951 as stated in the article. The Division departed Fort Benning by rail, arrived on the island of Kyushu, Japan, via navy transport in early October 1950 and sailed for Wonson, North Korea, arriving around 15 November 1950.

After the 3d Division made its renowned "Backward Invasion" (withdrawal from the bridgehead) from Hungnam, North Korea, it sailed south to Pusan, South Korea, arriving 26 December 1950. It was shortly thereafter that the 9th FA Battalion (Lieutenant Colonel John R. Magnusson, commanding) was assigned again to the Div Arty, replacing the 999th FA Battalion (155-mm self-propelled) as its organic, medium artillery. Brigadier General Roland P. Shugg was the Commanding General of the 3d Div Arty during this period.

The battalion participated in the Uijongbu Corridor withdrawal (some referred to it as the "Imjin River Bugout"—I was Commanding Officer, 39th FA Battalion, also 3d Div Arty) on Easter Sunday 1951. We had to retreat from the River and make a stand at the city of Uijongbu. The Iron Triangle battle also was fought during the early summer of 1951.

In a recent letter, Brigadier General Roland P. Shugg, US Army, Retired, confirmed the accuracy of the above information.

Anthony H. Shookus  
COL (Ret), FA  
Newington, CT

*Colonel Shookus recently was inducted into the Officer Candidate School Hall of Fame for his contributions to the Field Artillery.*

**Editor**





Concept:  
Multi-Dimensional  
Concept:  
**Multi-Dimensional  
Concept:**

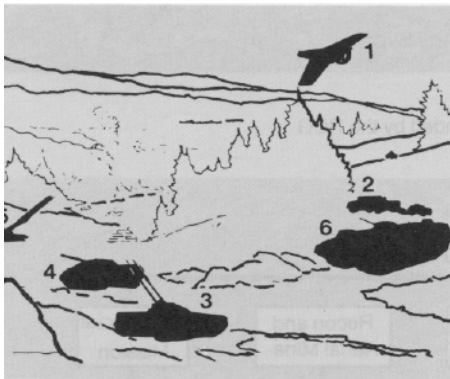

**Battlefield Robotics**

- 1 Unmanned Aerial Vehicle (UAV) for Reconnaissance, Survey and Target Acquisition
- 2 Tele-operated Anti-Armor Vehicles
- 3 Anti-Aircraft Robot
- 4 Main Battle Tank
- 5 Indirect Fire Missile Robot
- 6 Command and Control Vehicle for Robotic Systems

## The Force Multiplier for Future Battlefields

by Brigadier General John C. Bahnsen and Colonels Gordon M. Hunt, IN, and Robert C. Stack, IN, all USA, Retired

---

***This article is the first to be published on the new multidimensional concept, an advanced concept for the military's use of robotic and unmanned systems. The concept has been briefed to the US Army Armor Center, Fort Knox, Kentucky, and the Combined Arms Center, Fort Leavenworth, Kansas. It has not yet been adopted by the US Army.***

---

**A**irLand Battle doctrine is based on the use of operational and tactical maneuver to bring superior combat power to bear at the critical point and time in the battle. It relies on depth, agility, synchronization and initiative to defeat an invading force. The congressionally mandated, capped force structure and potential reduction in force strength, however, present Army leaders with an operational dilemma. Significant standing forces are not available for the worldwide commitment, forward defense and operational maneuver essential to implementing AirLand Battle tactical

concepts. Relying on combat-ready REFORGER (return of forces to Germany) units to deploy to Europe requires they receive enough early warning and be prepared for immediate commitment upon arrival. We cannot solve the dilemma simply by modifying current training programs, organization or doctrine. This article provides another alternative—using robotic and unmanned systems for economy-of-force on the mechanized battlefield to free frontline forces for maneuver warfare—the multi-dimensional concept (MDC).

The MDC focuses on fielding advanced technological systems in unique corps-level organizations, using tactics to enhance the combat power of US

Army manned maneuver forces. We can use these systems to deny the enemy access to crucial areas and to weaken or destroy his forces. Thus, we can free a significant number of friendly forces from the forward defense role to execute decisive combat on ground chosen by the friendly commander.

Figure 1 depicts the depth an enemy might penetrate into a sector defended by the robotic combat group (RCG). Maneuver brigades held in reserve to the rear of the MDC force are ready for the counterattack against the penetration. The MDC force can delay and attrit the enemy force. After attrition, the maneuver units attack. Using MDC, we defeat and destroy the enemy.

Maneuver warfare, the ability to *synchronize* and *mass* superior forces at the decisive point, has been employed and executed successfully. MDC supplies the *agility* we need to execute Air-Land Battle doctrine, provides *depth* to the friendly side of the battlefield and grants the commander the *initiative* to attack the enemy at the time he chooses. MDC draws its significant lethality from the *synchronization* and synergy of its multiple dimensions.

The term, multi-dimensional concept, describes the many dimensions needed for synergism on the battlefield. The term also acknowledges there may be several other dimensions, not yet included in the concept.

Individual weapons systems do not win battles. Battles are won through the unique contributions of several weapons systems skillfully coordinated and employed by the commander. However, one should not view MDC as an "all or nothing" concept. Individual dimensions may be selected for accelerated development, acquisition and inclusion in current forces.

The primary objective of employing all dimensions of the MDC is to exploit the significant effect of bringing a number of advanced technologies to bear simultaneously. The combat organization to implement MDC is the RCG. Its organization is shown in Figure 2.

The RCG is a conceptual organization that helps us realize the multiple dimensions on the battlefield. Currently, there are five dimensions to MDC: (1) minefields and obstacles; (2) robotic ground vehicles (RGV) positioned

- The Five Dimensions of the Multi-Dimensional Concept**

  1. Minefields and Obstacles
  2. Robotic Ground Vehicles (RGVs)  
Positioned Autonomously by a Robotics Command Center (RCC)
  3. Unmanned Aerial Vehicles (UAVs)
  4. Artillery-Delivered, High-Intensity Flash Munitions
  5. Directed-Energy Weapons (DEW) Systems

autonomously or by a robotic command center (RCC) to scan a sector of fire and identify, engage and destroy moving targets; (3) unmanned aerial vehicles (UAV) to provide observation and surveillance and deploy to engage selected armored and rotary-wing targets

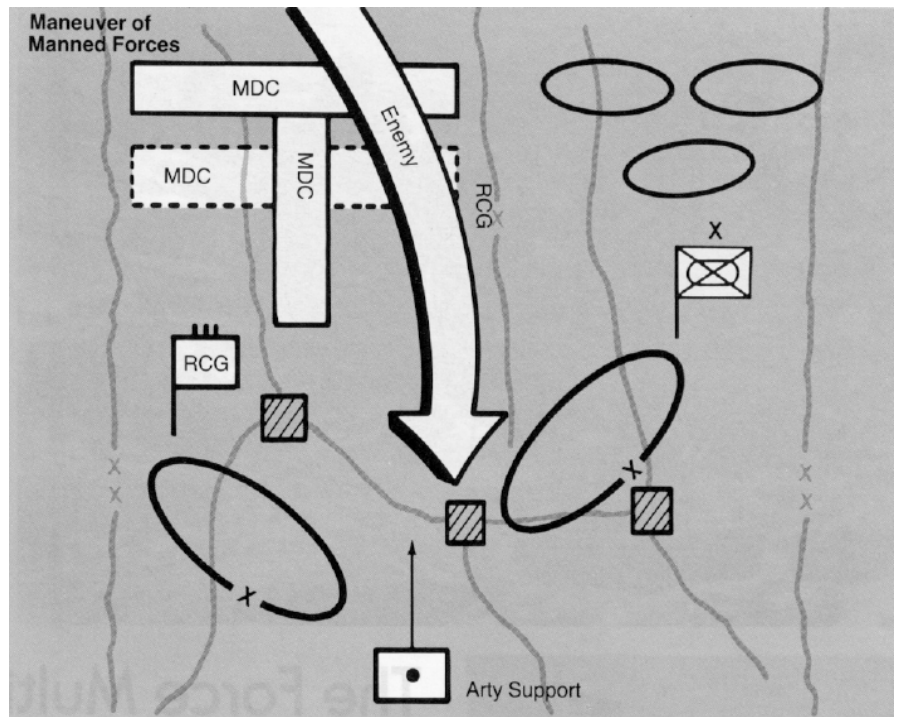

Figure 1: Enemy Penetration into the Sector Defended by the RCG

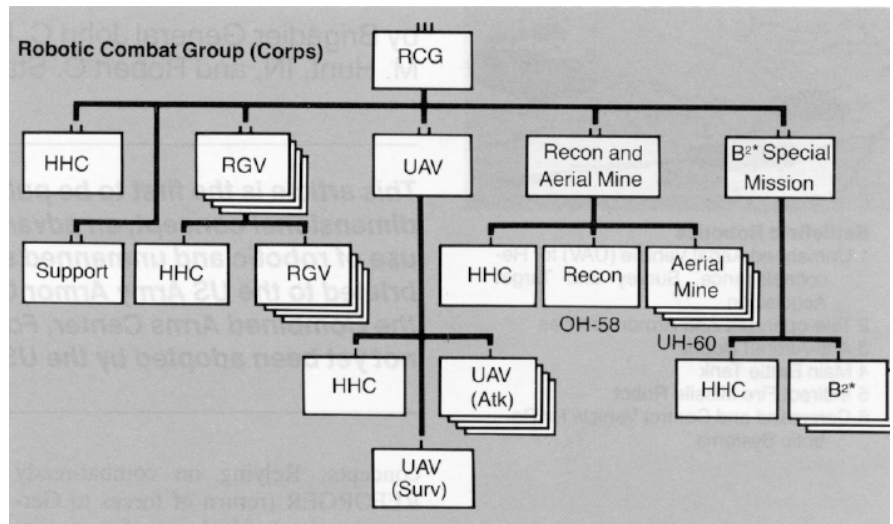

Figure 2: The robotic combat group is a conceptual organization to implement MDC. \*B<sup>2</sup> is brains and brawn. The brains are remote control centers to direct the brawn—unmanned DEW systems.

at and forward of the forward line of own troops (FLOT); (4) high-intensity flash munitions that are psychologically disruptive to soldiers and may render enemy optics unserviceable and (5) directed-energy weapons (DEW) systems (laser, particle beam and high-powered microwave) to disable enemy sensors and target acquisition devices. In addition to these

dimensions, we will use fire support of all types to further increase the lethality of this force. Figure 3 depicts each of the dimensions and the way they relate to each other.

## Operational Concept

To adhere to the premise that the reconnaissance elements of the enemy

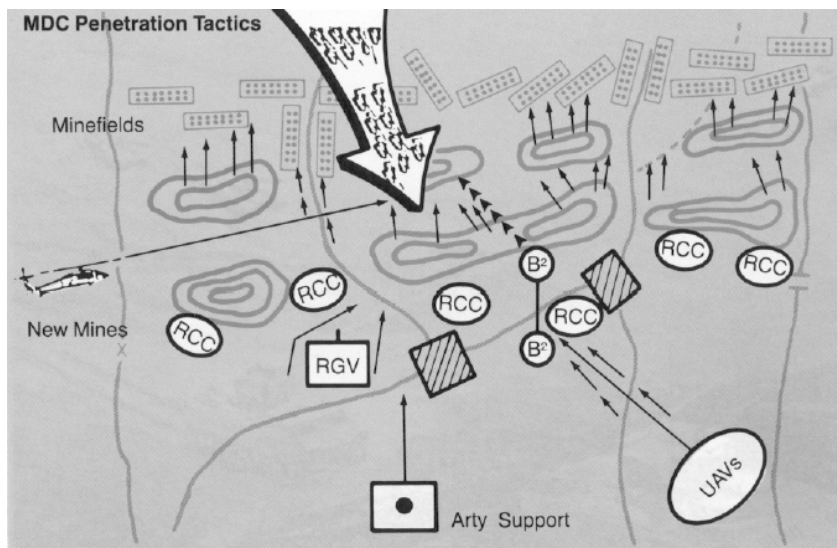

- Hasty minefield sown by helicopter and artillery.
- High-intensity flash munitions fired at column lead.
- RGV units moved into position in front and flank.
- UAVs employed en masse.
- DEW provides psychological impact and destroys electronics (C<sup>2</sup>).
- 120-mm mortars employed.
- Fragmentation and smoke grenade launchers employed.
- B<sup>2</sup> (brains and brawn) attacks enemy command and control systems.

Figure 3: The MDC Dimensions and the Way They Interrelate

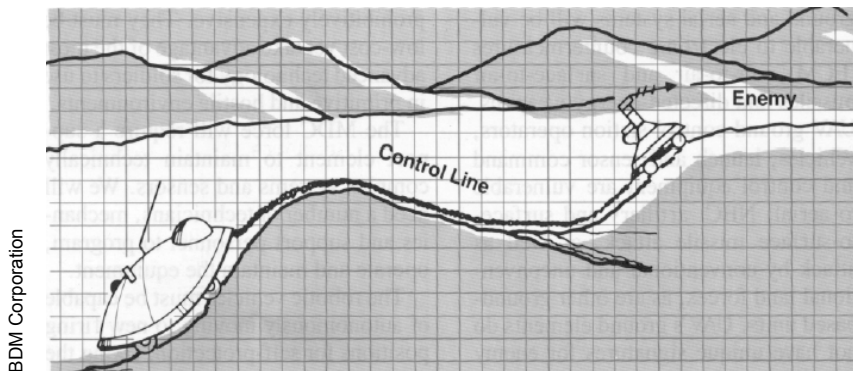

- | Brains                          | Brawn   |                                  |
|---------------------------------|---|----------------------------------|
| • Manned Control                | • High-Power Microwave Weapon System (Hard and Soft Kill) | • Own Power Source               |
| • Armored and Terrain Protected | • Robotic Vehicle Trailered into Position                 | • High Mobility Not Required     |
| • Secure Linkage with Weapon    |   | • Low-Observable Technology Used |
| • Day and Night Capable         |   |                                  |

Brains and Brawn (B<sup>2</sup>), A Robotic Weapons System

force must not be able to detect MDC easily, we must use standard obstacles. Therefore, the first dimension of the MDC is a series of **rapidly emplaced, smart minefields**. These obstacles will ensure the surprise critical to MDC effectiveness. We must inflict maximum damage by low-cost, expendable systems. Mines are available in belly- and

top-attack models, and a side-attack mine is being developed. We can expect enemy forces to use many means to overcome the obstacles. Planning aerial mine support must include providing continuous replacement and emplacement in depth of these obstacles as the battle develops.

A rapidly emplaced minefield ensures

that enemy reconnaissance, advance guard and main-body forces will have minimal time to alter their march route, deploy to battle formations and organize for breaching operations. The surprise and confusion caused by encountering a minefield contributes significantly to disrupting the enemy's timetable.

The planning and execution of the MDC must focus on embroiling the enemy force in an array of obstacles, attacking him with a variety of weapons, disrupting his formations and demoralizing his troops. Impeding the enemy in an array of obstacles creates favorable conditions for employing the second dimension: **robotic ground vehicle (RGV) weapon systems**. After the system is emplaced, the weapon becomes a patient, vigilant sentinel. The human crew in the robotic command center (RCC) is free to work or rest. The RCC crew places the robots in the search, warn or engage mode as determined by the battle situation and preparedness demands.

Currently, technology requires we use fiber-optic links to operate the RGVs remotely from a centrally located RCC. This remote operation provides safe, secure communication over a limited distance (up to 10 kilometers). For the long term, we will need a secure radio link to extend the distance between the operator and the robot. As technology matures, the RGVs will become highly autonomous.

**Unmanned aerial vehicles (UAVs)** are the third dimension of the MDC force. These systems have three capabilities: observation and surveillance well forward of the FLOT, anti-armor and anti-helicopter. A ground control station controls the observation and surveillance aerial vehicles throughout flight and recovery. In the anti-armor and anti-helicopter mode, these weapons are autonomous "Kamikaze" killers. We will launch them from a position in the rear and direct them to target or loiter areas selected by the commander. We can use UAVs in either the anti-helicopter or anti-armor roles and launch them en masse or individually.

The fourth dimension is a **Field Artillery-delivered, high-intensity flash munition**. We would use this munition in conjunction with the first and second dimensions to force the lead elements to bunch up. We would not direct the munitions at individual targets.

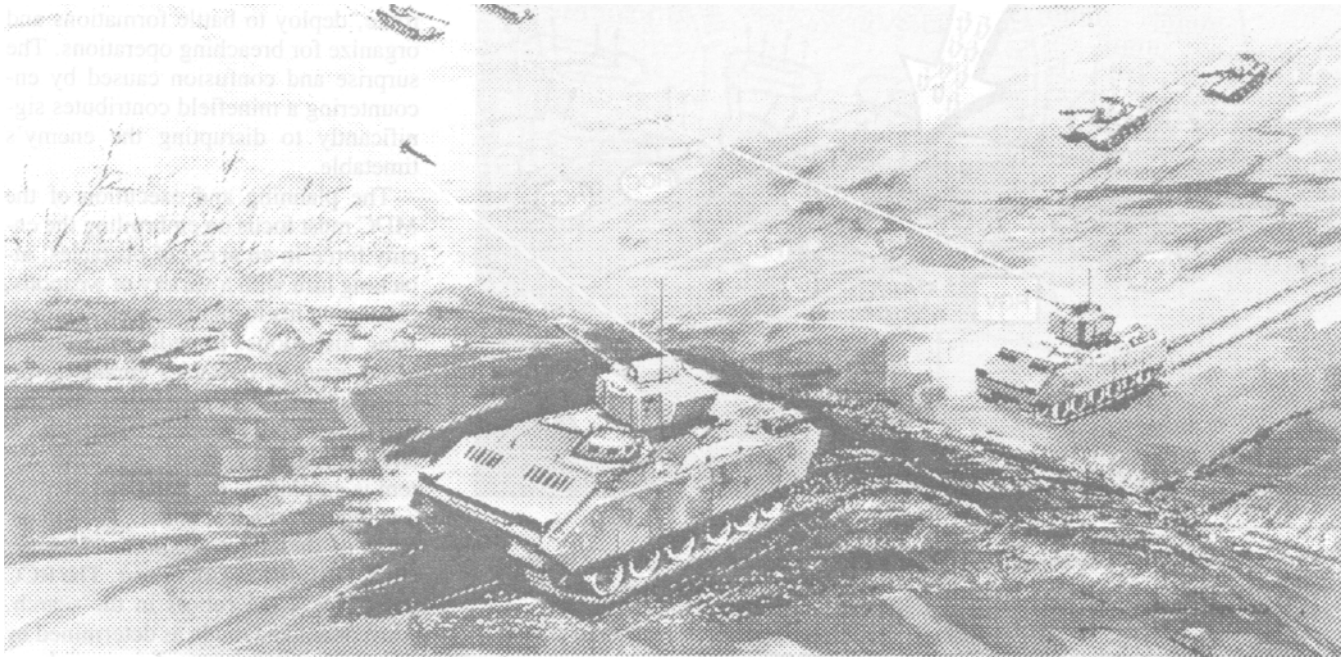

High-Energy Laser Employment Concepts

We could package them for howitzers in direct or indirect fire. Usually, direct support artillery would fire these munitions on orders from the RCG unit commander.

The fifth dimension is *directed-energy weapon (DEW) systems*. We would employ these weapons against armored vehicles, helicopters and dismounted soldiers. DEW systems employed in the MDC have several advantages over conventional weapons because of their unique effect on targets and their psychological impact. A major advantage of these systems is the very short duration of flight between the weapon and its target. Unmanned weapon platforms reduce or eliminate the hazard to friendlies using lasers, high-powered microwave and charged, particle-beam weapons.

As with any other maneuver brigade or battalion, support of the MDC unit with all available Field Artillery and air assets will significantly increase its lethality.

## Vulnerability

The RCG's vulnerability depends on the battlefield environment and is affected by terrain, time for preparation and the sensor and weapon mix of its robotic systems. Small arms and artillery fire can degrade these systems. They will not survive direct hits from large

caliber weapons. Both the ground and aerial systems will be vulnerable to electronic countermeasures (ECM), air-to-air and surface-to-air missiles and directed-energy weapons. UAV ground control station operators, vehicles, launch and sensor command and control equipment are vulnerable to aerial, NBC, artillery and surface-to-surface missile attack, as well as attack by conventional and unconventional land forces, as are other ground-based units. UAV's ground elements do not have unique signatures for enemy priority targeting.

## Operational Characteristics

The US Army should exploit the war-fighting potential of robotic weapons at the earliest possible opportunity. To a great extent, this requires using off-the-shelf technology as the foundation for systems development. The long-range objective is for the MDC force to be highly autonomous by the year 2004 to support AirLand Battle future doctrine.

We must employ the weapons systems in large numbers to obtain maximum effect from the MDC. Therefore, the weapon systems must have low acquisition, operation and sustainment costs. If we design the systems to meet every requirement, they

will become prohibitively expensive. They must be low-cost yet take advantage of the most advanced technology for soldiers to use in primitive and hostile environments.

The MDC force will require a support element to maintain technically complex systems and sensors. We will need a number of technicians, mechanics and support personnel to program, operate and maintain the equipment.

The robotic vehicles must be capable of autonomously moving to new firing positions for self-protection, fixing the enemy, thickening the force and increasing depth. They should be able to move 100 to 200 meters from one defilade position to another at speeds of up to 20 miles per hour.

The MDC force must retain a high degree of flexibility because the commander may not have enough MDC assets to cover all avenues of approach in his sector. Initially, he will place the MDC forces in depth, based on his estimate of the situation and the intelligence preparation of the battlefield. These robotic vehicles should have low profiles and be lightly armored (protection for the top of the vehicles, specifically), wheeled and mobile. They should be equipped with both antipersonnel and anti-armor weapons with a probability of kill equal to or exceeding that of Hellfire or its follow-on

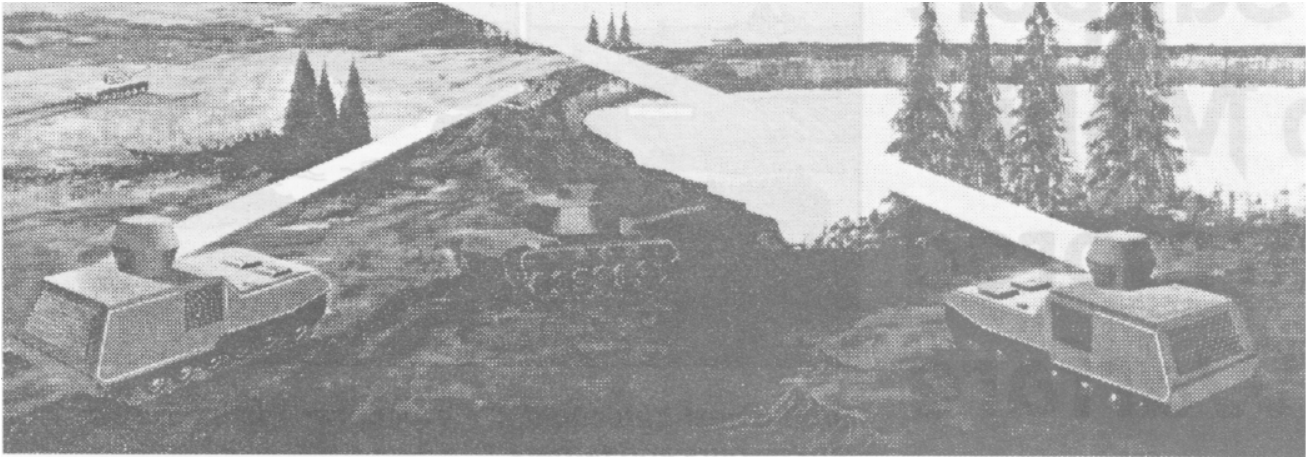

Low-Energy Laser Employment Concepts

replacement. They also should have fragmentation and smoke grenade launchers.

The UAVs in MDC should be capable of—

- Operation by soldiers who can program the air vehicle for a designated flight path before launch and reprogram it in flight, if necessary.
- Return to a location selected during mission programming if ground control fails.
- Determination of its true horizontal location to within 300 meters, two sigma (100 meters desired), using the universal transverse mercator (UTM) system and communication of this location to ground controllers via the data link.
- Performance of a mission of four hours to a range of 75 to 100 kilometers.
- Storage, transportation, fueling, programming and launch by the average soldier with minimum on-the-job training.
- Possession of surveillance and target acquisition sensors, fuel, data link, weapon(s) and associated equipment to accomplish the required flight missions.
- Possession of an ejectable, inexpensive, non-directional beacon and a low-cost system for recovery in the surveillance mode. UAVs must be able to fly designated surveillance paths and home to the beacon before each successive search.

Deception is an integral part of successful MDC tactics. The MDC force must not be readily identifiable by the enemy. Therefore, we should superimpose the concept on existing general defensive plans and carefully integrate it. We must use decoys and other deceptive measures. The signatures of vehicles or units must not reveal the MDC force disposition.

The MDC unit must be prepared to face many enemy attack formations—massed artillery, tanks and armored fighting vehicles, dismounted troops, airmobile forces and attack helicopters—as well as countermeasures: smoke and chemical weapons, jamming and ECM and nuclear and non-nuclear electromagnetic pulse (EMP). Eventually, we must enhance MDC force lethality so its battlefield area is the most dangerous for the enemy to attack.

## Conclusion

The MDC exploits those advanced technologies that have known military applications. The concept's major benefit to the Army is as a force multiplier. It combines advanced technology and techniques with the innovative use of existing technology and weapons.

The MDC is open and flexible. This advanced operational concept and its accompanying conceptual robotic combat group provide a solution to the lack of frontline forces for maneuver. It

gives our commanders *initiative*, forcing the enemy to conform to our purpose and tempo while we retain freedom of action. It provides *agility*, allowing friendly forces to act faster than an enemy embroiled in a series of obstacles. The commander achieves and maintains elasticity in the defense because he employs MDC forces in *depth*. MDC provides adequate reconnaissance beyond areas of immediate concern and positions uncommitted friendly forces in depth with enough maneuver room to strike critical blows against the enemy. Finally, it exploits *synchronization* by carefully integrating its multiple dimensions and arranging battlefield activities in time, space and purpose for synergy and maximum relative combat power at the decisive point. The product of effectively executing MDC is maximum economy of force.



Retired Army officers Brigadier General John C. Bahnsen, commissioned in Armor, and Colonels Gordon M. Hunt and Robert C. Stack, both Infantry, are part of a defense contractor's advanced concepts team, working in Williamsburg, Virginia. The team develops concepts for the military application of robotic and unmanned systems, one of which is MDC. The MDC development is for the US Army Armor Center, Fort Knox, Kentucky, and funded by the US Army Laboratory Command, Adelphi, Maryland. All the authors have attended the highest levels of Army schools and served in combat in Vietnam.

# Fire Support in Mobile Armored Warfare

by Lieutenant General  
Crosbie E. Saint, Colonel  
Tommy R. Franks and  
Major Alan B. Moon

War-fighting in the late 20th Century will present unique challenges—and opportunities. The AirLand Battlefield will be characterized by unprecedented violence and stress, accelerated tempo and technological complexity. The concept of Mobile Armored Warfare seeks to turn these characteristics to operational advantage by applying the tenets of AirLand Battle doctrine: initiative, agility, depth and synchronization. The idea is to create and (or) take advantage of enemy vulnerabilities. A great opportunity for fire support—a great opportunity for Field Artillery.

The focus of Mobile Armored Warfare is on winning. There will be no "honorable mention" for second place on tomorrow's battlefield. Winning implies offensive operations, and Mobile Armored Warfare is an approach to offensive war-fighting. Orienting on the enemy rather than on terrain, the objective is to destroy the appropriate Threat soldiers, their most dangerous equipment and their will to fight. This concentration on the enemy is not an endorsement of attrition warfare. Rather, we seek positional and organizational advantage by focusing and economizing combat power at key points and times to seize the initiative

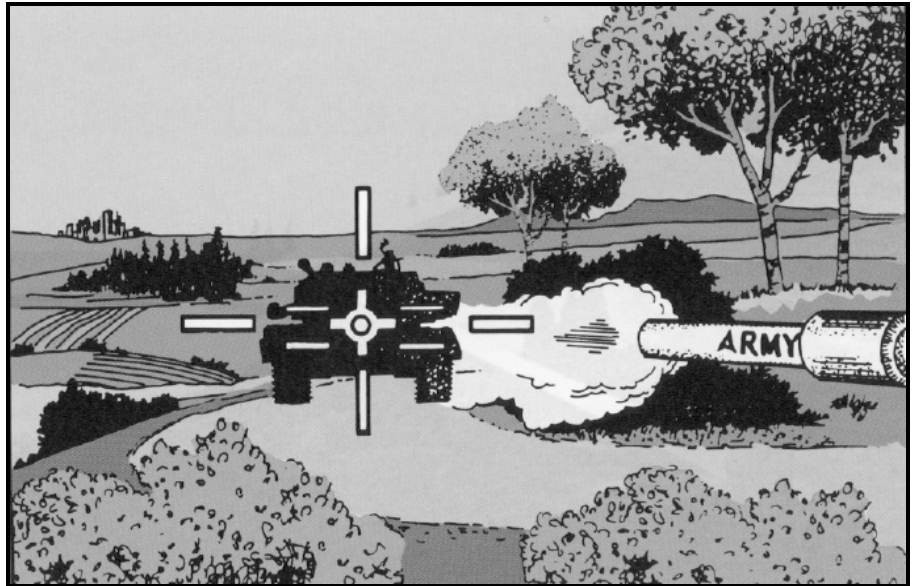

***On the next battlefield, we expect two distinctive kinds of tanks—ours and targets.***

and, thereby, force the Threat to react rather than allow him to act. Mobile Armored Warfare relies on focused violence and speed to overwhelm the Threat selectively at decisive points in time and space. Since we can't kill all of "them," let's get the right ones. A great opportunity for Field Artillery to shine.

## The Fire Support Scheme of Maneuver

To answer the challenges of the Air-Land Battlefield, the fire support system confronts a special set of needs. The fire supporter must be able to focus high volumes of fire quickly to create or take advantage of an enemy

vulnerability. He must "trigger" firing on critical groups of targets at the time and place of the commander's choosing. Shooting a lot of the correct type of rounds at a few targets is the order of the day; shooting a few rounds at a lot of targets simply wastes precious resources. He must attack and kill so the results contribute to the commander's intent and scheme of maneuver.

In the traditional sense, the fire supporter still provides timely and accurate fires to neutralize, suppress or destroy the enemy. This is nothing new. However, Mobile Armored Warfare requires that in addition to having a "ground scheme of maneuver," he must develop a "fire support scheme of maneuver." With it, he focuses all available combat



General Dynamics

**Field Artillery**

power, not only at critical points but also at *critical times*. By developing and executing such a fire support scheme, we can take advantage of the fleeting opportunities on the battlefield.

To be valid, the fire support scheme of maneuver must reflect the maneuver commander's intent. Predicated on the intelligence preparation of the battlefield (IPB), the fire support scheme complements the maneuver scheme. The commander's intent, tempered with IPB, is the foundation of both the maneuver scheme and the fire support scheme of maneuver. Not easy.

Since the fire support scheme doesn't imply "killing everybody" (the fire support system will never be able to do that by itself), the fire support scheme of maneuver doesn't mean driving around the battlefield in tracks looking for targets of opportunity.

Rather the idea is to *shape, silence and selectively attack* targets on a planned basis to complement the maneuver commander's intent and maneuver scheme. This means the fire supporter must plan, coordinate and integrate the complete fire support system—electronic warfare (EW), mortars, close air support (CAS) and Field Artillery—with other battlefield operations. The fire supporter's task is to develop a plan of action, not just target lists or overlays, radar queuing schedules, target priorities, organizations for combat, etc. The task is to focus fire support just as a prism focuses the sun's rays.

To develop the fire support scheme, the fire supporter must assess the IPB and the commander's scheme of maneuver. As a result of this assessment, he identifies the requirements, matches them with capabilities and acknowledges and accepts prudent risk. Accepting risk is key in planning and coordinating fires. The level of acceptable risk helps determine which targets to engage, when and how to engage them, what assets to use and what the desired results will be. With this information, he plans the positioning and employment of Field Artillery and establishes a system for command and control, mutual support and sustainment. This plan is the Field Artillery scheme of maneuver.

The fire support scheme satisfies a number of critical requirements, but it responds ultimately to one master: the maneuver commander. In conducting mobile armored operations, the maneuver commander will tailor the fire support scheme based on his intent and the assets available. But the commander will require certain fundamental capabilities, regardless of the



MAJ Charles W. Pope, Jr.

The fire support scheme of maneuver doesn't mean driving around the battlefield looking for targets of opportunity—rather focusing fire support as a prism focuses light.

situation. He'll need fire support assets to be in place as the battle opens and to retain agility. And the fire supporter must deliver timely, focused fires at decisive points while ensuring survivability. These tenets are consistent with the offensive nature of mobile armored operations.

### Fire Support Slingshot

As the battle opens, the fire support system must be in position and prepared to provide support. The commander will set priorities for the employment of scarce resources (EW, CAS and indirect fires) based on desired results (silencing, shaping or destruction). He will assess and accept prudent risks (for example, moving all firing units at the same time) to have positional advantage at critical points. Essentially, the fire support slice (intelligence assets, fire support command and control, targeting cells and firing units) will be in place well in advance of the maneuver force. The result is a fire support "slingshot" that generates momentum.

### Force Survivability

Equally as important as positioning is the ability of the force to survive the counterfire threat. Silencing enemy cannon artillery and multiple rocket launchers is vital to preserving combat power—both fire support and maneuver. The fire support scheme must address how to defeat the powerful array of enemy regimental artillery groups (RAGs), which support committed



LTV Missiles and Electronics Group

There will be no "honorable mention" for second place on tomorrow's battlefield.

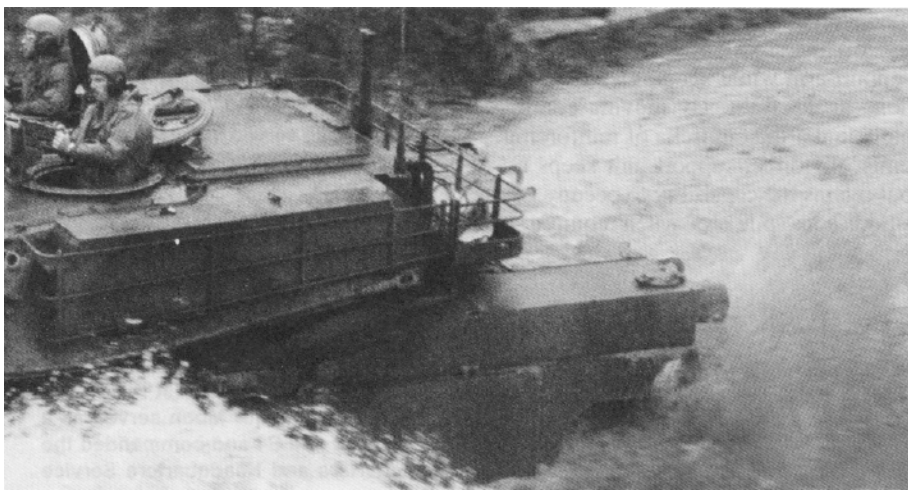

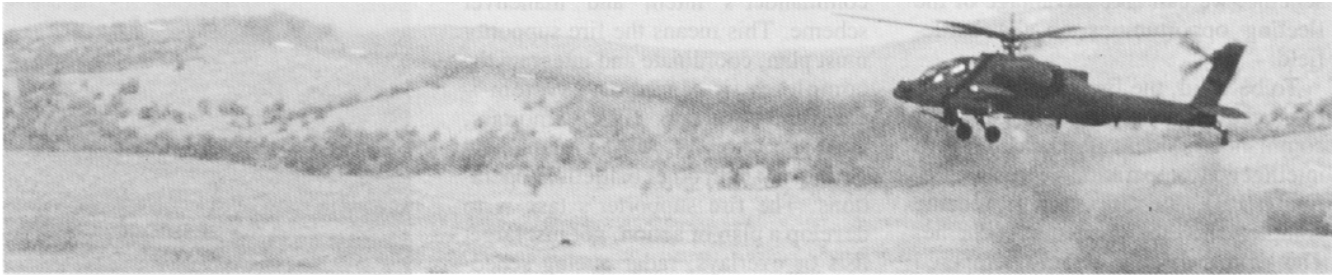

Dave Drummond

The fire support scheme includes attacking enemy artillery with Apache helicopters and FASCAM to neutralize the mobility of Threat guns.

Threat units and are the greatest danger to the success of our main effort. This artillery "crust" must be broken. This is done by engaging enemy command and control and fire units that pose a threat to mobile armored operations. The fire support scheme outlines a detailed plan identifying the counterfire command and control apparatus, target acquisition assets, firing units and the priority in which to attack the "crust artillery." It includes such novel ideas as attacking with Apache helicopters and with the family of scatterable mines (FASCAM) to neutralize the mobility of Threat guns.

## Storm Artillery

The next aspect of fire support for mobile armored operations concerns the delivery of indirect fires in support



Mobile Armored Warfare focuses on violence and speed to overwhelm the Threat selectively at decisive points in time and space.

of the attacking force. Delivering timely and focused fires while retaining mobility and agility is the business of "Storm Artillery." This technique has several distinct features. First, Storm Artillery provides high volumes of timely fires while traveling behind the lead task forces of committed brigades. Artillery hipshoots and direct fire are part and parcel of this business.

Second, Storm Artillery offsets the mobility difference between the Abrams tank and Bradley fighting vehicle on the one hand and the M109A3 howitzer on the other. Storm Artillery employs lean artillery platoons and batteries comprised of tracked vehicles moving tactically within maneuver formations. Careful use of terrain and cross-country movement enhances survivability. Proficiency with crew-served weapons and direct-fire skills take on added importance, and hipshoots are a way of life.

Storm Artillery is a technique designed to support offensive operations. When a mission is received, the cannons occupy emergency positions and provide fires 3,000 to 4,000 meters to the front and flanks, adjusting later. The idea is to suppress the enemy immediately and improve the survivability of the most maneuverable fire support arm while keeping all the cannons in the fight. By moving continually under the umbrella of reinforcing units, the direct support unit keeps up but retains the capability to occupy positions and "pile on" when required.

## The Challenges

The challenges of the AirLand Battlefield are real, but so are the opportunities. Mobile Armored Warfare takes advantage of the characteristics of that battlefield while it negates the imbalance

of Threat force ratios. The fire support community must continue to break the bonds of traditional fire support methods and seek to perfect workable solutions for tomorrow's battlefield. The alternatives are not acceptable. Can the Field Artillery community meet the challenge? We believe so. But it's time for mental flexibility so the Army can take advantage of our greatest asset—mobility of fire.



**Lieutenant General (P) Crosbie E. Saint will take command of the US Army, Europe (USAREUR) and Seventh Army this month. He has commanded III Corps and Fort Hood, Texas, since 1985. He commanded the 1st Armored Division, 11th Armored Cavalry Regiment and 7th Army Training Command, all in USAREUR. During his two tours in Vietnam, General Saint commanded the 1st Squadron, 1st Armored Cavalry Regiment, and served as G3 of the 23d Infantry Division. He also served as Deputy Commandant, Command and General Staff College, Fort Leavenworth, Kansas.**

**Colonel Tommy R. Franks commands the 1st Cavalry Division Artillery at Fort Hood. He commanded the 2d Battalion, 78th Field Artillery, 1st Armored Division; a howitzer battery and the 84th Armored Engineer Company of the 2d Armored Cavalry Regiment, USAREUR; and a 105-mm battery at Fort Sill, Oklahoma. Colonel Franks also served in the Office of the Chief of Staff of the Army and as Deputy G3 of III Corps.**

**Major Alan B. Moon is the Assistant Fire Support Coordinator of the 1st Cavalry Division. In the 1st Cavalry, he also served as a battalion fire support officer and commanded C Battery, 1-77th Field Artillery. In the 1st Battalion, 41st Field Artillery (Pershing), Major Moon served as a battalion S3 and S4 and commanded the Headquarters and Headquarters Service Battery.**





# "The Flying Box"

## Supporting the Mobile Armored Corps

by Captain Jorge M. Fernandez

**F**ire mission: The self-propelled guns of an M110A2 howitzer platoon stop in their tracks and pump out 200-pound projectiles in less than four minutes. Approximately 2,000 meters away, their rounds impact on the bunkers and fortified buildings of a well-prepared enemy position while teams of mechanized infantry and armor maneuver to assault the position from a flank. The 8-inch howitzer platoon is part of a highly mobile, combined-arms task force striking deep into enemy-held territory in an attempt to maintain the operational initiative.

### Mobile Armored Warfare

In the Mobile Armored Warfare concept of III Corps Commander Lieutenant General Crosbie E. Saint, the artillery must be prepared to stay close to the maneuver units they support or risk being unable to support them adequately. Comments heard at the National Training Center far too often refer to the artillery as being at the

wrong place, or if at the right place, arriving too late to make a difference. Are we Redlegs letting our maneuver brothers down?

Current doctrine calls for moving artillery by echelon—battalion, battery or platoon—and hipshooting the battery or platoon if necessary. Several units have experimented with ways of keeping up with maneuver units on rough terrain, staying 500 to 2,000 meters behind the leading combat teams. One of these is the 2d Battalion, 18th Field Artillery, which has developed the "Flying Box" formation.

### Flying Box for 3x8

The 2-18th Artillery is a 3x8, M110A2 howitzer battalion at Fort Sill, Oklahoma. In the 3x8 concept, the battalion moves by platoons, each of which consists of four guns. The idea is to keep some firepower in place while moving other platoons individually or in pairs to keep up with an offensive maneuver force. Whenever

possible, the Battalion maintains at least 16 howitzers (four platoons) ready to fire while moving two platoons (eight howitzers) at a time. With the maneuver commander's approval, the fire support coordinator (FSCOORD) can detach a battery or a battalion and attach it to a task force. Such a mission with a battalion (+) or a brigade-sized task force is ideal for using the Flying Box. This formation brings artillery close to the lead maneuver units while they're attacking and provides them quick direct or indirect artillery fire.

### Flying Box Operations

The key to the formation's success is the platoon leader. He must understand his mission and the intended scheme of maneuver completely. Understanding the route of march with the start point (SP) and release point (RP) is key, and platoon leaders should keep their platoons on roads as much as possible. When off road in the Flying Box,

the platoon leader must know where he is at all times and have a firm grasp of the tactical situation. He must know the SP, at a minimum. The platoon leader then knows when to deploy in the Flying Box.

After deploying into the formation, he should keep his platoon 500 to 2,000 meters behind the leading maneuver elements, 1,000 to 2,000 meters behind another artillery platoon or at a distance designated by the task-force commander. Keeping close to the maneuver forces enables the platoon to provide quick, effective direct and indirect fire from the Box formation.

### The Column

Deploying in the Flying Box formation is simple. From a column formation, the platoon leader, in his vehicle, can signal the unit to deploy into the Flying Box. The high-mobility, multipurpose wheeled vehicle (HMMWV) is ideally suited as the platoon leader's vehicle because of its cross-country capability.

### The Box

The "Box" has two columns, each led by an M548 followed by two howitzers. One of the columns has the fire direction center's (FDC's) M577 followed by an M548, and the other column has an M548 after its two howitzers. The two leading and two trailing M548s are positioned to provide the platoon maximum protection. Their high-mounted, .50-caliber machine guns are ideal for spotting and engaging threats.

### The Firing Position

When the platoon needs to stop and deploy into a firing configuration, the platoon leader once again signals the platoon and quickly turns his vehicle to get out from the front of the firing line. The two leading M548s turn and prepare to get behind their howitzers when the howitzers are laid. The two rear M548s carry out a similar maneuver.

The M577 stops, and for indirect fire missions, the crew prepares firing data while the platoon sergeant (chief of firing battery) sets up the aiming circle to lay the platoon. The two lead howitzers stop, emplace and prepare to receive commands.

For an indirect fire mission, the platoon sergeant should lay the two lead howitzers first. The fire direction officer

(FDO) determines the azimuth of fire and relays this information to the platoon sergeant. The platoon leader then orients one of the two center howitzers on the azimuth of fire, using his M2 compass (if necessary). One of the platoon leader's objectives while following the maneuver forces is to maintain roughly the direction of travel on a probable azimuth of fire.

On a direct-fire mission, the platoon leader must ensure the howitzer section chiefs understand what and where the target is. The platoon and gunnery sergeants are key figures in helping the platoon leader.

The two trailing howitzers veer left and right, respectively, to take up their firing positions. Wire is run, if possible, to the aiming circle from all howitzers and to the FDC, ideally through a TB-184/SB-16 terminal board. After

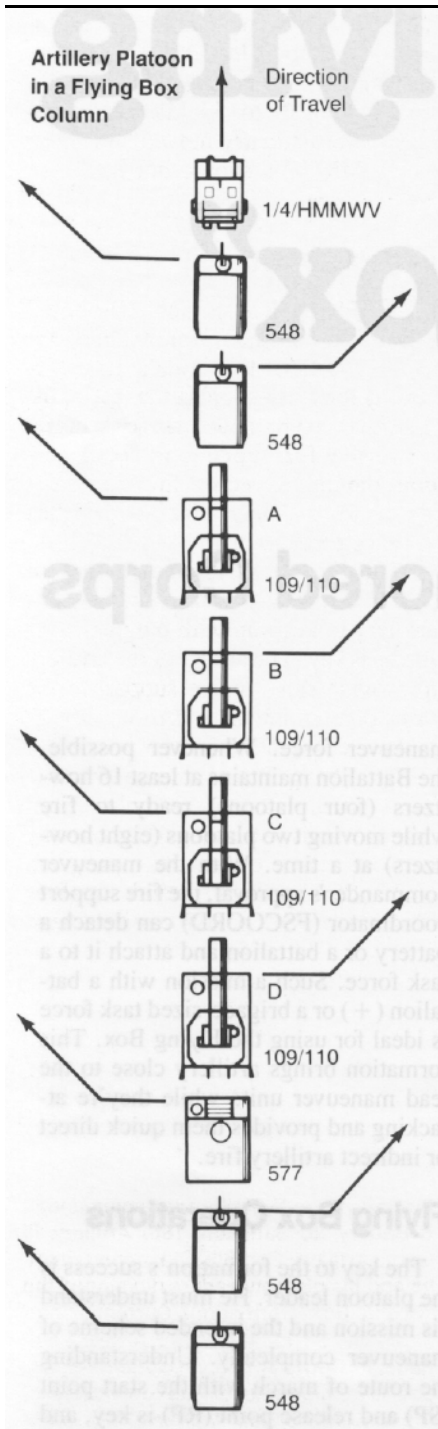

The platoon moves out of the column formation and off road.

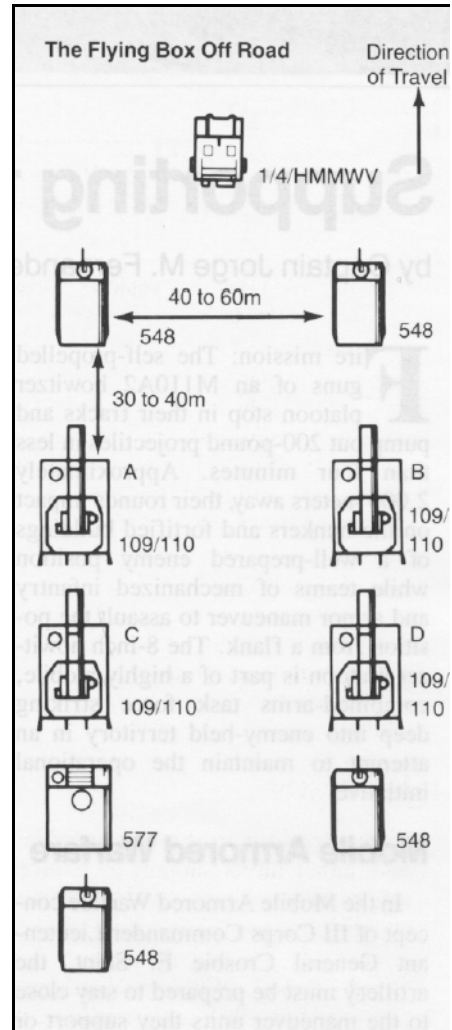

The platoon leader has moved his platoon from the column to the Flying Box off road.

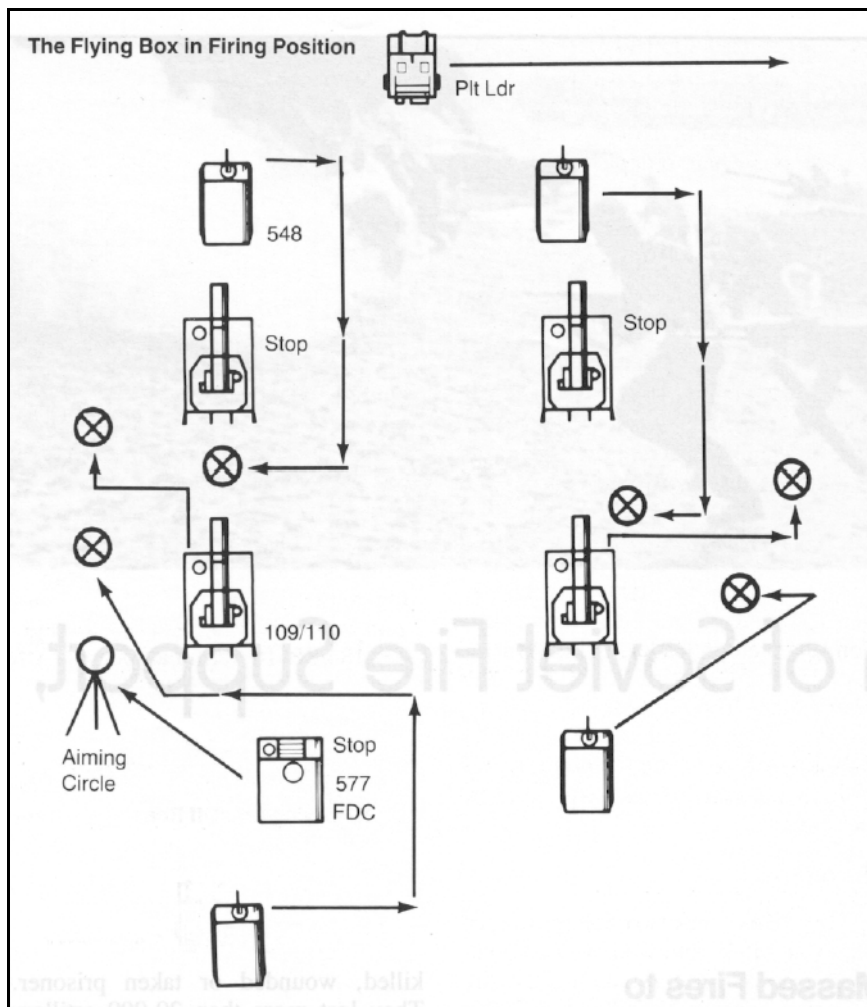

When the platoon needs to deploy, the platoon leader quickly turns his HMMWV to get out from the front of the firing line, and the vehicles reposition to fire.

completing the fire mission, the platoon can remain in place and perform position improvement, or if ordered to move, the platoon leader simply calls march order and the vehicle drivers return to the Box formation.

When approaching choke points such as bridges or tree lines, the platoon leader signals the platoon temporarily back into the column formation. The section chiefs and drivers are key players in the formation; they must rehearse their roles thoroughly.

## Diversity

The Box formation is useful for units with either direct support or reinforcing missions. Using two platoons or batteries in concert to provide close indirect or direct fire support is the preferred method. With one platoon in position, the other moves behind the maneuver forces and stops to emplace at a chosen point or time, allowing the first platoon to move forward in turn.

The use of two platoons fits into the scheme of an eight-gun, two-platoon battery. Command and control of these units must be well defined and, ideally, is conducted through the supported unit's S3 and its fire support element. With an entire battery employed, the battery commander can and should control the platoons while they have the mission.

## Limitations

An obvious limitation of the Flying Box is that you can't use it on all types of terrain. It is best suited for rolling terrain such as that found in portions of central Europe or in deserts and steppes. The formation is flexible enough to allow a platoon leader to bring the Box into column formation quickly to go around rough terrain features.

Another limitation arises in the difficulty of trying to follow maneuver

forces and occupy quickly without surveyed, prepared positions and shoot indirect fire without reliable meteorological data. In training with the formation, however, first-round accuracy consistently has been between 50 and 100 meters of the target. This is because the distance to the target is usually less than 4,000 meters. The Box was designed with direct fire and short-range indirect fire in mind.

Perhaps the most difficult limitation has been with the platoon leader's vehicle. Our platoon leaders' M151, 1/4-ton trucks are not well suited for high-speed (30 to 50 kilometers per hour), cross-country movement. Units with HMMWVs should not have this problem.

## Conclusion

The Flying Box is not a proposed end to the hipshoot for Mobile Armored Warfare. It is a deliberate formation for close support that gives the maneuver commander maneuverable, responsive fire support. In the formation, the unit expects a fire mission at any time, and there are no detached advance parties.

With the offensive implications of Mobile Armored Warfare, the need for artillery to keep up with the maneuver forces is key. The ability of the artillery to provide close-in fire support to the task-force commander will be critical to the success of the force.

The Flying Box formation works. The formation requires only minor modifications in training to meet Army training and evaluation program (ARTEP) "hipshoot" standards. It is ideal for self-propelled howitzers and 3x8 units that support mechanized or armored forces. 

**Captain Jorge M. Fernandez commanded B Battery, 2d Battalion, 18th Artillery, III Corps Artillery, Fort Sill, Oklahoma, where he and his platoon leaders developed the "Flying Box" formation. Currently, he's Assistant S3 for the 212th Artillery Brigade, III Corps Artillery. Captain Fernandez is a graduate of the University of Florida and the Field Artillery Officers Advanced Course. He also served with the 6th Battalion, 14th Artillery, 1st Armored Division, West Germany.**



# The Evolution of Soviet Fire Support, 1940-1988

by Captain John Gordon IV

Since the days of the czars, the Russian Army has always placed great stock in its artillery. Unfortunately, too little study is devoted to the evolution of Soviet artillery; Western writers usually concentrate on the more dramatic, tank-heavy maneuver forces. This article shows that Soviet artillery is the product of logical, methodical development. The traditionally conservative Red Army applied historical lessons to steadily mold its artillery into the powerful force it is today.

The artillery of the Red Army of the late 1930s was beginning to reap the benefits of Stalin's Five Year Plans. Large numbers of modern 76-, 122- and 152-mm guns and howitzers were leaving state factories and entering the artillery regiments. The first test of these new weapons came in late 1939 when Stalin launched his assault on Finland.

## Massed Fires to Replace Mobility

The 1939-40 "Winter War" clearly showed the Red Army was not prepared properly for mobile warfare. Whenever single, unsupported Red Army divisions tried to penetrate Finnish defenses, they were outmaneuvered, cut off and destroyed. The tactics of 1939 did not work.

What *did* work was Marshall Semyon Timoshenko's February 1940 offensive that massed hundreds of guns in support of a renewed offensive on a narrow front. The overextended Finns were forced back under bombardments that often exceeded 300,000 shells per 24 hours along a 20-mile section of the front. Thus, the Red Army gained practical experience in the techniques of massing a large concentration of guns. There was, however, relatively little time to reflect on the victory over the Finns; for on 22 June 1941, the Nazi Wehrmacht, together with Germany's eastern European allies, crashed across the Soviet frontier. In the first five months of the German invasion, the Soviet Union lost some 5 million soldiers who were killed, wounded or taken prisoner. They lost more than

20,000 artillery pieces, along with the trained soldiers needed to man them. Despite this loss, the Russians managed to hang on through the winter of 1941-42. As the decisive spring of 1942 approached, it was clear to the Russians that with such huge losses in weapons and trained manpower, their artillery would require massive reorganization.



The Soviets fire a 122-mm howitzer at the Germans during World War II.

## Soviet Artillery Reorganization

The first step in this process was to reduce dramatically the number of artillery pieces in a division. Whereas the 19,000-man 1939 rifle division had 82 guns and howitzers, the late-1941 rifle division had 12,000 men with only 24 artillery weapons. As partial compensation, the number of mortars (82- and 120-mm) went from 30 to 108. The reasons for this were simple: it was going to take many months for the factories to replace the huge losses of 1941, and in the meantime, mortars were far simpler for hastily trained replacements to use and much easier to produce. We must remember that the number of properly trained artillerymen was critically low, also a result of the disasters of 1941.

The Russians then concentrated the majority of true guns and howitzers in non-divisional regiments and brigades. Here, also, were the trained artillerymen. The Russians primarily reserved such formations for offensive operations where they moved them in behind the attacking infantry and employed traditional indirect fire. The less well armed and trained divisional units relied primarily on direct fire in the offense and defense. Thus was born the tradition of direct firing "accompanying artillery" still used today. An unfortunate consequence for the direct-firing divisional guns was they suffered roughly 10 times the losses of the non-divisional units.

## Impact of Massed Fires on Soviet Operations

The first really successful large-scale use of massed guns in support of an offensive came at Stalingrad in November 1942. With the Germans embroiled in street fighting, the Russians had the opportunity to move in hundreds of guns against the two Rumanian armies north and south of Stalingrad. The one-and-one-half-hour opening bombardment on 19 November included some 115 battalions of Katyusha multiple rocket launchers, the largest concentration yet of these weapons. This preparation shattered the Rumanian defenses and facilitated the breakthrough of mechanized forces, which three days later encircled the German 6th Army.

Once again, the decisive effect of a powerful bombardment was quite obvious.

As World War II progressed, the Red Army concentrated more and more of its guns and howitzers into large non-divisional units. By the end of the War, the Russians had created more than 90 artillery divisions (usually with 288 guns and howitzers) and some 140 separate artillery brigades. In 1941, roughly 20 percent of Soviet artillery was in non-divisional units; by 1944, more than 65 percent of the artillery was in artillery divisions and brigades. In 1943, the Russians formed artillery corps headquarters to control particularly dense concentrations of guns. By late 1944, the Red Army typically concentrated 200 to 400 guns, howitzers and heavy mortars per mile of front in an area of a major attack.

## Soviet Artillery Weaknesses

Despite these impressive figures, Soviet artillery still suffered from severe weaknesses. The most significant was that to achieve fire superiority, it had to assemble the huge quantity of weapons on major attack fronts. That required time, which implied a static front and a degree of air superiority. Before Stalingrad, such concentrations were impractical because the Luftwaffe would smash such attractive targets. Additionally, the training of individual batteries, battalions and brigades was still so rudimentary that, even in a two-to three-hour preparation, each battalion would rigidly engage only a few targets. The level of training would simply not allow for the rapid shifting of fires and concentration on targets of opportunity that the artillery of the German Army or the Western Allies was capable of.

The Soviet solution to achieving fire superiority was to mass weapons in great quantity. By the time of the battle of Kursk in July 1943, the Red Air Force was capable of achieving local air superiority. Thus, they could assemble huge concentrations of weapons safely.

Another significant problem experienced by the Soviet artillery until the end of the war was its inability to support a mobile force adequately following a breakthrough. Organizationally, neither the Soviet's World War II tank corps (forerunner of the present-day tank



East German soldiers fire a 120-mm mortar, the type used by the Soviets during World War II.

division) nor its mechanized corps had enough artillery to take with it following a penetration. The 1944 German panzer division of some 14,000 men had 180 tanks to the Soviet tank corps' 11,900 men and 220 tanks. But the Panzer division had some 70 artillery pieces of up to 150-mm to the twenty 76-mm self-propelled guns in a Soviet tank corps. Soviet mobile units were unable to fight through a strong blocking force thrown into their path as they tried to exploit a breakthrough. Following the war, they more than made up for this obvious deficiency in the organization of the new tank and motorized rifle divisions.

By the end of World War II, the Red Army was supported by a huge artillery organization, manning more than 500 divisional artillery units, 149 independent brigades and 90 artillery divisions. Additionally, the Soviet artillery had built up a rocket force without parallel, with units as large as rocket divisions. When the War ended in August 1945, the Red Army artillery could certainly feel proud of its accomplishments. It was only natural that such a gigantic amount of experience would influence Soviet artillery tactics and doctrine for years to come.

## Changes in Soviet Doctrine

After the War, the Red Army was very large. Its doctrine remained closely linked to World War II experience. Indeed, Stalin virtually prohibited any deviation from 1940's tactics and operations. This changed upon Stalin's death in 1953 when Nikita Khrushchev assumed power. He began



to draw down the conventional ground combat strength of the Soviet Army.

This was the era in which the Soviets felt nuclear war would be the inevitable consequence of any East-West clash. Khrushchev built up the tank forces to exploit nuclear fires. Conventional artillery was assigned a secondary role. The fact that it was almost exclusively towed meant it would lack the protection and mobility to accompany tanks on a predominantly nuclear battlefield.

This does not mean that advances had not been made in artillery since the end of World War II. Of particular importance was that the tank division, the primary agent to exploit nuclear strikes, had a more credible organic artillery component in the form of its artillery regiment. However, the Soviets considered nuclear weapons delivered by surface-to-surface missiles and aircraft the decisive fire support agent.

## Offensive Maneuver Combat

With the fall of Khrushchev, the Soviet Army began to re-think the possibility of an East-West conflict's having a protracted, non-nuclear phase. Simultaneously, the overall size of the Army began to grow rapidly. In 1965, the Soviet Army had 147 divisions. By 1974, they had 167 and by 1987, more than 200 divisions. As part of this increase, there has been an unprecedented growth in conventional artillery strength.



The Soviets tow the 1937 models of their 152-mm howitzers into place using their 1956 model AT-T artillery tractor.

To understand the huge increase in firepower Soviet artillery units have seen in the past 15 years, it's vital to understand the Soviets regard offensive action as the only way to achieve victory. They consider the prime means of gaining victory to be armor-heavy formations designed to penetrate an enemy's front and drive quickly on to operational and strategic objectives in the opponent's rear.

In the 1970s, Soviet strategic thinking began to come to grips with the prospects of *at least* the initial stages of a major war's being non-nuclear. At the same time, NATO began to introduce masses of anti-tank guided weapons (ATGWs). The proliferation of Western ATGWs spurred the increase in Soviet artillery.

Another decisive event that prompted the huge increase in Soviet artillery was the 1973 Middle East War. The extreme vulnerability of armored personnel carriers in that conflict, particularly the tank-accompanying BMP (a Soviet infantry combat vehicle), highlighted the need to suppress enemy anti-tank weapons. When combined with the possibility that the battlefield might not be nuclear, it was obvious that an increase in field artillery was the best solution. The latter half of the 1970s saw many Soviet moves in this direction.

- The artillery battery in motorized rifle regiments became a battalion.
- Many army-level artillery regiments began converting to four-battalion brigades.
- The 2S1(122-mm) and 2S3(152-mm) self-propelled weapons were introduced into maneuver divisions.
- Specialized artillery support and reconnaissance vehicles based on MT-LB (armored personnel carrier) and BMP chassis were introduced.

As the 1980s began, further steps were taken to improve the quantity and quality of Soviet artillery.

- Many non-divisional units increased their guns from six to eight per battery.
- New munitions were introduced, such as high performance flechette rounds for suppressive fires and incendiary rounds for multiple rocket launchers.
- Much equipment was added.
  - BM-27 rocket launcher (MRL).



The 2S1 self-propelled, amphibious howitzer, fielded in 1974, is used by the Soviets in Afghanistan.

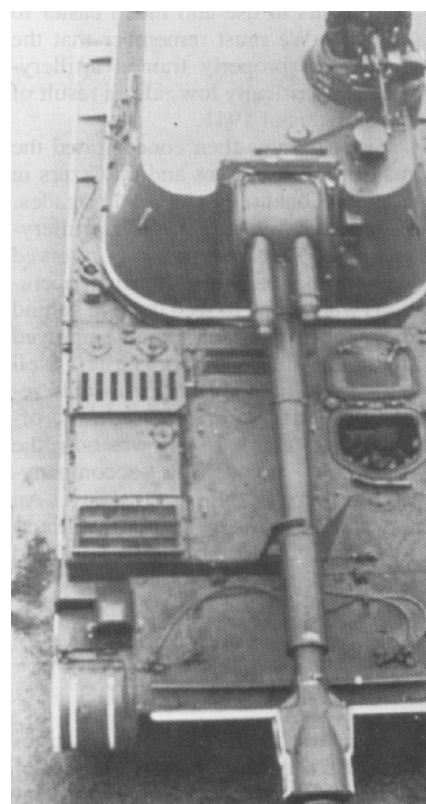

The Soviet 2S3, 152-mm howitzer, basically a copy of our M109, 155-mm howitzer, is used at the division level.

- 2S5, long-range, self-propelled 152-mm gun.
- 2S7 self-propelled 203-mm gun.
- 82-mm automatic mortar.
- Computerized fire control equipment.
- Some divisional battalions increased to 24 weapons per battalion.

One should not become engrossed with the weapons. The message is that

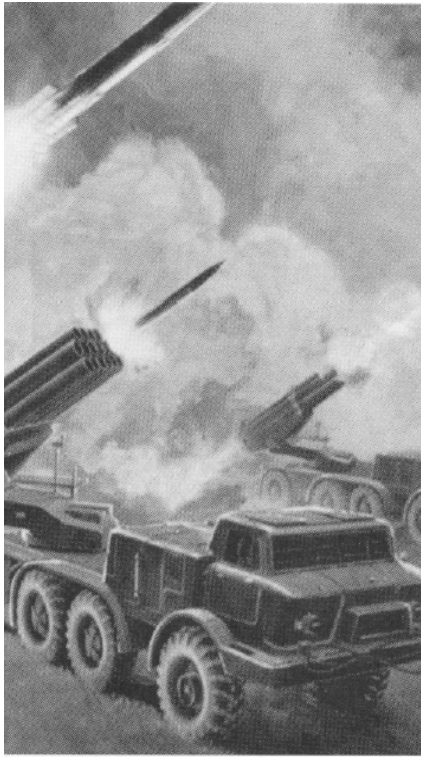

The 16-round BM-27, 220-mm multiple rocket launcher (MRL) provides the Soviets intensive, long-range fire support in Afghanistan.

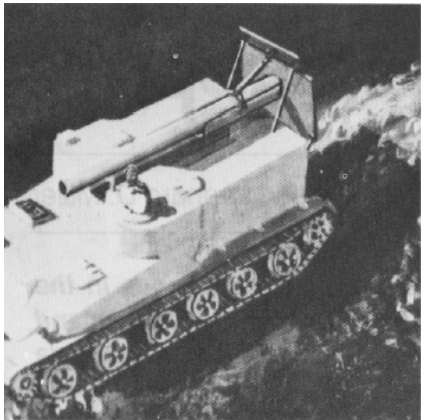

The Soviets' New Self-Propelled 240-mm 2S4 Mortar

the Soviet Army is firmly committed to offensive maneuver combat. The introduction of large numbers of Western ATGWs posed a real threat to the viability of this armor-heavy doctrine. The solution the Soviets have arrived at is to add guns, mortars and rocket launchers—lots of them—to suppress the ATGW threat. Large numbers of these weapons are self-propelled, which indicates the Soviets want mobile, responsive fire support for the core of the Army: the tank and its accompanying infantry.

Soviet Motorized Rifle Division		
	1976	1988
122-mm	54	96
152-mm	18	72
BM-21 MRL	18	18
US Heavy Division		
155-mm	54	72
203-mm	12	(12 moved to corps)
MLRS	—	9

Soviet Increase in Firepower as Compared to the US, 1976 to 1988

### Coordinated Non-Stop Artillery Fires

During the past 12 years, the US division saw a nine percent increase in its number of tubes while the Soviet division increased by 133 percent. The nine multiple launch rocket systems (MLRSs) in our heavy divisions don't compensate for the introduction of a regiment of fifty-four BM-27s at the Soviet Army level.

In 1982, Leonid Brezhnev stated the Soviet Union would not be the first to use nuclear weapons in a conflict. This declaration emphasized even more the need for conventional fire support for the Soviet Army's ground-gaining arms. Today, the Soviets probably have flooded the division with as much organic artillery as it can reasonably control: seven battalions of cannons, an MRL battalion, a free rocket over ground (FROG) battalion and an antitank battalion. Now the Soviets have more artillery battalions organic to a motorized rifle division than infantry battalions (nine). The introduction of six-weapon "Vasilek" automatic mortar batteries as replacements for the 120-mm mortar at battalion level substantially increases the suppressive firepower available to motorized rifle units.

Recently, Soviet Major General I. Vorobyev stated that Western emphasis on precision-guided munitions has increased the need for coordinated, nonstop fire attacks throughout the depth of Western defenses. The type of weapons being introduced (such as the BM-27, 2S5 and 2S7) all have the necessary range to attack targets deep in NATO positions. The shorter range mortars (122- and 152-mm weapons) provide direct support for the maneuver forces attacking the NATO forces along the forward line of own troops (FLOT).

US Versus USSR Firepower			
US*		USSR**	
155-mm	96	122-mm	384
203-mm	24	152-mm	552
MLRS	36	203-mm	24
		240-mm Mortar	24
		BM-21	72
		BM-27	54

*\*An Army of Excellence heavy division reinforced by three corps artillery battalions (4 Bns, 155-mm; 1 Bn, 203-mm; 1 Bn MLRS, 1 Btry MLRS).*

*\*\*A Soviet Combined Arms Army (3 MRDs, 1 tank Div, one army-level artillery Bde, 2 artillery Div Bdes, 1 high Command 8"/240-mm mortar Bde, 1 army-level BM-27 Reg).*

### Summary

As a scenario depicted in the chart "US Versus USSR Firepower," a US heavy division with its usual corps reinforcing Field Artillery is attacked by a Soviet Combined Arms Army, which is in front main-attack formation. Disparity in tubes is the Soviets' 7.8 to our 1, not including rocket launchers. Such ratios are the culmination of a 20-year build up in Soviet artillery strength. Complementing this build up is an aggressive doctrine that stresses achieving fire superiority to help the Soviets maneuver. The modern Soviet Army has learned the artillery lessons of World War II and post-World War II conflicts thoroughly. It now seeks the same margin of firepower superiority as in World War II, but it is far more flexible and capable than its predecessor of 40 years ago. 

Captain John Gordon IV, a frequent contributor to *Field Artillery*, placed second in the US Field Artillery Association's 1987 History Writing Contest with this article. *Army, Military Review* and Naval Institute Proceeding also have published several of his articles. A history major from The Citadel, Charleston, South Carolina, Captain Gordon just completed his masters in International Relations at Saint Mary's University, San Antonio, Texas. He has served as a Gunnery Department instructor, Field Artillery School, and a battery commander, both at Fort Sill, Oklahoma, and Chief of Marketing Branch, 5th Recruiting Brigade, Fort Sam Houston, Texas. He's currently enroute to the Republic of Korea.

# Fire the Prep:

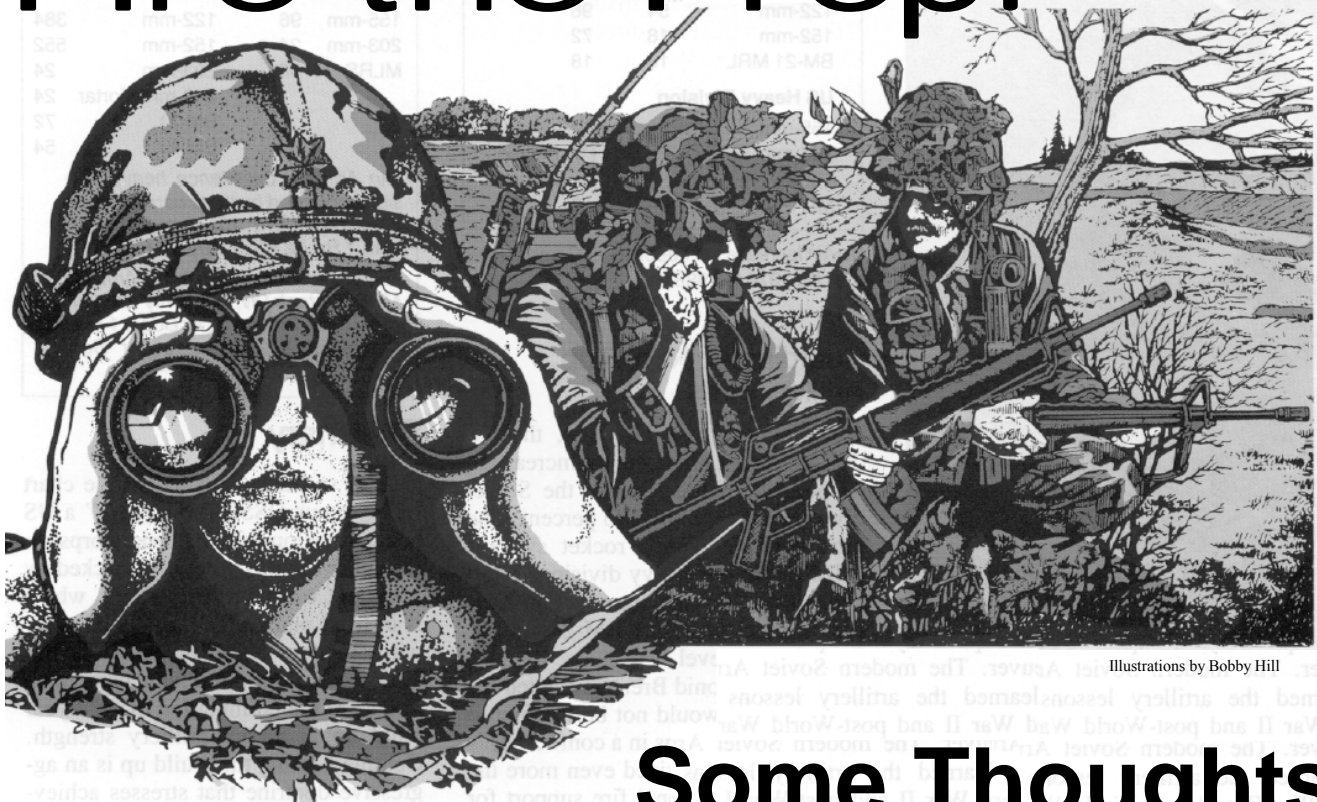

Illustrations by Bobby Hill

## Some Thoughts About Direct Support

---

by Colonels R.S. Ballagh, Jr., Floyd J. (Buck) Walters, IN, and Leonard D. Miller

---

*The company fire support officer (FSO) awoke to the low rumble of incoming rounds in the predawn light. He scrambled to his observation post adjacent to the team commander's command post and raised his glasses to observe his sector for the expected attack. Suddenly across the Fulda Valley, he saw an advancing regiment in column formation. He scurried to call for his preplanned fires to slow the formation; when they came two minutes later, he was informed that only one battery was in position instead of the two batteries and the mortars he had expected. In addition, the fires fell behind the attacking columns.*

*Almost too late, he noticed the scouts had failed to close the gap in the anti-tank obstacle; the responsible infantry squads were nowhere in sight. He called for his preplanned family of scatterable mines (FASCAM) field, but its arrival two minutes later was more than 500 meters from the gap. As he tried to input a correction to the fire direction center (FDC) on his digital message device (DMD), the team commander withdrew, and the fire support team (FIST) was left alone to watch the attackers roll through the barrier at the gap and in several other breaches not covered by effective fires.*

*As enemy soldiers closed on his position, he regretted not having confirmed the precise location of the obstacles and not calculating time-distance factors to attack the moving columns. Although his supported team fought well, the lack of effective artillery contributed to the position's being overrun and the eventual loss of the team.*



**H**istorically, Field Artillery has played an important role on the battlefield. In earlier times, the firepower of artillery created the conditions for infantry and cavalry successes. In this century, the mobility of the massed firepower of artillery has provided commanders with their most responsive combat power. Working in concert with Infantry, Armor and air power, modern Field Artillery contributed significantly to tactical success in World Wars I and II, Korea and Vietnam.

More recently, the role of Field Artillery as the "greatest killer on the battlefield" has been challenged, in part because of its performance at the National Training Center (NTC). In spite of technological improvements to increase the effectiveness of fires, artillery appears to be less effective. Technology has led to increased range and lethality, as well as timeliness and accuracy of fires. Yet NTC results suggest indirect fires do not kill an appropriate share of the enemy nor add proportionally to the combined effects of direct-fire systems and terrain enhancement.

Some Redlegs criticize the methods used by the NTC to assess artillery effectiveness; others blame doctrinal shortcomings. Although all areas can improve, closer analysis reveals fires too often are neither planned nor executed in concert with the task-force commander's concept.

Fire plans often are made only on maps and not confirmed by reconnaissance.



Observers fail to anticipate the tempo of battle and call for fires too early or late. Batteries are sometimes out of position when their firepower is needed most. Fire direction officers (FDOs) sometimes don't place enough volume of fire on a target to affect it, don't recognize high-pay-off targets or just simply don't know what's happening. The list of reasons for failure is endless, but the issues raised at the NTC challenge Field Artillery's ability to deliver tactically effective fires.

Critics of Field Artillery's contribution to the battle at the NTC are painting with a wide brush. Certainly a number of battalions have performed with distinction. Analysis of their performance, particularly those less successful, is instructive. Where artillery battalions have contributed significantly to the outcome, their performances inevitably reflected the truly complementary nature of fire support and scheme of maneuver. Fires were delivered at times and places considered critical by task-force commanders with devastating effect on the opposing forces (OPFOR). The key to success is the execution of doctrine using technical systems.

There are "glitches" in both doctrine and credit for artillery kills at the NTC. But these are not the reasons the artillery fire support system doesn't work. Not training to implement the doctrine and not expeditiously "fixing" problems on the spot are the reasons it doesn't work. This article offers views about achieving a better balance between the technical aspects of artillery delivery and the tactical application of its effects.

Some thoughts about doctrine and the NTC environment are appropriate. The doctrine for fighting found in *FMs 71-1 The Tank and Mechanized Infantry and Company Team* and *71-2 The Tank and Mechanized Infantry Battalion Task Force* is sound. These field manuals, developed jointly by Forts Knox and Benning, are excellent and contain a good balance of doctrine and

---

**Field Artillery's nearly total concentration on technical proficiency works against excellence in tactical proficiency.**

---

"how-to." They also spell out clearly the requirements for fire support. *FM 6-20 Fire Support in Combined Arms Operations* adequately elaborates fire support doctrine. The battalion training management system (BTMS) and the Army training and evaluation program (ARTEP) provide both maneuver forces and the Field Artillery effective training vehicles. We should not abandon these systems.

The NTC provides conditions we can't replicate at home stations—conditions that approach those of actual combat and often produce that feeling in the participants. While the tasks and standards are sound and remain the same regardless of training environment, the demanding conditions of the NTC amplify shortfalls in operations, readiness and training that may not be apparent in a more benign home-station environment.

## Commanders Set the Tone

Improving fire support requires some adjustments in our environment.

### What Commanders Can Do to Improve Fire Support

- Choose the best for fire support duties.
- Stabilize the team.
- Enhance relationships with maneuver units.
- Train from the top down, training as we'll fight.
- Develop soldiers tactically.

The tone set by commanders determines the focus battalions apply to the mission of fire support. The nearly total concentration of Field Artillery on technical proficiency in delivering fires and nuclear rounds works against excellence in the equally important tactical aspects. Symptoms of this imbalance include the way we assign people to fire support organizations, the status (or lack of it) given to fire supporters and the disproportional share of energy spent on technical delivery (gunnery) and nuclear weapons training compared to fire support training. Direct support battalion and division artillery (Div Arty) commanders can take fairly simple measures to give fire support a priority equal to that of nuclear and gunnery tasks.

## Choose the Best for Fire Support Duties

Fire supporters must be seen as important members of the battalion. The brigade FSO should be a major, even if only two majors are assigned to the direct support battalion. If only one major is in the battalion, the FSO should be a very senior captain who can hold his own with the executive officer, S3 and the headquarters and headquarters battery (HHB) commander, as well as with the supported brigade S3 and commander. The brigade FSO should, at a minimum, be rated by the direct support battalion commander and senior rated by the Div Arty commander. On occasion, the maneuver brigade commander may want to be the intermediate rater. Any other scheme makes the brigade FSO somebody else's assistant, not the direct support battalion commander's.

From this it follows that good captains should be the battalion FSOs. If lieutenants must be chosen for this job, they should be the very best available. The company FSO job should be a competitive one that good lieutenants seek; seniority and experience are not necessarily prerequisites. However, fire support jobs can't be a hiding place for a battalion's least effective officers.

On the noncommissioned side, we should give the brigade and battalion senior fire support sergeants the "green tab" responsibilities and support they deserve. They are, in reality, platoon sergeants and should perform that role. To reinforce this point, we should give all fire support sergeants the title "fire support section leader," which entitles them to wear the green tabs they deserve. Reinforcing their leadership role also clearly establishes their training responsibilities.

### Stabilize the Team

Another step toward enhanced fire support is for commanders to stabilize internal relationships and organizations. Continually reorganizing the FISTs to meet perceived requirements destroys essential team building and cohesion. We should view FISTs as we view our howitzer sections, where stability, working relationships and responsibility for equipment are essential to combat effectiveness. The brigade FSO, not the HHB commander, establishes clear command lines and the roles of others by setting priorities for

---

**We should give the brigade and battalion senior fire support sergeants the "green tab" responsibilities and support they deserve.**

---

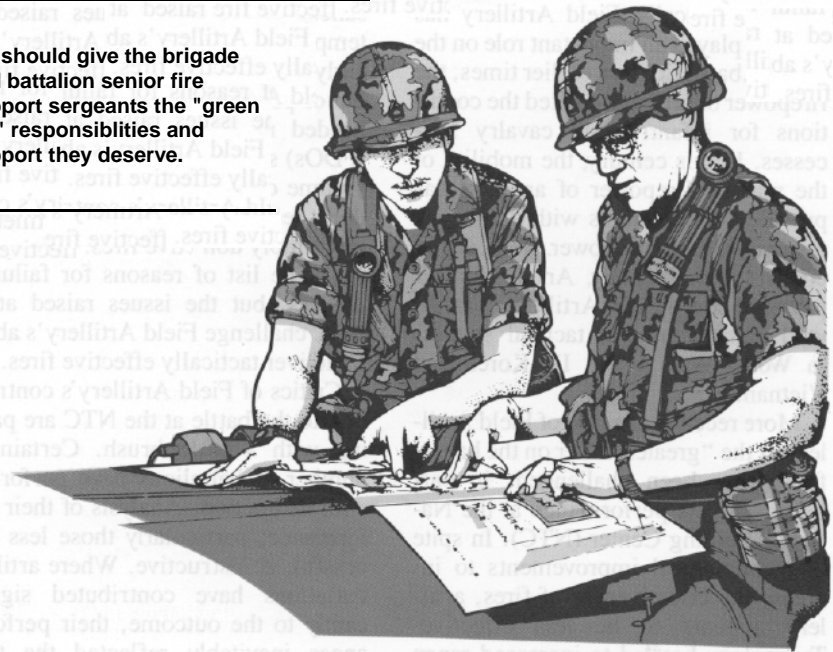

training and assigning personnel. Fire supporters are not a convenient "detail platoon" that serves at the mercy of non-essential requirements and receives a disproportionate share of major additional duties. Lots of people will work to undo efforts to provide organizational stability and enhancement—including senior fire support sergeants, first sergeants, S3s and HHB commanders—for perceived reasons that don't hold up when reviewed critically.

Battalion commanders have to protect fire supporters since Field Artillery has developed a contrary institutional view over the past several years. Direct support battalion commanders also need the support of Div Arty commanders in recognizing the importance of their mission and understanding the many competing demands.

### Enhance Relationships with Maneuver Units

The direct support battalion commander and his FSOs need to develop good working relationships with the supported maneuver brigade, battalion and company commanders. The brigade commander needs to be comfortable with and confident that Field Artillery can support his mission with timely and accurate fires—his major interest is the success of the brigade and its task forces on the battlefield! But he doesn't have the knowledge, resources

or time to train Field Artillery in the technical and tactical delivery of fires.

The Field Artillery commander and his FSOs apply artillery tactics and techniques to provide the required support. The direct support battalion commander must be oriented toward this aim. This doesn't mean he degrades his battalion's technical ability to deliver fires; on the contrary, he must continue to maintain high gunnery standards. The difference is that he harnesses the delivery of fires and focuses them to support the brigade commander's intent and scheme of maneuver. In the changing environment of the battlefield (or at the NTC), he must be prepared to support that intent when chaos develops or communications is lost.

### Train from the Top Down

The commander needs to adjust training too. He sets both the priorities and the tactical and technical standards of proficiency, allocates resources and follows up to ensure proper execution.

**Share the Training Responsibilities.** By dividing responsibilities between the brigade FSO, the S3, the executive officer, the battery commanders and the command sergeant major, the commander will be able to train successfully. He should give the brigade FSO responsibility for training the fire support sections to standards.

Dividing functions between FSOs and NCOs further simplifies training.

Some specific training points are—

- Officers should be experts in infantry and armor tactics. A reasonable goal is for FSOs to be good enough tacticians to be critical of their supported commander's plans and of the methods used to transmit those plans. They also need to be experts on all indirect delivery systems, including air.

- Officers can help train supported commanders and staffs in the fundamentals of fire support. They also can help train both soldiers for Expert Infantry Badge testing and platoon leaders in observed fire procedures.

- Officers and NCOs must share some responsibilities. Both must be experts in observed fire procedures and be able to train subordinates to shoot. Observed fire training done to tough standards under the supervision of qualified leaders will make procedures second nature to shooters. They should use the training set fire observation (TSFO) frequently with leaders present.

- Officers and NCOs need to be expert land navigators—not only to locate themselves on the battlefield, but also to locate targets accurately.



- NCOs must be responsible for the individual training of their soldiers and for the collective training of the sections. They also perform their traditional functions of enforcing field discipline, supervising maintenance and conducting common skills training.

**Be Selective About Field Training.**

Another element in the training equation is to be selective about going to the field with supported units. Too much emphasis on building better relationships with supported units by participating in every field training event often degrades fire support proficiency. Tank gunnery and mechanized infantry squad courses are classic examples of training events that are counterproductive to fire support training. In weapons and crew proficiency training, supported company and battalion

**The company FSO job should be a competitive one that good lieutenants seek.**

**Commander's Checklist of Questions for Battalion FSOs During Combined-Arms Training**

- Where does the FSO spend his time: with the task force commander, by himself or checking on his company-team FSOs?
  - Is he with the task-force commander during critical events?
  - Does he know what the critical events are?
- Does he really understand the task-force commander's concept of the operation and intent? (Make him brief it in detail.)
  - Does his fire plan support the concept of operation?
  - Has he ensured company FSOs understand priorities and confirmed they understand the overall concept?
- Has he issued clear instructions to the mortar platoon leader?
  - Does he plan for the movement of mortars to support the concept?
  - Is it in enough detail to be executed easily? (An execution matrix with preplanned positions is essential; the mortars must be in position to support the battle at critical times.)
- Has he coordinated the positioning of Field Artillery batteries?
- Does he know where supporting fire units are, where they will be and what their capabilities are?
- Has he integrated air support into the indirect-fire plan?
  - Does his use of air assets make sense?
  - Has he considered alternatives if aircraft can't fly?
- Are his planned fires adequate, but not excessive?
  - Is the number of targets reasonable for the battalion FDC to process and for fire units to shoot?
  - Does his fire support execution matrix make sense?
- Has he ensured the brigade FSO and the artillery battalion S3 understand his task-force commander's priorities?

commanders teach (and learn) their branch-particular skills; they have neither the knowledge nor the time to train fire supporters. If fire supporters go to the field indiscriminately, Field Artillery isn't accepting its full responsibility to train its people. Time can be spent better in the TSFO and in classes to achieve the needed proficiencies.

**Train as We'll Fight.** The key to effective tactical field training is combined-arms training under conditions that approach those found in combat. Doctrinally, combined arms means company-team or task-force level. For the fire supporters, company-team and task-force training provide the only opportunities to practice those elements of planning and coordination essential for success in combat. The team and task-force ARTEP evaluations and the exercises leading to them become focal points for the direct support battalion commander and the brigade FSO.

While in the field, fire supporters practice the habits essential to winning, including land navigation, terrain sketching, cleaning weapons and maintaining equipment. FSOs at all levels must plan their own internal training

objectives to complement task-force and team training objectives.

**Be There to Send the Right Signals.** As the brigade commander trains the task forces and company teams, the direct support battalion commander can help train his FISTs. His presence in the field with the brigade commander and his visits to his fire supporters will reinforce battalion training priorities. Realistically, he can't spend all of his time at maneuver tactical training since he is also responsible for the technical proficiency of his battalion. But he should spend enough time to send the right signals to his subordinates.

**Integrate FDCs in Combined-Arms Training.** Another aspect of training successfully for fire support is to integrate FDCs into combined-arms exercises. This is especially crucial with the tactical fire direction system (TACFIRE). Battalion S3s and FDCs must practice handling and processing target lists and executing fire plans under simulated combat conditions. The FDCs provide the critical link to the guns; too often they are left out of fire support training because of the need to practice gunnery. Training gunnery skills in a sterile environment doesn't train FDOs in setting priorities or developing finely tuned ears to keep up with the battle as it unfolds. This unfolding may be in accordance with the maneuver commander's plan and intent, or radical changes may have to be made.

FDCs are saturated, in reality overloaded, with fire requests and information during NTC rotations and will be during combat. FDOs must train to cope with that overload. Incorporating FDCs in the equation for the first time during combat will lead to disaster.

Opportunities for integrating training include simple tie-ins with the TSFO; off-set, live-fire shooting during force-on-force training; command post exercises; combined-arms, live-fire exercises and large maneuvers such as return of forces to Germany (REFORGER). We should exploit all exercises to direct the energy of the battalion toward tactically supportive, timely and accurate fires.

## Develop Your Soldiers Tactically

Commanders must establish an environment to train the traits of technical

### Commander's Checklist of Questions for Company-Team FSOs During Tactical Exercises

<p><input type="checkbox"/> Does the FSO know his precise location and those of his forward observers (FOs)?</p> <p style="padding-left: 20px;"><input type="checkbox"/> Where is he: with the team commander or by himself?</p> <p style="padding-left: 20px;"><input type="checkbox"/> Does he know when he should be with the commander?</p> <p><input type="checkbox"/> Does he have communications with the FDCs of supporting Field Artillery units or mortars?</p> <p><input type="checkbox"/> Does he know where the firing units are?</p> <p><input type="checkbox"/> Has he conducted a reconnaissance with the team commander?</p> <p><input type="checkbox"/> Does he thoroughly understand the commander's concept? (Have him brief it.)</p> <p><input type="checkbox"/> Does his fire plan support the concept?</p> <p><input type="checkbox"/> Has he physically coordinated with the supporting engineers to construct obstacles?</p>	<p><input type="checkbox"/> Does he know the patrol plan, and has he coordinated fires for it?</p> <p><input type="checkbox"/> Has he planned FASCAM to cover gaps in the obstacle plan?</p> <p><input type="checkbox"/> Does he have a terrain sketch (normally prepared by the FIST sergeant but checked and verified by the FSO)?</p> <p><input type="checkbox"/> Has he done his own analysis of METT-T to formulate his plan of execution?</p> <p><input type="checkbox"/> Has he issued a field order to the members of his team to spell out specific responsibilities for execution?</p> <p><input type="checkbox"/> Are his calls for fire timely?</p> <p><input type="checkbox"/> Has he designated a chain of succession?</p> <p><input type="checkbox"/> Do his principal subordinates understand the concept of operation?</p> <p><input type="checkbox"/> Does he have a plan for training his team during lulls in the battle?</p>
---	---

---

**Observed fire training done to tough standards under the supervision of qualified officers and NCOs will make procedures second nature to shooters.**

---

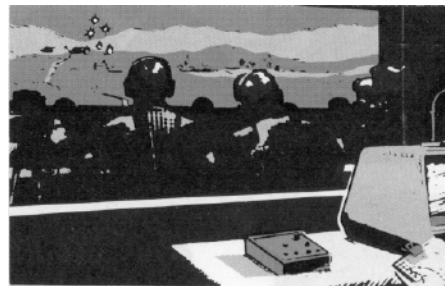

competence, leadership and decisiveness. They also must teach soldiers to develop and apply artillery tactics and techniques to accomplish the mission. Although some of our suggestions have yet to be incorporated in Field Artillery field manuals, they're of proven value.

**Teach Soldiers Combined-Arms Doctrine.** Field artillerymen need to understand more completely how Armor and Infantry fight. The best "fire support" manuals are FM 71-1 and FM 71-2, which need to be as commonplace in the direct support battalion as FM 6-20 and *FM 6-30 Observed Fire*

*Procedures.* To understand the flow of battle and the critical points for which fires must be planned leads to better fire plans and execution. It also allows commanders to position their batteries to ensure maximum support at critical points when they need it.

Artillerymen with well-developed knowledge of combined-arms doctrine plan fewer but more critical fires. They have learned to walk the ground with supported commanders to ensure the accurate location of planned fires, especially in the defense. They more fully understand properly integrated fires



---

**We should view FISTs as we view howitzer sections, where stability, working relationships and responsibility for equipment are essential to combat effectiveness.**

---

enemy, terrain, troops available and time (METT-T) and troop-leading procedures become the basis for planning and executing fires. Not only are these well-established methods, but also their use coincides with the considerations of maneuver commanders.

Commanders, FSOs and S3s can incorporate execution matrices into techniques for planning fires and positioning and moving batteries. To disseminate orders to subordinate commanders, reinforcing artillery and the Div Arty, they can use overlay orders, complete with execution matrices and battery position areas, logistics release

and develop standing operating procedures (SOPs) jointly with the brigades, battalions and teams supported to achieve that end.

**Use Combined-Arms Techniques.** There are also some specific techniques that direct support battalions can use to enhance their ability to support. The time-tested tools of mission,

points, combat and field trains locations, ammunition transfer and supply points, etc. These, combined with good internal SOPs, permit the battalion to support the battle more easily.

Field Artillery commanders should concentrate on developing their concept of operation to ensure subordinates clearly understand their contribution to the battle. The "Field Artillery Support Plan," as outlined in FM 6-20, does not work well at the battalion level; commanders should replace it with a Field Artillery operations plan or order in the five-paragraph format. Plans are just that—ORDERS are to be executed.

Direct support battalion commanders also need to learn how to divide the battalion tactical operations center (TOC)—with all the implications that has for TACFIRE—to be well forward and to stay with the battle. Communications with the FIST and FSOs demands forward positioning of the battalion FDC and TOC; the maneuver brigade TOC is too far to the rear in the actual battle for the battalion TOC to be able to collocate with it.

## Conclusion

Field Artillery remains an effective killer on the modern battlefield. Technology has made the delivery of fires easier and more lethal. But it is the human element that must ensure the full integration of those fires to achieve the right outcomes. We offer these thoughts as a way for direct support commanders to move toward that goal.



***The company FSO noticed the slowly rising dust cloud from moving columns just as the first rounds of the enemy's preparation landed. Having taken care to calculate time and distance factors, he called for his first intensive fires and alerted the FDC to be ready with subsequent targets. The first volleys from the battalion landed just as the main body reached the team's target reference point; the attackers, confused by the intense fire, slowed and appeared a little disorganized.***

**As the last of the task force's scout platoons cleared the obstacle, the FSO called for his allocated FASCAM. The mines effectively closed the gap, and he shifted fires to destroy the dismounted enemy infantry trying to breach the obstacle. When the attackers halted to clear a path, accurate fires sealed the flanks and rear of the enemy while the company team destroyed it with their tanks and tube-launched, optically tracked, wire-guided missiles (TOWs).**

**As the company team withdrew successfully to its next position, he confirmed the locations of his planned fires and of the obstacles, confident that he would continue to contribute significantly to his supported team's success.** 

Colonel R.S. Ballagh, Jr. commanded a direct support battalion of the 5th Infantry Division (Mechanized), Fort Polk, Louisiana, from July 1982 to December 1984. He led his battalion in support of the 2d Brigade, 5th Infantry Division, on two NTC rotations and during REFORGER 84 and is slated to take command of the 5th Division Artillery this month.

Colonel (P) Floyd J. (Buck) Walters, Infantry, commanded the 2d Brigade, 5th Infantry Division (Mechanized), from February 1983 to June 1985. During his tenure, he led his brigade and its supporting units on three rotations to the NTC and on REFORGER 84.

Colonel Leonard D. Miller commanded the 5th Infantry Division Artillery from October 1983 to February 1986. During his command, he led his division artillery on REFORGER 84 and evaluated his battalion's six NTC rotations.

## *View from the Blockhouse*

---

FROM THE SCHOOL

### **TSFO Operator Training**

During the past few months there have been field inquiries about the training set fire observation (TSFO) operator training. Although there is no formal operator's course, there are two solutions for increasing the numbers of trained operators.

Upon request, Fort Sill's TSFO manager will conduct a five-day training course at Fort Sill. (Units can schedule operators for the course by calling the Gunnery Department operations officer at AUTOVON 639-5625 or commercial (405) 351-5625.) The other option is self-paced instruction using the *Instructor's Utilization Handbook* (Part No. 14/002/0002) and the *Command Post and Observation Post (CPOP) Artillery Program Manual* (Part No. 14/001/0070B Part 1), both of which come with the TSFO system.

The instruction given by Fort Sill's TSFO manager takes about 40 hours, and the optimum class size is six people. The class, taken from the two manuals, covers all aspects of TSFO programming, operations and maintenance.

The instructor's handbook covers hardware description, formatting and copying software, indirect fire procedures and systems checks. It also discusses the capabilities and limitations of the TSFO.

The CPOP manual deals strictly with the conduct of fire missions. It explains the TSFO start and stop procedures, battery and gun selections, target and sheaf selections and adjust fire procedures. It explains how to incorporate meteorological

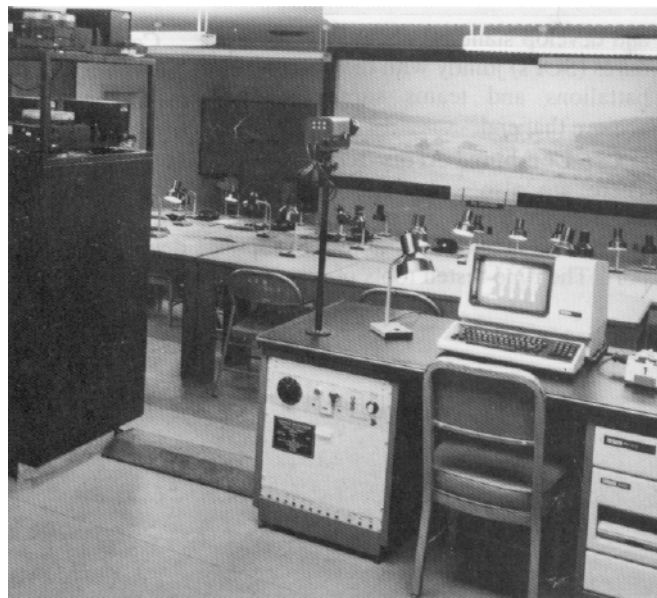

reports into firing data and how to use moving targets. All operators need to be familiar with these materials.

If you don't have these manuals with your TSFO, contact the Gunnery Department TSFO manager at AUTOVON 639-3085 or commercial (405) 351-3085 or write: Gunnery Department, ATTN: ATSF-G, TSFO Manager, US Army Field Artillery School, Fort Sill, Oklahoma 73503.

## Address Change for Training Materials

Because of a recent reorganization within the US Army Field Artillery School (USAFAS), the address for requesting Field Artillery-related training materials and publications has changed to: Commandant, USAFAS,

ATTN: ATSF-DRF, Fort Sill, Oklahoma 73503-5600. Telephone numbers to request materials are commercial (405) 351-3159 or 2520 or AUTOVON 639-3159 or 2520.

## GTA SAFETY HAZARD

The United States Army Field Artillery School (USAFAS) has received a number of comments from students taking Army correspondence course program subcourses about the poor quality of the range deflection protractor (RDP)—GTA 6-5-2 (5) — contained in subcourse *FA 4000-9 Fire Direction Kit*. The Field Artillery School and the Institute for Professional Development, Fort Eustis, Virginia, are exploring ways to resolve the problem.

In the meantime, students will continue to receive the graphic training aid (GTA) and must use the following expedients to complete the course work successfully.

**CAUTION: Students are not to use the GTA or the expedients for field training or live-fire exercises. They are to use them ONLY to complete course work.**

The first expedient deals with the problem of the vertex (or groove) at the zero end of the range scale. Some samples have the groove cut too deeply, causing all ranges to be short; others have the opposite problem. To correct this, glue

a piece of plastic cut from the RDP over the vertex. Using grid lines on the chart, bore a hole through this plastic patch exactly "1,000 meters" from the 10 graduation on the range scale. Be sure the hole is aligned with the left-hand edge of the range scale, otherwise azimuth and deflection readings will be off.

The second expedient resolves the inconsistently printed graduations along the range scale, again causing a range error. To fix this, measure the range between grid lines on the firing chart. Determine an average correction from these measurements and apply the correction to all ranges determined in correspondence course work.

If a student receives a sample of such poor quality that he can't use it after trying the above solutions, he should contact the Commandant, US Army Field Artillery School, ATTN: ATSF-DTD (Mr. Fogg), Fort Sill, Oklahoma 73503-5600, AUTOVON 639-6101 or commercial (405) 351-6101 to arrange for replacement.

**Do not use this GTA for any live-fire exercise.** Commanders must ensure personnel do not use this item when constructing any chart for field training.

## Military Officer Qualification Standards (MQS)

MQS, a series of manuals, is part of the Armywide officer professional development (OPD) system and applies to all active and reserve component officers. A guide for the educational and professional development of officers, it provides a standardized training program for officers from precommissioning through either the 10th year of service or promotion to major.

MQS has three levels: MQS I for precommissioning, MQS II for lieutenants and MQS III for captains. Each level builds on the skills and knowledge of the preceding one. Currently, the Field Artillery School is fielding the first two MQS II manuals: *STP 6-13EII-MQS, Field Artillery, 13E—Cannon* and *STP 6-13CHII-MQS, 13C—Heavy Missile*. The last MQS II manual, *13B/13D—Light Missile/Target Acquisition*, is scheduled for fielding in the second quarter of FY 89. The Army school system, the commander and the officer share responsibility for implementing MQS; however, each officer is accountable for individual performance.

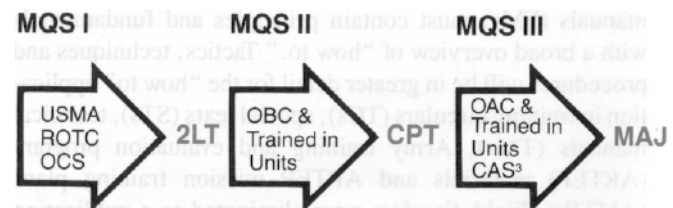

Implemented in 1987, MQS resulted from a study conducted during the 1970s: The Review of Education and Training of Officers (RETO). The study's purpose was to develop officer education and training requirements by examining Army missions and individual career needs. It found the Army had no common training curriculum for military skills, nor were officer qualifications defined precisely at any level. RETO also found that self-study was not encouraged, and those who were motivated, did so without guidance. Therefore, RETO developed MQS to cure these shortcomings.

Each of the three levels of MQS has two elements: *military skills* and *professional military education* (PME). Military skills are those tasks an officer needs to know to perform his duties now or in the immediate future. The second element provides a program to develop judgment, knowledge and conceptual skills.

MQS I, precommissioning, standardizes a branch-immaterial curriculum each future lieutenant must acquire, and it applies to all commissioning sources. Each cadet learns basic soldiering skills and receives the foundation for increasing leadership and job responsibilities throughout his career. The PME requires a cadet earn a bachelor's degree with courses in human behavior, written communications and military history. Officers commissioned through officer candidate school (OCS) may defer these educational requirements initially but must complete them by their 10th year of service or before promotion to major.

MQS II begins at commissioning and follows the lieutenant until enrollment in the officers advanced course (OAC) or promotion to captain. It standardizes branch training and continues his professional development. MQS II has three different types of tasks: common, branch and shared. (The latter tasks apply to more than one branch but are not common across the Army.) The Training and Doctrine Command published a common-task manual and a commander or supervisor's guide.

When officially approved, MQS III will address the officer's fourth through 10th year of service. It begins after promotion to captain or enrollment in OAC. OAC, which includes most MQS III tasks, teaches the skills to command a battery and work on a battalion- or

brigade-level staff. After OAC, some MQS III training will continue in the unit to help prepare the captain to attend the Combined Arms and Services Staff School (CAS<sup>3</sup>). MQS III is currently scheduled for implementation in FY 90.

In MQS II and III, the PME consists of directed reading programs. The goals are to acquaint officers with some of the standard works of their profession, develop an appreciation of military ideas and increase their understanding of the military's impact on world affairs. The four categories within the reading program are military classics, contemporary military, military ethics and the officer's branch.

Though there will be no Army-wide MQS testing or certification, commanders can develop certifications for their own programs. MQS is a tool to help the officer and his commander identify and correct weaknesses, so commanders and supervisors shouldn't indicate substandard performance of MQS tasks on the officer efficiency report (OER). Training and Doctrine Command (TRADOC) Regulation 351-12 MQS System: Products, Policy and Procedures stresses that commanders use MQS manuals only as professional development tools and training guides.

MQS places the responsibility where it belongs—on the officer. It provides him a comprehensive list of the critical tasks he needs to perform to survive and win on the battlefield.

For more information about MQS, write the Commandant, US Army Field Artillery School, ATTN: ATSF-DTD, Fort Sill, Oklahoma 73503-5000 or call the Directorate of Training and Doctrine at AUTOVON 639-4050 or 3420 or commercial (405) 351-4050 or 3420.

---

## Reconfiguration of Field Artillery Publications

In accordance with Training and Doctrine Command (TRADOC) guidance to reduce the number of manuals in the Army, the Field Artillery School has combined some manuals and deleted others entirely. One change is that field manuals (FMs) must contain principles and fundamentals with a broad overview of "how to." Tactics, techniques and procedures will be in greater detail for the "how to" application in training circulars (TCs), special texts (STs), technical manuals (TMs), Army training and evaluation program (ARTEP) materials and ARTEP mission training plans (AMTPs). Field circulars were eliminated as a publication medium; however, the FCs in the current inventory will remain valid until superseded, rescinded or expired.

The status of the new 6-20 series FMs is as follows:

- FM 6-20 *Fire Support in the AirLand Battle*, our capstone manual, is projected for pinpoint distribution in July 1988.
- FM 6-20-30 *Fire Support at Corps and Division* is in the coordinating draft stage. A writing team, composed of personnel of the different corps and divisions, collected input from the field in January. The FM has gone to other service schools and to the Combined Arms Center (CAC)

for comment. Although the projected fielding date is the fourth quarter of FY 89, a final draft will be sent to the field as interim doctrine in the third quarter of FY 88. Similarly, all other 6-20 series drafts will be distributed to the field as interim doctrine, once approved.

- FM 6-20-40 *Fire Support in Brigade Operations (Heavy)* and FM 6-20-50 *Fire Support in Brigade Operations (Light)* are being revised based on comments from the field and from other service schools. Final approval from CAC is expected this month, with a fielding date scheduled for late 1988 or early 1989.

- FM 6-20-1 *Field Artillery Battalion* is being revised to incorporate FM 6-20-1J. A coordinating draft of this FM will be sent to the field for comment the fourth quarter of FY 88. The projected fielding date is the second quarter of FY 89.

- FM 6-20-2 *Division Artillery, Field Artillery Brigade and Corps Artillery Headquarters* is being revised to incorporate FM 6-20-2J. A coordinating draft of this FM will be distributed late FY 88 or early FY 89. The projected fielding date is in FY 89.

The following are training circulars with proposed fielding

**Field Artillery**



dates in FY 88:

- TC 6-11 *The Pershing II Firing Battery*
- TC 6-40 *Field Artillery Cannon Gunnery*
- TC 6-50 *The Field Artillery Cannon Battery*
- TC 6-60 *Multiple Launch Rocket System (MLRS) Operations*

Printing funds available at TRADOC will dictate when these publications become available through pinpoint distribution. The Field Artillery School is making every effort to speed up fielding these doctrinal publications. Once approved, a manual will be sent to the field as

interim doctrine. However, budget constraints will limit the number of copies for distribution. Units may reproduce these manuals as required.

If units have questions about the publications, they can call the Doctrinal Management Branch, Directorate of Training and Doctrine, at AUTOVON 639-4225 or 4240 or commercial (405) 351-4225 or 4240. After hours, call the 24-hour Redleg Hotline at AUTOVON 639-4020 or commercial (405) 351-4020. Units also can write the Commandant, US Army Field Artillery School, ATTN: ATSF-DD, Fort Sill, Oklahoma 73503-5600.

### Reconfiguration of Field Artillery Publications

Number	Title	Proposed	Number	Title	Proposed
FM 6-1	TACFIRE Operations .....	TC 6-40	FM 6-161	Field Artillery Radar Systems.....	TC 6-161
FM 6-2	Field Artillery Survey.....	TC 6-2	TM 6-230	Logarithmic Tables.....	TM 6-230
ST 6-2-20	AirLand Battle Survey Operations.....	TC 6-2	TM 6-231	Seven-Place Logarithmic Tables .....	TM 6-231
FM 6-11	Pershing II Firing Battery .....	TC 6-11	FM 6-300	Army Ephemeris .....	TM 6-300
FM 6-12	Field Artillery Battalion Command, Pershing.....	TC 6-12	FC 6-1-2	The Gun Display Unit (GDU).....	TC 6-50
FM 6-15	Field Artillery Meteorology.....	TC 6-15	FC 6-1-3	TACFIRE Battalion SOP.....	ST 6-1-3
FM 6-16	Tables for Artillery Meteorology (Electronic).....	TM 6-16	FC 6-1-4	TACFIRE Division Artillery, Corps SOP .....	" "
FM 6-16-1	Tables for Artillery Meteorology (Sound Ranging).....	" "	FC 6-20-10	Fire Support Targeting .....	TC 6-20-10/34-118
FM 6-16-2	Tables for Artillery Meteorology (Visual).....	" "	FC 6-20-20	Fire Support Handbook.....	FM 6-20-40/-50
FM 6-16-3	Tables for Artillery Meteorology (Electronic and Visual).....	" "	FC 6-30-20	The Linked Observer .....	ST 6-30-30
FM 6-20	Fire Support in the AirLand Battle.....	FM 6-20	FC 6-34-10	The Targeting Process .....	TC 6-20-10/34-118
FM 6-20-1	Field Artillery Cannon Battalion .....	FM 6-20-1	FC 6-40-2	Battery Computer System (BCS) Job Aids .....	TC 6-40
FM 6-20-1J	Field Artillery Battalion .....	" "	FC 6-40-31	Backup Computer System (BUCS) Cannon Job Aid.....	" "
FM 6-20-2	Division Artillery, Field Artillery Brigade and Field Artillery Section (Corps).....	FM 6-20-2	FC 6-40-32	BUCS Lance Applications .....	TC 6-40-4
FM 6-20-2J	Division Artillery, Field Artillery Brigade and Corps Artillery Headquarters and Headquarters Battery.....	" "	FC 6-40-33	BUCS Survey Applications .....	TC 6-2
FM 6-20-30	Fire Support in Corps and Division Operations.....	FM 6-20-30	FC 6-42-101	Lance Planning Ranges .....	TC 6-42
FM 6-20-40	Fire Support in Brigade Operations (Heavy).....	FM 6-20-40	FC 6-50-3	Cannon-Delivered Chemical Munitions .....	TC 6-50
FM 6-20-50	Fire Support in Brigade Operations (Light) .....	FM 6-20-50	FC 6-50-16	M90 Chronograph.....	" "
FM 6-30	Observed Fire Procedures.....	TC 6-30	FC 6-50-19	Field Artillery Cannon Weapons Systems and Ammunition.....	ST 6-50-19
FM 6-40	Field Artillery Cannon Gunnery .....	TC 6-40	FC 6-50-20	Battery Executive Officer's Handbook .....	ST 6-50-20
FM 6-40-4	Field Artillery Lance Gunnery .....	TC 6-40-4	FC 6-60	MLRS Operations .....	TC 6-60
FM 6-40-6	Field Artillery Automated Gunnery.....	TC 6-40	FC 6-60-20	MLRS Battalion Operations .....	" "
FM 6-42	Field Artillery Lance Battalion.....	TC 6-42	FC 6-121-2	Visibility Diagrams .....	TC 6-30
FM 6-42-1	Field Artillery Lance Battalion (C) .....	TC 6-42-1	TC 6-1-2	Battery Computer System (BCS).....	Delete
FM 6-50	Field Artillery Cannon Battery.....	TC 6-50	TC 6-20-5	Family of Scatterable Mines (FASCAM) .....	FM 6-20-30/-40/-50
FM 6-60	Multiple Launch Rocket System (MLRS) Operations .....	TC 6-60	<b>Publications Under Development</b>		
TC 6-71	Fire Support Handbook for the Maneuver Commander.....	New	ST 6-2-20	AirLand Battle Survey Operations	
FM 6-121	Field Artillery Target Acquisition .....	TC 6-121	ST 6-121-3	Target Acquisition for the Light Divisions	
FM 6-122	Field Artillery Sound and Flash Ranging.....	Delete	TC 6-UAV	Unmanned Aerial Vehicle (UAV)	
FM 6-141-1	Field Artillery Target Analysis and Weapons Employment .....	TM 6-141-1	ST 6-30-30	Copperhead Firing Procedures	
FM 6-141-2	Field Artillery Target Analysis and Weapons Employment (C).....	TM 6-141-2	ST 6-30-40	Employment of the Aerial Fire Support Team (AFST)	
			ST 6-2-XX*	BUCS Astro Module	
			ST 6-50-60	M109A3E2 Howitzer Improvement Program (HIP) Howitzer	
			ST 6-11-10	Pershing Leader's Handbook	

\*Number not assigned yet

## New M40 Protective Mask

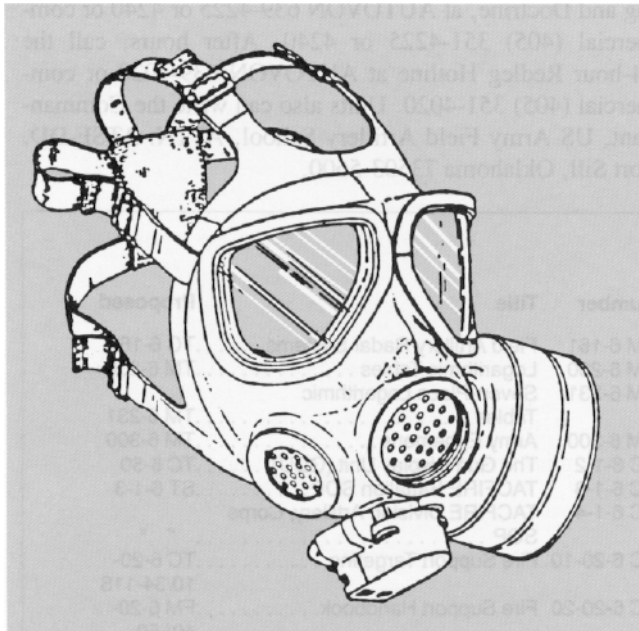

M40 Protective Mask

In the near future, the new M40 protective mask will replace the M17 series protective mask. The face piece is open-molded to allow for quick donning. Also, the mask has a quick-don pull tab to help in putting it on.

The eye lenses are similar to those on the M17 series. However, new optical insert frames will allow a greater field of vision (as compared to those used in the M17 series protective mask) and will provide a bifocal capability.

The wearer can screw the filter canister on the left or right side, as desired. It has a "NATO" thread that allows easy, rapid interchangeability with other NATO-approved filter canisters and contains a particulate filter and charcoal for removing agent vapors and aerosols.

A front voice meter allows face-to-face communications while additional side voice meters allow for telephone or radio communications. Soldiers can drink from an attached tube with the mask on.

The M40 can convert easily into a special-purpose protective mask, used by emergency ordnance disposal (EOD) personnel by adding components and changing the hood. This configuration is the replacement for the M9 and M9A1 special-purpose protective mask. Accompanying the mask is a new carrier with a velcro fastener that permits rapid removal of the mask from the carrier.

The M40 protective mask does have limitations, however. It can't protect soldiers from carbon monoxide and ammonia, nor is it effective in confined spaces with little or no oxygen.

---

## Intra-Theater Transfers Result in Longer Overseas Tours

Redlegs serving overseas who have an Intra-Theater Transfer (ITT) may have to serve longer overseas tours. Changes to policies affecting soldiers who transfer within the theater are part of Department of Defense (DOD) and Department of the Army (DA) initiatives to cut annual permanent change of station (PCS) costs and stabilize tour lengths for soldiers.

While policy changes affect all soldiers who receive entitlements in conjunction with an ITT, impact is primarily on soldiers serving in US Army, Europe (USAREUR), where ITTs are common due to geographical dispersion of units.

Before an ITT can be approved, new guidelines require soldiers to complete a "prescribed overseas tour" (usually 36 months) in the *old* location and to agree to complete a prescribed overseas tour at the *new* location. In USAREUR, the commander of the 1st Personnel Command may waive one year from either or both tours, resulting in an overseas tour of at least 48 months for soldiers who transfer within the theater.

Some soldiers have expressed concern over the impact of longer tours on their professional development. Personnel officials advise that soldiers who extend their overseas tours could help themselves professionally, depending on the assignment. In most cases, soldiers are encouraged to extend their overseas tours. AR 614-30 Overseas Assignments has detailed information on overseas tours.

---

## Field Artillery Restructures Survey Sections

The proposed restructure of artillery survey sections could affect corps artillery and division artillery (Div Arty) headquarters. At these levels, the survey platoon headquarters and survey information center (SIC) would combine into a command and control cell, now referred to as the survey planning and coordination element (SPCE). At the Div Arty and Field Artillery (FA) battalion levels, a standard survey section would consist of a headquarters, two position and azimuth determining system (PADS) teams and one conventional survey team. This new

structure is called 2 x 7 survey.

The Chief of Field Artillery, Major General Raphael J. Hallada, and the Combined Arms Center, Fort Leavenworth, Kansas, have approved the survey restructure. During the Army of Excellence Update this month, the survey restructure will be presented to the Chief of Staff of the Army for approval. If approved, the Field Artillery School will revise the tables of organization and equipment (TOEs) to reflect the restructure by the first quarter of FY 89. After the TOEs have been revised, it will take approximately

two years to implement the changes in the field.

The Div Arty SPCE would be manned by a survey officer (captain), a chief surveyor (sergeant first class), a survey computer (sergeant) and two FA surveyors. The survey officer and chief surveyor plan and coordinate the survey mission and supervise the execution of surveys. The chief surveyor and his driver would help the survey team perform conventional survey when needed. The SPCE must collect, evaluate and disseminate survey information.

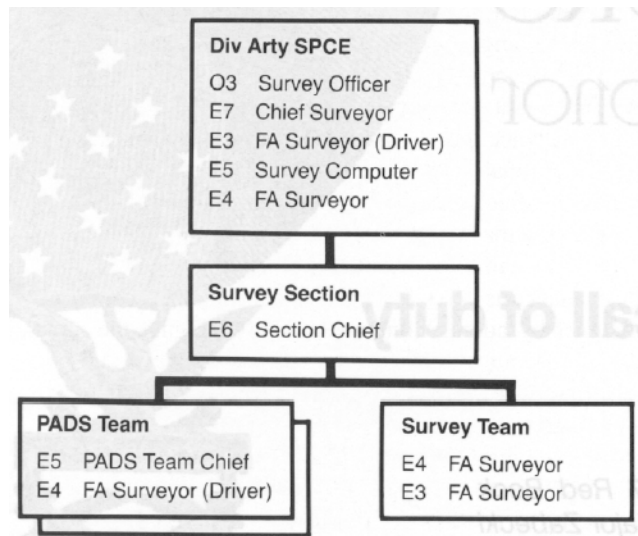

The 2 x 7 standard survey section would consist of a survey section chief (staff sergeant), one survey team and two PADS teams. The survey team would consist of two FA surveyors (specialist four and private first class), assisted by the survey section chief. The team would perform conventional and modified surveys to enhance the entire survey effort. The PADS team would consist of a PADS team chief (sergeant) and an FA surveyor (private first class) and provide the primary survey control.

The survey restructure depends on two pieces of equipment: the PADS and the survey electronic distance measuring equipment—medium range (SEDME-MR). Until these items are fully fielded, the conventional five-man survey team will continue to conduct the primary survey.

The Target Acquisition Department, US Army Field Artillery School, has developed a special text—*ST 6-2-20 AirLand Battle Survey Operations*—which supplements Appendix G (titled Pending Restructure of the Survey Section) of *FM 6-2 Field Artillery Survey*. The ST redefines accuracy requirements, describes how conventional survey teams and PADS teams work together, explains several revised survey methods and provides guidance on how to accomplish and sustain survey operations during continuous land combat.

The ST describes how the conventional survey team adds flexibility to the survey section and enhances survey operations. Planning the establishment and recovery of update-points with the conventional team overcomes the seven-hour, 55-kilometer operating radius limitations of the PADS. The time and distance traveled to return and

locate a final update-point degrades mission accuracy. Not having to return to the initial update-point reduces PADS' mission time, which means better and faster surveys.

If PADS can't occupy a survey control point (SCP), the conventional survey team can establish one that is accessible. Although the PADS team could do this, the PADS would sit idle while the point is surveyed.

Direction (azimuth) is the most critical element for firing units and target acquisition assets. The survey team can establish direction quickly whenever the PADS teams are busy with other missions. If the PADS team is not available, the survey team can place firing units and target acquisition elements on a common azimuth, rapidly using simultaneous observation (SIMO).

To accomplish the survey mission in the FA battalion, surveyors must use all available technology to the fullest. Proper use of the survey section is imperative in an AirLand Battle environment. The section chief must use the PADS teams and the survey teams as a single unit. Their combined efforts must accomplish the total mission in the minimum time.

The ST explains several modified survey methods the survey team may use to determine survey data rapidly. For example, you can use one- and two-point resection when existing control is available but the point is inaccessible (i.e., water, tower, churches, etc.). Although the preferred method to establish control from such points is still three-point resection, it is often difficult to locate three visible SCPs from one point. These modified methods allow the surveyor to get control from only one or two SCPs.

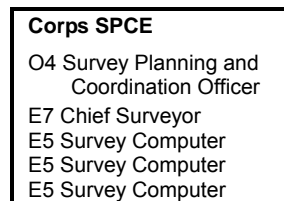

The ST covers several other methods of determining survey data rapidly and gives examples of the backup computer system (BUCS) computations of each method along with figures and instructions.

A chapter on higher-echelon survey operations describes the survey functions at corps, FA brigades, Div Arty and the corps topographic survey unit. It also includes the duties of the corps survey planning and coordination officer, schematics of a corps survey plan and the importance of coordination throughout the survey hierarchy.

The ST 6-2-20 is being mailed to every FA battalion this month. If units have questions, call the Survey Division, Target Acquisition Department, Field Artillery School, Fort Sill, Oklahoma 73503 at AUTOVON 639-6616 or 2805, or commercial (405) 351-6616 or 2805.

# Redleg Leathernecks and the Medal of Honor

**...above and beyond the call of duty.**

by Major David T. Zabecki, USAR

*This is a companion piece to the December 1987 Red Book article, "American Artillery and the Medal of Honor." Major Zabecki defines "Artillery" as by branch, by assignment (predominantly or when winning the Medal) or by performing traditional artillery tasks when winning the Medal. In keeping with the scope of the previous article, this one focuses on land-based artillery: field, coastal and air defense.*

**T**hough no Marines won the Medal of Honor for fighting in artillery actions on land during the Civil War, 11 won the Medal while serving on gun crews on Navy ships. Among these was Corporal John F. Mackie, the first Marine to win the Medal of Honor, who was a gun captain on the *USS Galena* during the action off Fort Darling, along the James River in Virginia, in May 1862. Interestingly enough, 11 sailors during the Civil War won the Medal while serving on gun crews on land. For example, at the battle of Natural Bridge, Florida, in 1865, four seamen from the *USS Magnolia* and two from the *USS Hendrick Hudson* won the Medal while serving "with the Army in charge of Naval howitzers during the attack."

## Vera Cruz

The first Medal of Honor won during a Marine Corps Field Artillery action came during the fighting at Vera Cruz in 1914,

but it was won by a Naval officer. Lieutenant John Grady won his Medal of Honor during the second day of the fight while he commanded the artillery of the landing force's 2d Marine Regiment.

Navy Lieutenant Jonas H. Ingram also won the Medal of Honor while in command of guns on the shore. He commanded the artillery of the landing force's seaman battalion from the *USS Arkansas*. Ingram's Medal of Honor came at the beginning of a distinguished Naval career. He won the Navy Cross in World War I and was later the head football coach at Annapolis. In 1944, he reached the high point of his career when he became Commander-in-Chief of the US Atlantic Fleet.

## World War II

The first Marine to win the Medal of Honor in a land-based artillery action was a coastal artilleryman. Lieutenant George H. Cannon was battery commander of a

defensive position on Midway Island when it came under heavy fire from two Japanese destroyers on 7 December 1941. Cannon was wounded early by shell fire, but he refused treatment or evacuation until the rest of his men who were wounded by the same round were treated first. He reorganized his command post and directed the return fire until he was removed forcibly. He later died from loss of blood. Cannon's was the only Medal of Honor won in a coastal artillery action.

Two other Marine artillerymen won the Medal of Honor during the course of World War II's island fighting in the Pacific. On Saipan in 1944, Private First Class Harold Agerholm, 10th Marines, single-handedly evacuated 45 casualties under intense enemy fire after a neighboring artillery position was overrun. Three hours into the action, he was killed by sniper fire while attempting to rescue two more wounded Marines. On Okinawa in 1945, 19-year-old

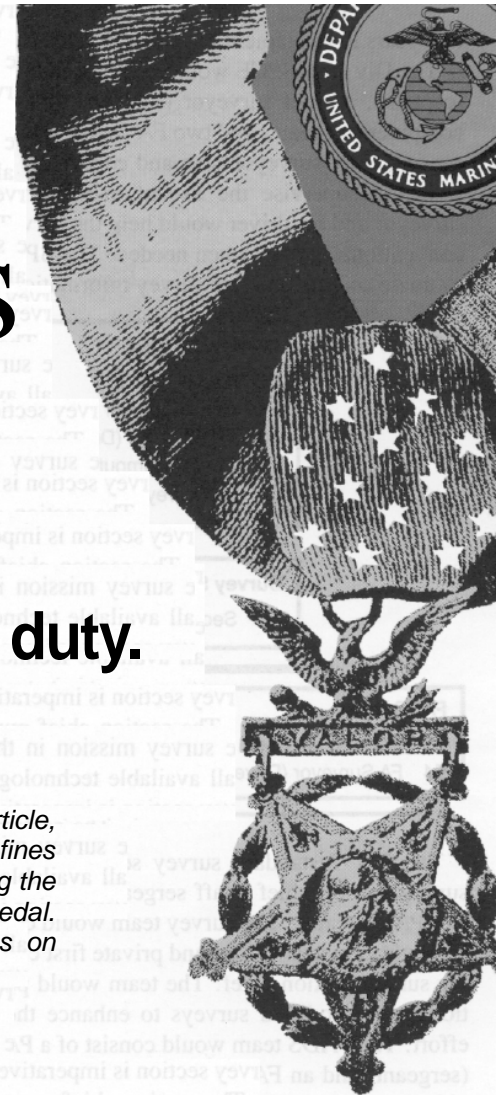



PFC Harold C. Agerholm

Private First Class Harold Gonsalves, an acting reconnaissance sergeant with the 15th Marines, was killed when he smothered a grenade that had landed in the middle of his forward observer (FO) team.

### Korean War

During Korea, America's "forgotten war," Lieutenant Sherrod E. Skinner, 11th Marines, won the Medal of Honor while serving as an FO at "The Hook" in 1952. On a cold October night, Skinner's observation point came under heavy attack as it lay in the center of a major North Korean thrust. He directed the defense of the position for several hours until their ammunition



PFC Harold Gonsalves

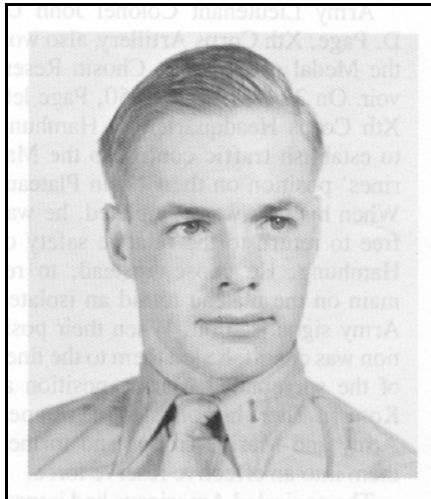

2nd Lt Sherrod E. Skinner



gave out. About to be overrun, Skinner realized they had no chance for anything but passive resistance. He ordered his men to fake death.

The enemy troops entered their bunker and searched their bodies, but Skinner and his men maintained the ruse for the three hours the North Koreans held the position. American forces counterattacked, but as the enemy withdrew, they tossed a grenade into the bunker. It landed between Skinner and two of his men. He threw himself on the grenade, smothering its explosion and saving his men.

Private First Class Herbert Littleton was assigned as a radio-telephone

Name	Rank	Unit	Location & Date
<b>Vera Cruz</b>			
Grady, John	LT	USN/2d Marine Regt**	Vera Cruz 1914
<b>World War II</b>			
Agerholm, Harold C.*	PFC	10th Marines	Saipan 1944
Cannon, George H.*	1st Lt	6th Def Bn	Midway 1941
Gonsalves, Harold*	PFC	15th Marines	Okinawa 1945
<b>Korea</b>			
Johnson, James E.*	Sgt	7th Marines/11th Marines	Chosin Reservoir 1950
Littleton, Herbert*	PFC	7th Marines	Chungchon 1951
Skinner, Sherrod E.*	2nd Lt	11th Marines	Korea 1952
<b>Vietnam</b>			
Barnum, Harvey C.	1st Lt	9th Marines	Ky Phu 1965
Foster, Paul H.*	Sgt	4th Marines/12th Marines	Con Thien 1967
Ray, David R.*	HM2	11th Marines**	Quang Nam 1969
* Posthumous			
** Also listed with US Navy			
*** Mortar Crewman			

operator (RTO) of an FO team attached to the 7th Marines when he won the Medal of Honor at Chunchon in 1951. When his company's position came under a night attack from a numerically superior force, his FO team moved into an exposed position and called in supporting fire. When an enemy grenade was thrown into their position, Littleton saved the other members of the team by smothering the blast with his own body.

Of the 12 Medals of Honor won during the 1st Marine Division's fight at the Chosin Reservoir, one was won by a Marine artilleryman and one by an Army artilleryman. Both fought essentially as infantrymen.



PFC Herbert A. Littleton

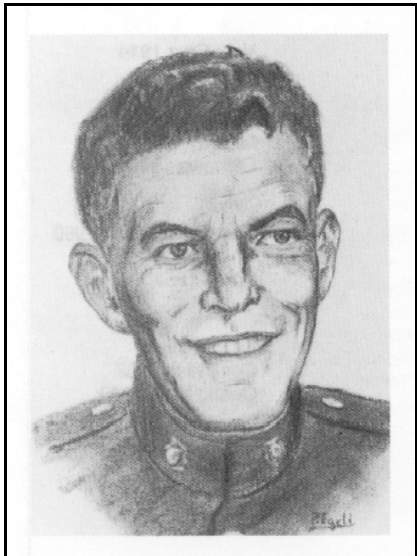

Sgt James E. Johnson

Sergeant James E. Johnson, 11th Marines, fought during the breakout from Chosin as a squad leader in a "provisional platoon composed of artillerymen" attached to the 7th Marines. During the fighting, a superior enemy force wearing uniforms of friendly troops attacked his platoon. Sergeant Johnson assumed command of the platoon in the absence of a designated leader. When the platoon was ordered to displace, he positioned himself to cover the withdrawal. He was last seen, wounded, holding off enemy troops in hand-to-hand fighting. During World War II, Johnson had fought at Peleliu and Okinawa. His father also had served in the 11th Marines during World War I.

Army Lieutenant Colonel John U. D. Page, Xth Corps Artillery, also won the Medal of Honor at Chosin Reservoir. On 29 November 1950, Page left Xth Corps Headquarters at Hamhung to establish traffic control to the Marines' position on the Chosin Plateau. When his task was completed, he was free to return to the relative safety of Hamhung. He chose, instead, to remain on the plateau to aid an isolated Army signal station. When their position was cut off, he led them to the lines of the surrounded Marine position at Koto-ri. There he collected the trapped Army and Marine troops and formed them into an effective reserve force.

The encircled Americans had improvised a landing strip on the frozen ground. It was their only means of evacuating casualties. But the strip extended partially outside the defensive perimeter and was under continuous attack. Twice during North Korean attacks, Page mounted the rear deck of a tank and drove the attackers back with fire from the turret machine gun. Several days later while making an aerial reconnaissance of enemy lines, Page dropped hand grenades into Chinese foxholes and sprayed their positions with his carbine.

The Americans finally succeeded in pushing to the edge of the plateau after 10 days of fighting. Page was flown to Hamhung to coordinate the artillery support for the impending breakout. This completed, he again passed up the opportunity to remain in a relatively safe area and flew back to the beleaguered force's position.

Page joined the rear guard as the breakout column started south. On the night of 10 December, his element of

the column was ambushed at the bottom of a steep pass. Page knew the danger to a stalled column in an ambush. He moved up to the head of the column and launched a one-man assault against the center of the enemy position. His aggressive action completely disoriented the North Koreans and Chinese and rallied the Americans. The column regained its momentum, but Page was mortally wounded.

## Vietnam Conflict

The first artillery Medal of Honor in Vietnam was won by a Marine: Lieutenant Harvey C. Barnum, Jr., an FO in support of the 9th Marines. In December 1965 in Quang Tin Province, Barnum's company was cut off from the rest of the battalion and pinned-down by a heavy Viet Cong force. The initial onslaught was so fierce that the company commander, his RTO and other key company personnel were killed. Barnum removed the radio from the dead RTO and assumed command. Operating as company commander, FO and RTO, he rallied the surviving members of the company and led a counterattack, calling in artillery fire and marking targets for helicopter gun-ships. After clearing the immediate area, he directed the landings of the medevac helicopters and then led the company in the assault on the battalion's objective. All of the Marine artillerymen Medal of Honor winners, with the exception of Navy Lieutenant John Grady at Vera Cruz and Barnum, won

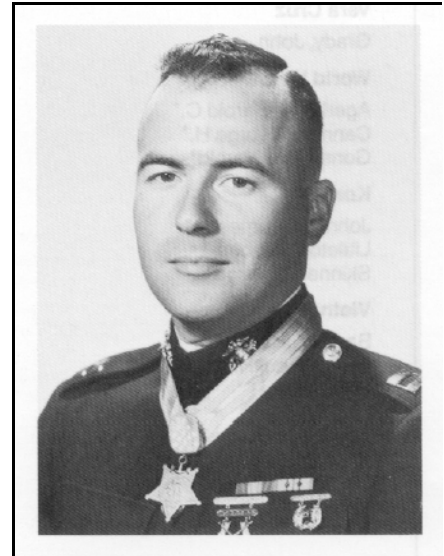

Capt Harvey C. Barnum, Jr.

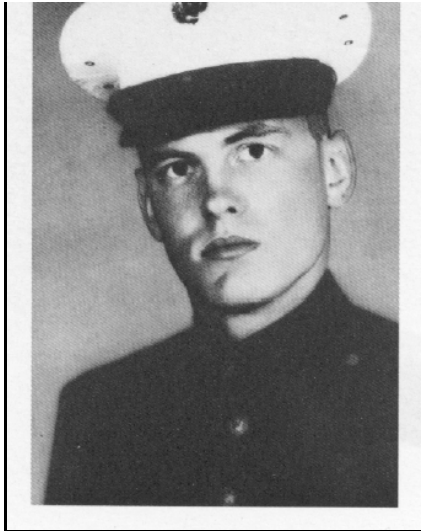

Sgt Paul H. Foster

the Medal posthumously.

Barnum remained a career artilleryman. In 1967, he returned to Vietnam for a second tour. Whether or not it is an official policy, Medal of Honor winners rarely are returned to combat, especially so soon after being decorated. In October 1968, however, Barnum assumed command of a firing battery in the 12th Marines near the demilitarized zone. During that tour of duty, Barnum won two Bronze Stars and a Purple Heart. Now a colonel, Barnum is at Marine Corps Headquarters in Washington, D.C.

The story of Sergeant Paul Foster, 12th Marines, is similar to those of Privates First Class Gonsalves in World War II and Littleton in Korea. In October 1967 near Con Thien, Foster was an FO team chief attached to the 4th Marines when his position came under heavy mortar and artillery fire followed by a ground attack. The enemy penetrated the position and

tossed a grenade close to Foster's position. Foster was wounded severely by the explosion, but he continued to call in friendly artillery fire. When a second grenade was tossed into the observation point, Foster threw himself on it, absorbing the explosion and saving the other members of the team.

Navy Hospital Corpsman 2d Class David R. Ray often is overlooked as a Marine artilleryman, but he won the Medal of Honor while assigned as a battery corpsman in the 2d Battalion, 11th Marines. On the morning of 19 March 1969 in Quang Nam Province, Ray's battery was hit by a battalion-sized force. Ray moved from gun position to gun position, giving medical treatment. He was wounded but refused medical aid and continued his rounds. While he was treating one wounded Marine cannoneer, he was forced to fight off two enemy soldiers who had penetrated the battery's position. He killed one and wounded the other. Weak from loss of blood, he continued to move among the parapets, giving assistance where he could and fighting when he had to. He ran out of ammunition and was wounded again, this time mortally. His last act was to throw himself on a wounded Marine cannoneer, saving the man's life when a nearby grenade exploded.

### The Leatherneck Legacy

In comparing the types of actions for which Marine artillerymen won Medals of Honor to those of Army artillery Medal of Honor winners, one finds little difference. The same scenarios seem to occur over and over again: FOs assuming command in a crisis, wounded leaders refusing to relinquish command, battery personnel defending their positions against tremendous

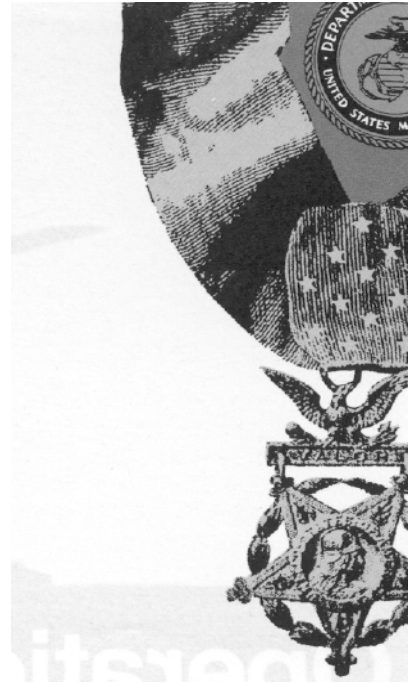

odds and Redlegs fighting as infantrymen when required to do so. The stories of the Medal of Honor winners of our Redleg Leathernecks are an integral part of the legacy of the United States Artillery.



**Major David T. Zabecki, Field Artillery, US Army Reserve (USAR), has written many articles for *Field Artillery* and other publications and serves as Contributing Editor for *Military History*. He extracted this article from his monograph "American Artillery and the Medal of Honor" (Weapons and Warfare Press). Major Zabecki is currently the Targeting Intelligence Officer, USAR Military Intelligence Detachment supporting the NATO Central Army Group in Europe.**

Name	Rank	Ship	Action	Date
Binder, Richard	Sergeant	<i>USS Ticonderoga</i>	Fort Fisher, NC	24-25 Dec 1864
Denig, J. Henry	Sergeant	<i>USS New Ironsides</i>	Fort Fisher	24-25 Dec 1864
Fry, Isaac N.	Orderly Sergeant	<i>USS Ticonderoga</i>	Fort Fisher	13-15 Jan 1864
Hudson, Michael	Sergeant	<i>USS Brooklyn</i>	Mobile Bay, AL	5 Aug 1864
Mackie, John F.*	Corporal	<i>USS Galena</i>	Fort Darling, VA	15 May 1862
Martin, James	Sergeant	<i>USS Richmond</i>	Mobile Bay	5 Aug 1864
Miller, Andrew	Sergeant	<i>USS Richmond</i>	Mobile Bay	5 Aug 1864
Oviatt, Miles M.	Corporal	<i>USS Brooklyn</i>	Mobile Bay	5 Aug 1864
Roantree, James S.	Sergeant	<i>USS Oneida</i>	Mobile Bay	5 Aug 1864
Smith, Willard M.	Corporal	<i>USS Brooklyn</i>	Mobile Bay	5 Aug 1864
Sprowle, David	Orderly Sergeant	<i>USS Richmond</i>	Mobile Bay	5 Aug 1864

\* First Marine to win the Medal of Honor

Marines on Navy Gun Crews Who Won the Medal of Honor

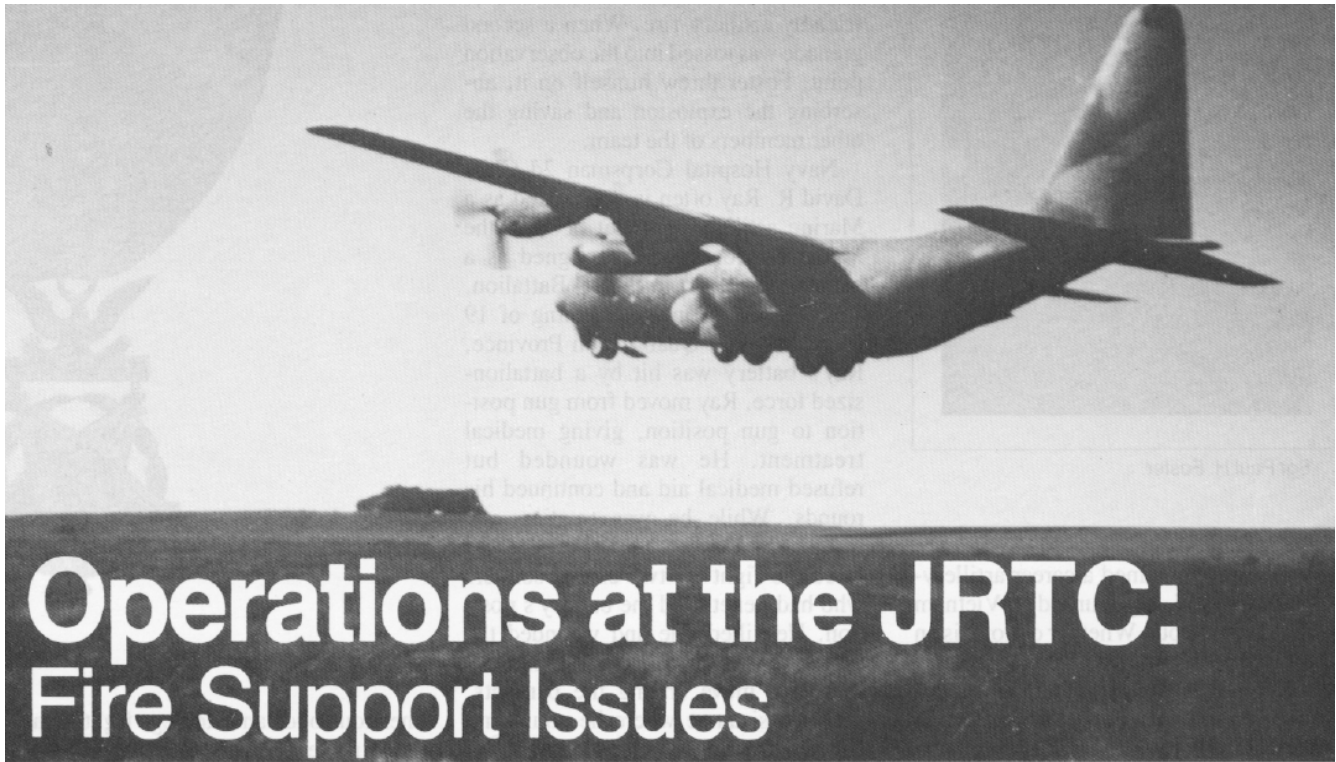

by Captain Robert H. Vokac

**T**he Joint Readiness Training Center (JRTC) at Fort Chaffee, Arkansas, with its headquarters at Little Rock Air Force Base, represents the Army's commitment to light-force excellence. JRTC's objective is "to provide an advanced level of training for Air Force and Army active and reserve component contingency forces in deployment and tactical operations under anticipated conditions of low- to mid-intensity combat." JRTC provides tough, realistic combat training to the Army's light, airborne, air assault and ranger units.

A typical rotation at the JRTC pits a battalion task force against a Soviet-style, surrogate opposing force (OPFOR) in an 11-day, force-on-force scenario. The mission essential task list (METL) provided by the higher headquarters of each rotating unit determines the missions the unit will perform at the JRTC. A representative scenario will include a forced or non-forced entry into the exercise area, search and attack missions, night attacks, movements to contact, infiltration attacks, raids, air assault operations and defense against an armored force.

Each unit—each soldier—performs under greater stress than ever encountered in a battalion-level exercise at home station. A unit's success is not measured by winning or losing, but by being able to synchronize all assets of the task force against a well-trained and disciplined OPFOR. The fire support community plays a critical role in helping the maneuver task-force commander at JRTC.

### Field Artillery Players

The deploying task force usually includes one Field Artillery battery and the fire support team (FIST) and fire support element (FSE) attached to the task force. Each artillery battalion supplements this "package" with a skeletal tactical operation center (TOC) and specialty personnel such as medics, wiremen, surveyors and logisticians.

The Field Artillery soldier must exert maximum effort in every task he performs. He is a player in the most realistic, light-force training available today—facing explosions, smoke, booby traps, air strikes and an OPFOR working around the clock to disrupt his plans and

operations. Adhering to our Army's light-force doctrine is the best way for a unit to prepare for a rotation, a point stressed continually in training at JRTC.

### After-Action Reviews

A total of 92 observer-controllers (OCs), spread throughout the battalion task force, observe each mission. Each OC has specific responsibilities: control the force-on-force fight, observe every facet of the operation and coach and train player-unit personnel. He's an experienced commissioned or noncommissioned officer who is well-versed in the doctrine applicable to his particular position.

Currently, the fire support OC team consists of five permanent personnel. These individuals observe activities in the task-force FSE and firing battery. Additional personnel come from the Field Artillery School on an as-needed basis.

The maneuver observers with each company observe all company-level fire support operations. The feedback provided during field-conducted platoon and company after-action reviews (AARs) is extremely valuable to company





Observer-controller SSG Joseph E. Hacia, Jr. conducts an AAR at the JRTC with part of the 10th Mountain Division (Light Infantry).

fire support officers (FSOs) and FIST members. Also, selected individuals attend the fire support systems and task-force AARs conducted periodically throughout the rotation.

These AARs serve as the critical training link between the unit and JRTC. During the initial JRTC rotations, the AARs identified several fire support issues of interest to company and battalion FSOs.

## Company Fire Support Observations

**Company Fire Support Plans.** *FM 6-20-50 Fire Support for Brigade Operations (Light)* states that "fire support planning is conducted top down." Too often this doctrinal statement is used as an excuse for inadequate company fire support plans. Many company FSOs have a tendency to take the battalion fire support plan and merely execute it. Only the company FSO is fully aware of his company's maneuver plan. To support his maneuver commander, he must develop his own fire plan, considering all aspects of mission, enemy, terrain, troops available and time (METT-T).

Many company commanders simply have an inadequate grasp of the importance of fire support; thus they willingly accept a mediocre fire support plan from the FSOs. Remember, the maneuver commander owns the fire

support plan. The FSO's role is to teach the maneuver commander how to use the available fire support assets properly.

The FSO must consider using mortars, artillery, close air support (CAS) and attack helicopters, when available. The company FSO who develops a fire support plan concurrently with the maneuver plan greatly helps the commander execute his mission. Planning smoke to screen friendly forces or obscure the enemy's vision, planning indirect fire to supplement barriers and obstacles in the company sector, using well-chosen targets to support a company movement to contact and assigning priority of fires to appropriate platoons are all examples of sound fire planning at the company level.

**Employment of 60-mm Mortars.** The company FSO must integrate the 60-mm mortar into his fire support plan completely. Companies habitually do not employ this fire support asset fully. The 60-mm mortar is particularly effective in providing rapid high explosive (HE) and white phosphorous (WP) fires to support initial contacts. Fire support personnel should learn the capabilities and limitations of this system and use it whenever possible in their fire support plan.

**Fire Support Matrices.** The fire support matrix, an excellent tool described in great detail in both *FM 6-20-50* and *FC 6-20-20 Fire Support Handbook*, helps the company FSO depict

his fire support plan. If kept simple, the matrix is understood easily, and fire support as well as maneuver leaders can use it. It must be clear and concise. The matrix can't be a tool that only the fire support community understands. The matrix belongs to the company commander, so the plan must synchronize fires with the scheme of maneuver.

If the matrix is completed properly, a commander and his FSO can review it quickly and determine the degree of synchronization inherent in the plan. The matrix should provide detailed execution instructions for subordinate fire support agencies. This information greatly simplifies the execution of the fire support plan. The matrix must state clearly the commander's priority of fires.

**Rehearsals.** While a fire support matrix depicts the plan, a rehearsal practices it. Fire supporters must rehearse to ensure everyone understands the mission and responsibilities. Ideally, this rehearsal is in conjunction with a maneuver rehearsal. If the commander doesn't understand the plan, he won't use it.

A rehearsal allows fire supporters to check critical issues. Who will initiate the prep before the assault? Which platoon will provide the priority target to support the advance?

Too often units jump into action without rehearsals. A unit tactical standing operating procedure (TACSOP) doesn't replace a rehearsal. I can't overstate the value of rehearsals.



An executive officer prepares to lay his battery at the JRTC.

CPT Robert H. Vokac

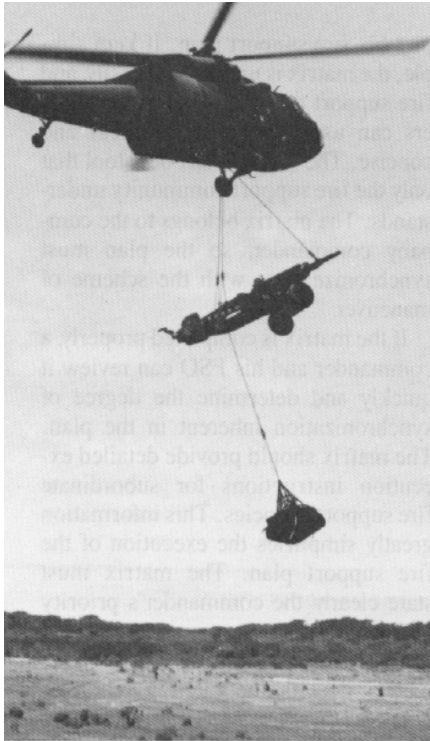

Air assault is an example of a mission requiring detailed coordination with the aviation community.



JRTC performance demonstrates units need rigorous doctrinal training to meet the multiple demands of combat.

## Battalion Fire Support Observations

**Expertise.** "Fire support planning is the continuous process of acquiring and analyzing targets, allocating fire support to targets, scheduling the attack

of targets and synchronizing all available fire support to the collective effort." This quote from FM 6-20-50 is the basis of all fire support planning. The task-force FSO and FSE must keep this statement in mind when planning fire support.

The FSO is the fire support expert for the task force. All FSOs must be able to advise the task-force commander and staff on matters relating to fire support. Most FSOs interact effectively with their maneuver commander and are able to advise him and his staff. The integration of the FSE as a full partner in a maneuver TOC is directly proportional to the relationship the FSO establishes with the commander and his staff.

**Planning and Coordination.** We must develop the fire support plan concurrently with the maneuver plan. This requires the FSO and his FSE to exploit the capabilities and information available from the other staff sections.

Often an FSO will develop a plan based on initial planning guidance and fail to leave enough flexibility to adjust to a changing maneuver plan. A good check is for the FSO to verify continually the congruence of target planning with the S2 and S3 graphics. Is the *current* objective targeted, not the one assumed two hours ago? Has the FSO checked with the S2 to ensure coverage of named and target areas of interest as appropriate? What's the current enemy order of battle and is the unit protected against possible avenues of approach? Are fires provided to cover friendly flanks and facilitate future operations? Are fires targeted to supplement friendly obstacles? Good targeting, though only one part of the fire support plan, is the most critical part.

**Target Acquisition.** Asset allocation is another critical process, and the FSO must plan to use all available assets for target acquisition. While this axiom is familiar from school days at Fort Sill, FSOs should not be afraid to broaden the context of the phrase.

Scouts are an invaluable intelligence and fire support asset. They can provide an accurate location of enemy forces and equipment, allowing the FSO to plan the correct shell and fuze combination to achieve the commander's intent. He must tell the air liaison officer (ALO) that in-flight reporting by friendly aircraft helps ground forces detect and attack enemy forces early. This information is also

extremely valuable to the S2 and S3, so the FSO must pass it along.

Is the FSO using electronic warfare (EW) capabilities? Perhaps by using voice intercept, the FSO can locate and attack an enemy force that has carelessly provided its location in the clear. Does the commander want to use the family of scatterable mines (FASCAM)? At this point, the FSO must coordinate with the engineer officer attached to the task force.

**Employment of FASCAM.** Most Army leaders don't understand how to employ FASCAM. The FASCAM expert is the engineer officer. He uses FASCAM to supplement an obstacle plan during offensive or defensive operations, while the FSO provides the technical expertise on Field Artillery delivery options. Many maneuver commanders have the FSOs advise them on the total use of FASCAM. A good FSO will do his best to provide the information required but will get the task-force engineer involved in the planning process immediately.

**Aviation Integration.** Air assault is an example of a mission requiring detailed coordination with the aviation community. A fire support briefing must occur during the air-mission brief (AMB). Before the air-mission commander or his representative conducts the AMB, the FSO must coordinate closely with other battalion staff sections. Besides the normal coordination with the commander and S3, the FSO also must coordinate closely with the S3 air, ALO and Army aviation liaison officer, if possible. He must avoid the temptation to receive planning guidance from the commander or S3 and then break off into a separate planning cell. The FSO's ability to provide fire support from pickup to landing zones is related directly to his knowledge of the air movement tables and ground tactical plan.

Appendix O of FM 6-20-50 has a checklist to conduct the AMB. This checklist helps the FSO prepare his part of the AMB. The FSO must control all fire support assets involved in an air assault to synchronize their employment with the commander's scheme of maneuver.

The FSO's establishing a "quick-fire" channel will help fire support coordination and execution. All assets must work on this single net. Allowing a forward air controller (FAC), for example, to control CAS on the landing

zone independently is not only doctrinally incorrect, but also potentially dangerous to the air assault force. The FSO must ensure the AMB makes very clear he is in charge of fire support. He must exchange frequencies and call signs with the assault helicopter pilots and determine if the mission will take place on secure nets. If so, he must be sure to synchronize the variables.

A successful technique to facilitate rapid suppressive fires is to plot targets in the vicinity of the aircraft checkpoints. The FSO can reference target numbers against the checkpoints (target 2000 is checkpoint 6, for example). A pilot reporting "small arms fire from vicinity checkpoint 6" will have given critical information to the FSO who has planned targets relative to the checkpoints.

The attack helicopter is a potent weapon. Its use, particularly as a fire support platform, can enhance the battalion's fire support plan immensely. To use this asset effectively, the FSO must integrate and coordinate the use of attack helicopters with other assets available to him. When available as a fire support asset, the attack helicopter is a combat multiplier for the light force.

Because the attack helicopter provides responsive fire support on the battlefield, the FSO must communicate with the pilots when they are operating in his sector. Aircraft operating without the critical communications link won't be able to influence the battle as the commander needs them to. The FSO must clear attack-helicopter fires in his sector. He must control the fires at all times to ensure the highest degree of troop and aircraft safety.

## Additional Tips

**Planning Checklist.** A checklist used by company and battalion FSOs helps the FSO develop his plan during periods of physical and mental stress. Units derive this checklist locally from FM 6-20-50 and FC 6-20-20. A checklist can't be all-inclusive, but it certainly helps the FSO prepare a logical fire support plan. Key fire support leaders are mistake-prone after a period of continuous operations. A checklist or memory aid helps them develop doctrinally sound fire support plans.

**Use of Subordinates.** During periods of continuous operations, using subordinates is critical for leaders to develop effective fire support. Preparing the battalion- and company-level fire support plans must involve the FSO and the fire support sergeant. Leaders must ensure all subordinates are briefed fully on their primary role and the role of the individual one position above them. Fire support plans fail when key individuals become casualties, and their subordinates can't step in and accomplish the mission.

**SEAD.** Suppression of enemy air defense (SEAD) is vital to the success of friendly airstrikes. While a battalion FSO may not be able to plan a doctrinal SEAD because he lacks targeting information, he still can provide protection for strike aircraft. Artillery or mortars fired in and around the target just before the aircraft strike will impose hardships on any surface-to-air weapons systems, particularly man-portable ones operating in the target area.

Close communications with the ALO ensures the FSO fully coordinates fires with the air effort. A well-trained

FSO and ALO can coordinate SEAD fires to protect aircraft before and after they strike the target. This takes total confidence in the capabilities of each system and practice in coordinating them.

**Use of 81-mm Mortars.** The FSO must incorporate the 81-mm mortars in planning at the battalion level. He must establish responsibility for positioning and moving mortars with the commander and S3. Mortars improperly managed will be out of range and unable to support elements in contact. The FSO must help the mortar platoon leader develop his plan of support and work with him closely, particularly during the planning and preparation phases. The mortar platoon is a critical fire support asset, which must maintain a high profile and complement other fire support agencies.

**Preplanned Fires.** The FSO must use preplanned fires whenever possible. Groups and series of targets are particularly effective in combating a force with superior mobility. Groups and series allow friendly forces to rain tremendous destructive force on enemy units at critical times and locations. Identification of "trigger points" to start the various preplanned fires is absolutely essential. The S2 can provide templating information that greatly helps the FSO identify fire support "trigger points."

## Conclusion

JRTC is an outstanding training opportunity available to the light forces; it helps the fire support community practice what it preaches. The tips I present are part of Field Artillery doctrine and familiar to most fire supporters. But JRTC performance demonstrates units need rigorous doctrinal training to meet the multiple demands of combat.



**Captain Robert H. Vokac is a Fire Support Observer-Controller at the JRTC. His previous assignments include serving as a company FSO; battery fire direction officer (FDO), executive officer and commander; and battalion FDO and S1 in his five years with the 2d Battalion, 20th Field Artillery, West Germany. Captain Vokac also served as a battery commander and battalion FSO for the 1st Battalion, 37th Field Artillery (redesignated the 5-11th Field Artillery), supporting the 6th Battalion, 327th Infantry, Fort Wainwright, Alaska.**

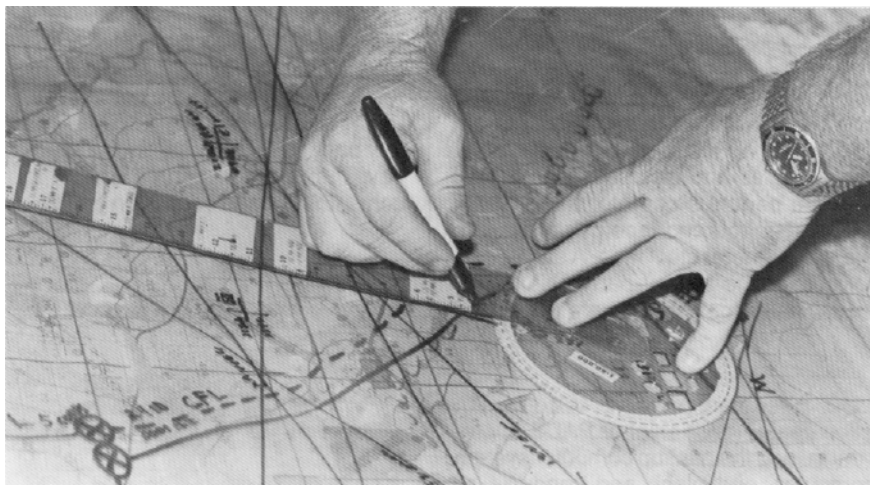

A successful technique to facilitate rapid suppressive fires is to plot targets in the vicinity of the aircraft checkpoints.

# Radar, Survey and Met MOS Career Guide

This article is the last of the three-part series dealing with the duties and career-developing assignments for specific Field Artillery MOSs. It covers the Radar, Survey and Meteorological MOSs.

## MOS &

## Skill level

## Duties

## Typical

## Assignments

### 13R10

A Firefinder Radar Crew Member performs a variety of tasks related to radar operations. He operates and maintains a vehicle (1/4-ton through 5-ton) and helps employ and march order the AN/TPQ-36, AN/TPQ-37, AN/TPQ-25 and AN/TPS-58B. He also performs pre-operational checks, starting and stopping procedures and preventive maintenance checks and services (PMCS) on radar systems.

Target Acquisition battery (TAB) or a separate or light infantry Field Artillery battalion.



### 13R20

After graduating from the primary leadership development course (PLDC), an E-5 becomes the senior radar operator (SRO). He must be able to perform all the skill level 1 tasks plus provide leadership and training for his soldiers. His main duties include supervising radar emplacement and march-order, controlling site defense and performing the section chief's duties in his absence. He should attend the basic NCO course (BNCOC) as soon as possible.

### 13R30

A staff sergeant becomes a section chief and must be able to perform both skill level 1 and 2 tasks plus supervise the activities of his section personnel. His main duties are to develop and control section training, evaluate the radar site after occupation and take command of the radar site in the absence of the radar technician. He should prepare to attend the advanced NCO course (ANCOC) when notified.



### 13R40

A sergeant first class will become the radar platoon sergeant in a radar platoon. He is responsible for training one mortar-locating radar (MLR) and up to six Firefinder radar sections. He controls, coordinates and assigns the radar platoon missions as required and coordinates with other units to ensure all radar sections receive logistics support. He also makes training schedules for the platoon and, if assigned to a TAB, provides a direct link between the battery and platoon.

### 82C10

A Field Artillery Surveyor is an instrument operator, rod and tapeman, assistant position and azimuth determining system (PADS) operator or vehicle driver. An instrument operator measures horizontal and vertical angles and distances with optical and electronic instruments. He performs operator adjustments and PMCS on his equipment. The rod and tapeman measures distances in the field, using the 30-meter steel tape. A surveyor is the driver and radio operator for the survey party chief, chief surveyor or survey officer. He helps the PADS operator run and maintain PADS.

Air Defense Artillery Patriot battalion, target acquisition battery, Field Artillery battalion survey section or a survey information center (SIC) in corps, FA brigade or division artillery.

### 82C20

After graduating from PLDC, a sergeant performs as computer, recorder, survey information center (SIC) chief or PADS operator. He computes survey data using the backup computer system (BUCS), a hand-held computer, and plans and conducts all PADS surveys. In the SIC, he computes all surveys turned into the center. He should attend BNCOC as soon as possible.

**MOS & Skill level**

**Duties**

**Typical Assignments**

**82C30**

A staff sergeant serves as the party chief of the survey section. He must be familiar with methods of survey, be able to teach these methods to his survey party and be prepared to conduct assigned survey missions. The party chief must perform as chief surveyor in his absence. He also modifies and carries out changes to the survey plan, based on the tactical situation. He should prepare to attend ANCOC as soon as possible.

Air Defense Artillery Patriot battalion, target acquisition battery, Field Artillery battalion survey section or a survey information center (SIC) in corps, FA brigade or division artillery.

**82C40**

A sergeant first class is the chief surveyor. He plans for his unit's survey assets and performs all survey officer duties when the survey officer is not available. He trains all artillery surveyors in their primary duties, ensures a cross-training program is in place and oversees SIC operations. The chief surveyor is usually a platoon sergeant in his unit.

**93F10**

A Meteorological Crew Member assembles, disassembles and operates Meteorological (Met) and auxiliary equipment. He measures and records raw Met data and converts the raw data into computer, ballistic and fallout Met messages.

Headquarters and headquarters battery (HHB) of a division artillery or separate Field Artillery battalion.

**93F20**

After graduating from PLDC, a sergeant operates the OL-192 computer when processing Met data. He provides technical guidance on operating Met equipment and applying Met data processing techniques and trains his subordinates in advanced Met data acquisition and evaluation procedures. He performs organizational maintenance on section Met equipment and supervises operator maintenance. He should attend BNCOC as soon as possible.



**93F30**

A staff sergeant is a shift supervisor during Met soundings. He provides leadership and technical training to subordinate personnel, performs quality control checks of Met data and inspects and tests section Met equipment. He should prepare to attend ANCOC at the earliest opportunity.

**93F40**

A sergeant first class serves as the Met section chief. He is responsible for the overall operation of the Met section: Met message production, tactical section employment, movement and adherence to safety procedures. He is also responsible for the administrative procedures within the Met section, such as radiosonde flight logs, message production schedules and message dissemination procedures. He coordinates Met support requirements with higher headquarters and adjacent Met sections to ensure designated areas are covered adequately.

**Note:** The 13T Remotely Piloted Vehicle (RPV) MOS remains a non-accession MOS with approximately 50 soldiers. In a joint effort with other services, the Army is developing a family of unmanned aerial vehicles (UAVs), which will have RPV deep-attack capabilities. When the Field Artillery School knows what effect the UAVs will have on 13T soldiers' assignments and duties, *Field Artillery* will provide additional information.

# Redleg News

## ITEMS OF GENERAL INTEREST

### KTD-1, The New Soviet Laser Rangefinder

The Soviets have long recognized the value of lasers for quick, accurate rangefinding. Soviet artillery target acquisition units have employed the rangefinder known as Sage Gloss for

more than 10 years. Descriptions and illustrations of what seems to be a more sophisticated rangefinder called the KTD-1 (*kvantovy dal' nomer-1*) have appeared in the

Soviet military press in the last year or so. The KTD-1 is distinguishable by its twin "spectacles." The right-hand lens transmits and the left receives the laser beam.

The KTD-1 has a transceiver with angle-measuring instruments, a stand, a storage battery and a carrying case. The laser beam is fired at an object and reflected. Since the speed of light is known, it's a simple matter to divide by two the time between transmitting the beam and receiving the reflected light and then to calculate the distance to the object in question.

Besides finding ranges to specific targets, the instrument also can perform rapid general surveys of an area. The receiver senses minute increases in electromagnetic energy as the reflected radiation falls on it. An electronic counter activates when the beam fires and stops when it senses return radiation.

The measured distance, displayed in meters on an indicator panel, can be seen through the sighting tube for four seconds. The rangefinder also can measure horizontal angles from 0 to 360 degrees and vertical angles from + 18 to - 18 degrees.

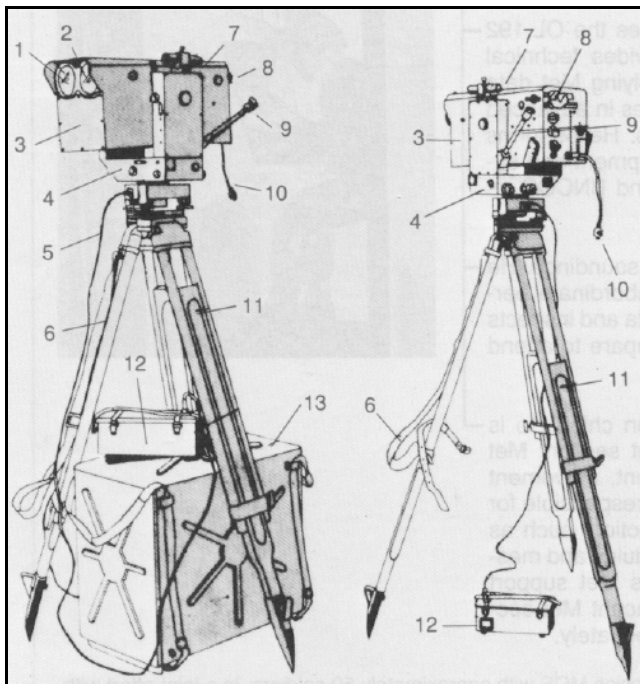

KTD-1, The Newest Soviet Laser Rangefinder: 1 Optical Transmitter, 2 Optical Receiver, 3 Transceiver, 4 Base, 5 Power Cable, 6 Strap, 7 Magnetic Surveying Compass, 8 Sighting Tube, 9 Microscope, 10 "Lase" Button, 11 Tripod, 12 Accumulator Battery, 13 Box

The KTD-1 can measure distances between 100 meters and 10 kilometers. However, two things affect its range: the size and reflectivity of the target. The range to a plywood



A Soviet artillery lieutenant operates the KTD-1 laser rangefinder.

screen two meters<sup>2</sup> in size does not extend beyond two kilometers. It can determine the distance to a tank or automobile, however, out to eight kilometers and a detached building out to more than 15 kilometers. The observer's training and experience are clearly crucial.

The rangefinder incorporates a number of labor-saving devices to help the observer and "cleansing" devices to filter out signal interference. Obviously, there will be other objects in the observer's line of sight close to the beam. A device for "strobing and selecting" the target cuts out interference from other objects either lying in the beam's path or falling into it. There is also a filter in the eyepiece to protect the observer's eye from radiation.

The Soviets expect the KTD-1 to make 5,000 measurements before needing servicing, and the transceiver has a life of 100,000 measurements. The KTD-1, like all Soviet equipment, can operate in extreme climates—from - 40 to + 50 degrees centigrade, in up to 98 percent humidity and at atmospheric pressures down to 460 millimeters of mercury or the equivalent altitude of 4,000 meters above sea level.

One man can carry and operate the instrument, which weighs 23 kilograms. It is not clear whether this includes the batteries. It takes about five minutes to set up the rangefinder. When ordered to measure a distance, the observer presses the "lase" knob and checks the reading on the range indicator. This process takes less than a minute. Measuring angles takes two minutes. These timings are obviously the norms to strive for in training.

The KTD-1 appears to be a robust, reliable but sophisticated piece of equipment. A tripod-mounted version is likely to be employed in artillery target acquisition units, and a vehicle-mounted version may also appear.

*Courtesy of Jane's Defence Weekly,  
26 September 1987, p. 685.*

## Another Soviet Artillery System Goes Self-propelled

The introduction of the self-propelled version of the 82-mm Vasilek automatic mortar was no real surprise to Western

observers. The Soviet magazine, *Red Star*, published a picture of the Vasilek mounted on an MT-LB multipurpose,

tracked vehicle. This picture showed the Vasilek on the rear deck of the MT-LB in a firing position in the rugged foothills of Afghanistan.

The choice of the tracked MT-LB as a firing platform for the Vasilek is consistent with the Soviet practice of using off-the-shelf equipment to cut development costs. This vehicle is used as a weapons platform for the SA-13 surface-to-air missile system and also as a utility vehicle for oil exploration in the Arctic regions of the Soviet Union. An extra-wide track helps make it a good off-road vehicle. The amphibious MT-LB has a boat-shaped hull made of light armor.

The towed version of the Vasilek weighs approximately 2,500 pounds. The Soviets remove the trails and road wheels to mount this weapon on the MT-LB. But how the mortar affixes to the deck of the MT-LB is not clear. It seems to be affixed permanently to the rear of the deck with the mortar barrel facing over the end of the vehicle. Some type of shock absorber probably is built into the MT-LB chassis to absorb the shock of the recoil when the weapon fires.

The Vasilek is an automatic mortar that fires four-round clips with an effective rate-of-fire of 20 to 30 rounds per minute and a cyclic rate-of-fire of 60 to 120 rounds per minute out to 5,000 meters. The Vasilek fires high-explosive, fragmentation and antitank ammunition. Onboard ammunition storage may be able to hold up to 40 clips of four rounds each.

Combining the MT-LB's mobility with the Vasilek's fire power has given the Soviet artillery yet another quick and

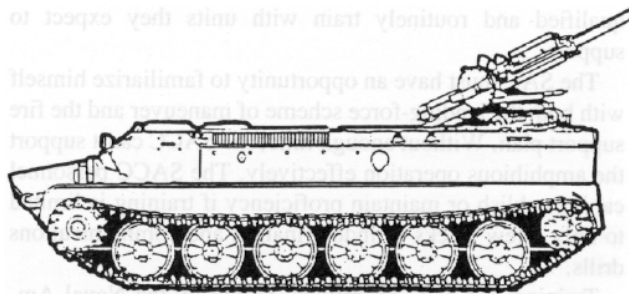

The Soviet 82-mm Vasilek automatic mortar, mounted on the multipurpose MT-LB, is now self-propelled.

mobile weapon system. Although shown in Afghanistan in a two-gun firing battery, it probably will deploy in four- or six-gun batteries. It's unusual that Soviet artillery would have a weapon system below 120-mm in caliber. But this seems to be the case with the self-propelled Vasilek.

The Soviets can learn much in Afghanistan about how this new weapon system works in actual combat. From these lessons learned, an improved self-propelled Vasilek mortar probably will show up within the next few years in the Soviet divisions facing NATO.

Robert R. Hiatt  
*Threat, Combat Developments*  
*Field Artillery School*

## *Fragments*

FROM COMRADES IN ARMS

### **Supporting Arms Coordination Center—The Combined Arms Approach**

The invasion of Grenada on 25 October 1983, achieved its objective of freeing American students with little loss of life or damage to the island. However, the operation did expose shortcomings in supporting arms coordination that we must correct.

During the invasion, anti-aircraft fire destroyed or badly damaged nine helicopters. This loss showed the need for coordinated fire support during the assault phase of an amphibious operation. Moreover, this recent experience has highlighted the requirement for the suppression of enemy air defense (SEAD) by naval gunfire (NGF).

It's no longer feasible to use NGF and air support as two completely separate agencies during amphibious operations. The proliferation of Soviet air defense weapons has made the combined-arms approach to supporting arms coordination the only feasible method for degrading the many enemy air defense systems. We must employ supporting arms effectively to mutually support and enhance the effectiveness of all involved agencies.

Such support is critical to the success of an amphibious operation. However, inexperienced personnel, a lack of training and misconceptions about supporting arms coordination hinder employment of these assets.

During amphibious landings, the operational commander is the Naval amphibious task-force commander. His fire support coordinator (FSCOORD) is the supporting arms coordinator (SAC), and fire support coordination is done in the supporting arms coordination center (SACC). Fire support personnel must be aware of SACC requirements because the landing force (Army or Marine) furnishes people to work in the SACC (as an additional duty). But the landing force does not control supporting arms until "control is passed ashore."

Army units that will be supported by NGF or Navy or Marine air can get observers, controllers and coordination personnel from the air naval gunfire liaison company (ANGLICO). This separate Marine company provides support to US Army and allied units; its personnel are jump

qualified and routinely train with units they expect to support.

The SAC must have an opportunity to familiarize himself with both the landing-force scheme of maneuver and the fire support plan. Without enough time, the SACC can't support the amphibious operation effectively. The SACC personnel can't establish or maintain proficiency if training is limited to only a few weeks of indoctrination and communications drills.

Training in SACC operations, taught by the Naval Amphibious School at both Coronado, California, and Little Creek, Virginia, is mainly for Marine and Naval personnel. However, an Army unit scheduled to conduct a joint exercise with the Navy may request a separate class for its soldiers. Army units also may send soldiers to either school for training on a space-available basis during training for deploying amphibious units.

Efforts are under way to enhance the one-week SACC trainer course by adding an automated tactical trainer exercise to the curriculum. A few SACC personnel also get to conduct live-fire training at Vieques, Puerto Rico, and on supporting arms coordination exercises at San Clemente Island, California. Live-fire exercises, which require coordinating NGF and air support, are irreplaceable. However, they are too infrequent and short to establish the level of proficiency needed for amphibious operations.

The SACC has few opportunities to work with NGF, air support or artillery assets. Live-fire exercises can provide the chance to integrate all three. And through

communications exercises and war-gaming, the SACC can continue to train and develop the techniques necessary for adequate supporting arms coordination.

We must abolish the misconception that supporting arms coordination is simply placing one firing agency into a "check fire" while the next one fires. During amphibious operations, simultaneously employing air and surface-delivered munitions is absolutely necessary for success. This requires extensive coordination we can't achieve using the "check fire" method. Instead, we must use the time-space separation methods to obtain the necessary mutual support.

Sophisticated weapons and stand-off tactics are not the solution to the coordination problems associated with supporting arms, even though they were successful against air defense targets in Libya. They can't fulfill the requirements of situations such as close air support (CAS) and heliborne operations. Again, the damage to nine helicopters by a relatively unsophisticated enemy during the Grenada operation demonstrates too well the fallacy of this position. Only with the coordination and mutual support of all fire support agencies will these missions be successful. Against a well-equipped and trained enemy, the combined-arms approach during the assault phase of an amphibious operation is essential.

M.E. Richmond  
*Capt, USMC*  
*Quantico, VA*

### Supporting Arms Coordination Center

For more information about SACC, contact the Naval Amphibious School, Coronado, San Diego, California 92155-5044, AUTOVON 577-2427 or commercial (619) 437-2427 or the Naval Amphibious

School, Little Creek, ATTN: Code 41, Norfolk, Virginia 23521-5290, AUTOVON 680-7609 or 7635 or commercial (804) 464-7609 or 7635.

## Forward Area Air Defense System

On 8 January 1986, the Army completed its analysis of the shortfall in air defense for forward maneuver elements and provided the Secretary of Defense with a comprehensive forward area air defense system (FAADS) program to overcome this shortfall. The Secretary of Defense approved the program and directed the requirements be incorporated in the FY 87 budget and FY 88-92 program objective memorandum.

A program of integrated systems, FAADS consists of the following components:

- The line-of-sight, forward-heavy system essential to a maneuver division as it travels with and protects the Abrams and Bradley fighting vehicles. Of the four evaluated systems, the air defense antitank system (ADATS) was selected. ADATS is tentatively scheduled to be fielded in 1992.

- A non-line-of-sight system to defeat helicopters and tanks that are masked (over-the-hill) from line-of-sight. Key to this system is the fiber-optic guided missile (FOG-M) that has a missile linked by fiber-optic line to a fire unit ground station. TV video and guidance information pass between the missile seeker and the ground station over the line. The current range of FOG-M is more than 10 kilometers, with planned modifications. Initial fielding is projected for 1992.

- A line-of-sight rear system for air defense in the division and brigade rear areas. In August 1987, the Army awarded a contract to the Boeing Aerospace Company to purchase a pedestal-mounted Stinger (PMS) system to be fielded in 1989. PMS includes eight ready-to-fire missiles for multiple and rapid engagements, a forward-looking infrared (FLIR) sight and an ability to fire on the move. PMS is a 24-hour system capable of operating in adverse weather to





PMS, a Line-of-Sight System for Air Defense in the Brigade and Division Rear Areas

defeat fixed- and rotary-wing aircraft.

- A command, control and intelligence (C<sup>2</sup>I) system to link FAADS together and integrate into the Army tactical command and control system. C<sup>2</sup>I incorporates a family of sensors (ground and airborne, active and passive) with data processing and distribution to provide real-time target cueing for the FAADS weapon systems. The forward area air defense C<sup>2</sup>I system is scheduled to be fielded in 1993.

- Combined-arms weapons improvements: air defense enhancements to main tank gun ammunition, modest sight

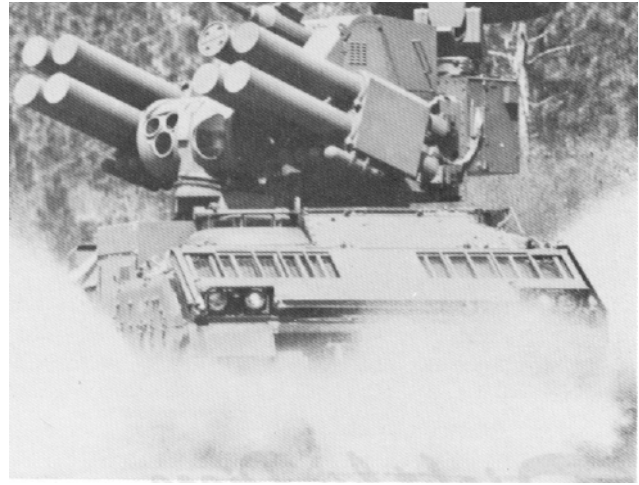

ADATS, a Line-of-Sight Forward-Heavy System that Travels with the Maneuver Division

improvements for the Bradley 25-mm gun systems and the air-to-air Stinger program. The C<sup>2</sup>I system also will have combined-arms weapons.

The FAADS program integrates weapons, sensors and command, control and communications as a system optimized to counter the current and projected air threat to the forward area.

"Speaking with One Voice," Public Affairs Office, Training and Doctrine Command, 22 January 1988.

## Future Artillery Standards—A Step in the Right Direction

Representatives to the Quadrilateral Alliance (United States, United Kingdom, West Germany and Italy) will soon sign a Quadrilateral Ballistics Agreement (QBA). This agreement formalizes the adoption of new standards to apply to extended-range Field Artillery systems, which will be introduced into the four nations' inventories during the next decade. The main standardized characteristics addressed in the QBA are a 52-caliber barrel length (caliber of the weapon times 52) and a 23-liter chamber volume for future 155-mm gun systems. This system with standardized characteristics will complement and possibly replace the current 155-mm weapons with their 39-caliber barrel length and 18.85-liter volume.

The new characteristics will give the projectile a "softer" ride and an increased range of up to 30 kilometers when firing an unassisted high explosive projectile. These projectiles will use a new top charge that produces a muzzle velocity of 920 meters per second. Ranges of 40 kilometers are possible with base-bleed projectiles such as the German Rh49 or the US XM864.

The United Kingdom (UK) originally advocated the 52-caliber, 23-liter formula, which greatly simplifies logistics problems and provides ammunition ballistically matched to the current North Atlantic Treaty Organization (NATO) standard ammunition used by the quadrilateral nations.

The US has built and tested a 52-caliber tube. While there was some opposition to a tube of this specific length, the US now fully supports the quadrilateral development. However, the US Armament, Research, Development and Engineering Center (ARDEC) at Picatinny Arsenal, New Jersey, has been sponsoring a dual-track 39- and 58-caliber advanced armament system (AAS) for the M109 howitzer improvement program (HIP). The XM283/4, 39-caliber cannon HIP conforms to the existing QBA provision, while the XM282 58-caliber cannon development does not. The HIP AAS would answer the US desire to achieve a 50-kilometer range with its new nuclear projectiles and second-generation, base-bleed submunition rounds. However, the HIP AAS and its eventual replacement (the advanced Field Artillery system—AFAS) are now unfunded, which could mean they

may never be integrated into the HIP program,

The US HIP AAS program originated for several reasons: the US quest for a 50-kilometer range, the extent of risk analysis the UK performed and the ability of the 52-caliber design to fire certain charges without exceeding operating pressure limits at temperatures above 32 degrees centigrade. In the same vein, the UK and Germany have reservations about the tactical mobility of a self-propelled howitzer with a 58-caliber tube length that is about a foot longer than the 175-mm M107 gun.

[Regardless of the additional national developments being pursued, the fact that the quadrilateral nations will soon sign and ratify the QBA is a step in the right direction for equipment and ammunition interoperability on the battlefield.]

*Reprinted by permission from International Defense Review, 1/1988, copyright 1988, Interavia S.A., Geneva, Switzerland.*

## ***Right by Piece***

---

### NOTES FROM UNITS

#### **PADS as a Moving Target Simulator**

The 1st Infantry Division Artillery (Div Arty), Fort Riley, Kansas, has developed a situational exercise to train fire support teams to engage moving targets. The Div Arty used the position and azimuth determining system (PADS) as an aid to train the teams. Not restricted to the impact area, Field Artillery units can use PADS to train observers in any training or maneuver rights area.

Processing a fire mission with the fire direction center (FDC) and PADS gives the fire support section a sense of immediacy through instant feedback. The purpose of this training is to teach the observer to select his trigger and aiming points in front of the moving target, based on the target's estimated speed and direction of travel. He then starts an "at my command" mission and commands "fire" when the target reaches the trigger point. The resources needed are a target, vehicle-mounted PADS with radio, a controller with radio (collocated with the fire support team) and a platoon FDC.

To train with PADS, use the following procedure:

- The controller instructs the target vehicle to begin moving on a predetermined path.
- He then gives the fire support team the mission to engage the moving target.
- The observer estimates the speed and direction of travel, selects the trigger and aiming points to engage the moving target and transmits the call for fire as a "fire for effect, at my command" mission.
- The FDC processes the mission and sends "ready." The observer commands "fire" when the target reaches his trigger point.
- The controller radios the target vehicle to stop when he receives "splash." The PADS vehicle stops and reports its grid.

- The controller compares the location of the target (PADS vehicle) with the impact grid.
  - If the rounds would have impacted within 150 meters of the target, then the target was suppressed and the observer successfully accomplished the task.
  - If the rounds would have impacted more than 150 meters away from the target, the controller tells the observer where his round landed and instructs the PADS vehicle to continue on its path. The observer then continues the mission.
- The platoon FDC sends the target grid of subsequent fires for effect to the controller, so he can compare the target and impact grids.

Units can expand the moving target simulation by using multiple targets, moving observers and gun crews. Units also can use this training method for Copperhead missions. Although the fire support team can't designate the target with a ground, vehicular laser locator designator (G/VLLD), it can start the call for fire and measure the target designation time. (A gun crew also should train on this mission to give realistic reaction times.) The PADS vehicle can provide a grid to compare the target location with the Copperhead footprint at the time of impact.

Units don't have to limit fire support training to the classroom or impact area. PADS is an excellent, cost-effective tool for training on realistic moving targets and Copperhead missions—just ask the 1st Infantry Division Artillery.

Peter S. Corpac  
MAJ, FA  
Bde FSO, 4-5 FA

# TOPFORM: 3x8 Tactical Operations

## The 3x8 Battery

by Captain Gary M. Stallings

**T**he unique role of a self-propelled 155-mm howitzer battalion in direct support of an armored or mechanized brigade demands that it provide continuous, accurate fires for maneuver operations while keeping a keen eye on its own vulnerability. To increase the firepower, maneuverability and flexibility of direct support (DS) units, the current TO&E calls for three, eight-gun firing batteries—better known as 3x8. Adding two guns to the existing six-gun batteries did not simply increase support to maneuver, but rather vastly changed the way we do business in DS units.

The move to a 3x8 configuration demanded we develop new battery movement and internal operations plans. In B Battery, 1st Battalion, 22d Field Artillery, 1st Armored Division, West Germany, we produced the tactical oval platoon formation (TOPFORM) to meet that challenge. TOPFORM operations focus on delivering superior fire support to maneuver while maximizing firing battery survivability.

In the 3x8 battery, there are two semi-autonomous, four-gun platoons, each with four ammunition carriers and one fire direction center (FDC). The support elements have become the battery trains—a third element. The battery now moves by tactically repositioning platoons. As one platoon moves, the other continues to shoot. This lets the entire battery move more often and still maintain adequate fire support for maneuver. Reducing the number of vehicles in each position provides not only for quicker displacements, but also for shorter, less obvious convoys. Most importantly, the quicker the platoon leaves a position from which it fired, the better its chances are of surviving.

As the number of moves increases, the number of tubes available for support stays the same. Assuming one platoon from each firing battery is moving, a battalion total of 12 tubes will remain ready to fire. In addition, the battery trains must be moved to ensure continual support of the firing platoons.

Positioning these three elements requires considerably more planning by the battery commander. Tactically, it's best for these elements to be located in three different positions; however, this creates much more of a command and control problem than moving an entire battery from one location to another. Also, it is impossible for the battery commander to scout every position, observe all occupations, conduct the administrative actions needed to sustain the battle and be in both platoons, continually providing command leadership.

## The Challenges

Therefore, Field Artillery must find ways to meet the new challenges created by the 3x8 structure. We must realign some of the duties and responsibilities of the senior leadership within the battery to maintain adequate command and control. With personnel split among three locations, the number of soldiers available for guard shifts at each site is reduced drastically; therefore, we have to adopt a new battery defense plan.

The rapid movement of firing platoons raises the need for a quick, controlled method to resupply ammunition

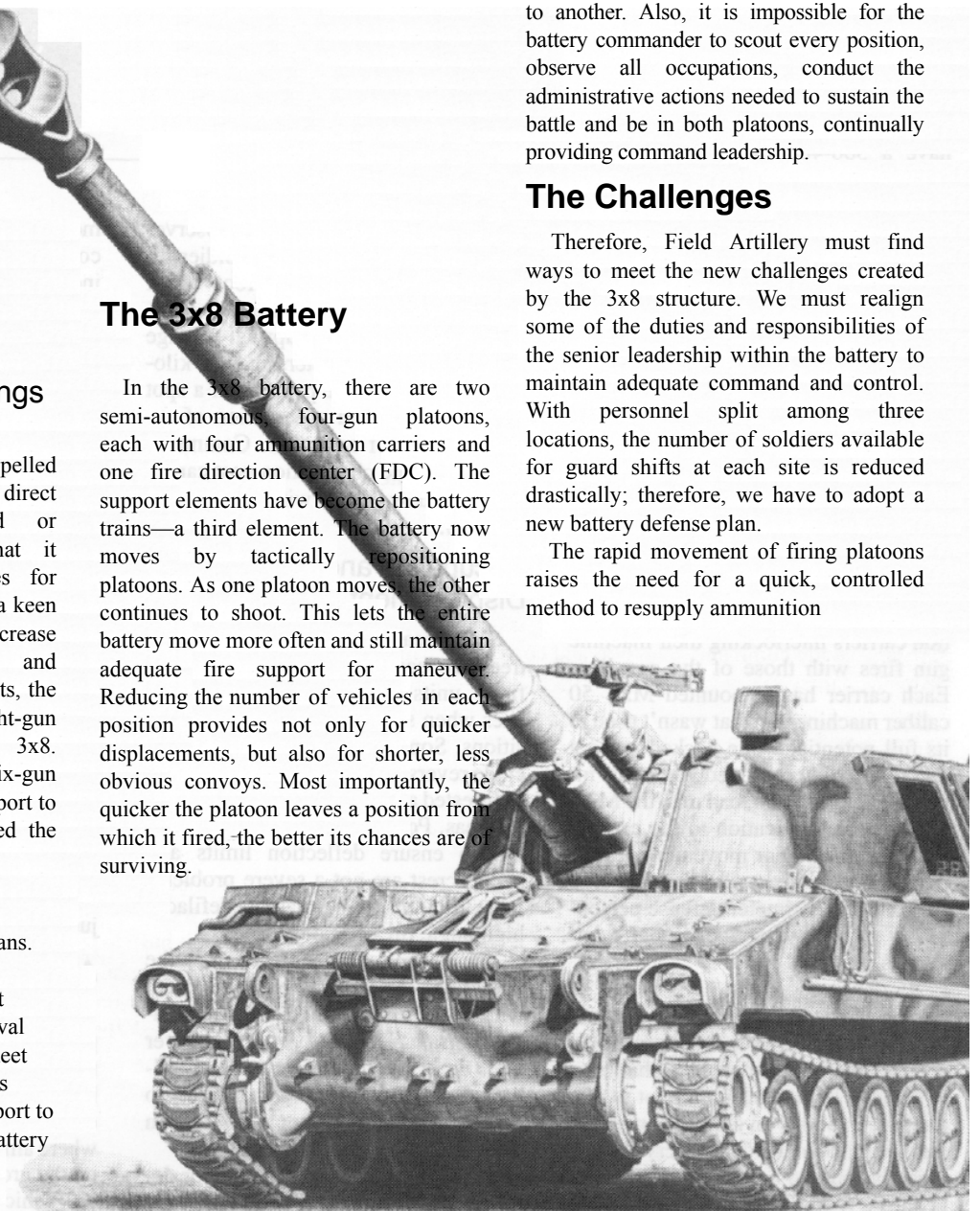

Jim Stovall

and fuel with minimum interference in platoon movements and firing operations. We also must establish operations procedures for maintenance and mess section support of the firing platoons.

## The Tactical Oval Platoon Formation

The firing platoons must be "stripped down" to increase agility. This allows quicker response to movement orders and creates a smaller, less-recognizable target. This means the battery trains must operate as a separate element. Ideally, the two firing platoons should emplace approximately one to three kilometers apart with the battery trains about two to three kilometers back and centered on the platoons. Platoon firing positions should have a 300-400 meter front and be about 200 meters deep. If not receiving or delivering ammunition, all ammunition carriers should be tactically at the rear and flanks of the firing platoon position and about the same distance apart as the howitzers.

Units must avoid placing vehicles in a linear position. The FDC should be to the right or left flank of the platoon's center because the center is more likely to be hit by hostile artillery if the position is targeted. This non-linear position layout is TOPFORM.

### Security

In a TOPFORM position, perimeter security is completed by the ammunition carriers interlocking their machine gun fires with those of the gun line. Each carrier has a mounted M2, .50 caliber machine gun that wasn't used to its full potential while backed up to a gun. One soldier, rotated within his individual gun section, can man the M2s.

Wire communication to the carriers isn't necessary. For movement orders, one soldier from the gun line can alert the carriers. Perimeter defense personnel, if attacked, can give standard alert signals.

An observation post (OP) should be established in front of the firing position for early warning of approaching enemy troops. This may be a challenge to control, but it's all-important to platoon survivability in a highly armored, threat environment. The observer's key objective should be to give the platoon at least a two-minute warning to allow personnel time to react. One effective

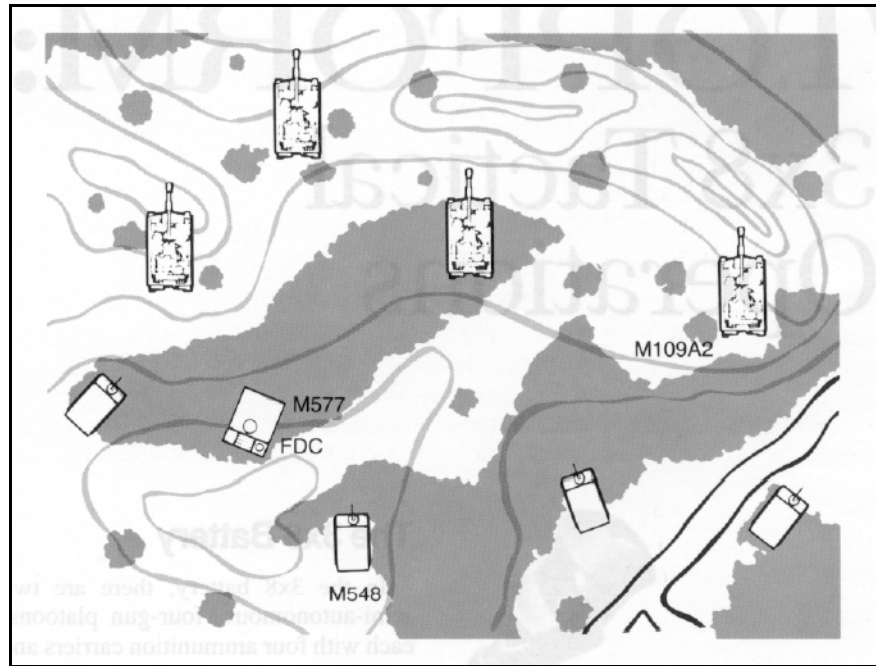

Tactical Oval Platoon Formation

method of emplacing the observer would be to send one or two soldiers to the observation point on foot or, if available, in the platoon leader's vehicle. They should occupy a vantage point between 300 meters and one kilometer in front of the position in a spot that provides good observation of the main avenue of approach. Communication with the observation post can be maintained by wire or with an AN-PRC 77 radio.

### Occupation and Displacement

Since areas such as the front edges of trees are easily templated for hostile fires, units should consider atypical sites when selecting firing platoon positions. Some position possibilities include reverse slopes of hills, in the rear of forested areas and in the rear of built-up areas. Positions should be well chosen to ensure deflection limits and site-to-crest are not a severe problem. In extreme cases of platoon defilade, high-angle fires could be used.

These types of locations open up the battlefield for artillery positions from what otherwise might have been unused terrain. Habitually, the maneuver units don't occupy these positions. Although they may be more difficult to occupy, they'll still support the mission and certainly increase survivability.

There is no clear-cut formula for deciding when and where a firing platoon should displace. Historically, displacement

has resulted from a position's becoming untenable through hostile indirect fires, direct enemy activity or when the mission could no longer be supported from that location. Action as opposed to reaction is a better concept to use in determining when to displace the platoons. Why wait until a platoon is acquired and begins to receive counterfire before deciding to move it?

A few guidelines may be used to determine when to move. Six to 12 volleys fired from one location are plenty. Chances of detection and counterfire increase significantly as the number of volleys from the same position increase. Units should remember short distance movements will achieve the needed effect for increased survivability. An alert from the platoon OP may be a signal to move based on occurring activity. Also, units must look ahead at the battle flow and reposition the platoons to maintain mission support. Ultimately, platoon displacement depends on the battery commander's judgment.

### Ammunition Resupply

Delivering ammunition to the firing platoon should be accomplished at the rear of the position or within one to two kilometers of the position. Resupply can occur at a central distribution point where ammunition is either dropped off on the ground, at which time the delivery vehicle will depart, or loaded directly into the back of the ammunition

carriers. Using either option, ammunition carriers from the platoon should move two at a time to the location, pick up the ammunition and return to the platoon. At that time, the other two carriers can depart to the pickup location if needed. At least two carriers should stay in the position to provide continuous perimeter security.

The howitzers can be resupplied by ammunition carriers' driving down behind the guns and filling the bustle racks. Carriers can deliver ammunition to all guns, not just their associated howitzers. If possible, all ammunition from one carrier should be issued before starting on the next carrier. This will facilitate future ammunition pickup for the carriers. Using this method of ammunition delivery ensures a continuous supply of ammunition for the howitzers without interfering with fire missions and still provides for perimeter security.

## Forward Area Rearm and Refuel Point

All refueling should be accomplished in FARRP operations unless it's absolutely necessary to refuel in position. With the batteries split among three different locations, it's much easier and faster for the battalion to support refueling operations from one or two locations than to try to hit each element. During movements, a battery should use a designated FARRP if the battery commander deems it necessary.

The firing platoons should be ready to fire from their new positions as soon as possible. Since the howitzers and the FDC are needed for immediate fire support, they should pass through the FARRP as one element, refuel and then proceed quickly to the new location. Howitzers should only refuel at the FARRP, since too much time would be wasted with ammunition resupply. The howitzers' bustle racks should be full already from the continual resupply by the ammunition carriers. Ammunition carriers then go through the FARRP for fuel and, if needed, ammunition.

## Trains

The third element, the battery trains, provides maintenance and mess support. The trains' mess section cooks all meals and brings hot "chow" to the firing platoons. The maintenance contact team is controlled by the trains and should stay with them until needed at a platoon

position. Communications can be maintained with the trains through the first sergeant, who should manage the support operations. Security of the trains rests with the personnel in that position.

Since the howitzers usually must make many short survivability moves, the trains won't move as often as the firing platoons. Although the trains should not get more than three kilometers from the firing platoons, they can support from one location until the mission requires a move.

## Duties and Responsibilities

**The Commander.** As mentioned earlier, moving and controlling the three battery elements would be difficult without realigning some duties and responsibilities. The battery commander must be the controller and problem-solver for all battery operations. Depending upon the time available and the mission, he may reconnoiter some positions by himself or with his platoon leaders. He'll spend much of his time on the road between the battalion tactical operations center (TOC) and his platoons' positions. He is the link between the battalion and the firing battery. The battalion must give the battery commander the flexibility to control his internal battery movements.

The battalion has the most current battle information and will see the need for battery movement earlier than the battery itself. Therefore, the battalion operations section should provide a mission order for the battery to execute, not specific movement instructions for firing platoons. For example, a mission may be: "Recon battery position vicinity grid xxxxxx. Be prepared to support from that location NLT 1500 hours. Use FARRP enroute at grid xxxxxx between 1300 and 1430. Have one fire unit always available for support." This gives the battery command the flexibility to choose the platoon he moves first, establish his exact movement times, select precise positions and control his own resupply times. This relieves the battalion of having to coordinate movement and positioning for each platoon.

**The Platoon Leaders.** The platoon leaders should be responsible for reconnoitering and selecting their platoons' positions, based on the battery commander's guidance. They should travel with the advance party and, in a short time, be prepared to receive the platoon for a hasty occupation. They must be quick and

decisive. Rapidly moving situations may allow only 15 minutes for advance party set up before the howitzers arrive.

A battalion survey team should meet the advance party at the proposed location to establish accurate position and directional survey. After selecting the primary position, the platoon leader, again with guidance from the commander, also should select a few alternate positions near the primary one for survivability moves. The platoon fire direction officer (FDO) should lead the FDC and howitzer convoy. The ammunition carriers may be led to the position by the platoon sergeant or a capable sergeant within the platoon.

**The First Sergeant.** The first sergeant is responsible for all of the logistics support for the battery. He provides the coordination link between the battalion's combat trains and the firing platoons. He pulls support forward from the battln and pushes it to the battery, ensuring soldiers are fed and all supply needs met. He maintains a radio watch in the trains location for 24-hour support. He also is responsible for ensuring coordination of all FARRP operations.

## Conclusion

Operations using 3x8 tactics have given direct support Field Artillery units movement options and flexibility never before experienced. Capitalizing on the concept will occur only by pursuing better ways to employ it. The 1st Battalion, 22d Field Artillery, has met those demands with the TOPFORM concept. It has proved to be the most effective means of tactically operating and employing a 3x8 firing battery.



**Captain Gary M. Stallings is currently attending the Operations Research and Systems Analysis course at Fort Lee, Virginia. He's a graduate of the Field Artillery Officers Advanced Course, Fort Sill, Oklahoma and the Combined Arms and Services Staff School, Fort Leavenworth, Kansas. His previous assignments include Assistant S3, Battalion Fire Direction Officer and B Battery Commander of the 1st Battalion, 22d Field Artillery, and Company Fire Support Officer, B Battery Executive Officer and Battalion S1 of the 2d Battalion, 35th Field Artillery, 24th Infantry Division (Mechanized), Fort Stewart, Georgia.**

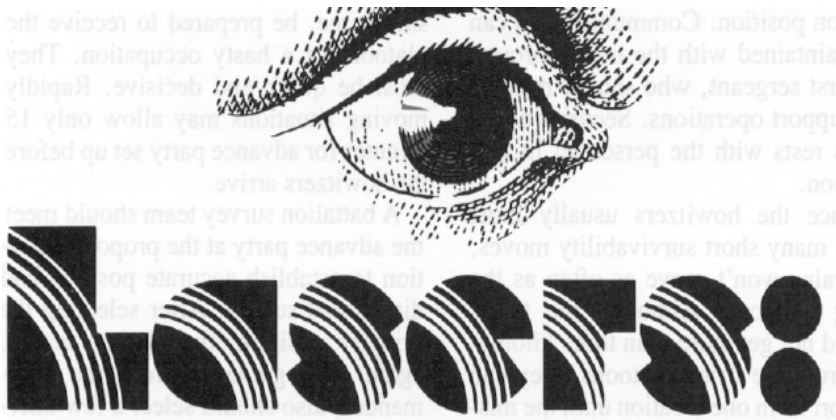

# Direct-Fire Weapons For and Against Us

by Captain William J. Spencer

**O**n the modern battlefield, our forces will encounter a large number of laser devices. We use lasers to locate and designate targets, but we also can use them to damage enemy soldiers' eyesight and electro-optic devices. Threat forces have similar capabilities, so it's important to understand not only how to use lasers, but also how to defend against them.

While a conventional light source emits all colors of the visible spectrum, a laser emits only one wavelength (color) of energy. It may be either a visible wavelength or in the infrared or ultraviolet range, so you may not be able to "see" laser energy.

Contrary to popular belief, no field laser can vaporize or sterilize you, although high-energy lasers can burn skin or ignite clothing. What you should be concerned about most are your eyes. Today's laser rangefinders and designators can do irreparable damage to vision.

The word "laser" stands for light amplification by stimulated emission of radiation. Unlike a conventional light source, which emits energy in the form of light in all directions, lasers act more like searchlights. Their energy is emitted as a collimated beam and isn't necessarily visible as light.

Lasers are much more powerful than searchlights. A tank searchlight can cause injury to the retina at distances of up to 200 meters at night. Compared with viewing a tank searchlight at 100 meters, the laser's narrow high-intensity beam would appear more than 100 million times brighter (if it emitted light).

## Laser Eye Damage

By emitting that much energy, lasers can cause many types of eye injuries,

including flashblindness, minimal lesions, temporary blindness and hemorrhagic lesions. Flashblindness is a temporary degradation of visual acuity resulting from a brief, but intense, exposure to visible (in-band) radiation. Recovery times range from a few seconds to a few minutes. Minimal lesions are characterized by minor retinal burns and dark spots in the individual's field of view. This is also a temporary condition. Temporary blindness is produced by intermediate retinal burns. Blinding effects can last from minutes to several days. Hemorrhagic lesions are characterized by severe retinal burns with bleeding and immediate loss of vision. Such lesions can result in permanent blindness.

With the current single-pulse rangefinders of the M1 and M60A3 tanks, there is a danger of hemorrhagic lesions within 200 to 250 meters of the rangefinder (during daytime viewing with the naked eye). With binoculars, inner eye bleeding can occur when viewing the laser beam from two kilometers away. Laser designators can cause even more damage because of the pulse repetition.

Dr. C. David Decker, a laser scientist, was partially blinded by the *reflection* of a relatively weak laser beam. He described the accident as follows:

*When the beam struck my eye, I heard a distinct popping sound, caused by a laser-induced explosion at the back of my eyeball. My vision was obscured almost immediately by streams of blood floating in the vitreous humor and by what appeared to be particulate matter suspended in the vitreous humor. It was like viewing the world through a round fishbowl full of glycerol into which a quart of*

*blood and a handful of black pepper have been partially mixed.*

*There was local pain within a few minutes of the accident, but it did not become excruciating. The most immediate response after such an accident is horror.*

*As a Vietnam War veteran, I have seen several terrible scenes of human carnage, but none affected me more than viewing the world through my blood-filled eyeball. In the aftermath of the accident, I went into shock, as is typical in personal injury accidents.*

As Dr. Decker stated, this not an extremely painful injury. The injured soldier doesn't need immediate first aid beyond removing him from a hazardous position and making him comfortable. You may need to treat him for shock and ensure he doesn't panic.

## Degree of Eye Damage

The damage a laser can do to the eye depends on several factors.

### Power

The more powerful the device, the more damage it will do to the eye.

### Wavelength

Some laser energy (wavelengths from 0.4 to 1.4 micrometers) will pass through optical devices (including vision blocks, binoculars, glasses and the lens of your eye). This is called in-band laser energy. Out-of-band laser energy will be absorbed by the first surface it strikes. For personnel not using any optical devices, this is the cornea. For people wearing glasses or using binoculars, it is the surface of the glass. Thus

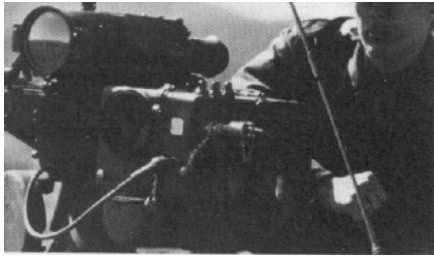

Jill Pronto

Some equipment has built-in eye protection, such as the G/VLLD.

if you wear glasses, you are reasonably safe from out-of-band laser energy, but you're still vulnerable to in-band. If you aren't wearing glasses or goggles or using binoculars, you are vulnerable to both types of lasers.

## Distance

Laser beams spread out as the distance from the weapon increases. Less energy impinges on a given area (e.g. the pupil) at a greater range.

## Atmospheric conditions

The movement of the atoms in the atmosphere can distort the projected energy of a laser. This is particularly true for a continuous laser, which can lose up to 85 percent of its energy this way. Optical turbulence, absorption and scattering, wind, temperature, rain, snow, fog and dust can dissipate laser energy.

## Binoculars

For in-band laser energy, using binoculars or other magnifying devices will increase the energy density of the laser beam by the square of the magnification power multiplied by the light transmission factor of the optic. For example, M17 binoculars have a magnification power of seven and a light transmission factor of 50 percent. The total increase in energy density would be  $7 \times 7 = 49$ , multiplied by 50 percent for a total of 24.5. This means that the individual would concentrate 24.5 times more energy on his retina by using binoculars than he would with the naked eye.

How will we know the enemy is using lasers on the battlefield? Very bright, colored flashes of light will indicate he's using in-band lasers. We can't see out-of-band laser energy and may only know the enemy's using it when injuries occur. Burns on electrooptics could occur as the result of either type of laser energy.

## Laser Countermeasures

For countermeasures, consider the laser a direct-fire weapon and react accordingly when the enemy's using one against your unit. Use cover and concealment and report enemy laser use immediately. Consider using smoke to diffuse the laser beam. You might suppress the laser source with indirect fire or engage it with direct fire to neutralize or destroy it.

Individual soldiers can reduce laser eye damage by limiting the use of direct-view optics (both magnifying and non-magnifying).

## Vision Blocks

Cover the interior glass of the vision block with tape leaving a horizontal opening about three millimeters high (the thickness of two quarters) across the width of the vision block. This procedure reduces the amount of laser energy entering the eye by 25 percent, even if the individual is looking through the slot. More importantly, since the eye may not be aligned precisely with the opening and the laser, it reduces the possibility of the laser's entering the eye at all. You can use the same procedure with goggles of various types.

To protect against out-of-band damage to the lenses, "sacrificial glass" can be affixed to the outside surface. Using this method, the whole lens won't need replacing if it's struck by out-of-band laser energy. A new piece of sacrificial glass can be affixed.

## Binoculars

Minimize search time. Stow the binoculars vertically when not in use. Scan with the naked eye first and then use one eye at a time, preferably the non-firing eye. Consider placing tape with a pinhole in it over one lens of each pair of binoculars. Look through this lens first to check for lasers. Use binoculars and other magnifying optics only when you have to.

## Laser Spectacles

These spectacles (NSN: 8456-01-024-4139) will protect against ruby and infrared rangefinders, like those found in the M60A3 and M1 tanks. The Soviets use most of the same types of lasers we do, so our filters, goggles and spectacles should protect us from theirs as well as from ours. Laser spectacles look like sunglasses, but regular sunglasses

are useless as protection from in-band laser energy.

Some equipment has built-in protection, such as the AN/GVS-5 and the ground vehicular laser locator designator (G/VLLD). Know your equipment. The Army currently is improving anti-laser hardware with adjustable filters, sensors to alert personnel to the presence of laser energy and the new laser-safe M22 binoculars. The new M22, 7x50 binoculars incorporate the latest in optical technology, including a target acquisition reticle and laser protection filters. When using electro-optic devices (such as TV cameras), the user is protected fully, but the optics may burn out.

## Conclusion

You should treat a laser with care and respect, as you would any weapon, but you shouldn't be afraid of it. Don't point it at anyone or look into the "business end" of it. Don't lase glass, chrome, standing water or mirror-like surfaces. Reflected laser energy can be hazardous at distances 100 meters away from the reflective surface. For range safety, AR 385-63 and local range regulations give specific guidance on operating lasers. Technical manuals also give important warnings (for example, "The G/VLLD can be hazardous 80 kilometers away").

The laser is a direct-fire weapon. We can use it to locate and designate targets and to damage the eyes and optical devices of our enemies. But we must be prepared to protect ourselves when it's used against us.



**Captain William J. Spencer commands E Battery, 3d Battalion, 321st Field Artillery, Field Artillery Training Center, Fort Sill, Oklahoma. He's a graduate of the Field Artillery Officers Advanced Course and served as a company FSO, battery executive officer and FDO with the 2-11th Field Artillery, 25th Infantry Division, Hawaii. Captain Spencer then served as an instructor in the Gunnery Department for both the officers basic and advanced courses from 1984 to 1987.**