

Field Artillery Journal



July-August 1986



Time for a Cool Change

Field Artillery Journal

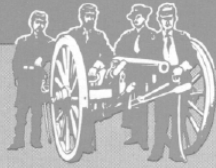

Volume 54

July-August 1986

Number 4

ARTICLES

- 8 Dogsled to SUSV—A New Prime Mover for the Arctic Artillery**
by Captain Michael G. Edrington and Captain Charles F. Gillis
- 12 Army Acquisition—From Concept to Disposal**
by Major Thomas H. Barfield
- 19 Liquid Propellants—A Potential Power Punch**
by Mr. Bob Lessels
- 23 Shooting from the HIP—A Change in Concepts**
by Mr. Robert M. Forrest
- 28 Much Ado About Something**
by Captain Suzann W. Voigt
- 31 Electromagnetic Propulsion: The Wave of the Future**
by Captain F.M. Aubin, Royal Canadian Artillery
- 36 The Positioning and Navigation Puzzle**
by Lieutenant Colonel (Retired) Roy E. Penepacker
- 43 Touchtone Dialing and the Redleg Connection**
by Mr. Richard F. (Dick) Brown
- 49 Movin' On: Advancing Logistics Support**
by Captain Scott R. Gourley, USAR

FEATURES

Front cover photo by CPT Michael G. Edrington

- | | |
|------------------------------------|--------------------------|
| 1 On The Move | 39 Right by Piece |
| 2 Incoming | 48 Redleg News |
| 18 Command Update | 51 Fragments |
| 33 View from the Blockhouse | |

The *Field Artillery Journal* (ISSN 0191-975x) is published bimonthly at the US Army Field Artillery School, Fort Sill, OK. Funds for printing are approved by Department of the Army. However, unless otherwise stated, material does not represent official policy or endorsement by any agency of the US Army.

PURPOSE (as stated in the first *Field Artillery Journal* in 1911): "To publish a journal for disseminating professional knowledge and furnishing information as to the field artillery's progress, development, and best use in campaign; to cultivate, with the other arms, a common understanding of the power and limitations of each; to foster a feeling of interdependence among the different arms and of hearty cooperation by all; and to promote understanding between the regular and militia forces by a closer bond; all of which objects are worthy and contribute to the good of our country."

SUBSCRIPTIONS: May be obtained through the US Field Artillery Association, P.O. Box 33027, Fort Sill, OK 73503-0311. Telephone numbers are AUTOVON 639-5121/6806 or commercial (405) 355-4677. Dues are \$16.00 per year (\$31.00 for 2 years and \$46.00 for 3 years) to US and APO addresses. All other addresses should add \$9.00 per subscription year for postage.

SUBMISSIONS: All letters and articles should be addressed to Editor, *Field Artillery Journal*, P.O. Box 33311, Fort Sill, OK 73503-0311. Telephone numbers are AUTOVON 639-5121/6806 or commercial (405) 351-5121/6806. Material submitted for publication is subject to edit by the *Journal* staff; footnotes and bibliographies may be deleted due to limitation of space.

REPRINTS: The *Field Artillery Journal* is pleased to grant permission to reprint articles. Please credit the author and the *Field Artillery Journal*.

POSTMASTERS: Second-class official mail postage is paid by the Department of the Army, DOD 314, at Lawton, OK 73501. Send address changes to the *Field Artillery Journal*, P.O. Box 33311, Fort Sill, OK 73503-0311.

Heads Up on What's New!

You won't have to walk the corridors of Snow Hall long before you hear a well-intentioned Redleg lament, "I wish these School guys would stop talking about the systems we'll *have* in 1990. Why can't they deal with *today's* problems? Making things happen *now* is my job; not developing some fantastic howitzer for the future." Such observations betray the deep-seated frustrations and concerns of those leaders charged with executing an ambitious doctrine in an age of evolving equipment and organizations. But are such emotional lamentations reasonable? Aren't they really rationalizations, even abandonment's of responsibility?

This issue of your *Journal* clearly establishes that we *all* share responsibility for the future of the King of Battle. Fort Sill's combat developers don't have a monopoly on foresight, shrewdness, and innovativeness. What's more, the whole developmental system mandates the involvement of "field soldiers" from the earliest stages of concept articulation to the ultimate retirement of a weapon system. True, our individual responsibilities vary. But we all have a reserved piece of the modernization *pie*.

To play our appropriate roles in this important enterprise, we Redlegs need to understand the developmental system. This magazine should help us not only gain an appreciation for the Army's complex acquisition program, but also learn something about many of the intriguing technologies that signify great things for the entire Fire Support Community. And, of course, this *Journal* underscores the abiding truth of General Matthew Ridgway's observation, "There is still one absolute weapon . . . That weapon is man himself."

Moze G. Nain

EDITOR



SECRETARY OF THE ARMY:

Hon. John O. Marsh, Jr.

FIELD ARTILLERY SCHOOL

Commandant:

MG Eugene S. Korpall

Assistant Commandment:

BG Jerry C. Harrison

JOURNAL STAFF

Editor:

MAJ Roger A. Rains

Managing Editor:

Tammy D. Hawthorne

Art Director:

Donna Jeanne Covert

Circulation Manager:

Joanne Brown

Field Artillery Journal

On the Move

Know Your Foe

MG EUGENE S. KORPAL

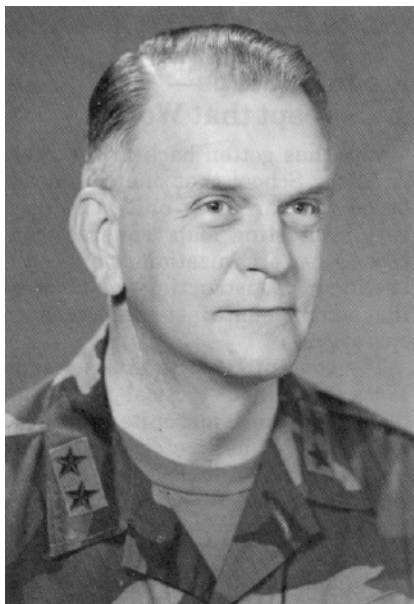

Churchill's words have never been truer than today. Before we can decide what, when, where, and how to attack, we Redlegs must *know our foe*. Our individual and collective training must include educating ourselves and our soldiers on the Threat's capabilities and likely intentions. We must know the size, quantity, organization, equipment, and tactical capabilities of the Threat forces we are likely to encounter. More importantly, we must know their weaknesses and vulnerabilities in order to strike them hard and leave their carcasses, not ours, lying in the sun.

At present and in the foreseeable future, the Soviets and their Warsaw Pact allies pose the single greatest threat to North Atlantic Treaty Organization (NATO) forces in Europe. Trends in Warsaw Pact doctrine suggest that in time of war the Soviets will rely on large-scale, combined arms operations employing numerically superior armored, motorized, air, air assault, and special forces. Furthermore, they will exploit massed indirect fires to achieve unprecedented destruction and prompt psychological paralysis while using speed and surprise to conduct close and deep battle operations simultaneously.

To counter this burgeoning Threat, Western planners are focusing on two areas.

However absorbed a commander may be in the elaboration of his own thoughts, it is sometimes necessary to take the enemy into account.

Winston Churchill

- First, they're relying on advanced technology and innovative doctrine to gain an advantage.

- Second, they're counting on knowledgeable, well-trained, and well-lead soldiers to withstand the initial Soviet onslaught and go on to win.

Armed with new, highly lethal weapon systems and advanced doctrine, these NATO warriors must strike Threat forces where their operational, technical, and human weaknesses make them most vulnerable. In order to do so, our Redlegs must be aware of some significant trends in Warsaw Pact military developments. We must understand that many of the reported weaknesses in the Warsaw Pact are disappearing, yet others remain. For example, the recently published *Soviet Military Power*, 1986 notes that:

- The Soviets are increasing the speed and effectiveness of their command, control, and communications systems by introducing numerous computer systems and automated aids.

- In 1985, the Soviets began activating high commands within their theater of military operations (TVD) and appointing very senior officers as their permanent commanders-in-chief. These steps increased the readiness of Soviet forces by moving the peacetime command structure much closer to a wartime footing.

- The Soviets are expanding and reorganizing their tank and motorized rifle divisions to conduct high-speed, combined arms operations on both conventional or nuclear battlefields.

- The Soviets have also formed two corps-level structures suited to act as operational maneuver groups (OMG). These highly armored, self-sufficient units should be capable of conducting high-speed operations deep into an enemy's operational and strategic rear areas.

- Some Army-level artillery regiments are becoming brigade-sized organizations

with the addition of a fourth battalion. What's more, their battalions are expanding from 18 to 24 guns each. These changes alone have resulted in a 40 percent increase in artillery pieces in the Soviet brigades facing NATO. Furthermore, large numbers of self-propelled artillery are reaching ground forces at all other levels of command.

Of course, it is not enough merely to know the facts. Each Redleg must also look for an approach to pit *our strengths* against *their weaknesses*. Soviet shortcomings may result from gaps in their dispositions or the predictability of their commanders or operations. Remember, the Threat is not "10 feet tall." Our challenge is to know the enemy and, when necessary, defeat him. To do this we must:

- Educate ourselves regarding the Threat's exploitable weaknesses and vulnerabilities.

- Understand how the Threat will likely operate and what countermeasures we can employ against him.

- Know how the Soviets make battlefield decisions and what can cause disruptions in their decision-making cycle.

- Train to demanding standards as our units rotate through the National Training Center (NTC) and participate in other realistic training activities.

In a 1939 radio broadcast Churchill commented, "I cannot forecast to you the action of Russia. It is a riddle wrapped in a mystery inside an enigma...." We must penetrate the Soviet's military enigma and unwrap their riddles if we are to prosper on a future European battlefield. Then we must put all our knowledge to work in our daily training and contingency planning. Only then can we ensure the synchronization of total combined arms operations and direct our growing firepower at the Threat's vulnerabilities. Only then will we be able to win the AirLand Battle.



Incoming

LETTERS TO THE EDITOR

Fresh Ideas and Big Concerns

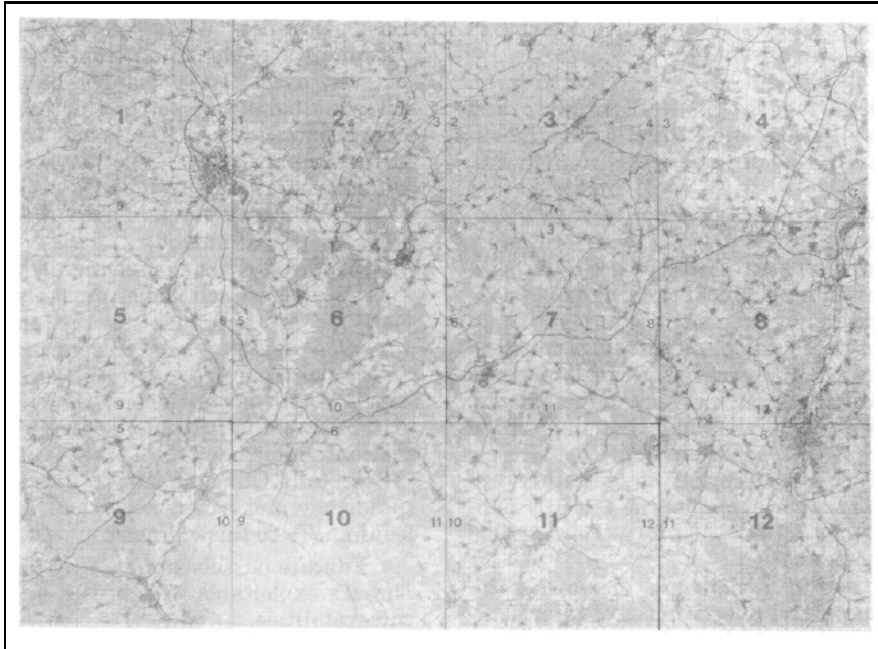

The map "squares" concept creates a situation map that covers areas of operation. The overlay numbering system makes it easier to identify adjoining map squares.

Modular Maps— A Concept that Works

Word has gotten back to the Field Artillery School that one European-based field artillery unit is using a very interesting map "squares" concept. Other organizations may find it useful in constructing mapboards that accommodate fast-paced, modern operations.

The concept consists of a series of 17½-x18½-inch tactical maps attached to ½-inch masonite hardboard squares. The back of the masonite squares have Velcro strips applied. Operations personnel can then use the Velcro-surfaced wall of the tactical operations center or hardboard as a portable mounting surface. The map squares are then quickly affixed in series to the mounting surface creating a situation map that covers the area of operations.

As movements occur, operations center personnel simply remove, adjust, or affix new map squares to keep the map up-to-date. Ease in identifying adjoining map squares can result from a numbering system similar to that shown in the accompanying figure.

Robert Adair
COL, FA
Fort Sill, OK

Observations on Fire Planning with TACFIRE

As a second lieutenant fresh out of the Field Artillery Officer's Basic Course, I was assigned as an instructor in the tactical fire direction system (TACFIRE) Training Division of the Tactics and Combined Arms Department (TCAD). One of the subjects I taught was non-nuclear fire planning (NNFP in TACFIRE jargon). After about 9 months of teaching and fielding thousands of "off-the-wall" questions I could honestly say that I knew TACFIRE fire planning inside and out. I also thought that was all anybody needed to know about fire planning. Then my bubble burst!

I can still remember the day; I was lecturing on the development of target

lists and explaining how to give instructions to place targets in phases when I saw a hand go up. The hand belonged to Major Joseph Sheridan, who just happened to be an instructor with the Advanced Tactics Division of TCAD. He asked me what types of targets are scheduled in what phases and why there was a Phase 4 on the format we were discussing, while doctrinally the most a schedule could have was three phases. Needless to say, I could not give him a satisfactory answer.

But the full significance of this event did not hit me until sometime later. Even though we instructors often hear questions we cannot answer, this question was *fundamental*. It was like a gunnery instructor not knowing the basic elements of a call for fire. What I had been teaching could hardly be called "fire planning." It

was more like "correctly filling out formats in sequence to produce the necessary reports." I was teaching TACFIRE fire planning when I should have been teaching *fire planning with TACFIRE*.

Fortunately, Major Sheridan worked with me the remainder of the course and led me to a great realization: Whether we use a scheduling work sheet or a TACFIRE computer, current doctrine dictates the manner in which fires are scheduled—not just because it is doctrine, but because maneuver battalion, brigade, and division commanders expect and deserve to have us support them with scheduled fires in accordance with the combined arms tactics found in FM 6-20, *Fire Support in Combined Arms Operations*.

The dichotomy between TACFIRE and doctrinal fire planning was made even more apparent to me when I became the fire direction officer of a battalion in Europe. One of the first things I noticed was that the fire planning annex in the units' TACFIRE standing operating procedures (SOP) was based almost exclusively on the "standard" SOPs distributed by the Field Artillery School and the Communications and Electronics Command (CECOM) new equipment training teams. It contained separate procedures for fire plans done by battalion operations and intelligence and by fire support officers. Other battalion SOPs were all much the same in this respect. If units are in fact following these SOPs for their operations and training, then I submit that both tactically and technically they are not fire planning correctly.

As a possible explanation, I will briefly review the programs of instruction for NNFP in TACFIRE school and for field artillery fire planning that I received in the advanced course. Ninety percent of NNFP instruction revolves around the TACFIRE fire planning sequence outlined in TM 11-7440-240-10-7. Students concentrate mainly on the sequence, the TACFIRE formats used, and the various entries for those formats. Little emphasis focuses on developing different schedules—preparations, programs, and so on—phasing of targets, or the rules of fire planning.

Maneuver commander's attack guidance is another area of disconnect. Most TACFIRE graduates would have a difficult time incorporating guidance such as "I want 10 percent effects on offensive targets and 5 percent on defensive" into a fire plan because they are trained on

specifics on what TACFIRE will accept; not on general guidance they will more than likely receive.

The advanced course approaches fire planning differently. The emphasis is on interpreting the operations order and fire support annex to develop appropriate schedules to support the scheme of maneuver. Responsibilities of fire support teams, fire support officers, and battalion tactical operations centers, are clearly defined right at the outset. There are no separate fire planning sequences for fire support officers and battalion operations and intelligence sections. Commander's guidance and the rules of fire planning are learned, understood, and incorporated into every schedule. Although the advanced course graduate may not know everything about fire planning, he has a much better idea of what is required than the TACFIRE long-course graduate.



What frequently happens, however, is that the TACFIRE graduate is assigned to a battalion fire direction center. After all, he knows more than anyone else in the battalion about TACFIRE fire planning. Of course, he ends up doing the fire plan himself, and in consequence, the fire plan reflects the TACFIRE fire planning sequence, not FM 6-20. Often, the entire plan is accomplished from the battalion fire direction center—because that is where the TACFIRE expertise is.

Now you might say, "If we have a problem here, wouldn't an external evaluation point it out?" Not when key elements of the battalion fire support system are not evaluated when their battalion is; and certainly not if the battalion tactical operations center is evaluated on fire planning from inside the TACFIRE shelter.

Furthermore, there is no single document today that adequately meshes TACFIRE procedures with FM 6-20 doctrine for fire planning. Unit, school, and new equipment training team SOPs tend to follow TACFIRE procedures exclusively. FM 6-20, although revised to include TACFIRE, is too general in the area of TACFIRE fire planning.

What I propose is an annex to battalion SOPs which integrates FM 6-20 into TM 11-7440-240-10-7. At the very least, this will give the TACFIRE battalions a single document with which to plan fire according to published doctrine and accepted TACFIRE procedures. The bottom line is that we need to learn to use TACFIRE to produce schedules not *fire plans*.

Peter J. Zielinski
CPT, FA
APO, New York

Take Another Look

No Guarantees on "It's Guaranteed!"

Although I fully agree with, espouse, and teach the situational leadership theory, I find the article "It's Guaranteed!" (November-December 1985 *Field Artillery Journal*) by Captain Brian M. Ludera to be an inadequate attempt to explain the theory and its practical

application. Several hours in the officer advanced course are dedicated to teaching situational leadership and developing an understanding of its application in the overall scheme of subordinate development.

The title "It's Guaranteed!" must be taken in jest. Nothing in leadership or the development of subordinates is guaranteed. I agree with the author that situational leadership tells leaders not

only what to do but also what they *ought* to do to be effective. Moreover, the theory does this better than other leadership models developed over the years. However, there are still no guarantees.

Situational leadership requires risk on the part of the leader. Varying one's style of leadership to correspond to the maturity level of subordinates and continuing to vary it as subordinates

develop is risky. As subordinates' maturity levels increase and the leader moves toward a delegative style of leadership, the perception often develops that the leader is no longer in control. Supervisors who use a high degree of control quite often view this approach to leadership as inappropriate in their organization.

Situational leadership encompasses the skills of counseling, motivating,

providing direction, and implementing. These skills are part of the be-know-do attributes presented in the new leadership manual, FM 22-100.

The rewards of developing subordinates are great. More mature subordinates equate to more time for the leader—more time to represent the unit, acquire resources, coordinate, create, and accomplish long-term strategic planning instead of micro-managing, fire-fighting,

and punishing. More mature subordinates also equate to subordinates who develop their own subordinates in the same way. The bottom line is more effective, confident, and cohesive units which are able to fight and win.

Michael E. Aston
MAJ, SC
Fort Sill, OK

Out with the Old

The article "A System That Could Make a Difference" (September-October 1985 *Field Artillery Journal*) by Captain Charles B. Brenner pictures two prototype versions of my company's products. The photo captions and the article's text refer to the older version known as Slammer VI. This older version adapted the Army's earlier MK-40 2.75-inch rocket for surface launches.

The newer version known as the rapid deployment integrated rocket system VI, or RADIRS VI, adapts the Army's new MK-66, 70-mm rocket for surface launch. The nonfiring photo in the original article is of RADIRS VI.

Though the two systems resemble each other they are *very different in performance*. RADIRS/HYDRA 70 is the result of a product improvement program that greatly improves system

performance. Many *Field Artillery Journal* readers will recall the older systems but will be unfamiliar with the newer ones. The change in names is deliberate to differentiate between

the older and newer systems and to acknowledge HYDRA 70's antiarmor capability.

Jack E. King
BEI Defense Systems Co.

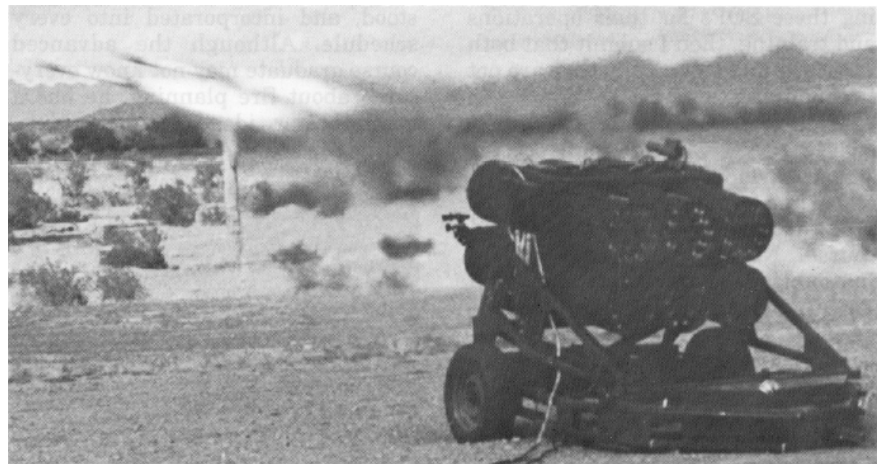

The RADIRS VI multiple rocket launcher.

More on "More Than Meets the Eye"

Although Major Mark D. Studer's article "More Than Meets the Eye" (November-December 1985 *Field Artillery Journal*) provides valuable insight into the inner workings and organization of detachment-type units, I feel the current image this type of assignment has within the Field Artillery Community merits further discussion.

Historically, the mission of artillery detachments originated as a result of various multinational agreements made during the Kennedy-McNamara era under provisions of the foreign military sales program (FMSP). Today, these units provide critical technical support to our Allies who have purchased American designed and manufactured weapon systems. An analysis of personnel figures

indicates that more artillerymen perform this mission at any given time than the sum of the personnel assigned to any two division artillery-sized organizations.

The Army's nine battalion-sized custodial units are continuously misrepresented by titles such as field artillery groups and detachments. Larger in many instances than a typical battalion or battery, some of these artillery organizations mystically fall under combat service support headquarters like the 59th Ordnance Brigade. Efforts to redesignate such units as batteries or battalions have been stymied by the fact that this action would invalidate the original international Service-to-Service Technical Agreements (SSTA) that still cover these organizations.

Perceiving field artillery officers and soldiers assigned to such units as something less than "True Redlegs"

not only constitutes a grave injustice, but also belittles the critical duties they perform. Unlike most "real" artillery units which merely train in peacetime for their wartime role, custodial units execute formidable peacetime missions as well as prepare for war. Actions on the part of terrorist groups and political activists exacerbate the difficulties of this peacetime mission. Located hours away from the nearest American community, these artillerymen work hard on behalf of their nation.

Obviously, soldiers assigned to these special units must meet extremely high reliability and proficiency standards. Providing capable leadership to these remarkable soldiers and meeting the difficult standards of both peacetime and wartime missions are tremendous challenges. But today's field artillery officers and their subordinate leaders are doing

just that. They have an opportunity to lead with much more discretion and autonomy than is ever possible in an ordinary battalion. Needless to say, they're making the most of it.

The newly established nuclear warhead detachment course (NWDC) will better prepare company-grade officers for such assignments. Although the concept of a resident course of instruction has helped

undercut the notion that Redlegs in detachments are "second-class artillerymen," this unfounded image still persists. Elimination of this unsupportable perception requires education. Artillerymen must learn that detachment soldiers often enjoy greater development opportunity and personal satisfaction than many of their line-battalion counterparts.

In the past, Redlegs have asked "Why should artillerymen perform this mission?" I contend that the answer should be "Only artillerymen are capable of doing this important job!"

Steve Artman
CPT, FA
Fort Sill, OK

Getting Back to the Four Rs

The problem described by Dr. Joseph Halloran in his article "The Four Rs" (September-October 1985 *Field Artillery Journal*) is one of the most pressing issues affecting the current fire support system. Our ability to select the right weapon and munition and attack the right target at the right time could well be a deciding factor between victory or defeat in the AirLand Battle.

For this reason, the Field Artillery is exploring a number of possibilities which could assist in resolving the problems associated with the allocation and distribution of fires. One of these possibilities is a planned, but as yet unapproved, exercise called the combined arms effectiveness evaluation. This exercise may offer an effective means of distributing the fires available at the maneuver brigade level. As currently envisioned, the evaluation will consider those types of fires

normally provided by the total fire support system including long-range, antitank, and aviation resources.

Field artillerymen everywhere can hold out some hope that this effectiveness evaluation will give us a clearer insight into how to *select* the four Rs.

Bill Rittenhouse
DCD, USAFAS
Fort Sill, OK



Set Your Priorities!

Providing fire support in the corps rear area is a problem that defies easy resolutions. Lieutenant Colonel Paul Treolo's article "Fire Support for the Rear Battle" (January-February 1986 *Field Artillery Journal*) outlines several options and deals with a number of questions and issues requiring detailed study by a variety of service agencies.

Unfortunately, there are errors in the article that we need to consider. The article addresses the Field Artillery as the primary provider of rear area fire support. It simply overlooks the other fire support assets that are more responsive and capable of providing corps rear area fire support

coverage. Rather than be "resigned to call for attack helicopters" as Colonel Treolo suggests, we should consider helicopters as one of the first options for fire support in the rear area.

Providing fires for the rear area is a complex issue upon which each corps and the Field Artillery School have taken a position. The School's view is that artillery ranks *last* on the priority list of rear area fire support means. In fact, it follows the organic mortars of the maneuver unit assigned the rear area mission, attack helicopters, and close-air support. Artillery resources are simply too scarce to loiter in the rear area waiting for a threat strike.

When the situation dictates, field artillery units should receive on-order

missions to support the rear area units. The responsiveness of such artillery organizations is obviously a limiting factor. It will take a considerable amount of time for the units to implement their on-order missions, move to the rear, orient themselves, and provide fires. But to reallocate fire support units to rear area duty is tantamount to robbing the front to support the rear. The front line maneuver commander who loses that support will be faced with a significant loss of a combat multiplier. Furthermore, if an artillery unit relocates out of its normal logistical support channel, someone must provide additional logistical assets to support that unit.

The command, control, communications, logistical support, and training of the rear area fire support assets require attention. FM 90-14, *Rear Battle*, attempts to address these topics, and participants at the 1985 Fire Support Conference at Fort Sill proposed several remedies to the inadequate doctrine contained in the manual. Those suggested cures included:

- Procedures for the clearance of fires and the decentralization of the levels I and II battles.
- Composition of the corps' rear area operations center and the addition

of fire support coordinators at all levels of rear area command.

- More rear area play in command post and field training exercises and better rear area operations center training for Reserve Component personnel.

- The need for prepackaged logistics for rear area resupply.

- The requirement for the corps rear area operations center to communicate

digitally with the corps fire support element.

Field Artillery School agencies will deal with these issues and many more as the Combined Arms Center revises FM 90-14. It's axiomatic to Redlegs that fire support must be provided when requested. Soldiers everywhere look to the field artillery to be the primary supplier of that support. This mind-set must be broken!

Field artillery is only one facet of the fire support arena. When commanders need fire support for rear operations, they must consider *all* fire support means. Artillery is not necessarily the primary asset!

William F. Clewe III

CPT, FA

Fort Sill, OK

Computer Views

Believe It or Not!

If you are the type of person who believes in doing everything by the book, then this information isn't for you. If you believe that the battery computer system (BCS) has some unknown capabilities which need to be exploited, then read on. You might be surprised!

The battery computer system was not designed by the wizards of the Field Artillery Community to *replace* the fire direction officer or fire direction center. Its primary purpose is to expedite firing operations by serving as a tool for professional Redlegs. To exploit the full capabilities of this system, users require technical skill as well as common sense. It takes skill to make the computer function correctly and common sense to put it to practical use.

One such practical purpose not found in the book is the process of using the battery computer system to compute hasty survey data. Valuable time is often consumed by using the hand-held TI-59 or doing the tedious process of manual traverse. By using the BCS pieces format, the coordinates for your new orienting station (OS) can be computed in a matter of seconds. This process requires the following inputs:

- Enter your original orienting station longitude coordinates into the format as gun 1.

- Enter gun 2 as being laid from gun 1.

- Skip over and enter the first angle (if 6400 use 0000), distance, and vertical angle in the polar data fields for gun 2.

- Repeat this process by entering the next angle as gun 3 laid from gun 2 and so on until all the angles turned

in hasty traverse to the new orienting station have been entered (figure 1).

- Execute and then recall by first pressing the previous segment and then the next segment on the keyboard. The location of your aiming circle will appear in the coordinate field of the last gun (figure 2).

Another interesting technique is the process of firing two or more firing platoons laid by two or more aiming circles as one battery. This technique works superbly as long as all firing units are laid on the *same azimuth of fire* and can be selected to

fire the same charge. This process was successfully field-tested by Battery C, 4th Battalion, 29th Field Artillery at Grafenwoehr, Germany.

Because of the difficult terrain at Grafenwoehr, the battery was forced to occupy two, three-gun positions separated by nearly 2,000 meters. The first platoon was set up in the computer under the normal setup procedure. The second platoon's aiming circle was entered in the computer as gun 7. Each gun of this platoon was then laid from gun 7 using the appropriate polar data (figure 3). The guns were linked to the

ORIGINAL	
BCS;PIECES;	
05	11: 1 ;FG: ;CORD: 09000 / 11000 / +551 ;POLAR: / / ;GRP:R;OK:Y;
1	12: 2 ;FG: 1;CORD: / / ;POLAR: 0800/ 708/ +10;GRP:R;OK:Y;
2	13: 3 ;FG: 2;CORD: / / ;POLAR: 0000/ 500/ -25;GRP:R;OK:Y;
3	14: 4 ;FG: 3;CORD: / / ;POLAR: 1600/ 500/ +15;GRP:R;OK:Y;
	15: ;FG: ;CORD: / / ;POLAR: / / ;GRP: ;OK: ;
	16: ;FG: ;CORD: / / ;POLAR: / / ;GRP: ;OK: ;
ANGLE	

Figure 1. Enter data, then execute to compute hasty survey location.

EOL	BCS;PIECES;	
	11: 1 ;FG: ;CORD: 50900 / 0381100 / +551 ;POLAR: / / ;GRP:R;OK:Y;	
	12: 2 ;FG: ;CORD: 509500/ 0381150 / +558 ;POLAR: / / ;GRP:R;OK:Y;	
	13: 3 ;FG: ;CORD: 509500/ 0381199 / +546 ;POLAR: / / ;GRP:R;OK:Y;	
	14: 4 ;FG: ;CORD: 509999/ 0381199 / +553 ;POLAR: / / ;GRP: ;OK: ;	
	15: ;FG: ;CORD: / / ;POLAR: / / ;GRP: ;OK: ;	
OS	16: ;FG: ;CORD: / / ;POLAR: / / ;GRP: ;OK: ;	
Note: If computing data while the BCS;PIECES format is empty, you can begin by entering gun 1 in the orienting station of the AFU:UPDATE format and start with gun 2 on the BCS;PIECES format. Also do not use guns 1, 2, and 3 if the battery computer system is loaded with current piece locations; jump to guns 7, 8, and 9 for doing the hasty survey computations.		

Figure 2. Results of executed figure 1. Gun 4 is new orienting station location.

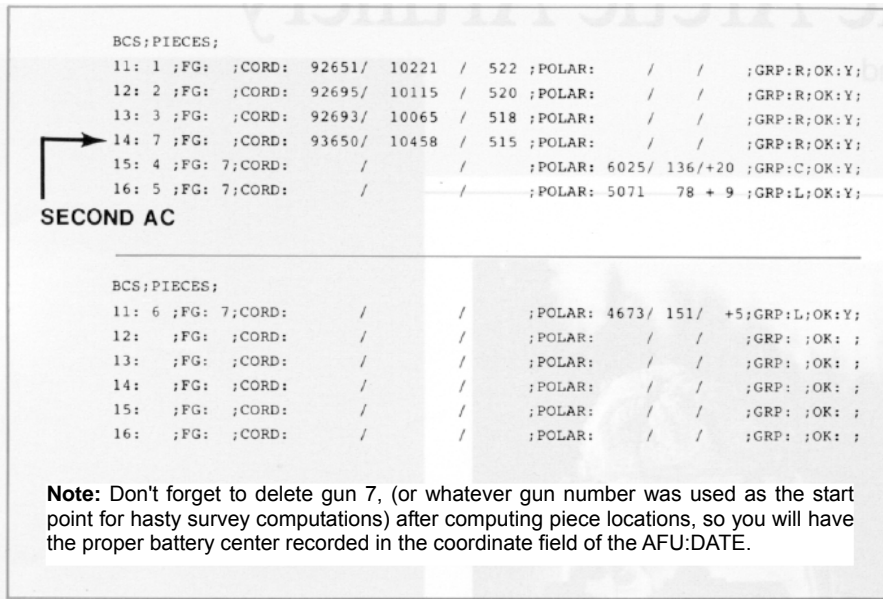

Figure 3. Gun 7 is the second aiming circle. Battery is fired as one fire unit.

fire direction center by several hundred meters of wire. As we began firing, the accuracy was excellent as all rounds impacted around the target area.

Subsequently we experienced a wire failure and were forced to revert

to our backup procedures. The guns in the firing platoon with the battery operation center (M561 BOC) were directed to place their terrain gun position corrections on their sights. The battery operation center established digital communications with

the fire direction center with a digital message device, and firing continued. For each mission the fire direction center would transmit a SYS;PTM with charge, deflection, quadrant, and time for the center gun to the battery operation center, who would then announce the fire commands to the guns over a voice land line. This procedure for split battery operations resulted in superb battery sheafs with minimum time delay in mission processing.

While it looks like high technology has infiltrated the Artillery Corps and is here to stay, here are four basic rules which can help you when dealing with the computer era:

- Use the computer as a tool; don't let yourself become its slave.
- Always put the mission first.
- Work at being innovative and practical.
- Use common sense.

It is important to remember that many of the best books are written based upon experience. Believe it or not!

Brett E. Morris
CPT, FA
APO NY

Computer Freebies

The Field Artillery Community is rapidly becoming fully automated in the area of fire control. The tactical fire direction system (TACFIRE), the battery computer system, and the back-up computer system have increased our accuracy and efficiency across the battlefield. Individual soldiers are quickly becoming computer literate as a result of courses taught at the Field Artillery School as well as by taking the personal initiative to purchase home microcomputers.

It behooves leaders to collect as much inexpensive or free software as they find useful without resorting to pirating copyrighted programs. But where does a leader go for public domain software? There are several options available.

- Free software can be obtained from your local computer club.
- It can also be obtained by tapping into certain services over the telephone lines. Of course, you need a modem

(a device which connects your computer to the telephone to exchange information digitally).

- Public libraries are beginning to stock public domain software. Nye Library on Fort Sill, for example, has over 550 free programs for the asking, and they have a computer that you can use by the hour.

- The best military programs can be found at Fort Leavenworth, Kansas, with the Command and Control Military User's Group (C²MUG).

The C²MUG is a central repository for free software with a military slant.

Members of C²MUG can:

- Learn about the latest developments in software.
- Contribute software ideas for Army use.
- Seek solutions to individual computer problems.
- Provide blank disks which will be loaded with public domain software and returned by mail.
- Get copies of the C²MUG Bulletin.

- Receive the semiannual software catalog of "freebies."
- Attend an annual microcomputer seminar at Fort Leavenworth.

There are over 200 systems in the C²MUG library. Membership is available to all Department of Defense personnel, both military and civilian. *The cost is absolutely nothing.* We also encourage you to share any software that you develop for microcomputers.

You can find the C²MUG at the Maneuver Control Directorate (Building 138) at Fort Leavenworth. To join the C²MUG, write to CECOM MCD, ATTN: AMSEL-FL-MCD (C²MUG), Fort Leavenworth, KS 66027-5600; or call AUTOVON 552-7550/7552.

Joseph Teeple
CPT, FA
Fort Sill, OK

Dogsled to SUSV—A New Prime Mover for the Arctic Artillery

by Captain Michael G. Edrington and
Captain Charles F. Gillis

At 0400 hours, 14 October 1984, the soldiers of the 1st Battalion, 37th (Arctic) Field Artillery responded to a recall. A mock war had begun, but this was no mere game for Alaska's only Redleg battalion. This was their *Superbowl*—an external evaluation of the unit's ability to perform in a wartime environment with the newly fielded prime mover, the M973 small unit support vehicle (SUSV). The subsequent evaluation proved what the Arctic gunners had anticipated: The tracked SUSV has virtually redefined the employment of artillery in an arctic environment.

Since that event, the SUSV has laid track in exercises across Alaska. Its performance has been nothing short of extraordinary. But it can be better. That's why the 1st-37th FA leadership has made several modifications to the SUSV. This article not only recounts the history of the SUSV, but also describes the 37th Field Artillery's adaptation and employment of this remarkable vehicle.

The Background

The earliest representatives of the US Army in Alaska relied on many forms of transportation in defense of the "Great Land." Of these, the best known and most widely used was the dogsled.

Since those early days, the prime mode of Army transport in Alaska has changed many times, but the *driving* factor regarding each of those changes has remained the *climate*. Unless a vehicle is mechanically reliable and has the ability to negotiate widely varying terrain under some of the harshest winter weather conditions in the world, it simply won't do in Alaska.

With the deletion of the M29 "Weasel" half-ton tracked cargo carrier in 1958, the Army began a



search for a new over-snow vehicle for support of extreme cold weather operations. To fulfill the Army's requirements for arctic operations, it was essential that the new support vehicle have excellent on- and off-road mobility, be easily maintainable, highly reliable in extremely cold weather, carry at least 1 ton of supplies, and be helicopter transportable.

Testing of various vehicles, including a joint American-Canadian development known as the SMJ71, continued for several years. Then in 1977 the Army became interested in a Swedish vehicle, the Bandvagn 202 (BV 202), manufactured by Volvo. The BV 202, already used by several North Atlantic Treaty Organization (NATO) countries, possessed excellent over-snow capabilities. Another Swedish vehicle, the Bandvagn 206 (BV 206), appeared to be a reasonable alternative to the BV 202.

A US Army team observed both vehicles during testing by the Swedish Army. They concluded that both vehicles exhibited the potential to fulfill the Army's requirement for an Arctic climate vehicle. Subsequently, the Army procured two vehicles of each model. In the testing that followed, the BV 206 proved superior, and in 1983 the Army negotiated a contract for nearly 300 BV 206s with the Hagglunds manufacturing firm. The official Army designation for the Bandvagn 206 became the M973 1½-ton tracked cargo carrier, what we now call the small unit support vehicle.

The SUSV consists of two plastic reinforced, fiber-glass compartments each mounted on a chassis with twin solid rubber tracks. An articulated steering joint joins the cabs. The front compartment contains the crew area as well as the engine which is readily accessible from the interior of the vehicle. The rear cab is heated and



The new support vehicle has excellent on- and off-road mobility year-round, is easily maintainable, and is highly reliable under extreme cold weather conditions.

serves as a cargo or troop carrier. A turbo-charged, five-cylinder Mercedes diesel engine provides the power for the SUSV.

The vehicle is capable of operating at speeds in excess of 30 miles per hour with a range of 120 to 200 miles depending on terrain. When traveling over deep snow, the SUSV tracks rarely sink more than a foot below the snow surface. And the vehicle will travel up to 150 miles cross-country at 10 to 15 miles per hour combat-loaded while towing a howitzer. The SUSV has the capability of climbing grades of up to 70 percent and has a bilge pump for swimming operations. The vehicle is capable of transporting 17 fully-equipped troops or a driver with over 2 tons of supplies. It is also air transportable in the C-130 aircraft and can be sling-loaded under a CH-47C helicopter.

Arctic Artillery Service

The 1st Battalion, 37th Field Artillery received its complement of M973 SUSVs during the summer of 1984. The new vehicles became the primary

transport for fire support teams (FIST) and survey parties; ammunition, supply, and communications support sections. They also serve as field ambulances, command and control vehicles, and, most importantly, as prime movers for the battalion's M101A1 105-mm howitzers.

SUSV TECHNICAL DATA

CURB WEIGHT: 9,790 lbs
 MAX WEIGHT: 13,980 lbs
 MAX PAYLOAD: 4,190 lbs
 MAX TOWED WEIGHT: 5,513
 FULL LOAD GROUND PRESSURE: 1.8 PSI
 MAX BRAKE HORSEPOWER: 125 at 4,350 RPM
 LENGTH: 270.8"
 HEIGHT: 94.56"
 WIDTH: 72.89"
 GROUND CLEARANCE: 11.82"
 TRACK WIDTH: 23.43"



With a towing weight of 5,510 pounds, the SUSV is capable of pulling the 5,000-pound M101A1 howitzer over any snow drift and most terrain.

Howitzer Section Prime Mover

As the howitzer section prime mover, the SUSV has increased the firing batteries' mobility over snow. The SUSV tracks across snow into which a 1½-ton truck would merely sink. With a towing weight of 5,510 pounds, the SUSV is capable of pulling the 5,000 M101A1 howitzer over any snowdrift and most terrain. The only obstacle to the SUSV is terrain with a heavy timber down-fall. In such cases, the only transportability option becomes air assault.

During emergency missions the SUSV allows the howitzer section to pull off the trail and be ready to fire in a few minutes. The vehicle's lower ground stance provides the howitzer section faster access to the towing pintle. The wide rear car door gives the crew greater accessibility to ammunition and equipment which is essential where timeliness is at a premium.

Battery Fire Direction Center Vehicle

The fielding of the battery computer system (BCS) brought some unique problems to the 1st-37th FA. The BCS and the battery fire direction personnel had to be able to accompany the howitzers. The battalion's leadership concluded that they needed a SUSV as the fire direction center's prime mover. Unfortunately, they had no installation kit available to fit the BCS into the SUSV. To solve this problem, the battalion sent a team to Fort Monmouth, New Jersey, to develop and fabricate an appropriate installation kit. The end result was that the BCS has been installed along with communications equipment in the rear car of the SUSV. This allows the operator to sit in the door and compute data.

With the BCS installed in the rear car of the SUSV, there was no room for other section operations. But that didn't stop the gunners of the 1st-37th FA. When the SUSV was first fielded, they developed an extension suitable



for use as infantry and artillery battalion tactical operations centers (TOC) and battery fire direction centers. The final product employed the lighter weight 10-man Artic canvas to allow ease in set-up and tear-down operations during extreme ice and cold. Local seamstresses moved the vestibule door to accommodate the SUSV door and tailored each tent corner to accommodate a Yukon stove. Furthermore, 1st-37th innovators developed a special entry mechanism so the SUSV could back into and away from the extension leaving it freestanding and light-secure. The framework of the extension was a standard M577 extension frame obtained through normal supply channels.

The battery computer system SUSV has improved the battalion's split battery capability dramatically. The vehicle's mobility and the computer's capability let it go virtually anywhere and compute data for widely disposed gun sections. The battery operations center also uses a SUSV.

Fire Support Team SUSV

The SUSV serves as a communications platform for fire support team operations.

The unit's battery computer system is housed along with communications equipment in the rear car of the SUSV. The outside view of the vehicle is shown above.



Preparing to fire is Battery B, 1st Battalion, 37th Field Artillery. The SUSV has ushered in a new era in the employment of Arctic artillery.

The vehicle can transport the entire company fire support team over almost any terrain. Because the SUSV bodies are made of fiberglass, they afford soldiers little protection against attack by even the lightest weapons; but the cars do provide a warm vehicle capable of getting rested soldiers to the fight quickly. The brigade and battalion fire support coordinator SUSV serves as an integral part of the infantry tactical operations centers. A SUSV extension connects to the battalion S3's SUSV extension thus allowing a third infantry SUSV to be used as a jump tactical operations center.

Captain Michael G. Edrington, FA, is the Adjutant of the 1st Battalion, 37th Field Artillery, Fort Richardson, Alaska. He was commissioned through ROTC at the University of California at Davis. He has served in the 1st-37th FA as an infantry battalion fire support officer, battery fire direction officer, and company fire support officer. He has also served as deputy public affairs officer and as a basic training executive officer at Fort Jackson, South Carolina. Captain Edrington is a graduate of the Field Artillery Officer Basic Course; Airborne School; and the Public Affairs Officer Course at the Defense Information School, Fort Benjamin Harrison, Indiana.

Conclusion

The advent of the M973 SUSV upon the Alaskan scene has ushered in a new era in Arctic mobility. Its widespread employment, coupled with the recent activation of the new 6th Infantry Division (Light), has set the stage for new and exciting tactics in the frigid lands of the North. The Arctic artillery has made a commitment to lead the way in the adaption of the SUSV for use by the King of Battle. And to date, the battalion is making good its commitment. *On The Minute!*



Captain Charles F. Gillis, FA, is the S4 of the 1st Battalion, 37th Field Artillery. He was commissioned through ROTC at the University of Maine and is a graduate of the Field Artillery Officer Basic and Advanced Courses as well as the Lance Missile Officer Course. His past assignments include Lance missile maintenance and assembly platoon leader, executive officer at a warhead detachment with a British missile regiment in Germany, and as an infantry battalion fire support officer. Captain Gillis is currently serving his second tour in Alaska.



The SUSV gets warm, rested soldiers on the move and to the fight quickly. The vehicle can transport the entire company fire support team over almost any terrain.

Photo by CPT Michael G. Edrington

ARMY ACQUISITION— FROM CONCEPT TO DISPOSAL

by Major Thomas H. Barfield

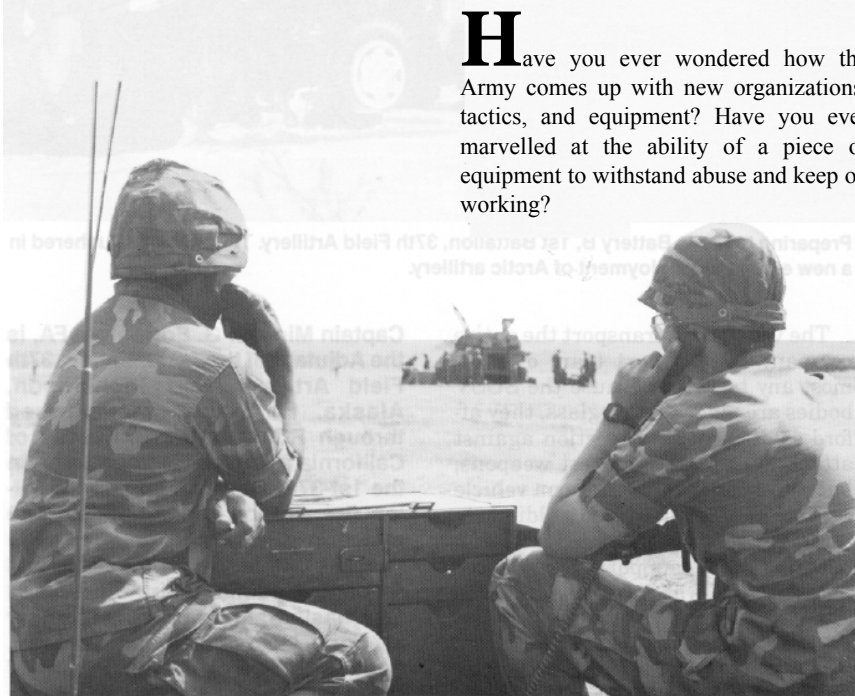

Have you ever wondered how the Army comes up with new organizations, tactics, and equipment? Have you ever marvelled at the ability of a piece of equipment to withstand abuse and keep on working?

(JSPD), which not only projects technological advances in Soviet and other foreign military hardware and changes in Warsaw Pact strategy, but also assesses the ability of our Allies to engage in mutual defense. The JSPD and several other documents are the springboards for change.

But of the various avenues of change available, the Army leaders regard materiel acquisition as the least desirable recourse when countering a new threat. They prefer to modify doctrine, change the way we train, or alter the way we structure units. For example, the use of special forces groups in a low intensity conflict epitomizes a doctrinal change to meet a threat to US interests in Central America, South America, and Africa. The upgrade of field artillery groups to brigades is a force structure change dictated by the "agility" component of our AirLand Battle doctrine.

Life Cycle Systems Model

But when doctrinal, force design, and training changes fail to deal with the evolving threat, the Army turns to the Materiel Development and Acquisition Community and ultimately to the associated life cycle system management model which takes a raw idea and eventually turns it into hardware. The life cycle management model also provides a system for monitoring the Army's developing materiel.

Under this complex system, the genesis of any change in materiel is a requirement: a statement describing a *need*. In materiel acquisition, the initial requirement expresses the need in tactic not equipment terms. A requirement merely identifies a specific deficiency in our existing capability. The acquisition process will determine the best equipment solution to meet that need.

The mechanism that brings concepts to fruition in the Army is the concepts based requirements system (CBRS). Combat, materiel, and training developers use it to design the structure of our forces, the shape of our hardware, the logic of our doctrine, and the foundation of our training.

The bedrock of the CBRS is a thorough assessment of the threat to US national interests as far as 20 years into the future. This analysis does not focus on war in Europe alone; rather it examines the entire spectrum of war from terrorism on one extreme to global thermonuclear war on the other. In fact, the continuing review of the Threat produces a series of semiannual documents which chart a course that responds to the greatest threat to national political and economic security.

One of these studies is the annual joint strategic planning document



The Army acquisition system depends largely on deficiencies identified during soldier training.

Actual requirements result from studies conducted by the 13 Army organizations charged with responsibilities for periodic mission area analyses. These analyses assess the capability of an area such as fire support. The analyses seek to discover deficiencies in doctrine, organizations, training, and materiel and to identify means for correcting these deficiencies.

After identifying a deficiency through a mission area analysis, combat developers prepare an operational and organizational (O&O) plan. Once the O&O plan is approved, the Army Materiel Command will assess the most likely cost. If they anticipate a solution to the deficiency will cost in excess of \$200 million for research and development or \$1 billion for procurement, they must prepare an additional requirements document—a justification of a major system new start. This comment notifies the Secretary of Defense that the Army envisions a necessary program which will consume a significant portion of the defense budget in the coming years. The Secretary of Defense must approve any such high-dollar initiative. All other lower-cost programs receive a detailed analysis at Headquarters, Department of the Army. Once approval is obtained to start and Congress has authorized the appropriate funds, the materiel acquisition process begins.



Looming large in the planning of new or improved field artillery equipment is the need. Often, merely changing the way we train can circumvent unnecessary developmental costs.

The life cycle model which governs the subsequent developmental course reflects, first and foremost, the acquisition policy of our government. The Federal Acquisition Regulation prescribes the way in which the Services will award contracts and maintain competition. In fact, all branches of the government are bound by this regulation. Moreover, Army materiel acquisition is subject to intense Congressional oversight. Like it or not, politics are often involved in the development of Army equipment.

Besides reflecting governmental policy, the life cycle model is also a management tool which outlines the procedures for developing, testing, purchasing, deploying, using, and disposing of military equipment. The life cycle model forms a master plan which divides the life of a system into four distinct management phases.

- Concept exploration.
- Demonstration and validation.
- Full-scale development.
- Production and deployment.



The wide variances in climatic conditions faced by soldiers make it vital for equipment to withstand the rigors of the heat and cold.

CONCEPT EXPLORATION

AFATDS
FIREFINDER II
MLRS SADARM AFAS

DEMONSTRATION AND VALIDATION

MLRS TERMINALLY GUIDED
WARHEAD
(TGW) ROUND
MLRS BINARY CHEMICAL
WARHEAD
(BCW)

FULL-SCALE DEVELOPMENT

ATACMS
CANNON HIP
RPV

PRODUCTION AND DEPLOYMENT

FIREFINDER
MLRS (BASIC)
PERSHING II

The developmental stages of various field artillery systems.

Definitions of Terms

ASARC – Army system acquisition review council. Provides advice and assistance to the Secretary of the Army.

BOIP – basis-of-issue plan.

CFP – concept formulation package. This document summarizes the results of the concept exploration phase.

DGP – decision coordinating paper. A decision paper for the Secretary of Defense that gives the reason for continuing, reorienting, or stopping a development program at each critical decision point during the acquisition process.

DSARC – defense system acquisition review council.

DT – developmental testing. Testing of materiel systems conducted by the materiel developer.

FUED – first unit equipped date.

IOC – initial operational capability. The date a unit and its supporting elements are able to operate and support a new item of equipment.

IPS – integrated program summary. Summarizes the various facets of the implementation plan for a major system acquisition.

JMSNS – justification of major system new start.

LOA – letter of agreement.

MAA – mission area analysis.

MFP – materiel fielding plan.

O&O plan—operational and organizational plan. The O&O plan is the program

initiation document in the materiel acquisition process. It is prepared to support the acquisition of all new materiel systems. The initial O&O plan should describe any deficiencies which were identified in the mission area analysis and any constraints applicable to systems development.

OT—operational testing. Testing and evaluation of materiel systems accomplished with typical user operators, crews, or units in as realistic and operational environment as possible.

PM—project manager—program manager—product manager. An individual, chartered by the Secretary of the Army, who is assigned the responsibility and delegated the full-line authority of the materiel developer for the centralized management of a specific acquisition of a materiel readiness project.

PMD – program management document. A document which contains records of program decisions and requirements. It provides analyses of technical options and the life cycle plans for developing, producing, training, and supporting materiel items.

POM—program objective memorandum. An annual document submitted to the Office of the Secretary of Defense containing the Army's proposals for resource allocation. It describes the forces, manpower, materiel acquisition equipment distribution, and logistics support needed by the Army to meet the strategy and objectives.

RFP – request for proposal.

ROC – required operational capability. A Department of the Army document which states concisely the minimum essential

operational, technical, logistical, and cost information necessary to initiate full-scale development or acquisition of a materiel system.

SCP – system concept paper. The decision management documentation prepared for the Milestone I decision.

SDDM—Secretary of Defense decision memorandum.

STF—special task force. Composed of the task force director, representatives of the user, materiel developer, trainer, Department of the Army, combat developer, operational tester, logistician, and the program manager-designee. This task force is convened during the concept exploration phase to conduct an in-depth investigation of the need for the system described.

TBOIP – tentative basis-of-issue plan.

TDLOA – training device letter of agreement. A jointly prepared document in which the combat and materiel developers outline the basic agreements for further investigations of a potential materiel system or its training devices.

TDR – training device requirements.

TEMP – test and evaluation master plan.

TOE – table of organization and equipment.

TQQPRI – tentative qualitative and quantitative personnel requirements information. A tentative plan developed by the materiel developer in coordination with the combat developer and trainer which identifies personnel, military occupational specialty, and annual maintenance manpower required to support the new or improved materiel system.

Concept Exploration

During *concept exploration* a special task force examines the requirement, develops a long-range acquisition strategy, and initiates systems engineering programs to devise several viable but competing solutions to the requirement. The leadership of the Army Materiel Command establishes centralized management immediately after initiation.

However, Army practice is to wait until a specific type of system emerges as the best solution from the competing alternatives before selecting the project manager.

The goal of concept exploration is to select two or more concepts to be developed into prototypes for a competitive "shoot-off." Concept exploration culminates in Milestone 1—the point where the Army system

acquisition review council (ASARC) decides to terminate or proceed with the program. For projects reviewed by the Secretary of Defense, a defense system acquisition review council (DSARC) follows the Army council.

There are two possible outcomes of a Milestone 1 decision: *cease* work or *continue* work. Most often, if the decision is to cease work it is because the concept being explored has dropped in

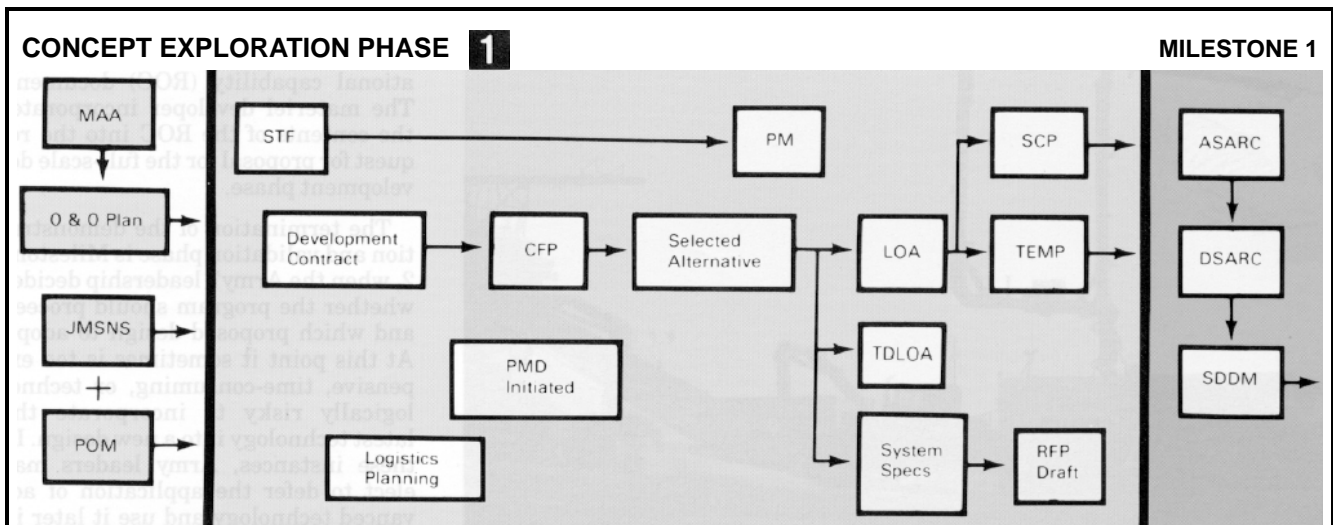

priority compared to other programs and, therefore, has lost funding.

Three documents result from the concept exploration phase.

- A system concept paper which is a summary of all the program management documents.
- A test and evaluation master plan which identifies the required testing, personnel, materiel, facilities, troop support, logistic support, and funds necessary to complete the test programs.
- A draft request for proposals—a critical document in the competitive selection of the contractors who will compete against each other in the next

phase of the life cycle.

Demonstration and Validation

In the *demonstration* and *validation* phase, the Army Materiel Command awards contracts for system development, testing, drawings, specifications, and other engineering data. Most of these research and development contracts call for cost reimbursement as opposed to fixed-price remuneration. This

arrangement is necessary because of the high technical risks associated with research and development.

The newly appointed project manager faces many challenges during this phase of the life cycle. For example, he must determine how much money should be spent on logistics, how many competitors receive contracts, and how much testing is adequate. He makes the decisions based upon data, experience, and a host of decision-making models available. He seeks to reduce risk but to produce the best possible system as quickly and economically as possible.

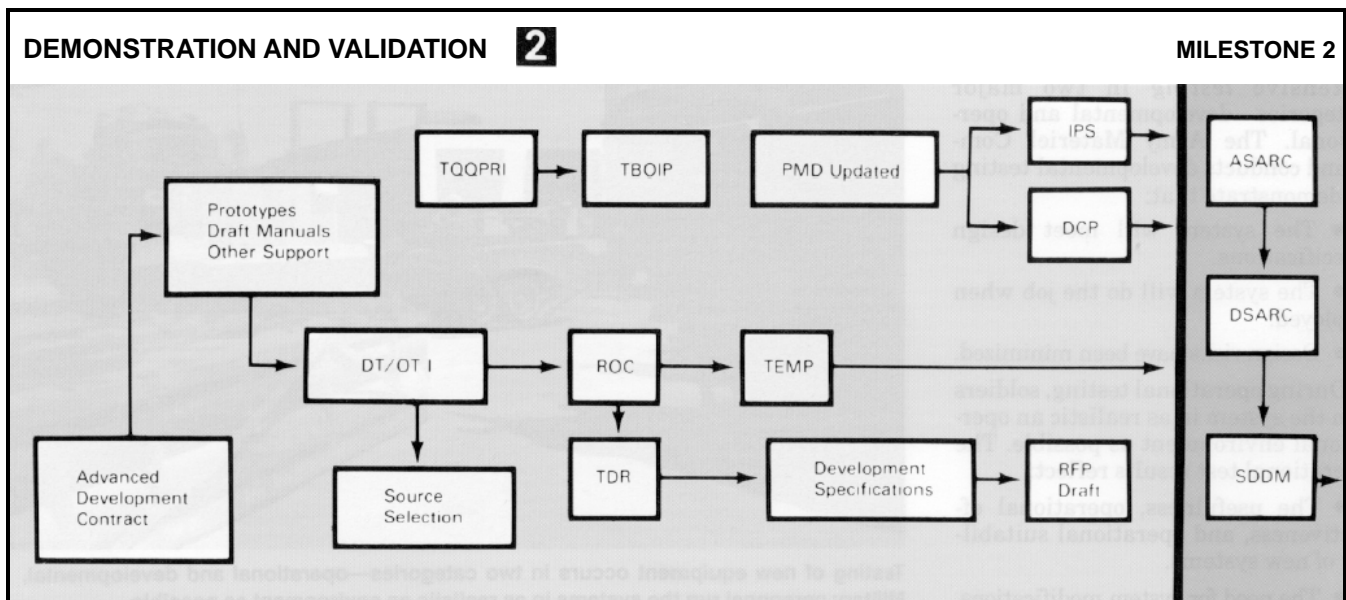



During the demonstration and validation phase, contract developers and the project manager conduct operational tests of new equipment like the remotely piloted vehicle.

Two very important events occur during the demonstration and validation phase. Combat developers publish the first tentative *personnel requirements* for the system, and the project manager oversees the first *development* (DT1) and *operational tests* (OT1) of the system. The personnel requirements allow all concerned agencies to project the number and kind of military occupational specialties necessary throughout the life of the equipment as well as the training and barracks facilities needed. The tests put prototype systems through their paces.

All acquisition programs involve extensive *testing* in two major categories—developmental and operational. The Army Materiel Command conducts developmental testing to demonstrate that:

- The system will meet design specifications.
- The system will do the job when deployed.
- Design risks have been minimized.

During operational testing, soldiers run the system in as realistic an operational environment as possible. The operational test results reflect:

- The usefulness, operational effectiveness, and operational suitability of new systems.
- The need for system modifications.

- The user's preference from among available prototypes.
- The adequacy of doctrine, organization, operating techniques, tactics, training for employment, maintenance support, and performance in the presence of countermeasures.



Testing of new equipment occurs in two categories—operational and developmental. Military personnel run the systems in as realistic an environment as possible.

After examining test reports and updated Threat forecasts, the combat developer prepares the required operational capability (ROC) document. The materiel developer incorporates the contents of the ROC into the request for proposal for the full-scale development phase.

The termination of the demonstration and validation phase is Milestone 2, when the Army's leadership decides whether the program should proceed and which proposed design to adopt. At this point it sometimes is too expensive, time-consuming, or technologically risky to incorporate the latest technology into a new design. In these instances, Army leaders may elect to defer the application of advanced technology and use it later in preplanned product improvements (P³I).

At the end of demonstration and validation phase, the Army evaluates the competing prototypes and selects a contractor based upon the source selection process. The winning contractor may be required to provide developmental specifications and drawings commensurate with the type of work done.

Full-Scale Development

The goal of full-scale development is a production-ready prototype. During this phase:

- Soldiers receive training on the system and assess the method and adequacy of their training.
- Army and contractor teams develop product specifications.
- A second operational test occurs to determine any additional weaknesses in materiel, organizational structure, or training.
- Personnel requirements are updated and a fielding plan is produced.

Full-scale development ends with a third and final milestone decision review. Based on this review, the Army's leaders

decide whether or not to produce and field the system. Ideally, the result is the release of a request for proposals to various contractors for the actual production of the system. In practice, however, the same contractor used for full-scale development usually captures the contract for production.

Production and Deployment

Production and deployment begins with an approval at Milestone 3, continues throughout the operational life of the weapon system, and ends when the last item goes to the scrap yard. Production occurs when the system's

design is relatively stable, money is available, and there is a valid need for the system.

As the pieces of equipment leave the assembly line, they go to selected Army units on a priority basis. Normally, the first items reach schools where operators and mechanics receive their training. The second production batch will go to a field unit having the highest priority as determined by the Army's Deputy Chief of Staff for Operations and Plans.

To assist the user receive and deploy the new systems, the materiel developer will prepare and coordinate a materiel fielding plan. During the fielding process the project manager supervises the distribution of support items—parts, manuals, training devices, test equipment, and so on—and

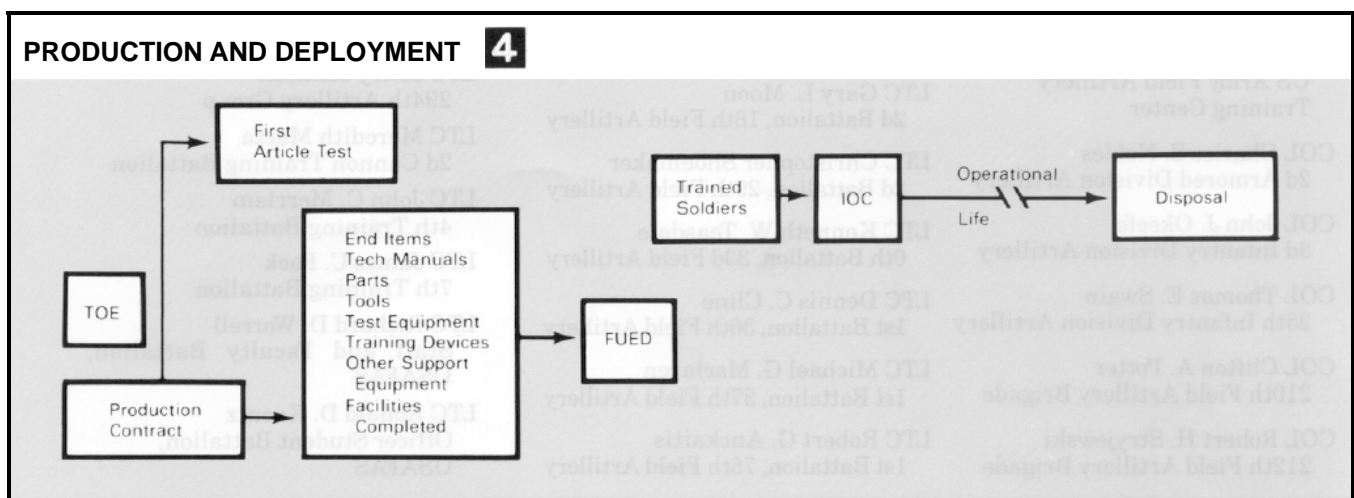
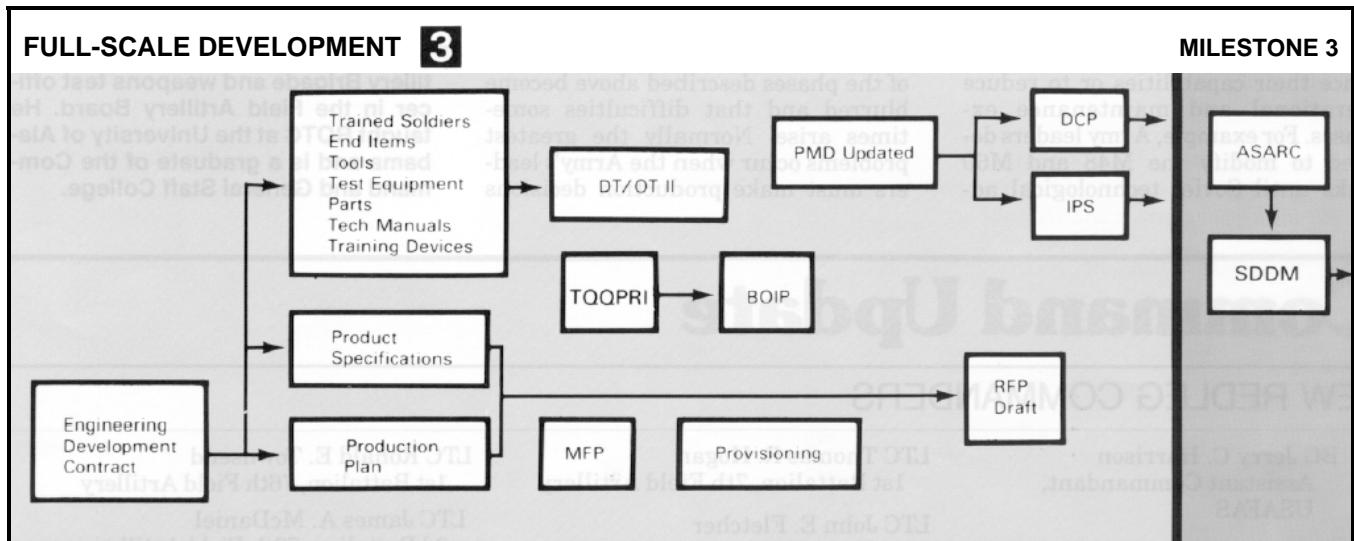

the development of new equipment training teams. His aim is to achieve the initial operational capability on schedule. Typically, the time between the unit's initial receipt of equipment and its initial operational capability date is the time needed to train a unit to Army training and evaluation program standards.

Operational Life

The operational life of a system occurs from the initial operational capability date until disposal of the system. The duration of a system's operational life depends on whether the system continues to meet a valid threat and is still affordable.

We have systems that are over 40 years old and yet continue to fulfill a need. But most systems have had a much shorter life. They have required periodic modifications in order to enhance their capabilities or to reduce operational and maintenance expenses. For example, Army leaders decided to modify the M48 and M60 tanks until Soviet technological advances

made it apparent that we needed a completely new tank. This increased threat prompted the Army to develop the M1 tank.

Disposal of a weapon or piece of equipment occurs after Army leaders decide we have no further use of that particular system. In such instances, the Army offers the system to our sister services. If they have no use for the equipment, it becomes a candidate for foreign military sales. Should the State Department, Congress, or the President decide it is not in the best interest of the United States to sell the weapon, the item is demilitarized.

Conclusion

This has been a cursory and simplified overview of the life cycle model by which the Army acquires materiel. Professionals must realize that often the left and right boundaries of each of the phases described above become blurred and that difficulties sometimes arise. Normally the greatest problems occur when the Army's leaders must make production decisions

very early in the life of a system. Such decisions naturally constrain subsequent events and developments. But Congressional pressure and a rapidly changing Threat can often force such risk laden decisions. But when all is said and done, the life cycle system management model is a good one. It has helped the Army deliver thousands of first-rate weapon systems into the hands of the world's best troops. 

Major Thomas H. Barfield, FA, is currently the Executive Officer of the 2d Battalion, 37th Field Artillery, Fort Sill, Oklahoma. He received his commission through ROTC at Vanderbilt University. He has held assignments as the adjutant of the 212th Field Artillery Brigade and weapons test officer in the Field Artillery Board. He taught ROTC at the University of Alabama and is a graduate of the Command and General Staff College.

Command Update

NEW REDLEG COMMANDERS

BG Jerry C. Harrison Assistant Commandant, USAFAS	LTC Thomas R. Hogan 1st Battalion, 7th Field Artillery	LTC Ronald E. Townsend 1st Battalion, 76th Field Artillery
BG Gerald P. Stadler III Corps Artillery	LTC John E. Fletcher 1st Battalion, 8th Field Artillery	LTC James A. McDaniel 3d Battalion, 79th Field Artillery
COL Jerry M. Sollinger US Army Field Artillery Training Center	LTC Everett E. Hawthorne, Jr. 1st Battalion, 17th Field Artillery	LTC Terrance D. Barcellos 2d Battalion, 83d Field Artillery
COL Charles S. Nobles 2d Armored Division Artillery	LTC Gary L. Moon 2d Battalion, 18th Field Artillery	LTC Jeffry Johnson 294th Artillery Group
COL John J. Okeefe 3d Infantry Division Artillery	LTC Christopher Shoemaker 2d Battalion, 29th Field Artillery	LTC Meredith Mazza 2d Cannon Training Battalion
COL John J. Okeefe 3d Infantry Division Artillery	LTC Kenneth W. Teasdale 6th Battalion, 33d Field Artillery	LTC John C. Merriam 4th Training Battalion
COL Thomas E. Swain 25th Infantry Division Artillery	LTC Dennis C. Cline 1st Battalion, 36th Field Artillery	LTC James C. Pack 7th Training Battalion
COL Clifton A. Potter 210th Field Artillery Brigade	LTC Michael G. Maclaren 1st Battalion, 37th Field Artillery	LTC Richard D. Worrell Staff and Faculty Battalion, USAFAS
COL Robert H. Stryjewski 212th Field Artillery Brigade	LTC Robert G. Anckaitis 1st Battalion, 75th Field Artillery	LTC Ronald D. Koontz Officer Student Battalion, USAFAS

Liquid Propellants— A Potential Power Punch

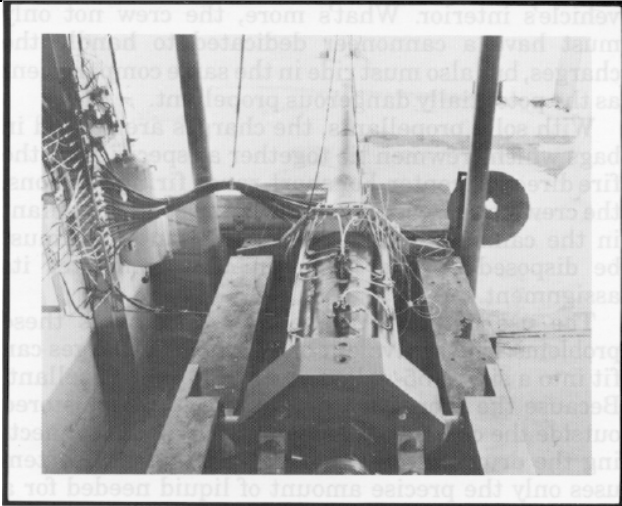

by Mr. Bob Lessels

The Army's Ballistic Research Laboratory (BRL) is conducting research into liquid propellants for Army tank and artillery ammunition. Program managers believe that their efforts may lead to a revolution in armored vehicle design, ammunition handling, logistics, and combat crew safety—not to mention billions of dollars in savings.

Army studies on liquid propellants began in the late 1940s when researchers looked at two systems using liquid propellants. The first system, commonly termed bulk-loaded, simply involved injecting a specified amount of propellant into a gun chamber and igniting it. This system proved to be impractical in weapons where repeatability is important. Chamber pressures and muzzle velocities of the projectiles varied significantly due to hydrodynamic instabilities in bulk-loaded systems. Today, experts see little potential for this form of liquid propellant guns, except perhaps as air defense cannons or small caliber weapons.

The second system, known as regenerative injection, is much more promising. It involves using a piston to force the liquid propellant in the form of a jet or spray into the gun chamber during the combustion process. The result is a controlled burn. With this system, the liquid propellant can be metered accurately, and repeatable pressures and muzzle velocities can be achieved.

Exploration of both systems accelerated as a result of the Korean War, and by the mid-1950s the Army was exploring the design of a tank gun based on a liquid propellant concept. However, 1950s technology proved lacking and the program languished.

EVOLUTION OF PROPULSION CONCEPTS

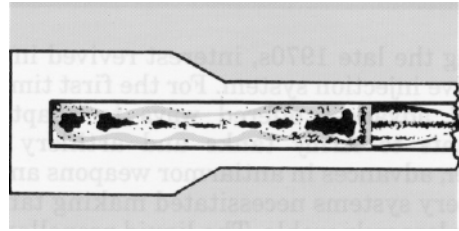

LP BULK LOADED

- SIMPLE
- BUT**
- DIFFICULT TO CONTROL

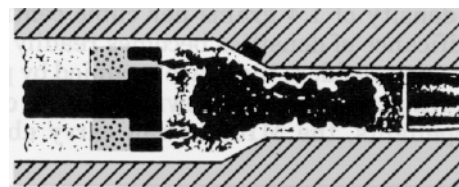

REGENERATIVE INJECTION

- BALLISTIC CONTROL
- BUT**
- MECHANICALLY COMPLEX

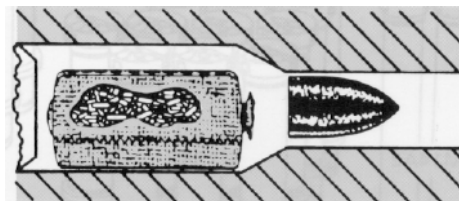

SOLID PROPELLANT

- UNDERSTOOD
- BUT**
- MATURE

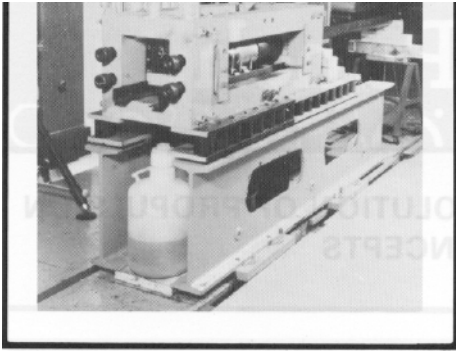

During the late 1970s, interest revived in the regenerative injection system. For the first time, technological advances offered ways to adapt liquid propellants to Army tanks and artillery pieces. Moreover, advances in antiarmor weapons and counterartillery systems necessitated making tanks and artillery less vulnerable. The liquid propellant gun's time had evidently arrived. In fact, the new technology promises to deliver tanks and artillery systems that are smaller, faster, and less vulnerable to enemy threats.

Because liquid propellants have a high density, they pack more energy into a smaller volume. Typically, solid propellants have a 1 gram per cubic centimeter packing density, but liquid propellants have a packing density of 1.4 grams per cubic centimeter. The significance of densities becomes readily apparent when one considers the space occupied by propelling charges in the M109A2 howitzer.

Using current solid propellants, the M109A2 can carry about 34 propellant charges for its projectiles. Each charge is in an individual canister which can weigh as much as the propellant itself. The 32 canisters (the M3A1 charge is packed two per canister) occupy much of the vehicle's interior. What's more, the crew not only must have a cannoneer dedicated to handle the charges, but also must ride in the same compartment as the potentially dangerous propellant.

With solid propellants, the charges are packed in bags which crewmen tie together as specified by the fire direction center. For short-range firing missions, the crewmen discard a portion of the solid propellant in the canister. This wasted propellant then must be disposed of after the gun crew completes its assignment.

The use of liquid propellants eliminates these problems. The equivalent of 34 M119A1 charges can fit into a single 55-gallon drum of liquid propellant. Because the propellant is a liquid, it can be stored outside the crew compartment, with a hose connecting the drum to the artillery piece. Such a system uses only the precise amount of liquid needed for a particular range, thereby eliminating the waste found with solid propellants. And, because the liquid passes directly into the gun chamber automatically, the need for an extra crewman to handle the propellant disappears. Although readily ignitable at gun chamber operating pressures, liquid propellants are difficult to ignite at ambient pressures. Their use in combat vehicle munitions should minimize vehicle loss which may occur as the result of projectile and spall impact on stowed solid propellants.

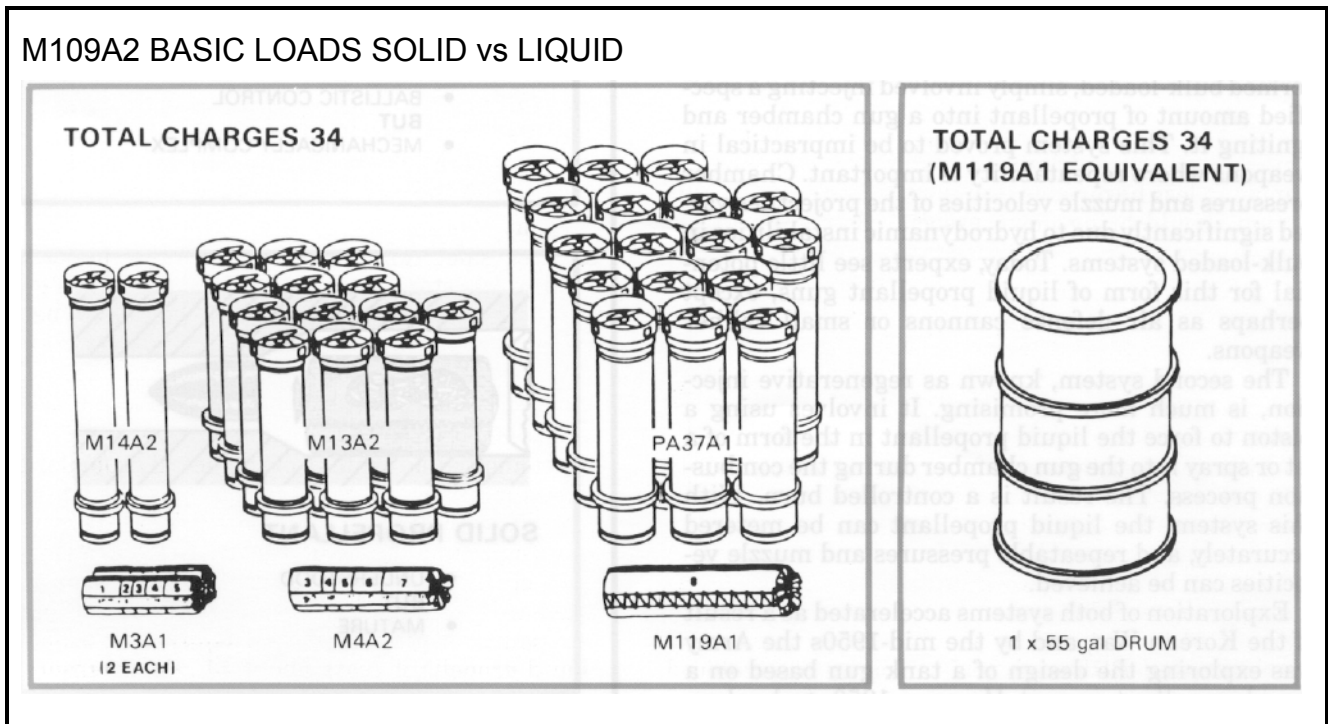

OPERATIONAL IMPACT

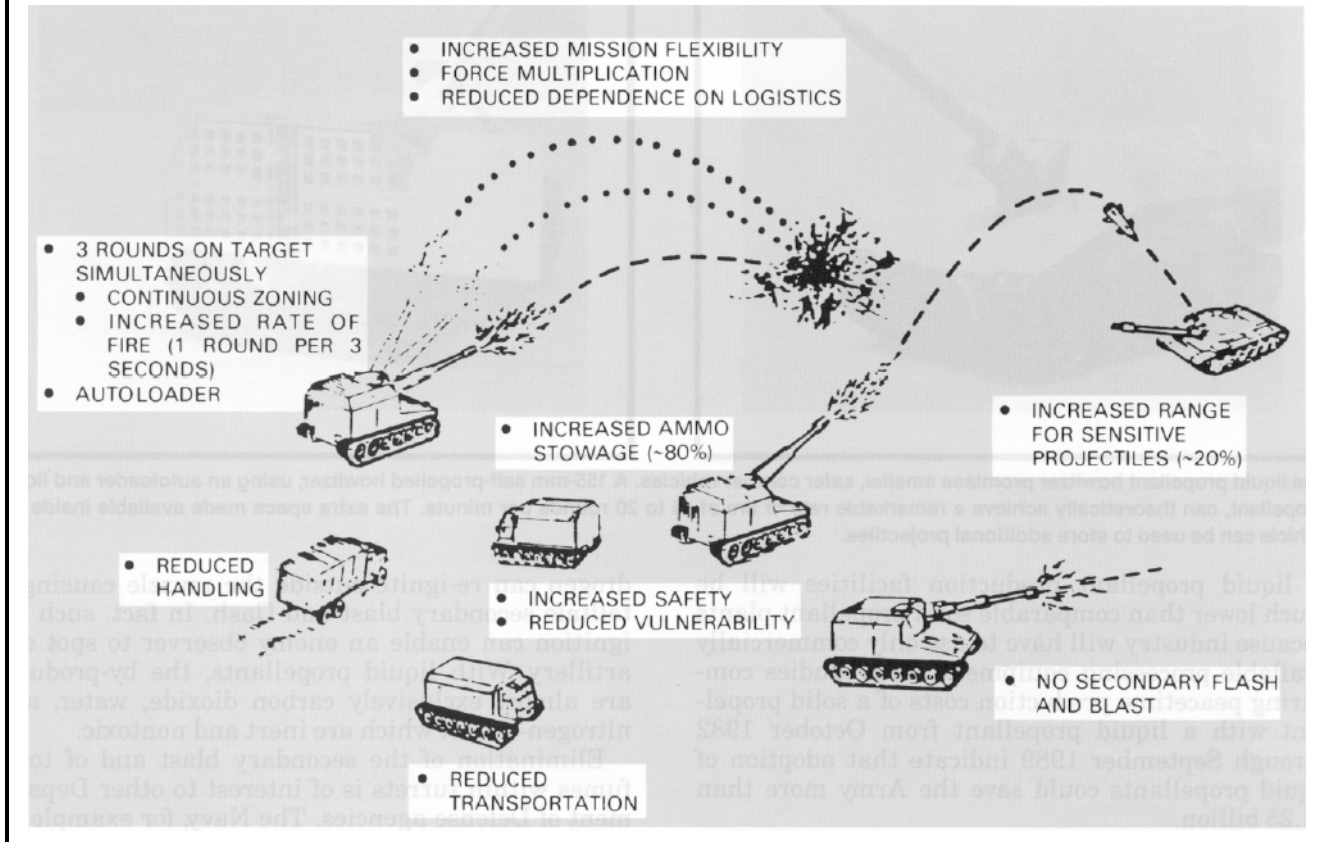

An additional benefit associated with liquid propellants involves transportation of the chemicals. Federal and state laws strictly govern the transportation of solid propellants. Many bridges and tunnels cannot be used, and transportation routes must avoid highly populated areas. Such restrictions may not apply to less hazardous liquid propellants. This situation should bring down associated transportation costs.

In fact, because the components of the liquid propellants are not propellants by themselves, they can be transported much more freely and with far greater safety. Once the chemicals arrive at their storage depot, they can be kept in complete safety for an indefinite period.

Like transportation safety, vehicle vulnerability on the battlefield is also a major concern. Studies of vehicles destroyed in the 1973 fighting in the Middle East suggest that most vehicle losses resulted when the impact of antiarmor munitions triggered a secondary explosion of the ammunition carried in the vehicle. If the vulnerability of on-board ammunition is eliminated, BRL analysts feel many more armored vehicles hit by enemy weapons can be repaired and returned to action.

More significantly, liquid propellants promise to *save*

the *lives* of crewmen. Experience suggests that if the on-board ammunition explodes, few vehicle occupants usually survive. If an antiarmor round should penetrate a vehicle carrying liquid propellants, only those soldiers caught in the small spall cone of fragments from the antiarmor weapon would be injured.

What this means for the Army of the future is smaller, safer combat vehicles. The propellant will require *less* storage space and *fewer* crewmen to handle it. The vehicles could not only be lighter because armor can be concentrated to protect the crew, but also faster because the lighter weight of the vehicle can be propelled with less demand on the engine's available horsepower.

Yet another advantage of the liquid propellant system is its potential cost savings. The system can be retrofitted to existing combat vehicles thereby reducing production costs. But even more significantly, the costs of the propellant will please most taxpayers. A standard packaged artillery charge costs about \$60 per pound of propellant. An equivalent amount of liquid propellant costs about \$1. Furthermore, the raw materials used in the production of liquid propellants are available commercially. Therefore, the cost



The liquid propellant howitzer promises smaller, safer combat vehicles. A 155-mm self-propelled howitzer, using an autoloader and liquid propellant, can theoretically achieve a remarkable rate of fire of 15 to 20 rounds per minute. The extra space made available inside the vehicle can be used to store additional projectiles.

of liquid propellant production facilities will be much lower than comparable solid propellant plants because industry will have to use only commercially available processing equipment. BRL studies comparing peacetime production costs of a solid propellant with a liquid propellant from October 1982 through September 1989 indicate that adoption of liquid propellants could save the Army more than \$1.25 billion.

In wartime if ammunition demands reach levels projected by the Army, the potential savings would be enormous. Basing their study on 155-mm ammunition alone, the researchers projected monthly savings of about \$200 million.

Of course, the real test of new weapons technology is its effectiveness on the battlefield. A 155-mm self-propelled howitzer, using an autoloader and liquid propellant, can theoretically achieve a remarkable rate of fire of 15 to 20 rounds per minute. Adjusting fire onto a target would be easier using liquid propellants because the amount of propellant used to launch the projectile can be metered more accurately than when using solid propellants. In fact, the "right" propelling charge is always there. Also, the extra space made available inside the vehicle can be used to store additional projectiles. The cannon can put *more* firepower on target *faster*, and it will be able to carry more projectiles which will reduce logistic support requirements.

Another concern for artillery crews deals with blast pressures near the cannon. Liquid propellants reduce the blast over-pressures caused by re-ignition of muzzle gases. Contemporary solid propellants produce carbon monoxide, hydrogen, carbon dioxide, water, and nitrogen oxides at the muzzle. Several of these gases are toxic, and carbon

monoxide and hydrogen can re-ignite outside the muzzle causing a telltale secondary blast and flash. In fact, such re-ignition can enable an enemy observer to spot our artillery. With liquid propellants, the by-products are almost exclusively carbon dioxide, water, and nitrogen—all of which are inert and nontoxic.

Elimination of the secondary blast and of toxic fumes within turrets is of interest to other Department of Defense agencies. The Navy, for example, is investigating the use of liquid propellant gun systems on its warships. They too realize the technology offers greater safety to gun crews as well as reduced danger to crewmen outside the weapon's turret. What's more, liquid propellants also reduce the need to protect ammunition storage areas with heavy armor.

Implementation of the liquid propellant technology is still 4 to 5 years in the future. Experts have proven the concept using 30-mm cannons. In fact, General Electric Company has independently demonstrated a rate of fire of about 500 rounds per minute in such a weapon. BRL researchers are now working not only to scale this technology to 155-mm caliber but also to establish the shelf life of the propellant. Even the disposal or demilitarization of the liquid propellant offers an unusual advantage. The simplest and most beneficial way of getting rid of waste stocks of a propellant may be to dilute it with water and pour it onto any farm field. BRL chemists report that the propellant is an excellent fertilizer!



Mr. Bob Lessels is a member of the media relations team at the US Army Test and Evaluation Command, Aberdeen Proving Ground, Maryland.

Shooting from the HIP— A Change in Concepts

by Mr. Robert M. Forrest

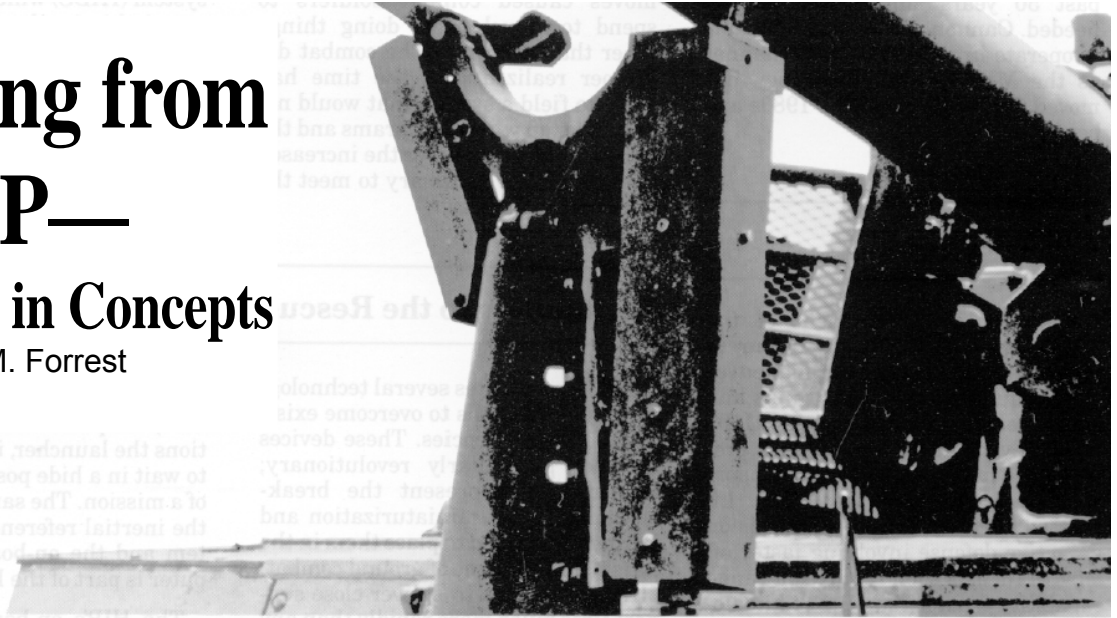

Sam Orr

The howitzer improvement program enables a single self-propelled howitzer to drive into an area, stop, fire an emergency mission, move a short distance, and then fire again without anyone leaving the cab of the howitzer. The improved cannon will operate in much the same manner as the multiple launch rocket system.

Artillerymen attending one of the new system demonstrations at Fort Sill's Moway House over the past few years witnessed several phenomena which herald a revolution in the business of fire support. Most observers draw a deep breath as the multiple launch rocket system (MLRS) and Copperhead provide spectacular evidence of new developments. In fact, few Redlegs will forget the awesome inferno of an MLRS ripple streaking off toward Quanah Range or the instantaneous destruction of a target on Signal Mountain by a single Copperhead. But the truly thoughtful observers are even more impressed by the least spectacular part of the demonstration: a single self-propelled howitzer which drove into an open area, stopped, fired an emergency mission, and then moved a short distance and fired again. What amazed the onlookers about this hipshoot was that no one left the cab of the howitzer—no collimator was emplaced, no gunnery sergeant stood by his aiming circle shouting "Battery adjust; aiming point this instrument!" The howitzer simply stopped and began delivering accurate indirect fire.

What the audience saw was the Human Engineering Laboratory's (HEL) Howitzer Test Bed III (HTB III). This howitzer contained prototype equipment that presaged the dramatically improved M109 howitzers which will

result from the howitzer improvement program (HIP). In fact, the improvements incorporated into the HIP will change our entire concept of providing close support to maneuver forces. Tactics we have used and refined over the past 50 years simply will not be needed. Cannon artillery will be able to operate in much the same manner as the MLRS does. Technology has moved the cannon into the 1980s and beyond.

The Need for HIP

The concept development of the M109 series of howitzers began in 1952. Designed to support maneuver forces equipped with M60 tanks and M113 personnel carriers, the M109 originally achieved ranges and provided the mobility needed to support our forces well into the 1970s. Increased mobility and an emphasis on an active defense involving faster offensive thrusts soon required a range capability greater than the 14 kilometers provided by the original M126 "short tube." Taking a slightly different tactic than our German Allies, who emphasized propelling charge modifications, the United States elected to increase range by increasing the muzzle velocity of the weapon with existing ammunition. The designers developed the longer, 39-caliber M185 Cannon which yielded essentially the same maximum range as the German M109G.

During the late 1970s and early 1980s, American maneuver forces received new armored vehicles which—by virtue of their increased protection, greater speed, and improved trafficability—allowed them to "outrun" their fire support. At the same time, new doctrine emphasized more bang for the buck by advocating attack of the Threat's second echelon, forcing early deployment and allowing attrition of these follow-on forces before they were able to enter the battle proper. Suddenly, artillery needed to be capable of firing to ranges of 30-kilometers and more.

Combat developers responded with rocket-assisted projectiles (RAP) and new weapons such as the towed M198 155-mm howitzer. These new "super charge" cannons could reach the magic 30-kilometer mark. Unfortunately, the M109, then in its second metamorphosis—the M109A2/A3 version—was simply not capable of handling such massive propellant loads.

What's more the time required to emplace and displace the weapon and the increased downtime caused by armament and automotive failures resulting from the increased stresses induced by high charges and frequent moves caused combat soldiers to spend too much time doing things other than shooting. The combat developer realized that the time had come to field a system that would not only keep up with the Abrams and the Bradley but also deliver the increased volumes of fire necessary to meet the anticipated threat.

Technology to the Rescue

HIP incorporates several technological breakthroughs to overcome existing M109 deficiencies. These devices are not particularly revolutionary; rather, they represent the breakthroughs in the miniaturization and hardening needed to place them in the harsh environment of ground combat. HIP will be able to deliver close support fires much more rapidly than any previous cannon system because it carries a navigation system which "knows" where the weapon is at all times. It has a computer which will use the location of the weapon, along with fire mission data delivered to it by the fire direction center (FDC) to compute its own firing data and lay the gun on the correct direction and quadrant elevation. Each of these systems bears closer investigation.

Inertial reference navigation systems have had aerospace applications for years. They are not new to the Army or the field artillery. In fact, most artillerymen are familiar with the position and azimuth determining system (PADS) which entered the surveyor's kit in the early 1980s. The PADS can provide fourth-order survey control in a fraction of the time needed by other methods.

Although the system on board a howitzer need not be as precise as PADS, it must be considerably smaller and must be able to withstand the harsh vibration profile associated with a tracked vehicle. The first such system to appear on a US tracked vehicle made its debut on the MLRS self-propelled loader launcher (SPLL). Coupled with the on-board computer which receives digital fire mission orders, computes firing data, and positions the launcher, it allows the SPLL to wait in a hide position until receipt of a mission. The same combination of the inertial reference navigation system and the on-board ballistic computer is part of the HIP.

The HIP's on-board ballistic computer produces all necessary firing data and activates gun drive servos which position the tube on the correct azimuth of fire and elevate it to the correct quadrant elevation. It performs much the same functions as the current battery computer system, and it uses the same computational algorithms. The computer uses the weapon position supplied from the navigation system; the nonstandard



The improvements incorporated into the HIP will change our entire concept of providing close support to maneuver forces.

input regarding muzzle velocity, projectile weight, meteorological data, propellant temperature; target data; shell-fuze combination; and the number of volleys which it has received as a digital message over an FM radio.

Fire commands appear on the section chief's display, but the only crew action necessary will be to set the fuze and load the projectile into the breech. The servos will traverse the turret and elevate the gun to the proper data.

Training and Materiel for Today's Gunner

by Sergeant Judy A. Ward

Only a few decades have passed since the era of the horsedrawn artillery, but how the King of Battle has changed! Today's Redlegs have the latest state-of-the-art armaments and equipment. Gunners train on high-powered computers and simulators as they master the complex skills associated with AirLand Battle tactics.

The tactical fire direction system (TACFIRE) ushered in the age of automation for the artilleryman. But it was only an important first step. As available technology became more sophisticated, so did the demands for other more advanced field artillery weapons and systems. Today the field artillery is expanding its inventory and capabilities with systems including lightweight TACFIRE, battery computer system (BCS), backup computer system (BUCS), remotely piloted vehicle (RPV), howitzer improvement program (HIP), meteorology data system (MDS), target analysis program system (TAPS), and the advanced field artillery tactical data system (AFATDS).

Of course, this technological boom has not altered the Field Artillery's basic mission. The contemporary artilleryman still seeks to "destroy, neutralize, or suppress the enemy by cannon, rocket, and missile fire and to assist in integrating all fire support into the combined arms operations." New technology merely improves the quality, responsiveness, and survivability of the system.

Computers play an integral part in today's artillery. Many systems such

as MDS, BCS, BUCS, and TAPS require some form of computer-assisted training. Howitzer crewmen are even entering the age of automation. The HIP, which updates the M109 with an on-board fire direction computer, a navigation and position system, and modern radios will require crew members to receive additional training with computers.

Training on such complex gear will occur both in the schoolhouse and in the field. In fact, there will continue to be emphasis on sustainment training. But unlike TACFIRE, which was extremely user unfriendly and training intensive, most of the new field artillery systems will employ "user's prompts" and have built-in training features.

AFATDS, for example, will have a touch screen that will display simple English instructions that will guide the operator through routines and reduce the amount of rote information operators will have to learn. Training on AFATDS will commence in 1991 and the TACFIRE replacement should begin to reach units in 1992. Of course, until TACFIRE is totally phased out, the Field Artillery School will continue to provide instruction on both systems.

The Field Artillery is moving full force to automation. Digital systems are not only increasing the King of Battle's combat power but also improving its training. Automation and Redlegs are inseparable; both are important tools in the ultimate game of fire support.

Should the computer fail, the HIP will be capable of operating in several backup modes depending on which components of the fire control system have failed. Combat developers refer to this capability as "graceful degradation." For example, if the digital communications link should fail, the section chief will have at his disposal a second radio dedicated to voice traffic. If the gun drive servos fail, the crews can use manually operated handcranks to traverse and elevate. If the computer itself fails, the battery computer system will still be available to compute firing data, which may be sent by voice or transmitted digitally. Furthermore, conventional indirect fire optics will remain in the howitzer. As in the past, there will always be a way to get rounds on the target when they're needed.

Repair of failed components will occur by simply replacing modules identified by built-in tests and built-in test equipment (BIT and BITE). But HIP will go one step further. The system will also incorporate *prognostics*. The section chief, serving as the computer operator, will receive a warning when certain critical components are *about to fail*. He can then take corrective action before the component breaks in the middle of a mission. This capability is not limited to the onboard fire control system; sensors will also provide data on the condition of the armament and certain automotive components. The crew will know what to fix and will be able to fix it before it breaks.

Armament Options — Reaching Out and Touching Someone

Of course, such improved reliability, availability, and maintainability (RAM) will increase the amount of firepower available to the maneuver commander; but it will not increase the range. The section would still have to make frequent moves in order to compensate for the lack of range inherent in the M185 cannon. Combat developers are considering two ways to solve this problem:

- Modifying the existing M185 cannon and its mount to withstand the increased firing stresses associated with the M203 charge.

- Using a new cannon tube and mount.

Howitzer Modernization Program Comparisons

by Captain Charles J. Fogle

For those following the progress of the howitzer modernization program, the comparison chart shown below highlights some of the differences between the howitzer extended life program (HELP), M109A3E1; and the howitzer improvement program (HIP),

M109A3E2/E3. The HIP will eventually incorporate the proven improvement items from the HELP to field a single, improved howitzer in 1989. For the background of the howitzer modernization program, see "Getting HELP and HIP," *Field Artillery Journal*, September-October 1985.

ITEM	HELP (M109A3E1)	HIP (M109A3E2/E3)
Cannon	Same as M109A2/A3 (M185 cannon tube).	Modified armament system Modified M185/39 caliber cannon (M109A3E2). Advanced armament M199 compatible cannon and an extended range cannon (M109A3E3).
Turret	Ammunition stowage is the same as the M109A2/A3.	At this writing, it will be the new (larger) HIP turret which will have a full width bustle to accommodate propellant segregation. All or most projectiles will be stored in floor racks or on the sponsons Ceiling is raised about 6 inches and there probably will be no right turret door.
Traversing and Elevation	Traversing and elevation are done manually with the aid of gunner assemblies (GA) which display the deltas () needed to zero out the required deflection and elevation differences from where the gun tube is pointing to where it should point.	Gun drive servos which automatically "point" the cannon by the COS interface with the automatic fire control system (AFCS).
Positioning and Navigational Capability	Automatic gun positioning system (AGPS) keeps track of HELP's position and direction by use of strap-down gyroscopic technology.	Modular azimuth positioning system (MAPS) will keep track of HIP's position and direction. It will be the generic positioning and navigational device for all DA-required systems.
Technical Firing Data	Section chief's display control unit (SC-DCU) is a "dumb terminal" able to receive digital fire mission data from BCS.	Automatic fire control system (AFCS) will perform the ballistic computations on board.
NBC Collective Filtering System	Ventilated face piece system (VEPS) provides filtered and warmed air to M25A1 protective masks.	VFPS is incorporated into the microclimatic system (MCS). MCS will also provide cooled air to vests that crew members wear beneath their MOPP suits.
Travel Lock	Remotely powered and operated from driver's compartment to permit the tube to be taken out of and returned to travel lock position without a crewman leaving the howitzer.	Same concept, different design from HELP.
Spades	Electric winch and controls permit the raising and lowering of spades from within the howitzer.	Same manual operation as on the M109A2/A3.
Radio	AN/PRC-68 Small Unit Transceiver (SUT).	At this writing, two single channel ground and airborne radio system (SINCGARS), AN/VRC-89.
Sights	Same sights as on M109A2/A3.	Panoramic telescope, M117A2, will incorporate improved a direct fire capability to eliminate the M118A2/M118CA1.

They refer to these alternatives as the modified armament system (MAS) and the advanced armament system (AAS), respectively.

The MAS involves the least modification to the existing turret. This is no small consideration because HIP is a retrofit to existing equipment and strives for low cost. The modification would fill in a keyway, which was cut into the cannon tube to hold a brass torque reaction key, and replace the key with an external device. Complemented by suitable upgrades in the mount, the MAS should be capable of withstanding the increased shock of the M203 charge.

The more radical AAS requires extensive modifications to the turret; however, the benefits may be worth the added expense. The AAS actually consists of two cannon tubes, which could be interchanged at direct support maintenance levels. The breech would remain attached to the new modular recoil system. The "short" tube will be similar to the M199 cannon tube used on the M198, a weapon already capable of firing 30 kilometers. The "long" tube will have a length of somewhere between 53 and 58 calibers, which will achieve ranges in excess of 40 kilometers.

Recent trade-off studies done during the course of design show that rather than modifying the existing turret, it will be safer and more cost-effective to design a new turret which will accommodate both the MAS and the AAS. This may also have an impact on the system's survivability.

Putting HIP to Work—A Radical Operational Departure

HIP will obviously increase survivability. It will do away with the entire system of occupying battery positions and firing from fixed, readily identified locations. Because the HIP carries a navigation system, the gun's location will be available to the onboard fire control computer at all times. This will allow the crew to stop the howitzer virtually anywhere and deliver fires without emplacement or laying. Previously, laying only served to place the weapon on "common direction." Provided the crew has properly set up the navigation system, the howitzer will be on common survey even while it is moving.

Individual howitzers will operate in an assigned firing area, which will be a roughly circular area about a kilometer

in diameter. The section chief will routinely displace within his firing area after every few rounds in accordance with the platoon or battery standing operating procedure. The HIP battery will include three subelements:

- Two firing platoons with four HIP sections and one fire direction center per platoon.
- A battery support area which will establish a trains position generally between and to the rear of the platoon operation areas.

Officers assigned to HIP units will find themselves discharging responsibilities generally associated with battalion-sized organizations. The battery commander will do many of the same things that the battalion executive officer, S3, and S4 currently accomplish. He will be primarily concerned with locating areas of operations for the battery and for the trains. The task of running the battery trains will fall to the first sergeant. The traditional first sergeant responsibility of battery defense will not exist as such. Because the howitzers will not be located together, local defense will be the responsibility of the section chief.

The platoon leader and the platoon sergeant will be doing tasks now associated with battery commanders and their executive officer. The platoon leader will reconnoiter platoon areas. The platoon sergeant will be directly involved in keeping up with the position of the howitzers, ensuring that they have adequate supplies of ammunition and other necessities, and keeping the section chiefs abreast of the tactical situation.

Perhaps the most radically changed position is that of section chief. With current equipment and organization, the section chief is responsible for the firing of his weapon. With HIP he will become a grass-roots tactician. The section chief will have to become a skilled map reader and be able to analyze terrain to select his own firing position. He will need to be more aware of the enemy situation, and he will have to make informed decisions on the spur of the moment regarding

whether he should displace or not. What's more, the section chief will also need to become proficient in the use of the on-board fire control equipment. Although the computer and its operating software will be relatively easy to use and self-prompting, he'll still have to be an expert.

Conclusion

After all the flash and dash is over at Moway House—after the MLRS has streaked off across the range, the Copperhead has devastated a tank, and the Aquila has peered behind ridges and into creekbeds to disclose unseen targets—after all that there is the improved M109. But this trusty old war horse is an Arabian stallion in disguise—it's the HIP—the revolutionary new American howitzer. 

Mr. Robert M. Forrest is a BMY data management coordinator on the howitzer improvement program. He recently left Active duty where he served as a project officer in the TSM-Cannon Division with the Directorate of Combat Developments at Fort Sill, Oklahoma.

Tune in to the Latest Field Artillery Developments— Read the Journal!



Name (Last, First, MI) Rank, Title

Address SSAN

City State

STATUS

- | | |
|--------------------------------------------------|--------------------------------------------------------------------------------------------------------------------|
| <input type="checkbox"/> US Army | I am a member of a certified
US Field Artillery Association
Local Chapter The name of
my local chapter is |
| <input type="checkbox"/> US Marine Corps | |
| <input type="checkbox"/> Active Component | _____ |
| <input type="checkbox"/> US Army Reserve | Name |
| <input type="checkbox"/> US Marine Corps Reserve | _____ |
| <input type="checkbox"/> National Guard | Location |
| <input type="checkbox"/> Retired Military | _____ |
| <input type="checkbox"/> Allied Military | |
| <input type="checkbox"/> Civilian | |
| <input type="checkbox"/> Industry/Office/Library | |
| <input type="checkbox"/> Other | |

RATES

	US & APO Addresses	Foreign Addresses Except APO
1 Year	<input type="checkbox"/> \$16.00	<input type="checkbox"/> \$25.00
2 Years	<input type="checkbox"/> \$31.00	<input type="checkbox"/> \$49.00
3 Years	<input type="checkbox"/> \$46.00	<input type="checkbox"/> \$73.00

Signature Date

**MAIL TO:
US FIELD ARTILLERY ASSOCIATION
P.O. BOX 33027
FORT SILL, OK 73503**

Much Ado About Something

by Captain Suzann W. Voigt



Much ado about something is probably the best way to describe the Army's drive to lighten its light forces. In fact, the most provocative news since the dissemination of the original AirLand Battle doctrine has been the Army's decision to field five suitably equipped light infantry divisions. This announcement spawned miles of print on topics ranging from historical precedents to detailed tactics and techniques. In the Fire Support Community, leaders have had to face challenges associated with supporting these new maneuver organizations. They've had to determine how to move, shoot, and communicate but keep their units light.

These challenges created materiel needs that initially appeared to surpass existing weapons technology. The

versatility and power of the towed 155-mm weapon like the heavy M198 just didn't seem achievable in a light, mobile howitzer. Today, all that has changed. Last December the Army awarded three technology-challenging contracts to develop a 155-mm towed howitzer at half the weight of the M198.

Background

American tactics have historically focused on heavy forces on a European battlefield. According to Army historian Steven L. Canby, this criterion no longer applies. Today *"the situation...has changed to the point where we can no longer defend Western Europe without destroying what we are pledged to defend,"* Canby writes. What's more,

experts like Lieutenant General James F. Hollingsworth contend that we won't be able to speed sufficient reinforcements to stall the overwhelming Warsaw Pact forces. In fact, these two experts believe *"the days of massive and slow build-up of forces through sealift are over forever. What we need are rapidly deployable light organizations."*

The Germans first grasped the value of the tactical advantages of a light, mobile infantry force during World War I. According to Canby, they realized that new communications capabilities coupled with displacement of troops and increased firepower required *"a combination of stealth and stalking microtactics and high-tempo operations."* The emphasis in this doctrine was flexibility of maneuver and

decision-making at the lowest levels. It mandated the creation of organizations that were "more independent and aggressive than those in...traditional units."

In 1980 former Army Chief of Staff General E.C. Meyer joined the light forces bandwagon when he observed that the greatest challenge for the 1980s would be to meet threats outside the European theater without compromising the availability of forces necessary for the defense of Western Europe.

General John A. Wickham, Jr., the present US Army Chief of Staff, agrees. He explains that there is a "critical window" within which a military force must act. Escalation in a crisis situation is less likely when the United States can respond with a formidable force within this limited time frame.

In a White Paper on the light forces issue, General Wickham called for the development of five light infantry divisions in two years. Two existing infantry divisions—the 7th and 25th—would be modified to meet the light requirements, while one Reserve Component unit—the 29th—and two more Active Army organizations—the 6th and the 10th—would have to be created. Each of these light-fighting divisions would have no more than 10,700 soldiers and be transportable in fewer than 500 aircraft sorties.

A Quick Fix

As virtually every Redleg knows, the modernization of the artillery is an unending process. But the need for a lightweight, high-performance howitzer has put tremendous pressure on the King of Battle to evolve quickly. Fortunately, the artillery has had some experience in the light howitzer development area. In the 1970s, the Army made an effort to upgrade the 105-mm by testing the M204. This weapon used a soft recoil design which pushed the cannon tube forward when the lanyard was pulled and thereby reduced recoil force and the reaction on the rest of the carriage. The M204 was never fielded, but in the process of its development Army experts learned a great deal.

Major Richard Kamakaris, a staff officer at Fort Sill, Oklahoma's US Army Field Artillery School explains, "The M204 was too heavy. When it misfired, the tube went forward and the whole thing tipped over. This was just one of its drawbacks."

With the advent of the light divisions, the Army found an immediate answer to the light gun problem in the form of the British Royal Ordnance

L119, now type-classified as the M119 and slated to replace the M102 and M101A1 towed howitzers.

The Field Artillery Board at Fort Sill completed its test of the M119 late last year. During the evaluation they conducted four major subtests on operation and mission performance; survivability, vulnerability, safety, and human factors; reliability, availability, maintainability, and training; and volume, accuracy, and range.

Captain Paul W. Barron, a Board Test Project Officer, reports that the howitzer passed with some qualifications. "There was some blast overpressure and the noise profile was high," he said, "It also had a tendency to bounce at higher elevations and charges. But the bouncing did not affect the accuracy of the weapon." The M119 can be fired at charge eight only under limited conditions due to safety considerations regarding overpressure. Continued exposure to overpressure and high noise levels could affect crew hearing. But Barron is quick to point out that "there are development efforts to reduce the blast overpressure."

The Board tested the mobility of the weapon by moving it seven times throughout the evaluation. They displaced using high-mobility multipurpose wheeled vehicles and the UH-60 Black Hawk helicopter—both of which can handle the howitzer's 4,100 pounds.

The M119 fires all 105-mm ammunition currently in the US stockpile

and will soon have rocket-assisted projectiles and dual-purpose improved conventional munitions. The piece can reach 11,500 meters with charge seven, and to 14,200 meters at charge eight. A crew of seven serves the M119. Each weapon will cost approximately \$100,000. Fielding will begin in fiscal year 1987 and is scheduled to be completed by 1992.

The New Challenge

The challenge facing the Research and Development Community now is to design a weapon that marries the range, accuracy, and versatility of the M198 with the deployability of the M119. The new light divisions do not have a prime mover that can tow a weapon like the M198. Nor can the UH-60 lift the existing 155-mm howitzers. In fact, the Black Hawk's lifting hook is load-tested only to 8,000 pounds under perfect conditions—a cold day, low fuel, and high air density. On an Army standard hot day of 98° F; a fully loaded Black Hawk can lift a meager 5,000 pounds.

What's more, at just under 16,000 pounds, the M198 will still be too heavy for the Black Hawk C-model configuration projected to enter the inventory in the 1990s.

The US Army Armament Research and Development Center (ARDC), Boeing-Vertol, and the Army's Technology Laboratory are looking at many lightweight 155-mm options. They have determined through several



The M119 British Light Gun will replace the current M102 and M101A1 towed howitzers in the Army's light infantry division.

studies that the current 155-mm howitzer can be reduced to 12,500 pounds using composite materials. But this is still too weighty to support the light fighters. So, the Army awarded contracts late last year to design a weapon system built around new technology. The requirements as drafted by ARDC are to demonstrate the full 155-mm capability in a 9,000 pound system.

COMPONENT WEIGHT REDUCTION (IN POUNDS)		
ITEM	CURRENT WEIGHT	REDUCED WEIGHT
UPPER CARRIAGE	1,295.8	646.8
BOTTOM CARRIAGE	3,421	2,156
TRAILS (2)	2,948	1,768.8
CRADLE	1,914	1,148.4
	9,578.8	5,720

The contractors will achieve some of this weight reduction using the composite materials produced in America's space program. Such materials can reportedly reduce selected component weights by 40 percent to 50 percent while maintaining characteristics similar to heavier metals. Major Kamakaris notes, "The technology is there for plastics with the requisite stiffness and strength. But there is a question of reliability when they are used in a ground combat system. . . . Previous applications have been in the Aerospace Community and in the rather clean environment of the flight line."

ARDC's Harold Liberman is less reserved. "There is a precedent in the aircraft industry. These contractors are leaders in the field of composite materials." He goes on to explain that the materials under consideration fall into two types—organic composites and metal matrix. Organic composites consist of a thick adhesive base with fiberglass cloth or with other fibers randomly placed throughout the viscous fluid. A metal matrix is essentially the same but instead of a resin base, aluminum is imbedded with a silicon or carbon fiber.

"The real challenge is *not* getting the weight down below 9,000 pounds, but in the system *stability*," Liberman adds. "Recoil is the real heart of the problem. Peak stress is what we're trying to get rid of. We've got to get that curve relatively flat." Major Kamakaris explains that "the M198 is stable because it weighs almost 16,000 pounds. Making the new howitzer shoot just as far as the M198 will require the use of innovative technology, and recoil must be reduced by 50 percent."

Current recoil technology uses a controlled compression of gases and oil. The light 155-mm contractors are exploring other engineering options including soft, dual, and curved, recoil as well as a combination of one of these with a computer microprocessor.

Each recoil system has its own peculiar design.

- **Soft recoil**, tested in the 1970s on the unfielded M204, involves a "super long recoil mechanism folded over. This cuts down on the recoil force and on the rod pull," explains Liberman. "It cuts down the reaction on the rest of the cannon."

- Regarding **dual recoil**, Major Kamakaris observes that it enhances stability by increasing the mass being recoiled. Under this approach the tube sits on one recoil mechanism and the carriage on another. The net effect is to increase the percentage of the howitzer being recoiled.

- **Curved recoil** is based on a traditional hydropneumatic mechanism as found on today's M198, but it is set on a curved track to use downward forces to enhance stability.

- A design that may be integrated into any of these recoil systems is the **microprocessed recoil** mechanism. This approach employs a computer chip to adjust the length of recoil depending on charge, quadrant, and temperature. "It can take into account mechanical things that we can't take into account right now," Major Kamakaris said. Although yet to be tested, the microprocessor promises to sense the parameters of gas pressure and then tailor the orifices through which recoil fluid flows. "Such a microprocessor can eliminate 35 percent of peak recoil forces," observes ARDC's Liberman.

Putting It All Together

The entire lightweight 155-mm strategy consists of three phases.

- The **concept definition phase** will last about 6 months.
- The **detail design phase** will take close to 9 months.
- The **test and fabrication phase** may be 15 months long.

Captain Suzann W. Voigt, FA, is assigned to the Directorate of Evaluation and Standardization at Fort Sill, Oklahoma. She received her commission through the Officer Candidate School after graduating from the University of Arizona. Captain Voigt is a graduate of the Field Artillery Officer Advanced Course and has served as platoon leader, assistant S3, and adjutant at a Pershing unit in Germany.

Liberman noted that the project is now only in the middle of the first phase. The developmental target is 30 months total duration.

At present three contractors are competing in the initial phase. AAI Corporation of Cockeysville, Maryland, is concentrating on the dual recoil system with a split carriage for stability and S2 glass epoxy as a composite light material. BMY of York, Pennsylvania, is working on a curved-recoil system composed of organic materials and titanium. With this recoil cycle, the mechanical parts, such as the cannon, revolve up and back when a round is fired. As the cannon rotates up, it exerts a downward force that makes the howitzer seem heavier than it is. FMC of Minneapolis, Minnesota, is designing a mortar-like weapon with trails facing to the front and a long recoil mechanism with a mechanically controlled orifice.

Paralleling these efforts is yet another contractual initiative to design a recoil mechanism that has application to the whole effort. The overall program, with its three phases, looks at the development of a total weapon. ARDC's tech-base development, on the other hand looks at ways to obtain better managed recoil. This program uses one contractor, ARES, Inc. of Port Clinton, Ohio, to come up with a better electronically-managed recoil design which can be integrated with any of the other contractor proposals.

The search for a light towed weapon also involves an in-house effort at ARDC. When phase one is complete, two civilian contractors will be invited to continue the project in competition with an in-house design. ARDC is developing a soft recoil design which involves firing the howitzer from a latched position for zones six and below. At higher zones, the recoiled mass will be accelerated forward and the cannon fired from an out of battery position.

All these designs will have their day in court during tests projected for December 1987. But the story doesn't end after the system tests. In December 1987 the gauntlet merely passes back to the leaders of the field artillery who are fully aware that all this effort on lightening the force is indeed "much ado about something."



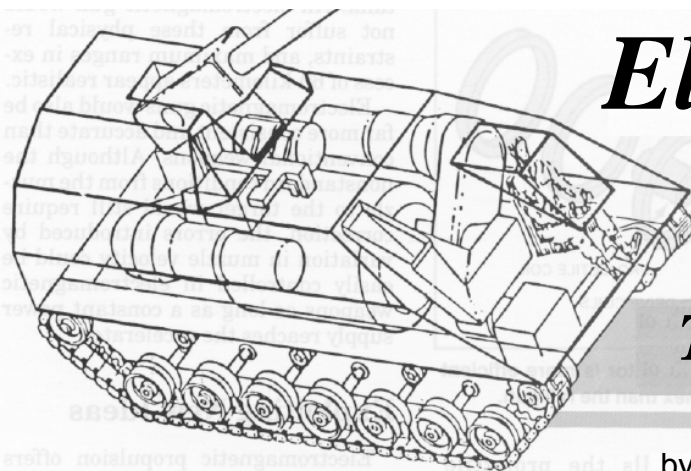

Electromagnetic Propulsion:

The Wave of the Future

by Captain F.M. Aubin, Royal Canadian Artillery

Whenever gunners hear the ominous words "electromagnetic (EM) propulsion" or "EM launch" they begin to conjure up images of Star Wars-type weapons in some futuristic flick. In reality the idea of accelerating projectiles by the interaction of opposing magnetic fields is nothing new. Various nations have tried producing electromagnetic guns since the turn of the century; but in each case, available technology simply failed. However, in the last 8 to 10 years sufficient technological breakthroughs have occurred to show that EM guns can become an alternative to present-day weapons by the end of the 1990s.

What is an Electromagnetic Gun?

Electromagnetic propulsion is the process of accelerating projectiles by the use of Lorentz forces. If you cause a high-powered pulse of electrical energy to flow through a conducting apparatus bridged by a projectile, a propelling magnetic field will form. This magnetic field exerts forces on the projectile causing it to accelerate along the length of the conducting apparatus. The subsequent velocity achieved may be extremely high.

There are three major components to an electromagnetic weapon system:

- The prime energy conversion unit (PECU).
- The storage and power conditioning unit (SPCU).
- The accelerator.

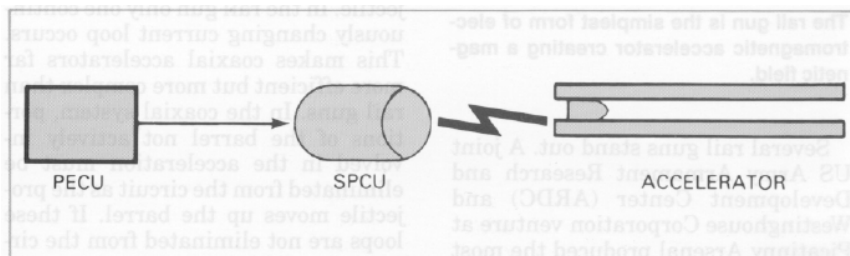

The storage and power conditioning unit (SPCU) converts the mechanical energy produced by the prime energy conversion unit (PECU) into electrical energy used by the accelerator.

The prime energy conversion unit provides the initial power to the weapon. It may be a vehicle engine or an auxiliary power unit. Ideally, the PECU should double as the vehicle engine and should run on a common, cheap fuel such as diesel.

The storage and power conditioning unit converts the mechanical energy produced by the PECU into electrical energy usable by the accelerator. It receives energy at a relatively low power rate and stores it for subsequent delivery to the accelerator at a very high-powered short pulse. Of the various types of paraphernalia being considered for employment as SPCUs, homopolar generators show the greatest promise. They convert energy to electric current as the PECU spins an iron disk to speeds ranging from 8,000 to 12,000 revolutions per minute within a magnetic field. The result is an electrical potential difference between the inner and outer radii of the disk. This potential difference enables the generator to extract the energy contained in the disk in the form of an electric current in less than two-tenths

of a second. This massive burst of electrical energy then goes to the accelerator—the actual gun.

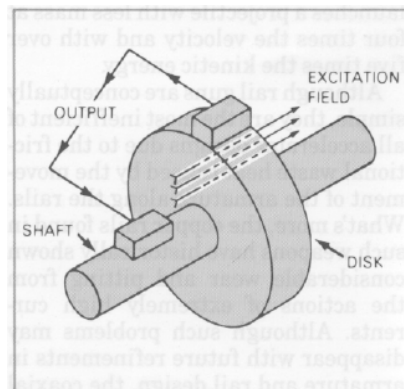

Energy is converted to electric current as the PECU spins an iron disk within a magnetic field.

Over the last few years scientists have produced a myriad of accelerator designs. Of these, rail guns and coaxial accelerators have been the most successful.

- **Rail guns.** A rail gun is the simplest form of electromagnetic accelerator.

It consists of two rails bridged by an armature which is connected to a projectile. Electric current passes through one rail, crosses the gap through the armature, and then goes back through the other rail. The resulting current loop creates a magnetic field which exerts an outward pressure on all elements of the accelerator. Because the rails are stationary, all these forces are directed to the armature which causes the projectile to accelerate along the length of the rails.

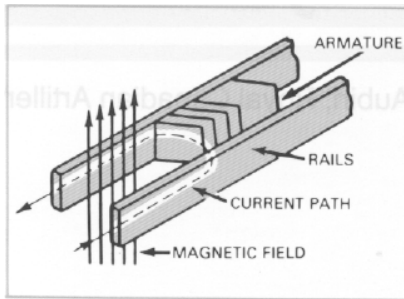

The rail gun is the simplest form of electromagnetic accelerator creating a magnetic field.

Several rail guns stand out. A joint US Army Armament Research and Development Center (ARDC) and Westinghouse Corporation venture at Picatinny Arsenal produced the most modern model. This weapon has launched, at velocities in excess of 4,200 meters per second, 500-gram projectiles which deliver over 2,700 kilojoules of kinetic energy at the target. Compared to a 40-mm Bofors antiaircraft gun, Picatinny's rail gun launches a projectile with less mass at four times the velocity and with over five times the kinetic energy.

Although rail guns are conceptually simple, they are the most inefficient of all accelerator designs due to the frictional waste heat caused by the movement of the armature along the rails. What's more, the copper rails found in such weapons have historically shown considerable wear and pitting from the actions of extremely high currents. Although such problems may disappear with future refinements in armature and rail design, the coaxial accelerator provides another alternative.

- **Coaxial accelerator.** The coaxial accelerator consists of a series of loops in which the currents all flow in the same direction. The flow of these currents creates a magnetic field. The projectile also has a current loop attached to it which creates another magnetic field. The interaction of

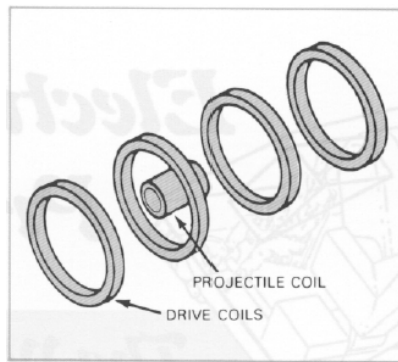

The coaxial accelerator is more efficient but more complex than the rail gun.

these fields pulls the projectile through the gun barrel.

The distinct difference between a rail gun and a coaxial accelerator is the nature of the current loops created. In the coaxial accelerator there are a number of loops which apply the same magnetic force against the projectile. In the rail gun only one continuously changing current loop occurs. This makes coaxial accelerators far more efficient but more complex than rail guns. In the coaxial system, portions of the barrel not actively involved in the acceleration must be eliminated from the circuit as the projectile moves up the barrel. If these loops are not eliminated from the circuit, they will detract from the projectile's acceleration. The coaxial system presents the developer a significant high-current switching problem. Current research focuses on attaching solenoids to the loops which would automatically short-circuit it as the projectile moves through the barrel.

Increased Performance

Electromagnetic weapons provide greatly increased muzzle velocities, stability, and projectile control in comparison to their conventional counterparts where the speed of the expanding gases limits the projectile velocity. Electromagnetic guns are not restricted by this limitation and as a result have achieved muzzle velocities far in excess of any weapon system to date.

Although the range of conventional guns has slowly increased over the last decade, so has their size, weight, bulk, and price. If we try to jam more faster-burning propellants into breeches, balance longer barrels, and design heavier chassis for increased stability in our quest for increased range, we will end up with a system as complex and costly as a

main battle tank. An electromagnetic gun would not suffer from these physical restraints, and maximum ranges in excess of 60-kilometers appear realistic.

Electromagnetic guns would also be far more consistent and accurate than conventional weapons. Although the nonstandard conditions from the muzzle to the target would still require correction, the errors introduced by variation in muzzle velocity could be easily controlled in electromagnetic weapons as long as a constant power supply reaches the accelerator.

Exploiting New Ideas

Electromagnetic propulsion offers versatility in both projectile and gun design. Because expanding gases no longer accelerate the projectile, rounds may feature many new and novel designs with potential advantages in extended range, increased fragmentation, and armor penetration.

In addition to projectile versatility, the electromagnetic gun system would be very versatile. One gun, for instance, could easily and accurately adjust its muzzle velocity over the entire range from short-range mortar to high-speed antiarmor engagement. This could result in a very efficient, multipurpose gun. Furthermore, artillery weapons would no longer have a finite number of charges. The precise electromagnetic charge for the munition would be available for every accomplishable mission.

Logistical Benefits

In tactical resupply, artillery, tank, mortar, and air defense ammunition accounts for almost 50 percent of all tonnage shipped between the ammunition supply point and the line of metal. Almost half of this involves the propellant and its packing. Because there is no propellant involved in electromagnetic guns, packing, movement, and storage of ammunition will include projectiles and fuzes only. The resulting 50 percent increase in the ammunition hauling capacity of a close support battery represents a significant tactical and logistical advantage. The only increase in logistics support would be for fuel to drive the energy source of the weapon. Most experts agree that this would not exceed 1 gallon of diesel per shot for a 155-mm weapon system, which still constitutes a substantial savings when one considers the size and bulk of 13½ pounds of M4A2 propellant and its packing.

The US in the Lead

The US presently has the lead in electromagnetic launch technology. In 1980, the US Department of Defense named the Army as the "lead service" for the development of electromagnetic launchers. Since then the Army has progressed considerably. They're also planning to produce full-scale armament demonstrators for artillery, air defense, and armor electromagnetic weapons in the 1993 and 1996 timeframe. If these tests prove successful, then production and issue of such systems could begin as early as the year 2000.

Technical Barriers

There are still some significant technical barriers along the developmental road to practical, high performance electromagnetic weapons.

- The weight of appropriate power supplies and homopolar generators needs to be reduced by at least another 20 to 40 percent.

- The high-speed switches needed for handling millions of amperes require considerable development.

- The gun barrels need to survive thousands of shots as opposed to the tens of shots.

- Measures must be taken to reduce the amount of resistive wasteheat residing within the weapon.

Fortunately, none of these challenges appears to defy solution. In fact, the "high-tech" firms working on electromagnetic projects are progressing in all these areas.

Looking to the Future

Electromagnetic propulsion offers the King of Battle the opportunity to

achieve higher velocities and longer ranges than chemical propellant weapons. But a practical electromagnetic weapon is still years away. Nevertheless, the economic and logistical savings associated with an efficient electromagnetic gun more than justify continued research and development in this arena.

In fact, one can easily argue that an electromagnetic weapon system will be mandatory in future land battles. It will provide Redlegs, air defenders, and tankers with ideal firepower and offer the logisticians relief to a massive supply and transportation problem. All in all, electromagnetic looks like a dream come true. 

Captain Fred Aubin enlisted in the Royal Canadian Artillery in 1977. He is a graduate of the Instructor in Gunnery Course and has spent 2 years in Inspector General-related duties. His assignments include regimental duty in the Second Regiment, Royal Canadian Horse Artillery, Special Services Force; Adjutant, Royal Canadian Artillery Battle School. He is currently assigned to the Third Regiment, Royal Canadian Horse Artillery where he is a Regimental Command Post Officer.

View from the Blockhouse

FROM THE SCHOOL

Warrant Officer Advanced Course to Go Modular

The Warrant Officer Advanced Course (WOAC) is changing. This September, four specialty-peculiar courses will replace the single advanced course now taught at Fort Sill's Field Artillery School. The new modular programs will provide training for warrant officers in radar, meteorology, Pershing, and Lance specialties.

Each modular WOAC will include a Training and Doctrine Command (TRADOC) common curriculum and a proponent common curriculum. Fort Sill experts will also teach additional technical modules where warranted. The TRADOC common core will cover those tasks and skills required of all warrant officers. The field artillery proponent common modules will provide training on those tasks and skills required of all warrant officers managed by the field artillery. The Field Artillery School's Target Acquisition Department will be responsible for the content and structure of the radar and meteorological modules, while the Weapons Department will plan and execute the Pershing and Lance system courses.

The School's Directorate of Training and Doctrine has developed the field artillery common curriculum for the 5-week advanced course and is presently monitoring the development of the military occupational specialty-peculiar modules. Field commanders should soon receive copies of the proposed curricula. Course developers will use their subsequent comments and suggestions to make final modifications to the courses.

For additional information regarding the Warrant Officer Advanced Course contact the Department of the Army, Commandant, US Army Field Artillery School, ATTN: ATSF-D, Fort Sill, OK 73503-5600.

BATTLEKING

- **BK 27-86, Pintle Lighting Bracket** (Source: CPT Hopkins, USAFAS). A pintle lighting bracket fitted on a 2½-ton or a 5-ton truck allows cannon crews to mount an Army anglehead flashlight over the low pintle. This local modification can reduce not only the likelihood of damage to equipment, but also

the safety hazards associated with the hook-up process. Two small screws secure the bracket to the underside of the vehicle bed and to the left of the pintle. For more information about the pintle lighting bracket write President, US Army Field Artillery Board, ATZR-BDO (BATTLEKING) Fort Sill, OK 73505-6100.

• **BK 23-86, Spare Tires for M102 Towed Howitzers** (Source: MAJ Hartsell, 2d Bn, 320th FA, Fort Campbell, KY). Neither the current M102's basic issue items list nor the authorized stockage list authorize a spare tire. But should a flat occur on the howitzer, it must be repaired before the howitzer can become operational again. The M102 uses a size 700x16 tire—the same as that used on the M151 jeep. Currently, if a flat tire occurs on an M102, the only source for a spare tire is the M151. When the M151 leaves the system this source of spare tires will be nonexistent.

In air assault units, the high-mobility multipurpose wheeled vehicle (HMMWV) has already replaced the M151. The spare tire source no longer exists, since the HMMWV uses a 36x12.5x16.5 tire. The problem of spare tire availability will continue and may compound itself with the fielding of the M110 light howitzer. This new howitzer uses a size 900x16 tire. Currently, there is no source for this size spare.

AR 710-2, chapter 2; and DA Pamphlet 710-2-1, chapter 8, outline procedures for adding items to the prescribed load list as mission essential. These procedures allow mission-essential items to be obtained until they can be supported by a history of demands.

Additional information on this proposal can be obtained by writing President, US Army Field Artillery Board, ATZR-BDO (BATTLEKING), Fort Sill, OK 73503-6100 or call Mr. Edgar Gunn, AUTOVON 639-4075/3717.

Looking for a Printer

Who wants a printer for their battery computer system (BCS)? *Everyone* is the answer. Everywhere Fort Sill's New Equipment Training Team went they grappled with the question, "How can I get a BCS printer?" In August 1985, the US Army Field Artillery School's (USAFAS) Gunnery Department took the initiative and began looking for a way to use the backup computer system's (BUCS) ThinkJet HP2225B printer with the BCS.

TELOS Federal Systems, a California-based company with branch offices located in Lawton, Oklahoma, developed a prototype interface device and presented it free of charge to the Assistant Commandant of USAFAS.

Fort Sill is now seeking funds from the Army Development and Evaluation Agency (ADEA) to produce several full-scale development model interface devices for

immediate field evaluation.

SP4 Antonio Muracha

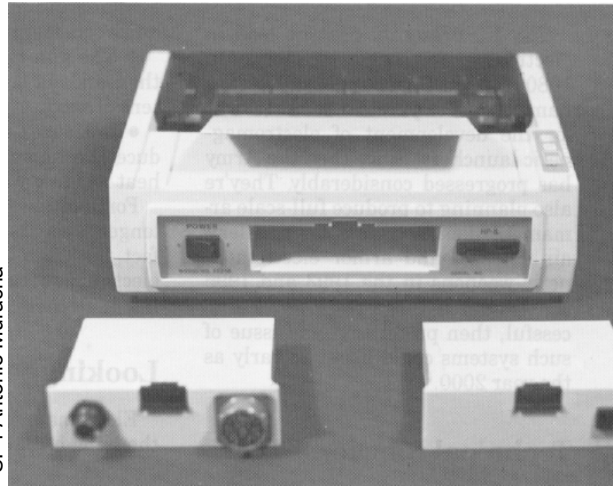

The printer interface device (PID) will be housed in the BUCS battery compartment. The PID will allow BCS or a fire support team digital message device (FIST DMD) to use the BUCS printer. It will also supply power to the BUCS printer and FIST DMD from the vehicle power source.

The Orders of Saint Barbara and Artillery Order of Molly Pitcher

The gala season of field artillery balls and Saint Barbara's celebrations is fast approaching. Commanders who intend to present the Orders of Saint Barbara to the "very best of stonehurlers, archers, catapulters, rocketeers, gunners, and their military and civilian supporters" should act *soon* to request appropriate certificates and accoutrements from the United States Field Artillery Association. The Association's address is P.O. Box 33027, Fort Sill, Oklahoma 73503; its commercial telephone number is 405-355-4677. Requests should conform to the format outlined in the "Order of Saint Barbara and Artillery Order of Molly Pitcher User's Packet" or the Association's 1986 brochure distributed at the recent Senior Field Artillery Commanders Conference. All requests must be accompanied by a fully completed order form and advance payment.

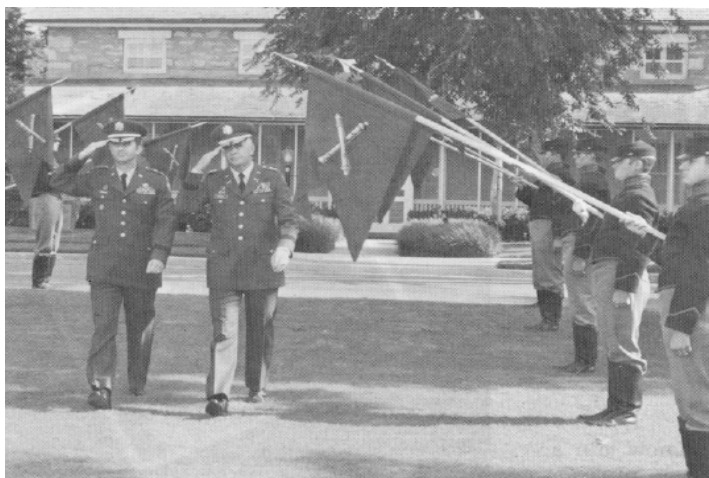

Photo by Jill Ponto

An Event to Remember!

The United States Field Artillery Officer Candidate School (OCS) Alumni Association will hold its second annual reunion 13-14 August at Fort Sill, Oklahoma.

All OCS graduates, cadre members, and friends should plan to attend this event. For more information, contact Captain Terry Shaw (405) 355-4677.

Accompanied by the Chief of the Field Artillery (right), Brigadier General Jerry C. Harrison (left) approaches the reviewing stand during a ceremony marking his recent assumption of duties as the Assistant Commandant of the Field Artillery School. Harrison comes to his new post from duty as Deputy Director, Weapon Systems, Office of the Deputy Chief of Staff for Research, Development, and Acquisition, Washington, DC.

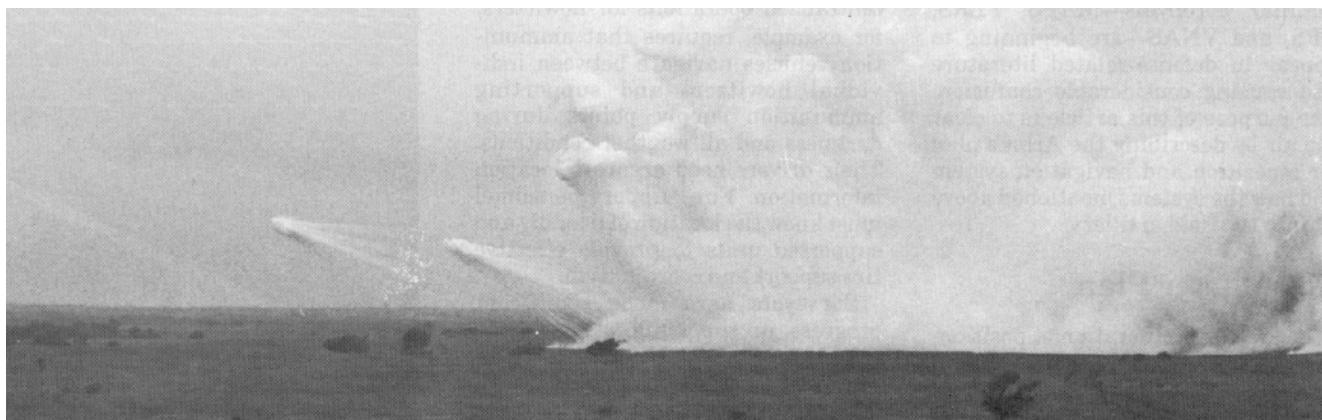

SP4 P. Hedden

Where There's Smoke...

The project manager for Smoke and Obscurants deals with a tremendous range of issues including specific systems, predictive models, and associated electro-optical (EO) systems technology. At least once a year, he conducts a variety of evaluations at diverse geographic locations both in the United States and overseas. In all these smoke week field trials the project manager seeks to simulate, as closely as possible, realistic battlefield conditions.

Smoke Week VII A occurred from 15-21 July 1985 at Fort Sill, Oklahoma. The US Army Field Artillery Board served as the host for this cooperative effort between the Smoke and Obscurants projects manager and the US Army Atmospheric Sciences Laboratory. III Corps Artillery provided supporting troops and equipment.

Smoke Week VII A had four major objectives:

- To measure obscurant effectiveness as typically delivered by Threat forces.
- To determine if existing and experimental computational methods of calculating firing data were reasonable predictors of smoke munition expenditure requirements.

- To evaluate the ability of limited use smoke test (LUST) devices to simulate field artillery delivered smoke.
- To evaluate the effects of long path, dense fog oil obscuration clouds on thermal imaging systems.

During the tests, two M109A2 howitzer batteries from the 1st Battalion, 17th Field Artillery fired smoke from a position approximately 4 kilometers south of the 1x2 kilometer test grid. Evaluators at the test site command post remotely also detonated prepositioned LUST devices, and the M3A3 smoke generator platoon from the 2d Company, 2d Chemical Battalion, 13th Support Command, provided long path, dense fog oil obscuration. Five operational tanks, positioned on the west side of the test grid, provided a target array for visual, optical, and thermal imagery observation. Video coverage was obtained by cameras located at the command post. The Chemical Research and Development Command (CRDC), Edgewood Arsenal, Maryland, also collected data on the effects of smoke on both inventory and experimental chemical alarm devices.

A detailed test report of Smoke Week findings is available through the Project Manager Smoke, ATTN: AMC-PM-SMK-T, Aberdeen Proving Grounds, Maryland 21005-5001.

The Positioning and Navigation Puzzle

by Lieutenant Colonel (Retired)
Roy E. Penepacker

The acronym PADS—position and azimuth determining system—has instant recognition among field artillerymen. Other less familiar acronyms—MAPS, PLRS, GPS, and VNAS—are beginning to appear in defense-related literature and causing considerable confusion. The purpose of this article is to clear the air by describing the Army's plan for a position and navigation system and how the systems mentioned above fit into the field artillery.

The Master Plan

In 1982, a proliferation of positioning and navigational systems caused the Department of the Army to direct the Combined Arms Center Development Activity to publish the Army's Position and Navigation Architecture Plan. Now in its fourth edition and retitled as the Army Position and Navigation Master Plan, the document is a component of the command and control subordinate system (CCS²) which is the Army's overall concept for executing the command and control mission on the AirLand battlefield. Briefly stated, the purpose of the position and navigation master plan is to identify relevant requirements for all Training and Doctrine Command mission areas and to describe the minimum set of hardware solutions that will fulfill those requirements.

Requirements

The traditional mission of field artillery survey is to provide a common grid which will permit the massing of fires, the delivery of surprise observed fires, the delivery of effective unobserved fires, and the transmission of target data from one unit to another. Although surveyors have traditionally concentrated on satisfying the precise positioning requirements outlined

in the figure, they now join a whole host of individuals who are concerned about the need for a common grid. The doctrinal emphasis on decentralized operations for howitzers, for example, requires that ammunition vehicles navigate between individual howitzers and supporting ammunition supply points during darkness and all weather conditions. Their drivers need accurate location information. Fire support personnel must know the location of friendly and supported units to provide effective fire support and coordination.

Surveyors have made significant progress in supplying precise positioning information through the fielding of the position and azimuth determining system, but to date the *principal* means of supplying general position and azimuth data has been the *map* and *compass*. The Army Master Plan defines a mix of new systems to satisfy the requirements.

NAVSTAR Global Positioning System

The NAVSTAR global positioning system (GPS) is a satellite-based radio system designed to provide passive user equipment with extremely accurate,

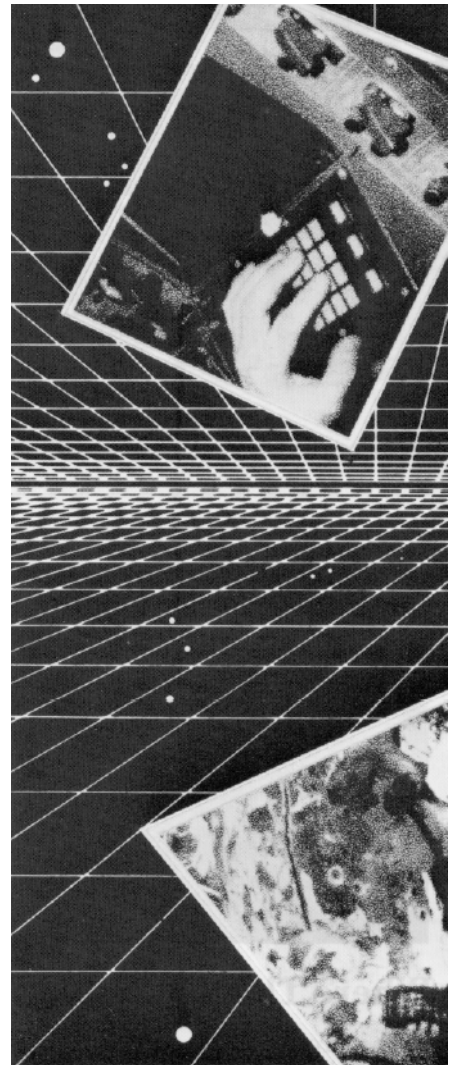

three-dimensional position and navigation information. The system contains major components in three separate categories—space, control, and user.

- The *space component* consists of 18 satellites in 55° inclined, circular orbits at 10,900 nautical miles altitude.

COMMON GRID		
TYPE DATA:	PRECISE POSITION AND AZIMUTH	GENERAL POSITION AND AZIMUTH
WHERE USED:	WEAPONS AND SENSORS	CRITICAL VEHICLES COMMAND POSTS
PURPOSE:	TARGET LOCATIONS FIRING DATA	NAVIGATION COMMAND AND CONTROL FIRE SUPPORT PLANNING AND COORDINATION

Positioning and navigation requirements.

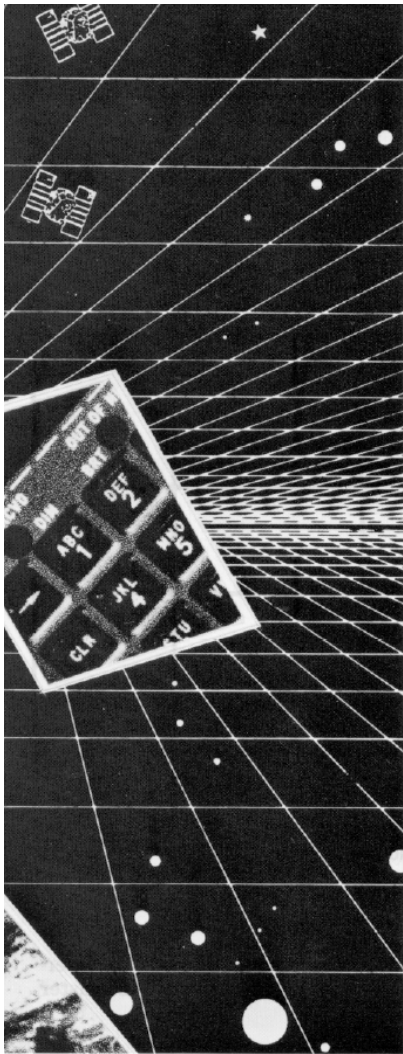

Each satellite transmits two radio signals which provide a means to compensate for ionospheric and atmospheric anomalies and contains codes and data for interpretation by the user component.

- The **control component** tracks the satellites and updates their position coordinates and timing information daily. The control organization includes an operations center that calculates signal accuracy, five monitor stations that passively track the satellites, and three ground antennas to relay data to the satellites.

- The **user component** is the equipment needed to put the satellite systems to practical use. The Army intends to adopt two types of user equipment—a manpack and vehicular set and an aircraft set. Both sets will determine a three-dimensional

position and a velocity based on earth-centered, earth-fixed coordinates. Users will receive output in the military grid or other coordinate systems. The global positioning system will also provide the operator distance and azimuth readings to way points as well as the time accurate to a fraction of a second.

The global positioning system is now in limited production for additional testing. The field artillery plans to use the manpack and vehicular set with the PADS to establish initialization and update points.

Modular Azimuth Positioning System

The modular azimuth positioning system (MAPS) components are:

A **dynamic reference unit (DRU)** which includes a gyroscope, accelerometers,

A **vehicle motion sensor (VMS)** which transmits velocity data from the odometer to the DRU.

A **control display unit (CDU)**. When these functions are incorporated into another system, that is, the MLRS fire control computer, the CDU is not required.

A **static reference unit (SRU)** which is a tripod-mounted azimuth gyro. The DRU-associated items promise to replace this static item in future production runs.

The initial and largest user of the dynamic reference unit will be the howitzer improvement program (HIP) M109A3E3, scheduled for fielding in fiscal year 1989. This unit provides the self-survey capability which permits individual deployment of the howitzers and significantly improves survivability.

Vehicle Navigation Aid System

The draft vehicle navigation aid system (VNAS) requirements document requires two versions of the system. The one for the M1 tank will probably be an inertial system. The other version for use on other tracked and selected wheeled vehicles should be an off-the-shelf system, such as the low-cost magnetic flux gate technology.

The VNAS program will provide a navigation aid with an accuracy of two percent of the distance traveled. Users will update their systems from landmarks such as road junctions and will easily navigate from 200 to 300 meters of their destination.

Use of this system is expected to improve significantly the tank's ability to operate buttoned-up and in battlefield obscurants. Other users, such as ammunition vehicles, will improve their operations in darkness and under all weather conditions.

A Hybrid System

The Army and US Marine Corps completed the development of the position and locating reporting system (PLRS) in 1982. The Marines are now fielding the system. The Army is adding a data transmission capability before distributing a hybrid system known as the PLRS/JTIDS (tactical information distribution system) or PJH in 1988. Users gain access to the system through a small, hand-held readout device. This user readout is

<p>ARMY OBJECTIVE SYSTEM GLOBAL POSITIONING SYSTEM</p> <ul style="list-style-type: none"> • Worldwide common grid • Precise position data
<p>MODULAR AZIMUTH POSITIONING SYSTEM (MAPS)</p> <ul style="list-style-type: none"> • On-Board Inertial Survey System • Azimuth Reference • Position Data • Requires initial/update from external source
<p>VEHICLE NAVIGATION AID SYSTEM (VNAS)</p> <ul style="list-style-type: none"> • On-Board Navigation System • VNAS-Heavy for Tanks • VNAS-Light for other vehicles • Emphasis on Low Cost • Technology to be determined
<p>PLRS/JTIDS HYBRID SYSTEM</p> <ul style="list-style-type: none"> • Primarily digital data communications system • Command and Control Features <ul style="list-style-type: none"> • Unit ID of Elements Patrols aircraft • Unit and element location Horizontal and vertical position • Auto reporting and display of unit location and status -limited to division headquarters initially

a computer, and a power supply. This box is similar in size and function to the stabilized reference platform and position determining system (SRP/PDS) on the multiple launch rocket system (MLRS) launcher.

connected to an enhanced position and locating reporting system user unit (EPUU)—a UHF radio receiver and transmitter-like device which displays locations in universal transverse mercator coordinates and navigation data including range and direction. The user must determine his heading by compass or other means. The user readout display also allows for limited free-text communications between users by means of short coded messages.

The heart of the PJH is the net control station, a sheltered computer center operated by division and corps signal battalions. The station controls a network of approximately 200 EPUUs by employing a technique known as multilateration —determining range to a EPUU by measuring the time of arrival (TOA) of signal bursts at least three or more known locations.

Because both the position and locating reporting system and PJH are line-of-sight systems, the design requires any EPUU to serve as an automatic relay. When many units deploy over a broad area, up to four levels of relays are available to establish paths between remote users and the net control station. The station continuously monitors communications reliability, track quality, and the geometry of the relay links. Moreover, it automatically designates new relays as the EPUUs move. The positioning and navigation capability is available to all users equipped with an EPUU.

Within the field artillery, the users equipped with components of the tactical fire direction system — commanders, ammunition officers, and S4s — will receive EPUUs.

The Operational Plan

The accompanying chart depicts the operational use of each of the systems mentioned above. The fire support mission areas of command and control-land navigation, weapon systems positioning, target acquisition systems positioning, survey, and digital data transmission appear at the left. PADS appears at the top of the figure because developmental problems with the global positioning system user unit and delays in the satellite launch program will necessitate reliance on this first generation system for some time to come.

Entries in the matrix identify projected users of the systems during the time period 1993 through 95. The PJH will not go to echelons above corps; therefore, VNAS will substitute for the EPUU in Pershing units.

POS/NAV SYSTEM	GPS	PADS	MAPS DRU	VNAS	EPUU
MISSION AREA					
C²/LAND NAV				Pll Cdr's Pll S3, S4 POL Vehicles Supply Vehicles Main Contact Tm Wrecker/Rec Veh Wheeled Ammo Veh FAASV	Cdr's (-HHB) Ammo Off S4
Weapon Systems			M109 How M110 How MLRS Lnch Lance Lnch Pll Lnch Towed Arty		
Tgt Acq Systems			FISTV FF II ETAS RPV		
Survey Sections	Survey Sec	Survey Sec			
Div Arty		Survey Sec			
Others		Survey Sec			
Data Transmission					TACFIRE components

Operational plan for the positioning and navigation system.

VNAS will also reach primarily combat service support elements as shown.

Note that all weapons and sensors, except towed howitzers and remotely piloted vehicle batteries, should eventually incorporate the dynamic reference unit. The reason for this is simple. All the systems need to move frequently to survive and must have instantaneous survey to achieve maximum effectiveness. Towed howitzers and the remotely piloted vehicle batteries will exploit dynamic reference units mounted on accompanying vehicles much as artillerymen use PADS today.

Initially the global positioning system will go to only division artillery survey sections. The developmental problems mentioned above have constrained planning for this equipment. But it still has tremendous promise. Employment of the user equipment in the multiple launch rocket system or howitzer improvement program platoon, for example, would create a true self-survey system because crew members can operate the user equipment. The leaders of the field artillery recognize this promise and are monitoring

the program closely to determine possible changes in the master plan.

Conclusion

The Army Position and Navigation Master Plan indicates significant changes ahead for the field artillery. The most operationally significant alteration will be the use of the MAPS dynamic reference unit on-board weapons and sensors to permit frequent changes in position with an instantaneous survey capability. Surveyors will no longer have to survey battery and platoon orienting stations and lines; our weapons and sensor will have azimuth and position data on board for instant use.

If the global positioning system can achieve its full potential, the system's user unit should allow surveyors to establish initialization and update points. Subsequent use of a hybrid dynamic reference unit and global positioning system can eliminate the need for the survey section of today. Personnel spaces made available by such changes can help fill other needs.

VNAS will provide a long-sought

navigation aid for our combat service support elements. The PJH system will significantly improve our digital data communications capability and make its positional navigation features available to anyone equipped with the EPUU.

The net result of all these changes will not only be a responsive system that supplies required data to an appropriate accuracy, but also significantly enhanced field artillery capabilities on future battlefields.



Lieutenant Colonel (Retired) Roy E. Penepacker is a field artillery specialist in the Systems Branch, Directorate of Combat Developments, US Army Field Artillery School at Fort Sill, Oklahoma. His military experience includes assignments as battery commander, battalion survey officer, battalion S3, battalion executive officer, division artillery S2, and field artillery brigade S3.

Savings on the Way!

The Troop Support Command's Belvoir Research, Development, and Engineering Center and Litton Guidance and Control of Woodland Hills, California, recently signed a contract modification that resulted in a net unit savings of \$12,550 for the position and azimuth determining system (PADS). Estimated future savings for the Army could run as high as \$3.6 million.

This savings is the result of a successful value engineering change proposal by Litton. The company's proposal involved replacing the present 32K core memory design with a 64K semiconductor memory.

This setup will increase reliability, guarantee availability of spare parts, and offer lower life cycle costs. Delivery of the first units incorporating the change occurred in February.

The Center's Value Engineering Program encourages contractors to submit cost-saving proposals as a means of reducing the price of Army materiel. The contractor then shares in the savings. Litton receives a 50 percent share of the net unit savings resulting from their proposal which equals the Army's savings of \$6,275 per unit. What's more, future procurements for the PADS will entitle the company to receive a 50 percent share of the unit cost savings.

Right by Piece

NOTES FROM UNITS



Reservists "On the Trail"

FORT SILL, OK—Everyone seems to agree that the Total Force concept is an outstanding idea. But will it actually work? We have never really seen the Total Force in action, so no one can be certain of the answer. What we can do, however, is to take advantage of every possible opportunity to train the National Guard and Army Reserve units on their actual mobilization tasks.

For 3 consecutive years at Fort Sill, Oklahoma, the 3d Field Artillery Training Brigade of the 84th Division

has done just that. A Reserve unit with headquarters in Milwaukee, Wisconsin, the 3d-84th has trained its most important personnel—drill sergeants—on their mobilization mission.

The 3d Brigade's wartime role is simple: To set up a Field Artillery Training Center at Fort Sill or Fort Hood, Texas, and conduct one-station unit training (OSUT) with a goal of turning out 19,000 qualified artillerymen in its first year of operation.

Until this year, the 3d Brigade was the only Army Reserve unit in the country with such a mission.

However, recently the Total Army activated the 402d Field Artillery Training Brigade, 95th Division, at Lawton, Oklahoma, to perform the same mobilization task.

To prepare for such an imposing mission, the 3d Brigade has stepped up its mobilization-related efforts. The unit has achieved 100 percent strength and has emphasized two important areas—producing capable drill sergeants and attaining individual proficiency in every position.

Much of this training cannot occur at the home station. To get the feel of the day-to-day operation of the Field Artillery Training Center, selected members of the 3d Brigade have trained with their artillery training center counterparts at Fort Sill. In doing so, they actually perform the mission they would have upon mobilization.



At Fort Sill, Oklahoma, reservists learn the job by doing the job. They train with their field artillery counterparts to learn the mission they would have upon mobilization. (This is overset from May-June)

The principle is that one has to learn to be a drill sergeant by doing a drill instructor's job. Or as the drill instructors themselves say, "by being on the trail." For Reserve Component field artillery sergeants, the trail leads to one place—the training battalions of Fort Sill's Field Artillery Training Center.

For the last three summers, the 3d Brigade has followed that trail. A dozen members of the Brigade, including seven drill sergeants, have formed the core cadre for one battery as it goes through the entire 13-week OSUT cycle.

From outward appearances, the battery is no different than the other 38 initial entry training (IET) units at Fort Sill. Its training schedules are the same and so are the expectations of the leaders of the Field Artillery Training Center.

There are no references to the "Reservists' battery." Even though the battery commander, executive officer, first sergeant, senior drill sergeant, and platoon sergeants are all members of the 3d Brigade, the battery is just another training unit.

Every 2 weeks additional Brigade drill instructors arrive for their 2 weeks of annual training. In all, nearly 50 drill instructors have taken part in such training over the last three summers. Because the Brigade wants to train as many drill sergeants "on the trail" as possible, few drill instructors have returned to Fort Sill for a second cycle.

Clearly, the mission performed by the 3d Brigade is an integral spoke in the Army's readiness wheel. If the Reserves and National Guard are going to carry out mobilization missions beyond the full capabilities of home station training, more "on the trail" opportunities like the Brigade's OSUT training battery will be helpful.



Copperhead Stockpile Reliability Test

FORT BRAGG, NC—In the hands of trained gunners, Copperhead can deliver a remarkable *whallop*. The 1st Battalion, 39th Field Artillery proved this when they recently participated in a Copperhead stockpile reliability test. During the test the "Speed in Action" gunners fired 16 Copperhead rounds. Other participating units from the 24th Infantry Division, the 101st Airborne Division Artillery, the

XVIII Airborne Corps Artillery, and the 82d Airborne Division Artillery provided the experts and equipment necessary to test the artillery's first "tank busters."

Copperhead is one artillery system that really extends the battlefield. When a commander employs a remotely piloted vehicle as a designator, he has a target engagement capability comparable to that of a 16-kilometer direct fire weapon. Such increased range means greater flexibility and lethality.

During the tests, observers measured Copperhead's accuracy in centimeters. Its circular error probability proved three times better than requested in the original design specifications. The warhead consists of a copper shaped charged liner and composition B explosive which can penetrate armored personnel carriers, tanks, bunkers, buildings, and a variety of hard targets. The warhead steel shell provides additional fragmentation. Copperhead's impact angle, accuracy, and demonstrated lethality results in an unprecedented single shot kill probability.

Take Charge!

WUERZBURG, GERMANY—Today's soldier often finds himself in leadership roles from the very beginning of his career. "Soldiers of the newly formed 4th Battalion, 27th Field Artillery, have a great deal of responsibility from private right on up," said Major John A. Sorrell, S3 for the multiple launch rocket system (MLRS) battalion.

Private Thomas C. Keedy agrees. "We learned how to read a map during our collective training at Fort Sill," noted Keedy. "They gave us a map and a grid coordinate, told us there was a ribbon tied on a tree at this location, and we had to find it," he explained. "You learn how to read a map fast when you do it like that."

Keedy's job is assistant driver of the heavy expanded mobility tactical truck (HEMTT), an ammunition resupply vehicle for the multiple launch rocket system. Keedy and his fellow HEMTT drivers often are on their own.

"Once they leave their section, they might well be on the road for as much as 24 to 36 hours before their section chief sees them again," said Staff Sergeant Stephen R. Brigham, an ammunition section chief. Brigham went on to explain that HEMTT drivers normally receive instructions by radio to pick up ammunition and proceed to another location.

Sergeant Brigham is well-pleased with his soldiers. "We depend on those privates to find the location, day or night, and accomplish their mission with little supervision... That's a lot of responsibility to give a private, but they do their job and do it well." (Story and photo by Sergeant Larry D. Byerly, Sr.)



PV2 Thomas C. Keedy, assistant driver for the 4th Battalion, 27th Field Artillery, VII Corps, prepares a heavy equipment mobile tactical truck for operation during training at the Grafenwoehr training area in West Germany.



The four-channel intercommunications system and digital message device are used for transmitting fire mission data to a fire direction center.

First FSV Fielding

FORT STEWART, GA—The 24th Infantry Division at Fort Stewart is the first unit to receive the Army's new M981 fire support vehicle (FSV). Fort Stewart's Redlegs acquired a total of 54 FSVs produced by Emerson Electric Company under contracts awarded by the US Army Tank and Automotive Command (TACOM).

The FSV provides the fire support team with unprecedented mobility and protection. Using the ground/vehicular laser locator designator (G/VLLD), the FSV's crew engages targets with both conventional and laser-guided munitions.

The FSV's other subsystems include a north seeking gyrocompass, day and night sights, a four-channel intercommunications system, and a digital message device for transmitting fire mission data to a fire direction center.

During a typical fire mission, the FSV targeting station operator locates and lases a target to determine its range. An on-board system then merges the target date with gyrocompass determined direction and transfers this information to the digital message

device within the FSV. The crew quickly validates the mission data and transmits it over one of the four available radios to the supporting fire direction center. The inherent accuracy of the total system reduces significantly the need for subsequent adjustments.

The FSV chassis is the US Army's proven M113 armored personnel carrier, which is also the base vehicle for the M901 improved TOW vehicle (ITV). The FSV and ITV share 70 percent hardware commonality, an important feature from the logistician's perspective. In fact, more than 2,500 M901 ITVs and more than 35,000 M113s are now deployed.

FSVs are also now in place in Korea and at Fort Bliss, Texas. European-based units will receive their new system between July 1986 and May 1987.



The FSV provides the fire support team with unprecedented mobility and protection.

CRETE, GREECE—Battery C, 2d Battalion, 377th Field Artillery, assigned to the 210th Field Artillery Brigade, recently received a perfect score on its North Atlantic Treaty Organization evaluation and annual service practice in Crete, Greece.

Commanded by Captain Thomas W. Woodley, Battery C became the first unit on record to receive 100 percent on this rigorous inspection. The six Lance battalions stationed in US Army Europe participate in the service practice once a year. During the evaluation, inspectors from the Federal Republic of Germany, Belgium, and the United States spend 3 days examining a battery's technical ability to launch a Lance missile.



CPT Denise I. Gifford



Surprise Visit!

GRAFENWOEHR, GERMANY—Members of Battery B, 2d Battalion, 28th Field Artillery were surprised and excited by a recent visit from the Honorable John O. Marsh, Secretary of the Army. The battery was at the Grafenwoehr training area preparing for its upcoming Army training and evaluation program when word came that Secretary Marsh was making a whirlwind tour of the area. At the conclusion of the Secretary's visit, the past commander of the 2-28th FA, Lieutenant Colonel Robert Michaud presented Secretary Marsh a plate as a memento of his time with the unit.



Touchtone Dialing and the Redleg Connection

by Mr. Richard F. (Dick) Brown

We've all heard the old adage, "There's more than one way to skin a cat." Perhaps nowhere is this more apparent than in today's Field Artillery. To win on tomorrow's battlefield, the Redlegs of today must have a full range of weapon systems upon which to rely. Just as the Fire Support Community cannot count on just one weapon system or one type of projectile to accomplish its mission, the Signal Corps must build multiple new systems to support its corps and division communications missions. After all, the modern battlefield operates in several dimensions each having

special requirements. Many of these dimensions have several requirements for *communications* support at the same time. In fact, there are three major types of communications equipment which meet the needs of the modern battlefield and the Field Artillery uses all of them.

- **Combat Net Radio.** When field artillerymen think of combat net radios they usually conjure up the VRC-46 radio with its cousin the PRC-77. Such radios communicate from one point to another in a net where only one station can talk at a time. In the not too distant future the single channel ground and airborne radio subsystem

(SINCGARS) will become the new combat net radio. Other such sets are the high frequency AN/GRC-142 radio teletypewriter and the new improved high frequency AN/PRC-104 and GRC-193 radios. Certain satellite communications found in some field artillery units also fall into the category of combat net radios as do aircraft voice communication radios.

- **Data Distribution.** The tactical fire direction system (TACFIRE), the battery computer system (BCS), Firefinder, and the meteorological data system all must use the combat net radio to pass data. As the field artillery equips more units with automated systems, the need for dedicated

data distribution systems will proliferate.

The so-called packet radio may be the answer to many data communications problems. It exists today as both the enhanced position locating reporting system (PLRS) and the joint tactical information distribution system (JTIDS). These are radios, but they operate differently than the combat net sets. First, they speak only to computers. Although a speaker could be hung on the radio, the TACFIRE or BCS operator would hear only the briefest click as tens of thousands of bits burst between receiving sets. Second, packet radio systems do not have to transmit from point to point. They are capable of using multiple paths to send data packets to the ultimate subscriber. By using multiple paths and several intermediate relays, the PLRS and JTIDS, operating with low power outputs, can cover relatively large areas.

• **Area Communications Systems.** Because packet radios are not designed to provide voice communications, there is a definite need for a system which can tie distant headquarters together. Such area systems would link field artillery units and the corps units they support. For example, the area communications system must allow Lance battalions to answer calls for fire directly from corps artillery and multiple launch rocket system (MLRS) battalions to receive general support missions and target acquisition information from

corps artillery target acquisition sources.

The Army's plan for providing such wide area coverage involves the mobile subscriber equipment (MSE). This system will be installed and operated by the Signal Corps, but it will provide a wide range of communications services for field artillery units.

area communications system simply because these Redlegs are constantly *moving*. Although the direct support cannon battalion doctrinally requires two "ports of entry" into the divisional area system, the headquarters and headquarters battery communications platoon leader charged with making the hook-up at the supported maneuver brigade's command post seldom gets to meet the signal corps multichannel platoon leader who provides access into the system.

Using the MSE, the battalion communications officer should have a better chance of success. MSE is, for the

An Overview

Field artillerymen in cannon battalions very seldom have access to an

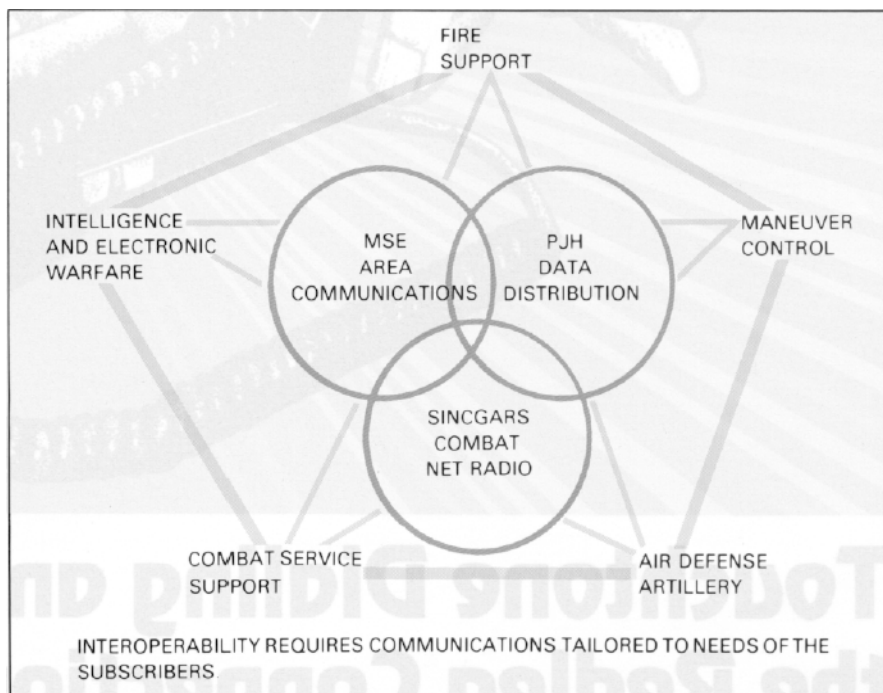

Command, control, communications, and interoperations for the AirLand Battle.

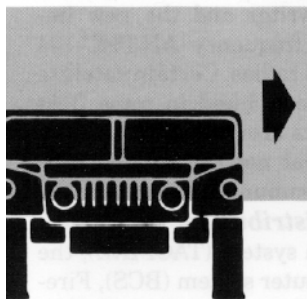

The M998 HMMWV.



The ER-222 radio is the UHF receiver-transmitter component of the mobile subscriber radiotelephone.

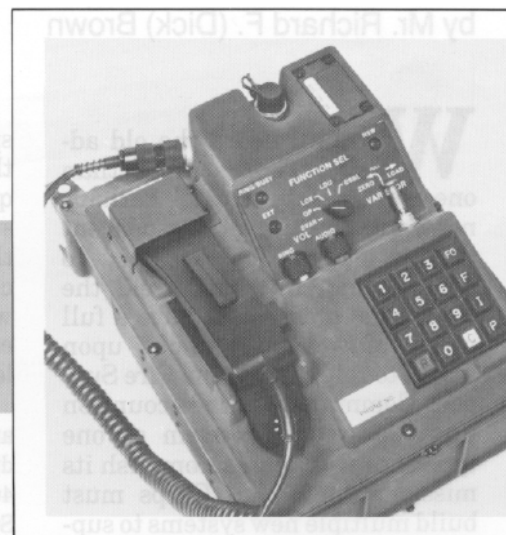

The digital secure voice telephone KY-68 connects to the ER-222 radio.

most part, operated and owned by the Signal Corps. Users of the system will have to provide their own push-button telephones, but the communicators do the rest.

The system will allow field artillery battalion personnel to talk to the division artillery and many other agencies within the division and corps. Think how convenient it would be to call the direct support maintenance unit to check on the status of equipment in for repair or to get an update from the local medical unit on casualties evacuated after the last action. Using MSE, an artillery unit could do just that. Here's how the battalion gets the telephone service in a very hypothetical situation.

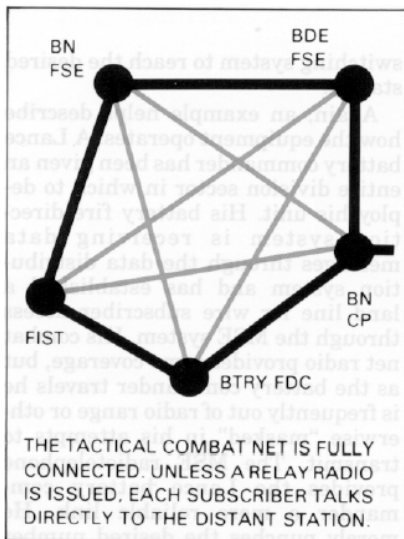

The combat net radio configuration.

As the states of alert increase and hostilities become inevitable, both field artillery and supporting signal units deploy. The signal unit's small extension node composed of two high mobility multipurpose wheeled vehicles (HMMWV) mounting ambulance-like shelters joins the field artillery unit almost immediately. As the battalion command post sets up, the signaleers park one HMMWV close to the fire direction center while the second moves to another area where its occupants quickly install two tall antenna masts. Individual field artillery sections previously designated as MSE wire subscribers run wire lines from their vehicles to either the signal HMMWV or to a local junction box and plug into marked connectors.

Obviously, training plays a part in this operation, but the habitual association of communicators with supported units makes the operation easy. A cable or short-range multichannel radio shot links the signal vehicle with the second vehicle by a multichannel radio shot or a multipair cable. The second vehicle is the access port to the full area communications system which allows many simultaneous conversations.

With MSE, the time to establish telephone service for the battalion is the time it takes to lay the wire to the small extension switch or junction box. This will often be less than 1 kilometer away.

Should the battalion operations noncommissioned officer (NCO) wish to call the division fire support element, he merely picks up the pushbutton

telephone, dials a seven-digit number, and waits for the tactical fire support element to answer. The call goes through the system of node control switches.

The four nodes within the division area are responsible for doing the switching of all the traffic coming through the system. Each node is an assemblage of ultra high frequency radios, directional antennae, generators, and cables. But under MSE the multiplexing equipment and computer controlled switches do the real work. In fact, they can accommodate numerous two-way voice or data conversations simultaneously.

Each of the four nodes has a communications path to at least two sister nodes. This gives the system redundancy. If the call from the operations sergeant to the tactical fire support element cannot be routed in the shortest direction for any reason, the dialed numbers will be held until a good link is established.

Nodes interconnect not only within the division, but also extend, through the corps' nodes to adjacent divisions as well. The actual placement of all these nodes and how they will interconnect is the job of the signal corps operations officer. The understanding of the division commander's concept of the operation and the resultant organization for combat becomes as critical to the communicator as to the fire support coordinator.

Other System Capabilities

Facsimile traffic is yet another useful feature of MSE. This little vignette

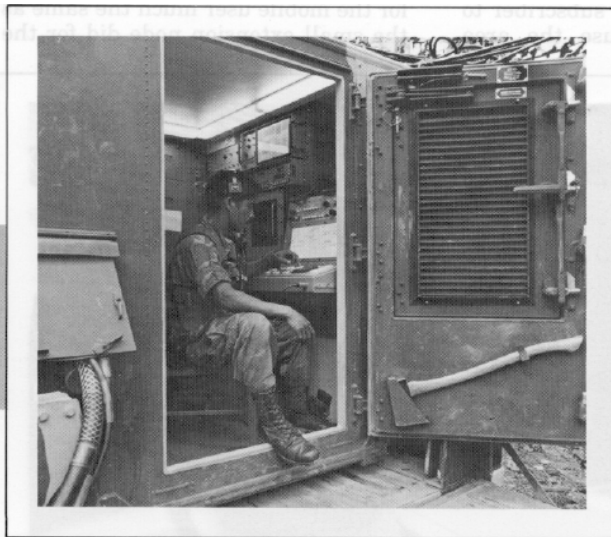

The node center switch is small, lightweight, and easily transportable.



The Erickson MF-15 super-high frequency radio is a highly directional unit.

shows why. Our operations sergeant during his voice call to the tactical fire support element learns that a restrictive fire area is to be imposed for a future operation. He asks if an overlay can be sent immediately. Because the TACFIRE digital plotter map is not available, the fire support specialist replies that he will send a facsimile copy within the next several minutes. There's no runner and no mad scramble to send encrypted grid coordinates.

Teletype service. As voice and facsimile communications pass between the operation sergeant and the fire support element, the battalion S2 finishes a message requested by the division artillery commander regarding the status of the AN/TPQ-36 performance. Because the message is lengthy, the S2 gives the copy to the radio teletypewriter (RATT) operator who "pokes-up" the message on the keyboard of his AN/UGC-74 teletype. However, rather than using his radio, he connects the UGC-74 through a four-wire cable to the special data connector on the push-button telephone. He makes a voice call to the RATT operator at the division artillery tactical operations center and then transmits the teletype message.

Point-to-Point Circuits

As it exists today, TACFIRE will be unable to access the MSE system as a normal wire subscriber. This is because the TACFIRE cannot automatically dial telephone numbers. However, units can establish a circuit linking the division artillery and battalion TACFIRE for limited periods. Obviously, this procedure monopolizes a precious communications channel

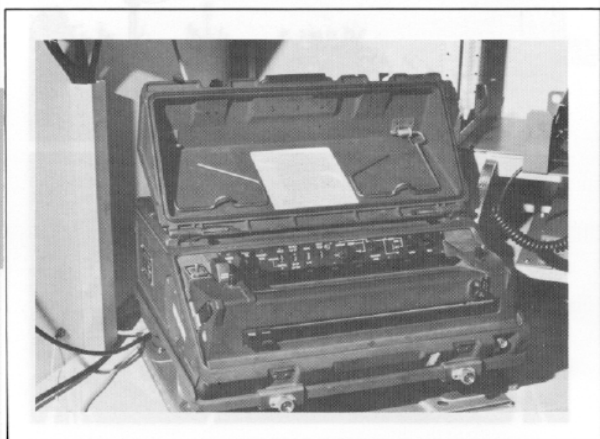

The UXC-7 lightweight tactical facsimile connects to a data port on the MSE telephones.

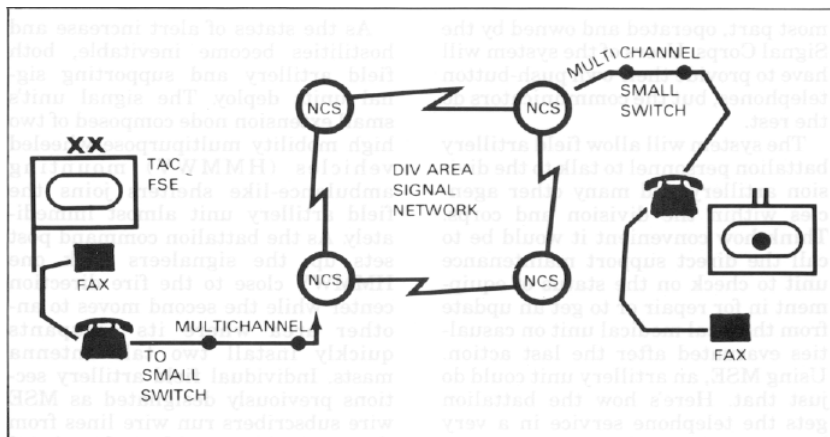

Facsimile (FAX) overlays are transmitted by digital burst communications over the mobile subscriber equipment.

ator dial the distant operator. Nevertheless, a commander may authorize such a seizure of point-to-point circuits. The MSE will have the capability to pass data, but field artillerymen should look at this option as a secondary means. The objective system for data communications is enhanced by PLRS and JTIDS. MSE will provide data only as an alternate means. Exceptions may exist in the case of widespread rocket-missile or target acquisition units.

Rapid Contact

The MSE provides another remarkable feature for selected individuals requiring rapid contact with other MSE subscribers at great distances. The mobile subscriber radiotelephone is a device installed on selected vehicles. It allows a mobile subscriber to dial a number and use the area

switching system to reach the desired station.

Again, an example helps describe how the equipment operates. A Lance battery commander has been given an entire division sector in which to deploy his unit. His battery fire direction system is receiving data messages through the data distribution system and has established a land line for wire subscriber access through the MSE system. His combat net radio provides some coverage, but as the battery commander travels he is frequently out of radio range or otherwise "masked" in his attempts to transmit. The MSE radiotelephone provides the Lance battery commander a more reliable link. He merely punches the desired number for the MSE radio to transmit the call to a radio access unit. This unit acts for the mobile user much the same as the small extension node did for the

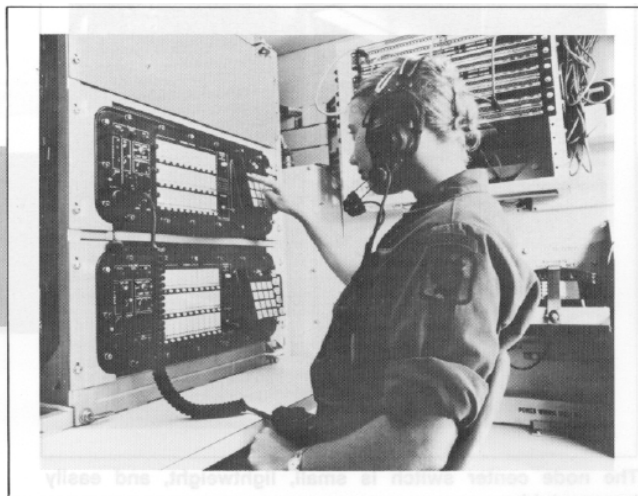

The small extension switch uses two SB-3614 digital switchboards to handle the traffic coming through the system.

cannon battalion; it provides access to a division or corps communications node and thereby to the entire system. The Lance battery commander will be

able to talk to his battalion commander, the battalion staff, or even to the corps artillery through his specific information immediately.

Conclusion

The mobile radiotelephone is a sophisticated piece of equipment and provides enormous capability. However, it is not without faults.

- First, the complete unit will be large. It consists of a push-button telephone with a built-in communications security, a sophisticated receiver transmitter, a VHF omnidirectional antenna, and associated power and signal cables. The entire assembly occupies more space than a VRC-46 radio.

- Second, the mobile radiotelephone uses the same frequency band as SINGARS.

- Third, the radiotelephone apparatus is expensive. Estimates place the cost in five figures.

Despite these drawbacks the mobile subscriber equipment system promises to be an invaluable tool for the future battlefield. It will improve the mobility and flexibility of tactical forces. And these characteristics may well spell the difference between death and survival in war. ☒

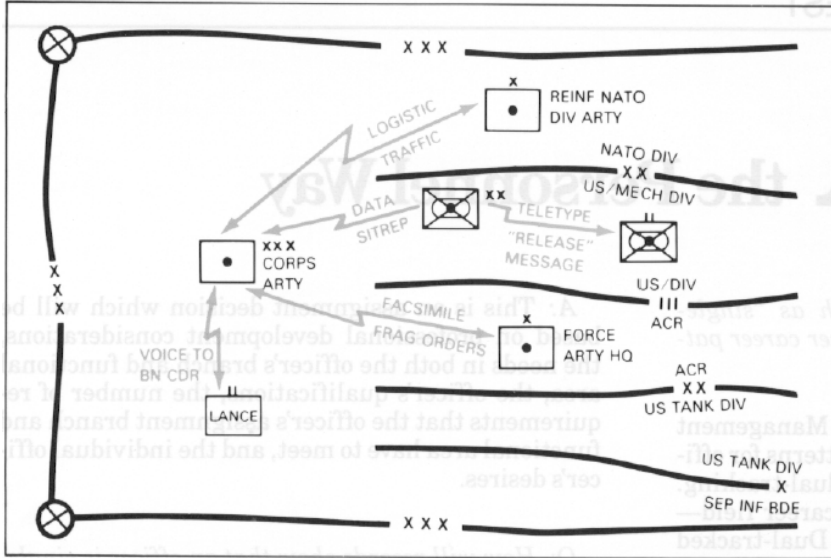

The mobile subscriber equipment supports the corps with wide area coverage.

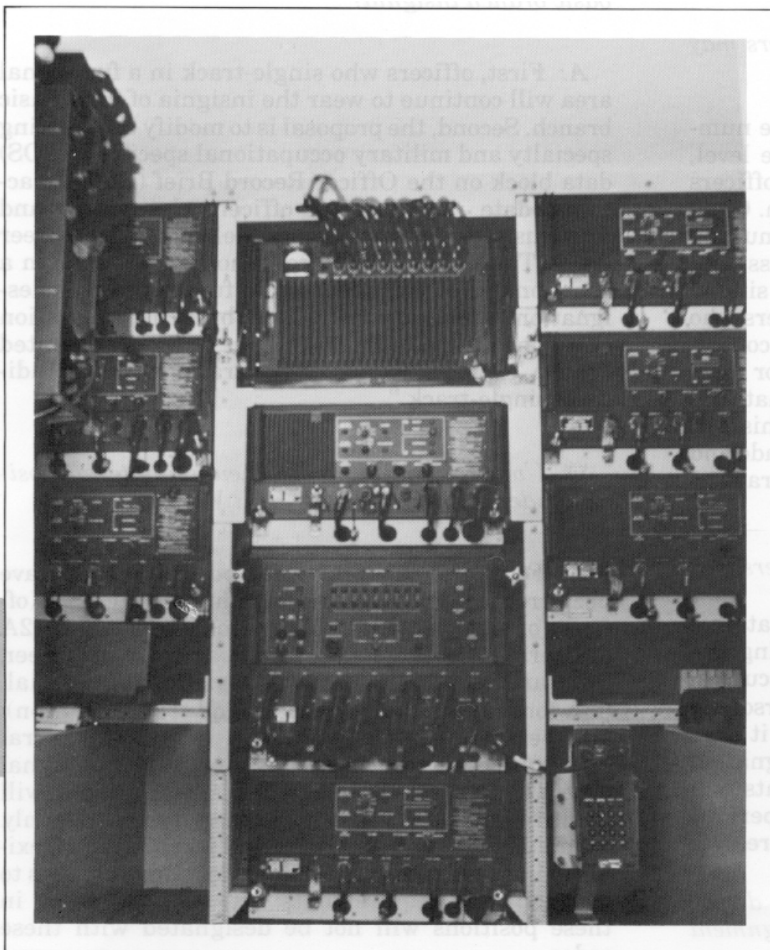

The radio access unit allows the mobile subscriber radiotelephones access to the entire area communications system.



The digital nonsecure voice telephone TA-954 (M2) is a four-wire, push-button telephone.

Mr. Richard F. (Dick) Brown is a field artillery specialist with Tactical Data Systems Communications at the US Army Field Artillery School at Fort Sill, Oklahoma. He has been involved with communications analyses for tactical automatic data processing systems and communications support media and has been the principal developer of the intrabattery radio.

Redleg News

ITEMS OF GENERAL INTEREST

Q&A the Personnel Way

Q: I have been hearing terms such as "single-tracking" and "dual-tracking" for officer career patterns. What do they mean?

A: The revised Officer Personnel Management System (OPMS) provides two career patterns for officer development: single-tracking and dual-tracking. A single-tracked officer has only one career field—either a branch or a functional area. Dual-tracked officers will have two career fields—a branch and a functional area.

Q: Are you saying that combat arms officers may single-track in their branch?

A: Yes! However, in order to meet the large number of Army requirements at the field grade level, only a very small number of combat arms officers will be allowed to single track in their branch. Combat arms officers who request to single-track must be aware of the potential assignment and professional development limitations associated with single-tracking in a combat arms. Specifically, officers who single-track in a combat arms branch will be considered for assignment only in positions coded for their branch as well as those labeled as branch immaterial (O1A) and combat arms immaterial (O2A). This will preclude assignment to positions such as brigade and division personnel officer (coded 41) and operations officer (coded 54).

Q: Who will decide career patterns for officers?

A: Every officer has an opportunity to state his preferences regarding his career track during the functional area designation process which occurs in the seventh year of service. The Military Personnel Center will manage this selection much as it does today's additional specialty (ADSPEC) designation process. Branch or functional area proponents will determine the number of officers who will be permitted to single-track in a branch or functional area.

Q: For dual-tracked officers, who will decide whether an officer will serve in a branch assignment or a functional area assignment?

A: This is an assignment decision which will be based on professional development considerations, the needs in both the officer's branch and functional area, the officer's qualifications, the number of requirements that the officer's assignment branch and functional area have to meet, and the individual officer's desires.

Q: How will records show that an officer is single-tracking in a functional area, and will he wear his basic branch insignia?

A: First, officers who single-track in a functional area will continue to wear the insignia of their basic branch. Second, the proposal is to modify the existing specialty and military occupational specialty (MOS) data block on the Officer Record Brief (ORB) to accommodate recording an officer's designated and previously designated career fields and his career track. The ORB of an officer who single-tracks in a functional area will show only a functional area designation. His previously held branch designation will appear in a block titled "previously designated branch." A block titled "career track" will also indicate "single-track."

Q: I understand that some new immaterial position codes have been established? What are they?

A: Four branch immaterial position codes have been created. They are: branch immaterial, O1A (officers of any branch); combat arms immaterial, O2A (officers from air defense, armor, aviation, engineer, field artillery, and infantry); logistics immaterial, O3A (ordnance, quartermaster, and transportation); and personnel immaterial, O4A (adjutant general corps officers and officers designated in functional area 41, personnel management). These codes will identify *positions* on authorization documents only. Establishment of these codes will permit more flexibility in the identification and selection of officers to meet specific requirements; officers who serve in these positions will not be designated with these codes.



Movin' On: Advancing Logistics Support

by Captain Scott R. Gourley, USAR

The idea of protecting critical supplies and equipment on the battlefield is almost as old as combat itself. Yet it was not until World War II that a coherent statement of need emerged for armored logistic vehicles possessing mobility equivalent to the maneuver force. The concept that resulted from that crucible of modern armored warfare emphasized the value of both mobility *and* protection.

B. H. Liddell Hart voiced his theories on this subject in his post-war examination of armored warfare, *Defence of the West*. In his vision of future armored forces, Hart saw the armored division as "an inverted turtle—with a small armor-clad head popping out of a huge soft-skinned body."

Although Hart felt that air transport should primarily fulfill the requirement to supply mobile forces, he did have some suggestions for increasing mobility and decreasing vulnerability. His proposals were relatively straightforward:

- Cut unarmored elements to the minimum.
- Cut road-bound elements to the minimum.
- Ensure that everything that moved on the ground was track rather than wheel-borne.

Since that time military theorists have regularly debated the merits of armored logistics systems. However, United States' military involvements yielded few opportunities to test the merits of such proposals. With a few notable exceptions, the ability to perform the critical battlefield operations of repairing, recovering, rearming, and refueling combat equipment in the forward area remained an "interesting idea" or a "nice-to-have" capability. The exceptions included the M548 tracked but unarmored cargo carrier, the M578 recovery vehicle, and the M88 medium recovery vehicle. Regardless of the successes enjoyed by these "exceptions," the debates continued. Armored logistics vehicles as combat multipliers just weren't fashionable enough to win a piece of the budget pie.

A Major Turn of Events

The 1973 Israeli War changed all that. The data that has slowly emerged from that conflict clearly indicates the incredible value of armored logistics vehicles. The need to repair combat equipment in the forward area is a perfect example. Vehicle statistics from the 1973 conflict showed that 75 percent of the 450 Israeli tanks present at the start of the battle were lost within the first 18 hours of combat. Of those damaged vehicles, 80 percent were repaired and returned to battle within 24 hours. In fact, Israeli maintenance crews repaired and returned some tanks to battle four or five times during the course of the war.

The use of armored logistics vehicles as combat multipliers has not been lost on Soviet military planners. In a copyrighted article in the December 1983 issue of *Tekhnika-Molodezhi*, Soviet Doctor of Technical Sciences Engr-Col Vladimir Medvedkov writes of special purpose vehicles based on regular production carriers. He includes armored recovery vehicles (BREM) and technical assistance vehicles (MTP) in that broad category.

The Soviet's new armored recovery and repair vehicle, the BREM-1, illustrates some emerging trends in this area. Although the Soviet military has historically used old tank chassis to create armored recovery vehicles, the BREM-1 is mounted on the chassis of the T-72 main battle tank. The BREM-1 reportedly features a dozer blade, a 19,000-kilogram crane capable of lifting a BTR-60, and a 25,000-kilogram winch.

As previously noted, the American military does have some rudimentary armored logistics capabilities. But in a combat environment the US' only viable armored logistics vehicle is the M88A1 recovery vehicle. This monstrous

track's primary mission is recovery operations, and any time spent by the crew in attempts to repair combat equipment is time that the M88 is not available for its primary mission. Recognizing this deficiency in tactical military equipment, US defense planners have finally begun investigating and testing other vehicles.

Some Impressive Initiatives

Eliminating the maintenance function from the list of additional duties assigned to a recovery vehicle will significantly increase its ability to perform its primary mission. Consequently, the Army is also looking at an armored maintenance vehicle (AMV) to perform the battlefield repair function. One such candidate vehicle successfully completed both concept evaluation at Fort Hood, Texas, during 1985 and additional testing at Fort Knox, Kentucky. Based on the M987 fighting vehicle system carrier—better known to field artillerymen as the chassis for the multiple launch rocket system—the armored maintenance vehicle is a giant step forward from transporting "contact teams" around the battlefield in soft-skinned maintenance vans.

In the associated areas of rearming and refueling, several "under-armor" ideas have surfaced. Artillerymen might be inclined to ask why new rearm concepts are necessary when the artillery already has an armored rearm vehicle in the M992 field artillery ammunition support vehicle (FAASV). There are several reasons why the FAASV is not an appropriate candidate for the rest of the Army.

- Chassis commonality is a driving force in putting a new vehicle on the battlefield. Although the



The standard M88A1 is presently in the US' only viable armored logistics vehicle for recovery operations. Eliminating the maintenance function from the list of additional duties assigned to a recovery vehicle increases its ability to perform its primary mission.

field artillery has the M109 chassis used in the FAASV, other Army elements don't.

- The FAASV chassis does not have the ability to keep up with modern maneuver forces on a highly mobile battlefield. This would be especially critical in potential deep attack operations.

Consequently, the Army is looking for a new vehicle candidate. But in the areas of rearm and refuel, there seem to be several schools of thought. One group wants to take the traditional approach of a dedicated vehicle for ammunition and another one for fuel. A second approach involves the use of one vehicle in a variety of capacities. Under the armored resupply multipurpose system (ARMS) concept, the same vehicle could be used to transport fuel containers or ammunition to forward combat elements.

Both the dedicated vehicle idea and the ARMS concept involve some use of the M987 MLRS chassis. Maintainability and mobility equivalent to the maneuver force are both ensured due to critical component commonality between the M987 and the other members of the Bradley fighting vehicle system.

Another battlefield logistics initiative that has recently spun-off from the armored refueler program is the "rapid refuel" concept. One approach calls for an automatic refueling arm on the armored logistics vehicle to deploy, connect, fuel an entire M1 tank, disconnect, and stow in less than 4 minutes.

Conclusion

The need for tactical armored logistics vehicles has never been greater. The Army needs to enhance the survivability of its logistics system to use them to multiply the fighting capabilities of combat forces. Recognition of these needs is the first step in correcting a major deficiency in American tactical hardware. The ongoing US Army initiatives in the areas of tactical repairing, recovering, rearming, and refueling vehicles should be applauded. Although not glamour systems, these armored logistics vehicles will play a critical role in helping to strengthen our deterrent and warfighting capabilities. ☒

Captain Scott R. Gourley, FA, USAR, is a frequent contributor to the *Journal*. He is employed by FMC Corporation Ordnance Division in San Jose, California. A former Threat and target acquisition instructor at the US Army Field Artillery School at Fort Sill, Oklahoma, he is the recipient of the US Army Forces Command Fourth Estate Award for Excellence in military journalism. Captain Gourley is a member of the US Army Reserve Control Group Reinforcement.

Fragments

FROM COMRADES IN ARMS

Can't Lose with This Fuze!

A prototype mortar fuze under development by Harry Diamond Laboratories (HDL) in Adelphi, Maryland, demonstrated tremendous timing accuracy during recent firing tests. The evaluation suggests the new multi-option fuze could dramatically improve the Army's mortar capability.

During the tests, Army experts fired 30, 60-mm, 81-mm, and 120-mm mortar rounds over the Potomac River from the Naval Surface Weapons Center's test firing range. Each round carried a prototype of a new digital, electronic time fuze. The fuzes were set to burst at predetermined times varying from 8.1 seconds to 32.8 seconds; and according to HDL officials, all rounds but one burst within 60 milliseconds of their preset times.

The digital electronic time fuze, known as the M734, includes a crystal-controlled digital clock with three miniature thumb-wheel decade switches for setting burst times in tenths of seconds. Because the switches make an audible click as they are advanced, soldiers can hand-set them even in the dark.

Representatives from a variety of Army agencies observed the test firings. Max Cogar, a specialist with the

US Army Infantry School at Fort Benning, Georgia, remarked, "We fire mortars in support of the infantry. This fuze gives us more accurate steel on target and also more burn time for illuminating the field."

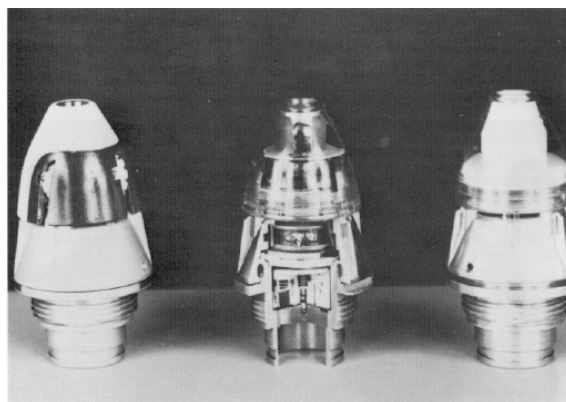

US Army Photo

The family of new fuzes being developed by HDL can be used with the 60-mm, 81-mm, 120-mm, and 4.2-inch mortars. The digital electronic time fuze is shown at left, the M-734 multi option fuze is in the center, and the XM-745 impact fuze is on the right.

Mechanical engineer Bob Epstein said the multi-option fuze has "definite potential" for the 120-mm smoke round he is responsible for at the US Army Chemical Research, Development, and Engineering Center at Aberdeen Proving Ground, Maryland. "Smoke rounds are used in both offensive and defensive modes," he said. "They disrupt the command and control of the enemy, and they shield your maneuvers and prevent the enemy from locking onto you as a target....The electronic time fuze has superior accuracy compared with the mechanical or pyrotechnic time fuzes we now use. It could replace those fuzes on the 4.2-inch white phosphorous round."

According to Dr. Carl Campagnuolo, HDL's mortar fuze project officer, the digital electronic time fuze is part of a three-member family of fuzes under development. The trio could replace some 25 fuzes now in the Army inventory while satisfying all 60-mm, 81-mm, 120-mm, and 4.2-inch mortar applications. The other two family members are the M734 multi-option fuze and the XM745 point-detonating and practice fuze.

All three fuzes share a high commonality of parts—including safing and arming devices that satisfy the latest Army safety standards—which should keep unit production costs relatively low.

Air Force Adds Combined Effects Munition

The CBU-87/B combined effects munition (CEM) is the latest addition to the US Air Force's cluster weapon inventory. CEM is a flexible weapon system used to attack a broad range of battlefield targets with a single payload.

Each 1,000 pound CEM is composed of an SUU-65 tactical munitions dispenser (TMD) and 202 BLU-97/B combined effects bomblets (CEB). System operation begins when the pilot drops the TMD from the aircraft. The dispenser spins, opens at a designated height, and then releases the bomblets over a large target area. Because the bomblets themselves do not spin to arm, there is no "torus effect" and no subsequent "doughnut" shaped impact pattern. In fact, the pattern is quite predictable. So the weapon can be more precisely aimed and used closer to friendly troops.

The cylindrically shaped CEB is the key to the effectiveness of the munition. Its shaped charge can penetrate 7-inch thick tank-top armor. Fragments from the bomblet body can disable trucks at distances of up to 50 feet and damage aircraft up to 250 feet away. What's more, its zirconium ring also provides a fire starting capability.

The combined effects munition is effective in all weather and on all surfaces. It provides important tactical flexibility by virtue of its compatibility with virtually all North Atlantic Treaty Organization and US Air Force

fighter and bomber aircraft. (1LT Louis J. King II)

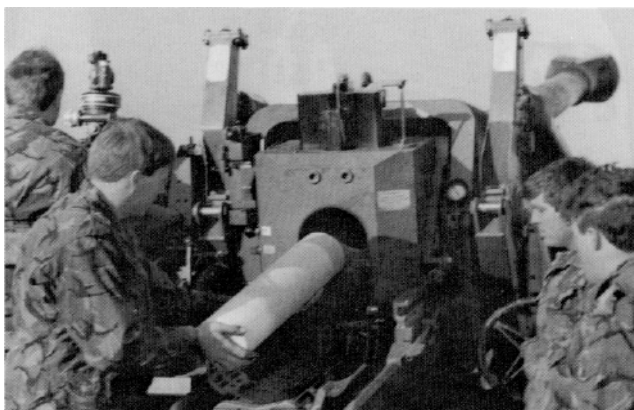
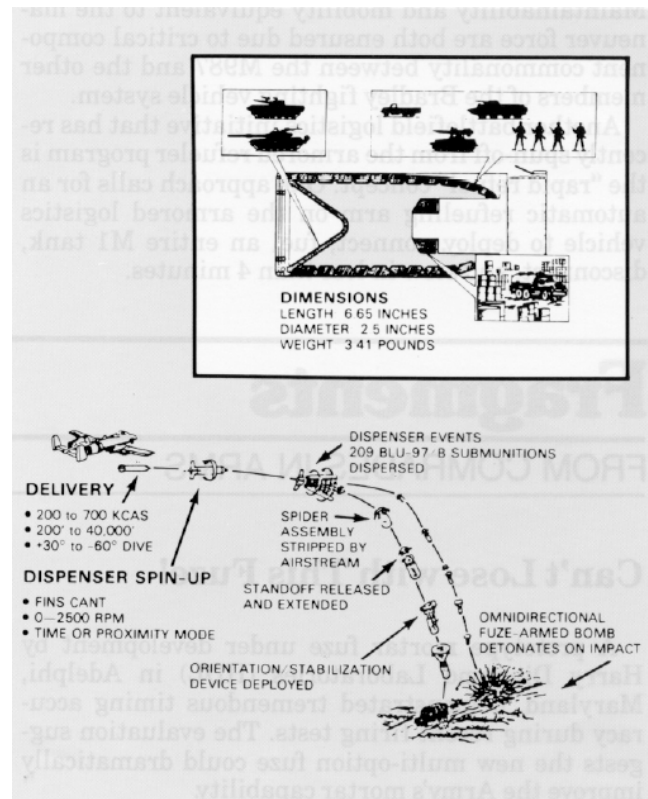

Quite a Charge!

Most Free World artillerymen recognize the 155-mm as a standard caliber and a 39 caliber barrel as a norm. With conventional projectiles, the generally accepted maximum range is around the 24,000 meter mark; but as always Redlegs are looking for yet more range. Over the last decade ballistic designers have answered the call by exploiting two range-enhancing developments: the extended range full bore (ERFB) projectile and the base bleed (BB) unit. When combined, these two developments can provide a considerable extension in the range achieved by existing 39 caliber barrels.

Of course, there is a price to pay for more range. The ERFB projectiles are heavier than orthodox projectiles and require a more powerful propelling charge, which in turn produces higher ignition temperatures and increased barrel erosion. The British Royal Ordnance Explosives Division has been in the forefront of research that seeks to mitigate the price paid for achieving greater ranges. Specifically, the company has developed a new propellant charge known as the BIS 14 which can send a ERFB/BB projectile some 32,000 meters downrange.

The charge's combustible container and slotted tubular stick propellant combine to make the BIS 14 a one-piece

charge that is robust enough for use in auto-load systems. The charge is compatible with all existing breech mechanisms and standard ignition systems. It burns without leaving any residue and plays its part in the reduction of barrel wear by the use of a wear-reducing additive in the basic material of the case. The result is that using the BIS 14, the minimum barrel life of a weapon such as the British FH-70 155-mm howitzer is 2,500 effective full charges (EFC). What's more, the BIS 14 also has a relatively "cool burn" which in turn reduces smoke and flash at the muzzle. (LTC N.J. Bird, British Liaison Officer, USAFAS)

More than a MULE

The Marine Corps will begin fielding a new laser designator and rangefinder system in the near future. Developed by Hughes Aircraft Company and dubbed the AN/PAQ-3 modular universal laser equipment (MULE), the system is very similar to the Army's AN/TVQ-2 ground vehicular laser locator designator (G/VLLD).

In fact, the two systems use the same night sight, tripod, and basic traversing unit. Like the G/VLLD, the MULE is powered by a rechargeable battery pack or vehicle power. As a precision target-locator, the MULE displays azimuth, distance, and vertical angle to the operator. What's more, the MULE will link directly to a digital communications terminal (DCT). As a target-designator, the MULE is compatible with the Copperhead round, the Hellfire missile, and the laser-guided munitions of the Navy and Air Force.

Unlike the Army system, the MULE can be shoulder-fired. And the MULE's tripod can accommodate a north-finding module which allows self-orientation.

Concurrent with fielding, the Field Artillery School's Gunnery Department will incorporate instruction on the MULE into its Marine-related courses.



Future Rifle for Today's Army

The Army's research laboratories are working on ways to increase the probability of soldiers hitting their targets and decreasing their ammunition expenditures. The objective of the Army Armament Research and Development Center effort is to produce an advanced combat rifle (ACR) which will replace the current M16A2 and its product improved versions.

Experts believe the lightweight ACR will not only be capable of "salvo fire," but also retain many of the desirable characteristics of earlier weapons. The salvo system discharges a rapid three-round burst which exits the weapon before recoil can affect the firer's aim. This innovative technique may well eliminate the "hosing" effect now associated with automatic weapons fire.

Researchers are also trying to develop a new optical sight for the advanced combat rifle. Such a high technology system would permit soldiers to sight around the clock on long-range targets even through obscurants. But the primary benefit accruing from the sight optics would be mitigation of stress induced aiming errors.

Army researchers also envision using caseless ammunition in the ACR system. This lighter, self-consuming ammunition

should enable the soldier to carry more rounds and to fight longer before he needs resupply. Also, the cost of each round should drop, allowing the Army to purchase more ammunition for use in training.

During fiscal year 1987, the Army's Armament Research and Development Center will participate in joint user and developer field experiments focused on the advanced combat rifle. These tests should be the first steps in designing, selecting, and producing the Army's rifle of the future.

