

Field Artillery Journal



March-April 1982

Conferences
set for April
see page 12

The Little
Old 37

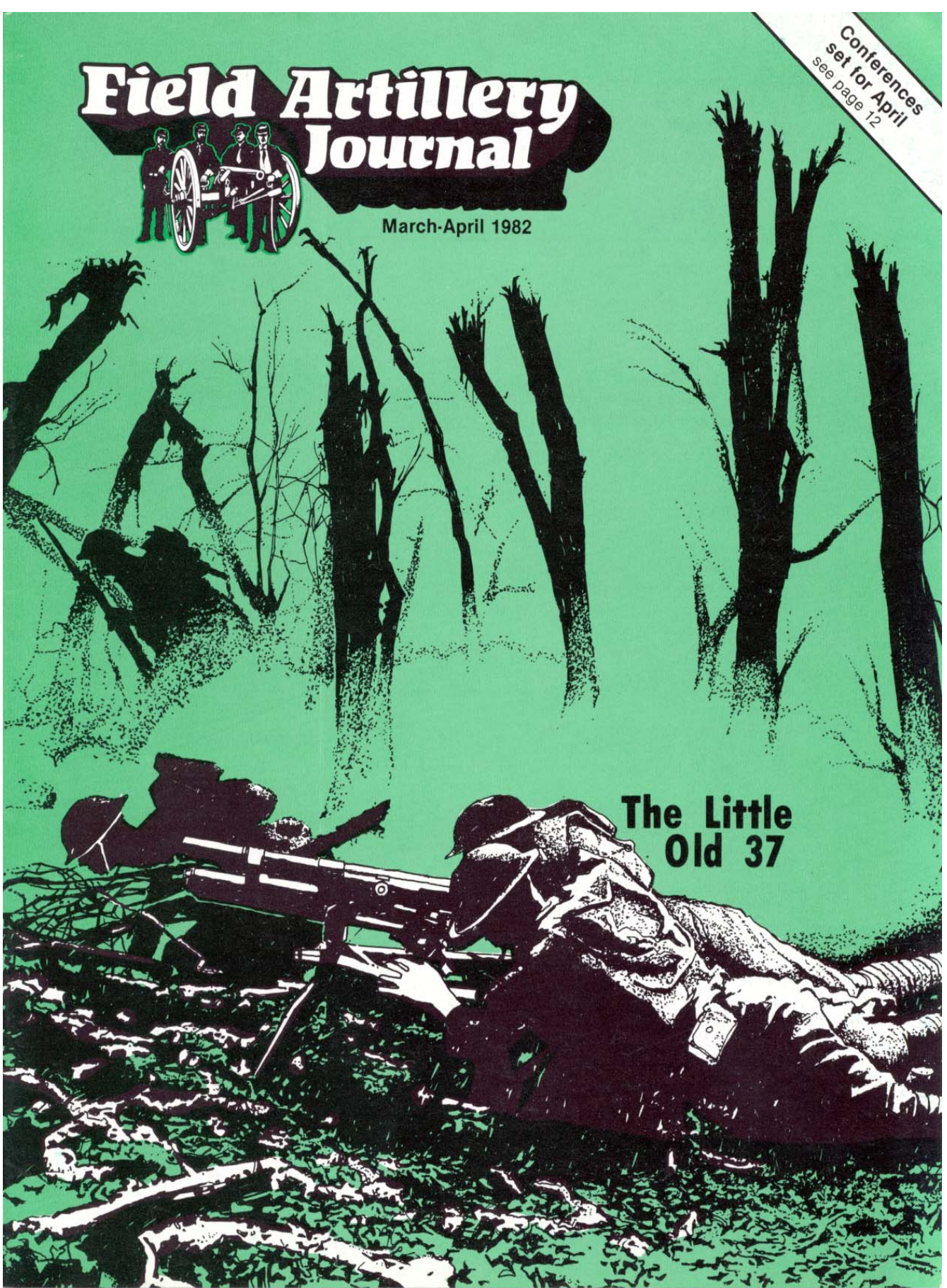

Field Artillery Journal



THE JOURNAL OF FIRE SUPPORT

Volume 50

March-April 1982

Number 2

ARTICLES

7 What Do You Want Us To Shoot?

by MAJ John D. Spengler

Author contends that, for the field artillery to conduct its primary mission of providing fire support, planners should seriously consider reorganizing fires and redefining missions.

10 The Artillery Position Directory: Moving Fast to Mass

by COL Bruce P. Holmburg

A document which can provide the force artillery commander a quick means to shift firepower on the battlefield with minimum confusion and information exchange.

17 A Job Well Done

by LTC (Ret) Albert N. Garland

Author expresses personal appreciation for the role of the field artillery in combined arms operations.

20 UPDATE: Computer Set, FA, General and Missile

by CPT William H. Coke and Donald J. Giuliano

General information on the TI-59, FA computer set.

26 Salute!

by personnel of Bravo Battery, 2d Battalion, 2d Field Artillery

Information provided on how a field artillery battery can organize, set up, and fire a salute.

36 SPAS—The Training Manager's Tool

by MAJ (Ret) Albert B. Cheatham

Training plan to improve a soldier's ability to operate and maintain equipment.

41 The Little Old 37

by LTC Ronald E. Olson

A historical sketch of the smallest field gun used by the Americans in World War I.

50 Logistics Raid

by MAJ Randall L. Rigby

Combat survivability may depend on logistical support as well as new tactics and training.

FEATURES

- 1 On the Move
- 3 Incoming
- 6 Hot Off the Hotline
- 12 View From the Blockhouse
- 24 Right By Piece
- 32 With Our Comrades In Arms
- 38 FA Test and Development
- 43 Redleg Newsletter
- 48 Commanders Update
- 49 Field Artillery Branch Team

The *Field Artillery Journal* is published bi-monthly at the US Army Field Artillery School, Fort Sill, OK. Funds for printing are approved by Department of the Army. However, unless otherwise stated, material does not represent official policy or endorsement by any agency of the US Army.

PURPOSE (as stated in the first *Field Artillery Journal* in 1911): "To publish a journal for disseminating professional knowledge and furnishing information as to the field artillery's progress, development, and best use in campaign; to cultivate, with the other arms, a common understanding of the power and limitations of each; to foster a feeling of interdependence among the different arms and of hearty cooperation by all; and to promote understanding between the regular and militia forces by a closer bond; all of which objects are worthy and contribute to the good of our country."

SUBSCRIPTIONS: May be obtained through the Field Artillery Association, P. O. Box 33027, Fort Sill, OK 73503. Telephone numbers are AUTOVON 639-5121/6806 or commercial (405) 355-4677. Dues are \$14.00 per year (\$27.00 for two years and \$40.00 for three years) to US and APO addresses. All other addresses should add \$7.00 for postage.

SECRETARY OF THE ARMY:

Hon. John O. Marsh Jr.

FIELD ARTILLERY SCHOOL

Commandant

MG Edward A. Dinges

Assistant Commandant:

BG Donald E. Eckelbarger

JOURNAL STAFF

Editor:

MAJ John Dobbs

Managing Editor:

Mary Corrales

Art Director:

Bob Coleman

Circulation Manager:

Jan McAdams

SUBMISSIONS: All letters and articles should be addressed to Editor, *Field Artillery Journal*, P.O. Box 33131, Fort Sill, OK 73503. Telephone numbers are AUTOVON 639-5121/6806. Material submitted for publication is subject to edit by the *Journal* staff; footnotes and bibliographies may be deleted due to limitation of space.

REPRINTS: *The Field Artillery Journal* is pleased to grant permission to reprint articles. Please credit the author and the *Field Artillery Journal*.

POSTMASTERS: Second-class official mail postage is paid by the Department of the Army, DOD 314, at Lawton, OK 73501. Send address changes to the *Field Artillery Journal*, P.O. Box 33131, Fort Sill, OK 73503.

Field Artillery Journal

On the Move

MG EDWARD A. DINGES

In my last column, I talked about the importance of our commanders using the Army Training and Evaluation Program (ARTEP) as a diagnostic aid to evaluate and plan unit training. The ARTEPs provide many critical tasks that units must perform to standard in order to deliver timely and accurate fires to support the force's scheme of maneuver and contribute to battlefield survival.

As a training manager, the artillery commander must maintain combat readiness through sustained training proficiency on these and other important unit tasks. However, it is becoming increasingly difficult to rely on live fire practice with service ammunition as the primary means of sustaining the required proficiency. For many of our battalions — both Active and Reserve Component — the availability of ammunition for training has become a serious challenge. Here, across the Army, many factors have combined to cause as much as a 30 percent reduction in the allocation of artillery ammunition for training in FY82. At the same time, however, the Army has historically received ammunition authorizations less than stated requirements; yet, units actually used fewer rounds than they were authorized!

While I fully understand that the unit commander must ultimately determine his training status and needs, the Field Artillery School shares the concerns of many of you who are wrestling with the problem of reduced amounts of service ammunition. Although, there is no real "book" solution to the training challenge you face, we here would be remiss if we did not offer what suggestions and help we can. Therefore, I'd like to restate some planning principles and techniques and share with you some ideas from the School and our field commanders.

Ammunition/allocation

In the past, S3s have taken a very simple approach to the ammunition they were allocated—distributing it evenly to all subordinate units. However, each unit has distinct differences that affect its requirement for ammunition, and training managers should analyze the following areas prior to allocating it to their subordinate units:

- ARTEP results.
- Unit training objectives.
- Personnel assigned and MOS proficiency.
- Status of unit training.

- Unit mission and readiness.
- Unit location.
- Personnel turnover.
- Availability of adequate impact areas.
- Target acquisition support.
- Calibration.
- Support requirements.

This analysis should result in ammunition allocations on a selective basis to insure that the optimum training value is achieved from each round.

Tailoring

Since all units are not the same, the ARTEP recommends that the commander select those training objectives that are aligned with his actual state of personnel, equipment, environment, training posture, and mission (primary and contingency). For example, a commander with interoperability considerations (e.g., German language mission) would add this new mission-driven task to those he selected in the ARTEP as critical to his mission accomplishment. He has now identified all firing tasks that *may or may not* require training ammunition.

Garrison and local area training

The next step should be to determine his current training proficiency. This can be accomplished by a dry fire rehearsal, normally conducted in garrison or in a local training area. Perhaps, during this evaluation, the FDC demonstrated that they could determine initial HE firing data well within the ARTEP standard (manual and FADAC) and could determine subsequent corrections within standards. The commander could then assume that his FDC can meet the standard for a low angle adjust mission using HE/PD. At the same time, however, the base piece receiving the fire commands did not perform to standard. Thus, the commander has now identified a training weakness that can be corrected without expending ammunition.

Work to remedy training shortfalls uncovered by this internal evaluation may start by focusing on the individual soldier's manual skills and tasks; e.g., an FDC having trouble meeting collective standards on a high angle mission might need to revert to renewed emphasis on the individual 13E tasks related to the high angle mission. Here it is imperative that his entire unit demonstrate proficiency in the field prior to live fire since units simply must not undertake



live fire until they are ready. To do otherwise wastes ammunition.

To assist the commander in conducting this evaluation and subsequent intensive training on identified deficiencies, there are several devices and simulations currently available. These can augment such traditional activities as enhanced individual training, gunner's tests, and howitzer section evaluations. Among these are:

- Various training fuzes and inert projectiles.
- Artillery Direct Fire Trainer (ADFT).
- Observed Fire Trainer (OFT)—Europe only (earlier models of BT-33, Marconi, etc.). Some units have integrated maneuver commanders, FISTs, FSOs, and direct fire system gunners into OFT training.

We are not, however, standing still with these training devices. As most of us know, they have many shortcomings and, in some cases, do not reflect current technologies and state of the art. As such, several major improvements on the horizon are:

- The Training Set Fire Observation (TSFO) (to be fielded during 1982-83). This training device, already fielded in some earlier versions in Europe, is designed to provide realistic classroom training in adjust-fire procedures for institutional and unit use. Through image projectors and minicomputers, it displays target and burst symbols on a slide-projected terrain scene. CONUS fielding begins in July 1982.

- The GLLD evaluator, which some units will see beginning in mid-1982, is designed to allow FIST personnel to practice GLLD tracking without the safety feedback to the operator via a scoring device.

- The Copperhead training round will provide cannoneers with realistic crew drill on a dummy, full-caliber 155-mm cannon-launched guided projectile. Crew drill will include inspection, arming, and loading. This round will begin reaching selected units in early 1982.

- The low cost Indirect Fire Training Round (LITR) will soon be issued to 155-mm units in lieu of the M107 HE projectile. While it is not a panacea, the M804 training round is adequate for conducting service practice and most other live firing activities. In addition, it can be particularly useful in noise abatement problem areas and in areas where a reduced size impact area is necessary.

- A major acknowledged Army-wide deficiency is the limited capability of field artillery to play realistically on the MILES battlefield. As such, a substantial research and development effort involving many Army agencies is now underway to seek a way to provide real-time effects of artillery fires in the MILES environment. This would be a giant step forward in the integration of fire support and maneuver training.

- With the advent of the TSFO this year, it is now possible to build a system which ties together the collective actions of the observers, howitzers, and FDC through the TSFO computer so that the mission fired on the screen reflects the did-hit data computed by the FDC and actually set off on the howitzers. We hope to develop a Closed Loop Trainer that will provide, for the first time, an effective dry fire training mechanism for the total gunnery team.

Live fire

Once the commander has determined that his unit can perform all of his selected delivery of fire tasks to ARTEP standards in a garrison or local training area environment, only then should he proceed to allocate training ammunition to verify his combat readiness in a live fire training exercise.

Our ARTEPs provide us with the number of rounds that would be required to fire one iteration of all the delivery of fire tasks. However, this figure is really the optimum requirement. Thus, the commander should "cut and paste" where appropriate in an effort to reduce this total

requirement. For example:

- Assume that if the unit can demonstrate proficiency in firing a high burst registration, it can also fire a mean point of impact registration, which saves 16 rounds (battalion and battery).

- Combine the low angle mission with the emergency mission and save eight rounds.

- Assume that if the battalion can fire a battalion mass, high angle adjust mission using an observer, it can also fire a battalion mass, low angle adjust to save another 16 rounds.

- Dry fire where applicable; e.g., large/irregular target, scheduled fires, etc.

Although these examples require changing shell/fuze combinations suggested by the ARTEP, this is totally permissible since the ARTEP tasks were developed to insure that the unit can demonstrate proficiency by firing any shell/fuze combination for any given mission. The major point to remember when combining tasks is to insure that each element (FDC, howitzer, observer, target acquisition system, etc.) can demonstrate proficiency in any type situation or combat scenario.

Additional specific measures which have helped conserve ammunition are listed below. Most are contained in DA Training Circular 25-3, "Training Ammunition," and in the ARTEPs now reaching the field.

- Avoid refring for flash when there is obvious effect on the target.

- Conduct joint training and evaluation between target acquisition and cannon units to avoid separate ammunition-consuming training programs.

- Avoid firing purely to see the effect on the ground; e.g., do not fire for effect with service ammunition just so the observer teams can see fire for effect on the target.

- Combine fire missions to save ammunition; e.g., a large or irregular target fire mission may be fired as a time-on-target fire mission.

- Use one howitzer or one platoon to fire for effect on adjust-fire missions and scheduled fires.

- Rotate adjusting howitzers so all sections receive this training.

- Exercise the complete system; i.e., howitzers, fire direction center, and FIST in a dry fire mode until standards are met. Only then should you move to live fire.

- Seek additional live fire opportunities for FISTs through mortar and corps artillery live fire training cycles.

Conclusion

The above conservation measures and suggestions are required even with a plentiful supply of ammunition, but they represent critical importance in the ammunition scarce environment many of our commanders face today. I hope that some of these are helpful to you.

We at the School together with TRADOC are continuing to work on this problem. What is clear at this point is that commanders will have to seek a mix of devices and simulations together with traditional live fire events to achieve their delivery of fire training goals.

We are hesitant to publicly prioritize ARTEP and/or Soldier's Manual tasks because this would tend to defeat the philosophy upon which these documents were developed. The many variables that exist between units dictate that the prioritization of tasks and the firing iterations required for sustainment training must remain the commander's decision.

Nor are we trying to insert ourselves into a commander's business. He must select a core of ARTEP tasks that allow a thorough but practical evaluation of his unit to indicate both his training strengths and weaknesses. Then he must conservatively allocate available resources, based on careful planning, and execute his program using all the ammunition-saving techniques at his disposal.

A logical, well planned, orderly approach that includes emphasis on individual training and lower level collective tasks prior to larger ones should help cope with scarce ammunition. If all measures still cannot limit the erosion of proficiency, then the significance of the training ammunition shortfalls may have to be included in the Unit Status Report.

We will continue to share our ideas with you as we gain information from ongoing study efforts and from our field commanders who are handling the challenge. I also want to again solicit your good ideas so that we can share them across the Redleg Community and with our maneuver brothers-in-arms who are facing many of the same challenges. Ideas, techniques, or other suggestions can be forwarded to my Collective Training Branch by calling the ARTEP Hotline, AUTOVON 639-2064, 24 hours a day (commercial: 1-405-351-5004, during duty hours), or by writing Commandant, US Army Field Artillery School, ATTN: ATSF-TD-CT, Fort Sill, OK 73503.

Incoming

LETTERS TO THE EDITOR

Speak Out

The *Journal* welcomes and encourages letters from our readers. Of particular interest are opinions, ideas, and innovations pertinent to the betterment of the Field Artillery and the total force. Also welcomed are thoughts on how to improve the magazine.—*Ed.*

Translation needed

In order not to lose the mood and to carry on the thoughts (?) by the *Ballad of Saint Barbara* on the back cover of the November-December 1981 issue, I have prepared a fitting companion-piece last stanza.

"Roses are when rammer staffs
Fed by Huns noisome howitzers hurdle
the meadows
Closed long tresses with mountain crown
And Altus slew the quadrant tower
surge."

Now, if that doesn't come through to you loud and clear, let's trade translations. You make up one for that ballad and I'll do the same for my gibberish. As an afterthought, no wonder the author is unknown; he was probably trying out a hoax.

Seymour Kravitz
COL, FA (Ret)
Great Falls, VA

Although the "Ballad of Saint Barbara" has us all scratching our heads, our purpose in publishing the material was to provide Journal readers something a little different. We have apparently succeeded.—Ed.

Roving MLRS?

I have learned that the first Multiple Launch Rocket System (MLRS) battery will be activated in the near future with the 1st Infantry Division (Mech) at Fort Riley, KS. This is welcome news to all members of the Field Artillery Community. When the USAREUR units are equipped with their MLRS units, NATO will have less to worry about in a conventional attack.

Has anyone given consideration to the use of a "roving launcher" concept in Europe? As I understand, because of the advanced fire control and position location systems, the MLRS missions can be rapidly computed and fired. These systems could be used by corps level

elements to send individual launchers over the corps area at random intervals and placement and tie the whole fire support network together by secure burst transmission through the fire control system on each vehicle. By using maps with marked survey points, trig lists, and coding to higher headquarters, these launchers could be used to support engaged units in the corps zone. Missions could come from the corps fire support element (FSE) or the launcher could be general support or general support reinforcing to a corps unit. Individually, they are not worth the effort and cost to fire a battalion-size counterbattery mission, but they have enough firepower to disrupt enemy formations from the main battle area through the covering force area and line of contact. They could be attached to the armored cavalry regiments (ACRs) in times of tension and be used as forward heavy artillery. It would be much less provocative to have a battery or two of MLRS vehicles join an ACR rather than putting an entire division on alert.

But, if you really wanted to keep the Soviets guessing, mount your rockets on their turntable launcher in the back of a large truck or tractor-trailer. Disguise the vehicle as a standard nondescript commercial vehicle; change the color, logos, license plates, drivers, operational areas, etc., as needed or desired. If hostilities broke out, the vehicles could move to any one of hundreds of prearranged points, contact the coordinating FSE by radio or telephone, and await missions. The sides of the cargo area or trailer could be blown off just prior to launching and the crew of one or two people could fire the rockets by electrical cables from 50 or 60 meters away — no armor, no tracked vehicles, no visible military markings. How many would be in Germany? Belgium? The Netherlands? Denmark? The uncertainty factor alone would be worth an armored division. Even if the area looks clear, how many of those "abandoned" vehicles in the next town are really MLRS launchers in disguise?

The roving launcher concept depends heavily on communications, of course, and a war in Europe will test all our communications to the limit. If our communications fail, we invite defeat in detail; if they survive, then we may be able to defeat the Warsaw Pact without using

nuclear weapons. A roving launcher concept on MLRS vehicles and/or in disguise could be a most unsettling factor in the total equation of European combat.

Larry A. Altersitz
CPT, FA (PAARNG)
Pittsburgh, PA

Employing the MLRS self-propelled launcher loaders in much the manner described as the "roving launcher concept" has been considered. To send an individual launcher from a "corps level element — at random intervals and placement" presents command and control problems that are addressed in FM 6-60, "MLRS Operations, Final Draft (Test)," which was published in January this year. The self-propelled launcher loader has a computerized fire control system capable of receiving and transmitting secure digital traffic, precluding the need for a digital message device in the launcher. Unfortunately, digital communications are limited to the capability of the current family of FM radios, making control over a corps front a challenge. Also, the inherent responsibilities of the GS and GSR missions cannot be fulfilled by the individual launcher. (Employment of MLRS to support the covering force is addressed in FM 6-60.)

Your concept of disguising launcher loader modules in commercial vehicles or other configurations may not be cost-effective due to reduced mobility, range limitations, resupply (the basic ammunition for MLRS weighs 5,032 pounds and requires special resupply vehicles and trailers) and survivability. The use of the launcher in the manner suggested has a cost the commander may not be willing to pay. With a system that has a longer range and a bigger pay load — such as a Lance, Lance II, Corps Support Weapons System (CSWS), or ground launched cruise missile (all given the onboard computerized fire control capability) — the concept may be viable.—Ed.

Hand-held calculator

For those field artillerymen who serve in Germany, the convergence of the 32U and 33U grid zones to the east of Grafenwoehr makes the manual solution to the zone-to-zone transformation problem more than just an academic exercise. Fortunately, the advent of the Computer Set,

Polaris II

I noted with great interest Colonel Kleypas' letter in the November-December 1981 *Field Artillery Journal*, and I am particularly pleased that the Polaris II project has been carried forward and may, in fact, be adopted.

I feel sure Captains Roeske and Veit join with me in congratulating Mr. McDonnel and Mr. Dere for the excellent work they have done on the project in realizing a physical tool from a fundamental idea and basic investigation. There is a substantial gap between a plan and its execution, and they justly deserve recognition.

Several other people's effort went into the work we did, including 1LT Taphorn who wrote the original *Journal* article, an unnamed Soviet Engineer who designed the "Stargazer" device and inspired us to develop a similar device for the M2 aiming circle, and Colonel Kleypas who insured that the project did not die after Captain Roeske, Captain Veit, and I went on to our respective assignments. Regardless of the contributions of the many individuals, named and unnamed, the most important result is that the Field Artillery may now be a better branch, the soldier better equipped, and the country better served.

Donald H. Zacherl
CPT, FA
Assistant Professor of
Military Science
Hofstra University
Hempstead, NY

The urban battle

The July-August 1981 *Field Artillery Journal* contained an article which struck a particularly important issue. The article "Field Artillery Training in Europe" by LTC Ronan Ellis and MAJ Marvin Wooten was a well-written report on training which stressed good, fundamental practices for field artillery in an environment which could one day be the actual battlefield. However, I would like to stress one major point: The CO and S3 *cannot* take a democratic approach and "encourage" battery commanders (BCs) to take maximum advantage of urbanized terrain; rather, they must *train* the BCs and make them use the terrain available, whether it is urban or rural.

There are so many advantages to the

March-April 1982

use of urban terrain that we cannot afford to disregard its benefits. It is a challenge and an adventure to use towns for training; in the future, this training may mean the difference between winning and losing!

John D. Spengler
MAJ, FA
Terre Haute, IN

As you may have noticed, our January-February 1982 issue highlighted the field artillery and the urban battle. As such, the thrust and timing of your letter couldn't be better.—Ed.

BTMS

Without question, the Battalion Training Management System (BTMS) has provided us a systematic approach to logically plan, organize, conduct, and assess training. CPT Craig D. Wildrick's article "Training Management in Small Units" (November-December 1981 *Journal*) amplified the application of BTMS to battery training programs. However, I feel a drawback to BTMS is the tendency to inundate ourselves with BTMS-related paperwork and procedures which contribute to BTMS being an end to a means rather than a means to an end. While Captain Wildrick's proposal to assess individual training at the section level through the use of a percentage oriented Individual Training Assessment Chart (ITAC) is unquestionably a workable method, I feel efforts along these lines are unloading more unwanted procedural requirements on our most important training asset: the section level trainer. A battery commander does not need charts to keep track of individual training proficiency; he should instead spend more time sampling training. The battery commander and the first sergeant, assisted by the chain of command, should frequently spot-check soldiers through performance testing in the field and in garrison. BTMS provides a simple distribution of responsibility for individual training. Let's keep it that way.

Terry G. Stewart
CPT, FA
AOAC 1-82
Fort Knox, KY

**Graphical Terrain Gun
Position Correction
Tables (GTGPCT)**

The article in the November-December 1981 *Journal* referred to Graphical Terrain Gun Position Correction Tables (GTGPCT) that were developed, tested, and utilized by the 2d Battalion, 41st FA, 3d Inf Div.

This unit (a National Guard SP 155-mm battalion) would like to obtain three sets of the GTGPCTs for use in training. The idea and method explained in the article sound good.

Any information you can provide us on how to obtain the GTGPCTs will be appreciated.

Vern C. Erickson
2LT, FA (SDARNG)
Assistant Adjutant
1-147th FA
Sioux Falls, SD

As it stands now, Graphical Terrain Gun Position Correction Tables must be locally produced. Incorporating the use of these tables into gunnery procedures outlined in FM 6-40 is being studied by the School's Gunnery Department. Should the School opt to adopt GTGPCT's for Army-wide use, action will be initiated to have them mass produced. A final decision is expected in the near future.—Ed.

Moving?



Subscribers should send their new address four weeks in advance to:

**Field Artillery Association
P.O. Box 33027
Fort Sill, OK**

Hot Off the Hotline

Your "Redleg Hotline" is waiting around the clock to answer your questions or provide advice on problems. Call AUTOVON 639-4020 or commercial (405) 351-4020. Calls will be electronically recorded 24 hours a day and queries referred to the appropriate department for a quick response. Be sure to give name, rank, unit address, and telephone number.

Please do not use this system to order publications. Consult your FA Catalog of Instructional Material for this purpose.

Question: What is the proper procedure for checking the fluid level on the 8-inch howitzer during laying? Also, can the gun be brought into battery and the hydraulic fluid checked during movement?

Answer: The proper procedure for checking the reservoir oil level is listed on page 2-22 of TM 9-2350-304-10 (8-inch Howitzer, M110A2). The fluid check cannot be performed while the howitzer is moving since the tube must be in the "in battery" position for an accurate reading.

Question: Reference the approved TFTs and GFTs for the M110A1 firing ICM or DPICM: What are the current firing tables and what are the federal stock numbers of the GFTs?

Answer: The TFT for the M404 ICM Projectile is FT 8-ADD-F-1 while the TFT for the M509 DPICM is a Provisional Firing Table: FT-8-T-O (PROV). The GFT for the M404 ICM is on the low angle HE, GFT: FT 8-Q-1 NSN: 1220-01-038-2410; the GFT for the M509 DPICM will not be produced until more data has been computed. Normally GFTs are not produced on provisional firing data.

Question: How does the School envision deploying FIST teams with the combat support and/or antiarmor personnel of the combat support company?

Answer: The organization of FIST provides for one team per maneuver line company. FIST is not deployed with the combat support unit. Close Support Study Group II provides for additional observation/lasing teams at the direct support artillery battalion; and, should the threat warrant, these could be used to

support the antiarmor personnel against an armor attack.

Question: We will soon receive the M198 howitzer as a replacement for the 155s we have now. Is there any allocation or special type of ammunition required for the changeover or transition firing of this weapon? Also, does this weapon require us to revalidate ARTEP standards? Do we need to calibrate each green and white bag charge for the M198?

Answer: There is no special allocation of ammunition for transition training to the M198. Since the weapons will have new/unfired tubes, calibration, during transition training, is not required. When the unit desires, calibration can be conducted during normal service practice utilizing the M90 velocimeter. A fall of shot calibration is definitely not required.

Question: Is it tactically sound for a field artillery brigade to be assigned a tactical mission of direct support to an infantry division that has a division artillery?

Answer: According to FM 6-20-2, "Division Artillery, Field Artillery Brigade, and Field Artillery Section (Corps)," the proper response to your question is no. Field artillery brigades may be assigned a direct support mission only to subordinate maneuver elements of an infantry division, if distance requirements preclude effective command and control by division artillery over those artillery units required to support the maneuver element. A review of the inherent responsibilities associated with the direct support mission eliminates the possibility of assigning it to a field artillery brigade in support of an entire infantry division that possesses its own division artillery. If such a mission were assigned, a situation would exist wherein two force field artillery headquarters were at odds as to fire planning authority, positioning authority, zones of fire, furnishing FISTs and FSOs, establishing communications with the division, and in direct competition with one another with regard to answering calls for fire. Obviously such a situation is intolerable and in violation of unity of command and control with respect to field artillery support. For more information relative to

appropriate missions for FA brigades, please refer to pages 1-7 through 1-10, FM 6-20-2.

Question: What is the cost of the M483A1 ICM and Copperhead projectiles per round? Also, what is the difference in cost of the 105 HE projectile and 155 HE projectile, and how much TNT is in the 155 projectile?

How many ICMs are fired per artillery battalion in the US Army? Is there a training quota?

What is the Army's policy as far as amount of ammunition that is used in training. Is there a dollar amount fixed or is there a percentage amount fixed for training? What kind of guidelines are we allowed to insofar as expenditures?

Answer: The cost of the 155-mm M483A1 DPICM D563 started at \$498.17 each in FY82 and will increase in price to \$728.68 in FY87, per Conventional Ammo Acquisition Plan USARMCOM, dated August 1981. Cost of the 155-mm M712, Copperhead, D510 started at \$37,632 in FY82 and will decrease to a cost of \$26,854 in FY87, per Conventional Ammo Acquisition Plan. Cost of the 105-mm M1, HE, C445 is based on figures from Fort Sill's Ammunition Supply Point and they cost \$98.02 each, without fuze. Cost of the 155-mm M107 HE, D544 will start at \$166.67 in FY83 and will increase in price to \$195.84 in FY87 per Conventional Ammo Acquisition Plan. There are 14.6 pounds of TNT in a 155-mm HE projectile or 15.4 pounds of Composition B (TM 43-0001-28).

The firing of dual purpose ICM rounds is covered in TC 2503, but not many units are firing these ICM rounds in regular service practice.

The Army's policy on the amount of ammunition used in training is contained in TC 25-3. However, the cost of ammunition is going higher and higher; therefore, units are urged to make use of the 14.5-mm M31 trainer and other such devices to reduce the cost of training with live ammunition.

**Field Artillery
and
Senior Field Artillery
Commanders
Conferences
5 through 9 April 1982
Fort Sill, OK 73503**

The scene is a dimly lit brigade operations center. It is D-Day+1 and things have not been going too badly for NATO forces, but the tide of the battle could be moving more favorably for the allies if there were more troops and materiel, particularly artillery. Second-guessing, however, doesn't help, so the brigade fire support officer (FSO) continues to plug in his fire support assets where he can best use them for the brigade tactical plan. The FSO has been successful to this point; at least he has pleased the brigade commander. In addition to his own artillery battalion, he is using the reinforcing battalion given to him by the division artillery commander for firing support missions.

Unfortunately, there is a tempest brewing for which the FSO has no solution. In comes the brigade commander, who recently returned from a meeting with the division commander.

"S3! FSO! Get over here!"

"S3. Prepare to execute the counterattack plan in the zone of fire of the 1st Battalion, 51st Artillery. Division has given us until 1800 hours to launch the attack. That gives us a little over three hours."

"FSO. We've located the second echelon tank regiment moving down Corridor Blue. I want you to shoot in all of the possible defile areas along that avenue of approach with field artillery delivered scatterable mines."

"What, sir?"

"I want you to delay that tank regiment with our scatterable mines!"

"Sir, that stuff is taught only at the Command and General Staff College!"

"Well, what *can* you shoot for me?"

"Sir, what do you want us to shoot?"

This skit may seem facetious, but it is used to point out two very real and very important problems with the field artillery. The first deals with the staff college experience of field artillerymen. The second problem relates to the capability of the field artillery to provide the plethora of fires expected of it during the next conflict.

At the US Army Command and General Staff College (CGSC), the field artillery is generally touted as the major killer on the battlefield. Statistics and numbers of all kinds from previous wars are used to illustrate the tremendous killing power of massed artillery fire. The hypothesis supposedly being proved by these demonstrations of kills versus rounds fired is that you get more kills with artillery for less cost. Hence, with a brilliant deductive leap, we conclude that we should use more artillery. In other words, use artillery whenever and wherever we can — use it and don't worry about the details. Regretably, the CGSC student is imbued with this idea of the power of the artillery and he uses the artillery with dreadful glee. He uses it when in doubt. He uses it when he is not in doubt. More critical, he uses it when he has it and even when he doesn't have it!

Now I don't want to be mistaken for a non-fire support person — I'm an artilleryman and proud of it! But, I don't want everyone to believe that our artillery,

What Do You Want Us to Shoot?

by MAJ John D. Spengler

today, is capable of achieving the great things that artillery achieved in past wars. We don't have, *today*, the number of artillery tubes needed for the next conflict. We don't have the people to man the available guns and we don't have the bullets to fire those guns. So, what is our ability to match the number of kills attained in previous wars? Can we logically be expected to reap the same benefits from our artillery today? I think the answer is no.

As students of history, we sometimes become mesmerized by the numbers we obtain from literature and don't really associate the real facts with the numbers used. For example, let's look at the number of kills obtained by artillery in World War I. Of course, this is general, but history shows that the number of kills on both sides was tremendous — but with regard to what variables? What stage of warfare are we talking about? The Allies and the Germans were very nearly matched tube-for-tube, kilometer-to-kilometer, and artillery exchanges sometimes lasted for hours. Who did the fighting and who were the targets? The tank was a little tried vehicle of low repute. It wasn't a killer on the battlefield — it wasn't even a target for the artillery. Soldiers traveled from place to place in trucks, on foot, or in carts. There were no armored personnel carriers (APCs), so soldiers fought on their feet and were therefore easy prey to artillery fires. But let us proceed to World War II.

Historians tell us that this was the war of tanks — but it was a war of tanks *and* artillery. The Germans learned lessons from World War I which the Allies only later discovered. The Germans knew that artillery had to be used to support tanks and that, without artillery support, the infantry was nearly useless. They employed all elements of the combined arms team; in fact, when artillery could not be used in the indirect mode, the Germans used artillery as a direct fire weapon. After all, why not? The artillery then in use was of the same general caliber as tanks; however, because of the lower muzzle velocity of the artillery, it was not as effective against "hard" targets (tanks, APCs, etc.) or "soft" targets (troops, POL, etc.). This era of warfare included a period of near parity for tanks and artillery. The number of kills accumulated by the artillery early in the war was significant, but then the targets in some cases were still horse soldiers, foot militia, and other unprotected targets. The Russians, who accounted for the largest number of casualties,



mobilized millions of citizen soldiers who took the brunt of the German attack. The German artillery was extremely effective against these poorly armed and equipped Russians. Eventually, the Russian industry and the Allies began to provide the tanks, artillery, and personnel carriers needed for the tide of the battle to change. At the same time, the bitter Russian winters were taking their toll on the German machinery. When the Russians were finally able to counterattack, they now had the larger numbers of artillery and tanks and began to account for massive numbers of kills. Once again, however, we must watch the numbers, because now the Germans were mostly reduced to being foot soldiers with few tanks and few personnel carriers. At the end of the war, all of the tallies available equalled tremendous tonnage of artillery fired, thousands of artillery kills, and many mistaken beliefs in artillery capabilities. A short lesson at the end of the war — a precursor for future battles — was that the newer Tiger and Leopard tanks of the Germans were not stopped by artillery fire.

As we proceed to the Korean Conflict and the police action conducted by the million or so United Nations troops and the several million Korean and Chinese troops, there is probably no sense in repeating the claims of artillery kills. It is sufficient to say that once again the principal battles in which artillery played the most prominent roles were battles of foot soldiers versus foot soldiers. We learned the lesson again that tanks, particularly the newer models, were better armored and could easily outgun the artillery. The artillery still claimed huge numbers of lives, but only against ordinary soldiers — not against "hard" targets such as tanks, APCs, and

bunkers. And did we learn the lesson this time? No!

Vietnam became the protracted war of the artillery and the sapper. That's generally the type of exchanges encountered. We shot tons of artillery rounds as the North Vietnamese and Viet Cong crept through our defenses and blew up our howitzers, tanks, and APCs. It would be an exhaustive research effort to try to estimate the tons of ammunition fired. More difficult to determine would be the number of artillery kills achieved. Whatever the case, we overdeveloped our sense of firepower and fire control so we could have instantaneous fires available at will. We luxuriated in the friendliness of our massed fires and we experimented with the extravagances of harassing and interdiction fires, counterfires, and "all available" fires. We practiced terrible habits and we still have not shaken them from our repertoire of acts.

To what does all of this lead? It leads to the argument that all Command and General Staff College students must learn to appreciate the scarcity of the artillery assets available to the US Army and its Allies. What was glory in the past with massive kills by the tremendous number of artillery rounds will not be the glory of the future. Oh yes, the artillery will contribute in its place and artillery will be devastating when properly applied in mass. But *today*, right *now*, right *this* minute, the artillery cannot do *all* of the things we'd like it to do. As mentioned before, the artillery is short on people and equipment. It is short of ammunition. Let's not perpetuate the myth of the artillery as the cure-all for the next war. Let's educate the CGSC student with the proper degree of respect for the artillery

and with the proper degree of innovation and initiative for the time when "the well runs dry."

Since education is part of the solution to the first problem, it is necessary at this point to bring up the second problem concerning the field artillery. This problem does not address the lack of assets; rather, it relates to the aspect of too many competing priorities for the scarce resources. There is an old Tom Leher song called "The Elements" in which Mr. Leher sings a song (?) naming only the elements — no other words or modifiers are used. I feel much the same way when I begin to name the artillery rounds:

-
- High explosive (HE).
 - White phosphorus (WP).
 - Hexachlorethane (HC).
 - Improved conventional munitions (ICM).
 - Dual purpose improved conventional munition (DPICM).
 - Field artillery delivered scatterable mines.
 - Illuminating shell (ILLUM).
 - Copperhead, etc.
-

But what do we do with all of this stuff? And who shoots it? To be honest, they all have specific requirements and they are all needed. But can it possibly be necessary for *one* battalion of artillery to be responsible for firing all of these types of rounds? This dilemma also includes the problems of transporting and storing the ammunition and computing the data to fire the ammunition. The essence of the problem really boils down to the question asked by the FSO in the hypothetical situation. "What do you want us to shoot?" The corollary question to this is, "Who do you want to shoot it?" The "Who" and the "What" are extremely important now, especially since we are at the point of overloading our direct support (DS) battalions with missions other than direct support.

An upsetting trend has developed in the past few years which has made the DS battalion responsible for fires other than the close support fires for the brigade. Now, a DS battalion may be part of suppression missions, interdiction missions, and even tank-killing missions (with Copperhead) or FA delivered scatterable mine missions (when available). Remember now, the other requirements for fire support haven't been cancelled. There still must be smoke, illumination, and of course nuclear missions. Well, how are we to handle these problems? Let's start at the bottom and work our way up from the perspective of an artillery battalion commander supporting a brigade.

"Okay. As commander of a direct support field artillery battalion, what do you want me to fire? I'll fire close supporting fires, including suppression, and let the mortars shoot the illumination—they're better than mine anyway. I'll use two howitzers from each battery to fire nuclear rounds. Wait—maybe only one howitzer per battery. What's next? All right, I'll fire smoke and I'll shoot ICM and DPICM. No! I'll put the smoke mission on a reinforcing battalion for me and make this a standard arrangement. It'll have to be a

155-mm battalion, of course, and I'll reciprocate the favor when the 155-mm battalion goes to a DS mission and I'm reinforcing it. Besides, I need more rounds than I can carry so the reinforcing battalion can help. I may as well put the scatterable mine mission on the reinforcing battalion, too—it's going to take two battalions of artillery to do all of the missions anyway." (Surprised?)

"That just about covers the reinforcing artillery so I'll consider the general support reinforcing (GSR) and general support (GS) artillery. Those GSR guys are going to receive the copperhead and other guided munitions and are also going to get the suppression of enemy air defense (SEAD) missions. That will take considerable coordination and planning—just right for those GS guys getting the counterfire missions and helping with SEAD and other interdiction fire. That's about it for the division artillery and I've only put a minor dent in the requirement for fires. Great!

"Now for the mighty field artillery brigade: (We'll assume this is a cannon brigade — no Lance missile battalions — that does the same things with its battalions that a division artillery does with its battalions — only we'll limit the missions to GSR and GS.) Perhaps the FA brigade could be used in direct support of a maneuver brigade in exactly the same way as the DS battalion is used, except on a larger scale with more firepower and more assets. That sounds pretty good. Now, what about corps artillery? All that's left is the Lance — that's going to be the corps commander's only true interdiction weapon until we get multiple rocket launchers or other long range systems. Lance will obviously have to stay nuclear capable and also be conventional. I'll use one battery per battalion (that's three per corps) strictly as nuclear and the rest as nonnuclear. That gets rid of all the nucs traveling around the battlefield. Lance can be used in general support of corps and in the SEAD missions, too. Pershing? Pershing is really high-level stuff. I think I'll find out what happens to Pershing II before I offer any suggestions. Maybe it could be a separate branch and be called Strategic Rocket Troops and Artillery. I wonder what the boss thinks of all this?"

This thinking may seem lighthearted or perhaps lightheaded, but the message is lamentingly serious. The artillery today is not able to handle its primary mission of providing fire support because its battalions are overcommitted. Let's take a serious look at reorganizing fires and redefining missions for the artillery. Too many lives can be wasted because we failed to think of alternatives when time was available for us to change. Let's educate and challenge our future leaders *when* and *where* they can respond. Wake up artillery and combat arms! What do you want us to shoot? 

MAJ John D. Spengler is assigned to the Military Science Department, Indiana State University, Terre Haute, IN.

The relative still of the night in the 1st Battalion, 76th Field Artillery, tactical operations center is shattered as the Div Arty Command Fire (secure) Net crackles:

V39 THIS IS A47. MESSAGE OVER.

V39 ROGER OVER.

A47. MISSION CHANGE. EFFECTIVE NOW YOU ARE RELEASED FROM GSR TO 2-41 FA AND BECOME GSR TO 1-10. POSITION AREAS 61 AND 63 AND FIRING POINTS 626 AND 627 ARE CLEARED FOR OCCUPATION. LAY TO FIRE ON COUNTERFIRE REFERENCE GRID FG. PRIORITY FOR YOUR MOVEMENT ON ROUTE GREEN IS COORDINATED. OVER.

V39. ROGER. OVER.

A47. ROGER. OUT.

To the ear of a casual observer, the dialog may sound like any live fire exercise at any one of a number of training areas. It is, however, the sound of well planned, flexible, fire support being conveyed to mass fire for a counterattack.

One of the advantages available to the defender is his knowledge and use of the available terrain. For the field artillery commander, this knowledge may be applied in preplanning and precoordination of artillery positions to facilitate rapid rearward, lateral, and forward movement to support the scheme of maneuver and also enhance survival. To such an end, the 3d Infantry Division Artillery has developed an "artillery position directory" to support the division's general defense plan. The

directory provides staffs and commanders (down to battery level) survey data and a reconnaissance/occupation sketch, which ascribes a firing point number to every artillery position in the division sector and to its flanks.

It was no easy task to arrive at the final product of a directory and be able to quickly shift artillery units in response to fire support requirements of the division and brigades. Extensive coordination and on-the-ground reconnaissance was required. First, the brigade and battalion fire support officers worked closely with maneuver operations and intelligence staffs to determine locations where the massed fires of available artillery would be required. Once the fire support requirements were determined of



by COL Bruce P. Holmburg

The Artillery Position Directory

Moving Fast to Mass

where and how much artillery was needed, reverse range arcs from the target area into friendly territory were developed.

Available terrain under the range arcs was then closely examined to determine what areas would not be required for execution of the maneuver plan or for maneuver combat support or service support activities. Avenues of approach, main supply routes or avenues of reinforcement, prepared or planned battle or blocking positions, and kill zones or areas of extensive engineer preparation were immediately eliminated as potential "artillery country." The remaining agreed upon terrain was tentatively "cleared" or at least artillery units were given priority for positioning. Some compromise was required to meet maneuver requirements for fire support; i.e., a planned battle position or kill zone in the main battle area was initially cleared for occupation by artillery in order to meet ranging requirements for deep target attack or covering force fire support requirements.

Once available terrain was established, a detailed reconnaissance was conducted by battery commanders to identify possible locations for battery occupation, keeping in mind that all positions must be occupiable by a "hard battery"; i.e., six guns, six ammo carriers, the battery fire direction center, and battery operations center. Locators for the softer battery tail support elements (mess, maintenance, supply, etc.) were not considered for all firing points. Detailed sketches were completed at the time of the reconnaissance to show locations for all "hard battery" vehicles. The sketch was supported by elaborating comments indicating location of available support or facilities. Major emphasis was placed on the identification of nearby local resources that could be employed; i.e., large barns or buildings could house maintenance facilities, fire houses could become decontamination points, and medium duty farm equipments could harden battery defenses. The

nearest available Bundespost commercial telephone was recorded on the sketch. All sketches were edited and reviewed for completeness and accuracy, keeping in mind that the positions could be occupied by not only the reconnoitering battery commander but also by Reforger, allied, or out-of-sector units moved in to thicken the battlefield.

Based on the natural division of the terrain by roads, streams, and other recognizable terrain features and the availability of positions in an area, the "artillery terrain" is divided into position areas. Position areas are used as a land management tool for artillery and contain three to seven firing points separated by 500 to 3,000 meters. These position areas ideally provide a battery with the ability to *rapidly* displace to alternate or supplemental firing points and continue the mission without detailed coordination with supported maneuver battalions or the brigade. Proper coordination and precleared terrain was directed toward preventing artillery batteries from trying to occupy maneuver battalion trains positions or tank battalions from crashing through battery positions, causing confusion and out-of-action time. Designated position areas are initially considered single battery position areas but (with coordination) may be subdivided to accommodate more units as required.

Final approval of the parceling of firing points into position areas was performed by div arty, working in conjunction with direct support battalion or force artillery commanders in the appropriate sectors. The position area numbers were allocated by div arty. Firing Point numbers were three digits — the first two digits were assigned to the position area and the last digit to the firing point within the position area.

Coordination with flanking units was continuous to insure that their position area data, at least to the div arty commanders area of interest (10 to 15 kilometers), was available. This data in some instances required

additional reconnaissance or low level liaison with flank units to examine battery operations plans or to develop the detailed data needed. This facilitated continuous fire support should minor boundary changes occur or should cooperation to provide massed out-of-sector fires be required. In all instances, updated information was added to the sketches as available to improve accuracy.

All data was then compiled and reproduced in sufficient copies to meet anticipated peacetime planning and wartime contingencies. Dissemination to battery level was considered a must. Fire support officers and battalion staffs used the document to facilitate continuous planning. The data was also useful in directing the employment of target acquisition resources. (Unoccupied battery firing points lend themselves to being good countermortar/counterbattery radar positions.)

Finally, the artillery position directory was a living document. Changes and additions will be published quarterly.

An aggressive program to find new positions and validate old ones is a continuous requirement. As maneuver commanders change or as the concept of the operation evolves or changes, information from the directory may be retired to a data base for future use or retained and expanded on to complement and support the scheme of maneuver.

An artillery position directory is not only suited to a European battlefield but also has application world wide. Though there is no substitute for on-the-ground reconnaissance, the use of overhead imagery, map reconnaissance, and available survey trig lists provides the force artillery commander a quick means of shifting firepower decisively on the battlefield with minimum confusion and information exchange.



COL Bruce P. Holmburg is Commander of the 3d Infantry Division Artillery.

View from the Blockhouse

FROM THE SCHOOL

Correction

In "View from the Block House," (January-February 1982, page 24 under "Field Artillery ARTEPs Being Revised," the following information under ARTEP 6-185 was inadvertently omitted. Applicable TOEs to ARTEP 6-185 are:

- TOE 6-115H FA battalions, 105-mm towed.
- TOE 6-125H FA battalions, 155-mm towed.
- TOE 6-155H FA battalions, 105-mm towed.
- TOE 6-165H FA battalions, 155-mm towed, 8-in SP.
- TOE 6-185H FA battalions, 105-mm towed.

Also under ARTEP 6-445, the second TOE 6-445H (FA battalion, 155-mm self-propelled) should read TOE 6-455H. (CPT Tuttle, DTD)

New FM 6-10 to be published

One of the goals of the Field Artillery School is to insure that all soldiers are thoroughly trained and qualified in the use of field artillery communications. As such, the Communication/Electronics Department is in the process of reestablishing FM 6-10, Field Artillery Communications, programed for publication in FY84.

Comments, ideas, and suggestions are encouraged and can be submitted to Mr. John J. Bilovecky:

Telephone: AUTOVON 639-4325
Commercial (405) 351-4325
Address: Communication/Electronics
Department
US Army Field Artillery
School
ATTN: ATSF-CE-OA-RA
Fort Sill, OK 73503

FA and Senior FA Commanders Conferences

Planning for Fort Sill's second Worldwide Field Artillery Conference and the 1982 Senior Field Artillery Commanders Conference is nearing completion.

The conferences, to be held 5-9 April, will include a brief Field Artillery Association general membership meeting. This year's Association theme is, "Serving the Professional." The conferences are intended to serve as a forum for discussion and exchange of information on topics of interest from the field, FA School, FA Training Center, FA Center, and the Army's leadership.

Scheduling of specific events, principal speakers and topics, and other administrative information will be announced via worldwide messages. All schedules will permit attendance at religious services scheduled in support of Holy Week.

The general schedule is as follows:

Monday (5 April)

0800-2200: Arrival and registration at Comanche House, Sandpiper Inn, Ramada Inn, and airport.
Evening Social (TBA).
Meeting of FA Association Executive Council and Executive Dinner.

Tuesday (6 April)

0700-0800: Late registration (Snow Hall).
0800-1200: FA Conference opens with keynote speaker and special presentations on subjects of vital concern to the Army and the Field Artillery.
Noon: Special luncheon.
1315-1600: FA Conference presentations continue.
1615-1715: Annual Meeting of FA Association:

- Voting for new council.
- Changes to constitution.
- Discussions on chapters and membership.

Evening: Cocktails/reception.
FA Association banquet.

Wednesday (7 April)

0800-1200: FA Conference presentations continue.
Noon: FA Conference ends.
Senior FA Commanders' Luncheon (Polo Club)—by invitation.
1315-1700: Senior FA Commanders Conference opens. Presentations on issues requested by senior commanders and open discussions.
Evening: Senior commanders' dinner (Officer's Club)—cocktails and speaker.

Thursday (8 April)

0800-1200: Senior FA Commanders Conference continues.
Luncheon at FATC dining facility.
Noon: Senior FA Commanders Conference continues.
1315-1700: Senior FA Commanders Conference continues.

Friday (9 April)

0800-1100: Senior FA Commanders Conference continues.
1100-1200: Final discussions and closing remarks.

Implement to interoperate

The United States participates in numerous North Atlantic Treaty Organization (NATO) and American, British, Canadian, and Australian (ABCA) working parties, working groups, and panels in an attempt to reach agreement on procedures, tactics, techniques, SOPs, equipment, interchangeability, and other mutual support activities.

Of particular interest and importance to all field artillerymen are the NATO Artillery Working Party and the ABCA Surface-to-Surface Artillery Working Group. As such, the Field Artillery School provides representation to both organizations. Agreements reached at those meetings are called draft Standardization Agreements (STANAGs) for NATO and draft Quadripartite Standardization Agreements (QSTAGs) for ABCA. After these STANAGs/QSTAGs have been properly and thoroughly coordinated, they are approved for national ratification. *Then* comes the most important step—implementation. Implementation is accomplished by the proponent field artillery field manual department/agency for preparation to implement the

ratified STANAG/QSTAG in that particular field manual. Table 1 shows all of the STANAGs/QSTAGs implemented in field artillery field manuals and also includes the actual location within the field manual. For example, note that STANAG 2887/QSTAG 217, "Tactical Tasks and Responsibilities for Control of Artillery" is implemented in FM 6-20.

When US field artillery interoperates with a NATO or ABCA ally, US field artillerymen must be aware and familiar with added or changed responsibilities . . . either in receipt of, or giving of, support.

Queries regarding the above information should be addressed to:

Commandant
US Army Field Artillery School
ATTN: ATSF-CD-S
Fort Sill, OK 73503

(Mr. B. M. Berkowick, USAFAS International
Standardization Coordinator, NATO/ABCA)

Table 1. STANAG/QSTAG implementation.

Title	STANAG No.	Ratifying date	Matching QSTAG No.	Implementing document	Current location	Draft location
Bombing, Shelling, Mortaring, and Location Reports	2008	16 May 75	503	FM 6-50 FM 6-121	Page 7-24; page H-1; app E	Para 4-21; page F-1
Target Grid Procedures	2011	24 May 72	505	FM 6-30	Chap 3, sec I	
Operation Orders, Annexes to Operation Orders, and Administrative and Logistics Orders	2014	Sep 76	506	FM 6-20	Page I-18; TAB C to App I; page I-C-3	App I
Method of Describing Ground Locations, Areas and Boundaries	2029	Mar 65	514	FM 6-121	App I	
Proforma for Artillery Fire Plan	2031	Mar 80	515	FM 6-20	App H and I	App H and I
Emergency Alarms of Hazard or Attack (NBC and Air Attack Only)	2047	Dec 72	183	FM 6-50	Pages 7-21 and H-1	Pra 4-17/20/22; page F-6
Relief of Combat Troops	2082	Aug 78	None	FM 6-20	Page 5-89	Para 4-7f and 5-12
Battlefield Illumination	2088	Jan 80	1:82	FM 6-30	Chap 6, sec II	
Fire Coordination in Support of Land Forces	2099	Nov 73	531	FM 6-20	Page M-2	App H and I
Principles and Procedures for Establishing Liaison	2101	Apr 76	533	FM 6-20-2	App D	
Friendly Nuclear Strike Warning to Armed Forces Operating on Land	2104	Aug 81	189	FM 6-20	Page M-5	App N
Destruction of Military Technical Equipment	2113	22 Jun 65	534	FM 6-50	Pages 7-16 and H-7	Para 4-17; page F-10
Recognition and Identification of Forces on the Battlefield	2129	Sep 78	538	FM 6-20-1	App I	
Call for Fire Procedures	2144	Apr 80	225	FM 6-30	Chap 5, para 5-7 and 5-11; chap 6, sec II and III	
Target Numbering System (Nonnuclear)	2147	16 Oct 79	221	FM 6-20	Pages 3-17; H-3, and H-4	App H
Regulations for Military Motor Vehicle Movements by Road	2154	5 Jan 76	539	FM 6-50	Pages 5-8 and H-11	Page F-15

View From The Blockhouse

Table 1 — continued.

Title	STANAG No.	Ratifying date	Matching QSTAG No.	Implementing document	Current location	Draft location
Recording of Data for Artillery Survey Control of Points	2865	1 Dec 75	None	FM 6-2	Page L-6; app P	
Radio Telephone Procedures for the Conduct of Artillery Fire	2867	11 Dec 75	246	FM 6-30	Chap 4 and 6	
Calls for Destruction Smoke, Illumination, and Danger Close Missions	2875	3 Feb 80	None	FM 6-30	Chap 5, para 5-11; chap 6, sec II and III	
Tactical Tasks and Responsibilities for Control of Artillery	2887	UNK	217	FM 6-20	Page 3-27; annex B (B-8.1)	App B
Offensive Air Support Operations (ATP-27 (B))	3736		None	TT 6-20-7		
Adoption of a Standard Atmosphere	4044	14 Jun 67	186	FM 6-15	Page 2-16	
Adoption of a Standard Ballistic Meteorological Message	4061	11 Jun 68	332	Fm 6-15	Chap 10; pages 10-1, A-1, and A-3	
Adoption of a Standard (Cannon) Artillery Computer Meteorological Message	4082	2 Aug 68	252	FM 6-15	Pages 1-1, A-3, and 10-5	
Adoption of a Standard (Cannon) Artillery Firing Table Format	4119	28 Sep 73	220	FM 6-40	US Army Ballistic Lab Firing Tables	To be referenced in FM 6-40 in the next change or revision action.
Adoption of a Standard Character by Character Meteorological Message Format	4131	13 Nov 72	267	FM 6-15	Pages 1-1 and A-3	
Howitzer, M1A1, Carriage, Howitzer, 155mm, M1AZ with Ammo and FCE	None	UNK	57	FM 6-81		
Manual Fire Direction Equipment, Target Classification, and Methods of Engagement for Post 1970	None	6 Mar 70	224	FM 6-40	Chap 2, sec III; chap 3, sec I and II	
Standard Survey Accuracy Requirements for Surface-to-Surface Artillery	None	4 Oct 77	269	FM 6-2	Fig 8-10	
Operational Meteorological Message and Forecasts	None	21 Mar 78	304	FM 6-16-2	Chap 4; annex C	
Format of Requests for Meteorological Messages for Ballistic and Special Purposes	4103	2 Nov 66	386	FM 6-15	Page 1-1; 3-7	
Principles and Procedures for Establishing the Minimum Scale of Communication for the use of NATO Land Forces	5048	16 Dec 77	522		No FM 6-series implementation	
Standard Target Acquisition	4140	UNK	389	FM 6-15		Will be included in on-going change due in FY82

School receives MLRS

The Multiple Launch Rocket System (MLRS) has come to Fort Sill!

The arrival of the first two self-propelled launcher-loaders (SPLLs) in February this year symbolized the beginning of a new era for the Field Artillery School. The self-propelled launcher-loader is the first MLRS hardware on which trainers can prepare instruction.

In June 1980, an MLRS Instructional Branch was organized in the Guided Missile Division of the Weapons Department to develop training for the system. Instructors reviewed concept documents, technical manuals, and

extension training materials provided by the contractor and also attended classes for instructors and key personnel at the Vought factory in Dallas, TX.

In addition to the SPLL, which is the heart and muscle of the system, the MLRS Branch also received the fire direction system (FDS)—the "brain"—(the MLRS application of the battery computer system). With its MLRS program, the "brain" of the system will provide tactical fire control for the nine SPLLs. The computer achieves this through a digital link with the control system (computer) on the SPLL and the platoon leader's digital message device (PLDMD) located in each of the three platoon headquarters.

Yet to be delivered are the heavy expanded mobility tactical truck (HEMTT) and the heavy expanded mobility ammunition trailer (HEMAT) to complete the system components.

The SPLs, FDS, and PLDMDs are currently being used by the contractor and the project manager for a command, control, and communications (C³) test. In April, MLRS Branch instructors will begin teaching battery artillery personnel (in four courses) to operate and maintain the equipment as well as to accomplish command and control operations. Upon completion of individual training in May this year, the administrative support (mess, maintenance, supply, air defense, PADS, etc.) personnel will join the battery, draw equipment, and move to the field.

By mid-June, four additional SPLs are scheduled to arrive at Fort Sill along with the HEMTT/HEMAT, then the battery (-) will begin collective training as part of a Field Artillery Training Center effort in preparation for a Force Development Test and Experiment conducted by the Field Artillery Board. This test will shake out the organization and doctrine for MLRS and prepare the first battery for participation in Operational Test III (October 1982 through January 1983 at Fort Bliss, TX).

Combat PLL—it's here

The Army Chief of Staff, in addition to field commanders, has expressed concern about the adequacy in combat of present prescribed load lists (PLLs) and direct support units' authorized stockage lists (ASLS). This concern stems from the fact that a unit's current PLL is based on peacetime demands only and does not take into account increased wearout rates or damage associated with combat. Additionally, Logistics Assistance and Instruction Teams (LAIT) have determined that current unit PLLs show a great difference in the type and level of stockage of repair parts—even between like units in the same battalion.

The Army standardized combat PLL is designed to improve current stockage lists and to develop, as far as practicable, standardized stockage lists for war. The program became effective 1 October 1981 and will be phased in during FY82 through FY88.

Department of the Army (DA) Pamphlet 710-3 and DA Circular 700-18-2 outline the total program, to include manual and automated procedures and the *how*, *what*, and *why* of the program.

The standardized combat PLLs have two basic elements — mandatory and selective stockage. The mandatory stockage, published in a DA pamphlet by TOE Standard Requirement Code, is called a Mandatory Parts List (MPL). Each unit activated under the same TOE Standard Requirement Code will stock the same items for selected end item requirements (considering make/model). Selective stockage includes mission-essential parts *not included* in the MPL. The Mandatory Parts List will include only those items that are critical to the unit's mission. End items on which MPLs are being developed are listed in DA Circular

700-81-2, dated 1 October 1981.

During the next few years (1982-1987), TOE units will receive mandatory parts list to support combat-essential maintenance for much of the units' equipment. These MPLs will be developed for TOE equipment according to priorities established by the Department of the Army. These listings, which are in the form of DA pamphlets, contain repair parts (keyed to the end item) that must be requisitioned and stocked and taken into combat to support unit equipment. Major commands (MACOMS) may supplement these MPLs by adding lines—provided the lines are added by all MACOM units with the same TOE and equipment on hand.

When these listings are received, they should be compared with the unit's present on-hand equipment. Then, all required repair parts which the unit does *not* have on hand—or does not have enough of—must be requested through supply channels. User guide for implementation and use of MPLs is included as appendix D, DA Circular 700-81-2.

When these mandatory parts have been received from the supply activity, they are added to the unit's "demand supported" PLL and are identified by stockage code "CS." MPL items are used as needed—even during peacetime. The primary difference is that MPL parts are identified by using the Urgency of Need Designator (UND) B. Combat PLL items are not otherwise segregated, boxed, or handled.

The 300-line limit to the unit PLL will still apply. If adding the items from the MPL pushes the total on-hand lines above 300, it will be necessary to scrub the stockage list to eliminate nonessentials. The recommended sequence for this scrub is:

- Nonessential items first (code G).
- Deferrable maintenance items next (code J).
- Legal/safety items eliminate last (code D or E).

Currently, two MPLs have been distributed:

- TOE 07-047H020, Rifle Company, Infantry Battalion.
- TOE 17-037H010, Tank Company, Armor Battalion.

Draft copies of MPLs for the following artillery units have been produced and are now under review:

- TOE 06-367H000, Field Artillery Battery, 155-mm SP Battalion.
- TOE 06-366H000, HHB, 155-mm SP Battalion.
- TOE 06-369H000, Service Battery, 155-mm Battalion.
- TOE 06-386H900, HHB, 155-mm SP Battalion.
- TOE 06-387H900, Field Artillery Battery, 155-mm SP Battalion.
- TOE 06-389H900, Service Battery, 155-mm Battalion.
- TOE 06-396H000, HHB, 8-inch SP Battalion.
- TOE 06-397H000, Field Artillery Battery, 8-inch SP Battalion.
- TOE 06-398H000, Service Battery, 8-inch SP Battalion.

End items currently authorized on Essential Repair Parts Stockage List (ERPSL) are exempt from the combat PLL program. (James M. Eubank, WD, AUTOVON 639-2323)

COUNTERFIRE SYSTEMS REVIEW

New radar maintenance training

The new AN/TPQ-36 and AN/TPQ-37 field artillery Firefinder radar systems are now replacing the AN/MPQ-4A mortar locating radars. As such, qualified direct support radar mechanics are needed to work on this new equipment.

Personnel with MOS 26B (weapons support radar repairer) can earn the additional skill identifier (ASI), K1, by completing a new 23-week resident Firefinder Radar Repairer Course (104-ASIK1) at the Field Artillery School.

All FY82 classes are dedicated to providing personnel in support of worldwide fielding of these new radar systems. To qualify for this training, a soldier must possess MOS 26B and have a minimum of 19 months time remaining on active duty as of the course completion date. This remaining service time requirement can be satisfied through reenlistment or extension of current enlistment.

Since 26B (ASIK1) personnel will eventually be assigned to direct support maintenance shops to supervise and perform the maintenance required on Firefinder radar systems, the Army now needs personnel to train on the solid state, digital logic, computer-driven technology of the Firefinder radar systems. Additional course information and specific class dates can be obtained from:

Commandant
US Army Field Artillery School
ATTN: ATSF-CF-D
Fort Sill, OK 73503
AUTOVON: 639-4925/4982

Applications for attendance can be submitted through appropriate channels (MILPERCEN) in accordance with AR 614-200, or worked out as an option with your unit reenlistment office.

SCP "Ken" is dedicated

A third order survey control point was recently established near I-See-O Hall to fill the need for a high order initialization point for the Positioning and Azimuth Determining System (PADS). PADS is a vehicle-mounted computerized system that, once initialized over a known survey point, is capable of transferring accurate position, azimuth, and height to any place within a 55-kilometer radius.

The survey point, dedicated on 11 November 1981, was officially named "Ken" in honor of COL Kenneth A. Kleypas. Colonel Kleypas, Director of the Counterfire Department from November 1979 to December 1981, was a strong supporter of artillery survey and was instrumental in the adoption of PADS by the Army. He was presented a plaque bearing a replica of the survey disk and a copy of the official station description which is being sent forward

to National Oceanic and Atmospheric Agency in Washington DC for publication in the National Survey Trig List.

Station "Ken" is located in the motor pool area at the east end of I-See-O Hall. While its primary purpose is for PADs initialization, it can also be used as a survey control point by both Army and civilian surveyors.

Coordinated Support Logistics Program

The Meteorology Division has been exercising the Coordinated Support Logistics Program (CLSP), commonly called *Closed Loop*. This program is designed to replace items of equipment due to age and/or continued maintenance problems. It is not designed, however, to replace equipment solely to solve unsuccessful maintenance or supply procedures (i.e., just because a part is unavailable through direct support/general support maintenance or supply, this does not qualify the equipment for CLSP).

The step-by-step procedure to utilize the program is as follows:

•**Step 1.** Contact the Directorate of Industrial Operations (DIO)/direct support (DS)/general support (GS) maintenance personnel about your piece of equipment.

•**Step 2.** Have a DA Form 2404 (T.I. Sheet) and DA Form 2407, Work Request, prepared. The DA Form 2404 should list everything wrong with the equipment.

•**Step 3.** DIO/DS/GS maintenance will forward the request for the item normally by teletypewriter message, referencing CECOM letter, DRSELMMO-PB, dated 15 February 1980, subject: CERCOM's Coordinated Logistics Support Program (CLSP) for PA Major Communications-Electronics (C-E) Equipment or PA Major Components.

•**Step 4.** Upon release of the item (normally within 45 days, depending on availability and receipt of the requested item at your location) the unit will have 45 days in which to return the old item to DIO/DS/GS.

Since the rawin set and radiosonde recorder will remain in the inventory for some time to come, it will be to your benefit to utilize this program. Since this is a maintenance requirement—not a supply action—one must insure that supply does not requisition the items identified as CLSP. The only involvement that supply will have will be to receipt for the new equipment and reflect the change in serial numbers when the old equipment is shipped to depot.

Note: Items are exchanged on a one-for-one basis (i.e., if only one receiver drawer comes in with the set, then only one receiver drawer is returned). Additionally, there are no TS-538's in this program.



A Job Well Done

by LTC (Ret) Albert N. Garland

As the deputy editor of *Infantry* magazine, I read a lot of articles written by infantrymen and thereby manage to stay abreast of what seems important to the Infantry Community — at least at the junior officer and senior noncommissioned officer levels.

In some of the articles, for example, the authors tell of maneuvering their M113s and Bradleys with M60 and Abrams tanks. Other authors discuss breakout operations, delay tactics, marksmanship, and such esoteric subjects as integrated, extended battlefields and air-land battles. Some even manage to extol the virtues of the combined arms team.

Seldom, though, do I read an article in which an infantry author shows an appreciation of the important role the field artillery plays in combined arms operations or a real understanding of the kinds and amount of fire support the artillerymen can give. I fear that infantrymen do not write

March-April 1982

on this subject because they know so little about it. When they mention it at all, they do so in an almost cavalier way, seemingly in a hurry to get a distasteful duty over and done with.

This is unfortunate. In fact, it is more than that; it amounts almost to criminal neglect. Take it from an old infantryman whose life was saved by his supporting artillery units on several occasions in Europe in 1944 and 1945; today's infantrymen had better learn right now what the field artillery can do for them and how they can get that help when they need it. If those foot soldiers think they are going to win the next war all by themselves, or in the company of tanks only, they have another think coming.

And lest they think that what happened to me in 1944 and 1945 in Europe cannot happen again, let me remind them that many infantrymen in Korea in

the 1950s and in Vietnam in the 1960s and 1970s owed their lives to their supporting artillery units. It's not going to happen again? Baloney! (I am also one of those infantrymen who was disgusted with the Army's hierarchy when it decided to reduce the grade of the division artillery commander from brigadier general to colonel and to use that general officer space to create an additional assistant division commander. Our divisions need two assistant commanders each like they need unicycles in their reconnaissance units! What they do need is a high-ranking fire support coordinator to put real meaning into the term "fire support.")

From its beginning, the United States Army has stressed the closest cooperation between infantry and armor (*nee* cavalry) units and their supporting field artillery batteries and battalions. In every one of our wars, US field artillery units have played their supporting roles to near perfection (and this despite the critics who say that the US Army depends too much on firepower and attrition and not enough on maneuver).

Unfortunately, between wars we seem to let things slip; the combined arms do not train together enough, because we let other things interfere or something else comes along that seems more important at the time. Fortunately, though, we have always had the time to get our act together and to learn again the spirit of mutual support before it was too late. In fact, we have come up with some mighty fine infantry-artillery-armor teams. But it has usually cost us dearly before we did, and I don't want to see this happen again, particularly when it is so unnecessary.

I was lucky. My division's combined arms elements had come together and understood each other before my battalion saw its first combat in northern Germany in mid-November 1944.

For seven straight days we tried to take the small, and by then devastated, German town of Beeck, which lay just beyond the last bunkers in the Siegfried Line in that area. Our progress was slow; our casualties heavy. We took some bunkers, but could not force our way into the town. The weather was frightful—wet and cold—and the sugar beet fields in which we dug our holes stunk with the foul smells from our living and our dead.

We tried, God knows, we tried!! And so did three supporting British tank crews, who barely moved their vehicles 100 yards before they were knocked out. And so did our direct support artillery unit—the 326th Field Artillery Battalion—a 105-mm howitzer outfit, which did all that was humanly possible to help us. But the 326th was short of ammunition, and much of what it had on hand had to be held for emergencies (October and November of 1944 were bad months in Europe for frontline supplies of all kinds).

Believe me, though, without that battalion, my particular company — the men totally exhausted after their seventh straight attack, all but one officer gone, the rifle platoons down to squad size — would never have left its particular

piece of ground outside Beeck if it had not been for the artillery's covering fire.

A month later we were in Belgium — although on 20 December 1944 we weren't even sure of that. We had loaded on trucks the day before in Holland expecting to go to the division's rest center for a few days. Instead, 132 miles and many hours later, we found ourselves in Marche, Belgium. The next day, my company was defending a three-mile front that extended from one small Belgian town — Marenne — to another equally small one — Menil. We weren't sure who was on our left, but a sister company was on our right, although it, too, had a wide front to defend.

But we did know we had one heck of a lot of artillery in support, and we were told to call for it on the slightest German provocation. That we did — in spades — even when one German force circled to our rear and then came out through Marenne. My company's last concentration was plotted right on top of the town and we called for it when a supporting tank destroyer unit couldn't help and our few bazooka rounds bounced harmlessly off the sides of the German tanks.

I don't know how many artillery battalions fired that concentration for us, but there must have been quite a few. What German soldiers and vehicles did not see their end in Marenne fled out of town, only to be mopped up by troops that had moved into Menil. Unfortunately, I think we took the second stories off most of the houses in Marenne and deposited them in the town's one street!!!

But I came up out of a cellar grinning from ear to ear and very happy to be alive. So were the few men I still had with me, including the company's mess crew that had brought us our Christmas turkey dinner just before the Germans rolled into town. The crew was forced to stay with us, and we all watched a German tank flatten the trailer that had our holiday meal on it.

I could go on telling more "war stories" — about our crossing of the Roer River in February 1945, for example, when both our field artillery and antiaircraft artillery battalions gave us magnificent close support, or about the crossing of the Rhine River in March 1945 when, as the Ninth Army history tells it:

"For some 60 minutes, 2,070 guns averaged better than 1,000 rounds a minute in delivering a stunning attack on the German defenders, their communications facilities, and their defensive positions. In the preparation firing alone, 65,200 rounds — 1,820 tons — of artillery ammunition struck the German defenses. From the beginning of the preparation to four hours after the launching of the crossings, 131,450 rounds — nearly 4,000 tons — were fired."

But I don't want anyone to think I am the only World War II US infantryman who owes a great deal, if not his life, to his supporting artillery. There were, for instance, the battles at El Guettar, Salerno, Anzio, Mortain, Manila, the crossing of the Sarre River, and dozens of other places where other US infantrymen survived and won because their

"Redleg" friends were there when they were needed.

Could it happen again? It did. In May 1951 in South Korea, the 3d Battalion, 38th Infantry, was preparing a defensive position on and around the top of a bald hill, labeled "Hill 800." Company K occupied the very top of the hill, which the men of the company started called Bunker Hill.

During 17 and 18 May the battalion came under heavy attack by Chinese forces, and its companies battled furiously to hold their positions. By the evening of 18 May the Chinese assault had been thrown back except in the area occupied by Company K. Here, as the historical report shows, the supporting artillery unit — the 38th Field Artillery Battalion — did an outstanding job of literally saving Company K's infantrymen.

"When darkness came on 18 May," the report says, "Captain [George R.] Brownell and his men crawled into their bunkers to wait. An hour or two passed. Beyond the barbed wire there were the sounds of whistles and horns and the usual commotion as the enemy formed to attack. After waiting and listening for several minutes, Brownell requested artillery fire. It came promptly, interrupting the enemy attack, or at least delaying it for 20 or 30 minutes. When it [the attack] was re-formed, the forward observer signalled for another concentration.

"Several attacks were held off in this fashion before any enemy succeeded in reaching Company K's line. When they did, the company commander warned his platoon leaders of what he was going to do and then asked for the artillery to drop proximity-fuzed shells squarely on top of his company. The first shell burst overhead within a minute. Two thousand 105-mm shells fell during the next eight minutes. It was the heaviest concentration of artillery fire any of his men had experienced. They sat in the rear of their bunkers, staying well clear of the openings.

"You think we'll ever get out of this alive?" one of the men asked his bunker companion. At the time, few men thought they would.

"The artillery fire ended and a sudden quiet settled over the area. It remained quiet for 20 minutes or longer before the shells—this time from the enemy—fell in preparation for the next enemy attack. Again, Company K waited until the Chinese were upon its position and then asked for another concentration. In the midst of the firing, Captain Brownell reported to Colonel [Lieutenant Colonel Wallace M.] Hanes.

"The position is completely covered with fire," he told his battalion commander. "Nothing could live above ground in this."

"Men of Company K did little fighting themselves that night. They just sat in their earth-covered bunkers and waited for the enemy. When they heard enemy activity, the men would notify Captain Brownell of the location, and the forward observer would shift the artillery's airburst to that area. The 38th Field Artillery Battalion alone fired more

than 10,000 rounds in support of the 3d Battalion during the night. Most of the shells fell between 2200 and 0400 the following morning (19 May) when the Chinese abruptly broke off the attack.

"When daylight came, the enemy had disappeared Emerging from their bunkers, men of Company K were in full possession of the hill."

And after Korea, it happened again. It was October 1966 in South Vietnam and the 1st Cavalry Division's Operation IRVING was in full swing. On 2 October, several of the division's battalions had cornered an enemy force near Hoa Hoi. Darkness fell, and with it, as one report put it:

"North Vietnamese soldiers tried in vain to shoot their way out. Effective artillery support contributed to the containment effort During the night, 883 105-mm rounds were fired in the effort to contain the enemy."

A few days later, during the last days of the operation, the same report says:

"An artillery raid was conducted by A Battery, 2d Battalion, 19th Artillery. Four howitzers with crews, 280 rounds of ammunition, and a skeleton fire direction center were airlifted into areas that the enemy had thought were secure to fire on previously selected targets that were beyond the range of other tube artillery. The 280 rounds were fired in less than 17 minutes, after which the artillery was airlifted back to its base."

Artillerymen supported hundreds of other infantry operations throughout the length and breadth of South Vietnam from the first days of the war to the last, and they were never found wanting. Because of their efforts, thousands of US infantrymen survived the brutal, and often bloody, fighting that characterized this latest US war.

And so I scoff at those infantrymen who look at my "brown shoes" and tell me, "Don't worry, old man, you're living in the past. Times have changed. We'll handle things our way."

Well, if their way ignores their "Redleg" friends, then I feel sorry for them, particularly if they ever have to go to war. They are going to be in one heck of a mess.

I gladly pay homage to our field artillerymen. Without them, a lot of my friends who now drink coffee and exchange war stories in Infantry Hall would not be doing so. For them, and for me, I gladly say to our artillerymen: "Thanks for a job well done." I only hope today's infantrymen learn to appreciate the field artillery before it's too late!



LTC (Ret) Albert N. Garland (Infantry), Deputy Editor of *Infantry* magazine, is co-author of *Sicily and the Surrender of Italy*, a volume in the Army's official World War II series, and editor of *Infantry in Vietnam*, published in 1967.

UPDATE:

COMPUTER SET, FIELD ARTILLERY, GENERAL AND MISSILE

by CPT William H. Coke and Donald J. Giuliano

The Computer Set, Field Artillery (TI-59), has proved to be an effective computational tool to compute firing data for cannon and Lance gunnery, survey, and sound/flash ranging data. The Field Artillery School, however, continues to receive questions from the field concerning the calculator and its components; therefore, the following information is provided as a matter of general interest.

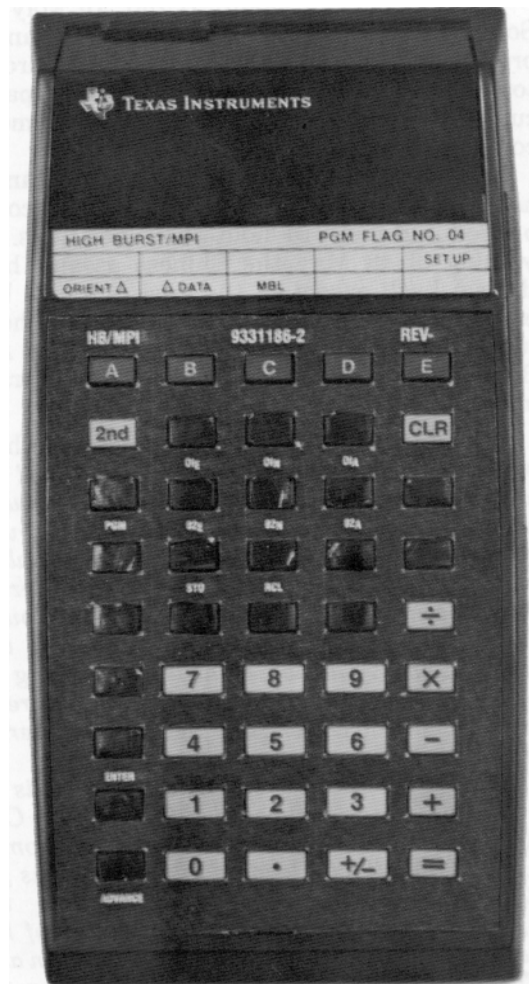

Requisition

Authority for the purchase of computer sets and program kits is Message, dated 212000ZJAN 80, DAMO-RQA.

The basis of issue for the computer set is as shown below:

•Cannon Units:	Type of set
Two per battery fire direction center.....	General
Three per battalion fire direction center	General
Two per survey party	General
•Lance Units:	
Four per battery fire direction center.....	One Missile and three General
Six per battalion fire direction center.....	One Missile and five General
Two per survey party	General
Two per survey information center.....	Missile

•Target Acquisition Units:

Two per sound/flash platoon	General
Two per survey party.....	General
Two per survey information center	Missile

•HHB, Division Artillery:

Two per survey party.....	General
Two per survey information center	Missile

•Pershing: Two per survey party

•HHB, Corps Artillery: Two per survey information center

•HHB, Pershing: Two per survey information center

The calculator and calculator accessories are stockpiled and can be requisitioned from the US Army Armament and Readiness Command. Requisitions should be sent to:

HQ, ARRCOM
ATTN: DRSAR-MMH-L
Rock Island, IL 61299

Item name	NSN	Part No.	Price*
Computer Set, FA, General (LIN C 17797)	1220-01-082-1646	11784958	\$310.00
Computer Set, FA, Missile (LIN C 18047)	1220-01-082-1647	11784959	505.00
Computer, Hand-Held (TI-59 only)	1220-01-106-9743	9331195	191.00
Charger Adapter-DC	1220-01-082-1622	9331180	13.78
Charger Adapter-AC	1220-01-082-1621	9331182	4.72
Battery Set, Rechargeable	1220-01-082-1629	9331175	9.53
Connector, Plug, Electrical.....	5935-01-082-1638	9331190	10.17
Cable Assembly, Special Purpose, Electrical	1220-01-082-1637	9331189	16.25
Adapter Connector (Adaptor Plug)	5935-01-123-4979	11785357	2.00
Program Kit, Computer Set, FA, M101A1/M102	1220-01-082-1624	9331239	60.78
Program Kit, Computer Set, FA, M109A1	1220-01-082-1617	9331237	46.31
Program Kit, Computer Set, FA, M109/M114A2	1220-01-082-1623	9331240	46.31
Program Kit, Computer Set, FA, M114A1	1220-01-082-1625	9331241	58.79
Program Kit, Computer Set, FA, M110A2	1220-01-082-1618	9331238	46.31
Program Kit, Computer Set, FA, Special Situation	1220-01-082-1628	9331245	46.31
Program Kit, Computer Set, FA, Survey.....	1220-01-082-1620	9331242	46.31
Program Kit, Computer Set, FA, Sound/Flash	1220-01-082-1627	9331243	46.31
Program Kit, Computer Set, FA, Lance	1220-01-082-1619	9331244	46.31

*FY82 prices.

Figure 1. Replacement parts and program kits.

Items may be preordered by calling AUTOVON 793-3263/3130. Any questions concerning requisitioned items may be discussed with the Item Manager, ARRCOM, by calling AUTOVON 793-6900/3313.

Maintenance

If a calculator becomes nonoperational, it may be sent directly to the manufacturer for repair at a cost of \$50.00. The address is:

Texas Instruments, PO Box 10508
North University Street
Mail Station 5873
Lubbock, TX 79408

If this option is not elected, a new calculator can be requisitioned as a replacement at unit level.

Figure 1 shows a list of replacement parts and program kits that are available through ARRCOM:

Units requiring the Computer Set, Field Artillery, Missile, should procure the inverter/vibrator PP-1703/U (NSN 6130-00-889-1207) through normal requisitioning procedures. The required technical manual which contains all components and stock numbers is TM 9-1220-242-12&P-HR.

New HB/MPI form

Since the calculator has been fielded, the Gunnery Department has evaluated several ideas and suggestions on optimizing its use in the fire direction center (FDC). Figure 2 (next page) depicts a new high-burst/mean-point-of-impact form for use with the computer set. This form was designed and submitted as a

suggestion from the field. It incorporates all HB/MPI keystrokes as outlined in the Field Artillery School's reference note RN GD05HC on one easy-to-use form. Field units are requested to use this form and provide comments as appropriate. The form, as shown, is suitable for local reproduction. Any comments and/or improvements should be forwarded to:

Commandant
US Army Field Artillery School
ATTN: ATSF-G-RA
Fort Sill, OK 73503

Copperhead HHC application

A module has been developed for the TI-59 to compute Copperhead firing data. This module along with the necessary instructional material will be hand-carried to field units on a first-time free-issue basis by the Copperhead/G/VLLD New Equipment Training Team (NETT). This team will also furnish GFT/GST equipment and Revision 6A FADAC tapes for the M109A1/A2/A3 and M198 weapon systems. 

CPT William H. Coke is the Tactical Operations and Doctrine Action Officer for the Development Coordination Center in the Counterfire Department, USAFAS.

Donald J. Giuliano is an Operations Research Analyst in the Research and Analysis Division, Gunnery Department, USAFAS.

HIGH BURST/MPI WORKSHEET

(For Use With Computer Set, FA General)

<p>I. Select Orienting Point (Announced by F00)</p> <p>(Easting) _____ (Northing) _____ (Tgt Alt + HOB) _____</p>	<p>15. <input type="checkbox"/> D (Compute) _____ FZ Setting _____</p> <p>16. <input type="checkbox"/> ADV _____ DF Fired _____</p> <p>17. <input type="checkbox"/> ADV _____ OE Fired _____</p> <p>NOTE: DO NOT EOM!!!</p>	<p>V. DETERMINE MEAN BURST LOCATION (MBL)</p> <p>30. Fire HB/MPI _____</p> <p>31. <input type="checkbox"/> B (Set up MBL Routine) Display 0. Displays of 0, 1, and 2 indicate ready for data input. 0 indicates ready for 01 Dir; 1 ready for 01 VA; 2 ready for 02 Dir.</p> <p>32. Input Observer Readings</p> <p>Rd No. 01 Dir <input type="checkbox"/> ADV 01 VA <input type="checkbox"/> ADV 02 Dir <input type="checkbox"/> ADV</p> <p>1 _____</p> <p>2 _____</p> <p>3 _____</p> <p>4 _____</p> <p>5 _____</p> <p>6 _____</p> <p>7 _____</p>
<p>II. SET UP (Use gunnery Module, overlay & Cue)</p> <p>1. 2nd <input type="checkbox"/> PGM * <input type="checkbox"/> A Displays * _____ *Refer to PGM flag Card</p> <p>2. <input type="checkbox"/> CLR _____</p> <p>3. 2nd <input type="checkbox"/> PGM <input type="checkbox"/> 02 _____</p> <p>4. _____ (BtryE) <input type="checkbox"/> ENTER <input type="checkbox"/> BTRYE</p> <p>5. _____ (BtryN) <input type="checkbox"/> ENTER <input type="checkbox"/> BTRYN</p> <p>6. _____ (Btry Alt) (1M) <input type="checkbox"/> ENTER <input type="checkbox"/> BTRYA</p> <p>7. _____ (AZ of Fire) <input type="checkbox"/> ENTER <input type="checkbox"/> AZ LAY</p>	<p>IV. ORIENT OBSERVERS (Use HB/MPI overlay & Cue)</p> <p>18. 2nd <input type="checkbox"/> PGM <input type="checkbox"/> 04 (Recall HB/MPI program)</p> <p>19. 2nd <input type="checkbox"/> E (Set up)</p> <p>20. _____ (01E) <input type="checkbox"/> ENTER <input type="checkbox"/> 01E</p> <p>21. _____ (01N) <input type="checkbox"/> ENTER <input type="checkbox"/> 01N</p> <p>22. _____ (01A) <input type="checkbox"/> ENTER <input type="checkbox"/> 01A</p> <p>23. _____ (02E) <input type="checkbox"/> ENTER <input type="checkbox"/> 02E</p> <p>24. _____ (02N) <input type="checkbox"/> ENTER <input type="checkbox"/> 02N</p> <p>25. _____ (02A) <input type="checkbox"/> ENTER <input type="checkbox"/> 02A</p> <p>26. <input type="checkbox"/> A Display 01 Dir _____</p> <p>27. <input type="checkbox"/> ADV Display 01 VA _____</p> <p>28. <input type="checkbox"/> ADV Display 02 Dir _____</p> <p>29. <input type="checkbox"/> ADV Display 02 VA _____</p> <p>Send MTO: "OBSERVE HIGH BURST REGISTRATION.</p> <p>01 Dir (26) _____ VA (27) _____ Measure The Vertical Angle.</p> <p>02 Dir (28) _____ VA (29) _____ Reprot When Ready to Observe."</p>	<p>NOTE: If error is made during input, Press B and input again.</p> <p>NOTE: Delete unusable rounds by entering a negative (+/-) value for 01 Dir; an opposite value for 01 VA (if + enter -; if - enter +) and a negative value for 02 Dir.</p> <p>34. _____ C = MBL E _____ (No. of usable rds)</p> <p>35. <input type="checkbox"/> ADV Displays MBLN _____</p> <p>36. <input type="checkbox"/> ADV Displays MBLA _____</p> <p>DO NOT TURN OFF CALCULATOR!!!</p> <p>VI. DETERMINE GFT SETTING (Use gunnery overlay & cue)</p> <p>37. Repeat Steps 1, 2, and 3.</p> <p>38. <input type="checkbox"/> A AZ to MBL Flashed; RG displayed. Displayed RG is GFT Cht Rg Cht RG _____ (CONTINUED ON REVERSE SIDE)</p>
<p>III. DETERMINE FIRING DATA</p> <p>8. _____ (TgtE) <input type="checkbox"/> ENTER <input type="checkbox"/> TGTE</p> <p>9. _____ (TgtN) <input type="checkbox"/> ENTER <input type="checkbox"/> TGtN</p> <p>10. _____ (Tgt Alt + HOB) <input type="checkbox"/> ENTER <input type="checkbox"/> TGTA</p> <p>11. <input type="checkbox"/> A (AZ Flashed, RG Displayed) AZ to TGT _____ RG to TGT _____</p> <p>12. <input type="checkbox"/> C (Chg selected by calculator)</p> <p>13. <input type="checkbox"/> CLR _____ <input type="checkbox"/> ADV (Display Chg desired) (Chg desired)</p> <p>14. 2nd <input type="checkbox"/> A (Override FZ Ti w/o 20/R)</p>		

FS Form 1389 (Test) (Gun) 1 Jan 81
Figure 2. High-burst/mean-point-of-impact worksheet.

HIGH BURST/MP/PI WORKSHEET (CONT'D)

<p>39. Manually Compute VI</p> <p>MBLA _____</p> <p>-BTRYA _____</p> <p>VI +/- _____</p> <p>40. Manually Compute SITE</p> <p>VI - "D" scale of GST _____</p> <p>Cht RG (38) on Chg/TAG/TBG scale</p> <p>SITE +/- _____</p> <p>41. Manually Compute ADJ EL</p> <p>QE Fired _____</p> <p>-SITE _____</p> <p>ADJ EL _____</p> <p>42. <input type="checkbox"/> D (Ignore FZ setting)</p> <p><input type="checkbox"/> ADV (Cht DF w/drift applied)</p> <p>DF _____</p> <p>43. Manually compute Cht DF w/o drift</p> <p>Cht DF w/drift (42) _____</p> <p>- Drift~ADJ EL (use TFT) - _____</p> <p>CHT DF _____</p> <p>44. Manually compute GFT DF Corr</p> <p>Cht DF (43) _____</p> <p>- DF Fired (16) _____</p> <p>Total DF Corr _____</p> <p>NOTE: L = +/-R = -</p> <p>45. Manually compute GFT DF Corr</p> <p>Tot DF Corr _____</p> <p>- Drift ADJ EL _____</p> <p>GFT DF Corr _____</p>	<p>46. Construct Lazy "Z"</p> <div style="text-align: center;"> </div> <p>NOTE: Interpolation routine may be required to compute exact Rg~EL and Ti~EL. If not required go directly to step 61.</p> <p>VII. INTERPOLATION (Use a separate calculator to compute this section)</p> <p>47. Use Spec Sits module, and interpolation cue card.</p> <p>48. <input type="checkbox"/> 2nd <input type="checkbox"/> PGM <input type="checkbox"/> 10</p> <p>49. <input type="checkbox"/> 2nd <input type="checkbox"/> E</p> <p>50. _____ (Closest small EL listed in TFT) <input type="checkbox"/> A</p> <p>51. _____ (ADJ EL) (41) <input type="checkbox"/> B</p> <p>52. _____ (closest larger EL listed in TFT) <input type="checkbox"/> C</p> <p>53. _____ (Rg~small EL) <input type="checkbox"/> 2nd <input type="checkbox"/> A</p> <p>54. _____ (Rg~Large EL) <input type="checkbox"/> 2nd <input type="checkbox"/> C</p> <p>55. <input type="checkbox"/> 2nd <input type="checkbox"/> B Displays Rg~ADJ EL _____</p> <p>NOTE: ROUND TO NEAREST 10 METERS.</p> <p>56. _____ (Ti~Smaller EL) <input type="checkbox"/> 2nd <input type="checkbox"/> A</p> <p>57. _____ (Ti~Larger EL) <input type="checkbox"/> 2nd <input type="checkbox"/> C</p> <p>58. <input type="checkbox"/> 2nd <input type="checkbox"/> B Displays Ti~ADJ EL _____</p> <p>NOTE: ROUND TO 0.1 TIME</p>	<p>VII. COMPUTE RESIDUALS</p> <p>59. Use gunnery module and cue card.</p> <p>60. Repeat Steps 1, 2, and 3.</p> <p>61. <input type="checkbox"/> TGTE <input type="checkbox"/> 2nd <input type="checkbox"/> BTRYN (override fixed decimal)</p> <p>RG K _____</p> <p>62. $\frac{\text{Rg~EL (55)}}{\text{Cht Rg (38)}} =$ _____</p> <p>Displays Rg K residuals = _____</p> <p>63. <input type="checkbox"/> ENTER <input type="checkbox"/> RG K _____</p> <p>DF CORR _____</p> <p>64. $\frac{\text{GFT DF CORR (R = -)}}{\text{ENTER DF CORR}} =$ _____</p> <p>FZ K _____</p> <p>65. $\frac{\text{(ADJ Ti) (15)}}{\text{ENTER DF CORR}} =$ _____</p> <p>Displays FZ K residuals = _____</p> <p>66. <input type="checkbox"/> ENTER <input type="checkbox"/> FZ K _____</p> <p>APPLY RESIDUALS</p> <p>70. _____ (Chg fired) <input type="checkbox"/> ENTER <input type="checkbox"/> RES/CHG _____</p> <p>NOTE: Display will flash Rg K; (2 decimal places) DF Corr (whole number) and FZ K residuals (2 decimal places) and then display FZ K as a whole number.</p> <p>GFT _____ : CHG _____ LOT _____ RG _____ (38)</p> <p>EL _____ (41) Ti _____ (15) GFT (DF Corr) _____ (45)</p>
--	--	--

Figure 2—Continued.

Right by Piece

NOTES FROM UNITS

Gillmore competition

FORT ORD, CA—On the morning of 14 December last year, with a cold wind biting, soldiers of B Battery, 2d Battalion, 8th Field Artillery, were blasting the ranges of Camp Roberts. The Gillmore Competition which determines the best firing battery in the 7th Infantry Division Artillery was in progress.

Gillmore award competition has been held annually at Camp Roberts since 1975. The competitors are the 7th Infantry Division Artillery's best firing batteries, one from each battalion. The competition honors MG William N. Gillmore, who was commander of the 7th Infantry Division during the Korean Conflict (1949-50). Gillmore is now retired and residing in the Monterey Peninsula area.

The soldiers of B Battery, 2d Battalion, 8th Field Artillery, had the honor of winning the award for the second time. The trophy is a plaque-mounted Korean rifle which Gillmore captured during the conflict.

"To prepare for the competition," said CPT Richard A. Grabowski, commander of the winning battery, "we were given a letter of instruction well ahead of time. This made us aware that the competition was based on the Army Readiness and Training Program, which we are now familiar with and proficient in."

"Morale of the troops was high throughout our training program. In preparing for this competition, attention to detail was important to us, and we took extra care in making sure that our systems were completely foolproof. If there had been a malfunction at any point, the end result would not have been the proficiency that B Battery demonstrated at Gillmore," Grabowski said.

Artillery training involves preparing the soldier to be an expert at his job as well as being a competent member of a team. The battery is a force of different sections. Fire direction, ammunition, communication, auto mechanics, and supply are all supporting elements of the cannoneers, who are the final link in an artillery team.

CPL Floyd S. Patterson, a native of North Carolina, is a gunner on his second tour with the winning battery. He has been with the battery this time since November 1980. 1SG Preston B. Howard, 2d Battalion, 8th Field Artillery, pointed Patterson out as one of the outstanding performers at the contest, and described him as the "chief of smoke."

Patterson is proud of his job and said, "I would hate to leave this battery because "we don't just work for the commander or the first sergeant; we perform because we all feel proud to be the best, and it can only stay that way if we keep the fire burning."

Grabowski, speaking of his soldiers, said, "We live here like one happy family and work like an organized team. I

compared the Gillmore competition with the Super Bowl for them, and they went out there bubbling with confidence and bursting with desire to win." Howard said, "Esprit de corps is the key to our success."

When it was announced that B Battery was the winner of the award no one seemed surprised. Soldiers only made comments which expressed the feelings, "We deserved it."

"Doing things right the first time saves much time and effort later on," said Grabowski. (Rolly Bain)

Fire Coordination Exercise

BAUMHOLDER, GERMANY — To successfully engage all critical targets on the battlefield, the capabilities of each indirect fire system must be maximized. In an intensive effort to insure expertise and instinctive application of successful fire support techniques, company teams with their attached fire support teams (FISTs) in the 8th Infantry Division (Mechanized) participate regularly in a fire coordination exercise (FCX).

The FCX represents only a part of the "Cardinal Point" training exercise conducted three times last year by each brigade of the division. Cardinal Point is a training period that gives each brigade an opportunity to conduct realistic sustainment training as a combined arms team. Interface between the maneuver arms and field artillery organizations is continuous during mortar and artillery live fire exercises, MILES, and the FCX.

Prior to each exercise, training and evaluation outlines (TEOs) are written to provide a standardized list of tasks which participants must perform in order to successfully complete the training exercise. These TEOs are helpful in determining areas of training strengths and weaknesses and, once completed, serve as the basis for refining training programs for the FISTs in a garrison training environment.

The training and evaluation standards for the FCX are completed under three conditions:

- First, the company team is assigned a defensive mission within a task force which is conducting defense in sector.
- Second, the team is assigned both initial and subsequent battle positions within their sector.
- Finally, the FCX takes place on a 1:10 scale 14.5-mm range facility.

Subordinate elements within the team are represented by one vehicle per platoon. Once the exercise begins, specific target arrays are displayed on the range which require the team commander and his subordinate leaders to execute corresponding fire coordination tasks. Leaders' actions and fire coordination tasks are evaluated in terms of GO/NO-GO standards.

To receive a satisfactory rating, the company team must:

- Achieve a GO on all indirect and direct fire tasks.
- Occupy the position and be prepared to execute the assigned mission in the specified time limit.
- Deliver effective suppressive fires.
- Deliver effective indirect fire on multiple targets beyond direct fire range, thus preventing enemy reconnaissance elements from gaining information on team positions.
- Deliver effective direct fire on 80 percent of exposed targets within 3,000 meters.
- Communicate to required standards.
- Keep higher headquarters informed concerning the friendly and enemy situations, without security compromise.

This simulated controlled combat environment provides the scenario for necessary fire coordination training. It places the maneuver company, including its attached FIST, in a low cost tactical situation which closely simulates the coordination and communication environment of a company in a defensive position. The exercise is easily controlled by evaluators equipped with a military incident list and communication system which assist in guiding the exercise toward evaluating all of the TEOs. Landline communication is established by the controllers with the artillery and mortar fire direction centers (FDCs), and FM communication is established with the company commander, FIST platoon leaders, the direct support artillery battery FDC, and the 81-mm mortar FDC. Evaluator personnel include an infantry company commander, a battalion fire support officer (FSO), and a group of eight radiotelephone operators and assistants. These evaluators must be able to identify training strengths and weaknesses by observing overall coordination and monitoring communication on FM nets.

Notes, taken during the exercise, are used in the after-action review to provide constructive feedback to the participants. The after-action review also allows the commander an opportunity to explain the overall operation, the FIST Chief to discuss the indirect fire plan, and other subordinate leaders to describe their actions. This interaction of evaluators and participants brings out many useful points and provides the forum for the evaluators to critique the participants.

The FCX range depicts typical German landscape on a 1:10 scale with an extensive road network and villages. The "battlefield" is built up with structures and covered with SAAB "pop-up" targets which are activated in accordance with the military incident list. Depending on the scenario, up to 25 targets on a 1:10 scale at ranges of 7,000, 6,000, 3,500, 3,000, 2,200, 1,500, 1,000, and 800 meters can be identified by the participants. These targets, which are positioned based on Soviet doctrine, "popup" in a pattern that generally corresponds to the deployment of a Soviet motorized rifle regiment. Indirect fire support for the FCX consists of one battery FDC, three M31 14.5-mm subcaliber artillery trainers, and a section of 81-mm mortars equipped with SABOT training rounds.

A typical scenario for the FCX begins with a spot report (sent on the TF Command Net) indicating

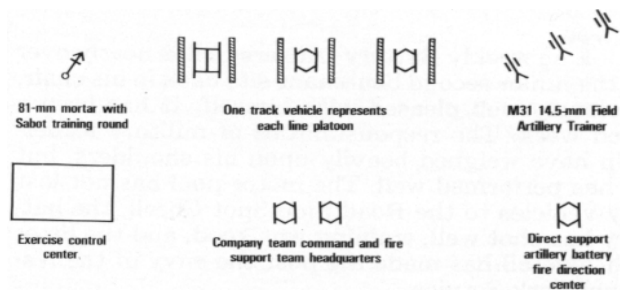

FCX range facility (not to scale).

that three enemy scout reconnaissance vehicles are approaching. Approximately 15 minutes later, the scout vehicles enter the company's field of vision. At a range of 6,000 meters, the first platoon forward observer (FO) adjusts fire on the enemy vehicles intent on destroying their communication capabilities. The threat vehicles are not visibly affected during the adjustment portion of the mission and quickly proceed along a road which winds through a tall pinewood forest, avoiding the fire for effect which impacts on a now empty road.

At a range of 3,000 meters, two enemy scout vehicles are again sighted by the first platoon FO, who immediately engages them with artillery. One vehicle is stalled by the fire for effect and the other moves back in the woodline. The immobilized vehicle is smoldering, thus preventing clear visibility of the woodline. (If the forward observer does not engage the enemy vehicles, these targets are "popped up" again in 15 minutes at a range of 800 meters.)

The battle continues with a battalion size enemy element advancing toward the defending company, and the company commander has a good idea of what to expect. As lead elements of the enemy formation begin dismounting within 1,000 meters of the company's position, the commander has the FIST chief engage them with a heavy volume of artillery. If the battle does not develop as expected, the commander adjusts the plan accordingly.

The commander and FIST chief must plan together to create the circumstances which cause the enemy to be stalled in kill zones. With effective coordination and the use of the right weapon system on the right target, they can maximize the effects of their limited battlefield assets.

The exercise also demonstrates the FIST chief's knowledge of maneuver tactics and gives him an opportunity to work with the company commander to preplan indirect fires and use the fire plan. The FIST chief must be familiar with maneuver terminology and understand the construction of battlefield geography and the tactical applications of maneuver arms and artillery doctrine.

The validity of the fire plan will be evaluated throughout the exercise. The evaluators determine whether the plan was written with the commander's assistance or by the FIST chief alone.

If the plan is understood by key personnel during the course of battle, coordination is easier to effect. This exercise has been extremely helpful in updating and refining the indirect fire planning and coordination portion of company SOPs. (CPT Warren K. Beer)

The weekly Battery Officers Call is nearly over as the junior second lieutenant sits back in his chair, obviously well pleased with himself. It has been a good week. The responsibilities of military leadership have weighed heavily upon his shoulders, but he has performed well. The motor pool has not lost any vehicles to the Road Side Spot Check, the battery has shot well, training was good, and the litter police detail has made the post the envy of the National Park Service.

The battery commander stands up to leave and then, almost as an afterthought, he drops the bomb. "Oh, by the way, Lieutenant Smith, the old man says some "VIPs" are coming in on the third. He's tasked us as the Salute Battery—handle it." When the lieutenant calmed down, he realized one inevitable fact; he was to be the officer in charge of the Salute Battery and he had best get on with the job.

Contrary to some opinions, a Salute Battery's requirements need not impair a unit's effectiveness nor prove detrimental to an officer's career. This is

particularly so if the unit develops a good standing operating procedure (SOP) and approaches the problem in an organized manner. For example, Bravo Battery, 2d Battalion, 2d Field Artillery, has been the Salute Battery for the US Army Field Artillery Center and Fort Sill (USAFACFS) and the Honor Battery for the State of Oklahoma for more than a decade and, as such, has represented the Field Artillery in dozens of ceremonies at Fort Sill and throughout Oklahoma. Nevertheless, Bravo Battery fires more than 35,000 rounds each year in support of the Field Artillery School. The 2d Battalion as a whole fires over 100,000 rounds each year in fulfilling its mission, as well as conducting required training, undergoing all of the normal inspections, and performing the usual functions of any howitzer battalion. (Bravo Battery also served as the custodian of the regimental mascot, "Big Deuce III," a beloved donkey who held the rank of E7 and participated in all salute functions with the unit. Big Deuce III was laid to rest 21 December 1982, but a replacement has been donated by John Lewis of Lawton, OK.)

Salute!!!

by personnel of Bravo Battery, 2d Battalion, 2d Field Artillery

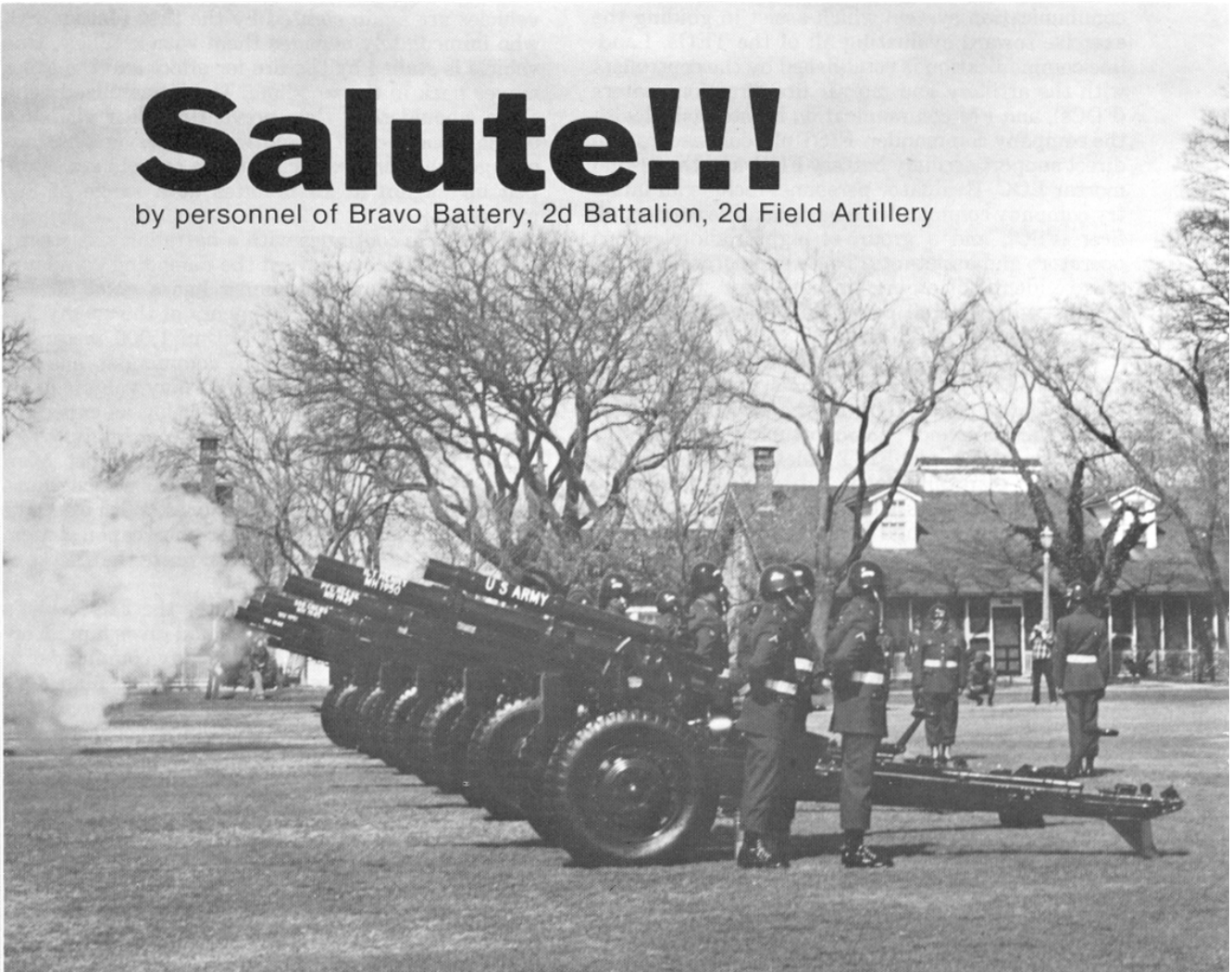

Since all salutes fired at Fort Sill are fired by Bravo Battery, 2d Battalion, 2d Field Artillery, the unit has developed an efficient, functional procedure which is outlined in the SOP. While this is certainly not the only unit to develop Salute Battery procedures, the following synopsis may be valuable for future reference should your unit be required to fire a salute.

Organization

The Salute Battery is composed of six 105-mm, M101A1, towed howitzers. Each howitzer section is manned by a chief of section, an assistant gunner, a loader, and two ammunition handlers. At Fort Sill, the battery is positioned in accordance with USAFACFS Reg 210-5 or as prescribed by higher headquarters. This directive sets forth the administrative, operational, and logistical requirements for the planning, coordination, conduct, and execution of ceremonies (e.g., honors, retirements, reveille, retreat, and special holiday ceremonies such as Memorial and Independence Days).

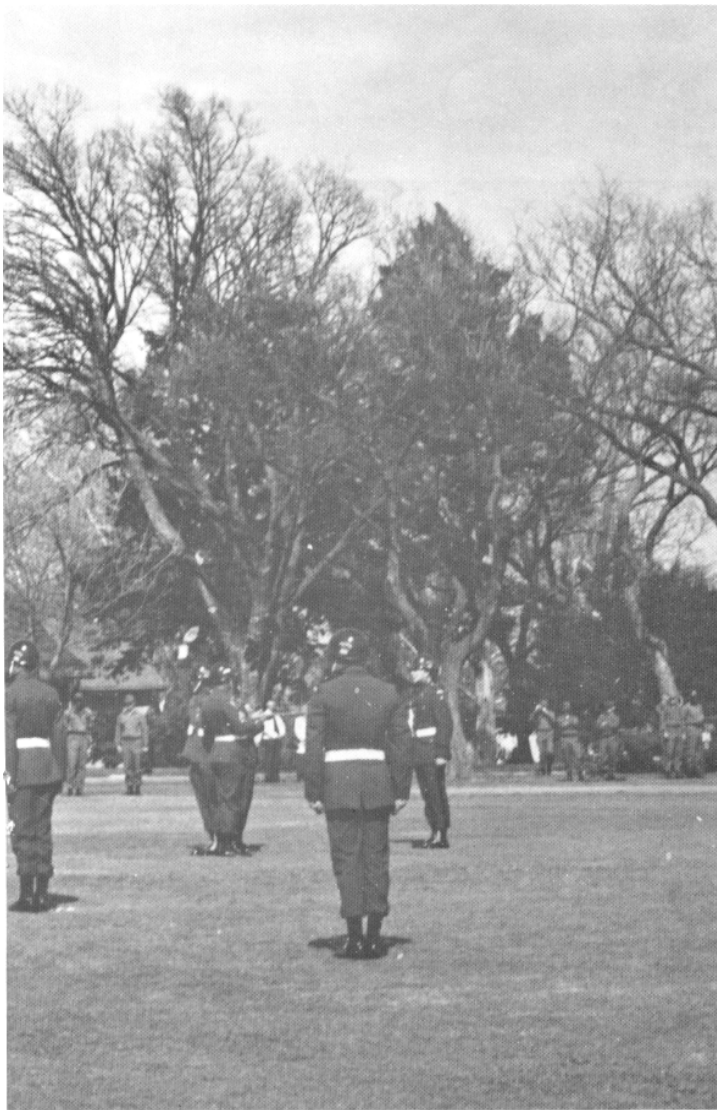

Ceremonies directed by subordinate commands/organizations are planned and conducted in accordance with FM 22-5 and appropriate military customs and courtesies. Once the direction of fire and Salute Battery line of troops are established, the howitzers are aligned parallel to the line of troops, pointed in the direction of fire. The line of metal is marked with WD-1/TT field wire or twine, and then the highly shined howitzers are moved on line so that the center wheel hubs are directly over the line and positioned at an interval of three paces from wheel-to-wheel, with all tubes parallel and at quadrant 300. The executive officer (XO) insures that each howitzer is an exact image of the others (i.e., pantel and handwheels in the same position, all levelling vial covers closed, etc.). A two-step interval is left between the line of troops and the ends of the lunette (figure 1).

Preparation

Although AR 600-25 specifies when salutes may be fired and the number of rounds to be used, it gives little detail on "how to conduct the salute." While the sequence of events for ceremonies varies depending on the occasion, the conduct of the salute itself is the same in each case except for the time interval between rounds and the number of rounds fired. Bravo Battery has adopted a locally approved SOP which outlines the specific sequence for firing.

The Salute Battery marches on line two paces to the rear of the howitzers under the command of the chief of firing battery (CFB). Upon the command of "BATTERY. . . HALT," the CFB halts, and executes a facing movement *toward* the direction of fire; he then gives a command to the battery to cause the cannoneers to do a facing movement so that they are facing opposite the direction of fire.

The CFB then commands, "CHIEF OF SECTION...LOAD," and the chiefs of section execute an "about face." With the command of execution of "ONE ROUND," the chiefs of section march to the breech of their respective weapons (figure 2) and from under the left trail pick up a round with their left hand, place it in the breech block, and close it with the right hand. This should be done in sequence starting with sections 1 through 6.

Note: It is imperative that each chief of section insure that his breechblock is completely closed to preclude a misfire and breaking of the firing pin.) After the chief of section has loaded his weapon, he will position himself to the left of the recoil tray and face in the direction of fire. When the CFB has ascertained that each chief of section is in the correct position, he will command: "CHIEFS OF SECTION...ABOUT...FACE." He then commands, "CHIEFS OF SECTION...FALL IN."

The chiefs of section now return to their positions in the line of troops, and the CFB executes an about face and exchanges hand salutes with the XO. On command of "POST" by the XO, the CFB executes an about face and marches to his position between sections 3 and 4 and executes another about face.

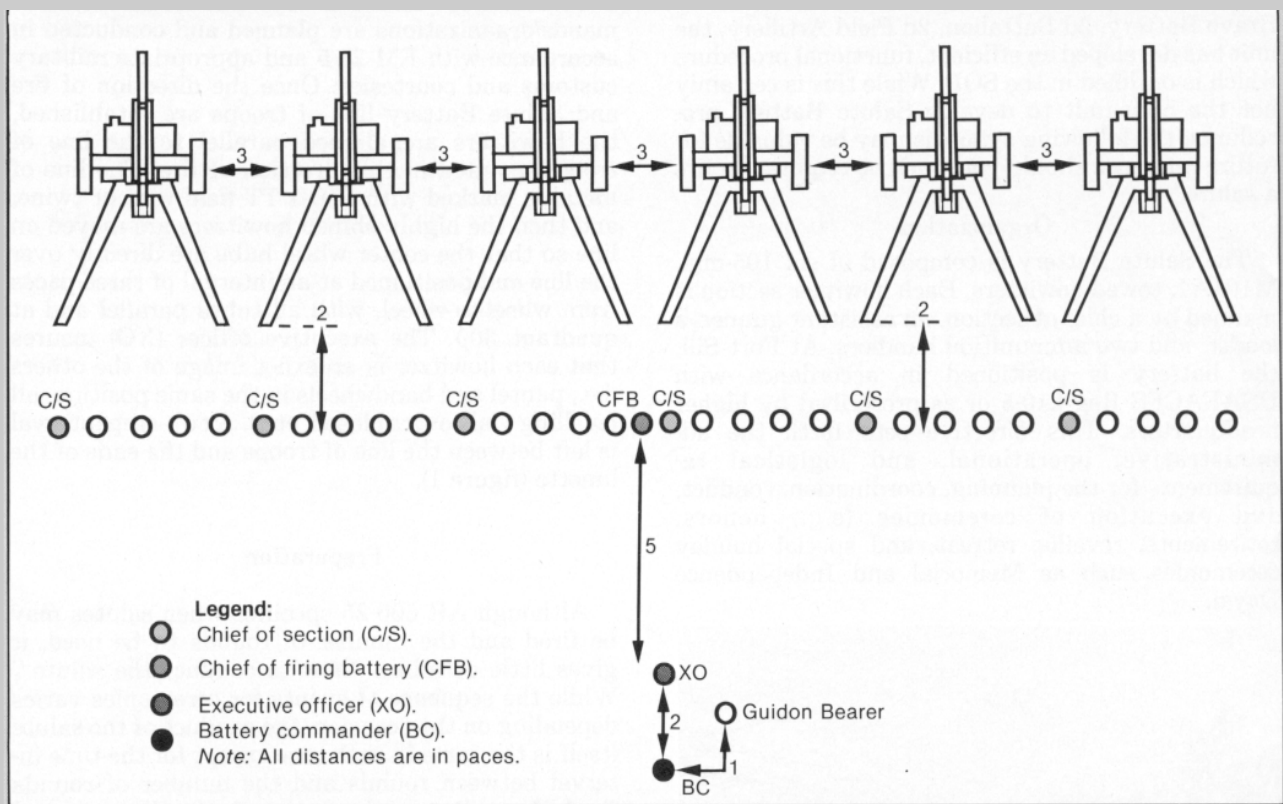

Figure 1.

(Photos by SP4 Dennis G. Wilson and SP4 LeRohne H. Williams)

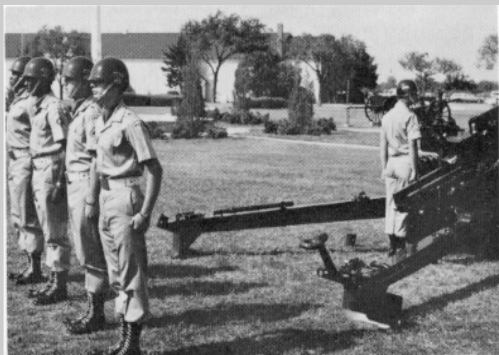

Figure 2.

With the howitzers loaded, the XO executes an about face and exchanges hand salutes with the BC who in turn commands, "PARADE REST," to the entire battery. He then does an about face and comes to parade rest and awaits the beginning of the ceremony (figure 3).

The salute

At the appropriate time for the salute to be fired (as designated in the ceremony letter of instruction), the battery commander does an about face, brings the battery to attention, and commands the XO to "POST THE CANNONEERS." On the preparatory command (given by the XO) "CANNONEERS," the guidon bearer brings the guidon to the raised position, and all cannoneers, except for the chiefs of section,

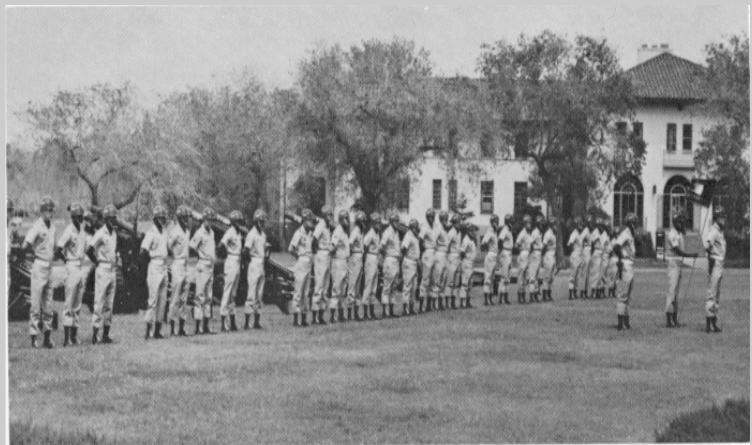

Figure 3.

do an about face in preparation for the command of execution, "POST" (figure 4).

On the command of "POST," the cannoneers take their respective positions at double time. Sections 1 and 2 position themselves in the ready-to-fire configuration (figure 5) and sections 3, 4, 5, and 6 position themselves in the parade rest configuration (figure 6). Also, on the command of execution, "POST," the chiefs of section of guns 1, 2, and 3 execute a right face and the chiefs of section of guns 4, 5, and 6 execute a left face, so that they face the center of the battery line of howitzers. After the chiefs of section complete the facing movement, they immediately (simultaneously) turn their heads so that they face their respective sections (figure 6). Additionally, the guidon bearer comes to present

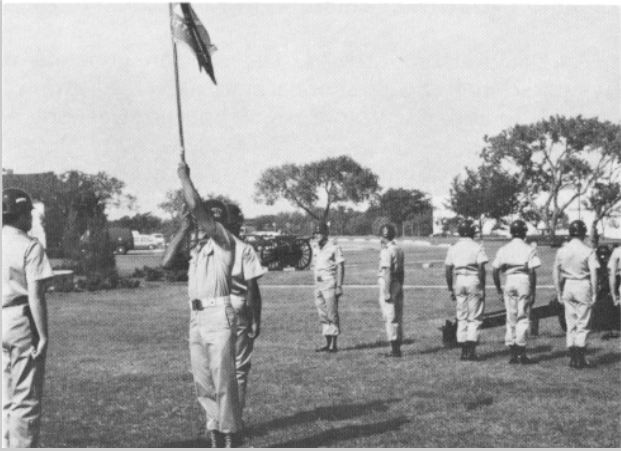

Figure 4. (Note: This picture shows only the number 3 howitzer section and the CFB on the line of troops. During an actual salute, howitzer sections 4, 5, and 6 would also be on line to the CFB's right).



Figure 5.



Figure 6.

arms with the guidon, the CFB marches forward until he is beside the XO (left shoulder to left shoulder) (figure 7), and the XO raises his right arm and waits for the signal to fire from the CFB.

The signal to initiate firing the salute is either given by the chief of firing battery or the battery commander; for example:

- In a ceremony, such as a review, the salute commences when the hand of the commander of troops (COT) touches his headgear on the hand salute when he is presenting the command to the honoree. This action can only be observed by the CFB; therefore, he initiates the salute by slapping the XO's left shoulder.

- In a ceremony, such as a military funeral, the BC gives the command to fire.

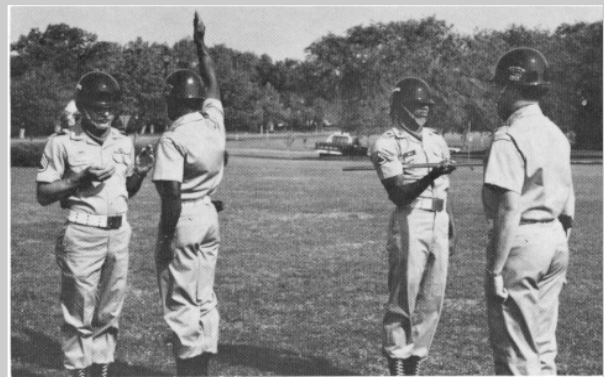

Figure 7.

In all cases, when the command to fire is given, the CFB slaps the XO on the left shoulder with the back of his left hand and simultaneously starts a stop watch which has been previously marked with the appropriate time interval between rounds. The time interval (normally three seconds) for salutes is prescribed in AR 600-25 for each type ceremony. When the XO feels the CFB slap him on the left shoulder, he drops his right arm, causing section 1 to fire. The XO instantaneously raises his arm back to the ready-to-fire position, the CFB slaps the XO on the left shoulder as the second hand on the stopwatch hits each mark on the stopwatch.

When section 1 fires, section 3 assumes the ready-to-fire position; when section 2 fires, section 4 assumes the ready position, etc., so that two sections are ready to fire at any one time (figure 8). This allows for immediate action should there be a misfire.

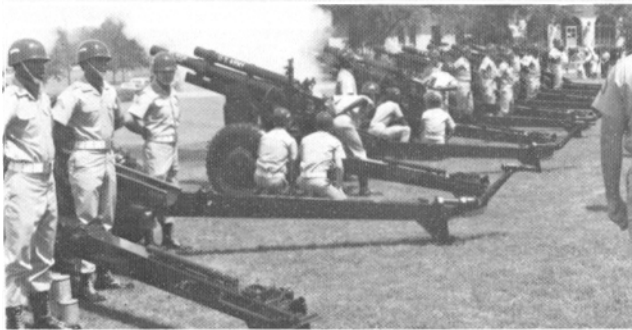

Figure 8.

Duties of the howitzer section

As previously outlined, the section consists of five personnel: the chief of section, assistant gunner, and 1, 2, and 3 cannoneers, whose duties are as follows:

- Chief of section: Loads/unloads initial and final rounds.
- Assistant gunner: Fires howitzer, renders command "READY," opens and closes breech for loading/unloading, and directs misfire procedures.
- Number 1 Cannoneer: Loads/unloads howitzer; performs misfire procedures.
- Number 2 Cannoneer: Receives expended canister from number 1 cannoneer and stacks neatly next to howitzer.
- Number 3 Cannoneer: Passes firing canister to number 1 cannoneer.

After each section fires and the loader has successfully loaded another round, the loader and two ammunition handlers come to the position of attention. When the assistant gunner sees that everyone in his section is at position of attention he gives the command "PARADE REST." Everyone in the section except the chief of section executes the command. The section stays at the parade rest position until the assistant gunner gives the command "READY." The assistant gunner commands "READY" when the howitzer two sections to his left fires. At the command, the section assumes the position as shown in figure 5.

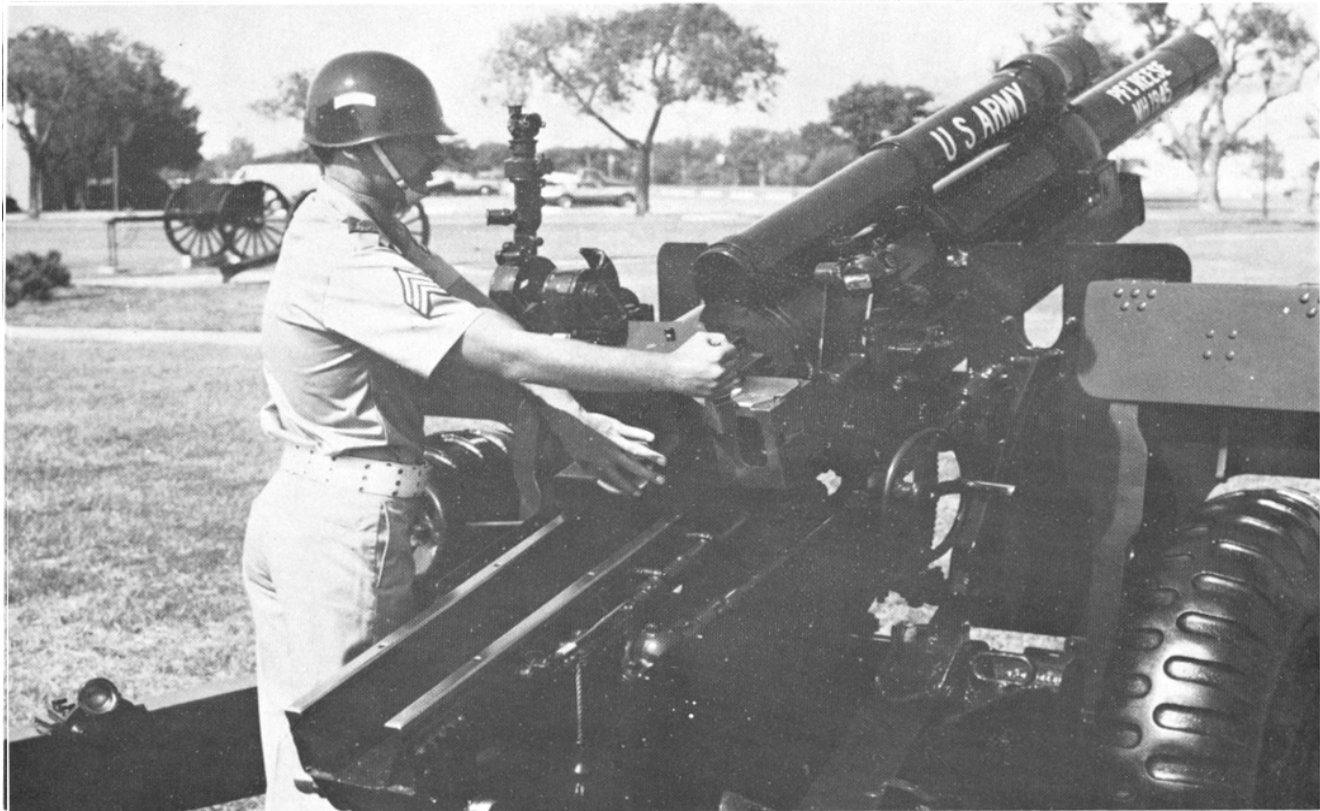

Figure 9.

For the above discussion, sections 5 and 6 may be considered to the left of the assistant gunner for section 1. If a misfire occurs, the assistant gunner next in line must instantly fire so that the time interval between rounds will remain constant. The XO commands the next round to be fired as if no misfire occurred. A section which has had a misfire takes the following action:

- The assistant gunner immediately commands "DOWN" in a loud voice (it is important that the entire battery know there has been a misfire); all members of the section drop to their right knee.

- The assistant gunner and number 1 cannoneer attempt to correct the malfunction, reload, and resume the firing sequence, taking care to observe proper safety procedures.

No matter how long it takes to correct the malfunction, the misfired section will stay "DOWN" until the firing sequence has passed by them at least once. The other sections will continue the salute in sequence. The section next in line to the section which has misfired must constantly be on the lookout for the misfired section to reenter the sequence so that two rounds will not be fired simultaneously. (In the above discussion, the first section is considered to be next in line to the sixth section.) The BC, XO, CFC, guidon bearer, and chiefs of section will remain at the position of attention for the entire salute.

The BC counts all rounds on a mechanical counter. When the required number of rounds has been fired, the BC gives the command "CEASE FIRING." Upon hearing this command, everyone in the battery comes to the position of attention and all assistant gunners drop lanyards and close breechblocks. When the XO sees that everyone is at the position of attention, he will give the command "TO THE REAR OF THE PIECE, FALL IN." At this time, all firing personnel double time to their position two paces to the rear of the lunettes. The chiefs of sections 1, 2, and 3 execute a left face and the chiefs of sections 4, 5, and 6

execute a right face. The CFB executes an about face and marches to his position between sections 3 and 4 and executes an about face (figure 1). When the XO has ascertained that everyone is in position, he lowers his right arm and executes an about face. *Note:* The XO must always be mindful that the lowering of his right arm at the incorrect time could cause a round to be fired out of sequence.) At this time, the BC commands either "PRESENT ARMS" or "PARADE REST" depending on the type of ceremony (i.e., a ceremony with ruffles and flourishes requires a command of "PRESENT ARMS"). He then does an about face and executes the command he had just given. If the ceremony is not over, the Salute Battery executes any other commands given by the commander of troops.

Upon conclusion of the ceremony, the BC turns the battery over to the XO, who in turn transfers the battery to the CFB. The CFB then gives the command "CHIEFS OF SECTION, UNLOAD...ONE ROUND." At the preparatory command "CHIEFS OF SECTION UNLOAD," the chiefs of section do an about face. At the command of execution "ONE ROUND," they march to the breech of their weapons and in sequence unload, close the breech, and place the canister on the ground to the left of the left trail (figure 9). The CFB then commands "CHIEFS OF SECTION . . . ABOUT . . . FACE" and the chiefs of section execute an about face. The CFB gives the command "CHIEFS OF SECTION . . . FALL IN." The chiefs of section return to their positions in the line of troops, and the CFB then marches the troops from the area, ending the ceremony.

It is hoped that this information will be of use to anyone planning a salute. If there are any further questions, feel free to contact the 2d Battalion, 2d Field Artillery, Fort Sill, OK 73503 (AUTOVON 639-6600/3910). 

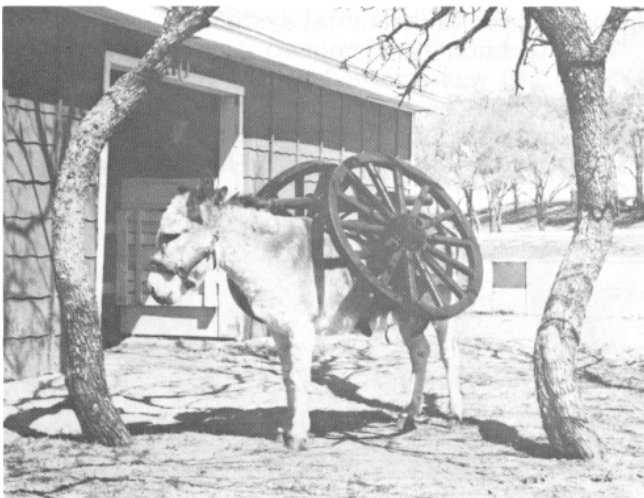

After nearly 11 years of faithful service, Big Deuce III, mascot to the 2d Battalion, 2d Field Artillery, was laid to rest 21 December 1981.



Big Deuce IV, the new mascot of the 2d Battalion, 2d Field Artillery, is shown with PVT Carmel Bradley, his new handler. (Photo by SP5 Diana Valdez)

With Our Comrades in Arms

NEWS OF OTHER BRANCHES AND SERVICES

New antitank missile

Hughes Aircraft Company is developing a new antitank missile system for the infantry that will have day/night operating capability and once fired will guide itself to the target.

Called Tank Breaker, the new missile system, consisting of the missile and launcher, will be a one-man portable weapon. This would be the first weapon system to use a focal plane array, an advanced infrared imaging sensor that offers significant reductions in size, cost, and complexity for tactical missile applications.

The focal plane array seeker will allow the gunner to acquire and lock onto a target and fire a missile in daylight or darkness and in fair or adverse weather.

Once the seeker is locked on the target and the missile is launched, the gunner will be able to seek safety immediately or to engage other targets, relying on the missile's "fire-and-forget" performance to guide the missile autonomously to the target. This is a significant advance over current infantry antitank systems which require the gunner to remain exposed to retaliatory enemy fire while a missile is being guided to the target.

"The key words that describe this missile system are 'operator survivability,'" said the manager of Hughes' Tank Breaker program. "This will be a simple missile to operate. The gunner will simply pick up the launcher, aim it, pull the trigger and forget it."

The Hughes missile will be four inches in diameter and 43 inches long. The complete system will weigh less than 35 pounds.

The missile's shaped-charge warhead will be capable of destroying the newest enemy armor, helicopters, low-performance airplanes, and field fortifications. Also, the guidance system will allow the gunner to choose whether to fly the missile along a line-of-sight trajectory or on one that will make a top-hit against the more vulnerable portions of a tank.

The missile will be packaged in a throwaway launcher. The reusable sighting and control assembly will be mated with the missile launcher prior to firing and then removed by the gunner after launch. No field testing or direct support maintenance will be required for battlefield employment.

Tank Breaker missile wind tunnel model.

Hypervelocity missile

The Air Force recently awarded Lockheed Missiles and Space Company one of two contracts to demonstrate technology for a hypervelocity missile (HVM)—a weapon lethal to any tank likely to be fielded during the next 20 years.

The concept is innovative in that, for the first time, multiple tactical missiles will be launched and laser-guided simultaneously to independent targets, through smoke, dust, or haze.

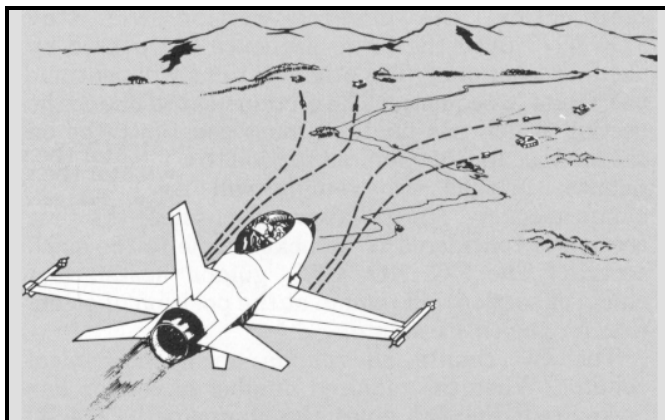

An F-16 aircraft launches four hypervelocity missiles which are laser-guided and independently targeted.

Up to 40 HVMs will be mounted in two carriers aboard tactical aircraft such as A-10s or F-16s. Each missile will be approximately 80 inches long, 3.52 inches in diameter, and less than 50 pounds in weight.

"Hypervelocity" lies between Mach 3 and Mach 5, or up to about 5,000 feet per second (3,400 mph). At Mach 5, Lockheed's HVM drives its solid metal warhead through the toughest armor to destroy one or more of the tanks' vital systems.

The technology demonstration contract for \$13,976,240 was awarded by the Air Force Armament Division at Eglin Air Force Base, FL. The HVM program manager for Lockheed said 25 missiles will be built for ground-launch demonstrations.

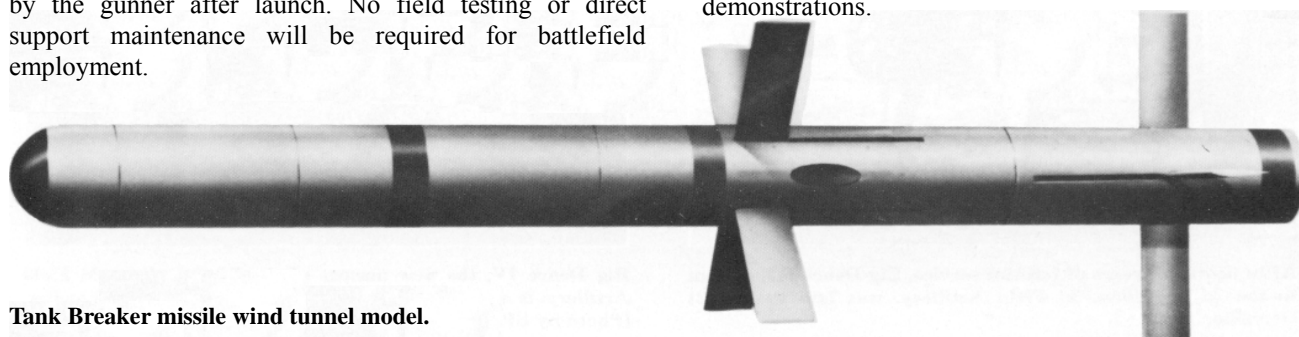

Field Artillery Journal

Antarctic observatory

A remote, automatic observatory—virtually an earth-based satellite that will be deployed on the vast ice fields of Antarctica—is now being developed by scientists at the Palo Alto Laboratories of the Lockheed Missiles and Space Company.

The work is being done under contract to the National Science Foundation.

Operating unattended for a year in temperatures below —100 degrees Fahrenheit, this automatic geophysical observatory (AGO) will continually observe the earth's restless magnetosphere—that complex system of interacting magnetic and electric fields which extends for thousands of miles into space.

The AGO is being developed as a prototype of what eventually could be a group of three such stations, sited 300 miles apart on the south polar ice cap, to make coordinated observations for a full year.

These stations would collect and store large quantities of data as they observe auroral activity in regions which remain in darkness during the austral winter. From these observations, scientists will be able to achieve a better understanding of the powerful coupling processes that link the solar wind, the magnetosphere, and the ionosphere.

A clearer understanding of these magneto-ionospheric influences could lead to prediction of disruption to radio communications, damaging voltage surges on electrical transmission lines and telephone networks, harmful high-voltage charging of orbital communications satellites, and possible other terrestrial effects.

But why place these geophysical stations in this kind of climate? Dr. S. B. Mende, Lockheed's principal investigator, explains: "The best place to observe the dynamics of the upper atmosphere is near the earth's magnetic poles. Here you find the auroral zones, which are the boundary of the open magnetic field lines of the polar cap. On the sunward side of this region is the cusp, where we see a lot of action as solar particles are injected into the magnetosphere."

Why the south pole instead of the north? Says Mende: "We want our observatory to measure this activity in the region where it is highest, but we also want the optical instruments to observe against a completely dark sky. Because the magnetic and geographic south poles are more widely separated than their north pole counterparts, more of the southern auroral region lies in the earth's shadow during the Antarctic winter. As a result, our instruments can look into dark skies 24 hours a day, for months at a time. This gives us a front-row seat for the whole performance."

Also at the south pole site, satellites which pass over the station on each orbit could provide coordinated observations. Another advantage is that the antarctic land mass already has several manned stations from which personnel and equipment can be deployed.

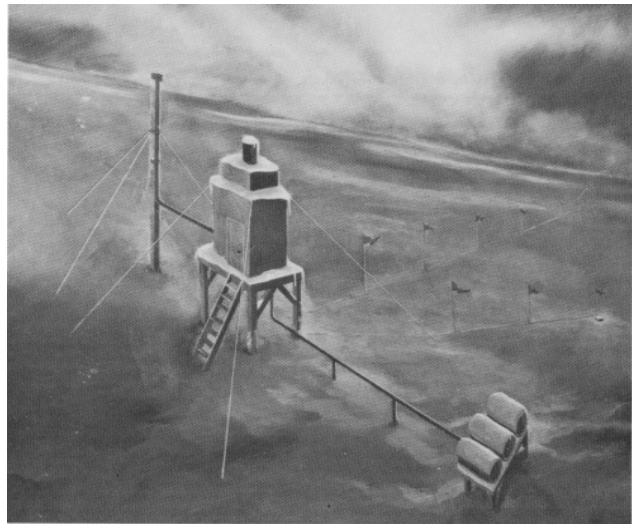

Displayed is an artist's concept of a remote observatory that will operate unattended for a year in temperatures as low as—100 degrees Fahrenheit.

But because Antarctica (the coldest place on earth) has long, harsh winters, it is virtually impossible to man, over a full year, remotely sited observatories without building expensive installations. Lockheed therefore must design a station using off-the-shelf hardware and common materials that will operate reliably and automatically, observing and recording auroral events continuously for a year.

The scientific community in past years has been aware of the advantages of automatic geophysical observatories and there have been previous attempts at operating observatories in the Antarctica.

But none of these could satisfy two basic requirements:

- A reliable source of power and heat.
- Adequate data storage and retrieval.

Lockheed engineers propose a power supply using a thermo-electric converter that will be fueled with propane and provide 50 watts of electrical power and a kilowatt of heat continuously.

Instrumentation will consist of magnetometers, photometers, riometers, as well as a very low frequency receiver. The data storage system will use a unique, large volume tape recording technique that will enable an entire year of data to be stored on one tape. The system incorporates a data multiplexer developed by the University of Maryland which is also providing one of the riometers to be used to measure radio absorption in the ionosphere.

Electric power and heat will be automatically monitored and controlled by a microcomputer so that varying load demands are met and temperatures acceptable to all equipment are continuously maintained.

The automatic geophysical observatory will undergo shakedown testing early this year and subsequently will be shipped to the Antarctic.

After one year of observing and recording data, the prototype station will be revisited and data tapes removed for analysis by scientists at Lockheed and the University of Maryland.

AFARV to improve Army combat effectiveness

A joint effort involving the US Army Tank-Automotive Command (TACOM) and FMC Corporation has led to the development of an armored ammunition carrier which can travel inside forward combat areas and serve as a rearm vehicle for combat vehicles. Currently, the Army does not have a carrier specifically designed for this purpose; so it has to rely on 2½-, 5-, and 10-ton trucks which afford no armor protection for the crew and ammunition and are unable to operate safely in forward areas. Thus, if a combat vehicle requires more ammunition, it must leave its battle position and move to the rear of the combat area for resupply.

The new ammunition carrier, called the Armored Forward Area Rearm Vehicle (AFARV), is designed to fill the gap between the ammunition transfer point and the battle position. The AFARV will pick up ammunition from the transfer point, move into the forward area, and resupply vehicles in close proximity to their battle positions.

The AFARV, which has a carrying capacity of 12,000 pounds, consists of an armor shell mounted on an XM993 Fighting Vehicle System (FVS) carrier chassis.

This vehicle features an ammunition-handling system comprised of a front-mounted, 2,500-pound-capacity crane and a conveyor for feeding ammunition into the combat vehicle.

In operation, the crane will pick up pallets of ammunition at the transfer point and load them through any of four cargo doors onto either a front or rear roller floor inside the vehicle. The two-man AFARV crew, who will occupy space between the roller floors, will secure the pallets.

At the battle position, the AFARV will pull alongside the vehicle being rearmed, and the crew will extend the conveyor out of the AFARV and attach it to the combat vehicle's loader's hatch. A crew member will then lift individual rounds from the pallets and place them on the conveyor (which is manually operated) and push them up to the loader's hatch with a ramrod.

A manual conveyor was chosen over an automatic version because of its simplicity and because the rate at which ammunition can be received and stowed aboard combat vehicles can be maintained more easily.

Though this procedure for rearming combat



The AFARV compared to an M60 tank.

vehicles will be a dramatic improvement over the current method, efforts are now under way to improve packaging of ammunition to make rearming even more efficient.

Currently, tank rounds are packaged in fiber containers. Two of these containers are packed in a wooden box, which is then secured to a pallet along with 14 other boxes.

The only way to unpack the rounds is to break the pallet open, pull out a box, break the box open at the top, pull out the fiber container, remove the tape that holds the end cap on the container, and finally pull out the round. This is a very time-consuming and labor-intensive procedure and results in large piles of debris.

To resolve this problem, the Armor and Infantry Communities are working to develop a new pallet that would open on one end and allow an AFARV crew to remove each round separately without having to break the pallet open. The ammunition could then remain in the pallets until it would actually be needed, thereby eliminating the time-consuming job of securing individual rounds in storage racks.

Many of the AFARV components are the same as those used by the entire FVS family, which will simplify stockage and storage of spare parts. Current requirements call for eight AFARVs to support a mechanized infantry battalion, eight to support a cavalry squadron, and seven to rearm a tank battalion.

If all goes well in the upcoming tests, the Army expects to buy a total of 700 AFARVs which may be fielded as early as 1986. (George Taylor)

New truck expands tactical fleet mobility

The Army's new 4x4 commercial utility cargo vehicle (CUCV) family will result in an expanded mobility capability of the tactical fleet and help to ease a current truck shortage.

Planned for introduction late this year, the CUCVs will replace about 20 percent of the current M151 ¼-ton trucks and all M880-series 1¼-ton commercial trucks. They will include a ¾-ton utility truck and a 1¼-ton vehicle that will be available either as a cargo truck or an ambulance.

The CUCVs will have commonality of major components and will feature diesel engines, automatic transmissions, and power steering. Additionally, they will have a payload capacity ranging from 1,200 to 2,900 pounds and a cruising range of 250 miles. Moreover, various kits will make them suitable for specific military applications.

"The CUCV will fill a growing need for a modern tactical standard-mobility commercial fleet for use in combat support and combat service support roles," explained LTC Lawrence W. Day, Weapon Systems Manager for the CUCV in the US Army Tank-Automotive Command's (TACOM) Research and Development Center. "They will be operating in areas where the environment is not severe and a more expensive high-mobility vehicle is not required."

The CUCV program began in July 1980 when Congress directed the Army to buy commercial trucks to replace many of the current M880 vehicles and those ¼-ton trucks operating in areas where high-mobility is not required.

On 27 April 1981, TACOM authorized the purchase of 26 candidate commercial trucks for technical feasibility testing to determine a commercial truck's adequacy to meet the Army's needs.

These vehicles, consisting of a variety of 1981 utility and cargo trucks built by the four major US auto companies, underwent 10,000 miles of tests at Aberdeen Proving Ground last summer.

All 26 trucks were equipped with gasoline engines, since none of the domestic auto manufacturers offered a diesel engine specifically designed for light- and medium-duty application in the 1981 model year. However, General Motors Corporation (GMC) has introduced a new 6.2-liter diesel in its 1982 truck models, and Ford, Chrysler, and American Motors are expected to have diesels in 1983.

So, to evaluate the use of diesel power in the CUCV, TACOM recently purchased two 1982 GMC vehicles equipped with the new power plant, and these are undergoing the same 10,000-mile test. Also, a 6.2-liter diesel is being tested at TACOM.

Following testing and a successful review, TACOM will initiate competitive procurement actions, with a multiyear production contract award projected for August, this year.

"The Army currently needs 110,000 ¼-ton trucks," Day said, "but has only about 58,000 in the inventory. Nearly half of these are nearing the end of their expected life of 15 years."

"A similar situation exists in the 1¼-ton category," he continued. "Our M880 trucks, which were bought during 1976 and 1977, are only two to three years away from the end of their expected service life of seven years."

"Procurement of the CUCVs will help to ease the current shortage and will allow the Army to phase out those vehicles which have served their expected life."

"In addition to filling its own vehicle requirements, Day said the Army will also be buying CUCVs for the US Marine Corps and Air Force. (George Taylor, TACOM)

German MOUT facility

"Support!" as the young sergeant yelled the command, the fire team opened-up on the building, riddling its doors and windows with automatic weapons fire. At that moment, a three-man team bolted from their nearby cover and made for a spot under the second-story window they had chosen to enter.

The first man in position took the grappling hook he was carrying and swung it in a wide arc into the window, pulling on the knotted rope. The hook caught and the soldier was up and into the room, firing as he went. Quickly the rest of the team followed. Room to room, floor to floor, they cleared the building, throwing a grenade

through each door before they entered a new room. When the building was secure, the team moved to the roof and prepared to move on to the next one, this time entering from above.

Combat in cities — street-to-street, house-to-house fighting that leaves so many casualties and homes and work places in rubble — is a military art that our combat forces haven't had much of a chance to practice in recent times. Except for limited battles in a few of Vietnam's big cities, our army's major experience in urban combat came from the Korean War and World War II.

In order to prepare for urban combat, the 7th Infantry Division, Fort Ord, CA, has designated the 3d Battalion, 32d Infantry, as its military operations in urbanized terrain (MOUT) specialists. The battalion has trained in MOUT facilities in Fort Lewis, WA, and Camp Pendleton, CA, and has conducted leadership classes for the rest of the division, covering the skills they have learned.

The "Bulldog" battalion has been training in the MOUT training facility of the West German Army located in Hammelburg, West Germany. This combat training facility rivals any in the world for its realism in training soldiers for urban combat, according to LTC Peter Igel, the US Army Liaison to the German Infantry School. "In 1963 the German government moved all the citizens from the small town of Bonnlund, which is located three miles from here, and provided the German Army with this 1,000 year-old town for training," said Igel.

"The relocated people were given new land and homes, so they were, of course, well compensated," Igel said.

Training in Bonnlund is being conducted in phases. During the first phase, the troops practice the individual and squad skills necessary for urban combat, such as preparing defensive positions, clearing of buildings, use of grappling hooks and rope ladders, and breaching wire obstacles.

Once the soldiers have mastered these techniques, the companies of the Bulldog battalion enter phase two—platoon and company operations. During this phase the units hold mini war games in which portions of the town are defended by one unit and attacked by another.

Besides using the town of Bonnlund for training, the battalion also gained skills from another facility, the forest. The forest training area is divided into two lanes, each of which is designed to test and teach the skills so necessary for survival in the infantry.

"The forest fighting area is a complex system of underground bunkers, tunnels, and trenches surrounded by obstacles and dense tactical wire," LTC George A. Fisher, 3d Battalion, 32d Infantry Commander said. "The course teaches soldiers how to maneuver against and breach such a defensive position in the forest. The approaches to the positions are laced with sniper pillboxes to emphasize good security procedures and sound movement techniques," he added. (Martin Shupe)

SPAS

The Training Manager's New Tool

by MAJ (Ret) Albert B. Cheatham

With the fielding of new systems employing new technologies in electronics and many other areas, the Army has encountered new and challenging problems in training crews to operate and maintain the new systems. The earlier generations of missile and rocket systems required personnel with an exceptionally high technical aptitude, but the newer and more complex systems require more knowledge and skill; thus more hours of training are needed at our service schools to develop these skills which, in turn, requires more highly trained instructors.

When the military draft was abolished, the problem was compounded—fewer personnel with the requisite technical aptitudes were enlisting; thus, training became more difficult. Also, the total hours of formal training in our service schools were reduced, and soldiers graduated with less developed skills, thus increasing the training requirements in the field. Although this aspect was undesirable because unit noncommissioned officers were already carrying a heavy training load, the concept offered many benefits. To relieve the training burden, US Army Training and Doctrine Command (TRADOC) initiated a program to provide tested and validated exportable training packets to the field.

Training packets

The first of the exportable packets was the Training Extension Course (TEC) system, an Army-wide program for providing multimedia instructional materials to Army units (Active, Reserve, and NG).

The second packet was the Skill Performance Aids (SPAS) program, a three-part plan for improving the ability of personnel to operate and maintain equipment through better technical manuals (TMs) and extension training materials (ETMs).

•The first phase of the SPAS program is a front-end analysis (FEA), which determines operator and

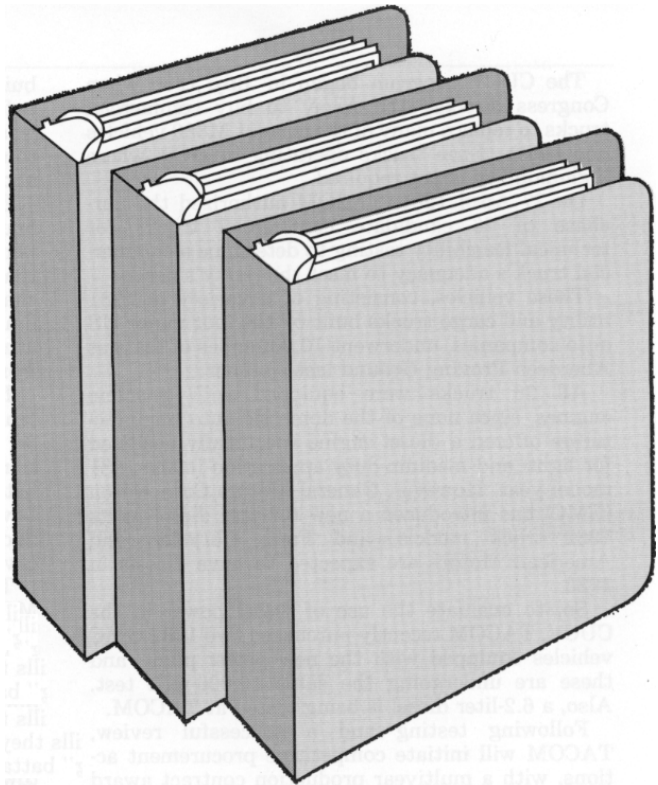

maintenance tasks, assigns each task to a specific maintenance level, and provides the initial identification of specific tasks that might be included in the ETM. The FEA also identifies the common and special tools required and the step-by-step procedures for the task.

•The second segment consists of the development of highly proceduralized, simply worded, and clearly illustrated technical manuals, which fully describe how to accomplish operational and maintenance tasks.

•The third and final part of the program consists of the extension training materials with the TM to guide, supplement, and evaluate on-the-job training. The ETMs are designed solely to assist the supervisor in training the soldier to operate and maintain specific equipment or systems, with a minimum of additional training preparation by the supervisor.

The proliferation of the complex weapon systems brought about an urgent need to communicate precise operational and maintenance instructions to a generally nontechnical audience. With "effective communications" as the key, the Army took a bold step forward and created the "new-look" manual—the backbone of the SPAS training concept. The new-look manual provides only the necessary information in the simplest form possible with definitive illustrations aimed at specific tasks. Each step within a procedure is treated as a stand-alone unit so that instructions on even the most complex equipment can be presented in an easily understood form.

A primary step in preparing a new-look manual is to identify the intended target audience and then organize jobs and tasks into specific modules of information. For example, when several subsystems have to be removed to gain access to the unit in question, the removal/installation procedure for these subsystems should precede those of the unit in question.

The TM will include a troubleshooting chapter, organized either by subsystem fault isolation or by rate of occurrence of malfunctions; that is, the most often encountered malfunctions are presented first, and the least common symptoms last. In this way, the user progresses from more common to less common malfunctions, until he isolates the fault to a user-repairable/replaceable assembly. The specifications governing the development of the SPAS technical manual call for stringent validation and verification of TM content to insure accurate coverage compatible with the authorized maintenance concept and the designated target audience. The ultimate goal is a manual that is accurate, interesting, appealing, and, above all, informative. The SPAS technical manual should provide front-cover indexing of areas most often referred to, and specific indexing preceding chapters and sections so that the user can find the information he needs quickly and easily.

Extension training materials

One product of the front-end analysis is a total list of tasks which are ultimately grouped into the appropriate level TM. Some tasks, however, cannot be taught by use of a technical manual only. Examples are tasks that must be performed quickly without reference to the TM and those which must be performed to precise standards. Some of these tasks are eventually selected for supervised on-the-job training and are prime candidates for inclusion in the ETM.

The SPAS extension training materials do not address the broad array of tasks for an assigned MOS as do TEC lessons, nor do they usually address employment tactics, doctrine, or common soldier tasks, such as map reading and first aid. They are written for a specific level of operation or maintenance and for a specific MOS and are designed solely to assist the soldier and trainer in operating and maintaining specific equipment or systems.

In the SPAS concept, an ETM package is provided for each equipment MOS for use with the associated TM. For example, one ETM package is provided for the equipment operator to use with the —10 (operator/crew) TM, one or more ETM packages corresponding to MOS/job positions for organizational maintenance is provided for use with the —20 TM, and one or more ETM packages covering the MOS(s) for direct support/general support maintenance is provided for use with the corresponding —34 TM.

An ETM package will contain guides for the manager and the student. The manager's guide, designed for use by the supervisor to administer on-the-job training, will

include an index of lessons, instructions for administering each lesson, and a course map. Also included are pre-test and post-test instructions, record-keeping materials, simulation and fault installation instructions, and order/reorder instructions.

The student's guide will contain instructions on how to use the guide and will list lessons included in the package. These lessons, attached to the guide, will be either audio-visual (AV), printed texts, or audio only. (The preferred medium is the printed text.) The same AV and audio hardware is used in both the ETM and TEC lessons. Each ETM lesson will give the following information, in the order listed:

- Lesson number and title.
- Soldier's Manual task numbers.
- Lesson objective (task, conditions, and standards).
- References.
- Tasks covered in the lesson.
- Tools, test equipment, and materials required.
- Prerequisites.
- Pretraining activities.
- Training activities.
- Post-test instructions.
- Comments.

The ETM for new equipment is developed by the contractor, concurrent with the development of the equipment. This procedure presents some problems, but it also has advantages; for example, when operational or maintenance tasks appear to be too complex or too difficult, the contractor can make the necessary design or operation changes during the testing period. At every step of the ETM development, it is subjected to review by training specialists from the appropriate Army service schools. Before it is accepted by the Army, it is validated by small group trials and verified by large group trials. Test personnel for both validation and verification trials are taken from the target audience. Often, its use is further tested in training player personnel for Force Development Testing and Experimentation (FDTE) and Operational Test III (OTIII).

The ETM may be developed for use with existing Army equipment or with new equipment. In either case, ETM lessons have been tested and proved to be effective and should be used with the new-look TM to the maximum extent possible.

The goal is to issue the entire SPAS package along with equipment to the receiving unit. A part of the family of TEC materials, SPAS ETMs are managed administratively through the TEC System. When they are available for your equipment, you are encouraged to use them. 

MAJ (Ret) Albert B. Cheatham is a training specialist in the Training Development Division, Directorate of Course Development and Training, USAFAS.

FA Test and Development

DESIGN • DEVELOPMENT • TESTING • EVALUATION

TACFIRE Version III tape

A new tape version for TACFIRE units will soon be available to the field. The new tape—Version III—was tested in late 1981 by the US Army Field Artillery Board. As with other versions, the new TACFIRE tape has enhancements for upgrading the weapon systems available for selection of specific missions as well as new munitions. Specific enhancements are too lengthy for listing in the *Journal* but a few of the more interesting items are:

- Field artillery scatterable mines (antiarmor and antipersonnel).
- Copperhead.
- 155-mm rocket-assisted projectiles.
- M198 howitzer.
- Battery Computer System interoperability.

Firefinder

The Firefinder Force Development Test and Experiment (FDTE) was conducted at Fort Hood, TX, in December 1981. This test focused on new concepts available for counterfire operations with the introduction of the Firefinder radar system. The results of the FDTE will be closely examined, and new operating doctrine will be published in the next edition of FM 6-20-2.

Army to "light-up" moving targets with precise laser device

The first production model of the Ground/Vehicular Laser Locator Designator (G/VLLD), a combination laser rangefinder and precision target designator which can pinpoint rapidly moving distant targets, has been delivered to the US Army by Hughes Aircraft Company.

Designed for use by Army forward observers, it can be mounted on armored vehicles or used with a ground tripod to designate targets for laser-guided and conventional weapons.

During recent G/VLLD reliability tests, the device achieved its goal of 100 hours mean time between failure. Four G/VLLDs were operated for the equivalent total of more than 41,000 designation missions and more than 17,000 ranging/location missions, for a period exceeding 200 hours.

Engineering development models of the G/VLLD, used under rugged conditions and in extreme heat, successfully designated targets during the recent operational tests of the Army's Hellfire laser-guided missile. The G/VLLD is designed to endure extreme shock and rough field handling and still maintain its precise optical alignment.

Under initial production contracts, Hughes' Electro-Optical and Data Systems Group, El Segundo, CA, will manufacture the first 295 G/VLLDs for the US Army Missile Command.

Four engineering development models of the G/VLLD have been mounted on M113 fire support team (FIST) vehicles, which are currently undergoing development tests at the Army's Yuma Proving Grounds, AZ.

These tests include evaluation of the FIST system's reliability and performance.

Six of the early production G/VLLDs will be used to support operational tests of the FIST system next year.

The G/VLLD passed the Army's extensive field test and evaluation, to include successful operation under arctic conditions. Engineering development models of the device have supported laser-guided weapon test programs since late 1977.

In operation, the G/VLLD directs an invisible beam of coded laser pulses at any target the operator can see. These pulses are reflected from the target and can easily be detected by laser sensors in aircraft or laser-homing missiles, bombs, or projectiles.

The wavelength and periodic pulsation of the laser beam allows the laser-homing weapons and aircraft sensors to differentiate the correct target from others designated by different G/VLLD units in the same battlefield area.

The device also can be used to pinpoint the range and bearing of moving targets for conventional artillery.

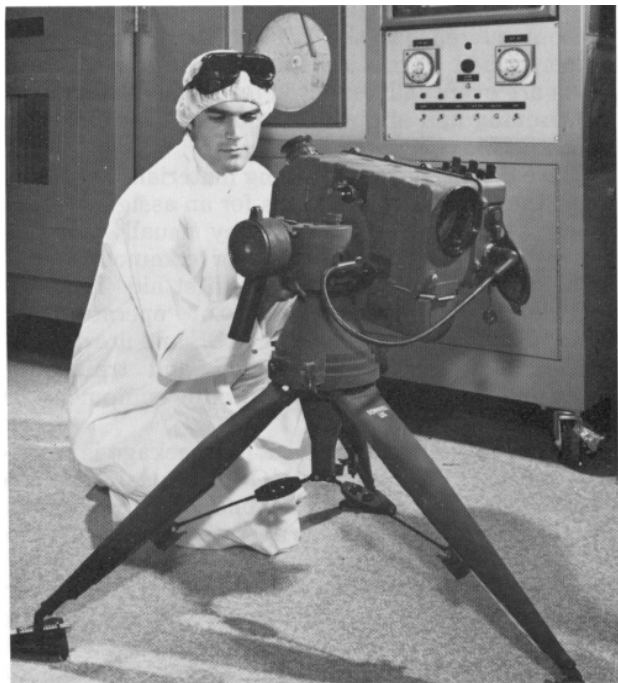

The Ground/Vehicular Laser Locator Designator, a combination laser rangefinder and precision target designator, can be mounted on armored vehicles or used with a ground tripod to designate targets for laser-guided and conventional weapons.

Lightweight tow bars

The US Army Tank-Automotive Command (TACOM) is testing a new lightweight tow bar to replace the heavy, bulky, and cumbersome medium-duty tow bar used to recover all combat vehicles and tactical trucks in the 10-ton category and over. The heavy tow bar (approximately 340 pounds), which is carried on the M578 and M88A1 recovery vehicles, is difficult to remove from the recovery vehicle and hard to hook up.

In addition to being heavy, the legs are excessively long, and the clevises and end fittings have close tolerances with the tow lugs on the towed vehicle. If a leg is bent or twisted, the end fittings cannot be aligned.

In September 1979, TACOM began a program to design a new lightweight tow bar that would be as strong, efficient, and durable as the old one but easier to handle.

Two design approaches were investigated and, in September 1979, a contract was awarded to EXXON Corporation for development of a medium-duty tow bar (figure 1) weighing about 125 pounds (light enough for two men to handle) and having the same performance characteristics as the current all-metal item. Space age plastics and a composite of materials—kevlar, epoxy, graphite, special adhesives, and steel were used to offer high-directional strength-to-weight ratio, increased stiffness, and low machining costs. The lightweight tow bar was the same size and could do the same job as the 340-pound, all-steel tow bar.

The composite tow bar uses standard, but redesigned, metal end clevises and towing lunette. The legs are made of strong composite materials. Kevlar is wrapped around a steel mandrel and cured. When the mandrel is removed, a hollow tube remains. The outer shell, or sheath, is the protective tube for the high-strength inner material.

The inside tube is made of graphite/epoxy compound. This material is inserted into the outer sheath, expanded against the shell by an inflatable innertube, and cured. After the innertube is removed, the composite tube ends are ground to size. Then the clevis ends and the lunette are glued in place with the adhesives.

EXXON's version of the composite prototype tow bar was delivered to TACOM in December of 1980 and is currently being field tested.

Simultaneously, TACOM's Engineering Design Division of the Engineering Support Directorate began work on designing a lightweight steel tow bar (figure 2) with improved geometry and no detachable end fittings.

The end fittings on the old tow bar are not only heavy but are also expensive and impose bending stresses on the tow bar legs. Also, the geometry is such that the legs will not accommodate different width tow lugs found on various combat vehicles with the same efficiency. On one vehicle, the legs will be in tension and compression while on another the geometry will be such that some of the legs will bend.

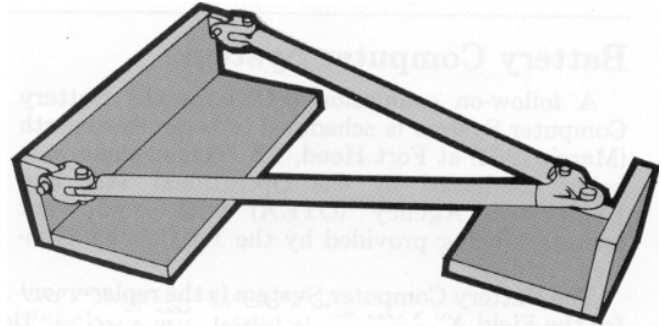

Figure 1. Composite lightweight tow bar.

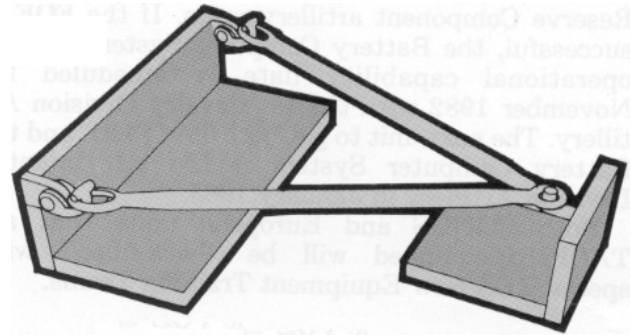

Figure 2. Steel lightweight tow bar.

The new design incorporates a set of two separate tow bars exactly alike. The two-piece steel tow bar has shorter legs, about 72 inches compared to the 83½ inches for the current bar.

Now, when the towing vehicle makes a sharp turn, the track will make contact with the hull of the towed vehicle rather than the tow bar leg.

The lunette, which is a doughnut-shaped connection, is a NATO requirement. It is heavy and bulky. Two lunettes will not fit in one pintle—unless the pintle is changed. The only viable solution here was to actually split the lunette in half, perpendicular to its axis. This makes a bagel-shaped ring with sufficient strength to tow a 50- to 60-ton load.

The lightweight steel tow bar consists of two identical bars, each weighing only 60 pounds. This is a 65 percent weight reduction. Stockage and storage of repair parts will be reduced from five to one—the tow bar itself.

The original design was completed in early 1980 and the stress analysis testing was completed in May of that year. Two tow bar sets (four bars) were completed in March 1981 and sent, along with the composite bars, to Aberdeen Proving Ground for field testing.

If both lightweight tow bars test successfully, the Army has a choice between the two. If only one tow bar version comes out successful, the Army still has a lightweight tow bar.

Also, it may be possible to combine the two technologies to reduce the material weight even further. By combining the steel tow bar's end fittings, the concept of two 1-piece bars, and the tube material of the composite tow bar, a 2-piece tow bar weighing only 48-pounds (24 pounds per bar) could be a reality. (Roger R. Smith and Jim Boblenz, *Army RD&A* magazine)

Battery Computer System

A follow-on evaluation (FOE) for the Battery Computer System is scheduled to begin this month (March 1982) at Fort Hood, TX. This evaluation is being conducted by the Operational Test and Evaluation Agency (OTEA) with equipment operators being provided by the 1st Cavalry Division Artillery.

The Battery Computer System is the replacement for the Field Artillery Digital Automatic Computer (FADAC) at battery level for both Active and Reserve Component artillery units. If the FOE is successful, the Battery Computer System's initial operational capability date is scheduled for November 1982 with the 1st Cavalry Division Artillery. The next unit to get both TACFIRE and the Battery Computer System is the 9th Infantry Division Artillery in January 1983.

Both CONUS and European units that are TACFIRE-equipped will be "back-filled" with special BCS New Equipment Training Teams.

Terminal guidance warhead for MLRS

The Army Missile Command (MICOM) recently awarded contracts to five multinational contractor teams based on their proposals for the cooperative development of a terminal guidance warhead for the Redstone-developed Multiple Launch Rocket System (MLRS).

Approximately \$750,000 was awarded to industrial teams from the United States, Great Britain, France, and West Germany. The six-month, Concept/International Program Definition contracts call for the consortia to propose warhead technical approaches and ideas on how the program might be managed quadrilaterally.

From these studies, the four countries will select the best technical approaches, develop system specifications, and prepare requests for proposals for the next stage of development.

Pershing II

The Army Missile Command (MICOM) has awarded an 18-month \$87 million contract to Martin Marietta Aerospace at Orlando, FL, for initial production of critical, long-lead-time items for Pershing II.

Pershing II accuracy is achieved by a terminal guidance technique called radar area correlation. As the missile reentry vehicle descends in the target area, the guidance unit compares radar images with stored images and makes course adjustments until the views coincide, producing almost pinpoint accuracy.

Pershing II, scheduled for deployment in the mid-1980s, will replace Pershing IA, currently operational in Europe with US Army and Federal Republic of Germany troops.

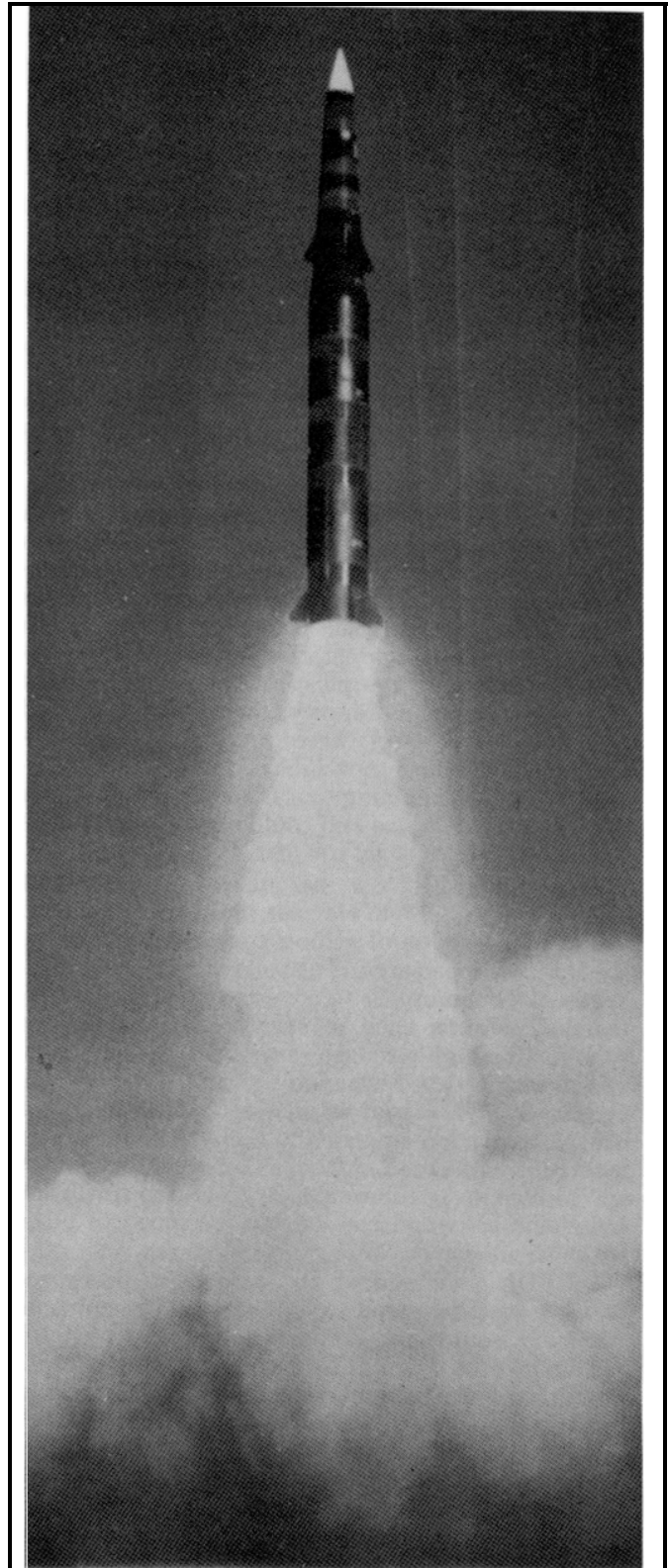

The reentry vehicle of Pershing II is marked by control fins that enable it to maneuver in response to signals from the radar guidance system and the ceramic radome on the nose.

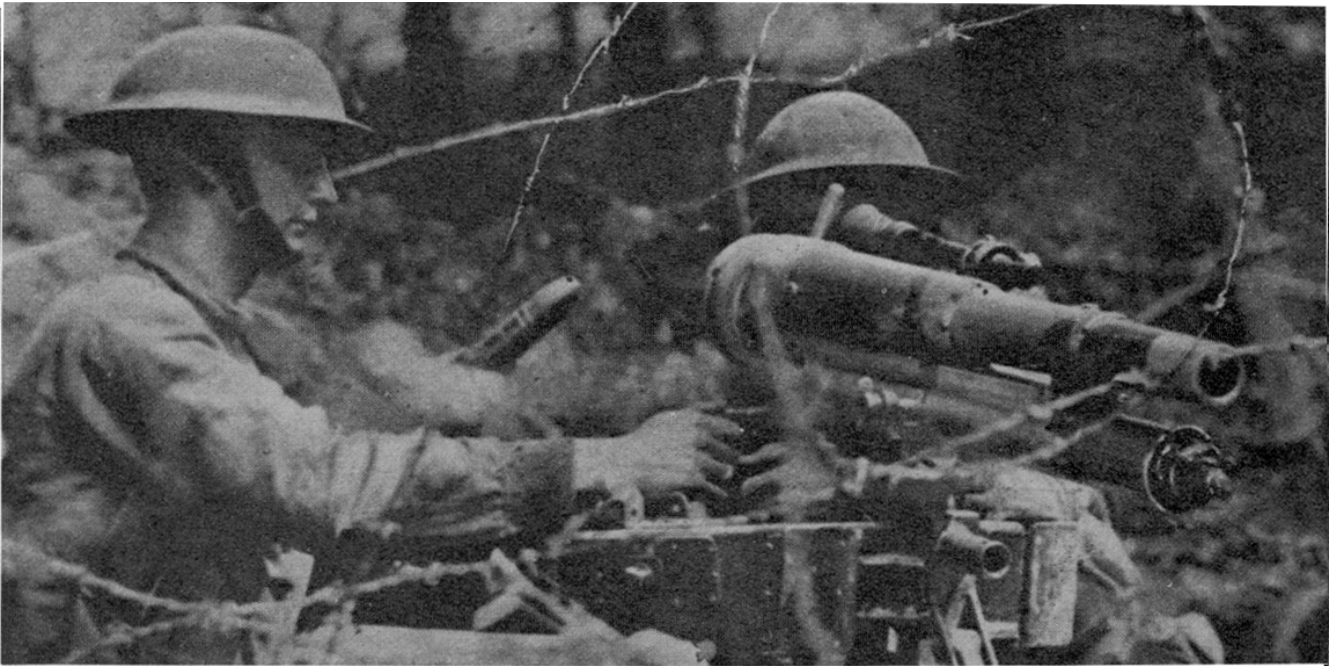

The Little Old 37

by LTC Ronald E. Olson

The country along the Paris Road was made up of rolling farmlands interspersed with clumps of trees and small woods. It was beautiful that June day in 1918 and quite untouched by war. The crops were green and the forests heavy with foliage. It was a virginal battlefield which the Germans were approaching from the east and the Americans from the west. In a week the trees would be bare skeletons, the villages tumbled in ruins, and the very earth tortured out of shape.

The smallest weapon of all the field guns used by the American Expeditionary Forces in World War I was the 37-millimeter gun, designed and built by the French. This so-called infantry field gun was carried by foot soldiers as they moved up to the "zone of the advance."

This weapon was used chiefly in World War I to break up German concrete pill boxes, machinegun nests, and other strongpoints of enemy resistance. In action, it was manned by infantrymen, rather than artillerymen, with a usual crew of eight (this number varied from eight down to two or three). The squad leader was the gunner, while the other ranking member of the squad was the assistant gunner whose duty was to load the weapon (he was

likewise trained to fire the weapon). The remaining members of the squad were ammunition bearers.

The 37-millimeter weapon as it existed during the United States' participation in the Great War (1917-19) consisted of the gun, with a split trail, mounted on axle and wheels. A trailer attachment on the ammunition cart allowed it to be pulled by one horse or mule. The ammunition cart itself was merely a redesigned machinegun ammunition vehicle, modified carriage M1916A1. The wheels and axle could easily be removed and left a short distance to the rear of the firing position.

The gun rested on its front leg which was dropped to form a tripod with the two legs of the split trail. The gun proper could be removed from the trail and the sponge staff could be inserted into the barrel through the opened breech. Two men could then bear this part of the weapon in advancing action, while two other men were able to carry the trail when its legs were locked together. The whole outfit weighed only 340 pounds and was 6 feet long. The other members of the gun crew would bring along the boxes of ammunition.

The ammunition cart held 14 ammunition boxes, each containing 16 rounds. A spare-parts case, strapped to the trail, contained a miscellaneous assortment of such parts that could be readily handled in the field. A tool kit in a canvas roll was also transported on the cart, along with entrenching tools and other accessories.

Equipped with a telescopic sight for direct fire and a quadrant, or collimating sight, for indirect fire, great accuracy was obtained by this small piece of artillery.

The length of the gun proper was 20 calibers, meaning that it was 20 times 37 millimeters in length, or 29.6 inches. The diameter of the bore was 1.45669 inches, and the length of the recoil was 8 inches.

At first, two types of ammunition were provided for this gun; however, the low-explosive type proved ineffective and was later abandoned in favor of the high explosive (HE) projectile weighing 1¼ pounds. The 37-millimeter gun was thus nicknamed by American Doughboys as the "one pounder" even though it weighed one-fourth pound more.

The HE projectile was loaded with 240 grains of TNT and detonated by a base percussion fuze. The gun also fired a shrapnel canister of 32 lead balls which, at 75 yards, would form a cone-shaped pattern that was most effective against advancing personnel. One other shell available had a delayed fuze that would pierce seven-tenths inches of armor plate at 2,500 yards. Maximum range of the gun was about two miles and at 1,000 yards, it was more accurate than a rifle.

The "one pounder" proved to be effective against enemy machinegun nests, whose withering fire raked the infantrymen from distances that rifle fire could not effectively reach. Only three to six shots from this gun were necessary to silence an enemy machinegun emplacement or other strongly held position. The rate of fire of the 37-millimeter gun was 28 to 35 rounds per minute with a muzzle velocity of 1,276 feet per second. It was equipped with a breech mechanism similar to that of the French "75" which accounts for the rapidity of fire. The weapon was cocked by hand for the first round, and then the recoil of the barrel cocked the gun after each shot.

The original 37-millimeter gun model was designed at the Puteaux Arsenal in France in 1885, but it was not until after 1914 that the weapon was produced in quantities.

In the United States, production of the 37-millimeter guns began in October of 1917 as Model 1916. While our shops were tooling up for the effort, 620 of these weapons were purchased from the French and turned over to the American Expeditionary Forces. To allow greater speed in manufacture, our ordnance experts took the gun apart and divided it into three groups—barrel, breech, and recoil—which were produced by different manufacturers. In addition to these, the axle and wheels and the trail had to be manufactured.

The gun parts were turned out by the following manufacturing companies:

Barrel group.....	Poole Engineering & Machine Co. Baltimore, MD. Subcontractor: Maryland Pressed Steel Co. Hagerstown, MD.
Breech group.....	Krasberg Manufacturing Co. Chicago, IL.
Recoil group	C.H. Cowdrey Machine Works Fitchburg, MA.
Axles and wheels	International Harvester Co. Chicago, IL.
Trails.....	Universal Stamping & Manufacturing Co. Chicago, IL.

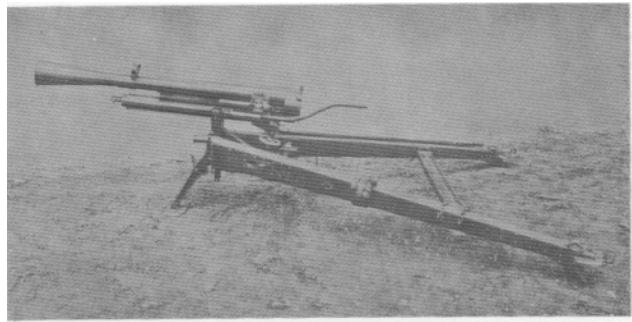

Table 1. Production statistics on the 37-millimeter gun

Guns procured from the French Government.....	620
Guns ordered manufactured in United States, October 1917.....	1,200
Increase in order, September 1918.....	1,397
Total number ordered in United States.....	2,597
Total number of guns completed prior to the armistice.....	884
Guns delivered for overseas shipment prior to the armistice	300
Guns shipped to various camps in this country	26
Guns shipped to other points in this country.....	4
On hand at Hagerstown Arsenal, proof fired.....	425
Completed and ready for proof firing.....	129

When crated for overseas shipment, the gun, along with the ammunition cart and all accessories, weighed 1,550 pounds and occupied about 15 cubic feet of space.

The various groups of this gun were shipped to the Maryland Pressed Steel Company plant at Hagerstown, MD, for assembly and then tested at a specially built proving ground, eight miles from the factory.

The first delivery of completed 37-millimeter guns from our factories was in June 1918; and, at the cessation of hostilities, manufacturers were turning out guns at the rate of 10 per day (table 1). Three 37s were issued to each infantry regiment, making one for each battalion; thus, the required equipment for a division was 12 weapons. Between June and November, 122 American-built 37-millimeter guns were shipped abroad, and more were ready to be sent over when the armistice was signed. The gun had been so successful in use abroad that our original order of 1,200 had been increased to 3,217 before the signing of the armistice, including the 620 purchased from the French.

To the enemy machinegunners and infantrymen who felt the sting of this little cannon, it was just as deadly as the heavier guns—the 75s and 155s. In any case, the lives of many American doughboys were undoubtedly saved by its presence on the battlefield.

*(The general characteristics and capabilities of the 37-mm gun as listed herein are based on information derived from the book, **Great Weapons of World War I**, by William G. Dooley.)*

LTC Ronald E. Olson is the Illinois National Guard State Historian and also historian for the 2d Battalion, 123d Field Artillery, ILARNG.

Redleg Newsletter

ITEMS OF GENERAL INTEREST

CAS³ not equivalent to CGSOC

Reserve officers will no longer receive Command and General Staff College Officer Course (CGSOC) equivalent credit for educational and promotion purposes by completing the Combined Arms and Service Staff College (CAS³) Course.

Headquarters, Department of the Army is preparing a forthcoming change to AR 135-155 which rescinds the recently established Army policy that the CAS³ be considered the full educational equivalent of the Command and General Staff College Officer Course.

The change will have limited impact upon the Reserve officer educational system. Those Reserve officers who completed CAS³ will be granted CGSOC equivalency for promotion purposes.

For most Reserve officers, completion of CGSOC is still required for promotion to O-6 and completion of 50 percent of CGSOC for promotion to O-5.

Individual Retirement Accounts

On 1 January this year, soldiers and civilian employees were able to set up Individual Retirement Accounts (IRA). The IRA is *not* part of the Army Pay System nor is it a military-related entitlement. It has no relation to regular military or civil service retirement benefits, but is a private, individual program that, for the first time, allows a wage-earner covered by an employer's retirement plan to set up a personal account to augment other retirement income.

An individual retirement account is created by a signed agreement between the wage-earner and any commercial establishment approved by the US Internal Revenue Service as an IRA trustee or custodian. Although the IRA is a personal investment program, potential participants are encouraged to "shop" as carefully for it as they would for any other tax-deferred investment plan.

Banks, insurance companies, mutual funds, investment firms, and other financial institutions are approved custodians for the IRA. Plans offered are flexible, and their features (interest rates and deposit requirements) may differ among the establishments selling the accounts.

Depending on the terms of the contract, an IRA may require monthly, quarterly, or even annual deposits — made in cash, check, or through a bank transfer. The amount deposited may vary as long as the total deposit doesn't exceed the annual limit set by law (\$2,000 for a single wage-earner; \$2,250 for a married couple when only one is a wage-earner; \$4,000 for a married couple when both are wage-earners).

An IRA is a long-term commitment; money deposited,

and the interest it earns, must be left on deposit until the investor is at least 59.5 years old. If any money is withdrawn or if the account is used as security for a loan, the withdrawn or pledged amount of the IRA becomes taxable immediately and carries a 10 percent penalty. The account may be moved from one trustee to another without tax penalty, as long as the entire account is moved.

If a soldier or civilian employee has established an IRA at his/her financial organization, one of the two authorized savings allotments may be used to make monthly IRA deposits. Allotments cannot be used when the deposit schedule is quarterly, semiannual, or annual. Most members may find that a bank transfer authorization to move money from an existing savings account to the IRA will be the better choice.

Deposits to an IRA account purchased from nonfinancial institutions such as insurance companies, mutual funds, and brokerage houses may be made by bank transfer of a specific amount from an existing savings account to the IRA at the appropriate times. Or, the employee may choose to make a direct IRA deposit in cash or by check. Investment counselors at the establishments involved are the best source of information about which program would provide the most benefit to the investor.

Finally, establishment of an IRA might result in changes to withholding tax status that make it advantageous to the depositor to re-file his/her W-4 Form to reflect the IRA withholding allowance. Since other factors must be considered, IRA investors should consult with the internal Revenue Service before making any W-4 changes.

Furlough reduced air fare

The Military Traffic Management Command has been successful in getting most major US airlines to participate in the 50 percent furlough fare program. This special air travel discount, available to active duty service personnel, provides a *reserved seat* on 19 US air carriers throughout the continental United States.

Results of a recent field survey on the use of this special fare by military personnel traveling on leave have shown that, despite considerable publicity efforts, many service members are still unaware of this important benefit. Continuation of this offer is dependent on the number of personnel who use it.

Extension training materials catalogs

In early 1981, there were thousands of separate products either in the field or in various stages of

Redleg Newsletter

development to support the Army-wide training effort. However, there was no single source of information on what these products were, how to get them, or how to use them. Thus, the US Army Training Support Center (ATSC), Fort Eustis, VA, set out to do something about it. The result was a two-pronged program designed to identify the entire range of training support materials in the field and eliminate those items which were obsolete, impractical, or duplicates of other products, while establishing a single, automated catalog system to provide trainers and training managers with a ready reference source of training materials available to support both individual (MOS) and collective (ARTEP) training.

After more than a year of effort, the ATSC project was recently completed with the publication of a series of extension training materials (ETM) catalogs which are now being automatically distributed to every unit in the Army. The 77 catalogs, published as Department of the Army Pamphlets (DA Pams) in the 350-series, are keyed to the existing ARTEP program, which means that each Army field unit will receive only the one catalog directly supporting its ARTEP. An additional catalog, published in January this year, is based on the enlisted MOS structure and is intended to support individual training requirements and those table of distribution and allowance (TDA) units not included in the ARTEP program.

The unit commander or training manager now has a practical reference tool at the unit level which provides easy-to-use information on what training support products are available, what specific skills or tasks each product supports, and simple instructions on how to order items not already on hand in the unit.

Typically, each ETM catalog devotes separate chapters to products in support of common tasks, general subjects, MOS training, and collective (ARTEP) training. Additional chapters cross-reference product availability to specific training and audiovisual support centers (TASC) worldwide and provide detailed ordering information for all products to include those not carried in the TASC system.

Simultaneously with the catalog effort, ATSC conducted a painstaking survey of the entire training product inventory, eliminating the obsolete and less than useful items while consolidating similar or duplicate items.

The training product reduction and catalog projects are not simply one-time efforts. Both functions are remaining under ATSC management and have already been incorporated into an automated system designed to maintain control over the development of training support materials while providing the means for periodic revision of the catalogs.

With the ETM catalogs now in the field, the old familiar service school catalogs and separate catalogs for such items as Training Extension Courses (TECs) have become a thing of the past. The entire range of exportable training

products is included in the new ETM catalogs, making continued publication of separate catalogs for separate products unnecessary (exceptions are the school catalogs for the Army Correspondence Course Program (ACCP) administered by the Army Institute for Professional Development (IPD), which is also an element of ATSC).

Because of the individual nature of the correspondence course program, course catalogs will continue to be published separately.

DA Pam number	Title	ARTEP
350-101-1	Aviation Company	1-127
350-101-2	Headquarters and Headquarters Detachment, Combat Aviation Group/Battalion	1-252
350-103-1	Nuclear, Biological, Chemical Units	3-87 3-266 3-267 3-500-1
350-105-1	Engineer Atomic Demolition Munition Company, Corps	5-57
350-105-2	Engineer Bridge Companies	5-64
350-105-3	Engineer Topographic Units	5-335
350-105-4	Engineer Cellular Teams	5-500
350-105-5	Engineer Equipment and Construction Support Companies	5-54 5-67
350-105-6	Engineer Combat Battalion, Heavy	5-115
350-105-7	Engineer Combat Battalion, Corps	5-35
350-105-8	Engineer Battalion, Armored/Mechanized Divisions	5-145
350-105-9	Engineer Battalion; Airborne, Air Assault and Infantry Divisions	5-25
350-106-1	Field Artillery, 105-mm, Direct Support Units	6-105
350-106-2	Field Artillery, General Support Cannon Units	6-165
350-106-3	Field Artillery Battalion, LANCE	6-595
350-106-4	Field Artillery, 155-mm, SP	6-365
350-106-5	Field Artillery Battalion, Pershing	6-615
350-106-6	Headquarters and Headquarters Battery and Target Acquisition Battery, Division Artillery	6-302 6-307
350-107-1	Infantry, Airborne, Air Assault and Ranger Battalions	7-15
350-107-2	General Support Aviation Company, Airmobile Division	7-202
350-107-3	Assault Helicopter Battalion, Air Assault Division	7-255
350-107-4	TOW Light Antitank Battalion	7-115
350-107-5	Mechanized Infantry/Tank Task Force	71-2
350-107-6	Combat Aviation Battalion, Infantry and Airborne Division and Combat Support Aviation Company, Corps	57-55
350-108-1	Division Level Health Services	8-25
350-108-2	Ground Evacuation/Air Evacuation Units	8-127
350-108-3	Clearing Company/Dispensary Detachment	8-128
350-109-1	Headquarters and Headquarters Company, Ammunition Group and Ammunition Battalion	9-22 9-38 9-48 9-520

DA Pam number	Title	ARTEP	DA Pam number	Title	ARTEP
350-109-2	Pershing and Hawk/Nike General Support Missile Maintenance Company	9-58	350-119-1	Military Police Company and Headquarters and Headquarters Company, Military Police Battalion/Brigade	19-17 19-76 19-77 19-272
350-109-3	Land Combat/Light Air Defense Missile Maintenance Company and Teams	9-550	350-119-2	Military Police Guard/Security Companies	19-97 19-247
350-110-1	Supply and Services Battalion-Type Units	10-7 29-46 29-47 29-48 29-107 29-147	350-119-3	Enemy Prisoner of War Operations	19-256
350-110-2	Supply and Transportation Battalion-Type Units	29-6 29-77 29-146 29-157	350-129-1	Maintenance Battalion; Armored, Infantry and Mechanized Divisions	29-16 29-17 29-18
350-110-3	Quartermaster Airdrop Company-Type Units	10-337 10-407 10-417	350-129-2	Maintenance Battalion, Airborne and Airmobile Division	29-56 29-58
350-110-4	Quartermaster Petroleum Units	10-202 10-206 10-207 10-226 10-227 10-560	350-129-3	Maintenance Battalion, Direct Support/General Support (Non-Divisional)	29-134 29-136 29-137 29-207 29-208 29-209 29-247 29-427
350-110-5	Graves Registration Units	10-296 10-297	350-129-4	Maintenance Company, Support Battalion	29-79 29-99 29-158 29-139
350-110-6	Division Material Management Center	29-3	350-131-1	Special Forces	31-101
350-110-7	Support Companies, General Support, Forward	29-114 29-118 29-119	350-131-2	Psychological Operations Battalion	33-500
350-110-8	Headquarters and Headquarters Company, DISCOM and Area Support Group	29-2 29-102 54-422	350-131-3	Civil Affairs Organizations	41-1
350-110-9	Heavy Material Supply Company, GS and Laundry and Renovation Company	10-437 29-127	350-134-1	Military Intelligence Battalion (CEWI)	34-166 34-167 34-168 34-169
350-111-1	Signal Battalion; Armor, Infantry and Mechanized Division	11-35 11-59 11-127	350-134-2	Military Intelligence Battalion (CEWI), Tactical Exploitation	34-127 34-128
350-111-2	Signal Operations Company	11-405 11-415 11-423 11-425	350-134-3	Military Intelligence Battalion (CEWI), Aerial Exploitation	34-147 34-148
350-111-3	Corps Area Signal, Command Operations and Radio and Wire Battalions	11-116 11-117 11-303	350-134-4	Military Intelligence Company/Detachment	30-14
350-111-4	Headquarters and Headquarters Detachment, Signal Battalion; Signal Support and Signal Radio Operations Company	11-358 11-367	350-144-1	Air Defense Artillery, Automatic Weapons Units	44-85
350-111-5	Signal Tropospheric and Signal Message Companies	11-205 11-435 11-455	350-144-2	Air Defense Artillery Battalion, Chaparral/Vulcan	44-325 44-425
350-111-6	Signal Battalion/Brigade; Airborne/Air Assault Division	11-175	350-144-3	Air Defense Artillery, Improved Hawk	44-245
350-111-7	Air Defense Artillery Signal Operations Battalion	11-402 11-500	350-155-1	Motor Transportation Units	55-12 55-16 55-17 55-19 55-28 55-84 55-540
350-111-8	Headquarters and Headquarters Company, Corps Signal Brigade	29-640	350-155-2	Plans and Movement Control Transportation Units	55-6 55-11 55-580
350-111-9	Signal Teams	12-7	350-155-3	Aviation Transportation Units	55-89 55-166 55-167 55-259 55-406 55-459
350-111-10	COMSEC Logistic Support Teams	14-7	350-155-4	Marine Terminal Transportation Units	55-112 55-116 55-117 55-118 55-128 55-138 55-157
350-112-1	Personnel Administration, Postal and Replacement-Type Units	14-7			55-530 55-560 55-1001
350-112-2	Finance Company/Finance Service Organizations	17-385 17-55			55-1002 55-1003 55-1004
350-117-1	Attack Helicopter Battalions	17-85 17-205			
350-117-2	Armored Cavalry Squadron				
350-117-3	Combat Aviation Battalion, Armored/Mechanized Division				
350-117-4	Air Cavalry Squadron				

Group life insurance

Soldiers enrolled in the Government's increased group life insurance programs may want to submit new forms designating how the insurance is to be paid.

Veterans Administration (VA) officials advise that unless a new form specifies how shares should be paid, an insurance claim will be based on the old form already included in the soldier's personnel records.

The Servicemen's Group Life Insurance (SGLI) and the Veterans Group Life Insurance (VGLI) programs both increased on 1 December 1981 from \$20,000 maximum coverage to \$35,000 for active duty soldiers, Reservists, and veterans. Active duty members were automatically enrolled for the maximum coverage even if they had reduced coverage or no coverage under the old rates. However, soldiers may withdraw from the program or reduce the amount of coverage at any time by submitting DD Form 93 and VA Form 29-8286 to their local finance offices.

SGLI may be secured in increments of \$5,000 for 75 cents. Under the new coverage, soldiers pay \$5.25 monthly for the full \$35,000 maximum coverage.

Reservists who qualify for full coverage pay the same rates as those soldiers on active duty. The premium for part-time SGLI coverage is \$3.50 yearly for \$35,000 insurance. Retired reservists pay according to age.

The VGLI's five-year insurance plan is available only to SGLI holders who leave the military. The higher rates affect soldiers separating from the Army on or after 1 December 1981.

Vacancies at Army War College

The Commandant, US Army War College (USAWC), is in the process of considering officers for assignments as Chairman of the Department of National and International Security Studies and Chairman of the Department of Corresponding Studies. Responsibilities of each position are listed below:

•**Chairman, Department of National and International Security Studies:** Plans, develops, and presents a course of instruction in national and international security which will help prepare graduates for senior command and staff positions within the Army and throughout the Defense Establishment.

1) **General Qualifications:** Sophistication in national and international security affairs; domestic policies, economics, and social order; concept of national power and its components as applied to the US; the international system to include a global perspective of political, economic, and social issues; and US interests, priorities, and policy alternatives toward specific regimes of the world.

2) **Specific prerequisites:** Be a colonel; have at least five years remaining prior to mandatory retirement; be available for assignment prior to June 1982; be a senior service

college graduate with a graduate degree in political science, economics, international relations, or a related discipline; have experience as an instructor at the staff or service college level; and have served on a national level staff (HQDA, OJCS, OSD). Command at the colonel level is desirable, but not mandatory.

•**Chairman, Department of Corresponding Studies.** Plans, develops, presents, and evaluates the USAWC corresponding studies course for selected officers and Department of the Army civilians to prepare them for senior leadership positions through professional military education in national security affairs with emphasis on the development and employment of military forces in land warfare.

1) **General Qualifications:** Sophistication in military strategy, leadership, management, and national and international security affairs.

2) **Specific prerequisites:** Be a colonel and available for assignment prior to June 1982; have at least five years remaining prior to mandatory retirement; be a senior service college graduate with a graduate degree; and have served on a national level staff (HQDA, OJCS, OSD). Command at the colonel level is desirable.

Interested officers are encouraged to contact the Secretary, US Army War College, AUTOVON 252-4515 and/or their assignment officer.

Reservists encouraged to apply for drill sergeant school

Army Reservists who wish to become drill sergeants are encouraged to apply for drill sergeant courses conducted at Fort Leonard Wood, MO, Fort Knox, KY, and five other stateside posts.

According to Army Reserve officials, new eight-week classes report approximately every four weeks throughout the year.

Applicants must be in the grade of E4 or higher and must be "hard-stripe" noncommissioned officers. Specialists may apply provided that they have been appointed as an acting sergeant by unit orders. Other details and requirements are listed in TRADOC Regulation 350-16 and AR 600-200. Potential applicants may also contact their major US Army Reserve Command for more information.

Applications must arrive at the Army level at least 45 days in advance of the class desired. Additionally, applicants must be prepared to pass the three-event physical fitness test upon reporting to drill sergeant school.

Many Army Reserve units, including reception stations and training divisions, have requirements for drill sergeants up to and including the grade of E9.

In addition to Forts Leonard Wood and Knox, Reservists may take the drill sergeant course at Fort Sill, OK; Fort Dix, NJ; Fort Jackson, SC; Fort Benning, GA; or Fort McClellan, AL.

New reenlistment policies

Beginning 1 January this year, soldiers in all grades and military occupational specialties (MOS) face new reenlistment rules.

One new policy — the Dual Component Option — deals with in-service recruitment and makes it easier for departing Regular Army soldiers to fill Reserve slots. Also, new reenlistment and reclassification rules will help the Army stay up to strength in certain critical specialties.

With the Dual Component Option, soldiers can enlist in the US Army Reserve 10 days before they start terminal leave, or within 10 days before they are eligible to return from overseas. Service members who have finished their six-year military obligations no longer have to enlist within 24 hours of their expiration terms of service (ETS).

The new option helps those soldiers who wish to reenlist, but are not at the separation/transfer point or another military agency at the time of their ETS. It also assists those who are not at the separation/transfer point for 24 hours, such as overseas returnees. The option prevents a break in military service by allowing soldiers to continue in their USAR status.

The new reenlistment and reclassification rules, according to the Army's Deputy Chief of Staff for Personnel, will improve the imbalance that exists among certain specialties.

The rules bar soldiers of all grades from reenlisting or reclassifying from a shortage MOS to a balanced or overstrength MOS. However, the policy does permit soldiers to reenlist in their own short, balanced, or overstrength MOS vacancy.

One restriction specifically affects E6s and above; e.g., they are not allowed to reclassify from one short MOS to another.

Sergeants and specialists five are presently allowed to move from one shortage specialty to another on reenlistment. The Army's Deputy Chief of Staff for Personnel is, however, considering placing E5s who reenlist for a second or succeeding hitch under the same restrictions that now govern E6s.

The only soldiers who are permitted reclassification to a balanced or surplus MOS are those who become medically unqualified for duty in their present skills.

Soldiers who are considering reenlistment or reclassification should visit their reenlistment NCO for further information.

Discharge of enlisted personnel

In recent years there has been an increasing number of sole parents and married service couples. Accordingly, a corresponding increase in problems relating to parenthood may be expected. Commanders should be aware of the following in order to deal with problems if they occur:

- Paragraph 5-35, AR 635-200, Enlisted Personnel Separations, provides for the involuntary separation of enlisted members for inability to perform prescribed duties due to

parenthood. This provision may be used to separate soldiers who are unable to perform prescribed duties, repetitively absent, or unavailable for worldwide assignment because of parenthood.

- General court-martial convening authorities or members of their staff who have been delegated approval authority may order discharge or transfer to the Individual Ready Reserve if soldiers have not completed their mandatory service obligation. Persons separated under this provision will be awarded an Honorable or General Discharge Under Honorable Conditions as appropriate.

The provisions listed above allow commanders to separate soldiers who are unable to respond effectively to both parenthood and the rigors of military life or who use parenthood as a means of avoiding their military responsibilities.

Senior officer flying positions

A policy change was recently made concerning the performance of limited flying duties of rated officers in grades O6 and above. Army Regulations (AR) 570-1 and 95-1, revised to implement this change, will decentralize the approval authority for senior officers to perform limited flying duties when it would enhance their managerial/supervisory role.

The changes include the following:

- Deletion of the annual DCSPER letter that identifies senior officer aviation positions.

- Approval authority to authorize limited flying duties 24 calendar days per year is delegated to appropriate MACOM commander, Joint and International Activity commander, Director of the Army Staff, or Deputy Assistant Chief of Staff. Information copies of approval will be forwarded to Headquarters, Department of the Army, ATTN: DAPE-MBU, and Headquarters, Department of the Army, ATTN: DAPC-OPA-V, as stated in AR 570-1.

- Operational Flying Duty Credit is not authorized. Aviation Career Incentive Pay for performing limited flying duties is not authorized unless otherwise qualified in accordance with Public Law 93-254.

- Senior officers performing limited flying duties must comply with the following:

- 1) Physical qualifications as outlined in AR 40-501.

- 2) Aircrew Training Minimums (ATM), Synthetic Flight Training System (SFTS), and other Annual Aviator Proficiency and Readiness Test (AAPART) requirements do not apply.

- 3) Fly with an Instructor Pilot/Standardization Instructor Pilot (IP/SIP) qualified, current, and proficient in aircraft being flown at one set of the controls.

Colonels (O6) in operational flying positions must maintain basic flying skills and meet all requirements outlined in AR 95-1.

Review of Reservist OMPF at MILPERCEN

All Army Reserve soldiers living or visiting in the Washington, DC, area may now review their Official Military Personnel File at MILPERCEN.

To request a records review, call the MILPERCEN Reserve Affairs Advisor's office at AUTOVON 221-8835, (commercial (202) 325-8835), or write to HQ, MILPERCEN, ATTN: DAPC-PO-RA, 200 Stovall Street, Alexandria, VA 22332. *Thirty days notice is required.* Records must be requested by MILPERCEN from the Reserve Components Personnel and Administration Center (RCPAC) in St. Louis, MO.

Minimum information needed to obtain records includes:

- Full name.
- Rank.
- Social security number.
- Requested date of review.
- Business or home phone where individual can be reached during normal duty hours (8 a.m. to 4:30 p.m. EST), Monday through Friday.

Wear of award

In the past, former soldiers have been permitted to wear lapel buttons or rosettes on civilian clothing at any occasion and miniature medals on civilian clothing at formal social functions. In an effort to recognize the service of these soldiers, the policy has been expanded to permit former soldiers to wear full size or miniature medals on civilian attire on Memorial Day, Veterans Day, and Armed Forces Day. This change in policy will be included in AR 670-1.

USAR patch change

US Army Reserve units that have training affiliations with Active Army units now may wear the shoulder sleeve insignia of the active component units.

Department of the Army Uniform Board officials note, however, that local approval for wear of the insignia is subject to mutual agreement between the Reserve unit's Major US Army Reserve Command (MUSARC) and the Active Army unit commander.

Commanders Update

LTC Harold Cooke 3d Battalion, 6th Field Artillery	LTC James Brickman 2d Battalion, 18th Field Artillery	LTC John Kelly 1st Battalion, 75th Field Artillery
LTC Charles Brown 3d Battalion, 17th Field Artillery	LTC Kenneth Koy 2d Battalion, 21st Field Artillery	
Marine Corps Artillery		
1st Marine Division Col E. B. Beall Jr. 11th Marine Regiment	2d Marine Division Col A. J. McCarthy Jr. 10th Marine Regiment	3d Marine Division Col W. C. Doerner 12th Marine Regiment
LtCol C. G. Blasi 1st Battalion, 11th Marines	LtCol R. F. Calta 1st Battalion, 10th Marines	LtCol L. C. Reifsnider 1st Battalion, 12th Marines
LtCol G. E. Gaumont Jr. 2d Battalion, 11th Marines	LtCol B. E. Barriteau 2d Battalion, 10th Marines	LtCol L. D. Mathews 2d Battalion, 12th Marines
LtCol D. F. Wyrach Jr. 3d Battalion, 11th Marines	LtCol R. A. List 3d Battalion, 10th Marines	LtCol D. J. LaBoissiere 3d Battalion, 12th Marines
LtCol R. E. Kirkpatrick 4th Battalion, 11th Marines	LtCol J. E. McClenahan Jr. 4th Battalion, 10th Marines	
	LtCol W. A. Sadler 5th Battalion, 10th Marines	

Field Artillery Branch Team

MAJ(P) Dan Crawford

Lieutenant
Colonel's
assignment officer



LTC Curt Lamm
Field Artillery
Branch Chief



MAJ Cork Colburn

Major's
assignment
officer

CPT(P) Dick Durden

Captain's
nominative
assignments CAS³



CPT(P) Ken Lund

Captain's
CONUS and
overseas
assignment
officer

CPT Byron Bryant

Lieutenant's
overseas
assignments
/Officer
Advanced
Course



All correspondence
should be
addressed to:
CDR, MILPERCEN
ATTN: DAPC-OPE-F
200 Stovall Street
Alexandria, VA 22332
AUTOVON:
221-0116/0117/0187/7817



CPT Steve Curry

Lieutenant's
CONUS
assignment
officer

MILPERCEN LOCATION

Officers desiring to visit the Field Artillery Branch at MILPERCEN should follow Interstate 495 (the Capital Beltway) towards Alexandria, VA, and take Exit 2 north on to Telegraph Road. Hoffman Buildings I and II are on the immediate right after exiting the Beltway, and are located adjacent to the Holiday Inn. Visitors should park in spaces marked in **red** only, underneath the overpass, and register POVs with the security personnel in the lobby of Hoffman Building I. Officers should then report to Room 4S33 in Hoffman Building II for interviews with the Field Artillery Branch.

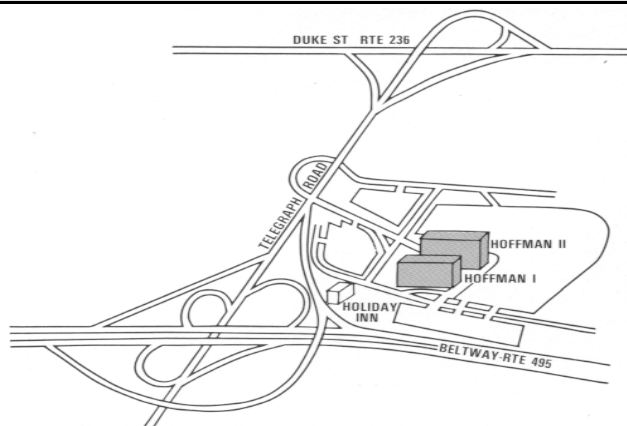

Logistics Raid

by MAJ Randall L. Rigby

During the past two years, a number of articles in the *Field Artillery Journal* have addressed the issue of survivability and the emerging tactics needed to meet the survivability problem. Additionally, in his July-August 1981 column, Major General Dinges summarized the extent of the threat's capability to locate and attack and also brought home the notion that field artillery survivability on the next battlefield is in many ways dependent on how units are now training.



Our response in the 6th Battalion, 10th Field Artillery, is to use a variety of dispersal techniques in our training, which include:

- Frequent displacement and greater dispersion between howitzers (up to 600 meters for a four-gun battery) in a single position.

- "Roving gun" positions for single gun missions.

- Split battery operations using two independent two-gun platoons.

In implementing these new tactics, we have been



using the recently published coordinating draft on survivability (March 1981) which provides commanders with newly developed guidelines for combat survivability. Omitted in this draft, however, is the topic of battalion-level logistical support for the emerging tactics. This concerned our commanders because of the noticed increase in POL consumption, Class IX supply usage, and ammunition distribution problems since using these survivability tactics. Although this increase can be adequately handled by our standard resupply methods in training, the question of how well can we do it in combat has caused us to rethink the traditional role of the service battery and the battalion trains.

Current resupply methods

Battalion commanders typically use variations of two primary methods to resupply firing batteries:

- The first is that of employing the firing battery with its organic combat support elements. Using this decentralized method, the battery has the mess, supply, ammunition, and maintenance sections located at the firing position area, and when resupply is needed, return these supporting elements to the rear combat or field trains for replenishment. While this method is responsive and provides maximum control by the battery commander over the combat service support sections, the liabilities in terms of survivability are great; e.g., the increased "signature" of the battery, larger position areas, and relatively larger convoy size resulting in greater vulnerability during movement. Also, there is always the increased possibility of wandering or lost vehicles because the battery often moves while the mess truck is en route.

- The second method, one that is commonly used today, is that of using centralized trains under the control of the battalion executive officer or S4. Comprised of the combat service support elements of all batteries, this method appears to better satisfy the survivability needs for artillery units. Under this concept, the battery trains may remain in a central location until resupply is needed and, when called for, move forward to the battery to fix and replenish. In addition to providing the battalion commander better control over the battalion's logistical assets, the trains concept allows the size of the firing battery to be reduced, resulting in a smaller signature, a faster deployment, and less vulnerability to air and ground observation and attack.

Although these advantages appear to meet the needs of the firing battery engaged in combat, there are some drawbacks to the trains concept. For example, the method requires movement of a number of support vehicles into a firing position, which in turn increases the possibility of uncovering the position area to an enemy with multi-dimensional target-locating and attack capability. Also, time and movement considerations may cause inefficient or incomplete servicing and may require that supply operations be postponed until the next position is occupied. Finally, the combat trains of an artillery

battalion becomes a "permanent target" unless it moves frequently.

Logistics raid

As an alternative, the 6th Battalion, 10th Field Artillery, has experimented with a combat service support technique called the "logistics raid." It is a simple operation that can be used effectively to provide support to all elements of a battalion while they are on the move. (Figure 1 lists some hints for initiating the logistics raid.)

-
- Reconnoiter site prior to use.
 - Conduct the logistics raid at night or during periods of reduced visibility.
 - Use wooded areas and available terrain to your advantage.
 - Remote radio; use operations codes from CEOI to reduce transmission time.
 - Use internal wire to monitor programs.
 - Tailor logistics raid to fit needs; focus on problem areas.
 - Place a noncommissioned officer in charge of each resupply point.
 - Rehearse and brief personnel.
-

Figure 1. Hints for a successful logistics raid.

A logistics raid is a variation on the theme of combat support using the combat trains. The technique involves movement of combat service support elements (trains) of a battalion to a concealed location along the route of firing elements, thus allowing firing elements to pass through the logistics raid site and take on needed POL, ammunition, and Class I and IX supplies, receive maintenance assistance, and then continue on the route of the march to the next firing position. Following the logistics raid, the combat trains elements march order and proceed from the site to another location. The major advantage of this technique is that it allows a commander to maintain maximum control over his logistical assets while providing a broad range of support activities to a firing battery in a relatively short time. Also, the flexibility of the logistics raid concept allows the commander to tailor the operation to the specific needs of his unit.

Preliminary field tests at Grafenwoehr during ARTEP training have shown that a firing battery can go through a logistics raid site in approximately two and a half hours and be completely resupplied with POL and Class I and V supplies, have all vehicles inspected, and make minor repairs on the spot. Under good conditions, three firing batteries could pass through a logistics raid in approximately six hours. Success depends on careful planning, rehearsal, and vigilant operations security (OPSEC).

Site selection

When the commander decides to conduct a logistics raid, he should appoint an officer, probably either the battalion executive officer or the service battery commander to be

the officer in charge (OIC). This officer should then reconnoiter and select a suitable position for the site.

Although the selected site will depend on the terrain, the position should be on or near the route of march for the firing elements, preferably near the next firing position so that the battery can infiltrate into the position as soon as the logistics raid is completed. Ideally, the site should be in a wooded area and have reasonably good trafficability throughout and a distinct entrance and exit point (figure 2). For maximum security, the actual logistics raid should be conducted during hours of darkness or periods of severely reduced visibility.

Site organization

The OIC should position the resupply and maintenance vehicles to facilitate rapid movement by the firing battery through the position. Since the position will be a key target for the enemy, each vehicle should be camouflaged and the operation spread over at least two or three kilometers. Because of this dispersion, internal wire should be laid to each logistic location; i.e., POL, ammunition, maintenance, and command post (CP). The OIC should not use radio transmitters from the logistics site location; rather, a remote antenna, positioned at least two kilometers away, should be used to keep from pinpointing the activity at the logistics raid site. All other radios should be turned off or on listening silence.

Logistics raid site activities

When the firing battery reaches the assembly area at the site entry point, the OIC should brief the commander on the organization of the site, the route of march through the area, and the security requirements needed for the battery while at the logistics raid location. In general, the firing battery should provide local security for the position since most of the personnel in the combat trains will be involved in the logistics raid activity.

The unit should begin moving through the position as soon as possible after the battery commander is briefed. The resources available to the commander are flexible and can be tailored to meet the unit's needs. Since refueling is a high priority, the POL point should be chosen first and then tankers are positioned to allow rapid movement. Fuel lanes are dedicated to either MOGAS or diesel fueled vehicles (figure 2). Additionally, sufficient personnel should be allocated to the POL point to insure a smooth and continuous operation.

As vehicles complete the refueling operation, they should proceed to the next station. For ammunition-carrying vehicles, the next stop is the ammunition resupply point which is organized to allow for rapid delivery of ammunition. For heavier ammunition loads, a wrecker should be available for lifting ammunition from the back of the ammunition section vehicle to the howitzer section vehicle. The M548 hoists can also be used to transfer palletized

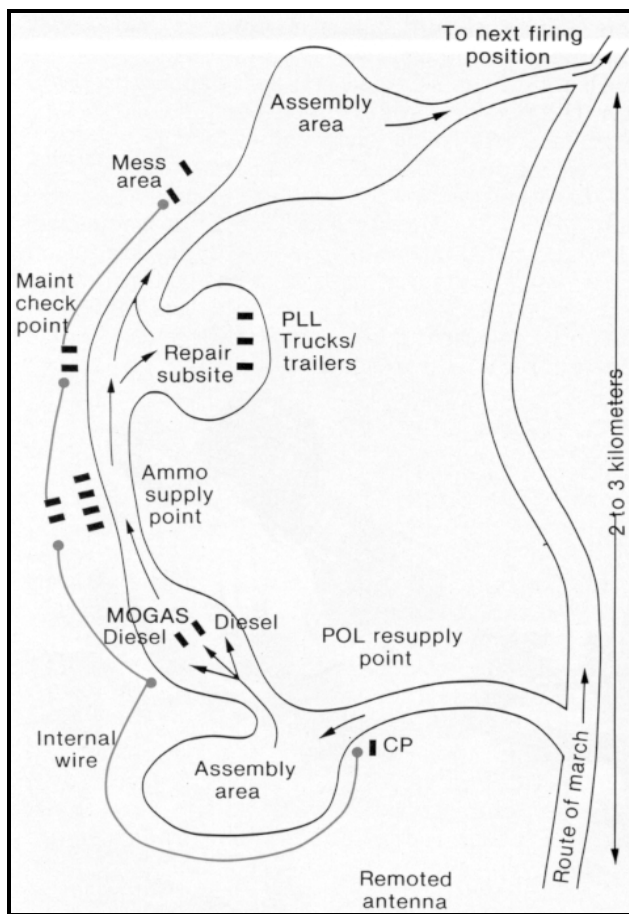

Figure 2. Sketch of a possible logistics raid site.

loading. Ammunition personnel from the battalion and battery ammunition sections assist in the ammunition resupply operation.

The next station is the maintenance checkpoint which includes battery maintenance personnel and equipment plus a contact team from battalion maintenance. After several trials, we found that this operation should be tailored to meet the needs of the unit and the current situation. As vehicles enter the maintenance point, they are inspected by maintenance personnel for serviceability. The extent of this inspection depends on the amount of time available but, as a minimum, fluids, brakes, engines, tires, and tracks should be inspected. This site will require more planning and preparation than others because, if repair is necessary, a repair subsite and personnel to accomplish the work must be available. Additionally, the repair subsite will need water, the prescribed load list (PLL), and packaged POL. The maintenance operation should be supervised by the battalion motor sergeant or maintenance technician. Recovery assets should be available for evacuation when repairs cannot be completed within a reasonable time at the logistics raid site. Also, an inspection time factor should be planned in advance to insure that each vehicle will get a quality inspection. For planning purposes, six to eight minutes per vehicle (using two inspectors) is sufficient to perform a minimum

inspection. If the vehicle needs parts or other repair action, it is moved into the repair area and the battery motor section initiates the repair. Parts are supplied from the PLL located at the repair subsite, and repair assistance is available from the battalion maintenance contact team, motor sergeant, and maintenance technician. We feel the brief inspection at the maintenance check site is one of the more important and innovative aspects of the logistics raid technique. The units can make minor repairs as well as an occasional major repair. During our recent ARTEP, we changed a turbocharger on an M110A2 howitzer without delaying the battery. Had the defective turbocharger not been detected at the logistics raid site, the howitzer would soon have been out of action.

Following the maintenance check, vehicles are moved to a site offering water and Class I resupply. Personnel can eat a hot meal (either A- or C-ration) in the assembly area or, at the option of the commander, move the vehicles directly to the next firing position. As the battery departs the area, coordination is made to transfer the responsibility for security of the area back to the OIC of the logistics raid.

The OIC of the logistics raid should monitor the progress of the firing battery through the site via internal wire and personal inspection while keeping the S3 informed of the status by way of the remoted radio. Depending on the tactical plan, follow-on batteries may begin to move through the logistics raid site as the first battery completes the operation. Using this technique, two batteries of a battalion may remain in firing position while another is undergoing the logistics raid. When the last vehicle is finished, the OIC gives march order and moves the combat trains away from the site, its mission accomplished.

Conclusion

The key to survivability on the next battlefield may not depend on how good you are at a particular tactic or technique of resupply; instead, those units that survive to continue the combat mission will be those who use a number of different techniques at different times so that habits will not become indicators to an enemy. The logistics technique is simply another method of accomplishing resupply, but it also has operational costs that must always be considered. For example, it requires the massing of many vehicles in a relatively small area; it is time-consuming and should not be used if movement must be hurried. Although it requires detailed planning, reconnaissance, and a certain amount of training, it does offer the battalion commander excellent control over his resupply operation, conducts them away from the firing position, and offers a full, tailored range of support at a single location. 

MAJ Randall L. Rigby is the Executive Officer of the 6th Battalion, 10th Field Artillery.

Salute!!!

Page 26

