

Field Artillery Journal



November-December 1979



Training and
Indoctrination
of the Soviet Soldier

Field Artillery Journal

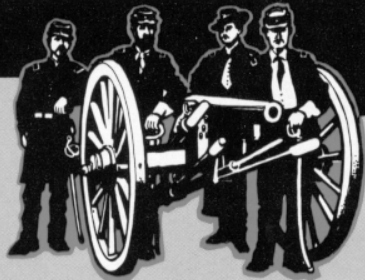

The Journal of Fire Support

Volume 47

November-December 1979

Number 6

The *Field Artillery Journal* is published bimonthly at the US Army Field Artillery School for the same purpose stated in the first *Field Artillery Journal* in 1911:

"To publish a Journal for disseminating professional knowledge and furnishing information as to the field artillery's progress, development, and best use in campaign; to cultivate, with the other arms, a common understanding of the powers and limitations of each; to foster a feeling of interdependence among the different arms and of hearty cooperation by all; and to promote understanding between the regular and militia forces by a closer bond; all of which objects are worthy and contribute to the good of our country."

Unless otherwise stated, material does not represent official policy or endorsement by any agency of the US Army.

Funds for the printing of the publication were approved by the Department of the Army, 23 February 1979.

All articles and information submitted are subject to edit by the *Journal* staff; footnotes and bibliographies may be deleted from text due to limitation of space.

All letters and articles should be addressed to Editor, *Field Artillery Journal*, P.O. Box 33131, Fort Sill, OK 73503. AUTOVON 639-5121/6806 or commercial (405) 351-5121/6806.

The *Field Artillery Journal* is pleased to grant permission to reprint articles. Please credit the author and the *Field Artillery Journal*.

Subscriptions to the *Journal* may be obtained through the Field Artillery Association, Fort Sill, OK 73503. The rate is \$9 per year to US and APO addresses. Canadian and Mexican addresses should add \$2 for postage, and all other foreign addresses should add \$3 for postage. There is a reduced rate for multi-year subscriptions. For further information write to the Field Artillery Association or call AUTOVON 639-5123/3703 or commercial (405) 355-4677.



Cover photo depicts Soviet Field Artillery section training.

The Field Artillery School

Commandant

MG Jack N. Merritt

Assistant Commandant

BG Edward A. Dinges

The Field Artillery Journal Staff

Editor

MAJ John Dobbs

Managing Editor

Mary Corrales

Art Director

Bob Coleman

Circulation Manager and Editorial Assistant

Ann Reese

POSTMASTERS: Controlled circulation postage paid at Lawton, OK, Department of the Army, DOD 314; Field Artillery Journal USPS 309-010.

Articles

- 8 **Training And Indoctrination Of The Soviet Soldier**
CPT Richard L. Dean
- 17 **The Modern Battlefield BOC**
CPT Lonnie A. Veldhouse
- 26 **Interoperability**
LTC (Ret) Charles W. Montgomery
- 28 **M110A1 Fallback Damage**
CAPT Richard L. Harmon, USMC
- 30 **Massing The Steel**
COL Donald E. Eckelbarger
- 39 **A Field Artilleryman As Military Attaché**
LTC(P) William E. Serchak
- 46 **Nuclear Weapons: Image Versus Reality**
MAJ John P. Rose
- 55 **Bragg—Valiant Artilleryman**
COL (Ret) Robert A. Stegmaier

Features

- 2 **On The Move . . .**
- 4 **Incoming**
- 13 **View From The Blockhouse**
- 22 **Right By Piece**
- 25 **Commanders Update**
- 35 **FA Test and Development**
- 42 **With Our Comrades In Arms**
- 51 **Redleg Newsletter**
- 58 **Redleg Review**
- 60 **Redleg Reference**
- 61 **Fragments**



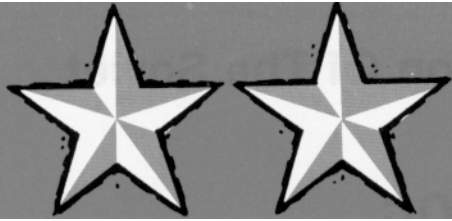

On the Move...

In recent issues of the *Journal*, I have focused my discussions on Field Artillery combat developments, particularly our involvement in the major division modernization effort known as "Division '86." I have talked about the artillery's battlefield tasks: *Target Servicing Indirect Fires*, *Counterfire*, and *Battlefield Interdiction*. It is not enough, though, to develop the materiel and the force structure. We must as well devise a training strategy for Division '86, since successful accomplishment of these tasks depends heavily on a well-trained force. We must have a training program which insures professional development and career progression for our soldiers. In other words, we must have a "logical plan" pointed toward training enlisted field artillerymen technically at appropriate skill levels if we are to meet the challenges of advancing technology and scarce personnel resources. At the same time, we must provide our noncommissioned officers with leadership training and the skills they need to train their subordinates.

Appraisal of CMF 13

For some time the Field Artillery School has shared the concern that our training program was not adequately structured to provide required skill level and leadership instruction. As a result we recently completed a detailed appraisal of the 12 MOSs in Career Management Field 13 which subsequently pointed out several "gaps" in our current training strategy. To fix these inequities we are making certain changes along with recommendations for other, more sweeping changes to Headquarters, US Army Training and Doctrine Command (TRADOC) for Department of the Army approval and implementation.

I believe our current training at skill level 1 is adequate. The basic training (BT)/advanced individual training (AIT) and one-station unit training (OSUT) graduates from Fort Sill are able to perform the skill level 1 tasks outlined in the Commander's Manual. However, because we now face shortages of noncommissioned officers, skill level 2 and 3 tasks for some MOSs require more attention. There are cases when the AIT graduate must join a firing battery and immediately



by MG Jack N. Merritt

assume the duties of gunner. Because of this situation we are now training selected soldiers in advanced skills as part of Initial Entry Training. To provide more detailed crew training for that individual, we are also conducting a test in which some 13B crewmen are being trained specifically on either the M109A1 or the M110A1. If this test is a success, we must then be sure that these weapon-specific soldiers are assigned to units with the correct type of weapon system.

At skill level 2 our major problem stems from a reluctance of some of our commanders to allow eligible soldiers to attend either the Primary Noncommissioned Officers Course (PNOC) or the Primary Leadership Course (PLC). This lack of command emphasis may be a result of the perception that there is a marked difference between PNOC and PLC; therefore, we have proposed a revised PLC at skill level 2 that all field artillerymen, regardless of MOS, would attend. This proposed course of instruction would be more rigorous than the current PLC and more in line with the PNOC curriculum. Its basic emphasis would focus on those common combat leadership skills required of all artillerymen.

Formal training at skill level 3 is crucial for the Field Artillery soldier. A basic tenet of our strategy that holds true for every MOS and for every type of unit in the Field Artillery is that *the E6 skill level 3 soldier is the key trainer in our units*. He is the one individual who can most directly influence the training accomplishment of a unit, particularly the training for ARTEP and Soldier's Manual requirements. The problem is that we now provide no formal training for our missile and target acquisition soldiers to prepare them to meet this awesome responsibility.

Even in the cannon MOSs the problem exists where excellent training is available in the Basic Noncommissioned Officer Course (BNOC) but is not *mandatory* for these key trainers as it should be. Our training strategy would require formal skill level 3 training before promotion to the grade of E6. We recognize, however, that this proposal, if accepted, would require Army-wide adoption by all career management fields.

Skill level 5 is also a critical point in the enlisted soldier's career. It is at this point that all field artillery MOSs merge to either 13W (Target Acquisition Senior Sergeant) or 13Y (Cannon/Missile Senior Sergeant). By "merge," I mean that the NCO must change from an MOS specialist at grade E7 (such as a chief of firing battery) to a *system specialist* (such as a first sergeant) at grade E8. At those times when an advancing soldier progresses from his accustomed MOS into another, there

is generally a training gap because the soldier must now operate, or supervise others on equipment for which he has not been trained. There is a definite need for training during this difficult transition that we are not really providing. To remedy this training gap, we have proposed the creation of a Senior NCO Course to Headquarters, TRADOC.

Mergers

Most of the foregoing are changes which have both resource implications and impact upon the personnel system and, therefore, require Army-wide coordination. There are other changes being made now which simply reflect changes in Field Artillery. The first is the Honest John crewman (MOS 15F). These soldiers now merge to MOS 15D, Lance Missile crewman, at skill level 4, and the next change to AR 611-201 will eliminate MOS 15F completely. In its place an Additional Skill Identifier (ASI) will be established for MOS 13B, and these 13B, ASI P2 soldiers will be assigned to duty positions now filled by 15F soldiers. All training material for these soldiers will be consolidated into an exportable package for use in custodial detachments where the Honest John training requirement exists. This package will be the only training material available for the Honest John system due to the small density of soldiers involved.

Another merger point (13C) in CMF 13 which will remain for some time has been created by the entrance of TACFIRE into the inventory. The new TACFIRE MOS, 13C, is now in use. As I previously indicated MOS 13E does not require any E7 duty positions due to the distribution of TACFIRE computers in a division. While MOS 13E will remain valid through the grade of E6, at grade E7 (skill level 4), all 13E cannon fire direction soldiers will merge to MOS 13C. To train these soldiers, we will provide resident instruction at Fort Sill as units become equipped with TACFIRE. The training for E7 soldiers on TACFIRE will be accomplished either in units (as they are equipped) or in the NCO Advanced Course.

Conclusion

As you can see the training of our enlisted soldiers becomes more critical as technology advances and as personnel assets diminish. I am convinced that the training strategy developed by the Field Artillery School is a step in the right direction for the entire Field Artillery Community. This strategy, when coupled with other ongoing enlisted personnel actions, will better prepare our soldiers to meet the increasingly complex challenges of maintaining individual and unit readiness. 

If all mankind minus one, were of one opinion, and only one person were of the contrary opinion, mankind would be no more justified in silencing that one person, than he, if he had the power, would be justified in silencing mankind. "On Liberty"—John Stuart Mill

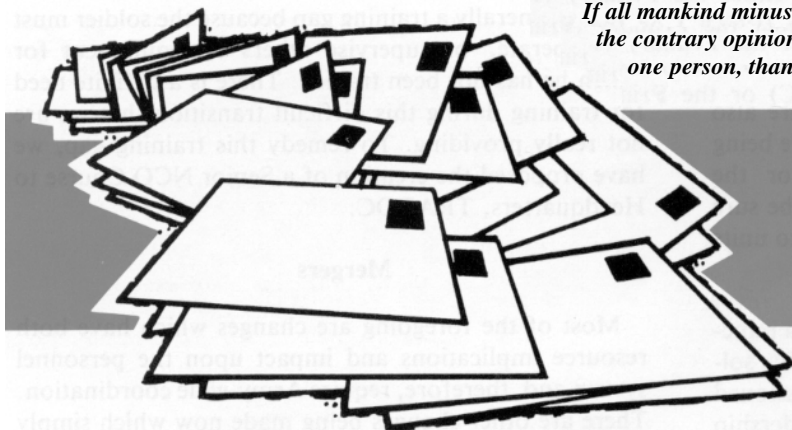

Incoming

letters to the editor

Hand-held hunting rangefinders

Any weapon that depends on the firer or crew to estimate distance to a target is not reliable for first-round hits. Ask anyone who has used the LAW. In today's battlefield environment, if you miss on the first shot, you may never get a second.

The range estimation problem has been solved for several weapons:

- Tanks use stereo-optic and/or laser range-finders.
- Air defense weapons use radar and homing warheads.
- TOW and Dragon missiles use optical tracking and correct by wire.

The Field Artillery uses a boresighted stadia sight elbow telescope on 155-mm SP howitzers and various other types of direct fire scopes for other weapons. Additionally, the panoramic telescope can be used for direct fire in emergencies; however, these sights have one grave drawback: they require the crew to estimate the range to target to get the proper data for firing. The present system therefore leaves something to be desired. The solution would appear to be a range-finder system, but the cost of out-fitting each 155-mm SP howitzer with a modified tank system would be mind bending and not worth the effort. And what of the other howitzers? There is a device in production at this time that is portable, inexpensive, and easy to use: a hand-held hunting range-finder (HHHRF).

As an example, I will use the Ranging 1000 Distance Finder by Rangematic, which costs approximately \$50. The Distance Finder weighs 22 ounces (0.624 kg), has a focal range of 50 yards (45 meters) to 2 miles (3,500 yards/3,220 meters), and has a 6x18 telescope eyepiece. A carrying case is available for \$6.97. For about \$57.00 per cannon, each howitzer section can have a device

that would greatly assist in direct fire. Some other uses would be:

- Accurate piece-to-crest range.
- Distance to high-speed avenues of approach.
- Accurate location of defensive positions (observation posts/listening posts).
- Piece displacement.
- Hasty surveys for battery center by distance and azimuth from a known point.
- Range cards.
- Ambush positions (use with LAWs for first-round hits or with any other direct fire weapon such as the 2.75-inch folding fin aerial rocket, high velocity grenade launchers, etc.).

Coupled with smoke grenade launchers and antiarmor mines, the HHHRF would greatly enhance the survival of the howitzer section in a highly mobile environment.

Larry A. Altersitz
CPT, (NJARNG)
Woodbury, NJ

More FO training needed

"Why FOs Can't Shoot" is an excellent article. Captain Kelly's recommendations for correcting the problems were good and FAOBC is doing its part. As an old World War II FO, I would like to throw in my two cents worth.

I was thoroughly surprised that time and money were spent on assessments and tests. I dislike repeating it but, "Those who do not learn from history are doomed to repeat it." Self location and target analysis could have come right out of the Field Artillery School circa WW II. They are almost word for word what I was taught in OCS. They still do not go far enough, though.

The one thing an FO *must* know *at all times* is his own location. Otherwise he becomes virtually helpless—and there is no worse feeling.

Night patrols are particularly difficult. An FO may get lost by two or three hundred meters. An error can cost *you* your life. I replaced an FO in Korea who dropped a round on himself. I also had to stand by and watch a battalion commander in Europe drop an HC smoke round on us when he insisted he was right. Fortunately only he was hurt—with a fragment of a canister in his arm.

Very often you are on the move, and there is no time for anything but quick "eyeball" self location and target location techniques. Some few have a natural talent for this as star athletes have some natural talent. This talent must be developed first in the minor leagues (training) before you go to the big leagues (combat). The best along with the ones who have difficulty need practice and more practice. It's too late when the guns fire in anger. Battles are won or lost based on the availability of accurate and swift artillery fire.

Training in self location and target location should be continuous in field units. Take the FOs out both on foot and in vehicles—moving about 5 to 10 mph—and, without warning, stop them along the route several times and point out a target. Let them determine the target coordinates. If they go wrong show them what they should have done, demonstrating as many ways as possible to quickly eyeball in the correct coordinates. There is no such thing as an overtrained FO. Find as many different types of terrain as possible. Let the good ones help the not so good. All will benefit.

Ralph R. Balestrieri
1LT (Ret)
Eatontown, NJ

The Artillery S4

There are very few company grade positions which present the challenges encountered by the Artillery S4/Service Battery Commander. His days are usually very long, but the hours fly because they are filled with planning, problem solving, and commanding. The responsibilities of the Redleg logistician are unique among his counterparts in the other combat arms. Lest we forget, the battalion's ability to move, shoot, and communicate is, to a great extent, dependent on the competency of the S4. In actuality, the pressures of the battalion S4 position may prove to be an ideal grooming ground for future battalion S3s. The logistics officer is an artilleryman and his position as S4 is part of his career progression. There are several things which can be done to prepare and assist the battalion S4 in both Active and Reserve Components:

- The *Field Artillery Journal* provides an excellent forum for the exchange of professional information regarding gunnery, weapons development, branch career progression, etc. However, the logistics field is noticeably absent. Although the *Army Logistician* magazine is devoted to the overall subject, it does not generally contain items for the battalion S4, particularly the Artillery S4. The *FA Journal* can fill the existing void by opening a forum for S4s or those who have been logisticians.

- Maybe the Tactics/Combined Arms Department, USAFAS, would consider packaging an orientation course for artillery battalion S4s. The major area of consideration being tactical logistical planning; e.g. RSOP for the service battery, ammunition resupply to the batteries, organization of a battalion combat trains, relationships of the close support battalion S4 with the supported brigade S4 and the Forward Area Support Coordination Officer, organization of a brigade trains area, etc. Such a course, resident or nonresident, would be a tremendous foundation for the new S4.

Artillery logisticians unite! We all wear crossed cannons and are as much a part of the Artillery team as the gunnery people. Let us use the *FA Journal* as a vehicle of exchange and education. Remember, we must be able to "... get there first with the right amount of logistical support."

William P. Kiley
MAJ, NYARNG
42d Inf Div Arty

Money well spent?

Recently I received the latest issues of *ARMOR* and *Field Artillery Journal*. Several articles in these fine publications led to some personal speculations, contrasting two major funded programs, TACFIRE and GSRs, with their field expedient equivalents.

I am not proposing that we drop the TACFIRE and GSRs programs in favor of field expedients which are cheaper, simpler, and currently available. Both programs are needed badly, and both can fill a definite function.

First, let's look at TACFIRE. In the May-June 1979 *Journal*, Edward D. Ray lists 13 major functions TACFIRE will perform. He also states it should be fielded by the 1980s. Additionally he points out it takes 10 times as much training time and 10 times as much programming personnel as FADAC, and it costs approximately \$2.2 million a unit. Mr. Ray makes it clear that, for what it will do, TACFIRE is well worth the cost.

By contrast, the Field Artillery has recently begun using the hand-held calculator to perform one function in a limited fashion, that of the equivalent of manual fire direction (chart operations). The advantages of this system are that it costs approximately \$4000 to totally outfit a battalion with full equipment, takes about a week's training time, and can be fielded by spring of 1980.

Comparison between these systems produces some interesting thoughts. TACFIRE will revolutionize artillery tactics and fire direction, but only for the Active Army. It has not been funded for the Reserves and National Guard, meaning that only 30 percent of the total Army artillery assets will be meshed into the system. In addition, TC 6-1 projects digital data links between the fire direction center (FDC), radar, guns, fire support team, and survey, not to mention several levels of the tactical operations center. In a high intensity electronic warfare environment, such as we project for any conflict in Europe, these data links will produce a fantastic electronic signature unless heavily shielded or used only for high speed messages (30 seconds or less). A question also exists as to survivability of the system under nuclear attack.

On the other hand, the hand-held calculator seems tailor-made for Reserve Component units for several reasons.

- 1) Its small initial cost would allow total system purchase without straining limited budgets.

- 2) The short training time provides for more efficient use within the limited training time available to a Reserve Component unit.

- 3) It is immediately available to Reserve Component units, the majority of whom either do not have FADAC or are having maintenance difficulty with the system.

- 4) Finally, the limited simplicity of the hand-held calculator makes it highly survivable in a nuclear situation. It can be procured and fielded in a matter of weeks under a local purchase system. A calculator out for maintenance problems or electromagnetic disturbance can simply be replaced by one which has been protected in the FDC. The low purchase price would allow two calculators per FDC.

The next war will be fought with assets immediately available, which means M113s instead of IFVs, M114s instead of M198s, and FADAC and manual FDC instead of TACFIRE. The handheld calculator can add to readiness.

On another matter, the same issue of *FA Journal* reported an FY 80 expenditure of \$72.3 million to complete the validation phase of the General Support Rocket System (GSRs). Several pages earlier, CPT Larry A. Altersitz discussed the multiple mounted M200 rocket pod for the 2.75-inch rocket as a possible battery defense system. In the March-April 1979 issue of *ARMOR*, CPT Samuel S. Wood discussed a similar system, called *Slammer VI*. He reported that field testing of *Slammer VI* proved it was highly mobile and reasonably accurate out to a range of 11,000 meters.

Review of Captain Wood's article indicates two missions for which *Slammer VI* is perfectly suited: battery defense and the dedicated battery immediate suppression mission.

Use of the *Slammer VI* in battery defense, as mentioned by Captain Altersitz, would allow the battery to place massive, immediately available firepower on an attacking force, giving the guns time to either continue their own mission or be deployed to a new location.

As far as the dedicated battery immediate suppression mission, the *Slammer VI* platoon can cover an area of 190,836 square meters in seven seconds. It can also provide a 4½- to 5-minute smoke screen after a 30-second buildup. Granted, the 155-mm is more effective after a matter of minutes, but *Slammer VI* can provide more firepower *immediately*, when it is needed most. Use of this

Incoming

weapon will also allow the dedicated battery mission to be performed without the loss of one-third of a brigade's artillery fire support.

Captain Wood reports that *Slammer VI* was constructed out of existing hardware at a total cost of \$7500 each, thus allowing each firing battery to be equipped with two at a total cost of \$15,000.

The real crux of this letter is not to endorse one system over another or recommend dropping TACFIRE and GSRs for cheaper substitutes. Both systems are vitally necessary and should be fielded as soon as possible, but both systems are still in the development phase.

Field-developed alternatives are far more limited in their capabilities; however they are simpler, cheaper, and available now. Dollars spent on systems such as the hand-held calculator and *Slammer VI* would be money well spent.

If the United States went to war tomorrow, both the *Slammer VI* and the hand-held calculator would participate, but with limited availability. I contend they should be available to all.

We as military professionals owe it to our service to be receptive to new ideas and not reject them simply because we have something better on the drawing board.

The first battle of the next war will be fought and won with what is available *now*, not what is expected to be fielded five years later.

George W. Olney
CPT, FA (GAARNG)
Waycross, GA

What we need

There are a bunch of folks in and around the Army today who can spout, at the drop of a hat, how deficient our forces are when compared with the Soviet Bloc forces in terms of personnel and firepower. In particular, artillery stands to lose a great amount of its effectiveness due to the dedication of counterbattery fire units fielded by the Soviet Bloc armies. Some experts estimate up to one-half of the enemy's artillery will be used in this role.

Not many solutions to this and other problems are being offered. Emphasis now appears to be placed primarily on increasing the ranges of our weapons while deep down inside remains the question of which is better, range or mobility? Common sense tells us that it's just as easy for the Soviets to build weapons with increased ranges as it is

for us. When facing an enemy force that has an advantage of five-to-one in terms of guns, many of which are equal to or better in range than ours, reliance on mobility becomes dominant. Yet, who is working on the problem?

Since the end of the Vietnam war, artillery has allowed its primary means of mobility to change roles. With the currently accepted notion of aerial field artillery being non-survivable on the midintensity battlefield, our helicopters have become tank-killers, troop carriers, and observation platforms. With the exception of the aerial observer, liaison role, and prime mover for "airmobile" artillery units, aviation has left the artillery. I for one would like to see some things done with aircraft to improve the artillery's ability to defeat a vastly outnumbered enemy force.

What we need is a multiple rocket launcher (MRL) of over 100-mm that can be helicopter mounted. The system must be able to deliver accurate fires at ranges up to 15,000 meters and be capable of being laid for azimuth and elevation. It must also have a mounting system that can be traversed and elevated.

The 101st Airborne Division (Air Assault) uses a technique called the "Artillery Raid," which makes use of the CH-47, internally loaded with an M102, weapon crew, and ammunition. The aircraft is flown to a preselected firing position and landed on the reciprocal of the azimuth of fire; the gun is pushed out, laid, fired, and winched back in; then the aircraft is flown away. The whole process is done in about five minutes. The scarcity of CH-47 assets and the size of the aircraft tend to defeat this concept from large scale use. However, a smaller helicopter (e.g., the UTTAS) could be outfitted with a lightweight MRL system. These aircraft could be employed singularly, in teams, in batteries, or as desired by the force commander. Operating behind the FEBA, they could be rapidly employed anywhere on the battlefield where the commander needs additional firepower. By using indirect fire methods, the survivability necessary to operate behind the FEBA is increased. The capability of being laid provides the accuracy, and the use of a 100-mm or larger rocket provides the range and firepower necessary against armor or protected targets. Submunitions, laser-guided warheads, armor sensitive cannister rounds, etc., could be adapted to make the system more effective.

It took the "Artillery Raid" somewhere between five to eight minutes to

accomplish the mission, but I believe a helicopter equipped with an MRL system could go into position, lay, fire up to 40 rockets, crank-up, and depart for another mission in two to three minutes. This, of course, does not allow the enemy adequate response time and therefore offers another plus for survivability. The mobility, surprise, firepower, and accuracy of such a system when coupled with the advantages in relative combat power gained with a multiplier such as this seem to more than justify the development.

Understandably, there will be many questions to be answered concerning the technical and operational aspects of this system. Following are a few which immediately come to mind with conceptual solutions offered:

Q. How do you prevent damage to the rotor blade system when the rockets are fired?

A. The UTTAS is equipped with a "rotor brake" system that allows the leading blade to be positioned on the longitudinal axis of the airframe. By using on-board flight instruments to position the aircraft within a few degrees of the azimuth of fire, any slight corrections that are made by traversing the launcher would be limited by safety stops. Another advantage of the "rotor brake" is that the engine doesn't have to be shut down, and once the mission is fired the aircraft can be airborne again before the rockets penetrate the enemy's counterbattery detection systems. "Rotor brake" systems can be put on just about any turbine powered helicopter to make them adaptable for this use.

Q. Do aircraft have to be dedicated for this role?

A. No. The launcher system can be designed for rapid installation/removal with only a mounting bar rigidly affixed to the airframe (similar to mini-gun mounts currently in use). The launchers themselves can be configured in "pod" form which are loaded in batches as done with the GSRs. This will expedite reloading as well as decreasing the ammunition handling time. Once the mission is completed, the launchers can be removed by "quick-disconnect" and the aircraft released to perform other tasks.

Q. How will firing data be computed?

A. A number of options are available to solve this problem, but the use of a mini-FDC consisting of a hand-held programmable calculator (HHPC) with an operator carried on board the lead aircraft seems a viable solution. Each aircraft would carry one artillery gunner

to precision lay and set the firing data on the launcher. The on-board communications system would be used to obtain firing position location and target data information from the controlling FDC (whoever it might be). Another option would be to pre-compute the firing data at the controlling FDC and relay it to the aircraft which would be operating on a preselected fire direction net. The artillery gunner would replace the airborne door-gunner normally carried and therefore would not add to the weight load.

Q. Won't the rocket "back-blast" cause damage to the helicopter?

A. A deflection device consisting of a curved rectangular metal duct would be part of the launcher system and would direct the blast away from the aircraft. Previously developed technology utilizing starter motors to get the rocket out of the launcher before ignition of the main rocket motor could also be investigated for application.

Q. Doesn't loss of the aircraft due to maintenance cause loss of a weapons system?

A. Not necessarily. Since the number of aircraft equipped with the rigidly affixed mounting bar is dictated by the needs of the commander, it appears plausible to maintain more aircraft in the inventory, capable of supporting the system, than launcher systems, assigned. Since there is very little capability lost in terms of aircraft performance when the mounting bar is installed, it also seems to be a favorable trade-off.

These are just a few of the questions that have to be answered in the development of the system. It is certain that many more will arise during the design and development phase. We cannot, however, stop thinking about better ways to get the job done in this time of constrained resources and unfavorable balance of weaponry on the battlefields of tomorrow.

Paul J. Florio
LTC, FA
TRADOC Combined Arms Activity
Fort Hood, TX

The concept of developing and employing an air transportable MRL larger than 100-mm is considered feasible but perhaps not practical. From an aviation standpoint, several areas warrant scrutiny to insure that the MRL is truly airmobile, such as size, weight, and aerodynamic qualities. The MRL should be

built so that it can fit inside current aircraft or carried smoothly as an exterior load.

The effectiveness of multiple rocket launcher fire seems to be much less when compared to other conventional means of indirect fire. The round to round dispersion and system delivery accuracy of the rocket may preclude adequate density of lethal fragments. In this it would probably not be worth the effort to precompute firing data and expend a large amount of time coordinating this type mission for such a low payoff in effectiveness on the target. It is also extremely doubtful that adequate fire control for accurate predicted fire could be established in a relatively short time.

The relatively small diameter of the rockets precludes packaging of many submunitions which would greatly enhance the effectiveness of the system. Also rearming may create some problems.—Ed.

Lower prices for calculator and cradle

We enjoyed your articles on the TI-59, PC-100C, and custom module applications for the Army Artillery. Our company, Government Marketing Services, Inc., was deeply involved in the development of this custom module for the Artillery.

On page 49 of your May-June issue, your pricing information is, however, incorrect. The new pricing for these models are: TI-59 (NSN 7420-00-T69-3395) \$224.95, PC-100C (7420-00-T68-6738) \$159 (PC-100C is an updated version of the PC-100A).

Frank M. Cohen
Executive Vice President
Government Marketing Services, Inc.

Thank you for the update on current prices. With costs what they are today, it's amazing that some items have actually gone down instead of up, and up, and . . . Ed.

More on "who shot more"

To date, two claims have been placed by Field Artillery battalions for the most artillery rounds fired by a battalion in Europe during World War II. The 87th Armored Field Artillery Battalion (March-April 1979 *Journal*) claimed 191,762 rounds. The 93d Armored Field Artillery Battalion (July-August 1979 *Journal*) claimed 235,855 rounds of 105-mm ammunition fired.

In an effort to continue to update the records, I would like to submit the following data as quoted in the historical log of the 151st Field Artillery Battalion (now a National Guard 105-mm FA battalion in the 47th Infantry Division in Minnesota).

The 34th Division Artillery, of which the 151st was a part in WW II, probably holds the record for the US Army in World War II in the amount of artillery thrown at the Axis forces.

Indicated below are the number of rounds fired by each battalion in the 34th in various campaigns:

Unit	Tunisian	Naples-Foggia	Rome-Arno	North		Total
				Appennines	Po Valley	
125	30,328	30,938	147,620	54,993	38,368	302,247
151	10,430	51,573	132,670	87,915	38,393	320,981
175	45,000	42,706	94,580	92,894	40,496	320,981
185	16,100	29,162	60,139	49,510	18,549	173,460
						1,112,364

Not counting the Tunisian Campaign (North Africa), the 151st Field Artillery fired 310,551 artillery rounds in Europe in WW II.

Also on 16 April 1945, the 151st FA Battalion reported 7,213 rounds expended, and on the following day, the 175th FA Battalion reported expending 7,215 rounds. These also, it is believed, were the biggest expenditures ever made in a like period by one battalion.

David W. Larson
MAJ, FA, MNARNG
St. Paul, MN

Can anyone top this?—Ed.

Training and indoctrination of the Soviet soldier

by CPT Richard L. Dean

The enormous manpower necessary to man the Soviet Union's armed forces is provided through a system of universal military service. The constitution of the Union of Soviet Socialist Republics (USSR) of 1936 as amended states that military service is a law and that it is the duty and honor of every citizen of the USSR to serve in the armed forces. Prior to 1967, the law required all 18-year-olds to register, and at age 19 a portion of these young men would be drafted to fill necessary quotas in the armed forces. They would then serve in the Army or Air Force for three years or the Navy for four. The law was changed in 1967, apparently to allow more manpower to be trained in the civilian economy. The new law reduced required length of service in the Army and Air Force to two years and the Navy to three years. Additionally it lowered the conscription age from 19 to 18 and instituted a mandatory pre-induction training program. The pre-induction training program was presumably to take the place of the year of active duty lost under the new law.

The military training that the Soviet citizen currently receives before and after his induction into the armed forces has basically three features: repetition, physical training, and political indoctrination. In comparison, the military training received by an individual in the United States can be said to have similar segments; however, political indoctrination is obviously not stressed as heavily as in the USSR.

The 1967 Law of Universal Military Science made pre-induction military training compulsory for Soviet youths in the two years prior to call-up. This training was to be conducted in all secondary schools, institutions, enterprises, organizations, and collective farms under the leadership and responsibility of the USSR



Ministry of Defense and the All-Union Voluntary Society for Assistance to the Army, Air Force, and Navy (DOSAAF). DOSAAF is an organization that is open to all citizens of the USSR 14 years of age or older. Ever before 1967, DOSAAF had set up training points to help prepare Soviet youth for military service. To provide funding, DOSAAF publishes a newspaper, *Sovetskiy Patriot*, and several magazines, charges membership dues, and conducts two lotteries annually.

The pre-induction training program consists of 140-hours, spread over approximately two academic years. Generally, this program includes the following:

- Learning the mission of the armed forces.
- Acquiring a good knowledge of regulations automatic weapons, light machineguns, and grenades.
- Practicing firing of weapons.
- Acquiring a military technical speciality, such as driver, motorcycle operator, radiotelephone operator, or electrician.



The DOSAAF specialist training not only prepares youths for specialties in military service but also provides technically trained persons for the civilian work force. In the summers, the pre-induction training program is supplemented with camps lasting 10 to 15 days. In these camps, registered draftees undergo extensive field training, while adhering to strict military regulations. Together with these summer camps, the pre-induction program prepares draftees physically and psychologically for service in the armed forces and makes it easier for them to become accustomed to the army environment and strict discipline. The pre-induction training program has several other advantages besides preparing conscripts for services in the armed forces:

- Since pre-draft youth can enter officer candidate schools, the program provides some incentive for the procurement of junior officers.
- Those who do not get drafted have received some military training in case an emergency arises.

- The program provides employment for reserve officers to continue their military activity as a civilian.
- This training embeds in the youth population military-patriotic sentiments and Communist Party discipline.

The Soviets consider the pre-induction training to be of great value; however, the military may debate its equal value to the one year of active military service lost under the 1967 Law of Universal Military Service.

The Soviet conscript is called up during one of two draft periods: May-June or November-December. About two weeks are required for this call-up procedure and for new soldiers to become familiar with military life. At this time, the new inductee is sworn in in an impressive ceremony where he kneels and speaks the following oath:

I, a citizen of the Union of Soviet Socialist Republics, take, by joining the files of the armed forces, an oath and solemnly swear to be an upright, brave, disciplined, vigilant soldier, to strictly preserve military and government secrets, and to execute, without contradiction, all military regulations and orders of commanders and superiors. I swear to learn conscientiously the trade of war, to protect with all means the military and people's property, and to be devoted to my people, my Soviet homeland, and the Soviet Government to my last breath. I will always be ready to report by order of the Soviet Government as a soldier of the armed forces for the defense of my homeland, the Union of Soviet Socialist Republics. I swear to defend it bravely and wisely with all my strength and in honor, without sparing my blood and without regard for my life for the achievement of a complete victory over the enemy. Should I break my solemn oath, the severe penalties of the Soviet Law, the overall hatred, and the contempt of the working masses may strike me.

The oath and the ceremony are obviously designed to impress upon the young soldier the importance of his duties and obligations as a member of the armed forces.

The new recruit then spends the next two months in basic training (an extension of his pre-military training), which includes political indoctrination; tactical, small arms, NBC, and engineer training; study of regulations; drill; sport training; military topography; and first aid. In some cases, the pre-military training is equated to about one month of active duty, which allows the basic training period to be reduced to one month or less. If a recruit was given extensive specialist training, such as that given a motor vehicle driver, he may be sent immediately to a regular unit where he receives further on-the-job training. As in the United States Army, there may be instances where a recruit was trained in one speciality and then sent to a unit where that speciality is not applicable, thus forcing the recruit to be retrained in a required speciality within the unit.

The training Soviet soldiers receive at the unit

remains basically the same from year to year with changes made only when new equipment is introduced. Since the draft call-up is twice a year, the training program is actually repeated every six months. Each six-month period is further divided into cycles which cover training of crews, squads, platoons, companies, and battalions. (Approximately 75 percent of the time is devoted to individual and platoon level training.)

A key word in the Russian language which relates to training is the term "navyk" which translates to the word "habit." In actual practice, as can be seen by the amount of time allotted, the Soviet system of training revolves around repetition; in other words, repeat until the task becomes second nature.

The total number of duty hours a Soviet soldier serves each day remains the same in winter and summer. The training day consists of approximately six hours of military



training with an additional amount of political indoctrination. Meals are not more than seven hours apart with a 30-minute break after the noon and evening meals. Eight hours a day are set aside for sleep. The following is a typical daily training schedule.

- 0600-0605 Reveille
- 0610-0630 Calisthenics
- 0630-0650 Morning hygiene
- 0650-0720 World political highlights (or inspection)
- 0725-0755 Breakfast
- 0800-1350 Training period
- 1400-1440 Lunch
- 1440-1510 After-lunch break
- 1510-1530 Cleaning weapons and equipment
- 1530-1830 Political training (Monday and Thursday)
Care of military equipment (Tuesday and Friday)
Sports and cultural activities (Wednesday and Saturday)
- 1830-1940 Study
- 1940-2010 Supper
- 2110-2140 Free time
- 2140-2155 Roll call and evening walk
- 2200 Taps

This rigorous training schedule is used not only for training new recruits but also for all personnel in the Soviet armed forces. Saturday training is a bit shorter to allow for maintenance of personal equipment. Sundays are devoted entirely to organized athletics in which

participation is mandatory. The "free time" seen in the training schedule cannot be equated to what we think of the term since activities are planned for them by either the commander or the political officer. According to the Soviets, the soldier should spend much of this time enriching himself spiritually, extending individual horizons, and furthering his aesthetic education, such as reading books which deal with heroic and patriotic subjects, military subjects, and army comradeship. To further their aesthetic education, commanders organize meetings with art workers and attend theatrical performances, art museums, and war memorials. The Soviets believe that this aesthetic culture largely underlies the understanding of a soldier's patriotic duty and the ideals of communism, which, in turn, directly or indirectly affects a soldier's training and service.

The Soviet military training appears to be much more strenuous than that of the West. This is possible because the soldier has few wants and has been conditioned to hardships by the combination of the realities of civilian life and pre-induction military training. In combat training, oral orders are required and unquestioned compliance is expected. This tends to differ a great deal from the American soldier's need to understand "why" he should carry out the directives issued. The Soviet soldier's unquestioned compliance to orders and the requirement for an order to act upon may inhibit the personal initiative of the NCO and young officer which,



in the heat of battle, is necessary when lines of communication sever between them and their commanders. The soldier is trained to react instinctively in combat by repetitive training in the use of his individual weapons, field engineer work, construction of field fortifications, and camouflage procedures. He is frequently confronted with simulated situations of chemical, biological, and radiological warfare. Cold weather training is emphasized with long forced marches and combat training in the harsh tundra climate. These individuals are basically trained to fight without regard to human life—their own or others.

The Soviets make extensive use of simulators in combat training which allows intensive training with negligible wear and tear on actual equipment. There are, however, some obvious training losses with this system. For example actual tank driving skills are not taught. By not operating the actual pieces of equipment, there would obviously seem to be a lack of familiarity with the actual equipment the soldier will be using in combat to include solving maintenance problems.

Since Soviet tactics stress a strong continuous attack, physical training has been a very integral part of the USSR program. The physical training in the Soviet Union is a two-stage process:

- The first stage begins in the civilian sector with children at age 10 and continues throughout life. This stage is referred to as "Ready for Labor and Defense" (Gotov k trudu i oborone) or simply the GTO program, designed to maintain the physical fitness of all citizens of the Soviet Union. When the period of military services was reduced in 1967, the GTO program was intensified for youths between the ages of 16 and 18 to prepare them for the rigors of military service. Some of the activities of this program include forced marches, ski races, cross-country races, and orientation.

- The second stage of physical training is the "Military Sports Program" (Voyenno-sportivnyy kompleks - VSK) which is designed to supplement the standard PT programs and better prepare the soldier for the rigors of combat. Soldiers participate in team sports activities in two-hour training sessions once or twice weekly. In addition to these team sports activities, the unit commander is responsible for the normal PT program in his unit. This program basically encompasses 12 hours of PT training per month (6 hours of gymnastics and 6 hours of obstacle crossing and jogging) in addition to the daily morning exercises. These sports activities and unit PT programs provide excellent vehicles to develop the speed, agility, and endurance required for Soviet combat training.

To the Soviets, psychological conditioning of the soldier is equally as important as the physiological conditioning process. Political education classes

represent one kind of ideological education of Soviet soldiers. These classes are the primary responsibility of the political officer in the unit, with assistance provided by the unit commander. The political information classes are to promote ideological conviction, devotion to the Motherland and the people, patriotism, internationalism, fidelity to the oath of allegiance, discipline, and vigilance. The goal is to produce soldiers who are thoroughly trained in Communist dogma and who have the determination to die for their political beliefs. These two-hour political information classes are held twice a week by political officers who explain the current events, familiarize personnel with orders from superiors, and explain the tasks of combat training and political indoctrination. The psychological preparation for war is oriented around four main premises:

- War might start any time.
- Soviet victory would be easy and swift.
- There would be few casualties.
- The Soviet soldier is the best in the world.

The Soviet soldier is convinced through persuasion that the West may attack at any time and it may be necessary for the Soviet Union to attack first in self-defense. Political officers convince their soldiers that a war with the West will end quickly because the Soviet cause is righteous and that the Soviet soldier is the best fighter in the world. The American soldier is represented as a spoiled boy, wearing a handsome uniform, but lacking in fighting spirit or resoluteness.

Propaganda is another form of ideological training widely used. The Soviet soldier is bombarded with propaganda through radio broadcasts, newspapers, lectures, discussion groups, films, television programs, and books. Another method used is participation in cultural activities. The soldier is allowed to reaffirm his Russian heritage through such activities as field trips, celebrations, parades, and performances. Other activities include question and answer evenings, young men's forums, quizzes, and amateur theaters. As can be seen from this discussion, political supervision and control of the military is very pronounced and the soldier is therefore largely immune to outside political influences.

The Soviet soldier as described in this article will be a tough opponent and accustomed to hardships, but he is no superman. The Soviet system does not encourage him to seek responsibility or take the initiative when the situation warrants. He is expected to only execute orders with blind obedience. Due to this lack of initiative, the Soviet soldier may become, to a certain extent, less effective in a future offensive situation. 

CPT Richard L. Dean is assigned to the 1st Battalion, 36th Field Artillery.

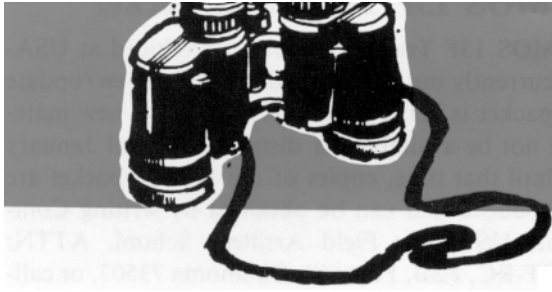

View From The Blockhouse

notes from the school

Calibration requirement

FM 6-40 indicates that calibration should be accomplished annually for any weapon in service. "In service" does not mean active or reserve, it means "not in storage." If the weapon is being fired, cleaned, and serviced, it should be calibrated at least annually to determine what change in velocity has occurred.

Reserve units then should experience minor changes in velocity while active units must keep a closer watch on calibration requirements. If considerable firing takes place, recalibration may be needed more often than annually as is shown on page 7-2 of FM 6-40, 1 December 1978. (SFC Ives, GD)

Battery Computer System update

The Battery Computer System (BCS) Development Acceptance In-Process Review (DEVA IPR) was held at Fort Monmouth, NJ, 14 August 1979. Recommendations to the Department of the Army were:

- Enter production of the BCS with correction of deficiencies no later than six months after contract award.
- BCS type classification standard.

Production model testing in laboratory and operational environments will be conducted during 1980-81. The BCS is scheduled for deployment commencing February 1982.

Naval gunfire: danger-close procedures

The Field Artillery School has received numerous inquiries from the field concerning the parameters governing danger-close procedures for naval gunfire.

The size of the naval gun being used in the adjustment determines the point at which danger-close procedures are entered.

As defined in Chapter 7 of FM 6-30, 1 August 1978, danger-close procedures are entered if the adjustment will cause the expected impact of the round to be within 750 meters for 5-inch guns and 1,000 meters for 6-inch and larger guns. (SFC Ives, GD)

Fire Suppression Symposium

A two-day Fire Suppression Symposium hosted by the Directorate of Combat Developments was held recently at Fort Sill. The purpose was to arrive at a unified approach for studying the suppressive effects of fires on the modern battlefield. Key individuals possessing a wide range and depth of experience in both hard and soft areas that encompassed the suppression phenomenon were invited. A total of 50 individuals participated in the five work groups with approximately 40 members being from the civilian and military analytical community outside Fort Sill. These 40 members represented some 28 military and civilian organizations.

An address by the Commandant, MG Jack N. Merritt, opened the symposium which was divided into three half-day sessions. The first morning was devoted to formal presentations by four participants whose organizations had studied suppression extensively, as follows:

- Mr. Clifford J. Landry—Methodology for Quantifying the Suppression Effects of Artillery.
- Mr. Roger Willis—Suppression in the TRADOC.
- Dr. Marion Bryson—Suppression testing.
- Mr. Paul Kunselman—Suppression modeling with data from Yom Kippur War.

The second session began with a presentation concerning Suppression of Enemy Air Defense (SEAD) by the United States Air Force representative, LTC Kenneth Redding, followed by a brief discussion to arrive at a consensus definition of "suppression." The consensus definition was: "Suppression is the process of temporarily degrading unit or individual combat performance through psychological and physical means." The symposium members also decided that within the framework of the definition and the limited amount of time allotted that the focus of the five work groups would be on the *direct fire* and *indirect fire* aspects of suppression; *electronic warfare*, *psychological operations*, and *obscuration* were considered. The symposium members then separated into their five designated work groups, centering attention on their specific topic areas as follows:

View From The Blockhouse

- Work Group I—Suppression variables (effects).
- Work Group II—Suppression variables (causes).
- Work Group III—Data base requirements.
- Work Group IV—Suppression modeling.
- Work Group V—Suppression/countersuppression combat and training developments.

Later that evening, symposium members heard a presentation about human behavior in combat by COL Trevor N. Dupuy.

The third session was held on the second day and the members were again in work groups. "Crossfertilization" between groups was made possible by providing each group member a copy of what transpired in each work group the previous day. Also, the groups were honored by the active participation of GEN (Ret) William DePuy, LTG (Ret) Walter Kerwin, and MG (Ret) Vernon Lewis. After the third session, all adjourned to the Combined Arms Room in Snow Hall where each work group leader presented a summary of his group's efforts.

Ground work was laid for a coherent approach to achieving a unified method for study suppression. Proceedings of the symposium will be published, and an action plan will be written to follow through on the ideas generated during the working sessions.

Reorganization of DCD

The Directorate of Combat Developments, USAFAS, has recently been reorganized in an effort to better carry out responsibilities inherent with the Training and Doctrine Command's (TRADOC) missions concerning materiel development, doctrine development, and force structuring. The following diagram highlights this reorganization:

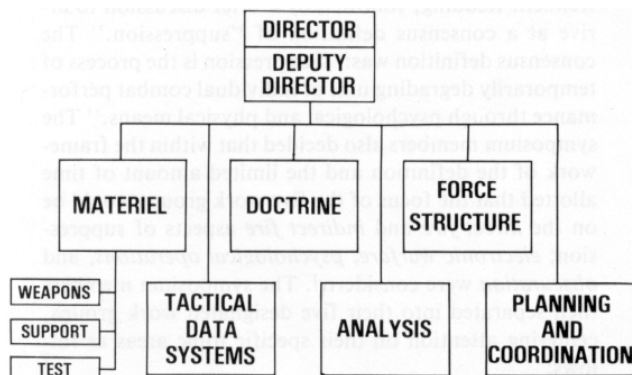

MOS 13F Transition Packet

The MOS 13F Transition Packet produced at USAFAS is currently out of print. An annual review/update of this packet is being conducted; however, new material will not be available for distribution until January 1980. Until that time, copies of the 1978-79 packet are being produced and can be obtained by writing Commandant, US Army Field Artillery School, ATTN: ATSF-CT-RC, FSB, Fort Sill, Oklahoma 73503, or calling Mr. Max Howard AUTOVON 639-1406.

FIST of the future

Much has been said and written about the fire support team (FIST) concept since its approval in June 1977. Efforts of the TRADOC-directed Close Support Study Group I in developing the FIST concept have paid dividends in increased fire support at the company level. The consolidation of mortar and field artillery observers into a cohesive and highly trained fire support organization, responsible for fire support coordination and employment of fire support assets available to the maneuver force, was a vital step in optimization of limited fire support resources.

Most will agree that the FIST concept is sound, but there have been some problems. Personnel and equipment shortages have prevented the full realization of FIST capabilities as a fire support organization. Despite growing pains, the FIST concept of integrating fire support has matured as a fire support organization that can greatly assist the maneuver company commander.

A concern now however is "What about the FIST of the future?" The introduction of automated data systems, laser designation devices, and precision guided munitions into the Army inventory requires an in-depth review of the ability of the FIST and other fire support organizations to effectively manage and integrate these systems/equipment into the battle.

Recognizing present "fine tuning" and future FIST problems in aligning new technologies, manpower needs, and doctrine, the Commandant, USAFAS, initiated action to convene Close Support Study Group II (CSSG II). Chaired by COL John E. Donohue, the Director of the Tactics/Combined Arms Department, USAFAS, CSSG II is composed of members from the Infantry, Armor, Aviation, Field Artillery, and Signal Schools. This study group is focusing on a front-end analysis of FIST and fire support element (FSE) organizations, paying close attention to how the FIST/FSE will accomplish their missions for the supported maneuver forces. The entire fire support function is being examined from the brigade fire support officer (FSO) to

the forward observer within the FIST. Other major areas of research include: manning levels, equipment needs/deletions, voice and digital communication, fire support for air maneuver units, integration and development of procedures for digital communications and laser acquisition devices, FIST R³ (Robustness, Resiliency, and Redundancy) and fire support requirements for Division '86, the army study for the heavy division in 1986.

Initially, CSSG II examined the current FIST organization and identified the "fine tuning" needs. Before new equipment could be introduced into the FIST, the team itself needed to be correctly organized and equipped to perform its current duties. Field comments from units with FIST experience, SCORES data, battle gaming, and professional judgment of the study group members assisted in the development of optimal FIST organizations to support the respective maneuver forces. With this type of foundation, CSSG II

then weighed the impact of new technology, such as TACFIRE, on the functions and duties of the FIST and developed FIST organizations which incorporated the best operating procedures in the digital world. CSSG II continued in this direction, culminating with the mid-1980 time frame and the integration of laser and digital technology into the proposed FIST organization.

Presently, CSSG II is completing its study of fire support within the brigade. The report will be forwarded to MACOM for concurrence in late 1979.

The efforts of Close Support Study Group II will have a marked impact on the future development of the FIST concept and fire support in general. The recommendations of this group should provide the roadmap and direction that fire support will take in the future, to include continuous refinement of fire support teams to accommodate new equipment, munitions, and operating procedures. (MAJ Feret, TCAD)

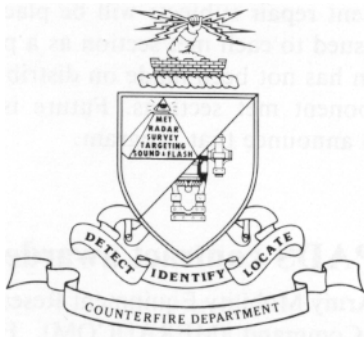

COUNTERFIRE SYSTEMS REVIEW

PADS at CFD!!!

The Counterfire Department (CFD) recently received a Position and Azimuth Determining System (PADS) on loan from the developer to train key instructor personnel and conduct an informal system evaluation. CFD will receive six of the first production models in early FY 80 while delivery to field units is programmed for the second quarter of FY 81. The PADS will be operated by an 82C20 E5 and driven by an 82C10 E3. The system can move as rapidly as the weapon system it supports and has an all-weather capability.

The first KIP/NET (Key Instructor Personnel/New Equipment Training) course was conducted during the

week of 10-14 September 1979, and additional courses will be conducted periodically until CFD receives the six PADS production models. Institutional training will begin approximately 90 days after receipt of the six systems to provide trained PADS operators to the field prior to initial unit issue of equipment.

CFD began an informal system evaluation on PADS in September and will continue through December 1979. Results of the evaluation will be used to establish future doctrine for field artillery survey and accuracy criterion for PADS. The evaluation will also determine whether PADS can consistently meet fourth-order survey accuracies. The test will utilize a scenario incorporating all requirements of a division artillery survey plan to include firing units and target acquisition agencies. The system will be evaluated in the scenario in three configurations utilizing PADS mounted in a ¼-ton M151 jeep, the OH-58 helicopter, and the CH-47 helicopter. For tests with the CH-47, PADS will be mounted in the M151, initialized over a survey control point and loaded into the helicopter for airlift to an area requiring survey control.

PADS represents the greatest technological advancement in the history of field artillery survey. CFD welcomes any input on the system evaluation or additional uses for the system. Please contact evaluation directors Mr. Jim Alexander (AV 639-2805) or Mr. Herb West (AV 639-1108) at the Counterfire Department, USAFAS. Think PADS!!!

View From The Blockhouse

New computers for sound/flash platoons

Of the training problems associated with manual processing of sound ranging and flash ranging data, the two most significant are reading sound ranging records and processing data.

For example, when the sound ranging tape becomes cluttered with signals from a number of weapons firing simultaneously, it is very difficult to determine which signals were caused by the firing of a given weapon. In this situation the following procedure is required:

- The record reader must determine times of arrival for three microphones while a computer determines time differences.
- A plotter constructs the two rays on the plotting chart and reads the approximate times of arrival for the other microphones.
- The sound ranging personnel then compute time intervals, determine and apply weather and curvature corrections, and plot the corrected time intervals on a previously prepared plotting chart.
- The coordinates of the location are then read from the chart and reported to the div arty TOC.

This procedure (to be changed in the near future) is obviously time consuming and requires many weeks of training for personnel to become even marginally proficient.

Currently there is an effort underway to program the Hewlett Packard 9825 calculator with its cathode ray tube (CRT) to process the times-of-arrival input data and display the resulting plots on the CRT. This will speed up the process significantly and eliminate the need for manual processing. Additionally the operator can enter the approximate location of a weapon, as reported by the observer, and the time of arrival at any one of the microphones and the calculator will print out approximate times of arrival at the other microphones.

The HP-9825 will have the following programs:

- Sound ranging.
- Sound-on-sound adjustment.
- Sound ranging visual met message.
- Flash ranging.
- Flash adjustment.
- Polar to rectangular coordinates (data obtained using the M65 BC scope and the GVS-5 laser Rangefinder (to be fielded in FY 80).
- Self location by trilateration.

The HP-9825 calculator (to be fielded in FY 81), supplemented with the TI-59 programmable hand-held calculator (which has been programmed to process sound and flash ranging data), will eliminate the need for manual processing of data and record reading. These

improvements will greatly simplify the training problem while allowing the field artillery to acquire targets more quickly.

TV tapes on repair of met equipment

By January 1980 all Active Army Field Artillery meteorological (met) sections will be issued a set of seven TV tapes on repair of meteorological equipment. The TV tapes are being developed by the US Army Field Artillery School to enable met crewmembers and repair personnel to review maintenance procedures not now readily accessible.

For example, a malfunction of a paper advance assembly for the AN/GMD-1 control recorder can result in significant down time while awaiting repair. The TV tape will show a malfunction of the paper advance unit and talk the mechanic through disassembly, inspection, repair, reassembly, and operational adjustments.

The TV tapes should be a major aid in maintaining operational capability of the GMD-1. This library of met equipment repair subjects will be placed on seven tapes and issued to each met section as a package.

A decision has not been made on distribution to Reserve Component met sections. Future issues of the *Journal* will announce that program.

PADS contract awarded

The US Army Mobility Equipment Research and Development Command (MERADCOM), Fort Belvoir, VA has awarded a \$43 million contract to Litton Guidance and Control Systems for production of the Position and Azimuth Determining System (PADS).

The PADS contract covers production of 99 systems during a three-year period—nine systems the first year, 30 systems the second year, and 60 systems the final year. Under the terms of the contract, Litton will also conduct engineering design of system hardware and software, develop test equipment, and revise the user handbook.

PADS will provide the Army with a mobile all-weather accurate field artillery survey system that can be used at battery, battalion, and division levels. Although its primary mission will be for jeep-mounted field survey work, PADS can be transferred from a jeep to a helicopter with no loss of survey. The system is designed to work at all vehicle speeds, whether on wheels or airborne. The system will improve mobility of the field artillery by permitting survey operations to keep up with today's faster moving weapons.

The Modern Battlefield BOC

by CPT Lonnie A. Veldhouse

By doctrine and TOE, an M561 gama goat is authorized for use as the field artillery firing battery operations center, more commonly known as the BOC. The BOC serves as both the battery command post and the alternate fire direction center. Additionally, it must perform a multitude of other duties, ranging from convoy escort to personnel transportation, if the battery is to move, shoot, and communicate as required by its mission. As doctrine evolves to cope with the requirements of the modern battlefield, the BOC is destined to play an increasingly important role in fire support operations. For this reason, the importance of a well-organized battery operations center, designed to effectively perform a variety of tasks, cannot be overlooked. It is unfortunate that very little information or guidance has been published describing how this can be accomplished. Culminating a 23-month research program, I would like to offer some suggestions toward the production of an effective BOC shelter design for use on the M561 carrier.

As issued, the gama goat is poorly configured and inadequately equipped to perform BOC-related missions in a hostile, around-the-clock, all-weather environment. Developing this vehicle into an effective battery operations center capable of sustained operation is a problem that has plagued battery-level artillerymen since the concept was officially introduced over four years ago. Wooden shelters have been constructed to go on the carrier portion of the gama goat, but little effort has been expended to develop these structures to more effectively satisfy the requirements associated with sustained, full-capability fire direction operations. The key question revolves around whether the battery operations center can fulfill the critical fire direction mission if the FDC is destroyed or not available. After visiting 26 other Europe-based artillery firing batteries in search of an answer to this question, here are my findings:

- Two BOCs could not perform the role of alternate FDC because of equipment shortages; i.e., no dedicated FDC equipment for use in the BOC.

- Twenty-three BOCs satisfied minimum operating requirements, but 14 of these still required the transfer of certain items of equipment from the FDC (RDPs, GFTs, GSTs, TFTs, and plotting equipment).

- One shelter was organized and equipped to perform sustained fire direction operations. It was evident that the unit commander had emphasized the full development of this capability.

Based on my observations, improper organization and poor design/construction are the two most critical factors that influence BOC performance. While organization is a problem that units must address internally, we all can assist in the solution of the design/construction problem.

Construction

The BOC finished structure must be sturdy, durable, lightweight, and waterproof—over 60 percent of the structures analyzed failed to satisfy these requirements. The gama goat is an exceptionally rough riding vehicle, even when operated on hard-surface roads. As a result, a poorly constructed shelter will not survive the rigors of vehicle operation for any appreciable length of time, necessitating the expenditure of additional building resources at an early date. To improve structure durability, the use of wood screws (instead of nails) and wood glue (in conjunction with screws) between mating surfaces should be considered. Materials that provide the proper balance between strength and weight should be selected and procured early to eliminate delays and shortcuts in case needed material is not immediately available.

Construction must be simple and straightforward so that a minimum of special tools and materials will be required. If possible, materials obtainable through normal supply channels should be used. Further, all construction operations must be accomplished using the hand tools provided in the battery carpenter's tool kit—difficult operations must be avoided.

The interior layout must provide sufficient space for the conduct of sustained, full-capability FDC operations. The BOC must be capable of performing as the alternate FDC for extended periods of time; therefore, all materials needed to accomplish this mission must be readily available at all times. A slanted firing chart/FDC equipment storage cabinet configuration is recommended since it provides a securable storage location for required forms and equipment while promoting effective space utilization.

Lighting

A well lighted working environment is essential to an around-the-clock operational capability. Personnel must be able to read the detailed map and perform fire direction computations.

A switch blackout (BO) lighting system must be incorporated in the design to facilitate continuous operations when the rear door is open at night.

All seams and structural joints must be properly sealed to prevent light leakage during normal operation at night.

Communications

The BOC must be capable of monitoring two different radio frequencies in order to function as a viable command post and alternate FDC. FM 6-50 (June 78) depicts the mounting of an AN/VRC-47 radio system in the BOC; however, based on different TOEs, two AN/VRC-46 systems could be mounted. It is recommended that the KY-38 encryption device also be mounted in the battery operations center. There are two advantages associated with this configuration:

- Reports and messages can be dispatched without disrupting the FDC during the processing of fire missions.
- Sensitive messages are directed to the battery command element in the most expeditious manner possible.

Note: *If two KY-38 sets are available, one should be mounted in the BOC and the other in the FDC.*

The communications system must include a remote control capability to insure that the vehicle commander can maintain continuous communications while moving. Unless communications are remoted to the front seat area, the vehicle commander (normally the battery commander or executive officer) cannot keep abreast of the tactical situation. (This is particularly important during peacetime convoy operations when the BOC must be utilized as a convoy escort vehicle.) The AN/VIC-1 intercom system, employing two CC-2298 control boxes, is used to provide this essential communications link. Because of the high engine noise levels associated with normal vehicular operation, one H-161/U headset-microphone assembly should be used

in conjunction with each control box.

An RC-292 antenna mount, similar to the one on M577 carriers, should be fabricated and mounted on the rear of the vehicle to facilitate the establishment of long-range communications during offset and split battery "shoot and move" operations. It is provided for short term use only, after which the antenna must be properly remoted and erected in the normal manner.

External wire connections must be provided to facilitate the connection of field wire and DR-8 circuits. This feature alleviates the routing of wires through the door jamb where they can be tripped over or cut. Two separate circuits should be provided—one for intrabattery communications and another for battalion or outpost line communications. Terminal post connections and DR-8 plug jacks should be utilized for added versatility.

Storage

Adequate securable storage space for all personal and mission-related equipment are requisite aspects of effective shelter design. The rough ride of the M561 can make a deadly missile of any loose equipment laying inside the carrier. Securable storage containers/areas and strapped equipment mounts, capable of restraining equipment even when traversing the roughest terrain, are required to prevent personnel injury and equipment damage.

The shelter must furnish the maximum amount of uncluttered floor, fender well, and side wall area to provide sufficient space for the safe transport of up to 10 fully equipped personnel (advanced party operations). Further, the floor and sidewalls must be free of protrusions that might hinder standing, sitting, or rapid entrance/exit. The relocation of the fender-mounted radio equipment was necessitated by this constraint.

Design

The design must insure that all required preventive maintenance checks and services can be performed without hindrance so that a high level of combat readiness can be maintained. Additionally, shelter construction must not degrade the readiness reported condition of the vehicle.

The entrance to the BOC must be securable to deter theft and vandalism and provide a safe storage for FDC forms, records, reference manuals, on-vehicle material, etc.

The structure must provide a safe environment for the conduct of all battery operations center missions.

To present the shelter design in the clearest, simplest format possible, design details are depicted using drawings of the finished product (figures 1 through 4). Dimensional information is provided only when essential;

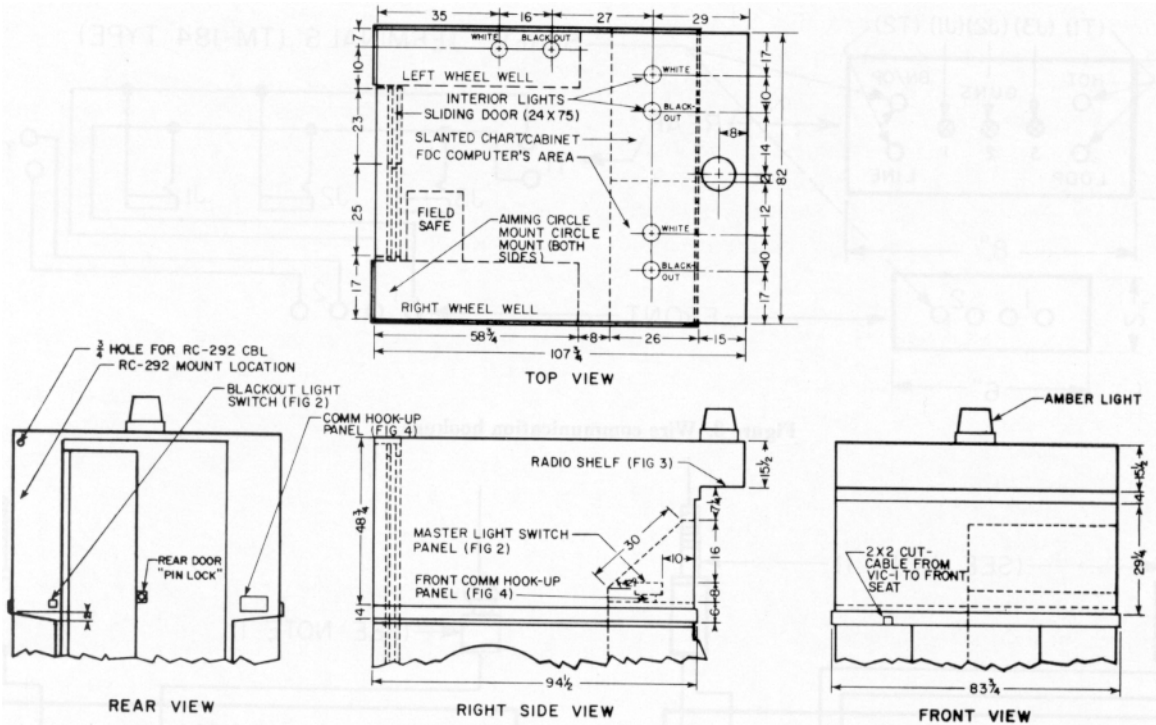

Note: All dimensional information is based on the use of three-fourth inch plywood on the exterior surface of the shelter.

Figure 1. General layout.

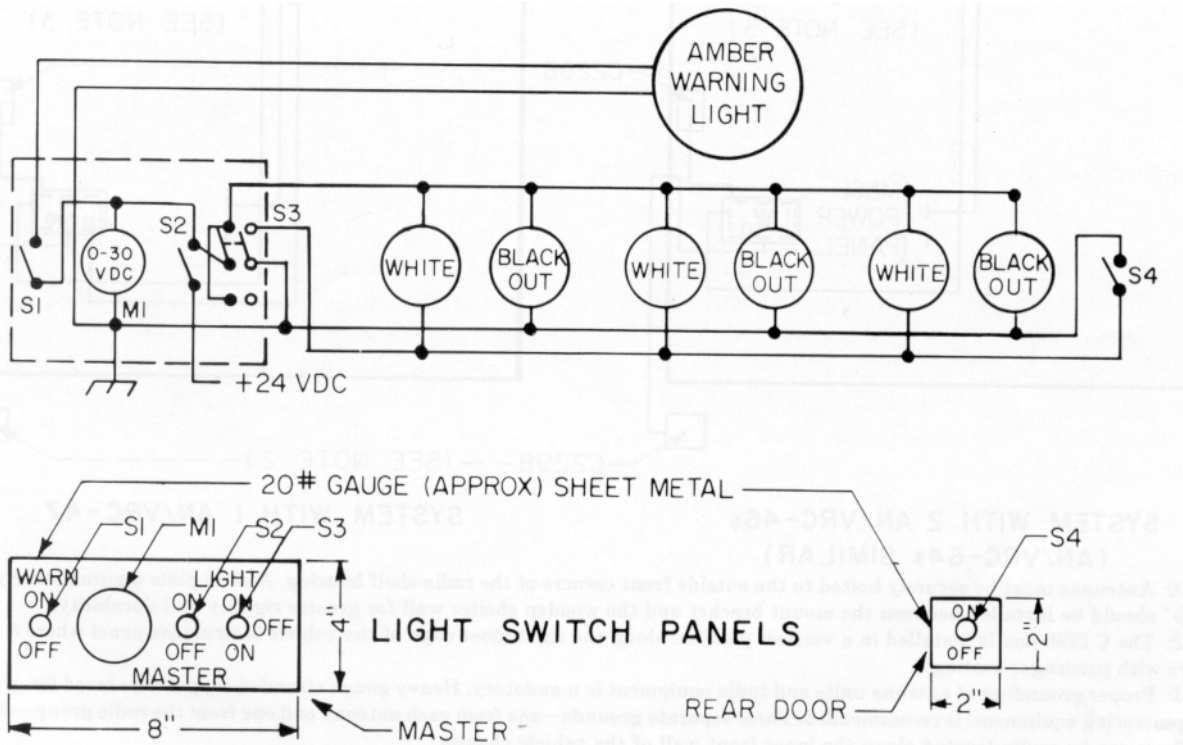

Figure 2. Interior electrical circuitry.

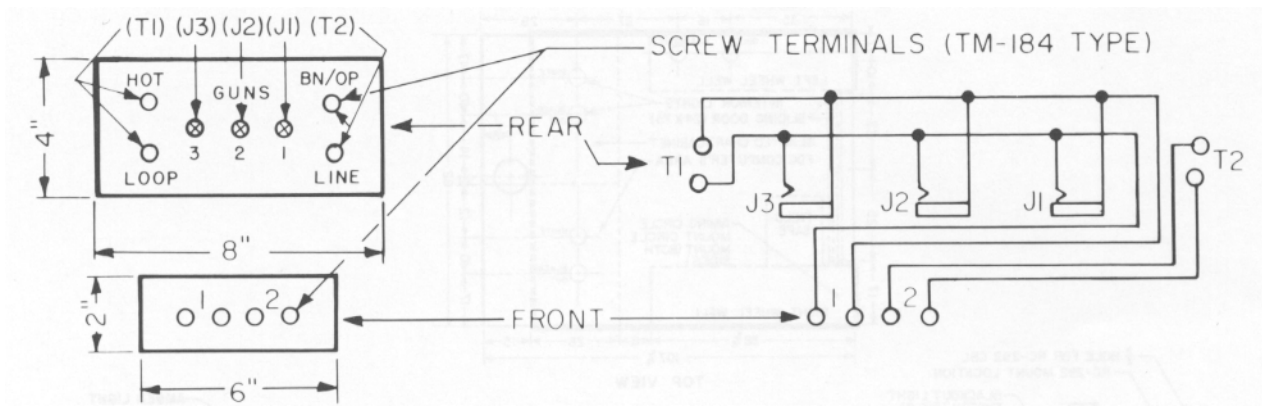
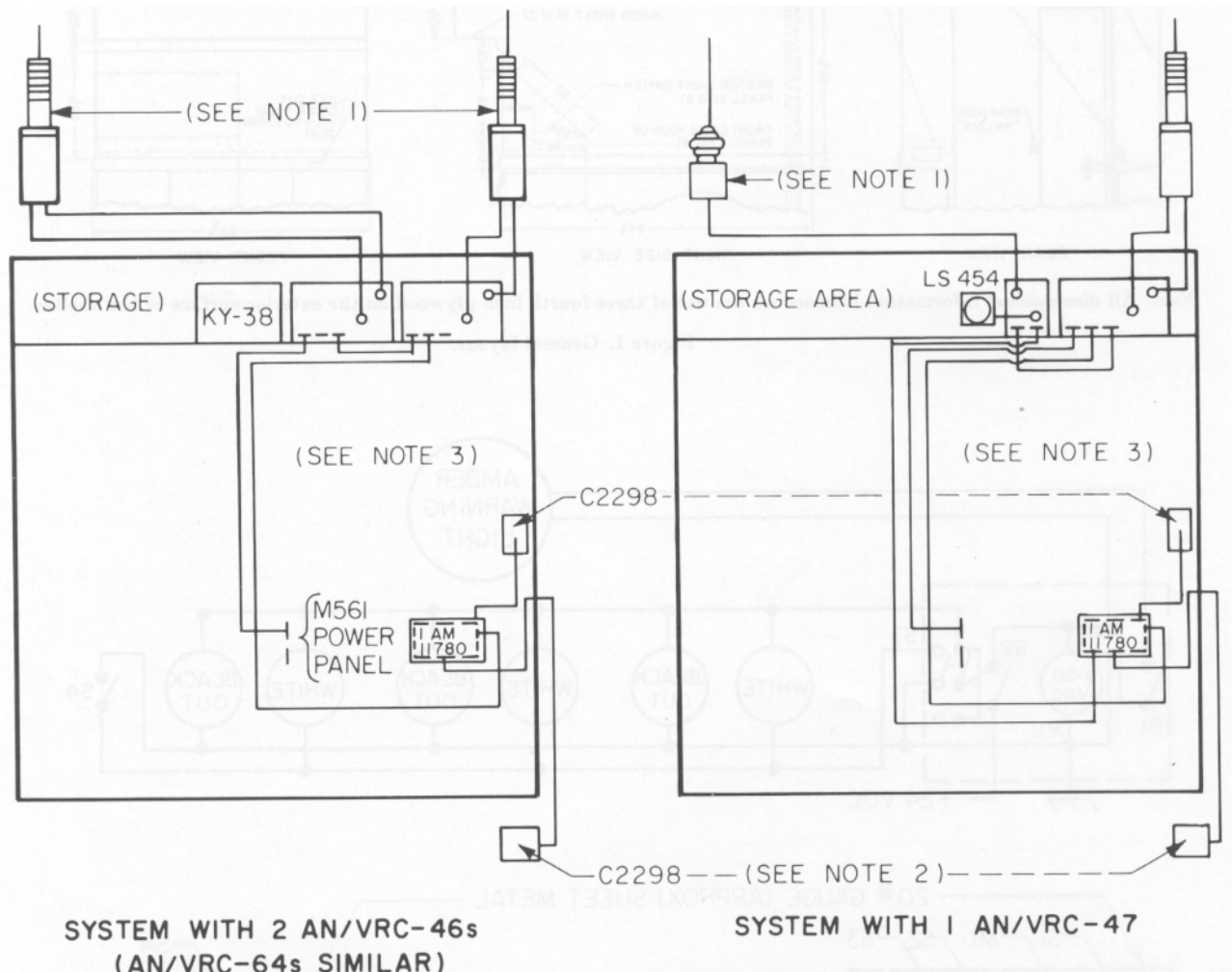

Figure 3. Wire communication hookups.



Note 1: Antennas must be securely bolted to the outside front corners of the radio shelf housing. A steel plate (approximately 1/8" x 7" x 13") should be installed between the mount bracket and the wooden shelter wall for greater rigidity and durability.

Note 2: The C-2298 box is installed in a vertical position along the right-most edge of the vehicle instrument panel where it will not interfere with passenger seating.

Note 3: Proper grounding of antenna units and radio equipment is mandatory. Heavy-gauge stranded copper wire (used for grounding power generating equipment) is recommended. Three separate grounds—one from each antenna and one from the radio group—should be used. These can be easily located along the inner front wall of the vehicle chassis.

Figure 4. Communication configurations.

Use	Material	Dimensions	Qty	Location
Frame	Wood (boards)	2" x 2" x 8"	4	Rear door frame.
		2" x 4" x 8'	25	Base frame, side wall uprights, ceiling and side wall cross beams, FDC work table, rear door frame.
	(plywood)	2" x 4" x 12'	3	Ceiling beams.
		2" x 8" x 12'	3	Rear wall/door framework.
		3/4" x 4' x 8' ADX ¹	1	Rear door (cut in half and glue pieces together.)
	Miscellaneous	1/2" x 4' x 8" x	1	FDC work table, chart cabinet, storage cabinets.)
		48" sliding door track ³	1	Rear door (top slide track). Used during frame assembly.
		Assorted screws, bolts, corner brackets, wood glue		
	Exterior	Wood (boards) (plywood)	2" x 4" x 8'	1
3/4" x 4' x 8' CDX ¹			8	Exterior walls, radio shelf, inside rear wall.
Metal (plate)		1/8" x 7" x 13" ²	2	Antenna mount backing plates.
		(20-gauge sheet: e.g., wall-locker)	4" x 8" ²	1
Miscellaneous		2" x 2" ²	1	Rear door light switch panel.
		Canvas	270 FT ²	Exterior covering.
		Roofing tar	10 gal	Exterior waterproofing.
		Assorted screws, bolts, wood glue		Assembly.
Electrical		Switch, SPST	1	Rear door light switch.
		Jack, plus (PJ-059)	3	Rear comm hookup panel.
	Terminal, screw	4	Rear comm hookup panel.	
Interior	Wood (boards)	1" x 8" x 6" ³	2	Bottom side wall trim board.
		2" x 4" x 8'	2	Chart cabinet, storage areas.
	(plywood)	1/4" x 4' x 8' ADX ³	5	Chart cabinet, ceiling and side wall panels.
		1/2" x 32" x 42" ACX	1	Chartboard.
	Metal (20-gauge sheet)	2" x 6"	1	Front comm hookup panel.
		4" x 8"	1	Master light switch panel.
	Miscellaneous	Hinge, piano 42"	1	Chart cabinet.
		Long Paint, white enamel ³	3 gal	Interior painting.
	Electrical	Assorted screws, electrical staples, tape, solder, wood glue		Assembly.
		14-gauge, 3 cond (type UF) cable	35'	Interior and warning light circuits.
OR				
16-gauge, MIL SPEC electrical wire		110'		
Voltmeter 0-30 VDC		1	Master light switch panel.	
Switch, SPST		2	Master light switch panel.	
	Switch, DPDT (Center off)	1	Master light switch panel.	
	Light assembly	6	Interior lights.	
	24 VDC			
	18-gauge, 2 cond MIL SPEC wire (WD-1)	20'	Circuit between comm hookup panels.	
Terminal, screw	4	Front comm hookup panel.		

¹Three-fourth inch plywood is recommended; however, one-half inch plywood may be used instead.

²These items can be locally fabricated.

³These finishing items are optional and may be deleted

Figure 5. Required construction materials.

otherwise, the drawings serve as general layout illustrations, representing recommended locations for the mounting of key equipment. This design has been thoroughly field-tested, incorporating refinements based on over 20 months of operational evaluation in conjunction with REFORGER, ARTEPs, and Emergency Deployment Readiness Exercises.

Construction of the shelter can be accomplished within two weeks if two or three men with some carpentry skills are gainfully employed and supervised. Approximately \$300.00 is required to cover cost of material, although this figure can be trimmed considerably if material used in the old shelter is salvagable. Many of the materials (figure 5) are available through normal military supply channels, but most of the wood must be acquired through local purchase. Area property disposal officers are good sources of construction material. By utilizing all available sources of supply, we constructed this shelter for less than \$65.00.

Conclusion

The effective employment of the battery operations center is only one of the many problems confronting firing battery leaders as they strive to accomplish an increasingly complex mission with the same or fewer resources. If we are to survive on the next battlefield, we must aggressively resolve problems that reduce our efficiency and create bottlenecks in our operations. More than ever before, we must critically analyze the solutions of others and benefit from their experiences. The BOC shelter plan I have presented is provided for this purpose and will hopefully stimulate the publication of other approaches to this problem.

On the modern battlefield we must plan to engage an enemy force superior in size to our own. Since fire support will play a key role in the defeat of the enemy, we, as artillerymen, must strive to develop our resources into a highly efficient, well-organized force capable of providing adequate support when and where it is needed. 

CPT Lonnie A. Veldhouse is assigned to the Material Development Team, Directorate of Combat Developments, USAFAS.

Captain Veldhouse states that the BOCs were at a minimum operating level due to a shortage of fire control equipment. The introduction of the hand-held calculator (scheduled to be fielded in calendar year 1980) will greatly assist in providing another source of fire control information.--Ed.



Right by Piece

Arkansas ARNG unit trains in Germany

BAUMHOLDER, WEST GERMANY—Men of Battery A, 2d Battalion, 142d Field Artillery, Arkansas Army National Guard made their own July 4 fireworks in the darkness of a West German Army training area. The Van Buren, AR, unit participated in a level 2 Army Training Evaluation Program (ARTEP) field exercise, hosted and evaluated by the 3d Battalion, 16th Field Artillery, 8th Infantry Division. The ARTEP was the culmination of the 142d's two-week stay in Europe.

The 30,000-acre Baumholder training area, with its 88 firing points, presented a number of different training aspects for the reserve unit. "At Fort Chaffee we use treeline positions," said CPT Charles Linch, battery commander.

"The realism of being in Europe gave us a real boost," commented Linch. Morale was high as the guardsmen learned the latest techniques from the 16th Artillery's "Convincers," such as the methods of erecting camouflage nets over 8-inch howitzers. Hand-held calculators and development models of the Army's newest radar, the AN/TPQ-36, were also part of the training program.

The trip to Baumholder was only the second time in 14 years that the unit had not trained at Fort Chaffee. "We know Chaffee so well that we don't need to use maps," said SFC Jim Pryor. In Germany the unit used maps.

The 142d was one of 75 units or unit elements deployed to Europe. It was the only field artillery battery involved in the program that has grown from 17 visiting units in 1976 to 1979's total of 75.

Members of the unit got to see more than the dusty Rheinland-Pfalz training area. They were hosted by the 51st Field Artillery at the German Army Artillery School in Idar-Oberstein, took a cruise on the Rhein River, and visited the East-West German border near Bad Hersfeld.

Battery A, 3d Battalion, 16th Field Artillery, served as the host battery. Over 150 men were involved in planning and supporting the visit.

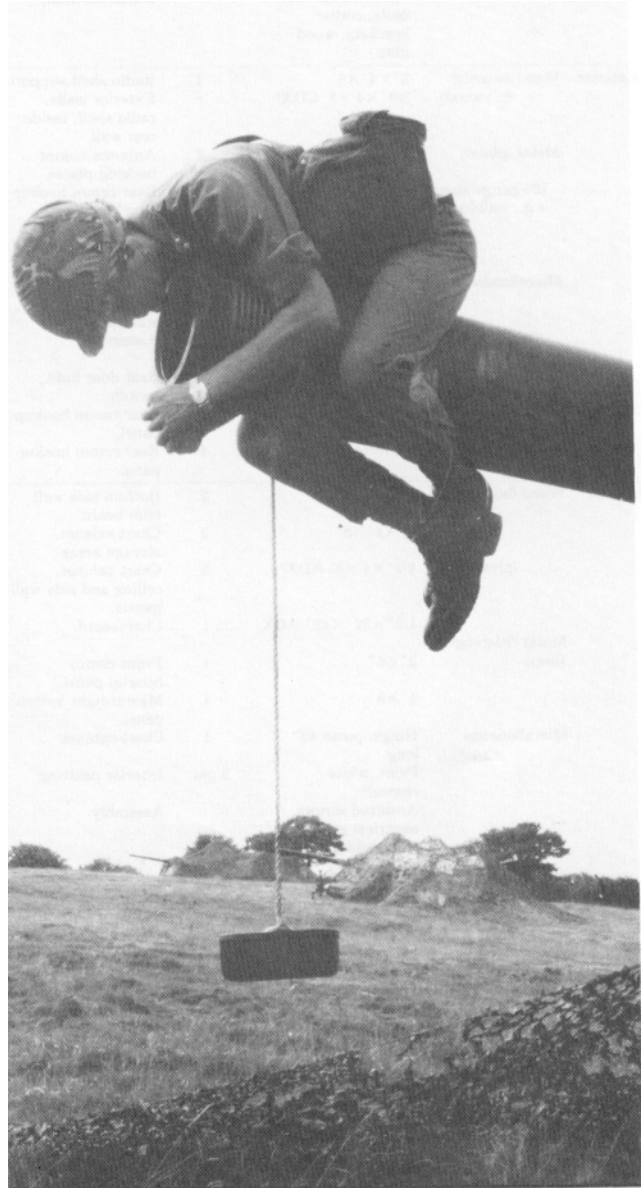

Arkansas National Guard PVT Dale Souza adjusts the cross hairs on the end of an 8-inch howitzer at Baumholder, Germany. The procedure is required to boresight the giant gun. (Photo by Greg Enos)

2-222d FA is the first!

CEDAR CITY, UT—In the high desert country of southwestern Utah, the 2d Battalion (155 SP), 222d Field Artillery, Utah Army National Guard, recently successfully completed an externally evaluated level 1 Army Training and Evaluation Program (ARTEP) which included all nuclear tasks except Emergency Action Procedures (EAP) and Permissive Action Link (PAL) operations. (National Guard units are prohibited by regulation from training on EAP and PAL.) The 2d Bn, 222d FA, is the first Reserve Component unit to successfully complete this type of training exercise.

The 2d Bn, 222d FA, is affiliated with the 9th Infantry Division at Fort Lewis, WA. In January 1979, representatives of XI Corps Artillery and Utah ARNG met with members of the 9th Infantry Division Artillery and the 1st Battalion (155T, 8-inch SP), 84th FA, to begin planning for Annual Training (AT) 79. During this meeting, the feasibility of conducting a level 1 ARTEP (including the nuclear tasks) was discussed at length. Although the battalion was not scheduled for its triennial ARTEP until 1980 and is not required to exceed level 2 standards, it was agreed that a level 1 ARTEP would be an excellent training vehicle. The ARTEP plan would be written by members of the 9th Inf Div Arty and approved by the Commander, 2d Bn, 222d FA. It was also agreed that, if at any time during the ARTEP the battalion became so overloaded that training effectiveness was lost, some tasks would be deleted from the scenario or the scenario could even be stopped to allow time for a critique and regrouping.

The ARTEP plan was very ambitious and proved to be an outstanding indicator of the unit's capabilities and shortcomings. The evaluation lasted approximately 36 hours, incorporated all conventional fire missions except radar (not available), and included all nuclear tasks except EAP and PAL. Additionally over 400 messages impacting on operations, logistics, and personnel were received by the battalion message center. Fifty-two fire missions, expending approximately 600 rounds, were fired during the ARTEP.

The battalion had undertaken a difficult task and had set a very high goal for itself. It accomplished the task and reached the goal in a manner in which all concerned could take pride, but it was not done flawlessly. The excellent evaluation team provided by the 9th Inf Div Arty was very thorough and provided a comprehensive report that lists, by ARTEP task, those areas in which the battalion required additional training. For example:

- In a fast moving situation a very strong SOP is required and all personnel must follow it. There isn't time or communications capability to provide solutions to each of the many problems that arise.

- Communications security was a weakness throughout the exercise. Even though the lack of secure radio capability contributed to the problem, personnel were not well trained in the use of the encoding and decoding capabilities available. Additional training and the use of these devices throughout the training year are essential.

- Knowledge of NBC defense was a weakness on both the individual and team levels. Good NBC training is essential for survival in an NBC environment.

- Completion of the ARTEP and exit critique (emphasizing weaknesses) while the unit still had field training time available proved most valuable. The unit was able to use the remaining time to train on the live firing task weaknesses instead of having to wait until the next AT period when ranges and ammunition again become available.

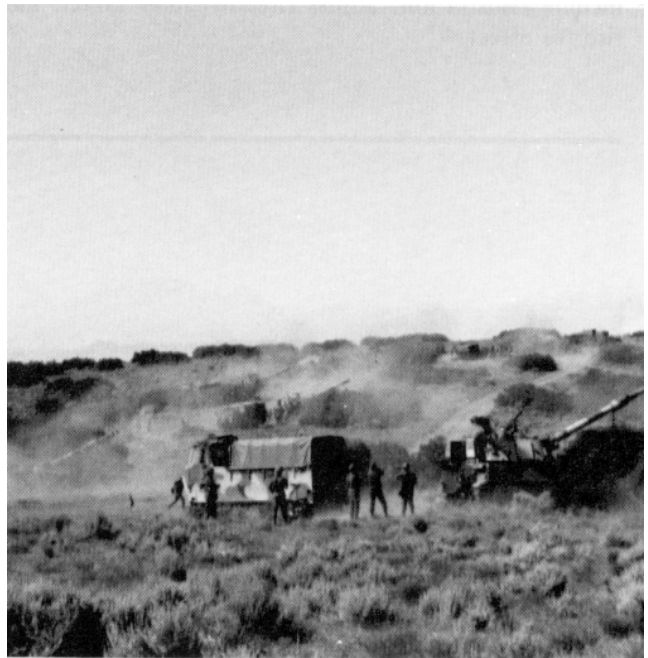

C Battery, 2d Battalion, 222d Field Artillery, fires on ARTEP enemy forces.

Sill wins award

WASHINGTON, DC—Fort Sill has won its second Secretary of Defense Environmental Quality Award for leadership and achievements in handling the installation's environmental quality program. A selected committee of environmental experts singled out Fort Sill as having a comprehensive environmental program, citing outstanding efforts in pollution, resource recovery, wildlife management, and historical preservation.

Fort Sill last received the award in 1973.

Right By Piece

Gilmore Competition

FORT ORD, CA—Bravo Battery, 2d Battalion, 8th Field Artillery, commanded by 1LT Stover S. James, shot its way to first place in the fourth annual Gilmore Competition conducted recently at Camp Roberts, CA.

The Gilmore Competition, named after retired MG William N. Gilmore, is conducted by the 7th Infantry Division Artillery to select its best firing battery. In addition to delivering timely and accurate artillery fires, the battery must demonstrate sound field artillery procedures.

Each participating unit was required to conduct a "hip shoot" and make a deliberate occupation of a firing position. Each fire direction center computed an initial and subsequent meteorological message, while individual howitzer sections fired a variety of missions, to include registration, adjust fire, irregular target, and fire for effect.



Section Chief, SGT Glenn M. Stanley (center) of B Battery, 2d Battalion, 8th Field Artillery, prepares to catch a 105-mm canister during the Gilmore Competition while SP4 Curtis R. Watts (left) and SP4 Willie E. Davis Jr. (right) look on. (Photo by Scott Miller)



WHITE SANDS, NM—Members of the 1st Battalion, 33d Field Artillery (Lance), participate in the first tactical annual service practice conducted for a European based Lance missile crew. Twenty-six soldiers from the unit located in Wiesbaden, Germany, traveled to the New Mexico desert to undergo an intensive, two-day training operation.



MOUNT RAINIER, WA—Six officers from the 2-4th FA raised the battalion's colors at the summit of 14,410-foot Mount Rainier to herald its July 29 Organization Day. The climbers also posted the five battery guidons on ice axes set in the snow. The two-day climb, made in near-perfect weather, capped three months of planning, preparation, and rehearsals. From left are 1LT Jason Ploen, 2LT David Thompson, 1LT Kathy Smith, 2LT Robert Madden, 1LT Dennis Moorman and 1LT Kalev Sepp, the team leader. (Photo by Scott Miller)



DEATH VALLEY, CA—147 feet below sea level, SP4 Dwight D. Wright (right) a vehicle driver with the 1st Battalion, 3d Field Artillery, takes the oath of enlistment. Administering the oath is Wright's Battery Commander, CPT Michael L. Combest. Wright and 3,000 troopers from the 2d Armored Division at Fort Hood, TX, were at the Mojave Desert for a 30-day exercise called Operation Desert Fire. (Photo by SP4 John Sleezer)

Commanders Update

COL Patrick B. O'Meara
1st Infantry Division

COL Richard L. Reynard
24th Infantry Division

COL Gerald Holland
528th Artillery Support Group

LTC Randall J. Anderson
1st Battalion, 6th Field Artillery

LTC William P. Collier Jr.
3d Battalion, 6th Field Artillery

LTC Larry R. Tinberg
3d Battalion, 9th Field Artillery

LTC William S. Bolen

1st Battalion, 15th Field Artillery

LTC Phillip G. Dombrowski
1st Battalion, 17th Field Artillery

LTC John R. Cavedo
1st Battalion, 19th Field Artillery

LTC Donald M. Moore
1st Battalion, 20th Field Artillery

LTC George P. Bare
1st Battalion, 29th Field Artillery

LTC Stanley L. Shaw
6th Battalion, 37th Field Artillery

LTC Thomas P. Tysdal
2d Battalion, 39th Field Artillery

LTC James H. Chapman
2d Battalion, 75th Field Artillery

LTC Joseph D. Armistead
1st Battalion, 84th Field Artillery

LTC Ronald P. Forrest
3d Battalion, 84th Field Artillery

LTC William A. Dow
1st Battalion, 94th Field Artillery

LTC Robert H. Stryjewski
1st Battalion, 321st Field Artillery

LTC Aaron M. Royer
552d Group



INTEROPERABILITY

by LTC (Ret) Charles W. Montgomery

During a recent NATO training exercise there were numerous instances of multi-nation teamwork in evidence. One such action involved a British forward observer calling for and adjusting field artillery fires through an American fire direction center (FDC); a second action involved pilots of German fighter aircraft recognizing and adhering to the constraints imposed by the fire support coordination line (FSCL) of a US corps. These were but two of many examples of *interoperability* at work. These events didn't just happen—they were planned and trained for beforehand.

What is *interoperability*? The Joint Dictionary (JCS Pub 1) defines it as "the ability of systems, units, or forces to provide services to and accept services from other systems, units, or forces and to use the services so exchanged to enable them to operate effectively together." A discussion of interoperability between US fire support agencies and those of allied nations requires an explanation of how national differences are recognized and circumvented through the use of Allied Publications (APs) and Standardization Agreements (STANAGs).

Within the 15-member NATO alliance, the success of military interoperability depends on planning and preparation and the guidance laid down in APs and

STANAGs. These documents are developed, ratified, and implemented by some or all of the NATO nations to establish a common ground for members of the NATO team.

Allied Publications

APs are devoted to tactics, intelligence, doctrine, training and exercise procedures, security rules, technical and administrative matters, and terminology. There are numerous categories of APs. The two most commonly used by the field artillery are Allied Administrative Publications (AAPs) and Allied Tactical Publications (ATPs). Within each category of APs there may be two types—*informative* and *action*. Each action type AP is covered by a STANAG providing national agreement to use the publication.

The two most commonly used Allied Administrative Publications are:

- AAP-4, Index of NATO STANAGs and APs—outlines STANAGs and Allied Publications by area. This index keeps the reader informed of which agreements are of concern to the US military.
- AAP-6, NATO Glossary of Terms—provides an up-to-date listing of commonly accepted terms (in English and in French).

Some of the most commonly used Allied Tactical

Publications involving fire support are:

- ATP-4, Allied Spotting Procedures for Naval Gunfire.
- ATP-27A, Offense Air Support.
- ATP-35, Land Forces Tactical Doctrine.

Standardization Agreements

Each STANAG represents a record of agreement among several or all NATO nations to adopt the same type or similar military equipment, ammunition, supplies, and stores and similar operational, logistical, and administrative procedures. For some STANAGs, certain nations may ratify the document with reservations on selected provisions of the document.

Within NATO's Military Agency for Standardization (MAS), each Military Board is assigned a block of numbers to identify its STANAGs. For example:

- Naval Board, 1001-1999.
- Army Board, 2001-2999.
- Air Board, 3001-3999.

STANAGs provide the common sheets of music needed to orchestrate NATO military teamwork. They establish ground rules for a common fire support effort and help to circumvent national differences in organizations, equipment, and procedures.

To date, the Artillery Procedures Working Party (APWP)—under the Army Board—has conducted nine meetings. During this time, it has developed and recommended for ratification numerous STANAGs and modifications thereto. The STANAGs incident to *fire support* include:

- STANAG 2008—Bombing, Shelling, Mortaring, and Location Reports.
- STANAG 2011—Target Grid Procedures.
- STANAG 2031—Pro Forma for Artillery Fire Plan.
- STANAG 2099—Fire Coordination in Support of Land Forces.
- STANAG 2144—Call for Fire Procedures.
- STANAG 2147—Target Numbering System (Nonnuclear).
- STANAG 2865—Recording of Data for Artillery Survey Control Points.
- STANAG 2867—Radiotelephone Procedures for the Control of Artillery Fires.
- STANAG 2875—Calls for Destruction, Smoke, Illumination, and Danger Close Missions.
- STANAG 2887—Tactical Tasks and Responsibilities for Control of Artillery.

In addition to those agreements reached by the Artillery Procedures Working Party, there are additional STANAGs developed by other Army Board working parties. These STANAGs often govern how the field artillery will operate during NATO operations. They are

indexed in AAP-4. Some of these include:

- STANAG 2014—Operations Orders and Annexes/Administrative and Logistical Orders.
- STANAG 2019—Military Symbols.
- STANAG 2022—Intelligence Reports.
- STANAG 2029—Methods of Describing Ground Locations, Areas, and Boundaries.
- STANAG 2047—Emergency Alarm of Hazard of Attack (NBC/Air Attacks Only).
- STANAG 2082—Relief of Combat Troops.
- STANAG 2101—Principles/Procedures for Establishing Liaison.
- STANAG 2104—Friendly Nuclear Strike Warning to Armed Forces on Land.
- STANAG 2111—Target Analysis.

Each US ratified STANAG establishes the norm for US participation in NATO operations. This establishes the commonality needed for effectiveness and removes the guesswork which, in turn, enhances teamwork.

National differences

Since each NATO nation's military is configured and equipped to meet its national needs, there may be considerable differences in the fire support assets of several nations. The purposes of APs and STANAGs are to overcome these differences and to get the most from what's available.

Commanders preparing for participation in NATO operations must be prepared to work harmoniously with the military forces of other nations since fire support may come from the resources of several nations. APs and STANAGs go a long way toward establishing commonality, but commanders must overcome those differences which do exist, such as command and control relationships, alterations for field SOPs, coordination needs to include liaison, language obstacles, national organizations, combat plans and orders, symbology, terminology, tactical missions, communications, intelligence, combat service support, and environmental considerations. Effectiveness of fire support operations will depend on this advance preparation.

If US field artillery and other fire support agencies are to be fully responsive when supporting FA or maneuver forces of another NATO nation, participating personnel should be knowledgeable of agreed standardization. Commanders should frequently review AAP-4 to keep abreast of established standardization. Better understanding of multi-nation operations will result in better NATO teamwork. 

LTC (Ret) Charles W. Montgomery is a research analyst in the Research and Analysis Section of the Tactics/Combined Arms Department, USA-FAS.

M110A1 Fallback Damage



by CAPT Richard L. Harmon, USMC

Recently, four more M110A1 8-inch howitzer cannons (M201) were damaged in Europe when projectiles were fired from the "fallback position." Commanders, however, report that the loader/rammers were properly timed. Two previous letters in the *Field Artillery Journal* (Nov-Dec 78, page 46, and Mar-Apr 79, page 37) addressed the problem of fallback and outlined certain procedures that must be followed to reduce or possibly eliminate the problem. It might be wise for our 8-inch units to get out these old issues of the *Journal* and review the information.

As pointed out in the *Journal*, as well as in a letter to the field from the Commandant of the Field Artillery School, an improperly timed loader/rammer is not necessarily the only cause of the problem. Cannoneers, by their own admission, are still short-cycling or "jumping" the rammer to shorten the time required to ram a projectile. The loader/rammer on the M110 was designed to be operated a certain way; the chain must travel fully forward before it is retracted. Therefore commanders, section chiefs, and cannoneers should insure that the loader/rammer is operated only in this way. Procedures cannot be sacrificed for speed without creating a potentially hazardous firing environment.

What has been done to eliminate the problem? The Blue Ribbon Panel committee has directed several modifications be developed, tested, and evaluated for the weapon which may solve the fallback problem. Once it is determined which modifications will be adopted, fielding should be faster than for normal modifications because of the urgency and seriousness of the problem.

The following is a brief description of each of the proposed modifications:

Loader/rammer modifications

Ram and return control—(automatic rammer with disabling MICRO switch). This modification will be an automatic system which will insure that the loader/rammer is properly timed and also eliminate short-cycling the ram. Once the RAM button is depressed, the rammer will perform a full ram and retract cycle, automatically checking timing on the retract phase. Should the loader/rammer timing get out of adjustment, the MICRO switch will prevent ramming until the loader/rammer has been re-timed. There is also an emergency KILL switch that can be used to stop the ram if necessary; however if this switch is used, the rammer will automatically retract.

Nitrogen pressure gage—This pressure gage (0-3000 PSI) will be externally attached to the nitrogen side of the accumulator to permit checking for proper gas pressure when the oil side is dumped.

Differential PRESSURE switch—A PRESSURE switch will be added between the oil and gas sides of the accumulator, which will energize a signal light to indicate that recharging of the accumulator with nitrogen gas is needed, due to a low gas charge.

Trough latching and TRAY INTERLOCK switch—The TRAY INTERLOCK switch will be relocated to allow better access for adjustment. The retaining screw on the trough handle will be replaced with a rod with a tang, which will actuate the TRAY INTERLOCK switch when the handle is engaged. A spring-loaded plunger will be added to the handle to obtain a positive locking engagement.

Other modifications

Fallback sensor—This gage will provide the user with a positive indication of a seated projectile. A series of strain transducers will be mounted to the exterior of the cannon tube in the area of the origin of rifling. These transducers will be attached to a computerized "BLACK BOX" that will analyze the amount of strain on the tube caused by a rammed/seated projectile. If sufficient strain or pressure is achieved, indicative of an adequate ram, a green indicator light will be energized as long as the projectile is properly seated or until it is fired.



Fallback sensor.

Battery level borescope—A special length borescope, M3, has been designed to inspect for damage of cannon bores just forward of the origin of rifling. The M3, which can be operated by one man, weighs 45 pounds, including the carrying case.

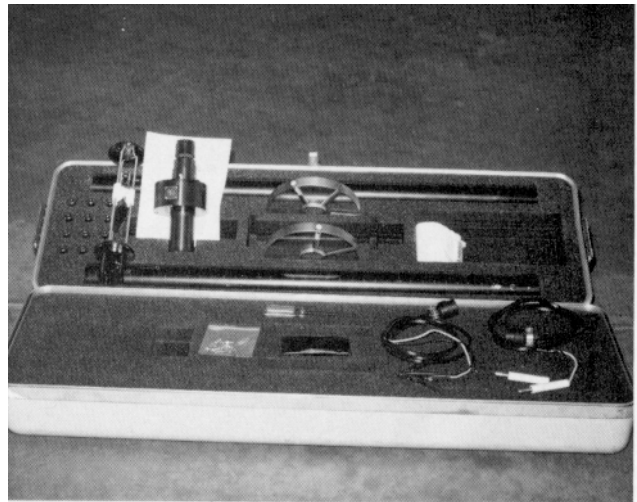

Battery level borescope.

Training projectiles—Several new training projectiles, along with the old M14, and new projectile extractors are being tested. Once fielded, the new projectile will provide more realistic (dry fire) training for the howitzer sections. Loading and ramming training can be conducted without damaging the loader/rammer assembly or violating procedures described in the operator's manual.

The office of the M110E2 Project Manager has made early distribution of the new operator's manual, TM 9-2350-304-10, to all M110A1 units. This manual includes all procedures, including changes and warnings, dealing with the fallback problem.

It is imperative that procedures as described in TM 9-2350-304-10 be followed to the letter. So far, only equipment has been damaged, but loss of life or injury could occur if the procedures outlined in the technical manual are not followed.

Several units have expressed problems in meeting ARTEP standards if the procedures in TM 9-2350-304-10 are followed; however, ARTEP times are currently being revised to allow the units administrative time to perform all required checks and adjustments. 

CAPT Richard L. Harmon, USMC, is assigned to the Cannon Division, Weapons Department, USA-FAS.

Massing The Steel

by COL Donald E. Eckelbarger

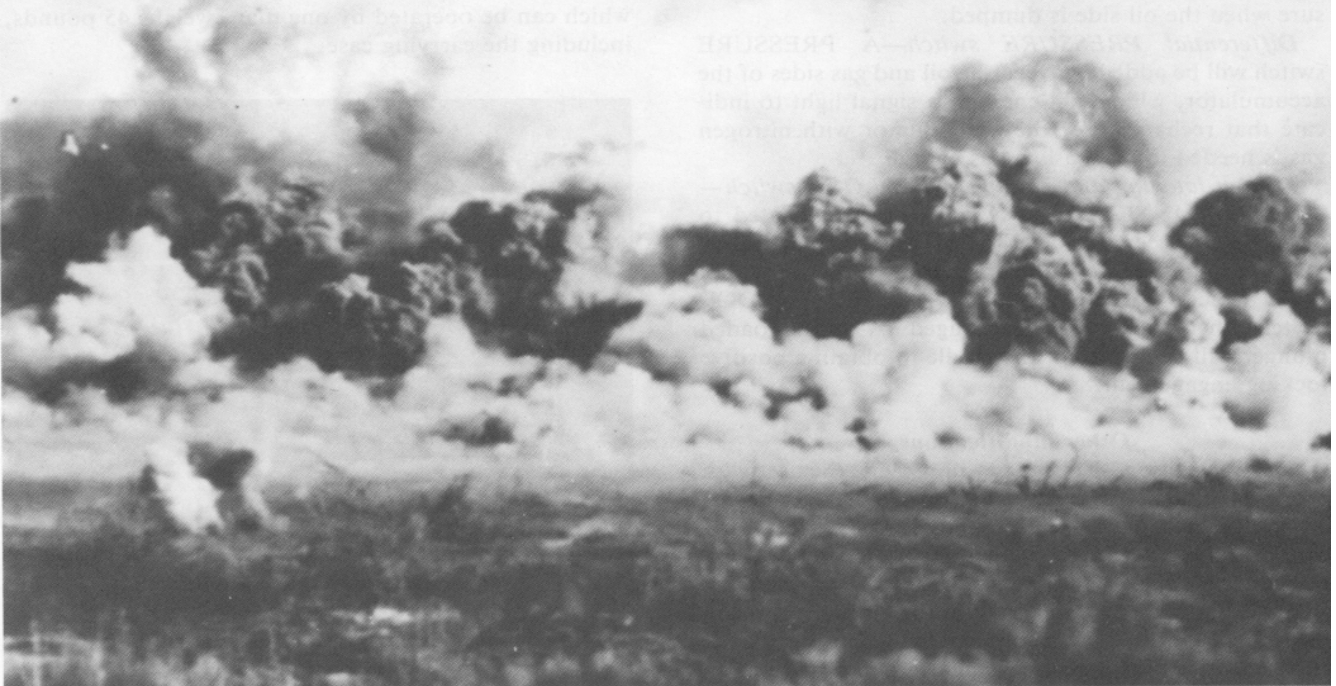

During the past two years the 3d Armored Division Artillery has attempted to arrange three-day live-fire training periods at Grafenwoehr which would allow employment of all four organic battalions and the supporting 42d FA Group. It was felt this much time was required to exercise the command and control aspects required to mass the division artillery. Additionally these periods of multiple battalion training would allow refining of field techniques which were found wanting during other exercises.

The most recent division artillery field training exercise (FTX) (19-21 June at Grafenwoehr) was valuable in several respects, and the purpose of this article is to share some of these experiences with the professionals who read the *Journal*.

Background

In January 1979, the 3d Armored Division Artillery and the 42d FA Group's command post conducted an FTX designed to exercise the counterfire system and employ massed fires of four battalions. Since the 42d FA Group is our habitual partner we were able to refine and strengthen several weaknesses revealed during REFORGER 78 which included:

- Ability to effectively communicate over the width of the division.
- Being able to efficiently follow cumbersome nuclear release procedures.
- Providing the counterfire system more target acquisition inputs and insuring better communications capabilities for organic target acquisition batteries (TAB).
- Providing additional FA brigade resources for the 42d Group.

Next, during the fire support Army Training and Evaluation Programs (ARTEPs) in April, a concerted effort was made to strengthen the fire support structure of division artillery battalions. This effort included instruction, seminars, exams, and evaluation of performance during maneuver task force ARTEPs. Work began at home station where fire support team (FIST)/fire support officer (FSO) personnel began intensive preparation, to include taking a written examination. At Hohenfels, seminars were conducted with company commanders and their FIST personnel which covered capabilities, tactics, communications, fire planning, and other fire support matters. Another written examination was administered to FIST/FSO personnel on the eve of their task force ARTEP. A division artillery evaluation



team then accompanied FIST/FSO personnel during the actual task force ARTEPs and conducted an extensive examination of fire support strengths and weaknesses. The evaluations determined that greater emphasis was needed in land navigation, battlefield reporting, use of mortars, and integration and coordination of fire and maneuver.

Based on the January and April experience, planning began on a larger, more comprehensive FTX to be conducted during the summer at the Grafenwoehr major training area (MTA). The objective was to design an FTX that would involve and exercise every part of the field artillery system and include training which would improve weak areas noted earlier. During the ensuing months we worked out details of an exercise and titled it "Counterfire—Combined Arms FTX." Our efforts were rewarded with an exciting three-day exercise that surpassed/established goals which were to:

- Activate all our normal command and control channels.
- Mass conventional fires.
- Exercise counterfire system.
- Conduct nuclear operations.
- Train FISTs.
- Employ combined arms.

The organization which we established for the FTX is shown in figure 1. Participating units were:

- 3d Armored Division: 1-40 FA, 2-3 FA, 2-6 FA, and 2-27 FA; 503d CAB, 1-32 AR, and 143d Signal Battalion (Company A).
- 41st FA Gp: 2-5 FA.
- 42d FA Group: 2-92 FA, 3-79 (Lance), and 6-9 FA.
- 17th FA Brigade: 6-10 FA (M110A2).
- 11th Armored Cavalry Regiment: 3d Squadron howitzer battery (under operational control of 2-92 FA).

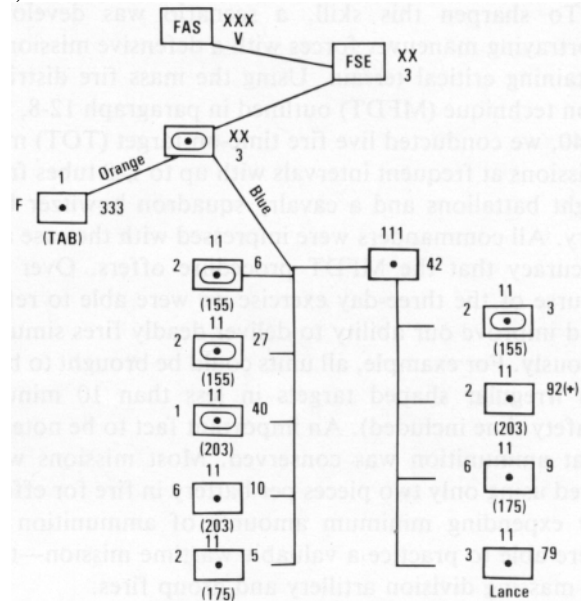

Figure 1.

General defense plan

This live fire FTX afforded a very close analog to the organization we would employ if combat came tomorrow. All planned communications channels among the corps Field Artillery Section (FAS), division fire support element (FSE), 42d FA Group, 3d Armored Division Artillery, and the firing battalions were established and maintained throughout the exercise. Field standing operating reporting procedures so critical to effective, smooth operations in a fluid battle were used and refined. Moreover, the artillery system from FIST through batteries and battalions to corps was exercised in both conventional and nuclear roles. We were, therefore, able in a very real sense to rehearse those field artillery operations which would be employed in support of 3d Armored Division's active defense. Approximately the same number of weapons were actually fired, using the same techniques, and controlled by many of the same people that would normally be available to the 3d Armored Division. In short, we practiced in a live fire mode the full system we would use in the first battle.

From this perspective alone, the division artillery FTX produced a tremendous return for a relatively small investment.

Mass conventional fires

In Germany, with Warsaw Pact forces mere kilometers distant, one becomes starkly aware of their awesome capability to outgun us should they decide to attack. Thus it is imperative that artillerymen retain the skills necessary to deliver massed surprise fire accurately and quickly.

To sharpen this skill, a scenario was developed portraying maneuver forces with a defensive mission of retaining critical terrain. Using the mass fire distribution technique (MFDT) outlined in paragraph 12-8, FM 6-40, we conducted live fire time-on-target (TOT) mass missions at frequent intervals with up to 120 tubes from eight battalions and a cavalry squadron howitzer battery. All commanders were impressed with the ease and accuracy that the MFDT procedure offers. Over the course of the three-day exercise we were able to refine and improve our ability to deliver deadly fires simultaneously. For example, all units could be brought to bear on irregular shaped targets in less than 10 minutes (safety time included). An important fact to be noted is that ammunition was conserved. Most missions were fired using only two pieces per battery in fire for effect. By expending minimum amounts of ammunition we were able to practice a valuable wartime mission—that of massing division artillery and group fires.

Exercise counterfire system

The need to fully exercise the counterfire system has been apparent since the division artillery was assigned the counterfire mission. To achieve this end all organic target acquisition assets were fielded, along with command and control elements and cannon units. The division artillery tactical operations center (TOC) was activated in its counterfire role with the target processing section receiving actual acquisitions from the flash/sound base and radars while scenario information was passed to the order of battle section. They jointly derived targets and passed them to the fire control section.

To add interest to the exercise, TAB assets which included sound, flash, and radar were employed as Orange Forces opposing firing units designated as Blue Forces. Throughout the problem, cannon units had the option to use lowest allowable trajectories and offset registration techniques to avoid detection. Using recently acquired AN/TNS-10 sound equipment, the target acquisition battery was able to combine radar, flash, and sound inputs. Being able to locate firing units within rated accuracy standards was a great morale

booster to radar/flash/sound personnel. They gained greater confidence in their equipment and in their ability to accomplish their wartime mission. Thus, for the first time, we were able to use all authorized, organic target acquisition resources against "live" targets.

During the course of the FTX, the AN/MPQ-4 radars were maintained under centralized control. This training was useful on those occasions where all radars were concentrated to cover a particular enemy avenue of approach or to lend intensive counterfire support to a friendly counterattack. By using centralized control, counterfire missions were quickly directed to artillery units not committed to direct support of maneuver forces. This phase tested and confirmed the expeditious fire channel procedures used by division artillery and group artillery headquarters. Being able to exercise the doctrinal flow of information in the division artillery TOC proved to be extremely beneficial. Analyzing target rays, using crater analysis data from units, cueing radars to appropriate azimuths, and compiling other Orange Force data allowed all personnel to gain proficiency in this important area of operation.

The acquisition of a firing battery was considered successful if it was reported to be within 300 meters of the firing point marker. This accounted for the 200-meter accuracy of the AN/MPQ-4 and the option of the unit to have its battery center up to 100 meters from the firing point marker. The exercise of the counterfire system was accomplished as indicated in figure 2.

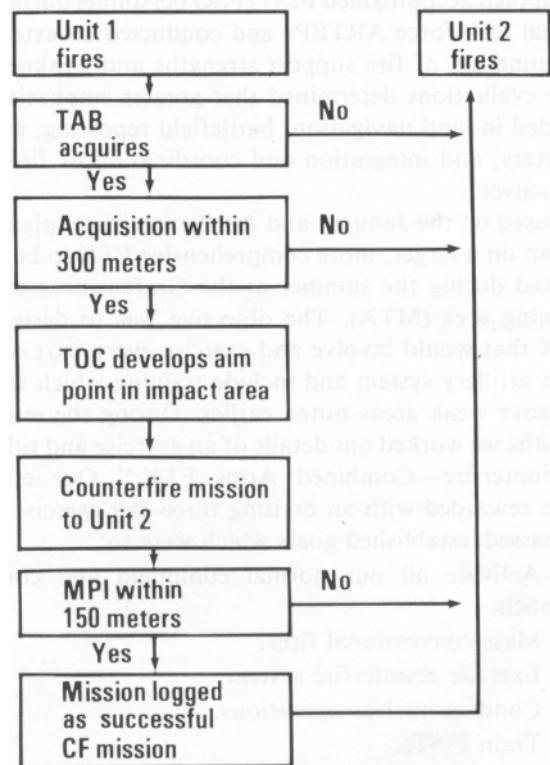

Figure 2.

The development of a target in the TOC was accomplished by establishing an aiming point (Point B) in the impact area which was offset from a known target (Point A) as shown in figure 3. The offset distance of this aiming point was equal to the location error in the acquisition. The effects of the counterfire mission are then figured against the known target (Point A), thereby incorporating the errors in both target acquisition and firing, giving a better measure of system effectiveness.

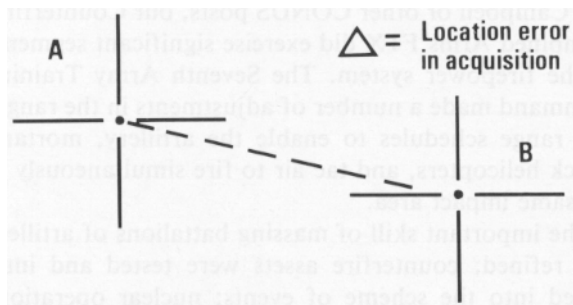

Figure 3.

The option of course exists to force the displacement of a battery attacked with a successful counterfire mission. This does add tactical realism and stimulates an appreciation of counterfire at battery and battalion levels. We did not exercise this option, however, because of the constraints on training funds. It was felt that more training value would be derived at battery and battalion levels from planned displacements. In lieu of moving a battery, the battery was simply informed that it had been subjected to accurate counterfire. The opposing force concept, pitting Orange target acquisition against Blue cannon batteries, creates a competitive environment which pushes units to care just a little more—to do just a little better.

Conduct of nuclear operations

During REFORGER 78 we learned a great deal about tactical employment of nuclear weapons and the precise planning and coordination required to integrate nuclear and conventional fire support. Many established procedures were found to be slow and cumbersome. Thereafter, nuclear procedures were refined and improved. Participation of the corps FAS and division FSE in this exercise gave us an excellent opportunity to test these changes. As the tactical problem unfolded, division FSE targets analysts prepared nuclear subpackages and submitted them to the corps FAS for approval. Upon receiving release from corps, the FSE reviewed the tactical situation, confirmed targets, adjusted aimpoints as necessary, and sent nuclear

missions to fire units with appropriate time-on-target, yield, height of burst, and other details required to deliver nuclear munitions. These missions were disseminated by FM radio, radio teletypewriter (RATT), and courier as Emergency Action Message (EAM) traffic. A nuclear pulse of one round from each of 19 batteries was fired on the second and third days. The corps FAS and the division FSE provided valuable training links in this chain of nuclear related events. Although the new procedures eliminated most deficiencies, several shortcomings still remained:

- Emergency action traffic associated with multiple round pulses excessively ties up operational FM nets. RATT, pulse code modulation (PCM), or courier must be used in lieu of FM when several missions must be transmitted.
- Fire missions must be sent to specific batteries, but the batteries must be informed that they will be required to fire a round from a specific position as early in the planning process as possible.
- Secure PCM must be available for the division main FSE, tactical FSE, div arty TOC, 42d Gp TOC, and the corps FAS.

While higher headquarters were planning nuclear fire and disseminating warning orders and fire missions, battalions conducted technical operations and prepared nuclear rounds for delivery. Units also demonstrated their capability to perform other important nuclear surety functions such as receipt, security, transportation, and storage of nuclear weapons. Thus, the entire spectrum of special weapons operations was exercised and integrated into the conventional mission. The "nuclear" pulses were fired using high-explosive rounds with fuze time, giving an assessment of the timeliness and accuracy of delivery.

FIST

An important activity incorporated into the FTX was special training for the fire support team personnel. A FIST Reaction Course (FIREC), requiring approximately five hours to negotiate, challenged the FIST to function as a cohesive fighting element. This intense, performance oriented course stressed and evaluated collective training. Round-robin stations were established which required the FIST teams in M113 track vehicles to accomplish selected tasks. At one station they were required to link up with a maneuver company commander and plan fires to support his scheme of defense, to include preparing target lists, encoding target grids, operating a directional antenna, and acting as the fire support coordinator (FSCOORD). Upon departure from this station, the FIST was ambushed and evaluated on its ability to identify enemy vehicles fleeing from the scene.

At another point the FIST was required to establish surveillance over an assigned zone of observation, select and occupy an observation post, construct a terrain sketch and visibility diagram, and conduct maintenance checks on the M113 FIST vehicle. Movement to the next station required map reading and off-trail navigation. Crater analysis tasks were presented en route.

A third station evaluated the FIST's ability to adjust a variety of live fire missions. These included both mortar and artillery missions using simultaneous, irregular target, massed, and adjust fire techniques. Although FIREC highlighted collective training, it also offered FIST members a significant amount of 13F SQT training and preparation.

Combined arms

In addition to the critical field artillery tasks accomplished during the FTX, perhaps the most important aspect was integrating the other arms and services with artillery in combined arms training. The FIST training conducted during FIREC emphasized the important role the FIST chief plays as the FSCOOD for the maneuver company commander. It reaffirmed the artillerymen's role in coordinating the fire support requirements of the commander's combat power. Thus, an important segment of the Counterfire-Combined Arms FTX was FIST/FSO instruction which included the use of a variety of fire support means. The purpose of this instruction was to familiarize FISTs and FSOs with the employment of combined arms in a company level, covering force scenario. During the two-day period, over 200 FIST personnel, commanders, senior officers, and other interested personnel witnessed a FIST chief actually coordinating the employment of mortar, artillery, attack helicopters and close air support, with the latter being simulated by a helicopter-borne officer representing the forward air controller (FAC). It was agreed that these observers gained a greater appreciation of control procedures needed to facilitate employment of all fires delivered in close combat support. The scenario used depicted a penetration which required FIST personnel to employ mortars on leading enemy recon elements, and then call one, two, and finally all available firing units to halt the advancing force. When attack helicopters arrived on the scene, artillery and mortar fires were shifted to suppression of air defense (SEAD) targets and to vehicles located behind the leading elements; the helicopters fired TOWs and 2.75 rockets at the enemy tank formation and the "FAC" simultaneously described his A10's attack on the tanks.

A major value of this class was the visual demonstration of the skill and boldness required by the FIST to properly coordinate and deliver fires in support of maneuver forces. Handling four radios during fast

moving

situations while bringing in tac air, helicopters, mortars, and artillery fires on enemy targets is an awesome responsibility. Only through live fire training can the FISTs develop their proficiency and confidence in their ability to pull it all together on the target when the maneuver commander needs it.

Conclusion

Although current major training areas in Germany do not permit complete freedom of maneuver and live fire support and cannot support full scale combined arms exercises such as those conducted at Forts Bragg, Hood, and Campbell or other CONUS posts, our Counterfire-Combined Arms FTX did exercise significant segments of the firepower system. The Seventh Army Training Command made a number of adjustments in the ranges and range schedules to enable the artillery, mortars, attack helicopters, and tac air to fire simultaneously in the same impact area.

The important skill of massing battalions of artillery was refined; counterfire assets were tested and integrated into the scheme of events; nuclear operations were routinely conducted along with conventional missions; FIST personnel got a head start on 13F SQT tasks and team training; and combined arms operations were given rightful high priority.

With only minimum additional costs for deployment of division FSE and corps FAS, it was possible to use the base structure of the division artillery and group units to train two higher echelons. Meanwhile, battalion commanders, as training managers, integrated their unit training into the exercise activities. All battalion commanders had high praise for the exercise and felt that their unit had received valuable training. They gained needed training in command and control, nuclear procedures, "all available" fire missions, and support of combined arms activities. Leaders at all levels were enthusiastic about conducting a similar exercise during our winter training period next February. Plans are already being made to accomplish this. Our next step is to integrate more fully the recently arrived A10s firing their 30-mm cannon and also tanks firing their weapons. The more we can do to work our systems effectively and collectively with our wartime partners, the heavier we'll be in the scales of battle in those critical hours when the success or failure of the first attack is being weighed out.



COL Donald E. Eckelbarger is Commander of the 3d Armored Division Artillery.

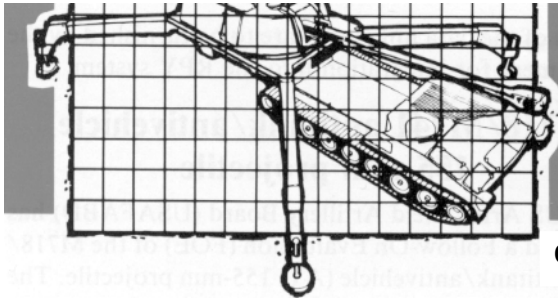

FA Test and Development

design • development • testing • evaluation

RPV contract awarded

On 31 August 1979, the US Army awarded a \$101 million contract to Lockheed Missile and Space Company for full scale engineering development of a remotely piloted vehicle (RPV) system to be used for aerial target acquisition, designation, and reconnaissance missions. The 43-month contract will be managed by the Project Manager's Office for Tactical Airborne RPVs and Drones, US Army Aviation Research and Development Command, St. Louis, MO.

COL Sherwin Arculis, the TRADOC System Manager for RPVs, has overall responsibility for the combat and training development effort required to prepare the Army to accept and utilize the system. The Field Artillery School was designated as the user proponent of the system after completion of the successful Aquila RPV system technology demonstration program in 1978.

In support of the program Lockheed will provide the Army with 22 air vehicles, four ground control stations,

three launchers, three recovery units, three maintenance shelters, training simulators, and manuals.

The primary mission of the RPV system will be to acquire and locate targets for engagement by artillery weapons to include the General Support Rocket System (GSRs). Through the use of its on-board laser and TV camera, the system will provide accurate target location, artillery adjustment, and designation for precision guided munitions such as the Copperhead.

The system will provide high-quality, real-time reconnaissance imagery of targets far beyond the normal visual line-of-sight of ground observers. Effectiveness of the RPV will increase when it is provided potentially lucrative target areas detected by other systems such as the Stand-off Target Acquisition System. "Cueing" the RPV to target-rich areas will enable the Army to gain maximum benefit from the system.

An RPV can be set up and ready for launch in less than one hour after arrival at a tactical location. At the completion of a mission, the system can be stowed and ready for displacement in 30 minutes.

The airframe will be made of Kevlar, will be approximately 6½ feet long, with a nearly 13 foot wingspan, and will weigh approximately 220 pounds at launch. Mission duration is slightly more than three hours.

The mission payload weighs 42 pounds and consists of a single integrated unit, containing a TV camera, automatic target tracker, and laser rangefinder/designator as well as an optical stabilization system and microprocessor electronics. The optical line-of-sight is stabilized in order to remove movement caused by air vehicle attitude changes. This feature allows high quality video imagery to be obtained even during fast maneuvers.

The ground control station, launcher, and recovery unit are truck-mounted and are operated by a crew of 13.

The ground control station (GCS) is the operations center of the system. It houses a three-man crew consisting of an air vehicle operator, a mission payload operator, and the mission commander. Each of the three crew members has a control and display console to control mission operations and view the video data being

Full-scale mockup RPV mounted on pneumatic rail launcher.

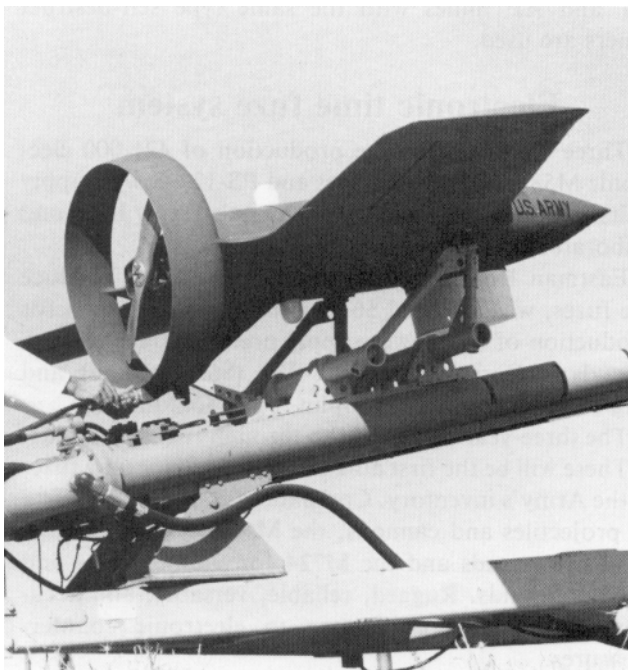

FA Test & Development

gathered by the air vehicle. Also included in the station is an X-Y plotter which constantly monitors the progress of the air vehicle and video recording and playback equipment which preserves the data for future use.

The truck-mounted launcher is a pneumatically operated catapult for accelerating the air vehicle to flight speed. All pneumatic and electrical power requirements are self-contained.

The recovery system is an improved vertical ribbon-barrier similar to that used in more than 200 successful recoveries during the Aquila program. The single net mounts on the back of the 5-ton truck, and it can be raised and lowered quickly after each recovery and moved to a concealed position between recovery operations.

During a typical mission, the control and support equipment will be set up at an unimproved tactical location. The air vehicle will then be fueled and placed on the launcher for GCS controlled prelaunch checkout. Geographic waypoints, which the air vehicle will pass through during its missions, are preprogrammed in the ground control station computer prior to launch; update commands are sent intermittently, via a data link, to the on-board autopilot which controls air vehicle flight. Once the air vehicle has been launched, it automatically seeks each preprogrammed waypoint until it returns to the recovery area, which is the last programmed waypoint. The air vehicle operator can override the preprogrammed flight plan and manually send the airborne air vehicle new speed, altitude, and heading commands if desired. At the completion of a manual segment, a flick of a switch will send the air vehicle back to its preprogrammed mode.

The mission payload operator controls the payload during the flight, to include the pointing and the field of view of the television camera, and he can actuate the laser for rangefinding and laser designation of targets. An automatic tracking mode can also be selected that will keep the stabilized sensor and a boresighted laser pointed precisely at a selected target or at a point on the ground, regardless of air vehicle maneuvers or turbulence. This autotrack mode is effective for both fixed and moving targets and is "locked on" to targets by an operator pointing a light pen designator on the TV monitor.

Recovery of the air vehicle is automatic. An infrared sensor mounted on the recovery unit detects the air vehicle and "flies" it into the net by sending a split-second course correction command via the GCS computer through the data link during the air vehicle's terminal flight phase.

Harris Corporation, Melbourne, FL, is prime contractor to the Army for the Modular Integrated Communication and Navigation System (MICNS), which consists of the data link hardware to be furnished by the

Government for integration into the RPV system.

M718/M741 antitank/antivehicle 155-mm projectile

The US Army Field Artillery Board (USAFABD) has conducted a Follow-On Evaluation (FOE) of the M718/M741 antitank/antivehicle (AT) 155-mm projectile. The FOE was conducted primarily to evaluate the system's software; i.e., firing tables, employment tables, preclusion tables, and a draft training circular. Reliability was also tested.

The field artillery delivered scatterable mine (FASCAM) M718/M741 projectiles each contain nine mines. The mines in the M718 projectile have a factory-set "long" self-destruct timer (longer than 24 hours), while the ones in the M741 projectile have a factory-set "short" self-destruct timer (less than 24 hours). This self-destruct capability allows the commander to emplace a minefield that can be crossed after a specified time lapse. Each projectile has an undisclosed number of mines that incorporates an anti-disturbance device to prevent easy enemy removal or tampering.

During the FOE the M692/M731 artillery delivered antipersonnel (AP) mine system was used to "cover" each antitank/antivehicle minefield emplaced. The M692/M731 projectile contained 36 antipersonnel mines. The M692 has a long destruct timer while the M731 has a short destruct timer.

The current concept for employment of artillery delivered scatterable mines is to emplace AT mines prior to delivering the AP mines. When employed together, AT and AP mines with the same type self-destruct timers are used.

Electronic time fuze system

Three contracts for the production of 421,000 electronic M587/M724 time fuzes and PS-127 power supply units awarded last week by the Army's Harry Diamond Laboratories (HDL).

Eastman Kodak, Rochester, NY, who will produce the fuzes, was awarded \$67.8 million. The contract for production of the power supply unit was split between Accudyne Corp., Janesville, WI (\$6.3 million) and Eagle-Picher Industries, Joplin, MO (\$6.2 million).

The three-year contracts run through fiscal year 1981.

These will be the first all-electronic artillery time fuzes in the Army's inventory. Compatible with a wide variety of projectiles and cannons, the M587 is used for high explosive rounds and the M724 for submunitions and canister rounds. Rugged, reliable, versatile, and accurate, the fuzes are immune to electronic countermeasures.

Firefinder Radar Operator Trainers

The US Army Field Artillery Board (USAFABD) conducted a Concept Evaluation Program (CEP) with the Firefinder Radar Operator Trainer, A17E11, in July and August 1979. The evaluation was conducted at the Hughes Aircraft Corporation plant in Fullerton, CA, and at Fort Sill.

The A17E11 Trainer is designed to simultaneously train up to eight students in the operation of either the AN/TPQ-37 artillery locating radar or the AN/TPQ-36 mortar locating radar. Both radars are controlled from a Weapons Locating Unit (WLU). The A17E11 Trainer consists of six operator stations that duplicate the radar WLU. Operator stations are connected through two computers to an instructor station which contains two display assemblies to monitor and control student actions. Students and instructors are equipped with headsets and communicate with each other through an intercom system.

Instruction at the Hughes facility was divided into eight exercises which included approximately 40 hours of self-paced, hands-on instruction on the Trainer designed to teach the following tasks:



Weapons locating unit for either the AN/TPQ-36 or AN/TPQ-37 radar.

- Initialization of the AN/TPQ-37.
- Location, processing, and transmission to TACFIRE of coordinates and altitude of up to eight enemy gun locations.
- Making adjustments to the method of target presentation while processing targets.

Note: When the trainer is fielded, the actual course of instruction will be approximately three weeks.

Four exercises were used for initialization, two for enemy weapons location, and two for making adjustments to the method of target presentation. Each exercise was divided into five different segments, called "learning scenarios," that provided operator practice before the student took the first scenario again as a "proficiency scenario." During each "learning scenario," the student was allowed to communicate with the instructor and the instructor was allowed to abort, stop, or restart each scenario as required. While the operator performed the "proficiency scenario," the instructor was not allowed to intervene, and the Trainer graded the student's performance against time and accuracy standards. The student then progressed to the next exercise.

The purpose of the Concept Evaluation Program was twofold:

- First, to compare the performance of trained A17E11 operators with others of similar background who had received no training on initialization of the AN/TPQ-37 or locating, processing, and transmitting target coordinates and altitude to TACFIRE.
- Second, to compare student performance on the Trainer using a 1:6 and a 1:3 instructor-student ratio.

The current plan is to buy three A17E11 Firefinder Radar Operator Trainers and one A17E12 AN/TPQ-36 Organization Maintenance Trainer for institutional training at the US Army Field Artillery School. Each trainer will consist of a central computer, instructor station, and six student stations. The instructor stations will provide a capability to program specific training scenarios, to insert malfunctions requiring emergency actions, and to monitor and evaluate student performance. The student station will stimulate the radars' common shelter and, with the A17E12, the trailer maintenance assemblies. The central computer will create, in the student station, responses identical to those in the radar.

The US Army Field Artillery Board will conduct an On Site User Test, in two phases, at Fort Sill. Phase I will test the A17E11 Operator Trainer from November through December 1979 and Phase II will test the A17E12 Maintenance Trainer from April through May 1980. Both phases will assess the effectiveness and overall operational suitability of the devices in their intended environment.

FA Test & Development



Battery Computer Unit with keyboard open.

Battery Computer System operational test completed

The US Army Field Artillery Board recently completed Operational Test (OT) II of the Battery Computer System (BCS) at Fort Sill. The purpose of this test was to provide field test data and associated analyses for an evaluation of the operational effectiveness and military utility of the BCS. During OT II, emphasis was placed on determining the suitability of the BCS as a replacement for the battery display unit (BDU) and the M18 FADAC within each firing battery of a TACFIRE-equipped field artillery cannon battalion.

The AN/GYK-29 Battery Computer System (BCS) is a compact, lightweight, portable ballistic computer system. It is capable of digital communications with TACFIRE-equipped battalion fire direction centers (FDC), fire support officers (FSO) equipped with the Variable Format Message Entry Device (VFMED), and fire support teams (FIST) equipped with the Digital Message Device (DMD). Digital communication is extended to the firing units via the Gun Display Unit (GDU). The BCS was designed to provide the firing battery with essential technical fire control capabilities. It was also designed to compute individual fire commands for up to 12 pieces allowing for maximum dispersion of firing units on the ground while maintaining uniform coverage in the target area. Additional design capabilities include fire plan

storage and execution, storage of ammunition status, and computation of meteorological and moving target data.

The BCS consists of two major assemblies: the Battery Computer Unit (BCU) and the Gun Display Unit (GDU). The BCU contains a high speed microprocessor, a 64,000-word memory capability, an operator keyboard, a control and display panel, a program load unit, communications and peripheral interfaces, and a power distribution unit. Universal mounts allow installation in 1/4-ton and 1 1/4-ton vehicles and the M577 command post carrier. The GDU consists of the Section Chief's Assembly (SCA), two Gun Assemblies (GA), and a carrying case with battery. The SCA provides a display of all fire commands to the section chief. The GAs are mounted on the weapon. One GA displays deflection to the gunner while the other displays quadrant elevation to the assistant gunner.

The primary BCS power source is a 1.5-kilowatt, 28-volt, direct current generator. As backup, the vehicular 24-volt, direct current electrical system with a 100-ampere kit can be used.

Improvement kits

An \$11½ million contract was recently awarded to Rock Island Arsenal for improvement kits for the M110A2 howitzer.

The kits, scheduled to be completed by December 1981, include 11 modifications to the howitzer systems, most of which are a result of suggestions received from the field.

Among the improvements are an adjustable gunner's seat to help crewmen use the gunsight; an external warning light to help the driver monitor engine, transmission, and radiator coolant pressure and temperature while outside the vehicle; a redesigned parking brake to prevent failure during firing; and a modified storage area to accommodate some of the new-type projectiles.

Too expensive?

In 1808, an American horse artillery was formed, and a successful demonstration of its efficiency was held in Washington, DC. Later the unit was sent to New Orleans where it was disbanded because the Secretary of War decided it was too expensive to maintain. On 22 June 1809, the Secretary of War wrote General James Wilkinson: "Horses for the artillery cannot be maintained at such an expense; they must either be sent to some part of the country where they can be maintained at one-fourth the present expense, or they must be sold. Imagine for an instant the whole regiment of light artillery on this scale of expense."

Courtesy COL (Ret) Robert M. Stegmaier

A Field Artilleryman as Military Attaché

by LTC (P) William E. Serchak

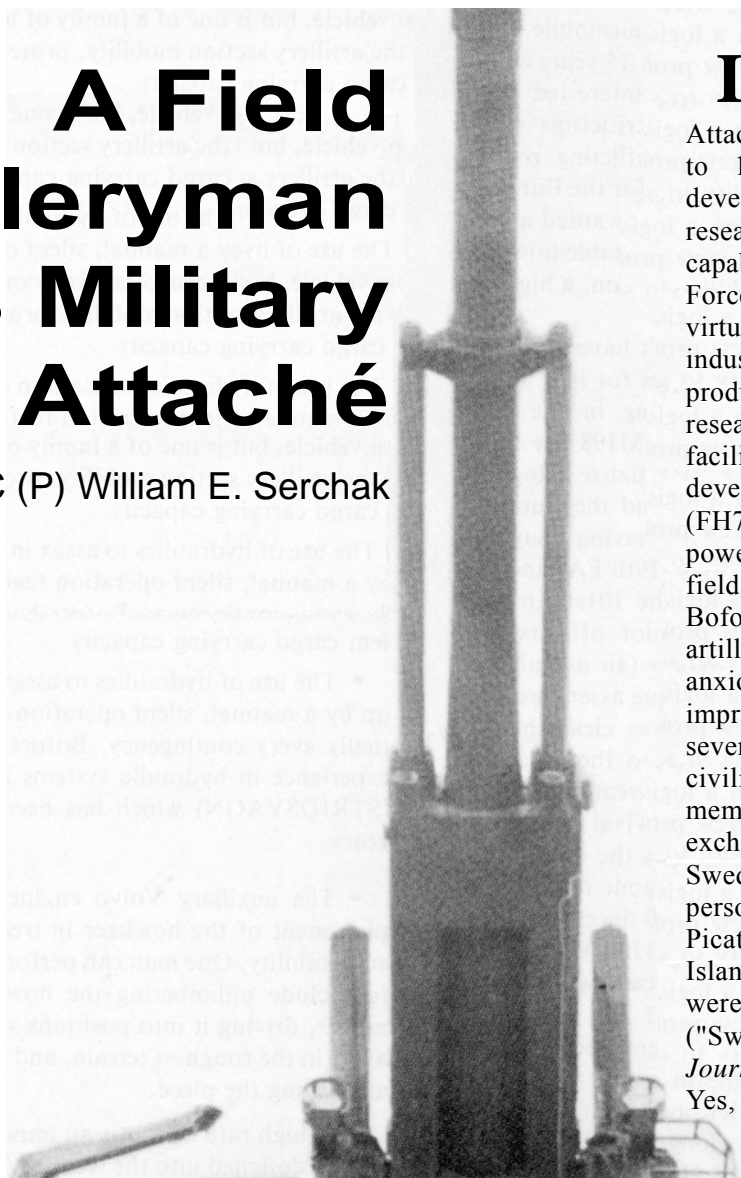

I served as Assistant Army Attaché in Stockholm, from 1972 to 1976 during which time I developed a great respect for the research and development capability of the Swedish Armed Forces. During that tour, I visited virtually every major defense industry involved in Army materiel production and several of Sweden's research, development, and test facilities. I followed the development of Field Howitzer 77 (FH77), a 155-mm auxiliary powered towed howitzer, through field visits and liaison with the Bofor design team. As an artilleryman, I was naturally anxious to compare my impressions of the FH77 with several visiting US military and civilian delegations who were members of a technical data exchange between the US and Sweden. US delegations included personnel from Frankford, Picatinny, Watervliet, and Rock Island Arsenals. Their comments were similar to Major Whelihan's ("Sweden's Field Howitzer," *FA Journal*, January-February 1979). Yes, the FH77 was certainly an

innovative and interesting development. No, it didn't appear likely that the US Army would be interested in the FH77 because it was too heavy for airmobile operations. One member stated that perhaps 15 years earlier, the US Army would have been very interested in the weapon but not now (1975). Their criticisms of the FH77 were based on apparently conflicting requirements for the design of a US howitzer for the European battlefield. On one hand, the US Army wanted a lightweight, easily man-handled, air-transportable howitzer. On the other, it looked for crew protection, a high volume of fire, and a nuclear capability.

Well, it's my opinion that you can't have it all! Our M198 will certainly not cap any prizes for lightweight, air transportability, or crew handling in the field! Granted the FH77 outweighs the M198 by 9,000 pounds, but does anyone seriously visualize using Chinook Super Cs to move M198s around the European battlefield? No way! In fact, after having fought in Vietnam with the 1st Air Cavalry (2-19th FA) and participating in REFORGER 76 with the 101st Airborne Division, I discovered that few senior officers were knowledgeable enough in air mobility (air assault) tactics to properly capitalize on the unique assets provided by airmobile artillery. Further, it was clear that the 105-mm was slowly being relegated to the "elephant graveyard" of weapons that had had great moments in our history but were not capable of survival in the European scenario. Why else had we made the 155-mm the division artillery's basic weapon and gone nuclear with it? Why else were the M198 and FH70 developed along with even heavier versions of the M110? Why are we concentrating on developing new nuclear rounds for the 155 and 8-inch, but none for the 105?

During REFORGER 76, it was discovered that lightweight howitzers were desirable in an air assault environment from a logistical viewpoint, but we needed more muscle, crew protection, longer range, and self-propelled mobility to survive against potential 3 to 1 artillery odds in Europe. Shoot and scoot, lone guns, and jump capabilities were in. What was not in, however, was to be dropped within 10 to 20 kilometers of the enemy by Chinooks with all their attendant noise signature and then watch the Circle Trigon armor close at 35 kilometers per hour while the supporting Chinooks flew off to another mission.

In 1977, the 3d Battalion, 319th Field Artillery, at Fort Campbell was tasked to test the 105-mm XM204. As battalion commander, I came down very hard on the XM204 in the written appraisal as did the division artillery commander. In an air assault environment, the ability to rapidly move light batteries by Chinook is a distinguishing feature. Granted, the air assault capability has several severe limitations as evidenced during

REFORGER 76. The 105-mm XM204 howitzers are no match for enemy armor—yet several times air assault artillerymen were faced with "zero elevation, max charge" missions against the Orange Forces. One can't continue to lose batteries and still win the battle in a real war. It was also clear that the XM204 could not be man-handled into the nearest treeline once it was deposited by a CH-47—yet camouflage and concealment are essential to survival in an air assault environment.

The lack of a nuclear capability for the 105 must also be mentioned as a severe limitation which was apparent to all the Redlegs from the 3-319th FA and 2-320th FA that participated in REFORGER 76.

Now, how many features of the Swedish FH77 are desirable in our artillery weapons?

- Cross-country mobility of the FH77 is excellent. The new family of military vehicles made by Saab, one of which is the prime mover for FH77, is something to behold. This is not just an ordinary general purpose 5-ton vehicle, but is one of a family of heavy trucks that give the artillery section mobility, protection, and excellent cargo carrying capacity.

- The use of hydraulics to assist in operations backed up by a manual, silent operation feature allows for virtually every contingency. Bofors has had considerable experience in hydraulic systems including their S-tank (STRIDSVAGN) which has been in service nearly 15 years.

- The auxiliary Volvo engine allows for easy emplacement of the howitzer in treelines, thus enhancing survivability. One man can perform the entire operation to include unlimbering the howitzer from the prime mover, driving it into positions several hundred meters away in the roughest terrain, and finally spreading trails and laying the piece.

- A high rate of fire is an important military characteristic designed into the weapon. It follows on the heels of the rapid fire capability built into the self-propelled 155 that the Swedes fielded in the 1950s and is an extremely important element in their tactics. Six rounds in 20 to 25 seconds and a sustained rate of three rounds per minute for 20 minutes is not bad in my book. The current US interest in increased rates/volume of fires to offset enemy artillery superiority is clearly attested to in the development of the GSRS ("GSRS," *FA Journal* March-April 1979). The FH77 cannisters or cartridge cases are cheap and light. They may be reused several times or thrown away as the situation permits.

NATO military specifications are followed closely in nearly all items produced in Sweden. Sweden is not a member of NATO, but foreign sales are needed to help offset the cost per copy of new weapons.

If we have unanswered questions about the FH77, the Swedish Army Materiel Administration would gladly loan the US a battery of FH77s *with* prime movers for unlimited tests and evaluations. They loaned us two of their well-known turretless Swedish S-tanks along with ammunition and technical advisors for a thorough checkout by US armor experts at Fort Knox in 1976. The US paid all shipping and handling expenses—a pittance compared to what we spend on research and development on any new piece of hardware.

It used to be my understanding that one of the first tasks of the US Army Materiel Development and Readiness Command (DARCOM) agency responsible for development of a new piece of military equipment was to cast around the free world for information on foreign-built equipment that could perform (with perhaps some modification) the desired function. The negotiation of a license to build the item in the United States or outright purchases would certainly be cost effective and prudent. With very few exceptions, I do not believe this is being done. One exception was the Roland system which was negotiated while I was in Sweden and which was hailed as a significant first US purchase of a major item of foreign military equipment.

Another notable exception was the BT33 Field Artillery Trainer, which I reported on in 1973 as being something that had great potential for use at the Field Artillery School and in artillery training rooms around the world ("View from the Blockhouse," *FA Journal*, November-December 1976). I sent copies of my report to Fort Sill, Fort Benning, DARCOM, USCINCEUR, and CINCUSAREUR. Enthusiastic followup reports were met with the same dull silence—was no one interested? Then, after returning home, I spent one week at Fort Sill in February 1976 for the new battalion commander's orientation—lo and behold, there in Knox Hall was a full-size BT33! The project officer told me that he had found my report on the BT33 gathering dust in late 1975. It had arrived at Fort Sill just after the dark period in US-Swedish relations following the Christmas 1972 bombings of Hanoi. At that time no high level visits were permitted between the two countries and each country's respective ambassadors were recalled. A few years later, a visiting NATO officer at Fort Sill commented that our FO training could be considerably enhanced by the BT33 which his country and several other NATO countries were using. These included West Germany, Norway, and Denmark.

The BT33 and FH77 represent only a small fraction of the items observed by military attachés. I wrote over 120 reports, many on Swedish military materiel developments, based on experience and firsthand knowledge of their capabilities. At least two other significant Swedish developments—the Swedish oversnow vehicles BV202 and BV206 now being tested

at Fort Greely, Alaska, and the Carl Gustaf recoilless rifle—are now being examined.

The Swedes have made significant strides in developing and fielding a host of devices for small arms, antitank, and air defense training that are clever, efficient, and very cheap. Their new family of military vehicles is simply outstanding. Not only do they have superior cross-country mobility in mud and snow, but they have many interchangeable parts and all—even the heaviest 10-ton trucks—have automatic transmissions! Instrument panels are even designed to resemble the interior of Saab and Volvo automobiles so that conscript soldiers can come back for refresher training every four years, step right into the trucks, and drive off since the instrument panels nearly duplicate those of their privately owned vehicles.

The new Swedish SAM RB-70—with its nearly invisible signature, ease of ground handling and launching, and design simplicity—certainly warrant comparison to Stinger and other US SAM developmental items. The new IKV91 light tank and the follow-on S-tank developments plus a host of antimagnetic, antitank mines, RAP projectiles, and new antipersonnel weapons have all been duly reported on—and virtually ignored.

In a more general sense, a case could be made that reports on foreign materiel developments by most military attachés have been ignored. These materiel developments could lead to great savings in US dollars, if properly pursued. I represented only one service in one country, but I suspect that officers from other services and in the 80 or so other countries in which we have military attachés must frequently feel the same degree of frustration. The US Department of Defense selects and trains its officers very carefully for attaché duty and the Defense Intelligence Agency instills in them the need for accurate, complete, overt reporting. To do the job conscientiously for four years and then to perceive that no one is really that interested (and the prevailing attitude is that if it's not "made in Detroit" it's unacceptable out of hand) is, to say the least, disheartening.

To return to Major Whelihan's questions at the conclusion of his excellent report on how reliable is the FH77 and how survivable will the system be against a strong armed mechanized threat! "Why don't we find out?" My reply to this question concerning a new and innovative weapons system is the same for all who read such reports on foreign materiel developments:

Let's find out!



LTC(P) William E. Serchak is assigned to the Research, Development, and Test Division, Office of Military Application, US Department of Energy.

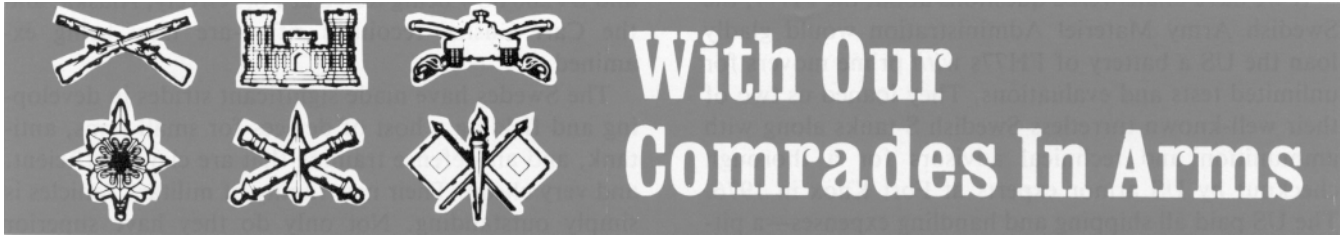

Using UHF-AM radios in tanks

At the request of the US Army Armor Center, the US Army Combat Developments Experimentation Command (USACDEC) recently conducted a small experiment to determine the feasibility of using UHF-AM radios in the tanks of tank companies and platoons. This idea stemmed from the fact that the use of UHF-AM radios would make more frequencies available that would be directly compatible with those of attack helicopters. To provide the type of information sought by the Armor Center, USACDEC designed an experiment that focused on determining the line-of-sight and range limitations of VHF-FM (AN/VRC-46) and UHF-AM (AN/VRS-24) radios when used in ground tactical nets in various types of terrain.

Courses of travel for the experiment were laid out over four types of terrain: flat/open, undulating, rolling, and precipitous. Three M60A1 tanks were VHF-FM configured and three were equipped with UHF-AM radios.

For each trial, one UHF and one VHF tank proceeded from a start point along a prescribed course and, at preselected transmission points, exchanged transmissions with two comparably equipped tanks which had remained stationary at the start point. Upon completion of the course, the moving tanks became the stationary vehicles and the other two proceeded through the course in the same fashion.

Throughout the experiment, calibration and performance checks were made in accordance with the radio technical specifications to insure that established tolerances were maintained.

To assure consistency, transmitted messages were taped alphanumeric messages which had been recorded by a professional radio announcer using standard phonetics. Each was approximately one minute in length and included a message identifier, a five-line message with four characters per line, and a message termination. One retransmission per message was permitted at the request of the receiving vehicle.

A message score (legibility) for each transmission was computed on the basis of the percentage of characters correctly transcribed at the receiving radio.

The experiment results, forwarded to the Armor School for analysis and evaluation, showed that the

message scores for the UHF-AM radio were generally lower than for the VHF-FM radio over all terrain types and under both day and night conditions. Similarly, UHF communications were more adversely affected by terrain and range.

The experiment was executed in less than two weeks by a small team at a direct cost of approximately \$1,000. Valuable informational input to a materiel or conceptual acquisition/adoption decision process can be gained without great expenditure of time and money. (MAJ George E. Newman, USACDEC)

Air Force realigns space and missile systems functions

Effective 1 October 1979, the Air Force deactivated its Space and Missile Systems Organization (SAMSO) in Los Angeles, CA and established two new organizations within the Air Force Systems Command: the Ballistic Missile Office (BMO) at Norton Air Force Base, CA, and the Space Service Division (SSD), with headquarters at Vandenberg Air Force Base, CA, and an East Coast center at Patrick Air Force Base, FL.

The BMO is responsible for current and advanced ballistic missile development, particularly the new MX land-based intercontinental ballistic missile. The SSD assumed the space-related activities previously the responsibility of SAMSO.

Air launched cruise missiles tested

The air launched cruise missile (ALCM) flyoff between competitive Boeing and General Dynamics models began in mid-July and will continue through December 1979.

The first 10 of 20 planned test flights are "captive carry"; that is, the cruise missile directs its B-52 missile carrier over a predesignated route to test the missile's guidance system. The second 10 will be free flight launches, spanning some 1,400 nautical miles.

The purpose of the tests is not only to find out which is the best weapon but also which is the cheapest in terms of total life cycle cost. Subsequent production involves 3,000 missiles worth \$1 million each.

Contract selection is expected in the February-March 1980 timeframe.

New long-range radar

A target acquisition and weapons delivery system for defense against mass armor attack is being developed by Hughes Aircraft. The defensive system will detect and track enemy armor at long range, and then guide air-and ground-launched missiles to critical target areas.

The new tactical concept, called TAWDS (Pave Mover/Target Acquisition Weapons Delivery System), is part of a broader assault breaker program designed to defeat enemy armor before it moves into a battle area.

TAWDS consists of long-range airborne radar with a data link to a ground-based data processing and control station. The side-looking radar uses a scanned-array antenna that will function in real time during all weather conditions.

Capable of detecting fixed and moving targets, the airborne radar sends surveillance, detection, and tracking information via data link to the ground control center. The ground station evaluates the threats, computes guidance commands, and sends task information to air and ground missile-firing units.

Once a missile is launched, TAWDS radar guides it to the target area.

Ammo boxes dangerous

The US Army Environmental Hygiene Agency warns that the preservative used in treating some ammunition boxes may cause a violent allergic reaction.

The preservative solution, pentachlorophenol, is toxic whether touched, inhaled, or swallowed.

When heated, the solution will quickly vaporize; therefore, ammunition boxes should not be used as fuel for heating in a closed or inadequately ventilated area.

Pentachlorophenol can also become airborne in sawdust; for this reason wood from ammo boxes should not be sanded or sawed.

The agency recommends that the following additional precautions be taken when handling ammo boxes:

- Wear leather-palmed gloves and protective clothing that has not been soiled with the preservative.
- Wear goggles when boxes are wet or when crystals are visible.
- Wash frequently when handling the boxes, even when protective gloves and clothing are worn.

People with kidney or liver disorders should totally avoid exposure.



Improved Phoenix—A technician at Hughes Aircraft Company's Missile Systems Group in Canago Park, CA, makes final adjustments to the first engineering development model (EDM-1) of the improved Navy AIM-54C Phoenix air-to-air missile. This missile is the first of 15 EDMs which will be delivered to the US Navy Pacific Missile Test Center at Point Mugu, CA.

Hughes Missile Systems Group is upgrading the radar-guided Phoenix to meet anticipated airborne threats through the 1990s under provisions of a Naval Air Command contract. The current model, the AIM-54A, now carried on the Navy's F-14 Tomcat fighter, is the service's primary long-range air defense weapon and is regarded as one of the world's most technologically advanced tactical missiles.

As many as six Phoenix missiles can be launched against six separate targets from a single F-14. Targets may range from small, highly maneuverable aircraft or missiles through larger high-speed threats. In more than 140 flight tests and Navy operational launches, the AIM-54A Phoenix has had an 85 percent success rate, including a hit on a target at a range of more than 100 nautical miles.

With Our Comrades In Arms

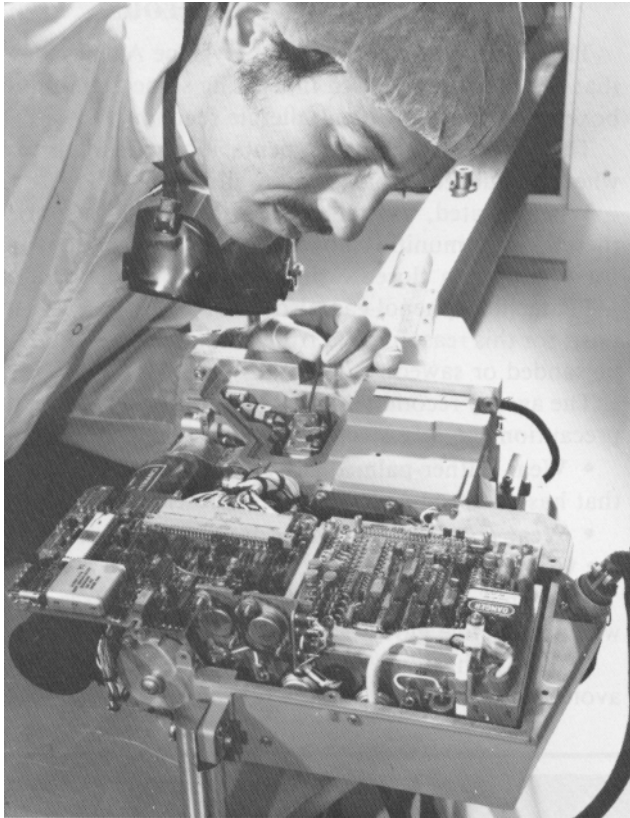

Compact laser—Optics are aligned on a laser device that enables aircrews of the F-5F jet fighter to pinpoint ground targets for laser-homing weapons. Senior research assistant Lee Wofford adjust the device, called a laser designator, at Hughes Aircraft Company's electro-optical and data systems group, Culver City, CA. The compact laser designator is part of a Laser Target Designator System (LTDS) that is designed to fit the narrow space between the back seat and the left side of the F-5F fuselage. In operation, the observer sights a target through an optical telescope and fires the laser designator. The beam passes through the aircraft canopy to the target and is reflected like a beacon. Laser-homing weapons sense the reflected laser light and guide themselves to the target. Hughes is producing the laser designator for Northrop Corporation, prime contractor for the LTDS, which is being manufactured for foreign military sales.

Philip A. Connelly awards announced

In late June the US Army Troop Support Agency (TSA) announced the following final standings in the Eleventh Annual Worldwide Philip A. Connelly Award competition for excellence in Army food service:

- **Small Dining Facility Category:**

Winner: Company A, 9th Signal Battalion
9th Infantry Division
Fort Lewis, Washington

Runner-up: 123d Maintenance Battalion
1st Armored Division
VII Corps
Fuerth, Germany

- **Large Dining Facility Category:**

Winner: Company E, 407th Supply &
Service Battalion
82d Airborne Division
Fort Bragg, North Carolina

Runner-up: Special Troops Consolidated
Dining Facility No. 3
Redstone Arsenal, Alabama

- **Division Field Kitchen Category:**

Winner: 3d Battalion, 39th Infantry
1st Brigade, 9th Infantry Division
Fort Lewis, Washington

Runner-up: 12th Engineer Battalion
8th Infantry Division
Anderson Barracks
Dexheim, Germany

Realistic training for 2d Armored

Selected units of the 2d Armored Division recently began a five-month cycle of instruction based on TRADOC's Battalion Training Management System (BTMS). The BTMS is a coordinated effort to provide troop leaders in FORSCOM what TRADOC considers the most effective, up-to-date methods of conducting performance oriented training. The system is based on five seminars:

- One, the executive seminar, is given only once—it's a two-to-four hour session with the brigade and division staffs to provide them with the background needed to support BTMS.

- The second seminar is a Training Management Workshop, which lasts three to four days, focusing on the battalion commander, the S3, and the company commanders and how they plan training.

- Third is a Training Supervisors' Workshop involving the command sergeant major and first sergeants for three days emphasizing their specific role with other noncommissioned officers.

- A fourth seminar is the Platoon Trainers' Workshop, lasting three days, with the platoon leaders and platoon sergeants.

- Finally, there is a three-day Trainers' Workshop for squad leaders and section chiefs. Whereas the supervisors' seminar focuses on collective training such as the Army Training and Evaluation Program (ARTEP), this one centers on individual tasks.

The workshops overlap so that the entire process takes one week per battalion.

Armor crews to get fire-resistant outfit

First issue of a new, fire-resistant uniform for armor vehicle crewmen could begin within 18 to 24 months, according to Army supply officials.

The new combat vehicle crewman's uniform will consist of a one-piece coverall, a jacket, and two pairs of gloves. The garments are made from Nomex, a fire-resistant fabric.

Supply officials said that the new uniform will replace the existing two-piece fire-resistant garment.

The new coverall will have suspenders that can be used to help pull the wearer from an armored vehicle if the soldier is unconscious or injured. The jacket, which is supposed to be worn over the coverall, will provide the soldier with additional protection against fire.

Additional protective garments are expected to become part of the ensemble later. They include a fire-resistant face mask, fire resistant boots and overboots, and special body armor.

The armor will include an improved crewman's ballistic helmet and a new armored vest.

The vest, designed specifically for armor crews, is different from the new armored vest the Army plans to issue infantrymen and other ground troops.

Air Force conducts health study

A six-year health study of "Operation Range Hand" aircrews who sprayed Herbicide Orange defoliates during 1962-1971 in Vietnam is being conducted by the Air Force.

While there is no valid scientific data currently linking Herbicide Orange to long-term side effects, the Air Force study is aimed at determining whether any casual relationship between the herbicide exposure and subsequent health changes can be established.

Both government and civilian scientists will be used to preclude any organizational bias. The study, involving 1,200 exposed active duty personnel and veterans, will compare test results against a control group of 1,800 nonexposed individuals.

Telephone health surveys began in October, with follow-up surveys and medical examinations continuing for at least the next six years to insure coverage of possible long-term health effects.

The compact British Army Laser Target Marker and Ranger is operated by a British forward observer during recent tests at WSMR. The tests were conducted to demonstrate the compatibility of the target marker with the Copperhead guided projectile.

Equipment compatibility

With rapid development in complex state-of-the-art equipment, it isn't always possible to take an item from column "A" and couple it with an item from column "B". But if the engineering homework has been done well, systems compatibility can be inbred.

Such equipment compatibility has been the focus of recent tests by a joint team of British and American researchers at White Sands Missile Range. The tests were designed to prove the interoperability of the British Army's man-portable Laser Target Marker and Ranger with the Copperhead laser guided artillery projectile. The Copperhead, one of several precision guided munitions now being developed, can be fired from any 155-mm gun in the North Atlantic Treaty Organization (NATO) forces. The precision guided munitions concept provides an alternative to more conventional artillery methods which can result in using several rounds to achieve the same firepower delivery.

Cooperhead projectiles are guided to the target by the Ground Laser Locator Designator (GLLD), developed by the Hughes Corporation. Another system, the small hand-held Laser Target Designator (LTD), can also be used.

Compatibility of the British Laser Target Marker and Ranger, which is manufactured by Ferranti Limited, with its American counterparts is vital to maximize the effectiveness of NATO forces, particularly against armored and fortified targets.



Nuclear Weapons:

"Whether technological progress creates new weapons or better ways of living, we can no more stop that progress than we can stop the earth from rotating. We cannot explain it away nor can we ignore it away. The results of progress are here and we must live with them."

*General Nathal F. Twining
June 1955*

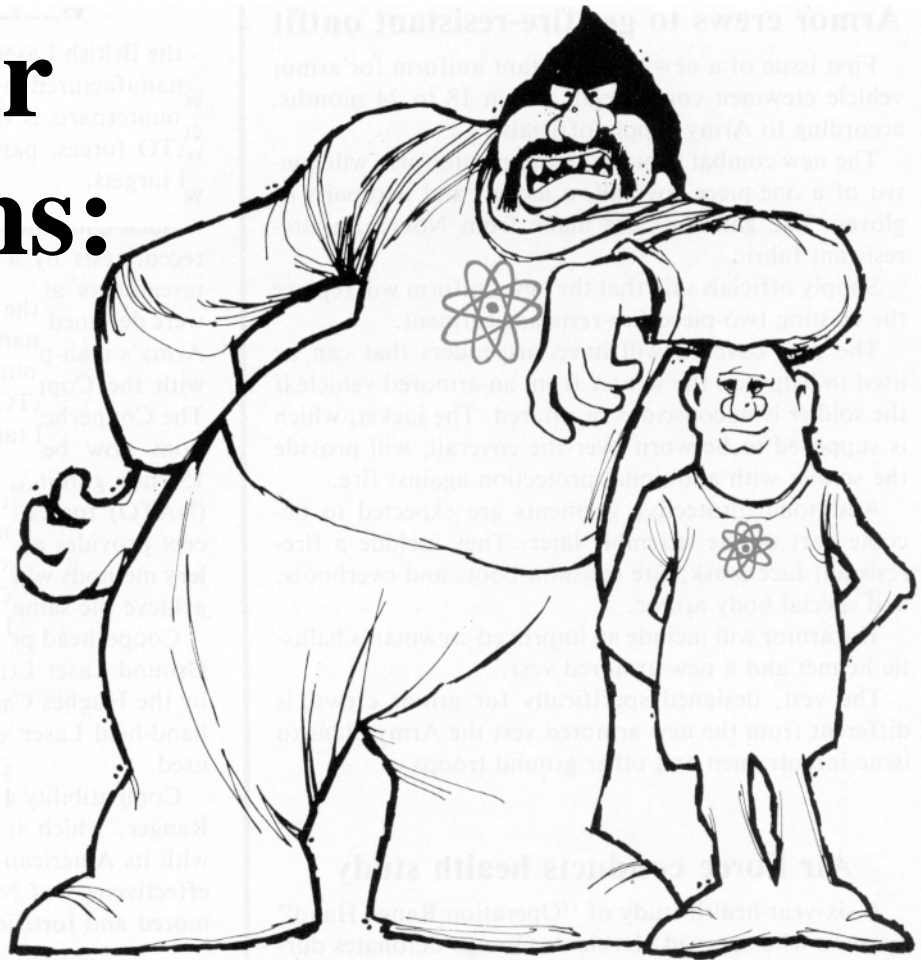

Image Versus Reality

by MAJ John P. Rose

The ending of World War II with the destruction of two Japanese cities by atomic weapons set the stage for much speculation about the nature of future war. Prophets of fantasy with little more than a wild imagination exploited the sensational aspects of the atom bomb and alarmed the world with notions of how terrible and destructive such a future conflict would be. Some even predicted civilization would be annihilated and provided horrifying visions of a shattered earth. Future war was seen as a push-button affair in which the battle would be controlled by personnel in underground control panels dispatching atomic armed missiles to any area on earth. Armies, navies, and air forces were seen by some as obsolete.

The purpose of this article is to correct the image that nuclear weapons are absolute while showing that, in reality, they inflict only finite damage and that defenses

against this threat are possible and effective. Current technology is capable of producing nuclear weapons that do not have the destructiveness and radioactivity associated with earlier models. Advanced concepts for exploding a nuclear device can provide weapons designed to confine damage to the immediate target area. Nuclear weapons technology allows for the effective destruction of a wide variety of military targets while clearly reducing the collateral damage generally associated with their use. Subkiloton weapons with increased accuracy offer a credible tactical weapon to promote utility as warfighting instruments.

Claims and prophecies regarding new weapons

Human nature has a tendency to oppose change and cling to the customary way of doing things. A report

made to the Privy Council in Great Britain in the late 16th century comparing the bow and the new musket provides an illustration:

"The bow is a simple weapon, while firearms are very complicated things which get out of order in many ways . . . they are heavy weapons that tire out soldiers on the march. Also a Bowman can let off six aimed shots a minute while a musketeer can discharge but one in two minutes."

During the American Civil War 300 years later, a report made to the Secretary of War by an ordnance officer comparing the muzzle-loading musket with the new repeating rifle again illustrates opposition to change. According to the report:

"It is not believed that what are called repeating arms are desirable for infantry. They are complicated . . . more liable to get out of order and more difficult to be repaired than the muzzle loading muskets. The revolving repeater fires so rapidly it leaves the soldier with an empty weapon which requires considerable time to replenish even under favorable conditions, rendering it quite practicable in time of action for a soldier to discharge a muzzle loading gun seven times in as short a space of time as the same number of discharges could be made from a repeater. Excessive rapidity of fire is not the great desideratum for military guns."

Prior to the first world war the invention of the machinegun and other developments in warfare appeared so revolutionary that they caused Jean Bloch, a student of military affairs, to make this prediction:

"The very development that has taken place in the mechanism of war has rendered war an impracticable operation. The dimensions of modern armaments and the organization of society have rendered its prosecution an economic impossibility. It is impossible for the modern state to carry on war under modern conditions with any prospect of being able to carry that war to a conclusion by defeating its adversary by force of arms on the battlefield. Neither is any war possible that will not entail, even upon the victorious power, the destruction of its resources and the breakup of society. War therefore has become impossible, except at the price of suicide."

French statesman Georges Clemenceau was reported to have asked a military officer prior to World War I to explain to him the strategic importance of the machinegun. The officer replied: *"Faced with the machinegun, every strategy ceases."*

Indeed there are other precedents for faulty prophecy. In the interwar period, there were those who developed theories of airpower which argued that any future war

between big powers would be decided in the initial stages through bombardments from the air. Advocates such as Douhet and Mitchell believed that future wars would be won by the side able to command airspace alone.

Statements made since the United States first used the atomic bomb against Japan have been no less emotional, opinionated, or seemingly absolute as those noted above. Bernard Baruch, speaking on behalf of the American government at the first commission meeting to examine proposals for the International Control of Atomic Energy in New York on 13 June 1946, said:

"Behind the black portent of the new atomic age lies a hope which, seized upon with faith, can work our salvation. If we fail, then we have damned every man to be the slave of fear. Let us not deceive ourselves: We must elect world peace or world destruction. . . . Science has torn from nature a secret so vast in its potentialities that our minds cower from the terror it creates. Yet terror created by weapons has never stopped man from employing them; for each new weapon a defense has been produced, in time. But now we face the condition in which adequate defense does not exist."

Winston Churchill, in a speech in the Commons on 1 March 1955, spoke of the gulf between the atomic and the hydrogen bombs. He said:

"The atomic bomb, with all its terror, did not carry us outside the scope of human control and manageable events in thought or action, peace, or war. But when Mr. Sterling Cole, the chairman of the United States Congressional Committee, gave out a year ago—17 February 1954—the first comprehensive review of the hydrogen bomb, the entire foundation of human affairs was revolutionized and mankind placed in a situation both measureless and laden with doom."

General Douglas MacArthur was quoted in the *New York Times* on 27 January 1955 as saying:

"No longer is war the weapon of adventure whereby . . . a place in the sun can be gained. If you lose you are annihilated. If you win, you stand only to lose. . . . It contains the germs of double suicide."

Colonel R. S. Broke wrote in *Military Review* in June 1955:

". . . the atom bomb was only a very big bomb; with the thermonuclear principle the scientists now have it within their power to destroy all life on earth. . . ."

Statements such as these convinced millions of people that the "absolute weapon" had been discovered and many uncritically accepted the notion that any future war if fought with atomic weapons would result in universal destruction. Likewise many believed that the more orthodox forms of land and naval warfare had become obsolete. The destructive effects of the atom

bombs were believed to be immeasurable.

However, if nothing else one should have been warned by the fate of previous predictions that seem to indicate immediate and fundamental changes in warfare.

"Past experience has shown that no development is ever quite so overwhelmingly potent as it appears in anticipation, or even on the promise of its first performance."

In attempting to correct the erroneous image that atomic war automatically equates to mass destruction, Gordon E. Dean, as President of the Atomic Energy Commission, testified before Congress in 1957, pointing out technological advancements in the field of atomic weaponry then taking place. According to Dean:

"We must cease associating with an atomic war the ideas of a gigantic explosion by which great cities and their inhabitants are converted to rubble and ashes. . . . We are working today on weapons which may be used on the field of battle, on artillery shells, guided missiles, torpedos, rocket bombs for the tactical air force . . . of almost as many varieties as the conventional weapons. We shall have something for all situations, large weapons for large targets and small ones for the small."

Research and development since the mid-1950s have resulted in a new generation of nuclear weapons designed to confine damage to the immediate target area. These include enhanced, suppressed, and induced radiation weapons.

- The enhanced radiation weapon—also known as the neutron bomb—is a nuclear device which yields high concentrations of prompt radiation with little blast and heat effect.

- Suppressed radiation weapons involve a combination fission-fusion warhead that converts the neutrons into blast effect, markedly reducing fallout.

- Induced radiation weapons, by employing fusion rather than fission and absorbing the neutrons with a special material, short-term radioactivity—a matter of hours or at most days—could deny an area to an enemy temporarily without causing longterm contamination.

In summary, current technology is capable of producing nuclear weapons that do not have the destructiveness and radioactivity associated with earlier technology. Effects can be practically tailored to order, and, depending on what one desires the weapon to accomplish, the undesirable effects can, for the most part, be programmed out of the weapon.

The impact of these innovations leads to far-reaching changes in military application of nuclear weapons for defense. For example, a "clean" nuclear weapon—one that eliminates most residual radiation—is now feasible for use in a tactical role on the battlefield in support of ground troops. Hence, the distinction can be drawn between tactical nuclear weapons and strategic nuclear

weapons and between "clean" and "dirty" bombs.

In view of nuclear technological developments, weapons can be designed and employed in different ways depending on the target and the employment objective. For example, enhanced radiation weapons could be employed against troops using the cover and concealment in a city, without the blast or heat effects which cause significant damage to buildings and property. Likewise, tank crews holed up in tanks will fall victim to the effects of an enhanced radiation weapon while no significant damage is caused to the tank itself. In this instance prompt nuclear radiation effects (neutrons and gamma rays which last but a fraction of a second) become the primary kill mechanism. In contrast then to the Hiroshima and Nagasaki atomic bombs, the enhanced radiation weapon is not a physically destructive weapon. It is designed to be singularly effective against enemy personnel, and its application can be made in a manner that affords a degree of discrimination that is not achievable even with conventional weapons.

For tactical targets which require physical destruction, military efficiency can be improved and collateral damage reduced through use of suppressed radiation weapons and improved delivery accuracy. (Improved delivery accuracy may substantially drop yield requirements.) In January 1971, Robert M. Lawrence wrote:

"First, the yield requirements for many of these targets can be brought down substantially through delivery accuracy refinements that now appear to be possible. Specifically, developments that are now underway promise to provide a short range air-to-surface missile having an accuracy far greater than that associated with current bombing techniques. This will result in the reduction of yield requirements to levels that are orders or magnitude below those demanded by present gravity bomb accuracies. For such extreme accuracy, yields in the range from tons to tens of tons should suffice to destroy a large variety of small hard physical targets. This application of a single, precisely delivered nuclear charge designed to target specifications may be contrasted with the many hundreds of high explosive charges that have been required against many targets in the Vietnam War, the use of which needlessly destroy adjunct population. Considering the inaccuracies of the bombing attacks against North Vietnam the collateral effects from this precise form of nuclear delivery could be far less than those that have affected populated areas in the bomb cratered land."

Coupling improved delivery accuracy with suppressed radiation weapon technology, the weapon could be effectively

employed against relatively small hard targets such as command and control bunkers or nuclear weapons storage sites.

On the other hand, use of induced radiation weapons to create a short-lived radioactive zone or area without giving long-term contamination could provide a militarily effective way to channel an enemy advance or force him to cross the area at increased risk to personnel and equipment. Such short-lived radioactivity without long-term contamination involves a technique known as "salting" in which the neutrons from the fusion reactions from clean explosives can be absorbed by an appropriate element, rendering it radioactive. In contrast to the radioactivity from nuclear fission weapons, which is not controllable and involves such isotopes as strontium-90 which can last for decades, this so-called "induced radioactivity" could be restricted to hours or days—depending on the specific military requirements. As such, it would bear little resemblance to the unwanted fallout that arises from the detonation of current fission weapons.

This discussion has focused on nuclear weapon concepts (and advances) which are quite different from those described in the Hiroshima and Nagasaki bombings. Their application is viewed in terms of specific tactical military collateral damage—an effect often exaggerated in reports on the Japanese bombings in 1945. One discovers that these technological advances foster an image of tactical nuclear warfare whereby the mission is accomplished in a manner quite opposite to the image of a nuclear battlefield characterized by widespread destruction and contamination.

Tactical nuclear weapons and escalation

In April 1974, MG Frank A. Camm—the Atomic Energy Commission's assistant general manager for national security—testified before Congress strongly advocating the future of subkiloton nuclear weapons especially in the event of a war with the Soviet Union in Western Europe. Calling for the making of subkiloton nuclear shells for the 155-mm and 8-inch artillery guns for use in military operations against military targets, Camm said:

" . . . the yields of the nuclear artillery projectile are very much smaller than the bombs or missiles that we are using at longer ranges. Therefore, we are much less likely to inflict serious damage in the area we are fighting in than if we use larger yield weapons. . . . You don't have radiation on the ground. You burst them in the air. The blast and radiation damage the target you are hitting. Then you can move right through the area immediately because they are airbursts. . . . Airbursts minimize immediately any residual effects that might remain on the ground."

MG Edward B. Giller testified that the "mininukes"

could be less damaging than conventional weapons saying: *" . . . for instance, the (conventional) artillery barrage might create more casualties on some targets than a single small nuclear weapon."*

The combination of high delivery accuracy and controlled weapon effects for use against military targets is not easily described in the destructive spectrum leading to general nuclear war. Controlled weapon effects and high delivery accuracy seem closer related to conventional weapon uses than to large scale nuclear destruction. Further, since the radius of effect for nuclear weapons is calculable, they may be more sparing on noncombatants and nonmilitary facilities than conventional explosives. The reduction in collateral damage alone sets it in a category apart from earlier fission nuclear technology.

Further, the advent of tailored effects weapons increasingly enhances the utility of tactical nuclear weapons on the battlefield. Tailored effects weapons offer a greater degree of discrimination in warfare than ever before known. In fact, their use can result in significantly less physical and biological damage than the use of certain conventional munitions. Arguing in favor of tailored effects weapons, Robert M. Lawrence has said:

"They are different because they derive their energy from a radically different nuclear fuel, because their application is viewed in terms of specific tactical target needs, and because they are designed to reduce collateral damage so often associated with modern war. In essence, they are different weapons because they seek to exploit, or restrict, different weapons effects. These differences spell out a pattern of tactical nuclear warfare in which it becomes possible to fulfill military needs in a manner that hardly conforms to the dominant image of widespread destruction and contamination. Furthermore, and perhaps even more revealing of persistent shibboleths, differences between these weapons and conventional weapons indicate that conventional warfare may not be as relatively virtuous as many presently believe."

"This separation of weapon effects adds a dimension to warfare that has not before existed in any effective measure. It offers the opportunity, should the need arise, to attack enemy personnel near or within urban areas without inflicting high levels of physical damage to these areas. This holds true even for personnel inside buildings since in most cases there is probably insufficient structural mass to cause serious attenuation of the nuclear radiation."

"Looking back over this comparison between advanced nuclear and conventional weapon effects, rather than a comparison involving undefined nuclear

weapons interpreted in terms of their (excessive) destructive power, it would seem that one particular nuclear effect—prompt radiation—does not conform to a widely held image of nuclear warfare. In fact when compared to conventional weapon effects, to produce the same end result, this particular effect can be used not only with a much higher degree of efficiency but with a degree of discrimination that conventional weapons cannot match. Using this particular effect against the target for which it is most effective makes possible an aftermath to war that can be considerably more sparing, in terms of physical and biological damage, than the effects of conventional weapons."

Nevertheless, some yet argue that escalation will be difficult, if not impossible, to control after the initial use of nuclear weapons, even subkiloton tactical weapons. Opponents argue that there is no natural limit comparable to the distinction between nuclear and nonnuclear war. Failing to accept the realities of subkiloton nuclear weapons, the commonly accepted belief is that any use of subkiloton weapons will inevitably lead up the destruction escalation ladder to large scale general nuclear war. Statements by high public officials have reinforced this erroneous notion. As the Deputy Assistant Secretary of Defense for Systems Analysis, Alain C. Enthoven, was quoted as saying:

"The reason strong conventional forces are required is that there are many situations in which the use of nuclear weapons would be inappropriate. For the same reasons that a sledge hammer does not make a good substitute for a flyswatter, nuclear weapons are not a good substitute for nonnuclear forces against a wide range of military threats. Even if they could be used to apply the minimum force required to achieve our objectives, their use would risk triggering escalation to a more and unnecessarily destructive level of conflict."

The fact that the United States can build a "clean" artillery shell of fractional kiloton yield, suitable for targeting against enemy tanks, mechanized infantry, and infantry and guaranteed to be free of residual contamination or excessive debris is ignored by opponents. The reality of the situation is that the constrained use of these subkiloton weapons in war need not lead to escalation. In any case, reserves of far greater destructive power can be readied in such a manner to inhibit an enemy from raising the nuclear level.

Summary

Fantastic claims and prophecies regarding new weapons are not new—as noted earlier. The introduction of gunpowder, the machinegun, the tank, and even the airplane brought drastic predictions that each were so destructive that no nation could afford to wage war. But as history shows, men challenged such notions, studied

and analyzed the capabilities of new weapons, and each instance found ways of defending against them. Tactics and techniques were modified to meet the effects these developments had on military operations. Applied in the light of basic principles of war, revised tactics and techniques became the doctrine used by successful military leaders.

The same logical trend appears to apply in the case of nuclear weapons—particularly tactical nuclear weapons. Improvements in nuclear weapons technology permit effective destruction of a wide variety of military targets without inflicting the collateral damage generally associated with their use. Subkiloton weapons with increased accuracy offer a credible tactical weapon to promote utility as warfighting instruments. One cannot legitimately assume that the introduction of subkiloton tactical nuclear weapons on the battlefield will automatically lead to a strategic exchange. If anything, as had been suggested, such weapons represent a firebreak to a strategic exchange. Limited and controlled effects would seem to make tactical nuclear weapons more politically acceptable and an enhancement to deterrence. At the same time they provide an improved warfighting capability in the event deterrence should fail. Nevertheless, in spite of the realities as they exist, many still believe that the use of any type of nuclear explosive will result in strategic nuclear war with mass destruction of people and property.

Theoretically, there may be a question as to whether future conflicts will involve the use of nuclear weapons. However, the US Army cannot afford the luxury of choice in the matter. The Army of the 1950s acted under the assumption that nuclear weapons would be used in waging future land combat. Perhaps the Army of the 1980s should give greater thought to that possibility.



MAJ John R. Rose is assigned to the Department of Social Sciences, USMA, West Point, NY.



Your "Redleg Hotline" is waiting around the clock to answer your questions or provide advice on problems. Call AUTOVON 639-4020 or commercial (405) 351-4020. Calls will be electronically recorded 24 hours a day and queries referred to the appropriate department for a quick response. Be sure to give name, rank, unit address, and telephone number.

REDLEG

NEWSLETTER

Reorganization of OPMD

A major reorganization of the Officer Personnel Management Directorate (OPMD) has begun at MILPERCEN. The reorganization effort, to be phased in over a 19-month period, is directed at providing officers a single point of contact for career matters, increased personalized management, and greater emphasis on non-accession specialty development.

Under the reorganization, three divisions—Combat Arms, Combat Service Support, and Combat Support Arms—will manage careers of lieutenants through lieutenant colonels. Present colonel and warrant officer divisions will remain unchanged. Each officer will be managed by the career management division responsible for one of his two specialties. For most, this will be the specialty received upon entering active duty.

Each management division will have an assignment branch and various management sections which have the responsibility for one or more other specialties.

The new management sections and the specialties they will be managing are shown in table 1.

For officers whose specialties fall within separate divisions, assignments will be coordinated between the management sections responsible for those specialties.

According to MILPERCEN the new organization will improve "life cycle" management by providing one point of contact for grades 01 through 05. Each management division will be responsible for personnel actions, assignments, and professional development in both accession and non-accession specialties.

Table 1. Specialty assignment controller responsibility.		
Combat Arms Division	Combat Support Arms Division	Combat Service Support Division
Infantry Mgt Sec: 11—Infantry *54—Opns Force Dev	Chemical Mgt Sec: 74—Chemical *52—Atomic Energy	Personnel and Admin Mgt Sec: *41—Personnel Management 42—Personnel Administration 43—Club Management
Armor Mgt Sec: 12—Armor *28—Training Development	Engineer Mgt Sec: 21—Engineer *49—Opns Research/Sys Anal	Financial Mgt Sec: 44—Finance *45—Comptroller
Aviation Mgt Sec: 15—Aviation	Military Intelligence Mgt Sec: 35—Tactical/Strategic Intel 36—Counterintelligence/HUMINT 37—Electronic Warfare	Maintenance Mgt Sec: *51—Research and Development 73—Missile Materiel Mgt 75—Munitions Materiel Mgt 76—ARM Materiel Mgt 77—Tk/Grd MOB Materiel Mgt *91—Maintenance Mgt *97—Procurement
Field Artillery Mgt Sec: 13—Field Artillery *48—Foreign Area Officer	Law Enforcement Mgt Sec: 31—Law Enforcement	Supply Mgt Sec: 81—Petro Mgt 87—Food Mgt 92—Supply Mgt
Air Defense Mgt Sec: 14—Air Defense *46—Public Affairs	Communications/Electronics Mgt Sec: 25—Combat Comm/Elec 27—Comm/Elec Engineer *53—ADP 72—Comm/Elec Materiel Mgt	Transportation Mgt Sec: 71—Aviation Materiel Mgt 87—Marine/TERM Opns 88—Highway/Rail Opns *95—Transportation Mgt

*Denotes non-accession specialties.

GI Bill for ROTC officers

According to officials at The Adjutant General Center (TAGCEN), some officers are having difficulty in getting GI Bill benefits approved through local Veterans Service Centers.

Earlier this year, TAGCEN announced that officers, who entered the Reserve Officers' Training Corps program before 1 January 1977 and were commissioned and served on active duty before 2 January 1978, were eligible for educational benefits under the GI Bill.

The Veterans Administration (VA) announced the new policy in Change 9, Appendix P, DVB Circular 20-76-84 in April 1978. Veterans Administration officials say that the change has been circulated throughout the VA organization and that those officers having difficulties should tell Veterans Service Center officials about Change 9. The circular has also been distributed to Army installation education services centers.

The GI Bill, which provides service members with up to 45 months of financial aid of education programs, was replaced with the Veterans Educational Assistance Program (VEAP). The old GI Bill was ended by Public Law 94-502 for persons entering the service after 31 December 1976. The new VEAP program requires that service members contribute to their own education benefits. The VA provides two dollars for each dollar set aside by the soldier for post-service education.

The ruling applies only to officers who took part in ROTC programs before 1 January 1977 and served as officers before 2 January 1978. All service members who came on active duty after 31 December 1976 are eligible to participate in VEAP.

Survivor Benefit Plan for Reserve Component members

A new policy has been announced concerning survivors of Reserve Component members who died before being given an opportunity to choose an option under the Reserve Components Survivor Benefit Plan.

The law became effective 1 October 1978, but the actions necessary to implement it have delayed efforts to give eligible members an opportunity to participate. In view of these circumstances, it has been ruled that otherwise eligible members were in an entitlement status as of 1 October 1978 and that the eligible survivor(s) of these members are in an entitlement status for receipt of an immediate annuity, provided the member:

- Was entitled to participate in the plan as set forth by the law on or about 1 October 1978.
- Was deceased on or after 1 October 1978.
- Was unable to exercise an election option due to the actions necessary to implement the law.

- Had not executed a statement of intent to participate which provided for a deferred annuity or had not declined to participate.

This immediate annuity payment will be awarded upon application to the surviving eligible spouse, if any. If there is an eligible surviving spouse and children, payment is awarded to the spouse only. If eligible child/children are the only survivors, payment will be made to the child or children in equal shares. A person with an insurable interest is not eligible for an annuity under this ruling, but payment may be directed by the Secretary of the Military Department as a result of consideration by the appropriate Board for Correction of Military Records.

If they choose, survivors can receive an annuity beginning on the 60th anniversary of the deceased member's birth. If a statement of intent has been executed by the deceased member and validated, an annuity will be awarded in compliance with his intent. This immediate annuity is not available to survivors of members who had been notified of their eligibility for retirement and executed their options within the 90-day period set forth by the law.

Survivors who are eligible for an annuity under this announcement should contact the Commander, US Army Reserve Components Personnel and Administration Center, 9700 Page Boulevard, St. Louis, MO 63132, ATTN: AGUZ-RAS.

More MOSs added to SQT list

A recent announcement by MILPERCEN indicates skill qualification test (SQT) scores will be used to determine E5/E6 promotion qualifications in 13 additional MOSs. Field Artillery related MOSs which were affected are:

- 13B, cannon crewman.
- 13E, cannon fire direction specialist.
- 15D, Lance missile crew member.
- 15E, Pershing missile crew member.
- 17C, field artillery target acquisition specialist.
- 41C, fire control instrument repairman.
- 45L, artillery repairman.
- 93F, field artillery meteorological crewman.

Soldiers can receive between 51 and 250 points on the 1,000-point worksheet by attaining a score of 80 or by finishing in the top half of their skill examination. Those who fail the SQT, according to MILPERCEN officials, face little chance for promotion; however, the point difference could be made up if very high scores are achieved in other areas of the worksheet.

Scores are adjusted twice a year—March and April for potential E5s and April and November for E6s.

Simultaneous Membership Program

National Guard and Reserve enlisted soldiers may now enroll in advanced ROTC courses while continuing to serve in a Reserve Component (RC) unit. Additionally, ROTC advanced course cadets may enlist in Army National Guard (ARNG) or Army Reserve (USAR) units as officer trainees.

Called the Army ROTC/Selected Reserve Simultaneous Membership Program (SMP), it is a voluntary officer training program requiring Reserve Component enlisted status for eligibility.

Participants in this program will drill with RC units as officer trainees, hold the rank of cadet, and be paid for the enlisted grade by total years of service. Pay however will not be less than that for grade E5, and since these soldiers will also receive ROTC training they will be paid a monthly \$100 subsistence allowance up to 20 months.

After completing ROTC, SMP participants will be commissioned and assigned to USAR or ARNG units until they graduate from college. At their request they can then be considered for regular Army appointments or three-year active duty tours, or they may be able to fulfill their obligation in RC units. According to MILPERCEN, the SMP is expected to increase the number of officers entering the selected reserve.

Enlisted RC members and ROTC cadets must meet the following criteria to participate in the program:

- Be a US citizen.
- Be enrolled or intend to enroll in ROTC advanced courses.
- Have at least four years remaining on their enlistment when they enroll in SMP.
- Be less than 25 years of age when accepted in the program.
- Have completed basic combat training, MS I and II, basic ROTC summer camp, junior ROTC, or one year at a service academy to qualify for entrance into advanced ROTC.
- Be enrolled or plan to enroll with at least two years remaining (or be an advanced ROTC cadet) in a full-time course of instruction leading to a bachelor or advanced degree at a college or university hosting or having a cross-enrollment agreement with another school hosting Army ROTC programs.

Individuals on ROTC scholarships or participating in a Federal tuition assistance program are not eligible to enroll in the Simultaneous Membership Program.

Questions on the Simultaneous Membership Program should be addressed to local National Guard or Reserve recruiters or to the Professor of Military Science at local schools.

Soldiers can complete service obligation in the IRR

As of 1 October soldiers separating before completing their first enlistment may be transferred to the Individual Ready Reserve (IRR) instead of receiving a discharge.

Soldiers separating after completing basic training or at least eight weeks of one station unit training will be transferred to the IRR to complete their six-year obligation. This new policy applies to Regular Army soldiers, Army Reservists, and National Guardsmen separated for such reasons as:

- Dependency—because of death or disability of a member of the soldier's family, other members of the family become principally dependent on him for care or support.
- Hardship.
- When the soldier is unable to perform duties due to parenthood.

Additionally, soldiers separated under the trainee discharge program, the expeditious discharge program, or because of unsuitability due to apathy may also be transferred to the IRR; however, in these cases commanders will direct discharge of those soldiers identified as having no potential for useful service during full mobilization.

The policy, as outlined in recent changes to AR 635-200, AR 135-178, AR 140-10 and NGR 600-200, is to assure that no servicemembers who have not completed the six-year obligation are discharged if they have potential for useful service during full mobilization.

13F Added to "BEAR" Program

The 13F MOS (Fire Support Specialist/Zone A) has recently been added to the Army's Bonus Extension and Retraining (BEAR) Program.

This program is designed to allow soldiers to extend their enlistment for retraining in an MOS which has a Selective Reenlistment Bonus (SRB) multiplier. Upon completion of training, individuals are awarded the 13F MOS as their primary specialty and are reenlisted in that MOS.

Moving? Subscribers should send their new address four weeks in advance to:

**Field Artillery Association
c/o Fort Sill Museum
Fort Sill, OK 73503**

The Field Artillery MILPERCEN Team



COLONEL'S DIVISION
AV 221-7862/7863

LTC Joseph W. Bagnerise
SC 13 (A-Z)



LIEUTENANT COLONEL'S DIVISION
AV 221-9789/9529

LTC William E. Bacon
SC 13 Overseas and
Aviator Assignments



LTC Michael W. Gilmartin
SC 13 CONUS
SC 54 Overseas



MAJOR'S DIVISION
AN 221-0686/0687

MAJ Leo J. Baxter
SC 13, 54 Overseas



MAJ John C. Truesdell
SC 13, 54 CONUS

COMPANY GRADE COMBAT ARMS DIVISION
AV 221-7817/0187



LTC(P) Leslie E. Beavers
Chief, FA Branch



MAJ William H. Ott
SC 13
Captains, CONUS



MAJ James E. Shane
Advanced Course and
Lieutenant Assignments



CPT(P) Dennis C. Cline
Combat Arms
Lieutenant Assignments



CPT Joseph W. Eszes
SC 13 Overseas and
USMA Combat Arms Div

US MILPERCEN
200 Stovall Street
Alexandria, VA 22332

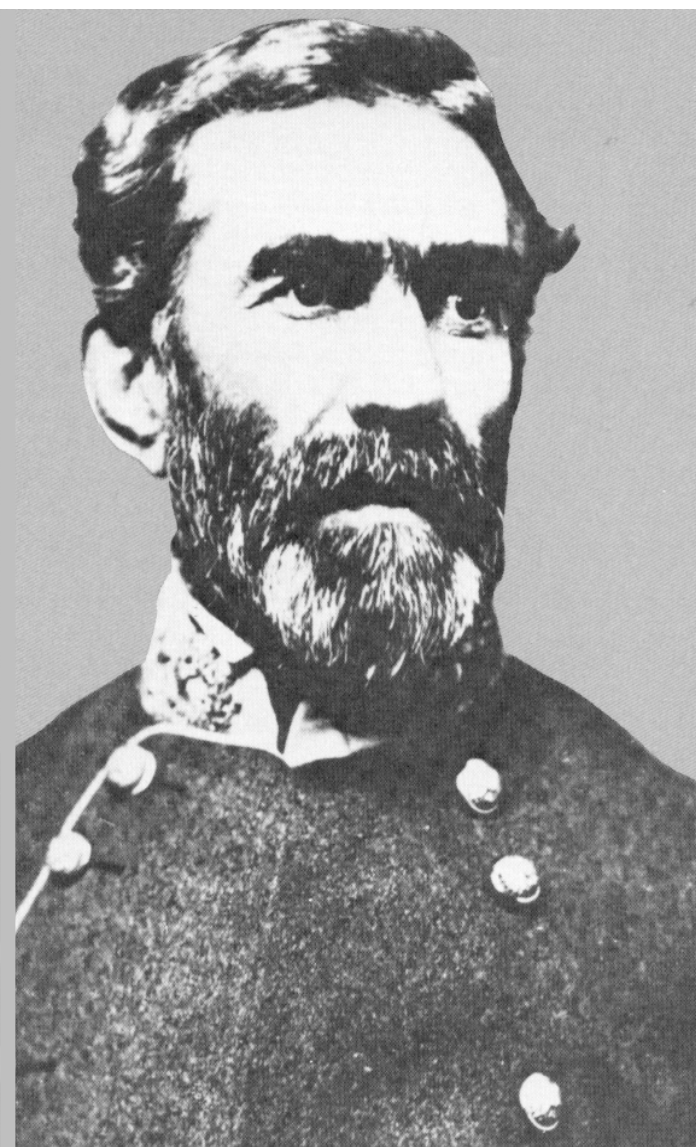

Bragg— Valiant

Artilleryman

by COL (Ret) Robert M. Stegmaier

At Buena Vista in northern Mexico on 23 February 1846 Captain Braxton Bragg and his Company C, 3d Artillery, demonstrated most effectively the mobile role of the "flying battery" in combat. Bragg, sensing that the enemy, after being repulsed on the American left, would initiate an all-out attack on the right flank, headed his battery without orders in that direction. Bragg left this description of events that occurred:

"As they (the Mexicans) were retiring by the very route they had advanced, I feared they would avail themselves of our weakness at that point (right of our line) and renew the attack, regardless of our (white) flag. I accordingly reversed my battery, and urged my horses to the utmost. They were so exhausted, however, that a walk was all that could be forced from them by both whip and spur. . . . Having gained a position from which my guns could be used, I put them in battery, and loaded with canister. Now, for the first time, I felt the imminent peril in which we stood. Our infantry was routed, our advanced artillery captured, and the enemy in heavy force coming upon us at a run. Feeling that the day depended upon the successful stand of our artillery, I appealed to the commanding general, who was near, for support. None was to be had, and under his instructions to maintain the position at every hazard, I returned to my battery, encouraged by men, and, when the enemy arrived within good range, poured forth the canister as rapidly as my guns could be loaded. At the first discharge I observed the enemy falter and in a short time he was in full retreat. . . ."

General Taylor's own account of the event was as follows:

"Captain Bragg, who had just arrived from the left, was ordered at once into battery. Without any infantry to support him, and at the imminent risk of losing his guns, this officer came rapidly into action, the Mexican lines being but a few yards from muzzles of his pieces. The first discharge of canister caused the enemy to hesitate; the second and third drove him back in disorder, and saved the day."

Bragg had two outstanding characteristics: He was forthright and outspoken in viewpoint, and he was ever-ready to fight. As a young lieutenant, he openly in writing criticized measures approved by Major General Winfield Scott and probably paid dearly for this brash-ness. Although Bragg was acknowledged as the commander of the outstanding battery in General Taylor's army, his unit was not transferred to Scott's Army at Vera Cruz—Duncan's Company A, 2d Artillery, was chosen instead. To illustrate his ever-readiness to fight, a Charlestonian dared, in the hearing of Bragg, to call North Carolina, Bragg's home state, a strip of land between two states. Challenged to a duel by the fiery impetuous Bragg, the South Carolina native narrowly averted a show-down by apologizing, an action encouraged by William T. Sherman and John F. Reynolds, friends of Bragg.

Bragg was a disciplinarian and a doer. Landing at Corpus Christi without guns, he procured whatever guns were available, no matter the age or the origin, and trained his men. Under his command were Lieutenants George H. Thomas, John Reynolds, and D. H. Hill, all destined for stars in the Civil War. Bragg even had the novel experience of twice being "fraggged" (the attempt of an aggrieved or disconsolate soldier to eliminate an officer of whom he disapproved). Luckily the shell missed Bragg but the fragments tore holes in the blanket on which he lay.

During the first battles of Palo Alto and Resaca de la Palma, Bragg's unit had little to boast about. The outfit was ensconced in Fort Brown, was subject to heavy bombardment by Mexican cannon, and had to conserve ammunition to repulse an expected all-out Alamo-type attack. His battery however vigorously helped with fire to precipitate the Mexican retreat across the Rio Grande.

At Monterey, Bragg's E Company, 3d Artillery, highly distinguished itself in the severe street fights. Unfortunately as General Taylor had beforehand been told, cannon with firepower greater than 8- and 6-pounders were needed to neutralize enemy barricaded behind adobe walls and fortified with artillery. Enemy shot and shell made the streets untenable. Lieutenant French, in his book *In Two Wars*, stated that the cannon were pulled into an intersection by ropes to fire; even so, four gunners were lost. In the open, however, at Monterey, the unit proved its value; when an enemy cavalry force assembled to charge the scattered American infantry, Bragg turned his rapid firing weapons upon the mass. As proved throughout the Mexican War, cavalry could not sustain the death-dealing effects of American light artillery.

In the interval between the battles of Monterey and Buena Vista, Bragg had a change of command. He was assigned to the finest "flying battery" in the Army,

Company C of the 3d Artillery. This company had been commanded by Major Samuel Ringgold, father of the "flying batteries." It was the unit that had performed so splendidly at Palo Alto and was one to whose command all artillerymen aspired. When Ringgold was killed at Palo Alto, General Taylor chose Bragg to carry on the unit's proud tradition of being first in maneuver and in firepower.

Of Bragg's new outfit, a subordinate officer wrote that the battery ". . . was in the highest state of efficiency, discipline, and drill of any organization, of any arm, that I have ever seen. It had six guns . . . each having six horses as teams, and each gun served by a detachment of 12 men mounted, not on the boxes, but on high-mettled and well-trained horses, which followed the guns as they moved at a gallop, and swept over the plain of exercise like a whirlwind."

At Lobos Island, General Scott requisitioned all Taylor's regular infantry units and the regular artillery battery of Lieutenant James Duncan. Bragg, feeling that he had been slighted, was determined to prove that his unit was the outstanding battery in the Army.

On the field at Buena Vista just prior to the heroic action described in the second paragraph of this article, Bragg had already distinguished himself. In his own words:

". . . I directed my attention to the large infantry and cavalry forces which had turned our left flank and was still advancing. At this time I saw that Lieutenant Kilburn had joined me with his gun. . . . Seeing that the force which had turned us was gradually moving along the foot of the mountain toward Saltillo and was only held in check by Captain Sherman, with one gun under the support of the Mississippi riflemen, which he had daringly advanced against at least 4,000 of the enemy, I put my battery in motion toward them, and sought support from scattered parties of mounted men in the vicinity of the train. About 50 followed me. By the time I arrived within range of the enemy—my movement being very slow, owing to the jaded condition of my horses—I noticed the Mississippi regiment gallantly led against a force immensely superior. Overwhelmed by numbers, it was forced to fall back. I am happy to believe that my rapid and well-directed fire, opened just at this time, held the enemy in check until Colonel Jefferson Davis could gain a position and assume a stand. Under my fire, the enemy retreated some hundred yards, and I advanced the

same distance, and again came into action. From this point, I several times fell back and as often advanced, regulating my movement by those of the enemy, my support being weak and uncertain. The effect of my fire was very apparent, frequently throwing whole columns into disorder. Whilst thus engaged, General Wool came up, and at my request, ordered our cavalry, then some distance to my left, to move to my support. I at once approached within canister range and felt confident I should inflict a loss upon the enemy from which he could not possibly recover. A white flag, however, rapidly passed me, and I ceased my fire. The enemy seized the opportunity, availed themselves of the protection of our flag, and drew off beyond the range of our guns."

While this was occurring, General Santa Anna prepared his troops on the Mexican left for a final all-out assault. The situation there was desperate. Lieutenant John Paul Jones O'Brien, with his section of two 6-pounders, found himself unsupported. As O'Brien stated:

"My own loss was severe. I had two horses shot under me. . . I remained with the guns

to the last, until the enemy came within a few yards of them, when I was forced to retire for want of a single cannoneer to load or fire. . . ."

It was at this moment Captain Bragg's battery and General Taylor arrived. General Taylor commanded to Bragg: "Double-shot your guns and give them hell!" The guns flamed, the enemy broke, the battle was won. The sacrifice stand of O'Brien and the timely arrival of Bragg, responding without orders, to the feel and sound of battle, had saved the day.

Bragg, acknowledgeably a courageous man, knew that victory belonged only to the strong and to the organization willing to follow its leader regardless of fatigue, long battle hours, loss of sleep, or seemingly impossible tasks. It was in those desperate moments that Bragg's leadership and discipline proved their value.

After the battle, General Wool stated: "Without our artillery we could not have maintained our position a single hour." He may well have added: "Without Bragg and the well-trained disciplined crew of C Company, 3d Artillery, the battle of Buena Vista would never have been won." 

COL (Ret) Rober M. Stegmaier, a regular contributor to the *Journal*, lives in Sun City, AZ.



Battle of Buena Vista.

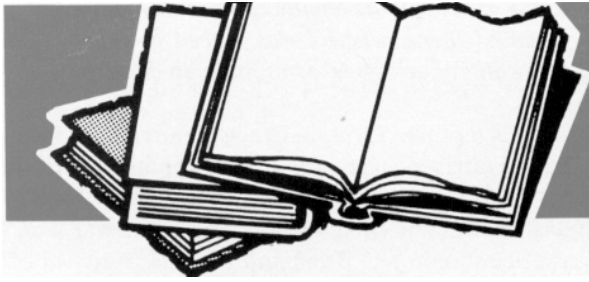

Redleg Review

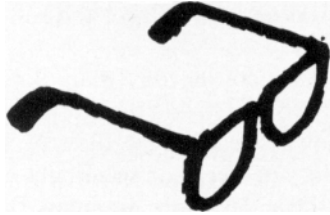

WARSHIPS OF THE WORLD: ESCORT VESSELS, by Bernard Ireland, Charles Scribner's Sons, New York, 1979, 153 pages, \$12.50.

This book, the second of Bernard Ireland's three volume series. *Warships of the World*, contains a wealth of information of those warships whose displacement tonnage is between 1,000 and 5,000 tons. Of particular note is its focus on several of the world's smaller navies, to include NATO and Western powers, whose emphasis lies in defense of costal waters and shipping lanes rather than offensive operations.

Escort Vessels provides comprehensive data on machinery (power), armament, and sizes of most of the important classes of this type ship. The book is supported by over 140 photographs and line drawings and contains short, well written naratives of many strong and weak design characteristics.

Escort Vessels gives readers an attractive, convenient and compact reference source, one which is valuable to the novice as well as the expert.—Ed.

ULTRA GOES TO WAR: THE FIRST ACCOUNT OF WORLD WAR II'S GREATEST SECRET BASED ON OFFICIAL DOCUMENTS, by Ronald Lewin, McGraw-Hill, New York, 1978, 378 pages, \$12.95.

After more than 30 years of absolute secrecy, comprehensive knowledge and understanding of *Ultra* and its significance in the course of World War II are slowly being realized. Ronald Lewin's book, based largely on formerly highly classified and tightly held signals and documents, makes some remarkable and fascinating progress toward this appreciation.

The early chapters pick through the incredibly complex, tedious, and seemingly impossible tasks of cryptanalysts in their breaking of the ciphers of the *Enigma* machine. The middle chapters describe the organization that grew and developed to collect, analyze, and disseminate *Ultra* intelligence to users at all echelons. The last several chapters, perhaps the most important to most readers, chronical numerous campaigns and battles in the light of *Ultra* or its absence. The book contains a useful index for handy reference.

Throughout the book runs a threat of a dilemma: The need for secrecy so necessary to protect the source on one hand, and the need to disseminate and use the products of *Ultra* on the other.

Ronald Lewin, a respected military historian, is at his best in describing decisions and actions taken by major commanders during crucial battles throughout World War II. He makes crystal clear the contribution of reliable intelligence to battle outcome when properly used. Even in its infancy, *Ultra* provided significant assistance to the winning of the Battle of Britain. As it matured and grew, *Ultra* was key to Rommel's defeat in North Africa and Allied success in Normandy and subsequent continental campaigns.

By the same token it is possible that the *Ultra* may have precluded the Battle of the Bulge and prevented the debacle at Arnhem, a bridge too far.

Ultra Goes to War provides a key that helps to explain many events, achievements, and failures during WW II. It also provides some sage and timely insights into the use of intelligence.

LTC C. Kelly McCord, FA, is Deputy Director, Counterfire Department, USAFAS, with an alternate specialty of tactical and strategic intelligence. His previous service includes assignments with the US Army Intelligence Threat Analyst Detachment, Arlington Hall Station, VA, and Office of the Assistant Chief of Staff for Intelligence, Washington, DC.

MILITARY VEHICLES OF THE WORLD, by Christopher F. Foss, Charles Scribner's Sons, New York, 1979, 189 pages, \$8.95.

This is the first revision of the reference work published in 1976. *Military Vehicles* is one of four books by the author covering nearly all types of materiel used by the armed forces of the world.

There is at least one photo of every vehicle in the volume, and the accompanying descriptions include a short narrative on the development and uses of the items plus detailed specifications such as speed, cargo capacity, turning radius, and fording capability in addition to all the more routine data. Metric measurements are used throughout.

Both tracked and wheeled vehicles are cataloged. Some World War II vehicles which are still in use have been left out, and many of the listings are in various stages of research or development. Most of the photographs are of excellent quality, though the majority are manufacturers' "hard stand" shots with little action or troop involvement.

LTC W. A. Cauthen is the Public Affairs Officer at Fort Jackson, SC.

NO VICTOR, NO VANQUISHED, THE YOM KIPPUR WAR, by Edgar O'Ballance, Presidio Press, San Rafael, CA, 1978, 370 pages, \$14.95.

If one who knew of the author were to read the book title, he would expect to find within the covers an account of a standoff conflict as viewed through the eyes of an impartial military writer. Indeed, in his foreword, Major O'Ballance (UKA, Ret) states that his purpose in writing this account was to "compile an accurate, contemporary, warts-and-all history. . . ." His purpose was not achieved, since the work's documentation is strikingly one-sided. Sir Liddell Hart, the military scholar, once expressed concern over a lack of truthfulness in military history. He felt that generals and others who write on military matters become overly cautious when

asked to place thoughts and beliefs on paper. One senses that Major O'Ballance was confronted with this type of reticence in attempting interviews with participants from both sides. Apparently he received better cooperation from the Arabs since most of the interviews, maps, and records contained in the book are of Egyptian, Syrian, or Jordanian origin. His failure to obtain more first-hand material from the Israelis is a troublesome limitation.

The author's underlying thesis is that militarily the war was a standoff with both sides giving up equal shares of land. Politically, he argues, the edge went to the Arabs since they broke the crystallized "no war, no peace" situation that had existed since the end of the War of Attrition in August 1970.

There are errors. O'Ballance calls the RF-5A aircraft the "Blackbird"—he meant the SR-71 reconnaissance aircraft. He states that the ZSU-23-4 antiaircraft gun had to be stationary when it searched or fired—it doesn't. He identified the Walleye as a laser weapon—it is an electro-optical guided weapon. He mentions that the Israelis wanted the Skyhawk aircraft because of its machineguns—the plane has cannons, but no machineguns.

What, then, is the value of this book? It is easy and interesting reading. As the various battles of the War are chronicled, the reader is presented with controversial and sometimes thought-provoking material. This book provides the casual reader with an excellent overview of the Yom Kippur War.

Lt Col Kenneth L. Redding, USAF, is assigned to the office of the USAF Representative, USAFAS.

PRIMACY OR WORLD ORDER: AMERICAN FOREIGN POLICY SINCE THE COLD WAR, by Stanley Hoffman, McGraw-Hill, New York, 1978, 333 pages, \$12.50.

Just as Solzhenitsyn in his famous Harvard commencement address caused Americans to examine our domestic policy, Stanley Hoffman calls on us to examine our foreign policy. Hoffman is a realist about the past and present futile attempts at world order. Noting throughout the book the utter complexity of the international system, he still maintains a sense of the "growing, indeed the decisive, importance of world affairs in the life of each of us."

Primacy or World Order begins with a review of the last 30 years of foreign

policy, with special emphasis on the cold war, Vietnam, and Henry Kissinger's contributions, and proceeds to an analysis of the complexity and unmanageability of the present system, which he calls the nightmare of world order. Having specified the predicament of America in quite precise terms, he concludes by defining a set of recommendations for "a process of world order."

In the course of the text Hoffman uses the concept of "games" and "actors" effectively. In fact, the author outlines, structures, and documents his ideas very well, leaving little room for ambiguity. Subtle, but insightful, comments spice up the text.

Primacy or World Order is full of quotable quotes which are incisive, in addition to being universal generalizations; e.g., "What many liberal Americans resent is not so much isolation as betrayal." Out of all this Hoffman recommends a program of solutions which neither causes us to throw up our hands in despair nor allows us the illusion of easy, perfect efficacy. This work begins and ends with a challenge that "a world order policy is a pattern of education." The author quotes Henry Kissinger's *A World Restored*: "For men become myths, not by what they know, not even by what they achieve, but by the tasks they set for themselves." Kissinger may have been speaking of himself, but for the careful reader he has set forth the lasting value of Hoffman's contribution.

Don W. Chenoweth is an associate professor of Social Science at Cameron University.

SUMMONS OF THE TRUMPET, U.S.-VIETNAM IN PERSPECTIVE, by Dave Richard Palmer, Presidio Press, San Rafael, CA, 1978, 277 pages, \$12.95.

Some say the Vietnam War was "lost" due to antiwar activities. Others claim it was "lost" because of the media. This book does not deal with such superficialities. It gets to the deeper reasons for the outcome of that conflict.

Palmer, an Army Brigadier General and Vietnam veteran, states the book's purpose is to present a broad history of the American military involvement in Vietnam. His focus is on military strategy as derived from national policies.

Palmer points out that the American objective in Vietnam had not been made clear and many Americans did not understand why their country was fighting. Government leadership could not define

"victory" in the conflict. As the war dragged on, Washington strategists came up with definitions like "favorable settlement," "demonstrate to the Viet Cong that they cannot win," and "avoid humiliation."

The author claims the US imposed its own limitations on the Vietnam War. With the entry of North Vietnam into the war on a major scale, the Johnson administration used the strategy of graduated response. This led to a wider war because Ho Chi Minh believed the US would not fully support South Vietnam. Johnson allowed North Vietnam to retain the initiative by not taking the strategic offensive as evidenced by a limited air campaign against North Vietnam and prohibition against operations into the sanctuaries in Cambodia and Laos.

By 1966 General Westmoreland was calling the conflict a "protracted war of attrition," and Palmer concludes that by then we were strategically bankrupt in the war. This war of attrition had its effect on battlefield tactics. The old concept of "closing with and finishing the enemy" became "finding the enemy and killing him with firepower."

Palmer states that Westmoreland's call for reinforcements just after TET 1968 was looked on by many Americans as a means to prevent Allied defeat. Support for the war effort declined.

Under Richard Nixon a new strategy, Vietnamization, appeared. Although Allied forces were being withdrawn, the war was carried to the enemy in his over-the-border sanctuaries, the air campaign against the North was intensified, and harbors were mined. A major North Vietnamese offensive in 1972 was beaten back with heavy losses inflicted by the South Vietnamese—an indication that Vietnamization was succeeding according to the author.

March 1973 marked the pullout of the last of US forces from Vietnam and completes the period of Palmer's study. He briefly touches on the final outcome in 1975.

In the epilogue titled "No More Vietnams," Palmer traces the many conflicts the US had been involved in during this century. He argues that, unless the people support a war effort, the war can be lost at home. The people must know the objective of the war.

In his well-written, readable book, Palmer succeeds in describing how national policies affect military strategy. *LTC Joseph P. Frankoski is Deputy Director, Public Affairs, US Forces Japan.*

1979 Redleg Reference

The following is a list of Journal articles and "View From The Blockhouse" items for calendar year 1979 and the issue in which the material was published. The letters (VB) indicate "View From The Blockhouse" items.

Ammunition/Fuzes

Artillery Scatterable Mines, Sep-Oct.
Development Of Point Detonating Fuzes, Mar-Apr.
Simulated containers for nuclear 155-mm and 8-inch projectiles, Sep-Oct (VB).

Communication/Electronics

Communicating In Desert Environment, May-June.
The Trumpets Of War, Jul-Aug.
VINSON communication security equipment, Sep-Oct (VB).

Counterfire

Do not destroy old FM 6-16, Sep-Oct (VB).
Error in the Army Ephemeris (FM 6-300), May-Jun (VB).
Field Artillery Meteorology Crewman (MOS 93F), Jan-Feb (VB).
Firefinder training devices, Sep-Oct (VB).
Good news for sound rangers, Jan-Feb (VB).
More map reading for lieutenants, Sep-Oct (VB).
More power for hand-held calculators, Mar-Apr (VB).
New computers for sound/flash platoons, Nov-Dec (VB).
New parts manual for Rawin set, Sep-Oct (VB).
PADS and laser rangefinders in survey, Jan-Feb (VB).
PADS at CFD!!!, Nov-Dec (VB).
PADS contract awarded, Nov-Dec (VB).
Reducing radar vulnerability, Mar-Apr (VB).
Remotely piloted vehicle, May-Jun (VB).
Shelter S-13A/MPO-4A, May-June (VB).
Super Surveyor Reborn, Sep-Oct.
TAB conference held, Jan-Feb (VB).
Target acquisition battery—how to improve peacetime utilization and training, Jul-Aug (VB).
Target Card (DA Form 4695) is here! Sep-Oct (VB).
The latest on met, May-Jun (VB).
TV tapes on repair of met equipment, Nov-Dec (VB).
Viable Counterfire Is The Answer, Mar-Apr.
Why FOs Can't Shoot! Jul-Aug.

Doctrine

FIST of the future, Nov-Dec (VB).
Interoperability, Nov-Dec.

Equipment

Battery Computer System update, Nov-Dec (VB).
Damage to 8-inch tubes, Mar-Apr (VB).
8-inch M110A2 and the M404 ICM, May-Jun (VB).
FADAC Procedures for 155-mm FASCAM rounds, Jul-Aug (VB).
GFT fan cursor, Jul-Aug (VB).
GSRs is MLRS, Jan-Feb (VB).
HHCs getting field test, May-Jun (VB).
Illumination Simulator, Sep-Oct.
Lance And The Hand-Held Calculator, May-Jun.
M110A1 Fallback Damage, Nov-Dec.
Muzzle velocity differences for 8-inch M110A2, Jul-Aug (VB).

RDP—30,000 meters, Jul-Aug (VB).
TACFIRE—A Quantum Leap In Data Processing, May-Jun.
TACFIRE—Where Do We Go From Here? Jan-Feb.
Theatre Nuclear Weapons: Begging The Soviet Union To Pre-empt, Sep-Oct.
The Battery Computer System, Mar-Apr.
Transition to BCS, Mar-Apr (VB).
We've Got 30! May-Jun.
Whence The 105-mm Howitzer? May-Jun.

Foreign

Sweden's Field Howitzer, Jan-Feb.
The Soviet Theater Nuclear Offensive And The European Battlefield, Sep-Oct.
Training and Indoctrination Of The Soviet Soldier, Nov-Dec.

Gunnery

Ballistic Similitude: Why It Is Necessary, Jan-Feb.
Calibration requirement, Nov-Dec (VB).
Filling The G-a-p-s In Transfer Limits, Sep-Oct.
Firing the 155-mm RAP, May-Jun (VB).
FIST Fire Planning Or "On Time, On Target" Mar-Apr.
FSO suggestions, Jan-Feb (VB).
OFT not selected, Mar-Apr (VB).
The Modern Battlefield BOC, Nov-Dec.

History

Artillery Hall of Fame marks 10 years, Jan-Feb (VB).
Bragg—Valiant Artilleryman, Nov-Dec.
Dilger—Artilleryman Of Note, Mar-Apr.
Henry Knox—The Father Of American Artillery, Sep-Oct.
Samuel Ringgold And The Flying Batteries, Jul-Aug.

Interviews

BG Edward A. Dinges, May-June.
Col Gerald E. Monteith, Jan-Feb.

Miscellaneous

A Field Artilleryman As Military Attaché, Nov-Dec.
Close Support Study Group reconvenes, Mar-Apr (VB).
Commanders' Conference follow-up, Mar-Apr (VB).
Fire Support Conference, Jan-Feb (VB).
Fire Suppression Symposium, Nov-Dec (VB).
Marine Corps Artillery—An Update, Mar-Apr.
Naval gunfire: danger-close procedures, Nov-Dec (VB).
New department directors, May-Jun (VB).
New USAFAS department director, Sep-Oct (VB).
Redleg Hotline works! Jan-Feb (VB).
Reorganization of DCD, Nov-Dec (VB).
Senior Commanders' Conference, Jan-Feb (VB).
Update on FMs 6-30 and 6-40, May-Jun (VB).
USAFAS leadership changes, Jan-Feb (VB).

Organization

DRS—A Battery Commander's Perspective, Jan-Feb.
Quick-Fix Delivers FIST Now! Jan-Feb.

Personnel

Career Patterns For Field Artillery Company Grade Officers, Jan-Feb.
FADAC mechanics, May-Jun (VB).
TACFIRE MOS structure, Mar-Apr (VB).
The Company Grade Years—A Decade Of Development, Jul-Aug.
Why aren't there target analysts? May-Jun (VB).

Research and Development

GSRS Status Report, Mar-Apr.
The Hand-Held Calculator: A Status Report, Mar-Apr.
The Medical Effects Of Blast Overpressure, Mar-Apr.

Reserve Components

Are Our Reserve Components Ready? Sep-Oct.
The Total Force, Jul-Aug.

Tactics/Strategy

A Dying Issue, Sep-Oct.
Battery Perimeter Defense-The Last Resort, Sep-Oct.
Lance Tactical Concepts: Positioning and Movement, Jul-Aug.
Defending the Battery, May-Jun.
Nuclear Weapons: Image Versus Reality, Nov-Dec.
Suppression Of Enemy Air Defenses, May-Jun.

Training

Affiliation—Key To Improved Readiness, Jan-Feb.
Changes to 13E training, Jul-Aug (VB).
Deployment Training, Mar-Apr.
Initial SQT results, Mar-Apr (VB).
Integrated Fire Training Exercise, Jul-Aug.
Lance ARTEP, Mar-Apr (VB).
Lance Missile Mechanic Course, Jul-Aug (VB).
Lance TVI, May-Jun (VB).
Massing The Steel, Nov-Dec.
New FADAC tapes, Jan-Feb (VB).
New intercom TEC lesson, Sep-Oct (VB).
NSI—TPI—TVI? Jul-Aug.
Nuclear and chemical target analysis training, Jan-Feb (VB).
Operations/Intelligence extension course, May-June (VB).
REFORGER—Golden Thunder I, Jan-Feb.
SQT In The Soldier's Manual, Jul-Aug.
SQT policy being reviewed, Jul-Aug (VB).
TACFIRE Training System Arrives at Fort Sill, Sep-Oct (VB).
The "Nuclear" ARTEP In USAREUR—An Idea Whose Time Has Come, Jul-Aug.
Training literature update, May-June (VB).
The SQT: Sergeant's Business, Sep-Oct.
Validation tests pay off, Mar-Apr (VB).
Wirkungsschiessen (Fire For Effect), Jul-Aug.

—FRAGMENTS—

Although "Right By Piece" continues to rank first in popularity among *Journal* features, the method by which we obtain the majority of materials sorely needs improvement. For example, each week a screen is conducted of major unit/command newspapers, many of which arrive two to three weeks after publication. During this review, articles and photographs reporting interesting news from our field artillery units are singled out for reprint, rewrite or follow-up. Should a copy of a photograph be required, request is made with the appropriate editor or public affairs officer. Quite frankly this procedure lacks the timeliness of good journalism.

I submit that news of "what's going on and who's doing it" should come directly from the unit since nothing is better than first-hand account. Not only will information be more up-to-date, but factual accuracy will improve.

In short, the stories are there—the interest is here—all we need to do is get together.



As we all look ahead to the new year with great expectation, the *Journal* staff wishes to express sincere thanks and appreciation for *your* continued interest in and support of our efforts in 1979. Whatever success we might have enjoyed is because you—our readers, contributors, and critics—made it happen.

Have a safe and happy holiday season.

A handwritten signature in black ink, reading "John Dobb". The signature is written in a cursive style with a large, looping initial "J".