

A Salute
To Pershing

FIELD ARTILLERY JOURNAL

May-June 1977

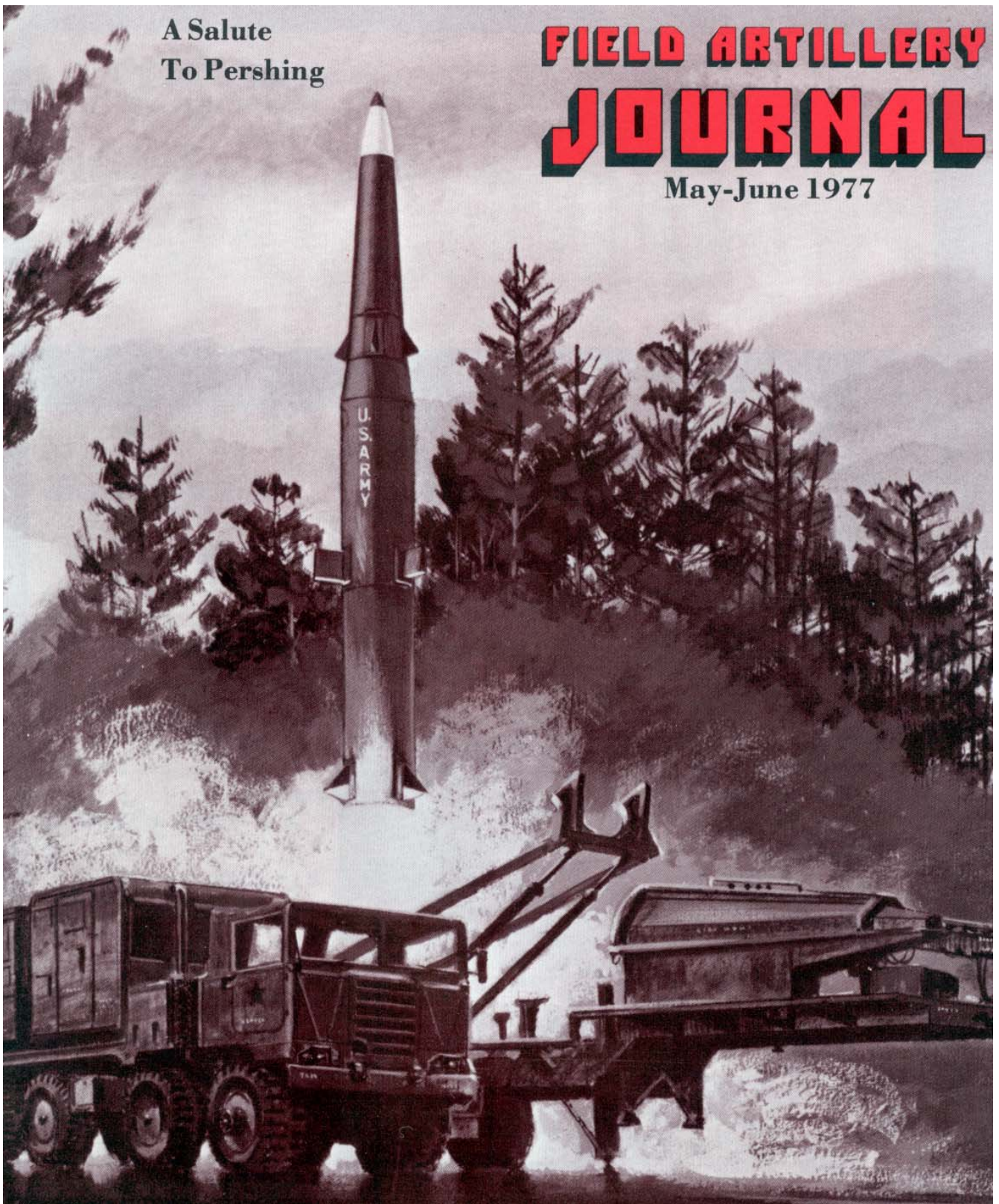

FIELD ARTILLERY JOURNAL

Volume 45

May-June 1977

Number 3

The *Field Artillery Journal* is published bimonthly at the US Army Field Artillery School for the same purpose stated in the first *Field Artillery Journal* in 1911:

To publish a Journal for disseminating professional knowledge and furnishing information as to the field artillery's progress, development, and best use in campaign; to cultivate, with the other arms, a common understanding of the powers and limitations of each; to foster a feeling of interdependence among the different arms and of hearty cooperation by all; and to promote understanding between the regular and militia forces by a closer bond; all of which objects are worthy and contribute to the good of our country."

Unless otherwise stated, material does not represent official policy or endorsement by any agency of the US Army.

Funds for the printing of the publication were approved by the Department of the Army, 1 September 1973.

All articles and information submitted are subject to edit by the *Journal* staff: footnotes and bibliographies may be deleted from text due to limitations of space.

All letters and articles should be addressed to Editor, *Field Artillery Journal*, PO Box 3131, Fort Sill, OK 73503. AUTOVON 639-5121/6806 or Commercial (405) 351-5121/6806.

The Field Artillery is pleased to grant permission to reprint articles. Please credit the author and the *Field Artillery Journal*.

Subscriptions to the *Journal* may be obtained through the Field Artillery Historical Association, Fort Sill, OK 73503. The rate is \$6 per year. Subscribers in foreign countries (except Canada and Mexico) must include an additional \$5 per year for postage; Canada and Mexico subscribers must include an additional \$3 per year for postage.

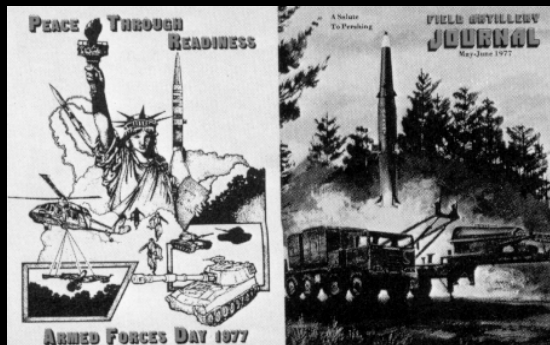

The front cover depicts the artist's concept of a Pershing II launch. The back cover is a drawing by Ms. Linda Jeleniewski commemorating Armed Forces Day.

THE FIELD ARTILLERY SCHOOL

COMMANDANT

MG Donald R. Keith

ASSISTANT COMMANDANT

BG Albert B. Akers

THE FIELD ARTILLERY JOURNAL STAFF

EDITOR

MAJ William A. Cauthen Jr.

MANAGING EDITOR

Ms. Mary Corrales

ASSISTANT EDITOR

Mr. William Finnegan

EDITORIAL ASSISTANT AND CIRCULATION MANAGER

Ms. Elaine Henrion

POSTMASTERS: Controlled
circulation postage paid at Lawton,
OK, Department of the Army, DOD
314.

Articles

- Pershing — The Ultimate Challenge** 9
by MAJ Robert J. Baker
- POTU — Testing Pershing In Europe
And CONUS** 15
by LTC Donald R. Lyman
- The Journal Interviews . . .** 22
MG Richard G. Trefry
- Minimum Required . . .
The MFDT Works!** 24
by MAJ Earl W. Finley
- Pershing — A Weapon For Long-Range
Fire Support** 26
by MAJ Alan L. Moore Jr.
- EPMS And The Field Artillery** 29
by COL Sam A. Brown
- Pershing II** 38
by COL Larry H. Hunt
- Field Artillery Brigade** 40
by COL Edward P. Coleman
- Limited Defense Option — Part III** 46
by LTC William M. Carrington, USAF, et al.
- Outpost of Democracy** 52
by Robert Thomson
- Winning The West** 58
by COL (Ret) Robert M. Stegmaier

Features

- Editor's Notes** 2
- Forward Observations** 3
- Incoming** 5
- FA Test & Development** 18
- With Our Comrades In Arms** 20
- Right By Piece** 34
- Redleg Newsletter** 44
- View From The Blockhouse** 55
- Commander's Update** Inside Back Cover

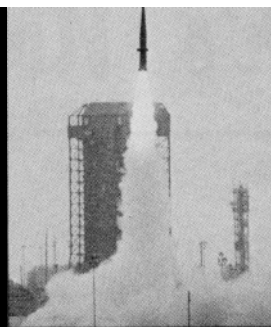

pg. 15

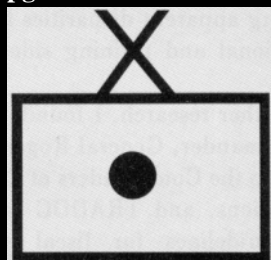

pg. 40



pg. 20

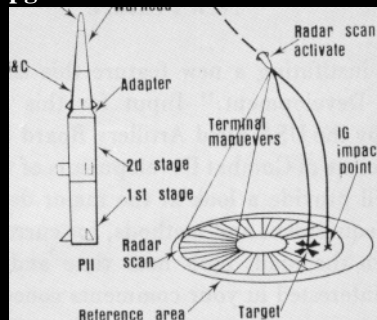

pg. 38

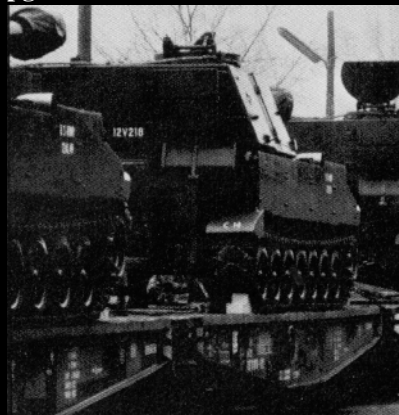

pg. 52

Editor's Notes

Since my last column (March-April 1977) which discussed my perceptions of the ARTEP, some additional information has come to light which impacts on my comments concerning apparent disparities in the positions held by the operational and training sides of the Army house.

In doing some further research, I found, that while still the FORSCOM Commander, General Rogers, our Chief of Staff, wrote a letter to the Commanders of CONUS Armies, FORSCOM Installations, and TRADOC Installations, to address training guidelines for fiscal year 1977. A paragraph in that 17 August 1976 letter addressed the ARTEP and said, in essence, that the unit commander was responsible for training and that ". . . the ARTEP is the tool they [commanders] will use to diagnose a unit's training deficiencies and to develop a relevant training program." That says exactly what the trainers (ARTEP designers) are saying. So it seems that the views I described as being divergent, are really very much in sync.

New Feature

We are instituting a new feature this issue called "FA Test And Development." Input for this feature will be provided by the USA Field Artillery Board here at Sill and the Directorate of Combat Developments of the School. The feature will provide a look at the major development and testing of equipment and methods, for current systems and those down the road, both near time and long range. I would be interested in your comments concerning this new feature.

Survey

Included in this issue of the *Journal* is our annual readership survey. This is an invaluable tool in helping us make the *Journal* what you want it to be. Please take a few minutes to complete it and drop it in the mail.

FA Command List

More than 20 colonels and promotable lieutenant colonels have been selected for assignment to div arty/group command positions that will become vacant during FY 78.

MILPERCEN officials did not release selection rates because many officers were considered for more than one command category and because the number of officers selected was determined strictly by the number of command vacancies projected for FY 78.

The following Field Artillery officers were selected for O-6 command:

Dirmeyer, Robert P.
Drummond, James E.
Eckelbarger, D. E.
Ely, Arch H., Jr.
Ganahl, Joseph
Herring, B. M., Jr.
Krausz, G. M.
May, Elmer C.
McCarty, D. W.
McGowan, P. A.
Modica, Giac P.

Monteith, G. E.
Nock, C. C.
O'Neil, Henry R.
Scales, D. E.
Skinner, G. N., Sr.
Soyster, Harry E.
Stein, E. J., Jr.
Sweet, W. E.
Symons, John W.
Teeter, C. E.
Wolfgang, A. E.

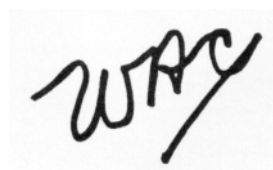

forward observations



by MG Donald R. Keith

The division, with balanced combat elements, technical services, and logistical support has been the primary fighting formation of the US Army since World War I. The division, the "Soldier's Pride," has always been a dynamic organization which we frequently change to adapt to the requirements of contemporary combat. Over the past 40 years we have gone from "square" and "triangular" structures to the pentomic division and finally to the ROAD (Reorganization Objective Army Divisions) organizations; each time the objective was to improve our combat effectiveness. The realities of modern combat will require us to be prepared to fight outnumbered against an enemy possessing weapons generally as effective as ours. We will fight this type of battle by concentrating superior combat power at the critical time and place.

Today, analyses of the modern battlefield and an upgraded view of the threat indicate that serious structural deficiencies may exist within the current division.

- Today's battlefield demands mobility, survivability, and responsiveness; our organizations at company and platoon level have grown too large and cumbersome to effectively control and support.

- Today's battlefield is dominated by firepower; our divisions are massively out-gunned by the supporting artillery which will oppose us.

These shortfalls must be corrected if we are to fight successfully.

The growing recognition of these and other deficiencies comes at an opportune time for the Army. We face within the next 5 to 8 years the most significant equipment modernization programs ever experienced in any similar period in our profession's history. Much of this equipment is truly revolutionary — mechanized infantry combat vehicle, XM1 tank, single channel ground and airborne radio subsystem, Stinger missile system, and surface launched unit, fuel air explosive. In the field artillery alone, we will add TACFIRE, the battery computer system, PADS, the Firefinder radars, and CLGP. These systems must be brought into the field in such a way that we optimize the dramatic new capabilities they can provide. In the past, the Army has been criticized for a tendency toward simply introducing new equipment into old organizations on a one-for-one substitution basis. Recently, we've made a conscious shift away from infusing weapons into existing organizations to a systems approach of organizing around weapon systems. Using this approach, the numbers and types of new weapons systems dictate that we reexamine the entire "division system."

These two goals — (1) correct deficiencies in current structure and (2) integrate and optimize organizations for the emerging new weapon systems — were established for the restructured division pilot study of an armored division, conducted by HQ TRADOC from April to December 1976. This study concluded that the present armored division should be restructured to provide more and smaller maneuver battalions with additional firepower integral to the division and with new logistic systems and procedures keyed to support weapons systems. Weapon systems and their best mode of employment are the driving rationale for the structure. As an outgrowth of the study, the Army will test new organizational concepts and structures in the 1st Cavalry Division at Fort Hood, TX, beginning this summer. Maneuver battalions within the restructured 1st Cav Div will be smaller. Companies of the battalion will be built around individual weapon systems. The tank and mechanized infantry battalion will have a common base of an antitank company and a combat service support company. Integration of the combined arms will occur at battalion rather than company level. Cross-attachment will normally be accomplished within the battalion task force, but no lower. The smaller maneuver battalion will be more agile and responsive and will be able to apply a greater percentage of available combat power.

The big change for us as field artillerymen lies in the division artillery. The reorganized division artillery will be organized with the same major components it has now: a headquarters and headquarters battery, a target acquisition battery, three direct support battalions, and a general support battalion. This organization will feature increases in weapon density and fire direction nets. Improved command and control and target acquisition will facilitate massed, simultaneous attack of the diverse target arrays we can expect to face.

The direct support battalion of the restructured heavy division will have four firing batteries, each with eight M109A1 155-mm, SP howitzers; a fire direction element; and a small, lean headquarters. The HHB of the DS battalion will be totally oriented on command and control with TACFIRE as the central operational system for tactical and technical fire direction.

With the advent of the CABL concept, administrative functions are consolidated in the service battery which still retains its traditional role of combat service support. A firing battery will normally be employed as two 4-gun fire units separated from 400 to 1,600 meters. With the introduction of the battery computer system, and a capability for automated individual piece corrections, the guns will be "terrain positioned" for increased survivability.

The HHB and service batteries of the GS battalion will be structured similar to those of the DS battalion. The four firing batteries will each contain four M110, 8-inch howitzers, an FDC element, and a battery headquarters. The GS battalion, together with habitual augmentation units from corps artillery assets assigned general support or general support-reinforcing missions, will normally be oriented toward counterfire missions. The restructuring of the divisional cannon battalions significantly increases the division's cannon density.

	Current	Restructure
155-mm	54 tubes	96 tubes
8-inch	12 tubes	16 tubes

This represents a 70 percent overall increase in weapons strength.

The target acquisition battery (TAB) will focus on acquiring enemy indirect fire systems; later, incorporation of five sections of five remotely piloted vehicles (RPVs) each and three moving target acquisition radars (MTAR) will provide a real-time capability against other targets as well. The TAB will eventually have three AN/TPQ-36 countermortar radars, two AN/TPQ-37 counterbattery radars in lieu of the current Q4 radars, and two sound and flash platoons.

The TAB will continue to feed targets to the div arty tactical operations center (TOC) — the centralized management facility for all artillery supporting the division. The div arty TOC will use TACFIRE as an integrated command, control, and communications system which permits the timely, flexible and responsive management of fire support.

The combat service support of this division will be a significant departure from previous concepts. Ammunition resupply will feature forward mobile supply points located in the vicinity of brigade trains. Materiel handling equipment will reduce turn-around times. Direct support maintenance will be provided by a DS maintenance detachment which supports each battalion and furnishes teams to each company and battery-sized unit. These teams will have master mechanics who are expert on the weapons system with which the unit is equipped.

Other features of the restructured division include increased air defense, an engineer battalion which is oriented on mobility/countermobility tasks, a chemical defense company, improved intelligence, and new electronic warfare capabilities.

The test of this organization will occur over the next 18 to 20 months at Fort Hood. The test will be progressively structured to examine the validity of concepts at lower levels before going on to more detailed tests at higher command echelons. Testing in the fall of 1977 will be at maneuver company and battalion level; testing in 1978 will continue through brigade and finally division level.

I view the test of the restructured division as a matter of the highest priority for the artillery and the United States Army. I am convinced that it will point the way for significant improvement in our combat capability. ☒

INCOMING

letters to the editor

"There are improvements to be made in nearly everything we do, if we will but exploit all the resources available to us, including soliciting the ideas of all soldiers, from private to senior general."
—GEN Bernard W. Rogers, 17 Aug 76

Training Developments

The US Army Training Support Center (TSC), established at Fort Eustis, VA, in July 1976, is involved in the management of training support materials for both Active Army and Reserve Component forces. This includes the development, production/procurement, and distribution of Skill Qualification Tests, Army correspondence courses, Army training literature, Soldier's Manuals, Training Extension Courses, television and motion pictures, and training and simulation devices.

Because of the impact TSC has on the training world, it is our desire to obtain wide dissemination of information regarding our activities which training managers and trainers need to know to successfully conduct training in units. We have placed you on our distribution list for future bulletins to keep you up-to-date on training support matters.

Paul F. Pearson
Brigadier General, USA
Fort Eustis, VA

We look forward to the input and will pass this essential information to our Active and Reserve readers. —Ed.

"AAR" Revisited

Reference the article "All American Redlegs" in the January-February 1977 *Journal*, I would like to recognize various individuals who contributed to its preparation and in providing the environment that allowed such a viable training program to develop. The chain of command, from Division Commander through the Div Arty Commander, provided the necessary emphasis and guidance to allow this extremely productive and beneficial training program to evolve. Two individuals who provided input to the article were LTC Stacy Reeves and LTC Nick Halley.

As an example of dynamic execution, I would like to cite my most recent six-week mission cycle which contained two infantry battalion ARTEPs, a full-scale artillery battalion FTX, a combined arms live-fire exercise, an artillery battalion ARTEP, and an emergency deployment readiness exercise. Being challenged helps one, either as an individual or a unit, grow in such a way as to approach full potential. The philosophy in the 82d frequently seems to be that of overchallenging so that personnel are forced to reach goals they thought were impossible. The surprising thing is that it works! As a final comment, I would like to give full credit where it belongs: to the individuals — the enlisted troopers down in the ranks — who actually execute and accomplish these multifarious, sometimes simultaneous and frequently arduous, missions. NOTHING COULD BE FINER THAN TO BE A THREE-ONE-NINER!

James E. Walsh
LTC. FA
1st Bn (Abn), 319th FA
Fort Bragg, NC

ARTEP Discussion

Your Editor's Note on the use of the ARTEP in the March-April 1977 issue of the *FA Journal* (page 2) causes me some concern. Having recently been reassigned from the Field Artillery School, where I was Director of the Tactics and Combined Arms Department, to a FORSCOM command, I am unable to reconcile your contention that there are two "basically different views" of how TRADOC and operational units view the use and role of ARTEP.

Certainly a tool such as the ARTEP will be used and managed differently by different commanders. However, to state that ARTEP is necessarily tied directly to readiness reporting is a generalization which is unsupported.

The introductory chapter to ARTEP 6-165 states as follows:

The ARTEP is a diagnostic tool that is used to evaluate performance and program training to achieve a specific level of proficiency It is a new concept designed to assist commanders in planning, conducting, and evaluating training and *readiness*. Once a unit's performance has been evaluated, a unit commander, knowing his training weakness, can develop within his established priorities training programs to overcome the revealed deficiencies.

A div arty or group commander has the same latitude in using the lessons derived from an ARTEP as the battery/company or battalion commander; i.e., evaluating training and readiness. Prudently used, ARTEP can satisfy both the needs of the evaluated unit and the needs/requirements of higher headquarters.

The sections, batteries, and battalions in the 212th Field Artillery Group are currently trained, using ARTEP standards. Commanders at each level have benefited from the diagnostic aspects of ARTEP — mistakes have been made, weaknesses determined, and resources or training identified to overcome these problems. Battalions also undergo a periodic Formal Evaluation of Tactical Training (FETT) from Headquarters, III Corps Artillery. The FETT consists of numerous tasks that a battalion can expect to perform on a conventional or nuclear battlefield. The tasks that are included in the ARTEP are evaluated, utilizing the ARTEP standards. Nuclear tasks are graded using current nuclear security inspection standards. Here too, commanders are made aware of their strengths and weaknesses as applied against ARTEP so that they may make appropriate adjustments in training efforts and resource application. The Corps Artillery Commander makes a

Incoming

judgmental call of SAT/UNSAT based on the summation of all results from the FETT. This causes no conflict in interpretation of the use of ARTEP. Certainly, unit commanders wish to do well. But ARTEP training and evaluations are conducted every time a unit has an opportunity to train, and they are not construed to be a "once a year" affair. Otherwise, we are back to the "peaking" caused by Army Training Tests or Operational Readiness Training Tests. An ARTEP, or FETT, administered in this context places no burden upon the commander to "paint the rocks."

ARTEP is good. In the final analysis, it is a diagnostic tool. I would hate to see its use inhibited by purported "different views" in how and by whom it is administered.

Howard R. Guffey
COL, FA
Commander, 212th FA Gp

The editor's column in the March-April issue concerning an apparent conflict between TRADOC and FORSCOM relating to the intended use of ARTEP needs to be addressed. More specifically, the Editor discussed an alleged element of confusion in the function of ARTEP at the unit level. Admittedly, the previously unknown tool called ARTEP did initially generate concern in the field as rumors of its content and function spread. The times allowed for fire missions were believed to be unattainable; the conditions and tasks were thought unreasonable; the administration of ARTEP was confusing. As time has passed, we in the field have become more attuned to the benefits which can be derived from this new concept. In fact, most of us probably prefer the graduated training guidance the ARTEP provides to the previous, less defined, training programs where our sole objective was the passing of an all-inclusive ORTT. As we gain experience with ARTEP, we become more aware of the potential it offers the commander.

There is no reason this same tool should not be used to measure a unit's overall combat readiness as perceived by an outside agent. Included in the early rumors about ARTEP was the contention that ARTEP should not be used to determine the readiness of a unit. TRADOC, in a recent message to the field, dispelled that rumor by permitting a SAT/UNSAT determination, based

on ARTEP. This realization should cause no concern. Granted, there are some commanders who will feel compelled to "paint the rocks" in order to attain a more favorable rating. In fact, we are all probably guilty of this to varying degrees. This effort is not all bad. By striving to do as well as possible in an ARTEP evaluation, each unit cannot help but benefit from its related intensified training efforts.

Considering the above, and contrary to the editorial comment of last month, ARTEP can adequately serve the requirements of both TRADOC and FORSCOM without contradiction and without compromise on the part of the field commander.

John O. Neal Jr.
LTC, FA
Commander, 3-18th FA

The letters from Colonel Guffey and Lieutenant Colonel Neal certainly emphasize the manner in which FORSCOM units are using the ARTEP as a diagnostic tool. I would only add in response to Lieutenant Colonel Neal's comment reference SAT/UNSAT determination for ARTEP events, FORSCOM Regulation 350-1, 12 November 1976, does not require commanders to assign a rating of satisfactory or unsatisfactory upon completion of the ARTEP.

It appears that my intent to write a "controversial" editorial was achieved — but that it suffered somewhat from a lack of full knowledge of both sides of the question. I hope this response, coupled with the timely letters above, serves to put this issue back into proper perspective.
—Ed.

NSI And The ARTEP

The letter to the editor, "Nuclear Training," from MAJ C. F. O'Donnell (March-April 1977 *Journal*), was most timely and states the problem well. For years we field artillerymen have deluded ourselves by not training as we will fight with our nuclear capabilities. We have taken training tests separate from technical proficiency inspections for the sake of getting passing grades. We have to bite the nuclear bullet now and combine nuclear surety inspections (NSI) with ARTEPs, even if it means a few "UNSATs" given until field artillery battalions get the additional personnel (for guard and special weapon assembly), radios, and vehicles needed.

Regulations and directives must be streamlined. A field artillery battalion needs to practice moving their conventional basic load and *several nuclear rounds* (trainers) at once.

There will be no "transition" to a nuclear war. Once a unit moves out it has to be ready to fight in a nuclear environment. Tactical nuclear warfare, if approved by National Command Authorities, will be an extension of the conventional war and we must be ready to fight it right the first time.

Gordon A. Longabach
LTC, FA
Fort Leavenworth, KS

1-5th FA—No Argument

In the November-December 1976 and January-February 1977 issues of the *FA Journal* I noted a discrepancy regarding the claim of the 1st Battalion, 5th Field Artillery, to the title "Oldest Unit."

I have been the NCOIC of the Alexander Hamilton Color Guard for more than 18 months, and, feeling the proud tradition of our unit, I believe the facts should be set straight once and for all.

The Department of the Army does not recognize "continuous service" as such. DA only recognizes the date that the organization was formed. In the case of the 1-5th FA, the date was 1 March 1776. Therefore, the fact is that the 1-5th FA is the "Oldest Regular Army Unit."

The title of "Oldest RA Unit" was given to the 1-5th FA by DA after detailed research by the Military History Department. In August 1976, the prestigious title was reconfirmed during a Revolutionary War Unit Awards Ceremony held in Washington, DC.

The members of this Battalion are the beneficiaries of a proud tradition, and we feel that our heritage should be recognized by all — for the record!

David H. Bucholtz
SGT
D Btry, 1st Bn, 5th FA
Fort Riley, KS

There is no "discrepancy." Both items — page 28 of the November-December issue and page 5 of the January-February issue — reinforce the 1-5th's right to the title of our "Oldest Regular Army Unit." Amen.—Ed.

Questions From Europe

I am a survey party chief, and I had never seen the *Field Artillery Journal* until recently when I saw the July-August 1976 issue. I was impressed and I passed the magazine on to the men in my section. Since then I scrounged the November-December 1976 issue. The articles on the MRL and smoke were particularly interesting to me.

Since the time when I was with the 1-12th FA (Lance), I have wondered whether the idea we came up with for the Lance firing position had been passed on or improved upon.

After deciding where the firing point (FP) would be, we would determine the back azimuth of the azimuth of fire and add and subtract 400 mils from it. Using a compass and pacing we would set up two orienting stations (OS), each approximately 30 meters from the FP and on the azimuths 400 mils to either side. Here is a drawing:

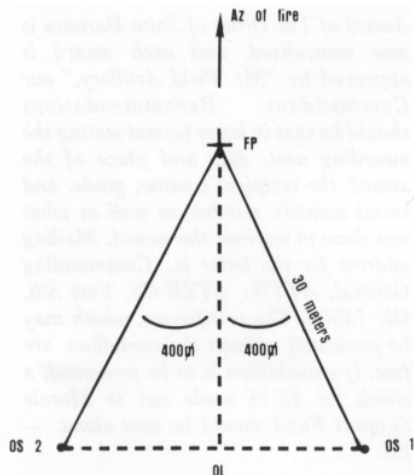

Before we used this system, the biggest reason for busted missions was a lack of visibility between the theodolite on the OS and the one on the side of the missile. Using the system in the sketch, if things didn't work, you took the theodolite on one OS and traded with the target on the other. We never again busted a mission for lack of visibility. It also made everything easier for the launcher crew to find.

On another subject, as a surveyor, my prime mover is the Gamma Goat. A lot of things about the Goats are headaches, but no headache is bigger than the operator's manual. I don't know where they got the pictures and descriptions for the lubrication instructions but they are wrong. Change 2 and the lub order leave

much to be desired. Does anyone have any plans to give us decent publications for our Goats?

Can you write an article for us giving us an idea of the things we would be doing on a 1980-1985 battlefield. I get the feeling that technology is going to do away with the surveyor and perhaps even the FDC as we know it. What will our job become — and do we have a future in the artillery?

Phillip M. Stevenson
SSG
HHB, 6th Bn, 14th FA
APO New York

P.S. My subscription check is on its way to the FA Historical Association. I don't want to scrounge any more.

Your kind comments about the Journal are appreciated. In answer to your questions, sources here at the School say:

The suggestion for Lance laying has merit, but the system described in TM 9-1425-10-2 is better. After the commander indicates the firing point and general azimuth of fire, the survey section must locate the orienting station to the left rear of the firing hub. With the required distances between the OS, EOL, and hub of 35 to 70 meters, all azimuths of fire 400 mils left and right of the azimuth of lay can be fired without displacing the launcher. Also, parallax can become a problem at shorter distances.

On the "Goat," we are told that the revised "-10" operator's manual is at the printers and should be in the field by early summer. Many of the revisions correct problems found with Change 2. Everyone is invited to use DA Form 2028 to let DA know of suggested changes or improvements to manuals.

Finally, an artillery survey in 1980-1985. The Positioning and Azimuth Determining System (PADS) will be a reality. The Analytical Photogrammetric Positioning System (APPS) using a photo data base; the Global Positioning System (GPS), providing position data worldwide using satellites; and the Position Locating and Reporting System (PLRS) will be used to navigate from a known point. These last three have no firm acquisition forecasts. Field Artillery Journals July 1973, January-February 1975, and January-February 1977 have pertinent data on some of these devices.

Regardless of the device or systems,

there will still be a need for the Field Artillery Surveyor in the foreseeable future. —Ed.

Bias?

Although I enjoyed your "Winning The West" series as a factual account of the role of the field artillery during the Indian Campaigns, I take affront from some of the author's references, descriptive phrases and words relating to the American Indian.

The author's reference to the Plains and Southwest tribes as "wild Indians" is particularly offensive. In what context did the author mean to use the adjective "wild"? Another such offensive word would be that of "murderous." The author's use of such descriptive adjectives when used in the same article as those describing peaceful or reservation Indians tends to show a lack of understanding of the true nature of the Indian Wars. Such terms are most offensive. Why must a writer of history use such terms? Could it be an ingrained reaction to an unknown society or an expression of bias?

I believe that a researcher, particularly during this period of truth toward historical research and, most important, during the period of US Army involvement, must present a thorough knowledge of not only his particular subject, but also that of the people against which the weight of military power was used.

One must or should realize why the "military arm" of the Government was used against the American Indian. The shelves of Morris Swett Library, the Fort Sill Book Store and the Curio Shop at the Old Stockade have many volumes that lend understanding of the subject. The military was the unwitting and sometimes sympathetic force of the Federal Government in the policy of extermination directed at the American Indian.

In honest examination, who can be called the "wild" or the "savage" when one views the social and biological destruction which the white man brought upon the American Indian? Why is one so labeled when he is fighting for his heritage, his culture, his lands and his very mortal existence? Why is one considered savage or wild when he renders similar treatment perpetrated upon him by his foe?

As a field artillery officer I greatly have enjoyed the articles. However, as a Native American, I must react to those

Incoming

terms that I feel only reinforce the ingrained misconceptions of American history.

Frederick A. Camacho
CPT, FA
Wisconsin Rapids, WI

The Journal does not endorse the adjectives used by the series author, but to delete them from the manuscript would be unwarranted editorial encroachment. —Ed.

8-Inch OJT Packet

Reference your "8-inch OJT packet" article in "View From The Blockhouse," November-December 1976 *FA Journal*: I have reviewed the packet and find it a poor substitute for the one-week course no longer presented by the School. It is not even a good instructor's aid because the lesson plan constantly refers the instructor back to the 8-inch manuals. In other words, the unit's presentation of the 8-inch OJT program will depend on the experience of the instructor.

It is unfortunate that the resident course became the victim of a budget cut. If commanders in the field had been more "vocal" by official correspondence, the course might have been saved, or a mobile training team could have been formed to go to the units.

Charles F. O'Donnell III
MAJ, FA
Fort Sill, OK

The comment that the lesson plan refers the instructor to the manuals is correct. This was done deliberately because the manuals change quite frequently and by not including this material in the lesson plan, the lesson plan will not have to be revised so often. —Ed.

Pantel Training

The January-February 1977 issue of the *Journal* (page 4) addresses "M100 Pantel Errors." I violently disagree with this proposed modification. We must educate our inexperienced gunners on the proper use of the M100 panoramic telescope. The pantel has an azimuth counter that is used for laying, establishing aiming points (AP), boresighting, and measuring, all of which are very important.

There is no need for a cotter key to

avoid M100 pantel errors. I resent efforts to modify Army equipment at the expense of its intended use. Proper training will eliminate errors.

In establishing APs for weapons with the M100, the gunner, under direct supervision of the chief of section, should establish all required APs. The tube is not moved nor is the weapon traversed from the direction of lay. The gunner should record each reading from the azimuth counter scale (top scale) for each of his APs. These readings are recorded on the Gunner's Reference Card. The azimuth counter window has a door that should remain open during the laying process and remain open until a primary AP is selected for firing. When a fire mission is received by the section, the gunner should verify that the azimuth counter reading corresponds to the AP being used for firing and that the reset counter reading is 3200. The door of the azimuth counter window should then be closed and remain closed for the duration of the mission. When "end of mission" is given, the gunner should use the azimuth knob to turn the reset counter to 3200 and open the door covering the azimuth counter window. Once the gunner has traversed onto the selected AP, he should then insure, using his Gunner's Reference Card, that the reading on the azimuth counter corresponds to the selected AP. Built-in flexibility of the reset counter affords the gunner the ability to select different APs using the common deflection 3200.

The modern firing battery has all the necessary tools to train our gunners. The bibles for the artilleryman are FM 6-50 and the respective user's manual for his weapon system. I say thumbs down to making equipment idiot-proof and full speed ahead in training our gunners to master our weapon systems.

Lemuel Harkey Jr.
1SG, FA
B Btry, 1st Bn, 38th FA
APO San Francisco

A Journal First

Thank you for the support that you and the *Field Artillery Journal* have given to our College Research Program. We are grateful and hope that we can send you other useful manuscripts.

I am particularly pleased with the three part serialization of our group study on tactical nuclear weapons [page 16, January-February 1977 *FA Journal*]. This is the first of our group

studies to be published, and we are proud that it is appearing in the *Field Artillery Journal*.

I wish your publication continued success.

Jeremiah A. Denton, Jr.
Rear Admiral, USN
Commandant
Armed Forces Staff College

Saint Barbara Awards

I am enclosing a copy of a letter that I sent to the USAFAS Bookstore recently requesting The Order of Saint Barbara certificates.

I have heard informally that the Bookstore has closed, so would you please redirect this request to the appropriate office.

James M. Donnell, Jr.
CPT, FA
1-81 FA

Award of The Order of Saint Barbara is now centralized, and each award is approved by "Mr. Field Artillery," our Commandant. Recommendations should be sent in letter format stating the awarding unit, date and place of the award, the recipient's name, grade, and social security number as well as what was done to warrant the award. Mailing address for the letter is: Commanding General, ATTN: ATZR-CS, Fort Sill, OK 73503. The certificates, which may be presented without the medallion, are free. If a medallion is to be presented, a check for \$2.75 made out to Morale Support Fund should be sent along. —Ed.

1-14 FA Unit History

The 1st Battalion, 14th Field Artillery, is compiling information for a unit history. We would appreciate any information concerning the unit, such as names of commanders, dates, and places that would aid in the project. Of particular interest are data from the WWII and Vietnam time frame. Any personal anecdotes or pictures will be greatly appreciated.

Anyone having information about the 1-14 FA, should write:

Eugene F. Madigan
LTC, FA
1st Bn, 14th FA
Fort Hood, TX 76546

A leader is best when people barely know he exists, Not so good when people obey and acclaim him, Worse when people despise him. "Fail to honor people and they fail to honor you." But a good leader, who talks little, When his work is done, his aim fulfilled . . . They will all say . . . "We did it ourselves."

For those who subscribe to McGregor's (Douglas McGregor, "The Human Side of Enterprise") theoretical approaches to management and are practitioners of the "Theory X" approach, the preceding ancient Chinese philosophy may seem not only impracticable, but also unworthy of consideration. Hopefully, the modern military leader sees his subordinates not as lazy, indolent slackers requiring the most base forms of motivation and impetus to perform their assigned tasks as the "Theory X" approach implies, but rather through the somewhat more enlightened "Theory Y" viewpoint. This latter leader sees his soldiers as willing workers who can generally be depended on to get the task done — the mission accomplished — with minimal guidance or supervision. It is this type of leader to whom this article is addressed.

The selection of a vocation, profession, permanent job or means of making a living is normally the first major decision of our independent lives. The exact point in one's life at which that decision is made depends on the individual himself and any number of variables. Among these are family influence (often so great a factor that the decision of vocation is made by the parents!), marketability of the training or educational background, education level *per se*, existing state of the economy and personal motivations. In the day of an all-volunteer Army, it should be safe to assume that many members of the officer corps, particularly the more youthful members, are such by their own choice. At the same time and traditionally, the greatest attrition from the officer ranks has been from the company/battery grades because, for many, that decision of "What do I want to do with my life?" had not been made at the time of military obligation.

Thomas Bowen's "green eyed monster, who exists at all levels . . . and doesn't trust anyone nor does he give credit to his subordinates," need not read further. There is no intention to give an officer a retention presentation, a dissertation on patriotic responsibilities or an overview of the cultural, sociological and economic advantages of living in a foreign land. At the same time it is not the intent to slight these. This is directed to those field artillerymen among the 45 percent of all captains and lieutenants who are serving obligated tours and have not yet made a firm decision as to what will follow the completion of that obligation.

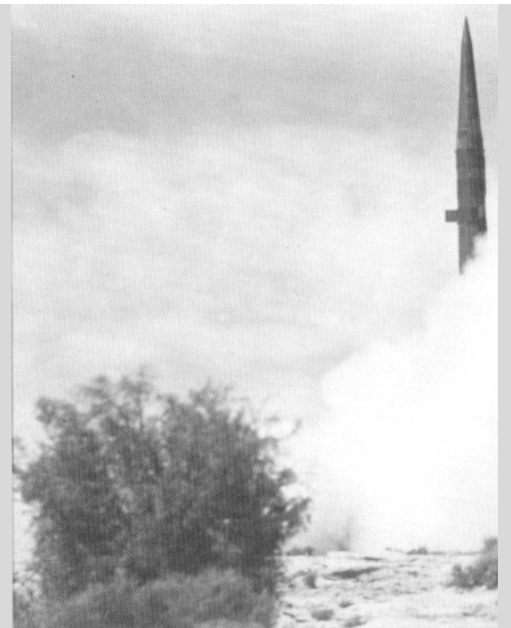

Pershing — the ultimate challenge

by MAJ Robert J. Baker





By frequent training countdowns, the Pershing firing platoon leader becomes expert in the duties of each crew member.

The reader may discern from the title that there will be some discussion about missiles, specifically the Pershing missile, and the job of field artillery officers serving in Pershing missile assignments in Europe. There exists only one field artillery brigade on the Active Army roles, and that is the 56th Field Artillery Brigade, located in the picturesque West German town of Schwaebisch Gmuend. The 56th is the only unit in the Army equipped with the Pershing missile and tasked with a wartime mission. (There is a Pershing unit at Fort Sill, the 3d Battalion, 9th Field Artillery; however, it supports Pershing missile test firings, developmental projects and the Field Artillery School, and provides a limited CONUS sustaining base for Pershing-skilled noncommissioned and warrant officers.)

For a field artilleryman there are few assignments that are as challenging as a tour with Pershing in Europe. Like most Army units in Europe, the 56th is an assigned unit of the US European Command's Army component, US Army Europe (USAREUR) and Seventh Army, and is earmarked for operational command to Allied Command Europe during hostilities. Unlike other Army units, the brigade has a peacetime quick-reaction alert (QRA) mission, similar to the mission of the Navy's Polaris and Poseidon submarines and the Air Force's Strategic Air Command. In support of that mission, a significant portion of the brigade's missile assets, located at remote firing sites, remains on constant alert. It is this duality of mission, the size of Pershing units and the state of readiness which must be maintained that

make an assignment to the brigade the ultimate in challenge and responsibility, short of combat, that a field artilleryman can face. A recent Military Personnel Center survey indicated that, of those company/battery grade officers who were leaving the service, more than one-fourth were doing so because they had not found job satisfaction in the Army. It is doubtful that a young officer recently completing a tour of duty with the 56th could make such a statement.

The jobs performed by field artillerymen in Pershing missile assignments require no special talents — only a dedicated application of those possessed by most officers in a professional Army. Although emphasis is placed on applied knowledge of the technology of a moderately sophisticated weapons system and its employment and nuclear weapons technical proficiency, these in themselves present no unique challenges or requirements. Just as the howitzer battery fire direction officer makes himself the unit's expert on gunnery matters, so the Pershing firing platoon commander soon becomes the platoon's most knowledgeable member on missile countdown procedures. The day-to-day duties of an officer in the Pershing battery include all those duties for which any other artillery battery officer might expect to be responsible.

Thus far, duty with Pershing in Europe doesn't sound much different from duty in a division or corps artillery unit in USAREUR. But it is — the challenge is greater, the reward is greater. Perhaps to provide an appreciation of the difference in the magnitude of responsibility, an overview of the 56th FA Brigade with a more detailed outline of its activities would help.

Activation

All Pershing missile battalions in the US Army were activated at Fort Sill in the early 1960s. Following extensive system testing, three of these battalions were deployed to the Federal Republic of Germany during 1964 and 1965. These battalions were equipped with the track-mounted, nuclear capable Pershing I missile system, a second generation successor to the Redstone. The controlling headquarters in Germany was the 56th Artillery Group, which was charged with the mission of providing fires in general support (GS) of the field army.

QRA

Considered a significant improvement over preceding systems, the Pershing I incorporated the capabilities of high mobility, relatively small size, rapid response, high yield and easily handled solid propellant. The battalions were organized generally the same as conventional field artillery battalions. In late 1965, Pershing received a significant additional mission, the role of peacetime QRA. For the first time the Army had a weapons system in its inventory with a strategic as well as a tactical mission.

Pershing Ia

Subsequently, major improvements were made to the system, and, in 1969-1970, Pershing Ia was fielded. All equipment was mounted on wheeled vehicles rather than tracks; reaction times were decreased to provide greater responsiveness in both QRA and GS missions. Also, and most significant, the total number of launchers was increased from eight to 36 per battalion. The battalions in Europe were reorganized under new tables of organization and equipment (TOEs); an infantry battalion was authorized and formed to provide additional security for the system; and, the 56th Artillery Group was reorganized and redesignated the 56th Field Artillery Brigade, to be commanded by a brigadier general. Since that time there have been no major changes in the 56th FA Brigade's organization or mission, although the process of minor modification of TOEs based on field experience has been continuous, as in any unit. At the same time, a program of minor equipment improvement and modification has also been conducted to increase system reliability and responsiveness.

Organization

The staff and the supporting headquarters battery are not significantly different from those of any other artillery battalion, although the staff is larger in order to administer a larger organization. The battalion has four firing batteries and a service battery. The service battery, normally commanded by a field artillery major, does differ from a conventional service battery. This specialized organization includes a direct support maintenance platoon of nearly 100 officers, warrant officers and enlisted men who perform all direct support maintenance on the battalion's missile, engineer and signal equipment. There is also a technical supply facility which supports the battalion's needs and maintains an NCR-500 computer. The battery includes an ammunition platoon, a security platoon, the battalion supply (S4) section and the battalion vehicle maintenance section. In all, the service battery has more than 300 soldiers.

Firing Battery

The Pershing firing battery, commanded by a major, is composed of three firing platoons and the necessary elements to support those platoons. Considerably larger than a conventional firing battery, it is authorized 230 men. It contains such diverse elements as an engineer section, a survey section, its own missile maintenance and PLL section, a communications platoon (with wire and FM, single sideband and tropospheric scatter radio equipment), a battery control central and operations section and, of



Included in the Pershing firing battery of 230 men is a Signal Corps lieutenant who oversees operation of the Radio Terminal Set, AN/TRC-80B, as well as other, more common communications equipment.

course, mess, vehicle maintenance and supply sections. A senior field artillery captain is the executive officer. A field artillery lieutenant is the battery reconnaissance and survey officer and normally has the additional duty as battery operations officer. A signal corps lieutenant is the battery communications-electronics officer. To achieve mobility, each firing battery requires 80 vehicles with trailers; 20 of these are part of each firing platoon's authorized equipment.

Firing Platoon

The basic Pershing operating unit is the firing platoon, commanded by a field artillery captain. The firing platoon owns three complete Pershing missiles with associated launching and ground support equipment. The platoon is designed to, and frequently does, operate independently from the rest of the firing battery. The platoon TOE calls for a warrant officer technician and more than 40 men, whose job titles include missile maintenance supervisor, programmer test station (computer) operator, missile crewman and security guard. The platoon has the equipment, personnel, training and expertise to execute orders from the National Command Authority and launch its missiles while operating separately from the parent battery or battalion.

Battalion

The Pershing battalion is large — nearly 1,500 men and 400 vehicles. The battalion commander faces a very real challenge in leading these men and managing his resources to accomplish his mission. He has considerable help in doing that. His officer force includes 10 majors, 51 captains and lieutenants and 22 warrant officers. Noncommissioned officer strength ranges from the first line sergeants E5 through the command sergeant major. Each firing platoon contains seven "hard stripe" noncommissioned officers from assistant chiefs of sections to platoon sergeants. The challenge that faces each man, starting with the battalion commander, is to execute the responsibilities of leadership effectively in light of the dual mission that the Pershing unit performs and to meet the established peacetime measures of effectiveness in accomplishing the missions.

Dual Mission

The two missions may often appear contradictory. The QRA mission requires the full-time commitment of one

firing battery or that equivalent in men and equipment from each battalion. That QRA unit maintains its "ready-to-fire" posture at an improved but remote field firing site a considerable distance from garrison. The flexibility of that battery to train during its QRA tasking period is generally limited to those areas and subjects which can be covered away from the garrison facilities and within the confines of the field site. QRA tasking rotates among the four batteries of the battalion — the tasking period itself usually lasting about six weeks, or a total of 12 weeks per battery each year. Few other units can match Pershing's QRA posture of constant alert readiness, prepared to fire when ordered. The entire battalion stands ready to support the QRA battery on a moment's notice, whether it be with technicians or critical repair parts from the service battery or major equipment components, end items or personnel from another firing battery.

Testing

The readiness of the QRA force to execute its mission is tested regularly and the results of that testing are evaluated

Pershing firing batteries convoy to QRA sites where they cover targets critical to NATO for as long as six weeks.



by headquarters both in the US and the NATO chains of command. This is accomplished in the form of no-notice exercises which, as closely as possible within peacetime constraints, simulate an actual situation and cause the battery to execute its mission to a point just short of missile lift-off. At least annually, one QRA element from each battalion returns to CONUS, complete with all personnel and equipment from the field site, for the conduct of follow-on operational test firing of missiles.

Training

When not on QRA status, the Pershing battery goes through a training cycle not unlike any other artillery unit. During the training period, time is devoted to those subjects required of every Army unit, the mandatory subjects and training. Considerable effort is also spent in field training and field training exercises. There has been a tendency by many to feel that, because of the size of Pershing units and their somewhat unique mission, standard field artillery defensive tactics do not apply. That is a misconception. Standard field artillery tactics do apply to a Pershing platoon, battery and battalion — just as they apply to any artillery unit. Pershing units, too, must be able to communicate, move, shoot and survive. The commander who takes the proven approach to tactics is the one whose unit is the most effective in the field. During field training, the Pershing platoon commander may expect to operate independently. Although the battery commander retains command responsibility for his entire battery, his time in the field is divided between two or three occupied positions, and he must be constantly reconnoitering new positions. As one might expect, a Pershing firing position is a very lucrative target; consequently, reconnaissance, selection and occupation of position (RSOP) procedure for the Pershing artilleryman is on-going, with frequent covert movements to escape detection. Throughout all this, the platoon commander is the man in charge, and his platoon is a separate, independent, functional and operational entity. The firing position area is his; he is responsible for position area security, missile countdown operations, the safety and welfare of his troops and all convoy operations.

Inspections

But the platoon functions on its own in many situations beyond field training. Like other nuclear-capable units, Pershing battalions receive regular inspections by the Defense Nuclear Agency, DA or USAREUR to determine the units' technical proficiency in nuclear weapons operations. Unlike other units, the Pershing battalions receive these annual inspections at the battery rather than the battalion level. Further, each firing platoon within the battery must separately demonstrate its proficiency in all phases of nuclear and related operations to the inspection teams. Obviously, then, training in preparation for these

inspections must be accomplished at the platoon level and must be continuous. Again, the key man is the platoon commander. He must plan, conduct, monitor and evaluate the training program for his platoon. Of course, he receives considerable assistance in this from the battery and the battalion. But, in the final analysis, the responsibility rests with the platoon leader. The battery will not receive a satisfactory rating for the inspection unless each platoon performs satisfactorily throughout the inspection.

As a NATO unit, each Pershing battalion is required to undergo successfully an annual NATO tactical evaluation (TACEVAL). Equivalent to an Operational Readiness Evaluation Training Test, the TACEVAL is normally preceded by a month of concentrated training at the Seventh Army Training Center, Grafenwoehr, and culminates with the administration of a thorough two-day test by the 56th, usually under the observation of a representative of one of the NATO headquarters. That testing technique, however, is under revision at present. To date, the changes made have been to designate the Allied Air Forces Central Europe (AAFCE) responsible for developing and conducting all Pershing tactical evaluations. The AAFCE is a combined Air Force headquarters, which has the task of administering all NATO tactical evaluations in Central Europe, nearly all of which are to Air Force units. In addition to the 56th, there are two other battalion-sized Pershing units in Europe — Surface-to-Surface Missile Wings 1 and 2, which are a part of the German Air Force. The AAFCE tactical evaluation element, when fully manned, will include both German and American representatives experienced in the Pershing system in Europe.

Consideration is currently being given to the development of a platoon- or battery-level evaluation to be administered by the battalion or the 56th Brigade. This would be wholly a US evaluation and the culmination of all unit training. It would also provide a means by which the brigade commander could measure the unit's progress toward those goals and standards he has established. The new tactical evaluation concept under NATO does not provide that.

Of course, Pershing units must also undergo annual general inspections (AGIs) which are conducted by the USAREUR Inspector General Office and require one week to conduct per battalion. Continuity of the battery officer's challenge is certainly maintained during the preparation for and conduct of an AGI.

Other mission tasks the Pershing officer at every level must face include no-notice alert exercises generated by Supreme Headquarters Allied Powers Europe (SHAPE) and subordinate headquarters, requiring mustering of personnel, partial or complete equipment load-out, move-out to predesignated field positions and possible simulated

execution of the wartime mission. Specific time constraints are established for the accomplishment of these tasks. To meet all the readiness requirements and the many evaluations and to insure that his unit can move, the platoon commander must dedicate himself and insure that his platoon applies itself toward a program of on-going, effective maintenance of equipment. Finally, in preparing to assume the QRA mission responsibility, the battery officers must insure that their troops are refamiliarized with those subjects of particular importance at the QRA site. Paramount among those are missile countdown and security procedures. Toward that end, more intensified training at the platoon level is conducted, and that training and each platoon's proficiency are evaluated and must be satisfactory before the unit may assume QRA status.

Initially, the point was made that duty in a Pershing assignment offers a greater challenge than equivalent duty in other field artillery assignments. Certainly the challenge is not one that cannot be met. Many lieutenants and captains are meeting it today. Pershing units spend no more time away from garrison than do conventional field artillery battalions. Also, those serving with Pershing in Europe have the same opportunities to travel on the European continent and experience the different cultures.

How then are field artillerymen in the 56th FA Brigade able to accomplish their mission? It is a great, but certainly not an insurmountable, challenge. The reward to those who meet it is often only the personal knowledge that a difficult job has been done well. That lieutenant or captain will have worked as hard as any and harder than most of his contemporaries. He takes the risk of receiving less recognition than he probably is entitled to for his efforts; nevertheless, he has had the opportunity to develop and mold men into a highly competent technically proficient team of soldiers — a team which will be tested exhaustively and proven capable of performing a critical wartime mission and a strategic deterrent peacetime mission professionally and effectively. That is what job satisfaction is. For those who are willing to devote two or three years of hard work, Pershing in Europe will provide that satisfaction. Army life has never been an easy road. The degree of job satisfaction that a Pershing missileman realizes will be in direct proportion to the effort he expends. 

MAJ Robert J. Baker, FA, served with Pershing in the 56th Field Artillery Brigade, Germany. He is now a Staff Training Advisor, 123d US Army Reserve Command, Readiness Region VI, Indianapolis, IN.

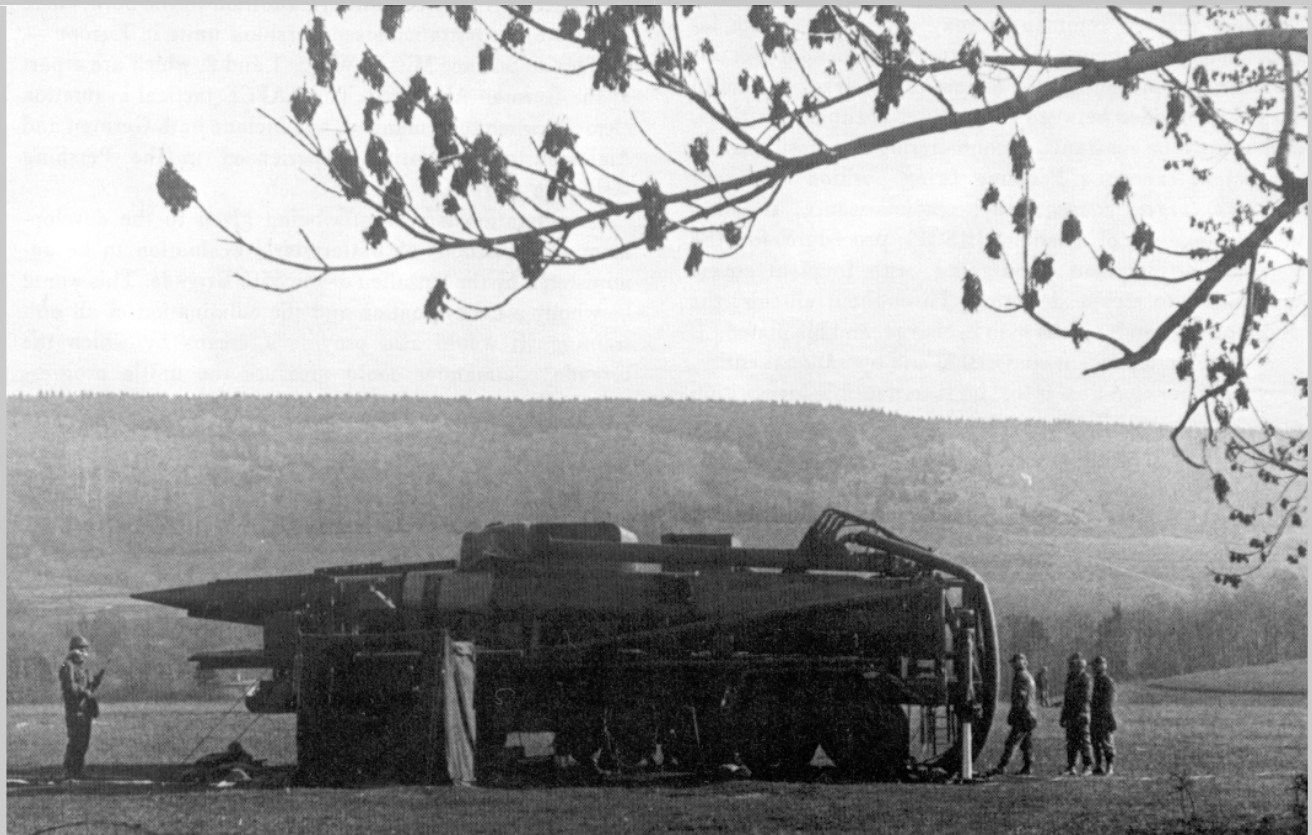

POTU

by LTC Donald R. Lyman



Testing Pershing In Europe And CONUS

The familiar gate at Rhein-Main greets the "tapped" battery as the first stop en route to Complex 16 at the Cape.

STAND BY FOR TRAFFIC — BLACK JACK — BLACK JACK, SOUND THE KLAXON — POWER-UP — RED HATS AT THE EXCLUSION GATE — POWER STATION ON! These sounds accompany the visit of the Pershing Operational Test Unit (POTU) for a field alert status verification (FASV) at one of the 56th FA Brigade's (Pershing) quick reaction alert (QRA) sites in southern Germany.

What Is POTU?

The Pershing Operational Test Unit is assigned to United States Army, Europe and Seventh Army, located in Heidelberg, Germany. POTU has one lieutenant colonel, two majors, one captain, two warrant officers, and four NCOs. The "Red Hats" (so named for the red baseball caps they wear during FASVs and other field evaluations) conduct the Pershing Operational Test Program (OTP) under direction of the Joint Chiefs of Staff (JCS). POTU also provides the US Commander in Chief, Europe, with appropriate information on which to base his Pershing evaluation report to JCS. POTU plans, schedules, and executes the necessary tests, evaluations, and firings for

US European Pershing units in support of the OTP. The firings are conducted in CONUS at either White Sands Missile Range, NM, or the Air Force Eastern Test Range at Cape Canaveral, FL. Evaluations (FASVs) in Europe are conducted at random times, the missiles are counted to T-2 minutes (two minutes prior to launch), and liftoff is simulated. During FASVs, POTU observes nuclear release authentication procedures, missile crew procedures, and Pershing maintenance.

Each year POTU normally selects three units from the 56th Brigade to participate in Follow-on Operational Tests (FOT), using an unannounced FASV at the QRA site. Missiles, equipment, and personnel are designated and, after approximately three weeks, are positioned at Cape Canaveral — ready for firing.

Major Events In Europe

At the conclusion of the FASV, POTU informs the battery commander that he has been selected to participate in an FOT. He is told to inform his battalion headquarters of the selection and to begin preparation for the move to CONUS. A thorough briefing is given to the battery personnel

by the POTU and work begins. Two platoons, each with three missiles, are normally returned on an FOT. Serial numbers and exact locations of major items of equipment are recorded so they may be placed in the same configuration at the launch site. Disassembly of the missiles is accomplished under the direct supervision of the POTU. Technical ordnance inspectors assist in the physical inspection of the propulsion and guidance sections before these are placed in containers for transportation to Florida. The missiles are delivered to Ramstein Air Base where they are placed on C-141 aircraft and flown directly to the launch site.

Personnel, launchers, power stations, programmer test stations, and other support equipment are returned to their home station and prepared for movement to Cape Canaveral. Approximately two weeks later, the unit's equipment is convoyed to Rhein Main Air Base near Frankfurt and personnel follow by bus. Four C-141 aircraft are used to transport the unit directly to Cape Canaveral. POTU sends a seven-man team to conduct the CONUS phase of the test.

Events In CONUS

When the missiles arrive at the Cape, POTU personnel install instruments to record various missile functions during flight and add range safety components in case a missile must be destroyed during flight. Picatinny Arsenal representatives provide instrumented warheads at the Cape when the unit is ready to assemble the missile. Personnel and ground support equipment arrive at Cape Canaveral and are met by members of the support battery, 3d Battalion, 9th Field Artillery, from Fort Sill. The support battery provides billeting, mess, additional equipment, and vehicles for the tested unit.

For Florida firings, the tested unit's personnel are billeted at Patrick Air Force Base and transported daily to the launch complex at Cape Canaveral. The tested unit

An Air Force crew loads an erector-launcher into a C-141 for the flight to Florida.

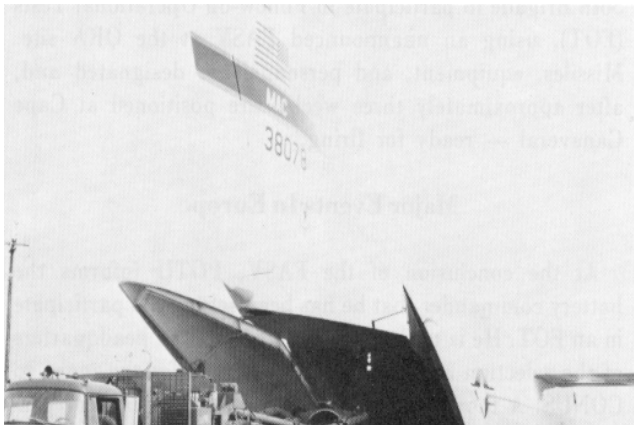

Pre-launch activity at Complex 16 as troops from the 56th Brigade and technicians assemble and check out these Pershings.

prepares its equipment and missiles for its QRA role just as it would in Europe. Generally this takes three to four *long* days.

POTU personnel insure that the unit assembles its missiles and positions its equipment in the identical configuration used during the FASV in Europe. Eight remote controlled TV cameras monitor the unit's procedures, and members of the Applied Physics Laboratory of John Hopkins University gather data for the final evaluation report.

Firing Day

Once the tested unit has its missiles ready and the range support personnel give the "OK," a release message, similar to that given in Europe, is sent to the battery control central. The missiles are sequenced through prelaunch checks, and the command to fire is given.

Normally two missiles per platoon are fired. The third missile is programmed through the launch sequence; but, instead of ignition, fuzes are connected to the electrical circuits and these indicate a positive launch sequence. This provides valuable reliability data at a reduced cost since the third missile is not fired. At the conclusion of the firing exercise, the unit prepares its equipment for return to Europe.



All bedded down in protective revetments, these Pershings and their crews await the firing command from Launch Control.

Those personnel desiring leave prior to their return to Europe need only provide their own transportation to a port of debarkation after leave. Port calls are provided to those personnel on leave, and the other members of the tested unit return to Europe with their equipment. During previous operations, tested units have found time to go to

Launch gantries from the American space program dwarf this Pershing as it heads for an Atlantic target "somewhere down range."

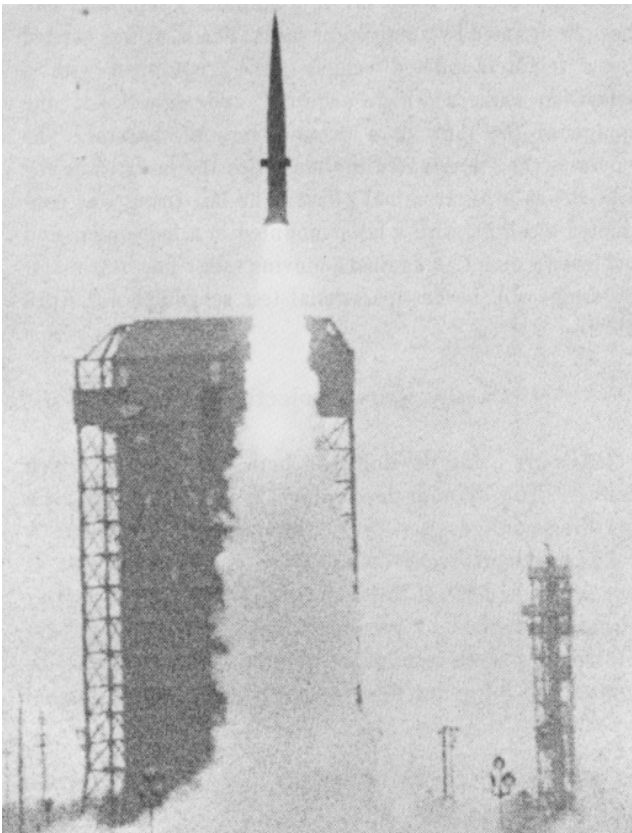

Disney World, the Space Center, and the beach, which is only a block from their billets at Patrick Air Force Base.

Results Of Firing

Once firing is completed, radar data, bushels of printouts, and other evaluations must be examined in order to prepare a complete report. The objective of this report is to provide the JCS with the current quantitative performance estimates of the operational capabilities of the Pershing weapon system in its peacetime QRA role. Data from the FASVs, live-fire operations, and a math model of the reentry vehicle or warhead are used to develop performance estimates. Initial results are furnished to the firing unit before it returns to Europe. The unit is told how the flights looked and whether the missiles hit near the target. Final comprehensive data are presented to the firing unit at a later date. The JCS evaluation report is a technical report, used for planning the use of Pershing.

Even though POTU is responsible for CONUS firings, many European and CONUS organizations are needed to support this major effort. The Pershing Operational Test Program was established in 1965 and should continue well into the future. POTU performs a very valuable service in insuring that Pershing is always ready.

NCOs, warrant officers, and officers find the POTU assignment challenging, and technically qualified personnel are encouraged to apply for interviews. ☒

LTC Donald R. Lyman, former Chief of the Pershing Operational Test Unit, is now Commander, 3d Battalion, 9th Field Artillery, the Pershing battalion at Fort Sill.

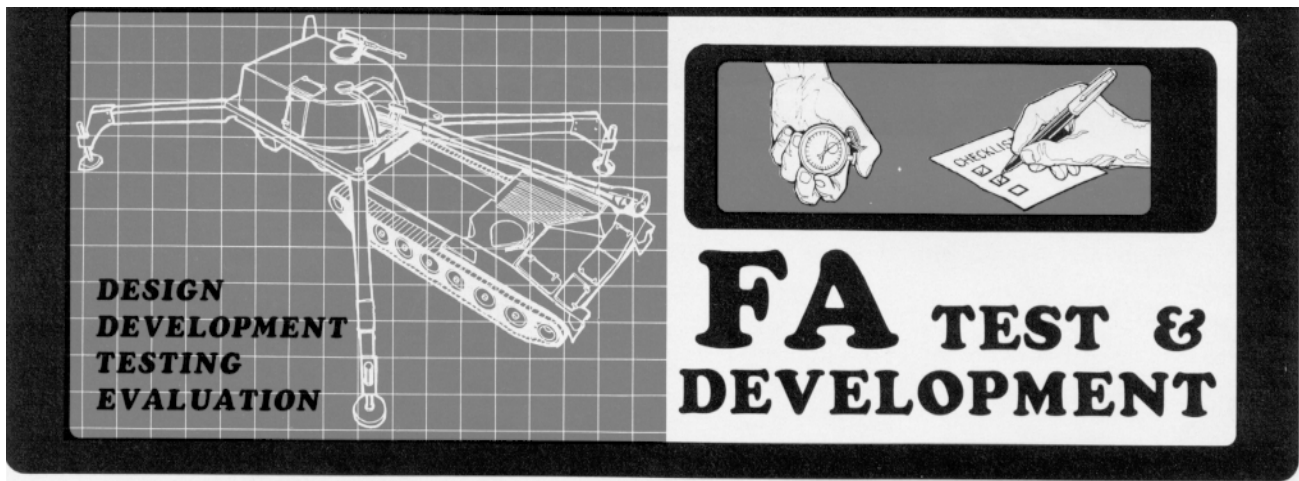

This is a new feature section devoted to field artillery tests and developments. Material will be furnished by the Directorate of Combat Developments of the US Army Field Artillery School and the US Army Field Artillery Board.

Directorate of Combat Developments

Field Artillery must be organized as a total system to effectively provide the capability to detect, locate, identify, and engage targets with sufficient first-round accuracy, to destroy or neutralize them. The Field Artillery School has the responsibility to determine materiel requirements and to provide recommendations to support development programs which will insure the best possible Field Artillery System. Consequently, DCD is organized so that the Director acts as the principal advisor to the Commandant/Assistant Commandant on all actions encompassing combat developments for which the school is the proponent. The Directorate is organized into five distinct elements: Doctrine Team, Weapons Team, TACFIRE Team, Systems Team, and Project Seeker.

This issue of the *Field Artillery Journal* will address three projects of considerable interest for which the Weapons Team has responsibility.

XM712, 155-mm Cannon-Launched Guided Projectile (CLGP)

The final round of the CLGP Advanced Development (AD) tests was fired 7 April 1976. Based on the impressive results achieved during the tests, Martin

Marietta Corporation was awarded a three-year engineering development contract. During AD tests, CLGPs were fired from the M109A1, 155-mm howitzer, and the targets were designated by a ground laser locator designator (GLLD). On 3 October, another major milestone was achieved when a CLGP scored a direct hit on a stationary tank that had been designated by an airborne laser. The laser was carried by a remotely piloted vehicle (RPV) equipped with a television camera which acquired and data-linked the image of the tank to a ground station operator. The operator then designated the tank with the laser while the CLGP was in its terminal phase. The last firing was conducted at night, with a laser mounted in a helicopter, and achieved a direct hit against a moving tank. The next major milestone will be an operational test scheduled for April 1978.

Rocket-Assisted Projectiles (RAPs)

RAPs are being developed in both 155-mm and 8-inch calibers. The 155-mm development is the M549. This is a low-drag configuration projectile optimized for range. A solid-propellant rocket motor with a delay element is housed in the base of the projectile. When fired, the delay element is ignited by propellant gases and burns for approximately seven seconds, at which time the rocket motor ignites and burns for three seconds, providing additional

thrust and extended range. The M549 has already been type classified for use in the M109 howitzer. Firing table firings with the M110 and developmental propelling charges in the M109A1 howitzer are scheduled for completion in early 1977. Additionally, the M549 has been fired with developmental propelling charges in the M198 howitzer during operational test (OT) II of the M198. The 8-inch RAP is designated the XM650. Its operation is essentially the same as that described for the M549 RAP except that the rocket motor burns for four seconds rather than three. Development test/OT II began in September 1976 with type classification scheduled for fourth quarter FY 77.

XM204 Howitzer

The XM204 is a towed 105-mm howitzer being developed to replace the M101A1 and M102 howitzers. It employs soft recoil; i.e., the recoiling parts are held in the rearward position by a latch. When the lanyard is pulled, the latch releases and the recoiling parts move forward from energy stored in a compressed spring. At a time during forward movement, predetermined by setting on a dial corresponding to the charge fired, the weapon fires. The recoil overcomes the forward momentum of the recoiling parts and returns them to the rearward position. This process reduces the recoiling shock by approximately 70 percent over conventional recoil weapons. The weapon has a 6400-mil on-carriage traverse and incorporates the bearing method of lay. The scheduled OT II (February 1976) was not initiated as planned due to excessive "hop" in the zone 8 misfire mode and unsuitable weapon stability on side slopes. A General Officer In-Process Review (IPR) was convened in February 1976. The IPR directed that the prototype weapons be redesigned to correct these problems and conduct OT II beginning March 1977 at Fort Campbell, KY.

US Army Field Artillery Board

The US Army Field Artillery Board is the operational testing agency for field artillery systems. Organized in 1902, it is the oldest test board in the Army. Working closely with the Field Artillery School, the Board is involved in examining all facets of the artillery problem. Its primary purpose is to determine how effectively new equipment will function when operated in the field. Developing tests that can measure operational effectiveness, the Board seeks to duplicate actual field conditions, using soldiers from the III Corps Artillery as well as other FORSCOM and TRADOC units.

Radar Chronograph Test

The Field Artillery Board recently concluded tests of three radar chronographs which are designed to give the battery commander the capability to maintain accurate up-to-date information on the muzzle velocity performance of weapons and ammunition in the battery. Field artillerymen may thus be a step closer to achieving the goal of first rounds on target every time.

Three competing manufacturers each provided a chronograph for the Board to test against the requirements for accuracy, ruggedness, reliability, and ease of maintenance. The three chronographs, or velocimeters, are similar in that they are small, light, simple devices designed to be mounted directly on a howitzer and to permit a crew member to read the muzzle velocity of a round as it is fired.

The manufacturers are competing for a production contract to replace the M36 chronograph, which was developed in the late 1950s. Because the M36 is bulky and heavy, requires specially trained operators and mechanics, and needs its own generator for power, its use has been limited to teams which could only periodically check a unit's weapons. The characteristics of the new velocimeter should permit it to be much more widely distributed, hopefully down to firing battery level.

Position and Azimuth Determining System

The Board will conduct Operational Test (OT) II on the position and azimuth determining system (PADS) from April through July 1977 at Fort Sill.

The test will evaluate the PADS, an inertial surveying system, for use in fifth-order survey at direct support battalion level. PADS, containing two gyroscopes, is self-orienting for direction, and can operate worldwide between 75 degrees south and 75 degrees north. The system specifications call for a 40-kilometer survey, consisting of a position area survey and a connecting survey, to be completed in six hours or less. PADS can accompany the battalion reconnaissance party and give the battery commanders survey data in the initial stages of the preparation of the position. The system can be mounted in an unmodified ¼-ton truck or light observation helicopter. It can conduct a survey at normal vehicle speed, and give a real-time readout of horizontal, vertical, and azimuth data. In the middle of a truck-mounted mission, the system can be loaded into a helicopter, fly over terrain obstacles, and then continue its survey mission. If PADS is adopted, PADS survey parties — consisting of the party chief and the PADS operator — could replace about 50 percent of the conventional survey parties of the field artillery.

with our comrades in arms

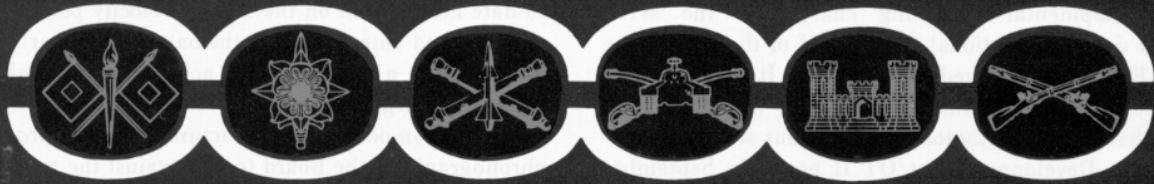

New TOW Carrier

A weapon station designed to provide increased mobility and improved armor protection has been developed for the Army's tube-launched, optically-tracked, wire-guided (TOW) antitank missile system. The Army expects to receive delivery of the first 10 vehicles equipped with the new weapon station by August under terms of a \$7-million contract awarded to the Emerson Electric Company. These Improved TOW Vehicles (ITV) will be tested and, if the tests are good, the Army will decide whether to procure an additional 550 ITVs for introduction to the troops late next year.

Introduced into the Army during the late 1960s, the original TOW system is a very effective missile, but it is vulnerable to enemy attack because it has no armor protection and has to be launched from a stationary, land-based tripod. The ITV will provide protection for both the TOW crew and the missile system. It consists basically of an M113A1 armored personnel carrier that has been modified to carry an armored cupola or weapon station. A large pod, containing two TOW launchers and all sights, is attached to the base of the cupola by lifting arms. When not in use, this pod rests on the vehicle's rear deck. The gunner operates the TOW from inside the cupola, which is designed to

The Improved TOW Vehicle will be ready for testing in August 1977.

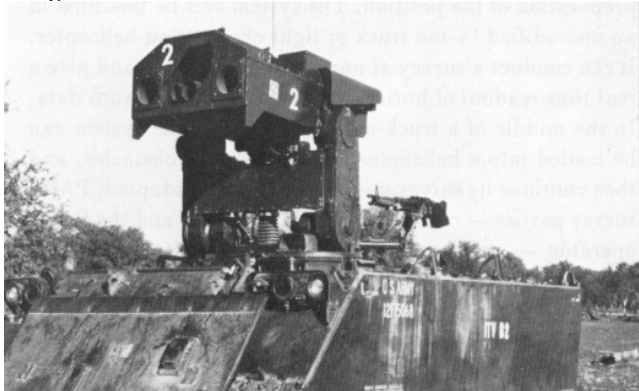

provide protection equal to that of the M113A1. The cupola is equipped with power controls to raise and lower the pod and rotate the cupola 360 degrees. A system of lenses and prisms enables the gunner to use the TOW sights.

XM1 Tank To Have New Laser and Infrared Systems

Crews of the Army's new XM1 tank will be able to engage enemy tanks at night and will be better protected as a result of three electronic devices provided by Hughes Aircraft Company under contracts from Chrysler Corporation, the tank developer. Hughes will provide:

- An infrared night vision system that will give tank crews a TV-like picture of targets and the surrounding area.
- A laser rangefinder that will increase first-round hit capability.
- A fast-acting fire suppression system.

Under a \$7.2-million contract, Hughes will develop and build thermal-imaging systems that can form an image in total darkness from the heat radiated by objects in view. The systems will become part of the tank's basic periscope.

The company will build and incorporate into the system the thermal-imaging, common modules developed by the Army for other night-vision devices, but will substitute electronic multiplexing and a cathode-ray-tube display for light-emitting diodes. This will provide greater flexibility of installation and permit use of electronically produced symbology and a computer-controlled moving target reticle.

The company will also build 15 models of a "mini" laser rangefinder which provides precise range information to the tank's ballistic computer and a digital read-out.

The fire suppression system for the XM1 will include infrared sensors and related electronics. Using these sensors, the life-saving system is designed to suppress a fuel explosion inside the tank within 100 milliseconds of its start. Tank crews will be able to survive a fuel explosion and the tank's survivability will be enhanced.

New Utility Copter Enters Production

The Utility Tactical Transport Aircraft System (UTTAS) is entering production.

Visible improvements in airmobile capabilities are seldom obvious because of the cost and lead time involved with such changes, but incorporation of the UTTAS UH-60A into the force structure will be visible and have a profound effect on Army aviation for many years.

During the last stages of Vietnam, the Army defined utility helicopter mission needs of the 1970s and desires for the 1980s to include validated advancements in technology to produce the UTTAS. In 1972, two prime contractors were funded to competitively develop prototype UTTAS vehicles for evaluation.

Aircraft from each contractor were then subjected to a rigorous evaluation, including a total of nearly 3,000 hours of flight test to establish each vehicle's specific capability and to meet the mission description.

For operational testing, personnel of the 101st Airborne Division (Air Assault) were equipped with the UTTAS candidates as well as the standard UH-1 aircraft. For a three-month period, the 101st flew each type aircraft approximately 250 hours in a sustained simulated tactical environment, with a typical combat unit in a remote site without benefit of paved surfaces or sheltered maintenance facilities.

This test turned out to be more realistic than planned since the weather during the evaluation period at Fort Campbell varied the operations sites from a "sea of mud" to a "severe dust bowl" on a weekly basis. A team of data recorders monitored all activities to evaluate the actual performance and the adequacy of training courses and maintenance publications.

As a result of these tests and studies, the Secretary of the Army announced on 23 December 1976 that the Sikorsky UH-60A had been selected for production. Hence, the UTTAS will be the backbone of Army airmobility through the year 2000.

The UH-60A will transport a full squad of 11 combat-equipped troops at cruise speeds up to 147 knots in an environment of 4,000 feet pressure altitude and 95°F, for 300 nautical miles. At lower altitudes and temperatures, the UH-60A can lift an external load of 8,000 pounds.

System survival in a hostile environment is an inherent part of the design. Critical components using advanced materials and parallel load paths have demonstrated "get home" capability after direct hits with 23-mm high explosive, incendiary rounds. A 75 percent reduction in detectability is achieved by the ability to fly nap-of-the-earth, including tight 3.5 "G" maneuvers. Additionally, the rotor system incorporates a unique swept-tip blade,



The UTTAS, shown here lifting a 105-mm howitzer, can lift an external load of 8,000 pounds at lower altitudes.

eliminating the characteristic blade slap or popping sound which announced the presence of the current UH-1 helicopter.

If an in-flight emergency situation should occur, the crew and passengers have an unprecedented level of added protection by a 95 percent improvement in single-engine capability due to the UH-60A's high rotor efficiency, as well as power available. Crash survival is enhanced by primary structural integrity at impact speeds of up to 35 feet per second and roll-over; crew and troop protection is obtained through the energy attenuation capability of the landing gear and structure under crash loads and crashworthy seats for all occupants.

Retaining approximately the same silhouette as current utility helicopters, the UH-60A has a 40 percent superiority in speed and range, while transporting up to five times the single ship payload.

During 1977, primary attention will be focused on the production of the UH-60A, correction of minor deficiencies identified in the previous testing, and completion of subsystem qualification tests. The modified prototype will then undergo a series of environmental tests in 1978 in the Panama Canal Zone, New York, Arizona, and Alaska. Issue to field units is programmed for early in calendar year 1979.

Plans call for production of 1,107 of the UH-60A helicopters. This may appear to be an inadequate number until one recalls the significant increase in productivity of a single UH-60A as compared to several UH-1 aircraft. The inherently lower maintenance and operating cost of the UH-60A will be further magnified by the reduced inventory of aircraft required, notwithstanding its expanded mission.

The *Journal* interviews . . .

MG Richard G. Trefry

MG Richard G. Trefry is Director of Management in the Office of the Chief of Staff. General Trefry is a 1950 graduate of the United States Military Academy and was a Cadet company tactical officer from 1959 to 1962. He has eight years of command experience, the most recent commands being a 175-mm battalion on the DMZ in Vietnam and 1st Armored Division Artillery at Fort Hood, TX.

He was recently at Fort Sill as guest speaker for the West Point Founder's Day Dinner and discussed the West Point Honor Code and events related to the widely-publicized honor violations associated with an Electrical Engineering 304 take-home assignment. During the time the EE304 controversy was at its height, General Trefry was Assistant Deputy Chief of Staff, Personnel, DA, and was the principal staff officer involved with the actions taken by the Secretary of the Army in the Honor Code matter.

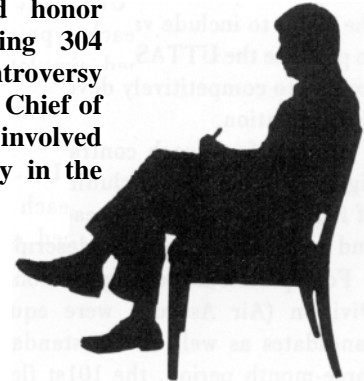
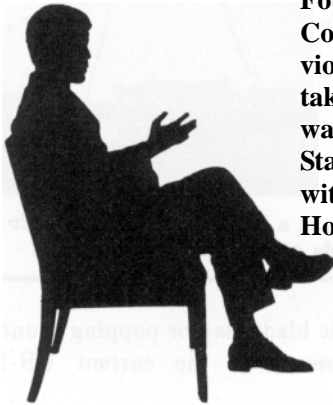

Journal: To what major cause do you attribute the massive 1976 honor violation?

Trefry: There was no one thing that anyone can point to as *the* main cause. There were a combination of factors and a series of events that individually would not have affected the Honor Code and the system, but, together, and with the general societal changes in our country over the past two decades, resulted in the incident. There has been a general erosion of standards in the fabric of our society, and there is probably no other one place in America where such a cross section is present. Cadets arriving at West Point in the 1970s brought with them different mores than those brought by cadets in the 1950s and 1960s. Our society has become more self-centered and competitive, resulting in conflicting standards. There is sometimes a feeling of "I want such-and-such, and I'll do whatever I have to do to get it."

I do not mean to place the blame for the EE304 mess on the nation and imply that the Academy was blameless. Events simply outpaced internal actions that were underway to correct aberrations that existed in the system. The major improvements that will come from this horrible experience will be the use of a degree of discretion in applying sanctions, separation of the Code from regulation enforcement, and a better understanding of the "spirit" of the Honor Code.

Journal: Do you feel that events at West Point "spill over" into the rest of the Army?

Trefry: West Point is the most fundamental and permanent institution we have in the Army. The War College, Leavenworth, and our other institutions have been open, closed, reopened, and moved and have had varying levels of impact on the Army, but West Point has stood the test of time and has a sense of "permanence" that cannot be found anywhere else in the Army. Even its outward appearance of huge grey stone buildings high on the palisades above the Hudson gives the image of strength and permanence. Its graduates have been, and are, leaders of our nation in the military, in the legislative and executive branches of government, and in civilian life. There is a certain mystique about the Academy and how it instills in its graduates such attributes as intelligent discipline, morals, a quest for excellence, and values such as service and sacrifice. An example of this national interest in the Academy — what other college-level institution could draw 100,000 spectators to Kennedy Stadium and millions more on national TV, to watch it play football, carrying a 2 and 8 record — or worse? The Academy belongs to all Americans. One author has described West Point as a "national shrine" that belongs to all Americans, and particularly to the Army.

Journal: In the Army we seldom have such obvious honor challenges as those which occur in the academic environment. How do you see the state of honor in the Army?

Trefry: The vast majority of officers and soldiers are honorable, but, again, the Army is a cross section, so we

have a few problems in this area. The portion of each officer's commission which says ". . . special trust and confidence . . ." imposes a great responsibility for honor and integrity on each of us. What is incumbent on every officer is to stand up and be counted for what he or she feels is right — the hard, unpopular decision — even though it may not be in that officer's best personal interest. Argue, debate, and fight for the position that you believe is right, but once the decision is made, the officer is just as honor-bound to support that position, unless of course that position is illegal. I have supported a lot of decisions I did not agree with, but I have never been placed in a position of having to go against my honor or my integrity.

Journal: In the last dozen years, West Point's product has changed — the curriculum has changed considerably, the size of the Corps has doubled, women have been added, and the Honor Code appears to have lost some of its impact. With these changes, is it really worth the sizeable cost differential between a West Point graduate and a Distinguished Military Graduate produced by ROTC?

Trefry: No one has been able to accurately quantify the cost of an Academy graduate. The "R" in ROTC is for Reserve. The ROTC program is designed to provide officers of limited tenure for active duty for the Reserve Components while the service academies are designed to be a wellspring of life-long public servants.

On the difference between today's West Point graduate and the graduate 15 years ago, I would say that the current graduate is more diverse both in his interests and backgrounds. The quality is the same, but the motivations are different. They are more idealistic and inquisitive than their predecessors, and that's not all bad.

Journal: What will be the end result of the current debate over problems we have filling the volunteer force roles and possibly reverting to the "draft"?

Trefry: The Active Army is not really having insoluble problems in this area, but the Reserve Components are reaching the end of the era where soldiers came on active duty for two years and then had four years of Reserve service. The Reserve rolls are being seriously depleted as these Reservists complete the obligation they incurred when they entered service in the early 1970s. I believe Congress will have to "bite the bullet" and provide the incentives necessary to fill the Reserves, or at least increase their present strength. I do not see the draft returning in peacetime at this time.

Journal: Many military personnel perceive serious erosions in benefits they feel were at least unwritten parts of their entry agreement. With reports of the Fair Market Rental program, decreasing the 2½ percent per year retirement pay formula, and decreasing the availability of dependent medical care, can unionization of the Army be prevented?

Trefry: These are very sensitive issues that Congress will ultimately decide. The problems have contributed to the issue of service unions. I think a major misunderstanding is based on the past inability of the military to properly

articulate to the service men and women that the military service is a way of life and from this stem certain benefits that the military departments are working hard to protect. The soldier and officer in the Army *do* have friends — in Congress, on the DA Staff, and the top civilian and military leadership of the Army — who are working hard on these matters.

One point that often escapes attention is that there are requirements and an environment that the soldier must accept and embrace in a career. In the Army, this environment includes work weeks usually in excess of 40 hours, remote locations for service, certain hardships, etc. It means that when you join you are saying you are here because you want to be. Remember, without the draft, everyone on active duty today is here because he wants to be. In return for this service, the soldier rightfully expects that he and his dependents will be cared for and that the rules will not be changed several times during a career, particularly in those areas that affect his sense of belief that his services, and sacrifices, if necessary, are appreciated.

Journal: You are obviously a very successful Field Artilleryman and your record shows you do not possess some of the traditional "tickets" felt by many to be essential for success. Would you comment on this?

Trefry: I did not attend Airborne, Ranger, or aviation training and I did not return from two tours in SE Asia bedecked with Bronze Stars and Air Medals [General Trefry has neither award]. I am neither proud nor embarrassed about that. My goal has been to seek the jobs I wanted to do and felt qualified for, or those that I believed would train me for positions of higher responsibility. I sought command opportunities at every chance because command is something I enjoyed and when you enjoy what you are doing you usually do well at it.

I think every officer should aspire to be a General Officer. One makes GO rank by professional and personal development, performing in a variety of assignments and, most important, doing all of them to the best of his ability and well. I honestly believe that if an officer develops himself along those lines, he or she won't have to live in a constant state of concern, trying to hit all the "gates" at the right time. The gates will naturally open. Be professional and look out for your people — seniors, peers, and subordinates — be generous with your time, concern, and efforts; and subordinate yourself to the good of the Army and the nation, and you'll do all right.

Journal: What is your impression of your visit to Fort Sill?

Trefry: I'm impressed as hell at what I've seen and what has evolved since my last real involvement with the School during HELBATs 1 and 2 at Fort Hood. I think the one thing that comes through is the inquisitive nature of all the people I have met at Sill. They are truly interested in sharing ideas with the other combat arms and getting Army-wide comment on the great things being done at Sill for the betterment of the service as a whole. 

Journal: Thank you.

Minimum Required . . .

The MFDT Works!

by MAJ Earl W. Finley

*In an article "Request All Available! Why Not Minimum Required?" in the March-April 1977 issue of the **Field Artillery Journal**, COL John P. Caruso described a technique developed by the Artillery Staff Section of Headquarters I Corps (ROK/US) Group which offered a simplified approach to the challenge of providing responsive, effective, and economical delivery of massed fires on the modern battlefield. This technique was called the Massed Fire Distribution Technique (MFDT). Although the MFDT appeared simple enough and seemed to offer obvious advantages, the technique had not been tested in the field at the time the article was written. —Ed.*

That which looks good on paper and in discussions does not always live up to expectations when put into practice. Therefore, the only way to confirm the efficacy of the MFDT, and thereby promote its adoption, was to test it in a live-fire exercise. Accordingly, a massed fire exercise was developed.

The 2d Infantry Division enthusiastically agreed to handle the fire control and shooting for the test. Eighth US Army approved the nickname Caper Mass I for the firing test.

In order to provide maximum exposure for Caper Mass I, and thus encourage adoption of the MFDT (assuming a successful outcome), a large number of senior ROK and US Army officers were invited to view the test.

Caper Mass I was viewed as a "high confidence, high risk" venture. There was "high confidence" by virtue of the Artillery Staff's belief in the basic soundness of the technique. There was "high risk" in that an actual test (as opposed to a demonstration) with "uncanned" missions was to be fired before so many senior officers. A bad showing, no matter what the cause, would have a disastrous effect on gaining acceptance of the MFDT by the Republic of Korea Army (ROKA).

Twelve firing batteries of the US 2d Div Arty occupied assigned firing positions at 1300 hours, 17 November 1976. Dry-fire missions were conducted during the afternoon to exercise communications, as well as MFDT procedures, and to coordinate the timing of the firing with the narration which was to be conducted in Korean.

A heavy ground fog on the morning of 18 November

hampered the battery registrations, but the weather cleared beautifully and registrations for all batteries were completed by 1200. Caper Mass I began at 1400 and included the firing of four massed TOT missions. All missions were controlled by the division artillery FDC and coordinated with Caper Mass control established on the OP.

The Results

Mission 1, Target 1: Target 1 was a large rectangular area, and 12 batteries fired at a single aiming point, a technique employed by ROKA artillery units. Effective fire was localized around the aiming point, leaving virtually no coverage of the major peripheral area. Full target coverage would have required repeated shifts to fire, with an attendant loss of surprise.

Mission 2, Target 1: Mission 2 employed the same 12 firing batteries against Target 1, using the MFDT. On this mission, effective first-round fire was distributed throughout the target area, demonstrating the characteristics of improved target coverage and enhanced surprise.

The article explaining the MFDT indicated that the FDO, after locating the target trace on his firing chart, has the option of reorienting the template if such action will achieve a better distribution of aiming points; i.e., better coverage and/or a lesser number of aiming points. He then must take the additional step of sending the template orienting direction to the firing batteries when he transmits their aiming points.

In Mission 2, the long axis of the target was oriented northeast to southwest. With the template oriented on grid north, 15 aiming points fell on or within the target trace and still only covered about 90 percent of the target. Reorientation of the template gave 100 percent target coverage with 12 aiming points.

To accomplish this, the 2d Div Arty FDO, MAJ Tom Raley, centered the standard target grid (with the template aiming points superimposed on the grid) over the grid location announced for aiming point E9. After orienting the target grid on grid north and constructing a north index, the FDO rotated the grid to get a best-fit situation for aiming points. He then announced to the fire units the grid location for E9 and the template orienting direction, which he read directly off the target grid. Once the template orientation had been established, the FDO assigned aiming points to the fire units.

A reorientation of the template, during Mission 2 of Caper Mass I, gave 100 percent coverage of the target area with only 12 aiming points.

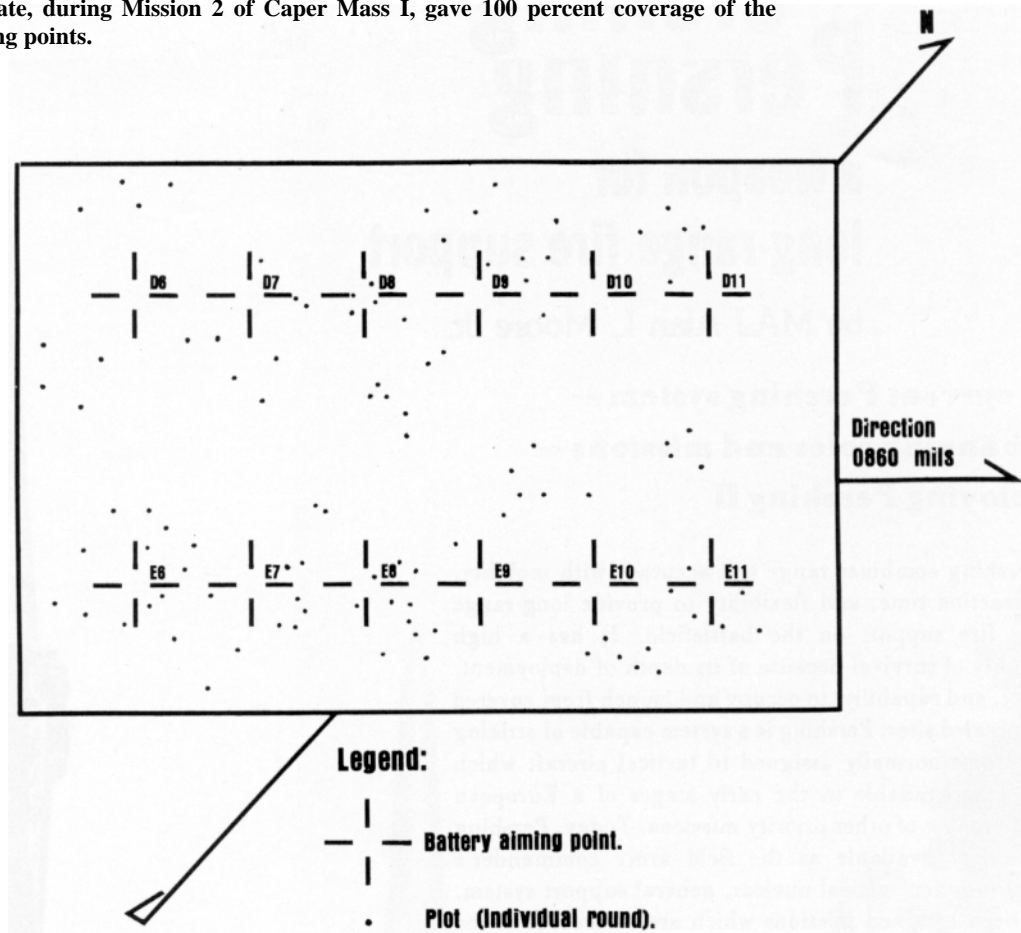

Mission 3, Target 2: Target 2 was a long narrow rectangular area. Again, effective fire was quickly distributed throughout the target area. This mission reinforced the characteristics of the MFDT previously mentioned, as well as pointing out the simplicity, economy, and responsiveness of the system.

Mission 4, Target 3: Mission 4 was fired at an irregularly shaped target selected by one of the ranking ROKA visitors, Lieutenant General Mun.

General Mun was provided a target template, depicting three infantry companies in attack formation. He was asked to place it on the map in any orientation he desired, provided that the entire target remained within the safety fan for the impact area. Selection of the target in this manner — a clear demonstration of "high confidence, high risk" — insured that the observer would receive a clear impression of the value of the MFDT.

Dame Fortune intervened at this point. Since there was no way to mark this target ahead of time in the impact area, it was thought that the visual impact might be lost in a large cloud of dust and smoke with one subtarget masking another. By sheer chance, the target was selected with such an orientation to the OP that the distribution of fires on the three subtargets would be clearly visible to the observers.

The 2d Div Arty, continuing the pattern established on the three preceding missions, performed magnificently. The mission was processed quickly and flawlessly, and the effect on the ground would make any gunner's heart swell with pride. Each subtarget was completely covered in a sudden flash of destruction. The observers, normally not given to emotional outbursts, broke out in spontaneous applause. This mission reinforced the demonstrated MFDT characteristics and displayed the flexibility of the MFDT and the ease with which irregularly shaped targets can be effectively engaged.

Caper Mass I vividly portrayed that the MFDT is a responsive cost-effective, surprise-enhancing solution to many of the requirements for massed fires. This test showed that — regardless of the size and shape of the target — first-round coverage of the entire area can be achieved with a minimum number of firing units. The successful accomplishment of Caper Mass I led to the adoption of the MFDT by Third Republic Army. Now, how about the US Army? ☒

MAJ Earl W. Finley is assigned to I Corps (ROK/US) Group in Korea.

Pershing

a weapon for long-range fire support

by MAJ Alan L. Moore Jr.

The current Pershing system — Its changing roles and missions — Employing Pershing II

Pershing combines range and accuracy with mobility, rapid reaction time, and flexibility to provide long-range nuclear fire support on the battlefield. It has a high probability of survival because of its depth of deployment, mobility, and capability to occupy and launch from covered and concealed sites. Pershing is a system capable of striking those targets normally assigned to tactical aircraft which may not be available in the early stages of a European conflict because of other priority missions. Today, Pershing is no longer available as the field army commander's primary organic, tactical nuclear, general support system. It has been assigned missions which are considered to be more important to the battle plan.

Two very important changes are now taking place which could alter this situation. First, the development of Pershing II, the third generation of the system. Second, the new policy for nuclear weapons employment in Europe. A strong potential now exists for returning Pershing to its original role.

Background

When Pershing was first activated in the late 1950s, deployment plans called for 10 battalions. These original Pershing battalions were organized with one launcher in each of four firing batteries. The number of battalions activated was subsequently reduced to five. Two of these battalions were stationed at Fort Sill to provide a CONUS training base, with a contingency mission for deployment as needed. The remaining three battalions were deployed to Germany to replace the Redstone; these units were used as Seventh Army's organic, tactical nuclear, general support (GS) weapon system. Thus, Pershing joined Sergeant, a corps GS weapon system, to provide the Seventh Army with a family of tactical surface-to-surface missiles.

During the mid-1960s, the NATO allies enjoyed a decided nuclear superiority over the Warsaw Pact. This relative

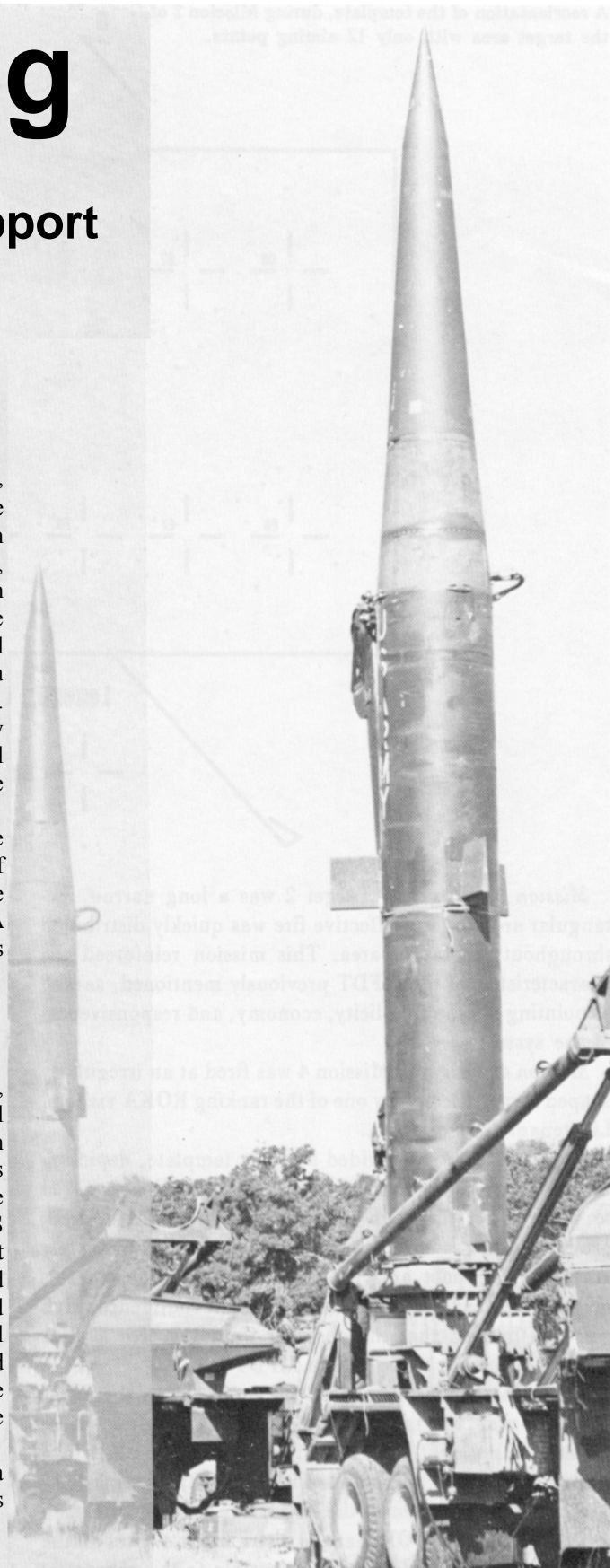

force posture led to the philosophy of nuclear weapons employment based on the "trip wire" theory. If the Warsaw Pact were to attack conventionally, with their superiority in tanks and conventional forces, NATO would retaliate promptly with a theater-wide nuclear attack. This NATO policy required adequate forces of the appropriate mix to be ready and continuously available even in a peacetime environment. The Supreme Allied Commander, Europe (SACEUR), faced with a growing number of priority targets and lacking the strike means, was searching for an augmentation to the forces then available to NATO. Nike Hercules and Sergeant were both studied, but discarded as unsuitable candidates. The next choice was Pershing. A two-month field test, TIGER CLAW, in the spring of 1965 resulted in Pershing I being selected for a role in SACEUR's General Strike Plan (GSP). The next step in Pershing's evolution was to improve the system reaction time and to increase the available launchers/missiles to permit greater participation in, and more rapid response to, SACEUR's GSP requirements. This move released some tactical aircraft for other missions. Pershing Ia came into being in 1969 with a much reduced reaction time and nine times the number of launchers in each of the three deployed battalions. A total of 108 launchers as compared to the original 12 launchers were now available. These were available, however to SACEUR; Seventh Army was given second priority.

The GS mission of Pershing as an organic Seventh Army weapon system did not actually disappear, but it did take a back seat. The new mission dictated that if the GS role were required, it would be *after* completion of GSP requirements. Consequently, the new role resulted in placing Pershing under operational control of Central Army Group (CENTAG) for both the GSP mission and the post-GSP GS missions.

During the critical, early phase of a potential conflict in central Europe, the army and corps commanders now have only cannon artillery and the Lance battalions as organic fire support means, immediately responsive to their requirements. Those targets in the commander's zone of primary interest beyond the range of the Lance missile can only be attacked with tactical aircraft sorties allocated by SACEUR. The commander has lost his organic, long-range, GS nuclear firepower until after Pershing fires on its GSP targets. There is also the possibility that SACEUR might retain Pershing for restrike or other priority targets in the post-GSP phase.

Improved Technology

Pershing II (PII), the third generation of Pershing, is now in the advanced development phase and the latest available technology is being incorporated. The major change is terminal guidance, which will result in accuracies so improved over today's missile system that the use of very low nuclear yields for the surgical attack of targets is

now possible. This attack can be made with a minimum of collateral damage. Another major improvement is the earth penetrator warhead which provides the capability to attack the type of choke points now included in an atomic demolition munition barrier mission. This warhead gives the theater commander a standoff capability of impeding or channelizing the enemy in zones of penetration. Additionally, the potential for a nonnuclear warhead exists because improved accuracy insures adequate effectiveness.

Now What?

So where do we go from here? The direction seems to be clearly emerging from the wealth of articles and papers on the subject of NATO nuclear weapons employment policies. Now that NATO no longer enjoys a clear-cut nuclear superiority, it is quite apparent that, in this era of nuclear parity, SACEUR's "trip wire" philosophy ceases to be so appealing. The *capability to react* may continue to be a strong deterrent to aggression, but the "when," "where," and "how much" of NATO's "warfighting" nuclear capability must be reexamined. This becomes even more critical when we consider the continuing advantage that the Warsaw Pact enjoys in conventional force superiority.

A recent article by LTC W. A. Shoffner entitled, "The Time Has Come," which appeared in the January-February 1976 issue of the *Field Artillery Journal* was of interest. Pertinent parts of LTC Shoffner's article, which concentrated on Lance's part in the new environment, are cited here:

The strategy for defense of NATO was realigned in 1967 when a plan of flexible response was adopted. The role of tactical nuclear forces in a strategy of flexible response has gradually come into agreement. The role has shifted away from deployment of these weapons principally for deterrent value with their use as the trigger for a strategic exchange. The current strategy requires that deterrence derive from a credible war-fighting capability.

In a recent message to Congress, the Secretary of Defense identified improvements for theater nuclear forces which must be achieved if they are to remain effective. The improvements demand, among other things, that the commander have at hand the capability for selective, carefully controlled nuclear options that will enhance his ability to deal with a major penetration of an allied sector and achieve a quick, decisive reversal of the tactical situation.

Whenever a tactical situation has deteriorated to the extent that a quick, decisive reversal is a vital requirement, the commander must have a viable option to employ his tactical nuclear resources. These resources must be committed decisively, not piecemeal, and must be committed so that the enemy's tactical advantage is clearly eliminated. The nuclear resources available to the corps commander

to deal decisively with the penetration consist of cannon artillery, tactical aircraft, and the Lance field artillery battalions of the corps. Each of the systems has certain inherent advantages. Cannons are best used against targets in the vicinity of maneuver forces; their existing conventional fire direction and control capabilities are vital in coordinating a schedule of fires. Tactical aircraft offer a unique capability to strike targets deep in the enemy zone as well as those targets which may not be well defined.

It is quite interesting to note that Lieutenant Colonel Shoffner cites as "available nuclear resources" the corps weapons (cannon artillery and Lance) plus tactical aircraft; no mention is made of Pershing. This is further evidence of the prevailing tendency to disregard Pershing as an available, or even potentially available, weapon system for use in the limited option environment. Each tactical nuclear-capable system possesses specific inherent advantages which, under certain circumstances, make it the best system for accomplishing the desired mission. In an environment where Warsaw Pact nations have an air defense superiority, it may not be prudent to risk the loss of tactical aircraft by sending them against targets beyond the range of Lance and other suppressive fires. Under these circumstances, which are probable in the early stages of a conflict, it might be better to employ Pershing II because its penetrability and increased accuracy would provide the degree of target kill probability desired without the risk of losing aircraft; also, because of its increased accuracy, it could be used to surgically attack targets unsuited for Lance due to collateral damage. The basic point is that *the commander at every level must consider all means available to him to accomplish his objective.*

Pershing in the General Support Role

Now that the "flexible response" policy of NATO is accepted, how might PII fit into the employment planning under this philosophy? First of all, and with the highest priority, Pershing *must*, in whole or in part, retain its mission in support of SACEUR's GSP. Pershing II, with its increased accuracy, shorter reaction time, and improved survivability, may permit SACEUR to accomplish the GSP objectives with fewer PII missiles being committed to the mission. The one clear message which emerges with the new policy is that once again there will be a need for a long-range missile system in general support of engaged combat forces. To provide SACEUR with complete flexibility and the full capabilities of employing tactical nuclear weapons at these lower option levels, he must be able to strike appropriate military targets in any area of the theater of operations where penetration poses a serious threat. This means that all nuclear-capable systems, from tactical aircraft down to organic divisional artillery, must be capable of participation. The extent to which any one system may be tasked depends on the existing situation. Because of their range capabilities, PII and tactical aircraft

would provide the greatest flexibility for employment against selected targets in the theater. Corps and division weapons would be the primary choice within their range capabilities against targets in the area of local penetrations. To gain the maximum advantage SACEUR must be able to employ any combination of his total capabilities. At the same time, he must retain the capabilities for execution of the GSP mission, not only for its deterrent value but also for any other need.

Pershing's Employment Flexibility

Pershing II's characteristics make it well suited for many options selected by SACEUR. Its accuracy, low yields, and potential warhead types provide the capability to engage precisely any or all of the following typical battlefield targets:

- ADM barrier targets.
- Headquarters and airfields.
- Logistic installations.
- Large troop concentrations.
- Surface-to-air or surface-to-surface missiles.

Although many of these targets will most likely be assigned to corps or divisional weapons, there is strong likelihood that, by the time the decision is made to employ tactical nuclear weapons, many of the priority targets will be beyond the range of the corps and division systems.

Why Pershing Makes Sense for More Than One Job

Based on the obvious necessity for SACEUR to retain his GSP capability, the question naturally arises relative to the use of Pershing in *both* roles. There are a number of approaches which could be taken to provide this capability. The first solution, involving some element of risk, is to accept a temporary and partial degradation of total GSP capability during the period of limited option employment. This same capability, with attendant risk, would apply to the use of tactical aircraft under the same circumstances. A second solution might be to activate a "lean and mean" PII battalion whose only mission would be general support. Such a battalion would provide the GS capability without any impact on the balance of the Pershing force's GSP requirements. It would restore to the theater commander an organic and immediately responsive capability of directly influencing the conflict throughout his area of interest and responsibility — a capability he has not enjoyed for many years.

Therefore, Pershing II, with its unmatched accuracy, rapid response, flexibility, and survivability, should now be restored to its rightful place as a member of, and complement to, the army/corps general support weapon system. 

MAJ Alan L. Moore Jr. is assigned to 1st Battalion (Lance), 12th Field Artillery, Fort Sill, OK.

EPMS AND THE FIELD ARTILLERY

by COL Sam A. Brown

Implementation of the Enlisted Personnel Management System (EPMS) is in full swing throughout the Army! The Field Artillery has been rapidly developing its portion of the system and is at a peak of activity. Under EPMS, each Field Artillery soldier has a clearly defined, systematic way to manage his career and progress up the promotion ladder from E1 to E9. The Field Artillery career management field, CMF 13, has been revised. The education system has been strengthened, and dynamic training and testing tools are being developed.

CMF 13, Field Artillery

The EPMS has resulted in significant changes to the structure of the FA career management field. CMF 13 is a consolidation of the old CMFs 13 and 15 and part of CMF 17. Figure 1 shows the career progression and MOS relationships that exist within CMF 13. The MOSs shown in parentheses at the bottom of figure 1 are the old MOSs that are now included within the revised MOS. For example, MOS 13B10, radio/telephone operator, and driver positions associated with 13E functional areas (forward observer, fire direction center), have now been converted to 13E positions. For each MOS, duties are matched with a skill level corresponding to the position. Exact job descriptions for the revised CMF 13 are listed in Change 6 to AR 611-201.

The fire support team (FIST) concept requires the establishment of a new MOS—13F, fire support specialist. This new MOS will combine the forward observer duty positions of MOS 11C, infantry indirect fire crewman, and all the fire support duties currently a part of MOS 13E. When MOS 13F is approved, 13E requirements will be reduced in scope from cannon fire direction/fire support

to that of cannon fire direction only.

Training

The training system has also been modified under EPMS. At each level, training is designed to insure that the soldier is qualified to perform in duty positions of increasing responsibility (figure 2). At entry level, the trainee is prepared to perform most of the skill level 1 duties in the ranks of E1 to E4. The Noncommissioned Officer Education System (NCOES) prepares the career soldier to perform duties at higher skill levels. The training system includes formal resident and nonresident courses, supervised on-the-job training (SOJT), the Army Correspondence Course Program, training extension course lessons, and individual and collective unit training. Since all MOSs do not have the same training requirements, the training system varies from one MOS to another.

Entry level training is provided through one station training (OST), one station unit training (OSUT), or the more familiar basic combat training (BCT) and advanced individual training (AIT). OST and OSUT began at Fort Sill on 20 February 1976 and is the responsibility of the Field Artillery Training Center. Under the OST program, the trainee receives all his training at Fort Sill. The trainee first completes eight weeks of BCT and then begins AIT in one of the field artillery specialties. The length of AIT varies with each MOS. OSUT is designed specifically for MOS 13B (cannon crewman). The BCT/AIT system required 16 weeks; but, under OSUT, the 13B trainee is assigned to one unit for all of his training and graduates in just 12 weeks. The OST and OSUT programs have drastically reduced the number of FA soldiers that complete BCT on one post and AIT at another.

After entry level training, there are four levels of training that comprise the NCOES. Primary, basic, advanced, and senior level training prepare the soldier for duty positions in skill levels 2 through 5, respectively.

- **Primary level** training prepares soldiers to perform skill level 2 (grade E5) tasks and is normally given to those E4s who have either entered, or exhibited qualifications to enter, the career force. The system now provides leadership and supervisory training for MOSs 13B and 13E (and subsequently 13F) through a four-week Primary Noncommissioned Officer Course (Combat Arms) conducted at local NCO academies and through SOJT. A three-week resident Primary Leadership Course (PLC), now being developed, will provide leadership training for the 15D, 15E, 15J, 17B, 17C, 82C, and 93F MOSs. PLC is designed to be taught at local NCO academies and includes training in supervisory and managerial skills. Technical training for

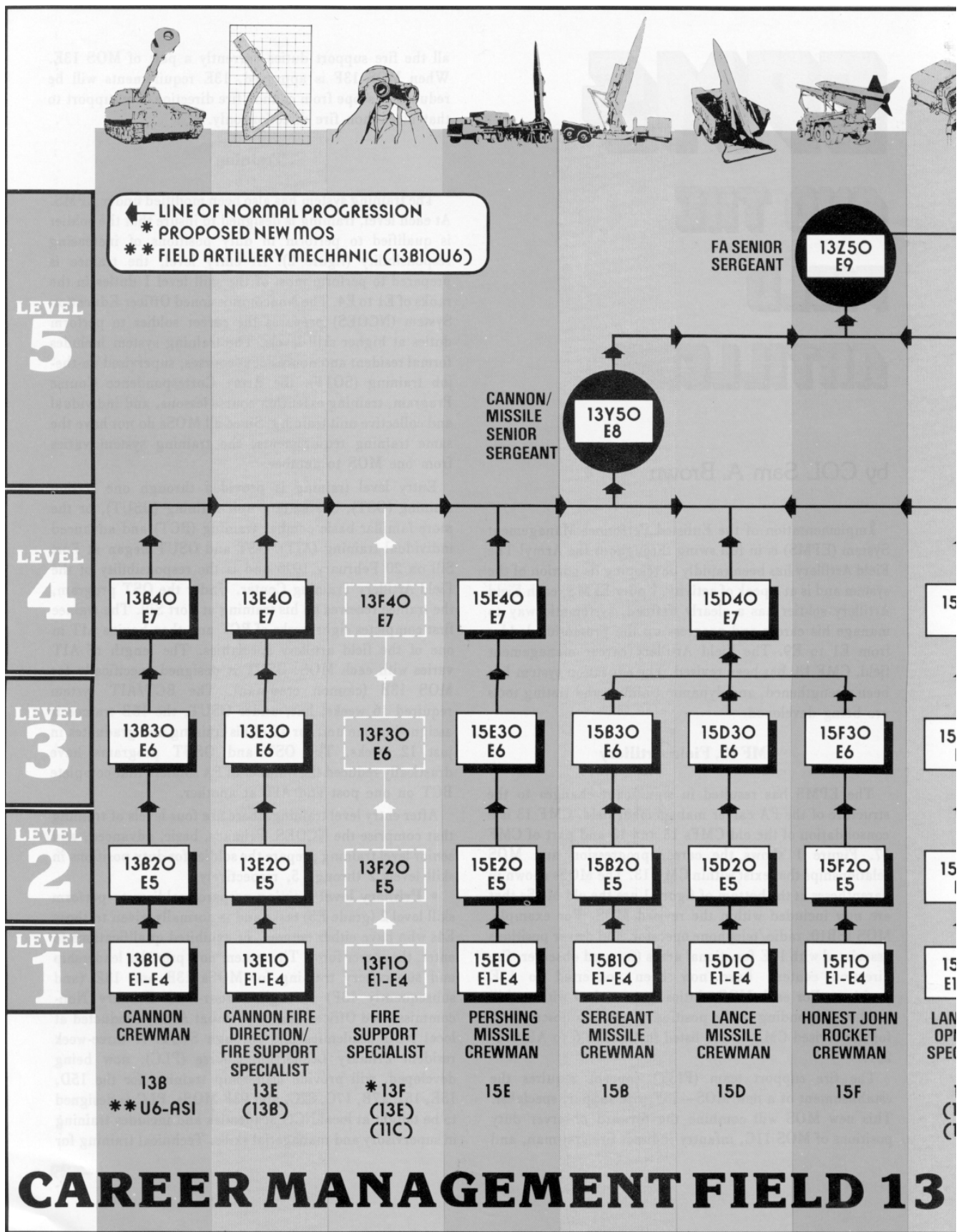
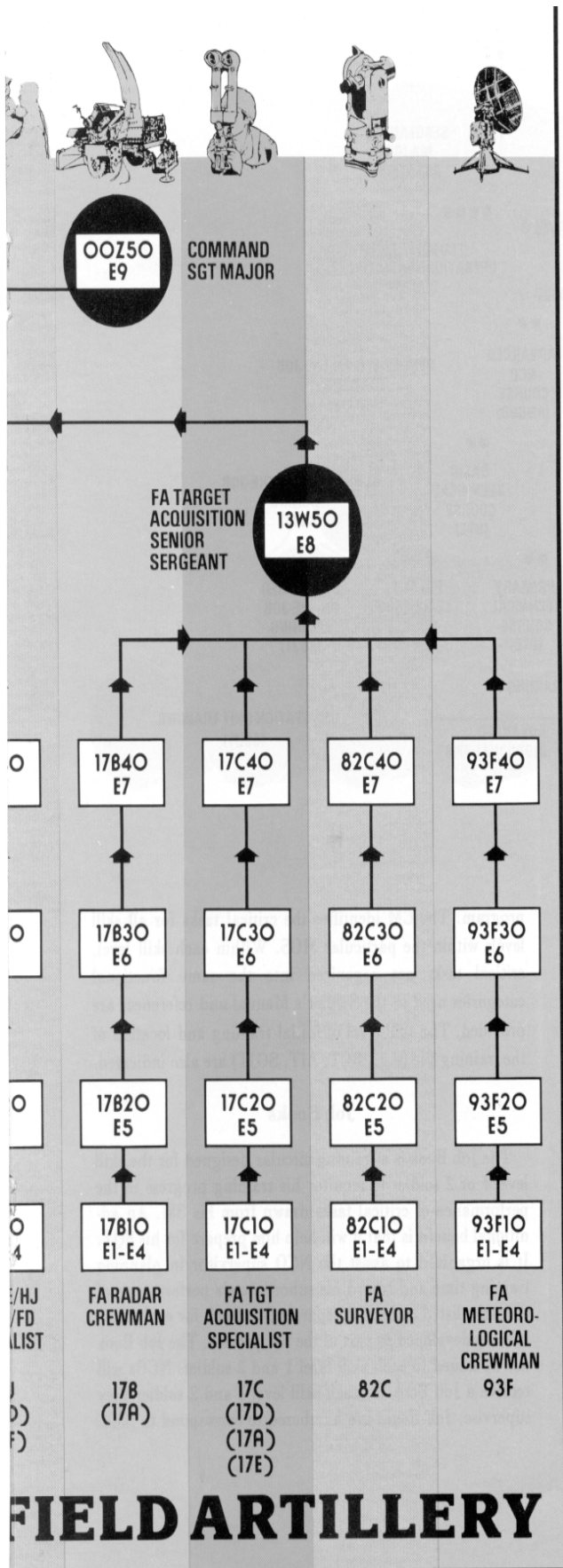

Figure 1. Career progression and MOS relationships.



E4s in MOS 15E (Pershing missile crewman) will be provided through a Primary Technical Course (PTC).

- **Basic level** training will prepare the E5 artilleryman to perform to skill level 3 (grade E6) duty positions. It teaches MOS-related tasks and prepares the E5s (MOS 13B, 13E, and subsequently 13F) to conduct individual and collective training in support of the Army Training and Evaluation Program. This four-week course is taught at NCO academies. A resident BCT for E5s in MOS 15D (Lance missile crewman) will be implemented at Fort Sill in the near future.

- **Advanced level** training focuses on broadening the skills and knowledge required of soldiers at skill level 4 (E7) and is offered to E6s. The Advanced Noncommissioned Officer's Course focuses on skill level 4 tasks. ANCO courses for the FA cannon, FA missile, and combat surveillance and target acquisition MOSs are taught at Fort Sill.

- **Senior level** training for E7s is offered almost exclusively in the extension mode. Senior level courses will provide training to support functional duty positions at skill level 5 (grades E8 and E9). The Operations/Intelligence Course is an extension training program designed for senior NCOs who require training for operations or intelligence positions. The US Army Sergeants Major Academy designed for E8s, is the capstone course for all NCO training in the Army.

At each level, from entry level training through the entire range of NCOES, the total training *system* must be used. A soldier cannot be taught everything he needs to know in resident courses. It takes a combination of all parts of the training system to qualify the soldier to serve in each duty position. The Commander's Manual clearly defines the training requirements of each part of the training system.

Training And Evaluation Tools And Procedures

Soldier's Manuals (SM), Job Books (JB), and Skill Qualification Tests (SQT) are now being developed by USAFAS for all Field Artillery MOSs. Figure 3 shows SM/SQT implementation dates.

Soldier's Manuals

To do a job well, the soldier must know exactly what his job involves. For the first time, the Army has developed a series of documents that clearly define exactly what is expected of each soldier at each skill level. This document is the Soldier's Manual — the basic individual training tool — and each soldier will be provided his own manual.

The SM is a collection of critical tasks (defined as those tasks necessary for mission accomplishment or individual survivability) organized by subject matter and skill level. These tasks are based on lists developed through job

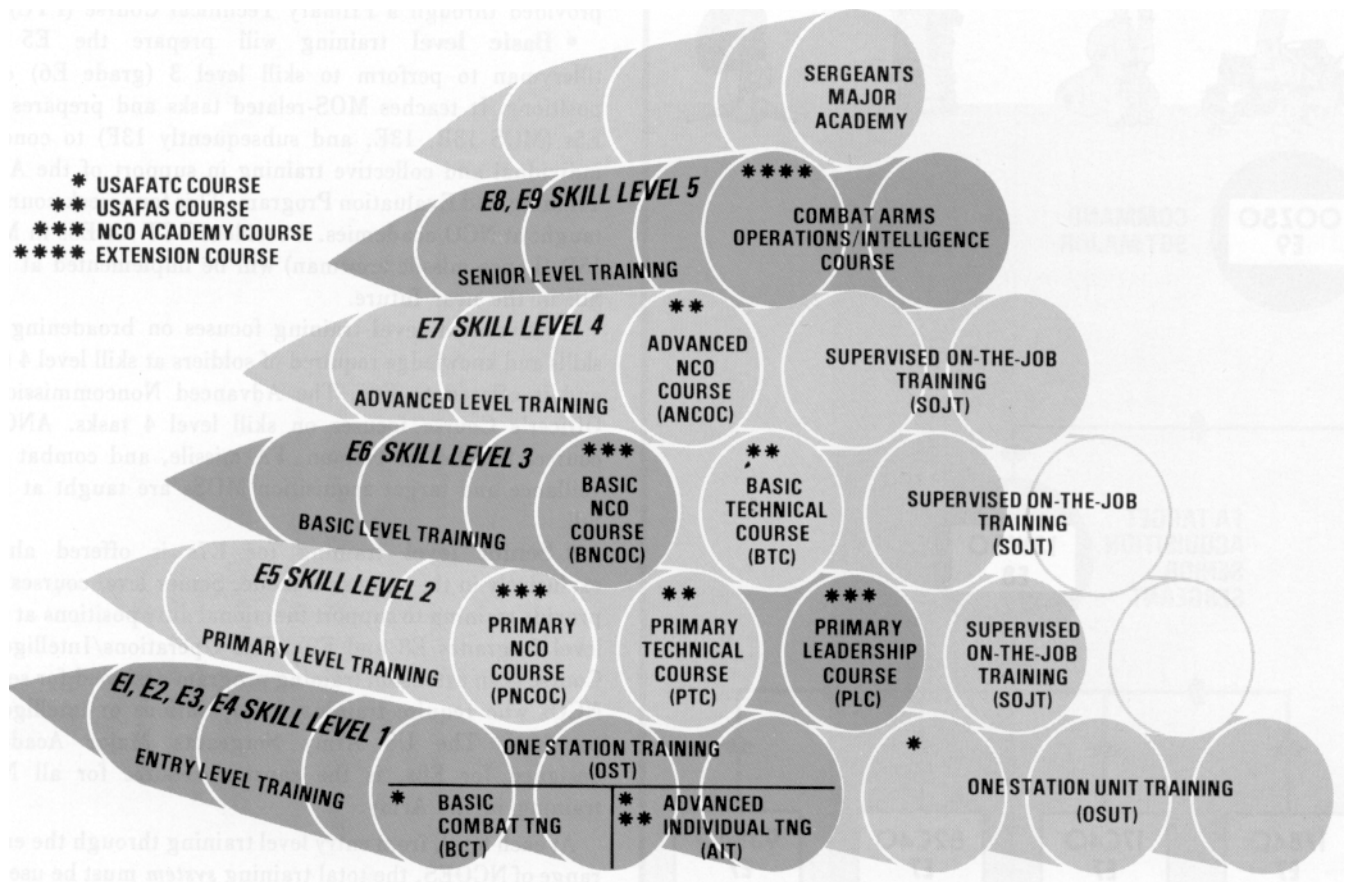

Figure 2. Training required at each level.

analysis. For each task, a training and evaluation outline was written that defines the task, conditions, and standards. The outline also identifies training requirements or steps to perform each task and lists appropriate reference material. The soldier must master the tasks in the SM to be proficient at his MOS skill level. To progress up the EPMS ladder to positions of increased responsibility, the soldier must also master the critical tasks defined for successively higher skill levels. Soldier's Manuals are designed on the modular system. Each skill level manual builds upon the other. The soldier should always have the Soldier's Manuals for his present, past, and next higher skill level. Upon promotion to grades E5, E6, or E7, the soldier must order the next higher skill level manual. An order form is provided in the back of each SM for the purpose of maintaining manuals.

Commander's Manual

The Commander's Manual for each MOS is designed to assist the commander in preparing his unit training

program. The CM identifies the critical tasks for all skill levels within the particular MOS. Within each skill level, critical tasks are organized into the same functional categories used in the Soldier's Manual and references are provided. The skill level of initial training and location of the training site (e.g., BCT, AIT, SOJT) are also indicated.

Job Books

The Job Book is a training circular designed for the skill level 1 or 2 soldier to monitor his training progress in the performance of critical tasks drawn from his SM. An additional benefit is that it will help him prepare for his SQT. It is organized to assist the NCO supervisor in planning training time and record his subordinate's performance of the tasks listed in SMs. A separate Job Book for each MOS is being developed as part of the SM process. The Job Book will be issued to each skill level 1 and 2 soldier. NCOs will receive a Job Book for each skill level 1 and 2 soldier they supervise. Job Books are numbered to correspond to SMs.

Skill Qualification Test

The concept of the SQT is based on the belief that retention and career progression criteria should include a measure of the soldier's ability to perform the critical tasks required by his job. SQTs measure the professional competence of soldiers and serve the needs of personnel management. The SQT is developed directly from the critical tasks contained in the SMs, and will relate to those critical tasks. Since the testing time is limited, not all tasks in the Soldier's Manual can be tested. The selection of tasks for testing insures that each functional area is adequately evaluated. A task may be tested in either the hands-on component, written component, or performance certification component. The hands-on component is a series of performance tests. In the written component, critical tasks are measured objectively. The third component, the performance certification, contains critical tasks (e.g., weapons qualification or physical fitness) too complicated or time-consuming to be reasonably tested by the hands-on or written component method. The supervisor uses the conditions and standards prescribed in the SMs to insure a thorough evaluation of each task identified. The commander will then certify the soldier's ability to perform these tasks. The key is that the commander/supervisor will certify task performance ability over the past 12-month period.

Under the current program, the soldier will be formally evaluated every two years by taking the SQT for the *next higher* skill level. If the soldier scores below 60 percent on the SQT, he is considered unqualified in his MOS and must

take the SQT again the following year. If he fails the second time, he may be reclassified or barred from reenlistment. If he achieves a minimum qualification score of 60 percent, he will have verified his ability to perform effectively at his present skill level. If a soldier with a low verifying score believes he can improve his score, he may ask to retake his SQT the following year. To be awarded the next higher skill level and be eligible for promotion, the soldier must achieve a score of 80 percent.

The mystery has been taken out of testing. With the SM in each soldier's possession, he knows the source of all items to be tested. To clarify testing even more, the soldier and the commander will receive an "SQT notice" 60 to 90 days prior to the actual SQT. The notice will tell the soldier exactly which tasks will be tested. It alerts the soldier as to which tasks he will see in the hands-on and written components and specifies what tasks will be certified in the performance certification component.

Results from the SQT will be available to the individual soldier, the commander, personnel managers, and SQT developers 30 days after the test. These results will provide the best profile of individual proficiency the Army has ever had and will tell the commander if modifications must be made to sustain on-going individual training programs or if remedial training is needed.

The Total Package

It's all there! The Soldier's Manual defines the skills that must be mastered at each skill level. The training system provides the necessary training to acquire the skills, and the Skill Qualification Test determines the soldier's capability to perform these skills. Passing the SQT does not, however, guarantee the soldier a promotion. To be promoted, the soldier must also achieve high performance evaluations on enlisted evaluation reports, meet time-in-service and time-in-grade criteria and, of course, be recommended by his commander. ☒

COL Sam A. Brown is Director of Directorate of Training Developments, USAFAS.

MOS	SM distribution	
	dates	SQT dates*
13 B	Oct 77	Apr 78
13E	Oct 77	Apr 78
13F	Oct 77	TBA
13W	Oct 78	Apr 79
13Y	Oct 78	Apr 79
15D	Oct 77	Apr 78
15E	Oct 77	Apr 78
15J	Oct 77	Apr 78
17B	Oct 77	Apr 78
17C	Oct 77	Apr 78
82C	Oct 77	Apr 78
93F	Oct 77	Apr 78

* Indicates earliest date the MOS will be tested.

Figure 3. Soldier's Manual/SQT schedule.

RIGHT BY PIECE

Met Computations

SPRINGFIELD, MO — During a recent FDC CPX of the 3d Battalion, 75th Field Artillery, (USAR), SGT Edward F. Paschal Jr, Alpha Battery chief computer, developed a useful device for computation of eight octant meteorological (met) corrections which other units may be interested in trying.

WIND COMPONENTS AND DEFLECTION					
DIRECTION OF WIND 5020		5000	POS MET TOT	ROTATION CORR	0.7
CHART DIRECTION OF WIND		100	R20 + L9 = R11	DRIFT CORR	9.0
CROSS WIND SPEED	20	* CORR 0.10	2	CROSS WIND CORR	0.7
RANGE WIND SPEED	20	* CORR 0.99	20	MET DEFL CORR	9.0
MET RANGE CORRECTION					
KNOWN VALUES	STANDARD VALUES	VARIATIONS FROM STANDARD	UNIT CORRECTIONS	PLUS	MINUS
RANGE WIND	20	0	20	+12.2	244.0
COMPUTATION OF VE				TOTAL RANGE CORRECTION	
MET RANGE CORR				MET RANGE CORRECTION	+259
MET FUZE CORRECTION				TOTAL FUZE CORRECTION	+312
AV	VARIATION FROM STANDARD	UNIT CORRECTION	PLUS	MINUS	
RANGE WIND	20	-0.012		0.24	
AIR TEMP					75.2
AIR DENSITY					7230
PROJ WEIGHT					415
MET FUZE CORR				MET FUZE CORRECTION	-0.3
				FUZE CORRECTION	
				TOTAL FUZE CORRECTION	-0.2
OLD FZ CORR	NEW FZ CORR	BATTERY	DATE/TIME		

Blocks that change in each octant are cut out of DA Form 4200.

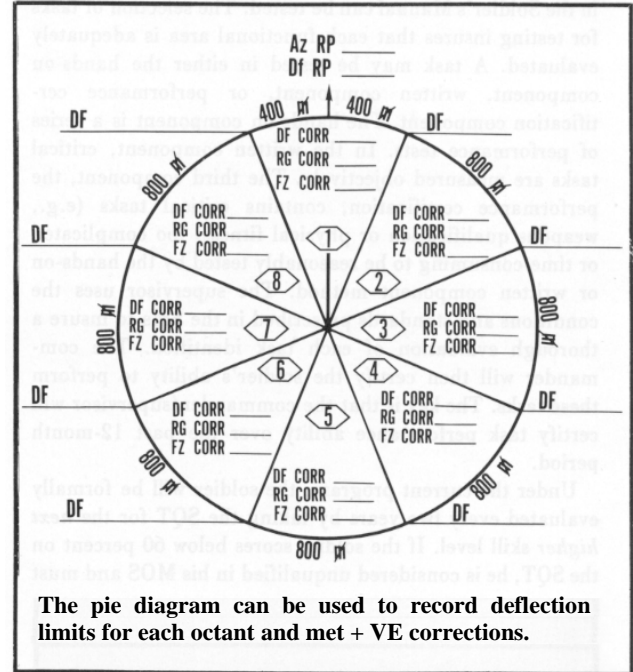

This device is basically a DA Form 4200 with all blocks that change in each octant, cut out. This form is taped to an acetate notebook sleeve and a piece of frosted acetate is taped over the face of the form (frosted acetate is used so a lead pencil instead of a grease pencil can be used to record data). After the initial concurrent met correction is computed, it can be recorded under the sleeve and the met data can be computed for another direction. By using four sleeves and a loose-leaf binder, a met book can be made and eight octants can be figured and kept in a handy format. The front page would contain a pie diagram indicating the deflection limits for each octant as well as the met + VE corrections for each, providing a quick reference for corrections. This system has three advantages:

- It saves forms.
- It saves copying time.
- It decreases the possibility of error.

These devices require only a couple of hours to make and are inexpensive.

Leads To

This



This



FORT CAMPBELL, KY — LTC William Serchak (right), Commander of the 3d Battalion, 319th Field Artillery, reenlists six members of his battalion. All firing batteries were represented as the following 101st Airborne Division Redlegs were sworn in: SP4 William Thomas (left front); SP4 James McMahan (left rear); (center to right) SGTs Danny Thomas, John Smith, Eugene Sewell, and Robert Dickson. (Photo by Billy Nixon.)



FORT CAMPBELL, KY — COL Wendell Gilbert, 101st Div Arty Commander (left), and MSG Sidney Brown, career counselor (right), accept the monthly major subordinate command reenlistment trophy from MG John A. Wickham Jr., 101st Division Commander, Div Arty, who won the award for achieving 245 percent of its objective, also won the major subordinate command trophy for 1976 and seems to have a good chance at it for 1977. (Photo by SP4 Sharon Foley.)

Training With a Plus

FORT LEWIS, WA — The 9th Div Arty believes in going that extra mile to make training interesting and meaningful.

The 9th Div Arty Commander, COL Charles D. Franklin, issued an alert order to his target acquisition platoon that they were to undergo an emergency deployment readiness exercise (EDRE) in a "non-local training area." The non-local area turned out to be Boardman Naval Bombing Range in Oregon! This area had never been surveyed as far as anyone could tell, and the only maps available for assistance were geological survey maps with distances in miles and longitude and latitude for horizontal control.

The three-day event was designed to test the platoon's ability to move to any place in the world within 18 hours and perform its mission. The relatively uninhabited area was fog-bound most of the time, but the sun broke through

long enough at one point to allow taking a sun shot for starting control. Several firing points were surveyed, providing good section training, bringing control to a previously unsurveyed area, and establishing enough data to allow use of this site for future firing battery EDREs.

The radar section employed its AN/TPS-25 in a simulated search of aggressors. The only enemy turned out to be a local farmer, armed with a bottle of wine and a shotgun. The farmer claimed the platoon was on his land. State police finally arrived and escorted the farmer from the Navy reservation.

After an interesting and educational three days, the platoon returned to Fort Lewis on C-130 aircraft. Among the other innovative training recently conducted by 9th Div Arty elements are a battalion EDRE in the California desert and portions of another battalion going to Alaska for exercise Jack Frost. Never a dull moment

Right By Piece



FORT BRAGG, NC — Loading Up . . . Paratroopers from the Canadian Airborne Regiment recently underwent five weeks of field instruction with the 82d Airborne Division Artillery. The Canadian Redlegs fired 105-mm howitzers provided by the 2d Battalion, 321st Field Artillery. The training was part of the US/Canadian annual army exchange program. (Photo by PFC Scot Heino.)

Europe's First FIST

HANAU, WEST GERMANY — The 3d Armored Division Artillery is first with FIST in Europe! After reviewing the results of numerous FIST concept and vehicular studies conducted during the past year, the Division Artillery Commander, COL John B. Tanzer, recommended the immediate implementation of a modified "quick fix" solution for the Spearhead Division. Impressed with the critical need for operational FISTs in an armored division "on line" in Europe, the Division Commander, MG Charles Simmons, directed its immediate implementation. Subsequently, FISTs for each maneuver company were fielded on 24 January 1977.

Using the general guidance provided in the FIST report, the combined assets of the direct support field artillery and maneuver battalions were sufficient to man and equip the FISTs at an effective level. A departure from the Fort Sill "quick fix" solution was the adoption of the M60 tank as the primary FIST vehicle in the armored companies. The principal benefits gained were less vulnerable transport, mobility on a par with the supported element, enhanced target acquisition capability, immediate availability, and lack of signature. Mechanized infantry FISTs used the M113.

A comprehensive FIST training program has been developed. Concurrently, FISTs are receiving training in fighting, operating, and maintaining their primary vehicles

in anticipation of crew qualification exercises with their supported companies. In addition to crew training, the FISTs are scheduled to shoot the annual artillery battery and battalion ARTEPs and the mortar ARTEPs scheduled for May and June. The final evaluation of their training efforts will occur at Hohenfels when the FISTs deploy in support of maneuver battalion ARTEPs during July and August.

Maneuver commanders at all echelons have recognized the value of the FIST concept and are energetically supporting its implementation. It has become readily apparent that FIST offers the Spearhead Division the assurance that continuous indirect fire support will be there when and where it's needed.

Busman's Holiday

FORT DERUSSY, HI — While most artillerymen find an avocation that is not duty-related, four members of the 3d Battalion, 13th Field Artillery of the 25th Division, spend their free time maintaining guns.

Shown here are SP4 Alex Sowiecki (top), LT Tom Warren (left), and LT Doug Dawes (right) working on the breech of an old 7-inch naval gun which belongs to the museum at Fort DeRussy.

The guns originally were part of Battery Randolph, a Coast Artillery installation which also contained two 14-inch guns. There were plans to demolish the battery until the local museum intervened and accepted responsibility for the weapons. A call went out for volunteers to help restore the weapons and these three artillerymen, in addition to LT Michael Chychota, volunteered to donate one day per weekend to this community project.

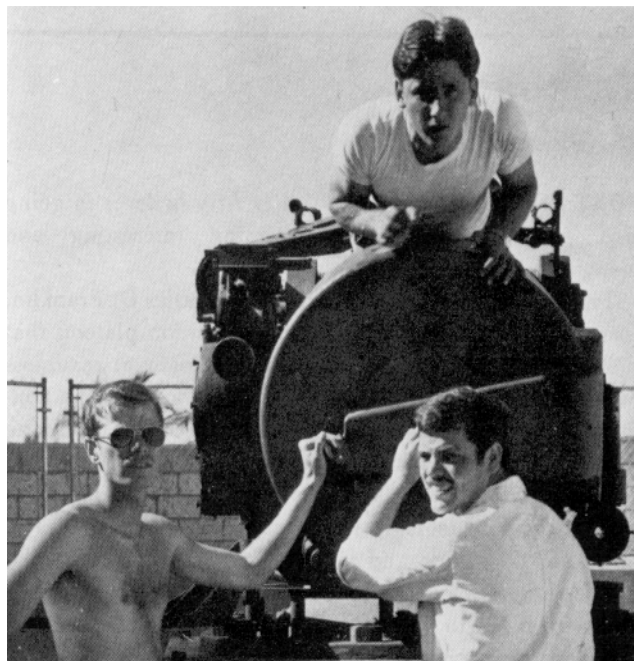

Artilleryman Chosen Fort Lewis SOQ

FORT LEWIS, WA — MG Volney F. Warner, Commander of 9th Infantry Division and Fort Lewis, presents the Soldier of the Quarter post trophy to PFC Martin E. Kilmer, C Battery, 2d Battalion, 4th Field Artillery. After being selected Soldier of the Quarter for his battalion and div arty, Kilmer, 19, was chosen to compete for Post Soldier of the Quarter. A board comprised of five sergeants major then selected Kilmer from among 10 nominees. Kilmer said he came into the Army for the educational benefits and to see what the Army was like. "I guess I just tried a little harder than average," he reasoned. He is on levy now for Hawaii and is really looking forward to it. Being an outdoorsman has helped the soldier adjust to Army life. "I kind of like field duty," he admitted. (Photo by T. Matuso.)



TAB Activated at Ord

FORT ORD, CA — With the recent activation of Battery B (Target Acquisition), 333d Field Artillery, a relatively new concept in artillery organization has been added to the ever-expanding 7th Infantry Division.

This unit, which incorporates various target acquisition sections previously in Div Arty Headquarters and Headquarters Battery, or scattered among the assigned

battalions, centralizes these assets in a separate battery directly under control of Div Arty Headquarters.

In addition to providing information on location of hostile targets within the division area, the battery has a mission of establishing survey control for all artillery units within the division sector, performing calibration of artillery weapons and collecting other battlefield information. During a nuclear situation, this unit provides post-strike analysis and accuracy information of friendly nuclear strikes.

The new div arty unit is commanded by CPT Terrence R. Redding who was previously assigned to the Field Artillery School as an instructor in the Counterfire Department. During that assignment he helped develop this new concept and wrote the training circular on counterfire techniques.

In describing the employment of this unit and its capabilities, Captain Redding stated, "With the target acquisition battery concept, there is centralized control and processing of target information, which enables the more timely delivery of fire on targets as they are located. Of course, when the mission dictates, we are flexible enough to attach specific elements to the various battalions in div arty to more adequately provide the target acquisition capability across the division area of responsibility."

The target acquisition battery is composed of a radar platoon with the AN/MPQ-4 countermortar radar and the AN/TPS-25 ground surveillance radar, a survey platoon with distance-measuring equipment and theodolites, and a sound and flash ranging platoon.

The colors of the battery were presented to Captain Redding by Assistant Division Commander, BG Robert Arter.



BG Robert Arter (left) presents the colors of the newly activated B Battery, 333d Field Artillery, to CPT Terrence R. Redding, commander. (Photo by J. C. Fairbank.)

Pershing II

by COL Larry H. Hunt

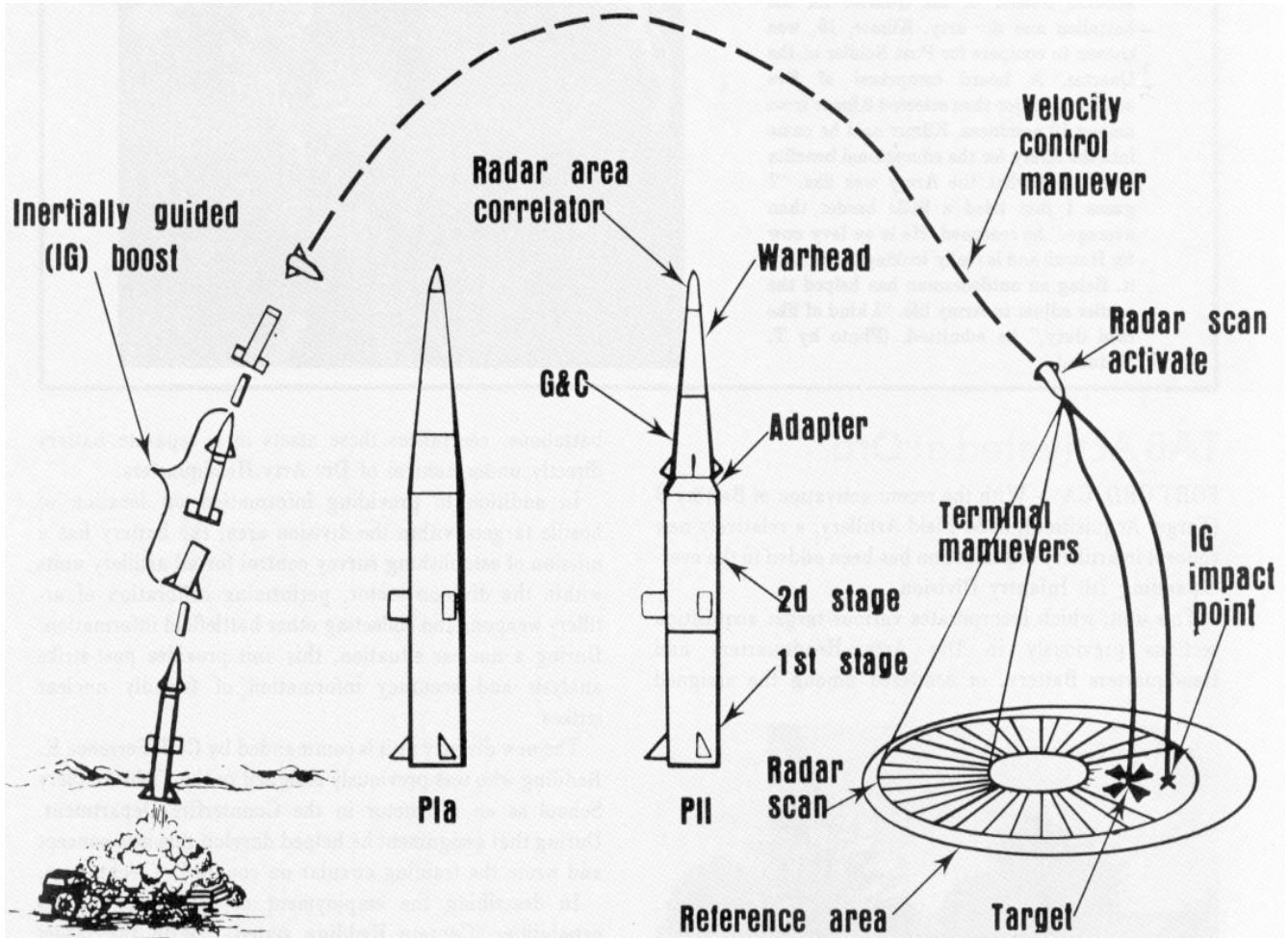

Pershing is an outstanding example of modernization through modular improvement. The Pershing story is one of constant evolution in both equipment and organizational structure. The 1,101 men who comprised the original Pershing I battalions, with their missiles mounted on modified M113 tracked vehicles, would not recognize today's 1,368-man Pershing Ia battalions as they roll along the autobahns of West Germany on wheeled vehicles at speeds of 40 to 50 miles per hour.

Those first "Pershing Professionals" would marvel at the greatly reduced reaction times for a firing platoon to launch its basic load of missiles, using a sophisticated sequential launch adapter to switch electrical signals, high

pressure air, and conditioned air from one missile to the next.

The survey crews of those old days will watch with awe as the new automatic reference system does in minutes what used to take hours of taping and angle-turning. Even the language — quick reaction alert, combat alert status, reduced quick count, platoon location position — is full of new terms.

The steady improvement in the operational capabilities of the Army's longest range and most powerful weapon system continues today. The next generation — Pershing II (PII) — is currently under development by the Army's Missile Research and Development Command at Redstone Arsenal, AL.

Pershing II will incorporate a highly accurate terminal guidance system in a new maneuverable reentry vehicle. The improved accuracy will provide a substantially higher probability of target kill with smaller warheads.

This combination of improved accuracy and smaller warheads, along with Pershing's rapid response and assumed penetration, permits the destruction of critical, time-sensitive targets with minimum collateral casualties or damage in the immediate target area.

PII will be launched, like PIa, on an inertially guided trajectory to the point where the reentry vehicle separates from the second-stage booster. Inertial guidance position information will be continually updated as it proceeds on a ballistic path through the outer atmosphere. Soon after reentry, an all-weather radar system is activated to sweep the target area below the rapidly descending reentry vehicle.

The live radar returns are compared in a special correlation tube with a pre-stored reference image of the target area. The amount of adjustment necessary to achieve a perfect match or correlation between the live radar return and the pre-stored radar image of the target area provide a measure of guidance error. Corrective commands are computed and the reentry vehicle is maneuvered to bring it back onto course.

Several such correlations are obtained during the terminal descent with each providing increased accuracy. This technique, called radar area correlation, is one of the most accurate guidance concepts available today, and PII will open a new dimension in the Field Artillery's ability to deliver firepower accurately by long-range surface-to-surface missiles.

The terminal guidance system is currently being tested in captive flights. Results to date in both helicopter and high speed jet aircraft have indicated that PII's performance will exceed specifications.

With this improved accuracy, nonnuclear payloads may become effective, thus permitting consideration of a wide range of new missions for Pershing. For example, the Defense Department has recommended to Congress that funds be provided to examine the feasibility of Pershing II as a conventional airfield attack missile.

Pershing II takes full advantage of existing equipment by using the present first- and second-stage missile motors and the existing ground support equipment. In addition, its similarity to the currently deployed missile will allow transition to operational status with a minimum of personnel retraining.

The advanced development program will be complete in 1978 with the launching of six flight-test missiles at White Sands Missile Range. In addition to the new radar guidance system, these flights will test the feasibility of a new earth-penetrator warhead for use in attacking hard, point targets.



Pershing crew member checks azimuth reference unit of new ARS/SLA ground support equipment. Reference unit uses a laser beam in an automatic optical link to align missile gyro with true north, thus eliminating the requirement for launch from pre-selected and surveyed points.

When the PII program is fully implemented, Pershing's life will be extended nearly two decades, into the 1990s. This will mean a total useful life of 30 to 40 years, surely some sort of record for a major weapon system in a world of rapid technological progress.

The improved military effectiveness and the increased deterrence value which PII will bring to Pershing's quick-reaction-alert role in Europe will continue a long tradition of service for this Field Artillery system to which the Supreme Allied Commanders in Europe have long entrusted the task of attacking the highest priority, most time-sensitive targets whose destruction is vital to a successful NATO defense of Western Europe. ☒

COL Larry H. Hunt is the Pershing Project Manager at the US Army Missile Research and Development Command, Redstone Arsenal, AL.

Field Artillery Brigade

by COL Edward R. Coleman

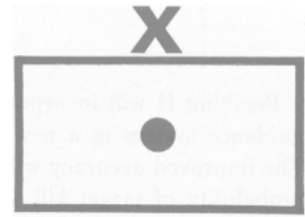

Modern battlefield doctrine has the division artillery providing both close support fires and counterfire. It also changes the corps artillery headquarters to a small corps field artillery staff section and deletes the target acquisition battalion. Obviously, our corps artillery cannon battalions and their command and control headquarters — the Field Artillery Groups — need to adapt accordingly. During the past year, an extensive effort by the Field Artillery School and several FA Groups has been underway to make this adaptation. The result of this effort is taking shape as the Field Artillery Brigade. This article will explain what the FA Brigade is, how it differs from the Group, how to fight with it, and how to train its members and components.

Like the FA Group, the FA Brigade is a command and control headquarters for corps cannon battalions. The FA Brigade, however, is designed to do four specific things on the modern battlefield:

- Reinforce a division artillery within the corps zone.
- Serve as a force artillery headquarters in corps or division covering force area (CFA) operations.
- Provide direct support for a section of the main battle area (MBA).
- Serve as an alternate division artillery tactical operations center (TOC).

The FA Brigade may control up to six corps FA battalions as could the Group. When the General Support Rocket System (GSRS) becomes a reality, these units may also be a part of the Brigade. When the corps commander determines, on recommendation of his corps artillery officer, that a division in the corps zone must be weighted with artillery, he may task one or more FA Brigades to reinforce a division artillery. The FA Brigade commander then reports to the div arty commander. Reinforcement is a term applicable to the several relationships of the units involved. Both status (attached) and tactical mission (reinforcing) must be further defined by the corps. Major factors in determining the status of an FA Brigade include the factors of METT (mission, enemy, terrain, and troops available), how much control the corps commander wants or is able to retain, and the capability of his corps support command (COSCOM) to support his units in forward areas. Based on exercise experience, the FA Brigade may be tailored to meet the needs of the supported force. A light TOC may have utility in airborne division airhead operations. A medium FA Brigade headquarters, with TOC, communications, and command elements forward may be best suited for covering force operations. Both these and a heavy FA Brigade were found workable alternatives. The

key is flexibility. Once assigned a status and a tactical mission, the FA Brigade becomes a major temporary asset of the maneuver force. In division operations, it is not appropriate to assign a corps cannon battalion a direct support (DS) mission because it breaks the relationship of the habitually associated maneuver brigade DS battalion and it forces the corps unit to provide fire support assets (FISTs, liaison sections, communications equipment, etc.) which it does not own. A major role of the FA Brigade headquarters with a mission of reinforcing the div arty is to fulfill the inherent reinforcing responsibilities and to serve as an alternate tactical operations center (TOC) within the division zone. If div arty is destroyed or must move, the FA Brigade TOC can function as a "jump" TOC or can assume the role of div arty TOC.

The most flexibility for div arty is gained by placing the FA Brigade in an attached status as shown in figure 1. The

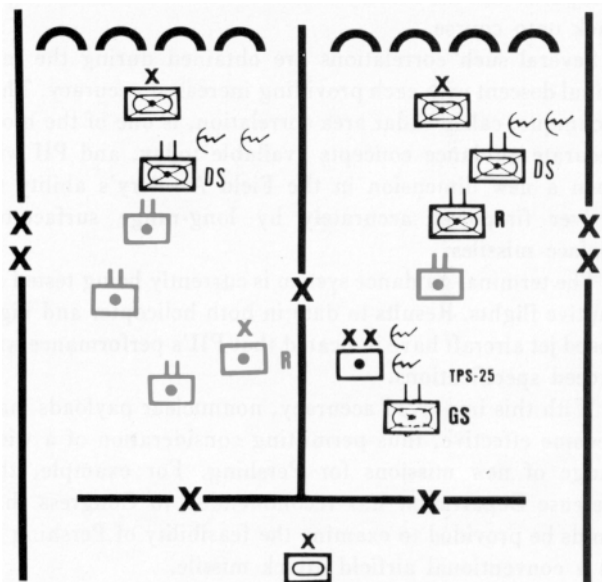

Figure 1. FA Brigade reinforcing a div arty.

limitation here, however, is that the FA Brigade is assigned a mission of reinforcing; thus its command and control capability is only partially used. One of the most important roles for the FA Brigade is as the force artillery for division or corps covering force operations. In developed defensive areas, such as along the border of West and East Germany or North and South Korea, the covering force for the corps has a major role in delaying the enemy, deceiving him,

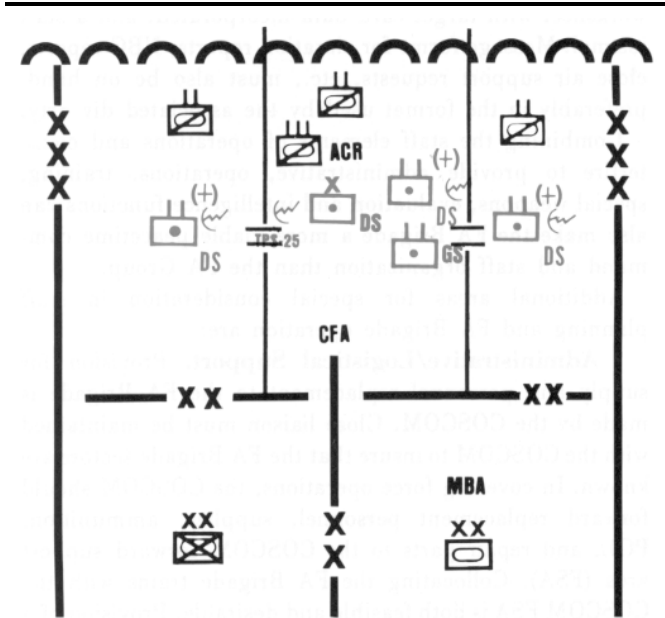

Figure 2. FA Brigade as force artillery headquarters in support of ACR corps covering force.

decreasing his strength, and identifying his main thrust. Field artillery support is needed to achieve these objectives. The FA Brigade, operating independently of div arty but augmented with some divisional artillery assets, is ideally suited to support the covering force due to its light configuration. The DS role may be required for GS battalions though they are not equipped for this mission. As such, it becomes the force artillery headquarters for the armored cavalry regiment (ACR), cavalry brigade (air combat) or a maneuver brigade task force. Exercises have shown that div arty can lend support to the covering force by providing forward GS fires in the CFA on call. Light batteries (5 guns with Btry XO and radio communications) can be positioned forward while the enemy main thrust is being identified. In an exercise with the 82d Airborne Division, this concept of maximum firepower forward, was highly useful in the initial phase of the antiarmor defense. Typical covering force operations are shown in figures 2 and 3. The DS role in the MBA is highly appropriate for the FA Brigade when the division commander needs to weight a sector with firepower or to cover wide fronts. As a second artillery TOC in the division zone, it can provide the division with a significant increase in FA command and tactical fire control. It is critical that the habitually associated DS battalion retain its mission and become part of the FA Brigade task organization. Cannon battalions then should be further assigned appropriate tactical missions. A possible organization for this type of operation is shown in figure 4. Generally, the reinforcing role is more appropriate to the defense while the DS role is more appropriate to the offense.

The FA brigade must be capable of communicating on the same nets as div arty, should it be required to assume div arty control. Battalions must also be prepared to communicate on div arty nets when the FA Brigade assumes div arty control. In figure 5, the nets for FA Group TOE are shown in black and those recommended for FA Brigade TOE in color.

The Brigade's TOC is the nucleus of its capability to support the div arty, a maneuver brigade task force, or a covering force. The FA Brigade TOC is patterned after the div arty TOC, but it does not have the direct target acquisition battery representation in the target processing section that div arty has. Functionally, the TOC relies on two principal skills — fire support operations and target processing. The tasks associated with these skills are listed in Soldier's Manuals FM 6-13F, FM 6-17C, FM 6-13Y, and FM 6-13W. Collective section skills are enumerated in the Operations and Fire Direction Section of ARTEP 6-302. A handy overall training reference is TC 6-20-4, *Counterfire*. Additionally, the new FM 6-22, *Div Arty/FA Brigade Operations* and TC 6-10-1, *Modern Battlefield Communications*, will devote considerable discussion to FA Brigade operations and communications. Training in basic radio and wire communications, vehicle/generator operations and maintenance, common combat survivability, weapons, tactics and intelligence is also critical for TOC personnel. Whenever the FA Brigade is operating independently, e.g., in other than a reinforcing role for div arty, it is recommended that a target production section be

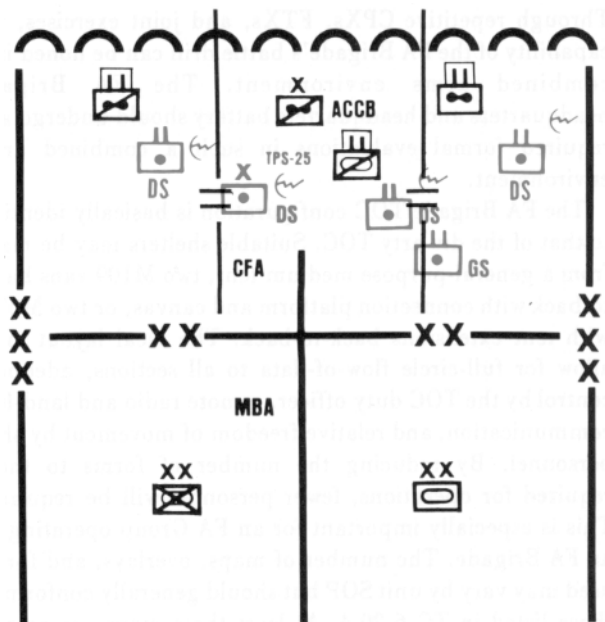

Figure 3. FA Brigade as force artillery headquarters in support of ACCB corps covering force with divisional/corps armored cavalry squadron attached.

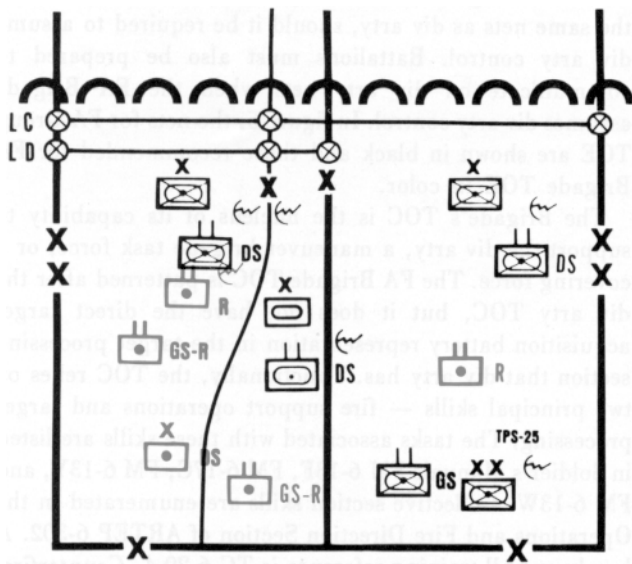

Figure 4. FA Brigade DS to a maneuver brigade in division zone.

constituted from corps military intelligence assets or the div arty target production section. Recommended tasks for individual training are shown in figure 6. Tasks for collective training are those listed in the Operations and Fire Direction Section of ARTEP 6-302.

A further training need is for habitual association of the FA Brigade with a division artillery. If sufficient Active or Reserve Component FA Brigades are available, a habitual association with a div arty is a combat training must. Through repetitive CPXs, FTXs, and joint exercises, the capability of the FA Brigade's battle drill can be honed in a combined arms environment. The FA Brigade headquarters and headquarters battery should undergo any required formal evaluations in such a combined arms environment.

The FA Brigade TOC configuration is basically identical to that of the div arty TOC. Suitable shelters may be made from a general-purpose medium tent, two M109 vans back-to-back with connection platform and canvas, or two M577s with tent extensions back-to-back. The ideal layout must allow for full-circle flow-of-data to all sections, adequate control by the TOC duty officer, remote radio and land-line communication, and relative freedom of movement by shift personnel. By reducing the number of forms to those required for operations, fewer personnel will be required. This is especially important for an FA Group operating as an FA Brigade. The number of maps, overlays, and forms used may vary by unit SOP but should generally conform to those listed in TC 6-20-4. At least three maps are recommended — one in operations/fire control and two in target production/processing. Minimum forms required are a standard message form, a fire mission form, an artillery counterfire information form, a modified target list worksheet with target card data incorporated, and a staff

journal. Message forms for situation reports, NBC reports, close air support requests, etc., must also be on hand, preferably in the format used by the associated div arty.

Combining the staff elements of operations and counterfire to provide administrative, operations, training, special weapons, evaluation and intelligence functions can also make the FA Brigade a more viable peacetime command and staff organization than the FA Group.

Additional areas for special consideration in staff planning and FA Brigade operation are:

- **Administrative/Logistical Support.** Provision for supply and personnel replacement to the FA Brigade is made by the COSCOM. Close liaison must be maintained with the COSCOM to insure that the FA Brigade sectors are known. In covering force operations, the COSCOM should forward replacement personnel, supplies, ammunition, POL, and repair parts to the COSCOM forward support area (FSA). Collocating the FA Brigade trains with the COSCOM FSA is both feasible and desirable. Provision of a liaison element by COSCOM to the FA Brigade should be considered if collocation cannot be accomplished. Within the division zone, COSCOM should forward personnel and logistic support to the maneuver brigade trains area in which the FA Brigade is operating. The division support command must be informed, through the div arty S1 and S4, of all logistic and personnel support actions affecting the FA Brigade's strength and supply status.

- **FA Liaison.** Liaison with supported artillery and maneuver forces is another critical training and operational requirement. The fire support tasks contained in FM 6-13F and the liaison tasks in ARTEP 6-302 should be used as the basis for training. Liaison in combat requires the best trained personnel because of the critical importance of accurate and timely flow of information, decision data and coordination between the supported unit and the FA Brigade. Too often in peacetime, this is not adequately addressed.

- **FA Meteorology (met).** The FA Brigade is authorized an organic met section. When reinforcing div arty, the met section should be positioned to support the div arty and provide met data to div arty in addition to div arty met for broadcast to all units. In the DS role, the met section should be positioned to support the FA Brigade sector of the division zone. In covering force operations, one or more divisional met sections may be placed under FA Brigade control to provide forward met data to units in a CFA more than 20 kilometers deep.

- **Target Acquisition (TA).** The four field artillery aerial observer (FAAO) teams organic to the FA Brigade are its only organic target acquisition assets. Div arty target acquisition assets include eight FAAO teams and the TA battery with five AN/MPQ-4A countermortar radars, one AN/TPS-25 ground surveillance radar and two sound/flash

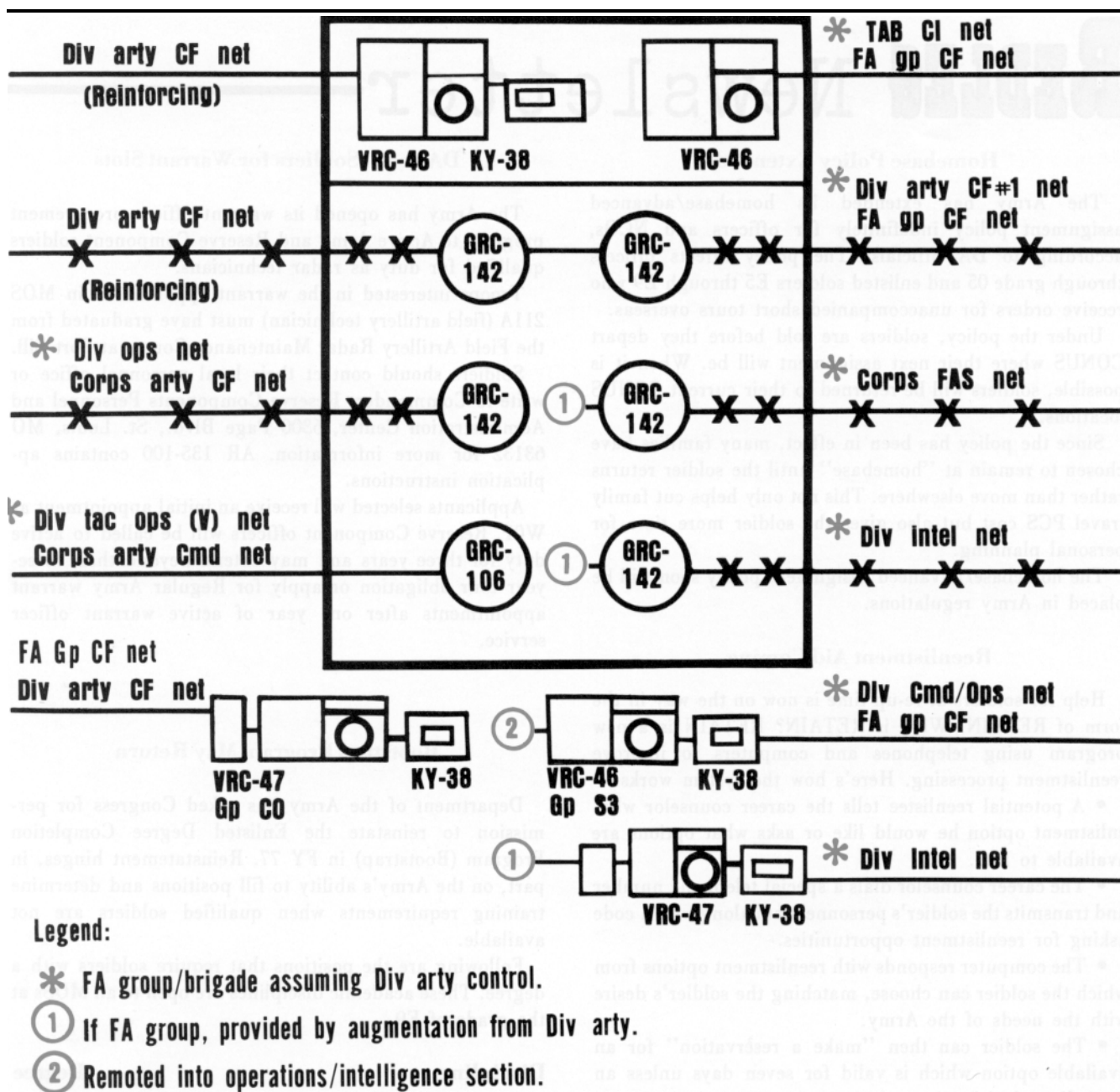

Figure 5. FA Group/Brigade TOC radio net configuration.

bases, and a survey platoon. The FA Brigade relies heavily on div arty target acquisition capability. In covering force operations, mobile TA assets of div arty must be made available to the FA Brigade. These could include several countermortar radars, the ground surveillance radar, and four to six FAAO teams. In the DS role, the FA Brigade sector should receive appropriate coverage by div arty's positioning and orienting its target acquisition systems in a responsive manner by attachment or other appropriate status. In the reinforcing role, the FA Brigade's FAAO teams could be placed under div arty

control. Survey support must be provided to the FA Brigade firing elements to insure that they are on a common grid with div arty. This requires close coordination between the FA Brigade S3 and the div arty survey information center.

- **TACFIRE.** The tactical fire direction system (TACFIRE) presents a problem being resolved in part. Active FA Brigades will receive a TACFIRE capability. The acquisition of TACFIRE by Active div arties will widen the

(Continued on page 51.)

REDLEG Newsletter

Homebase Policy Extended

The Army has extended its homebase/advanced assignment policy indefinitely for officers and NCOs, according to DA officials. The policy affects officers through grade O5 and enlisted soldiers E5 through E9 who receive orders for unaccompanied short tours overseas.

Under the policy, soldiers are told before they depart CONUS where their next assignment will be. When it is possible, soldiers will be returned to their current CONUS locations.

Since the policy has been in effect, many families have chosen to remain at "homebase" until the soldier returns rather than move elsewhere. This not only helps cut family travel PCS cost but also gives the soldier more time for personal planning.

The homebase/advanced assignment policy soon will be placed in Army regulations.

Reenlistment Aid Coming

Help for soldiers at re-up time is now on the way in the form of RETAIN. What is RETAIN? RETAIN is a new program using telephones and computers to improve reenlistment processing. Here's how the system works:

- A potential reenlistee tells the career counselor what enlistment option he would like or asks what options are available to him.
- The career counselor dials a special telephone number and transmits the soldier's personnel data along with a code asking for reenlistment opportunities.
- The computer responds with reenlistment options from which the soldier can choose, matching the soldier's desire with the needs of the Army.
- The soldier can then "make a reservation" for an available option which is valid for seven days unless an immediate decision is made.

The total scanning time is about three minutes — the soldier knows what is available to him and has seven days to make his decision.

Project RETAIN has been implemented at several CONUS installations and will be fully implemented by September 1977. Eventually, the system may be used overseas.

RETAIN was tested at Forts Carson, Dix, Knox, and Jackson and these forts will be first to receive RETAIN.

The career counselor's job will be easier, and — most important — the soldier who must make that important decision to reenlist will have better information on which to base that decision.

DA Seeks Soldiers for Warrant Slots

The Army has opened its warrant officer procurement program to Active Army and Reserve Component soldiers qualified for duty as radar technicians.

Troops interested in the warrant appointment in MOS 211A (field artillery technician) must have graduated from the Field Artillery Radar Maintenance Course at Fort Sill.

Soldiers should contact their local personnel office or write to Commander, Reserve Components Personnel and Administration Center, 6300 Page Blvd., St. Louis, MO 63132 for more information. AR 135-100 contains application instructions.

Applicants selected will receive an initial appointment as W01. Reserve Component officers will be called to active duty for three years and may extend beyond their three-year tour obligation or apply for Regular Army warrant appointments after one year of active warrant officer service.

Bootstrap Program May Return

Department of the Army has asked Congress for permission to reinstate the Enlisted Degree Completion Program (Bootstrap) in FY 77. Reinstatement hinges, in part, on the Army's ability to fill positions and determine training requirements when qualified soldiers are not available.

Following are the positions that require soldiers with a degree. These academic disciplines are open to all MOSs at the grade of E9.

Discipline	Degree
English	B/BS
Public Speaking	BA/BS
International Relations	BA/BS
Foreign Affairs	BA/BS
Psychology, Counseling	BA/BS
Political Science	BA/BS
General Social Science	BA/BS

Qualified soldiers who wish to be considered for assignment to one of these positions are encouraged to send transcripts to Commander; USA MILPERCEN; ATTN: DAPC-EPT-S; 2461 Eisenhower Avenue; Alexandria, VA 22331.

Reserve Components Adopt OPMS

The Army National Guard and the Army Reserve have adopted the Active Army's Officer Personnel Management System (OPMS). The Reserve Components are conducting system tests in New Jersey and Pennsylvania. After this initial testing, the Army Reserve plans to expand the effort to Readiness Region VI (Indiana, Kentucky, Michigan, and Ohio). The goal of the system is to insure that Reserve officer career development parallels that of their Active Army counterparts. Because of structural and mission differences, the two Reserve Component OPMS systems will not be identical with each other or with the Active Army system.

With 44 percent of the Army being Reserve Component personnel, Department of Defense requirements for the Reserve Components have reached unprecedented importance, and a reliable, responsive personnel management system is mandatory. Computer technology will assist in identifying and classifying what the Army has available for immediate recall from Reserve officer assets. All career Reserve officers will have a personnel management officer to provide training and development guidelines and to audit Reserve officer's duty performance.

OPMS-USAR objectives will —

- Develop and train officers in the right numbers — with the right skills — to meet mobilization requirements.
- Provide officers a personalized, professional development plan that includes rotation within the Ready Reserve.
- Improve the training, motivation, professional satisfaction, and retention of quality officers in the USAR.

OPMS-USAR will manage each officer as an individual, and consideration will be given to the realities of "citizen-soldier" status. The needs of the Army and the professional development needs of the officer will be the key assignment considerations. Geographic constraints, job and family commitments, community responsibilities, and the amount of time the individual officer can give to military activities will also be carefully considered in managing the career Reserve officer.

Training funds will be used to reach the skill levels officers will need if mobilized. A highly successful program — Counterpart Training — has been developed to train Reserve officers with Active Army units to improve and update required military skills. The Reserve officer will also complete military education requirements to keep pace with technological advances in the military arena.

OPMS-USAR offers several advantages to the career Reserve officer since it will —

- Provide for the first time, centralized officer management for all officers in the USAR not on extended active duty.
- Recognize the importance of the individual non-unit officer as a mobilization asset on an equal basis with the unit officer.
- Provide non-unit Ready Reserve officers the

opportunity for 35 days of structured, professional training annually.

- Assure the optimum use of USAR training funds to directly influence the planned development and maintenance of officer skills.

- Provide a management structure that can adjust resources to changing mobilization requirements.

OPMS-USAR will be implemented over a three-year period with all 74,000 officers coming under the umbrella of centralized management by FY 79.

Both unit and non-unit officers will be managed and will be rotated between unit and non-unit status as required by the professional development plan prepared by the officer's personnel management officer. The approach to professional development will be based primarily on development of a single specialty, with limited training and assignments for alternate or acquired specialities when appropriate. Additional specialities will be validated, based on military-related civilian skills and specialities acquired through unit assignments. Officers will be phased into the system on a geographic basis by readiness regions to insure proper coordination and control.

NCO Nonresident Course

Outstanding senior noncommissioned officers can take a giant leap forward in the NCO Education System by taking the challenging nonresident course of the US Army Sergeants Major Academy, Fort Bliss, TX. The Sergeants Major Academy is accredited by the Southern Association of Colleges. Many colleges recognize up to 18 semester hours of undergraduate credit for completion of the course.

Successful completion of the two-year nonresident course counts equally in competition with senior NCOs who complete the 22-week resident course. The nonresident course emphasizes leadership, human relations, resource management, military organization, and world studies. A significant segment of the course is the requirement for assignments answered on audio tape. Students are required to attend a two-week resident session prior to graduation.

All selections for the nonresident course will be determined by a special panel at Department of the Army. A significant change in the program is that applications will be returned to those not selected with instructions to reapply next year if still interested. This will insure that the selection board has the most current information for each applicant and will reaffirm the applicant's interest.

Active Army personnel may apply by letter through channels to: Commander, MILPERCEN, ATTN: DAPC-EPZ-HA, 2461 Eisenhower Avenue, Alexandria, VA 22331.

Army Reserve personnel should apply on DA Form 145 through channels to Headquarters, Department of the Army, ATTN: DAAR-OT, Washington, DC 20310.

Limited Defense Option



- Is it feasible from a weapons availability standpoint?
- Warsaw Pact response?

by LTC William M. Carrington, USAF, et al.

The detailed discussion of the availability of weapons and delivery systems is classified. Only the conclusions, which are unclassified, are presented here.—Ed.

An analysis of the wide variety of weapons and delivery systems available in Europe and a consideration of the distribution of these systems, along with the high state of nuclear unit training in USAREUR, indicate that the LDO concept can be fully supported with available US weapons systems. The probable availability of additional nuclear delivery units and warheads from other NATO national forces strengthens this conclusion.

If the LDO concept is employed, a sufficient number of weapons and delivery systems would be held in reserve to support follow-on operations and to allow for controlled escalation, if necessary. The great number and variety of weapons and their forward locations (readily accessible to the delivery units) leave little doubt as to the feasibility of the concept.

Probable Warsaw Pact Response

Previous sections of this study on the concept of using low-yield tactical nuclear weapons to halt a Warsaw Pact conventional attack have addressed the objectives of weapon use, political acceptability, collateral damage limitation, and escalation control. The concept is based on three key features:

- The employment is defensive in nature.
- The weapons are limited in yield.
- The Soviets must have a clear understanding of NATO's intent.

The third feature is most important. The Soviets *must* recognize and accept the premise that the weapons to be employed are very low-yield and are to be employed strictly defensively. Otherwise, the Soviet's response could result in nuclear escalation and possible nuclear holocaust for all of Europe, the Soviet Union, and the United States.

There is presently an inconclusive debate among NATO military and political leaders on whether the Soviets view nuclear warfare to be inevitable if armed conflict occurs in Europe. Soviet policy statements and military writings on the use of nuclear weapons show ambiguity, partly as a result of the Soviet's uncertainty over NATO's resort to nuclear weapons in a conventional conflict in Europe. This uncertainty makes conventional conflict in Europe possible, but extremely dangerous for the Soviets.

A study completed in 1975 at the US Army War College, used years of US Department of Defense policy to assert:

Little doubt is expressed by anyone that the Soviets sufficiently believe in NATO's resolve to use nuclear weapons.

However, doubt does exist, at least within the United States government and among our NATO allies.

In a report to Congress in April 1975, then Secretary of Defense Schlesinger emphasized that the US flexible response strategy provides the *option* of using tactical nuclear weapons if conventional NATO forces failed to halt a conventional Warsaw Pact attack in Europe. He also acknowledged a *reluctance* to use nuclear weapons in his last Annual Defense Department Report by stating:

After 30 years of the nuclear era, most nations have developed a deep and understandable reluctance to resort to the use of nuclear weapons. By contrast, the inhibitions against use of traditional force are not nearly so great. However unpredictable the course and outcome of conventional conflicts, we probably understand them better than the risks and consequences of a nuclear campaign. If military force finally seems in order, familiar force is most likely to be used.

This reluctance is stressed in an article by John Marriott, the Deputy Editor of NATO's Fifteen Nations. He concludes a detailed analysis of the development and viability of NATO's nuclear policies with the following doubt of United States' support when the "chips are down":

Can anyone really believe that if Europe was [sic] invaded by the Soviets, America would agree to the use of nuclear weapons with nagging fear that escalation might lead to a nuclear exchange between herself and Russia? Of course she would not. France has realized this and the sooner the rest of NATO Europe does so, the better for all of us.

French lack of faith in the United States' agreeing to employ nuclear weapons to defend Europe caused France to pull out of NATO. This same fear, as well as the fear that a tactical nuclear war would destroy Europe while trying to save it, has caused the West Germans to not only doubt the validity of using tactical nuclear weapons but also refuse to allow deployment of low-yield tactical nuclear weapons on West German soil.

The Soviets are well aware that in the past decade, while they were obtaining strategic nuclear parity and conventional superiority, NATO has been preoccupied with second thoughts about its nuclear weapons policy. Soviet writings have taken advantage of this and attempted to discredit US nuclear weapons policies.

These writings also reflect a possible change in Soviet policy on conventional and nuclear warfare in Europe. In the late 1950s, NATO's massive nuclear retaliation policy and capability forced the Soviets into an acceptance that any conflict in Europe would escalate to tactical and strategic nuclear war. In the early 1970s, the Soviets obtained strategic nuclear parity, causing the US to emphasize a flexible response policy, which employs gradual escalation of tactical weapons as a deterrent. Soviet official military doctrine does not recognize flexible response as a viable policy. In fact, it stresses mass employment and first

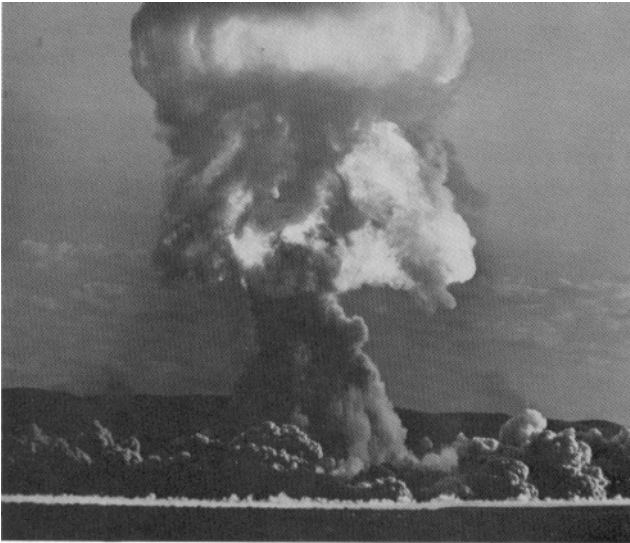

A 500-foot balloon burst from a yield of 9.7 KT.

use of nuclear weapons in any major conflict in Europe. Such a doctrine, if followed exactly, would not only preclude the conventional attack proposed in this study, but also guarantee a Soviet nuclear response to NATO's use of low-yield tactical nuclear weapons.

Recently Soviet military writers have begun to overtly express the belief that their nuclear capability provides sufficient deterrence to make a purely conventional conflict in Europe possible. They also express confidence in their conventional superiority and feel NATO is incapable of counteracting it. Although there are some NATO experts who feel that a Soviet conventional offensive would not be overwhelmingly superior to a NATO defensive, there is almost total agreement that Soviet superiority does exist. The question then is not whether the Soviets could be stopped, but rather how fast they would advance. Recognizing this, the Soviets must assume that, at some point in the conflict, NATO would resort to tactical nuclear weapons to halt the Warsaw Pact advance. Therefore, it might be realistic for the Soviets to assume that a conventional conflict in Europe is possible, but only if the objectives of their aggression are limited.

The lack of solidarity within NATO over the employment of tactical nuclear weapons has led a few to conclude that there would be a costly delay in using these weapons against a Warsaw Pact conventional force. Use would be delayed until it was obvious that NATO's conventional forces could not stop the Warsaw Pact advance and nuclear release was agreed to by the NATO allies or decided upon by the US unilaterally. Such a delay would allow the Soviets to make sizeable territorial gains. It is conceivable that the West Germans would allow the *deployment* of low-yield tactical nuclear weapons in their country, but that does not solve the lack of solidarity within NATO over *employment* of these weapons. This problem will remain until mutual

agreement on flexible response is obtained among all NATO partners. Therefore, it is probable that the Soviets foresee little chance of NATO employing these low-yield defensive tactical nuclear weapons until considerable debate within NATO has determined that there is no acceptable alternative.

Earlier in this study it was analyzed and concluded that the problems of deploying and employing low-yield tactical nuclear weapons could be overcome so that their use would be a viable addition to NATO's flexible response concept. However, the study assumes that the Warsaw Pact has attacked conventionally. This implies that the Soviets, recognizing NATO's reluctance to use tactical nuclear weapons, have called NATO's bluff. The Soviets would view NATO's official policy as credible only after receiving an actual threat of nuclear weapon use.

Before analyzing Soviet response to such a threat, a key question must be addressed. Would the Soviets view NATO's use of low-yield tactical nuclear weapons as a defensive act? History and the special awe over nuclear weapons argue against it.

The Soviets have traditionally been suspicious of other nations, and detente has not dispelled their inherent distrust of NATO. Although NATO's policies have stressed a defensive force for deterrence, the Soviets view it as an offensive force, particularly the tactical nuclear weapons. In fact, the Soviets have belittled NATO proposals to use tactical nuclear weapons, claiming their use in a European conflict would escalate hostilities to general nuclear war. This is a "worst case" analysis by the Soviets and probably reflects their inability to retaliate with equivalent low-yield tactical weapons.

Soviet perception of defensive intent by NATO will depend on the status of battle at the time. Although each side will have different perspectives on the status of the conflict, it should be obvious to both whether the Warsaw Pact forces are advancing rapidly over NATO territory, lending credence to a NATO claim of defensive intent. If the battle status is not so evident or if NATO attempts to regain some of its lost territory, the Soviets must assume offensive intent. This would certainly impact unfavorably on the Soviet decision to negotiate or escalate. This dependence on the battle situation to measure defensive intent argues strongly against the use of low-yield tactical nuclear weapons early in the conflict.

In response to NATO's threat to use low-yield tactical nuclear weapons to halt the Warsaw Pact advance, the Soviets would have three basic alternatives:

- Initiate a preemptive nuclear strike.
- Continue the conventional attack until struck and then retaliate with nuclear weapons.
- Stop the aggression and negotiate.

The first two options are the most dangerous because they both would seriously escalate nuclear warfare.

A preemptive strategic nuclear strike on Europe and the United States would be the most drastic response. Stated Soviet policy does not rule out strategic nuclear warfare. With the strategic parity that exists between the US and the Soviet Union, each has the capability to inflict unacceptable levels of damage on the other. However, neither has a disarming first-strike capability against the other, but the surviving forces on each side would initiate second and third strikes. The resulting destruction from these strikes could be devastating. Although a strategic nuclear war could be the end result of successive nuclear escalations between the US and the Soviets, it is certainly not a reasonable Soviet response to NATO's first use of low-yield tactical nuclear weapons.

A tactical nuclear attack in West Germany would be a less drastic preemptive option. Such an attack could be extensive or just a "shot across the bow." Either action would demonstrate to NATO that the Soviets were prepared to employ the full might of their nuclear power to attain their objectives. An extensive attack would be most credible because Soviet doctrine and Warsaw Pact training emphasize theater-wide nuclear strikes against NATO. This type of strike would effectively use the element of surprise to devastate a portion of NATO's war-making capability. Taking such an escalatory step as a preemptive tactical nuclear attack would argue for the extensive attack option in order to maximize the impact on NATO.

Lack of impact on NATO's military capability would make it unlikely that the Soviets would opt for the preemptive "shot across the bow." Although such a limited attack might serve to blackmail NATO into capitulation, this is extremely doubtful. More than likely it would increase NATO's resolve by making it clear that nuclear war was inevitable and cause NATO to retaliate with an extensive tactical nuclear attack at a much higher level than threatened, resulting in extensive damage to Warsaw Pact forces.

Both types of preemptive tactical nuclear strikes have overriding disadvantages. These attacks would create desperation within NATO and eliminate any hesitation to retaliate. The resulting tactical nuclear exchanges would create enough destruction in Europe to eliminate the usefulness of newly acquired NATO territory by the Soviets. In addition, these exchanges would probably insure escalation to the strategic level with England, France, and the United States. The inherent risks in this option are very high. Since the Soviets had already considered and rejected this option before attacking conventionally, it is not likely that they would consider it viable the second time unless they were sure that NATO was going to employ its low-yield weapons as part of an offensive counterattack.

A second alternative for the Soviets would be to continue their aggression until NATO used its nuclear weapons and then retaliate with nuclear weapons of their own. This scheme would be based on the hope that further

NATO procrastination would allow the Soviets to obtain more territory and possibly fully achieve limited objectives. Such an option is risky in that it trades the acquisition of additional territory against possible significant loss of Warsaw Pact forces to NATO's nuclear weapons.

Any tactical nuclear retaliation by the Soviets would be a form of escalation because they do not possess low-yield tactical nuclear weapons. The available nuclear warheads for the US weapons range from sub-kiloton to the 100 kiloton range, while Soviet warheads range from 5 to 100 kilotons for the Scud missile and into the megaton range for the Scaleboard. The Soviet nuclear forces are more suited for blanket fires or strikes against large airfields and logistic installations rather than discriminate targeting to limit collateral damage. Consequently, Soviet retaliation with tactical nuclear weapons could cause escalation to massive nuclear destruction of Europe, the United States, and the Soviet Union.

Fearing this escalation, the Soviets could negotiate, but this would be difficult for them. They would be backing down, while NATO's credibility and resolve to use nuclear weapons would be dramatically increased. The Soviets would be negotiating from weakness, but this weakened negotiating position would be much less risky and costly than tactical nuclear retaliation.

The Soviets' third alternative would be to stop their aggression and negotiate before NATO employed their low-yield tactical nuclear weapons. This option would restrain NATO from initiating nuclear use and prevent possible nuclear devastation on both sides. It would also allow the Soviets to keep the territory they had gained and negotiate from a position of strength. It would prevent major casualties to Warsaw Pact forces and allow them to regroup into tactical nuclear configurations, if either the preemption or retaliation option became a viable alternative.

This course of action has some disadvantages also. Warsaw Pact force momentum would be lost, giving NATO a chance to augment and regroup its forces for conventional or tactical nuclear defense or counterattack. The objectives of the Warsaw Pact aggression might then no longer be attainable by conventional forces.

The advantages override the disadvantages for this option because the threat of immediate nuclear confrontation and possible disaster to both sides is reduced. Soviet fear of possible escalation and the dire consequences of a nuclear war make this option reasonable and desirable from a rational point of view.

Summary

The Soviets recognize that their conventional superiority could eventually force NATO to resort to low-yield tactical nuclear weapons to halt a Warsaw Pact conventional attack. They also recognize that tactical nuclear warfare, if

not strictly limited, could destroy Europe, decimate Warsaw Pact forces, and possibly escalate to general nuclear warfare, with massive destruction in both countries.

Lack of low-yield tactical nuclear weapons would force the Soviets to negotiate or escalate in response to actual or threatened use of these weapons by NATO. Their only logical response would be to negotiate when first officially threatened by NATO. This would prevent escalation to nuclear warfare and allow the Soviets to negotiate from strength. Responding to NATO's threat with preemptive nuclear strikes or to NATO's use with retaliatory strikes would rapidly escalate the conflict to general nuclear war and would be totally unacceptable. Regardless of Soviet military policy, tactics, and training, rational Soviet leaders would avoid risking nuclear war, because their slightest miscalculation of the policies and resolve of NATO leaders could result in a catastrophe for the Soviet Union.

Therefore, it can be concluded that NATO's actual or threatened use of low-yield tactical nuclear weapons in a defensive role could successfully influence Soviet leaders to halt a Warsaw Pact conventional attack and negotiate. Such a concept provides a lower risk — less escalatory tactical nuclear option — and should be included in NATO's deterrence and flexible response strategies.

Conclusions

This analysis began with the identification of four primary objectives which might be gained from the implementation of the limited defense option:

- To demonstrate NATO resolve.
- To deny the enemy the goal of his aggression.
- To limit collateral damage.
- To gain time for political consultations.

A fifth objective which results from simply adopting the concept was also examined. This broad objective, to increase deterrence, was found to be very important.

Political acceptability was measured by addressing three questions:

- Would the governments of the United States and the Federal Republic of Germany (FRG) agree to deploy tactical nuclear weapons in the manner outlined in the limited defense concept?

- What would be the political effect of this deployment?

- What political purposes would be served, if deterrence failed and these weapons were used?

These questions were examined in detail with the following conclusions:

- The US and the FRG *would* agree to the deployment of low-yield defensive weapons.

- The political effect of this deployment would be to promote deterrence.

- The primary political purpose of actually employing these weapons would be to stop the enemy's aggression.

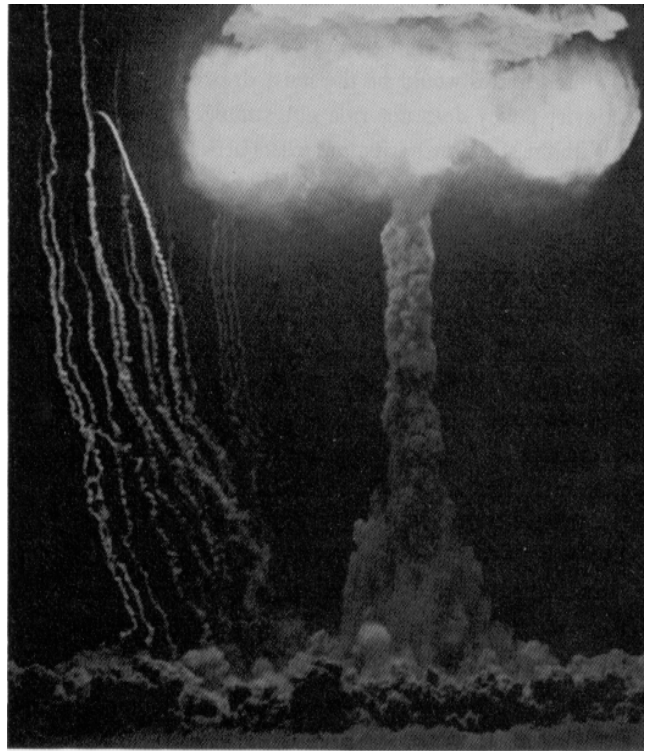

A 1300-foot air burst from a yield of 60 KT.

Collateral damage limitation was defined as the ability to eliminate an enemy target without causing extensive damage to militarily unimportant property or inflicting massive civilian casualties. Collateral damage impacts in some way on all the other criteria used in the analysis — in fact, it is the overriding consideration in judging any concept for the employment of tactical nuclear weapons. Political acceptability, particularly to the European NATO countries, centers on collateral damage limitation. Escalation control is enhanced by weapons which are damage-limiting, and such weapons provide for a more predictable enemy response.

Political evaluation and judgment were assumed to be the key to escalation control. Two basic sets of subcriteria were developed for political leaders to use in measuring the escalatory features of the concept. Physical factors included geography, yield control, and target selection. Clarity of intent, conceivability of limited nuclear war, and linkage to strategic nuclear war were considered psychological factors. The concept was tested against each of these factors with the following results:

- Geography — nonescalatory.
- Yield control — no effect.
- Target selection — escalatory.
- Clarity of intent — nonescalatory.
- Conceivability of limited nuclear war — escalatory.
- Linkage to strategic nuclear war — no effect.

A wide variety of weapons and delivery systems available in the central European theater, their distribution, and state of nuclear training were analyzed. Study results

showed that there are sufficient weapons in forward locations, readily accessible to delivery units to support the concept.

There is a great deal of ambiguity in Soviet policy statements and military writings concerning the use of nuclear weapons. This causes confusion and uncertainty in any attempt to predict a Warsaw Pact response to the employment of a NATO nuclear option. Three basic alternatives are available to the aggressor within the parameters of the analysis:

- Initiate a preemptive nuclear strike.
- Continue the conventional attack until struck and then retaliate with nuclear weapons.
- Stop the aggression and negotiate.

Each of these alternatives were examined in detail, and it appears that the most likely Warsaw Pact reaction would be to halt their aggression and negotiate.

The conclusions resulting from the analysis of each criterion considered are as follows:

- The concept is politically acceptable.

Members of Study Group 4, Class 58, Armed Forces Staff College, are: LTC William M. Carrington, USAF; LCDR Harold W. Gehman Jr., USN; MAJ Ralph W. Holm, USAF; MAJ Patrick L. O'Donovan, CF; LCDR Robert D. Stiger Jr., USN; MAJ Patrick E. Walker, USA; MAJ Dale O. Wiener, USAF; and, MAJ Thomas W. Young, USAF.

- The concept does minimize collateral damage.
- The concept is escalatory in that it would probably lead to a limited nuclear war in Europe, but it would not result in general nuclear war.
- The concept is feasible from the standpoint of weapon and delivery means availability.
- Threatened or actual use of this concept could influence Warsaw Pact leaders to halt a conventional attack and negotiate.

The individual conclusions indicate that this limited defensive concept is viable and realistic and it should be formally adopted as one of NATO's flexible response options. ☒

This concludes the three part series discussing the issue of using low-yield tactical nuclear weapons in a defensive effort to limit Soviet conventional attack. The ideas expressed reflect the collective opinion of the authors and do not necessarily reflect official US policy. —Ed.

Field Artillery Brigade *(Continued from page 43.)*

gap between div arty and Reserve Component FA Brigades because of equipment disparity and increased div arty

processing capabilities. This issue will grow in criticality during the next several years as some of our Active Army divisions receive their initial TACFIRE equipment and training. Increased liaison support may provide a temporary solution; however, in the long run the FA Brigades and nondivisional cannon units must be equipped with TACFIRE or a compatible system.

The FA Brigade represents a significant improvement in the way we fight. It gives the corps commander more combat command and fire control capability with little increase in personnel. It gives the div arty commander greater flexibility. It gives divisional and corps artillerymen a greater common purpose and increased common skill. It is a light, mobile, effective, and survivable tactical organization. In a series of exercises with the 1st Cavalry Division, the 82d Airborne Division, the 6th Cavalry Brigade (air combat), and the 3d Armored Cavalry Regiment, the 75th FA Group has attempted to integrate the FA Brigade concepts and capabilities discussed in this article. Sound doctrine and TOE changes are emerging to provide viable corps field artillery fire support on the modern battlefield. For the 75th FA Group, the development of this capability is the most important thing we are doing and can do to win the first battle. ☒

COL Edward R. Coleman is Commander of the 75th Field Artillery Group, Fort Sill.

Operations/Fire Control (FM 6-13F)
Transmit conduct-of-fire information.
Establish/maintain communication with supported element and fire support agencies.
Prepare/maintain fire support situation map and status chart.
Select registration/reference points.
Plan fires to support an offense and a defense.
Request and adjust fire as an aerial observer.
Consolidate/process target lists.
Advise supported unit of friendly and enemy fire capabilities.
Coordinate and monitor requests for close air support and naval gunfire.
Record and disseminate coordinating measures.
Monitor supported unit operation plans.
Monitor FA plans and operations.
Coordinate fire support for maneuver unit.
Target Processing (FM 6-17)
Disseminate intelligence information.
Prepare/maintain target indicators map and overlay.
Locate defilade and observable areas from visibility diagrams.
Prepare/maintain order-of-battle overlay.
Maintain target card file.
Evaluate targeting information.
Request information from targeting agencies and record resulting input.
Conduct briefings on enemy situation.

Figure 6. FA Brigade TOC individual training tests.



C Battery, 94th Field Artillery, at the 14.5 trainer range in Berlin.

Outpost of Democracy

by Robert Thomson

(Photos by SGT Gail E. Thueson.)

When you wake up in the morning, this is the first question you must ask yourself: "Am I prepared to go to war today against the Russians and East Germans?" You do not have any more time to train or to prepare your equipment. You cannot make a final telephone call or write one more letter. You are more than 100 miles behind enemy lines, surrounded and outnumbered 50:1 in artillery pieces. You are a member of C Battery, 94th Field Artillery, Berlin Brigade. Your mission is to provide artillery support to the American, British and French forces that defend the outpost of democracy.

C Battery, 94th FA, is a unique separate battery, but it is no more unique than the city in which it is stationed. Berlin's history dates from 1307, when the villages of Berlin and Koeln merged. Berlin's recent history began in 1871, as it became the German Empire capital. The city was an established trading center and rivaled Paris and London as a European cultural mecca. By 1933, the year of the Nazi ascent to power in Germany, Berlin was the second largest city in Europe. Twelve years later Berlin was a bombed, burned hulk.

After Germany's unconditional surrender on 8 May 1945, Berlin was divided into four sectors, one sector under each of the major Allied powers — the United States, Great

Britain, France and the Soviet Union. By 1948 the status of Berlin had become a major cold war issue. The Western powers insisted that the settlement of the Berlin question was directly tied to the reunification of Germany. The Soviets were relentless in their efforts to remove all Western influence from Berlin. They established a 16-month blockade of all land and water routes between West Germany and West Berlin in 1948. Because of the now famous Berlin airlift, the attempt to force the Western powers to surrender the town was unsuccessful.

A period of strained quiet followed. The West Berlin standard of living continued to improve at a more rapid pace than that in the communist-controlled part of town. To escape the oppression of East Berlin, thousands of Germans sought jobs and homes in West Berlin. This caused a serious drain on the skilled labor force of East Berlin and was a constant source of embarrassment to the communists. In the pre-dawn hours of 13 August 1961, thousands of workers and soldiers labored to erect the most famous of Berlin's landmarks — the 29-mile long Berlin Wall. The exodus to West Berlin and freedom was now stopped and, more than ever before in the preceding 16 years, West Berlin was the outpost of freedom.

Political tensions in Berlin today are more relaxed than they have been in many years, but Britain, France and the United States still station approximately one brigade each in West Berlin. C Battery, 94th FA, takes its place among these elite forces as the only artillery unit on the Allied side of the wall. As the only field artillery in Berlin, the battery's mission is complex. It encompasses direct support of the American brigade, a requirement to answer calls for fire from the British and French brigades and artillery

support of major American honors ceremonies. The unit is equipped with six M109A1 howitzers to accomplish the first two missions and five 75-mm pack howitzers to accomplish the latter.

The uniqueness of C Battery's MTOE is not apparent in its firing battery organization since it has howitzer, ammunition and FDC sections common to all M109A1 units. However, instead of FO sections, C Battery has three liaison sections, each with a lieutenant, an E6 and an E4. The sections train with infantry battalions in the American brigade. The all-important FOs are from the infantry battalions and are assigned to the 4.2-inch mortar platoon.

C Battery's maintenance and communications sections are approximately twice the size of comparable sections in other M109A1 batteries. The lack of normal battalion-level maintenance and communications capabilities makes the size necessary. The battery is attached to an infantry battalion for routine garrison activities, but the battalion lacks the expertise to deal with artillery equipment. Consequently, the men in the maintenance and communications sections of the battery are some of the most highly qualified in the Army. Problems in automotive and electronic maintenance that cannot be handled at the battery level are sent to the direct support maintenance unit of the Berlin Brigade. Most maintenance work short of depot level can be accomplished there. It is with this unit that C Battery keeps two of its major assets — a seventh M109A1 and M548. At all times these "floats" are kept ready to replace any howitzer or ammunition carrier in the battery.

The battery's supply and mess sections and headquarters are similar to those of other M109A1 units. C Battery

Fourth of July parade, 1976.





Loading to go to Grafenwoehr.

personnel receive no special training prior to coming to Berlin, but, once in the battery, each is expected to be the best.

It is significant that there are no special-weapons-trained men assigned to C Battery. This, of course, is no accident, for C Battery is probably the only M109A1 unit in Europe that does not have a nuclear mission.

In a city of more than two million people in a mere 184 square miles, it would be easy to assume that the unit trains very little in artillery skills. This is not true. Not only is Berlin richly endowed with forested areas for maneuver purposes, but the West German government has given the US Army special funds to build and maintain training areas within the city. With these funds, the unit has established an excellent 14.5-mm trainer range only a few hundred meters from the wall. (Caution: Rounds going out of the impact area could trigger an international incident!) Additionally, there are two modern small arms ranges where members of the battery frequently fire the .45 pistol, M16 rifle, shotgun and M60 machinegun. Several times each year, Allied soldiers meet at these ranges to compare weapons and marksmanship skills.

C Battery does much more than shoot small arms with its British and French compatriots. At least once each year the entire battery participates in a full-scale field training exercise (FTX) conducted by the other Allied nations. These exercises, which usually last three days, give all parties ample opportunity to coordinate operations. Fire support coordination is provided on the basis of one liaison team to each Allied battalion. The C Battery commander acts as the brigade fire support officer during the FTX, just as he does during FTXs with the American brigade. A better understanding of Allied operations and a renewed spirit of teamwork and cooperation in the defense of Berlin

result from these exercises with British and French forces.

Physical training is an integral part of every soldier's day in C Battery. Each morning begins with exercises, followed by a long run. During every athletic season, C Battery fields a team that competes for brigade championships. Excellent facilities are available for swimming (two indoor Olympic pools), tennis (eight indoor courts), basketball (five indoor courts), bowling (more than 30 lanes), weightlifting, handball, boxing and all outdoor sports. Additionally, a majority of the men participate in mountaineering and alpine ski training in the German Alps.

The variety and intensity of the battery's training is facilitated by a master training program from the Berlin Brigade. It calls for training in three 6-week blocks: One block is to improve individual and section skills; the next is for unit-level tasks; and, the last is to perform guard duty, brigade details and limited unit training.

During the first block, soldiers are encouraged to attend college courses, foreign language classes, vocational or technical programs and MOS improvement courses — all conducted during the normal duty day. The second block is the heart of the program. It allows the battery to conduct meaningful training with minimum interference. During two of the three unit training blocks in a 12-month period, the men of C Battery put their tracks on flatbed railroad cars and leave Berlin to do what Redlegs do best — send steel downrange. Each trip to Grafenwoehr, Wildflecken or other major US Army Europe training areas lasts three to four weeks and culminates in a unit evaluation. The Redlegs of C Battery have consistently demonstrated that they are worthy of their distinct position in the defense of Europe and Berlin by scoring exceptionally high in their tests.

Returning to Berlin could mean perfecting the motions of the salute battery, which must be prepared at a moment's notice to render honors to a visiting dignitary or spit-shine a howitzer for display at a German-American activity. Even though the hours worked are long and demanding, most members of C Battery agree that the off-duty activities make Berlin a desirable place to be stationed.

The pride of each unit member is remarkable — every man knows that he is a representative of a unique battery that has a tradition of excellence. This pride is apparent in each Redleg's voice as he salutes an officer with the 94th Artillery's motto, "Flexible, sir." And flexible he must be while stationed in Berlin. Dealing with East and West Germans, Russians, French, British and, of course, other Americans requires a unique, flexible approach. Each day this task falls upon the men of C Battery, 94th Field Artillery — the unique Redlegs doing their part to defend the free world's outpost of democracy. ☒

CPT Robert Thomson, former commander of C Battery, 94th Field Artillery, became a civilian 1 January 1977.

Notes from the School

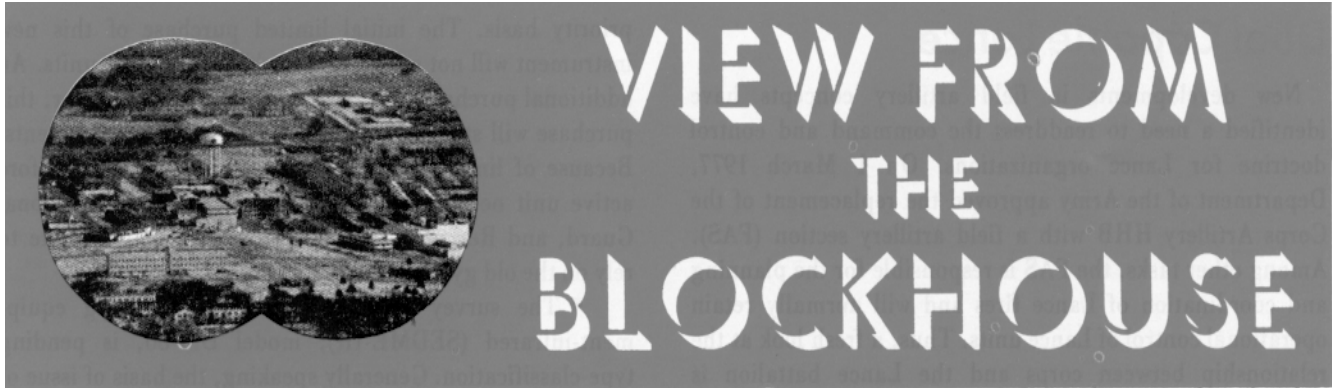

Improved Maintenance Program for M109

For many years the operator and organizational preventive maintenance checks and services have been recognized as the foundation of a unit preventive maintenance (PM) program. However, in actual practice, a wide gap existed between the commander's recognition and the soldier's implementation. Listed among the major causes for this gap were:

- Functions are hard to understand.
- PM checks and services are time-consuming.
- Unnecessary checks and services are prescribed.

Last year commanders of some Materiel Development and Readiness Command (DARCOM) activities were tasked to develop procedures for reducing resource expenditures in the performance of scheduled maintenance services. A plan was formulated for a reduced maintenance test using an M109 howitzer battalion from III Corps Artillery at Fort Sill. The basic concept reduced the operator/crew checks and performance of organizational services and lubrications.

Operator/crew maintenance actions	Old system	Revised
Before operation	85	22
During operation	17	4
After operation	33	13
Weekly	0	8
Monthly	0	13
Total	135	60

Organizational Maintenance actions	Old system	Revised
Monthly	6	0
Quarterly	63	2
750 mi/75 hr/annually	0	36
Total	69	38

On 21 March 1976, the test started with two firing batteries maintaining their weapons using the revised PM

checks and services with the remaining battery operating under the prescribed checks listed in current technical manuals. The test was scheduled to run a minimum of six months, with each weapon operating for 750 miles, 75 hours, or one year — whichever came first.

During the test, information was collected concerning the costs of parts and supplies, labor expended, and availability of equipment. Firing battery personnel were receptive to the more realistic set of checks and services. The consensus of opinion from those involved in the test and the test data confirmed that the revised procedures should be adopted. Savings in time, materiel, and money will be made without adversely affecting maintenance.

The final result of the test will be a revision of the present "-10" and "-20" manuals to reflect these new procedures. Similar reductions in scheduled maintenance for other vehicles and equipment will be made.

Operations/Intelligence Training Available

During the summer of 1977, two operations/intelligence courses will be available for supervisors (advanced course) and soldiers (basic course) working or training in those type sections in Field Artillery, Infantry, Armor or Air Defense branches. This course fills a void in the NCO/soldier training program and is designed to be administered in the unit by the man's supervisor.

The modular design of the course allows the student to study training management, intelligence and security, administration, and operations in any order desired. The student will be required to perform tasks normally associated with his job and will use the regulations, references, and local SOPs which apply. Step-by-step guides and job aids will be a part of the course and can be retained for use in actual operations/intelligence duties. A common scenario which places the lessons in the context of possible actual situations will make the training more realistic.

Details concerning course content and enrollment methods will be provided when available. Operations officers and S3s might also benefit from this course.

View From The Blockhouse

Dual Capable Lance

New developments in field artillery concepts have identified a need to readdress the command and control doctrine for Lance organizations. On 1 March 1977, Department of the Army approved the replacement of the Corps Artillery HHB with a field artillery section (FAS). Among other tasks, the FAS is responsible for the planning and coordination of Lance fires and will normally retain operational control of Lance units. Thus, a fresh look at the relationship between corps and the Lance battalion is required. This is especially important when considering the various ways the Lance battalion may be employed: As a separate battalion operating directly under the corps FAS or as a part of a field artillery brigade/group. Procurement of nonnuclear Lance for US Forces is currently undergoing review at the highest levels of government. Although the final outcome is far from certain, it is equally important to address appropriate command and control doctrine in either a nuclear or nonnuclear role. At first glance, it appears that the inherent problems are the same for either use. Detailed analysis reveals that command and control problems are more involved for nonnuclear Lance since its greater potential is for tactical use. This new look is described in a concept paper entitled *Dual Capable Lance* which has been forwarded to all division artillery and field artillery brigade/group commanders, corps FASs, and selected senior officers Army-wide. These new concepts will be incorporated in the upcoming revision of FM 6-42, *FA Battalion, Lance*. The coordinating draft of this new unclassified manual is to be distributed on or about 1 August 1977.

Availability of Survey Material

In response to the numerous inquiries received from readers assigned to National Guard and Reserve units, about the packets of instructional materials; computation forms for use with the Texas Instrument SR-56 calculator; and lesson plans mentioned in "What's Happening In Survey," *Field Artillery Journal*, January-February 1977, the following information is provided:

- Hand-held calculators (Texas Instrument SR-56) have been purchased by DA and the basis of issue is two calculators to each field artillery survey party in the Active Army. This calculator is a component of surveying set, artillery fire control, 4th order, and is listed in SC 6675-97-CL-E29, June 1976. A total of 15 survey computation forms for use with the SR-56 have been developed and tested and are pending submission to the Adjutant General for DA form identification numbers, printing, and inclusion in the normal publications supply channels.

- The surveying instrument, azimuth gyro, lightweight, is being issued to Active Army units on a unit priority basis.

The initial limited purchase of this new instrument will not satisfy the needs of the active units. An additional purchase has been contracted for; however, this purchase will still fall far short of satisfying requirements. Because of limited funds, it may be several years before active unit needs are met. Many Active Army, National Guard, and Reserve field artillery units must continue to rely on the old gyro system — the ABLE orientor.

- The survey electronic distance-measuring equipment-infrared (SEDME-IR), model DM-60, is pending type-classification. Generally speaking, the basis of issue of the DM-60 will be one instrument per Active Army fifth-order survey party. An additional purchase of the DM-60 will be required to fill Active Army needs. We have no knowledge of plans to supply National Guard and Reserve units with this device at this time.

- Reference notes have been prepared and published by USAFAS concerning the operation of the lightweight azimuth gyro and the SEDME-IR. Lesson plans have been prepared on the use and application of the hand-held calculator SR-56 in solving survey problems, using flow-type forms. The initial distribution of the packets of instructional material, lesson plans, and samples of the new survey forms for the SR-56 calculator was limited to Active Army units.

Based on phone calls to the Survey Division, Counterfire Department, USAFAS, many National Guard units are planning to make local purchase of the SR-56 to satisfy their computational needs. Units desiring sample copies of the new forms developed for use with the SR-56 and a lesson plan for their use, or units desiring copies of the reference notes mentioned above, should contact the Survey Division, Counterfire Department, USAFAS, Fort Sill, OK 73503 (AUTOVON 639-6616/2805).

What Happened To The FA Mechanic

What caused the recent shortage of Field Artillery mechanics? This is a recurring question and a very real problem in many units.

In September 1976, The Field Artillery mechanic MOS of 13B30 was changed to 13B10U6. This change also included a new title, the Field Artillery weapons mechanic. While this appears to be a purely administrative shuffle to improve MOS identification, the final result was devastating.

The change from the FA mechanic MOS to the FA weapons mechanic MOS caused an improper course/MOS identification which resulted in a student input of only 30 at Fort Sill for FY77 in lieu of an expected 300. This problem has been identified and corrected, and USAFAS is scheduled to train 325 FA weapons mechanics between now

and the end of the current fiscal year. Scheduled input for FY78 now stands at 630.

Reduced student input, however, is not the most serious problem. Many mechanics may have failed to get the additional skill identifier (ASI) when their MOS was changed from 13B30 to 13B10U6. This means that many FA weapons mechanics could have been reassigned as a 13B10 or 13B20. Therefore, all commanders and personnel managers should screen personnel records and ask their cannoners if they have attended the Field Artillery Mechanic or Field Artillery Weapons Mechanic Course and, if they have, insure that those personnel are awarded the ASI of U6.

Thank You!

In October 1976, the Field Artillery School sent a request to the field asking for a one-time submission of questionnaires in the Soldier's Manuals and ARTEPs. The response from the field was great.

The Directorate of Evaluation received 363 completed questionnaires on the Soldier's Manuals (SMs) and/or the accompanying Commander's Manual. The field support was gratifying and the comments were extremely pertinent. Some of the most frequently mentioned items were the need for more diagrams, illustrations, and pictures; more maintenance tasks for equipment, communications, and vehicles; improved indexes; and the readjustment of skill levels for particular tasks. Many comments implied that soldiers were confusing the SM with the SQT or did not understand the relationship between the two. Many other comments were MOS-related. Comments have been consolidated and distributed to the appropriate directorates for action.

There were 328 ARTEP questionnaires received, and the field universally agreed that the ARTEP is extremely useful as a training tool and a tremendous improvement over the ATT. Units use the ARTEP for evaluation of units/sections, planning of training, and projection of resources. A very large number of the responders stated that a shortcoming of the ARTEP is the lack of detailed information on how to use the document, particularly for the NCO section chief who must integrate this document with the SMs and all other applicable training references and literature. Numerous useful comments were received on adjustments to tasks, conditions, and standards to include some suggestions on additions and deletions of entire tasks. A very significant revelation to the School was the inadequacy of the questionnaire itself, which we are modifying. The responses were candid, useful, and much appreciated by the Field Artillery School.

Field comments **are** being heard by the Field Artillery School!

Firefinder Fielding

The Department of the Army has announced that 32 tactical counterbattery radars have been authorized for production to expedite fielding of this critically needed system.

The Hughes Aircraft Company was awarded a \$27 million contract to produce 10 radars to be delivered beginning in July 1978. The remaining 22 radar systems will be procured at a later date. Units in the field will begin receiving the radar system in early 1980.

New Training For FOs

Air Force jets roaring over the West Range signal a new twist in training for the basic officer student at Fort Sill. In order to better cope with the problems of the modern battlefield, students of the Field Artillery Cannon Basic Officer Course are now being taught emergency airstrike procedures, under the direction of Air Force officers and Tactics/Combined Arms Department instructors.

As a result of an agreement with the US Air Force, doctrine now calls for the fire support team (FIST) chief (formally the forward observer) to direct close air support (CAS) strikes under certain circumstances. This will normally be the case in a "high air defense threat" area. In such a situation, airborne forward air controllers (FAC) operating near the FEBA would be too vulnerable. This means that responsibility for directing CAS strikes is left to ground personnel — ground FACs, if they are available; but, more probably, the FIST chief.

The Air Force technique calls for the attacking aircraft to fly from an initial point to a pull-up point (PUP) at very low altitude. At the PUP, the aircraft pops up, identifies the target, and rolls in. The FIST chief must maintain radio contact with the aircraft, ascertain its position, mark the target with artillery white phosphorous, and direct the aircraft to the target in relation to the smoke.

Twice each month, Air Force pilots from southwest United States fly over Fort Sill to deliver practice ordnance under the direction of a second lieutenant. Selected students are scheduled to begin directing live ordnance strikes. Active, Reserve, and Air National Guard pilots from Oklahoma, Texas, Arkansas, Kansas, and Louisiana take part. All who have participated — Army and Air Force, students and instructors — agree that the training is most beneficial and that it adds a new positive dimension to the concept of combined arms training.

Chapter Eight (conclusion)

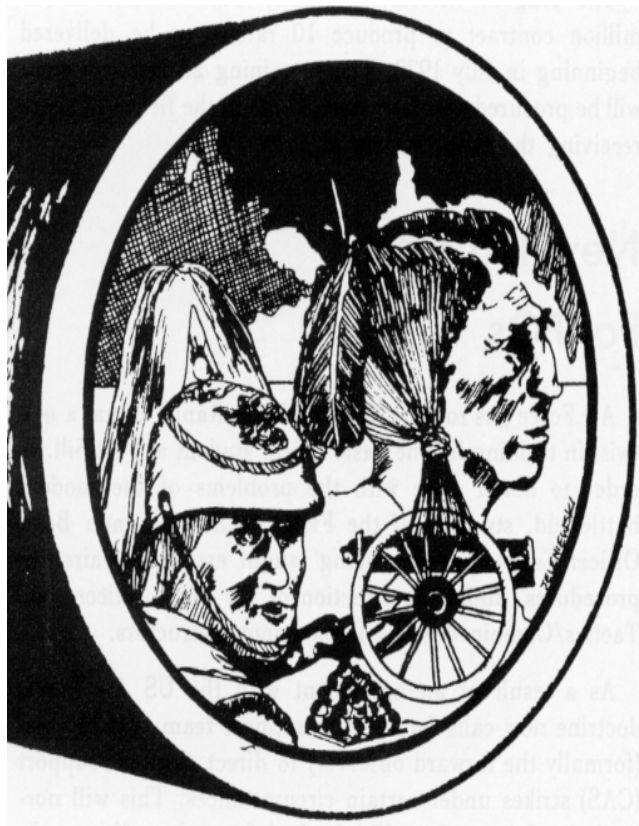

Winning The West

by COL (Ret) Robert M. Stegmaier

In the northern plains, trouble came to Minnesota in 1862. The halting of widespread Indian war depended on Fort Ridgely. Its armament consisted of one 6-pounder, two 12-pound mountain howitzers, and several 24-pounders, with ample ammunition and equipment. Little Crow's Sioux had driven the infantry back to the Fort, but the Sioux were halted by a 12-pounder which raked the flank of the Indian attack. As warriors gathered elsewhere, the gunners aimed and fired. A barn filled with Indians was set afire. Canister scoured the ravines, and a 24-pounder bursting shell landed in the main Indian camp.

Despite their dread of artillery, the Indians drove the infantry back upon the barricaded guns. A 12-pounder, fired point blank into the onrushing ranks, stopped the drive and blasted stables, sheds, and other buildings. Then a 24-pounder loaded with canister fired alongside the 12-pounder. On the final Indian assault, both cannon rapid-fired. The Indians halted. The 24-pounder loaded with shell struck behind the advance Indian line. Lieutenant Gore described how ". . . ponderous reverberations of the big gun echoed up the valley as though 20 guns had opened, and the frightful explosion struck terror to the savages." With that mighty blast, Fort Ridgely was saved. Big Eagle, a Sioux chief, later explained: "But for the cannon, I think we would have taken the fort."

In 1863, Fort McPherson was established at Cottonwood Canyon, 100 miles west of Fort Kearny. Two fieldpieces were brought from Fort Kearny and set up on the parade ground. Captain O'Brien, an artilleryman in command, required every soldier to become proficient in crew drill. In December, Indians infiltrating on an island facing the fort were forced to flee when a cannon was fired.

In 1864, General Sully came upon a hostile Sioux camp at Killdeer Mountain. The Indians, outnumbering the soldiers, eagerly awaited the battle. The native women and children scattered on the hills to watch the massacre. Using artillery, Sully drove the Indians out of fixed positions. The squaws hurried into the village to take down lodges. One participant wrote: "Their haste to escape was expedited by shells dropped into the village, which caused great consternation."

In 1865, Captain O'Brien and Lieutenant Ware with 12 troopers and one howitzer approached Fort Sedgwick in Colorado to find it under Indian attack. About one mile away from the fort, they ran into strong opposition; they halted and relied upon howitzer fire to apprise the fort of their position and the enemy of their determination. The garrison dispatched a howitzer to their assistance and the siege was broken.

With the Civil War almost over, the bulk of the Second Missouri Light Artillery, the Twelfth Missouri Cavalry (Cole's command), and the Sixteenth Kansas Cavalry (Walker's command) were threatened by cannon and forced to retreat on a 1,100-mile march. Cole had a section of 3-inch rifled guns. Both Cole's and Walker's units became

lost on the prairies. The men were hungry, and horses died by the hundreds. Indians threatened attack, but cannon kept them away. Cole, hearing that Walker was surrounded only three miles away, hastened to his rescue with one battalion of infantry and a section of artillery. Cannon again saved the day when Sioux and Cheyenne were about to outflank the Sixteenth Kansas Cavalry. The units soon thereafter linked up with General Conner and the supply wagons. George Bird Grinnell in *The Fighting Cheyennes* recounts: "It is altogether possible that Cole and Walker would have been wiped out were it not for his [Walker's] artillery. The big guns . . . frightened the Indians, and it was usually practicable to disperse any gathering by firing the cannon at them."

On the Tongue River, General Conner drove the Arapahoes 10 miles from their village. In a counterattack, the Arapahoes forced the soldiers to take refuge in the Arapaho village under protection of two howitzers. The big "talking" guns filled the air with whistling metal, stopping the Arapahoes.



In 1865, the Sioux, aided by the Cheyennes, agreed to clear all outsiders from the Platte River valley. To accomplish this, they attempted to seize the bridge crossing the Platte. The bridge was guarded by 119 men with one 12-pound howitzer in a strongly constructed fort. Infantry and howitzer fire prevented the bridge take-over. A supply train approached, and CPT Henry C. Bretney ordered 20 to 25 men under LT Caspar Collins to its aid. The Indians inundated Collins' command and overran the supply train. Captain Bretney refused to weaken the fort's strength further. Twenty-eight soldiers and civilians were killed, while the Indian loss was 68. When military reinforcements arrived, the Indians departed. Artillery and infantry had combined to save the bridge, the capture of which would have halted travel on the Oregon Trail.

In 1867, at Fort C. F. Smith, 19 defenders of a hay camp beat off four attacks although outnumbered 20 to 1. A relief force reinforced with a howitzer hastened the withdrawal of the Indians.

At Fort Buford, there was an Indian scare in December 1867. Indians approached within 500 yards and killed a civilian. Colonel Rankin reported: "A few shots from my

12-pounders soon drove them skulking away to the cover of the gullies, willows, and woods." On 1 January, when the Sioux appeared in force, a single shot from the big guns scattered the attackers. No more serious threats endangered the fort, but no mail was received until the end of March.

About 15 miles from Fort Berthold, Dakota Territory, Colonel deTrobian's camp of 250 men was attacked. "The band of warriors began to caracole at a distance of 2,000 meters and to make all sorts of gesticulations in sign of triumph. A small cannon was trained on the principal group. A shell flew whistling to burst in their midst . . . It needed no more to put to flight the 600 warriors, and the entire band, at a gallop, quickly disappeared at full speed, hastening to cross the river 20 to 30 miles below. Since then, nothing more has been heard from them, and not a hostile Indian has shown himself above the horizon . . ."

Against the Modocs on the Pacific Coast in 1872, the Army had mountain howitzers, but the crews were inexperienced. In the first day of battle on the Lava Beds, the Army lost 16 killed and 53 wounded to the Indians' none. Coehorn mortars were brought in with artillery crews. The Modocs had been promised immunity against Army bullets

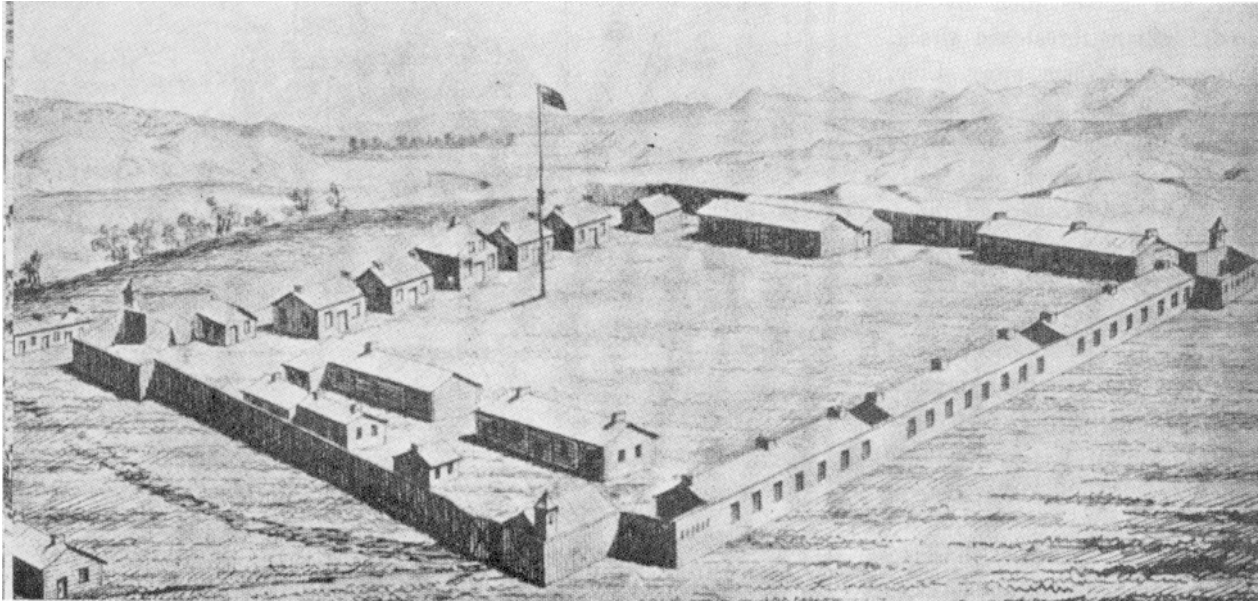

Fort C. F. Smith's adobe ruins could be seen almost to the turn of the century. Mounds still remain and match this sketch almost perfectly. Officers' quarters were the five buildings next to the flagpole; barracks were the three long buildings in foreground. Fort was 300 feet square. (Courtesy Antional Archives.)

by their medicine man. One of the mortar shells fell, seemingly a dud. A Modoc tried to pull out the fuze with his teeth; there was no immunity. The Modocs fought stubbornly thereafter but their confidence was shaken.

At Fort Kearny, the Sioux attempted once again to repeat their Fetterman massacre. Thirty-two men under command of Captain Powell took refuge behind upturned wagons. Unknown to the Indians, this group was armed with repeating rifles. An attack on horseback was driven back, and an attack as infiltrating infantry was thwarted although some bodies were found within five feet of the barricade. A relief party with a howitzer in tow hastened from the fort. Seeing this piece of ordnance, the Indians dashed for the hills.

In 1874, when Custer went into the Black Hills country of Montana, he took along Gatling guns and other artillery. Two years later, going into the Little Bighorn country, Custer refused a Gatling gun platoon. Artillery was rarely used against the Sioux and northern Cheyennes. Crook believed that artillery was of no use against Indians. MacKenzie destroyed the northern Cheyenne camp (1876) without the aid of artillery. Of all the generals operating in the north, Miles was the only one who appreciated artillery.

In October 1876, after Custer's defeat, Miles ran into Sitting Bull's main army. The Americans were outnumbered 3 to 1. The troops formed into a hollow square and artillery opened fire. As Fairfax Downey states: "Shells, ever dreaded by the redskins, broke them and cavalry drove them for 40 miles."

Miles followed Crazy Horse's trail in January 1877 with 436 men of the 5th and 22d Infantries and a wagon train, including wagons carrying special cargo. On 8

January at Wolf Mountain, the two forces met. Again the Sioux, superior in numbers, held the heights. A frontal attack was necessary. Defeat would have meant annihilation of the soldiers. In the midst of preparations, the canvas was stripped off the two special wagons; inside were two fieldguns — one Napoleon and one Rodman. Fire from the fieldpieces demoralized the Sioux, and only the fierce fighting spirit of Crazy Horse rallied them. Artillery and rifle fire swept the bluffs. The Indians fought valiantly, but the death of Chief Big Crow, who commanded the defense, caused them to give way and eventually go to a reservation.

The Sioux never learned how to fight artillery. Even at Wounded Knee, with Hotchkiss guns dominating the scene, they attacked the infantry instead of the guns.

The Indian tribe that mastered fighting against artillery was the Nez Perces under Chief Joseph. In July 1877, Howard's force, reinforced with a howitzer and two Gatling guns, encountered this tribe on the Clearwater River. Chief Joseph's men charged the artillery, overran it, and departed the battlefield with the guns. On the following day, LT C. F. Humphrey with 11 men rushed the Indian lines and recaptured the guns. Howitzer and rifle fire forced the Nez Perces to retreat.

On 8 August, COL John Gibbon with 200 men and one howitzer attacked a surprised Nez Perces camp. He captured the village only to be driven back by intense hostile fire. Without water, the troops were in desperate shape. The howitzer was dragged up within one-half mile of the fight. Seeing the howitzer, Chief Joseph ordered 30 of his followers to charge. Two of the gunners ran; others



Chief Joseph of the Nez Percés, one of the ablest generals the North American Indians produced. After his surrender, General Miles, his antagonist, constantly befriended him out of admiration and personal liking. (From a photograph by Delancey Gill, courtesy Smithsonian Institute.)

defended their position in the best field artillery tradition. Two shots were fired, but the Indians overran the position. The wounded crew temporarily put the gun out of action by shoving the barrel off the trunnion. The Indians hid the wheels. Chief Joseph's orders to capture the artillery were paying off. General Miles later picked up Chief Joseph's trail at Snake Creek. Miles had his breech-loading Hotchkiss gun and a Napoleon gun. After his cavalry met strong resistance, Miles settled back for a siege. "Excepting the fieldpiece that occasionally mouthed a shell into that seemingly deserted hollow," recalled Scout "Yellowstone" Kelly, "the battle had degenerated between sharpshooters on either side." At this time the guns were too well-guarded and the troops too numerous for a direct Indian assault. Tactics which had won victory for the Nez Percés on previous battlefields were no longer practicable. Miserable with cold, pessimistic with the arrival of more troops, and downcast with warrior deaths, Chief Joseph uttered those prophetic words: "I will fight no more forever."

With the aid of artillery, the Indian threat to the settlement of the northern plains had been met and overcome.



Writing this series of articles on the proud history of the Artillery has been a distinct joy. I strongly encourage young authors to consider delving further into the Branch history and share their findings with others.

*Robert M. Stegmaier
Colonel, Retired*

Commanders Update

COL G. Monteith
United States Army Field Artillery
Training Center
Fort Sill
COL R. E. Leard
1st Cavalry Division Artillery
COL G. L. Turner
2d Armored Division Artillery
LTC W. F. Kelly
4th Battalion, 4th Field Artillery
LTC J. C. Lucas
2d Battalion, 5th Field Artillery
LTC R. C. Stovall
2d Battalion, 6th Field Artillery
LTC D. D. Clark
6th Battalion, 9th Field Artillery
LTC E. D. Maddox
1st Battalion, 13th Field Artillery
LTC R. B. Hoogstraten
3d Battalion, 19th Field Artillery

LTC W. L. Heiberg
2d Battalion, 28th Field Artillery
LTC J. B. Fairchild
1st Battalion, 31st Field Artillery
LTC W. W. Robocker
2d Battalion, 33d Field Artillery
LTC H. Guenther
6th Battalion, 33d Field Artillery
LTC A. Bartholomew
3d Battalion, 34th Field Artillery
LTC J. M. Bowers
1st Battalion, 38th Field Artillery
LTC R. Rosenkranz
1st Battalion, 76th Field Artillery
LTC H. J. Gibbs
1st Battalion, 77th Field Artillery
LTC W. M. Breit
3d Battalion, 81st Field Artillery

LTC M. E. McAleer
1st Battalion, 84th Field Artillery
LTC J. R. Hubbard
1st Battalion, 319th Field Artillery
LTC F. N. Halley
2d Battalion, 321st Field Artillery
LTC R. A. Brown
1st Battalion, 333d Field Artillery
LTC D. M. Evans
557th Group
LTC J. T. Glenn
2d Training Battalion
Fort Sill
LTC R. S. Rudesill
3d Training Battalion
Fort Sill
LTC H. P. Van Gorder
2d Battalion, 3d Training Brigade
Fort Leonard Wood