

THE FIELD ARTILLERYMAN (NAAPTB)

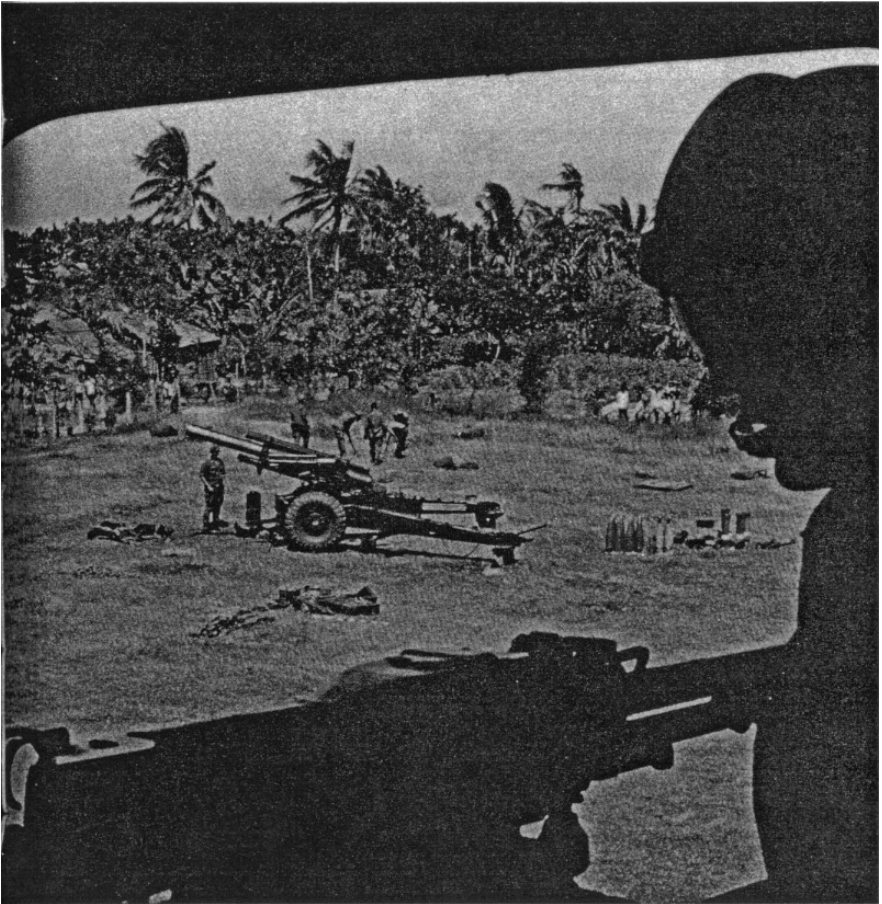

U. S. ARMY FIELD ARTILLERY SCHOOL
Fort Sill, Oklahoma

INTRODUCTION

THE FIELD ARTILLERYMAN (NAAPTB)

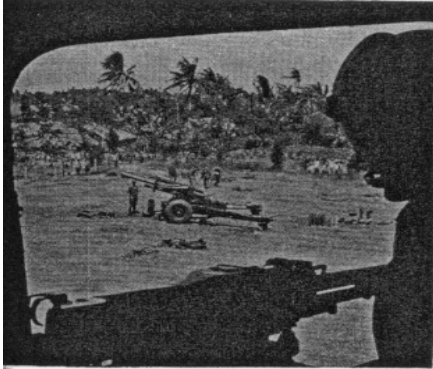

U. S. ARMY FIELD ARTILLERY SCHOOL
Fort Sill, Oklahoma
NOVEMBER 1969

Mobility has always been of paramount importance to the field artillery in its mission of timely and accurate fire for the ground-gaining arms. But in the conduct of stability operations in developing countries, mobility assumes an even greater significance. Frequent displacement in a 6,400-mil environment compounded by variable terrain taxes the field artillery's mission effectiveness.

To assure the ground-gaining arms of necessary fire support, the field artillery has become increasingly reliant on the aviation team, and the helicopter has become virtually essential as a prime mover. In a continuing effort to keep readers informed of the latest helilift techniques, **THE FIELD ARTILLERYMAN**

features "Tips for the Airmobile Field Artillery." The article contains the latest information concerning airmobile rigging, safety and ground crew procedures. To supplement this information, the 101st Airborne Division presents its guidelines of air movement courtesy in a feature titled "Helicopter Etiquette."

Also in this issue, the Gunnery Department discusses two new procedures in the adjustment of field artillery fires in articles titled "Adjustment Procedure For Area Time Mission" and "Radar Registrations." In both articles, sample missions are conducted to exemplify the new technique.

Other articles cover the spectrum of field artillery subjects, including field expedients, safety procedures, the status of TACFIRE, and many other items designed to assist the field artilleryman in expanding his professional knowledge.

All readers of **THE FIELD ARTILLERYMAN** are invited to submit articles for publication, comment on previously published articles, or offer suggestions for the improvement of this instructional aid's content and format. Correspondence should be addressed to:

Commandant
US Army Field Artillery School
ATTN: AKPSIAS-PL-FM
Fort Sill, Oklahoma 73503

INSIDE THIS ISSUE

INSTRUCTIONAL AID NUMBER 44

INTRODUCTION	1
INSTRUCTIONAL DEPARTMENT NOTES	5
NOTES FROM THE US ARMY FIELD ARTILLERY BOARD	14
CARRER MEMO	17
ARTICLES	
Tips for the Airmobile Field Artillery	19
Helicopter Etiquette	30
Adjustment Procedure for Area Time Mission	34
Radar Registrations	43
Canopy Clearance	52
Extracting/Ramming Tool	54
Are Your Ammunition Procedures Dangerous	57
Common Mistakes With FADAC	63
Here Comes TACFIRE	67
Australian Army Field Artillery	69
Improvised Heliotrope for Survey Signal	73
Friend or Foe	76
Enlisted Evaluation System.	83
SOUTHEAST ASIA LESSONS LEARNED	87



THE FIELD ARTILLERYMAN is an instructional aid of the United States Army Field Artillery School published only when sufficient material of an instructional nature can be gathered.

THE FIELD ARTILLERYMAN

As an instructional aid of the United States Army Field Artillery School, **THE FIELD ARTILLERYMAN** is published only when sufficient material of an instructional nature can be accumulated. It is designed to keep field artillerymen informed of the latest tactical and technical developments in the field artillery.

In accordance with AR 310-1, distribution of **THE FIELD ARTILLERYMAN** will not be made outside the command jurisdiction of the School except for distribution on a gratuitous basis to Army National Guard and USAR schools, Reserve Component staff training and ROTC programs, and as requested by other service schools, ZI armies, U. S. Army Air Defense Command, active army units, major oversea commands, and military assistance advisory groups and missions.

Paid subscriptions to **THE FIELD ARTILLERYMAN** on a personal basis may be obtained by qualified individuals by writing to The Book Store, U. S. Army Field Artillery School, Fort Sill, Oklahoma 73503.

Primarily, articles are prepared by individuals assigned to departments of the School or to artillery units and agencies outside the School. All articles, no matter what the source, are coordinated by appropriate departments in the School and with the U.S. Army Combat Developments Command Field Artillery Agency and the U. S. Army Artillery Board collocated with the School at Fort Sill, Oklahoma. This coordination is effected in an effort to arrive at a "Field Artillery Community" position before publishing the information. The Field Artillery Community is Fort Sill's term for the center team concept of Continental Army Command, Army Materiel Command, and the Combat Developments Command.

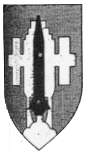

U. S. Army Field Artillery School



Commandant	Major General Charles P. Brown
Assistant Commandant	Brigadier General Lawrence H. Caruthers, Jr.
Deputy Assistant Commandant	Colonel R. H. Deason
Secretary	Colonel Sheldon H. Wheeler
Director of Instruction	Colonel T. F. Perpich
Director of Logistics	Colonel Bernard S. Kern
Office of Doctrine Development, Literature and Plans	Colonel Claude C. Stewart
Artillery Transport Department	Colonel W. W. Sifford
Communication/Electronics Department	Colonel H. G. Gordon
Guided Missile Department	Colonel Ralph I. Williams

Gunnery Department Colonel A. C. Anderson
 Nonresident Instruction Department Colonel Jesse B. Hollis, Jr.
 Tactics/Combined Arms Department Colonel O. L. Tobiason
 Target Acquisition Department Colonel Harry R. Jackson
 USAFAS Brigade Colonel L. C. Downs
 Officer Candidate Brigade Colonel T. E. Watson



U. S. Army field Artillery Center



Commanding General Major General Charles P. Brown
 Chief of Staff Colonel Ross N. Lillard, Jr.

III Corps Artillery

Commanding Officer. Colonel William H. Hamilton

U. S. Army Training Center, Field Artillery

Commanding Officer. Colonel Thomas G. Ferguson

U. S. Army Field Artillery Aviation Command

Commanding Officer. Colonel F. C. Goodwin



U. S. Army Field Artillery Board



President Colonel Paul S. Cullen



**U. S. Army Combat Developments
 Command Field Artillery Agency**



Commanding Officer. Colonel Frank A. Sandholm

INSTRUCTIONAL DEPARTMENT NOTES



GUNNERY DEPARTMENT

PLOTTING PINS FOR THE FIRE DIRECTION CENTER

Correspondence from units in Southeast Asia and comments of returnees from that area indicate considerable difficulty in obtaining plotting pins (maptacks) for use in the Fire Direction Center (FDC).

Supply Catalogue 1290-95-CL-E01, Fire Direction Sets, Artillery FSN 1290-299-6891, 1290-299-6893, 1290-299-6892, July 1965, authorizes glass maptacks (FSN 7510-634-3256), metal maptacks (FSN 7510-205-1566) and plastic, $\frac{3}{8}$ -inch long maptacks (FSN 7510-272-3087 (blue), 7510-272-3091 (green), 7510-272-3096 (red) and 7510-272-3099 (white)). These are being deleted and all three types are being replaced by maptacks, spherical $\frac{1}{4}$ -inch head, 1 $\frac{1}{8}$ -inch long, FSN 7510-272-5450 (black), 7510-274-5451 (blue), 7510-274-5452 (green) and 7510-274-5453 (red), 100 to a box.

When the maptacks originally issued as component parts of the FDC set are exhausted, replacement by tactical units should be made by requisition or purchase in a self-service store. The 1 $\frac{1}{8}$ -inch long maptack is in the category of expendable office supplies and is obtained in the same manner as are paper clips, pencils, etc.

The maptacks are listed in Federal Supply Schedule, FSC Group 75, Part 1, Section A, Office Supplies, Index Numbers 213, 214, 215, and 216. The price (\$1.30 per box of 100) is in Amendment No. 1 to the Federal Supply Schedule and the source of supply (Woodhouse Stationery Co., Inc., 2235 18th St., N.E., Washington, D. C. 20018) in Amendment No. 2.

Those agencies and installations authorized to purchase items from the Federal Supply Schedule may order maptacks from the Woodhouse Stationery Co. There is an ample supply of maptacks and Woodhouse is prepared to fill orders within three working days of the receipt of order. If requisitions submitted by tactical units are not filled within 30 days, copies of the requisitions may be sent to GSA, Region 9, ATTN: Order Processing and Control Division, 49 Fourth St., San Francisco 94103.

USING FADAC TO COMPUTE DATA FOR THE M485 ILLUMINATING SHELL

The M18 gun direction computer (FADAC) is capable of computing excellent data for the M109 or the M114A1 155-mm howitzers firing the M485 illuminating shell even though it has not been specifically programmed to do so. This illuminating shell performs ballistically the same as the M107 HE shell until it ejects the illumination parachute. The computer can therefore determine data to a burst point at the optimum height above target. The FADAC operator simply enters projectile flag 1 and fuze flag 7 and inserts an observer correction of UP 750 meters. After FADAC has determined the gun data, a fuze setting correction of minus (-) 2.3 seconds is applied to the displayed fuze setting. These data are fired. This technique will be published in FM 6-3-1 in the near future.

SPEED SHIFTING THE 155-MM HOWITZER M114A1

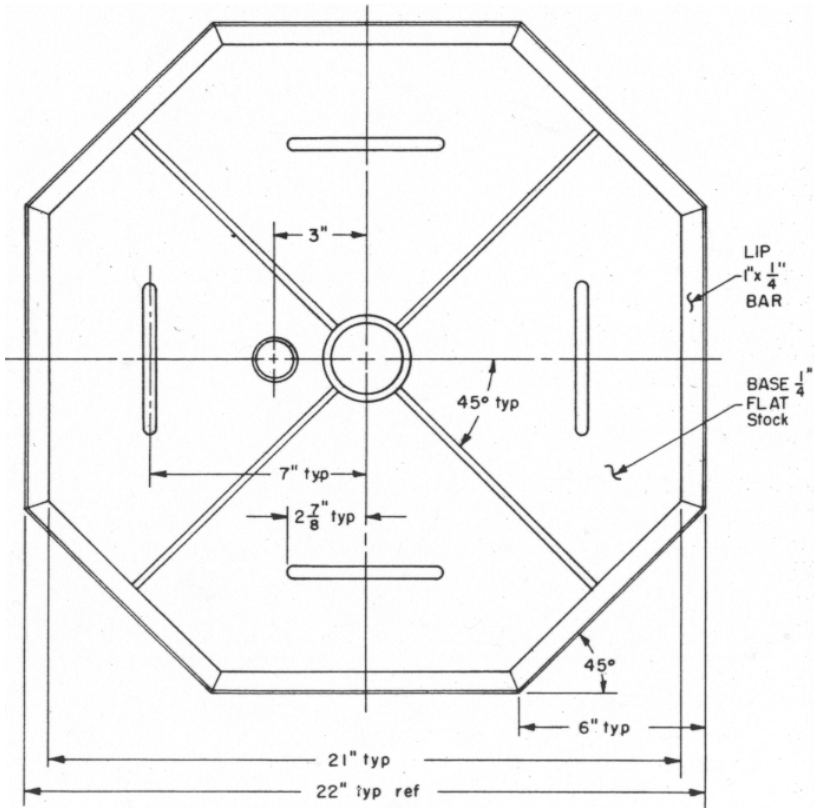

Figure 1. Top view of base assembly.

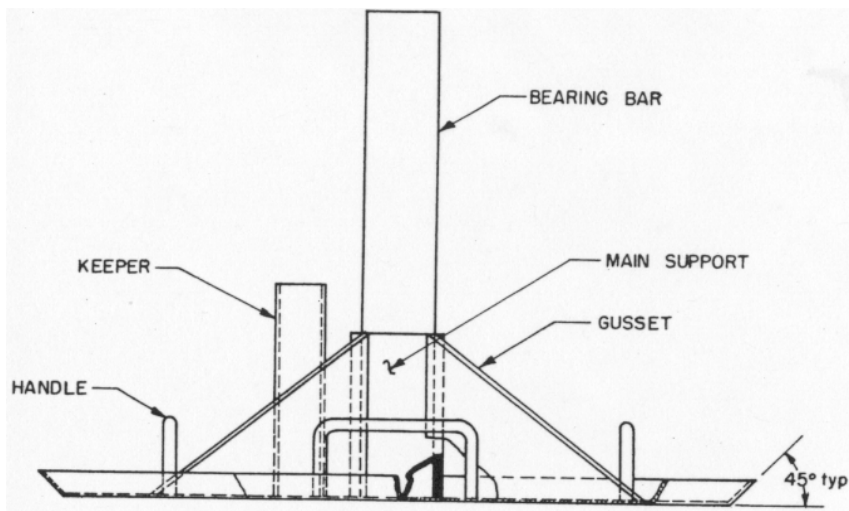

Figure 2. Side view of base assembly.

A rapid, 6,400-mil traverse capability is a continuing requirement in towed artillery units. This capability is especially difficult to achieve with the towed 155-mm howitzers M114A1, particularly when the howitzers are emplaced in mud or other soft soil.

The field artillery community has fabricated several different types of speed shift devices—from simple pedestals to modified hydraulic jacks mounted on base plates—in an effort to arrive at a simple, inexpensive, and effective solution. Most of these devices offer only marginal improvement in the traverse capability of the M114A1; even so, some have meant the difference between making a large, though difficult, shift and no shift at all.

Consideration is being given to the development of a device that will incorporate the best features of several of the locally fabricated devices; however, because of the time required for research, development, testing, and procurement, such a device will not be available to units in the near future. It is suggested that, in the meantime, units equipped with the M114A1 consider the standard adjustable height pedestal shown in figures 1 through 4. Direct support maintenance units have the capability for fabricating these pedestals.

*A related article titled "Speed Shifting the 155-mm Howitzer, Towed" appeared in the January 1967 ARTILLERY TRENDS.

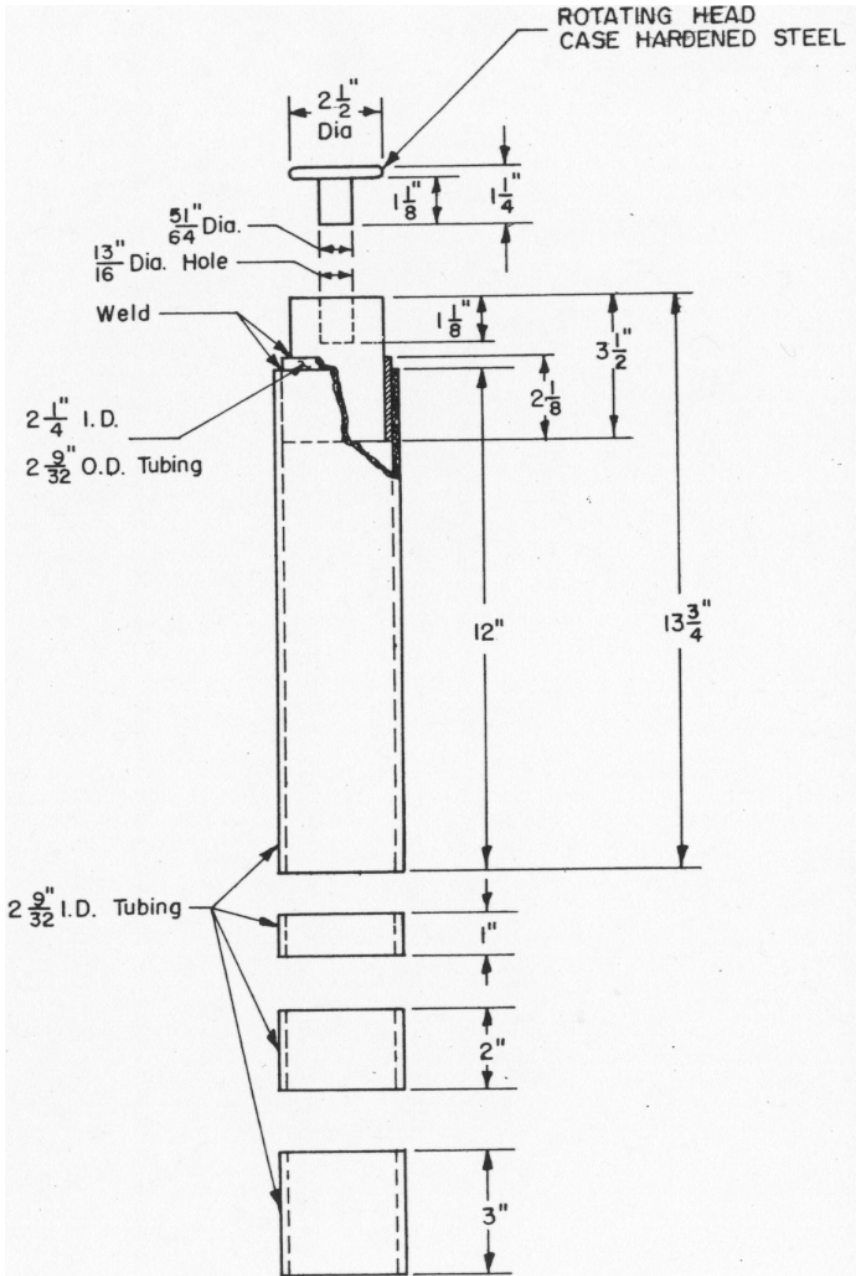

Figure 3. Bearing shaft assembly.

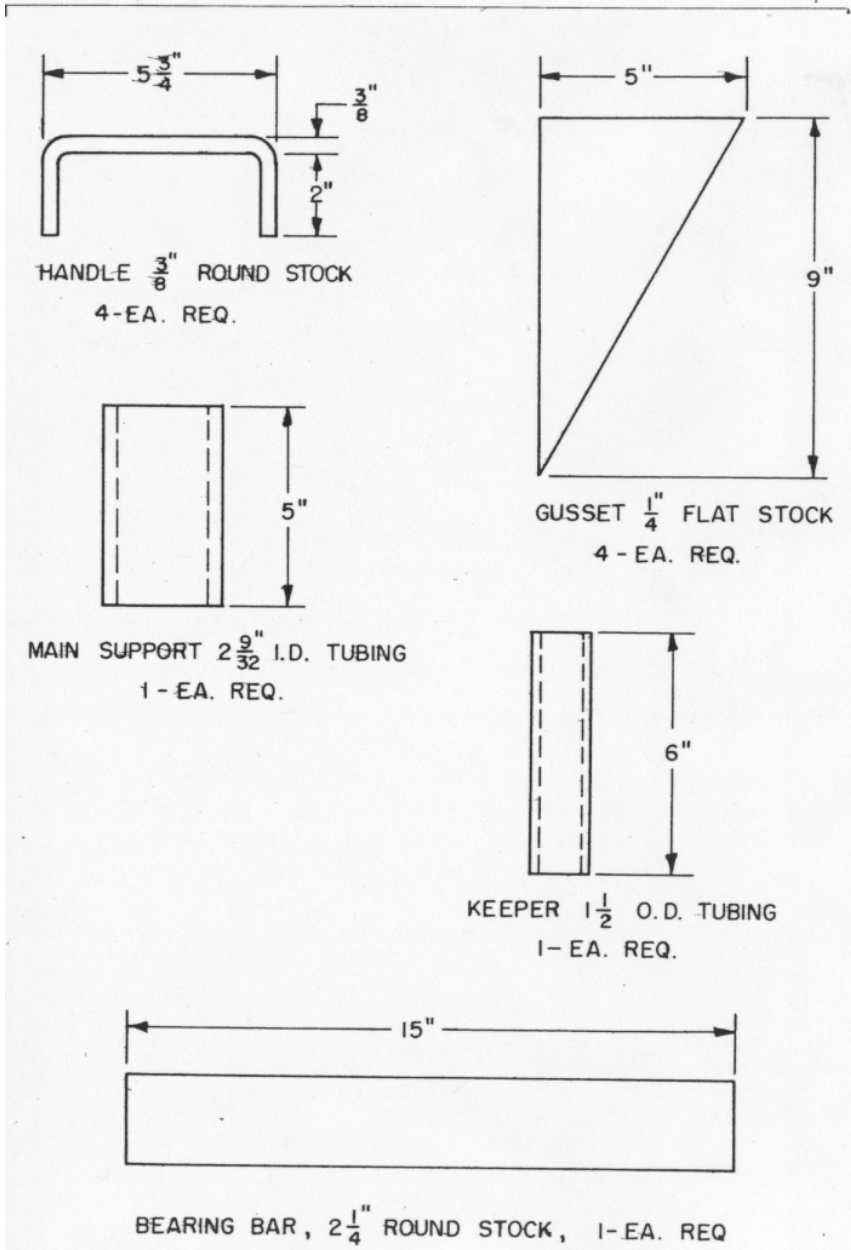

Figure 4. Parts detail.

GFT CARE AND MAINTENANCE

The graphical firing table (GFT) is a scale which is constructed to withstand heat, moisture, and just about any climatic condition in which field artillery units can be expected to operate. A reasonable amount of preventive maintenance and, when necessary, minor repair will provide a smoothly functioning piece of equipment.

The GFT must meet rigid military specifications which are designed to insure satisfactory operation. The GFT base is made from waterproof masonite. The scales are printed on the highest quality paper and are glued to the base with waterproof glue. The GFT is then placed in a high-pressure vise until the glue dries. After the edges of the GFT have been sanded to get rid of excess paper, two coats of a lacquerlike substance are sprayed on the GFT to provide a hard, clear finish. The spray which was especially developed for this use, has two necessary qualities—it is waterproof, and it does not cause the print on the paper to bleed. The cursor is made of frosted cellulose acetate which was carefully selected to provide the proper combination of transparency and opaqueness to permit reading the scales under the cursor and still permit writing on the cursor with a pencil. The top of the cursor contains a stainless steel spring which applies pressure on the rule, and the bottom of the cursor contains a nail which rides in a groove cut into the edge of the GFT. Stops ($\frac{1}{4}$ -inch brass escutcheon pins) are imbedded in each end of the GFT to keep the cursor from sliding off the end.

Unless it is abused, the GFT should provide satisfactory service until the scales become so worn that they are unreadable. The GFT, however, like any piece of equipment, does need some minimal care. The following are steps which should be taken to insure proper functioning of the GFT.

1. As required, remove surface dirt by lightly rubbing the GFT with a mild solution of soap and water; then wipe it dry.
2. If the cursor becomes so worn (and glossy) that it will no longer take a pencil line, rub the cursor lightly with very fine sandpaper or crocus cloth.
3. Periodically lubricate the GFT edges with a light coat of soap, paste wax, candle wax, or graphite. A number 1 pencil is an excellent source of graphite.
4. When the GFT is not in use, store it in a container, such as a footlocker or fuze box. Place a desiccant (drying agent) in the box with the GFT. Desiccants which absorb moisture are shipped with many items of equipment, and some types are reusable after being dried out.

Sometimes even the above precautions are not enough. If the GFT still does not operate satisfactorily, after the above measures have been

taken, the problem is usually that of a binding cursor. This can usually be determined and corrected as follows:

1. Take out one of the brass escutcheon pins and slide the cursor off the base.
2. Check to see that the bottom of the cursor from which a nail is protruding was riding in the groove on the bottom of the GFT.
3. If the nail was not on the edge with the groove, turn the cursor upside down and replace the nail. If the cursor now slides properly, tap the brass pin back in place.
4. If the fault is not in the placement of the cursor, then the edges of the GFT must be sanded until the cursor will operate smoothly. The best method to do this is to place a full sheet of sandpaper or crocus cloth on a smooth, level surface and rub the edges of the GFT on the sheet. This will prevent a wavy edge.
5. Lubricate the edges of the GFT and replace the cursor and pins.

The only other problem which can cause the GFT to malfunction is that of the cursors being too loose. In this case, remove the cursor and place it on its edge on a level, hard surface. Put a metal or hardwood block on top of the cursor and tap the block sharply with a hammer or similar tool. Repeat this operation as necessary until the cursor fits the GFT correctly.

If the above precautions are taken, the GFT should provide satisfactory service for a long time. Abuse of the GFT, like that of any other item of equipment, will cause it to become unserviceable.

STATUS OF GFTs

Low-angle, slant scale graphical firing scales (GFT) are presently available for high explosive munitions for the M101A1, M102/M108, M107, M109, and M110 cannons. They may be requisitioned by appropriate Federal stock number (FSN), using a table of organization and equipment line item number (TOE LIN) as authorization. Requisitions should be submitted on a MILSTRIP card, DA Form 2765-1 (1 May 67). Accurate and rapid processing of the requisition and delivery of the munitions can be assured by observing the following instructions in preparing the DA Form 2765-1:

1. Enter AOE in the DOC IDENT space. This indicates that the requisition is to be processed manually. Circle the AOE in red to draw attention to it.
2. Enter the numeral 2 in space 65 and the letter B in space 66 of the ADVICE block. This code prohibits substitutions. Circle the 2 and the B in red.
3. Print or type NO SUBSTITUTIONS in the ITEM DESCRIPTION block. This draws attention to the 2 and B in spaces 65 and 66.

Production has started on the last high explosive GFT, the 155-Q-4 for the M114A1 which consists of two rules. Requisitions should be submitted in October 1969, by FSN 1220-133-6219.

The slant scale GFT 804HESM424 (FSN 1220-937-8284, TOE LIN S45487) for the 8-inch howitzer, M424 projectile, two rules, should be available in January 1970.

The GFT 155AH21LLM485 (FSN 1220-442-2444) for the 155-mm howitzer M109, M485 illumination projectile, two rules, should be available around December 1969. These rules replace GFT FSN 1220-764-5420 (M118 illumination). Master drawings for the M485 illumination GFT for the M114A1 howitzer are currently under construction. These rules should be available during January 1970.

The U.S. Army Field Artillery School often receives complaints that requisitions for GFT's are not being filled. When sufficient information is available, the School investigates the circumstances through USAMC channels. Investigation often reveals that the GFT's are not yet available, as is the case with the 155-Q-4 for the M114A1, or that there was not, in fact, a properly forwarded requisition. If a unit requisition for GFT's has not been filled within 45 days, the unit should check through its channels to insure that the requisition has not been pigeonholed somewhere. If the requisition was properly forwarded, inquiries should be made through channels to:

Commanding General
US Army Weapons Command
ATTN: MASWE-SMD-FC
Rock Island, Illinois 61201

GUIDED MISSILE DEPARTMENT

IMPROVEMENT OF PERSHING ONE CREATES PERSHING ONE ALFA

The Pershing One ALFA (P1a) embodies the concept of improvement rather than total replacement of an existing system. The advantages of this concept are twofold—it precludes complete replacement of old equipment with new and saves many man-hours that would otherwise be needed for training and operation. Personnel can be retrained for P1a in short transition courses and still retain their original MOS because of their previous experience; if necessary, they can be unit-trained on the new system while continuing to operate the retained equipment. The concept of improvement, retention, and reengineering has worked extremely well. The original Pershing equipment, mounted on M474 tracked vehicles, consisted of the erector-launcher (EL), the programmer-test station, the power station, the AN/TRC-80, and auxiliary ground support equipment, such as the 45- and 10- generators. An advanced, and greatly simplified, erector-launcher increases the platform working space and travel storage for the warhead. The new programmer-test station, with its second generation computer, substantially reduces the probability of human error and increases the capacity of malfunction detection. The power station is currently undergoing an extensive study for repackaging and redesign to improve its maintainability and operability. The remaining components of the Pershing system, including the missile, are

unchanged. A battery control central has been added to further enhance the operation of the entire system. By means of the BBC, the battery commander will not only have continuous information concerning the progress of an individual countdown but will be able, at the same time, to control the entire firing sequence. The most noticeable improvement of Pershing One's transformation into Pershing One ALFA is the transportation of all equipment on M656 wheeled vehicles. The M656, or standard A vehicles, will improve equipment maintainability by decreasing the transportation-wear, which causes many malfunctions. All of these improvements, stressing the retention of the best facets of Pershing One while redesigning and reengineering into Pershing One ALFA, enhance quick reaction alert, the primary purpose of the Pershing system.

TACTICS/COMBINED ARMS DEPARTMENT

ISSUE OF GRAPHICAL EFFECTS TABLES

A graphical effects table for field artillery fires is now available for issue. Units in Vietnam should submit requisitions to Inventory Control Center (ICC) #14, Vietnam, Backup stockage (CONUS) is Sacramento Army Depot.

Nomenclature/Identity:

Table, graphical effects, WE

Line Item No: U94656

Federal Stock No: 1220-855-5922



ARMY TERMINATES PRODUCTION OF CHEYENNE

Department of the Army has terminated the production phase of the AH-56A Cheyenne armed helicopter program for default of the contractor, Lockheed Aircraft Corporation.

At the same time, it was announced that Lockheed may be issued a cure notice on its research and development contract for the same aircraft, notifying the company of deficiencies.

This action is based on the Army's conclusion that any aircraft delivered in accordance with the contractual schedule would fail to meet performance specifications in several significant respects. In particular, problems of rotor stability and control, for which the contractor has developed no adequate solution, have significantly limited the safe speed and maneuverability of the aircraft.

Army studies indicate that an advanced armed helicopter could make significant contributions to combat effectiveness on the modern battlefield. The Army still requires the capability which the Cheyenne program was intended to provide. This action means that because of the contractor's default, production efforts of this particular advanced armed helicopter could not be allowed to proceed without unacceptable risks.

GUARDIAN OF THE SOLDIER'S WARRANTY



NOTES FROM THE US ARMY FIELD ARTILLERY BOARD

The Swiss rammer was tested by the US Army Artillery Board in the fall of 1968. The test item is similar to the tube-mounted rammer manufactured in the United States, but incorporates several improvements, including—

- (1) Automatic loading and ramming action from stow position.
- (2) The capability to operate at any elevation or to operate while the tube is being elevated (or depressed).

Approximately 300 rounds were fired with the test item. The reliability and operating characteristics were suitable. There were no human-factor engineering defects. The test item was found to have military potential. The recommendation was made that the Swiss rammer be subjected to engineer testing by the appropriate agency. The test model of this item remains at the US Army Field Artillery Board and is used to facilitate ammunition and materiel testing. A log book is being kept on the item, and supplementary reports will be submitted in the future.

M18 FLASH DATA REDUCTION PROGRAM

The M18 flash data reduction program (COMCO) automates manual flash computation procedures in a testing environment. The program is executed on the M18 field artillery digital automatic computer (FADAC), with a 100-word-per-minute teletypewriter as the primary output device.

COMCO accepts azimuths and vertical angles from three or four surveyed observation posts. These data are keyed into the computer on a round-per-round basis. Individual burst coordinates are then computed and printed.

Upon completion of a fire mission, the following data can be obtained: average coordinates of burst; range and azimuth from gun to average coordinates; probable errors in range, deflection, altitude, and time, computed according to the standard deviation and successive differences formulas.

Because FADAC is field operational, COMCO can supply a test officer with all needed flash data on a real time basis in the field where the test is conducted.

SERVICE TESTS

The US Army Field Artillery Board is presently service testing two new experimental weapons—the M109E1 (fig 1) and the XM164 (fig 2). The M109E1 is a long-tube variety of the present 155-mm self-propelled



Figure 1. M109E1.

howitzer. It is designed to accommodate the newly developed charge 8, which will increase its range to more than 18,000 meters. If the service tests are successful, the weapon will replace the present M109.



Figure 2. XM164.

The XM164 is a lightweight towed 105-mm howitzer developed for the US Marine Corps as a replacement for the M101A1 howitzer. The experimental weapon is 3,500 pounds lighter than the M101A1, however it has a range capability of 15,000 meters with rocket-assisted projectiles and has an accuracy comparable to that of the M101A1. The Army is considering the XM164 as a possible replacement.

DEGRADATION EFFECTS PROGRAM

A team from the Board recently participated in a joint service test series aimed at determining the effects of snow on the terminal effects of assorted conventional munitions. This series of tests was conducted under the Degradation Effects Program, formerly called the Joint Environmental Effects Program, which tests conventional Army and Air Force munitions in a variety of non-ideal terrains. In the past, tests have been conducted in Panama (jungle and high canopy tests), Eglin Air Force Base, Florida (sand tests), and Aberdeen Proving Ground, Maryland (mud and water tests).

In the most recent series of tests 14 different Army and Air Force munitions were tested in two types of snow. Among the items tested were the M1 105-mm high-explosive projectile and the M107 155-mm high explosive projectile. Results of these tests will be of particular interest to field artillerymen. Data obtained from this test series will be reduced at the Army Materiel Systems Analysis Agency, Aberdeen Proving Grounds, Maryland.



NEW INTERNATIONAL AGREEMENT

The United States, the United Kingdom, Canada, and Australia recently announced agreement on continuation into Phase Two of the advanced development of the MALLARD Project. This project is an unprecedented international undertaking in which a joint tactical communication system is being developed for the armies and associated navies and air forces of the four nations.

A design for the future, the long range task is being carried out in phases as an international cooperative venture. The first phase, begun in April, 1967, is nearing completion, and was devoted to intensive study and system design by both government and industry teams. Three major system studies have been completed, two in the United States and one in the United Kingdom. These studies were augmented and complemented by 58 separate studies of the techniques involved.

Career

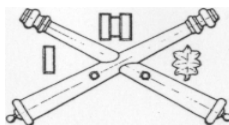

Memo

According to change 21, AR 600-200, students enrolled in correspondence courses will now be granted one promotion point for each credit hour successfully completed, up to a maximum of 30 points.

The Extension Courses Division, Nonresident Instruction Department, is offering in correspondence form most of the resident courses taught at the Army Field Artillery School. Over 150 such subcourses are presently available at no cost to nonresident students.

The most recently offered nonresident instruction is Subcourse 400, **Artillery Operations in South Vietnam**. This 15-credit-hour subcourse has four lessons and an examination. It briefly outlines the climate and terrain and the political and geographical structures of South Vietnam. It also discusses airmobile operations; road movements; gunnery; communication; Viet Cong boobytraps; reconnaissance, selection and occupation of the position; and defensive considerations in the battery area. It is based on the field experiences of field artillerymen in South Vietnam and, as such, is oriented primarily toward field artillery operations.

Another new subcourse is Artillery Subcourse 600, **Communication Maintenance and Supply Procedures**. This subcourse consists of three lessons and an examination and yields 8 credit hours upon satisfactory completion. The purpose of maintenance publications, the categories and principles of maintenance, unit readiness, and the conduct of inspections are discussed. It also contains pertinent information pertaining to The Army Equipment Records System (TAERS), to include equipment historical records, maintenance scheduling, and maintenance request forms. The subcourse is oriented entirely toward the communications field and, thus, goes further by discussing signal equipment request and turn-in procedures. It also includes repair parts supply procedures and related publications and forms.

To enroll simply prepare one copy of DA Form 145 and send it to the Commandant, United States Army Field Artillery School, Nonresident Instruction Department, ATTN: Extension Courses Division, Fort Sill, Oklahoma 73503.

ADVANCED CIVIL SCHOOLING

Since 1946, the United States Army Air Defense School has conducted the Guided Missile Systems Officer Course (4F-1181) at Fort Bliss, Texas, to provide commissioned officers in the grade of first lieutenant through lieutenant colonel with advanced and comprehensive instruction in the

physical sciences related to the guided missile field. The course is 30 weeks in length and is an educational, as opposed to a training type, series of studies. Two classes are conducted annually beginning in February and May. Each class normally consists of 15 to 20 officers (all volunteers) and is open to officers of any branch of the Army. Graduates are awarded MOS 1181.

Under the provisions of AR 350-200, the Field Artillery branch selects the most highly qualified field artillery graduates of each class for advanced civil schooling at the University of Texas at El Paso. The university will award a graduate degree in engineering or physical science to those officers successfully completing 1 year of graduate study immediately following graduation from the Guided Missile Systems Officer Course.

Selection for both the 1181 course and subsequent advanced civil schooling is made on a best qualified basis. Emphasis during selection is placed on the officer's demonstrated manner of performance and potential, as reflected in his efficiency file, as well as his academic qualifications. Prerequisites for the Guided Missile Systems Officer Course (4F-1181) are contained in Department of the Army Pamphlet 350-10. The service obligation specified for this course has been changed from 4 to 2 years. An additional obligation of 2 years will be incurred by those officers participating in the graduate school program at the University of Texas.



HUNTER ARMY AIRFIELD RETAINED

Department of the Army has announced a decision to permanently retain Hunter Army Airfield, formerly Hunter Air Force Base, Savannah, Georgia, as a support of Fort Stewart, Georgia, to conduct increased rotary wing pilot training there.

Hunter Army Airfield has been selected for permanent retention as an Army training facility because of its excellent aviation facilities and the excellent aerial gunnery range at nearby Fort Stewart. Training there includes initial entry helicopter and fixed-wing training, and Huey Cobra transition and gunnery training.

With the increase in Army helicopters to the present level of more than 11,000, there has been a corresponding increase in the requirement for training facilities for helicopter pilots. The field was transferred from the Air Force to the Army in April 1967, to provide required facilities for the expansion of Army flight training.

Tips for the . . .



Airmobile Field Artillery

Lieutenant Colonel T. H. Simpson, USMC
Captain David LaBoissiere, USMC
Tactics/Combined Arms Department
USAFAS

Because of the increased lift capacity of the modern helicopter and the improvements which have been and are being made both in helicopters and in light and medium field artillery weapons, the artilleryman now is more capable than ever before of providing the commander with flexibility, mobility, and added depth in combat. Today in South Vietnam artillery men are placing their weapons in areas heretofore thought inaccessible for artillery positions. Mountain tops, deep jungle positions, rice paddie dikes, and airmobile firing platforms emplaced in inundated areas have become commonplace artillery positions as a result of the helicopter's use as a prime mover. It is, therefore, imperative that the

artilleryman at all levels have the knowledge and skills required to meet the demands of the airmobile operation.

The objective of this article is to pass on helpful tips on the proper preparation of the 105-mm and 155-mm towed howitzers for external lift by helicopter. The specific techniques and procedures for preparing loads for delivery by helicopter are described in TM 55-450-11. The following tips are intended to reinforce those techniques and pass on information gained through experience in the field.

The helicopter delivery of artillery pieces and other items of equipment by means of the external load technique requires the use of nylon aerial delivery slings. These slings are each 1 3/4 inches in width and are available in various lengths. Appendix B on pages 165 and 166 of TM 55-450-11 includes a complete list of slings and associated rigging equipment with their Federal stock numbers (FSN). The aerial delivery slings are either two-loop or three-loop slings. The two-loop sling has a rated lifting capacity of 6,500 pounds, whereas the three-loop sling has a rated capacity of 10,000 pounds. These lift capacities include built-in safety margins.

CARE AND LIMITATIONS OF RIGGING EQUIPMENT

Now that each field artillery battery is responsible for furnishing the aerial delivery slings and equipment for the rigging of its wheeled vehicles and howitzers, battery personnel must understand the safety limitations of the slings and their associated equipment. The battery is also responsible for insuring that the helicopter external loads are properly and safely rigged. For insured safety, each aerial delivery sling has a rated life of 6 months from the date of the first lift in which it is used. The month and year of the initial lift in which the sling is used should be marked on each end of the sling near the keeper. However, slings should be inspected before and after each lift for evidence of unserviceability.

During airmobile operations each section chief is responsible for the care and maintenance of his rigging equipment. Slings must be stored in a dry place and must be protected from the direct rays of the sun. The slings are easily stored by being rolled into tight rolls and placed in a section chest in such a manner that they do not come in contact with sharp or abrasive objects. Each section chief should be able to recognize nylon damage and should know the techniques used for preventing it. Burns and cuts are the most prevalent forms of nylon damage. Nylon burning is the result of friction and the heat that results from the nylon's coming in contact with other nylon or metal surfaces. Nylon burning is the fusion of nylon fibers which causes unusual hardening or softening of the affected sling area. A sling which shows indications of nylon burning should be declared unserviceable and turned in for replacement. To prevent nylon burning, each sling or the equipment should be padded at any point at which the sling will come in contact with metal surfaces or other slings.

Air delivery slings have a tendency to vibrate during flight. These vibrations can cause the sling strands to rub and thus can result in nylon burning. Therefore, **each sling should be twisted one turn for each 3 feet of sling length** to dampen vibrations and prevent nylon burning.

Cutting, as mentioned earlier, is another cause of sling failure and can occur when the sling comes in contact with sharp metal edges of the load. Vulnerable areas of each sling and all exposed sharp edges of the load which could cause cuts must be padded with a heavy padding material to avoid cuts during flight. Padding material that can be used includes felt pads, cellulose wadding, scrap canvas, clean rags, newspaper, and sandbags.

The metal items used in rigging, such as clevises and bolts, must be checked for corrosion, cracks, and sharp edges. Metal items that are cracked or bent must be replaced; however, rust can be cleaned off corroded items and sharp or burred edges can be filed smooth. The section chief should store these metal items in the section chest along with the slings.

As mentioned earlier, the field artilleryman does his own rigging and must be cognizant of both personal and load safety at all times. Each leg of the load must be capable of supporting 100 percent of the total weight lifted to insure load safety. If two slings must be used on each lift point to meet this requirement, the second sling will increase the lift capacity by only 75 percent. Therefore, if two 3-loop slings, each rated at 10,000 pounds, are used, the total lift capacity of the two slings for the leg is rated at 17,500 pounds. The same type ratio is applied to the 2-loop sling. The crewmen who hook the load to the helicopter must wear earplugs, helmets, and goggles and must keep their sleeves buttoned so that they are protected from flying objects caused by the rotor wash of the helicopter.

RIGGING M101A1 AND M114

The following tips apply specifically to the rigging of the M101A1 and M114 howitzers.

Light howitzers always carry ammunition as part of the external load. The M102 howitzer and the new XM164 are relatively easy to prepare for movement, since lifting brackets are permanently mounted on the weapon. However, the M101A1 requires extensive preparation before an airmobile lift. The trails must be heavily padded in front of and to the rear of the cradle lock shift. This padding should be approximately 10 inches long and 1 inch thick to prevent cutting of the slings which are choker hitched around the trails at these points (fig 1). A good field expedient pad can be made from sandbags tied around the trails with sandbag strings. The tube and recuperator must be wrapped with light padding to prevent nylon burning of the sling which is choker hitched at this point. Sight mounts are a very high casualty item during the lifting and landing phases of an airmobile operation. The fouling of

lifting slings during liftoff or the impact of the falling clevis during release operations can cause extensive damage to the on-carriage sighting equipment. The sight mount must be turned down and covered with padding (1 inch minimum) for protection from the falling clevis. Sandbags tied around the sight mount provide excellent protection for sighting equipment. The slings should be taped or tied together (fig 2) to prevent fouling during hookup. Sandbag strings or cotton cord can be used. If slings are not tied or taped, two cannoneers should hold the slings until the slings are drawn taut by the helicopter to prevent them from wrapping under the sight mount or other protruding areas of the weapon that can be damaged on liftoff.

In the rigging of the M101A1, it is important that the two A-22 cargo bags of 40 rounds of ammunition each be positioned so that they are side by side next to the weapon (right or left side) and are approximately 4 feet from the trails (fig 1).

The medium howitzer M114 must be rigged in accordance with TM

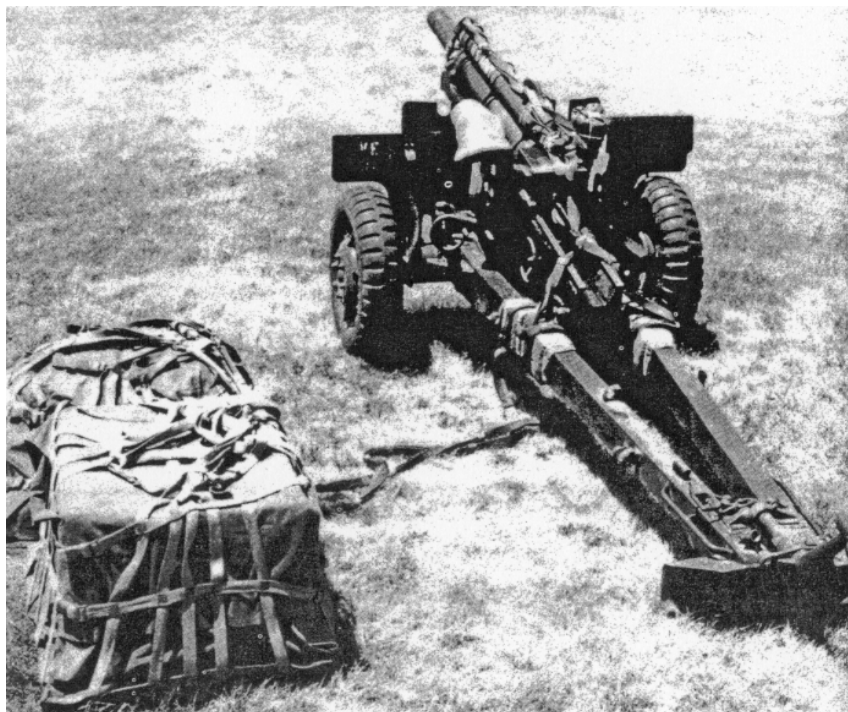

Figure 1. M101A1 howitzer rigged for airmobile lift. Note that trails and sight mounts are heavily padded and that the two A-22 cargo bags are positioned approximately 4 feet from the weapon.

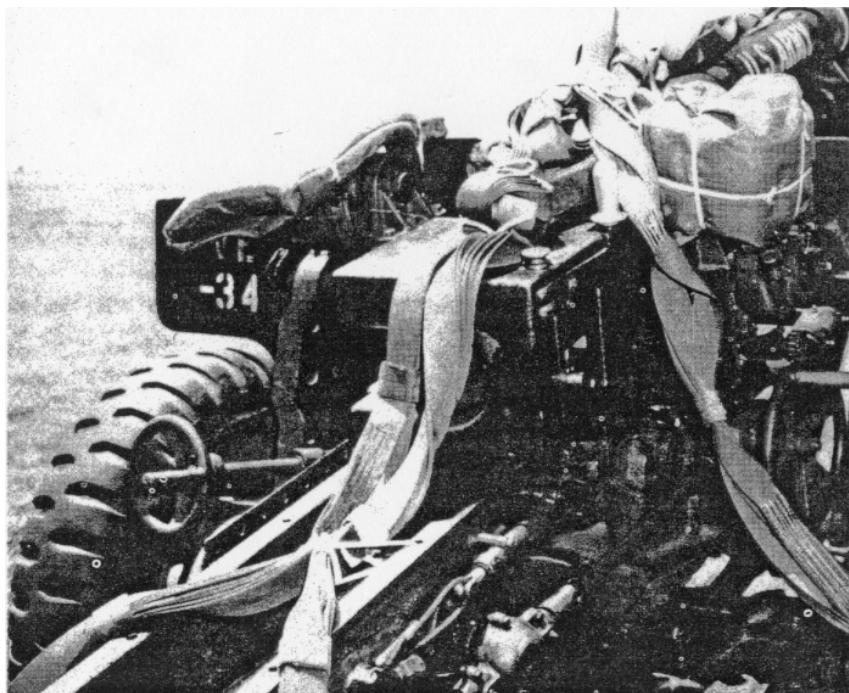

Figure 2. Slings tied together to prevent fouling.

55-450-11; however, the following tips will facilitate the rigging operation. The clevis assemblies at the axle lift points should be tied to the shields (fig 3) to prevent damage to the brakes and also to permit firing the howitzer without derigging. The sight mount, again, must be heavily padded against clevis damage, and the slings must be taped or tied to prevent fouling during hookup (fig 3). Sandbag padding should be placed under and around the equilibrator rods (fig 4) to prevent howitzer or sling damage that could occur if the slings were to catch on the equilibrator rods during liftoff. A 10- to 12-foot rope should be attached to the lunette so the cannoneers on the ground can orient the tube in the direction of fire before the helicopter sets the howitzer in position. This technique can also be used with the light artillery weapons, but the technique is not as critical as that for the medium howitzer. Although 155-mm ammunition normally is not carried in the same external load as the howitzer, it may be necessary to carry both in one external load. In such instances the A-22 cargo bag filled with 16 projectiles and 16 powder containers and fuzes (2,000 pounds) can be affixed to the trails

of the M114 just behind the breech, and the howitzer and ammunition can thus be carried in a single external load. An 8-foot sling and lift ring are attached to the A-22 bag to expedite the offloading of the ammunition by the helicopter.

GROUND CREWMEN

The battery must have well-trained ground crewmen (cannoneers) who act as signalmen and ground hookup men to facilitate hookup. Each howitzer section should have one signal man and two hookup men.

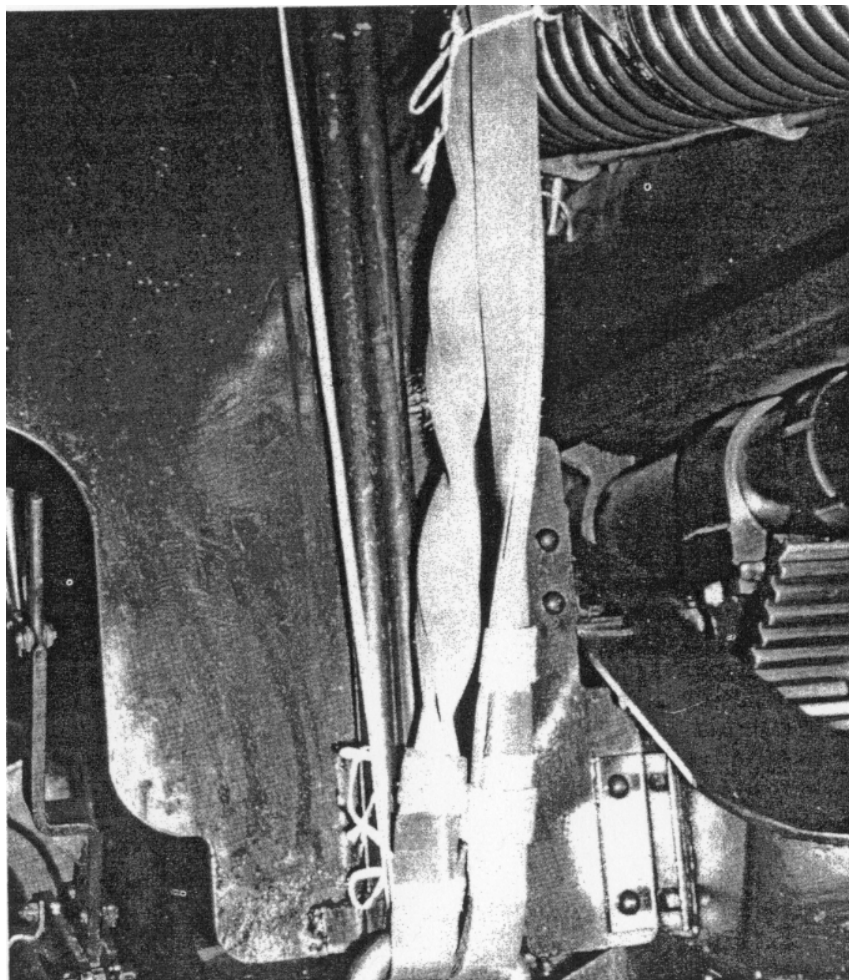

Figure 3. Clevis secured to the shield of a M114 howitzer. Note the second tie on the equilibrator rod to maintain sling position.



Figure 4. Ends of equilibrator rods padded to prevent sling or rod damage.

The hookup men insure that the load is correctly and safely rigged and properly oriented for pickup. Vehicular loads are prepared with the ignition switch in the off position, the transmission in neutral and the front of the vehicle pointed into the wind. Howitzers are properly prepared when the tubes are pointed into the wind and the brakes are in the off position.

After the pilot is directed to guide on colored smoke or a colored panel displayed on the load, the signal man directs the helicopter over the load by hand and arm signals. He positions himself 30 to 50 meters upwind of the load so the pilot can see him at all times and wears a vest with the same color as displayed on the howitzer. Then, when the helicopter is over the load, the helicopter crew chief gives precision hover

instructions to the pilot. This system is fast and efficient and can be used in most situations.

The two hookup men station themselves at the load with one handling the static electricity probe and the other handling the hookup (fig 5). The crewman with the static probe stands on the ground to the left of the howitzer and touches his probe to the helicopter cargo hook to dissipate any static electricity that it may have built up. The other crewman positions himself on the right trail of the howitzer next to the breech. He must not sit on the breech block or get into any position which would prohibit his moving quickly in case of an emergency. When the helicopter hovers over him, the second hookup man firmly places the lifting



Figure 5. Ground crew with safety equipment in position for hookup.

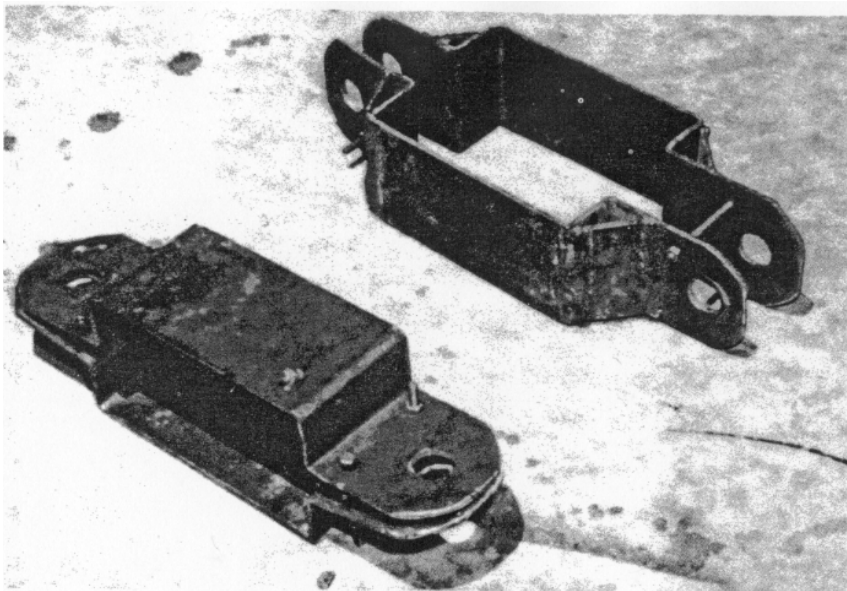

Figure 6. Prefabricated lifting shackles designed for medium or large suspension clevis on a M101A1.

ring (3-foot, three-loop sling) in the cargo hook; then, as the helicopter starts to climb, he and the static probe man hold the slings until they are taut. Then, as the load leaves the ground, the hookup men move away to the right of the helicopter's direction of flight but constantly observe the liftoff for any corrective action that might have to be taken. The crewmen always move off to the helicopter's right, since, if it should have a failure, the aircraft will attempt an emergency landing bearing to the pilot's left.

The battery must insure that the pickup zone is in a good state of police, since both aircraft and personnel casualties can be caused by debris blown around the landing zone by the 110-knot winds generated by the rotor wash. Foreign objects, such as panchos, helmet liners, and fatigue jackets, can be sucked into the intake system of a helicopter and thereby can cause aircraft failure; field artillerymen on the ground can be killed or seriously injured by jagged pieces of ammunition boxes hurled through the air by the rotor wash.

New techniques continue to be developed for ease of rigging the M101A1 towed howitzer. Presently being tested at Fort Sill is a prefabricated lifting shackle that can be attached to the trails of the weapon by the cannoneers without a modification work order (fig 6). This shackle can be attached easily and facilitates rigging by eliminating the need

for the heavy padding and taping of the trails (fig 7). A further advantage of the shackle is that it permits rigging the weapon with six 8-foot slings instead of the two 8-foot and four 11-foot slings currently used. This eases the logistic problem by providing commonality of slings and allows the commander some latitude in rigging since damaged slings can be switched or doubled to insure a safe lift.

Today, helicopter-transported field artillery is moving farther and faster than ever before to provide the close fire support needed by the ground-gaining arms. Field artillerymen must continue to keep abreast of the rapidly changing capabilities of the helicopter and must be prepared to rig their equipment for helicopter lift to meet any contingency.

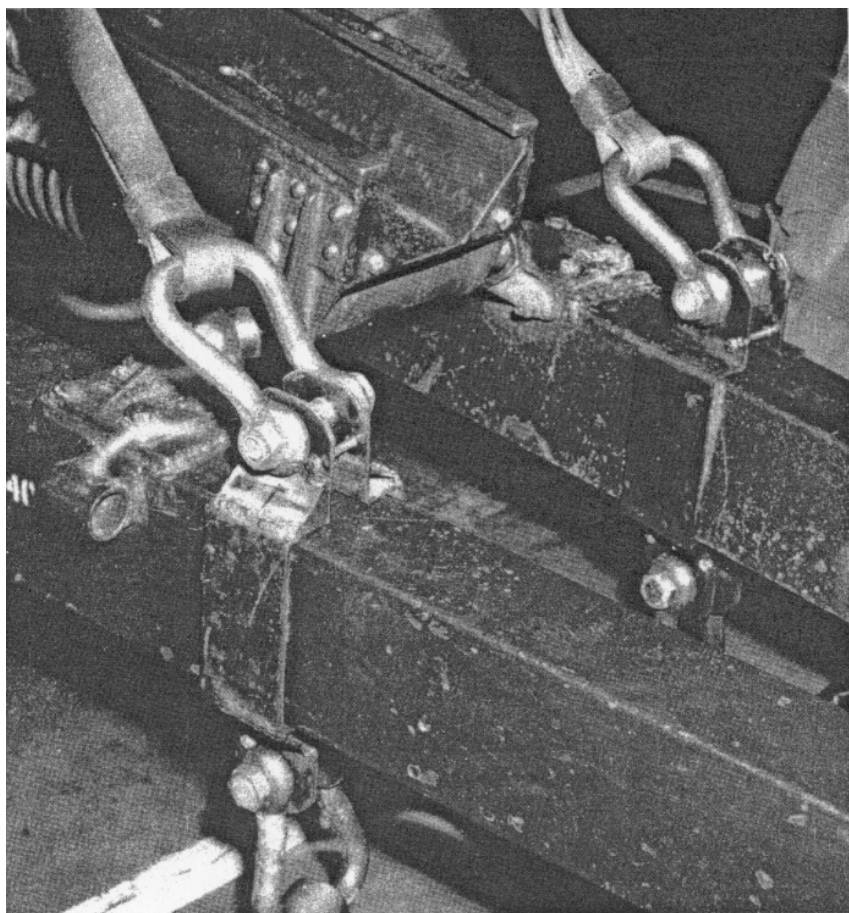

Figure 7. Lifting shackles attached to M101A1.

The above tips are given to inform field artillerymen of the current helicopter lift capabilities. As new howitzers and helicopters are developed, new techniques will also be adopted; however, only field experience can provide the fine details necessary to insure useful rigging procedures. Pass on your tips.

FIELD ARTILLERY RIGGING CHECKLIST

1. Check rigging procedures prescribed by TM 55-450-11.
2. Check slings for proper length and for serviceability (cuts, nylon burning, 6-month sling life).
3. Insure that the lifting ring and each sling leg will support 100 percent of the weight of the load.
4. Pad and tape weapon or slings to prevent cutting or nylon burning.
5. Twist all slings, one twist for each 3 feet of length.
6. Tie slings together in the vicinity of the breech with cotton cord to prevent fouling during hookup.
7. Pad sight mounts (1 inch minimum) to prevent damage from the falling clevis during release operations.
8. Orient howitzers with tubes pointed into the wind and put brakes in the OFF position.
9. When two slings are used on each lift point of the load, the total lifting strength is increased by 75 percent of the second sling (for example, two 3-loop slings = 17,500 pounds; two 2-loop slings = 11,375 pounds).
10. The A-22 cargo bag for a light (105-mm) howitzer is positioned next to the trails approximately 4 feet from the howitzer.
11. Maximum load for the A-22 cargo bag is 2,000 pounds (for example, forty 105-mm rounds in fibers or sixteen 155-mm projectiles with powder and fuzes).
12. The lift ring (donut) for the CH-47 Chinook helicopter is the 3-foot nylon sling (NYLON TO METAL).
13. The lift ring (donut) for the CH-54 Crane helicopter is a large metal clevis with the bell portion of the clevis on the hook (METAL TO METAL).
14. Minimum safety equipment for a ground crew is helmets (with tight chinstraps), goggles, and earplugs.
15. For a helicopter emergency all ground crewmen move RIGHT; helicopter lands to the left.
16. Insure that the pickup zone is thoroughly policed to prevent foreign object damage to the helicopters and to protect cannoneers on the ground from injury or death from debris blown around by the rotor wash.

Helicopter Etiquette



In stability operations environment, movement of medium and light field artillery units by helicopter has become the rule rather than the exception. The movement of field artillery by air has been proved invaluable time and time again in combat, but the movement by air of large numbers of troops who are unfamiliar with aviation creates a number of problems.

To assist both the ground soldier and the aviator in obtaining a better understanding of the problems involved in the movement of field artillery by air, the following helicopter etiquette guidelines were developed by the 101st Airborne Division:

FOR FIELD ARTILLERYMEN

- You must accept the fact that helicopters are noisy, wind-producing beasts. When a helicopter becomes noiseless and windless, it automatically becomes motionless and useless, so plan your operations accordingly. Don't insist that Peter Pilot land you in the chow line; if you do, he will!
- Two wrongs don't make a right! The soldier who tries to retaliate by flailing the main rotor blade of an offending Huey with a tent pole or an entrenching tool is courting disaster. Sandbags, when properly used, are lifesavers. Improperly used, i.e., lying on a helipad,

slingout area, or LZ (landing zone), they become tools of destruction if sucked up by the rotor wash. The latter applies to ponchos, cartons, lug-a-jugs, etc. The soldier who allows debris, equipment, and antennas to clutter a tight LZ during an extraction may find his stay in the LZ extended because the aircraft that was going to extract him becomes an FOD (foreign object damage) casualty.

- The CG (center of gravity) on the Huey depends on the seating arrangement and the loading of the aircraft. A sudden change in attitude of the helicopter caused by a sudden change in position of the personnel in the helicopter may or may not be overcome by the pilot. Don't start unloading the aircraft until told to do so by a member of the crew. Besides, you may break a leg if you jump from the helicopter at an excessive height—some have.

- When clearing an LZ for an extraction, make it big enough to allow the pilot a little room for error. Clearing an LZ with the main rotor blade of a Huey is exciting but in most instances it is expensive and nerve-wracking, especially to the pilot. And don't forget—if that helicopter crashes during approach or departure, you may become the object of the floundering chopper's wrath.

- Nothing unnerves a pilot more than the unannounced explosion of a 40-mm round in the trees right in front of his chopper as he





tries to nurse it out of a tight LZ, so don't fire any weapons (or throw grenades) out of the aircraft without the aircraft commander's approval. To do so is to overtax the central nervous system of all concerned.

- The practice of getting the pilot's attention by tapping on his helmet with an M16 magazine is somewhat risky. If you must talk to him, have the crew chief or the gunner relay your message. They know whether or not he is too busy to talk. If at all possible, avoid conversations with the pilot during approach or departure.

- Remember, the pilot at whom you rant and rave for blowing dust into your chow or dusting off your tent may be the same one you can't praise enough when he comes in and hauls you out of an LZ surrounded by "Charlie." So be a little tolerant—he probably didn't intend to blow your mess tent down.

FOR AVIATORS

- Don't land your helicopter in the middle of the chow line. If there is one thing that is sacred to every field artilleryman, it's his food. Don't fill it with sand and debris.

- Land far enough away from all tents, buildings, and bunkers to preclude blowing them full of sand or blowing them over. One-holer latrines are especially susceptible to the latter. If your passenger insists on being set down in the middle of troops or buildings when another suitable area is within walking distance, pretend the intercom system is on the blink and you can't hear a word he says. The troops on the ground will love you for it!

- Don't drop in unannounced; establish radio contact. If this is not possible, overfly the area and give the personnel on the ground a chance to police the area, secure loose objects, and pop smoke. The wind may have shifted since you were last there, and a downwind approach can be rough on the old torque meter, not to mention the possibility of the skids ending up around your ears.

- Landing an LOH in the middle of a VIP welcoming ceremony is not a recommended practice. If you see troops in formation, guidons flying, and the band standing by, you will probably be safe in assuming that the men have not gathered to watch you post-flight your LOH. Unless you are carrying persons participating in the ceremony, don't land.

- All aviators are aware of the requirement to run the Huey engine at flight-idle for a 2-minute cooldown prior to engine shutdown, but after the 2-minute period expires, shut it down! Or better yet, drop off your passengers and move to a shutdown area away from the troops if such an area is available.

- When passengers board your aircraft, give them time to get seated, fasten their seatbelts, and secure their personal gear before you start pulling pitch. Personnel hanging from the skids during takeoff create an unpleasant and unsafe condition.

- So every field artilleryman doesn't know everything there is to know about helicopters—you might find it difficult to organize and conduct a fire mission. And when you've finished your day's work in the cockpit, parked your aircraft, eaten dinner, and hit the sack, stop a moment and reflect—if it weren't for all those howitzers out there, you might find going to sleep rather difficult.

Adjustment Procedure For Area Time Mission



*LTC (Ret) Matthew J. Ringer
Gunnery Department
USAFAS*

The field artillery has adopted a new procedure which will simplify, expedite, and economize the area time mission. With the previous procedure, time-fuzed projectiles were fired throughout the mission—from adjustment through fire for effect. Under the new procedure, the forward observer (FO) adjusts with fuze quick until an appropriate range bracket is split, normally 100 meters.

To expedite computing data, slant-scale GFTs include a change to fuze setting for a 10-meter change in height of burst scale. To date, slant-scale GFTs with this scale have been produced for the self-propelled 155-mm howitzer M109, self-propelled 8-inch howitzer M110, self-propelled 105-mm howitzer M108, and towed 105-mm howitzer M101 and M102. Scales for the towed 155-mm howitzer, M114 are presently being manufactured.

Evaluation of the new procedure shows a marked decrease in the time and ammunition necessary to bring time-fuzed fire for effect on a target, with no loss in accuracy. First, less time is required in the firing battery, since personnel are not required to place a fuze setting on projectiles used during the initial phase of the adjustment. Second, the FO is no longer faced with difficult range spottings, such as airbursts which are too high or graze bursts which are within 200 meters and short of the target. An inability to provide a range spotting requires expenditure of additional time and ammunition. Bonus results are simplified FO and fire direction center (FDC) procedures, which reduce teaching and training time. This new procedure is now being taught in the US Army Field Artillery School.

When he splits the 100-meter bracket, the FO will request time fuze and begin to adjust the height of burst. A burst height of 20 meters produces the desired lethality from time-fuzed projectiles. This height of burst is a mean height suitable for all cannon artillery and will produce effective results without an excessive number of graze bursts or high airbursts due to the height-of-burst probable error.

FDC COMPUTATIONS

For the nonadjusting batteries, the FDC computes a 20/R at the initial gun-target range and adds this to the site determined for the ground location. The computer determines this angle by using the 100/R scale of the GFT at the initial chart range to the target. The value of 100/R indicates the number of mils required to move the burst 100 meters vertically or laterally. Since only a 20-meter height of burst is desired in time fire, the computer uses only 0.2, or one-fifth, of 100/R. For example, at a range of 6,000 meters, the 100/R factor is 17 mils. One-fifth, or 0.2, of 17 is 3.4 mils. Thus, 3 mils must be added to the site to place the trajectory 20 meters above the target. Complementary angle of site for the increased vertical interval is insignificant and is ignored. Site and 20/R are combined with elevation to determine the quadrant elevation to be announced in the initial fire commands.

For the adjusting battery, the FDC determines 20/R as described above, but this information is not included in the initial fire commands. At the observation post, the FO adjusts for range and deviation, using fuze quick. When the appropriate range bracket is split, he adjusts for

the height of burst only, using fuze time. For the initial rounds of time fuze, the FDC adds the 20/R, determined at the initial range, to the site and elevation to determine the quadrant elevation to fire. The computer determines the fuze setting from the time gage line or, if no time gage line is available, he determines the fuze setting corresponding to the elevation.

When the observer announces a subsequent height-of-burst correction, the computer converts the correction to a fuze setting correction by determining, from the GFT, the change in fuze setting for a 10-meter change in height of burst corresponding to the fuze setting to be fired and multiplying it by the number of 10-meter increments in the observer correction. (Units not having the slant-scale GFT may use the data in Table I.) For example, using GFT 155-AH-2, charge 5, a fuze setting of 17.5, and an elevation of 258, the change to fuze setting for a 10-meter change in height of burst is 0.12. Assuming an observer's height-of-burst correction to be UP 40, the correction to fuze setting is -0.5 ($4 \times 0.12 = -0.48$, or -0.5). Applying -0.5 to 17.5, the computer determines a fuze setting of 17.0. Assuming the observer's next correction to be DOWN 20, FIRE FOR EFFECT, the correction to fuze setting is $+0.2$ ($2 \times 0.12 = +0.24$, or $+0.2$). Applying this correction to 17.0, the last fuze setting fired, the new time to be fired is 17.2 ($17.0 + (+0.2)$). The observer announces height-of-burst corrections to the nearest 5 meters.

Because fuze quick is used during the adjustment, the fire commands for the adjusting battery will include, as part of the method of fire, the number of time-fuzed rounds to be used in fire for effect. A typical fire command for an adjusting battery would be: BATTERY ADJUST, SHELL HE, LOT XRAY YANKEE, CHARGE 5, FUZE QUICK, CENTER 1 ROUND, BATTERY 3 ROUNDS TIME IN EFFECT, DEFLECTION 3132, QUADRANT 345. For nonadjusting batteries, a typical fire command would be: BATTERY ADJUST, SHELL HE, LOT XRAY YANKEE, CHARGE 5, FUZE TIME, BATTERY 3 ROUNDS, DO NOT LOAD, DEFLECTION 3122, TIME 24.3, QUADRANT 358.

When the final height-of-burst correction has been received, the adjusting battery computer will determine and announce to the nonadjusting battery computers the total observer height-of-burst correction. The computers for the nonadjusting batteries determine their fuze settings from the fire-for-effect chart data and apply corrections for the total height-of-burst correction in the same manner as that described above for the subsequent height-of-burst corrections.

PROCESSING A FIRE MISSION

The following fire mission is an example of an observer adjusted mission, using fuze time in effect with a 155-mm howitzer battalion. Radio communication and short-phrase, repeat-back procedures are used between the observer and the battalion FDC. Wire communication is used between the FDC and the firing battery. The firing battery's read-back is omitted.

Observer	RED BANNER 18, THIS IS RED BANNER 44, FIRE MISSION, OVER.
Radiotelephone operator (to FDC personnel):	FIRE MISSION.
Radiotelephone operator:	RED BANNER 44, THIS IS RED BANNER 18, FIRE MISSION, OUT.
Observer:	FROM REGISTRATION POINT 1, DIRECTION 810, OVER.
Radiotelephone operator:	FROM REGISTRATION POINT 1, DIRECTION 810, OUT.
Observer:	RIGHT 240, DROP 600, OVER.
Radiotelephone operator:	RIGHT 240, DROP 600, OUT.
Observer:	DOWN 10, OVER.
Radiotelephone operator:	DOWN 10, OUT.
Observer:	PLATOON OF INFANTRY DIGGING IN, TIME IN EFFECT, ADJUST FIRE, OVER.
Radiotelephone operator:	PLATOON OF INFANTRY DIGGING IN, TIME IN EFFECT, ADJUST FIRE, OUT.

Note: The chart operators and computers follow the mission by listening to the repeat-back by the radiotelephone operator.

S3:	BATTALION BRAVO, USE GFT, LOT XY, CHARGE 4, 4 ROUNDS, TARGET ALFA FOXTROT 2413.
Radiotelephone operator:	BATTALION BRAVO, 4 ROUNDS, TARGET ALFA FOXTROT 2413, OVER.
Observer:	BATTALION BRAVO, 4 ROUNDS, TARGET ALFA FOXTROT 2413, OUT.

Note: From the data contained in the call for fire and the fire order, the computers determine, transmit, and record the preliminary fire commands.

Battery B computer (to firing battery):	BATTERY ADJUST, SHELL HE, LOT XY, CHARGE 4, FUZE QUICK, CENTER 1 ROUND, BATTERY 4 ROUNDS TIME IN EFFECT.
--	--

Nonadjusting battery computers (repeated back by the nonadjusting batteries): BATTERY ADJUST, SHELL HE, LOT XY, CHARGE 4, FPZE TIME, BATTERY 4 ROUNDS DO NOT LOAD.

HCO: BRAVO, RANGE 4530.

Battery B computer: RANGE 4530.

Note: The computer places the hairline of the GFT over the announced range but does not record the range at this time.

HCO: DEFLECTION 3282.

Battery B computer DEFLECTION 3282.

Note: If deflection corrections are known, the computer applies the deflection correction to the chart deflection announced by the HCO and transmits the results to the firing battery.

Battery B computer (to firing battery): DEFLECTION 3282.

Battery B computer (to VCO): SITE BRAVO?

VCO: SITE BRAVO, PLUS 4.

Battery B computer: SITE BRAVO, PLUS 4.

Battery B computer (to firing battery): QUADRANT 274.

Note: The computer combines the site of +4 announced by the VCO with the elevation of 270 read on the GFT and announces the sum as QUADRANT 274. When time permits, he will determine 20/R for use during the time adjustment. Because the nonadjusting batteries will fire only time fuze, 20/R is included with site and elevation in the initial fire commands. The HCO then announces the chart data for the nonadjusting batteries in the order set forth in the unit SOP. Initial chart data, site, and 20/R for the nonadjusting batteries are as follows:

	Battery A	Battery C
Range	4500	4360
Deflection	3382	3180
Site	+3	+5
20/R	5	5

Battery B computer:	SHOT.
Radiotelephone operator:	SHOT, OVER.
Observer:	SHOT, OUT. . . . ADD 100, OVER.
Radiotelephone operator:	ADD 100, OUT.
HCO:	RANGE 4610.
Battery B computer	RANGE 4610.
HCO:	DEFLECTION 3270.
Battery B computer (to firing battery):	DEFLECTION 3270.
Battery B computer (to firing battery):	QUADRANT 280.
Battery B computer	SHOT.
Radiotelephone operator:	SHOT, OVER.
Observer:	SHOT, OUT. TIME, RIGHT 10. DROP 50, OVER.
Radiotelephone operator:	TIME, RIGHT 10, DROP 50, OUT.
Battery B computer (to firing battery):	FUZE TIME.
HCO:	BRAVO, RANGE 4550.
Battery B computer	RANGE 4550.
HCO:	DEFLECTION 3272.
Battery B Computer:	DEFLECTION 3272.

Note: The computer combines the site, +4, with 20/R, +4, and adds the sum to the elevation, 272, to determine the quadrant, 280, to fire the first rounds of time fuze. He also notes the change in fuze setting for a 10-meter change in height of burst to be used for observer height-of-burst corrections. Since the adjustment of range and deviation has been completed, the HCO can now determine chart data for the nonadjusting batteries as follows:

	Battery A	Battery C
Range	4550	4400
Deflection	3372	3171
Battery B computer: (to firing battery):	DELECTION 3272, TIME 16.2, QUADRANT 280.	

Battery B computer: SHOT.

Radiotelephone operator: SHOT, OVER.

Observer: SHOT, OUT. . . . UP 10, FIRE FOR EFFECT, OVER.

Radiotelephone operator: UP 10, FIRE FOR EFFECT, OUT.

All computers (repeated back by firing batteries): BATTERY 4 ROUNDS.

Battery B computer: CORRECTION, UP 10.

Note: During the height-of-burst adjustment, no plotting is required by the chart operators. The observer height-of-burst corrections are converted to a correction to fuze setting by the computer. In this example mission, with only one height-of-burst correction required, each computer will apply a correction to fuze setting for a total correction of UP 10. Each battery computer determines and transmits fire commands for his battery and reports when his battery begins firing.

Battery B computer (to firing battery): TIME 16.1, QUADRANT 280.

Battery B (at firing battery): TIME 16.1, QUADRANT 280. . . . SHOT.

Battery B computer: SHOT.

Radiotelephone operator (as one battery begins firing for effect): SHOT, OVER.

Note: Each computer reads back when his battery reports ROUNDS COMPLETE.

Radiotelephone operator (as last battery's fire for effect is completed): ROUNDS COMPLETE, OVER.

Observer: ROUNDS COMPLETE, OUT. . . . END OF MISSION, PLATOON DISPERSED, ESTIMATE 15 CASUALTIES, OVER.

Radiotelephone operator: END OF MISSION, PLATOON DISPERSED, ESTIMATE 15 CASUALTIES, OUT.

All battery computers (to their batteries): END OF MISSION, TARGET ALFA FOXTROT 2413.

If the HE was adjusted correctly, the fire for effect with fuze time will be within 50 meters of the adjusting point and no range or deviation corrections will be necessary in adjusting for a proper height of burst. It is necessary to understand this, since with a large angle T a graze burst or high airburst with the initial time rounds will not burst on the OT line. For example, if the angle T were 800 mils, guns on the left, and the initial time rounds were graze bursts, the observer would spot these rounds as OVER RIGHT on the OT line. If the initial time rounds were high airbursts, the observer would stop the rounds as SHORT LEFT even though the trajectory had passed through the adjusting point within the 50-meter tolerance.

Correct vertical shifts in polar plot and in shift from a known point missions are especially important when fuze time is fired. If the observer ignores an obvious vertical shift, the site determined by the FDC will be in error and, therefore, the fire-for-effect quadrant elevation and initial fuze setting will be in error. Such errors will necessitate excessive height-of-burst corrections and may require the observer to make a correction for range and deviation.

If the observer makes range or deviation corrections after height-of-burst corrections have been made, the computer determines a fuze setting corresponding to the new range and applies a Δ FS correction for the cumulative height-of-burst corrections to that fuze setting to determine the fuze setting to fire. For example, assume the following additional events in the above mission:

Radiotelephone operator:	ROUNDS COMPLETE, OVER.
Observer:	ROUNDS COMPLETE, OUT. . . . RIGHT 50, ADD 100, REPEAT, OVER.
Radiotelephone operator:	RIGHT 50, ADD 100, REPEAT, OUT.
HCO:	BRAVO, RANGE 4640.
Battery B computer:	RANGE 4640.
HCO:	DEFLECTION 3255.
Battery B computer:	DEFLECTION 3255.
Battery B computer (to firing battery):	DEFLECTION 3255, TIME 16.5, QUADRANT 286.

Note: As in the previous fire for effect, the HCO reads range and deflection for Batteries A and C and each computer determines and transmits fire commands for his battery and reports when his battery begins firing. All computers will apply a correction to the new fuze setting for the total height-of-burst correction; in this case, UP 10.

FUZE SETTING FACTORS FOR A 10-METER CHANGE IN HEIGHT OF BURST

FS	FS	FS	FS
6.0	0.40	16.0	0.13
7.0	0.31	17.0 — 18.0	0.12
8.0	0.26	19.0	0.11
9.0	0.23	20.0 — 22.0	0.10
10.0	0.21	23.0 — 25.0	0.09
11.0	0.19	26.0 — 29.0	0.08
12.0	0.17	30.0 — 32.0	0.07
13.0	0.16	33.0 — 41.0	0.06
14.0	0.15	42.0 — 50.0	0.05
15.0	0.14	51.0 — 60.0	0.04

The above table lists changes in fuze setting factors (Δ FS) for a 10-meter change in height of burst which are applicable for all charges with 105-mm, 155-mm, or 8-inch howitzer firing projectile HE and fuze MTSQ. The argument for entry is the fuze setting fired expressed to the nearest whole number.

Note 1. The Δ FS values depicted in the table are not the exact values for all calibers and charges. To reduce the size of the table, mean values are represented; however, these mean values are never more than 0.01 from the exact value for the usable ranges for each charge and weapon.

Note 2: When neither the slant-scale GFT nor the above table is available, acceptable Δ FS data may be derived between 8 and 60 fuze settings by use of the formula Δ FS = $\frac{2}{FS}$.



FIELD ARTILLERY SYSTEMS REVIEW

The first Field Artillery Systems Review, a conference designed to focus high level attention on current and planned field artillery systems, was held at Fort Sill on September 24-25.

The Department of the Army-sponsored session was hosted by the Continental Army Command (CONARC) represented by Major General Charles P. Brown, Fort Sill Commanding General.

Twenty-two general officers and several Department of the Army civilians of equivalent rank were among the 115 attendees at the review. Heading the list of general officers was General Bruce Palmer, Jr., Army Vice Chief of Staff, who chaired the review.

Major subjects discussed were TACFIRE, target acquisition, ammunition, and cannon, rocket and missile systems. Many of the developments and modifications resulting from the review will be discussed in future issues of THE FIELD ARTILLERYMAN.

Radar Registrations



Radar Registrations

A recently developed technique for conducting radar-observed registrations is currently being taught at the United States Army Field Artillery School.* This method, which uses the AN/MPQ-4A radar section attached to a direct support artillery battalion, is designed to replace observers in conducting registrations. Either high-burst or mean-point-of-impact (MPI) techniques may be used.

In addition to being more accurate than a registration conducted by an observer, a radar-observed registration is faster, requires only one observation post (OP) (the radar itself), and requires less survey, communications, and coordination because only one point need be occupied. Radar MPI registrations can be conducted during periods of poor visibility and with high-angle fire, and since the radar need not observe the actual

*A related article titled "Radar on the Gunnery Team" appeared in the May 1968 issue of **ARTILLERY TRENDS**.

impact of the rounds, it can be positioned in defilade for troop and equipment protection. The radar will provide coordinates and altitude or polar plot data to the mean burst location of six usable rounds or separate data for each round.

EMPLOYMENT

Employment and position requirements for the radar set depend on the tactical mission assigned to the radar section and on certain technical and tactical factors which influence the operation of the radar set. The complete suitability of a radar site can be determined only by the accomplishment of the assigned mission from this site.

A site should be selected that will enable as many batteries as possible to take advantage of the radar's registration capabilities without degrading the radar's countermortar or counterbattery role. The radar position should be adjacent to at least one of the firing batteries. Such a location simplifies communications, survey, and logistics and enables the radar section to take advantage of an existing defensive perimeter.

The radar should be placed in defilade to protect personnel and equipment from hostile fire and to reduce the effects of electronic countermeasures.

CONSIDERATIONS OF RADAR REGISTRATION

A high-burst registration should be conducted only when the burst is visible from the radar in order to maintain accuracies within acceptable limits. Ranges measured from the radar to the high burst (or MPI) are slant ranges. For plotting and computational purposes, the horizontal range error introduced is insignificant and the radar slant range is considered to be horizontal range.

SELECTION OF AN ORIENTATION POINT

Some coordination and mutual understanding must exist between the fire direction center and the radar personnel in the choice of a high-burst (MPI) orientation point. The FDC requires that the quadrant elevation and the vertical interval to the predicted burst point computed from the battery center not exceed the limitations stated on the back of the appropriate GST (graphical site table). Exceeding these limitations introduces unacceptable errors. For example, the limitations for a 155-mm howitzer M109, stated on GST 155-AH-1, are as follows:

The vertical interval must be between —400 and +1,000 meters.

The quadrant elevation must not exceed the following:

Green bag

Charges 1 through 4 QE 525
Charge 5 QE 560

White bag

Charges 3 through 6 QE 525
Charge 7 QE 560

(If the quadrant exceeds the stated limitation, use the next higher charge.)

For a high-burst registration, direct line of sight to the selected point is necessary. In order to optically observe elevation deviations below as well as above the selected point, the pointing elevation of the radar should be 10 mils above the elevation to the radar screening crest. The elevation to the screening crest is measured from the radar along

the azimuth to the selected point by sighting through the optical telescope. The pointing elevation of the radar, if possible, should not exceed 50 mils. The need for coordination between the FDC and the radar personnel in selecting the orientation point is readily apparent.

For an MPI registration, only an electrical line of sight is necessary. However, the pointing elevation must be determined in the same manner as it is for the high-burst registration to ensure electrical beam clearance. A characteristic of the radar MPI registration is that the rounds usually cannot be observed at impact because the radar is normally sited behind a mask. Therefore, it is necessary that the radar observe the rounds at some place in space where they pass through the radar beam. This place in space is called the selected datum plane—the theoretical horizontal plane of the radar beam from which the radar personnel compute the "did hit" or chart location of the six usable rounds (fig 1).

The location of the orientation point is designated to the radar by grid coordinates. For a high-burst registration, the radar section will compute the selected altitude of the high burst to be fired. This altitude is reported to the FDC for computation of site for the initial quadrant to be fired. For a radar MPI registration, the FDC will utilize the ground site determined from the map-inspected altitude of the orientation point to compute the quadrant to be fired. If either the sighting requirements of the radar or the limitations of the appropriate GST are exceeded, the FDC must select another orientation point or cancel the mission.

MESSAGE TO OBSERVER

The registration is initiated by a message to observer. The purpose of this message is to inform the radar crew of the mission and to provide the crew with the information required to prepare the radar set for this mission. The message to observer consists of four to six elements; the

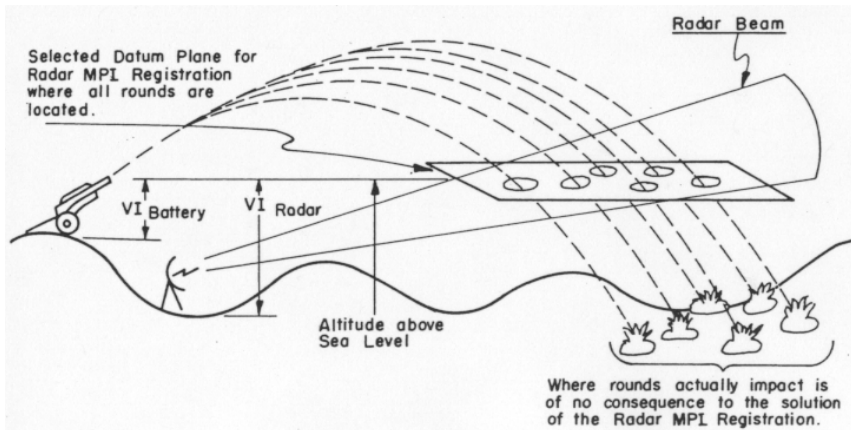

Figure 1. Theoretical MPI selected datum plane.

number of elements depends on the type of registration to be fired. These elements are discussed below in the sequence in which they are transmitted.

Warning Order. The warning order must always be included. This element consists of the order OBSERVE HIGH BURST (MEAN POINT OF IMPACT) and informs the radar section of the type of registration to be fired and notifies the section to begin preparations immediately.

Unit to Fire. The unit to fire may be eliminated by SOP when the radar section is not required to contact the battery to fire or to know the battery location. This element consists of the word FOR, followed by the call sign or code name of the unit to fire.

Grid. The grid must always be included. This element specifies the military grid reference of the selected point to the nearest 10 meters.

Minimum Acceptable Altitude. The minimum acceptable altitude consists of the phrase MINIMUM ALTITUDE followed by the altitude (in meters) below which the orientation point should not be selected. This altitude should be high enough to ensure airbursts when conducting a high-burst registration. Fifty meters is usually a good height of burst but in no case should the height of burst be less than $2 PE_h$ above the selected point. The minimum acceptable altitude is omitted for mean-point-of-impact registrations.

Altitude Report. The altitude report consists of the command REPORT ALTITUDE. This requires the radar section to determine the altitude of the announced high-burst orientation point based upon the range and elevation of the radar to that point and to report this value to the FDC as soon as possible. The FDC uses this predicted altitude to compute the site for the initial quadrant to be fired for the high-burst registration. If the predicted altitude is below the minimum acceptable altitude, the minimum acceptable altitude is then reported to the FDC and the radar is oriented to that point in space. If the predicted altitude causes the FDC to exceed the limitations of the GST, the FDC must either move the orientation point or cancel the mission. The altitude report is omitted for radar MPI registrations.

Report Order. The report order consists of the order REPORT WHEN READY TO OBSERVE and directs the radar section to inform the FDC when it is ready to observe the registration. When the AN/MPQ-10A radar system is used for MPI registrations, this element must be preceded by the weapon caliber, charge, and quadrant to be fired. This information is necessary for further orientation of the radar set.

CONDUCT OF RADAR REGISTRATIONS

Radar registration procedures are identical to standard MPI and high-burst registration procedures except as noted in the preceding paragraphs and the following example problems and when the vertical interval from the battery to the reported altitude of the high burst exceeds 100 meters.

When a small vertical interval (100 meters or less) is obtained from a high-burst registration, the effect on the fuze setting is negligible. However, in the conduct of radar high-burst registrations, large vertical intervals (greater than 100 meters) are frequently obtained because of the positioning requirements of the radar. When the vertical interval is greater than 100 meters, the complementary angle of site must be considered in determining the total fuze correction. The procedure for determining and applying the total fuze correction when the vertical interval is greater than 100 meters is as follows:

Determine the angle of site and site to the reported mean location of the high burst (GST).

Determine the complementary angle of site.

Determine the fuze setting for the adjusted elevation plus the complementary angle of site (GFT).

Determine the total fuze correction by subtracting the fuze setting for the adjusted elevation plus complementary angle of site from the fuze setting used to fire the high-burst registration.

Add the total fuze correction to the fuze setting for the adjusted elevation (GFT). At this value (adjusted fuze setting at the level point), construct the time gageline on the cursor of the GFT. The GFT setting now permits accurate transfer of time fire within small vertical intervals (100 meters or less). When fuze time is fired and first-round accuracy is required for a target with a large vertical interval (greater than 100 meters), the fuze setting should be determined by applying the total fuze correction to the fuze setting for the elevation plus the complementary angle of site to the target.

EXAMPLE—HIGH BURST, SMALL VERTICAL INTERVAL

A 155-mm howitzer M109 battalion has just made a night occupation of position. Position area survey has been completed. There are no surveyed observation posts. An AN/MPQ-4A radar section is located in a nearby direct support artillery battalion perimeter. In order to deliver accurate unobserved fires from this new position, the S3 decides to have Battery B fire a radar-observed high-burst registration with charge 5 green bag. Upon inspection of the map, the S3 decides to fire the high burst at grid intersection 6237 with a desired height of burst of 50 meters. The map-inspected altitude at the grid intersection is 376 meters.

From the firing chart constructed by the HCO, the following data to the 6237 grid intersection are measured and announced:

RANGE 6420.
DEFLECTION 3287.

The VCO computes the minimum acceptable altitude to be sent to the radar.

Minimum altitude 426 (376 + 50).

Message to observer.

OBSERVE HIGH BURST FOR LOUD THUNDER 18, GRID 62003700, MINIMUM ALTITUDE 426, REPORT ALTITUDE, REPORT WHEN READY TO OBSERVE.

Altitude report from radar: ALTITUDE 456.

The VCO computes and announces the following site:

BATTERY B ALTITUDE 352.
VERTICAL INTERVAL +104 (456 — 352).
SITE + 18 (+104/6420 GST).

The computer determines and sends the battery the following fire commands:

BASE PIECE ADJUST, SHELL HE, LOT XZ, CHARGE 5, FUZE TIME, BASE PIECE 1 ROUND, AT MY COMMAND, DEFLECTION 3287, TIME 21.6, QUADRANT 342.

Note: Computed data cannot exceed previously stated GST limitations.

When the radar reports READY TO OBSERVE and the base piece reports READY, firing is begun. If the burst from the first round appears above the horizon but is not seen on the radar B-scope, the pointing angle of elevation must be changed to cause the next round to burst in the radar beam. The antenna may also have to be moved in azimuth to cause the burst to appear near the center of the telescope. When the antenna is moved in either azimuth or elevation, the new pointing data must be entered on the high burst form. As each round is fired, the radar operator reports OBSERVED or UNOBSERVED. Early in the registration if the bursts occur too low or too high to be visible within 10 mils of the center of the radar scope, the radar operator reports OBSERVED, REQUEST SITE INCREASE (DECREASE). The S3 will have the computer increase (decrease) the quadrant by the number of mils necessary to raise (lower) the bursts approximately $2 PE_h$, using the $100/R$ factor.

The computer determines the PE_h from the supplementary data table by interpolation, using the range to the registration (orientation) point expressed to the nearest 100 meters:

$$PE_h = 17$$

$$2 PE_h = 34 (30)$$

$$100/R = 16$$

$$\text{Site increase} = +5 \text{ mils} \left(\frac{30 \times 16}{100} \right)$$

The quadrant previously fired is increased by 5 mils, and the computer announces QUADRANT 347 (342 + 5).

When six usable rounds have been observed by the radar, the radar operator reports END OF MISSION.

The location of the mean burst is computed by the radar section and is reported to the FDC by one of the three previously stated methods. The grid coordinates and altitude are the most rapid and the easiest data to report, since the radar location need not be plotted on the firing chart.

Report from radar:

HIGH BURST OBSERVED 2315 HOURS, GRID 62403688, ALTITUDE 438.

The chart operators plot the announced high-burst location and determine the following data:

HCO: RANGE 6310, DEFLECTION 3282.

VCO: Vertical interval +86 (438 — 352).

SITE +15 (86/6310, GST).

Note: Since the vertical interval does not exceed 100 meters, standard procedures are followed.

The following data are derived from this registration:

	Chart data		Adjusted data	
Range	6310	QE	347	
Deflection	3282	Elevation	332	(347 — (+15))
Site	+15	Deflection	3287	
		Time	21.6	

GFT B: Chg 5, lot XZ, rg 6310, el 332, ti 21.6.

Total deflection correction L5

EXAMPLE—HIGH BURST, LARGE VERTICAL INTERVAL

The following problem illustrates the conduct of a high-burst registration and the determination of registration corrections when the vertical interval from the battery to the altitude of the high burst reported by the radar exceeds 100 meters.

The S3 decides to have Battery A fire a radar-observed high-burst registration at grid intersection 6337 with a desired height of burst of 50 meters. The map-inspected altitude at the grid intersection is 370 meters.

The following data are measured and announced by the HCO:

RANGE 6530.

DEFLECTION 3198.

The VCO computes the minimum acceptable altitude to be sent to the radar.

Minimum altitude 420 (370 + 50).

Message to observer:

OBSERVE HIGH BURST FOR LOUD THUNDER 18, GRID 63003-700, MINIMUM ALTITUDE 420, REPORT ALTITUDE, REPORT WHEN READY TO OBSERVE.

Altitude report from radar: ALTITUDE 538.

The VCO computes and announces the following site:

BATTERY A ALTITUDE 355.

VERTICLE INTERVAL + 183 (538 — 355).

SITE: +32 (+183/6530, GST).

The computer determines and sends to the battery the following fire commands:

BASE PIECE ADJUST, SHELL HE, LOT QR, CHARGE 5, FUZE TIME, BASE PIECE 1 ROUND, AT MY COMMAND, DEFLECTION 3198, TIME 22.0, QUADRANT 363.

Note: The computed data cannot exceed the previously stated GST limitations.

When six usable rounds have been observed by the radar, the radar operator reports END OF MISSION.

Report from radar:

HIGH BURST OBSERVED 1835 HOURS, GRID 61063682, ALTITUDE 522.

The chart operators plot the announced high-burst location and determine the following data:

HCO: RANGE 6340, DEFLECTION 3191.

VCO Vertical interval +167 (522 — 355).

SITE: +30 (+167/6340, GST).

Angle of site: +27 (167/6340, C and D series, GST).

Note: The vertical interval exceeds 100 meters; therefore, the complementary angle of site must be considered in the determination of the total fuze correction.

The computer determines the total fuze correction and the adjusted fuze setting at the level point:

Complementary angle of site is +3 (+30 — (+27)).

Adjusted elevation is 333 (363 — (+30)).

Adjusted elevation plus complementary angle of site is 336 (33 + (+3)).

Fuze setting for adjusted elevation plus complementary angle of site is

22.2.

Total fuze correction is —0.2 (22.0 — 22.2).

Fuze setting for adjusted elevation is 22.1.

Adjusted fuze setting at the level point is 21.9 (22.1 + (—0.2)).

The following data are derived from this registration:

	Chart date	Adjusted data	
Range	6340	QE	363
Deflection	3191	Elevation	333
			3198
Site	+30	Deflection	3198
		Time	21.9 (at level point)

GFT A: Chg 5, lot QN, rg 6340, el 333, ti 21.9.

Total fuze correction —0.2.

Total deflection correction L7.

Note: When time fuze is fired with first-round accuracy on the target and with vertical intervals exceeding 100 meters, the constructed time gageline should not be used and the total fuze correction should be added to the fuze setting for the elevation plus complementary angle of site to the target.

EXAMPLE—MEAN POINT OF IMPACT, SMALL VERTICAL INTERVAL

A 155-mm howitzer battery has just occupied a position during an intense fog. Survey is complete but, because of the fog, the established OP's have very limited visibility. An AN/MPQ-4A radar section is located in an adjacent battery's perimeter. The battery fire direction officer decides to fire a radar-observed mean-point-of-impact registration using charge 4. The fire direction officer decides to fire the MPI at grid intersection 6336. The map-inspected altitude at this grid intersection is 382 meters.

The HCO measures and announces the following data to the 6336 grid intersection:

RANGE 5180.
DEFLECTION 3047.

Message to observer:

OBSERVE MPI LOUD THUNDER 69, GRID 63003600, REPORT WHEN READY TO OBSERVE.

The VCO computes and announces the following site:

BATTERY C ALTITUDE 348.
VERTICLE INTERVAL +34 (382 — 348).
SITE +8 (34/5180, GST).

The computer determines and sends to the battery the following fire commands:

BASE PIECE ADJUST, SHELL HE, LOT LS, CHARGE 4, FUZE QUICK, BASE PIECE 1 ROUND, AT MY COMMAND, DEFLECTION 3047, QUADRANT 328.

When six usable rounds are observed by the radar, the radar operator reports END OF MISSION. The location of the MPI in the selected datum plane is computed by the radar section and is reported to FDC.

Report from radar:

MPI OBSERVED 0945 HOURS, GRID 62933566, ALTITUDE 434.

The chart operators plot the announced MPI location and determine the following data:

HCO: RANGE 4830, DEFLECTION 3053
VCO: Vertical interval +86 (434 — 348).
SITE +20 (+86/4830, GST).

The following data are derived from this registration:

	Chart data		Adjusted data
Range	4830	QE	328
Deflection	3053	Elevation	308 (328 — (+20))
Site	+20	Deflection	3048

GFT C: Chg 4, lot LS, rg 4830, el 308.

Total deflection correction R5.

Canopy Clearance

*LTC Sam T. Dewhirst
LTC (Retired) Matthew J. Ringer
Gunnery Department
USAFAS*

The difficulties of adjusting fire in a heavy jungle are frequently compounded by the forward observer's inability to see either the target or his own rounds and by the necessity for adjusting fires by sound. The ultimate danger occurs when he brings fires in close by creeping, since friendly casualties can result if the rounds do not clear the canopy but instead burst directly overhead.

The FDC can earn the undying gratitude of the FO by looking out for his interests in this situation. If the FO knows the location of friendly units in the area and the height of the canopy in feet (and it is highly desirable that he report these), the FDC can make reasonably sure that all rounds fired clear the treetops. If the FO doesn't know his own position, then he must provide a direction and an estimated distance to the first round so that the FDC can back-plot his position.

Once the FO has reported the location of friendly elements on or near the gun-target line and the height of the canopy, the FDC can compute safety data. Table I provides information to guide the FDO in determining whether fires will or will not clear the treetops.

EXPLANATION OF TABLE I

Column 1 lists angles of fall from 100 to 1,000 mils and is used as the basis for entering the table.

Columns 2 through 4 list the minimum horizontal distance (in meters) from the FO to the burst which will clear canopies of 100 feet (col 2), 200 feet (col 3) and 300 feet (col 4). Interpolation for angle of fall or canopy height is permitted.

The values in columns 2 through 4 of table I provide FO-to-burst distances at which the base piece will clear the canopy with an associated probability of 50 percent. If the complete battery is to fire, the distances in columns 2 through 4 must be increased by one-half the battery depth. In addition, if a probability greater than 50 percent is desired, the number of PE_r for the desired probability listed in table II must be added to the FO-to-burst distance obtained from table I.

USE OF THE TABLES

Assume that a battery of 105-mm howitzers M102 is firing charge 6. Battery depth is 80 meters. The FO has reported that he is in a jungle

canopy which he estimates to be 200 feet high. The FO estimates the OT distance to be 400 meters, but he requests initial rounds (by polar plot) at 600 meters. A canopy clearance probability of 98 percent is desired.

Rd no QE FO-burst distance Comment FO Correction

1 180 600 meters Safe DROP 100

Note 1. The FDC enters TFT 105-AS-2, charge 6, table G, at elevation 180 and extracts an angle of fall of 215 mils for elevation 180.0. Safe distance with a probability of 98 percent is 290 meters (table I, interpolated) plus 3 PE_r (24 meters) or 315 meters.

2 175 500 Meters Safe DROP 100

Note 2. Safe distance (from table 1) is 297 meters plus 24 meters, or 321 meters.

3 170 400 meters Safe DROP 100

Note 3. 303 plus 24 meters = 327 meters.

4 170 400 meters Safe FIRE FOR EFFECT

Note 4. Since the battery will fire, one-half the battery depth must be added to the 327-meter minimum safe distance computed for round 3. The safe distance then is 327 plus 40, or 367. Since the estimated FO-burst distance is 400 meters, the six rounds in fire for effect should clear the trees.

A little experience in the use of tables I and II will eliminate the need for most of the computations in the above problem. A glance will normally show whether the QE is safe, unsafe, or marginal. Computations would be necessary only in marginal situations. If a round is computed as unsafe (friendly troops-to-burst distance is equal to or less than computed safe distance), then the FO must change to a lower charge, fire high angle, or accept a lower probability of clearing the canopy.

A modification to table I would further simplify computations. It is recommended that the FDC, instead of using the angle of fall in column 1, determine a corresponding elevation (table G, columns 2 and 8) and list these elevations for the specific weapon and each charge. For example, a table for an M102 would look like this for an angle of fall of 400 mils:

CHG	QE and charge							Distance from FO to burst (meters) to clear canopies of—		
	1	2	3	4	5	6	7	100 feet	200 feet	300 feet
QE	373	369	364	358	347	328	291	73	147	221

QEs for the remaining angles of fall are completed in the same manner.

Table I.

Angle of fall (mils)	100 feet	200 feet	300 feet
50	622	1,244	1,867
100	311	622	933
200	153	306	460
300	100	201	302
400	73	147	221
500	57	114	171
600	46	91	137
700	37	74	111
800	30	61	91
900	25	50	75
1,000	20	41	61

Table II.

Probability of NOT hitting the treetops	Number of PE _r to add to friendly unit-burst distance
50 percent	0
75 percent	1
91 percent	2
98 percent	4
99.9 percent	4



Safety Information

Extracting/Ramming Tool

Recently the propelling charge of a 105-mm cartridge inadvertently exploded and resulted in serious injury to four persons. An investigation of the accident revealed that during a night fire mission, a round did not fully chamber when loaded, and the extracting and ramming tool was used in an attempt to seat the round. During this procedure one tip of the tool struck the primer, causing ignition of the propellant and subsequent shattering of the cartridge case. Only one of two things could have caused this type accident; either the wrong extracting and ramming tool was used or, if the proper tool was used, it was inserted upside down into the breech recess.

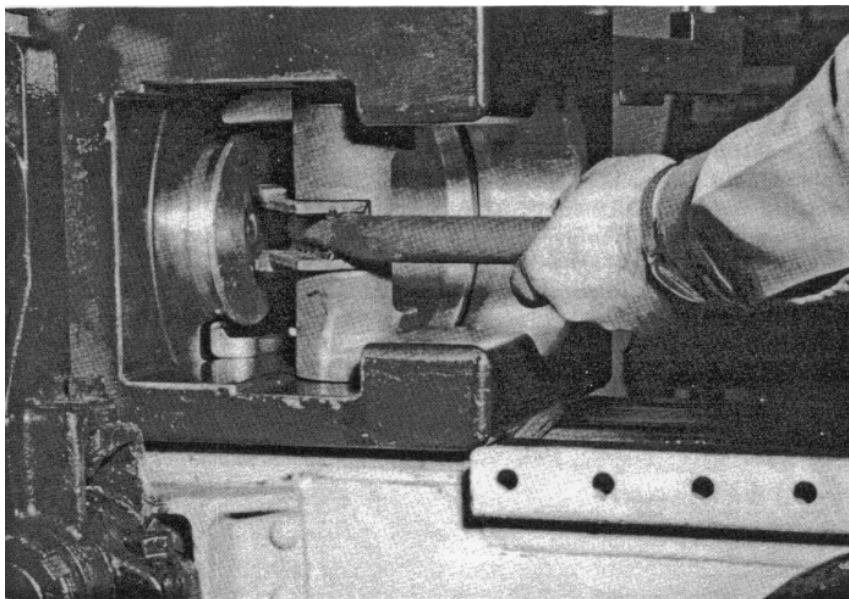

Figure 1. Correct method of inserting tool into the breech recess of an M101A1.

Research at the Field Artillery School has revealed that several different tools have been issued to 105-mm units. Seven tools, each bearing a different part number, were found. Of these, there were three different models of the same numbered tool, and two different models of another. Some of these tools were designed for use with M60 series, M48 series and M41 series tanks.

It is recommended that all 105 units check the part numbers of all extracting and ramming tools on hand to insure that the correct tool is being used. For the towed 105-mm howitzers, M101 or M101A1, the correct tool is part number 7306159. This part number is found on the face of the extractor end of all extracting and ramming tools. In addition to checking the part number, since there are at least two different models of this number, the cylindrical portion, or fulcrum, should measure $6\frac{1}{2}$ inches across and the inside dimension between the ramming plates should be at least $1\frac{1}{2}$ inches. For the towed 105-mm howitzer M102 and the self-propelled M108, the correct tool is part number 11577644. The cylindrical fulcrum of this tool should measure at least $6\frac{3}{8}$ inches across and the interior dimension of the ramming plates should be at least $1\frac{1}{2}$ inches.

All tools which do not bear the proper part numbers or which do not meet the measurements specified should be turned in to unit supply and the correct tool requisitioned. Authority for requisition for part number 7306159 (M101 or M101A1 howitzer) is contained in change 5 to TM 9-325 and authority for requisition of part number 11577644 (M102 howitzer) can be found in TM 9-1015-234-12. Part number 11577644 for the M108 howitzer is found in change 4 to TM 9-2350-217-10. Further implementing instructions for disposition and replacement of incorrect tools are being published by USA Weapons Command.

In addition, all units are strongly urged to conduct instruction on the proper use of the extracting and ramming tool with special emphasis on the ramming application. The tool should always be placed in the breech recess so that the curved sides of the ramming plates are toward the cartridge case (fig 1 and 2).

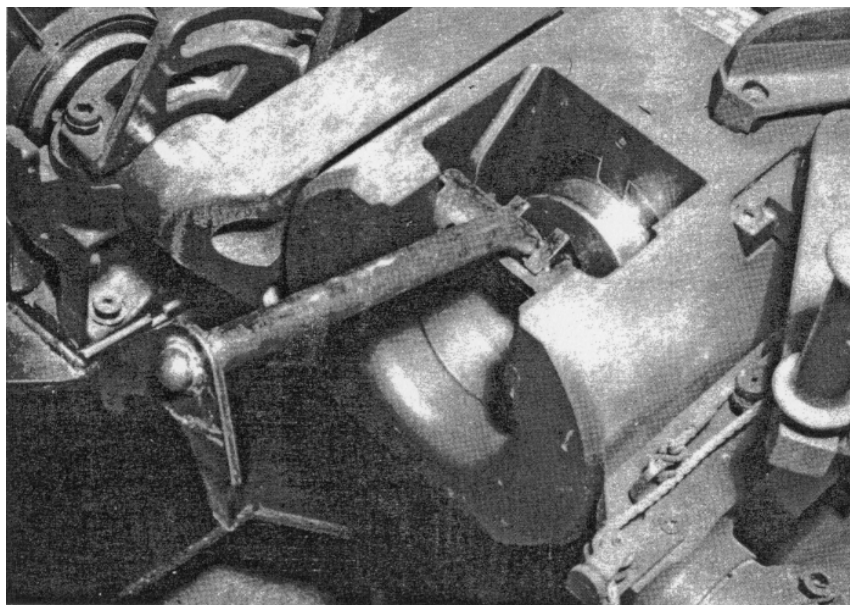

Figure 2. Correct method for M102.

●

ARMY TESTING IMPROVED JEEP

A third generation model of the jeep is currently undergoing testing by the U. S. Army Combat Developments Command in an effort to provide a safer, more economical, and easier-to-maintain vehicle for military forces.

The new version of the quarter-ton, general purpose truck, designated M151, includes improvements in the suspension system and brakes.

Are Your Ammunition Procedures Dangerous?

*MAJ Charles W. Jackson, Jr.
Gunnery Department
USAFAS*

Field artillerymen will agree that the required procedures for storing and handling ammunition are important and that neglect in this area may have tragic results. In fact, many field artillery firing incidents, can be attributed to such neglect. The correct procedures are not new or obscure but are well established and should be standard in all units. Hopefully, this article will assist field artillery units in evaluating their current operations. The procedures and safety precautions presented in this article are particularly important and have been included because information from the field indicates that they are sometimes overlooked. Although this oversight does not always create an immediate and obvious problem, correct procedures must be relentlessly enforced to insure safe and reliable ammunition functioning.

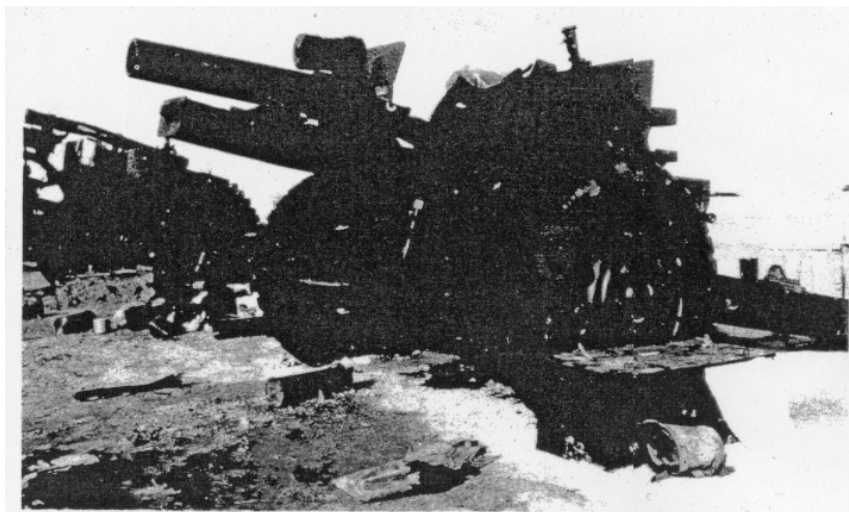

Figure 1. The result of an inbore explosion probably caused by an M513 VT fuze that was not fully seated.



Figure 2. This howitzer section demonstrates IMPROPER ammunition handling.

The following procedures and precautions have an important bearing on the safe and reliable functioning of ammunition:

- Do not tumble, drag, throw, or drop any ammunition components.
- Store ammunition in the driest possible location and place it on dunnage to raise it off the ground.
- Unpackage only enough ammunition for immediate requirements.
- Do not break the moisture resistant seal on containers until the items are needed.
- Always keep a lifting plug or fuze tightly screwed into the nose of a projectile.
- Try to maintain ammunition at a uniform and moderate temperature. Special attention must be given to the prescribed temperature limits. (Reference para 1-9, TM 9-1300-203.)

FUZES

When fuzing a projectile tighten the fuze by hand and then with the M18 fuze wrench. Firmly seat the fuze with a sharp snap of the wrench. After a fuze is tightened, there must be no space between the shoulder of the fuze and the projectile.

A ROUND WILL NOT BE FIRED IF THE FUZE IS NOT FULLY SEATED. UNDER NO CIRCUMSTANCES WILL AN UNFUZED ROUND BE FIRED.

WARNING: Firing an improperly fuzed round or unfuzed round can cause an inbore explosion.

Premature functioning of superquick fuze elements must be anticipated when firing during heavy rain or hail storms. The following rules should be used as guidance for selecting fuzes in such situations:

- The M51A5, M57 modified, and M500A1 fuzes should not be used, since they are liable to function and detonate the projectile at the muzzle. The M557, M572, M520A1, and M564 fuzes should be used instead because they cannot function until they are at least 60 meters from the muzzle.

- The M548 should not be used with improved conventional ammunition (ICM) since premature functioning could endanger friendly troops.

- Point-detonating fuzes should not be set on delay unless a significant number of early bursts are known to be occurring.

Note: Point-detonating fuzes set on delay have a considerably higher dud rate than the same fuze set on PD.

In addition to the restrictions that prohibit firing M513-series and M514-series proximity fuzes in the rain, use of these fuzes is limited to the propellant charge combinations outlined in the table below:

PROPELLANTS AND PROJECTILES

The use of flash reducers is not mandatory but is strongly recommended. Currently, the primary need for a flash reducer is to decrease muzzle blast, thereby increasing crew comfort and minimizing vehicle damage. Flash reducers should be used with 155-mm, 8-inch, and 175-mm white bag propellants. (Reference para 4-7 and 4-8, TM 2300-216-10; para 2-118, 2-157, and 2-173, TM 9-1300-203.)

The additive jacket M1 should always be used firing charge 3 with the 175-mm gun. (Reference para 4-8, TM 9-2300-216-10.) This item reduces bore wear.

Prior to firing, inspect all M86 and M86A1 propelling charges for the 175-mm gun in accordance with the procedures referenced below. Those propellants which fail to pass any step of the inspection will be replaced in their containers and returned to the ammunition supply point. (Reference para 4-8, TM 9-2300-216-10.)

WARNING: The use of a damaged propellant may cause damage to the weapon and injury to the crew.

Prior to its use, all ammunition will be subjected to a thorough inspection. If an item of ammunition exhibits any of the first three defects listed below, that item will not be used.

- Inspect fuzes for dented, cocked, or loose parts.
- Inspect projectiles for surface damage or filler leakage. Be especially watchful for leakage around the base of the projectile, around the base of the fuze for fuzed ammunition and in the fuze well for unfuzed ammunition.
- Inspect propellants for dampness and torn powder bags.
- Inspect each complete round just before loading to insure that it is clean and is assembled as specified in the firing commands.

A round should be loaded just prior to firing and then only after both the requirement and clearance to fire are definite. In spite of these precautions, the situation may arise in which a round is loaded and cannot

PROXIMITY MODE

Fuze model	Weapon system	Charge
M513 (all series)	105-mm howitzer	2 through 6; charge 7 in emergency combat conditions only.
M514 (all series)	155-mm howitzer	3 green bag and above or 5 white bag and above.
M514 (all series)	8-inch howitzer	3 green bag and above or all white bag.
*M514A1 (with KEL-F)	175-mm gun	All charges.

*All lots of M514A1 fuzes are suitable for firing at charges (zones) 1 and 2 with the 175-mm gun, but only those lots marked "Tested Nose Cone KEL-F" or "Tested Nose" are suitable for firing at charge (zone) 3. The M514 and M514B1 fuzes are not suitable for use with the 175-mm gun.

POINT-DETONATION MODE IMPACT ACTION**

Fuze model	Weapon System	Charge ***
M513A1 (T226E2) M513A2 (T226E3)	105-mm howitzer	4 through 6; charge 7 in emergency combat conditions only. Use fuze PD M557 or fuze MTSQ M564 if available when charge 7 is necessary.
M514A1 (T227E2)	155-mm howitzer	4 green bag and above or 6 white bag and above.
M514A1 (T227E2)	8-inch howitzer	4 green bag and above or 6 white bag and above.
*M514A1 (with KEL-F)	175-mm gun	All charges.

In order to achieve maximum reliability, set the M513A1, M513A2, and M514A1 fuzes for 90 seconds when PD action only is desired. The M513, M513A1, M514, and M514M1 fuzes **cannot be set for PD action only because the proximity element must be armed before the impact element can become armed.

***This mode requires a higher minimum charge to insure the arming of the PD element.

be fired*. The following procedures apply in this situation:

When it is necessary to remove a projectile from a tube, it will be done by firing if at all possible.

- If ramming is necessary, extreme care must be exercised to insure that the fuze is not damaged. Only the bell rammer which is authorized for a particular caliber should be used. In addition, the fit of brass rammers must be checked frequently because they tend to stretch with use.

- Projectiles and fuzes which have been unloaded by ramming must not be fired and should be destroyed or returned to the ammunition supply point for disposal.

- Hot tube and misfire procedures are very specific and must be followed precisely. Until recently, the prevention of a cookoff was the primary concern in the procedures outlined for a hot weapon. These

**A related article titled "Extracting /Ramming Tool" also appears in this issue.*

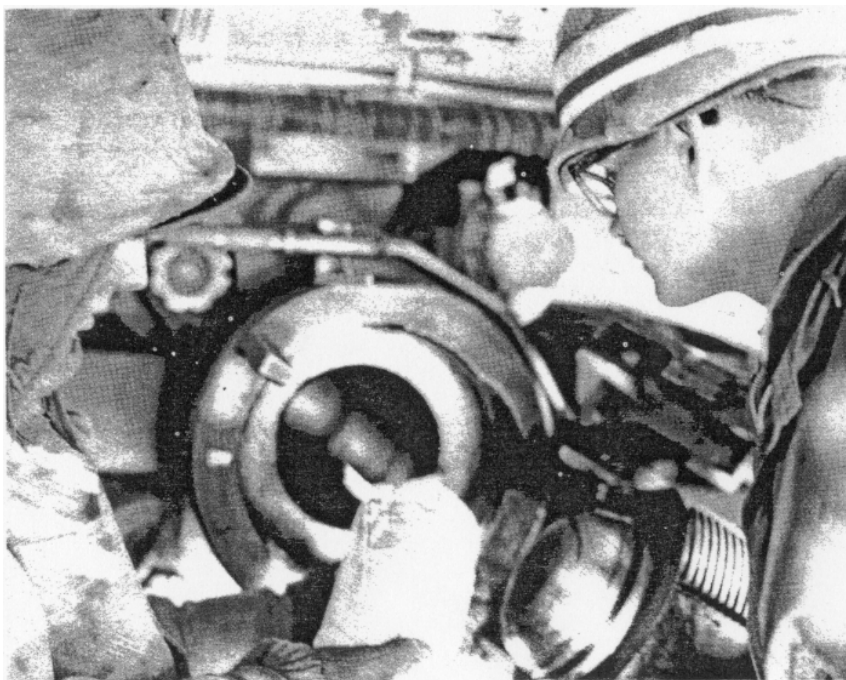

Figure 3. Battery officer inspects the powder charges for a 155-mm howitzer to insure safe firing.

procedures have been modified because the Composition B and TNT fillers in HE projectiles melt at about 160°F and then may exude from the projectile into the tube. If the weapon is fired after this has occurred, there is a high probability of an in-bore explosion. (The following reference contains the detailed procedures as modified: paragraph 1-9, TM 9-1300-203; paragraphs 52 and 53, Notes for the Battery Executive, July 1968.) Many of the weapon operator technical manuals do not contain the updated procedures.

REFERENCES

The references listed below contain a complete coverage of ammunition characteristics and procedures.

Notes for the Battery Executive, July 1968.

FM 6-40, October 1967 (Field Artillery Cannon Gunnery).

TM 9-325, May 1948 with changes 1, 2 and 5 through 8 (Operator and Organizational Maintenance Manual: Howitzer, Light, Towed, 105-mm M101 and M101A1).

TM 9-1015-234-12, March 1965, with changes 1 through 3 (Operator and Organizational Maintenance Manual: Howitzer, Light, Towed, 105-mm M102).

TM 9-1025-200-12, March 1965, with changes 1 and 2 (Operator and Organizational Maintenance Manual: Howitzer, Medium Towed, 155-mm, M114 and M114A1).

TM 9-1300-203, April 1967 with changes 1 through 8 (Artillery Ammunition).

TM 9-2300-216-10, June 1962, with changes 2, 4, 5, 7, and 8. (Operator's Manual: Gun, Field Artillery, Self-propelled: 175-mm, M107, and Howitzer, Heavy, Self-propelled: 8-inch, M110).

TM 9-2350-217-10, November 1964, with changes 1 through 3 (Operator's Manual: Howitzer, Light, Self-Propelled, 105-mm, M108, and Howitzer, Medium, Self-propelled, 155-mm M109).

All the above publications should be available at battery level except TM 9-1300-203, which is a comprehensive manual covering all cannon ammunition. It contains a description of each item of ammunition, describes its functioning, and outlines any special handling requirements. Commencing with change 8, the distribution of this technical manual was expanded to include field artillery batteries. However, until the next revision is published, only the new changes will be automatically distributed to battery level. The basic manual (which has been reprinted to include changes 1 through 5) and changes 6 and 7 must be ordered by each unit. These should be ordered through AG Publication channels from the CO AG Publications Center, 1655 Woodson Rd., St Louis, Missouri. 63114

Common Mistakes With FADAC

*MAJ Martell Fritz
Computer Systems Command
Fort Belvoir, Virginia*

Lieutenant Jones, forward observer, initiates a call for fire on a defensive target for a short-range patrol. The fire mission is received in the fire direction center and the initial data is computed with FADAC. Lieutenant Davis, fire direction officer, checks the initial data on the firing chart and obtains clearance from Captain Gillespie,



the battalion liaison officer, to fire the target. After the initial round is observed, Lieutenant Jones requests a shift of LEFT 700 meters from the first round. Lieutenant Davis checks the plot for this shift and determines that it is unsafe to fire, since the gun-target line passes over a friendly village. When Lieutenant Jones is notified of this, he corrects his shift to LEFT 400, DROP 600 meters. Since the FADAC operator has already typed, entered, and computed the original shift of LEFT 700, he attempts to compensate for the correction in the observer's shift by typing and entering a RIGHT 700 meters **but fails to depress the compute button.** Then he types, enters, and computes the data for the observer correction of LEFT 400, DROP 600. The RIGHT 700 meters, which has been typed and entered but not computed is canceled by the LEFT 400 meters. Consequently, data is computed for a LEFT 1,100 meters (L 700 + L 400). Lieutenant Davis sends the firing data to the firing battery and

this data is subsequently fired. The rounds impact in a friendly village, injuring four innocent civilians and resulting in another "artillery incident."



The incident just summarized is a hypothetical example of one of the common mistakes made with FADAC (gun direction computer M18) that produce tragic results. Inaccuracies in FADAC computations and lack of faith in the reliability of

FADAC are too often the result of mistakes and malpractices of a recurring nature.

The best preventive for mistakes and malpractices is the formation of proper habits in training; personnel responsible for training FADAC operators must insist on exactness and allow no deviation from correct procedures. A further preventive for errors is to establish proper supervisory procedures for the fire direction officer and chief computer so that all errors are detected and corrected prior to firing.

COMMON MISTAKES

Some of the common mistakes made by FADAC operators in determining firing data with FADAC are as follows:

- Failure to end the mission. The end of mission function erases the override data (charge, projectile, fuze, etc.) associated with a particular mission. If this function is not used, the overrides will remain in effect for subsequent missions.

- Incorrect entry of observer corrections. If an error in observer corrections is detected before the computer is placed in the compute mode, the operator can correct the error by entering the correct data. If the error is detected after the computer is in the compute mode, the operator must enter and compute an equal and opposite shift prior to entering the desired observer's shift.

- Incorrect computation of registration corrections. Since FADAC is used to compute only the adjustment phase of a precision registration and the fire-for-effect (FFE) phase is completed using manual computations, the operator must use the end of mission function to clear the adjustment phase data from the computer before using the compute registration point before entering the adjusted data. This will insure that registration function. He must enter or recall the actual location of the registration corrections are correctly computed on the comparison of "should hit" to "did hit" data.

Whenever registration corrections are computed and a meteorological message is **not** available, the corrections must be re-computed when met is subsequently received. However, it is essential that these meteorological conditions existed at the time the registration was fired and that the "did hit" data is still valid.

Failure to "zero corrections" before re-computing the new corrections will result in erroneous data since the "should hit" range will be in error by the amount of the previously computed correction. The use of matrix function H-7 (ZERO CORR) should always precede the use of matrix function H-8 (COMP REG).

- Failure to set up the desired calibers. The setup function is used to associate the program information for the caliber and type of weapon with selected batteries. When this function is used, all constants for a desired caliber are set to standard. This function must be used whenever FADAC is reprogrammed or whenever different calibers are associated with the battery buttons.

- Failure to cancel the gun-target line adjust function. The gun-target (GT) line adjust function is used to inform the FADAC that all observer corrections will be made with respect to the gun-target line. Should the observer desire to change to a given direction, the GT line adjust function must be canceled. If the operator does not cancel prior to entering a new observer target direction, the FADAC will continue to use the GT line even after an observer target direction has been entered.

- Failure to detect a change in charge. If the operator does not specify a certain charge to be used in computations, FADAC will select the optimum charge for the range in consideration. If the observer's adjustment involves a large range change, the optimum charge determined by FADAC may change during the mission. The operator must be especially alert to avoid firing a charge error when this situation occurs. A procedure which the operator can use is to override the charge prior to computing the observer's corrections. The charge selected would be the one chosen by FADAC for the initial firing data.

- Failure to properly apply registration corrections. If all ballistic parameters have been entered into FADAC prior to the registration, the computed corrections will reflect the accumulative error of the existing input parameters. The major part of this error is normally the result of the meteorological conditions used in FADAC differing from the actual conditions that existed at the time of the registration. To minimize the effect of these errors, this residual should be reduced to an adjusted muzzle velocity as described in para 2-18, (10) (b) FM 6-3-1. This adjusted MV should be used rather than the range K correction.

MALPRACTICES

Significant malpractices which detract from the proficiency of fire direction centers using FADAC are as follows:

- Failure to periodically check input data. The variable ballistic parameters which are entered by the FADAC operator (muzzle velocity, projectile weight, propellant temperature, etc.) as well as battery and target information stored in the computer should be recalled periodically. As a minimum, this periodic check of information stored in the computer should be performed whenever the FADAC operator is changed. This procedure will insure that the operator is always aware of the information used in computations. It will also serve as an additional check of stored information.

- Failure to check the data displayed on the Nixie panel. This error occurs where an operator attempts to enter data too rapidly. The data displayed on the Nixie panel must be verified by the FADAC operator

as well as the fire direction officer. This step is essential in any system of checks with FADAC, since it is the only positive means of detecting keyboard entry errors.

- Failure to clean air filters. The air filters used with FADAC should be cleaned at least once daily. If the FADAC is operated in a dusty or dirty environment, the air filters should be cleaned and changed more often. Failure to clean the air filters will cause increased FADAC downtime.

- Poor generator maintenance. Two 3-kw, 400-hertz, 3-phase, 120/208-volt generators are authorized for each FADAC. The second generator is authorized to insure operational capability at all times, including periods of generator maintenance. The generator should be rotated every 12 or 24 hours to allow time for periodic maintenance in accordance with TM 5-6115-271-15 and TM 5-2805-14.

- Use of unauthorized procedures. Each FADAC program is designed to accomplish certain tasks in a prescribed manner. The development of local procedures for specific problems is not a sound practice. Complete operator instructions are found in FM 6-3-1 and periodic USFAS Fire Control and Coordination Information Letters. All problem areas concerning the use of FADAC are of interest to USAFAS. Units are encouraged to submit descriptions of problem areas, with or without suggested solutions, for inclusion in future instructional material. Problem areas should be submitted to

Commandant
U.S. Army Field Artillery School
ATTN: AKPSIAS-G-RA
Fort Sill, Oklahoma 73503

●

VOLUNTEER FOR RVN DUTY

Many field artillerymen do not know how or when to volunteer for Vietnam duty. A recent survey showed that many men would have requested assignment to Vietnam earlier had they known more about application procedures while in training.

Commanders, personnel officers, trainers and drill sergeants should orient trainees on how and when to volunteer for combat zone duty. If interested in a Vietnam assignment, trainees should follow procedures outlined in Army Regulation 614-203. A formal application, however, is not required. Over 180,000 soldiers have volunteered for Vietnam since 1 July 1964.

Here Comes TACFIRE

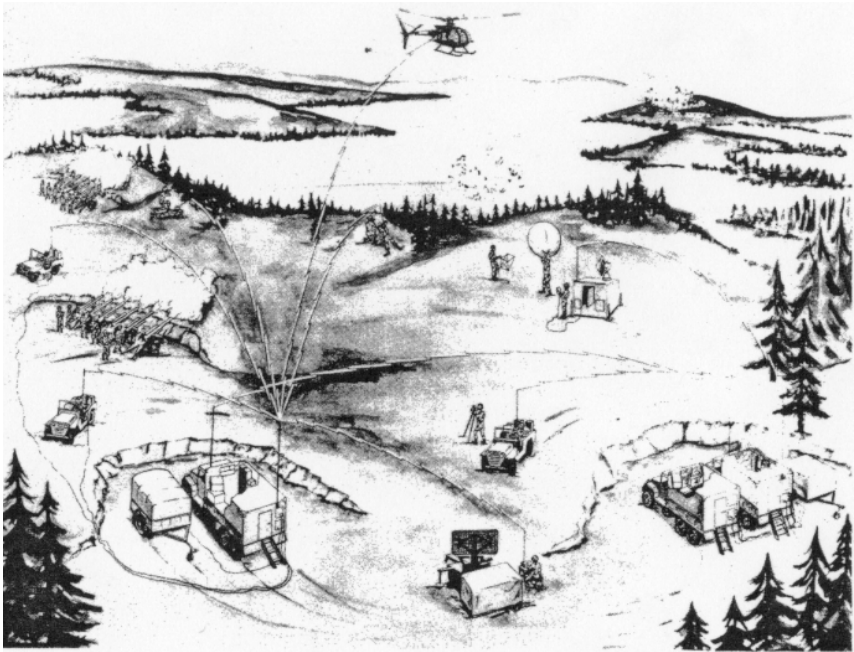

*MAJ Raymond Spigarelli
Doctrine Development, Literature and Plans, USAFAS*

*MAJ Martell Fritz
Computer Systems Command, Fort Belvoir, Virginia*

The automation of many field artillery functions is just around the corner. Since the award of a fixed-price total-package procurement contract to Litton Industries, Inc., on 8 December 1967, the tactical fire direction system, TACFIRE, has been undergoing an intensive development cycle. Present plans call for the research and development acceptance test to begin on 24 February 1970 and for the engineering test (ET) and the service test (ST) to be conducted concurrently during the 12-month period from June 1970 to June 1971. The engineering test will be conducted at White Sands Missile Range and the service test will be conducted at Fort Sill. Before the ET and ST begin, the contractor will conduct special courses of instruction to train TACFIRE staff planners, operators, programmers, and maintenance personnel.

The objective of TACFIRE is to provide greater effect on more targets in less time with less ammunition.*

TACFIRE instruction is presently scheduled to begin at the Field Artillery School in July 1972 and will be incorporated in the programs of instruction for all courses presently taught by the School. During this introductory period, the instruction on current manual techniques will be retained. Even though most of the manual techniques will no longer be used after the deployment of the TACFIRE system, the field artilleryman must have a mastery of the tactics and techniques employed to provide him with the necessary background to properly utilize the capabilities of the TACFIRE system. Three new courses will be taught at the Field Artillery School. The first course will be the TACFIRE operator's course, which will be 4 weeks in duration and will include both TACFIRE and FADAC operator procedures. The TACFIRE maintenance course will include both TACFIRE and FADAC organizational maintenance procedures. The third new course will be the TACFIRE orientation course, which is designed for those officers who completed the Field Artillery Officer Advanced Course before the introduction of TACFIRE instruction and were not assigned to field artillery units when the new equipment introductory teams conducted initial training. The key instructor personnel at the USAFAS are scheduled to begin their training at the contractor facility in late 1971. These personnel will return to Fort Sill to form the nucleus of the TACFIRE instructor base.

Due to the major impact of TACFIRE on the courses of instruction at Fort Sill, the USAFAS assigned a full-time liaison officer to the contractor facility on 8 May 1968. The liaison officer monitors the development of the system, assists the contractor in the preparation of the massive software package for the system, maintains close liaison with the instructional departments of the USAFAS, and assists USAFAS personnel with preparations for TACFIRE instruction.

The preparation of training literature for the TACFIRE system will be a major task of the utmost importance. The Gunnery Department has published a reference note entitled "The TACFIRE System" which is an excellent summary of the development progress to date. Work has also begun on a new 6-series field manual for the TACFIRE system and on the incorporation of TACFIRE information in existing training literature. Although many of these manuals are in draft form, they will be evaluated during the ET/ST to determine their adequacy for use by troop units.

As the TACFIRE system proceeds along the development cycle, it becomes obvious that the thorough training of all field artillerymen in the computerization of artillery tasks is essential to insure success on the battlefield of tomorrow. It is with this thought in mind that USAFAS personnel have laid the groundwork for future TACFIRE instruction.

*A detailed description of the TACFIRE system was presented in an article by Major General Charles P. Brown in the May 1968 issue of **ARTILLERY TRENDS**.

Australian Army Field Artillery

*LTC D. D. Weir
Commanding Officer*

School of Australian Military Forces Artillery



Since they first saw active service in the Sudan in 1885, Australian artillerymen have provided fire support for armies in South Africa, France, Gallipoli, Palestine, North Africa, Syria, New Guinea, Borneo, Malaya, Korea and currently in Vietnam. Traditionally their operational affiliation has been with British Commonwealth armies as well as their own, but more recently they have taken their place alongside the

US Artillery in Vietnam. The aim of this article therefore is to familiarise readers of **THE FIELD ARTILLERYMAN** with the way that the Royal Regiment of Australian Artillery, the RAA for short, is organised and deployed to provide surface-to-surface fire support for the front line troops.

The RAA consists of four regular regiments (US battalions) plus a number of independent specialist batteries for air defence and locating (target acquisition). In addition there are some eleven regimental equivalents of part-time soldiers of the Citizen Military Forces (CMF). The CMF is territorially based within Australia and the regular units are deployed in Australia, Malaysia and South Vietnam. The RAA component of the Australian Task Force in Vietnam consists of a regimental HQ, two field batteries and portion of a divisional locating battery.

ORGANISATION AND ASSIGNMENT

Each division in the Australian Army has assigned as organic components, three regiments of field guns and a locating battery. In addition it is usual for a battery of medium guns to be assigned from Army troops, and other artillery might be added if the occasion warrants the extra firepower. The whole of the artillery component of the division is commanded by a brigadier with a staff at divisional headquarters.

The field gun is the 105mm (US M101A1), though in special cases where air portability is of prime importance a battery might have the Italian 105mm pack howitzer L5. The medium gun is the 5.5-inch gun of British origin firing an 80 lb. shell to a range of about 16,000 metres.

The Field Regiment

Field guns are organised in batteries of six guns each and there are three field batteries in each field regiment.

It is normal for a field regiment to be assigned to a task force (brigade) and a field battery to an infantry or armoured battalion. The organisation allows for an artillery representative to be attached to the task force HQ and each of three battalion groups. More will be said later about the tactical missions for the batteries.

It will be seen that the six guns of a battery are divided into two sections. It is usual for all six to be deployed together, but, should the battery be operating independently, and it is capable of so doing, the ability to operate two sections allows for continuous fire support in fast moving operations by 'stepping up' the guns in sections.

Each field battery has its own communications, limited survey, and administrative capacity. The Headquarters Battery provides the personnel for administration of the regiment and manning of the headquarters as well as providing survey and communication support for the field batteries.

The Locating Battery

To support the field regiments and to provide specialist services, the divisional locating battery is organised.

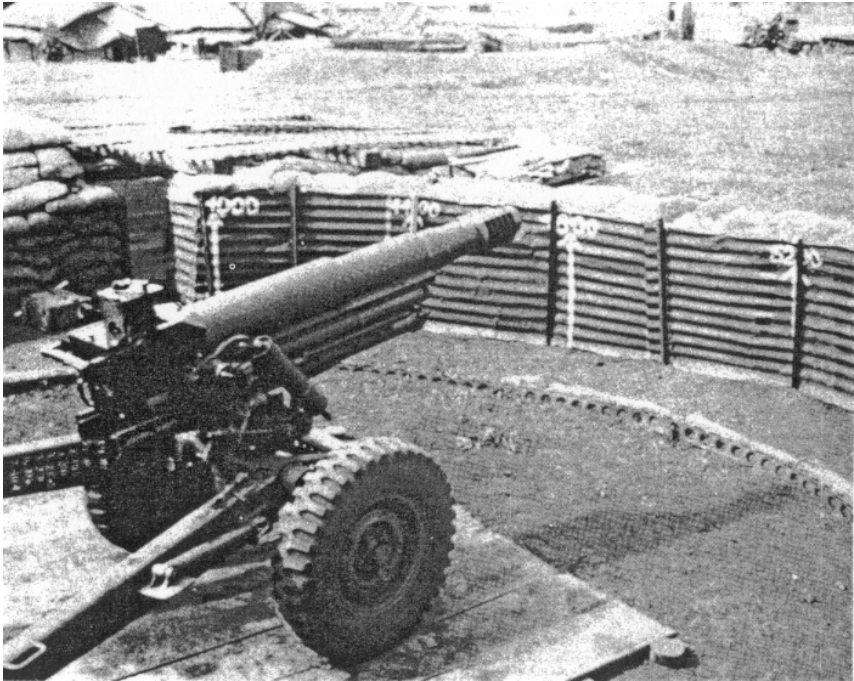

Figure 1. Italian 105mm pack howitzer L5 employed by an Australian artillery unit in Southeast Asia.

Although grouped together as a battery for command and administration, each element works independently. The survey troop and met sections provide their service for the divisional artillery as a whole whereas the radar and artillery intelligence sections are usually assigned to task forces, the latter forming part of the artillery cell of the task force headquarters.

COMMAND AND CONTROL

Command

For command and liaison, the RAA is represented at the headquarters of the division, the task force and the battalion group respectively by the divisional artillery commander (known as the Commander Royal Artillery—CRA) the field regiment commander (CO) and the battery commander (BC). These representatives of the artillery have the task of advising the commander to whose HQ they are attached on artillery matters and of planning all forms of fire support for operations for which the commander is responsible. All three are responsible to the commander for ordering and implementing the tactical missions of the units under their command to conform with the requirements for fire support.

Control

Control of the fire of batteries is governed by a series of tactical missions which differ from those used by the US Artillery. The missions are in direct support, in support, and at priority call. The implication of the missions is best illustrated by an example. When a battery is ordered in direct support of an infantry battalion, it must provide liaison with the supported arm in the form of the BC's tactical headquarters and FOs', and the fire of the guns is available as first priority to that battalion. The same battery can also be placed in support of any other infantry or armoured units whose areas of operations are within range. In this case the battery will only give support when so directed by the main HQ; it is not required to maintain liaison with the supported units.

Yet again the same battery can be ordered 'At priority call' for a specific period to a supported arm unit or formation with which it has no liaison. Calls for fire have priority over those from other units, whether directly supported or supported, but only for the specified period. Allocation of a fire unit at priority call for counter-battery fire is a typical example of this mission.

The Fire Support Co-ordination Centre (FSCC)

The Headquarters of each of the artillery representatives mentioned above can be transformed into an FSCC. They fulfill the functions of co-ordinating all types of fire support available to the formation or unit to which they are assigned. They also co-ordinate control measures designed to protect friendly aircraft (through the medium of the AWCC) and ground forces from artillery and mortar fire. To help in the task, the artillery commander has representatives from navy, airforce and air defence artillery units attached as necessary to the FSCC. It should be

emphasised that the formation of an FSCC is not automatic but is only carried out when warranted by the tactical situation.

The Forward Observer (FO)

The FO in the RAA has a triple role. He is the artillery adviser to the commander of any unit to which he might be assigned. He is responsible for selection of artillery targets in conjunction with the supported arm, directing the fire and deciding the nature of ammunition and the number of guns required to achieve the desired result. Lastly he is one of the sources for the artillery intelligence network. The communications nets of a field regiment allow the FO to talk directly to his CO at the task force headquarters when the need arises. This fact lends speed to the reporting of vital tactical intelligence to formation headquarters.

FIRE PLANNING

Because the artillery is represented at each headquarters by an officer who commands and controls the guns at the disposal of the headquarters, the planning of fire support is a quick and effective drill. It is the duty of the artillery commander to keep himself constantly informed of the movement and intentions of the formation or unit which he serves. This insures that when the supported arm makes a request for fire support, the guns and ammunition are in a position to provide it.

The production of a fire plan is the result of discussions between the supported arm commander and his artillery adviser. During the discussions the commander states his plan and the fire support he requires while the artillery officer advises on the availability of resources and how best to use them. The responsibility for the fire plan lies with the commander but he leaves the detailed staff work to his artillery adviser who issues the necessary orders. This principle applies from the level of divisional operations down to minor attacks by companies when the FO is adviser and fire director combined.

ABCA AGREEMENTS

Australia, as one of the signatories of the ABCA agreements (quadripartite ad hoc working group) has already adopted the standardized procedures produced as a result of the Fifth Quadripartite Artillery Conference in 1968. This standardization particularly in the field of call for fire formats and fire plan performance is of particular value to the RAA. Present trends indicate that the Austrian Army will find itself operating alongside US or US-trained armies, as indeed it is now, and any standardization of procedures will assist the co-operation with our allies.

It is the intention of the RAA to continue the process of adopting doctrine and equipment in step with Australia's allies. The work will be guided by the principle of providing the best possible fire support for those the regiment supports.

For Survey Signal

Improvised Heliotrope

*CDR Sidney C. Miller
Coast and Geodetic Survey Liaison Officer
USAFAS*

With the advent of electronic distance measuring equipment (DME), field artillery gained the capability to measure lines in excess of 50 kilometers. Although it is not an everyday requirement to measure these long lines in artillery survey, the capability is extremely beneficial. In order to use a long line measurement, however, we must also visually extend the azimuth along the line with a theodolite.

There is no equipment presently available in the artillery survey inventory which can be used as a visual signal over long lines, and therefore, it is necessary to improvise. Several methods can be used to include flares and mirrors. Flares do not provide an ideal signal, are limited in range, and are visible all around the horizon. Single mirrors cannot be pointed such that a steady beam of sunlight is reflected without the aid of a device to stabilize the mirrors. A device, composed of one or more plain mirrors, mounted and arranged such that a beam of sunlight may be reflected by it in any desired direction, is known as a heliotrope. This word "heliotrope" is derived from two Greek words meaning "sun" and "turn." A satisfactory heliotrope can be quickly improvised in the field using available vehicle or ordinary mirrors and salvage materials (figure 1).

Directions for making a heliotrope are as follows:

Drive two nails vertically about 2 feet apart into a board; the heads of the nails are used as sighting points for the beam of reflected light. Place the forward nail as close to one end of the board as possible. Next, attach a strip of cardboard or coated plastic to the front edge of the board in line with the forward nail. The strip should be slightly wider than and project slightly above, the nail head. Attach this strip with a single small nail or thumb tack so that it can be conveniently rotated to allow for shadowing of the forward nail or clear alinement of the two nailheads. Firmly secure the board on a tripod or stand by any convenient method.

With the front strip rotated out of nails alinement position, aline the two nailheads as precisely as possible, both horizontally and vertically, toward the location of the observing party. Then rotate the strip attached to the front of the board until it directly shadows the forward nail. Place an ordinary adjustable mirror behind the rear nail; and, using the reflected sun rays, project the shadow of the **rear nailhead** until it is perfectly superimposed over the forward nailhead's shadow. The

strip attached in front of the board merely serves as an aid for this alignment, and does not appreciably reduce the reflected light. The sunrays are now being reflected exactly down the line of sight projected from the two nailheads. The mirror may be held in position by tape or a mud pack, or a more permanent framework can be fashioned from wood or a coathanger. Since the sun is moving at a rapid rate across the sky, it is necessary to reset the heliotrope mirror at intervals of about 1 minute. The apparent diameter of the sun is about 10 mils and the cone of light shown from the heliotrope will also be about 10 mils. On light overcast days the sky near the sun is often bright enough to be reflected.

If the direction of the observer is nearly opposite the direction of the sun, it may be necessary to use a second mirror to reflect the sun's rays into the mirror which is in line with the nails. A wider board should be used for this situation to permit off-set of the second mirror.

Recently, the improvised heliotrope shown in the illustration was used in measuring a line 44 kilometers long at Fort Sill under less than ideal conditions. A similar improvised heliotrope has been observed from a station 64 kilometers away. Voice communications provided with DME can be used to aid pointing the heliotrope, if no other communication means are available.

Commanders of those field artillery survey elements which do considerable long line work and experience frequent long line of sight angle turning problems might consider requesting the current U.S. Army inventory

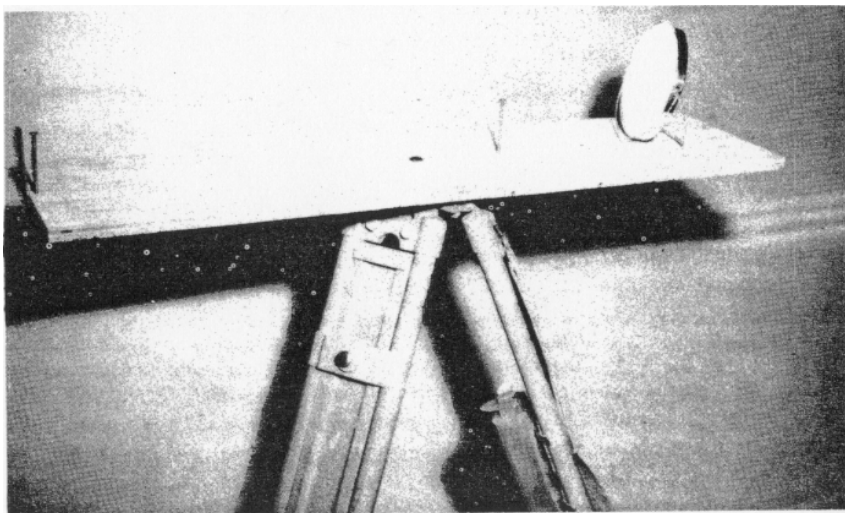

Figure 1. Improvised Heliotrope.

heliotrope through MTOE type action if felt necessary. The following Supply Bulletin 700-20 information is extracted for convenience:

Heliotrope, Line Item K33000, FSN 6675-240-1892

Current Authorization: 4 each per Survey Set Triangulation, Line Item U 71275, to Engineer Topographic Survey TOE.

Of course, heliotropes cannot be used without some sunlight. For long line observation in the daytime, which are out of range of available targets and other signals, this is about one's only resort. The heliotrope transmits a good light, and very accurate angle measurement can be obtained from these observations.

●

ARMY INTEGRATING ALL ADP SYSTEMS INTO NEW COMMAND

A new command, the United States Army Computer Systems Command (USACSC), has been established at Fort Belvoir. It will be the responsible agency for the design, development, test, installation, programming and system support of the Army's multi-command automatic data processing (ADP) systems.

The new command, using the present Automatic Data Field Systems Command (ADFSC) as its nucleus, will report directly to the Army Assistant Vice Chief of Staff.

Under the Computer Systems Command's jurisdiction will be almost all the ADP systems that cross command lines in their operation, or which can be used in more than one command. Systems will serve the Army in the field and also fixed installations at all echelons. Under the project charter issued by the Secretary of the Army, the Computer Systems Command will be assisted by militarized ADP equipment and by the Army's Computer Systems Support and Evaluation Command in the selection of commercial general purpose computers.

The task of the new command, ranging from worldwide administrative systems to worldwide combat support systems, and embracing hardware and software and systems support, represents a broader scope of ADP systems responsibility than has ever before been brought together in a single Army agency.

●

WALKING MACHINE

A Department of Defense-industrial joint development effort sustained over several years had produced a prototype Quadruped "walking machine." The 3,000 pound experimental unit uses an advanced system of levers, control linkage and servomechanisms to mimic and amplify movements of the machine's operator.

In an initial series of tests, the research prototype has walked across level ground, turned around, climbed obstacles, lifted a small military vehicle out of a mud hole, and hoisted a 500 pound load onto a truck with one of its mechanical feet.

Additional indoor tests of the Quadruped are scheduled before it is field tested.

Friend or Foe?



*Joseph B. Fries
U. S. Army Combat Developments Command
Air Defense Agency
Ft. Bliss, Texas*

EDITOR'S NOTE: *A discussion of visual aircraft recognition problems and solutions, oriented toward a reader concerned with Redeye, but not air defense qualified.*

THE QUESTION

You are the battery commander, Battery B, 1st Battalion, 53d Artillery. Your battery has an attached Redeye air defense guided missile team. Up the valley streaks a jet heading your way. Nobody told you he was coming, you can't see his markings, and he's not firing. The jet is a sweptwing job. Is it an Air Force F-100, or is it a MIG-19?

Your Redeye team chief's answer to the question is of more than passing interest to Battery B, and to the pilot of the plane. The price of error is high. The team chief has only a few seconds to make this life or death decision.

Let's leave the decision hanging for a moment and look at what's behind it.

WORLD WAR II EXPERIENCES

Your Redeye team chief is but one of many gunners who have had to make such a decision. To see how WWII anti-aircraft artillery (AAA) gunners did in making similar decisions, we can look at the official battle record of First Army AAA for the period June 1944 to May 1945.

Hostile aircraft destroyed—766
Friendly aircraft destroyed—12
Hostile aircraft damaged—429
Friendly aircraft damaged—no listing
Shot at, but missed—no listing

Not shown here, but of interest, is the fact that about 35 percent of the hostile aircraft seen by the forward area AAA went unengaged, primarily because of identification problems. First Army AAA did well, but each mistake or instance of indecisiveness must have been costly.

THE PROBLEM NOW

The price of error is even higher now than before. The enemy air threat is more deadly, so we can't afford to let him pass because of our mistakes or indecisiveness. Our air defense weapons are so many and so lethal that we can ill afford mistakes as far as our own aircraft are concerned. Yet, the modern gunner's aircraft recognition tools—his eyes—are no better than those of his WWII predecessors. So, aircraft recognition problems still exist. As with so many problems in the Army, the solution lies in improved training.

TRAINING

To appreciate the magnitude of the training requirements, consider that there are well over a thousand Redeye teams in the US Army. Add to these the many hundred of Vulcan automatic gun squads and Chaparral missile squads that are being added to the divisions for air defense. Then consider that the Army stresses that all troops must respond aggressively to air attack. Finally, keep in mind that our Army, Navy, Marine and Air Force pilots have a very personal interest in the quality of the training of all these people.

The training of Chaparral and Vulcan gunners is the responsibility of air defense artillery commanders. The training of riflemen to shoot back at an attacking aircraft is primarily a unit commander's problem, but his aircraft recognition training problem is simplified by the fact that—it is not normally restricted to engaging only attacking aircraft and it riflemen normally fire only at attacking aircraft. But Redeye is different is not managed by the air defense artillery structure. Rather, it is an effective air defense weapon manned by specially trained infantrymen, tankers, cavalrymen and field artillerymen. Thus, the problem of maintaining Redeye gunner skills in the field is a special one, falling directly on infantry, armor, and field artillery unit commanders.

Current methods of visual aircraft recognition training can produce reasonably satisfactory results, given enough effort. But the methods of training have demonstrated some weaknesses, both in the general approach and in the visual training aids used. All in all, they need modernizing to fit the needs of today's Army in solving today's problems.

IMPROVEMENTS UNDERWAY

Commanders, gunners, and pilots should know that modernizing of aircraft recognition training methods is underway. Improved training aids and training instructions have recently completed the final development phase at the U.S. Army Air Defense School at Fort Bliss, Texas. These aids and instructional methods are based on research conducted by the Human Resources Research Office (HumRRO). Research personnel of HumRRO Division No. 5 (Air Defense), which is located at Fort Bliss, developed and evaluated several types of training aids and instructional methods for aircraft recognition as part of the research project. The new

visual aids and instructions will replace equivalent material now included in the 5-QQ-8 (SLARK #1) 35-mm Aircraft Recognition Slide Kit that should be available to each Redeye section leader. The new material is currently identified as the Ground Observer Aircraft Recognition (GOAR) Slide Kit. The new GOAR slides are designed to teach aircraft recognition at tactically realistic ranges and flight aspects.

Figure 1 and 3 and figures 2 and 4 provide comparison of the old and new kits.

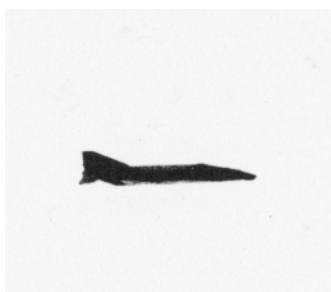

Figure 1. F4, New GOAR kit.



Figure 2. F4, Old SLARK kit.



Figure 3. MIG-21, New GOAR kit.

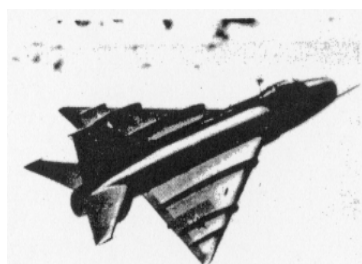

Figure 4. MIG-21, Old SLARK kit.

The new GOAR slides are certainly more difficult to distinguish than the SLARK slides, but they produce results in the field. The strengths of the new slides versus the weaknesses of the old slides are shown in the following table:

New strengths	Old weaknesses
<ul style="list-style-type: none"> ● Ground-to-air views ● Clear sky backgrounds ● No nationality insignia ● Consistency in view numbers and aspects ● Tactically realistic image size (small) 	<ul style="list-style-type: none"> ● Air-to-air views ● Distinctive backgrounds ● Prominent nationality insignia ● Inconsistency in view numbers and aspects ● Unrealistic image size (too large)

The new slides are shown during training in 5- to 8-second exposures—there being no tactical requirement for the "instant recognition" approach of years ago. Nationality insignia are taught as a subject

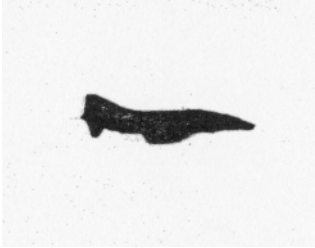

Figure 5. F4C, friend.

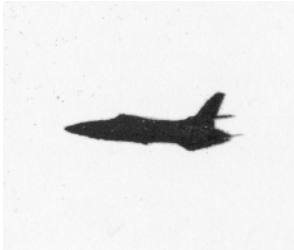

Figure 7. F105, friend.



Figure 6. F100, foe.



Figure 8. F101, foe.

separate from aircraft recognition, since insignia vary (for example, the F-100 is used by 12 countries) and may not even be visible in the field environment.

Slides alone, no matter how modern, are of no value unless presented as part of a properly designed training program. A modern training program that can be administered by a junior officer or an NCO is shown below.

THE NEW PROGRAM

WHAT	WHEN	WHY	HOW
Supplemental training	Throughout	Review and supplement	Self-study. Use card decks or substitutes. (Card decks are under development at Fort Bliss.)
Goal setting	1st stage	Inform and motivate	Set 95 percent class accuracy goal per aircraft per hour. (Achievable. ATT sets 90 percent minimum.)
Nomenclature familiarization	2d stage	Develop standard language	Standard pattern of recognition features. Simple terms. Use slides.
Aircraft familiarization	3d stage	Define the problem	Introduce theater tactical aircraft and their recognition features. Keep number of aircraft low. Use slides.
Recognition practice and comparisons	4th stage and as needed	Discriminate between aircraft	Stress look-alikes. Stress individual performance. Use slides. 5- to 8-second slide exposures. Informal tests and reviews. 90 percent class average before proceeding.
Achievement testing	5th stage and as needed	Expose problem areas	Formal test. Vary tests. Use test slides.
Remedial training	6th stage and as needed	Solve problems exposed	Variable, depending whether problem is with an individual or the class or with a single aircraft or a pair/group.

The specific techniques used during stages 4, 5 and 6 offer the most improvement over the older methods. It is here that individual problems are clearly brought out and methodically solved. It is not enough that the class average is good; **each man must be good.**

Such a program is not a one-time effort but rather is repeated and updated as necessary to maintain peak proficiency. The method is described in the new FM 44-30, Visual Aircraft Recognition, which should now be available down to the Redeye section level.

REDEYE TROOP TEST RESULTS

The new methods were tested successfully by the 101st Airborne Division in the Redeye Troop Test at Fort Campbell, Kentucky, in March 1967. In that test, 40 newly graduated Redeye personnel were given up to 14 hours (average 9 hours) training on the 12 test aircraft used; a specialist fourth class conducted the classes. Figures 5 through 12 show eight of the test aircraft:



Figure 9. F106, friend.



Figure 10. F102, foe.



Figure 11. UH-1D, friend.



Figure 12. UH-1C, foe.

The test included four other liaison aircraft and helicopters. To further complicate the problem, both the friend and foe jets had US markings. The exercise was a real challenge.

This class of newly graduated gunners started out with a measured aircraft recognition proficiency of 53 percent on the 12 test aircraft. This was quite good, considering that some of the test aircraft had not been covered in previous U.S. Army Air Defense School familiarization instruction. Using the improved methods, the class average was then raised

to 94 percent, with some gunners attaining 100 percent. This was about as expected for this new technique.

In the troop test itself, there were over 1,800 aircraft-to-team exposures. The teams used GI binoculars or the naked eye, as they saw fit. About 15 percent of the aircraft slipped by unidentified due to fleeting exposures, long range, etc. The remaining aircraft were identified correctly 96 percent of the time. These encouraging results are in part directly attributable to the use of the improved visual recognition training aids and techniques.

HELP NEEDED

Even a 96 percent correct identification capability is not good enough, by itself, when considering the requirement to clear the sky of hostiles while shooting down no friendly aircraft. Simple mathematics will show that if a friendly aircraft passes in range of a large number of Redeye teams—each with a 96 percent identification accuracy record—the aircraft's chance of making it through without getting shot at by mistake by at least one team is not as good as it should be. Of course, even one percentage point in identification accuracy makes a great difference. But, until the goal of perfect identification capability is reached, the number of friendly aircraft actually exposed to the small possibility of team error must be reduced. This is where pilot cooperation and the command and control system come into the picture. Pilots cooperate by adhering to air traffic control procedures designed to minimize unnecessary exposure to friendly Army air defenses. The Army's command and control system, through warning of forthcoming friendly air activity and/or through imposition of temporary hold fire orders, complements the Redeye gunners' identification capabilities. Thus, the combination of well-trained gunners, air traffic control procedures, and the Army's command and control system insures that Redeye poses maximum danger for enemy aircraft while not unduly endangering friendly aircraft.

THE ANSWER

Back to the question posed at the beginning of this article. That incoming aircraft is a MIG-19, and not an F-100, as our well-trained Redeye team chief knows. He positively recognizes overall form differences and differences in nose, canopy, and tail in this paired comparison. He shoots down the MIG, makes battery B and the F-100 pilots happy, and permits us to conclude this article with a happy ending.

To insure more happy ending and fewer "sorry about that" endings, infantry, armor, and field artillery commanders should help insure Redeye team proficiency by making available to the Redeye sections all required training aids. At present, each Redeye section should have at least one copy of FM 44-30, one SLARK #1 kit, and, when available, the GOAR kit—the SLARK #1 replacement. Self-study aids should also be improvised. But most important, commanders must be interested and they must provide command emphasis. Without these, the program will fail—modern training methods or not.

ENLISTED EVALUATION SYSTEM

COL C. A. Curtis
Commanding Officer
United States Army Enlisted Evaluation Center
Fort Benjamin Harrison, Indiana

Through a recent expansion of the enlisted evaluation system (EES), commanders at all levels now have an additional tool for evaluating their training programs for enlisted personnel and for effectively supervising the career management of their enlisted men.

The purpose of the enlisted evaluation system is to provide an objective measurement of the proficiency of enlisted personnel to perform the duties of their military occupational specialty (MOS). The evaluation score is a combination of values from written test results, enlisted efficiency reports, and performance tests when practical. Results of the enlisted evaluation are used in several personnel management areas.

Verification of military job proficiency. Each soldier must achieve an evaluation score of 70 or higher to be considered qualified for a job in his military occupational specialty code (MOSC).

Evaluation of soldiers in other than their primary skills. Evaluation of secondary skills enables the Army to retain potentially valuable personnel and to improve their skills to insure efficient use of manpower resources.

Promotion of enlisted personnel. The Department of the Army has designated an evaluation score of 110 as mandatory for promotion qualification unless a waiver is approved.

Proficiency pay program. Extra pay is awarded to those individuals who attain evaluation scores above a specified cutoff score and to personnel in selected MOS's which are considered critical.

Retention. When persistent failure to verify his MOS prompts the assignment of an individual into a different MOS or lower skill level, the evaluation test assists in determining that individual's potential value to the Army and his ability to learn a new job.

Grade. The evaluation also assists in determining appropriate grades for officers and warrant officers who revert to enlisted status.

The MOS evaluation score is transmitted to the individual on a MOS evaluation data report (EDR) (fig 1). Two copies of the EDR are forwarded to the installation test control officer; one copy is included in the man's field 201 file and the other is furnished to the individual **through** his unit commander. As explained on the back of the EDR

MOS EVALUATION DATA REPORT (AR 600-200-AR 135-205)	USAEEC		REFERENCE				
	EVALUATION PERIOD	TO SYMBOL	ROSTER NUMBER				
SECTION 1. INDIVIDUAL EVALUATED.							
THRU: COMMANDING OFFICER	MOS IN WHICH EVALUATED		MOS EVALUATION SCORE				
	26S20		105				
TO:	GRADE - PAY GRADE - PPD		SSAN/SVC NO.				
	SPE4						
SECTION 2. INDIVIDUAL'S MOS EVALUATION TEST PROFILE.							
MAJOR AREAS (DA PAM 12-	EVAL.	PD.)	VERY LOW	LOW	TYPICAL	HIGH	VERY HIGH
ELECTRICAL, RADIO AND RADAR FUNDAMENTALS					X		
OPERATION OF RADAR EQUIPMENT					X		
CAUSES OF RADAR EQUIPMENT FAILURE						X	
SCHEMATIC DIAGRAMS IN TROUBLESHOOTING RADAR						X	
OPERATION, USE, AND CARE OF TEST EQUIPMENT					X		
COMPLEX MALFUNCTIONS IN RADARS					X		
SAFETY, EMERGENCY ACTIONS, AND SECURITY PROCEDURES					X		
EPEEC	FORM II OCT 68	IO	EDITION OF 1 AUG 67 MAY BE USED		DISTRIBUTION:		ORIGINAL - INDIVIDUAL'S 2QI FILE FIRST COPY - INDIVIDUAL EVALUATED SECOND COPY - SPECIAL

Figure 1. Evaluation Data Report.

(EPEECO Form 10), possible scores range from 40 to 160. A score of 40 is equal to zero, and 100 is the midpoint, or mean, of the tested group. An individual must score 70 in order to verify his MOS, and those whose scores are 110 or more are evaluated under the same test and are thereby qualified for promotion consideration. Section II of the EDR provides the individual with an analysis of his test in terms of how well he did in each of several major areas covered by the questions. This analysis is depicted by means of five adjectival ratings ranging from **Very Low** to **Very High**. This information is furnished to assist the man in preparing himself for his next annual evaluation.

EVALUATION OF TRAINING

Although the system was not primarily designed with a training mission in mind, it is proving to be of great value to the commander in the field as an additional means of achieving or maintaining high standards of training among career soldiers. As mentioned above, each unit commander has access to the evaluation data reports of the career soldiers

assigned his command. Each commander, particularly each battery-level commander, should establish after-duty courses of instruction or on-the-job training for all personnel of his command whose EDR reflects poor scores in major areas of their particular MOS tests.

In 1968 this potential training use of the EDR was expanded by the development of a profile summary report (fig 2) which was originally produced and distributed to major commanders down to division level. This report has recently been expanded to include distribution to all installation commanders beginning late in May 1969. The profile summary report is, in its simplest form, a summation of individual evaluation data reports for a given MOS and unit in terms of three adjectival ratings—**Low**, **Typical**, and **High**.

A low or high rating indicates that a significant number of the men in the command or unit covered by the report did very poorly or very well on the various major areas of the test for their MOS. By reviewing this report, the unit commander can evaluate his unit's standard of training as mentioned before. As a minimum, the report should cause the commander and his staff to review the training being given in those areas in which below-average proficiency is reflected. The profile summary

EVALUATION TEST PROFILE SUMMARY REPORT

PART V

INSTALLATION LEVEL

NOV 1968 EVALUATION PERIOD

MOSC 17B400	EVAL	SMA 1	SMA 2	SMA 3	SMA 4	SMA 5	SMA 6	SMA 7
Blank BN	10	HIGH	HIGH	HIGH	TYP	TYP	LOW	LOW
Blank BDE	22	HIGH	HIGH	HIGH	HIGH	HIGH	HIGH	LOW

****LEGEND

- SMA 01 ARTILLERY PRACTICES
- SMA 02 RADAR PRACTICES
- SMA 03 AN/MPQ-10A, RD-54, PU-269A/
- SMA 04 AN/MPQ-4A, PU-T07A/U
- SMA 05 AN/TPS-25A, PU-450/G
- SMA 06 ADMINISTRATION
- SMA 07 SUPERVISION

SMA = SUBJECT MATTER AREA.

HIGH = SIGNIFICANT PERCENTAGE OF EXAMINEES HAVE ATTAINED HIGH OR VERY HIGH SCORES ON EDR.

TYP = SIGNIFICANT PERCENTAGE OF EXAMINEES HAVE ATTAINED TYPICAL RATINGS ON EDR.

LOW = SIGNIFICANT PERCENTAGE OF EXAMINEES HAVE ATTAINED LOW OR VERY LOW RATINGS ON EDR.

Figure 2. Sample profile summary report.

report is distributed on a monthly basis by a letter of transmittal explaining in detail the content and possible uses of the report.

Evaluation is mandatory for each active-duty enlisted man in grades E-3 through E-8 who has more than 2 years' service. At the present time, however, personnel on duty in Southeast Asia are exempt from evaluation. Individuals in grade E-9 are not required to be evaluated after their primary MOS's have been verified, but they frequently take the tests to qualify for proficiency pay. Testing in PMOS is required annually, and testing in secondary MOS is required biennially.

The evaluation system for personnel in reserve and National Guard units is essentially the same as that for active duty personnel. Evaluation of active duty personnel is conducted in accordance with AR 600-200, chapter 5; evaluation of reserve components, in accordance with AR 135-205.

CONCLUSION

In conclusion, the enlisted evaluation system is an important link in the Army's overall personnel management system. MOS tests administered under the system determine how much a man knows about the duties involved in his MOS. Efficiency reports reflect how well he applied this knowledge to his job. These two measurements are combined to produce an evaluation score which may entitle the individual to additional pay and place him in line for promotion. Similarly, the evaluation score is important to those responsible for the individual's career. It gives them a meaningful yardstick by which to gauge the man's present and potential value to the service. The system also produces an important by-product of concern to commanders and staff officers charged with maintaining high standards of training. These facts highlight the need for a more comprehensive understanding of this important personnel management system, not only by those directly concerned, but also by those who can put the broader aspects of the system to use.

●

HUMRRO SEPARATION

The Human Resources Research Office (HumRRO), which has been a part of the George Washington University since first established in 1951, has separated from the University and established itself as a private, non-profit corporation.

GWU established HumRRO in 1951 to undertake research and scientific studies evaluations for the Army. Until 1967, HumRRO worked exclusively for the Army; however, in that year the University-Army contract was modified to allow HumRRO to work for other sponsors—including other agencies of government (federal, state, and local) and non-profit and private organizations.

SOUTHEAST ASIA

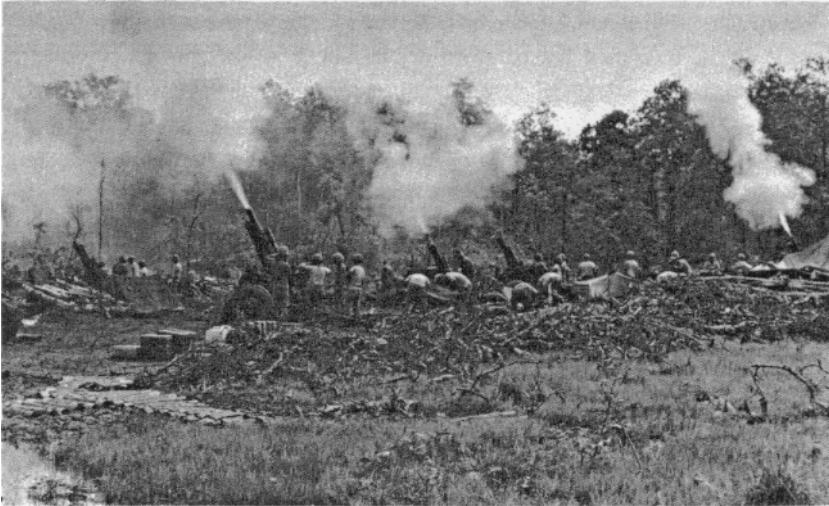

LESSONS LEARNED

The following material is extracted from correspondence from US field artillery units in Southeast Asia and from after action reports distributed by the Department of the Army. However many of the items are field expedients adaptable only to stability operations, and therefore do not always represent official US Army Field Artillery School doctrine.

SETTING AND CHECKING VERNIER SCALE FUZES

During a recent landing zone preparation with 105-mm high-explosive projectiles with time fuzes, rounds were observed bursting everywhere from the ground up to a height of burst (HOB) of 75 meters. Inspection of the battery's method of checking the time settings on the M564 MTSQ fuze revealed that the only thing checked by most section chiefs was the vernier scale setting to see if the 1/10-second mark was alined with a graduation on the lower cap scale above.

The following methods of setting and checking times on the M564 fuze are recommended by the United States Army Field Artillery School as the fastest, most accurate methods for use under field fire mission conditions.

Setting the Desired Time on the M564 Fuze

NOTE: In the following example, the desired time setting is 27.7 seconds.

Step 1: Using either the M34 or M63 fuze setter, set the whole second (27.0) graduation on the lower cap scale opposite the 0 mark on the vernier scale.

Step 2: Relax your grip on the fuze setter momentarily. (Too often the setting is overshot by attempting to set it with one continuous turn.) Then continue turning the lower cap past the 0 mark until the first graduation on the lower cap scale, above and to the right of the 7 mark on the vernier scale, is alined with the 7 mark on the vernier scale.

Step 3: Check the marks above (8) and below (6) the 7 mark on the vernier scale to insure that neither of them is alined with a graduation on the lower cap scale.

Checking the Time Setting

Checking only to see if the vernier mark is approximately alined with the lower cap scale graduation is the most common cause of error. In tests of over 50 cannoners, each of whom set three different times on the M564 fuze, 40 percent of the settings were off by at least one-tenth second.

The vernier scale is constructed so that only one vernier mark at a time can be exactly alined with a graduation on the lower cap scale above. If the alinement is only approximate, it is very easy for the mark above or below the desired time to also be approximately alined. The setting will be off by one-tenth second.

Now the section chief has a simple two-step method to check the setting.

Step 1: Insure that the 0 mark on the vernier scale is between the whole second graduation of the desired time and the next higher whole second graduation (unless the desired time is a whole second).

Step 2: Check the vernier markings above and below the desired 1/10-second mark. If neither is alined with a graduation on the lower cap scale, the setting is as accurate as possible under fire mission conditions. If the desired fuze setting is a whole second, two graduations on the vernier will be alined with graduations on the lower cap. These are the 0 mark under the whole second graduation and the mark corresponding to 10 on the vernier scale.

AZIMUTH ORIENTATION

A new method of azimuth orientation is presently in use to assist M102 guncrews in preventing errors while firing in a 6,400-mil environment. Azimuth markings on the base plate (fig 1) have proved more

reliable than signs or other markers which are often moved or knocked down during the rush of a fire mission.

Since the base plate is octagonal, each of its sides may be labeled in 800-mil increments and used to orient the tube. Each of the sides is

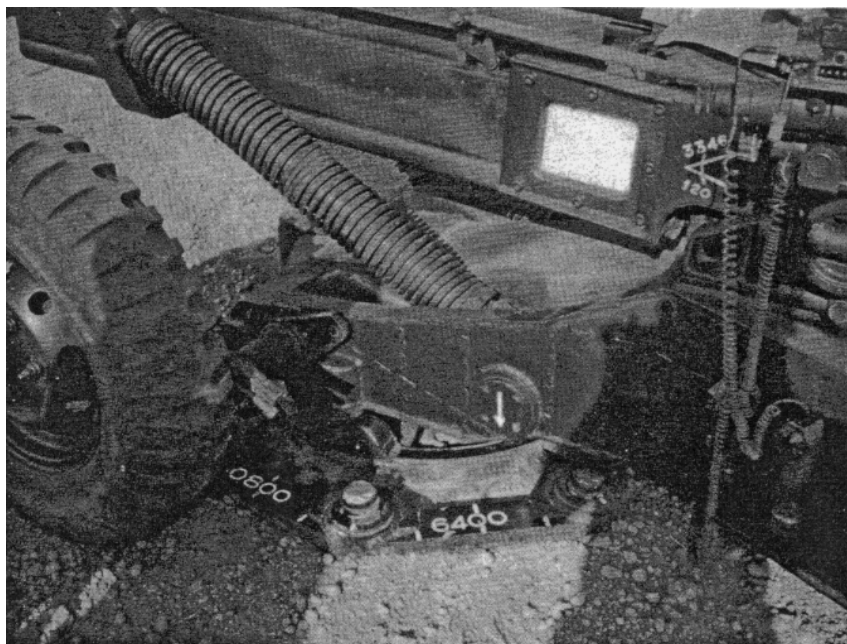

Figure 1. Base plate scribe marks.

further subdivided in 200-mil increments by marks which provide more definite azimuth orientation. An arrow is then inscribed on the carriage, preferably under the breech, pointing downward so that the howitzer can be traversed to coincide with the scribe marks on the base plate.

To insure proper lay of the weapon when this base plate azimuth orientation is being used, obtain a minimum of two readings from the aiming circle while the weapon is on the wheels. Then, orient the firing platform so that the azimuth of lay is directly under the arrow, lower the weapon, and complete the lay.

IMPROVISED REGISTRATION POINTS

The lack of clearly defined registration points in the terrain of Southeast Asia has often prevented field artillery units from applying accurate registration corrections to their firing data. To overcome this problem, brightly colored car bodies are emplaced in enemy-infested territory ??