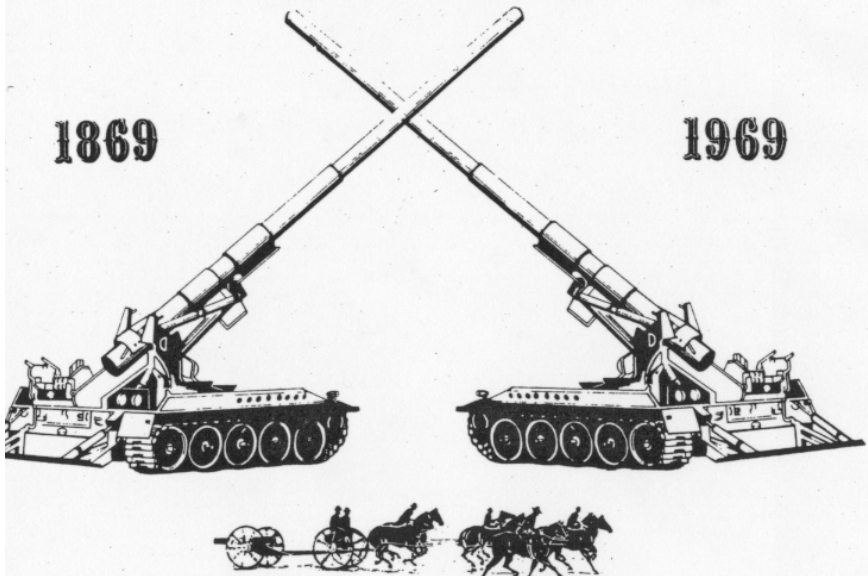


**THE  
FIELD ARTILLERYMAN  
(NAAPTB)**

**FORT SILL  
CENTENNIAL  
EDITION**



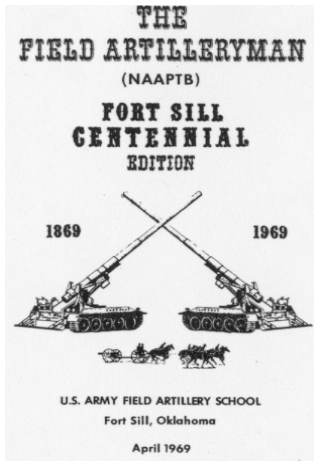
**U.S. ARMY FIELD ARTILLERY SCHOOL**

PROPERTY OF U. S. ARMY

**Fort Sill, Oklahoma**

MORRIS SWETT TECHNICAL LIBRARY  
USAFAS SNOW HALL

# INTRODUCTION



1969—The centennial year for the home of the US Army Field Artillery, Fort Sill, Oklahoma.

In the Fall of 1868, General Philip Sheridan, the Union cavalry leader of the Civil War, launched a campaign to bring the hostile Indians of Western Oklahoma under control. After initial movement into Comanche territory, Sheridan dispatched General Benjamin Grierson and troops of his 10th Cavalry to reconnoiter the Medicine Bluffs area as a base of operations for the Indian campaign. Grierson found the area ideal and recommended the establishment of what is now Fort Sill.

On January 8, 1869, General Sheridan personally laid out the ground plan for the new post and held the first stake that was driven to mark the site. Within a few months of its establishment, the post was named in honor of Brigadier General Joshua Sill, a West Point classmate of Sheridan, who had died while leading a brigade of Sheridan's troops in the Civil War.

From these meager beginnings, Fort Sill has grown into the largest and the most sophisticated field artillery complex in the world, accommodating the US Army Field Artillery Center and its subordinate commands; the US Army Field Artillery School, US Army Training Center—Field Artillery, III Corps Artillery, and the Field Artillery Aviation Command. Also located at Fort Sill are two major separate commands, the US Army Field Artillery Board, the field artillery testing agency, and the Combat Developments Command Field Artillery Agency, the developmental and doctrinal arm of the field artillery. Troop units normally include 25 battalion size units consisting of cannon, rocket, missile, and aerial artillery in addition to infantry, armor, transportation, and ordnance units.

Thus, the installation is comprised of the "Field Artillery Community" whose primary mission is, as is the mission of this instructional aid, to enhance the professional knowledge of the Field Artillery.

The material contained within this issue represents the best information available at time of publication. All readers and users of the handbook are invited to forward information concerning changes or suggestions for improvement of content and format to:

Commandant  
US Army Field Artillery School  
ATTN: AKPSIAS-PL-FM  
Fort Sill, Oklahoma 73503

# INSIDE THIS ISSUE

## INSTRUCTIONAL AID NUMBER 43

<b>INTRODUCTION</b> . . . . .	1
<b>INSTRUCTIONAL DEPARTMENT NOTES</b> . . . . .	5
<b>NOTES FROM THE US ARMY FIELD ARTILLERY BOARD</b> . . . . .	11
<b>CAREER MEMO</b> . . . . .	12
<b>ARTICLES</b>	
Mobile Riverine Force in Combat . . . . .	15
The Big Eye of the Old Reliable . . . . .	29
Revised Programs for FADAC . . . . .	36
FADAC Computations Versus Manual Computations . . . . .	40
Soft Recoil System . . . . .	43
A New Look of Pershing . . . . .	49
Let There be Light . . . . .	58
Radar Plotting and Capabilities Fan. . . . .	68
STANAG 4103 . . . . .	73
<b>SOUTHEAST ASIA LESSONS LEARNED</b> . . . . .	78
<b>STATUS OF TRAINING LITERATURE</b> . . . . .	80
<b>INDEX FOR 1968 ARTILLERY TRENDS</b> . . . . .	82



THE FIELD ARTILLERYMAN is an instructional aid of the United States Army Field Artillery School published only when sufficient material of an instructional nature can be gathered.

# THE FIELD ARTILLERYMAN

As an instructional aid of the United States Army Field Artillery School, **THE FIELD ARTILLERYMAN** is published only when sufficient material of an instructional nature can be accumulated. It is designed to keep field artillerymen informed of the latest tactical and technical developments in artillery.

In accordance with AR 310-1, distribution of **THE FIELD ARTILLERYMAN** will not be made outside the command jurisdiction of the School except for distribution on a gratuitous basis to Army National Guard and USAR schools, Reserve Component staff training and ROTC programs, and as requested by other service schools, ZI armies, U. S. Army Air Defense Command, active army units, major oversea commands, and military assistance advisory groups and missions.

Subscription to **THE FIELD ARTILLERYMAN** on a personal basis may be obtained by qualified individuals by writing to: The Book Store, U. S. Army Field Artillery School, Fort Sill, Oklahoma 73503

Primarily, articles are prepared by individuals assigned to departments of the School or to artillery units and agencies outside the School. All articles, no matter what the source, are coordinated by appropriate departments in the School and with the U.S. Army Combat Developments Command Field Artillery Agency and the U. S. Army Artillery Board collocated with the School at Fort Sill, Oklahoma. This coordination is effected in an effort to arrive at an "Artillery Community" position before publishing the information. The Artillery Community is Fort Sill's term for the center team concept of Continental Army Command, Army Materiel Command, and the Combat Developments Command.

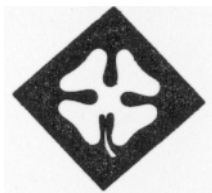


## U. S. Army Field Artillery School

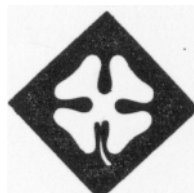


Commandant . . . . .	Major General Charles P. Brown
Assistant Commandant . . . . .	Brigadier General Lawrence H. Caruthers, Jr.
Deputy Assistant Commandant . . . . .	Colonel Francis E. Kramer
Secretary . . . . .	Colonel Sheldon H. Wheeler
Director of Instruction . . . . .	Colonel George P. Winton, Jr.
Director of Logistics . . . . .	Colonel Bernard S. Kern
Office of Doctrine Development, Literature and Plans . . . . .	Colonel Claude C. Stewart
Artillery Transport Department . . . . .	Colonel W. W. Sifford
Communication/Electronics Department . . . . .	Colonel H. G. Gordon
Guided Missile Department . . . . .	Colonel Ralph I. Williams

Gunnery Department . . . . . Colonel A. C. Anderson  
 Nonresident Instruction Department . . . . . Colonel Jesse B. Hollis, Jr.  
 Tactics/Combined Arms Department . . . . . Colonel T. F. Perpich  
 Target Acquisition Department. . . . . Colonel Harry R. Jackson  
 USAFAS Brigade . . . . . Colonel Salvador F. Taranto  
 Officer Candidate Brigade . . . . . Colonel T. E. Watson



**U. S. Army Field Artillery Center**



Commanding General . . . . . Major General Charles P. Brown  
 Chief of Staff . . . . . Colonel William C. George

**III Corps Artillery**

Commanding Officer. . . . . Colonel William H. Hamilton

**U. S. Army Training Center, Field Artillery**

Commanding Officer. . . . . Colonel Frank Hawthorne

**U. S. Army Field Artillery Aviation Command**

Commanding Officer. . . . . Colonel F. C. Goodwin



**U. S. Army Field Artillery Board**



President. . . . . Colonel Paul S. Culler

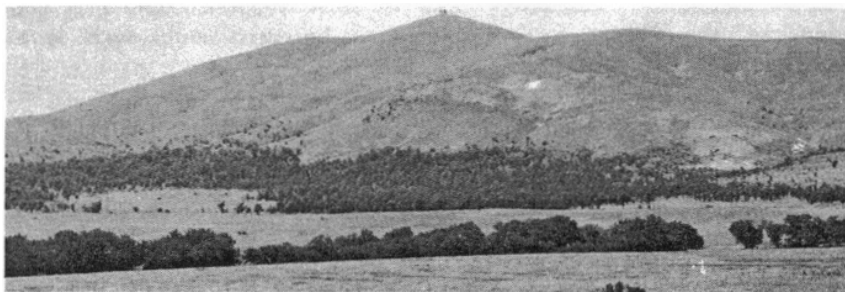


**U. S. Army Combat  
 Developments Command  
 Field Artillery Agency**



Commanding Officer. . . . . Colonel A. F. Rollins

# INSTRUCTIONAL DEPARTMENT NOTES



## GUNNERY DEPARTMENT

### DISTRIBUTION OF TABULAR FIRING TABLES

In the past, initial distribution of tabular firing tables has been made through lists of units and TOE's. This procedure has resulted in frequent late or non-receipt of the tables by using units.

In order to expedite distribution, the procedure was recently changed to the pinpoint method of issue. Effective pinpoint distribution is dependent upon each unit maintaining its current address and weapon assignment with AG Publications. DA Forms 12-37 and 12-40 are used for this purpose and are basis of supplying technical publications, including tabular firing tables. An excellent article on the pinpoint distribution system is on page 64 of the December 1968 issue of **Artillery Trends**.

All units requiring tabular firing tables should review their 12-series forms on file with AG Publications to insure that they are current. If not, DA Form 12-37 (for self-propelled weapons) and DA Form 12-40 (for towed weapons) should be completed and forwarded to the St. Louis AG Publications Center.

### WHICH FIRING TABLE?

Advances and improvements are constantly being made in the cannon materiel field. Examples are new weapons such as the M102, M107, M109, and M110; the new XM563, M564, and M565 fuzes; and projectiles such as the XM546 Beehive, M404, M444, and M449 HE cartridges. Although these items increase the field artillery's effectiveness in battle, their use has produced an undesirable side effect. Because of their different ballistic or operational characteristics, many of the new weapon-ammunition combinations require new tabular or graphical firing tables, or both. This has resulted in the problem of determining which firing tables are current and to what ammunition and weapons they apply.

## NAME CHANGE

By order of the Department of the Army, the US Army Artillery and Missile School was redesignated the US Army Field Artillery School effective January 1969. The School's name change reflects the separation of the air defense and field artillery into two branches and the increasing specialization of doctrines, missions, equipment and techniques of these two widely separated fields.

In keeping with the school's name change and this increasing specialization of the branches, the title of **Artillery Trends** likewise has been changed to **The Field Artilleryman**. This should further identify the publication as an instructional aid designed to keep **field** artillerymen abreast of the latest tactical and technical developments in their field.

Obviously, the large number of possible combinations is less than ideal. Every effort is being made by the field artillery community to minimize the number of firing tables (and computational procedures) required. This can best be accomplished by providing a matched family of munitions which require only one firing table for each weapon. Until that goal is reached, the proper firing table must be used with each type of ammunition.

In order to eliminate any possible confusion due to the number of authorized weapon-ammunition combinations, the firing tables and the materiel to which they apply are listed below. Unless otherwise noted, tabular firing tables will be requisitioned through normal AG publication channels. Graphical firing tables will be requisitioned as authorized by each applicable TOE. The following list includes current and proposed GFT's and TFT's and should be used as a guide in the selection of the appropriate firing table.

### STATUS OF GRAPHICAL FIRING TABLES

Weapon	Based on TFT	Description (* denotes slant scales)	FSN	Number of rules
<b>105mm Howitzer</b>				
M101A1	105-H-6	GFT for M1 HE (LO&HA)	1220-815-6192	2
	105-H-6, W/C2	GFT for M314 ILL	1220-978-9585	2
	105-H-6, w/C7	*GFT for M1 HE	1220-937-8279	3
	105-H-6	GST	1220-815-6190	1
M102/M108	105-AS-1	GFT for M1 HE (LO&HA)	1220-764-5419	2
	105-AS-1	GFT for M314 ILL	1220-764-5418	2
	105-AS-1	GST	1220-764-5422	1
	105-AS-2, w/C1	*GFT for M1 HE	1220-937-8280	3
<b>155mm Howitzer</b>				
M114A1/M123A1	155-Q-3	GFT for M107 HE (LO&HA)	1220-789-2985	2
	155-Q-3	GFT for M118 ILL	1220-898-4212	2
	155-Q-3	GST	1220-789-2986	1
	155-Q-4	*GFT for M107 HE	(Est 4th Qtr FY69)	3
	155-Q-4	GFT for M485 ILL	(Est 1st Qtr FY70)	2
M109	155-AH-1	GST	1220-764-5421	2
	155-AH-1	GFT for M118 ILL	1220-764-5420	2
	155-AH-1	GFT for HA (GB)	1220-764-5423	1
	155-AH-1	GFT for HA (WB)	1220-764-5426	1
	155-AH-2	*GFT for M107 HE	1220-937-8282	3
	155-AH-2, w/C1	GFT for M485 ILL	(Est 4th Qtr FY69)	2
	155-AH-2, w/C1	GFT for M485 ILL	(Est 4th Qtr FY69)	2
<b>8-Inch Howitzer</b>				
M110/M115	8-J-3	GFT for M106 HE (LO&HA)	1220-898-4213	2
	8-J-3	GST	1220-898-6786	1
	8-J-4	*GFT for M106 HE	1220-937-8283	3
	8-O-3	GFT for M424 HES	1220-876-8572	1
	8-O-3	GST	1220-876-8573	1
	8-O-4	*GFT for M424 HES	(Est 2d Qtr FY70)	2
<b>175mm Gun</b>				
M107	175-A-O (REV II)	*GFT for M437 HE	1220-937-8285	2
	175-A-O (REV II)	GST	1220-937-9522	1



## STATUS OF TABULAR FIRING TABLES

### **M101A1**

- FT 105-H-6 (Nov 61) (Basic FT)
  - C2 (Apr 62)  
(for subzone and M314 ILL and M327 HEP)
  - C6 (Jun 66)  
(for M314 series ILL w/fuze MT, M565)
  - C7 (Dec 67)  
(for fuze MTSQ M564)
- FT 105 ADD-B-2 (Nov 68)
  - (for M444)
  - C1 (Nov 68) (Close Support Card)
- FT 105 ADD-A-O (REV) (Mar 68)
  - (for M413)
- FT 105 ADD-D-O (REV II) (Jan 67)
  - (for XM546 Beehive)
- FT 105-H-6 WC (Jul 66) w/C1
- FT 105-H-6 WC (REV) (Being Published)
- FT 105-AV-O (Confidential)
  - (for XM548 RAP)
- FT 105-H-6 (PROV SUPP 1) (Nov 67)
  - (for XM629 CS)\*

### **M102 and M108**

- FT 105-AS-2 (Nov 67) (Basic FT)
  - C1 (Nov 67)  
(Says to use w/M102)
- FT 105-ADD-E-O (REV II) (Jan 67)
  - (for XM546 Beehive)
- FT 105-ADD-F-1 (Aug 68)
  - (for M444 w/fuze M565 MT and M548 MTSQ)
  - C1 (Sep 68)  
(close support card)
- FT 105-AR-O (REV II) (Dec 63)
  - (for XM482 ext range)\*
- FT 105-AS-2 WC (Sep 68)
- FT 105-AS-2 (PROV SUPP 1) (Nov 67)
  - (for XM629, CS)\*

### **M114 and M114A1**

- FT 155-Q-4 (Mar 68) (Basic FT)
  - C1 (Apr 68)  
(says can use w/M3A1 and M4A2 prop chg)
- FT 155 ADD-C-1 (Apr 68)
  - (for M449A1) (M449E2))
  - C1 (Apr 68)  
(close support card)

C2 (Apr 68)  
(for prop chg M3A1 and M4A2)  
FT 155 ADD-A-1 (Aug 62)  
(for M449)  
C2 (Sep 65)  
(for M449E1)  
C4 (Oct 66)  
(close support card)  
C5 (Jan 68)  
(for fuze M548 MTSQ and M565 MT)  
FT 155-AI-1 (Nov 65)  
(for XM454 NUC)  
C1 (Oct 66)  
FT 155-Q-3 WC (Apr 67)  
FT 155-Q-4 WC (Being published)

**M109**

FT 155-AH-2 (Jul 65) (Basic FT)  
C1 (Jun 67)  
(for M485 series ILL)  
C2 (Oct 67)  
(for fuze M564 MTSQ and M565 MT)  
C3 (Apr 68)  
(says can use w/M3A1 and M4A2 prop chg)  
FT 155 ADD-B-1 (Nov 67)  
(for M449A1 (M449E2))  
C1 (Nov 67)  
(close support card)  
C2 (Apr 68)  
(Says can use w/M3A1 and M4A2 prop chg)  
FT 155 ADD-D-1 (Aug 68)  
(for M449)  
C1 (Aug 68)  
(close support card)  
C2 (being published)  
(for M449E1)  
C3 (being published)  
(close support card for M449E1)  
FT 155-A-J-1 (Jan 66)  
(for XM454 NUC)  
C1 (Oct 66)  
FT 155-AH-2 WC (REV) (Feb 68)

**M110**

FT 8-J-4 (Jun 67) (Basic FT)  
FT 8-O-4 (Jun 67)  
(for M424 HES and M422 NUC)

FT 8-ADD-A-1 (Nov 67)  
(for M404)  
C1 (Nov 67)  
(close support card)  
FT 8-J-4 WC (Jul 68)  
FT 8-O-4 WC (being published)

**M107**

FT 175-A-O (REV II) (Feb 65) (Basic FT)\*  
C1 (Jan 66)\*  
(gives MV corr for Prop M86A1 w/additive jacket)  
FT 175-ADD-A-O (PROV) (Mar 64)  
(for XM403)

\*Requests for these tables should be made to: Commanding Officer, Ballistic Research Laboratories, ATTN: AMXRD-BED, Aberdeen Proving Ground, Maryland 21005.

## **DEFLECTION CORRECTION**

In the December 1968 issue of ARTILLERY TRENDS, the article by Captain Parham, "Applying the Deflection Correction Scale," contained the following statement:

"Figure 1 illustrates a GFT setting for an initial registration with the deflection correction (R6) applied to the cursor. Since this is an initial registration, the deflection index will be displaced on the chart, and the deflection correction at the adjusted elevation will effectively become zero."

Although this is an optional technique, the Field Artillery School does not teach displacing the deflection index after the initial registration. Instead, the total deflection correction determined from any registration is included in the deflection correction scale. The procedure outlined in the above mentioned article for subsequent registrations is now applicable to all registrations.

## **GUIDED MISSILE DEPARTMENT**

### **COUNTDOWN SHORTENED**

A modification, presently being applied to the SERGEANT missile system in the field, will shorten the time required for the automatic countdown from twenty to fifteen minutes. This modification is being incorporated into the circuitry of existing firing sets and will not require extensive operator retraining as crew procedures will remain substantially the same.

SERGEANT is an all weather, inertially guided, solid propelled, medium range field artillery ballistic missile and it has been in the field for approximately seven years. Highly mobile, this second generation guided

missile is normally employed in support of corps or field army. The SERGEANT is 100 percent ground mobile, and Phase II air transportable in C-130 or larger type aircraft. It can fire a nuclear, chemical, or biological warhead at ranges from 25 to 75 nautical miles.

Since the system was first deployed in 1962, improvements have been made to electrical and mechanical components to increase reliability, to improve accuracy and to shorten reaction time. The shortened countdown modification is one of the most notable of these improvements, resulting in a significant reduction in system reaction time.

The improved reaction time now inherent in the SERGEANT missile system will permit its employment on a great number of targets on the fast moving nuclear battlefield. SERGEANT is the Corps Commander's biggest punch and in its new "quick reaction" configuration is an even more valuable asset to his inventory of field artillery weapons.

## TARGET ACQUISITION DEPARTMENT ERROR NOTED

An error appeared in the article "AN/MPQ-4A Strobing Technique" in the December 1968 issue of **Artillery Trends**. In the fifth line of subparagraph (5) on page 60, the word used should be **decreased** instead of **increased**. The line should have read, "If the grid **decreased** on the one-half distance reading, subtract the difference from the one-half distance grid (line c, fig 1)."

---

●

## SEARCHLIGHT DEVELOPED

Interested in lighting up about half of the downtown section of Saigon at one time? This could be done with a newly developed Xenon searchlight designed for aircraft, according to the searchlight's manufacturers.

Called the Nightsun FX150, the 2000-watt searchlight would allow aircraft to fly at higher altitudes and still provide enough light to illuminate battle areas in Vietnam. The searchlight can also be mounted in ground and water vehicles.

---

●

## LIGHTING ITS WAY

A new technique in the employment of a time-honored weapon is being tried in Vietnam. Designed to first expose the enemy and then engage them, the new technique consists of an M42 "Duster" with a Xenon searchlight.

Mounted on the duster's turret, the searchlight has a 6,400-mil capability. The 40-mm guns always point in the same direction as the light, which can use either infrared light or white light to search out the enemy. Using the infrared light source, the gunner can fire the weapon without turning the bright searchlight on.

# GUARDIAN OF THE SOLDIERS WARRANTY



## NOTES FROM THE US ARMY FIELD ARTILLERY BOARD

The US Army Field Artillery Board, originally organized at Fort Riley, Kansas, in 1902, is the oldest user test agency in the US Army. It continued to function at Fort Riley, Kansas, until it moved to Fort Sill, the home of the Artillery School of Fire. In 1922 the Field Artillery Board moved to Fort Bragg, North Carolina where it remained until 1954. It then returned to its present location at Fort Sill, Oklahoma. The purpose of the move was to facilitate coordination and interchange of ideas and information between the Field Artillery Board and the US Army Field Artillery School. Since the reorganization of the Department of the Army in 1962, the Field Artillery Board has been a service test agency of US Army Test and Evaluation Command, a major subordinate command of the US Army Materiel Command.

Simply stated, the function of the Field Artillery Board is to insure that new developments in weapons and equipment for the Artillery can be effectively employed in combat by representative field artillerymen. The purpose of the notes from the Field Artillery Board is to keep the field artilleryman abreast of such developmental materiel being tested and of tested improvements for materiel already in the field. Readers are cautioned that a Field Artillery Board note on an idea is not in any way indicative of the item's availability.

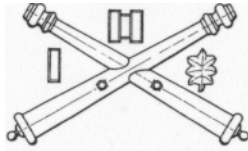
### MICROMS

A military potential test of the system called micro-maintenance information concerning the repair and operation of missile systems (MICROMS) is currently being conducted by the Board.

The system involves a microfilming technique designed to alleviate the three major problems associated with conventional technical manuals—volume, information retrieval time, and time required to reproduce, distribute, and update manuals. MICROMS places the information from 98 letter-size pages on a single 4- by 6-inch sheet of film. The system includes a viewer to magnify the microfilm and a copier to produce full-size copies of the pages.

The test of MICROMS is being conducted with the Sergeant missile system.

# Career



# Memo

## Field Artillery Branch, OPD

With the separation of the Artillery Branch into the Field Artillery Branch and the Air Defense Branch on 1 December 1968, the members of the Field Artillery Branch, Officer Personnel Directorate (OPD), welcome the opportunity of serving exclusively field artillerymen all over the world. We feel that we can better support you if you are aware of our mission, our organization, and the areas in which we may be of assistance to you.

### MISSION

The Field Artillery Branch, OPD, which is located in Tempo Building A adjacent to Fort McNair, Washington, D. C., has the mission of accomplishing personnel management of all active duty commissioned field artillery officers below the grade of colonel and all warrant officers for whom the branch is responsible in consonance with Department of the

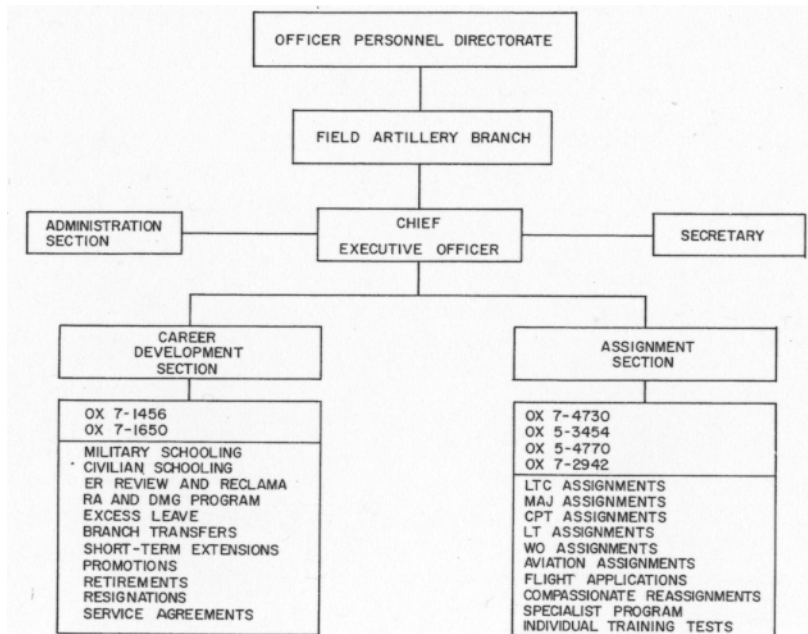


Figure 1. Organizational diagram.

Army missions and policies. The branch makes worldwide assignments to insure that individual skills and abilities are utilized in accordance with valid requirements and to increase individual professional capabilities through timely progressive assignments and attendance at military and civil schools.

## **ORGANIZATION**

To accomplish its mission, the FA Branch is organized as shown in figure 1. For future reference, the telephone numbers and general areas of responsibilities of the Career Development and Assignment Sections are shown, since the actions of these sections have the greatest impact on your career.

### **CAREER DEVELOPMENT SECTION**

The Career Development Section handles all actions within the branch with the exception of assignments and flight applications. As shown in figure 1, the areas of responsibilities of the section are numerous. The section can provide the field artilleryman with information on military and civilian schooling, promotions, and extension or change of service obligations and with expert counseling on overall performance. During the counseling session, the officer's strengths and weaknesses are identified in order to assist him in improving his manner of performance. Since selections for promotions, Regular Army commissions, and attendance at the Command and General Staff College and Senior Service College are determined by various Department of the Army selection boards, the Career Development Section can provide only an enlightened estimate of your chances for favorable consideration based on an evaluation of your overall record.

### **ASSIGNMENT SECTION**

The Assignment Section is responsible for the assignment of field artillery commissioned officers below the grade of colonel and warrant officers in MOS's 201A, 211A, 214E, and 214F. Although it has been speculated that assignments are made through the use of a dart board, we can assure you that individual attention is given to each and every assignment. In determining an officer's assignment, the assignment officer considers three major factors: the military requirement, the career needs of the individual, and the individual's preference. When a conflict exists, the military requirement takes precedence. It is the assignment officer's goal to combine as many of the three factors into one assignment order as possible. Therefore, you should insure that you have a current Officer's Assignment Preference Statement (DA Form 483) on file in the Field Artillery Branch.

## **REVIEW OF BRANCH RECORD**

We encourage field artillerymen to visit the branch whenever they are in the Washington, D. C. area, to review their records in detail and to discuss past performance, future assignments, extensions of service obligations, and general career development. If you cannot come in person, you may deputize another officer to act for you in accordance with paragraph 5, AR 640-12. Your efficiency report file must be reviewed by you personally or by your deputy; it cannot be discussed on the phone or in correspondence.

## **OPEN INVITATION**

We extend to all field artillerymen an open invitation to visit, write, or call the Field Artillery Branch whenever we can be of assistance. Our watchword is "tactful candor." We will answer all your questions honestly in a "straight from the shoulder" manner. Field artillerymen of all ranks have indicated that this is how they want it. We make no promises or deals and have no favorites. We are deeply interested in the career of each field artilleryman and will be particularly pleased to have an opportunity to serve you.



## **TOW ANTITANK MISSILE SYSTEM PRODUCTION CONTRACT AWARDED**

The Army has awarded a contract to the Hughes Aircraft Company for production of the TOW Antitank Assault Missile System.

Intended for employment at company or battalion level, TOW (Tube-launched, Optically-tracked, Wire-guided) will knock out any known armored vehicle. After launch, the missile unreels in flight two hair-thin wires through which it receives steering signals. All a gunner has to do is keep the sight on target and the missile is automatically guided to point of impact.

TOW has been subjected to intensive development testing during which the missiles were handled by soldiers under a wide variety of simulated battlefield conditions, including air drops. Gunners have successfully demonstrated TOW's long-range firepower and accuracy by scoring direct hits on moving targets at ranges of more than a mile while shooting from both ground emplacements and from helicopters. The missile has also proven its effectiveness in knocking out bunkers and concrete fortifications.

TOW is expected to replace the 106-mm recoilless rifle as well as the Entac and SS-11 missiles.

The Chrysler Corporation, Huntsville Space Operations, has been contracted as the alternate producer.



*In Combat*

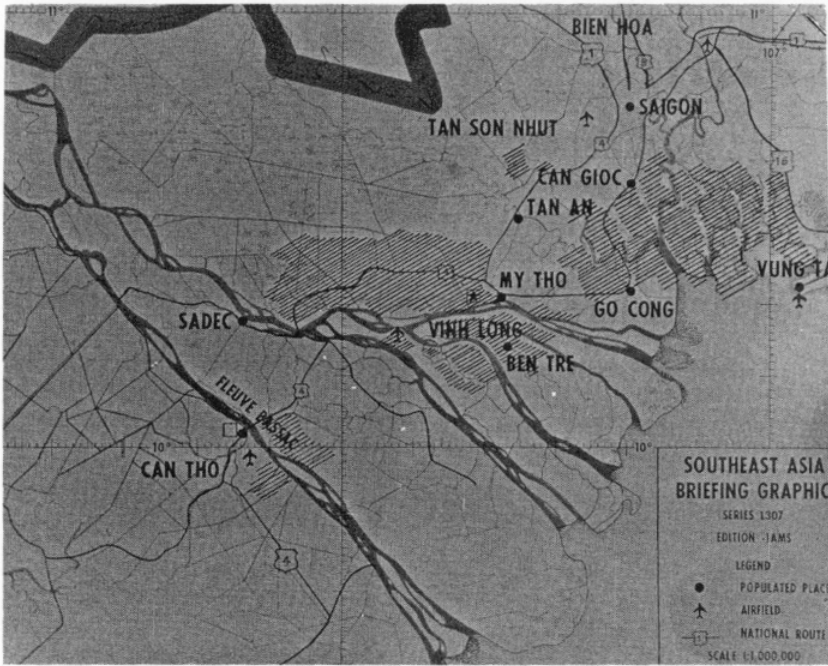
# Mobile Riverine Force



*Brigadier General William B. Fulton*

**EDITOR'S NOTE:** *The author was the commander of the 2d Brigade, 9th Infantry Division when that unit began operations as the Army's component of the mobile riverine force in the Mekong Delta, South Vietnam, in 1967. He later was the Assistant Division Commander of 9th Division unit operating in the Mekong area. Brigadier General Fulton is now in the Office of the Assistant Vice Chief of Staff.*

In 1966, it became apparent to General Westmoreland and his staff that in order to more fully assist the Government of South Vietnam forces in their fight against the enemy it would be necessary to project US combat power into the Mekong Delta. It was obvious that US forces would have to be configured to operate in this riverine environment and be given the capability of conducting riverine warfare.



**Figure 1. Area of operation.**

The Mekong Delta (fig 1) commences at Saigon in the III Corps and comprises all of the ARVN 4th Corps Tactical Zone. The Delta contains essentially four-fifths of the total population of South Vietnam, including Saigon. It produces the major portion of the food and livestock necessary to sustain the population of South Vietnam and for export. Control of its economy and the population is essential to the government.

The Delta has an extremely limited road net, and there is an overabundance of surface water. Inland waterways, both rivers and canals, provide the natural routes for transportation and communications. These water routes have both strategic and tactical importance to both sides. Control of the water routes is vital to the South Vietnamese Government. Because of the limited roads, large portions of the area are accessible only by water or air. Large-scale airmobile operations are somewhat limited because of the distance between suitable marshaling fields and remote enemy base areas. Consequently, greater reliance must be placed on the movement of large forces by water when there is a requirement for massing forces against the enemy in these less accessible areas.

The primary difference between riverine warfare and ground warfare is chiefly a matter of environment. In riverine warfare, waterways are the primary method of movement. Although the fundamental tactics and

techniques governing normal ground operations are applicable to riverine operations, special organization and operating procedures are required when offensive ground forces, supported by Navy ships and craft, operate directly from inland waterways. The Mekong Delta area, comprised of the major waters of the Mekong and Bassac River basins, is intersected by literally hundreds of man-made canals and natural rivers, streams, and creeks which are affected by tidal actions that cause the water level to rise as high as 13 feet at high tide.

The introduction of US combat power into the Delta required the development of a major tactical and logistical base in the Delta and the development of a riverine force. The development of both required appreciable lead time.

The Dong Tam Base is located 8 kilometers west of My Tho and was dredged from the sands of the Mekong River to a size of approximately 600 acres. It took a year to fill. The base houses from 11,000 to 12,000 troops and includes necessary storage and support facilities, airfields, and a harbor, cut out of rice paddies, that accommodates LST's. Dong Tam is the home base of the Mobile Riverine Force and of major elements of the 9th Infantry Division.

### **MOBILE RIVERINE FORCE**

General Westmoreland's Mekong Delta Mobile Afloat Force (MDMAF) concept was approved by the Joint Chiefs of Staff (JCS) in June 1966. The Navy was tasked to develop ships and small river boats which would be capable of supporting Army operations in this riverine environment. In September 1966, the Army component—2d Brigade, 9th Infantry Division—and the Navy component—River Assault Flotilla No. 1—were charged with teaming together to train for riverine operations and to develop operating procedures, doctrine, and tactics to facilitate riverine operations. The two forces conducted their training in actual combat actions on a limited scale from February through May 1967. On 2 June 1967, the Mobile Riverine Force became operational.

The Mobile Riverine Force consisted of approximately 5,000 Army and Navy troops and includes a brigade headquarters, three infantry battalions, a field artillery battalion minus, and 9th Division support troops, including combat engineers.

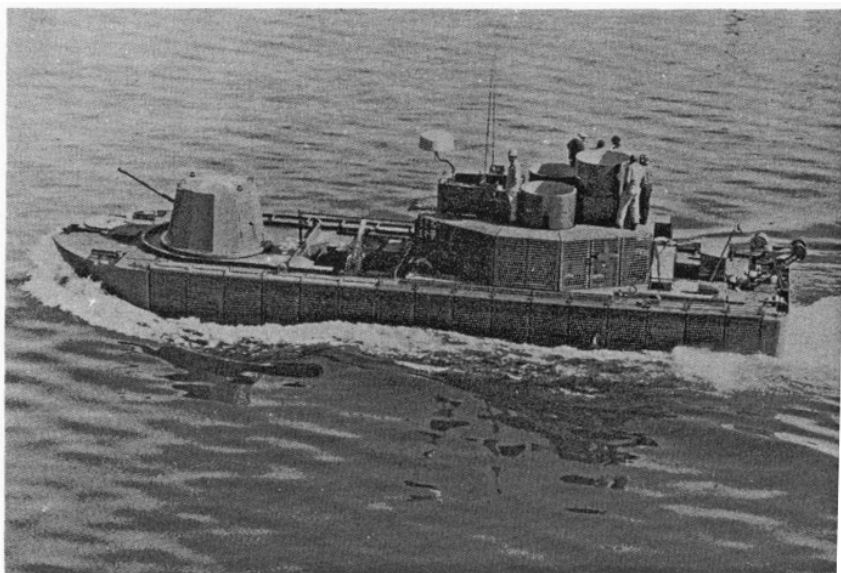
Four Navy barracks ships, World War II barracks LST's modified for riverine operations, are now authorized for this force. Each ship has a helipad and is capable of housing and messing approximately 1,100 Army and Navy troops. The USS Benewah is configured as a command ship with a joint tactical operations center and accommodates the Army and Navy staff. Each of the other ships is capable of taking aboard a battalion force plus its Navy supporting elements. Ammi pontoons, developed in-country, enable rapid loading of troops night and day. The pontoons are towed from base area to base area by the ships which they support.

In addition to the four barracks ships, the force is authorized a repair

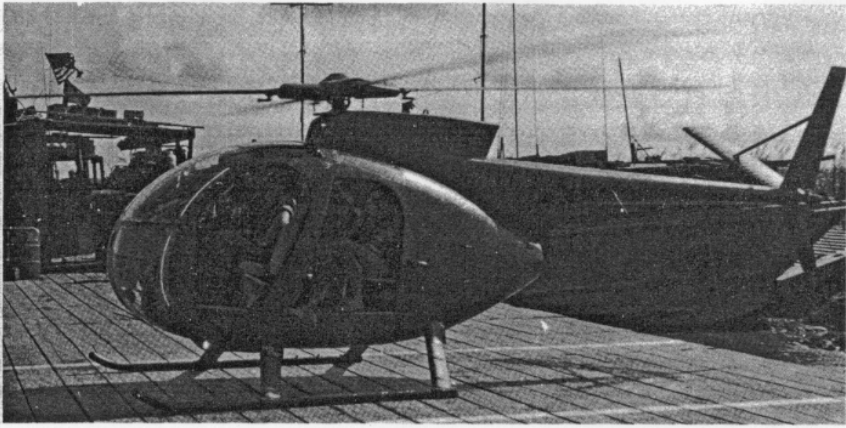
ship—the Askari—which is capable of repairing all of the Navy boats in the tactical area of operations. Also included in the force is an LST which contains the necessary Army and Navy supplies and ammunition for 10 days of operations and food for 30 days. The LST can be resupplied by the Navy LST's any place within the Delta area. These ships then comprise the MRB—the mobile riverine base. This base houses 5,000 troops, and it is capable of moving up to 150 kilometers within a 24-hour period of time, with combat operations capable of being launched within minutes after dropping anchor in the base area.

The Navy component of the Mobile Riverine Force—River Assault Flotilla No. 1—consists of two river assault squadrons and one support squadron. Each river assault squadron has 26 armored troop carriers (ATC), 5 Monitors, 3 command and control boats (CCB), and 16 assault support patrol boats (ASPB). These craft were developed by the Navy to support ground operations.

The armored troop carrier is a reconfigured LCM-6, which was used in amphibious operations in World War II. The craft carries 40 troops, has a speed of 6 to 8 knots, and is capable of operating in small rivers approximately 25 meters wide and 2½ feet deep. Three of these craft will move a company. The armored troop carrier mounts twin 20-mm guns in the rear turret, and two .50-caliber machineguns on either side turret. In addition, it has seven .30-caliber machineguns and two Mark 18 40-mm grenade launchers each capable of firing 200 grenades per minute. The boat has roughly 25 tons of armor and bar armor plus styrofoam flotations along each side.



**Figure 2. The Monitor.**



**Figure 3. Helideck of ATC.**

The assault support patrol boat is a 15-knot, double-hulled minesweeper with very heavy armament, which includes 40-mm and dual 20-mm guns, and is radar equipped. This craft acts as the reconnaissance and security element during movement of a riverine force.

The Monitor (fig 2) mounts a 105-mm turret forward, a Navy 81-mm breech-loading gun for direct or indirect fire amidships in the center well, and .50-caliber and 20-mm guns on the aft portion. It is specially armored and has a speed of approximately 6 knots; it is the battleship of the force.

The command and control boat is utilized as a joint tactical CP by the infantry battalion commander and his Navy counterpart. The brigade commander also utilizes the command and control boat during operations. This boat looks very much like the Monitor, but it has a command post located in the center well with ample Army, Navy, and Air Force communications equipment for contact with the mobile riverine base and the tactical units on the ground and water and for close air support and control of airlift helicopters.

### **INNOVATIONS**

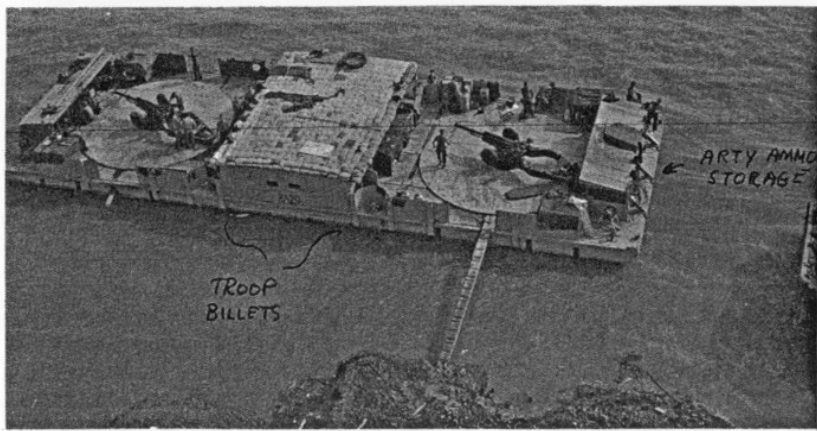
Several innovations were made in-country to facilitate tactical operations. One was the development of the aircraft carrier (light) by adding a helideck to the armored troop carrier. This was done in the mobile riverine base during actual operations. This carrier is capable of accommodating either the LOH or the UH-1 aircraft (fig 3). It is intended that, each of the 52 armored troop carriers in the force have a helideck. This feature enables the commanders to be continuously airborne since one armored troop carrier is paired with each battalion commander's command and control boat. This feature also permits medical evacuation and resupply at any point during operations. In effect, each armored troop carrier has become a one-aircraft landing zone (LZ).

Very early it became obvious that there would be a need for a helicopter barge to enable full use of helicopters in the area of operations. A barge capable of accommodating three UH-1 aircraft was built-in-country. Rubber bladders under the deck hold 1,500 gallons of JP4 fuel, giving the barge a significant refueling capability. The barge is normally towed by the artillery battalion with an LCM-8 into the forward area and is habitually located at the fire support patrol base (FSPB) for use as part of the brigade forward CP.

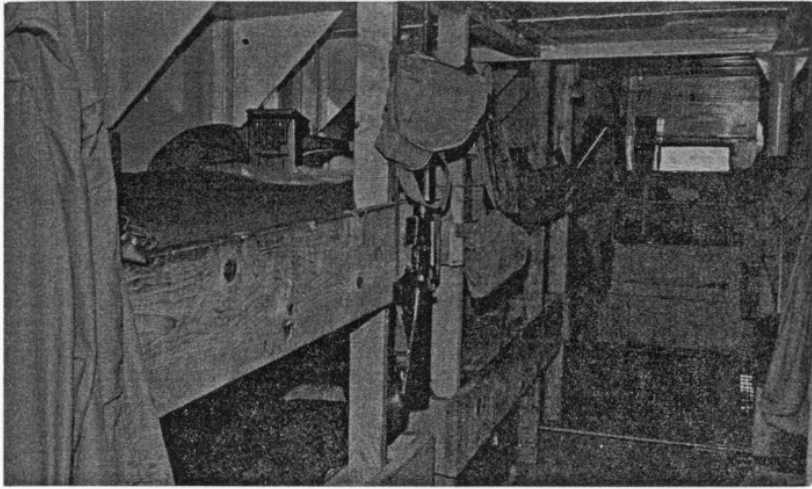
To complete its mobility, the Army obtained 60 "Boston Whalers" powered by an 85-horsepower outboard motor. The boat is capable of moving 10 men at about 30 knots and is the force "dismount" capability which the troops use in small streams that the larger Navy craft cannot enter. It also provides a courier, shuttle, patrol, and scout capability for units within the mobile riverine base, at the fire support patrol base, and within the area of actual operations.

### **FIELD ARTILLERY COMPONENT OF THE MOBILE RIVERINE FORCE**

Field artillery suitably adapted to the riverine environment was a prerequisite for successful force operations. The original Mekong Delta mobile afloat force concept provided for towed 105's and their prime movers to be placed aboard the Navy armored troop carriers for movement to the area of operations. The thought was that, hopefully, at a suitable location along the bank the prime movers could be driven off. The truck would then tow the 105 from a second ATC onto the shore where it would go into position. From the outset it was obvious that the concept could not be made to work since virtually all banks were too steep and the tidal action in the Delta ranges from 5 to 13 feet, depending on the season. The river banks are so soft and muddy that they simply are not negotiable by any type of truck, or track vehicle for that matter. Secondly, other than for the all-too-scarce roads, there are virtually no firing positions



**Figure 4. Riverine field artillery barge.**



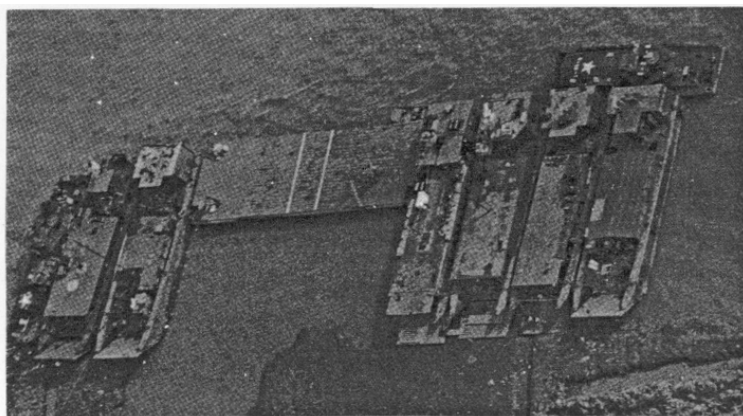
**Figure 5. Troop housing on barge.**

to be found along the streams, canals, and rivers even if a vehicle could be made to tow a howitzer off an ATC. Any suitable ground that is found above the water normally contains a house, a hamlet, or a small town. High ground has been man-made during the dry season for a purpose. Most ground found in the Delta along streams is too soft and wet to support the weight of the 105-mm howitzer.



**Figure 6. Ammunition storage shed.**

Faced with this simple reality, the 3d Battalion, 34th Artillery, under the command of LTC Carroll Meek, experimented with Navy pontoons to determine whether a 105 could be fired from the water with any degree of accuracy and stability. The experiment was made at Dong Tam Base with the cooperation of the Navy during February through April 1967. It was found that these barges could be towed by either the LCM-6 or LCM-8 craft. Numerous combat operations were run, day and night, to confirm the effectiveness of field artillery used in this mode. Upon verification that this was a feasible method of firing, the 9th Infantry Division requested six riverine artillery barges, which were fabricated out of pontoons at Cam Ranh Bay. These barges have armor siding and fixed plates so that the light 105-mm howitzer M102 can be fastened to them. Each barge contains positions for two howitzers (fig 4). Troop housing with bunks for the field artillery section was built amidships on the barge (fig 5), and storage sheds (fig 6) for approximately 750 rounds were built on either end of the barge, for a total of 1,500 rounds per barge, so that each piece could be serviced separately by its guncrew. These barges are towed by Army LCM-8's, which also carry additional artillery ammunition. The 1097th Army Transportation Boat Company was attached to the 2d Brigade and possessed approximately 23 LCM-8's. The field artillery battalion, while housed aboard the barracks ships, modified two LCM-8's to accommodate the battalion fire direction center. The LCM-8's also provided troop housing for the FDC and the headquarters battery, and one of the LCM-8's was configured into a large brigade tactical operations center, which is used by both the Army and Navy senior commanders to control operations in the forward area. The cabin area contains space for a situation map, a communications console, and a conference area. Additionally, on the CP LCM-8 there is office space and sleeping accommodations for six personnel. Using the CP craft in



**Figure 7. Fire support patrol base.**



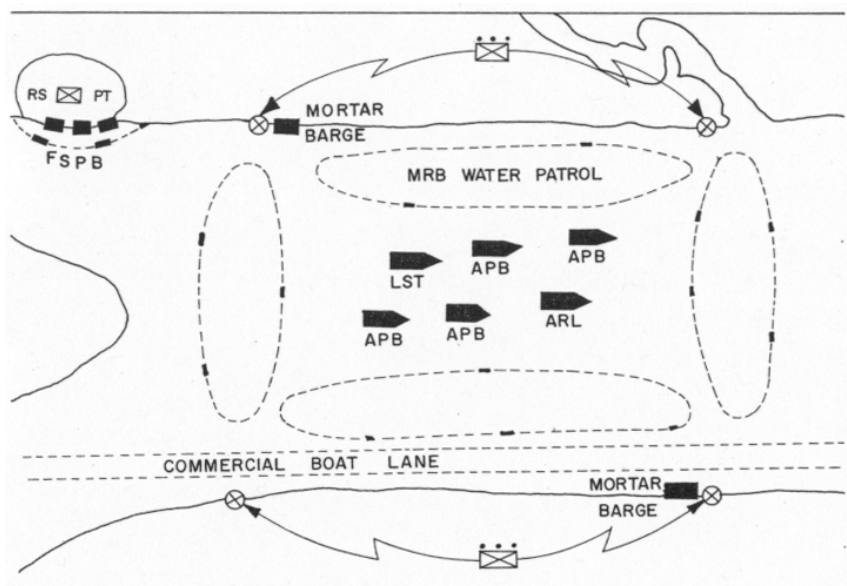
conjunction with the helo-barge, a very convenient brigade toward CP is established. The forward brigade CP is collocated with the field artillery battalion FDC in the fire support patrol base (FSPB, fig 7). The floating FSPB provides a ready area to facilitate command and control within 10,000 meters of the area of operations. The commander can extend his control to the air by using his C&C (command and control) aircraft or his CCB which is also located at this point.



**Figure 8. Barge in firing position.**

The field artillery battalion, thus accommodated on the field artillery barges and the LCM-8's, is a highly mobile force which, when escorted by Navy boats, moves independently to its firing positions for close support of ground operations (fig 8). The tubes are always poised in transit to fire an old-fashioned naval broadside against both banks simultaneously in case of ambush.

This force usually moves at night; establishes its firing positions alongside the river bank, where it anchors to the shore; and is laid and ready before daylight. It is capable of giving close and accurate fire support to ground operations around the clock in the area of operations. Without question, the creation of the "floating" field artillery riverine battalion is the greatest single innovation in riverine operations. Had the mobile riverine force been required to rely on the original concept of using towed howitzers moved by armored troop carriers, it is doubtful whether the force would have met with any success at all.



**Figure 9. Defense of mobile riverine base.**

### **Mobile Riverine Operations**

To gain an appreciation of how field artillery is used to support mobile riverine operations, it is essential to divide such operations into two phases. The first phase is base defense. The second is the conduct of strike operations.

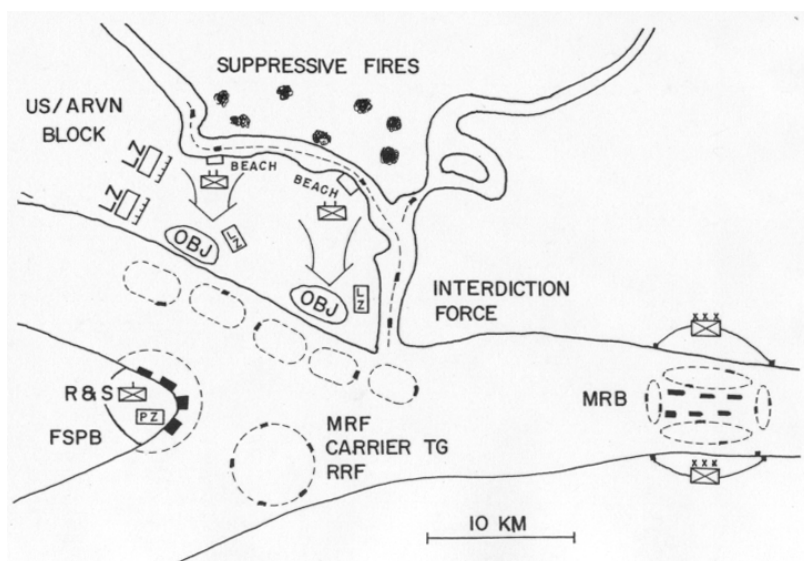
Figure 9 provides a schematic of how the mobile riverine base is defended. The major ships attempt to anchor in a relatively secure location. Navy assault support patrol boats move in stations around the base to protect it against waterborne threats—swimmers, high-speed craft, mines, and the like. Army elements establish foot patrol bases on the banks to preclude enemy direct and indirect fires against the base. Mortar barges, which were developed in-country and are capable of supporting two 4.2-inch mortars and three 81-mm mortars, are normally located on either side of the river. The field artillery fire support patrol base, when it is part of the mobile riverine base and not forward in an area of operations, is anchored in such a location that the close-in support fires of the mortars can protect it while, at the same time, the fires of the field artillery can support the overall mobile riverine base and the patrols operating on the shore.

Strike operations can be conducted from 50 to 70 kilometers from the mobile riverine base. When a large area of operations is involved, landings are made, as indicated in figure 10, normally in conjunction with other land forces participating in a blocking role. These forces get

into position either by land or air movement. The field artillery fire support patrol base is located so that it can provide offensive fires within the strike area. Normally, a ready-reaction force (RRF), in addition to fire base security troops, is positioned in the fire support patrol base area. If no suitable pickup zone (PZ) can be provided in the fire support patrol base, an aircraft carrier task group (TG) with lift aircraft can rendezvous in the middle of the stream. Roughly a company can be lifted in this manner into the strike area in a turn around time of 5 to 10 minutes.

Strike operations involve sealing off a major river by Navy patrol forces and moving up a subsidiary stream in order to form natural blocks with continuous patrols. Troops are then beached to move against the blocking forces or against the opposite shore, thus entrapping the enemy forces located in the area.

An extensive area of operations is often necessary so that sweeps can be made into the base areas and fortified campsites of the enemy, which usually are widely dispersed. Mobile riverine battalions often must operate independently of other battalions. In this situation, the mobile riverine support field artillery can be divided into two separate support elements. Efficient fire support is effected in this configuration from two positions along the river. However, it is more preferable to locate the two riverine support batteries in one fire support patrol base and establish as many as two additional fire support patrol bases on land, using a number of different alternatives. These additional fire support patrol bases are habitually located so as to reinforce the riverine field



**Figure 10. Riverine operation.**



**Figure 11. Airmobile firing platform.**

artillery battalion and be controlled by the fire support coordination center (FSCC) of the brigade.

On several occasions the self-propelled 155-mm howitzer was fired from an LCM-8. However, it was found to be more effective to transport the self-propelled 155-mm battery by LCM-8's to an off-loading location, such as a commercial ferry site, where it could then move into an ARVN compound and fire in support of riverine operations. The towed 155-mm battery has been airlifted by Chinook and placed in a town located close to the area of operations.

The airmobile firing platform (fig 11), which is used with the M102 howitzer, was especially developed for the 9th Division for use in the delta rice paddies and flooded areas. Normally, a firing battery of four M102's is airlifted into an inundated area and established as a fire support base in 4 or 5 feet of water. The base is located so that it can support, and be supported by, another fire support patrol base. Figure 12 indicates a concept of employment of multiple fire support patrol bases in the riverine environment.

The Army component commander is responsible for the coordination of all fire support for the Mobile Riverine Force. This includes naval gunfire in support of strike operations and base defense. The field artillery commander, therefore, acts in his normal capacity as the fire support coordinator. He performs these functions in the forward area at the brigade forward tactical CP which, as mentioned above, is collocated with the fire direction center. Since the helo-barge is also at this location, both the field artillery commander and his aerial observers can take off from and land at this location. With the field artillery liaison officer and the air liaison officer accompanying the brigade commander in his airborne CP, continuous communications and control of all types of fire support, to include air, are possible. Since the infantry battalion commanders have complete freedom of movement by virtue of the aircraft

carriers (light) which accompany their communications and control boats, quick coordination conferences can be effected at the fire support patrol base within a matter of minutes.

### Logistical Support

In Vietnam, logistical support for riverine operations is much simpler than for normal land operations. The LST in the mobile riverine base provides a floating base from which the entire force, both Army and Navy, can be resupplied. This includes artillery ammunition. The LST carries all types of supplies and ammunition for 10 days of operations. It is resupplied by a Navy LST once every 7 days. Resupply to the area of operations can be effected by both water and helicopter. Normally, artillery ammunition resupply is routinely effected by naval craft (ATC's) shuttling from the mobile riverine base forward to the fire support patrol base in the area of operations. In case of an emergency, artillery ammunition can be airlifted from the supply LST directly to any of the fire support patrol bases. The ATC's carry 3 days' supply of food, water, and ammunition. The LCM-8's, as part of the artillery afloat force, have a large carrying capacity for all items required to supply and support the field artillery battalion. Hence, the field artillery can stay in the area of operations for an indefinite period of time, depending on tactical necessity. Logistical support for the overall force is a Navy responsibility; resupply of ground operations, to include the field artillery, is an Army

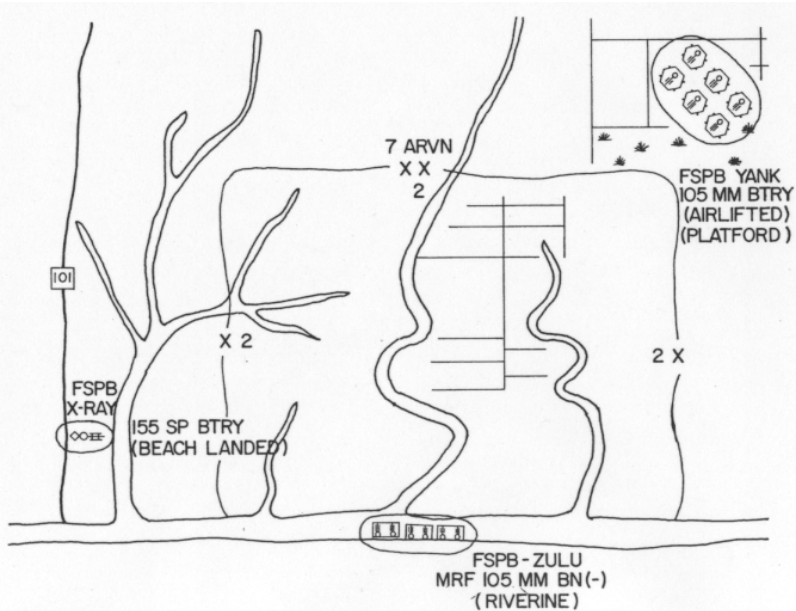


Figure 12. Concept of employment.



responsibility in coordination with the Navy. Incidentally, the Navy always insures that one hot, well-prepared meal is brought forward each day to the "gunners," regardless of the distance to be traveled.

Effective riverine operations have been conducted for approximately 18 months throughout the Delta from Saigon to Can Tho (shaded areas in fig 1). The field artillery has repeatedly demonstrated that it is capable of supporting riverine operations in any of the Delta provinces. The field artillery not only has operated from the major rivers but has repeatedly gone up small streams and canals to conduct its close fire support missions, thus insuring that necessary ingredient to all effective combat operations—decisive firepower.

---

●

### **LASER FOR TANKERS**

A total of 243 of the Army's M-60A1E2 tanks will be equipped with new laser rangefinders. In operation in a tank, the laser is bore sighted with the tank commander's sight and gun. When a target is selected, a laser beam flashes at it. The range appears in meters on a readout and then is fed automatically into the tank's fire control system.

# The Big Eye

## OF THE OLD RELIABLE

*Colonel Josiah A. Wallace, Jr.  
Former Commanding Officer  
9th Infantry Division Artillery*

Terrain as flat as a pool table, an abundance of the enemy, a skilled crew, high equipment reliability, plus a "let's go find 'em and shoot 'em" attitude are the factors which have led to successful employment of the AN/TPS-25 ground surveillance radar by the 9th Infantry Division Artillery in Vietnam's Delta.\* This doppler radar is rated as being capable of detecting personnel walking in the open to a range of 12 kilometers. With the radome elevated to a height between 40 and 50 feet, the 9th Infantry Division Artillery crew has repeatedly achieved this range on the battlefields and occasionally exceeded it. The AN/TPS-25 radar, or "Big Eye" as the troops call it, has consistently produced more field artillery targets than any other intelligence source available to the 9th Infantry Division Artillery. Additionally, maneuver commanders in the "Old Reliable" (9th Infantry Division) have learned to count on the "Big Eye" to help them determine where they may deploy their infantry with a high probability of making contact with hostile forces.

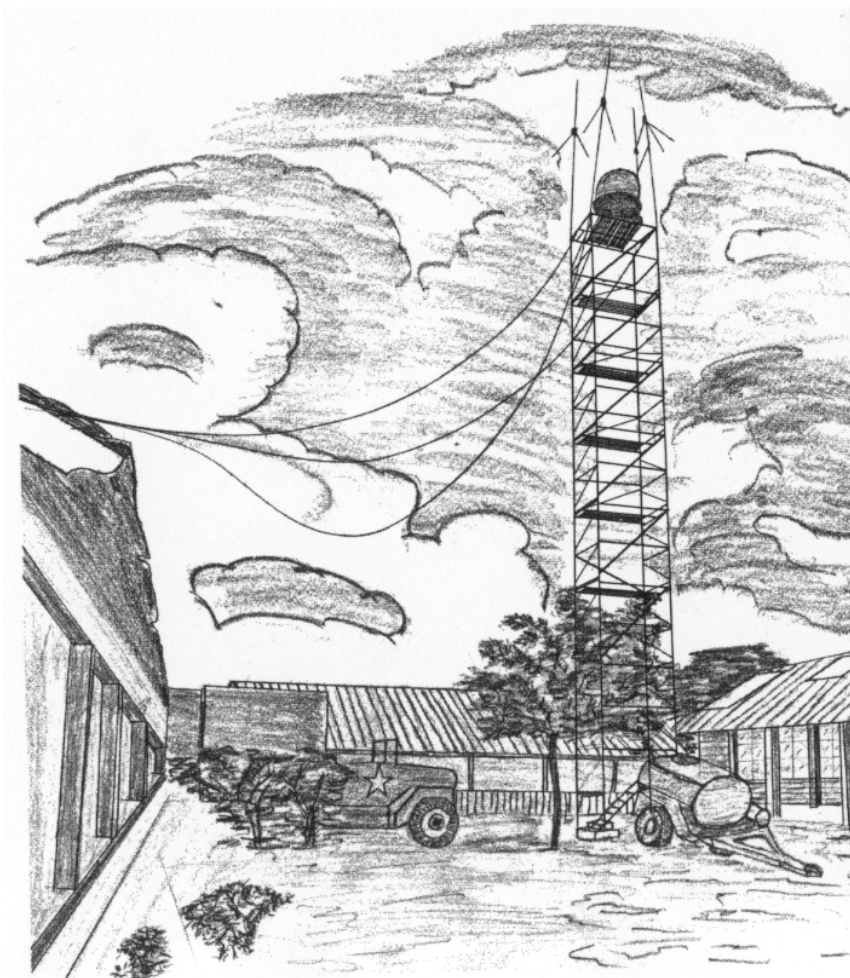
Prior to the 1968 enemy Tet offensive, the AN/TPS-25 radar of the 9th Infantry Division Artillery was used primarily to provide surveillance around US base camps. In this role it consistently produced a modest number of targets each night. In mid-March 1968, the "Old Reliable," working with allied forces, went on the offensive and at the same time radically changed the concept of employing the TPS-25. To help the infantry find and fix the enemy, the TPS-25 was moved out of its US base security role and repositioned every 5 or 10 days in an area in which other intelligence, such as agent or IPW (interrogation prisoner of war) reports, indicated there was a large concentration of the enemy. In a 9-day period in March 1968, 145 targets were sighted by the TPS-25 from its position on a rooftop in the center of an important Delta province capital. The enemy were attempting to seize or neutralize this key town to improve their political position in the Delta. The field artillery then fired on most of these targets, each of which consisted of 10 to 30 enemy personnel. The sustained high-attrition rate resulting from these field artillery fires on the radar-detected targets was a major factor in the successful defense of the province capital. In the defense of this town, and in other instances in which the radar has been employed, most

*\*A related article titled "You Don't Need a Crystal Ball" appeared in the October 1964*

**ARTILLERY TRENDS**

of the sightings were of 10- to 30-men groups that moved at random within an area. Identification of such groups of moving personnel as the enemy is determined by considering the time and location of movement, the location of friendly forces, and the proximity of populated areas. All fires are cleared with the local district chief to guard against casualties among civilians.

With that major political center secure, the radar was moved to another village astride a key Delta highway. Intelligence indicated that a sizable enemy force was preparing to blow a bridge and step up the interdiction of the highway. Already the enemy was establishing 15 to 20 roadblocks or craters nightly along one key 20-kilometer stretch of the highway which was the main artery of this area. The TPS-25 produced





approximately 25 targets a night along the highway. The targets were attacked by the field artillery and again produced a high attrition rate amongst enemy forces. Then, the 1st "Recondo" Brigade of the 9th Division also began to use intelligence produced by the TPS-25 radar in planning operations for the maneuver elements. Reacting to intelligence from the radar, infantry units of the "Recondo" Brigade made a number of contacts with platoon- and company-size enemy forces deployed to the north of the highway. These actions indirectly resulted in the radar's being given its appropriate nickname. Troopers passing by the bridge site had heard of the radar and knew that it was one of the reasons the "Recondo" Brigade was having repeated success in making contact. Consequently, the big, black mushroom-shaped radome atop the tower was quickly dubbed the "Big Eye." This sobriquet later suggested an interesting bit of psychological warfare in which a leaflet, aimed at the superstitions among the enemy, was dropped. The leaflet told of "a ghost who walks beside you at night and gives away your location." There was no direct feedback from this leaflet.

A system using combined aerial and radar observations was developed to train the radar crew and check its proficiency. An O-1 aircraft would fly over the radar surveillance areas during daylight. When the aircraft spotted farmers, sampans, Regional or Popular Forces, or water buffalo moving in the area, the aircraft would radio the grid to the TPS-25 and the radar crew would observe that grid and report the size and nature of the target. The radar crew then would be scored on their results. The reverse procedure was also used. The aerial observer would then tell the radar crew to search, find a target, and report its location and description to the aerial observer, who would then fly to the grid, check it out, and again score the radar. The TPS-25 crew was consistently more than 95 percent accurate in reporting the number of personnel in the target. Even this performance record did not convince some of the "doubting Thomases" who challenged the ability of the "Big Eye." One night, to stop these doubts, the division artillery S3 had an illumination time-on-target (TOT) mission fired over a sighting of 10 to 15 enemy personnel in an open paddy area. He then flew under the illumination in a helicopter and observed a squad of enemy personnel, carrying individual weapons, running for cover. This combination of daylight radar and aerial surveillance is used every 4 or 5 days to maintain a check on crew and equipment proficiency and also to check for dead space.

The AN/TPS-25 was moved again in April when intelligence indicated that the enemy forces were again massing to attack political centers. In the new position, an average of only four sightings per night was made; however, an enemy body count of 33 was reported by troops of the Regional and Popular Forces after a single night of field artillery fire. A much larger number of targets, 136, was located in another district in a 5-night period which began on 12 April. Several intelligence sources indicated the presence of main force battalions and supply and

command and control installations in this area. The field artillery fired 5,422 rounds in 5 nights on these sightings. On the first night, one sighting revealed approximately 130 enemy troops; numerous other sightings were made of smaller groups. On the next night, sightings were made of groups consisting of 50 to 60 enemy personnel. By the end of the fifth night of this radar shoot, the size of the largest groups sighted had dwindled to 20 or 30. Although agents reported 180 of the enemy killed the first night alone, US forces could not confirm a body count of more than 6 at this location, since US troops were able to get into only a few of the target areas reasonably soon after the firings. However, this operation proved that the radar can be employed during daylight in areas where scrub undergrowth offers concealment. Because of its power, the TPS-25 can detect movement inside enemy areas of vegetation. This was discovered when an operator checking the set during daylight called the FDC duty officer's attention to movement in an area where a target had been detected the night before. The officer relayed the information to a US cavalry unit, which checked the area, flushed the enemy out of an area of thick undergrowth, and killed 11 of the enemy.

In mid-April the "Big Eye" returned briefly to support both the 1st "Recondo" Brigade and the 2d Brigade of the Mobile Riverine Force as well as the Regional and Popular Forces. On 17-18 April the 1st and 2d Brigades killed 60 enemy personnel in a major engagement. The "Big Eye" maintained surveillance for several nights thereafter in this area of heavy contact and massed field artillery fires were placed on small enemy elements as they moved back into the area. This was, in effect, an extended pursuit by fire. Again, no high body count could be confirmed by US forces, since troops were seldom available to sweep the areas attacked. However, one wounded enemy platoon leader who rallied to ARVN troops in the area, stated that 33 of his company had been killed and 10 had been wounded by field artillery the night before he defected. He defected because he was tired of repeated accurate and powerful American field artillery attacks in the area.

In late April, the "Big Eye" was moved again to support defense of key political centers being threatened in the "Mini Tet" offensive. In 22 nights of operation from 3 locations, the radar detected 377 targets which were attacked by field artillery. Unfortunately, again, a high body count as a direct result of field artillery attacks of radar sightings could not be confirmed. Most of the sightings in this area, like those in other areas, were of 10- to 30-man groups moving within the area. The sustained high rate of field artillery attacks against these enemy groups was effective in attriting enemy forces and preventing them from regrouping. The largest target sighted in this operation was detected on the night of 9 May after a day-long contact between enemy and friendly forces. Shortly after dusk the radar began scanning the contact area and made a high number of sightings. However, friendly and hostile forces were so close that they could not be distinguished from one another by the radar. By 2100 hours a distinct movement of approximately 130 enemy was picked

up as they moved away from the battle area. This column of troops was observed as it used two motorized sampans to cross a stream 50 meters wide, then divided into small groups, and disappeared into a village. The target could not be engaged then, for it was in a populated area. Later, an analysis of the district senior advisor's hamlet evaluation sheet showed the area to be enemy controlled. This led to the conclusion that the enemy soldiers moved into the farmhouses for rest and shelter after a day of battle.

Some allied commanders have shown considerable initiative in reacting to radar intelligence. One ARVN infantry regiment reacted to radar sightings and killed seven of the enemy and captured two 82-mm mortars which had been firing on a US 8-inch howitzer/175-mm gun battery. Another regiment and Regional and Popular Forces mounted an operation into an area in which radar had reported numerous enemy sightings the night before. This allied force was in contact with the enemy all day and confirmed an enemy body count of 22.

During this campaign the radar also made several sightings of sampans. On one occasion, 18 to 20 sampans were detected moving along a canal apparently carrying supplies or reinforcements. Armed helicopters were vectored to the area and sank six sampans under "Firefly" illumination.

Throughout most of July and August 1968 the TPS-25 occupied various positions in support of both the 1st "Recondo" Brigade and the 3d Brigade operating in strongly held enemy areas. Infantry commanders routinely reacted to radar sightings and consistently made contact in areas where the radar indicated that enemy forces were located. On 7-9 August the 1st Brigade deployed nine US companies to completely encircle and destroy an enemy force initially located by radar. In this attack 40 enemy troops were killed (by body count) and 6 enemy troops, 15 individual weapons, and an 82-mm mortar were captured. Again, on 18-19 August, the 1st Brigade reacted to radar sightings and deployed two infantry battalions to encircle and destroy the enemy forces. Enemy losses were 93 killed in action (body count), 15 prisoners of war, 6 defectors, 33 individual weapons, and 9 crew-served weapons. By the end of August 1968, several night insertions had been made by the 1st Brigade on radar sightings, and contact was made on each. Circumstances in each case, however, prevented troops from remaining on the ground for a sustained search; therefore, the results of these night insertions were not great, but they were the initial steps of a later productive series of "night hunter" operations on which airmobile troops consistently and successfully exploited radar sightings.

In August, reacting to radar sightings, the 3d Brigade encircled a company-size force. The area within the encirclement was so pulverized by air and field artillery that it was difficult to count bodies. However, 14 bodies were counted and the 2 wounded prisoners of war who were

taken in the action stated that they believed their entire company was caught in the encirclement and wiped out.

Full exploitation of the potential of the TPS-25 requires continuous command interest and supervision, good staff organization, and solid communications. A small forward division artillery command post and fire direction center mounted in an M109 van accompanies the radar on each move. In the van FM radios are mounted for communicating with field artillery battalions/batteries, advisors, and ARVN forces artillery liaison officers with the US infantry units in the area of operations. An AN/GRC-46 radio accompanies this command post and fire direction center to pass information on sightings to and from the division fire support element. The Division Artillery Assistant S3 and his enlisted assistants operating this CP/FDC:

- Give specific directions to the radar on where and when it is to search hour by hour. Current intelligence and friendly dispositions, prisoner-of-war reports, captured documents, agents' reports, market gossip, and district advisor's hamlet evaluation sheets are among the sources used to guide the radar. This is a highly important bit of staff work. If the selection of time and place to search is left to the operator, who is in no position to be aware of what is occurring on the battlefield, mediocre results are the best that can be expected. Priority of search is always assigned to the last point of contact with hostile forces.
- Take the raw sights from the radar and pass them as raw intelligence over AM or FM radio to interested headquarters.
- Contact US, allied, and Regional and Popular Force commanders for assistance in determining if the sighting is hostile and for clearance to fire if it is.
- Contact government officials and obtain their approval to fire if the target is near a populated area.
- Execute fire missions on targets after they have been cleared for attack by all concerned. A target of 10 enemy personnel or less is attacked with one battery firing three volleys with a 50- to 100-meter range spread. For a target of 30 enemy troops or more, all available batteries (from two to six) fire; firing commences preferably as a time-on-target mission and continues until movement ceases. Targets are refired if movement reappears.
- Supervise gunnery aspects of firing (survey, registrations, full use of FADAC, and current metro) to insure that fires are fast and accurate.
- Early each morning, and this is a capital function, analyze the data and point out to the commander of US and allied infantry units and Regional and Popular Forces the areas in which radar intelligence indicates that these units are most likely to make contact with hostile forces.

In summary, the "Big Eye" tells the maneuver unit commander in what areas he can most probably make contact with the enemy. It is a highly productive source of artillery target. Employed offensively, it finds even more enemy troops than when it is used for a base camp security mission. Experience in Vietnam proves the "Big Eye" to be dependable, rugged and mobile. And when elevated to heights of 40 to 50 feet, the "Big Eye" proves even more effective. For best results a forward command and control element must accompany it and direct its employment minute by minute.

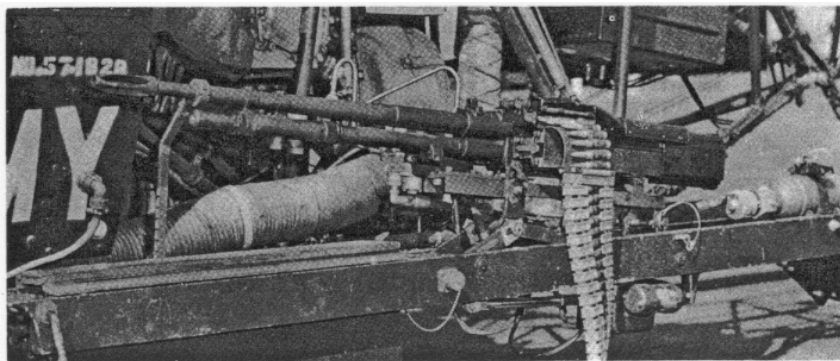
---

●

### XM-2 SUBSYSTEM

The XM-2 helicopter armament subsystem provides a means of mounting two M60C machineguns on a H-13E, H-13G or H-13H helicopter. The M60C gun fires 7.62-mm ammunition at a rate of 600 to 650 rounds per minute. The system has an ammunition storage capacity of 1300 rounds or 650 rounds per gun. The total weight of the subsystem with 1300 rounds of ammunition is 190 pounds.

One gun is mounted in each side of the helicopter between the front and rear cross tubes. The mount assemblies can be interchanged from one side of the helicopter to the other or can be removed from the helicopter in a few minutes. The guns are mounted to be fired only in the direction of forward flight and limited elevation (0 degrees to 9 degrees) is provided to compensate for the attitude of the aircraft during various flight configurations. A separate ammunition box is provided for each gun, and each is attached to the forward end of the mount. Elevation is provided by a linear actuator which is driven by an electric motor. The charging operations and making the guns safe are accomplished by use of a pneumatic charger which is controlled by a solenoid actuated valve, and is supplied with air from a bottle attached to the rear of the mount. The firing trigger is actuated by a solenoid.



**Figure 1. XM-2 armament subsystem.**

# *Revised Programs For FADAC*

*Major Martell D. Fritz  
Gunnery Department  
USAFAS*

**EDITOR'S NOTE:** *The following article applies to those units now receiving Issue 2 (Revised) tapes. A previous article appearing on page 66 of the December 1968 issue of ARTILLERY TRENDS applies to units now using the initial Issue 2 tapes.*

The M18 Gun Direction Computer (FADAC) has become the primary means of computing firing data for artillery units in Southeast Asia. The FADAC is a general purpose computer and will perform any computational task for which a program has been written and inserted into memory. It is limited only by the size of the rotating magnetic disk memory of 8,192 words. Programs are coded on punched paper tape and are inserted into memory by the signal data reproducer (SDR), AN/GSQ-64. Each field artillery cannon and rocket battalion is authorized one SDR. Once the program is loaded in the FADAC, it cannot be changed by normal operator actions.

Thus it becomes obvious that the value of the FADAC is directly related to the quality of the program being used. The artillery community (US Army Field Artillery School, US Army Field Artillery Board, and US Army Combat Developments Command Field Artillery Agency) is constantly at work seeking to improve existing FADAC programs. The testing of the first issue of FADAC cannon program tapes was completed in August 1966 and the tapes were distributed shortly thereafter. During 1966 and 1967 several needed modifications became apparent. The introduction of FADAC into Vietnam generated additional requirements that needed to be included in the program. These significant improvements were included in the new tapes which were designated Issue 2, Phase III, Cannon Machine Program Tapes. The Issue 2 tapes were shipped to Vietnam in June 1968.

Produced through the joint efforts of Frankford Arsenal, the US Army Combat Developments Command Field Artillery Agency, the US Army Field Artillery Board, an agency of the US Army Test and Evaluation Command, and the US Army Field Artillery School, these tapes each contain the ballistic program for two different calibers and/or models of weapons. Six tapes are now being issued. They contain combinations of calibers and/or models which provide for most ballistic and tactical

groupings that may be employed. These combinations are as follows:

Part Number	Weapon Combination
8213315-51	105mm (M101A1)/105mm (M108, M102)
8213315-52	105mm (M101A1)/155mm (M109)
8213315-53	105mm (M108, M102)/155mm (M114)
8213315-54	105mm (M108, M102)/155mm (M109)
8213315-55	155mm (M109)/8-in (M110)
8213315-56	8-in (M110)/175mm (M107)

The new programs use a different matrix design than the previous Issue 1 programs. The most significant improvements incorporated in the new tapes are:

- The ability to compute ballistic data for Improved Conventional Munitions (ICM) for all calibers as well as for the M454, 155mm nuclear round, and for the M426, 8-inch gas shell.
- The proper deflection display for either 3200- or 6400-mil fire control equipment.
- Increased flexibility gained by met input procedures which allow

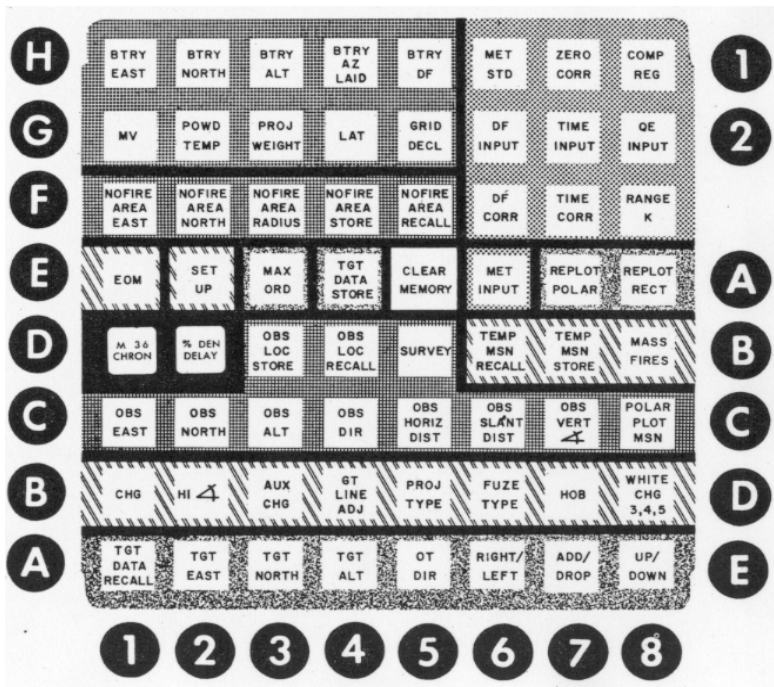


Figure 1. Matrix design for Issue 2 (revised tapes).

selective input, recall, or correction of individual lines of met data.

- In addition, fuze data for the M564 and M565 time fuzes can now be computed as well as for the M501 and M520 time fuzes.

- A provision to allow the operator to compute the maximum ordinate (altitude) of the trajectory. This altitude is displayed in meters above mean sea level to facilitate the issue of safety warnings for friendly aircraft.

- Application of registration corrections for only a specific charge and trajectory (high angle or low angle).

- A no-fire-area preclusion program permitting the operator to enter circular areas into FADAC for safety purposes.

- The entry of developed muzzle velocity for both green bag and white bag propellants for separate loading ammunition.

- Elimination of the ballistic coefficient factor input capability.

Revised Field Manual (FM) 6-3-1, dated June 1968, has been published. This manual contains instructions for using the Issue 2 tapes.

Commanders should be informed that a complete set of **revised** tapes will be available for issue in the spring of 1969. These tapes will be known as Issue 2 (Revised). They will supersede all other program tapes. There will be fifteen different tapes in all:

<b>Part Number</b>	<b>Weapon Combination</b>
8213315-64	105mm (M101A1)/105mm (M102, M108)
8213315-65	105mm (M101A1)/155mm (M114)
8213315-66	105mm (M101A1)/155mm (M109)
8213315-67	105mm (M102, M108)/155mm (M114)
8213315-68	105mm (M102, M108)/155mm (M109)
8213315-69	155mm (M109)/155mm (M114)
8213315-70	8-inch (M110)/155mm (M114)
8213315-71	175mm (M107)/155mm (M114)
8213315-72	155mm (M109)/8-inch (M110)
8213315-73	155mm (M109)/175mm (M107)
8213315-74	8-inch (M110)/175mm (M107)
8213315-75	105mm (M101A1)/8-inch (M110)
8213315-76	105mm (M102, M108)/8-inch (M110)
8213315-77	105mm (M101A1)/175mm (M107)
8213315-78	105mm (M102, M108)/175mm (M107)

Revised tapes will include a program that will permit the FADAC operator to automatically extrapolate M36 chronograph measured projectile velocity to muzzle velocity corrected for powder temperature, projectile weight, air density, quadrant elevation, and delay, using the FADAC. These revised tapes will also compute ballistic data for ICM munitions much faster than is done using the present Issue 2. Instructional material will accompany each set of fifteen tapes as **Fire Control**



**and Coordination Information Letter . . . 12.** Artillery commanders should insure that these updated program tapes, as well as the instructional material, are requisitioned and used. Further, old tapes should be destroyed after the new ones are on hand.

The urgent requirement for new capabilities with FADAC in Southeast Asia precluded making certain changes to the Issue 2 revised tapes. The artillery community has already completed a requirements statement for new tapes which includes the correction of shortcomings in Issue 2 tapes, the incorporation of new requirements, the addition of ballistic data for new munitions, and other significant improvements. These new tapes will be designated the Issue 3, Phase III, Cannon Machine Program tapes. The Issue 3 tapes are tentatively scheduled for completion by October 1969. Some of the more significant improvements in the new tapes will be:

- Reduction of solution time.
- Correction of all Issue 2 shortcomings.
- Addition of the ballistic data for the 155mm illuminating projectile, M485.
- Application of registration corrections in the form of a variable range K.
- Increased target storage capacity from 88 to 118.
- Increased No-Fire Area storage capacity from 21 to 39.
- Addition of the survey capability for zone to zone transformation of UTM coordinates.
- Addition of the capability of computing the azimuth by altitude survey method.

All of the problem areas concerned with the use of FADAC are of interest to USAFAS. Units and individuals are encouraged to submit descriptions of any problems encountered or any suggested improvements to current FADAC programs. Many of the present and planned program revisions are a result of recommendations from the field. Recommendations may be submitted to:

Commandant  
US Army Field Artillery School  
ATTN: AKPSIAS-PL-FM  
Fort Sill, Oklahoma 73503

# FADAC Computations

## VERSUS

# Manual Computations

*LTC USA (Retired) Matthew J. Ringer  
Maj Martell D. Fritz  
Gunnery Department  
USAFAS*

The introduction and use of FADAC in Southeast Asia has provided a greatly increased capability to US Field Artillery. The fatigue factor and resulting errors of FDC personnel have been reduced with a corresponding rise in efficiency. However, the use of FADAC has not eliminated the need for a reduced manual backup capability and a system of checks. The Gunnery Department has received numerous requests from units in Southeast Asia for a set of tolerances for use in checking the FADAC solution with manual computations.

A set of finite tolerances to be used in comparing FADAC with manually derived data is not practical. No single criterion would serve the large number of possible differences between the two systems. To list acceptable tolerances by weapon, charge, range, and other variable inputs not only would be misleading and inaccurate but also would require voluminous data. This is not to imply that a check of any system, FADAC or otherwise, is not essential. A system of checks must be an integral part of the operation of any fire direction center. Checks should be made during each step of a fire mission, but the purpose of these checks should be to identify rather than to compare the inherent accuracies of two systems. Good judgment and sound artillery procedures are still the best means of identifying and correcting errors.

A comparison of FADAC data versus manual data would vary under the three most general FDC cases, as follows.

a. Without met data, muzzle velocity data, propellant temperature, and before registration, FADAC and the manual system provide almost identical data. The only difference would be the round-off caused by measuring chart data to 10 meters while FADAC computes to less than 10 meters. In this case, differences of 2 mils in quadrant elevation and deflection and 0.2-mil increments in fuze setting are realistic.

b. Without met data, muzzle velocity data, and propellant temperature but after registration FADAC and the manual system may provide comparable data. Currently, FADAC is programmed to apply a

constant range K to targets within transfer limits. The new slant scale GFT's apply a variable range K. The difference in resultant data varies with the weapon, charge, and range. Issue 3 program tape for FADAC, when available, will include a variable range K solution. At that time, the tolerances in a above will apply.

c. With a knowledge of weapon and target location, met data, and muzzle velocity error, FADAC will provide a more accurate solution than either the manual met plus velocity error or range K techniques. Manual computation of met plus velocity error incorporates a number of inaccuracies caused by approximate mathematical techniques which are required by the need to simplify the procedure. The met data used in this method are weighted to produce an assumed constant wind, density, and temperature which have the same total effect as the actual varying conditions. The weighting factors are devised to account for the average total effect on projectiles of various atmospheric zones of all field artillery cannon and rockets, with emphasis given to a particular weapon. Weighting of the lower zones leans heavily toward the effect of a 105-mm howitzer projectile while weighting of higher zones leans toward heavier cannons. Weighting depends on the assumption of an average trajectory through a given maximum ordinate. It is unlikely that a fired trajectory would match a hypothetical average trajectory so that these weighting techniques introduce higher order inaccuracies.

In addition, tabular firing table data are published in a format to simplify their use. The data are tabulated as corrections for a change of a 1-knot wind, 1-percent density, 1-meter/second muzzle velocity, and 1-percent temperature. These data are in reality one-fiftieth of the correction for a 50-knot wind; one-tenth of 10-percent density, etc. The data as used in the manual solution assume that linear interpolation is valid when, in fact, these data may not truly be linear in effect.

Further, hypothetical standards are set, and each set of data is determined by holding the other variables constant at this standard value. This is a false assumption since temperature interacts with velocity, density, and the projectile drag coefficient to produce a drag force which is affected by the relative wind velocity. All effects act together, not separately. The inaccuracies introduced by these interaction errors of effects and the assumption of linear variance may be significant, depending on the degree of variance from standard conditions. The FADAC solution uses met data as it is actually measured. No weighting factor inaccuracies are introduced. The interaction errors are minimized, since the trajectory is simulated using all ballistic conditions. Provided all of the ballistic variables are determined accurately and entered correctly into FADAC, the computer will determine an accurate direction, fuze setting, and quadrant elevation for any target within the range of the weapon. Because of the disparity in results, an outright compilation of tolerances between FADAC and met plus velocity error solutions under these conditions

cannot be made. A possible solution is to determine data by using wind cards and a slant scale GFT with a current GFT setting. This would not check the basic validity of the FADAC solution but would provide a check for operator errors. Tolerances of 5 mils in quadrant elevation and deflection and 0.3 fuze settings would be realistic.

When high-angle fire is employed, the problem of checks is completely different. Only a check of gross FADAC errors is possible because larger and more significant errors are introduced into the manual system than when low-angle fire is employed. In all cases, it is stressed that the best system of checks is to validate the data as entered by the FADAC operator. For example, the input data (target coordinates, altitude, charge override and fuze) should be recalled to verify that the data have been entered correctly. Also, in those cases where a battalion computer is used to check a battery computer, recall and verification of input data will result in the same quadrant elevation except for the change due to difference in the input of battery altitude. Where firing batteries are located over a large front requiring use of different met data, the only way the battalion can assure accurate firing data at the battery is to recall and verify input data.



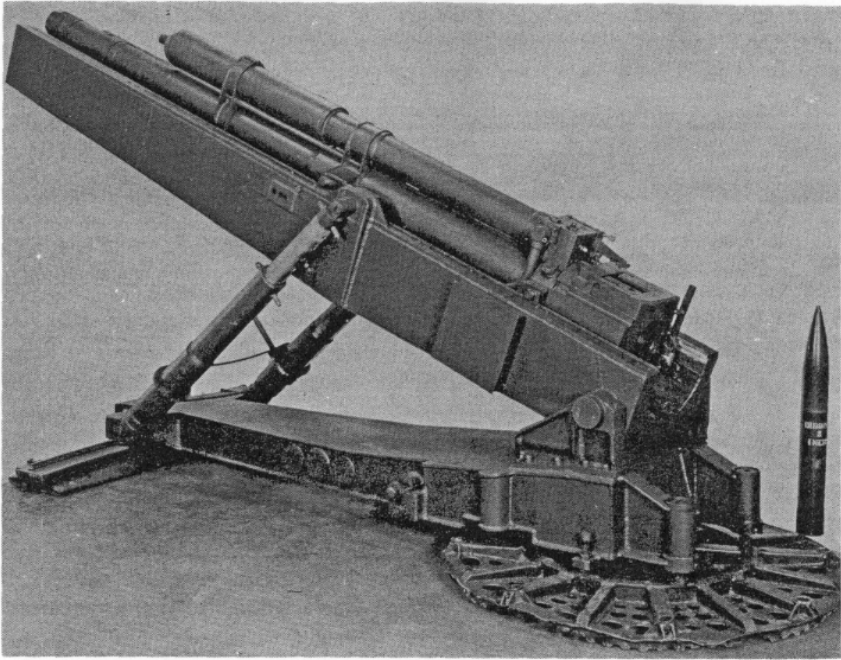
## **ASSAULT BRIDGE EVALUATED**

Testing of the first production unit of a lightweight assault bridge, carried and launched by the M-113 Armored Personnel Carrier (APC), has been started by the US Army Mobility Equipment Research and Development Center, Fort Belvoir, Virginia. The center developed the bridge for use in the rice paddies and swamps of Southeast Asia.

Five units will be used for research, development and testing while the remaining 24 units will be shipped to Vietnam for field evaluation.

The folding-type, weldable aluminum alloy bridge is capable of supporting 15-ton loads over spans up to 33 feet. It weighs 2700 pounds and can be emplaced where heavier bridge equipment would bog down. The carrier, with bridge, also has the same swim capability of 3.5 mph as an unmodified carrier.

The bridge is carried in a folded position, and can be emplaced hydraulically in less than 2 minutes without exposure of personnel. After manual hookup of two hydraulic connections, it can be retrieved by reversing the launching procedure. The bridge can be launched or retrieved from either end.



# Soft Recoil System

**EDITOR'S NOTE:** *The following article was prepared by personnel of the Army Weapons Command, Artillery Systems Laboratory, Rock Island Arsenal. Contributors are as follows: Harold R. Lohmann, Gilbert J. Melow, Jr., Robert E. Seamands, and Howard O. Sand.*

The strange looking field artillery piece shown above, with its trails on backward, is a 105-mm howitzer that fires its projectile from the out-of-battery position. This weapon is really only a test fixture. It has no wheels, lunette, or fire control; and can be elevated and traversed only within limitations. This system was built to demonstrate and prove the soft recoil principle. Figure 1 depicts a concept of a tactical 105-mm soft recoil FOB weapon.

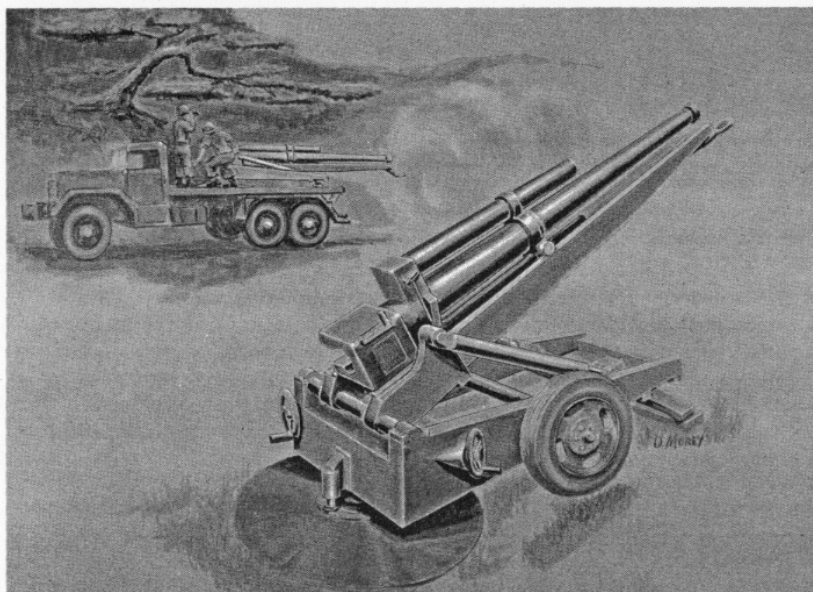
With its soft recoil cycle, this unique weapon offers a number of significant advantages. The soft recoil principle reduces the recoil force by as much as 70 percent which enables the designer to reduce the weight of a 105-mm weapon by 15 percent and by an even higher figure for larger caliber weapons. The overall weapon length can also be reduced by as much as 30 percent. Because of the shorter cycle time and the easy access to the breech for loading, a significantly faster maximum

rate of fire is possible. Perhaps the greatest benefit offered by a soft recoil weapon system is the improved stability. It can be emplaced and fired with little or no site preparation or anchoring.

Figure 2 illustrates the operation of the soft recoil cycle. The recoiling parts run forward and build up momentum in the counterrecoil direction. When the weapon is fired, these parts recoil back to (or slightly beyond) the initial position where they are caught by a latch.

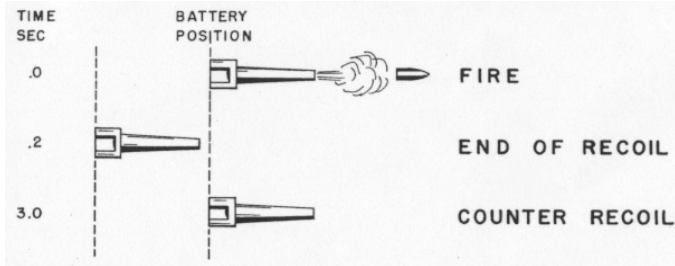
This cycle differs from the conventional firing out-of-battery oscillating cycle utilized in automatic weapons because the recoiling parts are seared in the full recoil position and the firing is initiated at various positions from the in-battery position. The various positions depend on the propellant zone used. As shown in figure 2, the complete cycle time is half that of the conventional weapon.

In operation, the recoil mechanism is essentially a pneumatic spring which stores the energy that moves the recoiling parts toward the in-battery position. When the recoiling parts reach the proper forward velocity for the zone to be fired, the weapon is fired and the direction of motion of the recoiling parts is reversed. As the recoiling parts return to the latch position, the energy expended to move them forward is replaced and stored for the next round. An advantage of this type of recoil mechanism is that the recoil cylinder will no longer require a precision

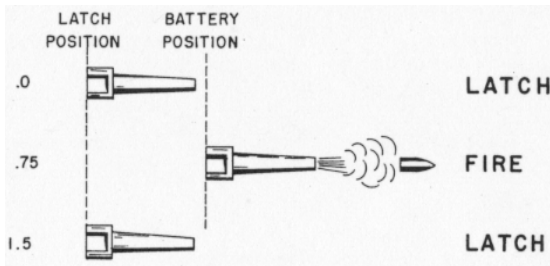


**Figure 1. 105-mm soft recoil howitzer.**

## CONVENTIONAL WEAPON



## FIRE OUT OF BATTERY WEAPON



**Figure 2. Recoil comparison.**

machined orifice and control rod. The recoil cylinder has a single hydraulic cylinder with piston rod and piston.

**TABLE I  
WEAPON COMPARISON**

Characteristic	M102	Soft Recoil Howitzer
Recoil—Counterrecoil cycle (sec)	3	1.5
Recoil Force (lbs)	11,000	3,500
Length (in)	258	172
Weight (lbs)	3,300	2,700
Range (meters)	11,500 (w/M-1)	11,500 (w/M-1)
Traverse (deg)	360	360
Elevation (deg)	—5 to +75	—5 to +75
Stakes Required		
Maximum	8*	2**
Minimum	4*	0

NOTES: \* 4-inch diameter × 24-inch stakes

\*\* 1 ½-inch diameter × 18-inch stakes which would not be required for most firing conditions

A buffing mechanism is positioned at both ends of the cradle to slow down and stop the recoiling parts should a misfire occur or should the crew attempt to fire a high zone round when the weapon is set for a lower zone.

A comparison of characteristics for the standard 105-mm, M102 Howitzer and the 105-mm Soft Recoil Weapon Concept (Figure 1) is shown in Table I.

Firing tests that were conducted in 1967 have demonstrated the accuracy of the 105-mm soft recoil firing fixture to be comparable with the M102 howitzer. The M102 howitzer and the soft recoil test fixture both use the same cannon. The results of the comparison accuracy tests that were conducted at Aberdeen Proving Ground and Yuma Proving Ground are summarized in Tables II and III.

**TABLE II  
INDIRECT FIRE ACCURACY**

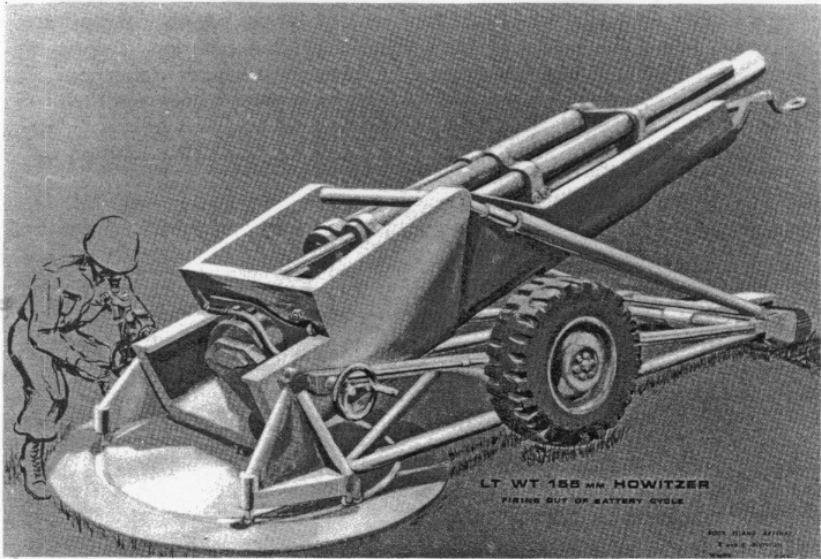
	<b>Elev (mils)</b>	<b>PE (r) (M)</b>	<b>PE (d) (mils)</b>
<b>Charge 3</b>			
Soft Recoil Howitzer	534	.23	.93
M102	534	.19	.45
Soft Recoil Howitzer	1155	.36	1.20
M102	1155	.63	1.29
<b>Charge 5</b>			
Soft Recoil Howitzer	534	.35	.79
M102	534	.28	.59
Soft Recoil Howitzer	1155	.26	.50
M102	1155	.24	1.54
<b>Charge 7</b>			
Soft Recoil Howitzer	534	.33	.46
M102	534	.13	.45
Soft Recoil Howitzer	1155	.24	.81
M102	1155	.49	1.14

**TABLE III  
DIRECT FIRE ACCURACY**

**Charge 7  
Range - 500 Meters**

<b>Weapon</b>	<b>Standard Deviation, Mils</b>	
	<b>Horizontal</b>	<b>Vertical</b>
105-mm Soft Recoil Howitzer	.26	.31
105-mm How M102	.36	.28
105-mm How XM164	.26	.25
105-mm How M101	.26	.25





**Figure 3. 155-mm soft recoil howitzer.**

The operational reliability of a soft recoil type weapon depends upon three requirements. First, it must fire at the proper time; that is, when the recoiling parts have reached the correct forward velocity. Second, the propellant must ignite and burn in a predictable and reproducible manner. Third, the latch must function properly every time. The first requirement has been satisfied. The second has been made less stringent with the invention of a device which senses the recoiling parts velocity, automatically actuates the firing lock at the correct velocity and simultaneously shuts off the accelerating force so if there is an ignition delay, the recoiling parts will coast until the charge ignites. This shut-off feature provides a high degree of assurance that the tube will return to the latch position. So far as the third requirement is concerned, the present latch system has never failed when the recoiling parts have returned to the latch.

The 105-mm soft recoil firing fixture was demonstrated to interested artillery personnel at Fort Sill on June 13th and 14th, 1968.

Figure 3 is an artist's sketch of a 155-mm Howitzer concept which incorporates the soft recoil cycle. This weapon would have a maximum range of 14,700 meters and would weigh only 7,200 pounds—5,500 pounds less than the standard weapon. A 155-mm soft recoil design cannot be finalized until the ammunition problem is resolved. Standard 155-mm propellant charges have an unpredictable ignition delay, varying from about 40 milliseconds to more than 80 milliseconds. A reproducible ignition delay, with a small variance, gives the designer no basic problems. A 40-millisecond variance does. First, he must allow up to 2

feet of extra forward travel to allow for the "coast period" of the recoiling parts when the weapon should have fired but did not. During this period the angle of air will change because of structural deflections. The change will cause a range error. Analysis indicates this error will be unacceptably large at both high and low quadrant elevations. Therefore, ammunition studies have been initiated to reduce the ignition delay variance in 155-mm propelling charges.

Use of the soft recoil cycle to provide increases in range and/or payload and to enhance stability of a field artillery system is another potential of this recoil cycle. A weapon utilizing the soft recoil system would allow great advances in these areas where stability may not be the primary operational objective.

The soft recoil cycle is one of the more promising applied research programs currently being investigated by personnel of the Weapons Command. Perfection of this recoil cycle will provide field artillery design engineers with an important technique for reducing weapon weight while improving weapon mobility, rate of fire and stability.

---

●

### **LUNAR RELIEF MAP**

The Army Map Service (AMS) will help the National Aeronautics and Space Agency to make simulated man-landings on the moon. The area on which they "land" will be a simulated surface being built by the AMS from a high-fidelity lunar relief map made from Orbiter IV and V photography provided by the space agency.

Technicians in the Relief Model Branch at AMS, a U.S. Army Corps of Engineers agency, are building the 22 by 14 foot hand-carved model of the landing site which astronaut trainees will see as they "approach" the "target area."

The model is a part of a Lunar Module Simulator (LMS) to be installed at the Kennedy Space Center to provide flight crew training and orientation on the Apollo landing site designated as II-P-8. Through the use of the LMS, including the crew station, optics, instructor console, compute complex, closed circuit TV and other equipment, astronauts will experience a lunar landing approach without leaving Florida.

---

●

### **TROOP CARRIER TESTED**

Navy and Marine Corps units are testing a new jet-powered armored troop carrier. Developed in the lines of modified landing craft now assigned to Navy riverine unit in Vietnam, the new carrier transports 44 combat-equipped troops behind 3 inches of armorplating.

# A New Look Of Pershing

*CPT Alan L. Moore, Jr.  
Guided Missile Department  
USAFAS*



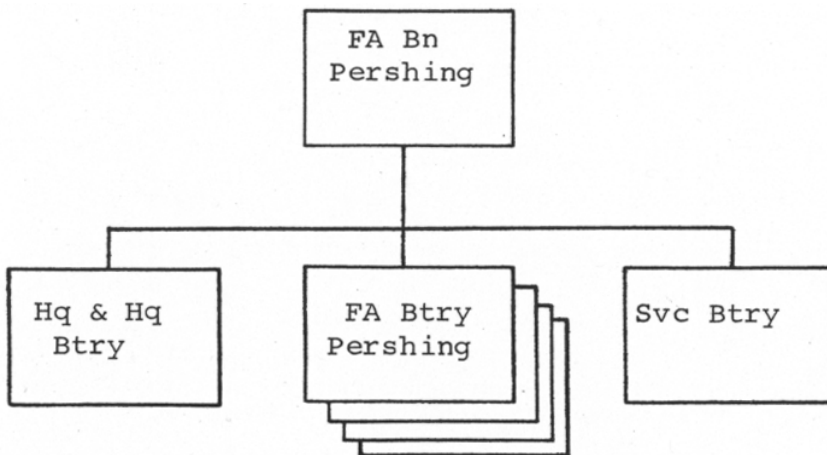
The Pershing missile system is taking on a new look, and with that new look comes an expanded responsibility and the most awesome firepower capability ever to rest with a battery or battalion commander.

Named in honor of America's World War I leader, General John J. "Blackjack" Pershing, the nucleartipped weapon was conceived by an army-industry team in late 1957 as a replacement for the Redstone. The first contract was issued in March of 1958 by the Army Missile Command, Redstone Arsenal, Alabama, to the Martin Marietta Corporation's Orlando Division, which still serves as prime contractor for the system.

Just 3 months after the design study contract was awarded, the first Pershing roared from a pad at Cape Canaveral (renamed Cape Kennedy). This first firing began a 3-year series of launches—one of the most successful strings for any major missile system.

Meanwhile, the first Pershing battalion, the 2d of the 44th Artillery, was being organized at Fort Sill, Oklahoma. Activated in June 1962, the new unit launched its first missile in August of the following year.

Pershing units were first assigned to Europe in 1964 with a mission "to provide nuclear fires in support of special employment or in general



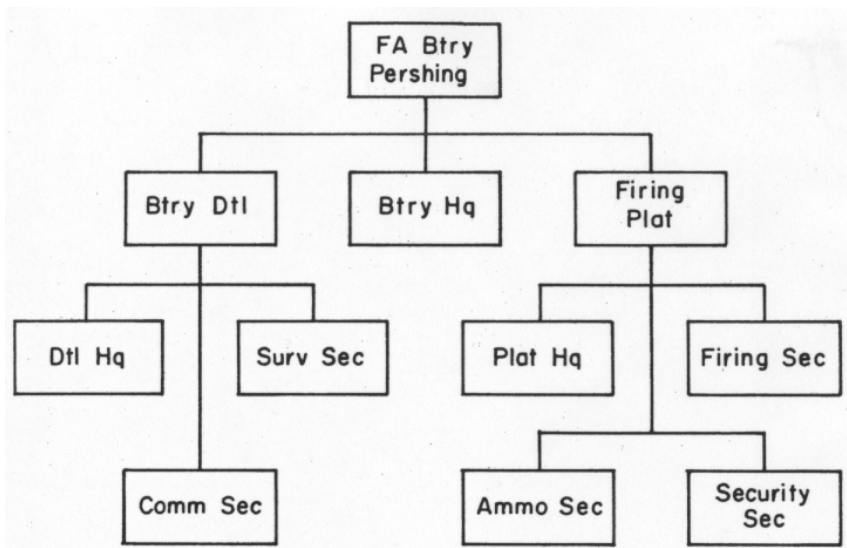
**Figure 1. Initial organization of a Pershing 1 Battalion.**

support of the field army or independent corps." To fulfill this requirement, each battalion was organized with a headquarters and headquarters battery, a service battery, and four firing batteries (fig 1). Not shown in figure 1 is the inclusion of a direct support maintenance unit as an organic part of the battalion. These maintenance sections are found in the service battery.

Each firing battery, in turn, operated under a table of organization and equipment (TOE) which called for only one programmer test station (PTS) and one erector-launcher. Both were mounted on the XM474 tracked vehicle and assigned to the battery's single firing platoon in late 1965. A second erector-launcher was eventually added to the platoon's firing equipment.

The long-range communication requirement between battalion and each firing battery is met by the use of the AN/TRC-80 radio terminal set. This tropospheric scatter radio uses a technique whereby radio waves are scattered in the troposphere to be picked up by a receiving station using a directional antenna aimed at a pre-calculated spot in the sky. Truly a pinpoint directional system, it can provide a high degree of immunity from jamming and interception. The radio set is also carried on the XM474 tracked vehicle.

The firing battery organization (fig 2) was acceptable as long as the primary mission was general support, but a new mission was being developed for the Pershing units in Europe. This mission was QRA—quick reaction alert.



**Figure 2. Initial firing battery organization for the Pershing missile system.**

QRA placed additional requirements on both men and equipment. To fulfill the new mission, each battery was augmented with the firing set equipment (one programmer-test station and two erector-launchers) from another battery in the battalion each time it went to the field. This solved the most immediate problem but caused several others, including the critical one of maintenance. This was the result of a natural tendency to maintain one's own equipment first and someone else's second.

In addition, a new piece of long-range communication equipment was added to each firing battery. The AN/TRC-133 radio set, composed of five single-sideband radios, became the prime means of Pershing communication.

In 1966 the Department of the Army authorized the development of new ground support equipment (GSE) for the Pershing system. The improved system was designated the Pershing 1a or P1a.

Asked why the Pershing was being improved, LTG Austin W. Betts, Chief of Army Research and Development, told the House Defense Appropriations Sub-Committee:

"The mission requirements are rather different. You will recall, as a field army support, surface-to-surface missile, we had planned that the

Pershing would have a refire capability. Consequently, we did not expect to have to get every missile launched as quickly as possible. That was not the nature of the mission.

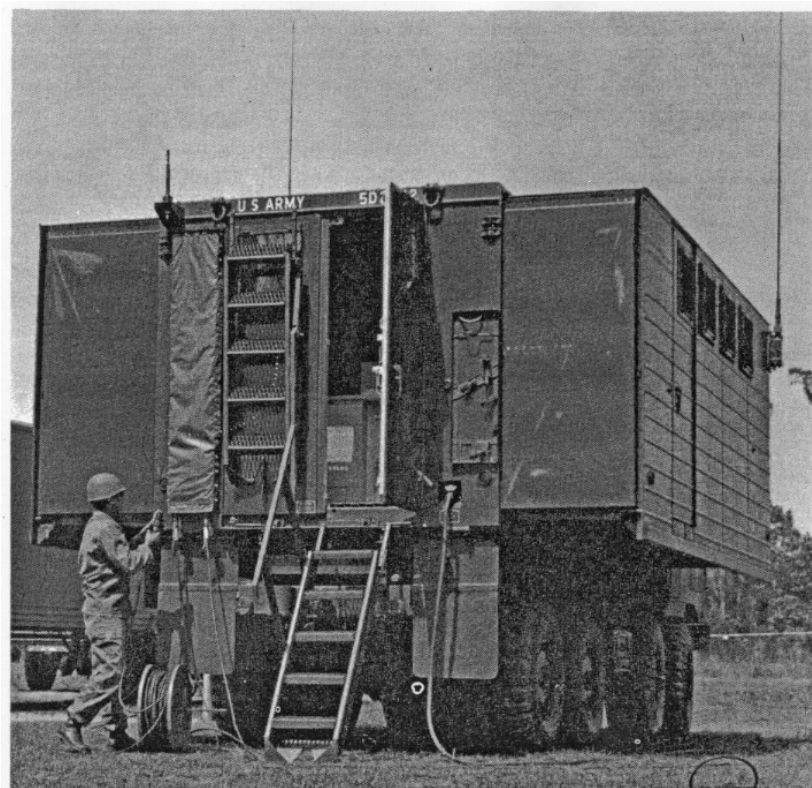
When we go to the QRA role for the Pershing, the object is to have as many launchers as reasonably possible so that we can get a maximum number of missiles off in the shortest possible time. It is rather a difficult requirement."

The most noticeable change which resulted was the switch from tracked to wheeled vehicles and a greatly increased rate of fire. The 5-ton, M656-series vehicles, developed by the Ford Motor Company, permit rapid movement over improved roads without serious loss of cross-country maneuverability. The new 8-wheeled drive (8×8) transporter reduces the vibration of equipment, which may further reduce the maintenance requirements. It is hoped that the increased system reliability will result in a smoother ride.

Other changes included the development of a new mobile countdown control station, the programmer-test station (PTS fig 3)). The new PTS incorporates the latest state of the art technology. Designed for



**Figure 3. The Pershing 1a improved programmer-test station (PTS) programs the trajectory of the missile, controls the firing sequence, performs tests that simulate post-launch missile operation, and provides the operator with a visual indication of the firing sequence. To the rear of the PTS is the power station, which supplies electrical power, conditioned air, and high pressure air to the missile and ground support equipment during the countdown.**



**Figure 4. The Pershing 1a battery control center (BCC) is being readied for tests in Orlando, Florida. It is designed to give the battery commander a better means for controlling and monitoring firing site activities, is mounted in an expando-van atop an M656 truck, and is linked by radio with higher headquarters.**

greater reliability and simpler operation than its predecessor, the P1a PTS presets, tests, resets, and monitors the missile and controls all phases of countdown. It has the capability of testing the missile sections separately while in their containers or testing the missile assembled on the erector-launcher. The programmer test station, completely computer-controlled, can isolate internal malfunctions down to plus-in-modules which can be easily replaced by the operator at the firing site. It can also detect malfunctions in the missile and the ground support equipment.

The PTS is mounted on an M656 vehicle along with a multifuel turbine-driven power station that furnishes electrical and pneumatic power and conditioned and high-pressure air to the missile and electrical power to the ground support equipment.

A redesigned fast reacting erector-launcher has also been added. Both the improved PTS and the improved erector-launcher were built to meet the requirement imposed by the QRA mission.

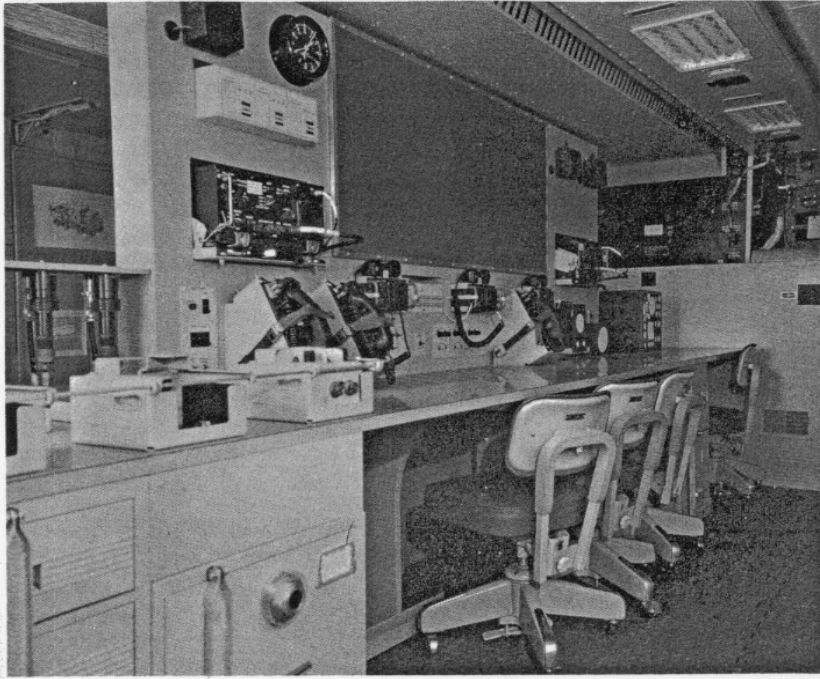
A new but integral part of the Pershing 1a system (P1a) is the battery control central (BCC). Mounted in an M4 "expando-van," the BCC provides the battery commander with a centralized command and control facility with which to monitor and control the firing platoons. In addition, it provides communication links with higher headquarters as well as extensive intra-battery communications.

The modified expandable M4 van is mounted on an M656 vehicle. Electrical power for the BCC is provided by a trailer-mounted 15-kilowatt



**Figure 5.** Being emplaced for action is the radio terminal set AN/TRC-80, with its 8-foot parabolic antenna. The communications set is transported on the new M656-series vehicle and is used in the battalion to battery communications link.





**Figure 6. The interior view of a battery control central with communication equipment.**

generator, which is towed by the battery control central vehicle. Communications equipment (fig 6) located in, or remotely, the BCC consists of the following: the MCC/17, AN/TRC-80, AN/TRC/133, SB/22/PT, AN/VRC-46 and -47, and AN/GRR-5.

An added convenience afforded the battery commander is that he may install both the PAL T-1500 device and the remote firing boxes in the BCC van. This will enable the commander to assemble the warhead and initiate the firing sequence from within the battery control central.

The fielding of the Pershing 1a system required a new TOE to reflect the QRA mission and the utilization of the new equipment in that role. Thus, the mission of the Pershing battalion, stated in TOE 6-615G, is "providing nuclear fires for special employment or for general support of field operation."

One change made by the current P1 TOE was to increase the number of men in a battalion from 1,102 to 1,680. The major changes occurred in the firing batteries (fig 7). The P1a battery is composed of three firing platoons. Each platoon has a firing section with one improved PTS and three improved erector-launchers. This firing platoon,

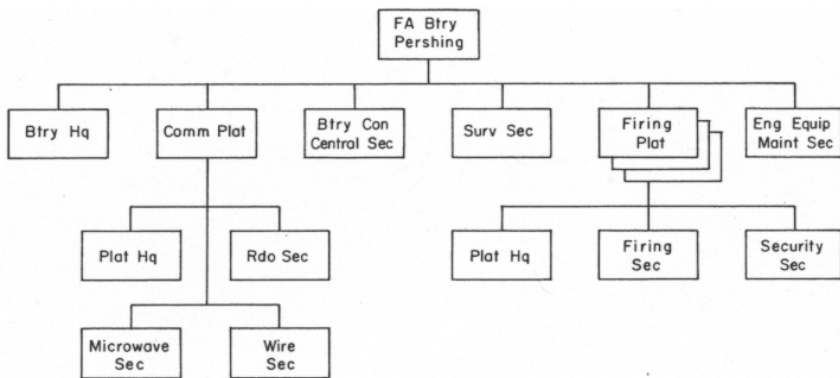
compared with the original P1 battery, has an increased firing capability of 50 percent.

Stepping up to battery level, each P1a firing battery has three PTS's and nine erector-launchers, and each launcher is loaded with an assembled missile. The result is a 450-percent increase in firepower. In effect, the P1a battery has greater firepower than the entire battalion had under the old P1 concept.

With the increased responsibility, the new TOE calls for a major as the P1a battery commander and a captain leading each firing platoon, thus providing a real challenge for commanders at both levels. By comparison, the major commanding a P1a firing battery with nine launchers has under his control one more erector-launcher than did the lieutenant colonel commanding the current P1 battalion. At the same time, unless the rank of the battalion commander is altered, that lieutenant colonel will have 36 launchers under the P1a organization, as opposed to only 8 under the P1 organization, which is a 450-percent boost in missile delivery capability.

The overall battalion structure, while radically changed internally, retains its external appearance as shown in the D-series TOE (fig 1).

A comparison of the equipment in the new P1a battery, with that of the old, is shown in figure 8.



**Figure 7. Pershing 1a firing battery organization.**

COMMUNICATIONS	TOE 6-617D	TOE 6-617G
AN/MGC-17	1	1
AN/GRR-5	2	4
AN/PRC-25	0	4
AN/VRC-46	4	8
AN/VRC-47	1	2
AN/TRC-80	1	1
AN/TRC-133	0 (1*)	3
AN/GRC-106	5 (0*)	0
AN/GRC-125	2	2
<b>VEHICLES</b>		
Trucks		
¾ ton	9	16
2½ ton	9	22
5 ton 6×6	9	16
5 ton 8×8	0	4
Fire Fighting	0	3
Tank, water, 1,000 gal	0	1
Tractor, 5 ton 8×8	0	9
Utility ¼ ton	6	9
Van: shop 2½ ton	0	2
Wrecker: 5 ton 6×6	2	4
<b>MISSILE COMMAND ITEMS</b>		
Azimuth Laying Set	2	6
Erector-Launcher	2	9
Battery Control Central	0	1
Programmer-Test Station	1	3

\*changed by MTOE

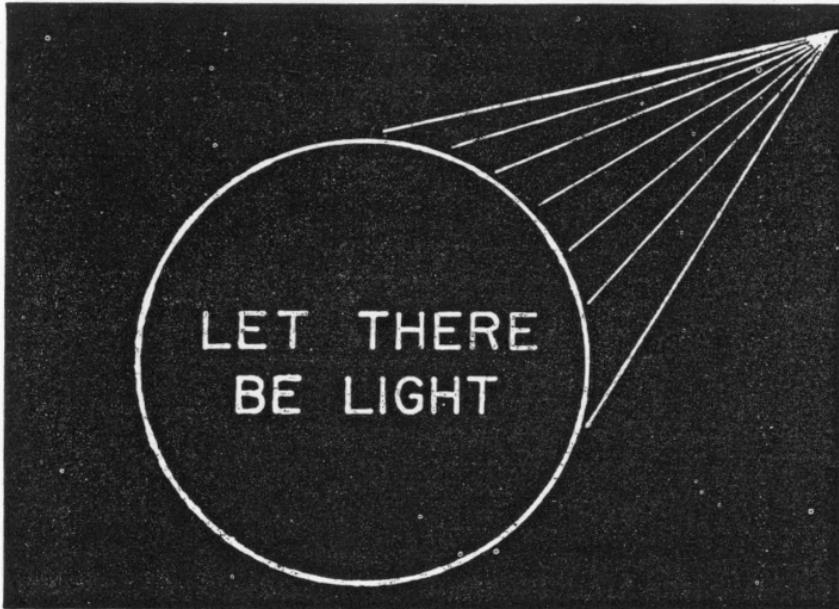
It should be pointed out that only the major items of equipment are shown in the three classifications.

**Figure 8. Table of equipment.**

One of the obvious changes that emerges is the ratio of increased firepower to the increase in manning necessary to maintain and operate the equipment. A little simple arithmetic shows that a 65-percent increase in people provides a 450-percent increase in destructive power and target coverage.

As General Betts told the congressional sub-committee, the object is to get as many missiles as possible off the ground in the shortest time. "It is a rather difficult requirement," he added.

Difficult? Yes. But not impossible with the improvements being made under Pershing One Alfa.



*LTC Charles W. Montgomery (Ret)*  
*Tactics/Combined Arms Department*  
*USAFAS*

**EDITOR'S NOTE:** *This article was derived from the recently concluded USAFAS Tactical Test, Illumination.*

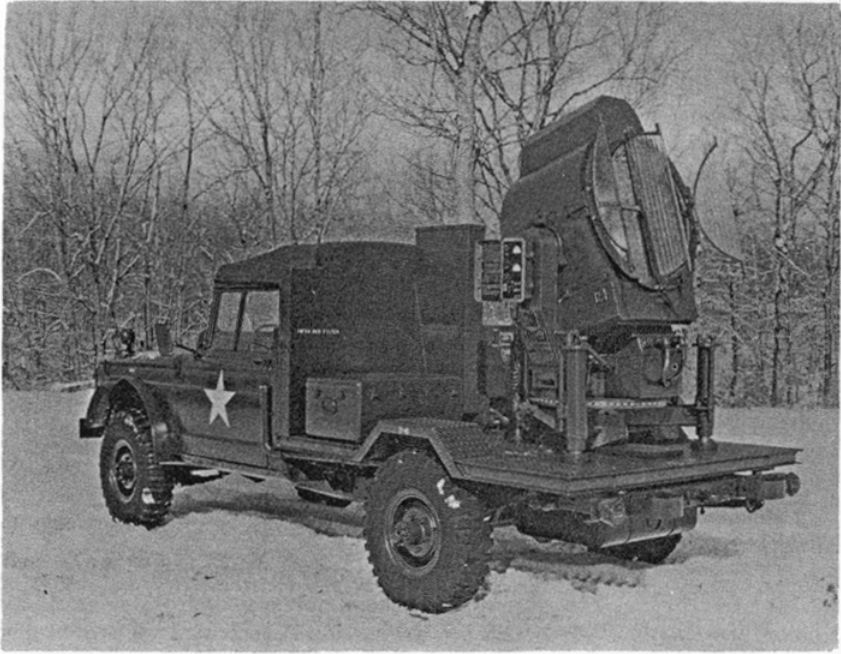
Darkness has always imposed a serious restriction on the effective use of US firepower and maneuver during combat operations. Prior to the present conflict in Southeast Asia, many of the advantages enjoyed by superior US forces during daylight hours disappeared as night closed in. Targets and routes of advance and approach were no longer clearly visible. Daylight observation posts reverted to listening posts, and distinguishing between friend and foe became a critical and monumental task. Illumination means from several sources became available to offset the handicaps inherent in darkness. They included searchlights, flares, and illuminating projectiles. Field expedients often included containers filled with petroleum and sand which could be ignited and used as torches. Even with such aids, the user still had visibility difficulties. Visible illumination which eased the darkness problem of one unit might well expose the activities of an adjacent unit. Attacking friendly troops supported by visible illumination means had to insure that such illumination did not silhouette their formations to enemy observers. Shadows created during this illumination often provided a haven for enemy forces and deceived supported troops as to the true composition of the battle area.

Since the commencement of active US participation in Vietnam, considerable time and effort have been expended to improve the night-fighting capabilities of our forces. FM 31-36 (Test) is an excellent manual on this subject. Improved illumination means have been devised and fielded. These include, but are not limited to, flares, projectiles, searchlights, and night vision devices; and new developments continue to be made. Infrared (ir) capabilities for searchlights and increased candlepower for many illuminants are but two of the many improvements achieved to date. Numerous night vision devices have been developed and are now in use. Some of this night viewing equipment is **passive** in that it uses only the available ambient light whereas other such devices are **active** because they use infrared illumination to provide the capability for night viewing. Xenon searchlights have been developed to overcome the weight and mobility problems peculiar to the older carbon arc searchlights and their associated power sources. It was the development of the Xenon searchlight which caused the field artillery to become actively engaged in the illumination testing programs. This new searchlight equipment created a need for revision in field artillery training and employment tactics.

One of the combat support requirements for field artillery is to provide battlefield illumination through the use of illuminating projectiles and/or searchlights. To accomplish searchlight support, a field artillery battery, searchlight (TOE 6-558G) is authorized. Such units are normally



**Figure 1. Searchlight, infrared, 23-inch, truck-mounted, AN/MSS-3.**



**Figure 2. Searchlight, infrared, 30-inch, truck-mounted, AN/TVS-3.**



**Figure 3. Searchlight, infrared, 30-inch, towed, AN/TVS-3.**

assigned to corps field artillery. One such unit, Battery C (Searchlight), 333d Artillery, is presently stationed at Fort Sill.

During fiscal year 1968, the US Army Field Artillery School (USAFAS) requested and was granted permission to conduct a tactical illumination test, from which to gather data necessary for the revision of training and employment documents concerning battlefield illumination. The test was conducted at Fort Sill during the period 21 May 1968 through 1 June 1968, and the final report of this test was published on 1 July 1968 and is on file at USAFAS. Xenon searchlights for the test were made available by the Office of the Project Manager, Night Vision, Fort Belvoir, Virginia. That



**Figure 4. Night vision sight, crew-served weapon, AN/TVS-2.**

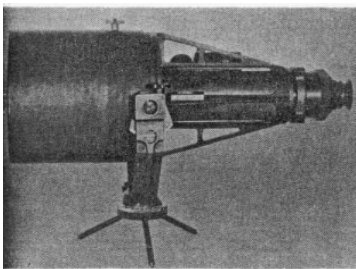
office also made available night vision equipment and technicians for the test. The remainder of this article is devoted to the test and some of its results.

\* \* \* \* \*

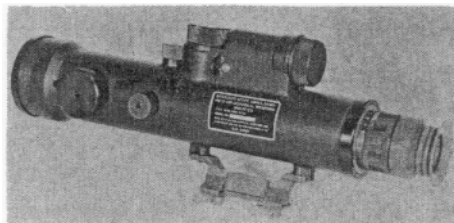
### GENERAL

Original plans for the test included provisions for testing only the new Xenon searchlights (fig 1 through 3).

Prior to the completion of the formal test plan, further provisions were included for comparing the visible illumination capabilities of these searchlights with illumination available from aircraft flares, mortars (81-mm and 4.2-inch), and field artillery (105-mm and 155-mm howitzers).



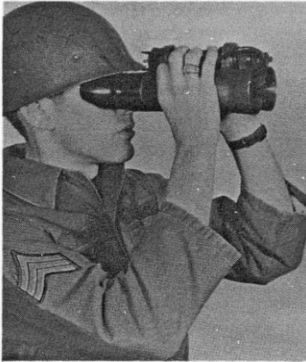
**Figure 5. Night vision sight, tripod-mounted, AN/TVS-4.**



**Figure 6. Night vision sight, individual-served weapon, AN/PVS-1 (starlight scope).**

A requirement was added to test the airborne capabilities of a 23-inch searchlight mounted in a CH-47 aircraft (Chinook). Finally, a requirement was included for the evaluation of several night vision devices for use by field artillery including those shown in figures 4 through 7.

### TESTING SEQUENCE



**Figure 7. Binoculars M18 (handheld).**

The test was conducted in two phases (fig 8), with the first phase devoted to the evaluation of visible and infrared searchlight illumination and night vision devices only. Phase 2 was devoted to a comparison of visible searchlight illumination with that available from other means. The effects of the 155-mm howitzer base-ejection smoke projectile on searchlight illumination and the use of night vision devices were evaluated. The airborne searchlight was employed only during phase 1. The aircraft was flown at varied heights

and ranges in relation to the target and light measurements were made. A flash base and plotting center were used to determine the vulnerability of the searchlight to enemy detection. Evaluation of reflected visible illumination by searchlight was planned for this part of the test; however, unsuitable weather prohibited this evaluation.

### INFRARED ILLUMINATION

During the infrared illumination evaluations for the 23-inch searchlight, it was found that this light could provide usable illumination to a range of approximately 5,000 meters. The 30-inch searchlight provided usable infrared illumination to a range of 7,500 meters. Greater range evaluation was not attempted. Figure 9 is a photograph of infrared illumination from this searchlight against a close-in target.

Of significant interest to field artillery was the potential shown during this test for the intersection of a target area with infrared illumination by two searchlights in order to assist an observer in the night adjustment of field artillery fires. Further sampling of this technique is needed.

The night vision devices which proved the most valuable were the crew-served weapon night vision sight (fig 4) for a ground observer and the M18 binoculars (fig 7) for an air observer.

### DIRECT VISIBLE SEARCHLIGHT ILLUMINATION

During the testing of the direct visible illumination capabilities of each searchlight, it was found that the illumination of the 30-inch searchlight was so effective that observers tended to degrade the efficiency of



23-inch searchlight illumination. To do so would be unfair. With the observer and searchlight at distances up to 4,000 meters from the target, the 23-inch searchlight can provide effective illumination. When the searchlight was employed at greater ranges, it became necessary for the observer not to exceed a 4,000-meter viewing range (with a range of 2,000 meters or less preferred).

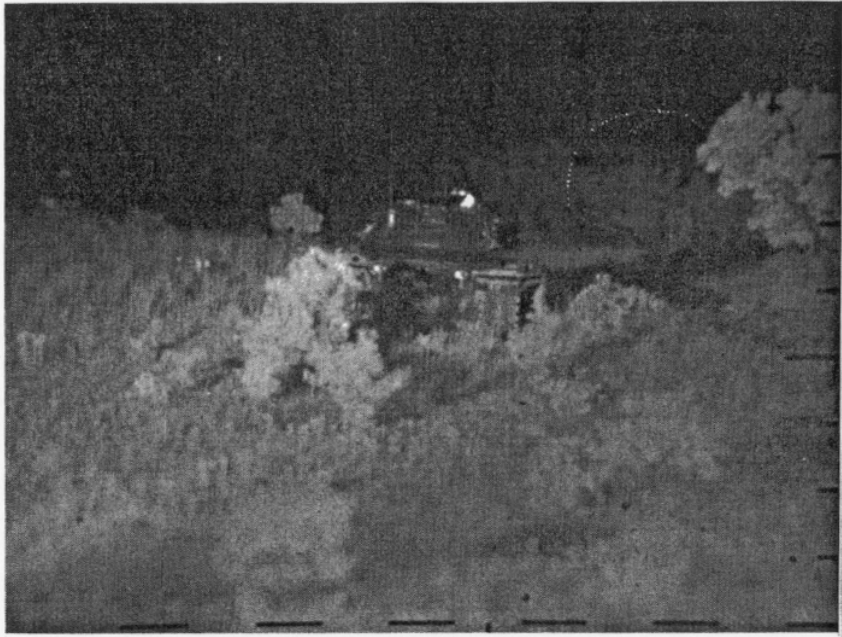
Of particular significance during the visible illumination testing was the fact that ground observers, using any device for viewing, could not distinguish and identify even large items of military equipment (tanks, APC, vehicles, etc.) in an illuminated area which exceeded 4,000 meters in range. To facilitate distinction between such objects, white sheets were draped across particular items in the target area when distinction was needed.

Ground observers found that the night vision device which had the greatest utility for viewing under visible illumination was the tripod-mounted

PHASE	NIGHT	TYPE OF SEARCHLIGHT ILLUMINATION	FO-TARGET DISTANCE (METERS)	SEARCHLIGHT-TARGET DISTANCE (METERS)
1	1	Direct (Visible and ir)	2,000	2,000
	2	Direct (Visible and ir)	4,000	4,000
	3	Direct (Visible and ir)	6,000	6,000
	4	Direct (Visible and ir)	4,000	7,500
	5	Diffused (Visible)	Under 2,000	Under 2,000
		Direct (ir)	Under 2,000	Under 2,000
	6	Direct (Visible and ir)	Under 1,500	6,000
7	Direct (Visible and ir)	Under 1,500	6,000	
	Diffused (Visible)	Under 1,500	3,000	
*	*	* * *	* *	* * *
*2	1	Direct (Visible and ir)	2,000	2,000
	2	Direct (Visible and ir)	2,700 and 4,900	2,700
*	*	* * *	* *	* * *

\* Mortar and artillery illuminating projectiles also compared during this phase.

**Figure 8. Sequence of events, USAFAS tactical test, illumination.**



**Figure 9. Infrared illumination (close-in) by one 30-inch searchlight.**

mounted night vision sight. The air observers preferred to use the M18 binoculars.

The vulnerability of the searchlights to detection and accurate location by the enemy while the searchlights are providing visible illumination was evaluated throughout the test. Figure 10 shows the times required to locate and plot the locations together with the accuracy to which the searchlights could be pinpointed. A word of caution is in order concerning these figures. It should be recognized that the figures represent the efforts of military personnel whose only duties during the test were to accumulate such data and whose proficiency increased as the test progressed.

The 23-inch searchlight is equipped with an "overdrive" capability whereby the light output can be stepped up for a period of approximately 15 seconds at the end of which the searchlight automatically reverts to normal output. The amount of this increased output was found to range from 30 to 45 percent, depending on the location of the observer in relation to the target. Possibly this overdrive capability could be put to effective use by field artillery observers. The observer might coordinate the use of overdrive with the FDC transmission of SPLASH and thereby afford himself maximum illumination at the precise moment of impact of the adjusting rounds. Time did not permit an adequate sampling of this technique during the test.

The effects of visible searchlight illumination on enemy troops (simulated by a squad of soldiers and crews of one tank and one APC) were recorded. Items for evaluation included the distances to which such troops could observe in the direction of the light source. These evaluations varied as the distance to each type of searchlight changed. However, throughout the entire test, when the 30-inch searchlight was employed with a focused beam, the evaluators experienced almost complete blindness from this illumination.

SEARCHLIGHT	TIME TO LOCATE		RADIAL ERROR OF LOCATION (METERS)	
	LONGEST	SHORTEST	GREATEST	SMALLEST
23-Inch	3 min 20 sec	1 min 06 sec	220	45
30-Inch	2 min 20 sec	55 sec	150	23

**Figure 10. Vulnerability of searchlights to enemy location.**

For evaluation of the airborne 23-inch searchlight, the searchlight was mounted in the bay (side) door of the helicopter and was manually operated from this location by searchlight technicians. This operation required considerable coordination between these technicians and the pilot in positioning the aircraft and holding the light on the target. This system was generally inadequate; however, on several occasions when the illumination was properly placed, illumination was more than adequate. Most ground observers were of the opinion that such a searchlight, controlled by the pilot, would be extremely efficient and very valuable for use in night operations. Also worthy of mention is the procedure used in this test to identify the target area to the pilot of the airborne searchlight. A ground searchlight was flicked onto the target and extinguished when the pilot acknowledged recognition. In this test, visible illumination was used; however, this same procedure could be used with infrared illumination to avoid alerting the enemy.

### **DIFFUSED VISIBLE ILLUMINATION BY SEARCHLIGHT**

For evaluation of diffused visible illumination, searchlights were positioned at several different angles of elevation and at several different ranges to the rear of the mask. Evaluators were positioned on the forward slope of the mask and throughout the illuminated area. At the

ranges tested, the focused beam was determined to be the optimum beam spread for the 23-inch searchlight, and the spread beam was best for the 30-inch searchlight. The simultaneous use of two searchlights was evaluated for each type of light, and it was determined that such use improved illumination with 23-inch searchlights by 25 percent. The percentage of improvement for 30-inch searchlights was estimated to be 45 percent. When an observer was provided diffused illumination by 23-inch searchlight, it was estimated that he could have directed fire to a distance of 500 meters from his position. When the 30-inch searchlight was in use, this distance increased to approximately 1,300 meters.

During the conduct of illumination by diffusion, the beam of one 30-inch searchlight was elevated and directed in such a fashion that the beam centered (unintentionally) just below the crest of a mountain 2,000 meters distant. This crest was not in use for the test evaluations. The air observer noted and reported that the illumination from this 30-inch searchlight was creating additional diffused illumination to a distance of approximately 1,000 to 1,500 meters beyond the second crest.

Troops representing the enemy were not seriously affected during diffused illumination. In fact, those positioned beyond the perimeter of this close-in illumination enjoyed an advantage of having opposing formations clearly outlined for them.

## **COMPARISON OF ILLUMINATION MEANS**

Phase 2 of this test was devoted to comparing searchlight illumination with that available from mortars and field artillery weapons. Unfortunately, aircraft flares were not available at the time of testing. When illuminating projectiles were fired, a diamond formation (or pattern) with four flares was used. As each type of illumination was in use, both air and ground observers, in turn, were allowed to adjust both airbursts and impact bursts of a 105-mm howitzer. During searchlight illumination events, one 155-mm howitzer fired smoke shells in order to determine the effects of smoke on the illumination and on the use of the night viewing equipment.

Smoke was used behind the target in an attempt to determine how effective it was in reflecting searchlight illumination back onto the target. Several tests were conducted under varying light conditions, and these tests indicated that this procedure was effective and would increase the illumination of the area by more than 40 percent.

## MISCELLANEOUS OBSERVATIONS

Concern was expressed before this test as to the utility of passive night viewing devices while artificial visible illumination was in use. It was felt by many that these instruments would "flood out" under such light conditions and would have little or no value; however, such incidents rarely occurred during the test. The tripod-mounted night vision device was very effective, and only on rare occasions was it noneffective due to "flooding out." These instances occurred when a user was looking directly (centered) on a flare or other illuminant.

Many other areas were examined during the USAFAS test and these results are documented. In addition, numerous other agencies have conducted similar tests and have prepared reports on their areas of examination.

\* \* \* \* \*

Darkness will remain a handicap to the full exploitation of combat power of US forces. However, solutions are being sought and the results are most promising. Much effort has been and is being expended to erase the darkness from night operations. New equipment is being devised, developed, and tested constantly to improve the night operational capabilities. Tests such as that conducted by the Field Artillery School and other agencies will contribute greatly to the development of such improvements.

Hopefully, the **night** is not far distant when a combat commander can direct "Let There Be Light," and equipment and techniques will be available with which to insure effective and immediate compliance with his directive.



## CHEMICAL ALARM

The Army has achieved a breakthrough in chemical warfare defense with a new chemical field alarm system nearing completion of development by scientists and engineers at Edgewood Arsenal, Md.

The new portable chemical agent alarm (XM8) will provide US field forces, for the first time, with automatic means of detection and warning of the presence of nerve agents. The Army previously had various effective detection devices but lacked automatic alarm capabilities suitable for use by field troops.

# Radar Plotting and Capabilities Fan

*Ruffin E. Redwine  
Training Specialist  
Target Acquisition Department  
USAFAS*

## **BACKGROUND**

Radar sections currently are using the aluminum range deflection protractor (RDP) for plotting targets and other points located by radar throughout a 6400-mil perimeter around each radar position. When the grid sheet or map is set up to cover a 6400-mil area, two or more sheets are required. This requirement complicates not only the grid sheet preparation but also plotting procedures and associated instruction.

These problems can be resolved by the use of a plastic radar plotting fan (fig 1), designed and tested by the Radar Operations Instruction Branch, Sensory Equipment Division, Target Acquisition Department, USAFAS.

The suggestion for the adoption of the radar plotting fan was initiated on 7 June 1957. The fan was tested, evaluated, and approved by the USAFAS, the US Army Field Artillery Board and the Combat Developments Command Field Artillery Agency. A US Army Electronic Command drawing was completed in February 1969. Coordination for the final design of the fan will be accomplished with the Target Acquisition Department, USAFAS, Fort Sill, Oklahoma.

Approximately 75 prototypes of this plotting device have been manufactured and sent to the radar units in the Republic of Vietnam.

## **RADAR PLOTTING AND CAPABILITIES FAN**

The radar plotting and capabilities fan is based on 1:50,000 meter scale and is graduated from 0 to 6399 mils in a counterclockwise direction around a circle. The fan center is slotted and is graduated in yards and meters. Etched on the circular portion of the fan is a coordinate scale. The fan provides the sector of scan and range capabilities of the counterbattery radar set AN/MPQ-10 and the countermortar radar AN/MPQ-4.

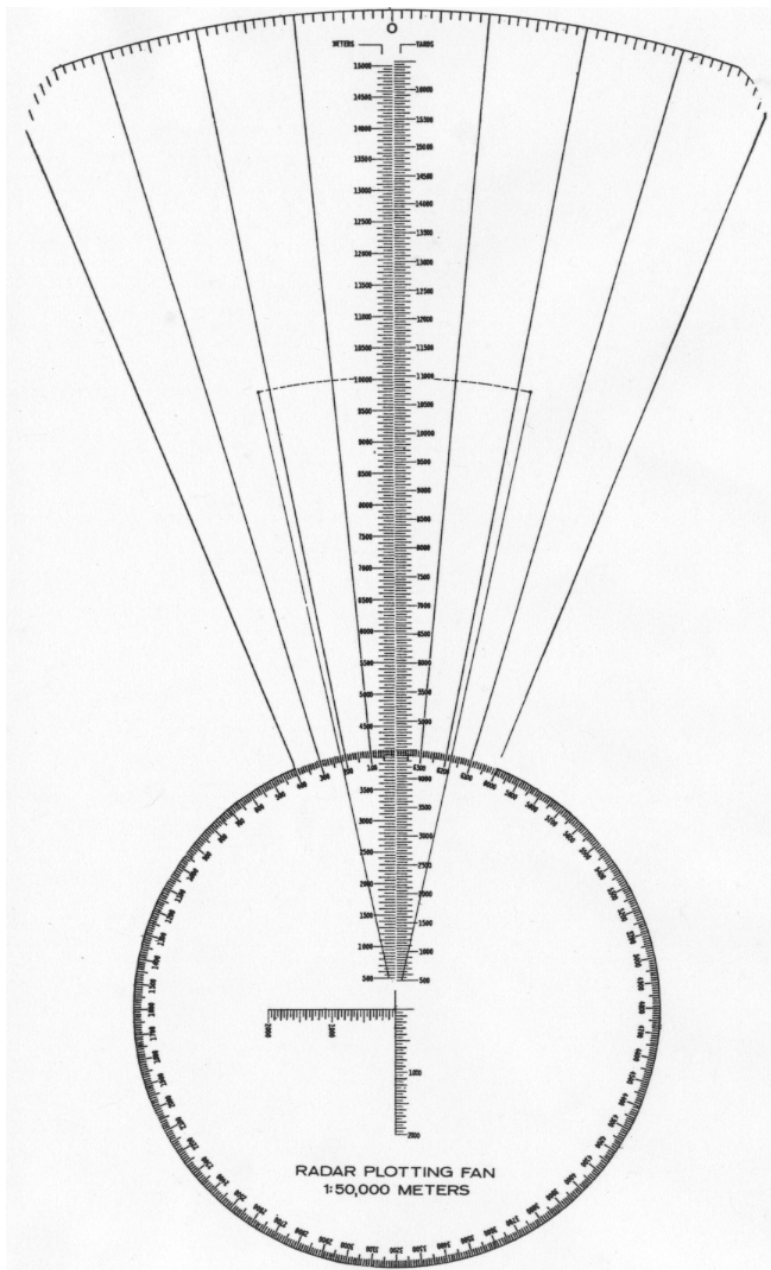
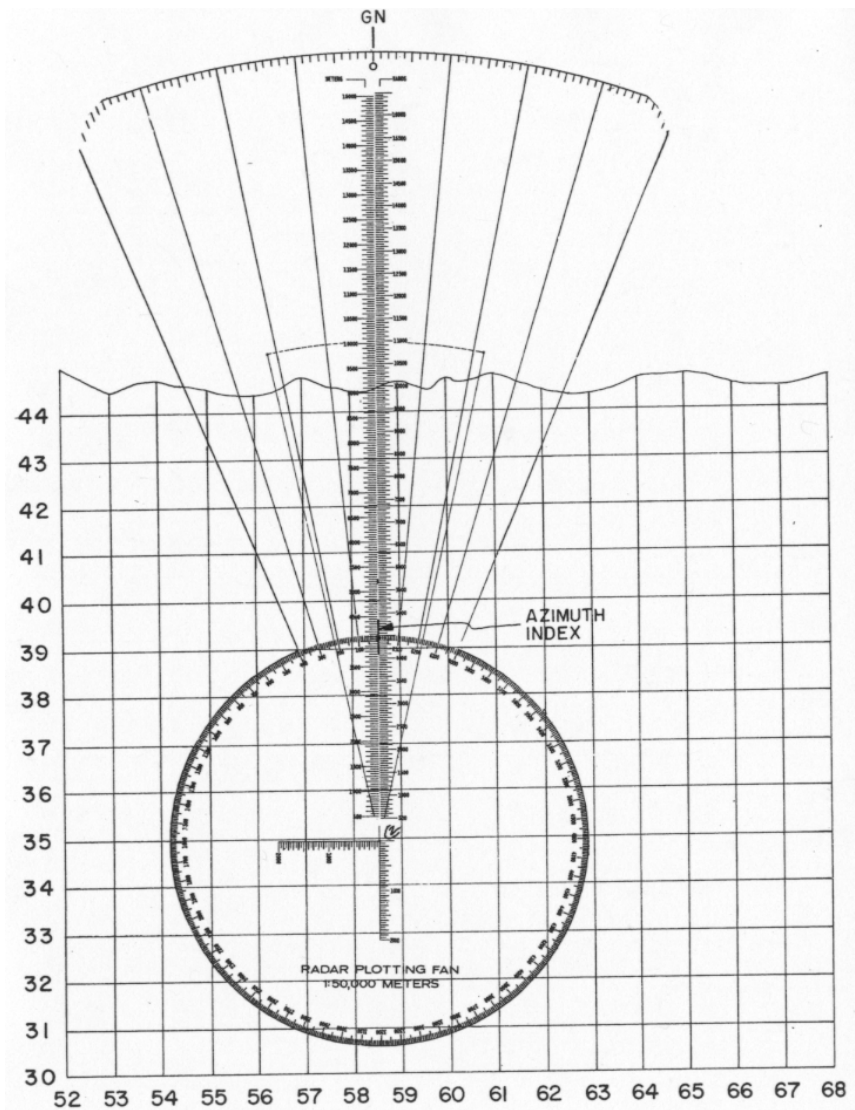


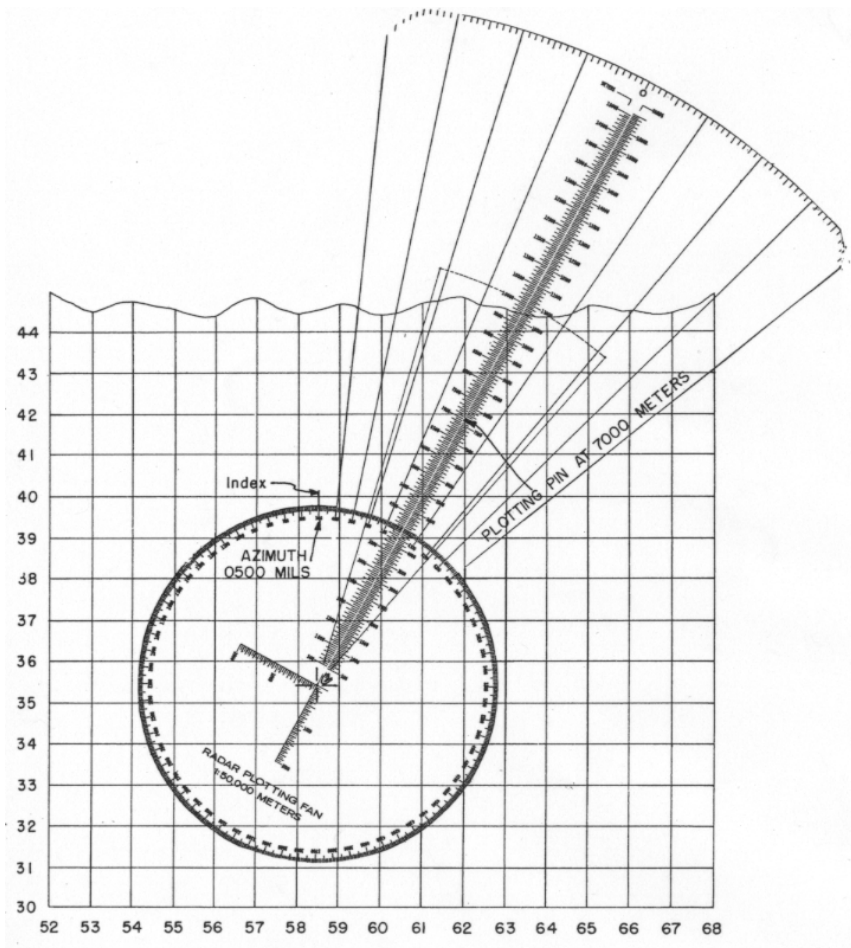
Figure 1. Radar plotting and capabilities fan.



**Figure 2. Zero azimuth index.**

The altitude of a target must be determined before the target location is reported to the FDC. The fastest method of determining altitude is to use the fan for polar plotting directly on a contour map. The procedures for plotting radar location, are as follows:





**Figure 3. Polar plotting.**

- Locate the proper 1,000-meter grid square.
- Place the easting portion of the coordinate scale on the EW grid line and slide the fan to the right (EAST) until the radar easting coordinate is superimposed over the NS grid line.

- Move the fan up (NORTH) until the radar northing coordinate on the coordinate scale is superimposed over the EW grid line.

- Without moving the fan, place a plotting pin through the hole at the apex of the coordinate scale.

Only the zero azimuth index is constructed to lay off an azimuth (direction).

The procedure for constructing the zero azimuth index (fig 2) is as follows:

- Aline the slotted portion (ZERO) of the fan parallel to the nearest north-south grid line.

- Draw a thin line approximately 1 inch long which will intersect the circular (mil) scale. This is the azimuth index.

For polar plotting, (fig 3) the procedure is as follows:

- Rotate the fan until the desired azimuth reading is over the azimuth index, for example, azimuth 0500 in figure 3.

- Place a pin through the slot at the desired range along the range scale, for example, range 7000 in figure 3.

The radar fan can be used in conducting fire adjustment missions by placing a target grid over the target and orienting the grid on grid north. The burst locations are polar plotted by placing the radar fan over the target grid. Thus, lateral and range shifts can be read from the target grid without moving the grid.

The radar plotting and capabilities fan is not limited to radar operation. It can also be used by field artillery S2 and S3 sections, by observation tower operators in base defense, and by AN/TPS-33, PPS-4, and PPS-5 ground surveillance radar sections.

The greatest advantages of the fan are its use in 6400-mil operation, the time which it can save in radar operation, and time saved in teaching, and its versatility.

---

●

## NEW TANK TURRET

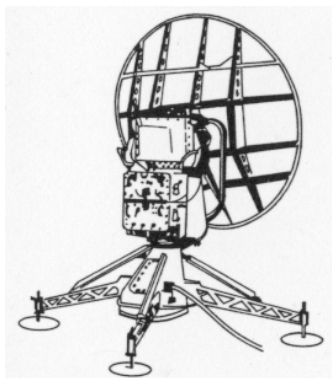
A new explosive-forming concept is being used in developing a nose-piece tank turret. The US Army Tank-Automotive Command is evaluating the turret.

The new explosive-forming concept entails placing the armorplate to be formed into a turret over a die. Explosives are then positioned along the plate. The plate and die are then submerged in a large tank of water and explosives detonated. Approximately 1.3 million pounds of pressure per square inch forces the plate into the shape of a turret in 4.5 milliseconds.

Current methods consist of welding seven to eight sections of armorplating to construct a turret.

# STANAG 4103

*CW4 George Carlstrom, Jr.  
Target Acquisition Department  
USAFAS*



Often it may be necessary for US Artillery units in Europe to request ballistic meteorological data from another NATO member. This request for information exchange has been complicated because of the language barrier and the lack of a standard format for requesting the data. This "commander's dilemma" has finally been resolved by the adoption of Standard Agreement (STANAG) 4103 by all NATO countries. Applicable portions of STANAG 4103, now in effect, are included in the remainder of this article. Item 1 is an explanation of the **prescribed format** to be used whenever requesting meteorological support from a NATO member nation. Item 2 is a table of the "**Q**" **Codes** (Octant of the Globe Location) to be used in the request. Units requesting support will determine the code for their location from this table. Item 3 depicts the NATO Met Message line number heights above MDP (see item 1b) to be used when requesting data. Based on the anticipated trajectory, units will determine the code for the lowest and highest message line numbers required. Item 4 includes a completed request for meteorological data, as well as notes explaining the content of the request.

The object of this STANAG is to define the format of a request for ballistic met data **between member NATO nations**. This format is **not** intended for use when requesting ballistic meteorological data from other US Army organizations.

## ITEM 1 MESSAGE STRUCTURE AND MESSAGE STANDARDS

### a. MESSAGE STRUCTURE

The number of information digits (or letters) shall be as follows:

GROUP 1	METRKQ
GROUP 2	LaLaLaLoLoLo or XXXXXX
GROUP 3	Y <sub>0</sub> Y <sub>0</sub> G <sub>0</sub> G <sub>1</sub> G <sub>1</sub> G <sub>1</sub>
GROUP 4	Z <sub>0</sub> Z <sub>0</sub> Z <sub>1</sub> Z <sub>1</sub> J <sub>0</sub> J <sub>1</sub>

**b. MESSAGE STANDARDS**

GROUP 1 MET	—Meteorological Message
R	—Request
K	—Type of Message: 2—Antiaircraft 3—Surface-to-surface
Q	—Octant of Globe of Unit Requesting Meteorological Message. (See Item 2.)
GROUP 2 LaLaLa	—Latitude of unit requesting meteorological message in tens, units and tenths of degrees.
LoLoLo	—Longitude of unit requesting meteorological message in tens, units and tenths of degrees. For longitudes 100° or greater the hundreds digit is omitted.
or XXXXXX	—Location (coordinates) of unit requesting meteorological message in clear or code.
GROUP 3 Y <sub>0</sub> Y <sub>0</sub>	—Day of month (GMT) on which delivery of the first message is required.
G <sub>0</sub> G <sub>0</sub>	—GMT time to the nearest hour of the day Y <sub>0</sub> Y <sub>0</sub> at which delivery of the first message of the series is required.

G <sub>1</sub> G <sub>0</sub>	—GMT time to the nearest hour of the day at which delivery of the last message of the series is required. The day can be determined by using J <sub>0</sub> (Group 4) and Y <sub>0</sub> Y <sub>0</sub> (Group 3).
GROUP 4 Z <sub>0</sub> Z <sub>0</sub>	—Lowest line of message required. (See Item 3.) NOTE: In order to speed up transmission time, some NATO members transmit only the actual line numbers that will be used. The US Army Field Artillery units always include <b>all</b> data up to the highest line number (Z <sub>1</sub> Z <sub>1</sub> ) requested. US Army Met Sections supporting NATO allies should only transmit the requested line numbers.
Z <sub>1</sub> Z <sub>1</sub>	—Highest line of message required. (See Item 3.)
J <sub>0</sub>	—The number of days from 0 to 9 which must be added to Y <sub>0</sub> Y <sub>0</sub> to find the last day for which support is required.
J <sub>1</sub>	—A number from 1 to 8 to designate a time interval in hours between successive MET messages and the number 9 to designate a 12-hour interval, when more than one message is required. When only one message is required, (G <sub>1</sub> G <sub>1</sub> is the same as G <sub>0</sub> G <sub>0</sub> and J <sub>0</sub> is 0) then J <sub>1</sub> from 1 to 8 designates the period in hours for which the message should be valid; the number 9 designates a 12-hour period

of validity. Where no period of validity is specified, J<sub>1</sub> is 0.

NOTE: for US Field Arty units, this time will never exceed 6 hours. Some NATO allies incorporate forecast (updating) of a single Met observation for Extended periods up to 12 hours.

**ITEM 2**

**Q CODE FOR OCTANT OF THE GLOBE**

Q = 0	North Latitude	0 to 90° West
1	North Latitude	90 to 180° West
2	North Latitude	180 to 90° East
3	North Latitude	90 to 0° East
4	Not used	
5	South Latitude	0 to 90° West
6	South Latitude	90 to 180° West
7	South Latitude	180 to 90° East
8	South Latitude	90 to 0° East
9	To be used when Latitude and Longitude are not used.	

**ITEM 3**

**TARGET OR VERTEX HEIGHT (STANAG 4061-NATO Met Msg)  
(Above Meteorological Datum Plane)**

Met Line Number	Meters
<b>CODE</b>	
00	0
01	200
02	500
03	1,000
04	1,500
05	2,000
06	3,000
07	4,000
08	5,000
09	6,000
10	8,000
11	10,000
12	12,000
13	14,000
14	16,000
15	18,000

**ITEM 4**  
**SPECIMEN OF REQUEST FOR METEOROLOGICAL MESSAGE FOR**  
**BALLISTIC PURPOSES**

M E T R 3 1  
3 4 5 9 8 3  
0 5 0 8 1 6  
0 0 0 6 2 4

This means:

- GROUP 1 Ballistic meteorological message is requested for surface fire applicable to the northern hemisphere between 90°W and 180°W.
- GROUP 2 34°30'N; 98°18'W is the location of the unit requesting the meteorological message.
- GROUP 3 Delivery of the first message is required on the 5th day of the month at 0800 GMT. Delivery of the last message of the series is required at 1600 GMT on the 7th day of the month. (For determination of the 7th day, see Group 4.)
- GROUP 4 00 is the lowest line and 06 is the highest line of the messages required.  
Messages are required for two successive days following the day of delivery of the first message. In this specimen, messages are required on the 5th, 6th and 7th days of the month.  
The time interval between successive messages is 4 hours.



**CRANE TO IMPROVE**

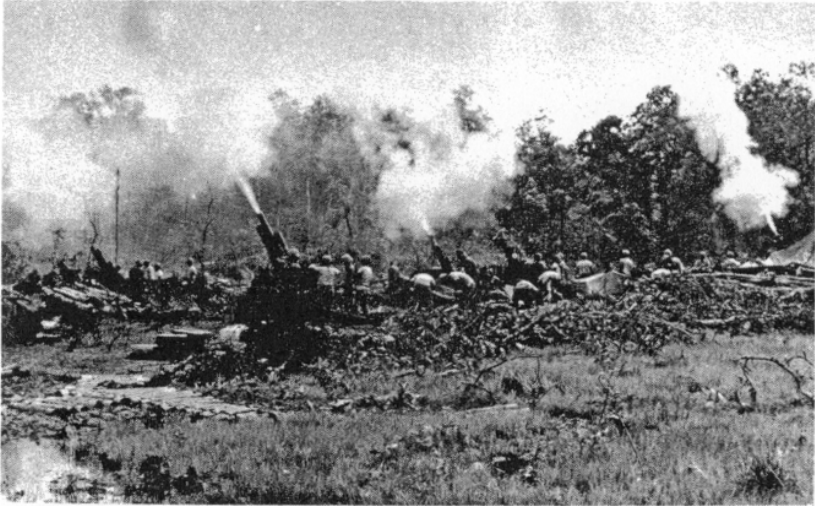
The US Army awarded a new contract to Sikorsky Aircraft to make several improvements on the CH-54 Flying Crane.

The most notable change in the aircraft is an increased payload of 25,000 pounds. This is an increase of 5,000 pounds over the original. This modification also will increase the gross weight of the Crane from 42,000 pounds to 47,000 pounds.

In addition, the contract calls for improvements in altitude performance, hot weather operating capabilities, and the dynamic components.

The new version of the Flying Crane will be designated the S-64F.

## Southeast Asia



# LESSONS LEARNED

*The following material originates from information extracted by the US Army Field Artillery School from correspondence which has passed between US field artillery units and USAFAS, efforts by departments of the School to solve problems experienced by units in internal defense operations, and after action reports distributed by the Department of the Army.*

### **VT FUZED ROUNDS**

The technique of firing VT fuzed projectiles above roads during hours of darkness is effective. However, the fragments imbedded in the road surface create an almost impossible task for mine detection personnel working such roads.

### **BEEHIVE ROUND**

Experience reveals that over a long period of time, the normal fiber container used to ship and store the Beehive round becomes badly worn. A substitute container can be made using one complete fiber container for the C444 or C445 round plus the cap from a second such container. Extend one inner sleeve of the main body of the fiber container approximately 6 inches. Remove the metal position of one C444 or C445 fiber cap and use it as a spacer inserted over the extended sleeve. To facilitate control, an identification code can be painted on the fiber to provide ease



of identification for the round. Though not officially approved, this expedient does provide a substitute container which will afford the needed protection for the round.

### **ILLUMINATION**

Flares and cannon/mortar illumination must be used with care while in a perimeter defense. The untimely misuse of illumination in the defense exposes friendly as well as enemy positions. The use of illumination should be secondary to the employment of night vision devices and employed only when necessary to repel a significant probe or attack.

When it is necessary to illuminate an area near a battery position, experience has shown that rounds are effective when direct fire is used with a fuze setting timed to eject the flare before impact. By using this technique, the flare burning on the ground illuminates a small suspect area well enough for high explosive rounds to be fired into it without lighting up the firing battery position.

### **MORTAR CRATER ANALYSIS**

When under mortar fire, units tend to fire preplanned countermortar programs automatically and to disregard the importance of crater analysis to determine the direction of fire. The enemy is well aware of the capabilities of the countermortar radar and usually plans his attack so that the effectiveness of the radar is minimized. Crater analysis should be made as soon as practicable to determine direction for countermortar can increase the site for low angle fires.

### **ARTILLERY SAFETY**

When units are operating in jungle areas where tree top canopy is extremely high and dense, the artillery forward observer should advise the fire direction center of this fact. If the supported unit is immediately under the trajectory of fire, the possibility of tree bursts occurring short of the intended target is great. The forward observer can use high angle fires to advantage when operating in such areas. If the forward observer knows the tree height in the area and reports it, the fire direction center can increase the site for lowangle fires.

### **SANDBAGS**

The life expectancy of mildew resistant cloth sandbags in a tropical environment is two months when moist sand is used as a filler. The cause of early failure is faster than normal decomposition of the bag when continually in contact with damp filler. When conditions permit, dry sand filler should be used.

# STATUS OF TRAINING LITERATURE

The following training literature either has been prepared or currently is under preparation by the US Army Field Artillery School for fiscal years 1969 and 1970. The completion date listed is that time at which the publications were submitted or are scheduled to be submitted to the Office of the Adjutant General. The publications may be under revision (R), or change (C), or may be new (N). Publications include Field Manuals (FM), Technical Manuals (TM), Artillery Training Programs (ATP), Army Subject Schedules (ASubjScd) and Army Training Tests (ATT).

PUBLICATION	DESCRIPTION	ESTIMATED DATE	
		FY	QTR
R FM 6-2	Artillery Survey	69	4
R FM 6-3-1	Operation of Gun Direction Computer M18 Cannon Application	70	3
R FM 6-10	Field Artillery Communications	69	2
R FM 6-15	Artillery Meteorology	69	3
R FM 6-20-2	Field Artillery Techniques	69	4
R FM 6-38	Field Artillery Battery (Sergeant)	69	4
C FM 6-40	Field Artillery Cannon Gunnery	69	4
R FM 6-40-1	Field Artillery Honest John/Little John Rocket Gunnery	70	3
R FM 6-40-1A (S)	Field Artillery Honest John/Little John Rocket Gunnery (U)	70	4
R FM 6-40-2 (C)	Field Artillery Missile Gunnery (U)	70	4
C FM 6-59	Field Artillery Rocket Honest John, With Launchers M386 and M33	69	1
C FM 6-60	Field Artillery Rocket Honest John, With Launcher M289	70	1
R FM 6-70	105mm Howitzer M102	70	1
C FM 6-75	105mm Howitzer M101 Series, Towed	69	2
C FM 6-94	8-inch/175 Gun Self-Propelled	69	3
R FM 6-122	Artillery Sound Ranging and Flash Ranging	69	3
R FM 6-135	Adjustment of Artillery Fire by the Combat	69	2
R FM 6-155-1	Special Procedures for Employment of Selected Ammunition with Free Rockets	69	3
R FM 6-160	Radar Set AN/MPQ-10A	69	4
R FM 6-161	Radar Set AN/MPQ-4A	69	3
R FM 6-162	Radar Set AN/TPS-25	69	3
R FM 105-6-1	Nuclear Play Calculator (U)	70	2
N FM 6- ( )	Lance	70	2

<b>PUBLICATION</b>	<b>DESCRIPTION</b>	<b>ESTIMATED DATE</b>	
		<b>FY</b>	<b>OTR</b>
R TM 6-300-69	The Army Eplemeris	69	1
R ATP 6-175	Field Artillery Missile Units Honest John/Little John	69	3
R ATP 6-555	Field Artillery Battalion, SERGEANT	69	2
R ATP 6-558	Field Artillery Searchlight Battery	69	4
R ATP 6-575	Field Artillery Target Acquisition Battalion	69	3
R ATP 6-615	Field Artillery Battalion, PERSHING	69	1
R ASubjScd 6-5	Communications Training for Section and Platoons	69	1
R ASubjScd 6-25	Field Artillery Sound Ranging	69	3
R ASubjScd 6-29	Artillery Survey	69	2
R ASubjScd 6-30	Umpiring and Aggressor Forces	69	3
R ASubjScd 6-42	Difficult Traction and Field Expedients	69	3
R ASubjScd 6-13A10	MOS Technical and Refresher Training of Field Artillery Basic	69	1
R ASubjScd 6-13D20	Mos Technical and Refresher Training of Field Artillery Rocket Crewman	69	3
R ASubjScd 6-13E20	MOS Technical and Refresher Training of Field Artillery Operations and Intelligence Assistant	69	1
R ASubjScd 6-15B10	MOS Technical and Refresher Training of Sergeant Missile Crewman	69	4
R ASubjScd 6-15E10	MOS Technical and Refresher Training of Pershing Missile Crewman	69	1
N ASubjScd 6-17A10	MOS Technical and Refresher Training of Field Artillery Combat Surveillance and Target Acquisition Crewman	69	2
R ATT 6-175	Field Artillery Bn (Btry) Honest John	69	4
R ATT 6-415	Field Artillery Battalion Gun or Howitzer (Heavy)	69	4
R ATT 6-558	Field Artillery Searchlight Battery	69	3
R ATT 6-576	Headquarters and Headquarters Battery, Field Artillery Target Acquisition Battalion	69	4
R ATT 6-577	Field Artillery Target Acquisition Batteries	69	4
R ATT 6-615	Field Artillery Battalion, Pershing	69	3
N ATT 6-725	Airmobile Field Artillery Battalion, Aerial Rocket	To be	est.
N ATT 6-727	Airmobile Field Artillery Battery, Aerial Rocket	To be	est.

# ALPHABETICAL INDEX FOR 1968 ARTILLERY TRENDS

## ARTICLES

Article	Issue	Page
A Breakthrough in Learning Motivation	December	41
A New Approach by the Big Red One	December	13
Adjust by Sound	January	28
Adjustment of Fire and Special Application of Counter mortar Radar	December	55
Aerial Artillery	January	50
Airborne Artillery (organization)	July	67
Airmobile Artillery (organization)	July	69
Ammunition (equipment)	December	18
AN/MPQ/4A Strob ing Technique	December	58
Applying the Deflection Correction Scale	December	77
Armored/Mechanized Division Artillery (organization)	July	62
Army/Corps Artillery (organization)	July	96
Artillery in the Arctic	May	27
Artillery Mathematics	July	96
Birth of RADA, The	May	27
Close Air Support and the Forward Observer	January	59
Collimator Training Aid, The	December	68
Common and Progressive Electives Program	December	34
Communications (equipment)	July	39
Communications (operations)	July	95
Conversion Factors	July	97
Counterfire	December	20
Defense of a Landing Zone	January	46
Defense of the Battery Position	May	60
Employment of Nuclear, Biological and Chemical Weapons	December	80
FADAC	May	45
FDC Hip Shoot	January	72
Field Artillery Equipment	July	4
Field Artillery Operations	July	78
Field Artillery Organization	July	57
Fire Marking, the Answer to True Simulation	May	80
Fire Support	May	77
Fire Support Coordination	December	73
First Round Smoke	January	25
FO Found by Sound	January	35
Gunnery (Operations)	July	78

<b>Article</b>	<b>Issue</b>	<b>Page</b>
Honest John FA Battalion (Organization)	July	66
How to Prep a Landing Zone	January	41
Improved Cannon FADAC	December	66
Infantry Division Artillery (Organization)	July	58
Intercommunication Set for M108 and M109	January	69
Meteorology (Equipment)	July	55
Metro Solution for Large Difference in H and MDP	January	77
Mortar and Rocket Location	May	68
On FADAC Maintenance	May	32
On to 'Graf'	December	20
Pinpoint Distribution System	December	64
Probable Error Slide Rule	January	96
Radar on the Gunnery Team	May	62
Radar Orientation by Sound Ranging	December	50
Riverine Artillery	January	14
Royal Regiment of Canadian Artillery, The	May	73
Tactics (Operations)	July	83
TACFIRE	July	19
Target Acquisition (Equipment)	July	48
Transportation (Equipment)	July	25
Warning Control Centers	December	61
Why is a Mil	May	86
Weapons (Equipment)	July	5

### **SHORT SUBJECTS**

<b>Article</b>	<b>Issue</b>	<b>Page</b>
Alphabetical Index Artillery Trends 1966-67	May	94
Probable Error Slide Rule	January	96
Resident Course	December	86
Status of Training Literature	January	83

### **INSTRUCTIONAL DEPARTMENT NOTES**

Adjustments by Sound	January	5
Aerial Observation	January	5
Ammunition Supply	January	9
AN/MPQ-4A	January	9
AN/PRC-25 and Its Derivatives	May	6
Artillery Mechanics Course	December	8
Battery Position Defense	January	6
Chief of Section Course	January	3

Collimator	May	4
Computation of Large Negative Sites	January	10
Counterinsurgency Oriented Training	January	5
Course Changes	January	9
Executive Post	January	7
FADAC	January	8
FADAC	May	5
FDC Personnel	January	8
Fire Direction Area	January	7
Fire Planning	January	8
Firing Battery Area	January	6
FO Duties	January	8
Gama Goat Contracted	December	4
H & I Fires	January	8
Illumination Debris	January	11
Large Negative Sites	January	7
Liaison Instruction	January	8
M102 Howitzer	January	7
Miscellaneous	January	9
Minimum Safe Distance	January	12
Missile Course Change	December	6
New Course for Reserve Component Officers	January	13
Observer Training	January	5
Pershing Courses Revised	January	10
Photogrammetry	January	9
Reading from GFT	January	11
Registration	January	6
Self-Propelled Weapons	January	7
Sergeant Officer Course Revised	January	10
Situation Overlay	January	7
Smoke Round	January	5
Survey	January	13
Tactics	January	7
Tactics Instruction	January	6
USAAMS Instructional Television	December	4
Walking Shoots	May	5
155 Slant Scale GFT	January	12
175-mm Gun	May	5
6,400 Mil Capability for M107 and M110	December	7
6,400 Mil Capability	January	6

#### NOTES FROM THE US ARMY FIELD ARTILLERY BOARD

Article	Issue	Page
Airmobile Firing Platform	May	11
Ammunition	May	12
Breech-mounted Rammer for M109	December	12

FADAC Program for Processing Meteorology Data	December	11
M109	May	12
M548	May	12
More Ground Stability for the M102	December	12
OSIS, AN/TSN-9	May	9
Pershing Azimuth-Laying Training Device	December	11
Radar Chronograph M36	May	10
Radioactive Illumination of Fire Control Equipment	December	12
TACFIRE	December	10
VATLS	May	10

### **NOTES FROM THE US ARMY COMBAT DEVELOPMENT COMMAND FIELD ARTILLERY AGENCY**

<b>Article</b>	<b>Issue</b>	<b>Page</b>
Artillery Studies	May	13
TACFIRE Status	May	13

### **SOUTHEAST ASIA LESSONS LEARNED**

<b>Article</b>	<b>Issue</b>	<b>Page</b>
Aerial Observers	May	89
Close-in Defensive Capabilities	May	88
Driver Training	December	83
Fuze Can Opener	January	80
General	December	84
Generators	December	84
Interdiction of Land Lines	May	90
Liaison with Allied Artillery	May	90
M107/M110 Elevating Slip Clutch Adjustment	January	82
Multiple Ammunition Lots	May	87
Premature Burst, Fuze M51A5	May	88
Preventive Maintenance	December	84
Preventive Maintenance Checks and Services	May	91
Recovery	December	84
Retention of Shell Casings	May	88
Self-Illumination	May	90
Vehicle Recovery and Canal-Crossing Techniques	January	79

*L1136 Army—Ft. Sill, Okla.*