

ARTILLERY SAAMS LIBRARY

TRENDS

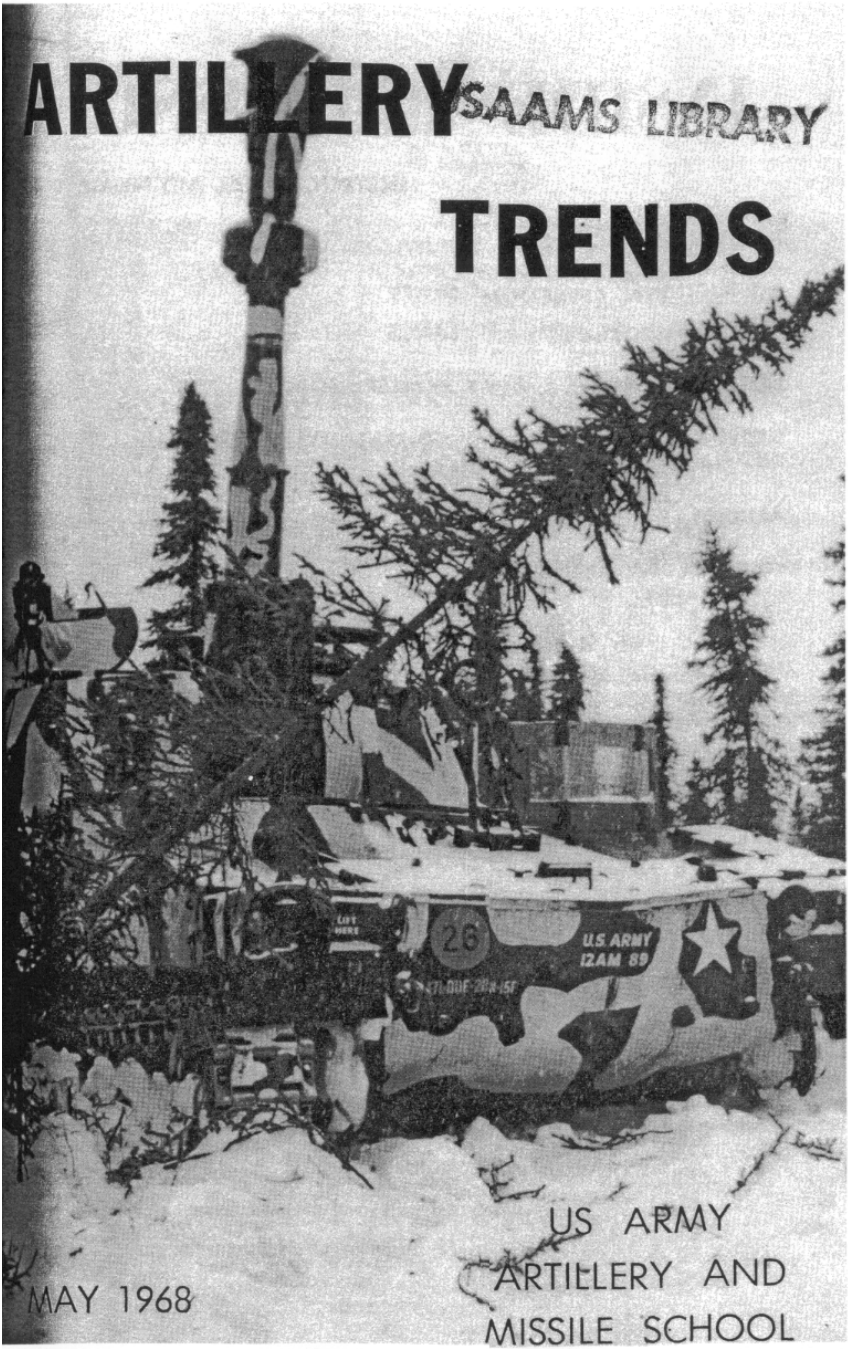

MAY 1968

US ARMY
ARTILLERY AND
MISSILE SCHOOL

INSIDE THIS ISSUE

INSTRUCTIONAL AID NUMBER 40

INTRODUCTION	1
INSTRUCTIONAL DEPARTMENT NOTES	
Items Collected from USAAMS	4
NOTES FROM THE U. S. ARMY ARTILLERY BOARD	8
NOTES FROM THE U. S. ARMY COMBAT DEVELOPMENTS COMMAND ARTILLERY AGENCY	13
ARTICLES	
Artillery in the Arctic	14
TACFIRE	19
The Birth of RADA	27
On FADAC Maintenance	32
FADAC	45
Defense of the Battery Position	60
Radar on the Gunnery Team	62
Mortar and Rocket Location	68
The Royal Regiment of Canadian Artillery	73
Fire Support	77
Fire Marking, the Answer to True Simulation	80
Why is a Mil?	86
SOUTHEAST ASIA LESSONS LEARNED	87
INDEX OF ARTILLERY TRENDS 1966-67	94



ARTILLERY TRENDS is an instructional aid of the United States Army Artillery and Missile School published only when sufficient material of instructional nature can be gathered.

Introduction

● COVER

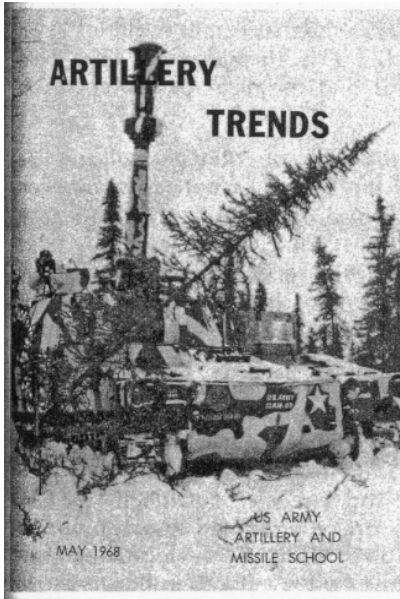

In past issues of **ARTILLERY TRENDS**, readers became acquainted with the operations of artillery units in counterinsurgency environments where difficulties were experienced in both soggy terrain and steaming temperatures. Both of these factors also confront artillerymen in the Arctic—but, of course, to opposite extremes. Solutions to these plus a myriad of other problems are related by officers of the 2d Battalion, 15th Artillery in "Artillery in the Arctic."

This issue also takes a futuristic look at the artillery in the 1970's in "TACFIRE" and the "Birth of RADA." With the awarding of a contract to Litton Industries for the development and production of the

Tactical Fire Direction System, the artilleryman's vision of an automatic data processing system draws closer to reality. In the second article, the author recognizes the requirement that all commanders have a communication system that is fully automatic, simple to operate, extremely reliable and, above all, secure. He proposes that the Random Access, Discrete Address communication system meets these requirements.

With an increasing number of units employing the M18 field artillery digital computer (FADAC), an article, "On FADAC Maintenance," has been written to maximize utilization of the equipment with minimum downtime. In another article, "FADAC", solutions are offered to problems experienced in an internal defense environment.

The use of the AN/MPQ-4A radar in effectively solving gunnery problems is described in "Radar on the Gunnery Team." Another article, "Mortar and Rocket Location," outlines the procedures used in the employment of three main types of sound bases.

An index of articles appearing in 1966-67 issues of **ARTILLERY TRENDS** is included in this issue in addition to the regular features, "Instructional Department Notes," "Southeast Asia Lessons Learned," "Notes from the U. S. Army Artillery Board," and "Notes from the U. S. Army Combat Developments Command Artillery Agency."

Artillery Trends

As an instructional aid of the United States Army Artillery and Missile School, **ARTILLERY TRENDS** is published only when sufficient material of an instructional nature can be accumulated. It is designed to keep field artillerymen informed of the latest tactical and technical developments in artillery.

In accordance with AR 310-1, distribution of **TRENDS** will not be made outside the command jurisdiction of the School except for distribution on a gratuitous basis to Army National Guard and USAR schools, Reserve Component staff training and ROTC programs, and as requested by other service schools, ZI armies, U. S. Army Air Defense Command, active army units, major overseas commands, and military assistance advisory groups and missions.

Subscription to **TRENDS** on a personal basis may be obtained by qualified individuals by writing to: The Book Store, U. S. Army Artillery and Missile School, Fort Sill, Oklahoma 73503.

Primarily, articles are prepared by individuals assigned to departments of the School or to artillery units and agencies outside the School. All articles, no matter what the source, are coordinated by appropriate departments in the School and with the U. S. Combat Developments Command Artillery Agency and the U. S. Army Artillery Board collocated with the School at Fort Sill, Oklahoma. This coordination is effected in an effort to arrive at an "Artillery Community" position before publishing the information. The Artillery Community is Fort Sill's term for the center team concept of Continental Army Command, Army Materiel Command, and the Combat Developments Command.



U. S. Army Artillery and Missile School



Commandant	Major General Charles P. Brown
Assistant Commandant	Brigadier General John J. Kenney
Secretary	Colonel Philip H. Riedel, Jr.
Director of Instruction	Colonel Francis E. Kramer
Director of Logistics	Lieutenant Colonel Thomas A. Miller
Office of Artillery Policy and Literature	Colonel John W. Clifford
Artillery Transport Department	Colonel Joseph R. Loftin
Communication/Electronics Department	Colonel George P. Winton
Guided Missile Department	Colonel Ralph I. Williams

Gunnery Department Colonel Salvo Rizza
 Nonresident Instruction Department Colonel Jesse B. Hollis
 Tactics/Combined Arms Department Colonel T. F. Perpich
 Target Acquisition Department Colonel Harry R. Jackson
 USAAMS Brigade Colonel Salvador F. Taranto
 Officer Candidate Brigade Colonel Marlin W. Camp

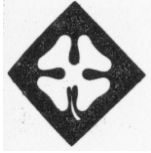

U. S. Army Artillery and Missile Center

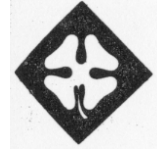

Commanding General Major General Charles P. Brown
 Chief of Staff Colonel Vincent M. Elmore, Jr.

III Corps Artillery

Commanding Officer Colonel William E. McLeod

U. S. Army Training Center, Field Artillery

Commanding Officer Colonel Frank Hawthorne

U. S. Army Artillery Aviation Command

Commanding Officer Colonel F. C. Goodwin



U. S. Army Artillery Board



President Colonel Paul S. Cullen



**U. S. Army Combat Developments
 Command Artillery Agency**



Commanding Officer Colonel A. F. Rollins

Instructional Department Notes



Gunnery Department

COLLIMATOR

The following publications contain an error on the illustration showing collimator displacement. The illustrations, which show the correct alignment, were erroneously labeled left displacement when they should be labeled right displacement.

- * **ARTILLERY TRENDS**, January 1967 issue, page 39.
- * **Fire Control and Coordination Information Letter 2, M1 Collimator**, 18 February 1967, page 14.
- * **Notes for the Battery Executive**, July 1967, page 17.
- * **PS Magazine**, Issue 183, 1968 Series; page 10.

The correct labeling of the illustration is as shown below.

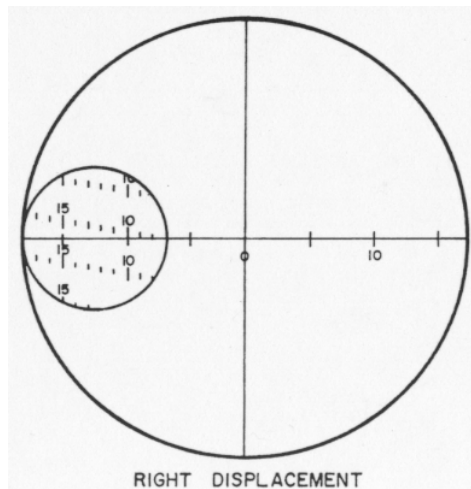

Figure 1.

The US Army Artillery and Missile School is publishing a revised information letter on the M1 Collimator. This letter, entitled, "**Fire Control and Coordination Information Letter . . . 2 (Revised), M1 Collimator**", will correct the error in sight picture labeling, and give increased coverage on employment, to include use of the collimator in conjunction with aiming posts for a 6,400-mil capability.

The article which appears in PS Magazine, Issue 183, 1968 series, contains excellent information on the care and handling of the M1 Collimator.

There is no organizational maintenance manual on the M1 Collimator. Information on organizational maintenance of the collimator will be included in future changes to pertinent weapons technical manuals. The only weapon technical manual which presently contains this information is **TM 9-1015-234-12, Operator and Organizational Maintenance Manual-Howitzer-Light Towed: 105MM, M102.**

TM 9-1240-324-35 covers DS, GS, and Depot Maintenance of the M1 collimator.

FADAC

The School has published Fire Control and Coordination Information Letter #5, FADAC. That information letter, and the article entitled FADAC in this issue of Artillery Trends, apply to the phase III, issue I Cannon Program tapes which are presently in use with FADAC,

Upon issue of the new phase III, issue II Cannon Program tapes, presently scheduled for issue in the near future, appropriate literature for the new tapes will be distributed.

175-mm Gun

Weapons Information Letter Number 1, 175-mm Gun, dated 5 November 1966, contains an error in section XIV. Section XIV should be deleted and replaced with the revised section XIV as shown below.

SECTION XIV. — TORQUE LOCK AND ELEVATING AND TRAVERSING TRAIN GEAR ALINEMENT

32 and 33. M107/M110 Elevating Slip Clutch Adjustment:

a. Some units in Vietnam have experienced problems with the Traversing Drive Assembly Slip Clutch and the Elevating Drive Assembly Slip Clutch for the M107/M110. It was found that some of the torque settings were either greater or less than the torque settings stated in TM 9-2300-216-85/2, paragraphs 23 and 59.

b. The U. S. Army Tank Automotive Command (ATAC) has authorized weekly instead of bi-monthly inspections of these weapons by Field Maintenance. During these inspections, Field Maintenance should test the torque on both the traversing and elevating slip clutches. Tests by Field Maintenance must be made with a torque wrench before applying any adjustment as authorized and described in figures 15 and 19, pages 31 and 35, of TM 9-2300-216-35/2.

c. ATAC has verified the slip clutch settings listed in the manual and no changes are required.

Communication/Electronics Department

AN/PRC-25 AND ITS DERIVATIVES

A number of new radio sets, derived from the AN/PRC-25, will be issued to troop units in the near future. A comparison of the characteristics of the AN/PRC-25 and the new sets and a brief discussion of the sets are given here.

When the AN/PRC-25 was designed, and subsequently manufactured and distributed to troop units, a transistor capable of handling the output load of the radio set had not been developed. Since that time such a transistor has been developed and is used in the final stage of the transmitter of the redesigned PRC-25, which has been designated the AN/PRC-77. The transistor eliminates the undesirable radio frequency interference with other electronic equipment caused by the vacuum tube, power amplifier circuit of the transmitter of the PRC-25. The newly designed circuit provides more reliable and sturdier internal components, extends the life of the internal components and batteries, and reduces maintenance time.

The AN/PRC-77 will eventually replace the AN/PRC-25 on an attrition basis. Therefore, both the PRC-25 and the PRC-77 will be in the hands of troops for some time to come. These radio sets are fully compatible with each other and with the VRC-12 series of radios. A separate, lightweight (4 ounce) speaker, the LS-549, has been designed for use with either the PRC-25 or the PRC-77.

The PRC-77 is more versatile than the PRC-25, since it can be used with the new radio frequency amplifier AM-4306/GRC without causing mutual interference. The addition of the amplifier AM-4306/GRC will increase the range of the PRC-77 two to three times its basic range, all other factors remaining the same. Because the PRC-77 includes an X-mode interface facility for secure voice communication, the radio set can be used with the KY-38.

The major end item in the PRC-25 series, the RT-505/PRC-25, is used in the following configurations:

AM-4306		
AN/PRC-25	Manpack only	AN/PRC-80
AN/GRC-125	Manpack or vehicular	AN/GRC-162
AN/VRC-53	Vehicular only	AN/VRC-66

The major end item in the PRC-77 series, the RT-841/PRC-77, is used in the following configurations:

AM-4306		
AN/PRC-77	Manpack only	AN/PRC-79
AN/GRC-160	Manpack or vehicular	AN/GRC-161
AN/VRC-64	Vehicular only	AN/VRC-65

In lieu of the short (3-foot steel tape) or long (10-foot whip) antennas, which are issued with the sets, the elevated ground plane antenna RC-292 or the long-wire antenna AT-984 may be used to increase the range. However, antenna AT-984 will not be used with a set that has been converted for high-power transmission unless the antenna is marked to warn personnel of the danger. (See TB Sig 291 for additional precautions.)

No special training is required for operation and maintenance of the AN/PRC-77 series if the personnel are familiar with the AN/PRC-25 series. However, operator and maintenance personnel must insure that the plug-in test set AN/GRM-55 is not to be used with the RT-841/PRC-77 at organizational level. Organizational maintenance authorized to be performed on the PRC-77 is described in TM 11-5820-667-12, (June 67).

Nonresident Instruction Department

Following is an unsolicited statement made by Captain Stephen L. Ammon, now assigned to the Gunnery Department, USAAMS:

"As Vietnam calls more and more artillerymen to take their turn, both officers and enlisted men are being assigned to duty they have been away from for awhile. The men of the 7th Battalion, 11th Artillery, 25th Infantry Division found a solution to this problem—to enroll in the extension course program offered by the Nonresident Instruction Department of the Artillery School at Fort Sill. The solution is not original but is quite effective.

"The extension courses not only were a valuable aid to junior officers in enlarging their store of knowledge, but also served as excellent, easy-to-read references for teaching classes. Since the extension courses are updated frequently, they are often more valid references than field manuals and technical manuals.

"In a combat situation well-trained personnel are essential, but are often difficult to find. Whether you need a sophisticated on-the-job training program or merely an effective MOS refresher program, extension courses provide an excellent foundation."



SPRINT TESTED

The Army's SPRINT anti-missile, in a successful October test flight at White Sands Missile Range, New Mexico, hit a computer drawn target in the sky.

The 27-foot long, high-acceleration missile hit the imaginary intercept point after a flight that included several planned sharp maneuvers.

The point, which was programmed into the missile's flight controlled computer, was designed to simulate the intercept point for a real incoming missile.

The SPRINT will be one of two interceptor missiles deployed with the nation's ABM system. It is currently in its flight test program at White Sands.

Test officials said the missile is launched from an underground cell and performed according to plan.

Notes from the U.S. Army Artillery Board

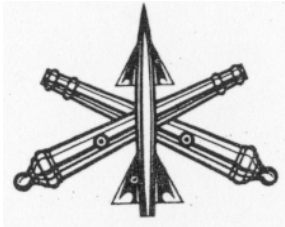

Guardian of the Soldiers Warranty



INTRODUCTION

Following are notes from the United States Army Artillery Board. Similar items will be published as a regular feature in future issues. These notes are intended to keep the artilleryman abreast of proposed artillery materiel being tested and of tested improvements for materiel already in the field. Readers are cautioned that an Artillery Board note on an item is not in any way indicative of the item's availability.

The Artillery Board, located at Fort Sill, Oklahoma, as a tenant, is a service test board for the U. S. Army Test and Evaluation Command. The U. S. Army Test and Evaluation Command is an independent test and evaluation agency for U. S. Army Materiel Command which insures that developmental items, once manufactured and released to the field, will answer the needs of the Army as far as effectiveness and efficiency are concerned.

The types of U. S. Army Test and Evaluation Command installations and activities are proving grounds, environmental test centers, and service test boards. The purpose of engineering tests conducted at the proving grounds is to determine the technical performance and safety characteristics of an item under test. However, the personnel who conduct the engineering tests are not representative of the ultimate users of the materiel. The environmental test centers determine if the materiel will operate satisfactorily in all climates. These environmental centers are located at Fort Greely, Alaska, Yuma Proving Ground, Arizona, and Fort Clayton, Panama Canal Zone. Service tests are conducted by soldiers representing those in the field, and thereby, providing a basis for a final appraisal as to the suitability of the materiel. Service test boards are generally collocated with branch oriented school, training centers, and combat development agencies.

To accomplish its mission, the Artillery Board is organized into two directorates under a president and a deputy. The Test Directorate is responsible for the testing of artillery materiel, and is composed of the Gunnery-materiel Division, the Missile Division, and the Plans and Analysis Division. The Test Support Directorate provides all the required assistance.

Since 1902, thousands of items have been tested by the Artillery Board. These range from a small torque key for the M109 155-mm self-propelled howitzer to an entire missile system such as Pershing. Many tests are military potential or feasibility tests for the new developments from the commodity commands. Therefore, one of the most interesting aspects of an assignment with the Board is the opportunity to operate many potentially suitable items for the Artillery's use several years before they may be introduced as standard items. Many, of course, are not found suitable for military use.

OSLS, AN/TSN-9

The Omnidirectional Sound Locating Set (OSLS) is an experimental 6,400-mil target locating system incorporating a sound system used in conjunction with an AN/MPQ-4A radar. The system should provide a 6,400-mil "ear" around any location. Designed to pick up sounds such as a mortar round being fired, the sound system provides pointing data in terms of azimuth and range for the AN/MPQ-4A radar. This should enable the radar crew to slew its radar to the sounded azimuth, pick up the second round, and fix an accurate location for the artillery FDC. Two tests at Fort Sill have resulted in improvements which will be further tested in Southeast Asia to determine the effectiveness of the concept and the hardware.

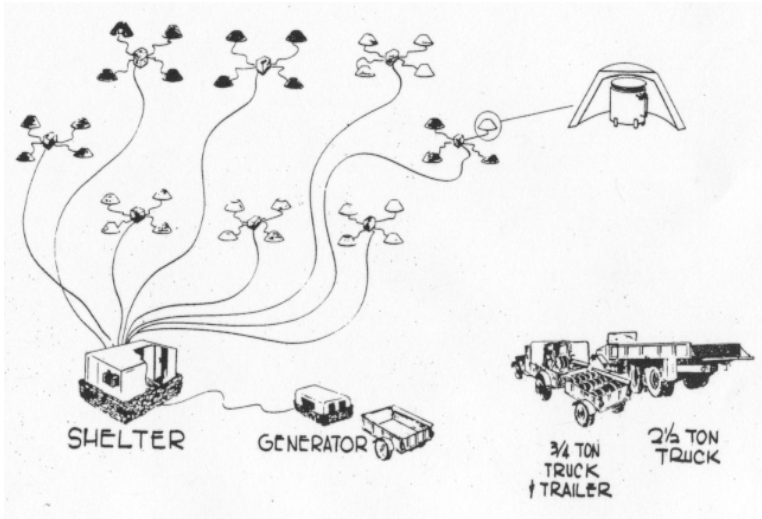

Figure 1. Omnidirectional sound locating set

RADAR CHRONOGRAPH M36

The M36 chronograph, tested in the spring of 1967, is designed to provide the Artillery with a faster method of measuring muzzle velocity. The M36 uses the doppler frequency shift effect to measure the projectile velocity at a point in space and the extrapolation table provides a correction that enables the muzzle velocity to be determined. A second contractor model of the M36 is currently undergoing evaluation at Fort Sill, Oklahoma.

VATLS

An improved Visual Airborne Target Locator System (VATLS) was evaluated by the Artillery Board in the summer of 1967 and has since been deployed to Southeast Asia for further testing. VATLS appears to have a highly accurate target locating capability and is also believed to have a more than satisfactory survey capability. The system consists of airborne equipment, which includes a stabilized telescope, a Laser rangefinder, and an airborne data handling unit mounted in a UH-1B Helicopter. Also necessary is a ground station consisting of a tracking radar, an M18, FADAC, a teletypewriter, a distance measuring subsystem and a conventional radio receiver transmitter. The single sight mode uses the Laser rangefinder to determine range from aircraft to target. In the two sight mode range is computed by triangulation. In tests a precise coordinate location has been provided immediately by the FADAC. Further testing is scheduled in Southeast Asia.

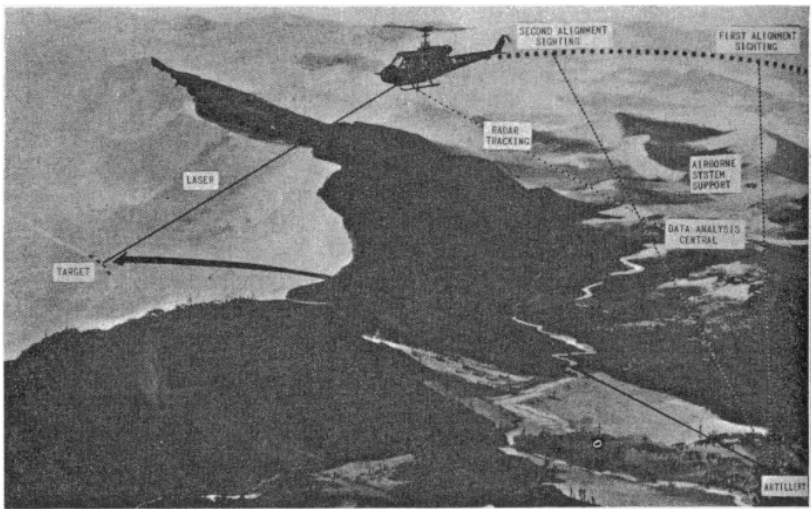

Figure 2. Illustration of VATLS in operation.



AIRMOBILE FIRING PLATFORM

An airmobile firing platform for the M102 howitzer was tested by the Artillery Board personnel at Jefferson Proving Grounds, Indiana. The platform was designed to give the Artillery a suitable and more stable firing base in rice paddies and marshy areas of Southeast Asia. The platform can be emplaced and extracted by a CH47B helicopter. The 9th Infantry Division Artillery was the first unit in Southeast Asia to use test models of the platform. Southeast Asia results were not available at press time.

Figures 3. Firing platform airborne.

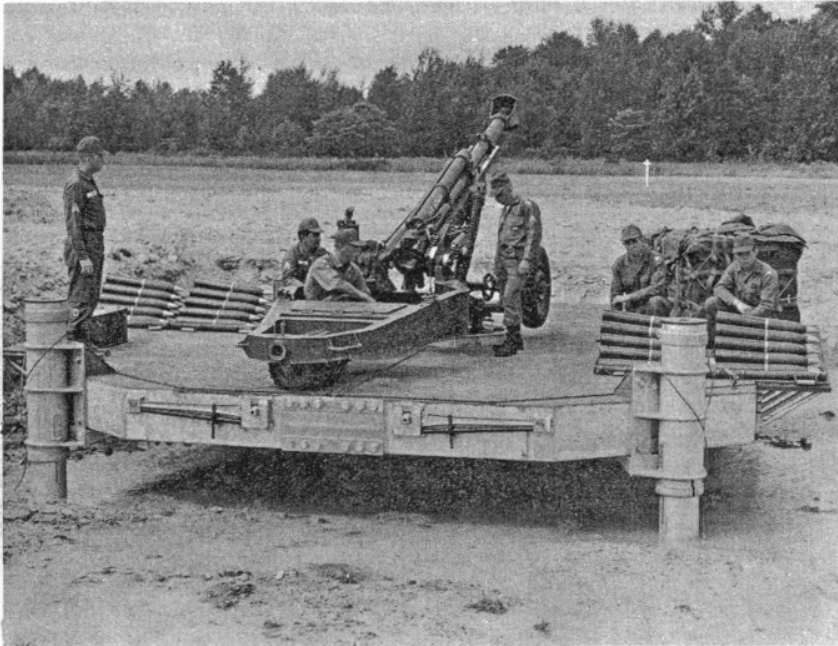

Figure 4. Employment of platform.

M109

Product improvement testing of the M109, 155-mm, self-propelled howitzer was initiated with the following modifications being tested:

- a new muzzle brake which will reduce muzzle blast while firing Charge 8.
- a weapon mounted rammer.
- a communications control box for the gunner.

These tests are incomplete. New torque keys were also tested with various types of lubricants and without any lubricants. It was noted after firing **many** rounds that any lubricant substantially reduced the amount of wear of the torque key. Pending final evaluation and possible acceptance of a special lubricant, it appears that greasing the torque key way with issue GAA grease every 300 rounds will save wear on the key and the breech mechanism, with an assured savings in downtime.

AMMUNITION

The following artillery ammunition has been tested recently and the test reports have been submitted for evaluation:

- Cartridge, 105-mm, HE, Boosted Artillery Cartridge (BAC), XM548E1
- Projectile, 155-mm, Boosted Artillery Projectile (BAP), XM549
- Projectile, 155-mm, Illumination, M485

M548

The M548 Cargo Carrier, an accompanying vehicle for self-propelled artillery, was recently tested at Fort Sill by the 3d Battalion, 30th Artillery

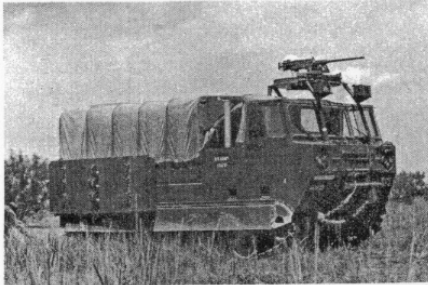

Figure 5. M548 Cargo Carrier.

under the supervision of the Artillery Board. The vehicle is a member of the M113 APC family with a 6-ton payload capacity and is equipped with a chain hoist materiel handling device. It was developed to provide the Army with a highly mobile, unarmored, air transportable, tracked vehicle to be employed as an accompanying or resupply vehicle. During the tests the vehicles traveled a total of approximately 4,000 miles over all types of terrain including several swims in Lake Elmer Thomas, Oklahoma, with a full payload.

IMR PROPELLANT RETESTED

The Secretary of Defense has directed the Secretary of the Army to suspend until further notice the distribution in Vietnam and the manufacture of 5.56-mm ammunition loaded with improved military rifle "IMR" propellant.

The action taken is precautionary and will be reviewed after detailed analysis of test data on the ammunition has been completed. The order does not apply to tracer rounds.

NOTES

from the

U.S. Army Combat Developments Command

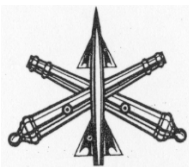

ARTILLERY AGENCY



ARTILLERY STUDIES

The Studies and Evaluation Division of the Combat Developments Command Artillery Agency, is currently conducting a series of major studies covering all elements of field artillery requirements in the future.

A Basic Derivative Study entitled Artillery-75 examines five geographical areas of the world in all intensities of conflict during the time frame 1970-1975. In each area a threat is postulated and a force derived to counter the threat. The study group is developing the artillery requirements for each force and upon completion of all areas will determine the world wide requirements for artillery weapons systems, supporting materiel and artillery organizations for the time period.

A separate study is being conducted to determine the maximum range that cannon artillery can efficiently be employed in both the direct support and the general support role.

TACFIRE STATUS

Additional study efforts include a trade off study of the Tactical Fire Direction System (TACFIRE). The purpose of the study is to determine the overall effectiveness of TACFIRE as related to both cost and efficiency. Also a study pertaining to LANCE is being conducted to determine the nuclear and nonnuclear missile requirements of the US Army Force Structure during the period 1971 - 1975.

On 8 December 1967, the Data Systems Division of Litton Systems Inc. was awarded a total package procurement contract for development and production of the Tactical Fire Direction System (TACFIRE).

TACFIRE is scheduled for 30 months of development followed by 41 months of production. Engineer service test is scheduled to begin in October 1969. First production delivery is scheduled for January 1972.

The Combat Developments Command Artillery Agency, as the "user representative," is monitoring development to insure that the stated objectives and requirements are met. (See article on page 19)

Artillery in the Arctic



Editor's note: The following article was prepared by personnel of the 2d Battalion, 15th Artillery. Contributors are listed as follows: Major James J. Helbling; Captains John F. Dewey and Theodore R. Harker; Lieutenants Allen H. Blake and John J. Gillespie, Jr.; and Warrant Officers Ronald J. Scheirer and Lyle D. Chatham.

The Arctic is a land of extremes, the most obvious of which is the temperature, but it doesn't stop there. Consider the fact that the ground, even in summer, is permanently frozen just below the surface. Think of yourself trying to establish your direction by use of the sun when the sun rises and sets in the south in winter and in the north in summer. Imagine the effect on your operational planning of a 24-hour "day" that contains 21 hours of darkness in midwinter. These are the obvious differences noticed by all newcomers to the Arctic. However, an artilleryman in the Arctic must be prepared to face a myriad of other problems in order to carry out his mission.

Before we discuss various phases of battery and battalion day-to-day operations in extreme temperatures, let's look at the organization of our artillery battalion in Alaska. Our battalion is designated as a 105-mm self-propelled battalion, but there are some surprising changes. Headquarters, headquarters and service battery is augmented with a meteorological section. Not so surprising yet? Battery A is equipped with M108 self-propelled howitzers, M116 "Husky" full-tracked command vehicles in lieu of jeeps, and an M8 tractor. Battery B is equipped with M101A1 towed howitzers with M113 armored personnel carriers as prime movers.

Battery C is equipped with M109 self-propelled 155-mm howitzers, augmented with M113 and M116 vehicles. The primary reason for these differences is to provide an over-the-snow capability, which will be touched on later.

Now that you have seen the organization of our battalion, you can readily understand the basis for the comments on the various types of howitzers and the meteorological section as employed in cold weather. To explain the problems not so readily apparent, let us begin the discussion with the guns.

The M101A1 105-mm towed howitzer with the M113 prime mover has a good over-the-snow capability. During movement, the breechblock must **always** be covered to prevent formation of ice on the breech mechanism. The sight mount must also be covered. If these items are not covered, the howitzer will be out of action until you thaw it out inside a warm tent or building. The panoramic telescope must be carried in the sight box on the carriage or on the outside of the prime mover. If it is carried inside a vehicle, the change in temperature when it is taken outside will cause moisture and ice to form. The hand-brakes must not be set, as they will freeze and cannot be released. It is virtually impossible to perform an emergency mission with a towed howitzer; since the ground is frozen solid, the trails cannot be "fired in," and the use of picks to dig in trail spades is hard, time-consuming work. Last but not least, the battery commander of a towed howitzer unit must make provisions to frequently rotate his crews into warming tents.

The M108 self-propelled howitzer has two definite advantages over the towed M101A1. First, the crew is protected from the elements and is provided warmth by the personnel heater. Second, the M108, being self-propelled, has an excellent over-the-snow capability. A problem with the M108 is that, when firing, it will slide on ice if it is not on perfectly level terrain. This is solved by using cut trees to build a platform for the howitzer, and the platform provides a bonus effect of keeping the tracks from freezing to the ground. During long moves with the M108, as with all tracked vehicles, the drivers must be rotated frequently to prevent frostbite.

The advantages and disadvantages of the M109 are virtually the same as those of the M108.

A problem common to all the howitzers is the placement of the aiming posts. Since the ground is frozen, the best solution is to place the aiming posts in the snow. Because of the long hours of darkness, aiming post lights are a must. To complicate matters, the cold temperature severely limits the life of the batteries, and several replacement sets must be kept warm at all times. The distant aiming point is seldom used because of the long hours of darkness, the reduced visibility caused by blowing snow, and the sameness of the terrain. The handling of ammunition is also a problem. Ammunition carried inside a prime mover will sweat, and when it is placed outside during preparation for firing, the sweat will freeze, making it impossible to load the ammunition. So what do you do? Our solution was to carry a minimum number of

rounds inside the prime mover (enough for an emergency mission) and the remaining rounds in the open, either on ammunition carriers or on top of the M113. Time fuzes of all types become extremely stiff, and extra time must be allowed for fuze cutting.

Now that some of the problems of the firing battery have been discussed, let's look briefly at the forward observer in Arctic regions. He must be an expert in establishing direction in terrain that has no distinguishing features when covered with 6 feet of snow. He must be an expert in the coordinated use of illuminating and high-explosive shells when the day has only 3 hours of actual light, and he must be an expert in his selection of fuze action. Fuze quick will not detonate until it has penetrated dry snow to a considerable depth, which reduces its effectiveness. However, if he selects fuze delay, the FO can expect from 80 to 90 percent airbursts because of the hard frozen ground. In addition, he should be aware of the effects of the cold on meteorological corrections. At minus 35° Fahrenheit and below, on a calm day, the met range **correction** for a 105-mm HE projectile can be as high as plus 1,600 meters at a range of 8,000 meters.

Assumed control for the surveyor is the rule rather than the exception. Control points buried under deep snow are extremely hard to locate. The survey planner must allot additional time for completion of each task, because the instrument operators and tapemen must wear bulky clothes and arctic mittens to combat the cold. Due consideration should be given to the latitude at which an azimuth gyro is used. The present gyro used by the Artillery, the Surveying Instrument Azimuth Gyro, Artillery, will not provide reliable results when it is operated at latitudes greater than 60 degrees north or 60 degrees south of the equator.

We have viewed the shooting part of our mission, so now let us take a brief look at how we communicate. The principles of wire and radio communications remain the same as in other areas, but the application of the principles differs. Wire communication is largely avoided for two good reasons. First, WD 1/TT field wire becomes stiff and brittle, and the recovery of lines is extremely difficult. Second, the time required to lay wire is six to eight times longer than that required in warm weather. FM radio communication becomes spotty in snowy periods, but during clear, cold weather the rated range of the set is usually exceeded. Consequently, the arctic artilleryman depends a great deal on his radio for operational needs and even for survival at times.

Meteorological personnel face an even greater challenge than the communicators. To set up the met station requires from 2 to 3 hours, principally because of the main cable for the rawin set. Before the cable can be unrolled, a tent must be set up and heaters must be installed to warm the cable. The reverse of this process must be conducted during march order, or you run the risk of breaking the cable. Stiffness of the elevation, IF, and OSC cables has resulted in breakage as the reflector is raised in elevation. A positive step in stopping some of this breakage has been to wrap the small cables with heat tape, the type normally used on water lines. A few other considerations for the met man. First, carry

a large supply of Thyratron tubes (8 to 10 for a 5-day operation) for they do not last long in the cold. Second, balloon conditioned ML-513/GM is an absolute must, because it is the only method of heating balloons prior to inflation. Last, field generated hydrogen gas cannot be produced. Water heated in 5-gallon cans and placed in a 32-gallon can will freeze before you can generate enough gas for even one balloon. The only answer, and not a good one at that, is to carry gas for the balloons in commercial cylinders.



Figure 1. Mobility in the Arctic region where travel through snow is further complicated by scatterings of 6- to 8-inch thick trees, is just one of many problems faced by artillery units.

Now that we have discussed communication and shooting, let us take a look at the last of the artillery big three, the ability to move.

Going from one place to another can be a real undertaking when the surface consists of 4 feet of snow over permafrost and is dotted with a generous scattering of 6- to 8-inch thick trees. If the time is available, make a reconnaissance of the route and avoid a lot of misery. Since daylight hours are so few, most moves will be made during darkness, so take advantage of checking your route by air. If aircraft are not available, plan your route with care, since getting lost even in daylight is not unusual.

The feat of making a 2,000-foot climb over rugged hills can be a real job in the Arctic. Under ideal conditions, you should have the assistance of an engineer platoon with bulldozers for breaking trails and towing stuck vehicles. If you must go it alone, here are some things to remember. Your track pads should be removed, but even this does not guarantee positive traction if your drivers over-accelerate and dig down to icy permafrost. Getting stalled on a grade can mean a long delay for your column, since breaking a new trail around a disabled vehicle can be a long, time-consuming process. Once you start on an ascent,

do not stop unless it is absolutely necessary because you run the risk of losing your momentum.

Keep your movement of wheeled vehicles down to an absolute minimum. When wheels are needed, alternate track and wheel vehicles in the column. Since the arctic artillery unit is no more than one-third wheels, there are usually enough track vehicles to provide emergency towing service.

A good source of information for solving the problems associated with vehicle maintenance in the Arctic is the section of the vehicle TM dealing with "Operations under Unusual Conditions."

Most people picture the Arctic landscape as a frozen mass of land covered with snow approaching the consistency of concrete, but this is not true. Hot springs, intermittently frozen ponds, lakes, and streams are common. If a crossing of one of these potential boobytraps is required, be careful. Fasten a cable from a second vehicle on to the trailbreaker and be prepared for a fast recovery if all does not go well. It pays to be cautious since a wet soldier in a climate at minus 50° Fahrenheit can easily be a dead soldier.

Our discussion of the Arctic would not be complete without a few words concerning the operation of your unit mess. In sustained subzero temperatures, hot rations are not only a morale factor, but an absolute necessity. Hot rations help in restoring body heat, thereby making your troops less susceptible to cold weather injury, namely, frostbite. Hot tea, coffee, and soup are in large demand and should be kept available whenever possible.

Standard messing equipment presents another problem. A cold metal fork touched to a wet tongue may cause the fork to freeze to the tongue, and it may take several minutes to remove the fork. The temperature of food placed on a cold metal messkit will approximate the temperature of the messkit within minutes. In place of metal messing equipment, it is necessary to carry an ample supply of paper plates and cups and plastic utensils.

Strangely enough, the most difficult problem you will encounter is keeping an adequate supply of water for eating and drinking. Although the ground is covered with snow, considerable time and fuel are required to melt the snow to sufficient quantities of water. Even at that, water melted from snow is good only for washing and shaving. In dire circumstances, it may be used for drinking. Water in water trailers freezes only at extreme low temperatures; however, provision must be made for removing the water through the top of the trailer, because the plumbing will be frozen. Water in cans will freeze and must be thawed before using. One method of transporting water is to carry blocks of ice on top of vehicles and thaw the blocks as required. The watchword is resupply, and every time you get a chance, it should be done.

With a little practice, patience, and caution you can overcome all the obstacles found in the Arctic climate. Preparation is the key. By preparing yourself, your men, and your equipment, you can move, shoot, and communicate.

TACFIRE



*Major General Charles P. Brown
Commandant, USAAMS*

AUTHOR'S NOTE: The following material was prepared in light of the danger of oversimplification and optimism. The reader should keep in mind that whatever the degree of automation, the success with which the artillery is employed ultimately rests with man, not with the computer.

The laser rangefinder zips a pulse of light out to a target just detected by the forward observer. In less than a second, the rangefinder registers the distance. The forward observer sets off the proper target data on the message box, and depresses a button. Before he can lift his finger from the button, his message has been duly noted at the battalion fire direction center (FDC). There, a tick mark is plotted on the digital plotter map (DPM), pinpointing the target's location. In less than 10 seconds the computer meticulously sifts the data and displays actual fire commands on the artillery control console (ACC). Approving the computer's recommended data, the S3 commands that a button be pressed and the fire commands immediately are flashed on the battery display unit (BDU) and then are relayed directly to the guns.

Upon completion of the fire mission, the computer automatically composes a message containing information about the target and the effects achieved, and awaits for the S3's approval. Deciding against a

request for additional fires, the S3 accepts the computer's message and then depresses a button sending the message up to the division artillery computer.

The sequence described above is what artillerymen presently envision for the near future—the 1970's to be exact. That's progress; that's TACFIRE.

But that is not all of TACFIRE, and TACFIRE is not all of the artillery's future. TACFIRE (tactical fire direction system) is part of a much larger package, the Automatic Data Systems within the Army in the Field (ADSAF). Formerly known as the Fire Support System of the Command Control Information System, ADSAF was approved in May 1965 for implementation. It consists of an automatic data processing system that provides automated acquisition, transmission, processing, and dissemination of information within the field army.

ADSAF has two objectives. First, it aims to increase the commander's ability to employ his available resources effectively by providing him with accurate and timely information for consideration in arriving at command decisions. Second, it provides an automated solution of many problems which are subject to mathematical analysis and to provide near-real-time dissemination of resulting data.

Under ADSAF, the tactical operations and intelligence functions are combined to form the tactical operations system (TOS). Personnel, administration and logistics functions are combined to form the combat services support system (CS3). The fire support function, being distinctly different from any of the other functions, is referred to as TACFIRE.

The research and development (R & D) acceptance test of TACFIRE is scheduled in the spring of 1969, training at USAAMS will commence in March 1972, and the first troop unit will receive equipment shortly thereafter.

The TACFIRE functional system design requirement (FSDR) contains 12 operational programs which will be developed by Data Systems Division of Litton Systems, Inc. The programs include all functions which the artillery must perform. Except for the technical fire control, artillery survey, and meteorological data functions, which are performed by the gun direction computer M18 (FADAC), these functions now are accomplished by employing manual methods.

The speed and accuracy attained by TACFIRE are made possible by digital computers with high speed core modules at battalion and higher levels and by digital data transmission to and from remote input-out-put devices. The message box used by the forward observers is called a fixed format message entry device (FFMED, pronounced ěff-měd). When requesting a fire mission, the forward observer sets off the data on his FFMED and depresses a button. Variable format message entry device (VFMED pronounced vēē' - ěff - mẽd) is being developed for missile battalions. Liaison officers and survey parties also will be equipped with a VFMED so that they can input and receive fire planning data, artillery target intelligence information, and survey data automatically.

Fire missions are processed through the same channels in TACFIRE as in the current manual system. The big difference between the two systems is the speed and accuracy with which the TACFIRE computer can compile and disseminate data. But the computer is only as accurate as the data with which it is programmed. Upon completion of the fire mission, replot data may be relayed by voice to the forward observer. At approximately the same time, the surveillance report is digitally transmitted to division artillery.

At division artillery the message is analyzed and the target list and ammunition files are updated. The target is displayed on an electronic tactical display (ETD) which permits a detailed display of friendly and enemy situations and target intelligence information. The tactical fire control program at the division artillery fire direction center operates as shown in Figure 1.

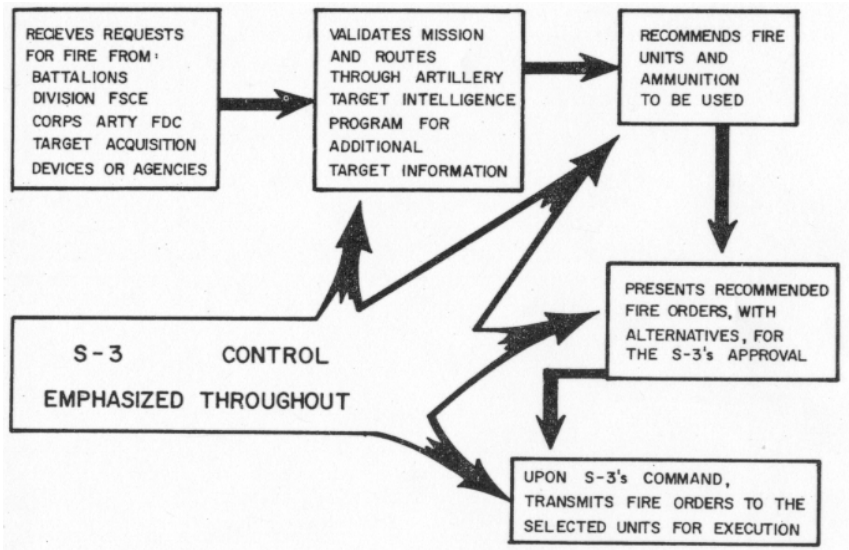

Figure 1. Division artillery FDC control.

A flow chart of the fire planning program at the division artillery FDC is shown in figure 2. The S3 has complete freedom in stating specific requirements that must be met. The computer notifies him of exceptions which require a command decision, and supplies adequate information for his decision.

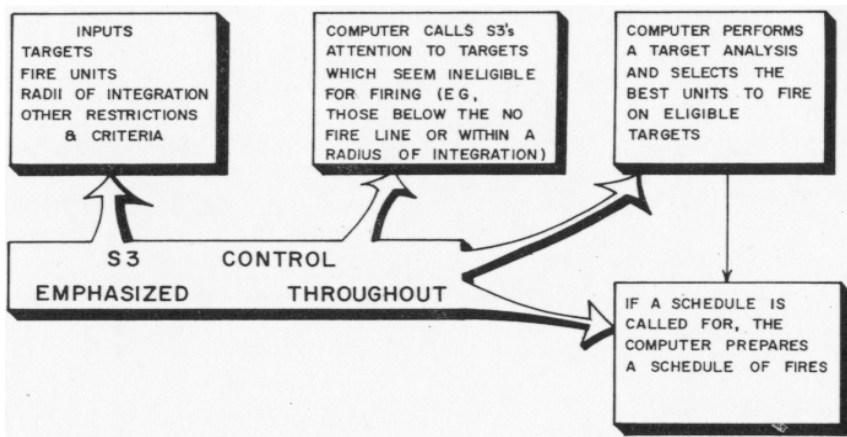

Figure 2. Fire planning flow chart at division artillery FDC.

Computer programs to be operated at the fire support coordination element (FSCE) are shown in figure 3. The preliminary target analysis, nuclear target analysis and nuclear fire planning programs are independent and can be run separately or on an interrelated basis.

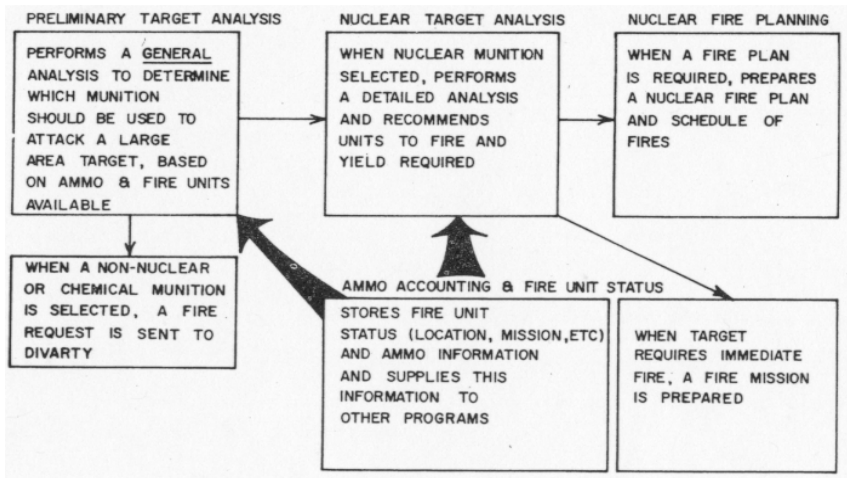

Figure 3. FSCE computer programs.

All reports of missions fired in addition to target information will be processed through the target intelligence program. The computer compares each report with all previously received reports and indicates on the electronic display devices and on the printer the information the S2 needs

to combine related reports or to revise location and description information. The S3 can take immediate action to deliver fire on target complexes as they develop. All information is retained as a complete, current, and accurate target list, which is used later in preparing fire plans.

There will be a digital link between TACFIRE and TOS at division headquarters. Intelligence information is sifted by each system, and information which meets predetermined criteria is automatically exchanged. Thus, target information desired by the G2 is sent to him immediately, while the artillery receives targets in time to deliver effective fire.

There are 12 TACFIRE operational programs planned primarily for use at battalion, division artillery, and the FSCE of the tactical operations center. When TOS is fielded, the programs solving nuclear target analysis, nuclear fire planning, chemical and biological analysis and fallout prediction will be performed by that system. Field artillery loses none of its present manual capabilities, and its ability to operate under decentralized conditions is not impaired. Following are the 12 TACFIRE operational programs listed at the echelon at which they are to be used:

TACFIRE PROGRAMS

PROGRAMS	FSCE	DIV ARTY FDC	BN FDC
Ammunition and Fire Unit Status	x	x	x
Preliminary Target Analysis	x		
Nuclear Target Analysis	x		
Nuclear Fire Planning	x		
Chemical and Biological Analysis	x		
Fallout Prediction	x		
Fire Planning		x	x
Target Intelligence	x	x	
Tactical Fire Control		x	x
Technical Fire Control			x
Artillery Survey		x	x
Meteorological Data	x	x	x

The ammunition and fire unit status program maintains current status information on all fire units, including each unit's mission, location, and strength and the types and quantities of ammunition available. Although maintaining and updating the information are not functions in themselves, this program is necessary to provide data used in the other programs.

The preliminary target analysis program consists of a preliminary target analysis to determine the most effective means of attacking targets, based on the capabilities of the delivery means at division artillery and at corps and army, as well as those of tactical air and naval gunfire, when appropriate. The analysis considers high-explosive, chemical and biological, and nuclear munitions. Based on these considerations and on guidance criteria established by the commander, the computer recommends the best munition and delivery means to defeat specific targets.

The nuclear target analysis program executes a detailed nuclear target analysis, based on all availability and allocation parameters, the commander's

criteria, and contingency and safety factors. The analysis produces a recommended solution for each target, including the fire unit, yield, height of burst, and desired ground zero. This recommendation is in the form of a complete fire order ready for transmission. In addition, the computer displays the various effects and safety radii and shows the fraction of casualties which can be expected.

The nuclear fire planning program determines an optimum schedule of nuclear fires within established criteria, based on pre-initiation factors and the capabilities of the delivery means selected.

Within the established criteria, the chemical and biological analysis program determines the casualty level which can be achieved and produces a recommended solution for each target. This recommendation includes the fire units, chemical or biological agent chosen, number of rounds required, type of attack, desired points of impact, and height of burst.

In the fallout prediction program, assumed or actual cloud measurements are combined with meteorological data and fallout patterns are predicted.

The fire planning program prepares a complete fire plan incorporating the nuclear fire plan prepared by the fire support coordination element. For nonnuclear fires the computer recommends the fire units, the number of rounds, the types of ammunition and fuzes, and the specific time each target is to be attacked. The computer prepares this schedule of fires in accordance with the priority guidance given by the S3, within the limitations imposed by boundaries, no-fire lines, and troop safety lines, and subject to the ammunition available.

The target intelligence program provides for the complete processing of target information from all sources, including the intelligence system. The computer correlates all target reports and combines related reports, when appropriate, providing the most probable location and description of each target. The result is a complete, current, and accurate target list at all times.

In the tactical fire control program, the computer makes a detailed analysis of each target and recommends the fire units, number of rounds, and type of ammunition necessary to defeat a target according to established criteria. The availability of ammunition, the capability of each fire unit, the safety limits, the no-fire lines, and other control parameters are considered in the analysis.

The technical fire control program includes the computation of ballistic data, based on meteorological and other information about non-standard conditions. The computer provides complete fire commands to the firing batteries and achieves accuracy not obtainable by the manual method.

To the extent required at each echelon, the artillery survey program provides for computation and adjustment of surveys and for storage of survey data.

Finally, throughout the system, meteorological data are received, processed, and used according to the needs of each particular echelon.

The value of automatic data processing in these functions lies not only in the storage, retrieval, and display of information, but also in the operational nature of the functions performed. These are the things the Artillery must do today. Automatic data processing does them so much faster, so much more completely, and so much more accurately that the gains are actually measurable. Whenever possible, the computer presents a recommended solution and is poised to carry out its recommendation instantly. TACFIRE incorporates the same field artillery techniques, procedures, and terminology that have been proved over the years. This will facilitate introduction of the system into artillery organizations and will make it simple for personnel to be prepared to revert to manual operations when necessary. TACFIRE is not designed to dazzle the commander with a mass of fancy displays of information he can't use. The system is based on operational programs which result in more effective fire on enemy targets. These programs are a part of a complete system.

For example, the ammunition and fire unit status program provides information for fire planning and tactical fire control. The target intelligence program produces a target list for fire planning. The nuclear target analysis program is used only after the preliminary target analysis shows that a nuclear round should be used against a target.

No additional artillery personnel are expected to be needed for operation of the system. Presently authorized personnel will be retained to provide manual backup.

In some cases the types of vehicles will have to be changed, but with very few exceptions, no increase in numbers of vehicles is contemplated.

Requirements for communications have been carefully considered. Digital data terminals must be developed, but the field artillery will use its standard radio and wire equipment to support TACFIRE. Although additional traffic probably will be generated by TACFIRE, the exceptional speed with which digital data is transmitted should more than compensate for the increased traffic.

When we compare the FADAC system of today with TACFIRE, we find that we can save approximately 80 seconds in getting fire commands to batteries. Even a minute saved can make the difference in whether or not a target is destroyed or neutralized.

When TACFIRE reaches the field, the response capability of the artillery will be significantly improved. Use of digital data communications will permit the rapid flow of accurate information directly to the computer. The computer can perform a host of complex operations in a fraction of the time now required and digital data transmission devices can speed the resulting orders and commands to the point where they are to be executed.

With computer target analysis, instantly available capabilities, and a more extensive use of the time-on-target techniques, TACFIRE will provide more effectiveness from ammunition and allow more targets to be attacked.

By correlating and up-dating target intelligence information, the computer permits even greater effectiveness to be achieved with automated fire planning techniques. As an example, in approximately 15 minutes, the computer can produce a fire plan for the attack of 150 targets with 30 fire units as compared to several hours when manual methods are used.

The intent of TACFIRE is not to reduce the amount of ammunition fired nor the number of tubes used to fire the ammunition. The battlefield payoff with TACFIRE is greater effect on more targets in less time with less ammunition per target.

●

PERSHING CONTRACT AWARDED

The Army has awarded a \$52,000,000, contract to Martin Marietta Corp. for production of ground support equipment for the Pershing 1-A system. Included in the total is a \$5 million increment awarded in August for long lead item procurement.

New ground support equipment involved has been developed for the U. S. Army Missile Command under a \$66 million contract awarded in January, 1966. Pershing 1-A involves a shift from tracked vehicles to wheels for all ground support equipment, including the erector-launcher. The change stems from the Army's continuing quest for faster rate of fire, increased reliability, less maintenance and overall lower costs.

The wheeled ground support equipment features an erector-launcher which carries the complete missile on a single carrier towed by the Army's most modern truck — the M-656 being developed by Ford Motor Company. Other equipment will also be transported by the M-656 or modifications.

There is no change to the basic 34-foot, 400-mil range missile under the Pershing 1-A program.

●

MARS ON CALL

About 60 radio stations of the Military Affiliated Radio System (MARS) in Vietnam are handling more than 30,000 phone calls home per month for servicemen in the combat zone. In addition, another 50,000 messages per month are being relayed by Vietnam MARS radio operators to the United States for service personnel who are unable to place the call themselves.

In the United States, to include Alaska and Hawaii, affiliated civilian and military MARS stations receive these radio messages and forward them via commercial lines. The cost to the addressee is the price of a collect long distance call from the stateside MARS station.

The program is administered within the Department of Defense by each of the services. Civilian operators who are at least 16 years old, hold a valid amateur's license, and have a station capable of operating on MARS frequencies can join MARS as a civilian affiliate.

The Birth of R_{andom}

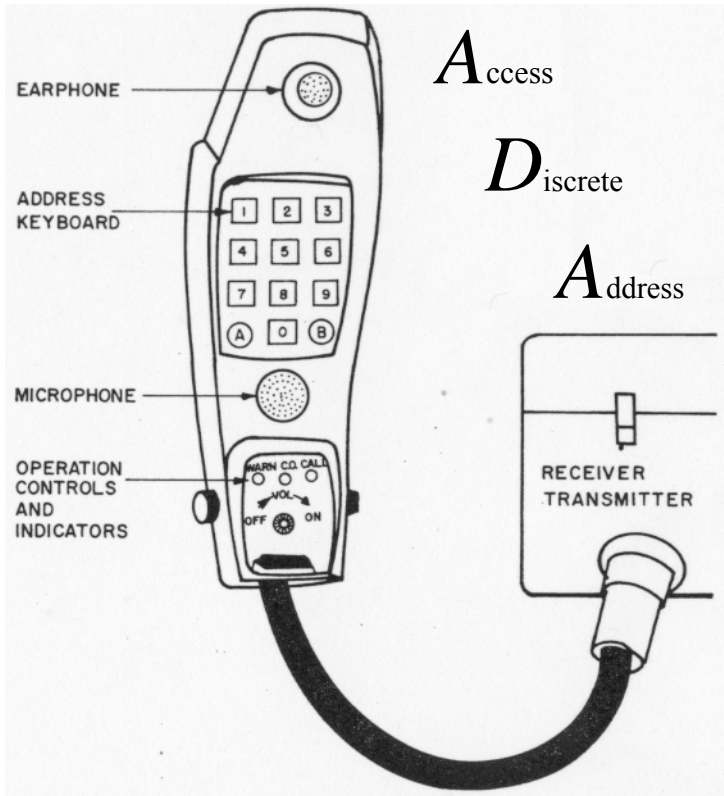

A_{ccess}

D_{iscrete}

A_{ddress}

Captain James F Elliot
Communication/Electronics Department
USAAMS

The effectiveness of the tactical principles of war as applied by General George S. Patton, Jr. in August 1944 during the breakthrough at Normandy supplied more than ample proof of the value of mobility in combat. General Patton was stopped in his advance, but not by the enemy. He was stopped by the inadequacy of the communications and logistics systems that supported him; they could not keep up with his advancing tank columns. Because of the relatively short lines of communications available, this genius of military offensive tactics was forced to stand and defend for many costly days. This delay allowed the Germans to regroup and reorganize, thus delaying the end of the war. In the memoirs of General Patton, this point becomes very evident. From the lessons learned from General Patton's after-action reports and the doctrine of that time concerning communications evolved the trends and future

policy that, for the most part, are current thinking today. Basically, that policy was, and still is, that a commander must have the means for controlling men and materiel into a directed, coordinated, uniform effort against a common enemy. In order for a commander to accomplish this, the communications serving the force must be highly mobile, flexible, reliable, secure, and, above all, simple to operate and maintain with a minimum of personnel.

To meet these many requirements, industry has, in concept, fulfilled these demands for survivability through extensive research and analysis. This concept bears the title RADA (Random Access, Discrete Address) communication system.

We find, from close analysis of the communication field, that radio/wire communications generally fall into one of three categories. The three categories are broadcast, point-to-point, and distributed communications. The first of these categories, the broadcast category, is a method of communication similar to that employed by our present-day radio/television stations in which one central transmitter sends out a signal on one frequency and all radio/television receivers turned to that frequency and within the range of the transmitter will receive that signal. The second category, the point-to-point category, is a method of communication, such as a closed system, in which an exchange of information occurs between two locations but is not necessarily confined to a single frequency or channel. Examples of this type of communication are the microwave stations used in the commercial telephone system. The third category, the distributed category, is a method of communication in which every individual has access to any other user of the same system. The best example of this category of communication is the private telephone found in almost every American home. The RADA concept combines the second and third categories of communication.

The civilian commercial telephone system that can be installed in any home employs a type of random access, discrete address system. Any user wishing to contact another individual can select from a telephone directory the group of letters and numbers assigned to that individual. Then, by dialing that group of letters and numbers, he can either contact the individual he is calling or receive a signal indicating that the line is busy. Additionally, by means of automatic recording, he can be informed that the number called is no longer in service. This system is ingenious, but it has one major defect. This defect is that all stations within the system must be permanently located in a fixed place; in other words, the system lacks mobility.

As early as 1950, the American electronics industry was asked to work toward a solution to this problem of lack of mobility. The first result was the development of the radio central communication system concept during 1954-1955. In 1957 a prototype system designated the communication system central AN/MRC-66 was built and delivered to the Army. In 1958 the U.S. Army Proving Grounds, Fort Huachuca, Arizona, conducted tests on the system to find out if the radio central concept was

feasible for military communication application. The end result of this test was that further studies were authorized. The communication central AN/MRC-66 was modified and redesignated the radio central AN/USC-3.

From 1958 through 1964, selected Army divisions field tested the radio central AN/USC-3. The results were that this system, in its present configuration, could not be bought in quantity for military use because the system would not replace any of the communication equipment presently in a standard Army division. The system had a lot of "nice to have" features but would not pay its own way. The radio central AN/USC-3 concept would require TOE increases of both personnel and vehicles. Additionally, highly trained technicians would be required to operate and maintain the system. Army representatives who tested this concept felt that the system was too bulky and required too much power for mobile operation. However, the major problem was that the system used frequencies that were already overcrowded by radio systems presently in the military inventory. The system was considered for future acceptance for military use if the contractor could eliminate the above deficiencies. This, however, would take years to accomplish. It now appears that the system has been discarded in favor of the more advanced RADA system.

The RADA system provides adaptive user-to-user random access, discrete address communications. RADA incorporates the inherent mobility advantages of radio with the signaling capabilities of an automatic telephone system and can handle transmissions of voice, facsimile, teletype, and data information. In addition, the system permits secure transmission, interface with switched-wire systems, conference calls, command override, and broadcast warning. The system combines the best features of the point-to-point and distributed communication categories. Signaling is accomplished by using a time-frequency-coded pulse sequence similar to that used in commercial telephone systems. This facilitates a random access to all users of this communication system. Discrete addressing is accomplished within the system by a frequency search technique. This technique allows the user's instrument to lock onto an interference-free channel for the duration of the call.

Three principal electronics firms were contracted to conduct a feasibility study of the RADA concept. In 1964 an advanced developmental contract was awarded to the Martin Company. The Martin Company proposal eliminates the use of field wire systems but allows interface of field wire in conjunction with RADA. Additionally, the Martin system reduces the number of personnel that are required for operation and maintenance of the system. The fact that the RADA system is fully automated and requires a minimum of maintenance has been one of the major attractions of the system. The proposed Martin system is not as vulnerable to enemy destruction as other proposed systems because no central synchronization is required. If a portion of the RADA system is destroyed, the system has the capability of automatically absorbing the workload of the destroyed facility until that facility can be replaced and normal user service renewed.



Figure 1. Basic subscriber unit (SU) used in RADA system.

The RADA system to be built and tested in the 1967-1975 time frame will have three major components. These components will be a subscriber unit (SU), a retransmission unit (RU), and an access unit (AU). The subscriber unit (fig 1) will be the user set in the RADA system and will be comparable to the home telephone. It will be adaptable for fixed, mobile, airborne, and manpack use. With ancillary units, it may be used for secure communications and for data, teletype, or facsimile transmission and reception. (Facsimile transmission and reception is simply the process by which a picture of an object, map, etc., is sent by electrical means to another location. This is basically the concept used by spacecraft to send pictures back to the earth.) As shown in figure 1, the SU is divided into two basic components which are a handset and a powerpack with a receiver/transmitter. The handset contains a microphone, an earphone, an address keyboard, and all operator controls and indicators. The powerpack houses the receiver/transmitter and a battery capable of operating the unit for 24 hours. A 3½-foot antenna is attached to the receiver/transmitter. The handset of the SU will be comparable in size to the handset of a commercial telephone and will weigh approximately 1.7 pounds. The overall SU will be a small, ruggedly constructed unit that will weigh less than 35 pounds. Present plans require that the SU be able to transmit directly to SU up to 10 kilometers away. For greater ranges, retransmission units will be required.

The retransmission unit will be used for extending the range of the subscriber unit. Additionally, the RU's will provide paths for communication around terrain obstacles that would render line-of-sight radio transmissions ineffective. The RU will operate on basically the same principle as the telephone central office to automatically route

calls; however, it will not be necessary for the SU to be in a stationary location. The RU will provide, through a time-frequency-coded, pulse-searching technique, automatic retransmission for an SU, providing the SU remains within range of one of the retransmission units, which will be located throughout the division area of operation. There will be a minimum of 10 RU's within a division area to facilitate all SU calls within a 160-kilometer radius. This minimum number will be adequate to facilitate reliable service to all subscribers within the division area. Additionally, RADA will facilitate unilateral communications with nondivisional units comparably equipped in the future.

The access unit of the RADA system will allow interfacing of trunk circuits from the smaller tactical unit switchboards to the SU's and RU's of the RADA system. The AU will allow anyone who has access to a field switchboard equipped with an AU and the directory of RADA numbers to place a call from present inventory equipment to any SU served by RADA.

The advent of global warfare and limited warfare has increased the requirement that commanders at all levels of command have a communication system that is fully automatic, simple to operate, extremely reliable and, above all, secure. RADA is the only proposed system that hopefully will satisfy all of these requirements in the near future.

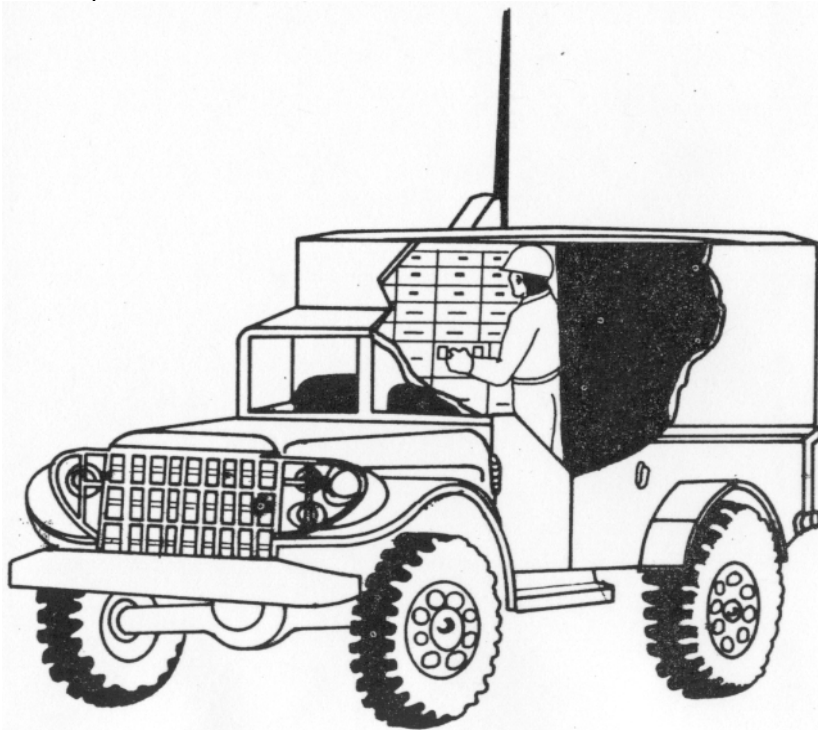

Figure 2. Truck mounted retransmission unit (RU) used in RADA system.

On

FADAC

Maintenance

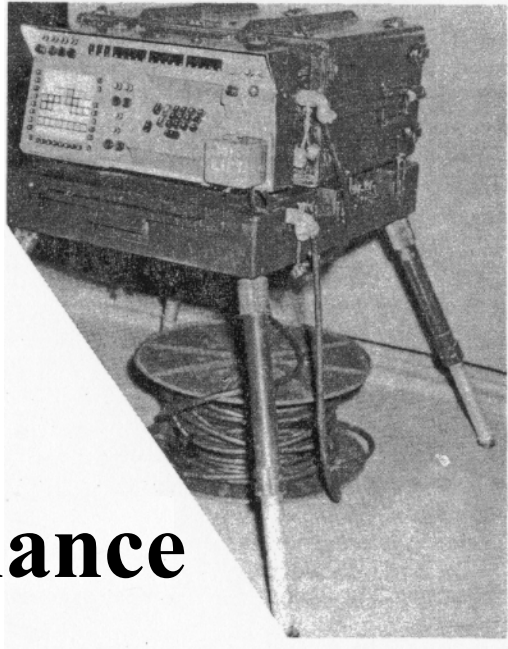

Figure 1. FADAC

*Lieutenant Albert R. Milavec
Communication/Electronics Department
USAAMS*

The ultimate objective of artillery is to place fire on a target with speed and accuracy. One method of obtaining timely, accurate fires is through the use of highly trained, well-drilled fire direction center (FDC) teams, coupled with simplified, approximate-method techniques for solving fire direction problems. However, the requirements for both speed and accuracy have increased proportionately with the changes in the character of modern warfare. To significantly improve accuracy, while retaining the speed provided by current FDC procedures, the field artillery digital automatic computer M18 (FADAC) has been developed. The FADAC, also known as the gun direction computer M18 (fig 1) is used in a variety of artillery applications but primarily is used in fire direction and survey.*

The FADAC is an all-transistorized, stored-program, general purpose digital computer designed primarily to compute firing data for a variety of artillery weapons. Weighing approximately 200 pounds, the computer is readily transportable in the field. The FADAC is issued with a field table, weighing approximately 40 pounds, which provides a level support for the computer. A standard 3-kilowatt Corps of Engineers generator

*Reference "FADAC Zeros In," Valerie Antoine, Army Information Digest, Jan 65.

supplies 120/208-volt, 3-phase, 4-wire, 400-cycle power to the computer and its associated equipment. The FADAC can operate between the temperatures of -40° F and $+125^{\circ}$ F. Voltage fluctuations of 16 percent above and below the rated voltage (100 volts to 140 volts) cause no loss of accuracy in the problem solution.

To compute firing data, the FADAC selects a charge and trial elevation. Then, using this trial elevation and applying all nonstandard conditions, it solves the equation which describes the path of the projectile. It then determines the location of the burst with respect to the target. If the miss distance is greater than 10 meters, it recomputes the data, using another trial elevation. If the miss distance is less than 10 meters, the FADAC displays the firing data.

In performing the computations to produce this firing data, the FADAC components utilize approximately 1,600 transistors, 9,000 diodes, 6,000 resistors, 500 capacitors, and many other switches, transformers, and neon lamps. In addition, there are some 12,000 wires and 15,000 soldered connections. This should give some idea of the maintenance considerations involved with the FADAC system.

In the past, a problem with most digital computers was that maintenance personnel required extensive training. The FADAC system, however, is based on the concept of module or component replacement at organizational level. The simplicity of this maintenance concept results in the maximum utilization of the FADAC with minimum downtime.

Artillery personnel are capable of performing such maintenance. The concept of module replacement by maintenance personnel at organizational level is a practical way of achieving maximum operating time from the FADAC and represents an impressive saving of training time and economy of personnel. In contrast to maintenance personnel trained from "scratch" in the traditional manner, the FADAC maintenance technician is a field radio mechanic who receives additional training as a computer mechanic. This radio and FADAC mechanic is identified by MOS 31B30.

The purpose of operator maintenance of the FADAC is primarily to prevent equipment breakdowns and the need for higher echelon repair services. The preventive maintenance consists of daily and weekly services as outlined in table I. The operator's training course for FADAC is a 1-week course conducted at the United States Army Artillery and Missile School (USAAMS), Fort Sill, Oklahoma. Publications required are three field manuals and one technical manual. No special tools or test equipment are required. Corrective maintenance by the removal and replacement of parts at the operator level is limited to the indicator lamps and air filters.

Determination of a computer malfunction is also an operator responsibility and is facilitated by utilization of proper computer checkout procedures and application of malfunction recognition principles. Several built-in maintenance aids are at the disposal of the operator to help him determine whether he has an operational computer.

Table I. Operator Daily and Weekly Preventive Maintenance Procedures.

Item	Procedure	Remarks
1.	Inspect exterior surfaces (before and after operation). Keep clean and dry.	Wipe exterior surfaces as necessary.
2.	Inspect for mechanical damage to the computer and table (weekly).	External visual examinations.
3.	Tighten loose hardware (weekly).	Use common hand tools.
4.	Inspect air filters (daily). Clean or replace if necessary.	Wash in warm, soapy water, rinse with clear water, and air dry.
5.	Clean windows of readout display and input display matrix.	Wipe with a soft, lint-free cloth.
6.	Insure that ventilation blowers operate when power is applied.	Listen for whine of blower motors.
7.	Check front panel controls for ease of operation, (no binding of pushbuttons, etc.).	Manually actuate push-button controls.
8.	Check illumination of indicator lamps. Replace if necessary.	To replace a lamp, remove the lens by unscrewing it in a counterclockwise direction. Install new indicator lamp and replace the lens.
9.	Perform program tests or sample problem computations in marginal test positions.	If a steady-state malfunction is generated by a marginal test, corrective maintenance by organizational personnel should be scheduled as soon as possible.
10.	Inspect all cable assemblies for wear, abrasions, kinks, or connector damage.	Replace if necessary.

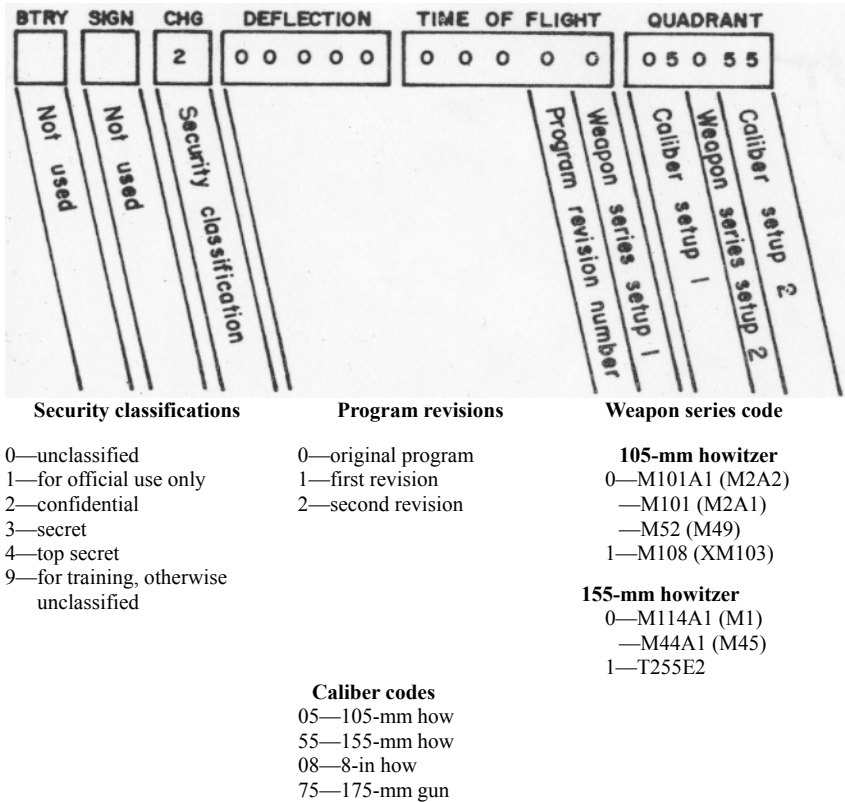

Figure 2. Program test 1 display for 105-mm, (towed) 155-mm (towed) weapons.

The first of these aids is the program tests. There are two such tests—the permanent storage program test and the temporary storage program test. The permanent storage program test, referred to as program test 1, is a check to determine whether the program is properly loaded in the permanent storage portion of the memory. In this test, all the numbers in the program are added together. The resultant sum is subtracted from a given prestored number in the memory, and the remainder is then displayed on the indicator display panel (fig 2). The temporary storage program test, or program test 2, is a check to insure that the proper information is stored in the temporary storage portion of the memory.

A second aid for the operator is the running of a precomputed sample problem the solution to which is known. Appropriate sample problems are given in the pertinent operation manual of the FM 6-3-1 series. In general, the steps in running a sample problem involve setting up the FADAC; associating the FADAC with a specific weapon system;

removing from the computer all previous battery corrections and target information; entry of all meteorological, battery, and target information; initial computations and solutions; entry of observer corrections; and computation of subsequent solutions and final solutions, as represented by fire-for-effect data. Once the operator has run a precomputed sample problem and has obtained the correct answer, he is assured that the computer is operational.

In addition to the built-in program tests and sample problems, the operator has available to him a marginal test circuit which permits him to perform a limited check of computer operation when intermittent malfunctioning is suspected or known.

The intermittent malfunction is perhaps the most difficult to locate and correct, since clear-cut indications of a malfunction are never present long enough to permit logical troubleshooting. The marginal test procedure is provided to allow variation of certain computer DC power supply voltages to marginal conditions. If a circuit function in the computer has degraded to the point where failure is imminent, the marginal test may be used to encourage the failure of the circuit, thus allowing replacement or servicing of the computer prior to sudden and unexpected breakdown. The use of a marginal test is preventive maintenance in the fullest sense of the word. The MARGINAL TEST control is located on the left side of the FADAC control panel assembly (fig 3). It consists of a six-position rotary switch. The six positions are one OFF position and five positions numbered 1 through 5.

The procedure used by the operator in performing a marginal test is as follows: First select a numbered position and attempt to run the program tests. If no malfunction is detected, then select another numbered position and repeat the tests. Continue testing until a malfunction is or is not indicated by successfully completing both tests and problems in all of the five numbered positions. The organizational maintenance technician must be called if a malfunction is found.

Table II. Authorized Parts for Replacement at the Organizational Level.

- a. Input display matrix (④, figure 4)
- b. Manual Keyboard (⑤, figure 4)
- c. Nixie indicator tubes (⑥, figure 4)
- d. Mechanical tape reader (⑦, figure 4)
- e. Circuit Board assemblies (figure 5, figure 6)
- f. Power control relays (figure 5)
- g. Matrix lamps and diodes (contained in ④, figure 4)
- h. Power terminal strip on the field table.

Organizational maintenance of the FADAC is corrective in nature and includes replacement of selected assemblies and parts and isolation of malfunctions by diagnostic troubleshooting. The assemblies and parts authorized for removal and replacement at organizational level are listed in table II and illustrated in figures 4, 5, and 6. Among those items authorized for organizational replacement is the keyboard assembly (fig 7). To replace the keyboard assembly, the organizational mechanic removes

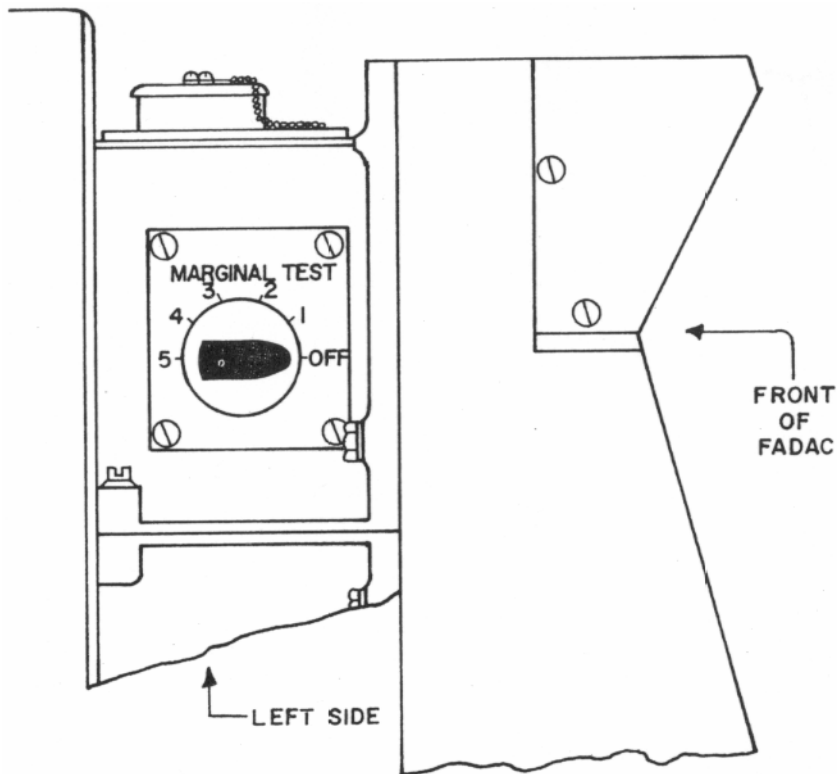

Figure 3. Location of the MARGINAL TEST control on the FADAC.

the screws which hold the keyboard in place, lifts the assembly out of the control panel assembly, disconnects a plug in the rear, inserts the replacement keyboard, and replaces and tightens the screws. Other components authorized for replacement at organizational level are replaced in a similar manner. No soldering is involved or authorized at this level. Training for the organizational maintenance technician consists of a 2-week course conducted at USAAMS, Fort Sill, Oklahoma. Five technical manuals are the required publications at this echelon, and a screwdriver, a wrench, and a board extractor are the only required tools.

Additional equipment used by the organizational maintenance technician in troubleshooting the FADAC are the diagnostic test tape kit (fig 8), the signal data reproducer AN/GSQ-64 (SDR) (fig 9), and the FADAC automatic logic tester AN/GSM-70 (FALT) (fig 10). The diagnostic test tape kit consists of a protective case, appropriate technical manuals, and a set of five prepunched, fan-folded paper tapes, lettered A through E, each of which is used in a malfunction troubleshooting role. Tape A is used

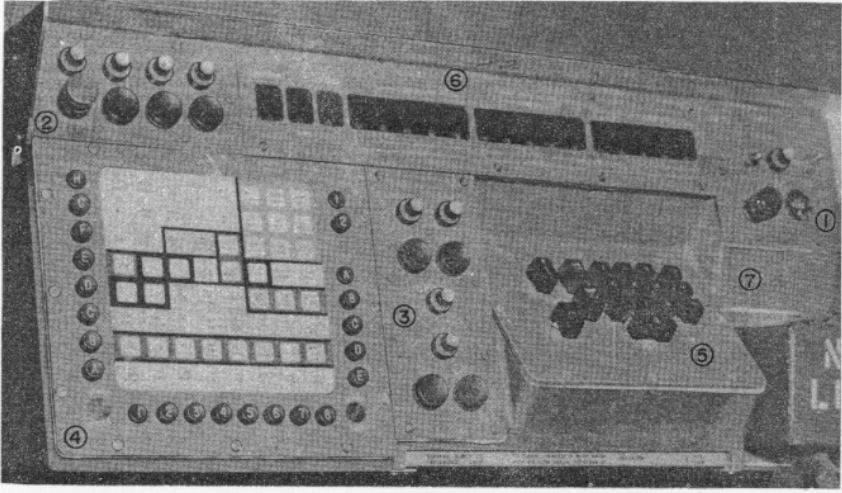

Figure 4. Control Panel Assembly

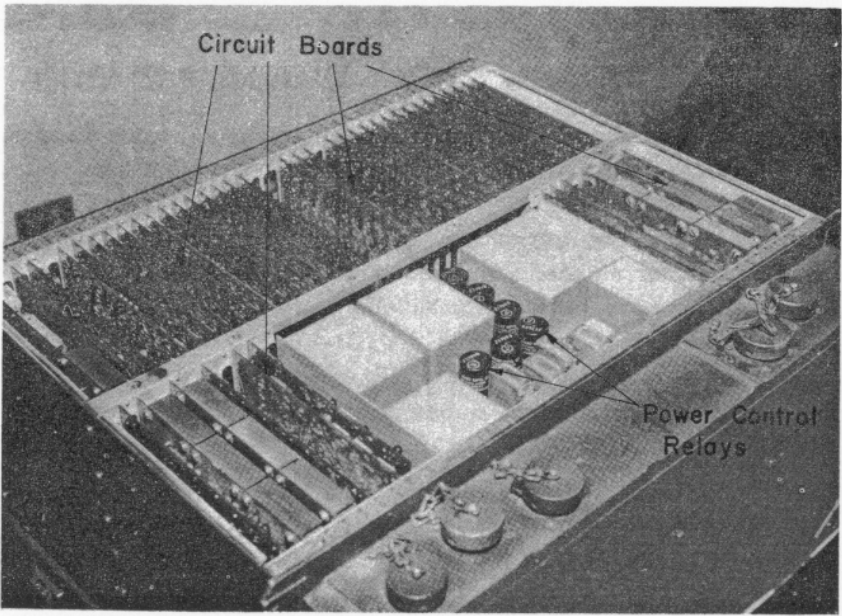

Figure 5. Computer Chassis Assembly

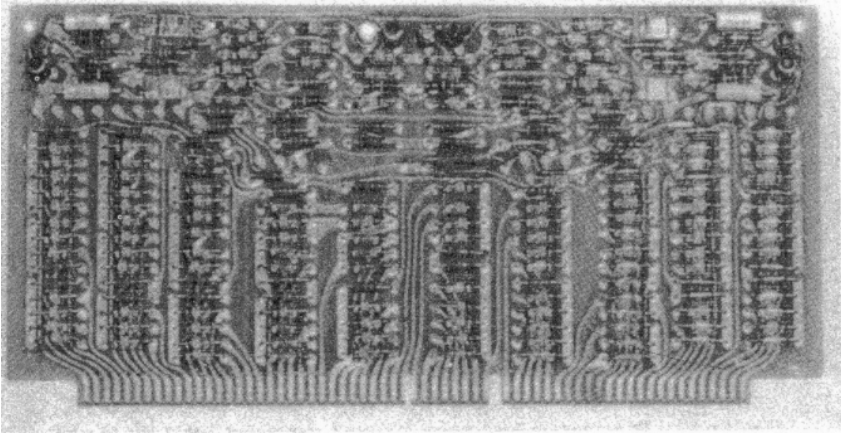

Figure 6. Modular circuit board

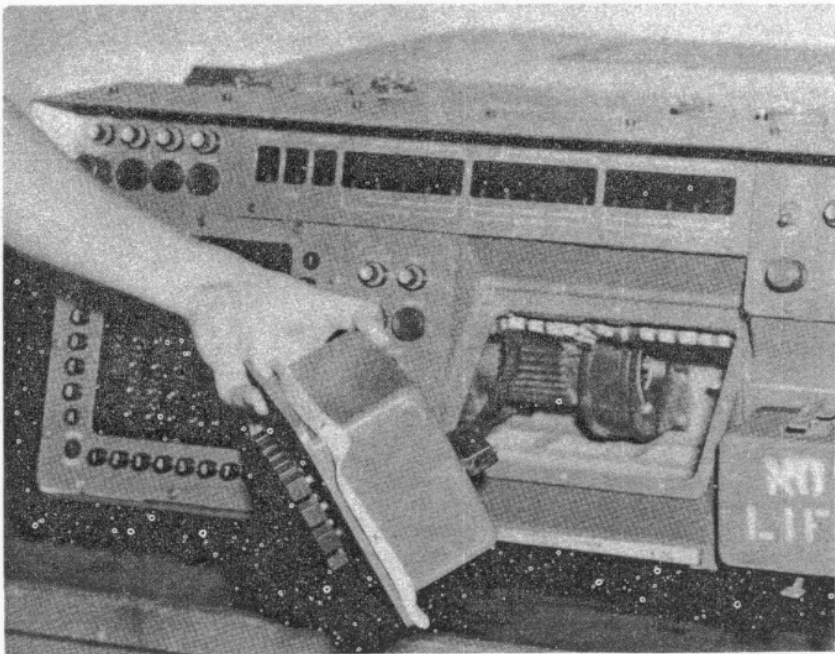

Figure 7. Replacement of manual keyboard

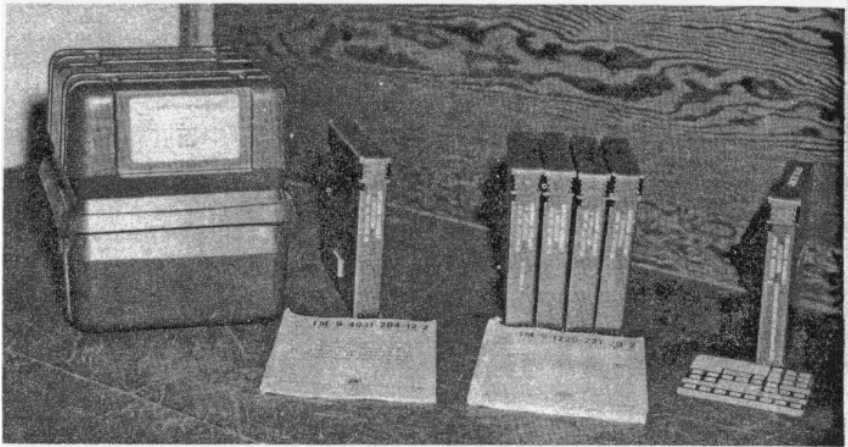

Figure 8. Diagnostic test tape kit and program tape kit (right)

as a confidence self-test of the test equipment. This self-test assures the maintenance technician that his test equipment is operating properly. Tapes B, C, D, and E, when run in association with the test equipment, provide a test of circuits within the FADAC. A sixth tape, shown in figure 8, is a program tape which, with its associated overlay, is used by the organizational maintenance technician to program the computer.

At one time the Signal Data Reproducer (SDR) was called the memory Loading Unit. The SDR is a portable, high-speed, photoelectric, punched-tape reader which translates input information from the punched holes in a moving tape into electrical pulse outputs at a speed

of approximately 700 characters per second. The SDR weighs approximately 89 pounds. When the SDR is running, the punched paper tape feeds between a light source and a bank of light-sensing photodiodes. Light passing through

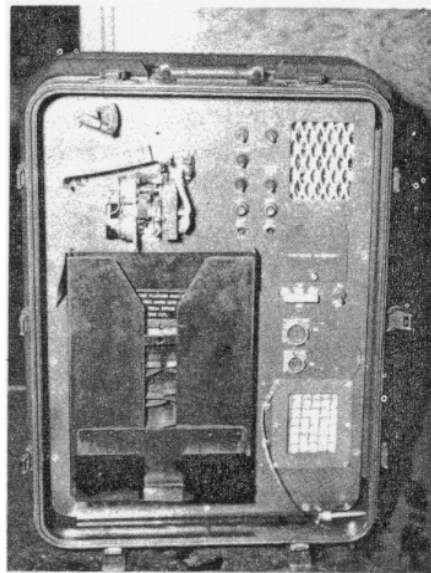

Figure 9. Signal data reproducer AN/GSQ-64 (SDR)

the punched holes causes the photodiodes to conduct so that current pulses are formed. These pulses are then amplified in the SDR and sent to the unit to which the SDR is cabled. The SDR has two uses in the FADAC system—to load prepunched programs into the FADAC memory and, in conjunction with the FALT, to effect corrective maintenance for the FADAC.

The FADAC automatic logic tester, contained in a watertight case, is field transportable, semiautomatic, and weighs approximately 185 pounds. The FALT receives the electrical pulses from the SDR. These pulses are interpreted as instructions which cause certain conditions to be established at the inputs of the logic circuits in the FADAC.

Isolation of the majority of FADAC malfunctions at the organizational level is semiautomatic through the use of the diagnostic test tapes. The FALT, driven by test tapes read by the SDR, is used in the isolation of FADAC malfunctions. Isolation techniques (diagnostic troubleshooting) identify malfunctions in both the plug-in type of etched circuit boards (fig 5) and the subassemblies of the control panel assembly (fig 4). Parts replacement to correct such malfunctions is limited to the replacement of those assemblies and parts listed in table II.

The FALT is also used to monitor FADAC power supply output voltages. Elements of the FADAC which are not checked by the diagnostic tapes are the power supplies and power circuits, the air blowers, and the cable assemblies.

The cabling arrangement for the FALT, SDR, field table, and FADAC, in preparation for diagnostic troubleshooting procedures, is shown in figure 11. In a field situation, a cable connection data can be verified by referring to the decal mounted on the top surface of the light hood above the control panel of the FALT. As another aid in cabling, the connectors are keyed so that they will fit in only one socket on the FADAC or FALT. Setup of the separate units for troubleshooting should include a check to insure that no power is applied to any unit until the controls of all the units have been audited for correct position. After the maintenance technician makes sure that all of the controls are in their proper positions, the equipment may be turned on. The FADAC is **always** the last unit to be turned on and the first to be turned off.

This is to prevent sending any stray pulses to the memory of the FADAC. Power for the FADAC, FALT, and SDR is obtained from the power terminal strip of the FADAC field table and is supplied by a 3-kilowatt generator.

Table III. Extracted Portion of Operator's Instructions for Test Tape E.

2	2	3
CH		
1.	RELEASE THE *RECALL* BUTTON.	
2.	PUSH AND HOLD THE *RESET* BUTTON UNTIL THE NEXT CH STOP.	
3.	START THE TAPE READER.	
2	2	4
CH		

1. RELEASE THE *RESET* BUTTON.
2. THIS TEST CHECKS THE OFF POSITION OF THE SETUP AND RESET BUTTONS.
3. START THE TAPE READER.

2 2 5

CH

PLACE THE *MARGINAL TEST* SWITCH IN ANY ONE OF THE ON POSITIONS.

THE *POWER READY* LAMP SHALL BE BLINKING.

PLACE THE *MARGINAL TEST* SWITCH IN THE OFF POSITION.

THE *POWER READY* LAMP SHALL BE LIGHTED AND SHALL NOT BE BLINKING.

START THE TAPE READER.

2 2 6

CH

THE *IN OUT* LAMP SHALL BE LIGHTED.

THE *COMPUTE* AND *KEYBOARD* LAMPS SHALL NOT BE LIGHTED.

THE *PARITY*, *ERROR*, and *NO SOLUTION* LAMPS SHALL BE LIGHTED AND NOT BLINKING.

START THE TAPE READER.

- NOTE:
- a. Digits, such as 2 2 3, etc., refer to the marker portion of marker-index numbers. The display which accompanies 22 3 is 223-000.
 - b. The designation CH means COMMAND HALT and indicates that the halt originates on the test tape.

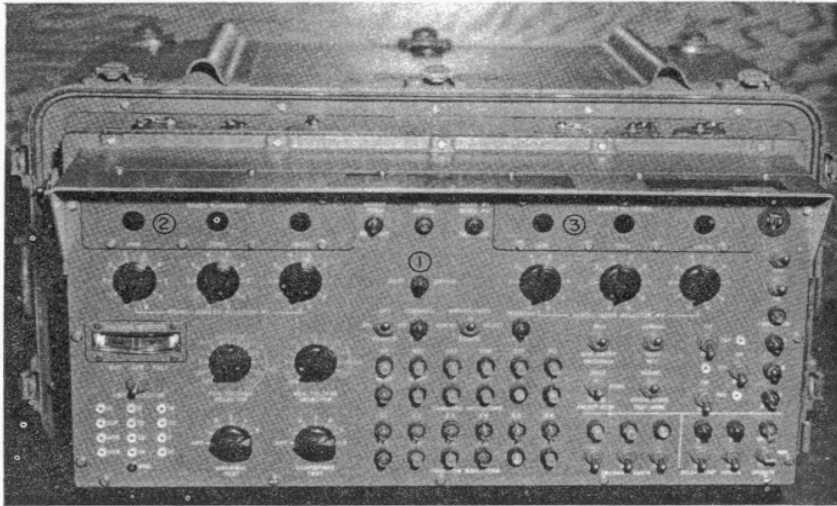

Figure 10. FADAC Automatic Logic Tester AN/GSM-70 (FALT)

With the B test tape loaded in the SDR, the maintenance technician starts testing the FADAC. The tape containing the coded test commands is fed through the readhead assembly of the SDR. The photodiodes sense the presence of holes in the tape and generate a current pulse. This pulse is then amplified and sent to the FALT. The FALT interprets the test command and sets up the logic circuits within the FADAC for the test. If the output of the logic circuit being tested is correct, the testing of the FADAC continues. If the output of the logic circuit is incorrect, the FALT sends a pulse to the SDR which stops the tape. The FALT indicates that an error has been found by flashing the TEST ERROR indicator lamp (①, fig 10) along with a display of the appropriate marker-index number (② and ③, fig 10). If the tape stops at a program halt, with a marker-index number displayed, the maintenance technician refers to the corresponding marker-index number in the test tape listing for instructions. An example of such instructions (as extracted from TM 9-1220-221-20/2, Organizational Maintenance Manual: Computer, Gun Direction, M18 (Composite Test Tape Program Print out)) is shown in table III. If the tape stops at a test error halt, as indicated by the flashing of the TEST ERROR lamp, the maintenance technician again refers to the corresponding marker-index number in the test tape listing for the circuit board(s) or other component(s) that should be replaced. Thus, it may be seen in table IV that an error halt at marker 312 - index 092 (or at any index

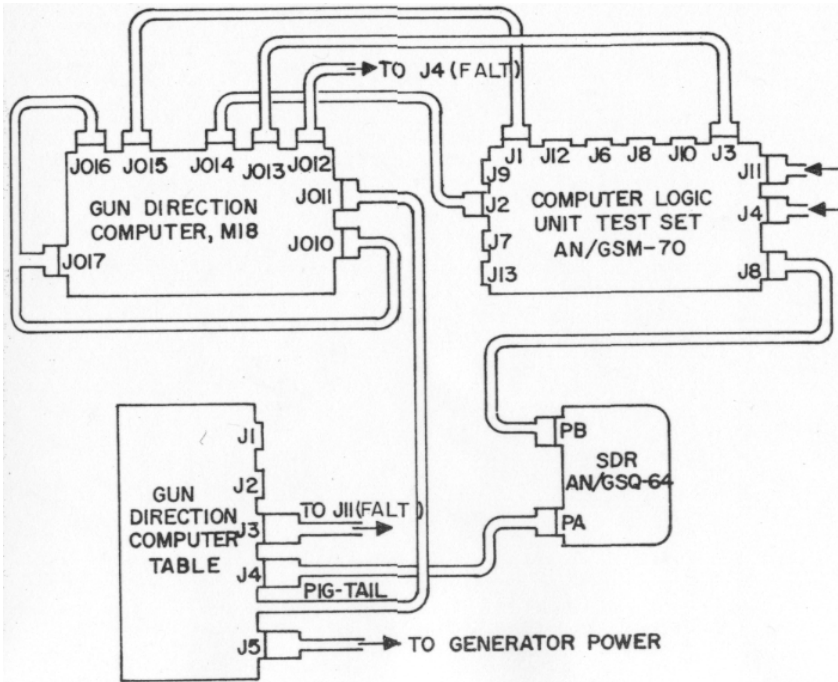

Figure 11. Cable connection diagram for FADAC troubleshooting.

number from 092 to 110) indicates that board 314 contains a malfunction. The board number refers to a location in the computer as designated by the position numbers on the frame of the computer. Once the mechanic has located the malfunctioning component, he shuts down the equipment and replaces the circuit board in location 314. He then backs up the test tape and reruns the error-producing portion of the tape. In the normal FADAC troubleshooting, all four test tapes (B, C, D, and E) are run, in sequence, beginning with the B tape. When all tapes have been run successfully, with no test error halts, the troubleshooting is complete. A defective board(s) or component(s) is forwarded through supply channels to depot maintenance facilities where the defect is repaired and the component returned to supply. New parts are obtained from supply to replace defective parts that have been sent in for repair. If a malfunction is determined to be in a component that is not authorized for replacement at the organizational level, correction of the malfunction must be accomplished by support or depot maintenance personnel.

FADAC has been designed for ruggedness and ease of maintenance. With only a moderate amount of training, personnel organic to artillery units may perform troubleshooting on the computer in order to locate and replace defective components. With this capability, artillerymen can be confident that fires will be on target when called for.

Table IV. Extracted Portion of Marker, Index, Board, and Associated Equipment Listing for Test Tape E.

Marker	Index		Board/s	
312	048-092	313	407	402
312	092-110	314		
313	001-008	303	304	402
313	009-037	304	305	
314	040-067	311	312	
315	001-006	303	304	408
316	100-160	314		
317	001-012	401	402	314
318	ALL	402		
319	001-021	408	409	

●

M109's PURCHASED

In January 1968, Swiss Government representatives signed an order with the United States Department of Defense for a purchase of selected U. S. Army equipment. Under this order, Switzerland will purchase a quantity of M109(155-mm) Howitzers (self-propelled), M113A1 Armored Personnel Carriers and fitter (maintenance) vehicles. The total value of the order approximates \$37 million. This purchase is subject to final approval of the Swiss Parliament.

F A D A C

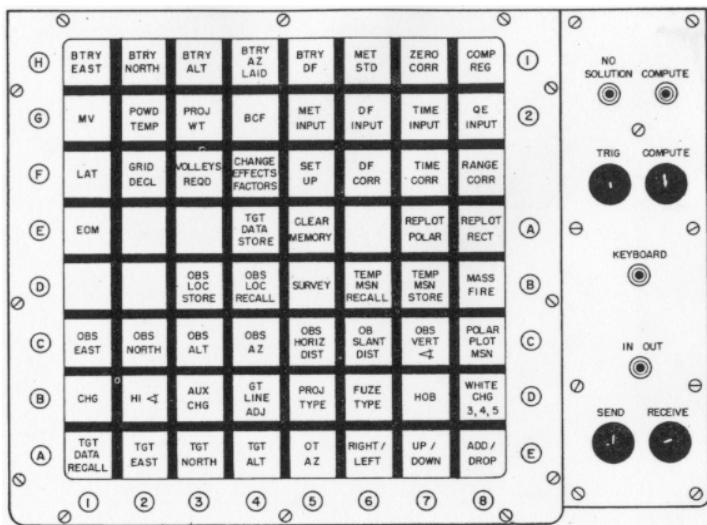

Figure 1. Matrix display of FADAC
Major Robert E. Gilbert
Gunnery Department
USAAMS

FADAC is fast becoming the primary means of computing firing data in Southeast Asia. However, present instructional material on FADAC is incomplete because of the introduction of new projectiles and the M564 series of fuzes and the unique tactical situations which sometimes develop in Southeast Asia. The purpose of this article is to describe, in the form of fire missions, the employment of FADAC in the —

- Determination of muzzle velocity, and use of the M564 series of fuzes.
- Use of a flash base for countermortar/rocket fire.
- Use of surveillance radar as an observer.
- Use of the AN/MPQ-4A radar as an observer for a high-burst registration.
- Conduct of an illumination mission, using illumination projectile M485.

Because of the illumination mission (mission 5), the 155-mm howitzer M114A1 and program 0 00000 00010 05055 were selected to demonstrate the use of FADAC in conducting the five missions described in this article. The techniques used for the other missions are applicable to all weapons, and the missions may be solved using the following M114A1 programs:

0 00000 00010 05055	0 00000 00001 55055
0 00000 00001 05055	0 00000 00010 08055
0 00000 00000 75055	9 00000 00000 05055

The normal fire unit in Southeast Asia is the battery or platoon. To accommodate either unit, we suggest the following setup procedure:

- Associate each platoon with a battery button: A = right platoon; B = center platoon; C = left platoon.
- If the position is organized so that one location is sufficient for battery fires, associate the D battery button with the battery coordinates.
- Associate the base piece with the E battery button for registrations.
- With pieces of masking tape, cover the battery button designations and relabel them appropriately.

SETUP DATA

Critical point	Coordinates	Altitude	Direction of Fire	Deflection
Right Platoon	43417-34300	550	200	2400
Center platoon	43321-34330	545	200	2400
Left Platoon	43242-34295	548	200	2400
Btry center	43327-34308	548	200	2400
Base piece	43350-34300	546	200	2400
Flash OP 1	48216-36142	650		
Flash OP 2	42861-36814	803		
Radar AN/MPQ-4A	41521-32987	515		
Radar AN/TPS-25A	46187-34710	787		
Reg pt 1	45017-40514	515		

Latitude: 17° N; grid declination: +10.

Powder temperature: +85° (all firing point locations).

Muzzle velocity: (chg 5, lot XY): 368.5 meters per second (m/s) (all firing point locations).

Enter flash base and radars in observer locations 1 through 4.

Enter registration point 1 as target 1. Enter the current met message.

INTRODUCTION

IDENTIFICATION	OCTANT	LOCATION	DATE-TIME	STATION HEIGHT (10's M)	MDP PRESSURE (% of STD)
METCM	1	165071	261620	056	974

BODY

LINE NUMBER	WIND DIRECTION (10's mils)	WIND SPEED (knots)	TEMPERATURE (1/10°K)	DENSITY (GM's/M ³)
00	010	011	2693	1277
01	048	019	2679	1266
02	032	014	2673	1243
03	056	037	2617	1195
04	014	015	2672	1093
05	540	014	2718	1016
06	512	022	2707	0953
07	516	033	2672	0903
08	504	060	2672	0846
09	492	070	2657	0802
10	491	065	2616	0763

Mission 1

Registration: Use of the M564 fuze. Use of FADAC to determine muzzle velocity.

The data entered into the FADAC at this time meet the requirements for accurate unobserved fires, using shell HE and the propellant charges for which the muzzle velocities have been entered. The battalion has received a large quantity of a new propellant lot, and the fire direction officer (FDO) desires an accurate muzzle velocity for this propellant. No chronograph is available, therefore, the FDO orders a registration on a surveyed registration point.

Call for fire

REGISTRATION POINT 1
DIRECTION 6310
REGISTRATION
ADJUST FIRE

Fire order

BASE PIECE
LOT XZ, CHARGE 5
REGISTRATION POINT 1

Solution:

- (1) Depress the base piece button E.
 - (2) Depress matrix buttons A-1 (TGT DATA RECALL).
 - (3) Depress the SM key.
 - (4) On the keyboard, type 1; then depress the ENTER key. The coordinates of target 1 (reg pt 1) will be displayed.
 - (5) Depress matrix buttons B-1 (CHG).
 - (6) Depress the SM key.
 - (7) On the keyboard, type 5; then depress the ENTER key. The FADAC will compute data for charge 5 as a result of this action.
 - (8) Depress the COMPUTE button. The following solution will be displayed: E, chg 5, df 2340, TOF 23.5, QE 361.
 - (9) Depress matrix buttons E-7 (REPLOTT POLAR).
 - (10) Depress the SM key. The error light will blink and the following solution will be displayed: E, az 267, rg 6434, VA -5. These data should compare with the chart data used to orient the weapons when the battery has a 6,400-mil firing requirement. After announcing the orienting data to the computer/recorder, the computer operator continues.
 - (11) Depress matrix buttons A-5 (OT AZ),
 - (12) Depress the SM key.
 - (13) On the keyboard, type 6310; then depress the ENTER key.
- The observer's direction to the registration point is now associated with the mission. The observer's correction is LEFT 80.
- (14) Depress matrix buttons A-6 (RIGHT/LEFT).
 - (15) Depress the SM key.
 - (16) On the keyboard, type LEFT 80; then depress the ENTER key.
 - (17) Depress the TRIG button, and the following solution will be displayed: E, chg 5, df 2352, TOF 23.3, QE 359. The observer's next correction is RIGHT 10, ADD 200.
 - (18) Depress the SM key.
 - (19) On the key board, type RIGHT 10; then depress the ENTER key.

- (20) Depress matrix buttons A-8 (ADD/DROP).
- (21) Depress the SM key.
- (22) On the keyboard, type ADD 200; then depress the ENTER key.
- (23) Depress the TRIG button, and the following solution will be displayed: E, chg 5, df 2361, TOF 24.3, QE 376. The observer's next correction is DROP 100.
- (24) Depress the SM key.
- (25) On the keyboard, type DROP 100; then depress the ENTER key.
- (26) Depress the TRIG button, and the following solution will be displayed: E, chg 5, df 2356, TOF 23.8, QE 367. The observer's next correction is DROP 50.
- (27) Depress the SM key.
- (28) On the keyboard, type DROP 50; then depress the ENTER key.
- (29) Depress the TRIG button, and the following solution will be displayed: E, chg 5, df 2353, TOF 23.6, QE 363. The observer's next correction, using the new registration procedure, is ADD 25.
- (30) Depress the SM key.
- (31) On the keyboard, type ADD 25; then depress the ENTER key.
- (32) Depress the TRIG button, and the following solution will be displayed: E, chg 5, df 2354, TOF 23.7, QE 365. The observer's next correction is RIGHT 10, DROP 25.
- (33) Depress matrix buttons A-6 (RIGHT/LEFT).
- (34) Depress the SM key.
- (35) On keyboard, type RIGHT 10; then depress the ENTER key.
- (36) Depress matrix buttons A-8 (ADD/DROP).
- (37) Depress the SM key.
- (38) On the keyboard, type DROP 25; then depress the ENTER key.
- (39) Depress the TRIG button, and the following solution will be displayed: E, chg 5, df 2352, TOF 23.6, QE 363. The observer's next correction is RECORD AS REGISTRATION POINT 1 AT ADD 10; TIME.
- (40) Depress the SM key.
- (41) On the keyboard, type ADD 10; then depress the ENTER key.
- (42) Depress the TRIG button, and the following solution will be displayed: E, chg 5, df 2352, TOF 23.7, QE 364. These data are recorded for use in computing registration corrections after determining the adjusted time.
- (43) The new registration procedure requires a 20-meter height of burst; therefore, depress matrix buttons A-7 (UP/DOWN).
- (44) Depress the SM key.
- (45) On the keyboard, type UP 20; then depress the ENTER key.
- (46) Depress the TRIG button, and the following solution will be displayed: E, chg 5, df 2352, TOF 23.7, QE 368.

Since the FADAC is programmed for the M520 time fuze and the mission will be fired with the new M564 fuze, a special procedure is required. The fuze setting for the M564 fuze approximates the time of flight therefore, fuze flag 1 (FUZE PD) is used, and FADAC displays the time of flight. A tabular firing table dated June 1967 or later or Ammunition

Information Letter Number 1, published by USAAMS on 11 October 1966, is used to determine a correction, which is applied to the displayed time of flight. Firing tables dated before June 1967 have errors in the "corrections to time of flight to obtain fuze setting" tables and should not be used. The information letter was distributed to all cannon units. In this problem, a correction of -0.2 second is applied and the announced fuze setting for the initial round is TIME 23.5. This procedure should be used for all missions fired with the M564 fuze when registration corrections are not known.

The adjusted time must be computed manually. For this problem, assume an adjusted time of 23.2. The true total fuze correction for the M564 fuze is -0.3 second.

(47) To compute registration corrections, depress matrix buttons A-1 (TGT DATA RECALL).

(48) Depress the SM key.

(49) On the keyboard, type 1; then depress the ENTER key. The coordinates of target 1 (rg pt 1) will be displayed.

(50) Depress matrix buttons B-6 (FUZE TYPE).

(51) Depress the SM key.

(52) On the keyboard, type 2; then depress the ENTER key. This will associate fuze time with the mission.

(53) Depress matrix buttons G-6 (DF INPUT).

(54) Depress the SM key.

(55) On the keyboard, type 2352 (the adjusted deflection); then depress the ENTER key.

(56) Depress matrix buttons G-7 (TIME INPUT).

(57) Depress the SM key.

(58) On the keyboard, type 23.2 (the adjusted time for fuze M564); then depress the ENTER key.

(59) Depress matrix buttons G-8 (QE INPUT).

(60) Depress the SM key.

(61) On the keyboard, type 364 (the adjusted QE for a zero height of burst); then depress the ENTER key.

(62) Depress matrix buttons H-8 (COMP REG).

(63) Depress the SM key. The following solution will be displayed: df corr LEFT 12.1, fz corr -1.0, rg K +5.

Since accurate meteorological, survey, and ammunition data were entered into FADAC prior to the registration, the range error can be applied to the muzzle velocity for the new propellant lot. The range to the registration point as originally computed (see steps 9 and 10) was 6,434 meters. The computed range K is +5 meters. A total range correction of 32 meters is computed by multiplying the range K by the registration point range in thousands of meters to the nearest 100 meters. The total range correction of 32 meters is divided by the unit correction for a decrease in muzzle velocity of +5.2 meters (from TFT 155-Q-3), and a decrease in muzzle velocity of 6 feet per second is determined. The decrease in feet per second must be converted to a decrease in meters per second for FADAC. The decrease in muzzle velocity of 6 feet per

second is approximately a decrease of 2 meters per second. The muzzle velocity used in FADAC for the registration was 368.5 meters per second. The trial muzzle velocity, therefore, is 366.5 meters per second.

- (64) On the keyboard, type a period to end the mode.
- (65) Depress matrix buttons G-1 (MV).
- (66) Depress the SM key.
- (67) On the keyboard, type 15; then depress the ENTER key.
- (68) On the keyboard, type 366.5; then depress the ENTER key.
- (69) Reenter the adjusted data and recompute registration corrections (steps 55 through 65). The following solution will be displayed: df corr LEFT 12.0, fz corr -1.0, rg K +0.

This procedure should be continued until the range K becomes zero. In this problem, the muzzle velocity is determined to be 366.5 meters per second. Associate this muzzle velocity with all firing point locations. The fuze correction is based on the M520 fuze; however, this correction will be valid for the M564 fuze until the quadrant elevation approaches 400 mils. Around that point, the relationship between the M520 time increments and the M564 time increments begins to break down. For quadrant elevations under 400 mils, the fuze correction determined by FADAC can be accepted and the displayed fuze setting used without further corrections. When the quadrant elevation exceeds 400 mils, the original procedure used to determine a fuze setting for the M564 for the registration must be followed. In addition, the total M564 fuze correction of -0.3 second, as determined from the registration, must be applied.

(70) Before ending the compute registration mode, associate the data with all of the firing point buttons, either for all charges or for charge 5 only. (Unit SOP).

(71) To prepare GFT settings for the manual backup, depress the battery center button (D).

(72) Depress matrix buttons A-1 (TGT DATA RECALL).

(73) Depress the SM key.

(74) On the keyboard, type 1; then depress the ENTER key. The coordinates of target 1 (rg pt 1) will be displayed.

(75) Depress matrix buttons B-1 (CHG).

(76) Depress the SM key.

(77) On the keyboard, type 5; then depress the ENTER key.

(78) Depress matrix buttons B-6 (FUZE TYPE).

(79) Depress the SM key.

(80) On the keyboard, type 2; then depress the ENTER key.

(81) Depress matrix buttons A-7 (UP/DOWN).

(82) Depress the SM key.

(83) On the keyboard, type DOWN 20; then depress the ENTER key.

This step is necessary to compensate for the UP 20 that FADAC will automatically apply when the fuze time override is used.

(84) Depress the COMPUTE button, and the following solution will be displayed: D, chg 5, df 2348, ti 23.2, QE 364.

Assume chart data of range 6440, deflection 2340.

The deflection correction is LEFT 8.

The vertical interval between the battery and the registration point is -35 meters. Using a GST, determine the site to be -6 mils.

The computed GFT setting is: GFT A: Chg 5, lot XZ, rg 6440, el 370, ti 23.2.

(85) Depress matrix buttons E-1 (EOM).

(86) Depress the SM key.

(87) On the keyboard, type O.

If slant scale GFT's are available, firing data to additional points near the minimum and maximum range for the charge should be computed and used in constructing the GFT setting. For a 6,400-mil manual capability, wind cards with the NATO met message can be used or additional GFT settings can be computed to targets or checkpoints for each 800 mils of the circle; i.e., if a checkpoint at grid intersection 40-29, altitude 635, were used and the DOWN 20 for a zero height of burst applied, FADAC would compute the following data: D, chg 5, df 2050, ti 21.3, QE 346.

Assume chart data of range 6270, deflection 2041.

The deflection correction is LEFT 9.

The vertical interval between the battery and the checkpoint is +87 meters. Using a GST, determine the site to be +16 mils.

The computed GFT setting is: GFT A: Chg 5, lot XZ, rg 6270, el 330, ti 21.3.

Mission 2

Use of a flash base for countermortar/rocket fire.

Directions and one vertical angle from a flash base to the sound or flash of mortars and rockets can be entered into the FADAC and a quick target area survey problem computed. With good communications and a little training, a battery can have accurate counterfire on the way in less than 2 minutes.

Two observation posts have observed the flashes from some rocket fire. They report the following data:

	Direction	Vertical angle
01	5520	-1
02	140	-45 (Do not enter)

(1) Depress the battery center button (D). This button should normally be depressed between missions unless it is known that battery fire will not be used on the next mission.

(2) Depress matrix buttons D-4 (OBS LOC RECALL).

(3) Depress the SM key.

(4) On the keyboard, type 1; then depress the ENTER key. The coordinates and altitude of 01 will be displayed.

(5) Depress matrix buttons C-4 (OBS AZ).

(6) Depress the SM key.

(7) On the keyboard, type 5520; then depress the ENTER key.

(8) Depress matrix buttons C-7 (OBS VERT ANGLE).

(9) Depress the SM key.

(10) On the keyboard, type -1; then depress the ENTER key.

(11) Depress matrix buttons D-4 (OBS LOC RECALL).

- (12) Depress the SM key.
- (13) On the keyboard, type 2; then depress the ENTER key. The coordinates and altitude of 02 will be displayed.
- (14) Depress matrix buttons C-4 (OBS AZ).
- (15) Depress the SM key.
- (16) On the keyboard, type 140; then depress the ENTER key.
- (17) Depress matrix buttons D-5 (SURVEY).
- (18) Depress the SM key.
- (19) On the keyboard, type 2; then depress the ENTER key. The coordinates and altitude of the target will be computed and displayed.

Coordinates	Altitude
43344-40303	647

The FDO issues the following fire order:

BATTERY, USE REGISTRATION POINT 1, FUZE TIME, 2 ROUNDS, TARGET AF7001.

The computer operator takes the following action:

- (20) Depress matrix buttons B-1 (CHG).
- (21) Depress the SM key.
- (22) On the keyboard, type 5; then depress the ENTER key.
- (23) Depress matrix buttons E-6 (FUZE TYPE).
- (24) Depress the SM key.
- (25) On the keyboard, type 2; then depress the ENTER key.
- (26) Depress the COMPUTE button, and the following solution will be displayed: D, chg 5, df 2614, ti 21.1, QE 355.
- (27) Depress matrix buttons E-7 (REPLOTT POLAR).
- (28) Depress the SM key. The error light will blink, and the following solution will be displayed: D, az 3, rg 5998, VA+16. These data should compare with the chart data used to orient the weapons when the battery has a 6,400-mil firing requirement.

Mission 3

Use of a surveillance radar as an observer.

The FDC receives the following mission from a surveillance radar, the location of which is stored as observer 4 in the FADAC:

AZIMUTH 5410
 RANGE 10520
 VERTICAL ANGLE -20
 PERSONNEL AND OX CART

While the VCO is plotting the target for the FDO, the computer operator determines the target location with FADAC, with the battery center button (D) depressed. Initially, the target will be associated with only this button.

- (1) Depress matrix buttons D-4 (OBS LOC RECALL).
- (2) Depress the SM key.
- (3) On the keyboard, type 4; then depress the ENTER key. The coordinates and altitude of the radar will be displayed.
- (4) Depress matrix buttons C-4 (OBS AZ).
- (5) Depress the SM key.
- (6) On the keyboard, type 5410; then depress the ENTER key.

- (7) Depress matrix buttons C-6 (OBS SLANT DIST).
- (8) Depress the SM key.
- (9) On the keyboard, type 10520; then depress the ENTER key.
- (10) Depress matrix buttons C-7 (OBS VERT ANGLE).
- (11) Depress the SM key.
- (12) On the keyboard, type -20; then depress the ENTER key.
- (13) Depress matrix buttons C-8 (POLAR PLOT MSN).
- (14) Depress the SM key. The FADAC will compute and display the following target location:

Coordinates	Altitude
37499-40639	589

The radar crew has the capability of computing coordinates of the target; however, altitude must still be determined from a map. FADAC can compute coordinates more accurately than an operator can scale them from a map. The FDO examines the target location and issues the following fire order:

LEFT PLATOON, USE REGISTRATION POINT 1, 2 ROUNDS, TARGET AF7002.

The computer operator takes the following actions:

- (15) Depress matrix buttons D-8 (MASS FIRES).
- (16) Depress the SM key.
- (17) On the keyboard, type 3; then depress the ENTER key. This will associate the left platoon button (C) with the target location computed by the FADAC.

- (18) Depress the left platoon button (C).
- (19) Depress matrix buttons B-1 (CHG).
- (20) Depress the SM key.
- (21) On the keyboard, type 5; then depress the ENTER key.
- (22) Depress the COMPUTE button, and the following solution will be displayed: C, chg 5, df 170, TOF 36.0, QE 600.

- (23) Depress matrix buttons E-7 (REPLOT POLAR).
- (24) Depress the SM key. The error light will blink, and the following solution will be displayed: C, az 5651, rg 8561, VA +4.

These data should compare with the chart data used to orient the weapons when the battery has a 6,400-mil firing requirement.

- (25) Depress matrix buttons E-1 (EOM).
- (26) Depress the SM key.
- (27) On the keyboard, type O.
- (28) Depress the battery center button (D).
- (29) Depress the SM key.
- (30) On the keyboard, type O.

Mission 4

Use of the AN/MPQ-4A radar as an observer in a High-burst registration.

For this mission, assume that the met message entered into FADAC is still current. The FDO decides to fire a high-burst registration, charge 5, on grid intersection 40-29, altitude 685. The radar location is stored in FADAC as observer 3.

- (1) Depress the base piece button (E).

- (2) Depress matrix buttons A-2 (TGT EAST).
- (3) Depress the SM key.
- (4) On the key board, type 40000; then depress the ENTER key.
- (5) Depress matrix buttons A-3 (TGT NORTH).
- (6) Depress the SM key.
- (7) On the keyboard, type 29000; then depress the ENTER key.
- (8) Depress matrix buttons A-4 (TGT ALT).
- (9) Depress the SM key.
- (10) On the keyboard, type 685; then depress the ENTER key.
- (11) Depress matrix buttons D-4 (OBS LOC RECALL).
- (12) Depress the SM key.
- (13) On the keyboard, type 3; then depress the ENTER key.
- (14) Depress matrix buttons D-5 (SURVEY).
- (15) Depress the SM key.
- (16) On the keyboard, type 3; then depress the ENTER key. The following solution will be displayed: Observer 3, az 3571, rg 4267, VA +40.

This data is used to orient the radar. (Terminate the survey mode with a period.)

- (17) Depress matrix buttons B-1 (CHG).
- (18) Depress the SM key.
- (19) On the keyboard, type 5; then depress the ENTER key.
- (20) Depress matrix buttons B-6 (FUZE TYPE).
- (21) Depress the SM key.
- (22) On the keyboard, type 2; then depress the ENTER key.
- (23) Depress matrix buttons A-7 (UP/DOWN).
- (24) Depress the SM key.
- (25) On the keyboard, type DOWN 20; then depress the ENTER key.

Steps 17 through 25 are necessary because the registration corrections from the first registration are used to compute the firing data. If no corrections were known and fuze M564 were to be used, these steps would be omitted and the fuze setting would be determined as in mission 1. The radar must be oriented prior to determining firing data due to the DOWN 20 applied to the target location.

(26) Depress the COMPUTE button, and the following solution will be displayed: E, chg 5, df 2046, ti 21.4, QE 356.

(27) Depress matrix buttons E-7 (REPLOT POLAR).

(28) Depress the SM key. The error light will blink, and the following solution will be displayed: E, az 3774, rg 6273, VA +19.

These data should compare with the chart data used to orient the weapons when the battery has a 6,400-mil firing requirement.

The radar should report polar data. The FDO selects six usable rounds, and the computer/recorder determines an average direction, distance, and vertical angle. For this problem, the average data is as follows:

AZIMUTH	3580	
RANGE	4240	
VERTICAL ANGLE		+38

- (29) Depress matrix buttons D-4 (OBS LOC RECALL).
- (30) Depress the SM key.
- (31) On the keyboard, type 3; then depress the ENTER key
- (32) Depress matrix buttons C-4 (OBS AZ).
- (33) Depress the SM key.
- (34) On the keyboard, type 3580; then depress the ENTER key.
- (35) Depress matrix buttons C-6 (OBS SLANT DIST).
- (36) Depress the SM key.
- (37) On the keyboard, type 4240; then depress the ENTER key.
- (38) Depress matrix buttons C-7 (OBS VERT).
- (39) Depress the SM key.
- (40) On the keyboard, type +38; then depress the ENTER key.
- (41) Depress matrix buttons C-8 (POLAR PLOT MSN).
- (42) Depress the SM key. The FADAC will compute and display the following high-burst location:

Coordinates	Altitude
39977-29041	675

- (43) Depress matrix buttons G-6 (DF INPUT).
- (44) Depress the SM key.
- (45) On the keyboard, type 2046 (adjusted deflection); then depress the ENTER key.
- (46) Depress matrix buttons G-7 (TIME INPUT).
- (47) Depress the SM key.
- (48) On the keyboard, type 21.4 (adjusted time); then depress the ENTER key.
- (49) Depress matrix buttons G-8 (QE INPUT).
- (50) Depress the SM key.
- (51) On the keyboard, type 356 (adjusted QE); then depress the ENTER key.

If the fuze setting for the M564 fuze was determined by using time of flight and point-detonating fuze, as outlined in mission 1, it will be necessary to apply a fuze time override by depressing matrix buttons B-6 (FUZE TYPE).

- (52) Depress matrix buttons H-8 (COMP REG).
- (53) Depress the SM key. The following solution will be displayed: Df corr LEFT 18.7, fz corr -1.0, rg K +8.

(54) The registration corrections should be associated with all firing point buttons. If the FDO considers all the parameters in the FADAC to be accurate at the time of registration, the muzzle velocity could be improved by following the procedures outlined in mission 1. The computed corrections are used for mission 5. Compute GFT settings for the manual solution as required.

- (55) Depress the base piece button (E).
- (56) Depress matrix buttons E-1 (EOM).
- (57) Depress the SM key.
- (58) On the keyboard, type O.

Mission 5

Use of illuminating shell M485.

An observer calls for illumination. The battery has the new M485 illuminating projectile, which is a ballistic match to the M107 high-explosive projectile.

Call for fire

GRID 3952-2895
DIRECTION 3250

SUSPECTED VC ACTIVITY
2 GUNS ILLUMINATING
ADJUST FIRE

Fire order

RIGHT PLATOON
USE HIGH-BURST
REGISTRATION
TARGET AF7003

Normally, high-explosive registration corrections are not applied to illuminating projectiles in the manual solution. FADAC will apply these corrections to all projectiles and for all charges for which the corrections were entered. Since the M485 illuminating projectile is a ballistic match to the high-explosive projectile, HE registration corrections should be applied in the manual solution. The nature of this projectile requires that the battery location be used for adjustment of illuminating rounds to keep the platoon location free for adjustment of high-explosive rounds under the illumination. Two guns illuminating was selected as the method of engagement to simplify the sample problem. Range spreads and deflection spreads can be computed as outlined in FM 6-40-3 except that the distances from the center of bursts should be 500 meters for the M485 projectile.

- (1) Depress the battery center button (D).
- (2) Depress matrix buttons A-2 (TGT EAST).
- (3) Depress the SM key.
- (4) On the keyboard, type 39520; then depress the ENTER key.
- (5) Depress matrix buttons A-3 (TGT NORTH).
- (6) Depress the SM key.
- (7) On the keyboard, type 28950; then depress the ENTER key.
- (8) Depress matrix buttons A-4 (TGT ALT).
- (9) Depress the SM key.
- (10) On the keyboard, type 440 (altitude determined by VCO); then depress the ENTER key.
- (11) Depress matrix buttons A-7 (UP/DOWN).
- (12) Depress the SM key.
- (13) On the keyboard, type UP 600 (optimum height of burst for the M485 projectile); then depress the ENTER key.
- (14) Depress matrix buttons B-1 (CHG).
- (15) Depress the SM key.
- (16) On the keyboard, type 5; then depress the ENTER key.

The M485 projectile uses the M565 fuze. The time of flight displayed by FADAC for fuze PD is approximately correct as a fuze setting for fuze M565. The error should not exceed 0.3 second which does not justify any correction for this round.

(17) Depress the COMPUTE button. The following solution will be displayed: D, chg 5, df 2000, ti 23.7, QE 442.

(18) Depress matrix buttons E-7 (REPLOTT POLAR).

(19) Depress the SM key. The error light will blink, and the following solution will be displayed: D, az 3829, rg 6625, VA +75.

The actual range to the burst is 6,576 meters. The displayed range includes a correction for the registration range K of +8 meters. FADAC adds the total range correction to the actual range for display when using this function. The direction should agree with the direction determined by the VCO for orientation. However, the range will be in error by the total range correction to the target as determined with the range K. In the first four missions, the range K was zero (actually +0.46 meter), which caused the FADAC to display the correct range.

The computer operator continues.

(20) Depress matrix buttons A-5 (OT AZ).

(21) Depress the SM key.

(22) On the keyboard, type 3250; then depress the ENTER key. The observer's correction is RIGHT 400, DROP 400, DOWN 50.

(23) Depress matrix buttons A-6 (RIGHT/ LEFT).

(24) Depress the SM key.

(25) On the keyboard, type RIGHT 400; then depress the ENTER key.

(26) Depress matrix buttons A-8 (ADD/DROP).

(27) Depress the SM key.

(28) On the keyboard, type DROP 400; then depress the SM key.

(29) Depress matrix buttons A-7 (UP/DOWN).

(30) Depress the SM key.

(31) On the keyboard, type DOWN 50; then depress the ENTER key.

(32) Depress the TRIG button. The following solution will be displayed: D, chg 5, df 1912, ti 23.3, QE 427.

The observer's correction is RIGHT 100, ADD 200, CONTINUOUS ILLUMINATION.

(33) Depress matrix buttons A-6 (RIGHT/LEFT).

(34) Depress the SM key.

(35) On the keyboard, type RIGHT 100; then depress the ENTER key.

(36) Depress matrix buttons A-8 (ADD/DROP).

(37) Depress the SM key.

(38) On the keyboard, type ADD 200; then depress the ENTER key.

(39) Depress the TRIG button. The following solution will be displayed: D, chg 5, df 1919, ti 24.2, QE 442.

The observer has located five VC and transmits the following call for fire

Call for fire

FROM ILLUMINATION
DIRECTION 3390

Fire order

RIGHT PLATOON
USE HIGH-BURST
REGISTRATION

LEFT 250
FIVE VC IN OPEN
ADJUST FIRE

FUZE VT
2 ROUNDS
TARGET AF7004

With the greater illumination and slower rate of descent of the new illuminating flare, it is possible to adjust high-explosive ammunition under the illumination with the same weapons.

- (40) Depress matrix buttons D-8 (MASS FIRES).
- (41) Depress the SM key.
- (42) On the keyboard, type 1; then depress the ENTER key.
- (43) Depress the right platoon button (A).
- (44) Depress matrix buttons B-1 (CHG).
- (45) Depress the SM key.
- (46) On the keyboard, type 5; then depress the ENTER key.
- (47) Depress matrix buttons A-5 (OT AZ).
- (48) Depress the SM key.
- (49) On the keyboard, type 3390; then depress the ENTER key.
- (50) Depress matrix buttons A-6 (RIGHT/LEFT).
- (51) Depress the SM key.
- (52) On the keyboard, type LEFT 250; then depress the ENTER key.
- (53) Depress matrix buttons A-7 (UP/DOWN).
- (54) Depress the SM key.
- (55) On the keyboard, type DOWN 550; then depress the ENTER key.

This step is necessary to move the illumination location back to the ground. If the observer gives the target location in a manner other than as a shift from the illumination, normal procedures should be used to enter the location and the right platoon button (A) should be depressed.

(56) Depress the COMPUTE button. The following solution will be displayed: A, chg 5, df 1938, TOF 23.2 QE 343.

The observer's corrections are HE, DROP 100; ILLUMINATING, REPEAT.

- (57) Depress matrix buttons A-8 (ADD/DROP).
- (58) Depress the SM key.
- (59) On the keyboard, type DROP 100; then depress the ENTER key.
- (60) Depress the TRIG button. The following solution will be displayed: A, chg 5, df 1931, TOF 22.8, QE 336.

The observer's corrections are HE, ADD 50, FIRE FOR EFFECT; ILLUMINATING, LEFT 200.

- (61) Depress the battery center button (D).
- (62) Depress matrix buttons A-6 (RIGHT/LEFT).
- (63) Depress the SM key.
- (64) On the keyboard, type LEFT 200; then depress the ENTER key.
- (65) Depress the TRIG button. The following solution will be displayed: D, chg 5, df 1944, ti 23.7, QE 434.
- (66) Depress the right platoon button (A).
- (67) Depress matrix buttons B-6 (FUZE TYPE).
- (68) Depress the SM key.

- (69) On the keyboard, type 3; then depress the ENTER key.
- (70) Depress matrix buttons A-8 (ADD/DROP).
- (71) Depress the SM key.
- (72) On the keyboard, type ADD 50; then depress the ENTER key.
- (73) Depress the TRIG button. The following solution will be displayed: A, chg 5, df 1935, ti 23.0 QE 343.
- (74) Depress matrix buttons E-1 (EOM).
- (75) Depress the SM key.
- (76) On the keyboard, type O.
- (77) Depress the battery center button (D).
- (78) Depress the SM key.
- (79) On the keyboard, type O.

All problem areas concerning the use of FADAC are of interest to USAAMS. Units are encouraged to submit descriptions of problem areas, with or without suggested solutions, for inclusion in future instructional material and distribution to other units equipped with FADAC. Problem areas should be submitted to:

Commandant
 U. S. Army Artillery and Missile School
 ATTN: AKPSIAS-PL-FM
 Fort Sill, Oklahoma 73503

NEW POSTS CREATED

Two top-level positions have been created in the Army Secretariat. They are Assistant Secretary for Manpower and Reserve Affairs and a Deputy Under Secretary for Operations Research.

The position of Assistant Secretary of the Army for Manpower and Reserve Affairs has been established to encompass manpower and reserve functions which were formerly performed within the office of the Deputy Under Secretary for Manpower.

The creation of this new position is the result of Public Law 90-168, which authorizes each of the Military Departments an Assistant Secretary for Manpower and Reserve Affairs. The Departments of the Navy and the Air Force have not yet named their new Assistant Secretaries.

A second new Army position, Deputy Under Secretary of the Army (Operations Research), has been created. Its functions will be to:

Establish policy guidance and monitor Army operations research activities.

Initiate studies of interest to the Secretariat and serve as a point of contact of similar activities in the Office of the Secretary of Defense.

Initiate, conduct, review and monitor studies and analytical reports basic to the justification of Army requirements and programs.

USE OF BEEHIVE IN-

DEFENSE OF THE BATTERY POSITION

Another dimension to the defense of the battery position has been added with the availability of "Beehive." The 105-mm "Beehive" round sprays 8,000 steel flechettes in an 18-degree cone more than 300 meters in front of the bursting point of the round. A flechette is similar to a small nail with the head stamped into four fins so that it will fly like an arrow.

The round is fitted with the XM563 series mechanical time fuze. The fuze comes set for muzzle action, that is, bursting immediately after leaving the muzzle of the howitzer, however the fuze can also be set for time functioning. The fuze ignites four detonators which rip open the ogive of the round allowing the forward tiers of flechettes to disperse by centrifugal force. A flash from a relay ignites an expelling charge which activates a piston and propels the rear tiers of flechettes from the lower half of the projectile. Further information on the round may be obtained from TM 9-1300-203, April 1967.

The key to the successful employment of "Beehive is **planning**. Although "Beehive" turns a howitzer into a huge shotgun for the final defense of the howitzer position, there is no need to limit its use to that of a disaster stopper. Plan and get the maximum effect from "Beehive" rounds.

"Beehive" fires must be integrated into the battery defense plan. Each section is assigned overlapping sectors of fire. Secondary sectors of fire should be assigned to insure coverage of a howitzer that is placed out of action.

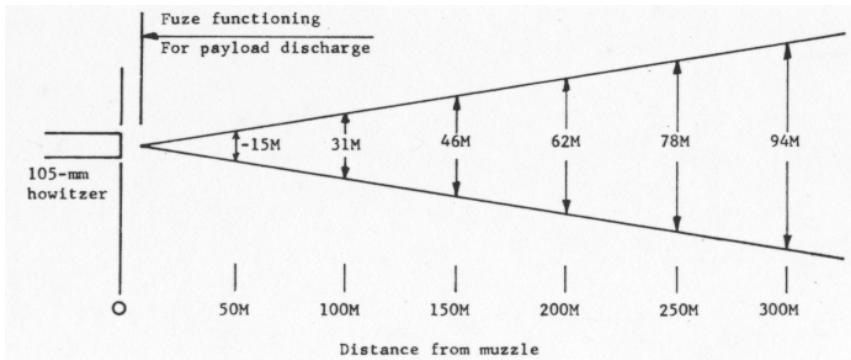

Figure 1. Dispersion with muzzle action setting

Just as with HE ammunition, range cards should be prepared to indicate the ranges to critical points on all likely avenues of approach whether they be within or outside the assigned sector. Provisional firing tables for "Beehive" are available. FT 105 ADD-D-O (REV II) (abbr) is applicable to the M101A1 and FT 105 ADD-E-O (REV II) (abbr) is applicable to the M102 and M108 105-mm howitzers. Quadrants, elevations, and time settings can be noted for points along avenues of approach. Individual howitzer sections can be assigned specific "Beehive" direct fire targets to be covered in the event of attack.

In firing "Beehive" it is necessary to have a method of alerting friendly troops that the round is about to be fired. Flares, verbal code words, or vehicle horns are examples of warning devices. Troops must be prepared to take cover to protect themselves from the effects of the round. A note of caution—the XM563E1 fuze is not safe for firing over the heads of friendly troops, however, the SM563E2 and higher numbered E-series fuzes are considered safe for employment over the heads of friendly troops.

Supplementary positions should also be prepared for those pieces unable to effectively fire from their primary position or to cover areas not covered by primary positions. Consideration should be given to shifting some "Beehive" rounds within the battery position. Distribution during a march is usually even, but the configuration of a position may indicate that weapons guarding certain avenues of approach will have a greater necessity to fire "Beehive." Shifting rounds beforehand can preclude the dangerous possibility of moving rounds while a position is under fire.

Using "Beehive" as added muscle for the battery defense, the door can be slammed even harder into the face of any enemy who chooses to run up against "monster shotguns."

●

CORRECTIONAL TRAINING

The Department of the Army will establish a new Correctional Training Facility (CTF) at Camp Forsyth, Fort Riley, Kansas. The Facility is scheduled to become operational on or about 1 July 1968.

The Correctional Training Facility will be under the command responsibility of the Provost Marshal General, Major General Carl G. Turner. It will provide a program of intensive infantry training and correctional instruction for military personnel confined for military offenses.

The facility's purpose is to return military offenders to duty as well-trained soldiers with improved attitudes and motivation, rather than merely to punish offenders.

The new facility will be staffed by approximately 600 officers and enlisted men. At full strength the facility will have the capacity to retrain 2,000 prisoners during a 10 week training cycle.

Radar on the Gunnery Team

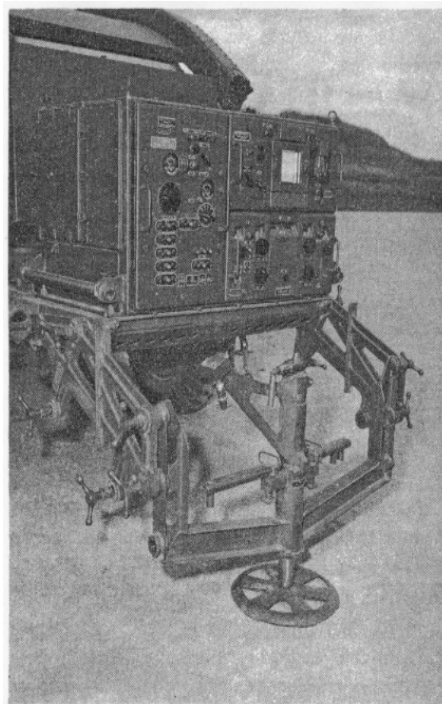

*CW 3 Marion L. Branham and Mr. Ruffin E. Redwine
Target Acquisition Department
USAAMS*

BACKGROUND

For quite some time a valuable device for effectively solving gunnery problems has been available to the artillery. This device is the Radar Set AN/MPQ-4A, which is organic to the direct support battalion in all divisions.

There exists, however, a lack of understanding between radar personnel, commanders, and fire direction personnel on exactly how registration data are obtained by radar and how the data are used by fire direction personnel. Also, a lack of confidence in data obtained by radar from firing a high-burst or mean-point-of-impact registration is almost universal in the S3 shops.

An understanding of the procedures used to obtain registration data by radar and the accuracy that can be expected will greatly dispel doubt about, and lack of confidence in, this equipment.

RADAR AS THE OBSERVER

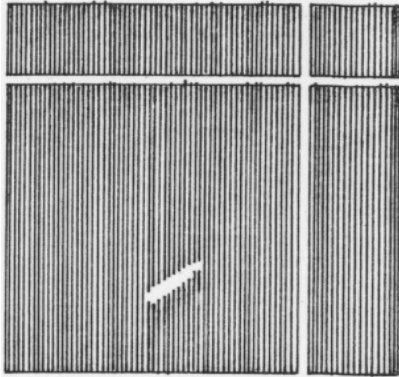

① Projectile first entering the beam.



② Projectile bursting in the beam.

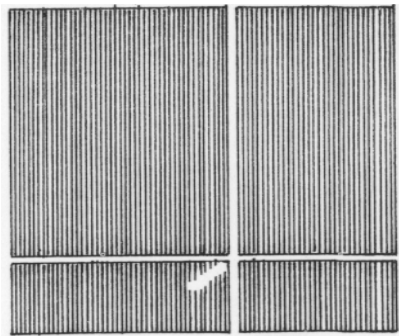

③ Strobing of marked burst.

Figure 1. Radar observed high burst

The Radar Set AN/MPQ-4A was designed to be employed in a countermortar role, and its primary purpose is the location of hostile mortars. However, the capabilities of the radar are such that it can be used profitably for observing high-burst and mean-point-of-impact registrations.

These registrations normally can be observed by the radar from its weapon location position. When the proper techniques and procedures are employed, the accuracy of the registration corrections obtained by radar-observed methods is comparable to that of corrections obtained by use of an 01-02 base.

When the Q-4A radar is used as the observer, the data necessary for massing fires within the battalion can be determined within 10 minutes after the radar section receives the mission.

RADAR-OBSERVED HIGH-BURST REGISTRATION

The message to observe a high-burst registration includes the grid "should hit" coordinates of the selected registration point. The radar optical telescope, which is mounted on the radar antenna, is sighted on this location.

As each round is fired, the fire direction center announces SHOT. The observer spots each round in the optical telescope and determines the deviations in azimuth and elevation angle. The radar operator observes the burst on the B-scope. After positioning the range strobe line over the burst echo (fig 1 ③), the operator reads the range to each burst from the radar computer. The deviations in azimuth and elevation angle and the range for each burst are recorded. The azimuth to the center of

each burst is determined by combining the deviation with the pointing azimuth. The elevation angle to the center of each burst is determined in a similar manner.

The average azimuth, elevation angle, and range are used to determine the coordinates (grid or polar) and altitude of the high burst. This is the "did hit" (chart) location of the high burst, which is transmitted to the fire direction center by the radar crew.

RADAR-OBSERVED MEAN-POINT-OF-IMPACT REGISTRATION

Since the radar is normally positioned in defilade behind a crest, the point of impact of the bursts cannot be "seen." The radar observes a mean point of impact at a selected datum plane (SDP.)

The selected datum plane (fig 2) is a plane in space through which all rounds that are fired during the conduct of the registration will pass. It can be thought of as a flat hilltop on which the rounds would impact.

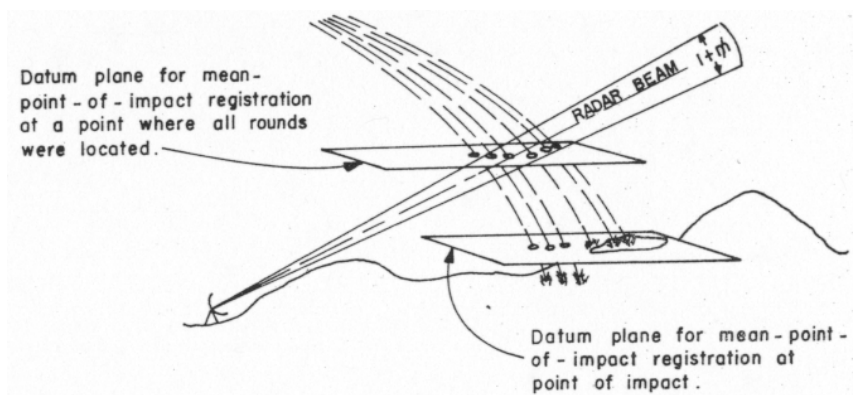

Figure 2. Datum plane for mean-point-of-impact registration.

The radar beam is positioned over the selected registration point. The beam is 445 mils wide and 14 mils thick.

As each round is fired, the projectile penetrates the radar beam, passes through the beam, and continues on to impact on the ground. While the projectile is in the beam, an echo return is displayed on the B-scope as a continuous straightline or as a series of dots (fig 3).

The operator marks on the face of the scope the first echo (where the projectile enters the beam) (fig 3 ①) and the last echo (where the projectile leaves the beam) (fig 3 ②). The point midway between the two marks represents the azimuth and range at which the projectile passes through the center of the radar beam (fig 3 ③).

The operator positions the azimuth and range strobe line over the midpoint (fig 3 ④) and reads the azimuth and range to this point from the radar computer. The average range and azimuth for all rounds are determined.

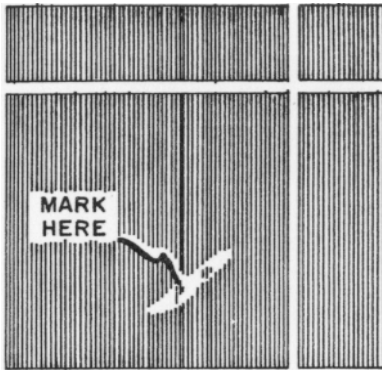

① Marking the point where the projectile enters the beam.

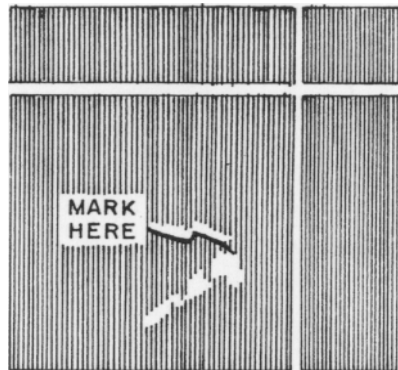

② Marking the point where the projectile leaves the beam.

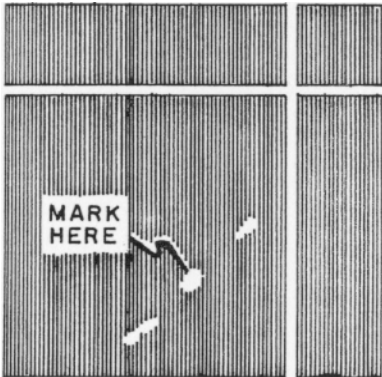

③ Marking the point where the projectile passes through the center of the beam.

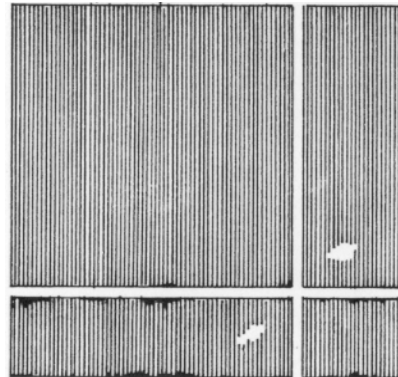

④ Strobing the midpoint.

Figure 3. Radar-observed mean point of impact.

The elevation angle setting on the radar set, which is the angle to the center of the beam, remains constant throughout the registration. The altitude of the selected datum plane is computed using the average range and elevation angle of the radar beam.

The radar crew transmits to the fire direction center the coordinates (grid or polar) and the altitude of the selected datum plane. This is the "did hit" (chart) location of the mean point of impact.

ADVANTAGES

Radar-observed registrations have certain advantages over registrations conducted in conjunction with an 01-02 survey base. These advantages are as follows:

- a. Less time is required for preparation.
- b. Less survey is required.
- c. Fewer communication facilities are required.
- d. Fewer computations and less coordination are required.
- e. Can be conducted when visibility is poor.

COMPUTATION OF REGISTRATION CORRECTIONS

The computation of registration corrections and the determination of the GFT setting are the same for both a high-burst registration and a mean-point-of-impact registration. The altitude of the selected datum plane in a mean-point-of-impact registration is comparable to the altitude of the center of burst in a high-burst registration. Following are computations of registration corrections.

EXAMPLE

Base piece is over battery center.

"Should hit" data

Weapon — 105-mm how
 Charge — 6
 Deflection — 2800
 Quadrant fired — 390 mils
 Deflection index — 2800

"Did hit" chart data

Deflection — 2820
 Deflection correction — R20
 Weapon registration point
 distance—6800
 NOTE: Place the deflection
 correction on the deflection
 correction scale on the GFT.

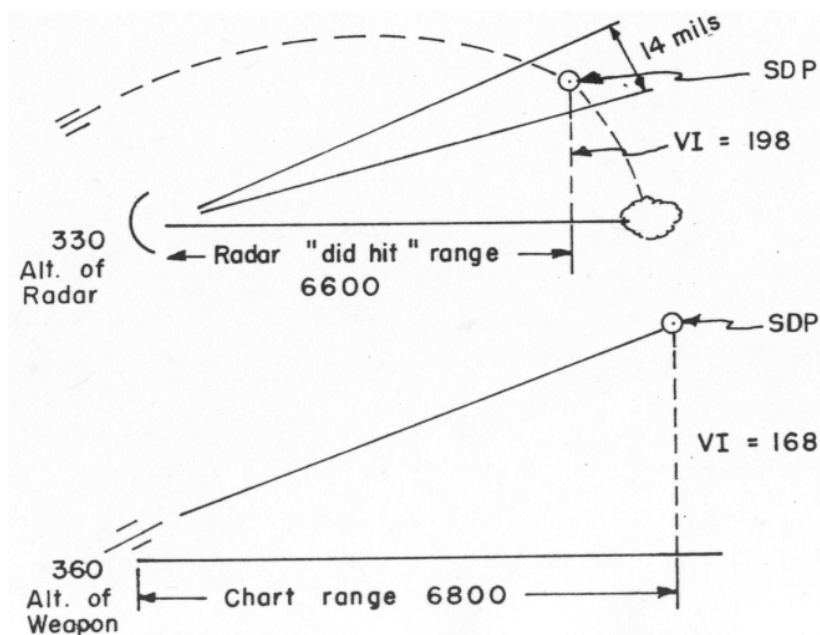

Figure 4. Illustrations of computations listed in the example.

Angle of elevation to the SDP = 30 mils
 Vertical interval of radar 6.6×30 = 198
 Altitude of radar = 330
 Altitude of SDP (198 + 330) = 528
 Altitude of weapon (528 - 168) = 360
 Vertical interval of weapon = 168
 Distance to "did hit" = 6800
 Site = $(168 \div 6.8)$: using GST, target above gun) = +30 mils
 Adjusted quadrant = $(390 - 30)$ = 360 mils
 GFT B: Chg 6, lot X, rg 6800, el 360.

CHEYENNE TESTED

The Army's newest and most advanced combat helicopter, the AH-56A Cheyenne, demonstrated its speed, versatility, and maneuverability in December 1967 during its first public flight at Van Nuys, California.

Observers at the demonstration included ranking military and U. S. Government officials, representatives of the prime contractor, Lockheed-California Company, and some 800 sub-contractors who helped build the technologically advanced rotocraft.

Termed a compound helicopter, the Cheyenne has rotor blades as well as stub wings and a pusher propeller. The rotors provide conventional helicopter performance, and in conjunction with the stub wings and pusher prop permit level flight at speeds of more than 250 miles per hour.

The Cheyenne is the first Army aircraft to be designed and built as an integrated aerial vehicle/armament/avionics/fire control gun ship and coincidentally the first compound helicopter to be developed by any of the U. S. military forces.

The versatile craft, when fully equipped, will be capable of firing machine guns, grenades, rockets and missiles. The swiveling belly turret mounts a 30-mm automatic gun. Both the pilot and gunner are protected by armor plate.

AGENCY ESTABLISHED

The Army will establish an Advanced Ballistic Missile Defense Agency, which will combine some elements of the Department of Defense Advanced Research Projects Agency (ARPA) Office of Ballistic Missile Defense and the on going NIKE-X advanced development.

MORTAR AND ROCKET LOCATION

Mr. W. R. Bursell
Sensory Equipment Division
Target Acquisition Department
USAAMS

Within the Artillery there are units whose capability of locating mortars and rockets is little known, and at the present time, not being put to use. These units, the artillery sound ranging platoons of the Field Artillery Target Acquisition Battalions, have the personnel and equipment to accomplish this.

Tests conducted at Fort Sill, dating back to 1948, proved that the 4.5-inch rocket could be located by sound ranging techniques at ranges up to 9,000 meters. The locating of mortars, 81-mm or larger, using artillery sound ranging equipment was proven feasible in WW II, the Korean conflict, and in tests conducted at Fort Sill. Several Field Artillery Observation Battalions (the forerunners of the Field Artillery Target Acquisition Battalions) installed sound ranging mortar bases in WW II and during the Korean conflict which were successful in locating enemy mortars. However, these bases were installed only on special occasions because they were operated in addition to normal artillery sound bases. Furthermore, the resultant drain on personnel and equipment prevented the mortar bases from being operated for more than a few days at a time.

Following the Korean conflict a new item of equipment was issued to the sound ranging platoons. This new equipment, the switchboard SB-223, enabled the platoon to operate two sound bases utilizing only one sound ranging set and with the same number of personnel that were required for a single base. This switchboard was designed for operating a crossed artillery sound ranging base to increase the amount of frontage that a sound ranging platoon could cover. The switchboard automatically places in operation whichever base is desired.

Although the location of mortars is not a mission of the artillery sound ranging platoon, the occasion may arise when no other acquisition means are available.

Mortars and rockets, 81-mm in size or larger, can be located by a sound ranging platoon if the following procedures are observed:

1. Bases of proper configuration are employed.
2. SB-223 is used.
3. Special techniques are applied.

It should be kept in mind that the larger a weapon's caliber, the greater the range is to which it can be located.

*The additional microphones are from the spare set.

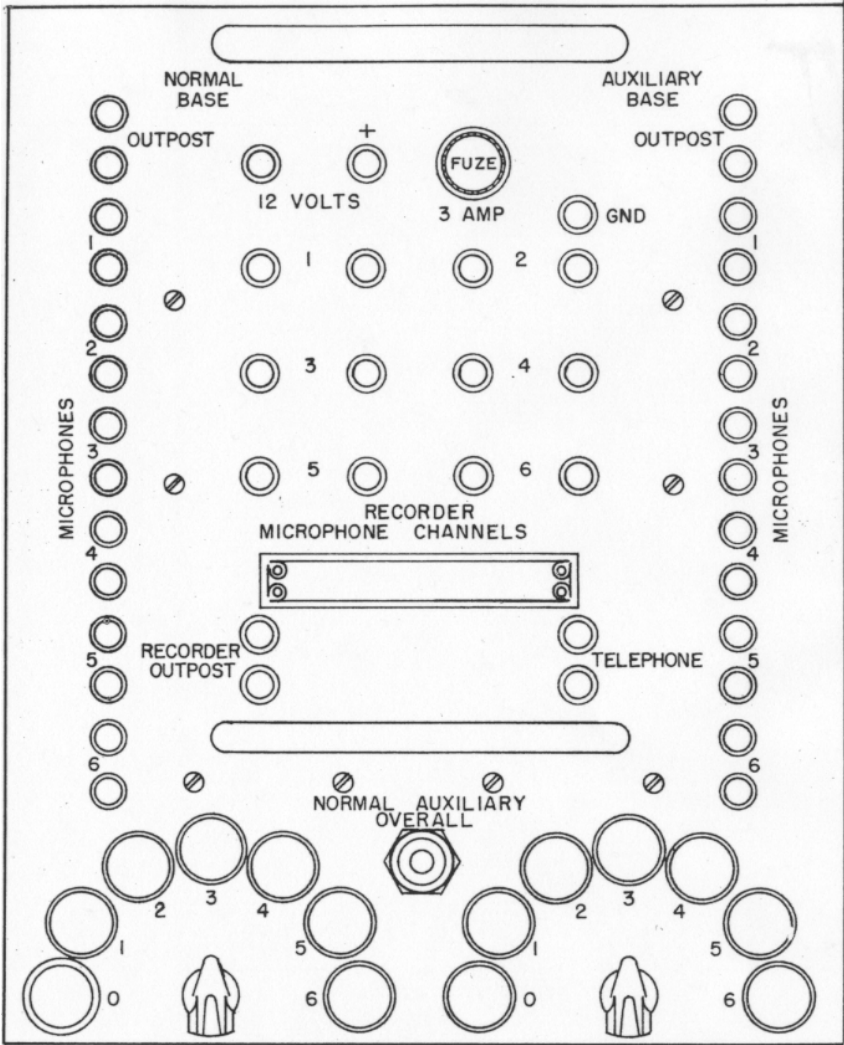

Figure 1. Switchboard SB-223.

When operating a deliberate sound ranging base (microphones are approximately 1300 meters apart), weapons that are located 1500 meters or less from the base cannot be plotted accurately. In addition, the sound from mortars with a caliber of 100-mm or less will not be recorded on all of the microphones as the sound wave loses energy rapidly. In order to locate mortars, it is necessary to install a shorter base with a subbase length of approximately one or two seconds (337.6 or 675.2 meters between adjacent microphones).

Many different configurations of sound bases may be used to locate artillery, mortars, and rockets, but only three types of bases will be discussed. Although the techniques for the different bases may vary, the fundamentals remain the same. If at all possible, a straight regular base should be employed for ease of record reading and plotting. Assuming that a four second, six microphone base is being employed to locate artillery, the following steps would have to be taken to locate mortars (or rockets firing from short range) using mortar bases Type 1 and 2:

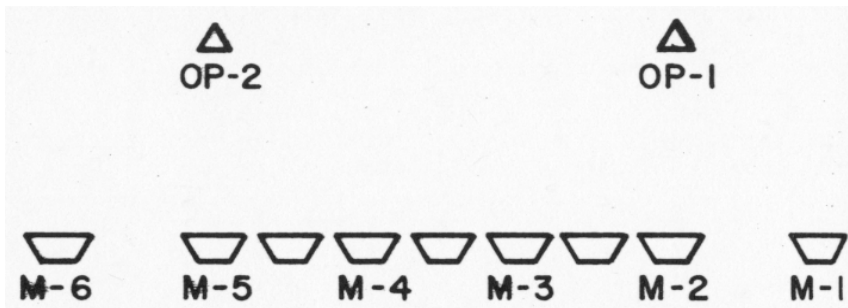

Figure 2. Artillery sound bases with mortar base superimposed.
Microphones 3, 4, and 5 are common to both bases (not to scale).

- Superimpose onto the artillery sound base three additional microphones at or near the centerpoints of three adjacent subbases (either right, left, or center of the artillery base depending upon the most likely location of hostile mortars).

- Prepare the sound plotting chart with centerpoints and normals for both bases, or prepare two charts, one for each base.

- Install sixty cycle per second acoustical plugs in all microphones (the twenty-five CPS plug has too low a frequency cut-off for some mortars).

- Connect the artillery base to the "normal base" side of SB-223 and the mortar base to the "auxiliary base" side.

The outpost operators start the sound set remotely on hearing hostile artillery fire. For mortar fire, the outpost operators would alert the set operator who would then start the sound set and operate the mortar base by means of the overall key on SB-223.

ADVANTAGES:

- Able to accomplish the primary mission of artillery location.

- Only one sound set is used.

- Able to locate mortars and rockets.

- No increase in personnel.

DISADVANTAGES:

- The mortar base is located too far (2,000 meters) from likely enemy mortar positions thus limiting the range capability.

- The outpost operators are unable to control the mortar base remotely.

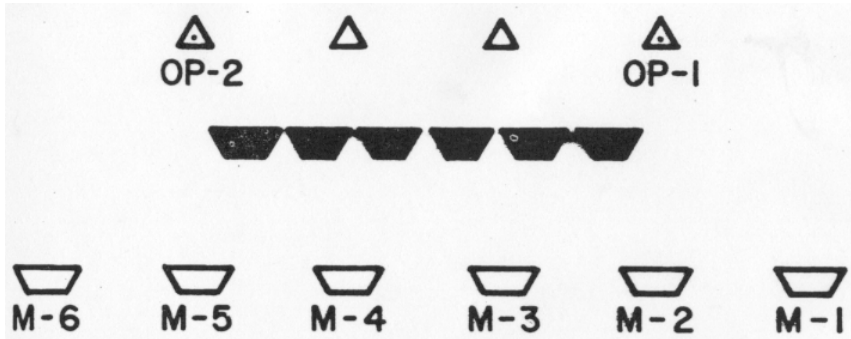

Figure 3. Artillery and mortar sound bases (not to scale).

TYPE 2 (Figure 3)

A one second (337.6 meters) sound mortar base is installed approximately 1,000 meters behind its outposts. A four second artillery base is, when possible, installed 2,000 meters behind its outposts.

The artillery base, with its two outposts, is connected to the "normal base" on SB-223. The mortar base, with its two outposts, is connected to the "auxiliary base." Each set of outpost operators would remotely control their own base.

Prepare separate plotting charts for each base.

ADVANTAGES:

Able to accomplish the primary mission of artillery location.

The mortar base has a greater range capability than a Type 1 mortar base.

Outpost operators are able to control both bases remotely.

Only one sound set is used.

No increase in CP personnel.

DISADVANTAGES:

Two additional outposts would have to be manned for the mortar base.

Greater survey and wire requirement.

Two mortar bases are installed, crossed and perpendicular to each other with the sound central located in the center of the cross.

The bases consist of from four to six microphones each, and have a subbase length of 1 or 2 seconds.

By using SB-223, either base can be activated by the set operator when he hears the sound of enemy mortars firing.

Prepare a separate plotting chart for each base. Plot the centerpoints in the middle of each chart to enable the draftsman to plot targets to the front or rear of each base.

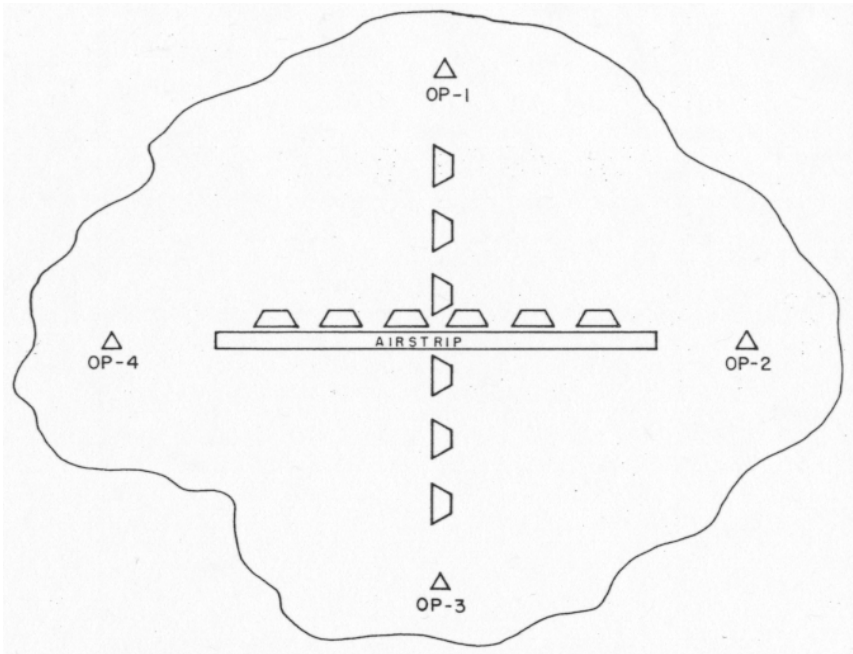

Figure 4. Third type of mortar sound bases (not to scale).

ADVANTAGES:

This type of installation would give 6,400 mil coverage.

Due to its reduced size, this type could be used to supplement fixed installation (base camp) coverage means. (Figure 4).

No outposts are used.

One sound set is used.

Reduced survey and wire requirement.

No increase in CP personnel.

DISADVANTAGES:

This type of installation does not have a one round acquisition capability as one of the bases would be activated only after the set operator had heard an enemy mortar fire. However, to obtain one round acquisition, four outposts should be employed. (Figure 4).

Enemy artillery could not be located accurately at ranges beyond 7,000 meters for the two second base and 3,500 meters for the one second base.

WHICH BASE TO EMPLOY

The decision as to which type and length of base to employ will depend upon several factors: mission, time available, terrain features, amount of terrain physically held by friendly forces, types of weapons being used by enemy forces, and sound ranging personnel available. The bases could be operated for an indefinite period with TOE personnel, unless four outposts are used, then the sound platoon would have to be augmented by six men.

The Royal Regiment of Canadian Artillery



*Major Gordon P. Walsh
USLO to the Royal Canadian School of Artillery
Shilo, Manitoba, Canada*

Kiska and Anzio are names which will continually appear in the annals of United States military history. Battle streamers on our regimental colors remind us of the achievements of brave men and proud units on the field of combat. However, there is a unique aspect of these victories which gives them added significance—the victories do not belong to American Armed Forces alone. For in these operations, the forces of two nations, the United States and Canada, combined to achieve the victory.

Great advances have been made since "Operation Cottage," the assault on Kiska. During the planning of this operation, considerable problems were encountered and, to quote one historian, "The differences in organization and terminology were so great that at times the two groups seemed hardly to speak the same language." Today, these differences have been partially resolved by the Quadripartite agreements which have provided the four nation members with a common language and thus have established a sound basis for mutual understanding among the four nations. To overcome the differences in organization it is required that a firm understanding of force structure, and the lines of responsibility which give this structure its efficiency, become common knowledge to officers of the participating nations. The purpose of this article is to illustrate how the artillery element of the Canadian Army—the Royal Regiment of Canadian Artillery—upholds the artilleryman's creed of supporting the ground gaining arms anytime and anywhere.

The infantry brigade group is the basic fighting formation of the Canadian Army. The brigade group is a combined arms team, self-contained and capable of sustained action on the modern battlefield. Organic to the brigade group are three infantry battalions, an armored regiment,

a field artillery regiment, and necessary combat support and combat service support units. Currently there are four brigade groups in active service—three in Canada and one in Germany, the latter being part of the NATO ground forces. Supporting each brigade group is a field artillery regiment. The field artillery regiment in Germany is augmented by a separate Honest John battery which provides the Canadian forces in Europe with a nuclear capability. Another Honest John battery is stationed in Canada and is used for training purposes. The organization which we will discuss is the field artillery regiment.

THE FIELD ARTILLERY REGIMENT

The field artillery regiment (fig 1) is composed of a regimental headquarters, three field batteries each armed with eight 105-mm howitzers, one medium battery armed with eight 155-mm howitzers, and an air observation post troop authorized three L19 observation aircraft.

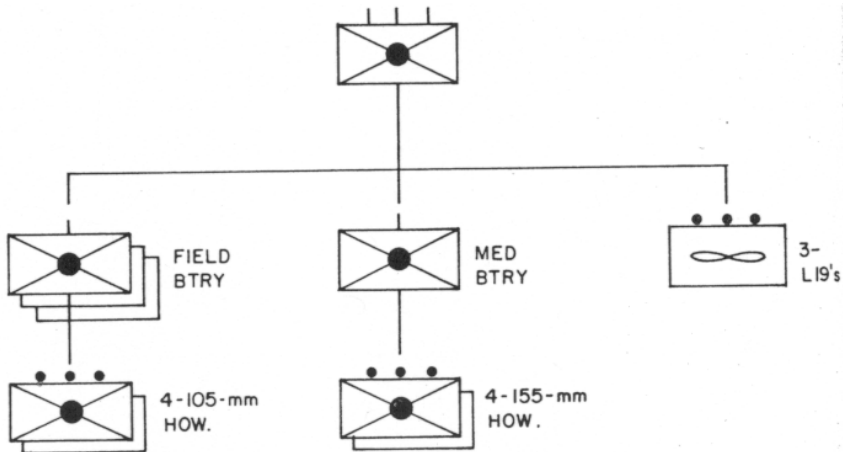

Figure 1. Organization of the organic field artillery regiment.

Each of the three field batteries is subdivided into two troops of four 105-mm howitzers each. The field battery, which is the smallest self-contained Canadian artillery unit, is capable of operating independently and is normally employed in direct support of an affiliated maneuver battalion.

The medium battery also is organized with two 4-gun troops and is normally employed in general support of the force to supplement the fires of the field batteries by adding weight and depth to combat.

The air observation post troop performs aerial observation and adjustment of fires and is capable of taking and processing oblique photographs, carrying out reconnaissance missions, and performing poststrike assessment of nuclear bursts.

COMMAND AND CONTROL

For command and control of the field artillery regiment in combat, a command-liaison system is employed. The regimental commander, a lieutenant colonel, commands the artillery resources organic or attached to the force and advises the brigade group commander on artillery employment. To accomplish the mission of fire support, the regimental commander establishes an artillery tactical headquarters at the brigade main headquarters. From this tactical headquarters the regimental commander establishes close liaison with the brigade group commander and coordinates and controls the fires of the artillery in support of the force. This tactical headquarters consists of the regimental commander, the regimental intelligence officer, and sufficient enlisted personnel to insure proper communications and the ability to operate for extended periods.

Each battery commander, a major, establishes himself at the tactical headquarters of the supported maneuver battalion. From this location the battery commander establishes close liaison with the supported commander and advises this commander on areas associated with artillery emplacement. In addition the battery commander coordinates the deployment of his observer parties and the activities of any artillery element allocated in reinforcement.

The troop commander, a captain, is normally employed as a forward observer and must establish liaison with the supported company commander. He is also responsible for observing his assigned zone, engaging detected targets, and reporting information of enemy activity.

In the regimental area, the regimental second-in-command (2IC) assumes command of the artillery regimental headquarters. From this location he implements orders from the regimental commander, insures efficient operation of the headquarters elements, and supervises administrative and logistic support for the regiment. The responsibilities of the battery 2IC are similar to those of the regimental 2IC and include insuring efficient operation of the battery command post (FDC), conducting reconnaissance for gun positions, and directing battery administration, supply, and maintenance.

FIRE PLANNING

The supported arms commander is responsible for the tactical plan to include the artillery fire plan. The artillery commander assists the supported unit commander in preparing the fire plan and prepares and issues the orders required for implementing the artillery portion of the force fire plan. Normally, the supported commander will determine the type of fire support to be adopted and will state what the fire plan must accomplish. The artillery commander will then prepare the detailed fire plan by using all available information and coordinating with the supported commander as often as required.

COMBINED OPERATIONS

In order to illustrate the compatibility of the US Army and the Canadian Army systems of artillery employment, let us assume that Canadian and US forces have been committed in a combined operation. It would

be normal to expect that the units committed to combat would include all organic subordinate units; therefore, the mission to reinforce the artillery of the other countries forces could be a realistic example. We must also consider the impact of the quadripartite agreements and assume that both forces have implemented these agreements.

Assume the 1st Battalion, 1st Artillery (US) has been ordered to reinforce the fires of the 1st Regiment, Royal Canadian Horse Artillery (RCHA) which is in direct support of the 1st Infantry Brigade Group. To satisfy the requirement of liaison and communications, the commander of the 1st Bn, 1st Arty, must send a liaison team to the regimental headquarters of the 1st Regiment, and this liaison team must be integrated into the operations of the regimental command post. Since fire planning and control and coordination of the artillery element take place at the regimental commander's tactical headquarters, there may be a requirement to establish communications or liaison at the regimental headquarters to allow rapid transmission of movement and fire planning orders. Depending on the artillery organization for combat, it may be feasible for the commander of the 1st Regiment, to request the commander of the 1st Bn, 1st Arty, to supplement the fires of any battery of the 1st Regiment in accordance with an established priority, thus saving the time required to obtain regimental approval. The fire order to the 1st Bn, 1st Arty would be monitored by the 1st Regiment tactical command post, with their silence indicating approval of the fire order.

Now let us consider the opposite situation. Assume that the 1st Regiment, RCHA, has the tactical mission of reinforcing the 1st Bn, 1st Arty (US) which is in direct support of the 1st Brigade, 1st Infantry Division. To establish liaison and communications with the 1st Bn, 1st Arty, the commander of the 1st Regiment, RCHA would integrate the elements of his tactical command post into the fire direction center of the 1st Bn, 1st Arty, located at the battalion command post. Since fire distribution and fire orders originate at the 1st Arty battalion fire direction center, there would be no further requirement for liaison and communications.

From these illustrations the reader may think that the integration of the forces of these two nations has been oversimplified. This is not really true, such integration is possible only because of hard and diligent work by representatives of both nations in standardizing their techniques and terminology. Because of these standardizations, an artillery commander from the armed forces of any participating nation has the same inherent responsibilities when he receives a tactical mission. Other areas have been coordinated to allow smooth transition and complete understanding. These are illustrated by the standardization of the call for fire format, target numbering system, artillery fire plans, and radiotelephone procedures. From this small analysis it is readily apparent that great advancements have been made since the days of "Operation Cottage" and that through continuous planning, we are eliminating the problems associated with different organizations and different terminology.

FIRE SUPPORT

Lieutenant Colonel Charles W. Montgomery (Retired)
Tactics/Combined Arms Department
USAAMS

Editor's Note: This is the first in a series of "Dear John" letters on field artillery operations and allied efforts.

* * * * *

APO
San Francisco, California
.....February 19.....

Dear John:

Not much of real interest to report on from here. The weather continues to be hot and sticky, and the enemy is just as elusive as ever. In your last letter you expressed an interest in my term "fire support" and who was involved with it. So here goes.

First off, it is necessary to understand combat missions and how they are fulfilled on the battlefield. The commander of a maneuver force is usually given a combat mission such as "Seize the high ground NE of" or "Defend Line....." or "Search out and destroy the enemy in area....." To accomplish this assigned task (mission), the combat commander is provided with the necessary resources (both organic and nonorganic). He has the combat elements (infantry and tanks). Combat support units (artillery, engineer, etc.) and combat service support units (administrative, logistical, etc.) provide assistance to his operations. The commander's basic tools to get the job done are **fires** and **maneuver**. He uses these in proper proportions. As an artilleryman, my job involves fires. The element of the field artillery with which I serve is required to coordinate this fire support. It may consist of air, artillery, mortars, and naval gunfires. The air effort may come from the Air Force, Navy, Marine, and armed Army aircraft. Sometimes we have all of these; on other occasions we may have only some of them. All fires must be coordinated into a single effort which is in concert with the maneuver planned by the combat elements.

Second, you need to understand military organization so that you can better appreciate how fire support is used at each echelon of a force. To keep this as simple as possible, let's look at the standard infantry division and its organization to wage combat. At the top, we find the division headquarters and other elements which serve as the base of this division. Subordinate to the division echelon, we find three brigades. Each brigade will normally consist of three or more battalions (tanks and/or infantry). Each battalion is organized with three line

companies; these are the elements of the division which usually stand "eyeball to eyeball" with the enemy. So you see, the division really has four combat layers. From front to rear they are: The company, the battalion, the brigade, and the division. When committed, each layer has its own need for fires.

For air support, the tactical air force not only provides attacking aircraft and ammunition but also sends in representatives to work at all levels throughout the division. A tactical air control party operates at each maneuver battalion and brigade and at the division headquarters. Members of these parties are responsible for advising commanders and staffs on the use of available aircraft and munitions, for requesting immediate air support, and for guiding attacking aircraft onto targets selected by the ground force. Air Force officers in these parties are experienced pilots who know the capabilities and limitations of the supporting air force fighters. By operating with the ground elements, they provide the supporting air force with a better appreciation of the ground force needs for air support and, more importantly, they afford insurance of immediate response when air fires are needed. Perhaps you have noticed that the maneuver companies do not normally have tactical air control parties. This is readily overcome when a maneuver battalion commander so desires. He can direct that elements, or all, of his tactical air control party work with a company or companies, or he can keep the tactical air control party at battalion and have the companies request air support as they need it. Naval air is handled in a similar manner. I will discuss it later. In addition, we have armed Army aircraft whose fires are available through the Army aviation representatives of the division.

Artillery support is provided for each level of command in the division. In most operations, this is accomplished by placing one or more artillery battalions (under a single commander) immediately responsive to each committed brigade. The remainder of the organic and attached artillery of the division is responsive to the needs of the division (as an entire force). An artillery forward observer operates with each maneuver company. He determines the company's needs for artillery fires, requests fires, and adjusts artillery fires onto targets, when necessary. An artillery liaison officer is placed with each maneuver battalion headquarters. He serves as a full-time fire support coordinator and, in addition, coordinates the activities of all artillery observers working with the companies of this maneuver battalion. If the maneuver battalion states a need for artillery fires, the liaison officer requests such fires from his own artillery battalion. The field artillery battalion commander (a lieutenant colonel) serves as the fire support coordinator for the brigade and as the principal advisor on the use of fires for the brigade commander. An artillery liaison officer "lives" full time at the brigade command post to assist the artillery battalion commander and insure responsive artillery fires when needed. At the division level, we find a division artillery headquarters which controls all artillery activities within the division.

Artillerymen at this level actually serve at both the division artillery command post and the division command post. The division artillery commander normally serves as the division's fire support coordinator and establishes a fire support coordination element at the division headquarters to assist him. If air observers are needed, the field artillery can provide them.

I indicated earlier that mortars provide part of the fire support. Each company and battalion has its own organic mortars. The observers for these mortars operate with the maneuver companies and can provide responsive and effective fires based on the needs of the company elements. The company commander coordinates these mortar fires with other fires available to him.

If naval gunfire and/or naval air support is available, the Navy provides the division with elements of an air naval gunfire liaison company, including both Marine and Navy representatives. Fires of the Navy are available through the communications established by these representatives. Each layer of the division force is provided with naval representatives. A spotter (Marine officer) will normally operate with the companies. At battalion, brigade, and division headquarters, we find advisors on the use of Navy support. This insures responsiveness of such support when needed. Naval air support is also available through this means, or all aircraft may operate out of the Air Force tactical air control parties.

By now, it should be evident to you that a division has all the "tools" needed to acquire fire support for its ground-gaining arms. Each echelon of the division has available to it considerable firepower from several nonorganic sources. An additional point to be made is the fact that the support I have discussed includes all types of ammunition, from conventional high explosives to nuclear munitions which cause mass destruction. If smoke is needed to hide operations from unfriendly eyes, each means of fire support can provide it. During the hours of darkness, a situation may arise which requires that a certain part of the battlefield be illuminated. This, too, can be accomplished by most sources of fire support. Through these various choices of fire support means, a commander has considerable flexibility in developing his combat plans.

From all the foregoing, you should now understand fire support and realize that the foot soldier and tanker have plenty of outside help available to them. Keep in mind that I have limited this letter to only a division. I have not discussed the fire support which also is available, if needed, from echelons higher than the division. Fire support is normally plentiful in a combat zone. However, this does not imply that it can be used indiscriminately. On the contrary, fire support must be coordinated to insure the maximum effect within the time required, but that's the subject of a later letter. For this time, that's it.

Sincerely,
Red Legg

FIRE MARKING--

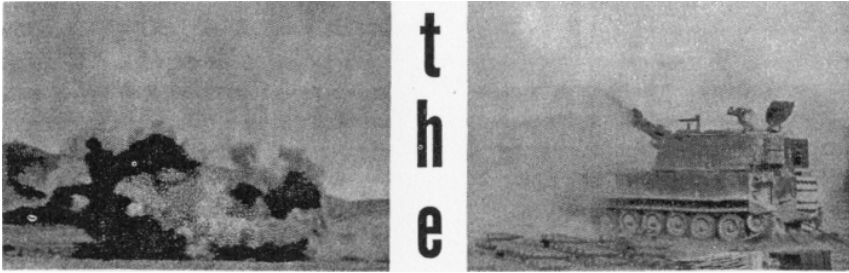

Answer to True Simulation

*Colonel Harold A Dye
Weapons Systems Evaluation Group
Arlington, Virginia*

The ultimate goal of all military training is to reach a degree of combat efficiency which will insure success in battle. Tactical exercises, if executed with firmness and force as coherent operations, are second only to combat itself as a means of attaining maximum combat efficiency. However, exercises must be realistic. In fact, the more realistic they are, the more they approach actual battle as a training means. There are many areas in which the degree of realism could be increased and by which exercises could be made much more than just parodies of actual combat. A very good place to start on this improvement of realism is in the sadly neglected area of fire marking.

During a recent field training exercise (FTX) an artillery group "fired" over 5,000 rounds of ammunition of various calibers. A large number of the group's targets were marked with pyrotechnics; yet, not one casualty or damaged piece of equipment was reported by participating troops nor did a single shell report reach the corps artillery counterbattery office. Group artillery batteries, which, probably would have been hit with counterbattery fire after they had fired three or four missions, received no artillery fire and stayed in the same position until they were eventually overrun by the same infantry and armor units which earlier had been hit by the simulated artillery fire. The intelligence play, replacement of casualties and damaged equipment, and tactical considerations which should have resulted from proper fire marking and reporting did not materialize. Therefore, the FTX lacked much of the realism which would have made it much more effective as a training medium.

In still another division exercise in Germany, one specific tank battalion was singled out at the end of the exercise for its ability to react rapidly. This was a "damn the torpedo" type of unit. It had surged forward through battalion volleys of 8-inch howitzer rounds, assembled

under fire, and then crossed a bridge (which had previously been destroyed by simulated 8-inch and 155-mm howitzer fire and had not been repaired), completely unmindful of the simulated artillery fire (marked with M80 firecrackers) which was falling around the tanks and supporting APC's. Thus, a unit that had been badly crippled by artillery was commended simply because no one would admit that the unit had been hit. In this case, the poorest tactics paid the highest dividends.

Exercises have been conducted in which artillery, mortar, and tank fires have been completely ignored. In most cases, this occurred because of poor or inadequate fire marking; however, in some instances fires were ignored simply because it was easier to ignore the casualties or fail to make a casualty assessment report than it was to report the casualties and suffer the consequences of being temporarily immobilized, or even forced to withdraw, and possibly be criticized for having been hit.

What is the answer to this ineffective method of training? How can we get more training out of the millions of dollars we spend on FTX's?

Under FTX conditions effective evaluation can be accomplished by using a sufficient number of well-trained fire-marking teams and by requiring participating troops to perform the proper follow up actions of reporting casualties and submitting shell reports and equipment damage reports. The work of the fire-marking teams is ineffective if it is not properly followed up by the participating troops. The play of the FTX becomes unrealistic and ineffective in direct proportion to the lack of effective fire marking even though the loss of effectiveness is not always apparent, since the total number of casualties, amount of damaged equipment, etc., are never known. The failure to learn "what we missed in the exercise" is the greatest loss to training.

Obviously, the fire-marking team is faced with a big problem from the beginning of an exercise. Targets must be properly marked **in time** to be of value to the requesting unit and to the "hit" unit. The numbers of casualties sustained and amounts of equipment damaged or destroyed must be assessed by individuals who are knowledgeable and whose authority will be accepted. The problem begins with the initial casualty/damage assessment because there are so many variables and intangibles involved. The troops fired on by artillery, mortar, or other simulated weapons do not react to a fire simulator in the same way that they would react to a volley of live rounds; therefore, evasive tactics by the unit hit are accordingly slow or nonexistent. For this reason, a controller could easily and correctly assess the unit's casualties and equipment losses as high as 50 percent or more. If reinforcing fire from other battalions or units were then to fall on the unit it would no longer be an effective fighting organization. However such a situation would be based on the **assumption** that the fire landed where the firing unit said it would land. Actually, fires could have hit over, short, to the right, or to the left of the target, resulting in a very small number of casualties or none at all. A partial answer to the problem of accurate assessment is the establishment of a casualty and damage assessment system which

takes into account accuracy, surprise, reaction time, and numerous other factors. This has been accomplished by the assessment tables published in FM 105-5.

The provision of adequate casualty assessment tables is only a partial answer to the fire-marking problem. Of the targets marked in one division-size FTX 75 percent were marked as "Negative Action," which meant that no forces were within or even **had been** within 500 meters of the so-called target. Thirteen nuclear rounds, fire-marked for both sides, resulted in a total of 44 killed in action and 107 wounded in action. Obviously, forward observers and other "target getters" sent in targets simply to meet a target quota - or else they needed to retake basic map reading courses. Probably they sent in targets to meet a quota since most firing by the division was placed on roads, bridges, and intersections which did require a basic map reading ability but demonstrated poor artillery techniques. In defense of such firing it should be noted that in many exercises the effectiveness of the artillery is judged solely on the basis of the number of rounds fired rather than the results obtained. This type of judgment becomes necessary if proper fire marking and followup actions are not practiced.

After the casualty/damage assessment part of the problem has been solved, another part still remains—that of reporting assessment. Who reports the assessment? The unit commander desiring to keep all of his men together as a fighting unit does not wish to have a large number of his men and quantities of equipment evacuated or lost. The preponderance of evidence shows that in an FTX the casualty assessment is almost never reported. It is lost somewhere in the earliest stages of the exercise. To counter this failure to report, the FTX controller at the scene of the assessment could keep a record of casualties and damage. However, a large number of fires are marked when only a player/controller is present. Consequently, records kept by controllers are only partial records. The fire-marking team chief can report the assessment, but only through his reporting channels. However, he can exert a strong influence on the player if the player knows the controller will report the effects and that he will be checked.

During the same exercise in which 75 percent of the targets marked were "negative action," numerous aggressor fire missions were marked on friendly forces, producing casualties and data for shell reports. In one period, 33 targets that were marked produced casualties and raw data for shell reports. But, even though unit designations and the name of the officer or NCO given the casualty assessment were recorded, of the 33 possibilities only one shell report reached division artillery.

There are answers to these problems which will produce the desired results. If all participants in an exercise understand the value of fire marking and follow a few basic rules, the overall value of exercise as a training means can be increased immeasurably. Each step properly executed generates still another step until the exercise becomes a vital, manifold operation producing lasting results.

For example, assessment during an FTX an infantry company commander requests that his forward observer call for mortar or artillery fire on an aggressor platoon which has been holding up the attack by the infantry company. The company commander would like to get the fire quickly and then to know how effective it has been. His tactical decisions depend on his receiving timely information concerning the results of the fire mission. Casualty assessment and damage evaluation are important to him, and to the artillery firing the mission. Proper fire marking will best satisfy all these requirements:

The artillery forward observer locates the target by coordinates; he then sends a call for fire to the direct support (DS) battalion and describes the target. On the basis of the nature of the target the DS battalion S3 decides to fire three rounds. Realizing the "need to know," the S3 requests that the fires be marked.

To facilitate the marking a **fire-marking liaison officer** (LO) from the **fire-marking control center** assists in developing a fire-marking request. The coordinates of the target to be marked, the azimuth of fire from each battery firing, the number of rounds to be fired, and a target number are the essential elements of information needed by the fire markers. The fire-marking team proceeds immediately to the target area and marks the target with simulators and smoke grenades. A "chopper" team can be used as necessary for marking distant targets.

A controller, if present in the target area, works with the chief of the fire-marking team to assess casualties and equipment damage. The assessment is based on prescribed percentages per volley of the total number of men and amount of materiel actually in the area marked. If no controller is present, the assessment is made by the chief of the fire-marking team. The assessment is computed from tables presented in FM 105-5. No guesswork is necessary.

The company commander who wanted the fire and the FO who requested the fire should be able to see the smoke and the simulators. They can then call for additional fires or shift in fire on the basis of what they have seen and their knowledge of the effects obtained from the volleys of artillery fired on the target.

A fire-marking tag, showing the casualty and damage assessments, the azimuth of fire, etc., is presented to the ranking aggressor in the hit area. His name and unit are recorded on a copy of the tag retained by the chief fire marker.

The chief of the fire-marking team reports by radio to the fire-marking control center giving the damage assessments, aggressor unit designation, and the name of the aggressor to whom the fire-marking tag was given.

The fire-marking control center passes obvious surveillance information from the assessment, such as "two trucks burning," to the DS battalion. The DS battalion S3 then passes this information to the FO who requested the mission, as information which the FO normally would have seen had the fire been real. This information, along with what the FO actually observed, is of vital importance to him and to the infantry company commander.

The fire-marking control center also passes the same information along with the target number, the designation of the unit hit, and the name of the Aggressor to whom the fire-marking tag was given to the fire-marking statistical center.

At the statistical center the information is recorded for the commander's briefing. It is also passed to the fire-marking LO located at the FTX control center who passes it to the G1, G2, G3, G4, and artillery controllers. On the basis of this information, controllers can evaluate reports coming through aggressor or friendly channels and can pinpoint these units which fail to submit reports.

At the commander's briefing, the total of all fires marked, the number of casualties, and the amount of equipment damaged or destroyed are announced and are used by senior commanders for determining how reports were sent to higher headquarters, what tactical decisions were made, and what should have been done. Since the name of a unit representative and the designation of the unit hit are available for each target marked, specific comments can be made and mistakes in actions or decisions can be pinpointed as desired.

So far in this example of fire marking, the actions of only the friendly forces have been discussed. However, fire marking involves both friendly and aggressor forces. While the fires are being reported through "neutral" fire-marking channels, the aggressor commander who received the fire-marking tag should report his casualties and equipment losses as required by the aggressor SOP. Since the tag given to him indicated the azimuth of fire and the number and type of rounds fired on his position, he can and should develop and submit a shell report.

The shell report, coupled with other information and other shell reports, should enable the aggressor to develop sufficient counterbattery information so that sooner or later he can initiate counterbattery fire.

The procedures for marking counterbattery fire on friendly DS battalion and for making assessments are the same as those used when the aggressor target was hit.

Assessments against the friendly DS battalion will reduce the overall strength of the battalion; therefore, in each future firing on the battalion the casualties assessed by the fire marker will progressively decrease until losses in the battalion have been replaced. In this example, the aggressor attack was against an artillery battalion. However, aggressor forces are not limited in their attacks any more than the friendly forces. Fires can be marked for the aggressor against any target.

As shown on this example, the initial request by the infantry company commander for fire on the aggressor platoon started the following chain reaction:

- A DS artillery battalion fired on the aggressor platoon.
- The fire on the aggressor was marked.
- The friendly infantry saw the results of the fire on the aggressor and took appropriate action.
- The aggressor reported his casualties, submitted a shell report, and built up his counterbattery information.

- The aggressor artillery fired on the firing battalion.
- The aggressor fire was marked and casualties were assessed.
- The friendly DS battalion submitted a shell report and built up counterbattery information.
- Casualty and equipment replacement actions were initiated.

In an exercise such as that described in this example, controllers and commanders observe what is taking place; they know the casualty figures; they know which units have been seen and hit, which units are seeing and which are hitting, who is reporting, and, more importantly at this stage of training, who is not reporting. The training is realistic. The battle begins to make sense.

Can such realistic training be attained at a reasonable cost? The answer is yes, largely because every participant in such an exercise, whether he is a player, a controller, or a member of a fire-marking team, receives valuable training which is directly related to his regular job. An artillery forward observer team serving as a fire-marking team is trained on those functions which are vital to the mission of the forward observer, such as map reading, range estimation, communication, etc. The value of this training more than offsets the cost of the pyrotechnics which is actually about the only cost that can be directly charged to fire marking. Even some of the cost of the pyrotechnics can be counted as a training cost in that the fire-marker team members receive training on the handling of explosives, which is no small consideration.

Costs are so low in comparison to the results obtained that no field exercise should ever be conducted without strong consideration being given to the use of active fire marking.

Now, reconsider the battalion which moved under fire across the destroyed bridge. The battalion commander did not know the bridge was out. He might have assumed that his friendly artillery had silenced the aggressor artillery. A good reaction under these conditions would be to get out from under the artillery fire which was being marked on his position. The commander's mistake was not in moving across the river. He made his greatest mistake before that and his mistake was in being uninformed of the situation because of an exercise control failure, i.e., the effect of fire was not integrated into the exercise, and therefore realism was missing.

Fire marking properly done and properly acknowledged would have gone a long way toward giving the battalion commander a realistic view of the situation which faced him. His artillery liaison officer, simply by checking with the direct support battalion, could have given the commander much information about the:

- Calibers, locations, etc., of aggressor artillery.
- Capability of friendly artillery to cope with aggressor artillery.
- Status of bridges and routes leading to bridges.
- Artillery smoke screening capabilities.

The battalion commander's attack, rather than a shot in the dark, could have been a coordinated knowledgeable effort from which the training results might have been so great as to make combat success a foregone conclusion.

Why Is a Mil?

Major (Retired) Thomas D. Lynch, Jr.
Office of The Director of Logistics
USAAMS

In 1917, Captains Robert M. Danford and Onorio Moretti, in their "Notes on Training Field Artillery Details," defined the mil, for practical purposes, as the angle at the center of a circle which is subtended by an arc equal to one one-thousandth of the radius.

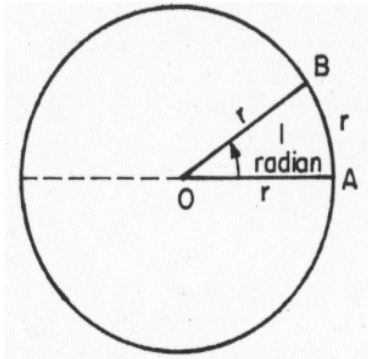

Figure 1. If arc AB is equal in length to the radius OA, or r, the central angle AOB is 1 radian.

Each radian will intercept an arc of 1,000 meters and each one-thousandth of a radian (mil) will intercept an arc of 1 meter. Therefore, we can state that an arc of 1 meter will subtend an angle of 1 mil at a radial distance of 1,000 meters.

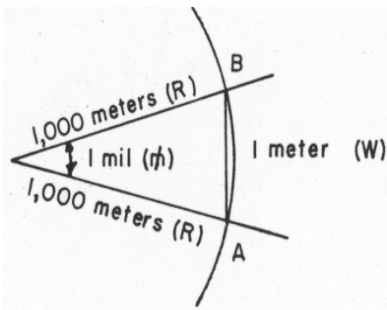

Figure 2. Chord AB \approx arc AB.

600 mils when data are estimated. However, when greater accuracy is required, the more precise mil relation ($mils = \frac{6400}{6283.2} \times \frac{W}{R}$, or $mils = 1.0186 \times \frac{W}{R}$) should be used.

We know from our study of trigonometry that a radian is that angle which, if its vertex is placed at the center of a circle, will intercept an arc on the circumference equal in length to the radius.

Also we know that a circle contains 2π radians and that π is approximately 3.1416. Therefore, a circle contains approximately 6.2832 radians. If we divide each radian into one thousand parts and call each part a mil (from the Latin word which means one one-thousandth), the circle will contain 6,283.2 milliradians. If the circle so divided has a radius of 1,000

As stated in FM 6-40, a mil is the angle subtended by a width of 1 meter at a distance of 1,000 meters, since for small angles (not greater than 330 mils) the chord is nearly equal to the arc.

To avoid computation with the cumbersome figure of 6,283.2 milliradians, we assume that the circle contains 6,400 milliradians and refer to them as mils. The mil relation ($mils = \frac{W}{R}$) produces

satisfactory results for any angle less than

$$mils = \frac{6400}{6283.2} \times \frac{W}{R}, \text{ or } mils = 1.0186 \times \frac{W}{R}$$

Southeast Asia Lessons Learned

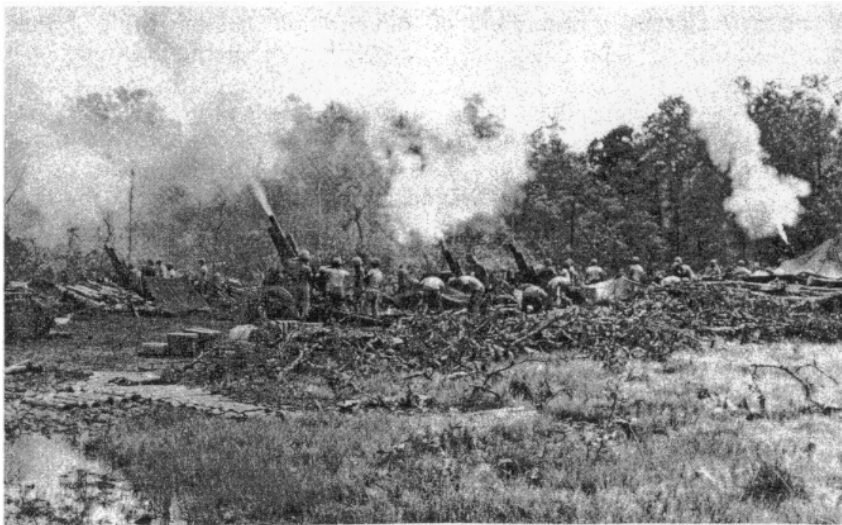

The following material finds its origin in information extracted by the U. S. Army Artillery and Missile School from correspondence which has passed between U. S. artillery units and USAAMS, efforts by departments of the School to solve problems experienced by units in counterinsurgency operations, and after action reports distributed by the Department of the Army.

MULTIPLE AMMUNITION LOTS

A persistent problem in all firing units is the multiplicity of ammunition lots. Several procedures can be adopted to help overcome this problem. Some of these are as follows:

- When ordering ammunition, specify to the ammunition officer exactly which lots are on hand and request that resupply be obtained from stocks of these lots at the ammunition supply point (ASP).
- Mark projectiles or fiber containers with an abbreviated lot code, using white or yellow chalk. This facilitates identification of different lots at night.
- Fire odd lots during harassing and interdiction missions.
- Segregate ammunition of different weight zones. If large amounts of ammunition of different weight zones are on hand, conduct a complete registration with ammunition in each weight zone.

PREMATURE BURST, FUZE M51A5

Information provided by the U. S. Army Munitions Command indicates that muzzle bursts with fuze M51A5 are frequently caused either by natural causes or by mishandling of ammunition in the firing battery. Some precautions to be followed to prevent such premature functioning are as follows:

- Avoid firing when large numbers of medium to large flying insects are prevalent in the firing position. Tests have proved that an insect the size of a bee can cause the fuze M51A5 to function.

- Reject damaged or disfigured ammunition. Turn back the round to the ASP, or, if explosive ordnance disposal (EOD) personnel are available, have them destroy the round in a safe place.

- Insure that fuzes are fully seated and tightened in the projectiles before firing. Projectiles and/or fuzes that have defective threads which prevent the fuzes from being fully seated and tightened should be turned back to the ASP or destroyed. A projectile should not be fired unless the fuze can be screwed into the projectile to a snug, tight fit (i.e., with no gap between the projectile and the base of the fuze ogive).

- When it is necessary to change the fuze on a projectile, insure that the supplementary charge is placed in the fuze well before installing fuze M51A5. Do not fire an M51A5-fuzed projectile without the supplementary charge.

- Be extremely cautious when firing fuze M51A5 in heavy rain; i.e., have personnel take cover.

- Inspect the bore periodically for obstructions (e.g., pieces of primer, shell casing, rotating band, etc.) from previous rounds. The report "bore clear" by the loader should be mandatory after each round to insure that the inspection has been accomplished and that no obstructions are present.

When premature bursts occur, determine and report as many details as possible concerning the incident. Pieces of the projectile and fuze are extremely valuable in determining and correcting the cause of premature bursts.

RETENTION OF SHELL CASINGS

Steel and brass shell casings should never be abandoned. There are two primary reasons for evacuating these items to the ammunition supply point:

- The enemy uses shell casings to make boobytraps, mines, and other forms of munition to use against us.

- Shell casings from expended rounds can be reworked into usable ammunition at the CONUS arsenals. Care should be taken to insure that shell casings are not needlessly damaged during evacuation.

CLOSE-IN DEFENSIVE CAPABILITIES

Although maneuver elements generally provide security for field artillery units, the responsibility for self-protection rests with the firing battery commander. Howitzers and guns are among the most effective weapons against close-in targets attacking or otherwise threatening an artillery position. Unit and crew training and a thorough knowledge of

ammunition and weapon capabilities are of key importance in attaining maximum effectiveness of available weapons and providing a secure perimeter defense. Some of the important facets of the employment of cannon against close-in targets are as follows:

- **Ammunition:** The 105-mm howitzer batteries have a distinct advantage over other artillery units, since the newly developed antipersonnel cartridge (See Reference Note CAN 7, Gunnery Department.) XM 546 (Beehive) was specifically developed for the 105-mm howitzer to provide a close-in defensive capability against personnel targets. (See earlier article on "Defense of the Battery Position.") High-explosive projectiles for all calibers, however, provide a potent means for repulsing attackers. The blast, or concussion effect, and the wider dispersion pattern of HE round make it effective in close-in defense. Also of considerable value is the white phosphorus projectile, which, in addition to being a casualty producer, has a psychological impact on the attacker and can provide an effective screen for the defended position.

- **Fuzes:** When personnel are engaged at short ranges, proper selection of fuze is of utmost importance. The variable time (VT) fuze M513 or M514 cannot be effectively used at short ranges because of its minimum arming time of 3 seconds. The mechanical time, superquick (MTSQ) fuze M500 or M520 has similar limitations, since the minimum arming time, coupled with the high muzzle velocity required for direct fire, will place the burst beyond targets closer than 300 meters. Fuze quick or delay provides the best fuze action for short ranges, but the muzzle velocity must be high to facilitate adjustment and to insure fuze arming. For cleared target areas, fuze quick, fired into the ground, into brush, or at rocks near the enemy, will produce an effective burst pattern. Fuze delay, fired to produce a ricochet on hard ground, will likewise provide an effective burst pattern. In brush or thickly vegetated target areas, fuze delay may be essential to insure a burst at the desired range.

- **Weapon emplacement:** Howitzers and guns must be properly emplaced to facilitate engagement of the enemy by direct fire. The minimum elevation of the M107 and M110, for instance, must be considered when emplacing these weapons.

- **Other considerations:** The disposition of friendly troops is of key importance and must be known to guncrews and all other firing battery personnel. Fields of fire must be cleared and, in some cases, prepared with berms or other obstacles which will insure fuze action. The training of firing battery personnel is of utmost importance. Live fire practice should be conducted periodically by each gun or howitzer section.

AERIAL OBSERVERS

Aerial observers must exercise extreme caution in selecting and reporting registration points for artillery units. Erroneous coordinates will produce invalid registrations and may create a serious hazard to friendly elements. Corrections obtained by the fire direction center based on a

misplotted registration point are invalid. When the corrections are subsequently applied to chart data for a close-in defensive concentration or other targets near friendly personnel, the resulting error may prove fatal to friendly elements.

INTERDICTION OF LAND LINES

An artillery interdiction program fired along isolated sections of a road is effective in disrupting enemy mining activity. Fires should be adjusted during daylight hours and then placed at random on selected targets during hours of limited visibility. VT or time fuze should be employed to enhance burst effects and to prevent or minimize damage to roadbeds. The surprise effect of apparently unadjusted artillery fire will restrict and discourage enemy mining activity.

SELF-ILLUMINATION

Field artillery units can provide self-illumination of their own position or of portions of their perimeter in two ways:

- High-angle fire (quadrant of 900 mils), charge 1, and a time setting of approximately 6 seconds can be used to provide a burst at the desired height and about 300 to 500 meters from the gun position. Care must be taken to insure that prevailing winds will not cause the flare to drift back into the battery position. Units should conduct live fire practice to determine the best quadrant and fuze setting for a particular position. Care must also be taken to insure that expended projectiles will not land in friendly positions.

- Direct fire procedures can be used to place a burning flare on a specific target on or near the perimeter. A low charge should be used and live fire practice conducted to determine the optimum quadrant and fuze setting. The flare from an illuminating projectile delivered by use of direct fire procedures will light only that small area where the flare is ejected and burns on the ground. The interior of the position area will not be lighted, and friendly elements will remain hidden from the enemy.

LIAISON WITH ALLIED ARTILLERY

Success in counterinsurgency operations throughout history has come to the commander that effectively coordinates **all means available**. The tendency to jealously guard our own means of fire support while ignoring others fails to take advantage of excellent support that is often available from our allies. Outstanding examples of cooperation and the benefits of such cooperation are available today. A few examples are.

- Close integration of all fire support means to the extent that survey is carried to allied units and a "coordination center" is established by the senior artillery headquarters in the operational area. This can and has been accomplished even at the direct support battalion level for separate operations.

- FADAC—Allied units are included in the FADAC and the FADAC is used to compute data for the allied fire unit. Reinforcing missions are exchanged in support of U.S. and allied units.

- The simple exchange of liaison officers and exchange of intelligence information through the liaison channel.

PREVENTIVE MAINTENANCE CHECKS AND SERVICES

Lack of proper organizational maintenance has resulted in many problems faced by units in Southeast Asia. Personnel in charge of a weapon tend to perform maintenance only when there is a malfunction with the equipment and then, not to perform the proper organizational maintenance. It is suggested that personnel check the following charts which indicate the weapon, the technical manual, pages and the number of checks to be performed (daily, weekly, monthly and quarterly). Weapons listed include the following: M1A1, 75-mm Howitzer (Towed); M101 & M101A1, 105-mm Howitzer (Towed); M102, 105-mm Howitzer (Towed); M52, 105-mm Howitzer (SP); M108, 105-mm Howitzer (SP); M12, 155-mm Gun (Towed); M53, 155-mm Gun (SP); M114 & M114A1, 155-mm Howitzer (Towed); M123A1, 155-mm Howitzer (Towed); M44 & M44A1, 155-mm Howitzer (SP); M109, 155-mm Howitzer (SP); M115, 8-inch Howitzer (Towed); M55, 8-Inch Howitzer (SP); M110, 8-Inch Howitzer (SP); M107, 175-mm Gun (SP).

Lube orders to be checked for preventive maintenance checks and services are as follows:

M1A1, 75-mm Howitzer (Towed)	LO 9-319
M101 & M101A1, 105-mm Howitzer (Towed)	LO 9-1015-203-10
M102, 105-mm Howitzer (Towed)	LO 9-1015-234-10
M52, 105-mm Howitzer (SP)	LO 9-2350-209-12
M108, 105-mm Howitzer (SP)	LO 9-2350-217-12 C 2, 3, 4, Oct 66
M12, 155-mm Gun (Towed)	LO 335
M53, 155-mm Gun (SP)	LO 9-2350-210-12
M114 & M114A1, 155-mm Howitzer (Towed)	LO 9-1025-200-10
M123A1, 155-mm Howitzer (Towed)	LO 9-1025-200-10
M44 & M44A1, 155-mm Howitzer (SP)	LO 9-2350-203-12
M109, 155-mm Howitzer (SP)	LO 9-2350-217-12 C 2, 3, 4, Oct 66
M115, 8-Inch Howitzer (Towed)	LO 9-1030-203-10
M55, 8-Inch Howitzer (SP)	LO 9-2350-210-12
M110, 8-Inch Howitzer (SP)	LO 9-2300-216-12
M107, 175-mm Gun (SP)	LO 9-2300-216-12

SENTINEL TRAINING ESTABLISHED

The Sentinel Central Training Facility has been established at the US Army Air Defense School, Fort Bliss, Texas, to train personnel for the first planned deployment of the Sentinel ABM system.

Officers, warrant officers, and enlisted men will be trained in artillery, ordnance, and engineer skills necessary to operate the Sentinel system. In addition to individual job training, the agency will monitor ABM research and development efforts. Director of the new agency will be Colonel Augustus R. Cavanna, Jr.

Ultimate size of the agency is still in the planning stage.

Active Army, Marine Corps, Reserve and National Guard, Allied Forces Weapons

		Maintenance Schedule								
		No. of Checks		Daily				Weekly	Monthly	Quarterly
Weapon	TM	Pages	Before Travelling	Before Firing and Operation	During Firing and Operation	After Firing and Operation	Weekly	Monthly	Quarterly	
M1A1 75-mm How (Towed)	9-319	186-187	7	4	1	5	10	12	1**	
M101 M101A1 105-mm How (Towed)	9-325 Changes 1-8	C 5 & 6	12	21	10	14	6	21	1	
M102 105-mm How (Towed)	9-1015-234-12	C 3 pp 48-51	9	15	7	11	-	13	-	
M52 105-mm How (SP)	9-7204 w/C 1, 4, 5, 6, and 8 Vehicle	138-139 143-151		7	6	8	15	27	42	
M108 105-mm How (SP)	9-2350-217-10 Arment	138-139 124-128	13	17	6	22	26	27	42	
M12 155-mm Gun (Towed)	9-3038 Arment	128-135 89-97	15	28 14	27 9	34 13	16 53	4 16*	7 15**	
M53 155-mm Gun (SP)	9-2350-210-12 9-3025 Vehicle	99 102-107		8	5	9	15	25	44	
M114 M114A1 155-mm How (Towed)	9-1025-200-1? Arment	99-108 93-98	12	20 6	5 1	22 5	44 -	26 17	47 -	

M123A1 155-mm How (Towed)	9-1025-12	93-98	9	8	4	5	-	19	-
M44 M44A1 155-mm How (SP)	9-7004 w/C 1, 3, 5, 6, 7, 8, 9, and 10 Vehicle Armament	C 6 10-35 10-35		7 27	5 21	17 27		1	40 12
M109 155-mm How (SP)	9-2350-217-10								TM 9-2350-217-20 w/C 1 & 2 pp 27-32 48 checks
M115 8-Inch How (Towed)	9-3004	124-128 128-135 77-86		6 30 13	5 28 7	18 38 10	18 32	4 12*	9 14**
M55 8-Inch How (SP)	9-2350-210-12 9-3025	99 102-107		8	5	9	15		
M110 8-Inch How (SP)	9-2300-216-10 w/C 2, 4, 5, 7, and 8 Vehicle Armament	C 2 pp 5 & 6 C 2 pp 5 & 6		20 7 41	5 4 27	22 17 40	44 26	25 26	44 47
M107 175-mm Gun (SP)	9-2300-216-10 w/C 2, 4, 5, 7, and 8 Vehicle Armament	C 2 pp 5 & 6 C 2 pp 5 & 6 C 2 pp 5 & 6		7 41	4 27	17 40	18 2	2	TM 9-2300-216-20 C 1 pp 5-9 38 checks 17

*8Monthly
**Semiannually

ALPHABETICAL INDEX

ARTILLERY TRENDS 1966-67

ARTICLES

Article	Issue	Page
Airborne Artillery (organization)	Jul 66	45
Airmobile Artillery (organization)	Jul 66	47
Airmobile Artillery in Combat	Aug 67	12
Ammunition (FA equipment)	Jul 66	12
Armored/Mechanized Artillery (organization)	Jul 66	40
ARSTRIKE Book Box	Jan 67	59
Artillery Fire Planning	Jan 67	53
Artillery Hops a Ride	Aug 67	21
Collimator — The Easy Aiming Reference	Jan 67	36
Command Control	Jul 66	34
Communications (FA equipment)	Jul 66	21
Communications (operations)	Jul 66	72
Defense of the Artillery Battery	Jan 67	23
Employment of the Honest John in a Conventional War	Jan 67	50
Expanded Communications in Vietnam	Jan 67	33
Forms and Orders	Jul 66	75
Gunnery (operations)	Jul 66	57
Honest John FA Battalion (organization)	Jul 66	44
How Now with Mini-How	Aug 67	82
Improvement of Artillery Target Acquisition Effectiveness	Jan 67	44
Infantry Artillery (organization)	Jul 66	36
Meteorology (FA equipment)	Jul 66	32
MOS Evaluation System and You	Jan 67	63
Plotting Board Eases FO's Job	Aug 67	79
Point-Blank Defense — Direct Fire	Aug 67	46
Precise Azimuth in a Pinch	Aug 67	68
Simple Solution to the 6400-mil Charts	Jan 67	11
Simplified Azimuth of Polaris	Aug 67	71
Speed Shifting the 155-mm Howitzer, Towed	Jan 67	17
Tactics (operations)	Jul 66	58
Target Acquisition (FA equipment)	Jul 66	27
Transfers Unlimited	Aug 67	58
Transportation (FA equipment)	Jul 66	14
Vietnam Operations Activate the Searchlight Battery	Aug 67	52
Vietnam's ARA	Jan 67	41
Weapons (FA equipment)	Jul 66	4

SHORT SUBJECTS

Article	Issue	Page
Alphabetical Index Artillery Trends - 1965	Jan 67	81
Artillery Mathematics	Jul 66	73

Artillery Publications	Jul 66	86
Basic Symbols	Jul 66	35
Collimator, Infinity Aiming Reference	Jul 66	3
Crossword Puzzle	Aug 67	11
Graphical Lethality Table	Jul 66	57
Pershing to Undergo Improvements	Aug 67	8
Sample Fire Request	Jan 67	68
TACFIRE	Jul 66	71
Vehicle Recovery Expedient	Aug 67	9

INSTRUCTIONAL DEPARTMENT NOTES

Article	Issue	Page
Armor Kits	Aug 67	5
Automatic Data Processing System	Jan 67	10
Capstan Kit	Aug 67	4
Know Your AN/PRC 25	Jan 67	4
DA Pamphlet 350	Aug 67	3
Master Mechanic Course	Jan 67	3
Embedded Corrections	Aug 67	5
FADAC Program Tapes	Jan 67	7
FADAC Training Films	Jan 67	7
Field Artillery Observation	Jan 67	6
Instructional Material	Jan 67	8
M562 Fuze	Jan 67	7
Metro Information Letters	Jan 67	10
New Cargo Truck in Vietnam	Aug 67	5
Nuclear Weapons Employment Officer Refresher Course	Jan 67	9
Pershing Integrated Maintenance Procedure	Jan 67	5
Radar Maintenance Warrant Officers	Jan 67	9
Senior Sergeant Extension Course	Aug 67	7
Use of the Antenna AT-984 A/G	Jan 67	5
Wind Cards	Jan 67	6

LESSONS LEARNED

Article	Issue	Page
AN/MPQ-4A in Vietnam, The	Aug 67	85
AN/MPQ-4A Receiver Crystal Trouble	Jan 67	78
Employment of Countermortar Radar AN/MPQ-4A	Jan 67	75
Firing Procedures in the Paddies	Jan 67	71
Gunnery Problems and Solutions in Vietnam	Jan 67	79
Improved Pibal Metro Data for Vietnam	Jan 67	73
Lost and Found	Jan 67	79
Operations Requirements in Vietnam	Aug 67	87
RDP for 6400-mil Chart	Jan 67	80
Traps 'n Tidbits	Aug 67	89
Traverse for the 175-mm Gun and 8-inch Howitzer, 6400-mil	Jan 67	70
Vehicle Recovery Operations	Jan 67	72

INFORMATION LETTERS

Information Letters are designed to inform groups of field artillery personnel of new developments occurring within their specific areas of interest. Normally unclassified, these letters bring to the artilleryman data on the latest techniques, procedures, equipment, and equipment modifications which will eventually be included in official Field Manual and Technical Manual publications.

During 1966-67, the following letters were published:

TITLE	SUBJECT	Date
Ammunition 1	M564 Fuze	11 Oct 66
Fire Control and Coordination..... 1	6400-mil Firing Chart	21 Nov 66
Fire Control and Coordination..... 2	M1 Collimator—This information letter is being revised, see Gunnery Dept. Notes in this issue	18 Feb 67
Fire Control and Coordination..... 3	175-mm Slant Scale GFT	1 Apr 67
Fire Control and Coordination..... 4	FADAC Met and Registration Corrections	4 Sep 67
Honest John/Little John..... 9	(categorized under previous systems)	25 May 66
Meteorology 11	(categorized under previous system)	3 Jan 66
Meteorology 12	(categorized under previous system)	20 Jun 66
Mobility 1	Maintenance—M107, M110 and M578 DC Charging Systems	27 Jan 67
Pershing 4	(categorized under previous system)	undated
Weapons 1	175-mm Gun (see Gunnery Dept. Notes in this issue for a change to this information letter)	1 Apr 67
Weapons 2	8-inch Howitzer	8 Mar 67
Weapons 3	M108 Howitzer	20 Jun 67
Weapons 4	Honest John/Little John	16 Aug 67
Weapons 5	M109 Howitzer	22 Aug 67

L1136 Army-Ft. Sill, Okla.