

# ARTILLERY RENDS



US ARMY  
ARTILLERY AND  
MISSILE SCHOOL

AUGUST 1967

# Introduction



The cover photograph was provided by Vertol Division of Boeing Company

## ● COVER

With the growing demand for greater mobility in Vietnam, the artillery has developed new techniques designed to keep in close support of the heliborne infantry. In past issues, ARTILLERY TRENDS' readers have been informed of the artillery's progress in airmobile (formerly referred to as air assault) operations. In this issue, the role of airmobile artillery is once again discussed, but now based on experience gained in combat. In "Airmobile Artillery in Combat," LTC Lloyd J. Picou, former Executive Officer of the 1st Cavalry Division (Airmobile) Artillery, describes techniques now used and compares them with those advocated in the articles

published earlier in ARTILLERY TRENDS. While not designated as Airmobile, other units in Vietnam have become extensively dependent on transportation by air. From compilations of reports from these units as well as procedures tested in CONUS, the Tactics/Combined Arms Department at the U. S. Army Artillery and Missile School is publishing an instructional note on airmobile operations. A portion of the handbook concerned with rigging external loads constitutes the basis for the article, "The Artillery Hops a Ride."

Operations in Vietnam renew the artillery's emphasis on the use of searchlights, direct fire procedures, and normal training operations. Such subjects are treated in separate articles also contained in this issue.

The material contained in this publication represents the best information available at the time of publication. All readers and users of this handbook are encouraged to forward information concerning changes or suggestions for improvement of content and format to:

Commandant  
U. S. Army Artillery and Missile School  
ATTN: AKPSIAS-PL-AT  
Fort Sill, Oklahoma 73503

# INSIDE THIS ISSUE

## INSTRUCTIONAL AID NO. 38

<b>INTRODUCTION</b> .....	1
<b>INSTRUCTIONAL DEPARTMENT NOTES</b> .....	3
<b>CROSSWORD PUZZLE</b> .....	9
<b>ARTICLES</b>	
Airmobile Artillery in Combat .....	12
The Artillery Hops a Ride .....	21
Direct Fire .....	46
Vietnam Operations Activate the Searchlight Battery .....	52
Transfers Unlimited .....	58
Precise Azimuth in a Pinch .....	68
Simplified Azimuth of Polaris .....	71
Plotting Board Eases FO's Job .....	78
How Now with the Mini-How .....	82
<b>LESSONS LEARNED IN VIETNAM</b> .....	84



ARTILLERY TRENDS is an-instructional aid of the United States Army Artillery and Missile School published only when sufficient material of instructional nature can be gathered.

# Instructional Department Notes

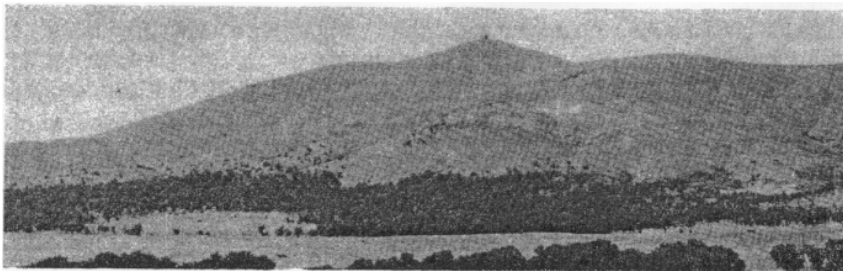

## **Artillery Transport Department**

Having problems with your organizational maintenance/operator training program? If so, check your publications library for the special edition of Department of the Army Pamphlet 350 series. Notice that reference was made to your library, not DA Pam 310-1. This series is not listed in the 310-1 and as best can be determined, it will not be listed. This special edition of the 350 series was issued on a one time distribution to all units in CONUS that expressed a desire or need for them. In all probability, if your unit is in CONUS, you have them.

Typical contents of one of the pamphlets is quoted for your information. Department of the Army Pamphlet 350-36, Operator Training Course, Miscellaneous Compressor, for example, is prefaced as follows: "This instructional pamphlet consists of seven lessons -- a conference, demonstration on safety; a conference on the Army Maintenance System; a conference on the Army Equipment Records Procedures; a demonstration, practical exercise on starting and stopping procedures; a practical exercise on compressor operation; and a test covering all material in these lessons."

One of the best features of the series is that by substituting references and extracting the proper technical information from the -10 or -20 TM's on the equipment concerned, these lesson plan formats can be used for many like items of equipment.

This special series of DA Pamphlet 350 was published as part of the new maintenance program to improve combat readiness and materiel readiness. They contain complete lesson plans to train operators, organizational mechanics, supervisors, and even supply personnel at organizational Direct Support/General Support levels. All the unit need provide is the equipment pertinent to the class being given, the references listed and the necessary instructors with their assistants. All of



the rest is in the pamphlet and a student work book packet on unit and organizational supply procedures can be ordered.

Probably, any one unit will not need the entire series; however, additional copies of the ones needed may be requisitioned through normal publications channels, providing your unit was on the initial distribution.

Here is a list of DA Pamphlets in the 350 special series:

**DA Pam 350 series. Distribution will be made direct from printer.**

**Resupply will be to addressees only**

DA Pam 350-20	Commanders Supply Handbook
DA Pam 350-21-1	Instructor's Guide—Unit and Organization Supply Procedures
DA Pam 350-21-2	Student's Workbook, Unit and Organization Supply Procedures.
DA Pam 350-22-1	Instructor's Guide—Stock and Supply Accounting Procedures
DA Pam 350-22-2	Student's Workbook—Stock Control and Supply Accounting Procedures
DA Pam 350-23	Commander's Course (Officers and NCO's whose primary duty is not maintenance)
DA Pam 350-24	Supervisor's Course — Motor Officer/NCO/Maintenance Officer
DA Pam 350-25-1	Organization Mechanic/Repairman Course—Armored Carrier, M113.
DA Pam 350-25-2	Organization Mechanic/Repairman Course—Self—Propelled Artillery.
DA Pam 350-25-3	Organization Mechanic/Repairman Course—Tank, M60A1
DA Pam 350-25-4	Organization Mechanic/Repairman Course—Tank, turret, M60A1.
DA Pam 350-26-1	Organization Mechanic/Repairman Course—Truck, Utility, M151.
DA Pam 350-26-2	Organization Mechanic/Repairman Course—Truck, Dump, M51.
DA Pam 350-26-3	Organization Mechanic/Repairman Course—Truck, Wrecker, M543.
DA Pam 350-26-4	Organization Mechanic/Repairman Course—Larc V
DA Pam 350-27-3	Organization Mechanic/Repairman Course—Communication — Radio Set AN/PRC-6
DA Pam 350-27-2	Organization Mechanic/Repairman Course — Communication — Teletype — Writer Set, AN/PGC-1.
DA Pam 350-27-1	Organization Mechanic/Repairman Course—Electronics — Radar Set — AN/PPS-4
DA Pam 350-28	Organization Mechanic/Repairman Course — Helicopter
DA Pam 350-29-1	Organization Mechanic/Repairman Course — Materials Handling Equipment.
DA Pam 350-29-2	Organization Mechanic/Repairman Course — Power Generator Equipment.
DA Pam 350-30	Organization Mechanic/Repairman Course — Compressor.
DA Pam 350-31-1	Operator Training Course — Armored Carrier, M113.
DA Pam 350-31-2	Operator Training Course — Self-propelled, Artillery
DA Pam 350-31-3	Operator Training Course — Tank M60A1.
DA Pam 350-32-1	Operator Training Course — Truck, Utility, M151.
DA Pam 350-32-2	Operator Training Course — Truck, Dump, M51.
DA Pam 350-32-3	Operator Training Course — Truck, Wrecker, M543.
DA Pam 350-32-4	Operator Training Course — LARC V
DA Pam 350-33-1	Operator Training Course Communication — Radio Set, AN/PRC-6.
DA Pam 350-33-2	Operator Training Course Communication — Radio Teletypewriter, AN/PGC-1
DA Pam 350-33-3	Operator Training Course Electronics — Radar Set AN/PPS-4
DA Pam 350-34	Operator Training Course Helicopter, UH-1B.
DA Pam 350-35-1	Operator Training Course — Materials Handling Equipment
DA Pam 350-35-2	Operator Training Course — Power Generator Equipment
DA Pam 350-36	Operator Training Course—Air Compressor.

**CAPSTAN KIT**

A self-recovery device has been developed recently for use on the M113 family of vehicles. The device, referred to as a Capstan Kit, consists of a removable capstan drum and an adapter which are attached to the outside of the drive sprockets. A one-inch nylon rope is connected between the capstan and a ground anchor. With minor modifications it could be used with other tracked vehicles and the Army Tank-Automotive Center is presently considering the development of capstans for some tactical wheeled vehicles as well.

## **ARMOR KITS**

Special armor kits have been developed for tactical vehicles and slow moving construction and earth-moving equipment to protect operators from enemy guerrilla fire. The armor plates are fitted together and joined by bolting, somewhat like an erector set. The modular plate is composed of dual-hardness steel in four basic sizes. For the M113 family of vehicles, additional protection against armor - defeating weapons has been designed. Counteracting the shaped charge principle, standoff shields will be placed along the sides of the vehicle.

## **NEW CARGO TRUCK IN VIETNAM**

The Goer 8-ton cargo truck, M52OE1, has been type classified Standard A and a few of these vehicles are being used by selected transportation units in Vietnam for resupply of ammunition and other supplies to Artillery units.

## **Gunnery Department**

### **EMBEDDED CORRECTIONS**

Questions have been raised on how the corrections embedded on breeches of the self-propelled M109, and M108 howitzers are applied to the end-for-end test. TM 9-2350-217-10 fails to cover specifically how such corrections are applied.

The reason for embedded corrections is to compensate for errors resulting from slight misalignment of tube and breech. The howitzer tube may be manufactured in one factory, and the breech in a second, and the two mated in a third. All tubes and breeches are threaded to prescribed tolerances depending on the accuracy limits of the individual metal lathe. As a result, the threads for each tube and breech may vary slightly in pitch and depth. When mated, the center lines of the tube and breech may not form a parallel with the center line of the breech. The angle in mils formed by the quadrant seats and the center line of the tube is the embedded breech correction.

To properly boresight, this error must be taken into account as follows:

- (1) Level the trunnions as accurately as possible.
- (2) Using the gunner's quadrant, perform the end-for-end test as prescribed. (Do not use the embedded correction at this time.) The end-for-end test has leveled only the breech (assuming the quadrant seats are parallel to the breech center line.)
- (3) To level the tube, add the embedded correction to the reading on the gunner's quadrant (determined from the end-for-end test.)

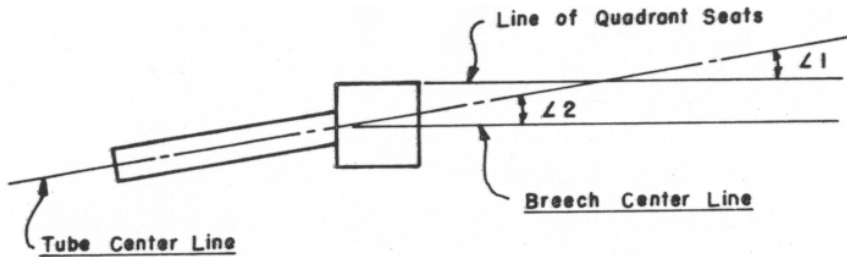

**Figure 1. Error in center lines, embedded corrections. 1 Error between quadrant seats and tube. Equal to embedded corrections. 2 Error between center lines of breech and tube.**

Example:	Embedded correction	+2.0 mils
	Reading on gunner's quadrant after end-for-end test	±0.3 mils
	Total correction	<hr style="width: 100px; margin-left: auto; margin-right: 0;"/> +2.3 mils

With +2.3 mils set on the gunner's quadrant, center the quadrant level vial bubble using the elevating mechanism. The tube is now level.

(4) Center the cross-level vial bubbles on both the panoramic and direct fire telescope. Insure that the elevation counters are set at zero. Inspect the elevation level vials on both the panoramic and direct fire telescope sight mounts. If the bubble is not centered to within one mil, the piece should be turned in to direct support maintenance to have its sight mounts adjusted.

(5) If the piece cannot be turned in to direct support maintenance the elevation level vial bubble may be centered by adjusting the elevation knob. The reading on the elevation counter is then placed on the correction mil counter during firing. The embedded correction may be forgotten and will not be used when firing since the correction has been compensated for by the correction mil counter or by the sight mount adjustment.

TM9-2350-217-10, page 62, figure 39, 0, states that after boresighting the direct fire telescope, set telescope mount slip scale to elevation 4, azimuth 4 to allow a plus or minus correction to be made in the graduated area of the scale. Reasons for this particular procedure are based on the following factors.

The telescope mount slip scales are graduated in tenths from 1 to 7 mils. The reason is to allow for small corrections to be applied for

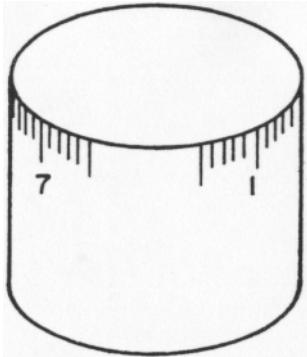

**Figure 2. Telescope mount slip scale**

area which is not graduated. If the scales were slipped to the number one or seven during boresighting, the "experience corrections" referred to above could fall in the ungraduated zone.

"factors peculiar to the individual weapon or its emplacement." In tank gunnery these scales are used to set an "emergency zero." This is a predetermined compensation for known characteristics of a weapon and effects of gravity.

This capability has been built into our direct fire equipment to allow the setting of those "experience corrections" that may be necessary on a particular weapon to improve direct fire accuracy.

Figure 2 shows the graduated slip scale. Notice that there is a 1/2-mil

## **Nonresident Instruction Department**

### **SENIOR SERGEANT EXTENSION COURSE**

A new extension course for the Field Artillery Senior Sergeant is being offered effective 1 July 1967. The new course, offered by the Nonresident Instruction Department of the U. S. Army Artillery and Missile School, is designed to provide the information required to meet the knowledge requirements of MOS 132Z50, (Field Artillery Senior Sergeant, E8 and E9). This knowledge, when supplemented by on the job training, can lead to qualification in the subject MOS.

This special career development extension course provides instruction in common subjects and branch material which is applicable to the organization and operation of field artillery cannon and rocket units. The program of instruction includes lesson material on fire direction; reconnaissance, selection and occupation of position; offense and defense; target acquisition; and communication.

Noncommissioned officers E6 and above are eligible to enroll in the course. They should, however, be fully qualified in at least one MOS in career Groups 13 or 17 to a minimum skill level of 40. This course consists of three phases of instruction with a total allocation of two hundred fifty credit hours and is designed for student completion in three years. Further, successful completion of this course is a prerequisite for enrolling in the USACGSC Sergeant Major and Operation Sergeant Extension Course. Enrollment can be accomplished by submitting DA Form 145, Army Extension Course Enrollment Application to the Commandant, U. S. Army Artillery and Missile School, Nonresident Instruction Department,

ATTN: Extension Courses Division, Fort Sill, Oklahoma 73503.

All eligible noncommissioned officers are strongly encouraged to take full advantage of this excellent opportunity to further their career development through the U. S. Army Artillery and Missile School Extension Course Program.

---

## PERSHING TO UNDERGO IMPROVEMENTS

A firing battery operating in the field with the Pershing soon will be taking on a new look as a result of improvements designed to increase rate of fire and reliability of the weapons system.

Under the improvement program — known as Pershing Ia — there will be no changes to the 34-foot-long missile, but several in ground support equipment.

The biggest outward change will be in shifting from tracked vehicles to wheeled vehicles for transporting the missile system. The change is designed to reduce vibrations to equipment during movement. And too, wheeled vehicles are not as expensive as those with tracks and require less maintenance.

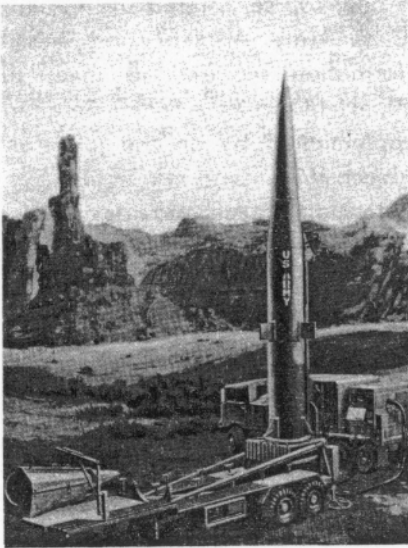

Pershing is a highly mobile, quick reacting Field Army support weapon in operation with U. S. Army troops in the United States and Europe, and West German troops. The missile has a range of from 100 to 400 nautical miles.

Mounting a firing battery on wheeled vehicles will not reduce the "shoot and scoot" capability of Pershing, because the range of the missile allows considerable choice in selecting a launch site.

A Pershing Ia battalion will be organized with four firing batteries as is the present Pershing battalion. A battery will have several missiles, each on an improved erector - launcher mounted on a semi-trailer.

The warhead section will be transported on the improved erector - launcher vehicle, ready for assembly to the missile.

The improved programmer test station/power station, radio terminal set and new firing battery control center will be mounted on five-ton trucks.

## Vehicle Recovery Expedient

In the event that natural anchors are not available for use in vehicle recovery operations, a handy expedient has been devised utilizing the baseplate of the 105-mm howitzer M102.

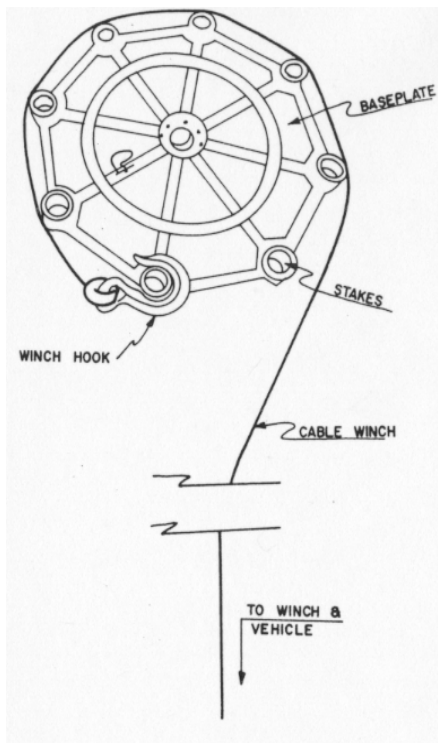

Personnel of Battery C, 2d Battalion, 319th Artillery at Fort Campbell, Kentucky, report that detaching and then emplacing the baseplate of the M102 about 50 feet in front of the vehicle to be recovered serves adequately as a dead man. The winch cable is fed out and around the baseplate which has been staked into position using the eight stakes. The hook of the winch cable then is hooked to the front stake nearest the vehicle. With the installation completed, the vehicle can be recovered by engaging the winch and pulling the vehicle out of most any situation.

The Fort Campbell unit reported that the method just explained can be installed, the vehicle recovered, and the baseplate reattached to the howitzer in approximately ten minutes. When compared to the trench dead man, this method was found to be easier and more desirable.

---

### TERMS USED IN RVN

**GOVERNMENT OF SOUTH VIETNAM (GVN)** — Term used to refer to the national government or to the entire governmental structure or used as an adjective to describe one of its agents or agencies.

**HAMLET** — The political subdivision of the village. The hamlet resembles a town but includes neighboring rural areas. Hamlets are usually too small to be a viable administrative unit, and the hamlet chief and deputy chiefs are primarily concerned with organizing local security and identifying the people with their own defense.

**LLDB** — Vietnamese Special Forces organized and patterned after the US Special Forces.

## ACROSS

1. Error-free (2 words)
9. Firing need
14. Linguist capability
19. Index for officers (abbr)
20. Spotter
22. Second in command (abbr)
23. One department (abbr)
24. Phonetic for 9
26. Paragraphing requirement
27. 1,000 meters
31. Close-in weapon
34. Type explosive (abbr)
35. A command (time fuze)
36. Army guidelines (abbr)
37. Canadian artillery (abbr) (abbr)
38. Artillery tactical mission
39. Fire direction term
42. Administrative record (abbr)
43. Lowest elevation (abbr)
44. Not new
47. A fire command (abbr)
49. Commander needs this
50. A full canteen prevents this
51. Aptitude area (abbr)
52. Reading from on instrument (abbr)
53. Order to travel (abbr)
54. First
55. An Army command (abbr)
56. See 32 down
57. Job element (abbr)
58. Type brigade (abbr)
61. Type bombing (abbr)
63. Society of Engineers (POL) (abbr)
64. Report on officers (abbr)
65. Nuclear Warfare Evaluating Team (abbr)
66. 4 quarts (Abbr)
69. Aptitude area (abbr)
70. Can be separated (abbr)
72. Military "Chief of Police" (abbr)
74. Map abbreviation
75. Place of duty
77. FBI conducts this (abbr)
78. Artillery tactical mission
81. Friendly dispositions (abbr)
83. See 34 across
84. Informed special staff officer (abbr)
86. State of readiness (abbr)
87. Type communications sketch
88. Pattern of fires
91. "\_\_\_\_\_ the way"
92. Not commissioned (abbr)
93. Career soldier (abbr)
94. Supply authorization for TD units (abbr)
95. A "must" for exams (abbr)
96. Runs post office (abbr)
97. Air defense targets (abbr)
98. \_\_\_\_\_ gunfire
101. \_\_\_\_\_ line (abbr)
102. Tank ammunition (abbr)
104. Provides illumination (abbr)
105. Firing term (abbr)
107. Climbing device
109. Rays (nuclear)
112. Capability (abbr)
114. Measurement of projectile speed (abbr)
115. An FDC sheet
119. Commander's representative (abbr)
120. Opposite of drop
122. Short duration duty (abbr)
124. Military manual (abbr)
125. Inspectors need one
130. Large printing office (abbr)
131. "\_\_\_\_\_, Honor, Country"
132. Ammunition rate (abbr)
135. Continent (abbr)
136. Task forces (abbr)
137. Same as 52 across
139. Missile posture
143. \_\_\_\_\_ or fires (firing planning)
146. AER asks for this
147. Starting line
149. Radar capability
151. Not an entrance
152. Cook's "tool"
153. Suspend firing
154. A solder's guidance (Abbr)
155. Ammunition load (abbr)
156. Before flight (abbr)
157. Type liaison officer (abbr)
159. \_\_\_\_\_ five cannoneer (abbr)
160. Line \_\_\_\_\_ (supply)
162. First one (abbr)
164. Firing table (abbr)
165. \_\_\_\_\_ act of aggression
168. By Direction of President (abbr)
169. Not forward
171. Beyond target
172. VCO's goal
173. Armor soldier (nickname)
178. "The Hour of \_\_\_\_\_"
179. Two-legged support (abbr)
180. Type control (MP)
181. Form for options (abbr)
183. A coat (abbr)
184. Branch not specified (abbr)
185. HCO has one
188. A combined arm (abbr)
189. Medical record (abbr)
190. Flat trajectory weapon
192. Direction of angle
193. Product of 152 across
194. Camera measurement (abbr)
195. Don't change (abbr)
198. Not shallow
199. Property record (abbr)
200. Defense organization (Europe) (abbr)
202. Type ammunition (abbr)
204. A manual (abbr)
205. Individual weapons (abbr)
207. Air Force Reporting Center (abbr)
209. 0001-1200 hours (abbr)
211. Combat
212. Burst height (abbr)
214. A firing area
217. Morale builder
218. Covered in 5th general order (interior guard)
219. Route order (abbr)
220. See 128 down

## DOWN

1. Area of interest
2. G2 responsibility (abbr)
3. Telephone capability
4. Type artillery support
5. Front line area (abbr)
6. Allow communication security
7. A bulletin (abbr)
8. Communications instructions (abbr)
9. Security classification (abbr)
10. \_\_\_\_\_ of approach (abbr)
11. Escapee does this
12. Educational test (abbr)
13. "Collar" an artillery weapons
14. Type artillery shell
15. Obey a command
16. Return from overseas (abbr)
17. Free from duty (abbr)
18. Baggage marking (abbr)
21. Road builder
25. Probable \_\_\_\_\_ (gunnery)
28. Will work
29. Stand \_\_\_\_\_ (posture)
30. Artilleryman's nickname
32. Does not apply (abbr)
33. Wrong discharge (abbr)
34. Part of a day (abbr)
39. Naval "depth finder"
40. Annual for Army units (abbr)
41. Everything correct (2 words)
42. Aerial radar (abbr)
45. Allowance table (abbr)
46. Distance measuring device
47. Information program (abbr)
48. Class III Supplies (abbr)
49. Term for survey computations (abbr)
50. Basics train here (abbr)
59. Opposite of depress
60. Fire again
62. Armored vehicle (abbr)
65. G5 does this (abbr)
67. Call off an airstrike
68. Phonetic alphabet — 12th word
71. One aircraft—one mission
73. Award
75. Fired
76. "Take \_\_\_\_\_"
79. Direction (5,600 mils) (abbr)
80. Capability of mechanic (abbr)
81. Vietnam is here (abbr)
82. Supply agency (abbr)
85. Requires a torch
89. Type pay (abbr)
90. To establish common control
94. Target acquisition units (abbr)
99. Veterans' Agency (abbr)
100. Not retired (abbr)
101. Reliability measurement (abbr)
105. Provides food (abbr)
106. Weapons instruction circle (abbr)
108. Artillery weapon (abbr)
110. Chief army administrator (abbr)
111. Saves manpower (abbr)
113. Combined arms team (abbr)
116. A target \_\_\_\_\_
117. Type telephone
118. G I bill recipient (abbr)
121. Enlistment day (abbr)
123. Provided by commander
126. Triangle has three
127. Carlson's \_\_\_\_\_ ers
128. A guard (abbr)
129. Task
133. Not over but, . . .
134. Formal parade (abbr)
136. Specialist (abbr)
138. Air Defense target (abbr)
140. "Bolo's" need this
141. Too much (abbr)
142. Technical evaluation (abbr)
143. To observe
144. Soldier's \_\_\_\_\_ (savings)
145. World organization (abbr)
147. Marine capability
148. Parachute capability
150. Emergency measure
153. See 116 down
158. Detonate (2 words)
161. More than 1 engine (abbr)
163. Communication system (abbr)
166. High official (abbr)
167. Greatest degree of emergency (2 words)
170. Naval base in Aleutians
173. Boobytrap capability
174. Ready, \_\_\_\_\_, fire.
175. Air defense command (abbr)
176. Nuclear weight (abbr)
177. "Understood" (communication)
179. Each howitzer has one
182. Fire planning unit (abbr)
183. Center of control (abbr)
184. A nautical twilight (abbr)
186. Motor capability measurement (abbr)
187. Wounded need this first
191. Completed tour (abbr)
192. Tilt of howitzer
196. Military trial (abbr)
197. A reserve (abbr)
201. Western hemisphere organization (abbr)
203. Gasoline, on, etc (abbr)
206. To activate a fuze
208. Angle measurement
210. 30 days (abbr)
211. Will adjust (abbr)
213. Branch (abbr)
214. Congress enacts these (abbr)
215. Measurements (abbr)
216. Commissioned member of guard (abbr)

The following crossword puzzle was submitted by Charles W. Montgomery, Research Analyst, Tactics Combined Arms Department of USAAMS, Fort Sill, Oklahoma. Terms and abbreviations used are not necessarily authorized nor in current use. For completed puzzle, see page 91.

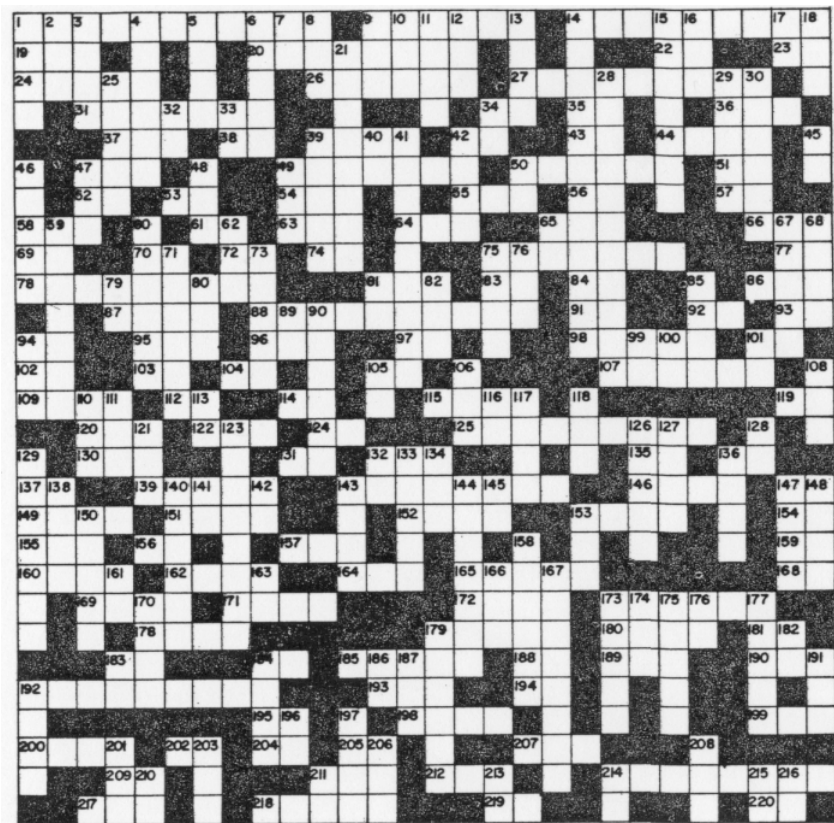



# *Airmobile*



# *Artillery*



# *in Combat*

*LTC Lloyd J. Picou  
Operations Group*

*US Army War College, Carlisle Barracks, Pa.  
(formerly Executive Officer, 1st Cavalry Division (Airmobile) Artillery)*

---

## **FORWARD BY**

*COL William F. Brand  
Formerly Commanding Officer  
1st Cavalry Division Airmobile Artillery*

"Successful beyond our highest expectations." This is the phrase most often used to answer the question, "How effective is the airmobile artillery in Vietnam?" In numerous campaigns — PLEI MY, IA DRANG, MASHER-WHITEWING, CRAZY HORSE — the artillery of the 1st Cavalry (Airmobile) has demonstrated its ability to furnish close and continuous support to the maneuver battalions. From the coast west to the Cambodian border, from rice paddies to trackless jungles, from flat sandy beaches to mountaintops, from the air and from the ground, artillerymen have constantly provided the means that were so often decisive in engagements with the Viet Cong and North Vietnamese.

In the April, July and November 1965 issues of ARTILLERY TRENDS, airmobile (air assault) tactics and techniques were discussed in several articles. These techniques were the synthesis of almost 2 years of testing by the 11th Air Assault Division. How well these tactics and techniques have proved out in battle in Vietnam is discussed in the following article.

The reader should bear in mind at all times the situation, the enemy, and the terrain of the central highlands of Vietnam. The fighting there is not the conventional-type warfare as experienced in Europe during World War II or in Korea in the early 1950's. Rather, it is characterized by operations over vast areas, numerous displacements, violent actions of short duration, an almost complete absence of boundaries, and an often undefinable front or rear. In this environment, airmobility is a must and a godsend.

---

"FIRST AND FOREMOST" is the motto of the 1st Cavalry Division (Airmobile) Artillery. These words have never been more applicable than in the present fighting in Vietnam. Often the artillery has found itself one of the first units inserted into the battle area. No matter where the "Cavmen" have gone, they have never been out of range, never been without fire support from the division's versatile artillery. The helicopters of the aerial artillery or the tubes of the airmobile direct support battalions have always been ready to strike any target within a few minutes of acquisition. Airmobile infantry with airmobile artillery have written new rules for the conduct of land warfare.

The airmobile concept was tested by the 11th Air Assault Division during 1964 and 1965. The lessons learned were translated into tactics, techniques, and doctrine. Artillery air assault experiences were discussed in several articles in the April, July, and November 1965 issues of ARTILLERY TRENDS. Since that time, the 11th Air Assault Division has become the 1st Cavalry Division (Airmobile) and has been deployed to Vietnam. The tactics, techniques, and doctrine advocated a year or so ago have been tried on the battlefield. How effective were these recommendations? This article proposes to sum up the experience gained in combat, to describe the techniques used, and to compare the findings with what was advocated in the articles published earlier in ARTILLERY TRENDS.

### **ENEMY AND TERRAIN**

To place the reader in the proper settings, it is necessary to describe the enemy and the terrain. Basically, these factors dictate our own tactics and techniques. The enemy is packaged in three categories — the North Vietnamese Regular Army units, main force units, and local forces (guerrillas). The last two groups may be comprised of both North and South Vietnamese. They all have few things in common — they are tough, resourceful, hard to find, and good fighters. They are most often widely dispersed in small units. Therefore, in order to destroy the enemy, our own forces employ many small-size units (companies or platoons) over a large area.

The division operates in what is called the Central Highlands of Vietnam. This term can be misleading, for the actual area stretches from the South China Sea to the Laotian and Cambodian borders. The terrain varies from coastal plains to rugged mountains. Some areas are flat, open, and relatively bare, whereas others are mountainous areas with steep slopes and covered by dense forest or jungle growth.

### **INTELLIGENCE**

The airmobile division has a tremendous intelligence-gathering capability. Unique to the division are the Mohawk aircraft with their side-looking radars, infrared sensors, and aerial cameras. In addition, each aircraft offers a visual reconnaissance potential. These devices, plus the normal agencies available to any division, produce a steady and voluminous flow of intelligence data which must be collated and evaluated. An alert S2 or fire support coordinator can produce good information and can develop target lists on which to base an effective harassing and

interdiction (H&I) program. Even with all this intelligence, it is difficult to positively identify and pinpoint enemy targets. Most targets are fleeting in nature. The Viet Cong move units and installations frequently and are masters at hiding their movements.

### **DIVISION ARTILLERY OPERATIONS**

The entire division is based in one large enclosure in which each unit has its own permanent home base. The division TAOR (tactical area of responsibility) extends 20 to 25 kilometers in all directions from the base. Platoon-, company-, or battalion-size operations are constantly being conducted throughout this zone. Artillery is positioned within the base or with one of the maneuver elements in the TAOR. A comprehensive H&I program is fired each night and sometimes during the day. Periodically, artillery units are moved away from the base in an "artillery raid" or a "show of force" type of operation. Aerial artillery is also employed in this fashion. Whenever sufficient targets are developed in an area which is beyond the range of artillery at the base camp, this type of operations is conducted. The operations usually last from 1 to 3 days.

The division conducts operations anywhere within a 150-kilometer radius. Since this is too far to exercise proper control from the base area, a division tactical operation center (DTC) is moved to the operational area. In this event, division artillery will displace a forward tactical command post (division artillery forward command post) and will collocate it with the DTC. In a situation in which more than one artillery battalion is supporting a force, a division artillery forward command post will be established whether or not the DTC is displaced.

The division artillery forward command post has been extremely valuable and highly successful in all past operations. Notable successes have been achieved in developing target lists, massing fires, firing TOT's, planning and executing H&I programs to include TAC air and naval gunfire, moving general support and reinforcing artillery, coordinating fire support with other US or Free World Forces, and insuring adequate logistical support.

The division artillery forward command post is tailored to the situation and to the duration of the operation. It normally consists of S2, S3, and S4 representatives and the necessary communication personnel. Communications are established with all artillery units in the forward area and with the division base camp. The division artillery S3 or assistant S3 is in charge of the installation, and either the division artillery commanding officer or executive officer moves forward to exercise command and control of all artillery in the operation. Regardless of the extent of operations away from the base, the functions of division artillery in the base camp are not reduced in scope. This procedure amounts to the manning of two tactical command posts.

### **FIRE SUPPORT COORDINATION**

If any single job can be classified as the most important, it is that of the fire support coordinator at any level. The normal tasks, coupled with the task of airspace management and control, the distances involved

in operations, the frequency of operations, and the speed with which operations are conducted call for highly qualified and competent individuals in the FSCE or FSE slots.

In the air cavalry division, airspace management and control is a constant problem. Airspace users include Air Force FAC's, fighters and transports, division assault and transport helicopters, aerial artillery; air cavalry and other reconnaissance helicopters, plus Mohawks and other light fixed-wing aircraft. In addition, there are transient aircraft which may be scheduled or unscheduled. The fires of mortars; 105-mm, 155-mm, and 8-inch howitzers; and 175-mm guns must be carefully controlled to prevent accidents.

To help solve the fire control problem, the division artillery first set up a system for the base camp. Here the helipad and airstrip are ringed by the firing positions. A clock system has been developed with zones corresponding to each hour and with the 12 o'clock position designating north. Each battalion reports to airfield control the time, zone, altitude, and range of the firing being conducted. All aircraft are warned and thus steer clear of the danger areas. A similar system is employed for operational areas. Warnings are broadcast when the artillery fires from any position. The warning includes the information listed above plus the code word of the firing position.

Of course, there is always the 10 percent who do not get the word. As an added safety measure, each gun section maintains surveillance of the sky in the direction of fire. Either aerial or ground observers scan the forward end of the trajectory.

Flight routes are published for each operation; danger areas and no-fly areas are noted. During the landing phase of an air assault operation, tube preparations are shifted or cancelled. When shifted, they are carefully coordinated. For instance, fires may be delivered parallel to flight routes. Another technique employed is to fire high-angle fire on the far edge of the landing zone and have the choppers fly under the trajectory.

Finally, there is the problem of TAC Air. Aircraft require a tremendous area in which to operate and fly at varying altitudes. Therefore, close coordination is required with FAC's and other Air Force personnel.

As stated previously, in order to find the Viet Cong, the division operates in small units over large areas. Companies and platoons (sometimes from different battalions) are constantly on the move and frequently converge on one point. A fire mission conducted by a ground observer will all too often be interrupted with "Cease Fire! Cease Fire! Someone is shooting near Coral 36's position." In these instances, fire support coordination becomes a headache. When more than one direct support artillery battalion is involved, it becomes a nightmare. This type of warfare is a far cry from the "line" concept so familiar in school problems. However, the problem can be licked by close attention to and

frequent changes in no-fire lines and fire support coordination lines. An aerial observer who can keep track of the units on the ground and who has the proper communications has proved to be a great help in this situation.



**Figure 1. FDC operations are established quickly in field operations as shown here by personnel of the 2d Battalion, 17th Artillery in support of the 1st Cavalry (Airmobile) Division.**

## **FIRE DIRECTION**

It goes without saying that fire direction and fire support coordination go hand in hand. The principles and techniques taught by the U. S. Army Artillery and Missile School and contained in FM 6-40 are as good today as they were years ago. However, the situation in Vietnam makes the jobs of the S3 and the fire direction officer more difficult than ever before. In World War II and Korea, gunnery errors (especially 10-mil or 100-mil errors) seldom resulted in friendly casualties. In the 1st Cavalry Division's operations in Vietnam, up to 50 percent of the missions are fired toward friendly troops or into an area virtually surrounded by converging forces. Any error (over, short, right or left) may well result in friendly casualties. Other considerations peculiar to combat operations in this area are: intermediate crests and tall trees on the descending leg of the trajectory; rounds that clear a crest or hilltop and fall into the next valley; impact areas of smoke or illuminating shell cannisters; gusty winds that hinder high-angle fire; delivery of fires in all directions from all positions; friendly Vietnamese forces (regular and irregular) that are operating in the area; villages with noncombatants; and the ever-present friendly aircraft. No wonder FDO's have gray hair!

Since fire units habitually fire in all directions, fire commands to the guns always include an azimuth of fire. This virtually eliminates the 3,200-mil error. (Some people still do not get the word, especially at night.)

Calls for fire are directed to the battalion FDC. This agency should technically, as well as tactically, control fires whenever possible. The value of massed fires is too often ignored for convenience. As one unit put it, "There are too many indexes on the battalion firing chart." The lazy man's way out is to let the batteries handle the missions. Under these conditions, most opportunities for massing fires are missed. Batteries will fire round after round, with rapidly diminishing results after the first one, when a battalion mass (one round) would do the job.

TOT's and "all availables" at battalion and division level have produced outstanding results. Prisoner of war reports indicate such results as a battalion commander and most of his staff killed by a massed fire or 13 out of 16 men in one platoon killed. These were the results of division artillery TOT's fired at suspected Viet Cong targets. The division conducts an intensive and selective interdiction program in every area of operation. Defectors attest to the effectiveness of this program. They invariably complain about the constant harassment by artillery fires.

## **RECONNAISSANCE, SELECTION, AND OCCUPATION OF POSITIONS**

Here again, the lessons learned during maneuvers are valid. Reconnaissance and selection of positions begins with the scheme of maneuver. Usually, the infantry and artillery commanders will make up a map reconnaissance and then make an aerial reconnaissance of positions. Commanders are always in a quandary. It's a damned if you do, damned if you don't situation. If a careful reconnaissance is made, which requires a low-level flight or touchdown of choppers, the helicopters may be taken under fire and the Viet Cong are alerted to an air assault. If a

medium-or high-level reconnaissance is made, then commanders cannot really determine the heights of the brush or elephant grass, the slope of the land, and whether there are stumps in the area. Of course, this is not true of every position, but it certainly does apply to those in jungle areas. Mountaintops and ridges have often been used for position areas; these are easily occupied and easily defended.

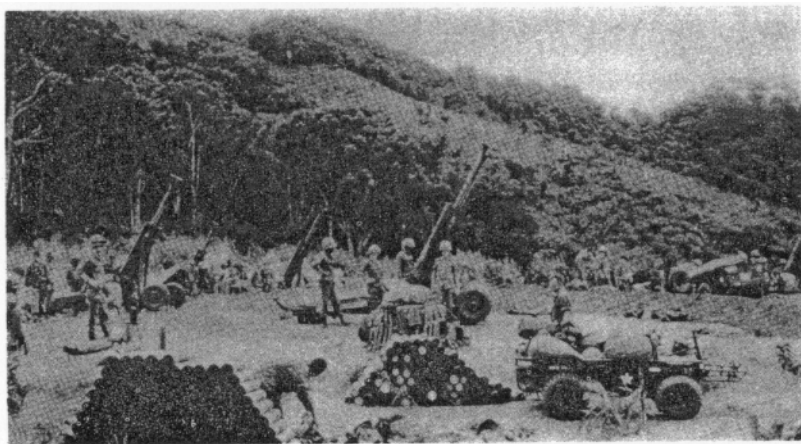

**Figure 2. A battery of the 1st Battalion, 77th Artillery retains the ability to provide fire support even while preparations are made for airlift to another position.**

Occupation of position is fairly routine. There is the ever-present danger of aircraft receiving fire as they come into the landing zones. In the majority of cases, howitzers are sling loaded, and each has a sling of ammunition suspended below it. In occupying the position, the ammo load is lowered to the ground and then the howitzer is placed alongside. This is the firing position. Howitzers are seldom moved more than a few meters.

### **SECURITY**

The security of artillery positions is another one of the big considerations in the airmobile division. Since operations are conducted deep in Viet Cong territory, greater emphasis must be placed on the standard requirement for a full perimeter defense. Artillery batteries will normally be emplaced singly. Early in the war it was concluded that artillery units could not protect themselves and also perform their missions. A solution to this was found by collocating the artillery battery(s) with the battalion or brigade command post. Both units man the perimeter, with the infantry commander in charge. This has proved highly successful, and even when these positions were under attack, the firing batteries were able to support other, more distant, units. Frequent checks of the area and close-in patrolling are required to detect infiltrators. Trees surrounding

the landing zones must be carefully scanned. A dawn and dusk patrol is usually flown around the area. Some units occasionally fire a "mad minute" just at dusk or before dawn. This has been effective in several cases. Position areas are often subjected to mortar or recoilless rifle attacks; therefore, a countermortar plan is essential. Close-in, direct fire data must be computed so that all areas which provide a "line of sight" into the battery position are covered.

### **OBSERVATION**

Although lessons learned during World War II and the Korean war apply to Vietnam, they are often forgotten. Personnel are still "blind" when walking through the jungles. Units still get "lost" when they have no visible and identifiable terrain features by which to guide themselves. One battallion in the southern part of Vietnam has termed the aerial observer valueless and even dangerous when enemy forces are engaged at close quarters in jungle areas. This is probably true in very dense jungle and if the aerial observer is operating alone. The experience in the 1st Cavalry Division has been that aerial observers are extremely valuable when used in conjunction with ground observers. The aerial observers can locate units (smoke, etc.), spot artillery (ground observers often rely on sound), monitor progress, and act as a radio relay. Like everything else, observation must be properly planned to be effective. Zones of observation must be properly planned to be effective. Zones of observation must be delineated and the entire area of interest covered. Aerial artillery has added a great deal to the observation capabilities of the Division.

### **SURVEY**

The electronic distance-measuring equipment has been the greatest single item in enhancing survey capabilities. Since helicopters are employed to move survey teams about, survey can be completed over long distances within a relatively short period of time. The limiting factor is security for the teams and the helicopters. Naturally all hilltops cannot be occupied, therefore, survey is limited in this respect. With the present equipment and survey techniques, it is still virtually impossible to carry survey control to position areas deep in the jungles or in enemy-held territory. In these instances, sun shots are taken to establish direction and battery centers are located by map inspection, firing, or resection.

### **AERIAL ARTILLERY**

The success enjoyed by the aerial artillery battalion has been astounding. It has been employed day and night and in every conceivable weather condition. When they are not firing, the pilots act as observers, perform aerial reconnaissance, adjust tube artillery, and perform emergency medical evacuation. A highlight of aerial artillery operation has been to bring fires to within 50 meters of friendly positions by flying parallel to the forward line of troops. Another highly successful



technique has been to adjust tube artillery and then use aerial artillery to attack the fleeing Viet Cong.

### **AIRMOBILE ARTILLERYMEN IN COMBAT**

The airmobile artillerymen entered combat with skill and confidence but with a certain degree of trepidation. Training had been long and arduous, but there still remained the crucial test of combat. They met this test by proving that they —

Could operate for extended periods of time, far from home base and with only aerial means of resupply.

Were as versatile and as mobile as the supported battalions.

Could habitually fire in all directions with no loss in efficiency or effectiveness.

Could displace quickly, to any position and in any weather condition.

Could learn to live in rice paddies or on mountaintops.

Could develop and master new tactics and techniques for close support by aerial artillery.

In short, they have met every challenge in a different and complex war, and have lived up to their motto. They have done more than was expected of them — they have made airmobile artillery indispensable in modern times.

---

### **HUEYS PASS SCREEN TEST**

The U .S. Army Limited War Laboratory's recently developed smoke generators for UH-1 (Huey) helicopters. These generators were scheduled to be sent to Vietnam late in January 1967.

The generator can produce a 1,000-meter linear smoke screen lasting two minutes in moderate winds. The device consists of a smoke agent tank, pump, piping, and a spray nozzle attachment which is mounted on the aircraft turbine exhaust stack so that the smoke agent is directed into the hot exhaust gases where it is vaporized.

One of the laboratory's engineering models of the generator successfully screened the recovery operation of a UH-1D by a CH-47 helicopter in Vietnam.

### **TERMS USED IN RVN**

AREA OF OPERATIONS (AO) — An area outside the area of responsibility in which US or Free World Military Assistance (FWMA) forces will operate tactically for prescribed periods of time. These areas and the responsibilities and authority of US or FWMA forces within them will be coordinated with RVNAF officials in the course of operational planning.

# The Artillery



## Hops a Ride

*Major Lereoy C. Bell*  
*Instructor Tactics/Combined Arms Department*  
*USAAMS*

(Former Battery Commander, A Battery, 2d Battalion, (Abn)  
19th Artillery, 1st Cavalry (Airmobile) Division

SAINT JOE 26. THIS IS SAINT JOE 6 SHORT HOOK 23 EN ROUTE TO YOUR LOCATION WITH TWO PLUS FOUR. CONTACT HIM ON CHANNEL 16ALFA. HIS ETA IS 30 MINUTES FROM NOW. POPCORN LINE ONE, ARNOLD (Fig 1) in 20 minutes. Battery C will fire a preparation in support JOE 18. OVER.

Messages similar to this one are being received and acted upon daily by young, eager artillerymen in Vietnam.

This order informs the Battery commander that his unit, Battery A, will move to Landing Zone (LZ) ARNOLD, some 15 kilometers from its present position. An assault support helicopter company, which should arrive in about 30 minutes, will provide the lift. Initially, only two helicopters will be available; however, they will be followed later by four additional helicopters. The move is to start at 1105 hours and the battery must be in position to provide support not later than 1145 hours.

From the liaison officer, the battery commander has learned that the supported battalion will execute a company assault on Landing Zone ARNOLD (fig 1) in 20 minutes. Battery C will fire a precaution in support of this landing. Once LZ ARNOLD is secured and the artillery (Battery A) is in position to provide support, the maneuver battalion will employ another company against Objective MIKE. Battery A must be in position to fire the preparation on Objective MIKE. The assaulting infantry company will provide security for the artillery battery at LZ ARNOLD.

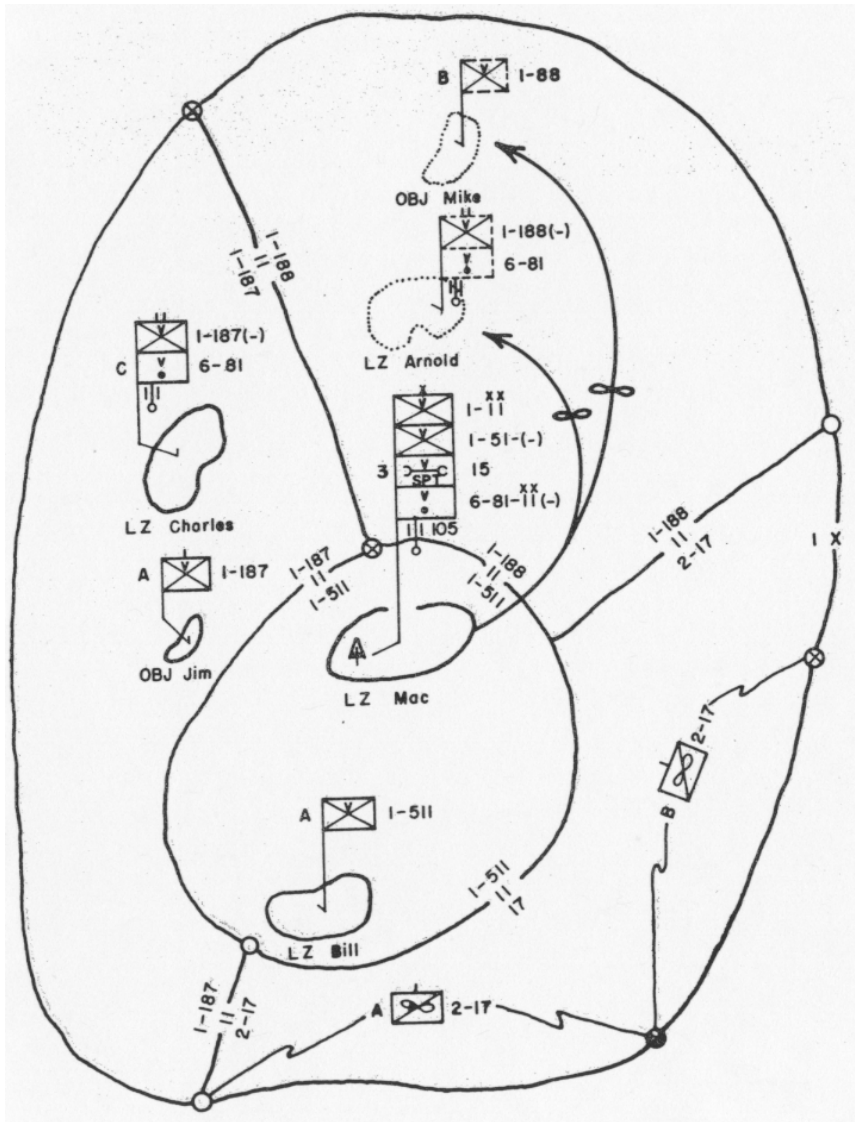

Figure 1. Brigade area of operations.

Oral orders, which are the rule rather than the exception during airmobile operations, provide the unit with the necessary information to act. The employment of airmobile artillery is characterized by detailed planning and coordination, aggressive execution, speed of displacement, and operation with minimum personnel and equipment.

The personnel of the units conducting the displacement in the situation described above know their trade. They will use their professional knowledge and the speed and flexibility of the helicopter to get the job done in the time required. But what about neophyte units or mass replacements? How and where can they obtain this knowledge?

The purpose of this article is to familiarize these personnel with some of the reference data, techniques, and procedures used in displacing artillery units during airmobile operations. Although the examples discussed in this article are limited to 105-mm and 155-mm towed units, the techniques are applicable to any artillery unit capable of being moved by helicopters in a tactical configuration.

### **AIRCRAFT LOADING DATA**

In order to efficiently load and transport an artillery unit by helicopter, the personnel involved must be familiar with the composition of the artillery unit, the essential characteristics of the aircraft to be used for the operation, and the method of computing aircraft requirements. Department of the Army TOE's provide information on the organization and equipment of the artillery unit; TM 57-210 provides detailed characteristics of Army aircraft and technical data.

Of the many methods available for computing aircraft sortie requirements, the weight and type load methods are used most frequently by the artillery.

The weight method is used when the total weight to be transported is the determining factor. Aircraft requirements are determined by dividing the allowable cargo load of each aircraft into the total weight of the unit to be transported. However, this method is not accurate enough to compute requirements for units that must transport major items of equipment and also maintain tactical integrity.

The type load method considers the allowable cargo load of the aircraft and the requirements to move personnel and/or equipment in a particular configuration. The type load method is the most desirable method of determining aircraft requirements to lift airmobile artillery units. It permits the transport of major items of equipment, while maintaining tactical integrity. Weights and dimensions used in airmobile movements planning are contained in table I.

Type loads are an arrangement of personnel, vehicles, equipment and supplies within the allowable cargo load of a particular aircraft. Tables II through IV show recommended loads for a reduced artillery battalion command post, M101A1 howitzer battery, and M102 howitzer battery, respectively. The loads shown in these tables are based on an allowable cargo load of 7,500 pounds. The establishment of varied type loads will provide flexibility in planning, loading, and supporting an operation.

Table 1. Weight and Dimension Tables for Airmobile Planning

Item	Length (in)	Width (in)	Height (in)	Height Reduced to (in)	Weight ((lb)	Rec. Payload (lb)	Gross Weight (lb (1)	Center of howitzer	Volume (cu ft) (3)
1. ¼-ton truck, M151	132.0	63.0	71	53.0	2273	400	2673		253.0
2. ¼-ton truck, M38A1	138.5	60.5	75.5	56.3	2665	400	3065	26.62	273.0
3. ¼-ton trailer, M100	109.0	56.0	42		565	750	1315	8.13	146.0
4. ¾-ton truck, M37	184.8	73.5	89.8	63.5	5950	750	6700	46.00	499.1
5. ¾-ton trailer, M101	147.0	73.5	83	50.0	1340	1550	2890	5.12	312.7
6. ½-ton carrier, M274	117.0	49.0	50	28.0	900	1000	1900	34.00	86.0
7. 105-mm how, M101A1 (w/o shield)	236.0	84.0	60		4480	200*	4680		302.0
8. 105-mm how, M102	263.5	76.0	62.75		3018	122	3140		
9. Cartridge, 105-mm how, in fiber container	Note (4)				45				0.8
10. Box, 105-mm how ammo w/2 cartridges	Note (4)				100				1.8
11. Individual soldier w/equipment	Note (4)				240				
12. Tlr, trk, water, 400-gal cap, M149	157.0	80.0	73.0		2600	3015	5615	42.00	572.0
13. 250-gal water bladder, filled	Note (4)				2500				

- Notes: (1) Less crew.  
(2) Center of gravity figures indicated. Items were measured in inches from front end when they were empty. New figures should be computed when items are loaded.  
(3) Volume shows reduced configuration where applicable.  
(4) Dimensions not given for personnel or sling-loaded items.  
\* Section equipment.

Table II. Reduced Artillery Command Post.  
Type Load CH-47

Vehicles	Personnel
2 ¼-ton trucks	1 S2
1 ¼-ton truck w/MK-95	1 S3
3 ¼-ton trailers	17 Operations and FDC
1 ½-ton mechanical mule	2 Medics
	6 Communications
	7 Survey

Load Number	Major Items	Weight
1	Truck, utility, ¼-ton, and trailer, ¼ ton	3988
	Truck, utility, ½-ton mechanical mule	1900
	Personnel — 6 at 240 pounds each	1440
		7328
2	Truck, utility, ¼-ton, and trailer, ¼-ton	3988
	Personnel—14 at 240 pounds each	3360
		7348
3	Truck, utility, ¼-ton, w/MK-95 and trailer	4000
	Personnel—14 at 240 pounds each	3360
		7360

Note: As aircraft become available and the tactical situation permits, the reduced command post echelon may be increased.

Both internal and external loads are used in airmobile operations. However, whenever possible external loading should be employed in order to minimize helicopter ground time. Hookup of an external load will require only a fraction of the time (as little as 20 seconds) required to put the same load inside the helicopter. Obviously, external loads must be prepared prior to the arrival of the helicopters. Little time, if any is saved if the helicopter must shut down and wait for the external sling loads to be prepared.

Normally a representative from the helicopter unit will assist the artillery unit in the technical aspects of planning and executing the helicopter movement. Sortie requirements, load configurations, and distribution of equipment for movement should be agreeable to both the artillery commander and the helicopter liaison officer. The helicopter liaison officer, if available, briefs the pilots; in his absence, the artillery personnel perform this function.

### **RIGGING ARTILLERY EQUIPMENT**

Helicopters CH-47 and CH-54 are used as the primary means of transporting airmobile artillery. Under ideal conditions, the useful payload of these aircraft, with a full load of fuel and crew on board, is 12,000 and 17,000 pounds respectively. As density altitudes\* increase, the lifting capabilities of the aircraft are correspondingly reduced. The allowable cargo loads (ACL) used in this article are 7,500 pounds for the CH-47 and 14,000 pounds for the CH-54. Units must be prepared to adjust their load configurations, depending on changes in the allowable cargo load. During the planning stage, artillery units should coordinate with the liaison officer of the support helicopter company to verify the ACL and to agree on the loadlist. Planned loads may exceed the ACL with the concurrence of the support helicopter liaison officer. However, the operating range is decreased accordingly. Aircraft fuel must be reduced in order to accommodate the increased weight.

The responsibility for providing equipment needed for externally rigging artillery equipment for displacement by helicopter is the responsibility of the artillery unit. Since all of the equipment required to rig external loads are not provided by the unit TOE, the unit must procure some of these items through special table of allowances. Tables VI and VII contain a list of items that may be used in rigging.

Loose ends and portions of the slings which are likely to come in contact with metal should be wrapped with tape or canvas. Vibration and friction during movement could cause nylon burning. The procedure described below are provided as a guide. The use of substitute items and/or procedures, which are equal to or superior to these, is encouraged. Slings not in use should be rolled and stored in a dry place.

---

\*Density altitudes are dependent upon the combined effects of air pressures and air temperature. The load capability of an aircraft decreases as air pressure decreases and temperature increases.

**Table III. Reduced Howitzer Battery (M101A1)****Type Load (CH-47)****Equipment and Personnel**

6 Howitzers M101A1, w/section equipment  
 2 ¼-ton trucks  
 2 ¼-ton trailers  
 1 ¾-ton truck (FDC)  
 900 Rounds 105-mm ammunition  
 75 Personnel

<b>Load Number</b>	<b>Major Items</b>	<b>Weight</b>
1	1 ¼-ton truck and trailer	3988
	1 Battery commander	
	1 Chief of firing battery	
	6 Gun guides	
	3 FDC personnel	
	1 Radiotelephone operator/driver	
	1 Recorder	3360
		<hr/> 7348
2	1 ¾-ton truck	6700
	3 FDC personnel	720
		<hr/> 7420
3-8	1 Howitzer M101A1, w/section equipment	4680
	30 Rounds ammunition (piggyback)	1350
	*6 Section personnel	1440
		<hr/> 7470
9-12	160 Rounds Ammunition (external)	7200
13	1 ¼-ton truck and trailer (light load)	3588
	1 Radiotelephone operator/driver	240
	40 Rounds ammunition (external)	3600
		<hr/> 7428
14	21 Personnel	4640

\*Note: Personnel may be deleted from these loads and additional ammunition placed in each ammunition bag. Load number 3 should then include 30 personnel, and other load numbers should be adjusted accordingly. Six personnel would be added to the 15th sortie.

**Table IV. Reduced Howitzer Battery (M102).****Type Load (CH-47)****Equipment and Personnel**

6 Howitzers M102, w/section equipment  
 1 ½-ton mechanical mule  
 1 ¼-ton truck  
 2 ¼-ton trailers  
 900 Rounds 105-mm ammunition  
 60 Personnel

<b>Load Number</b>	<b>Major Items</b>	<b>Weight</b>
1	1 ¼-ton truck and trailer	3988
	1 Battery commander	
	1 Chief of firing battery	
	6 Gun guides	
	3 FDC personnel	
	1 Ammunition personnel	
	1 Radiotelephone operator/driver	
	1 Recorder	3360
		<hr/> 7348

2-7	1	M102 howitzer, w/section equipment	3140
	70	Rounds of ammunition (piggyback)	3150
	*5	Section personnel	<u>1200</u>
			7490
8-10	160	Rounds ammunition (sling)	7200
11	1	½-ton mechanical mule	1900
	1	¼-ton trailer	1315
	16	Personnel	<u>3840</u>
			7055

**\*Note:** Personnel may be deleted from these loads. An additional sortie would be required for these personnel. This load should follow load number 1.

**Table V. Howitzer 155-mm Towed.  
Type Load, CH 54 and CH 47  
Equipment and Personnel**

	6	Howitzers M114 w/section equipment	
	2	¼-ton trucks	
	1	¼-ton trailer	
	1	¾-ton truck	
	600	Rounds 155-mm ammunition	
	70	Personnel	
<b>Load Number</b>		<b>Major Items</b>	<b>Weight</b>
1 (CH-47)	1	¼-ton truck and trailer	3988
	14	Personnel Battery commander Chief of firing battery	
	6	Gun guides	
	3	FDC personnel	
	3	Communications personnel	<u>3360</u>
			7348
2 (CH-47)	1	¾-ton truck	6200
	5	Personnel	<u>1200</u>
			7400
3 (CH-47)	31	Personnel	7440
4-9 (CH-54)	1	Howitzer M114 (155-mm) w/sec equip	13000
10-18 (CH-47)	67	Rounds of ammunition*	7370
19 (CH-47)	1	¼-ton truck	2673
	20	Personnel	<u>2800</u>
			7473

**Note:** If the CH-54 is used to transport ammunition, 600 rounds may be moved in 5 sorties.



**Table VI. Rigging Equipment Required for Individual Loads.**

TYPE LOAD	RIGGING EQUIPMENT								Quick-release	
	10"	Clevis	8'	9'	12'	16'	20'	A-22	Cargo net	Paulin tiedowns
M101A1 how, continuous-loop	1	1					2			
M101A1 how, separate-loop, w/single strap, piggyback	1	2		1	1		1		1	1
M101A1 how, separate-loop, w/Y-strap, piggyback	1	2	2				2	1		1
M102 w/piggyback	1	1	2				2			1
M102 rapid rack	1	1	2				1			5
M114A1 (155-mm) how	2	2	2	1	1					4
¼-ton truck	1	1			4					
¼-ton trailer	1	1			4					
½-ton mech mule	1	1		4						
¾-ton truck	2	1					4			
Ammunition, 91 or more rds	1	1							1	1

**Table VII, Rigging Equipment**

FSN	Nomenclature	Remarks
1670-090-5354	Clevis assy	At least one per load
1670-242-9169	Bag, cargo, aerial del, A-22	Ammo, ration, etc
1670-753-3790	Sling, cargo, aerial del, 13,500-lb chp 9'	Howitzers, vehicles
1670-753-3792	Sling, cargo, aerial del, 13,500-lb cap, 12'	Howitzers, vehicles
1670-753-3793	Sling, cargo, aerial del, 13,500-lb cap, 16'	Howitzers, vehicles, bulky cargo
1670-753-3794	Sling, cargo, aerial del, 13,500-lb cap, 20'	Howitzers, ammunition
1670-823-5044	Sling, cargo, 4-leg, adjustable, 10,000-lb cap	Ammunition, vehicles
3940-298-3985	Sling, cargo paulin, ctn duck, 12'×12'	Used inside cargo nets
3940-543-4698	Sling, cargo net, 14' sq, 7/8" mesh, 2½" arc rope	Ammunition and bulky cargo
3940-675-5001	Sling, endless, nylon webbing, 10,000-lb 10", 1¾" wide (donut)	Lift point
3940-856-7998	Sling set, cargo, univ type, set 1	Contains 8-foot slings used for vehicles and howitzers
3940-892-4375	Sling, cargo net, nylon, 12'×12'	Ammunition and bulky supplies
4030-185-0490	Shackle anchor screw	Howitzers
8110-900-8328	Drum, collapsible, water, 250-gal cap	Water resupply
1670-725-1437	Strap, aircraft, quick-release	Securing equipment

## M101A1 CONTINUOUS LOOP LOAD

The continuous loop sling method requires the use of two 20-foot slings, one 10-inch endless sling, and one medium metal clevis. To rig this load, lace one end of each 20-foot sling to the other sling, using a choker hitch. Double this extended sling, slip the two loose ends and the endless sling onto the clevis as shown in figure 2, and fasten the clevis securely. The endless sling is the lift point. Loop one end under the lunette of the howitzer and the other end under the tube. The location of the clevis is over the center of gravity (fig 3).

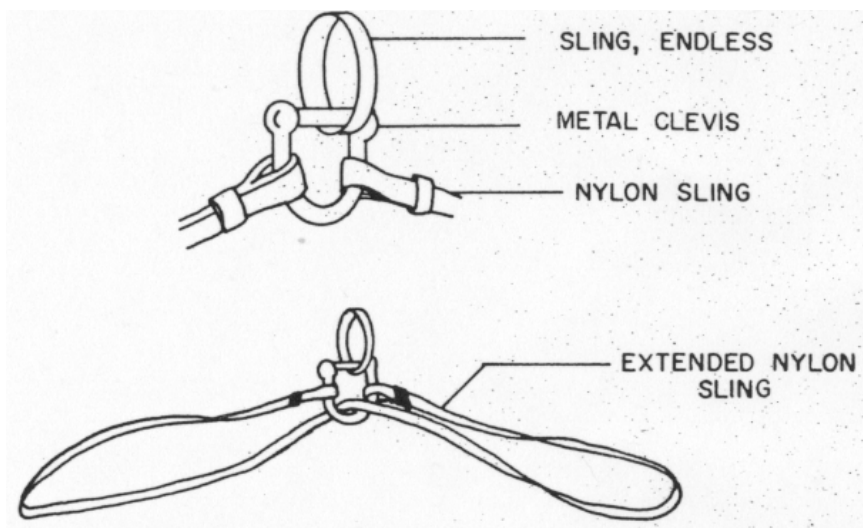

**Figure 2. Clevis arrangement for continuous loop load**

## SEPARATE LOOP LOAD

The separate loop sling method requires the use of one 12-foot sling, one 9-foot sling, one 10-inch endless sling, and one medium metal clevis. A loop is formed and securely taped on one end of the 12-foot sling. The looped end of the sling is wrapped around the pintle, and the free end is passed through the loop and pulled up tightly as with a slip knot. A loop is formed and securely taped on one end of the 9-foot sling. The looped end is placed around the recoil mechanism, tube, and sliding carriage, just forward of the shield. The free end of the 9-foot sling is passed through the loop of the sling and drawn up tight. The free ends of the 9- or 12-foot slings and the endless sling are placed in the clevis (fig 4) and the clevis is tightened. The endless sling is the lift point.

Piggyback loads permit the howitzer and ammunition to be moved by one helicopter. The ammunition may be suspended from the howitzer (fig 4) or it may be suspended directly from the aircraft (fig 5).

If the ammunition is to be suspended from the howitzer, two 8-foot slings, one metal clevis, and a cargo net or cargo bag A-22 are required. To rig the load, thread one sling through the loop of the other. Attach the ends, A and B (fig 3) to the tiedown hooks under the axle of the howitzer, and attach end C to the cargo net or A-22 by a metal clevis.

If the ammunition load is to be suspended from the aircraft, a 20-foot sling is attached to the cargo net or cargo bag A-22 by a metal clevis. The free end of the cargo sling is threaded through the right side of the howitzer, between the trails, up to the area where the lift point for the howitzer is located, as shown in figure 5. The 20-foot sling is hooked directly to the aircraft cargo hook during hookup procedures. Areas where the sling will come in contact with the howitzer should be well padded.

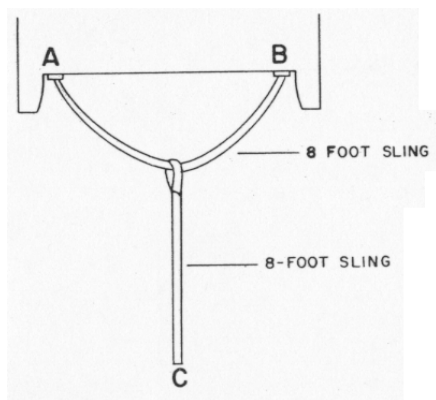
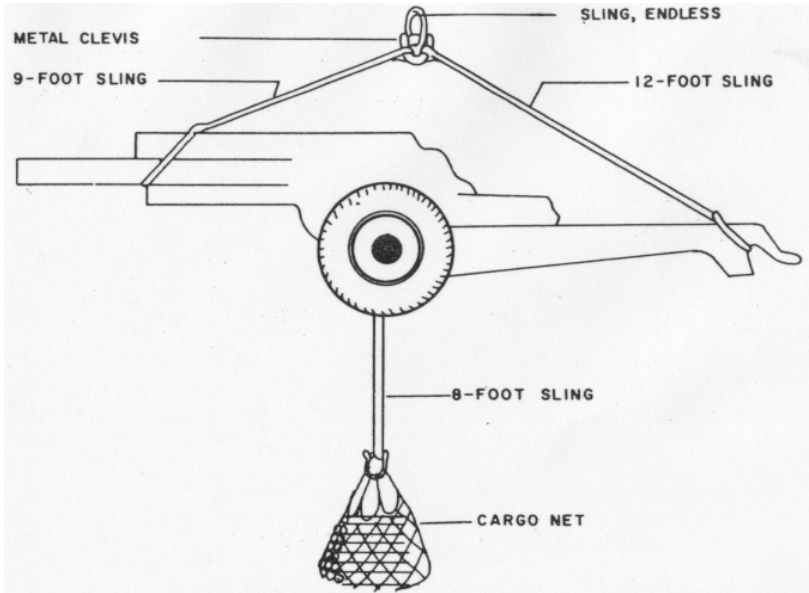

**Figure 3. Ammunition suspended from Howitzer.**

### **M102 WITH PIGGYBACK**

Normal sling loading of the M102 includes the ammunition as an intricate part of the load. The equipment required to rig this load consists of two 8-foot slings, two 20-foot slings, one endless sling, two metal clevises, one quick release strap, and one cargo bag A-22. Figure 6 illustrates the procedures for rigging the M102 and a piggyback load.

To rig the M102 piggyback load, double the 20-foot sling by passing one end through the endless sling at point D. Attach both ends of the 20-foot sling to the tube lifting shackle at point E. Attach ends of one 8-foot sling to the lifting brackets on the box trails at points A and B.



**Figure 4. Separate-loop load with ammunition suspended from the howitzer.**

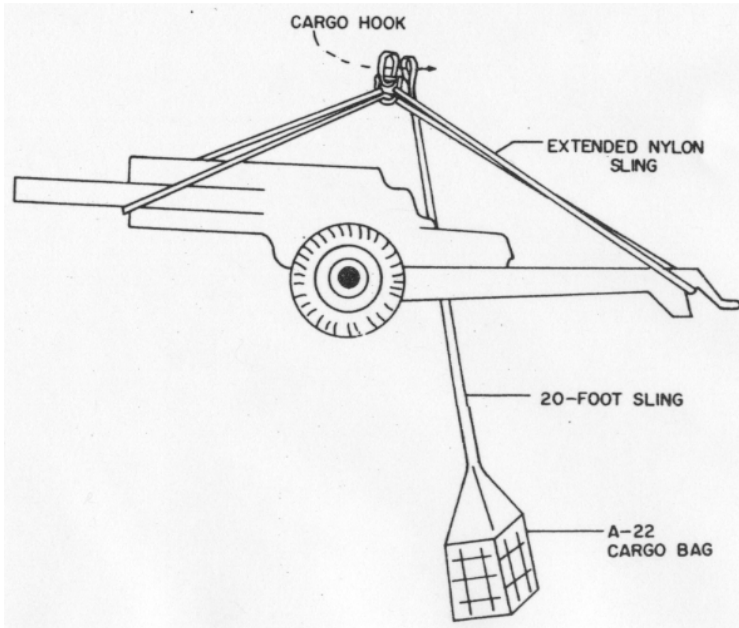
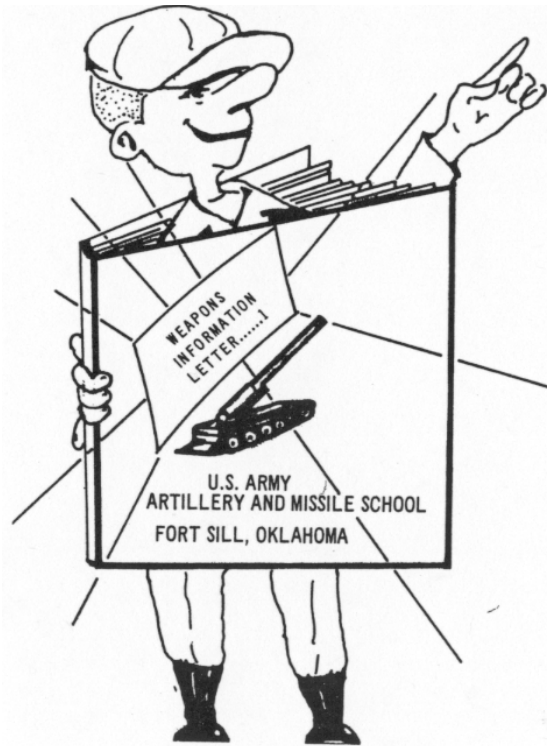

**Figure 5. Continuous-loop load with ammunition suspended directly from the helicopter.**

# INFORMATION LETTERS NOW WEAR NEW NAMETAGS

A new series of information letters supersedes the former series which were classified according to individual elements in the artillery. Under a new policy recently adopted, information letters will be cataloged according to elements listed in the field artillery system to conform with FM 6-20-1.

These systems are:



Target Acquisition  
Survey  
Ballistic Meterology  
Communications  
Mobility  
Logistics  
Automatic Data Processing  
Ammunition  
Organization  
Employment  
Fire Control and Coordination

Each letter dealing with a particular weapon will list the last previously published letter on that system.

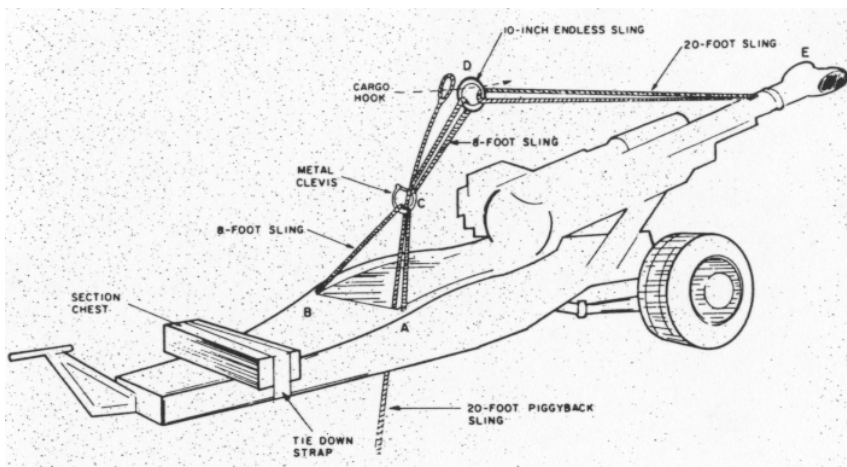

**Figure 6. 105-mm howitzer sling load**

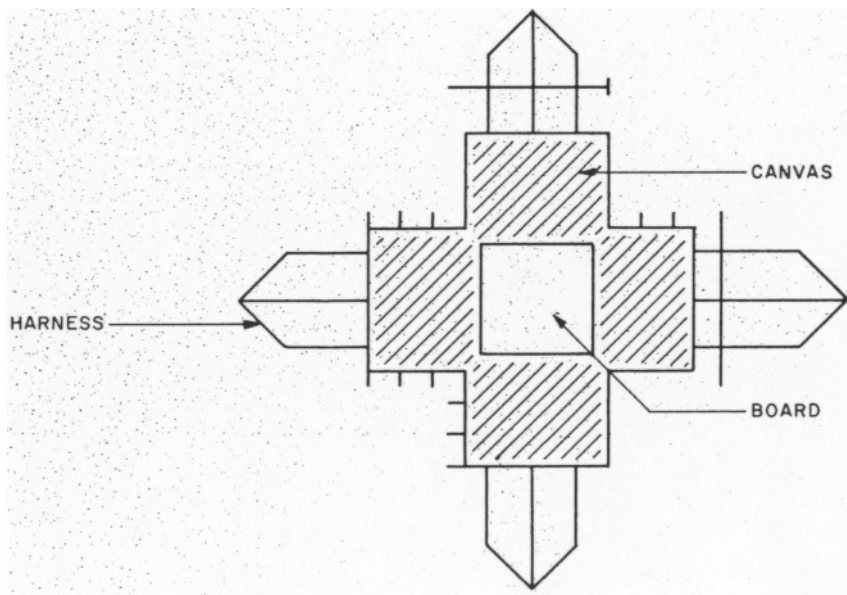

**Figure 7. A-22 cargo bag laid out**

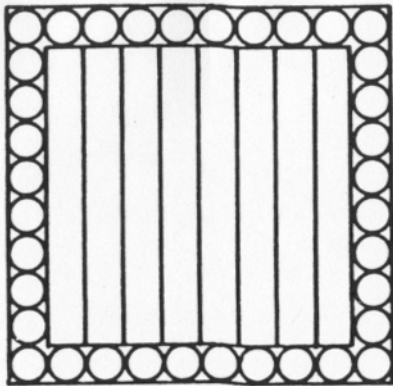

(A) TOP VIEW

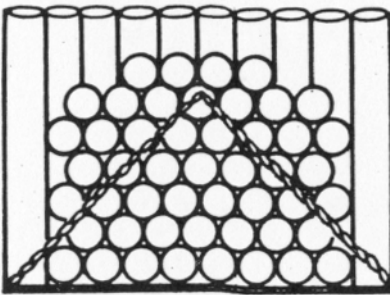

(B) SIDE VIEW

**Figure 8. Ammunition stacked in A-22 bag.**

with ammunition and section equipment (B, fig 8). Close the bag and attach the clevis and the 20-foot sling.

The M102 may be rigged for rapid action by carrying the ammunition between the box trails. A rack, which can be fabricated from steel engineer stakes, is fastened to the bottom of the box trails with quick-release tiedown devices. When the weapon is lowered to the ground in the landing zone, the straps holding the rack are released and the rack drops to the ground. The howitzer is then shifted into position and prepared for action using standard procedures.

To prepare the load for movement, place the empty rack under the trails and secure it to the trails with four quick-release tiedown straps. Place ammunition and section equipment on the rack, and then install

Pass one end of the second 8-foot sling through the endless sling at point D and then attach both ends of this sling to the metal clevis at point C. The endless sling at point D is the lifting point.

Secure section chest to the box trail by the quick-release, aircraft tiedown strap. Run the free end of the second 20-foot sling from the ammunition cargo bag through the metal clevis at point C, up to point D and during hookup, attach the ammunition and howitzer slings to the aircraft cargo hook at the same time.

Ammunition to be transported in the cargo bag A-22 is normally removed from the wooden boxes and transported in the fiber containers. To prepare the A-22, lay the harness on the ground so that all ends and straps are clear, as shown in 1, figure 7. Place the canvas and board over the harness. Pyramid three rows of ammunition horizontally on the board, and enclose these rounds with a row of ammunition around each side, vertically (A, fig 8). Pull the sides of the A-22 up and fasten the side straps. Fill the remaining space

an additional tiedown device over the ammunition and equipment to keep them in place. Rig the howitzer for lift in the same manner as described above for the M102.

### **M114A1**

The procedures for rigging the M114A1 are similar to those used for rigging the M101A1 by the separate loop method (fig 4). Because of its weight, the M114A1 is normally airlifted by CH-54's. The personnel and other equipment are moved by CH-47's. Two 10-inch endless slings, two metal clevises, two 8-foot slings, one 9-foot sling, one 12-foot sling, and four quick-release fasteners are required to rig the M114A1. The procedures are as follows: Tape one end of the 12-foot sling and, with the trails closed, wrap the taped end of the sling around the trails by threading the taped end of the sling through the trail handles. Pass the free end of the 12-foot sling through the loop of the taped end and pull it up tight as with a slip knot. Then tape one end of the 9-foot sling and wrap it around the recoil and variable recoil mechanism, forward of the cylinder yoke. Pass the free end of the 9-foot sling through the taped end as described above. Place the endless sling and the free ends of the 12-foot and 9-foot slings in one of the clevises and tighten the clevis. Secure the 8-foot slings to the axle of the howitzer, one on each side just inside the wheel assembly. Secure a second endless sling and the free ends of the 8-foot slings in the remaining clevis. During hookup, place the two endless slings in the aircraft cargo hook at the same time. The endless slings act as lift points for the load.

### **WHEEL VEHICLES AND TRAILERS**

Wheeled vehicles and trailers, ¼-ton through ¾-ton, may be rigged by using fixed length nylon slings or the four-leg adjustable sling. If bows are installed on the vehicles, the slings should be placed inside the bows. If fixed length slings are to be used and the vehicle to be lifted is not equipped with lifting shackles, then anchor screws must be attached to the vehicle to serve as lifting points. All rings and loose straps associated with the four-leg adjustable sling must be taped down to prevent flapping and possible damage during flight.

### **AIRCRAFT CONTROL**

Pathfinders, organic to the aviation group, may be used to aid in the terminal navigation and control of aircraft supporting an artillery movement. Pathfinders are trained and equipped to establish and operate electronic and visual navigation aids to assist aircraft in locating a designated facility within a landing area; to furnish ground-to-air voice radio communication to aircraft for the purpose of providing information, guidance, and control; to reconnoiter for and recommend suitable drop or landing zones; and to assist in the assembly of air landed forces.

In many cases TOE pathfinders are not available. In such cases, terminal guidance is furnished by artillery personnel of the moving unit, using equipment which is available or improvised. A departure airfield control officer (DACO) operates from the pickup zone (PZ) and a landing zone aircraft control officer (LACO) operates from the landing zone (LZ). These artillery personnel organize their respective areas and maintain contact with the supporting aircraft.



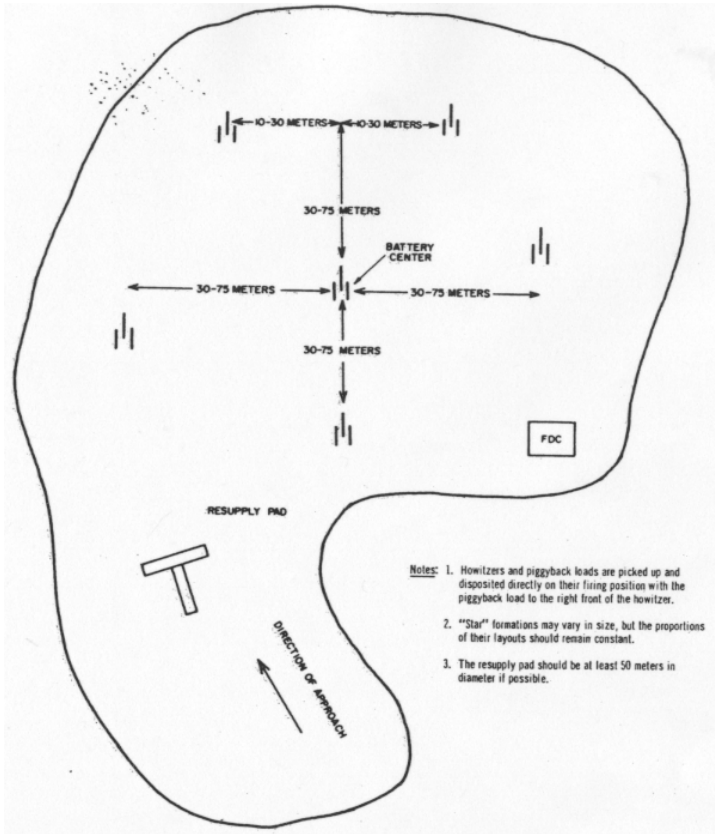

**Figure 9. Type of firing battery landing/pickup zone organization**

Positioning of loads according to a standard plan reduces the number of air-to-ground transmissions and personnel briefings and the amount of coordination required. Loads should be positioned to reduce flights over the battery as much as possible. All equipment should be positioned so that the aircraft can approach the landing zone into the wind. Wind direction takes precedence over battery overflight. Figure 9 shows a landing or pickup zone.

The DACO or LACO when providing instructions to aircraft pilots in flight, should be in a position where he can observe the aircraft, the loads and/or the ground markers. Some of the marking means available to artillery units are air-ground recognition panels, air-ground recognition vests, color-coded howitzers, smoke grenades, terrain features, and FM radios. An easily identifiable point of reference; e. g., a marking T, should be established as a reference point to vector the aircraft to specific point in the pickup zone and/or the landing zone.

## **LOAD IDENTIFICATION**

Aircraft may be directed to a specific load or location by radio. This method, however, is slow and requires excessive radio transmissions. To counteract this, a color code system may be employed. Each load is assigned a color, which is conspicuously displayed. The guide in the landing zone wears an air-ground recognition vest or uses an air-ground recognition panel of identical color. The pilot is told the color of his load during pickup. He notifies the landing zone control officer of his load color and is then guided to the position of the load with a corresponding color.

There are two methods used to guide a helicopter to its load pickup or release point. One method uses a signalman on the ground, the other method uses the aircraft crew chief as the signalman. The procedures for directing the aircraft are the same, but the method of informing the pilot is different. The method that is to be used should be established before the move starts.

The ground signalman instructs the pilot with hand and arm signals (fig 10 and 11). During daylight operations he wears a colored vest; at night he uses batons. He uses the load or panel marker as a reference point to guide the helicopter.

When the crew chief is used as a signalman in flight, he observes the load or panel marker through the hook hatch and uses the aircraft intercom to direct the pilot to the point. During daylight operations, a panel or color coded load may be used as a marking device; at night, colored landing lights are used to mark the load and/or release point.

### **DUTIES OF THE SIGNALMAN DURING HOOKUP**

When the ground signalman is used to guide the aircraft, he dons protective equipment and takes a position sufficiently beyond and upwind from the load, with his arms raised above his head, so that he is within sight of the pilot at all times (fig 10). He conveys his instructions to the pilot, using hand and arm signals. When the crew chief is used as a signalman, he stations himself on the helicopter floor and observes through the hatch.

#### **WARNING:**

To insure safety, a rope or harness should be fastened to the crew chief and anchored within the helicopter.

The signalman observes the cargo hook and the 10-inch sling at all times. When the hookup men have accomplished hookup, the signalman signals the pilot as required to maintain the helicopter directly over the load until the hookup men are clear from under the helicopter.

When the hookup men are clear of the helicopter, the signalman gives the pilot the "move upward" signal. This signal is given so that the helicopter rises slowly, taking up slack in the cargo sling. The signalman must insure that the sling legs are not fouled and that the load is properly attached to the cargo hook. If the sling legs are fouled or if the load is improperly suspended, the signalman gives the "move downward" signal and directs release of the load. After corrective action is taken by the hookup men, the hookup procedure is repeated.

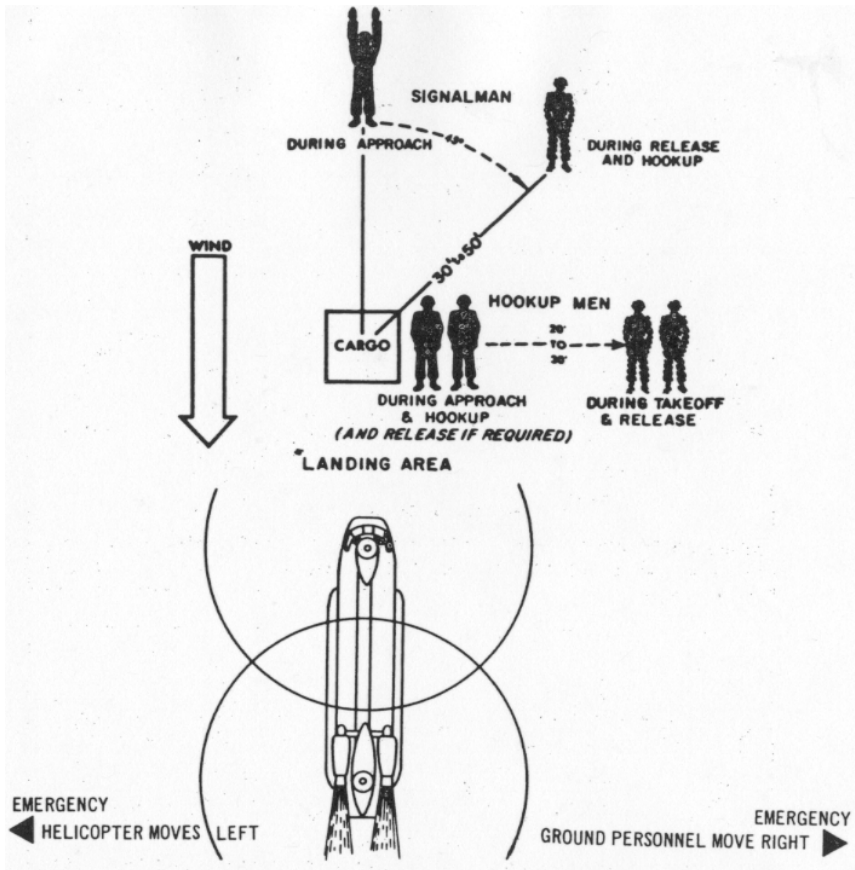

**Figure 10. Position diagram for hookup and release of helicopter loads.**

After the signalman insures that the load is correctly suspended, he gives the pilot the "takeoff" signal.

At this point, the helicopter pilot may elect to perform a power check with the load. This procedure is customary when there is doubt about cargo-weight limitations or helicopter readiness. It consists of lifting the load to a high hover (one-half of the load length), observing the pertinent engine instruments, and determining whether there is adequate power available for takeoff. If all readings are favorable, normal takeoff procedures are initiated. If power is inadequate for takeoff, the pilot lowers the helicopter and directs that the load be lightened.

### **DUTIES OF THE SIGNALMAN DURING RELEASE**

Using appropriate signals, the signalman guides the pilot in maneuvering the helicopter until the sling load is positioned a few feet above

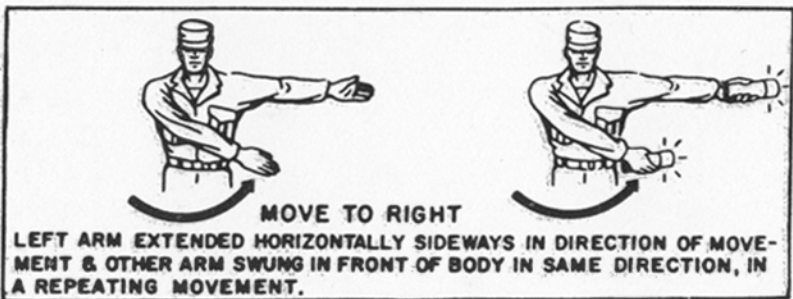
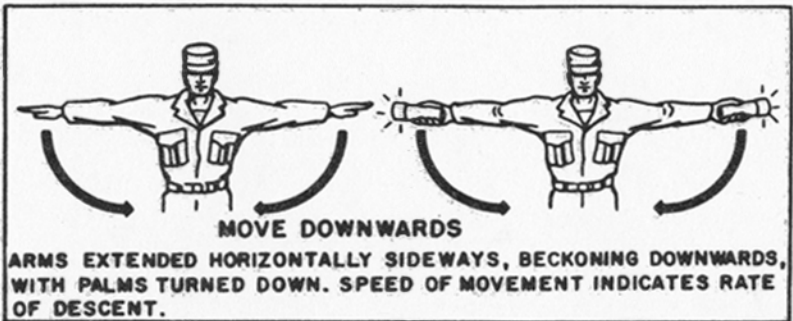
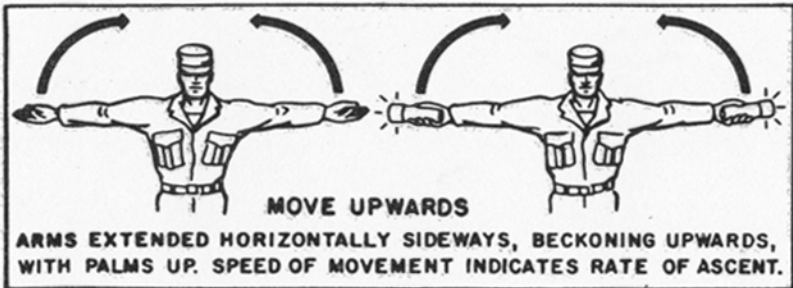
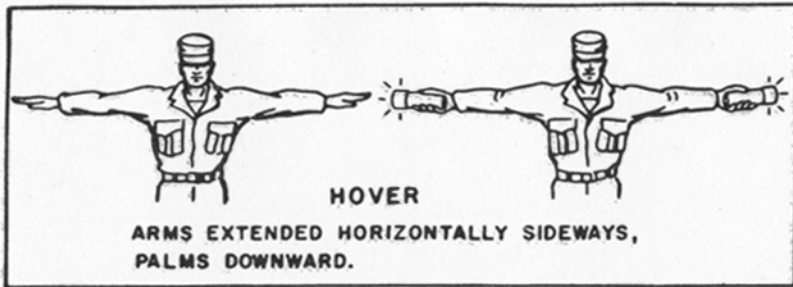

Figure 11. Hand signals for directing helicopters (day/night).

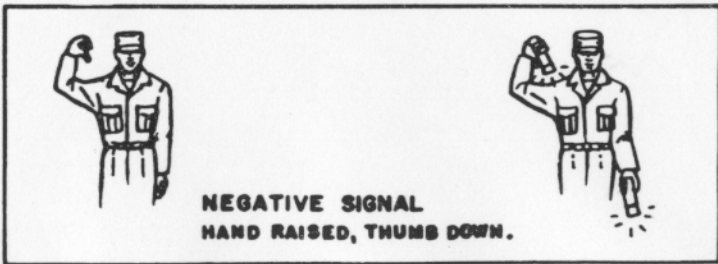
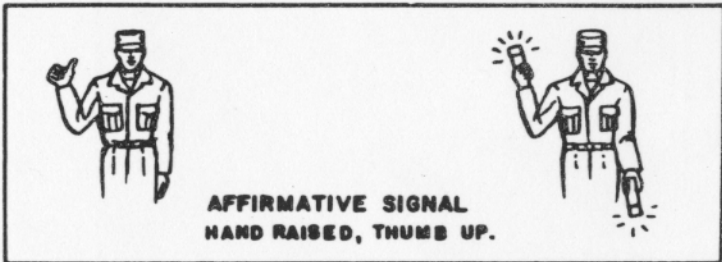
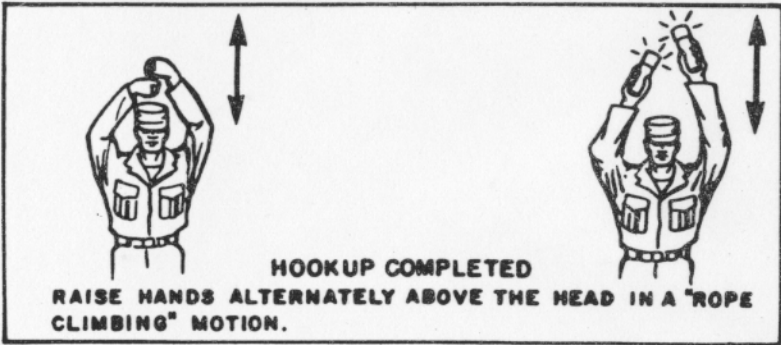
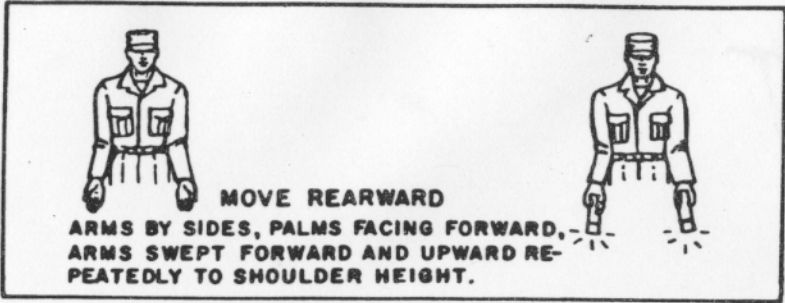

Figure 11. Continued.

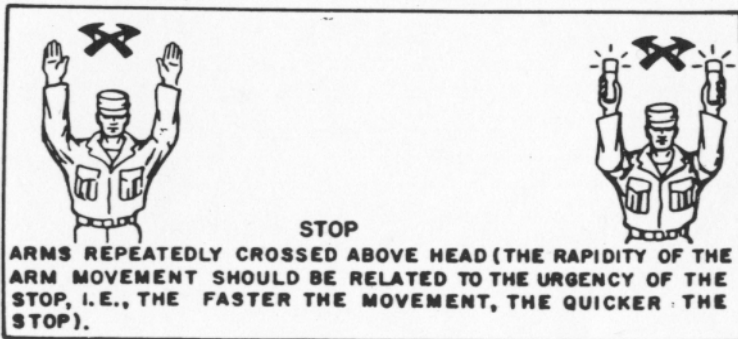
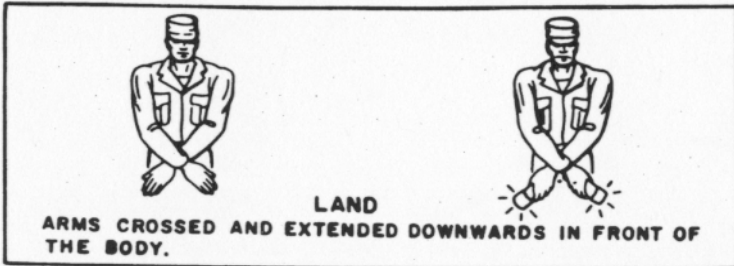
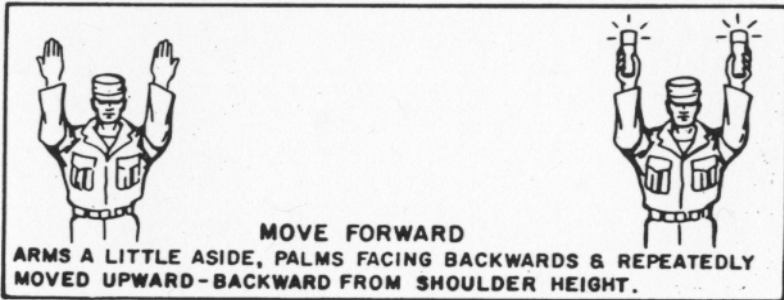
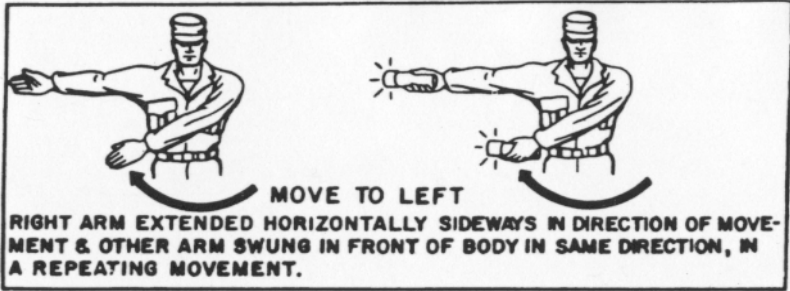

Figure 11. Continued.

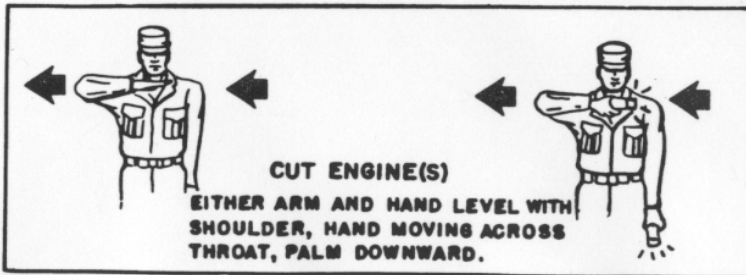
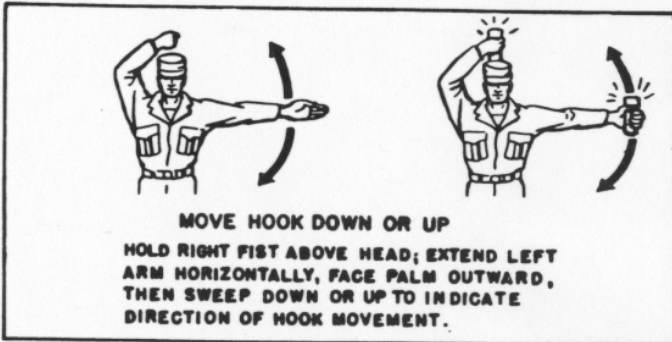
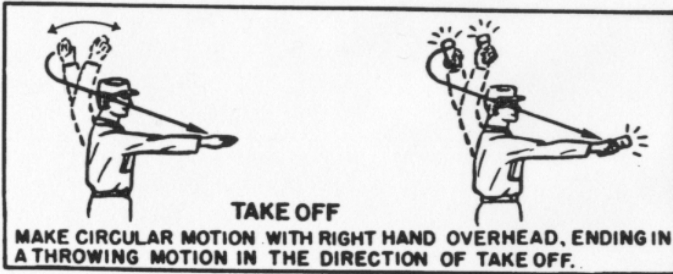
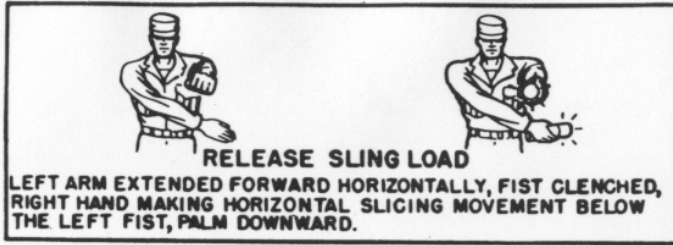

Figure 11. Continued.

the cargo release point. He then directs a gentle lowering of the helicopter until the load rests firmly on the ground. As soon as the load is safely on the ground, he signals the pilot to release the sling load. (When the crew chief acts as signalman it is difficult for him to tell when the load is on the ground, since he is directly above the load. For this reason, he directs the lowering of the helicopter until he observes slack on all sling legs, and as soon as the cargo load is resting on the ground, he gives the pilot the "release sling load" signal.)

The signalman insures that the load is properly grounded and that the 10-inch sling is released from the cargo hook. If the 10-inch sling does not release from the hook, the signalman gives the pilot the "hover" signal and then instructs the cargo-release men to manually release the load from the hook. When the load is free of the hook (and cargo-release men are out from under the helicopter), the signalman gives the pilot the "takeoff" signal.

### **DUTIES OF THE HOOKUP MEN**

Normally, two hookup men operate as a team; one man handles the static electricity discharge probe and the cargo hook, and the other handles the 10-inch sling of the sling load. Hookup must be accomplished rapidly and accurately to minimize helicopter hovering time and reduce the exposure time of the hookup men under the helicopter.

Before the helicopter arrives, the hookup men direct the spotting of the sling load for hookup, inspect the load to insure that the slings are not fouled, and insure that it is ready for hookup. As the helicopter approaches the hookup site, the hookup men, in protective equipment, maintain their position at or on the load. As the helicopter begins to hover over the load, the hookup men station themselves in such a position that hookup can be accomplished quickly and easily and that the signalman has a clear view of the operation at all times. After the signalman has guided the helicopter into position over the load, the hookup man handling the static electricity discharge probe grounds the cargo hook (to discharge the static electricity generated by the helicopter by contacting it with the probe).

The hookup man handling the 10-inch sling engages the sling in the cargo hook and insures that the hook is properly closed (and locked if required) after the sling and hook are coupled.

After hooking up the load, both men move quickly aside, out of the helicopter takeoff path.

Note: If the cargo sling legs are fouled or the load is improperly suspended from the cargo hook, the load is released and the hookup procedures are then repeated.

### **DUTIES OF THE CARGO-RELEASE MEN**

Cargo-release men are in a standby status and are employed only if the sling load cannot be released from the cargo hook by the helicopter crew. They act under direction of the signalman. Normally, one man handles the static electricity discharge probe, and the second man disengages the 10-inch sling from the hook. If required, both men work to release the sling.



As the helicopter approaches the cargo release site, the cargo-release men, in protective equipment, move to their positions about 20 to 30 feet from the cargo release point. The cargo-release men remain in this position unless directed by the signalman to move under the helicopter and manually release the sling load from a fouled or jammed cargo hook after the load is on the ground. If directed by the signalman, both men move in under the helicopter to release the load.

The man handling the static electricity discharge probe grounds the cargo hook by contacting it with the probe; he then grasps and steadies the hook. The second cargo-release man manually operates the cargo hook release or disengages the fouled sling from the hook. When the sling load is released from the hook, the cargo-release men move quickly aside out of the helicopter takeoff path.

### **PIGGYBACK TECHNIQUE**

When the howitzer and ammunition are to be transported by the piggyback method, the two loads are positioned side by side, approximately 4 feet apart. If the ammunition load is to be suspended from the howitzer, the hookup procedures are the same as describe above. If the ammunition load is to be suspended from the helicopter, the lift point of the ammunition load (free end of the 20-foot sling) is placed on the aircraft cargo hook at the same time the lift point of the howitzer (10-inch endless sling) is hooked up. After hookup, the signalman directs the pilot in such a manner that during lift the upper load (howitzer) is moved directly over the lower load before the lower sling becomes taut. This maneuver prevents dragging of the ammunition. During landing, care should be exercised to preclude dragging the load and/or placing the howitzer on top of the ammunition load. The pilot can tell when the weight of the ammunition is no longer on the aircraft. The signalman should direct the pilot to place the howitzer to the rear or either side, but not to the front, of the ammunition load. If the howitzer is positioned to the front during hookup or release, the weight of the ammunition may cause the howitzer to tip.

### **SAFETY**

Safety around helicopters cannot be overemphasized. Supporting and supported units should establish SOP's which are compatible with each other. Ground crew personnel working under a hovering helicopter are exposed to hazards resulting from both the rotor down blast and the noise created by helicopter operation. To provide for their own safety and health, ground crewmen should, as a minimum, wear the following protective equipment when performing hookup and release operations:

- Steel helmet. Provides protection against head injuries caused by flying debris and other objects.
- Protective mask or dust goggles with respirator. Provides protection against the entry of sand, dust, or insects into the eyes, nose, and mouth. In extremely dusty or sandy areas, the protective mask provides the better protection.

- Earplugs. Provide twofold protection — first, against noise; and second, against the entry of sand, dust, or other foreign matter into the ears.

In addition to the use of the above equipment, the following measures should be observed for additional protection:

Wear long-sleeved shirts or jackets with the sleeves rolled down and the sleeves and collar buttoned. Tuck shirttails or jacket bottom into the waist of the trousers. Tuck trousers cuffs into boot tops, or pull socks up over the trouser cuffs. To reduce the possibility of injury to ground crew personnel from flying debris and the possibility of an accident resulting from debris being drawn up into the helicopter rotor blades, police the operational area thoroughly before performing hookup and release operations.

Be careful and alert at all times while working under a hovering helicopter. Exercise sound judgment and common sense while near, or on, a sling load, and be prepared to clear the area immediately if the load is accidentally dragged along the ground or prematurely lifted from the ground by the helicopter. Be particularly careful when engaged in the hookup or manual release of oversize or odd-shaped sling loads; these types of loads pose additional safety hazards.

Standard operating procedures (SOP) should dictate that when an emergency occurs during helicopter external-load operations, the helicopter and the ground crew personnel will move in opposite directions to clear the hookup/release point and each other. With respect to the normal position of the helicopter during cargo hookup/release; that is, headed into the wind and hovering over the sling load (fig 10), the helicopter should move to the left and the ground crew to the right.

During routine hookup and release operations, the ground crew signalman faces the helicopter from a position in front of it and slightly to the pilot's side. In an emergency, the signalman moves to his left (to the helicopter's right) to clear the helicopter's takeoff path.

The hookup/release men working under the helicopter are required to move about in accomplishing their duties and, therefore, do not face in the same direction at all times. In an emergency, they exit from beneath the helicopter to the right to clear the helicopter's takeoff path; the pilot moves the helicopter to the left. Hookup/release personnel should station themselves at, and make every effort to work at, the right side of the sling load (with respect to the position of the helicopter hovering over the load) so that in an emergency they can clear from under the helicopter without climbing over or moving around the load.

Emergency measures for the release of cargo slings consist simply of cutting the sling load free of the hook with a pocket knife, sheath knife, bayonet, or other sharp-edged cutting tool. The sling legs attached to the 10-inch sling, but not the 10-inch sling itself, are cut loose as close as possible to the 10-inch sling (fig 6). Cutting the sling legs close to the 10-inch sling eliminates the danger of dangling sling ends becoming snagged during helicopter takeoff from the cargo release point and

subsequent landing and the danger of the ends whipping up to become entangled in the helicopter blades or controls.

Emergency measures for releasing the cargo net sling consist of releasing four cargo net snap fasteners and cutting one draw cable. First, the four snap fasteners which attach the draw cables to the 6-inch ring are released, and then the single draw cable which remains permanently attached to the 6-inch ring is cut loose close to the small retainer ring. A cable cutter, wire cutter, heavy duty lineman's pliers, diagonal cutters, or any other similar cutting device may be used to cut the single cable.

The following safety measures are applicable to all personnel involved in helicopter loading and unloading operations:

Wear steel helmets, with straps fastened, and goggles or protective mask.

Carry individual weapon in hand when entering or leaving the aircraft.

Do not smoke within 50 feet of the aircraft.

Obey all pilot and crew instructions.

Remove radio antennas before approaching or entering aircraft.

## **SUMMARY**

The helicopter provides the artillery with a mobility it has not previously experienced in land warfare. Full exploitation of this mobility is limited by the inherent capabilities of the aircraft; the weight of weapons and equipment; and the resourcefulness, skill, and training of the artilleryman. Airmobile artillery is already an established fact, and there is a continuous effort to improve present capabilities.



## **TERMS USED IN RVN**

**REGIONAL FORCES (RF)** — A nationally administered military force assigned to and under the operational control of the sector commander (province chief). The basic combat unit of the RF is the light infantry company, though in certain provinces there are also a number of RF mechanized platoons, intelligence platoons and squads, and river patrol companies. Normally the RF unit is recruited locally, placed under the operational control of the subsector commander (district chief), and habitually employed in the same general area. The primary missions given to RF units are to secure key installations and communication routes, to protect the local government officials and key people loyal to the government, and to provide a subsector reserve for assisting village or hamlet defense forces under attack.

**REPUBLIC OF VIETNAM (RVN)** — The nation itself although sometimes used interchangeably with GVN when referring to the government or with SVN when referring to the land.

*point-blank defense*

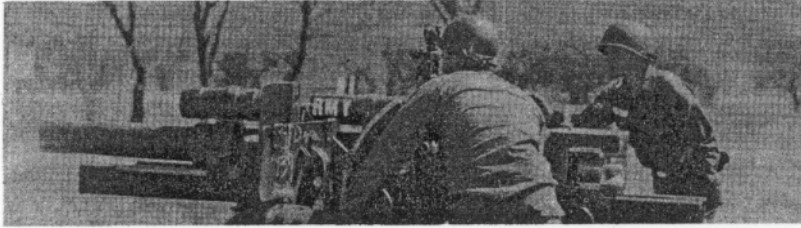

# Direct Fire

*2LT Howard C. Anawalt  
U. S. Army Artillery Board  
Fort Sill, Oklahoma*

---

## EDITOR'S NOTE:

The following is an article reprinted from the June 1961 issue of ARTILLERY TRENDS. The original article was a summary of the findings and recommendations of a Direct Fire Study conducted during the period 1954-1960 by the U.S. Army Artillery Board at Fort Sill, Oklahoma. Recent studies conducted at the School confirm the validity of the information contained in the article. The **Report of Study Direct Laying by Artillery Weapons** conducted by the Gunnery Department, USAAMS, in 1965-66 concluded that "currently prescribed procedures for field artillery direct fire are satisfactory" and recommended that such procedures be accepted as sound. The report further states that Army tests have been revised to add emphasis to direct fire procedures. Direct fire procedures are being included in new publications of tube weapons systems. The article below has been updated slightly, thus insuring that the information contained in the article is as applicable today as it was in 1961.

---

"Tanks, right front . . . fire at will!"

You had better be ready to fire this mission; if you don't end it, the enemy will. No mission takes priority over the direct fire mission; none requires greater speed and accuracy. Field artillery weapons are designed primarily for firing indirect fire, but they can and must be used for firing by direct laying, principally against moving targets. The speed and accuracy required in indirect laying become even more important for direct laying missions.

In direct fire, the howitzer section becomes the complete fire unit and incorporates the functions of forward observer and fire direction center as well as the firing battery. The chief of section estimates target

range and speed and then directs the section to fire at that range with an estimated lead. He senses and adjusts his fire as necessary.

### **THREE METHODS OF LAYING FOR DIRECT FIRE**

There are three methods of laying an artillery weapon for direct fire: **the two-man, two-sight system; the one-man, one-sight system; and the two-man, one-sight system.** The most effective technique is the two-man, two-sight system. In this method, the gunner lays the piece for direction using the panoramic telescope, while the assistant gunner lays for range using the elbow telescope. This system is the fastest, is comparatively easy to teach to cannoneers, and is the most accurate, particularly when the target is moving up or down steep slopes. In addition, in this method, the assistant gunner is able to check the direction of lead which has been set off, thereby increasing the accuracy. However, this check of the lead using the elbow telescope is possible only with those elbow telescopes which can be boresighted for deflection. The M16A1D telescope on the 105-mm howitzer M101A1 is not capable of deflection boresighting. The two-man, two-sight method should be used when firing direct fire with any weapon equipped with two sights.

The second most effective system is the one-man, one-sight system, in which the gunner lays for both direction and range by using the panoramic telescope, providing the telescope is equipped with a reticle graduated for range and deflection. The only weapon currently equipped with such a telescope is the 105-mm howitzer M101A1 equipped with the panoramic telescope M12A7D. Although effective, it is difficult to train a gunner in this system, since he must adjust simultaneously the lay of the weapon for both elevation and deflection.

The third method is the two-man, one-sight technique, in which the gunner lays for direction by using the panoramic telescope while the assistant gunner lays for range by using the range quadrant (elevation scale). This is an easy system to teach and it produces acceptable results against targets moving on level terrain. However, since it does not offer effective accuracy against targets moving on steep slopes, it is the least desirable technique to use against such targets.

Design limitations in some weapons prevent the use of the two-man, two-sight system of direct laying. If this is the case, the technique most favorable for the weapon and the section personnel should be used.

### **"LEADING THE TARGET"**

A crucial aspect of direct fire is the ability to "lead" the target accurately. Firing at a stationary target simply requires aiming at the center of mass. This is not possible with a moving target. Consider a moving tank; even as the projectile travels toward the target, the tank is moving from its original position. Instead of aiming at the original position of the target, the gun must be laid on a theoretical point at which the target and the projectile should arrive simultaneously. In other words, the weapon must be aimed ahead of the target. This is "leading."

There are two techniques for incorporating the correct lead into the lay of the piece; they are **reticle laying** and **central laying**. In reticle laying, the vertical crosshair of the panoramic telescope is placed a certain number of mils **ahead** of the target (fig 1). The lead is indicated on the **reticle pattern** of the telescope. Central laying involves setting the lead mechanically on the **azimuth scale** and then laying the vertical crosshair **on** the center of mass of the target (fig 1).

The two techniques are equally rapid, but central laying is more accurate. In firing tests conducted by the U. S. Army Artillery Board, Fort Sill, Oklahoma, central laying proved to be about seven percent more accurate than reticle laying.

### CENTRAL LAYING AFFORDS CHECKS

When using central laying, the chief of section can correct a lead applied in the wrong direction before the round is fired. He can do this by glancing at the azimuth scale. (This is possible only when the chief of section can stand directly behind the gunner which is an unusual situation for direct fire operations). In reticle laying, he cannot check the direction of lead until he sees the round burst, and then he will not know whether an error is due to the amount or direction of lead. The error may persist for two or three rounds if the gunner continues to apply the corrections in the wrong direction.

A difficulty with central laying is that the gunner may lose the target as he looks at the scale to set off the lead. This is particularly a problem in self-propelled weapons, in which "naked-eye" vision is restricted. A device which will reduce this possibility is a mechanism called the "click sight." A click sight makes a perceptible click when a fixed lead is set off, thereby allowing the gunner to set the lead without taking his eye from the eyepiece.

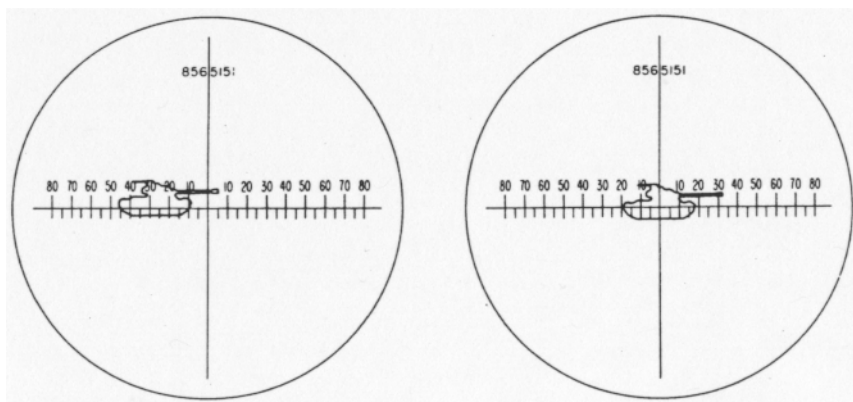

**Figure 1. Positions of vertical crosshair in reticle laying (left) and central laying (right).**

Another partial solution is for the gunner to traverse at a speed which approximates the speed of the target as he glances at the scale to set the lead value. A second assistant gunner can be used to set the lead. Because of these complications in laying enclosed, self propelled weapons, reticle laying seems to be the best solution when click sights are not available. Click mechanisms in five-mil increments are incorporated in all of the new family of panoramic telescopes.

A good combination of sighting and laying will increase the percentage of first-round hits. When a tank is barreling down on a gun position, that first round will be critical. If that all-important hit is not made on the first round, adjustment is necessary. Adjustment takes time, which allows the tankers to shoot back. It is best to hold fire until the tank is within the optimum direct fire range (about 500 meters for present weapons). "Don't shoot until you see the whites of their eyes" is a good suggestion to follow. If your gun position is concealed and the tank hasn't spotted it, wait until you have the odds; surprise is a factor in your favor.

### **CHIEF OF SECTION BECOMES FO, S3**

If it is necessary to adjust, it is best for the chief of section to do it; the muzzle blast may obscure the gunner's vision. The chief must stand where he can see the rounds burst and use judgment in spotting them. Direct fire bursts can be deceptive. At close ranges, a round which lands short of the target may bounce over it before exploding and cause a miss-spotting of OVER. Or the lead may be slightly too wide and cause the round to pass in front of the target. By the time the round bursts, the vehicle has moved in front of the burst. If the chief spots it OVER, he may command a range change which will give him a short on the next round. Time is wasted—and there may be no next round.

Learn these recommended procedures for adjustment.

If the initial range is 600 meters or less, make 100-meter range changes until you get a target hit. Open fire at the estimated range or 400 meters, whichever is greater.

If the initial range is between 600 and 1,400 meters, make 200-meter range changes until you get a bracket.

If the initial range is over 1,400 meters, make 400-meter range changes until a bracket is obtained.

Split brackets until you get a target hit.

When adjusting on a target which is moving toward the gun position, the decreasing range of the target must be considered. For example, if a spotting of OVER is obtained and the target moves 100 meters closer, a 300-meter range change must be applied to establish a 200-meter bracket (fig 2). Similarly, changes in site must be considered as the target moves up or down on slopes.

Field glasses can be used to aid in adjustment; however, US Army Artillery Board tests indicate that acceptable adjustment can be made without them at ranges up to 1,200 meters. Because of their narrow field of view, field glasses afford less accuracy than the naked eye at ranges below 500 meters.

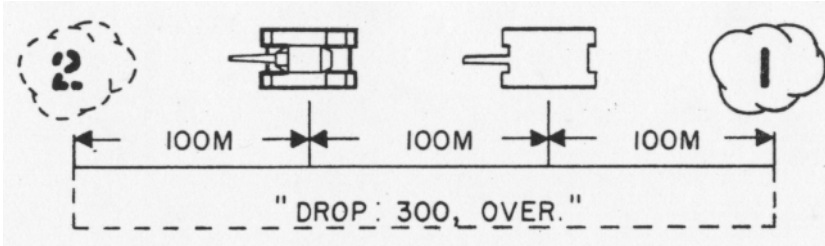

**Figure 2. Establishing a bracket on a moving target.**

### **TANK VS HOWITZER**

On the future battlefield, with units widely dispersed, the artillery battery will have an increased requirement to defend its own position area. Aggressor armor will frequently be used in deep penetrations because it is fast, maneuverable, and offers some protection against the effects of nuclear weapons. Artillery batteries will more than ever be exposed to tank attacks. To provide continuous support, artillery must be able to defend itself.

The tank is a direct fire weapon. It is constructed with all the necessary direct fire features. It has an extremely high velocity gun and a direct fire control system which make possible a high percentage of first-round hits at ranges up to 4,000 meters. Its chief weakness is limited "seeing." Compared with a tank, the artillery piece, an indirect fire weapon, has a low muzzle velocity, a low-power direct fire telescope, and no range finder. Artillery, however, is usually concealed and strives for 6,400-mil observation. Although at a disadvantage when face-to-face with the tank, artillerymen can depend on surprise; that is, seeing the tank before the tankers see them, and thereby getting off the first shot.

### **DIRECT FIRE IMPROVEMENTS**

The best range to open fire on a tank is approximately 500 meters with most artillery pieces. At this range, the maximum ordinate for high explosive (HE) and high explosive antitank (HEAT) shells never exceeds eight feet. In other words, at this range the shell never rises above the height of current tanks. If the deflection is correct and the round is not short, a first-round hit is assured. Higher muzzle velocities will extend this effective direct fire range. The high explosive plastic shell with tracer (HEP-T) M327 extends the flat trajectory range of the 105-mm howitzer to approximately 700 meters; as shells with even higher muzzle velocities become available, this range will be further extended. (For the 175-mm gun, using zone three, this distance is extended to 1,000 meters.)

Improving the optical characteristics of telescopes is another development in artillery direct fire capability. Increasing the power of the elbow telescope contributes to more accurate and consistent laying



for range and better target detection and recognition. Atmosphere turbulence limits the useful magnification of direct fire telescopes to 10 power or less. Future elbow telescopes will be 7 or 8 power—or more than twice the power of present models. (The 105-mm howitzer M102, as an example, has an eight-power direct fire telescope.)

Another development in direct fire optics is increased exit pupil diameter — the diameter of the beam of light leaving the telescope and entering the eye. The average eye can accommodate a 7-mm beam of light. A 7-mm exit pupil diameter allows the maximum amount of light to enter the eye and therefore permits more effective fire under poor light conditions. At present, the panoramic telescope has an exit pupil diameter of only 4.1. The increase to 7-mm will be a significant aid in twilight and moonlight situations.

As previously mentioned, click sights aid the central laying of self-propelled weapons, and they are provided on all new family artillery weapons to include the towed 105-mm howitzer M102.

Improved optical characteristics for telescope, click sights, high velocity rounds, and better training will increase the artillery's capacity to deal with tanks without complicating or decreasing the indirect fire capability. But with these developments must come an improvement in the ability to determine ranges accurately — and thereby increase the first-or second-round hit capability. The immediate goal should be to develop a simple means to determine range accurately to 2,500 meters. Artillery can and must be used for firing by direct laying, principally against moving targets. The artillery must be ready when he hears the commands. . .

"TANKS!"

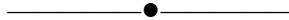

### **TERMS USED IN RVN**

REPUBLIC OF VIETNAM ARMED FORCES (RVNF) — The army of the Republic of Vietnam (ARVN), the Vietnamese Air Force (VNAF), the Vietnamese Navy (VNN), and the Regional and Popular Forces (RF and PF). Each of these elements has a specific role in the overall strategy for defeating the Vietnamese Communists (VC) and North Vietnamese Army (NVA) units.

PROVINCE/SECTOR — Identical geographic areas. Province is the major subnational roughly equating to a US state. The province chief retains all general administrative as well as budgetary and fiscal powers. In addition to his administrative duties, the province chief is the sector commander of the province paramilitary forces. He is usually an ARVN officer.

# Vietnam Operations

*Captain Gary E. Schultz  
Tactics/Combined Arms Department  
(Formerly with B Battery (SLT), 29th Artillery,  
1st Cavalry (Airmobile) Division  
1LT Richard H. Barkalow  
Target Acquisition Department  
USAAMS*

Although the use of searchlights in the Army is by no means a new development, searchlights received little attention in the period following the Korean War and, as a result, the last artillery searchlight battery was deactivated in 1961. A few years later, however, the conflict in Vietnam again created a need for the artillery searchlight, and B Battery (Searchlight), 29th Artillery was activated at Fort Sill in 1965 and deployed to Vietnam the same year. The role played by B Battery in Vietnam plus recent technical advances in night vision equipment have resulted in considerable interest in the artillery searchlight. New equipment has been issued, and additional searchlight units have been organized.

The searchlight, now issued to new units on an interim basis, is a jeep-mounted, 23-inch Xenon searchlight (Figure 1). This new model is smaller, more reliable, and hence better suited for international defense operations than the 30 - inch carbon arc searchlight system which it replaces (Figure 2). A 30-inch Xenon searchlight is planned to replace the 23-inch model.

## **ORGANIZATION OF THE SEARCHLIGHT BATTERY**

The field artillery searchlight battery is organized as shown in Figures 3 and 4. The battery is divided into three main functional groups — the battery headquarters, the communications section, and the searchlight platoons. The battery headquarters consists of administrative and supply personnel, a mess section, two searchlight electricians, and a maintenance section capable of performing organizational maintenance on equipment organic to the battery. The communications section consists of a radio section and four wire teams. Both maintenance and communications personnel may be detached from their sections to augment the searchlight platoons when tactically employed. The three searchlight platoons are made up of a platoon headquarters and six searchlight sections and two lights in each section. The platoon headquarters contains the light direction center, which is similar to the fire direction center of a cannon battery. Lastly, the searchlight section consists of four men and each section has two 23-inch Xenon searchlights.

## **EMPLOYMENT OF ARTILLERY SEARCHLIGHTS**

In conventional situations the searchlight battery would normally be assigned to corps artillery with the platoons further attached to the

# Activate the Searchlight Battery

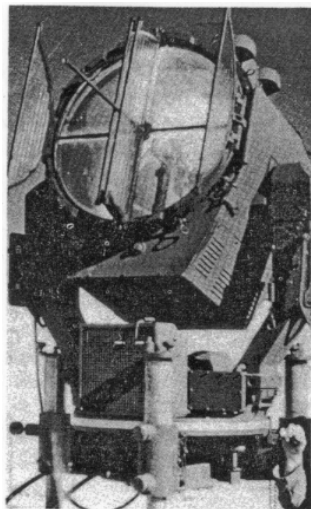

Figure 1. 30-inch carbon arc searchlight.



Figure 2. Jeep-mounted Xenon searchlight.

member divisions with direct tie-in to the division artillery FDC. Because the platoons have a minimum number of personnel, they must rely on the supported unit for assistance in providing survey control, security, and administrative and logistical support.

In the internal defense operation environment sections may be attached to combat units to provide necessary illumination support for night operations. The searchlight has been found useful in offensive action, such as search-and-destroy missions, and in defensive actions. The direct beam of the searchlight, for example, may be used to channelize infiltrating groups into less desirable avenues of approach. Today in Southeast Asia searchlights are situated at fixed installations to provide orientation light and on-call illumination in harassed areas. At times, ports, beaches, and engineer works are also provided illumination to facilitate their operations. Critical supply routes are provided "on call" light to insure the security of these routes or deny their use by the enemy.

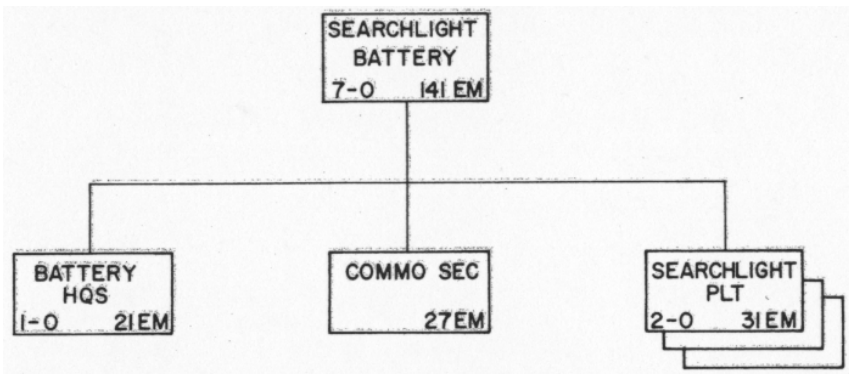

**Figure 3. Searchlight battery**

The value of the artillery searchlight has been clearly demonstrated in World War II, Korea and Vietnam. The presence of the searchlight bolsters confidence of friendly forces and conversely limits the enemy's initiative in choosing when and where to attack. The searchlight itself is not as vulnerable as one would think since it is extremely difficult for an enemy observer to estimate range when looking into the searchlight beam.

### **EMPLOYMENT IN AIRMOBILE OPERATIONS**

A Xenon searchlight section can be airlifted in a CH-47 (Chinook) helicopter, both internally or sling-loaded.

In airmobile operations two to four searchlight sections usually are employed in support of an infantry brigade. The lights normally are attached to the direct support artillery battalion for support.

### **CHARACTERISTICS AND OPERATING DATA**

The light source in the 23-inch searchlight is a short-arc xenon lamp rated at 2.2 kilowatts. The searchlight is capable of operating in visible

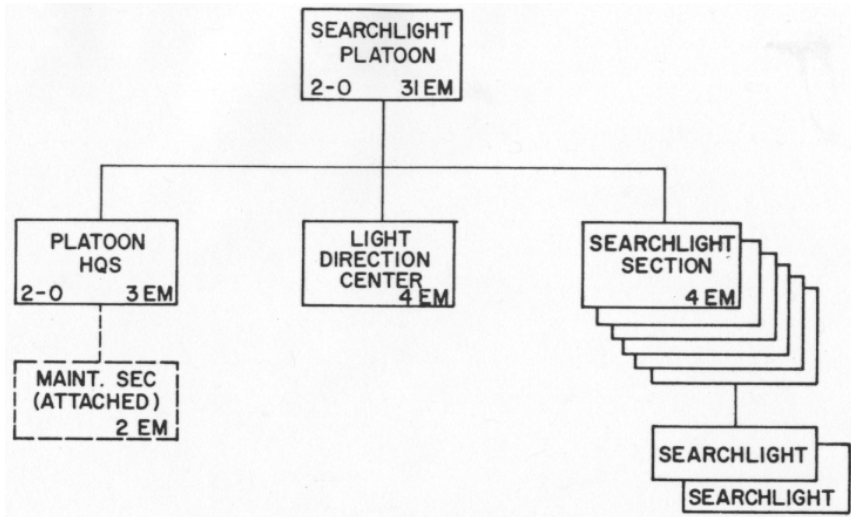

**Figure 4. Searchlight platoon**

and infrared modes. Ignition of the lamp and selection of the mode of operation simply are changed by a selection switch.

Power for the searchlight is supplied by a 180 ampere alternator-rectifier system installed in the jeep engine compartment.

The range of the searchlight, using the direct visible, focused beam, is approximately 4,000 meters. Under favorable conditions, however, useful illumination may be obtained at appreciably greater ranges. The range of the spread beam and infrared modes is understandably much less.

Operation data for the 23-inch searchlight is listed in Table 1.

**TABLE I**

Current requirement	100 amperes dc
Candlepower	125 million
Beam width	
Focused (Pencil) beam	10 mils
Spread beam	120 mils
Weight	250 pounds
Range	4,000 meters

### **CAPABILITIES AND LIMITATIONS**

The 23-inch Xenon, jeep-mounted searchlight is an appreciable improvement in mobility, reliability, and ease of operation over previously used searchlights. The xenon lamp combines the advantages of simplicity of an ordinary tungsten filament bulb and the high candlepower available only from an electric arc.

It should be pointed out, on the other hand, that its equipment was designed and intended for use on an armored vehicle. As an artillery searchlight, its candlepower and beam width are significantly less than desirable.

A 30-inch Xenon searchlight, which will provide a 50-mil-focused beam of 1.5 billion candlepower, is being developed as a replacement for the 23-inch Xenon light.

### ADJUSTMENT OF ILLUMINATION

As in normal target location, an observer requests illumination by grid reference, target number, or shift from a known point. However, searchlight illumination requests involve the use of vocabulary which varies somewhat from that of the normal fire mission. Following is listed special terminology used for conduct of an illumination mission.

**ACTION COMPLETE** — Report of compliance with last command.

**FLICK** — Command to turn on the searchlight; corresponds to the command **FIRE**.

**HOLD** — Command to keep the searchlight on the same elevation; corresponds to the command **REPEAT**.

**CUT** — Command to turn off the searchlight; corresponds to the command **CHECK FIRING**.

**Spread Beam** — A beam 120 mils in width.

**Pencil Beam** — A beam 10 mils in width.

The elements and sequence of a request for illumination and adjustment are illustrated below:

<b>Element</b>	<b>Example</b>
Identification of observer	FRANKSCOTT 30, THIS IS FOXTROT 41
Warning	ILLUMINATION MISSION
Target location	GRID 419631, DIRECTION 1680
Description of target	SUSPECTED ENEMY PLATOON
Method of engagement:	
Number of lights	LIGHTS — (Adjustment is usually made with one light.)
Type of illumination	INDIRECT — (Type of illumination omitted when direct illumination is desired.)
Beam spread	SPREAD BEAM — (Beam spread is omitted when pencil beam is desired.)
Control	ADJUST LIGHT, FLICK WHEN READY

Note: Adjustment is made by announcing beam spread corrections; for example, **RIGHT 2 BEAMS, UP ½ BEAM**.

## LIGHT DIRECTION

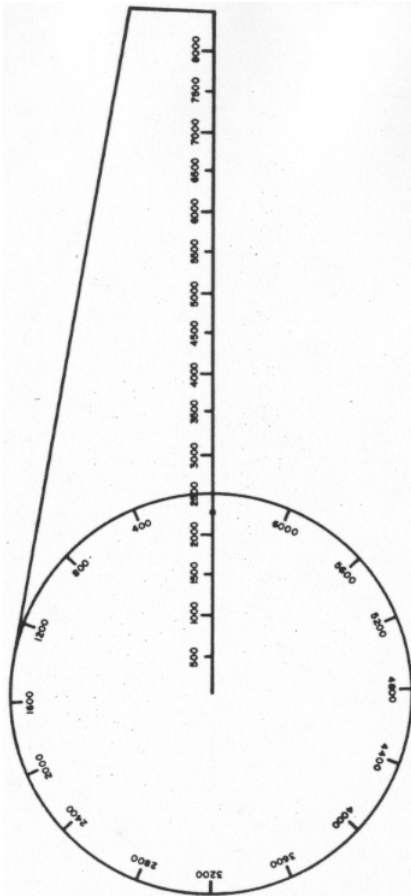

**Figure 5. Modified Protractor for Section Light Direction**

Light direction for searchlight operations is relatively simple. The lights are laid in azimuth individually with an aiming circle or a compass, on a distant aiming point, or on aiming stakes. At the light direction center the searchlight positions are plotted on a standard firing chart. Range, we find, is more easily obtained by using a modified mortar deflection fan rather than the aluminum range deflection protractor (Figure 6). The chart operator plots the target; determines the range and vertical interval; and announces this information to the computer. The computer determines elevation from a table and sends the commands to the searchlight section. Adjustments from the observer are taken directly by the section.

### SUMMARY

For the combat soldier, there is now a means of providing continuous, efficient battlefield illumination to locate the enemy, to aid in destroying him, and to prevent enemy guerrillas from infiltrating into friendly positions. The 23-inch Xenon searchlight is a welcome addition to the combat zone and, when used effectively, it can aid greatly in accomplishing a mission.

---

### TERMS USED IN RVN

**AREA OF RESPONSIBILITY (AOR)** — (Sometimes called tactical area of responsibility (TAOR). That area in which a US or Free World Military Assistance unit has the following continuing responsibilities to be coordinated as necessary with local GVN authorities, both military and civil:

- a. Defense of key installations.
- b. Conduct of operations including such reaction operations as are necessary to secure the area against organized military forces.
- c. Support GVN revolutionary development (pacification) activities as required.

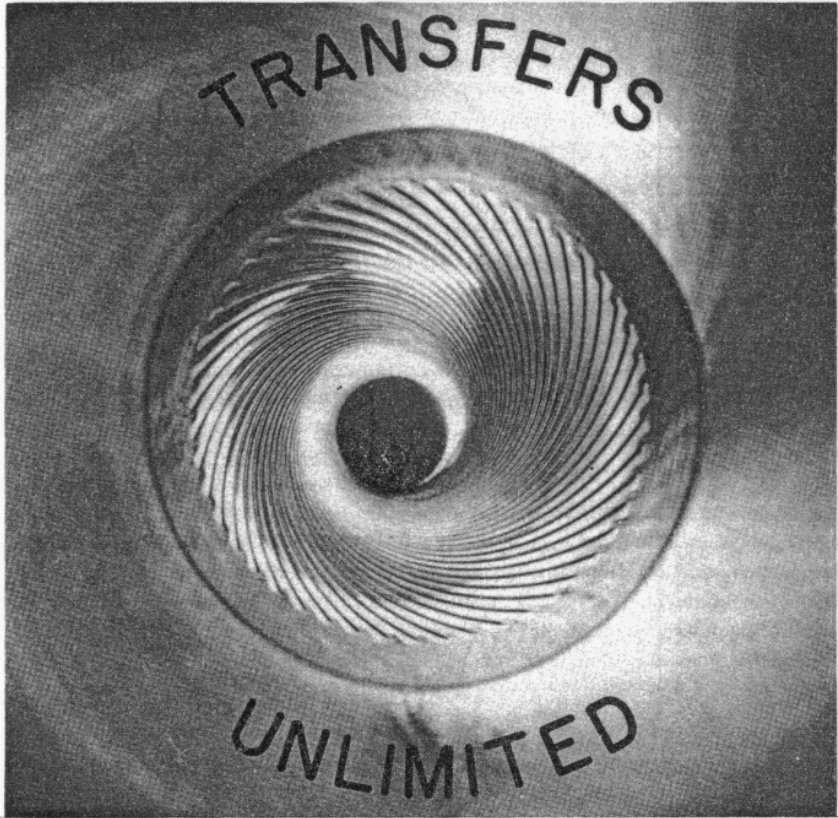

*Matthew J. Ringer  
Gunnery Department  
USAAMS*

The earliest recorded application of indirect fire was the use of catapults for hurling stones into enemy fortifications protected by stone walls. The catapults were usually in the open whereas the camps or towns against which the catapults were fired were hidden by the stone ramparts. As a result, the only objective of these first cannoners was to hit somewhere within those large, hidden targets, and, unless a large amount of ammunition was used, damage to enemy personnel or equipment was more or less left to chance.

The effect of a volume of artillery fire was recognized by Napoleon who, in his "Maxims of War," stated in part, "He that has the skill to bring a sudden unexpected concentration of artillery to bear upon a selected point is sure to capture it." Napoleon used massed artillery fire by either massing his tubes or placing them so that their fires would converge. When any degree of accuracy was required, materiel limitations



forced his artillerymen to resort to direct fire, adjusting the fall of shot by sighting on visible targets.

From its earliest days, artillery has been capable of firing at ranges exceeding those of human vision. Commanders then, and since have realized the advantages to be gained from positioning the artillery so that it is least likely to be seen (and fired upon) by the enemy. This ideal arrangement was impossible, however, before the beginning of the 20th century when improvements in equipment and advances in knowledge about ballistic trajectories permitted the artilleryman to measure and apply corrections to compensate for nonstandard conditions without being able to see the target from the gun positions.

It was learned that nonstandard conditions of weather and materiel could be measured either by firing or by computation. When conditions were measured by firing, the artilleryman had to know the locations of two points—the point from which fire was to be delivered (gun location) and the point which fire was intended to hit (base point). By knowing these locations the artilleryman was able to graphically measure the direction, range, and vertical difference (chart data) between the two points. Under standard conditions of weather and materiel, it was assumed that fires based on firing table data would impact on the base point. However, since standard conditions rarely exist, the use of standard firing data resulted in the projectile's impacting at some point other than the base point. The observer made the appropriate corrections for moving the point of impact nearer the base point; then, additional rounds were fired until a group of rounds (usually six), fired at the same deflection and range, was centered on the base point. Total corrections were obtained by determining the difference between the chart data (which should have caused the rounds to hit the base point) and the final data (which did cause the rounds to hit the base point.) With respect to range it was known that the correction was valid only for the chart range to the base point. To permit use of the correction at other ranges (it was reduced to a correction in terms of yards per thousand yards of chart range (range K). For example, if the base permit range was 5,000 yards, but it was necessary to fire at range of 5,100 yards to place the center of bursts in the base point, the range K would be computed  $+20$  ( $5,100 \text{ yd} - 5,000 \text{ yd} / 5.0 = +20 \text{ yd per } 1,000 \text{ yd}$ ). It was then assumed that the  $+20$  was a constant correction and could be applied to other chart ranges, i.e., for a chart range of 6,000 yards, the range field would be 6,120 yards ( $+20 \times 6.0 + 6,000 = 6,120$ ). The concept that range K remained a constant for all ranges was subsequently proved to be wrong, and in order to minimize the error when range K corrections were used, a limit was placed on the size of the area in which fires could be placed. From 1918 until 1942, range transfer limits, the limits within which unobserved or unadjusted fires could be delivered, were four-thirds and three-fourths of the base point range.

Laterally, the correction for direction (deflection) was considered a constant and was computed by comparing the chart deflection with the deflection which centered the group of bursts on the base point. This constant

deflection correction was also known to be correct only for the direction to the base point; however, use of the correction for other deflections was permitted within prescribed limits, which were 300 mils left and right of the base point. The reason for the selection of a limit of 300 mils is not definitely known, but it was probably based upon limited test firings which showed that 300 mils was a reasonable amount.

Field Manual 6-40, published in 1942, changed transfer limits to 1,500 yards short and over the base point and 400 mils left and right of the base point. In 1945, transfer limits were further modified for base points at ranges greater than 10,000 yards. These limits were set at 2,000 yards short and over the base point and 4,000 yards left and right of the base point. With the exception that 1,500, 2,000 and 4,000 yards were changed to 1,500, 2,000, and 4,000 meters, these limits remain in effect today.

Although it was known that range K and the deflection correction were not constants, the transfer limits were practical and fires within them were considered sufficiently accurate. In fact, these limits had no real justification, but their use was considered as being a practical gunnery technique. This concept was recognized in FM 6-40 (1942) by the statement that "the size and shape of the area limiting accurate K-transfers are not constant because certain variables are involved." The concept of transfer limits based upon corrections obtained from a base point registration (or met plus velocity error computation) was accepted because, in recent wars, the density of artillery units made it possible to mass large numbers of battalions without radically changing their direction of lay. The principles of mass and surprise have not changed, but the method of achieving these principles is undergoing change. Future conflicts in a nuclear or non-nuclear environment envisage independent or semi-independent actions requiring artillery support throughout greatly enlarged areas. The field artillery digital automatic computer (FADAC) is capable of providing first-round hits, without adjustment, in any direction and without regard to range limits. As a result, in the future, artillery will be massed by shifting the fires of widely spaced batteries and battalions. The manual backup system to FADAC should be able to do no less.

The U. S. Army Artillery and Missile School has virtually eliminated range and deflection transfer limits through the use of two items — a slant scale graphical firing table (GFT) and wind cards.

Previous GFT's were constructed with logarithmic range scales like the C and D scales on a slide rule. After determination of corrections either through firing or by computation, the hairline of the GFT cursor was placed on the registration point (formerly called the base point) chart range, and an elevation gageline corresponding to the corrected range was drawn. By moving the cursor with its hairline and gageline to a range other than the registration point range, a constant range K was graphically applied to the new range, and the elevation read under the gageline corresponded to the chart range corrected by the range K. To reduce or eliminate the error caused by assuming the range K to be

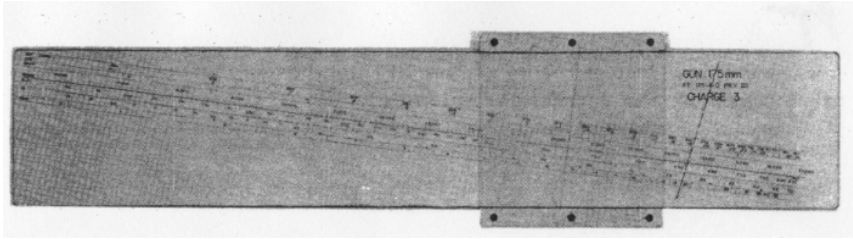

**Figure 1. GFT 175-mm gun, charge 3**

a constant, the range  $K$  must be changed with each change in range. If this could be done successfully, transfer limits could be enlarged and artillery effectiveness would be increased. The GFT shown in figure 1 provides the capability of applying a variable range  $K$ .

A detailed explanation of the concept of the variable range  $K$  determined by means of the 175-mm gun GFT is presented below. This GFT is the only one presently in existence; however, similar GFT's for other calibers are being manufactured as rapidly as possible. The GFT is capable of providing three types of data — standard data read under the hairline; corrected data read under an elevation gageline (or met plus VE computation); and corrected data read under an elevation gageline and based on multiple plot points, determined from two or more registrations, met plus VE computations, or a combination thereof. The detailed operation of the GFT is best explained by the following illustrative examples:

**EXAMPLE 1. DETERMINATION OF DATA—NO CORRECTIONS**

To determine standard data for a given range and charge, place the hairline over the desired range (rounded to the nearest 10 meters) and read data under the hairline as illustrated below.

- a. Given Data.
  - (1) Range: 25,400 meters
  - (2) Charge: 3
- b. Solution. See figure 2.
  - (1) Drift: 12 mils
  - (2)  $100/R$ : 4 mils
  - (3) Range: 25,400 meters
  - (4) Elevation: 438 mils
  - (5) Time of flight: 58.7 seconds
  - (6) Fork: 11 mils

**EXAMPLE 2. DETERMINATION AND CONSTRUCTION OF CORRECTIONS WITH A GFT SETTING BASED ON ONE PLOT POINT**

Registration range corrections (or met plus VE computation) are usually portrayed graphically on the GFT. When the registration point (or met check point) range is between the leftmost and rightmost met check gage points, transfers may be made to all ranges within the red numbered elevations. The elements of the GFT settings are always expressed and recorded in the following sequences:

- Unit that registered
- Charge
- Ammunition lot
- Chart range to registration or met check point (to the nearest 10 meters.)
- Adjusted elevation.

a. The GFT setting with one plot point is placed on the GFT in the following manner.

- (1) Place the hairline over the chart range to the registration or met check point.
- (2) Place a dot on the window of the cursor over the adjusted elevation.
- (3) Slide the cursor so that the dot is over the dashed line (range K line) at the right of the rule.
- (4) Draw a fine pencil line on the window of the cursor over the dot and at the same angle as the dashed line. This elevation gageline should extend from the top to the bottom of the cursor.

b. The following example illustrates the method for constructing the GFT setting with one plot point.

- (1) Given data.
  - (a) Battery B of a 175-mm gun battalion has completed a registration with charge 3, lot XY.
  - (b) Place a dot over the adjusted elevation (350 mils) (Fig 3.)
  - (c) Adjusted elevation is 350 mils.
- (2) Required. Construct a GFT setting for Battery B.
- (3) Solution.
  - (a) Place the hairline over the chart range to the registration point (22,100 meters).
  - (b) Place a dot over the adjusted elevation (350 mils) (Fig 3).

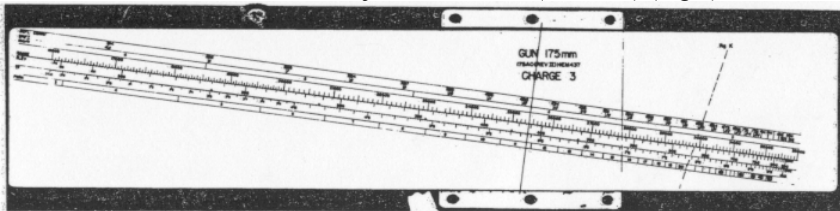

**Figure 2. Determining data under standard conditions**

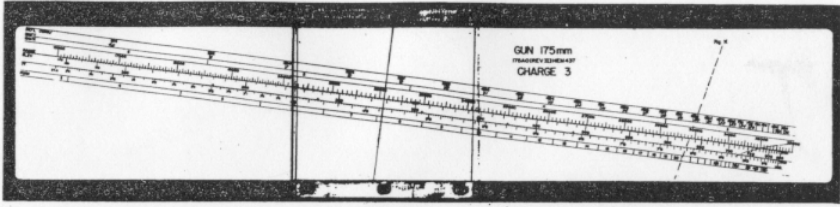

**Figure 3. Hairline at range 22,100 meters, dot at elevation 350 mils**

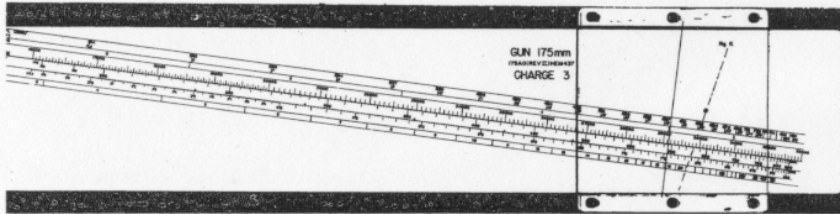

**Figure 4. Adjusted elevation dot over range K line**

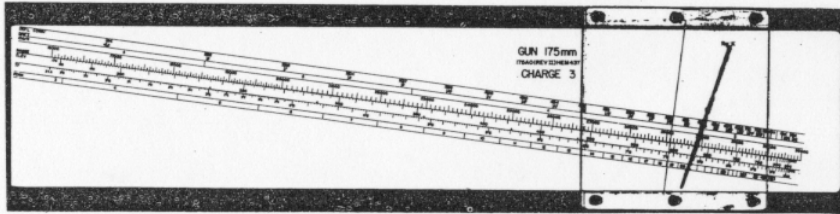

**Figure 5. Completed GFT setting based on one plot point**

- (c) Slide the cursor so that the dot is over the range K line (fig 4).
  - (d) Draw the elevation gageline over the dot and at the same angle as the range K line (fig 5).
- (4) Application. To determine data with a GFT setting based on one plot point, read the range and  $100/R$  under the hairline, and read all other data corresponding to the elevation gageline as follows:
- (a) Range. Read the range of 19,900 meters under the hairline.
  - (b) Other data. Read other required data as follows:
    - (1) Elevation: 284
    - (2)  $100/R$ : 5 (read under the hairline)
    - (3) Drift, time of flight, and fork are read under a visually simulated line parallel to the hairline and through the intersection of the elevation gageline and the elevation. These data are read in this manner as follows:
      - (a) Drift: 7
      - (b) Time of flight: 41.1
  - (4) Fork: 6

(c) The use of the range K line in constructing the GFT setting provides a means for predicting the variable range K for firing at ranges other than that to the registration point. This method represents a twofold improvement over the constant range K technique—it provides greater accuracy and larger range limits.

**EXAMPLE 3. DETERMINATION AND CONSTRUCTION OF CORRECTIONS WITH A GFT SETTING BASED ON TWO PLOT POINTS**

Whenever two registrations, two met plus VE corrections, or a combination thereof can be obtained, a more accurate GFT setting can be achieved by constructing the range K line based on two plot points. When a GFT setting is constructed with two plot points, it may be used for the full range of the GFT without regard to transfer limits.

a. The GFT setting with two plot points is placed on the GFT in the following manner:

- (1) Obtain corrections in the lower third and in the upper third of the ranges on the GFT for the appropriate charge.
- (2) Place the hairline over the chart range to one of the registration or met check points.
- (3) Place a dot on the window of cursor over the adjusted elevation.
- (4) Repeat steps (2) and (3) above for the other registration or met check point.

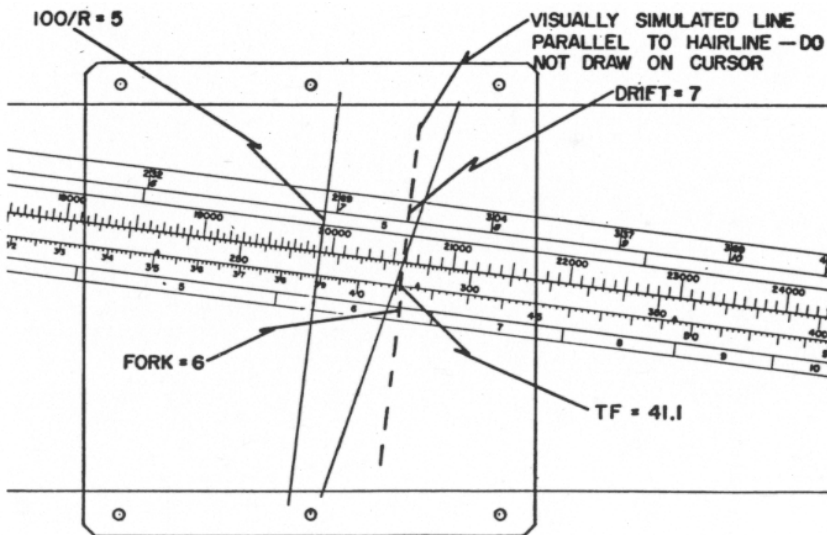

**Figure 6. Reading data with a GFT setting based on one plot point**

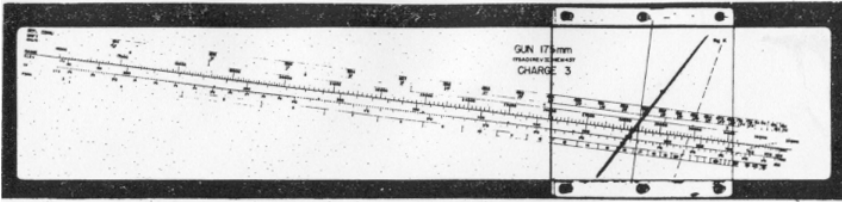

**Figure 7. Completed GFT setting based on two plot points**

- (5) Draw a fine pencil line on the window of the cursor and through the two dots. This elevation gage line should extend from the top to the bottom of the cursor.
- b. The following example illustrates the method for constructing the GFT setting with two plot points:
- (1) Given data.
    - (a) Battery A of a 175-mm gun battalion has determined corrections with charge 3, lot XZ.
    - (b) Registration data to the registration point are—range, 20,600 meters; adjusted elevation, 296 mils.
    - (c) Met plus VE data are — range, 28,400 meters; elevation, 552 mils.
  - (2) Required. Construct a GFT setting for Battery A.
  - (3) Solution.
    - (a) Place the hairline over the chart range to the registration point (20,600 meters. Place a dot over the adjusted elevation (296 mils.)
    - (b) Place the hairline over the chart range to the met check point (28,400 meters). Place a dot over the corrected elevation 552 mils.)
    - (c) Draw the elevation gage line through the two dots (fig 7).
  - (4) Application. The method for determining data with a GFT setting based on two plot points is the same as that used with a GFT setting based on only one plot point.

**EXAMPLE 4. DETERMINATION AND CONSTRUCTION OF CORRECTIONS WITH A GFT SETTING BASED ON MULTIPLE PLOT POINTS**

If the situation permits, a very accurate GFT setting can be constructed by determining corrections to three or more points and drawing the elevation gage line as a curve rather than a straight line.

- (a) The following example illustrates the method for constructing a GFT setting based on multiple plot points:
- (1) Given data. Assume that the M18 gun direction computer (FADAC) is available and that the GFT is being used as a backup system. The FADAC has been used for determining the following chart ranges and corresponding adjusted elevations:

Range (m)	Elevation (mils)
18,700	241
20,700	292
23,000	358
25,000	420
26,700	476
28,400	540
30,200	622
31,800	713

(2) Solution.

- (a) Move the hairline over each chart range and place a dot on on the window of the cursor over each corresponding elevation.
- (b) With a pencil, draw a fine curved line on the window of the cursor through each dot (fig 8). This elevation gageline is more accurate than that obtained by either the one-plot or two-plot procedures and can be used for transferring to all ranges on the GFT.

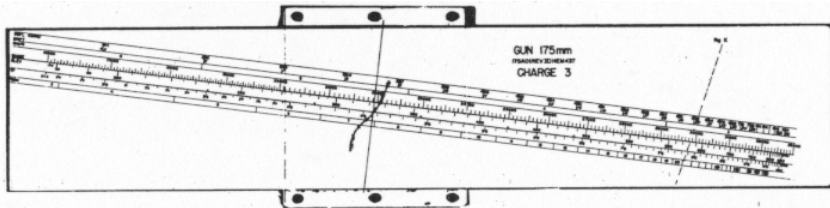

**Figure 8. Completed GFT setting based on multiple plot points**

(3) Application. The method for determining data with a GFT setting based on multiple plot points is the same as that used with a GFT setting based on only one plot point.

(b) The GFT settings based on two or more plot points portray the actual (not predicted) rate of change of range  $K$  for the existing conditions under which the registrations (or met plus VE computations) were accomplished. The accuracies achieved with these GFT settings are greater than those obtained with the GFT setting based on only one plot point.

Units desiring to obtain the new GFT and/or GST can requisition them through normal channels. If expeditious issue is required, requisitions should be forwarded on a Priority 2, through channels, to Weapons Command, routing identifier code B14. The stock numbers are:

GFT 175-A-O (Rev II SN 1220-937-8285

GST 175-A-O (Rev II) SN 1220-937-9525

Lateral transfer limits can be eliminated by applying corrections to deflection and range for the existing chart direction of the wind to the target as reported in a NATO met message. The accuracy of lateral transfers, even within current transfer limits, is dependent upon rotation of



CORRECTIONS TO RANGE AND FUZE SETTING										
NET LINE NO	RANGE METERS	CHART DIRECTION OF WIND - MILS								
		0	200	400	600	800	1000	1200	1400	1600
		6400	6200	6000	5800	5600	5400	5200	5000	4800
CORRECTIONS TO RANGE, IN METERS, FOR A ONE KNOT WIND										
0	1000	0	0	0	0	0	0	0	0	0
0	2000	0	0	0	0	0	0	0	0	0
0	3000	+1-	+1-	+1-	0	0	0	0	0	0
0	4000	+1-	+1-	+1-	+1-	+1-	+1-	0	0	0
1	5000	+2-	+2-	+2-	+2-	+1-	+1-	+1-	0	0
1	6000	+3-	+3-	+3-	+2-	+2-	+2-	+1-	+1-	0
2	7000	+4-	+4-	+4-	+3-	+3-	+2-	+2-	+1-	0
2	8000	+6-	+6-	+5-	+5-	+4-	+3-	+2-	+1-	0
3	9000	+8-	+8-	+7-	+6-	+5-	+4-	+3-	+2-	0
3	10000	+10-	+10-	+9-	+8-	+7-	+5-	+4-	+2-	0
4	11000	+12-	+12-	+11-	+10-	+8-	+7-	+5-	+2-	0
5	12000	+14-	+14-	+13-	+11-	+10-	+8-	+5-	+3-	0
5	13000	+17-	+17-	+15-	+13-	+11-	+9-	+7-	+3-	0
4		+15-	+15-	+13-	+11-	+9-	+7-	+5-	+3-	0

Figure 9. FT 155-AH-2 Wind card, charge 7

the earth, wind direction, and wind velocity. Rotation of the earth is considered negligible for all cannon artillery except the 175-mm gun.

For this reason, wind cards will not be made for the 175-mm gun.

Wind cards provide a rapid means of determining deflection corrections in mils, range corrections in meters, and fuse corrections in fuse settings when chart direction and velocity of the wind and range and direction to the target are known. The wind card contains corrections for a 1-knot wind, blowing from the chart direction. Corrections are divided into two components — the crosswind correction perpendicular to the plane of fire and the range wind correction parallel to the plane of fire. When a GFT setting and deflection correction are obtained from registration or met plus VE computation, they represent corrections for all nonstandard conditions at the range and direction fired. For targets at directions other than that at which the GFT setting was determined, data can be accurately computed by applying the difference of the wind correction to the chart deflection and range. An example of a 155-mm howitzer wind card is shown as figure 9.

By using the slant scale GFT and wind cards, given weapon and target locations, and current met data, the field artillery battery or battalion has the ability to fire effectively, without adjustment, in any direction and at any distance within range of the weapon. For the first time in the history of artillery, the manually operated fire direction center has eliminated the need for range and deflection transfer limits.

# PRECISE AZIMUTH IN A PINCH

*Mr. Malcolm Shaw, Jr., Operations Research Analyst  
Tactics/Combined Arms Department,  
USAAMS*

Although there are several conventional methods and techniques for astronomical determination of azimuth for survey control and orienting lines, all such methods entail varying degrees of sophistication. Unit survey personnel are trained in the hour-angle method, which requires precise time, latitude, longitude, current ephemeris data, logarithmic tables and computational forms. The altitude method uses all of the above requirements except precise time and longitude and adds air temperature to its computations. The gyro azimuth surveying instrument provides an all-weather capability of azimuth determination.

Suppose some of the above items of equipment or information are missing? In such a predicament, there is a simple way of obtaining precise direction with very little computation. This is a little-known technique called the equal altitude method. It requires an angle measuring instrument but can be performed without any equipment other than a watch, some paper, and a pencil.

When using the equal altitude method to observe a star, the following procedure is used:

If the T16 or T2 theodolite is to be used, a star in the northeast (southeast) is selected that is about 45 degrees in altitude and 1½ to 2 hours from the observer's meridian. (With the elbow telescope, altitudes up to 75 degrees may be observed.) When the aiming circle is used, altitudes of 800 mils or less can be observed. With the instrument oriented on the azimuth mark, both the horizontal and vertical recording motions are used to bring the star into view. Observing the star's direction of movement, the operator moves the horizontal crosshair ahead of the star and tracks it with horizontal tangent (recording) motion only until it is exactly centered on the crosshairs (1, fig 1). At this instant, tracking ceases and the horizontal angle is recorded (2, fig 1).

The operator leaves unchanged the vertical setting and, using the horizontal tangent (recording) motion, points the telescope west of his meridian to the approximate position to which the star will descend to the same altitude in the west.

When the star approaches this position, the operator observes it as it enters his field of view and tracks it with the horizontal tangent (recording) motion. (Note that on the second pointing the vertical motion is not used (3, fig 1).) When the star is exactly centered on the crosshairs, tracking ceases and the horizontal angle is recorded (4, fig 1). From the

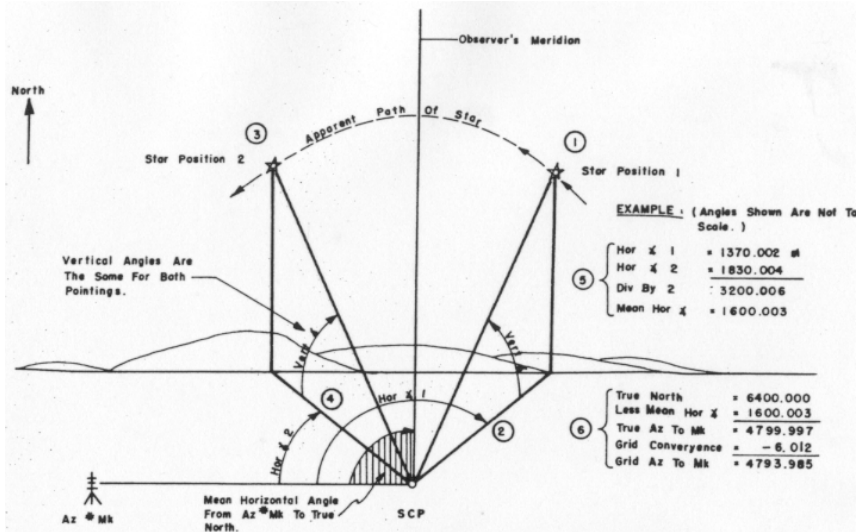

**Figure 1**  
**Star north of observer**

two horizontal angles, the mean angle to true north is determined (5, fig 1). In the example shown, the mean horizontal angle is subtracted from 6400 miles to give the true azimuth to the mark. The grid convergence correction must be applied to give the grid azimuth to the mark (6, fig 1).

Also the sun may be observed using the equal altitude method, but the latitude, declination, and daily change must be known in order to apply the correction for change in declination during the elapsed time between observations. The following formula is used to correct the true azimuth to the mark:

$$\text{Correction} = \frac{\cos \emptyset \sin \frac{1}{2} \dagger}{1440 \text{ min per day}}$$

Where  $\emptyset$  = Declination (table 2, TM 6-300-6, Army Ephemeris, 1966)

$\dagger$  = Elapsed time in minutes between observations\*  
converted to arc: (table 5A, TM 6-300-67)

$\emptyset$  = Latitude in degrees

and  $\Delta$  =  $o + \Delta \cdot \frac{1}{2} \dagger$

1440 min per day

$o$  = Declination for zero hours (table 2, TM 6-300-6)

$\Delta$  = Daily change in declination (table TM 6-300-6)

**Note:** All angular values must be expressed in the same units; either degrees or mils.

\*Precise time is not required; elapsed time is recorded to the nearest minute.

In the Northern Hemisphere, if the sign of the daily change is positive, the correction is applied to increase the mean horizontal angle. If the sign of the daily change is negative, the correction is applied to decrease the mean horizontal angle. In the Southern Hemisphere, the correction is applied in the opposite sense.

In actual tests, six sets were taken on the sun, and the mean azimuth determined was with 0.01 mil of the control azimuth, with a maximum spread of 0.04 mil. Results using selected stars were even better.

An example using a star south of the observer is shown in figure 2.

The equal altitude method of azimuth determination requires too much time to be adopted as a standard method, but it is very simple to perform and yields surprisingly accurate results. It is especially suited for areas with little or no survey control. It can also be used as a check on results obtained by other methods when ample time is available.

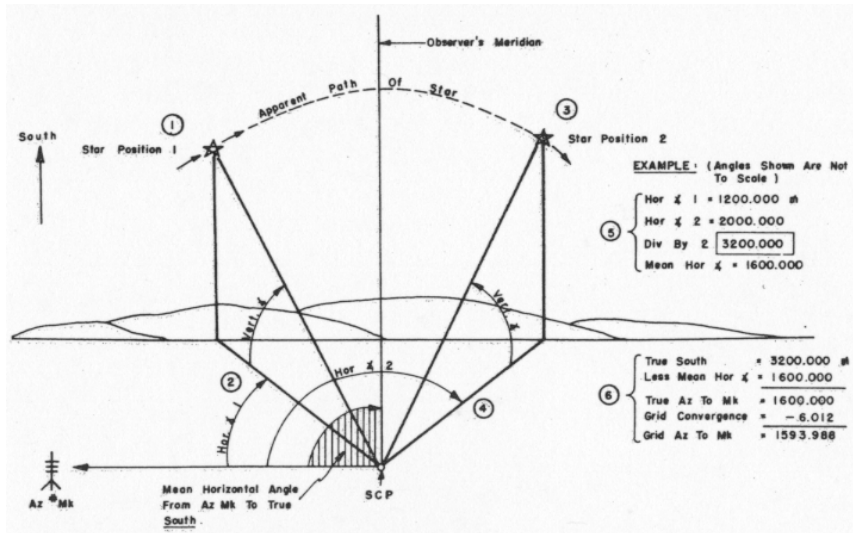

**Figure 2**  
**Star south of observer**

**TERMS USED IN RVN**

**SOUTH VIETNAM (SVN)** — Generally denotes the land itself.

**VIET CONG (VC)** — Organized insurgents directed by the Lao Dong Party dedicated to the overthrow of the established GVN.

**VIETNAMESE AIR FORCE (VNAF)** — Consists of tactical wings. Each is organized differently and may include any number of fighter, helicopter and transport squadrons.

# *Simplified Azimuth of Polaris*

*Hubert W. Keith, Jr.  
Commander, USESSA  
Coast and Geodetic Survey Liason Officer  
Fort Sill, Oklahoma*

---

## EDITOR'S NOTE:

Commander Keith's method of determining azimuth by polaris as described in the following article was tested in Vietnam by the 2d Battalion (175-mm SP), 32d Artillery, 25th Infantry Division during operation JUNCTION CITY. The method proved to be accurate within 0.5 mils. The British artillery is testing the "Keith" method as a backup to the gyro-orienter issued to each firing battery.

---

Should you find yourself one evening with a battery to lay and a magnetic needle that won't work, try laying your battery by the simplified azimuth of Polaris method. The time needed for computation is very short, yet the accuracy is at least three times that of the compass.

Astronomic observations are not generally used by anyone but surveyors and navigators because of the computations involved. These computations are rather long and somewhat complicated; they require special training to perform, and they also require the use of tables and publications that are not ordinarily at hand. Consequently, few people use astronomic observations unless they must.

When consideration is limited to one star, Polaris, and when an accuracy from 0.5 to 1.5 mils is accepted, the computations can be made very simple and the need for special tables can be reduced or eliminated completely.

Two methods for determining the azimuth of Polaris are presented here. These two methods, which might be termed the graphical method and the computational method, will give an azimuth of Polaris that in almost every case will be corrected within 1.5 mils. The necessary computations presented herein have been made as simple as possible and have been arranged for ease of use. Other than the formulas given, the only information necessary for the graphical method is shown on the two graphs reproduced in this article. For the computational method, a table of sines and cosines is needed.

The degree of accuracy for input information also has been reduced. For example, the time of pointing on Polaris need only be within two

minutes, and the longitude of the station is necessary only to the nearest degree. Although greater accuracy in latitude will improve the accuracy of the result, the latitude is necessary only to about 15 minutes. The difference in time between station and Greenwich time must be known and must be given in hours. When time is not in whole hours, it must be given in hours and tenths.

Both methods of determining the azimuth of Polaris require the same initial computations. Actually, the initial computations are used to determine the sidereal hour angle at Polaris in degrees but modified for further use. The computational steps are as follows:

	Number of month × 30 = _____	
	Day × 1 = _____	
	Hour × 15 = _____	
	Minute ÷ 4 = _____	
	_____ - 38 _____	(rounded off to the nearest whole number) (an arbitrary constant)
<b>Western Hemisphere</b>		<b>Eastern Hemisphere</b>
Time zone × 15	= _____	=Longitude
Sum	= _____	=Sum
Subtract longitude	= _____	=Subtract time zone × 15
Special angle of Polaris (SAP)	= _____	=SAP (if over 360 degrees subtract 360)

The computation is almost completely self-explanatory. For example, Polaris is observed at 0239 hours, 18 May, at latitude 34°25'. Longitude 98°14' W, and there is a time difference of 6 hours between Greenwich time and station time. The special angle of Polaris (in degrees) is determined as follows:

(May is the fifth month)	5 × 30 =	150	
(Day is the 18th)	18 × 1 =	18	
(Hour is 2)	2 × 15 =	30	
(Minute is 39)	39 ÷ 4 =	10	(rounded off)
		38	(arbitrary constant)

(Since longitude is west, use Western Hemisphere side of Form.)

(Time difference from Greenwich) 6 × 15 = 90 (no plus or minus required)

$$\text{Sum} = 336$$

Longitude = 98° (rounded off to nearest degree)

Special angle of Polaris SAP = 238°

# Graph Number 1

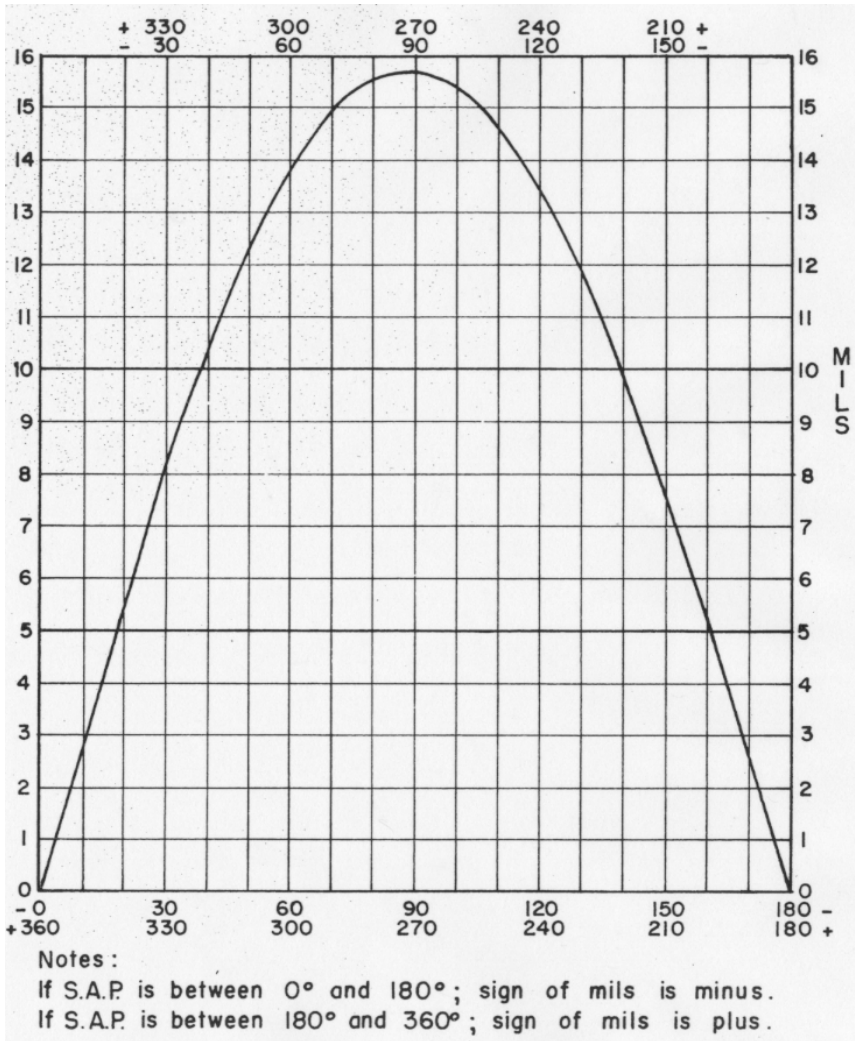

**Figure 1. Graph number 1**

Using the same latitude and time of observation, determine the SAP at longitude 101°45' E with a time zone difference of 7 hours. Be sure to use the Eastern Hemisphere side of the process.

Solution:

$$\begin{array}{r}
 5 \times 30 = 150 \\
 18 \times 1 = 18 \\
 2 \times 15 = 30 \\
 39 \div 4 = 10 \\
 \hline
 38
 \end{array}$$

Eastern Hemisphere

$$\begin{array}{r}
 102^\circ = \text{Longitude} \\
 348 = \text{Sum} \\
 \hline
 105 = \text{Subtract Time Zone} \times 15 \\
 \hline
 \text{SAP} = 243^\circ
 \end{array}$$

To complete the determination of azimuth by the graphical method, use the SAP to enter graph number 1. Find the SAP at the top or the bottom of the graph and move vertically to the point at which the vertical line intersects the curved line. From that point, move to the side of the graph and read an initial figure in mils. As is noted on graph number 1, if the SAP is between  $0^\circ$  and  $180^\circ$ , the sign of this figure is plus. In the first example, find 238 by interpolation, move vertically to the point of intersection, from there, move horizontally to edge of the graph, and read 13.3 mils. Since 238 is between 180 and 360, the sign is plus. In the second example, enter the graph using 243 and arrive at a reading of 13.95 mils, also a plus figure.

Take these figures and the latitude given in the examples and go to graph number 2. Enter the graph with the latitude (latitudes are shown across the bottom of the sheet) and move vertically to the curve representing the value determined on graph number 1, interpolating between the curves for the decimal part of the mils. From there move to the side and determine the second figure, in mils. In the first example, use latitude  $34^\circ 25'$  and move upward to the correct proportional distance between the 13- and 14-mil lines; then move to the side to arrive at a figure of 16.1 mils. Since the sign of 13.3 was plus, this value is also plus and is the true azimuth of Polaris. In the second example, a plus value of 16.9 mils is obtained. If the sign of the original mil value had been minus, the second mil value would also have been minus, and the answer would have to be subtracted from 6400 to determine the true azimuth in mils.

If the latitude is less than  $10^\circ$ , graph number 2 is not needed. The result from graph number 1 can be used directly, with due regard for sign, as the azimuth of Polaris. If the graphs are not available, a second method is used to complete the determination of azimuth by the computational method. The following formula is used:

$$\text{Azimuth} = 6400 - \frac{15.7 \sin \text{SAP}}{\cos \text{latitude}}$$

The sign of the cosine of the latitude is always plus. The sign of the sine of the SAP is plus from  $0^\circ$  to  $180^\circ$  and minus from  $180^\circ$  to  $360^\circ$ . Consequently, if the SAP is between  $0^\circ$  and  $180^\circ$ , the result of the second



# Graph Number 2

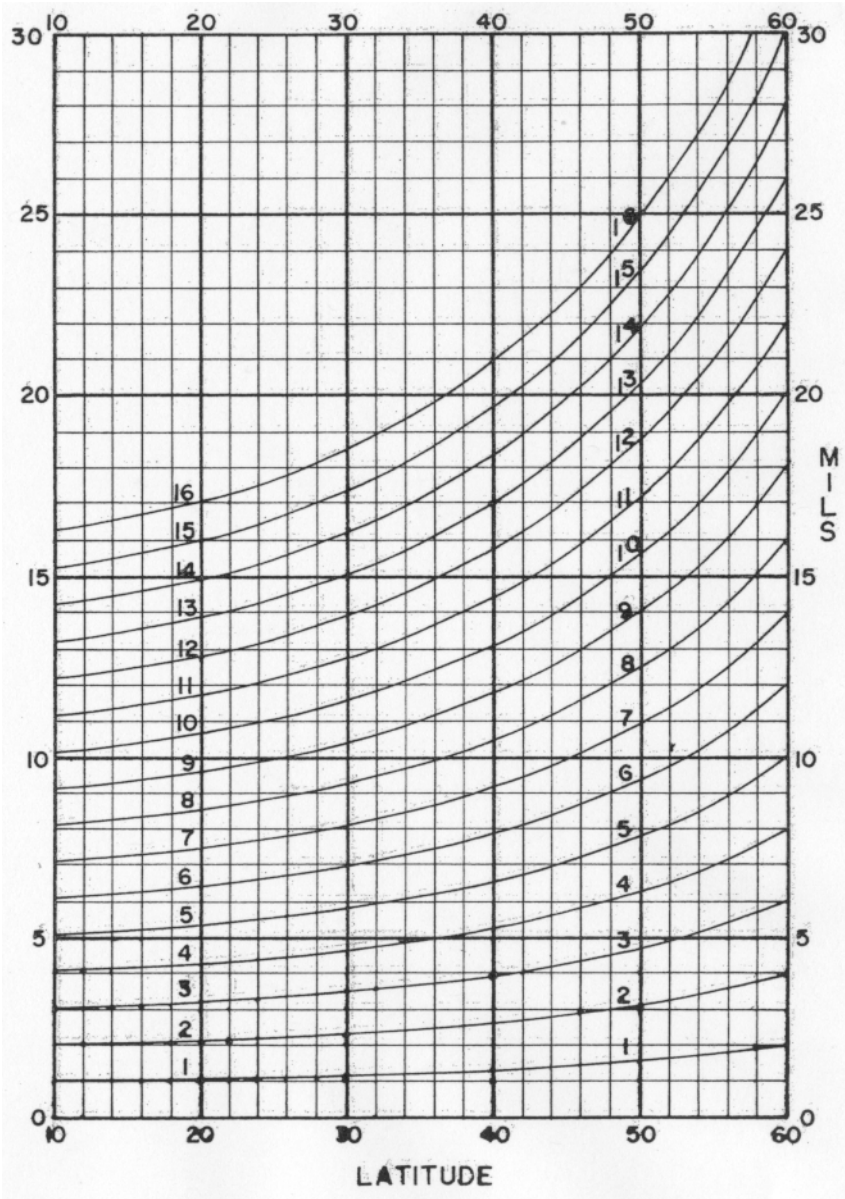

Figure 2. Graph number 2

portion is plus and is subtracted as shown by the formula for the azimuth. If the SAP is between 180° and 360°, the result is minus for the second portion, and, since minus and minus make plus, the second portion is the true azimuth directly.

Arranged for log computation, the second portion of the formula is as follows:

$$\begin{aligned} \text{Log } 15.7 &= 1.195\ 90 \\ \text{Add log sin SAP} &= \text{—————} \\ \text{Sum} &= \text{—————} \\ \text{Subtract log cos lat} &= \text{—————} \\ \text{Log result} &= \text{—————} \quad \text{Result} = \text{—————} \end{aligned}$$

The two examples worked by the computational method and by using logs are as follows:

Solution to example 1:

$$\begin{aligned} \text{Log } 15.7 &= 1.195\ 90 \\ \text{Add log sin } 238^\circ &= 9.928\ 42 \\ \text{Sum} &= 1.124\ 32 \\ \text{Subtract log cos } 24^\circ\ 25' &= 9.916\ 43 \\ \text{Log result} &= 1.207\ 89 \quad \text{Result} = 16.14 \text{ mils} \end{aligned}$$

Solution to example 2:

$$\begin{aligned} \text{Log } 15.7 &= 1.195\ 90 \\ \text{Add log sin } 243 &= 9.949\ 88 \\ \text{Sum} &= 1.145\ 78 \\ \text{Subtract log cos } 34^\circ\ 25' &= 9.916\ 43 \\ \text{Log result} &= 1.229\ 35 \quad \text{Result} = 16.957 \end{aligned}$$

Again, the SAP was between 180 and 360 so the azimuth is 6400—(—16.957), or 16.957 mils directly.

Since the SAP was between 180° and 360°, the sign of this second portion is minus. Azimuth = 6400 - (-16.14) = 6400 + 16.14, or 16.14 mils directly.

In these examples, had the SAP been between 0° and 180°, the result would have been subtracted from 6400 for the true azimuth in mils.

For comparison, when the 1966 Army Ephemeris is used and when the azimuth is computed by use of tables 2, 4a, 5b, and 12 and a set of log tables of functions of angles, the azimuth of Polaris are determined as 16.2 mils for example and 16.91 mils for example 2.

These two systems can be used for a number of years without change. After a period of from 5 to 15 years, they may have to be revised. Failure to revise the procedure or graph number 1 would increase the error slightly in some cases but would have little effect in others.

To use these systems in the field, measure the angle from Polaris to an orienting line with an aiming circle, noting the time of sighting on Polaris. Compute the true azimuth of Polaris and add the angle from Polaris to the orienting line for the true azimuth of the line. From a map of the area, determine the difference between true and grid azimuth (convergence) and apply that difference to obtain the grid azimuth of the orienting line.

It is true that these systems cannot be used 100 percent of the time. They are limited to night observation, to an area between 0° and 60° north latitude, and to the sighting and identification of Polaris. However, the cost of these systems is very little. If you don't lose this article, the cost is zero. At that price, something less than perfect should be considered.

If these two systems are found useful, the following method is suggested for keeping them at hand in the field: In the booklet "Notes for the Battery Executive, Cannon Artillery," pages 13 and 14 are not used and space is left at the bottom of page 12. The two graphs reproduced in this article can be cut out and pasted on pages 13 and 14, and the computational procedures can be written at the bottom of page 12.

\*NOTE — The convergence obtained from a map can be in error by as much as three mils in northern latitudes, if the actual observation point is located at one of the corners of the map sheet. A nomograph for converting from true to grid azimuth has been developed since the preparation of this article. The nomograph is  $8 \times 10\frac{1}{2}$  inches in size, and will give the correction to within one quarter mil. The nomograph is available through the C&GS Liaison Office, Target Acquisition Department, USAAMS, and will be included in the 1968 Ephemeris.

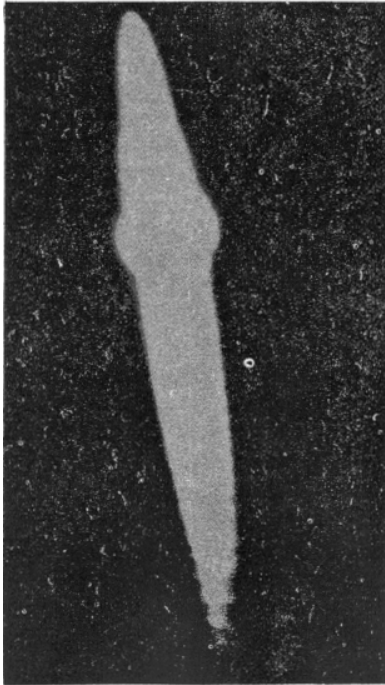

## HOTROD MISSILE

Streaming a comet-like wake behind it, the Army's Sprint antimissile streaks through the air during a flight test at White Sands Missile Range, New Mexico. The photo shows the second stage heated to incandescence by air friction. The bulges are created by the guidance fins on the rear of the stage. Sprint is being developed under the direction of the Nike-X Project Office, Redstone Arsenal, Alabama, to intercept ICBM's and submarine launched missiles in flight. Because of its hypersonic speeds in the relatively dense portions of the atmosphere, the missile's skin in places reaches temperatures hotter than those inside its own rocket motor.



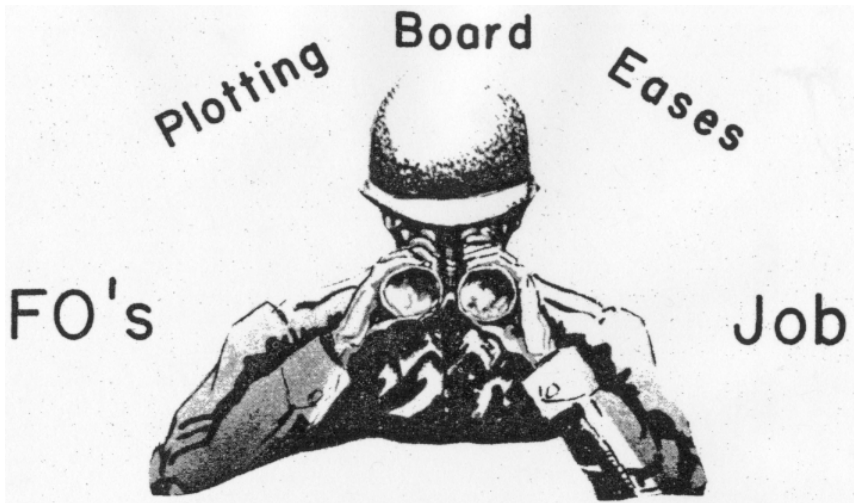

*Major Hardy R. Stone  
Gunnery Department,  
USAAMS*

The location of a target by shift from a known point requires the observer-target direction, a horizontal shift and a vertical shift. Direction is normally measured, and the vertical shift is estimated. Present procedures provides two methods for determining the horizontal shift. For deviations of less than 600 mils, the mil relation formula is applied. A computation based on approximate trigonometric functions is performed for deviations in excess of 600 mils. Both methods can be eliminated by following a simple graphical procedure involving the use of the M10 plotting board.

With the distance and direction from the observation post (OP) to the known point (plotted on the firing chart), the observer can quickly set up his M10 plotting board for measuring shifts to any target. The first step is to locate the OP in the center of the plotting board; then rotate the transparent disk of the board until the direction to the known point is above the arrow on the gridded face of the board. Using an appropriate scale, the observer plots the known point at the proper distance from the OP along this direction line. Now he is prepared for any mission.

When a target appears, the observer determines the direction to the target and rotates the transparent disk until this direction is above the arrow. By estimating the range, the observer plots the target in the same manner as the known point was plotted. Determining data to be sent to the fire direction center (FDC) is then simply a matter of reading data from the board. The lateral shift is determined by noting the perpendicular distance from the known point to the observer-target (OT) line now materialized on the face of the board above the red arrow. The direction of the shift (left or right) will be obvious.

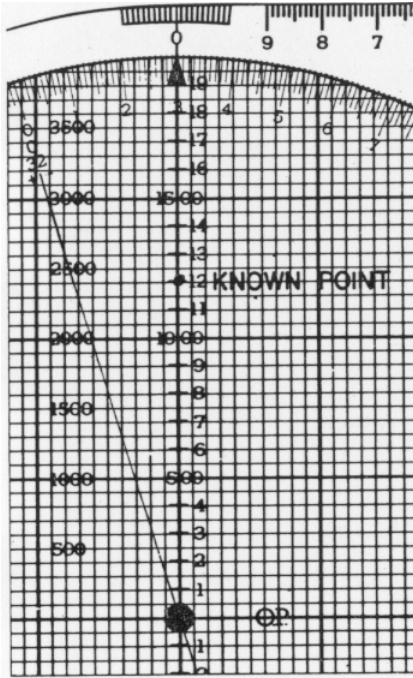

**Figure 1. Known point plotted at a direction of 300 mils and at a range of 1,200 meters.**

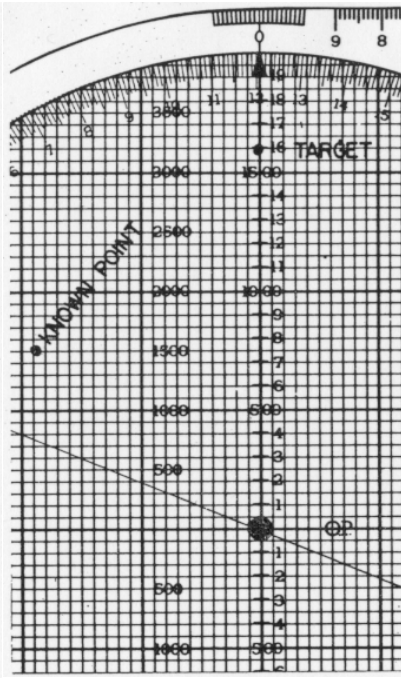

**Figure 2. Target plotted at a direction of 1,200 mils and at a range of 1,600 meters.**

The range shift is determined by visual comparison of the target plot and the intersection of the perpendicular from the known point on the OT line. This is done by using the established scale and counting the squares from the intersection to the target. Once again, the direction of the shift (add or drop) will be obvious.

It should be noted that the M10 plotting board computation for a target located in this manner can be accomplished in the FDC. It is not necessary that FDC personnel know the observer's location. However, the observer must transmit to the FDC the OP-KP direction and distance. The following example illustrates the use of the 10 plotting board:

OP-RP1	distance	1,200	meters
	direction	300	mils
OP - tgt	distance	1,600	meters
	direction	1,200	mils

- (1) Rotate the transparent disk until the 300-mil graduation coincides with the arrow. Plot the known point on the disk at distance 1200.

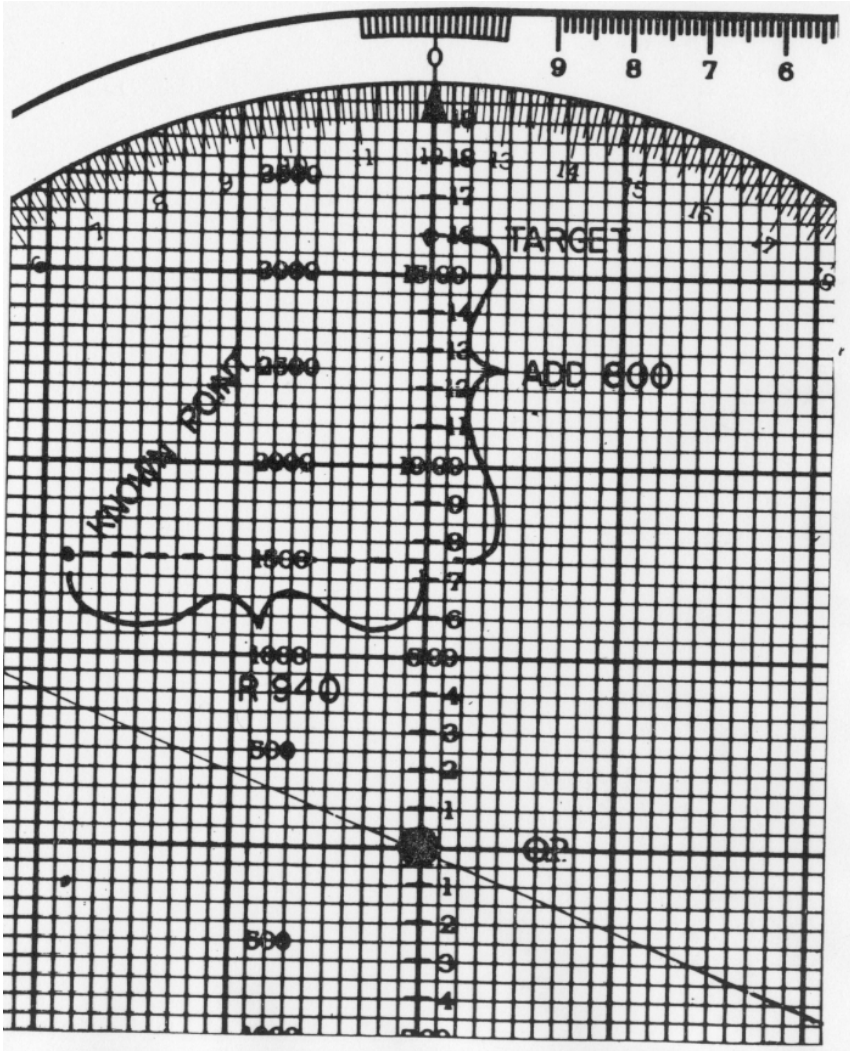

Figure 3. From known point, right 940, add 800

- (2) Rotate the disk until the 1,200-mil graduation is above the arrow.
- (3) Read the lateral shift as RIGHT 940.
- (4) Note that the perpendicular from the known point to the OT line intersects that line at 760 meters.
- (5) Compare this measurement with the OT distance and announce the range shift as ADD 800 (1600-760).
- (6) The target location element in the call for fire is "From RP1, direction 1200, RIGHT 940, ADD 800."

The graphical method of locating targets will prove more accurate and more rapid than present methods in almost all cases. Tests conducted under controlled conditions reveal that in computing data for shifts less than 600 mils, the graphic solution is accomplished in approximately two thirds the time required for the mil relation solution. The mil relation yields a more accurate solution when the subtended width is small (100 meters or less) because of the plotting and visual inspection limitations inherent in the M10. Beyond this, however, the M10 board is more accurate and becomes significantly so as the angle approaches 600 mils.

For angles 600 mils or greater, the M10 solution is twice as fast as the solution using rough trigonometric functions and is also more accurate. For the individual with a working knowledge in the present method of computation, the graphic solution can be learned easily and just as easily applied.

With speed and accuracy as the major concern, the forward observer, by using the graphic solution, increases his efficiency and, as a result, the efficiency of the artillery in providing fire support for the ground gaining arms.



### **TERMS USED IN RVN**

**VIETNAMESE MARINE CORPS (VNMC)** — Consists of one brigade. It normally forms part of the general reserve and, when not conducting tactical operations, it is stationed in the Saigon area.

**VIETNAMESE NAVY (VNN)** — Primarily a defensive force, consisting of a small sea force for off-shore counterinfiltration surveillance along the coast from the 17th Parallel to the Cambodian border, a coastal force — the junk fleet — for the patrolling of inshore coastal waterways, and a river force for inland waterway operations. The river force is organized river assault groups (RAGs). Each RAG is capable of transporting by water a battalion of RVNAF and supporting them for 10 to 14 days.

**VILLAGE** — The major political subdivision of the district. Traditionally, the Vietnamese village has been a strong political unit which is led by a village chief and village administrative committee. It is not a population center such as a town, but describes a rural area and population centers (hamlets) within the village geographical boundaries. A PF platoon and several squads will generally be at the village chief's disposal for local security. He looks to the PF leader to command the village forces.



# How Now with Mini- How

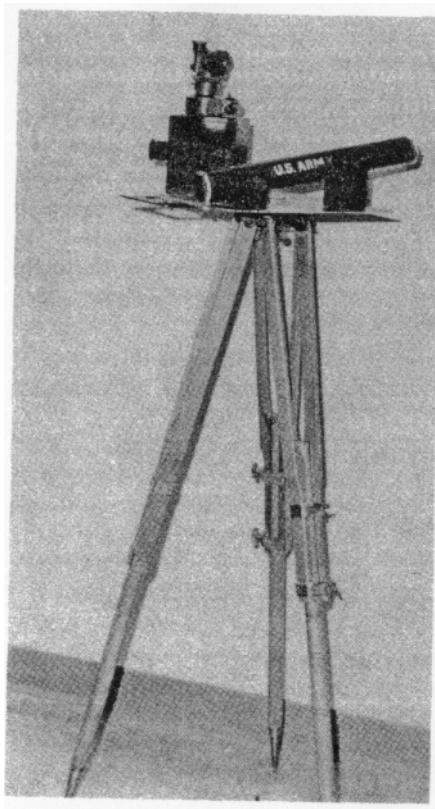

**Figure 1. The Mini-How**

To the veteran artilleryman, the principles and techniques involved in laying the battery are accepted as strictly routine. To the rookie redleg, however, an abrupt introduction to the firing battery looms awesome if not downright hopeless.

Platform instructors have armed themselves with an assortment of classroom aids for combating this situation. Perhaps the most informative period from the standpoint of the student is the class in which he takes the aiming circle in hand and proceeds to actually lay a battery of 105's or whatever weapons are available.

In the case in which the student is not afforded the opportunity to work with the weapons either outdoors or in the classroom, a substitute is in order. Among undoubtedly many others, a classroom expedient has been devised by an ROTC instructor at St. Bonaventure University. Faced with limited classrom space which prohibited the use of a weapon for indoor sessions, Major John S. Stycos, at that time an assistant professor

of military science, designed and built what he calls the "Mini-How" (fig. 1).

The Mini-How consists of a metal plate, a panoramic telescope, a cylindrical casing or cartridge, mounting blocks, and a heavy duty tripod. The metal plate, placed on the tripod, represents the pivoting mechanism of the howitzer carriage. The metal plate is designed to permit the placement of the panoramic telescope to the left of the cylinder. The cylinder, which rests on the plate, represents the tube of the weapon.

With the Mini-How now constructed, the theory of lay and the placing of aiming posts at a common deflection can also be illustrated, in this case by using a chalkboard (fig 2). The chalkboard can also be used to construct the end of the orienting line, which in the illustration is represented by a tree. An aiming circle can be placed wherever classroom space allows. With this setup, a complete fire mission can be talked through.

If a chalkboard is not available, figures could be mounted to walls or classroom objects could be used as needed.

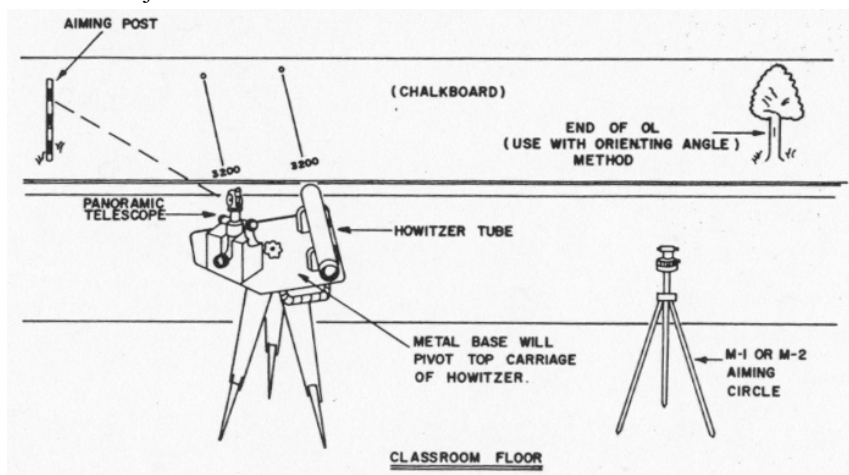

**Figure 2. Just how the Mini-How makes room in the classroom**

---

**TERMS USED IN RVN**

ARMY REPUBLIC OF VIETNAM (ARVN) — The Vietnamese regular army, primarily an infantry force, consisting of infantry division plus separate infantry, airborne, ranger, and armor units. ARVN is normally committed against VC/NVA regular army units in search and destroy or clearing operations. When not employed in offensive operations, ARVN units are often committed to securing areas where civilian police or revolutionary development (pacification) teams are operating and defending key installations or supply and communication routes.

# Lessons Learned in Vietnam

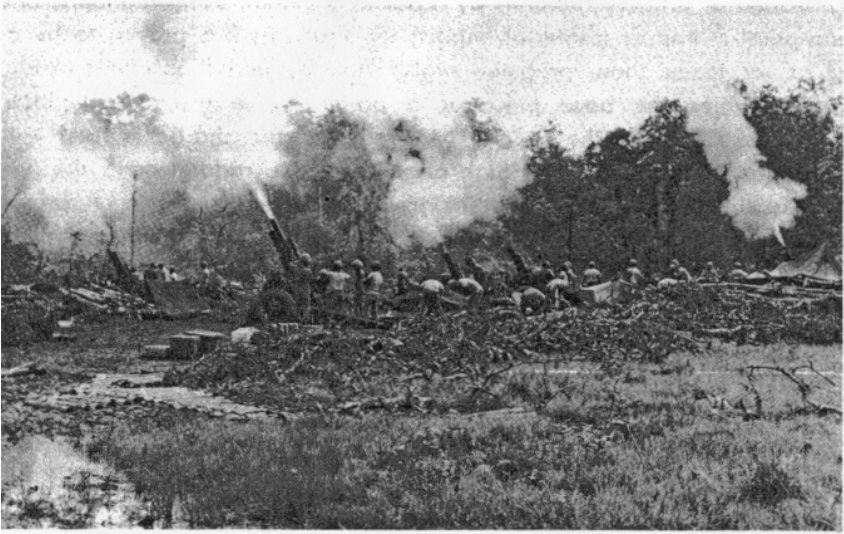

The following material finds its origin in information extracted by the U. S. Army Artillery and Missile School from correspondence which has passed between U. S. artillery units in Vietnam and USAAMS, efforts by departments of the School to solve problems experienced by units in Vietnam, and operational after action reports distributed by the Department of the Army.

## **THE AN/MPQ-4A IN VIETNAM**

The following information on the AN/MPQ-4A was submitted by CWO's George R. Gurney and Jon K. Colvin of the Target Acquisition Department, USAAMS.

Numerous lessons have been learned from operation of the radar in Vietnam. Tactically, close coordination must be maintained between the radar section, the S2/S3, and the liaison officers and their forward observers with the supported infantry. Hostile mortar fire, received by the friendly units, must be reported immediately so that the radar can locate the hostile mortars in time to insure their destruction or neutralization. Friendly mortar locations must be reported to the artillery S2/S3 so that these mortars located by the radar will not be confused with enemy mortars. Possible avenues of approach and possible mortar position areas should be determined by the S2/S3 and reported to the radar section to assist in the surveillance of suspect areas.

In addition to its countermortar role, the capabilities of the radar in observing registrations, in adjustment of fire, and in survey (see ARTILLERY

TRENDS, Oct 64, "Instant Survey," and FM 6-161, page 55) have added new dimensions to the artilleryman's traditional procedures. Registration of artillery batteries by radar in Vietnam, using highburst and mean-point-of-impact (center-of-impact) registrations, has proved to be as fast as, or faster than, precision registration by aerial observers. Radar survey enables the base piece of a battery to be located and placed on the same grid as the radar. The minimum safe charge is fired with the maximum safe elevation (high angle), and the radar locates the projectile in the same manner that it locates an enemy weapon. A second round is fired, if necessary, for the determination of azimuth to locate the point of burst. The coordinates determined are those of the base piece and are relative to the coordinates of the radar. This same procedure can be used to locate friendly patrols and frontlines. A mortar fired by a friendly patrol or frontline unit can be detected by the radar, and the coordinates of the location of the element firing can be determined.

The AN/MPQ-4A radar, properly maintained and employed, greatly assists the artillery in Vietnam in countersurgency operations.

If you are not using the AN/MPQ-4A radar, you are deriving yourself of a valuable tool and possibly jeopardizing the safety of the supported element, be it infantry, base camp, or other fixed installation.

The AN/MPQ-4A countermortar radar has proved to be most effective in Vietnam. However, experience shows that certain requirements must be met in order to keep the equipment both operational and effective. First, operational maintenance cannot be taken for granted and must be performed regularly. All filters require constant attention. During the dry season, a weekly cleaning of these components is a must! During the rainy season, however, a monthly cleaning is sufficient. Dirty filters (clogged either with dust or insects) reduce the air flow through the equipment, and this subsequently increases internal temperatures to the point of instability, particularly in the computer. The proper level of oil must be maintained in the oil reservoirs and all lubricated points and gears must be lubricated in accordance with appropriate TM's. Dry gears and low oil reservoirs may hasten failure of critical part, such as the scanner motor, dehydrator pump gears, azimuth and elevation gears, and antenna-erecting mechanism.

Secondly, the linear actuators (antenna reflector-erecting mechanism) of radars in fixed sites should be exercised weekly.

In addition, all drain plugs in the receiver-transmitter group should be opened. These drain plugs are located in the bottom of the receiver-transmitter compartment to facilitate the removal of any moisture which condenses, or leaks into, this area.

Finally, although the radar may be inoperative, power should be applied for several hours daily to avoid excessive condensation of moisture in all components.

## **OPERATIONS REQUIREMENTS IN VIETNAM**

What can you expect if you are assigned to a nondivisional artillery battery in Vietnam?

There is a good chance that you will not be collocated with the headquarters and service batteries—about an 80 percent chance—and the distance separating the units can be anywhere from 30 to 150 miles. With such resulting decentralization, one can expect complications in operations not experienced in a nontactical environment. And that is just what has occurred in Vietnam.

Despite these complications, however, it is essential that the operations requirements be maintained at a level equal to that of garrison units. The basic requirements of supply, training, maintenance, and administration for a unit remain the same regardless of where the unit is located.

### **SUPPLY**

With the distance involved and the restrictive nature of the terrain, the bulk of supply and resupply is accomplished by air. Due to various priorities placed on aircraft and cargo, many items that are taken for granted in a more stable situation suddenly become luxuries. As a result, conservation of supplies must be stressed as never before. Naturally the morale and esprit of the units are adversely affected which further complicates effective operations.

Divorced from his units, the S4 cannot provide the normal support, inspection, and advice for which he is responsible. This void must be filled by the battery officers and noncommissioned officers.

### **TRAINING**

A void also exists between unit staff and the battery personnel in training. As in the case of supply, officers and noncommissioned officers on the battery level must fill this void. And the void is considerable. An abrupt about face is in order for those who abide by the old standby, "We're in combat now, so it's not necessary to train; you can't get better training than that." Training is as essential in Vietnam as it is anywhere in the world, and the problem of implementation is as great if not greater.

Because of the large turnover and the uncertainties of personnel available, cross training becomes imperative. Since short cuts employed during darkness or conditions of relaxed supervision have proven costly for both personnel and equipment, the problem only can be absolved by an extended training program. Until every man knows proper operating procedures so well that they become second nature to him, we do not have a trained battery.

In addition, an imaginative training program can offer a much needed break from the routine day-to-day activities. The worth of this program depends on the initiative and imagination of the battery officers and noncommissioned officers.

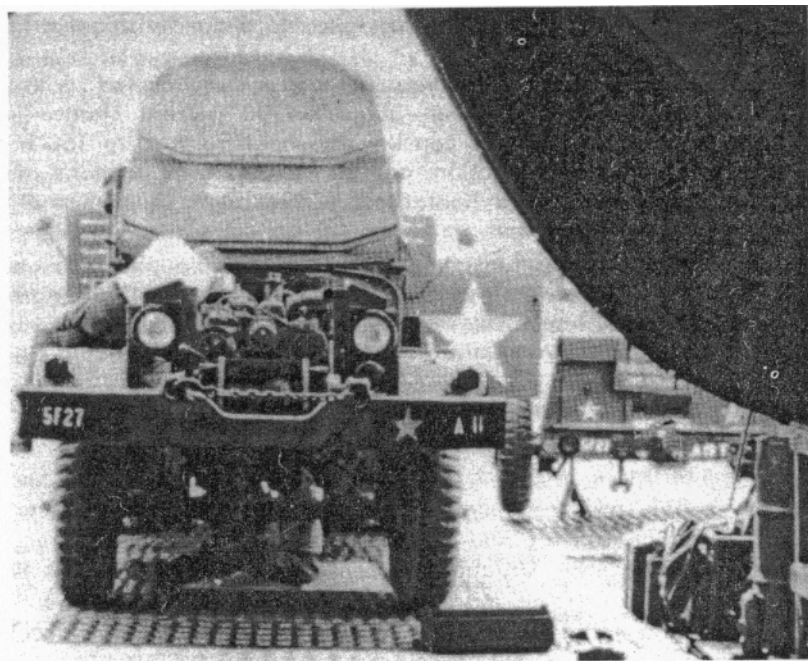

**Figure 1. Maintenance requirements receive as high a priority in Vietnam as elsewhere. An M-35 2½-ton truck is checked by a member of A Battery, 5th Battalion, 27th Artillery in a base camp area in Vietnam.**

If the goal of the training program is to be fulfilled, the personnel conducting the training must have a thorough knowledge of the subject which they are teaching. They must investigate all possible sources of information to include the Nonresident Instruction Department at Fort Sill, Oklahoma.

Of course, maintenance looms more important in Vietnam for the reasons listed above. It cannot be slighted for mission accomplishment but must be integrated into daily operation. Tool sets and the requisite knowledge for the use of these sets must be coordinated within each battalion. The tool sets normally authorized to battalion maintenance are a requirement in the isolated battery in order to perform periodic preventive maintenance service (PPMS). Training on the use of these tool sets must be accomplished.

Daily maintenance must be performed regardless of the tactical situation. It is incumbent upon the chief of section to remind his superiors that the maintenance is due. Seldom is the situation so trying that a weapon cannot be called out for a short period in order to perform

maintenance. The PPMS must be performed. It is not necessary to perform this maintenance in one period; it can be spread over two or three days. If this maintenance is performed on PPMS items, we are back to preventive maintenance instead of "breakdown maintenance."

Special attention to maintenance should not be restricted to the battery. The mechanics from the support maintenance echelon must be supervised also. Since the environment is poor at best for performing this maintenance, it is necessary to provide facilities which will allow the mechanics to work in a relatively clean and dry location. Maintenance tests and trucks will provide this. If the mechanic at the support maintenance echelon is not performing properly, the battalion motor officer should be notified. On the other hand, if this mechanic is performing in a better than average manner, his unit should be notified.

### **ADMINISTRATION**

Similar to problems of supply, normal administration is hampered due to distances involved and the lack of available transportation. If a man has to go to battalion or higher for one reason or another, he may be gone for a week instead of three or four hours. Administrative problems are also magnified when a battery is attached for an operation. In this situation, the battery must adhere to the SOP's of the unit to which it is attached. As a result, supply, training, and maintenance requirements are complicated.

As one can perceive, there is a challenging situation for battery personnel. No laxity can be tolerated. By the same token it can be the most rewarding period in the careers of these personnel. The battery which successfully accomplishes all of its tasks will provide a feeling of accomplishment for artillerymen which cannot be attained anywhere else in the world.

### **TRAPS 'N TIDBITS**

All soldiers should beware of:

- Dead foliage—it may be old camouflage over a trap.
- Tied down brush—it may be a firing lane for an ambush site.
- All civilians until they are properly identified.
- Villages where no civilians are visible—it may be an ambush.
- Moats around villages—they may contain punji stakes, mines, and booby traps.
- Booby traps in areas which you reoccupy.
- Likely ambush sites. Stay alert.
- Obvious by-passes at blown or damaged bridges—they may be mined.
- A decrease in alertness during long operations or periods of inactivity—death comes swiftly in the jungle.
- Unpurified water—it likely is contaminated.
- Indigenous modes of transportation—taxi drivers have been known to transport soldiers to dangerous areas.
- Traveling alone outside your base compound. Use the "buddy" system.

## **TACTICAL SECURITY**

Ambush of vehicles is a constant threat. During any vehicular road movement, a counterambush plan is a must and this plan should be understood by all.

Artillery, air, and when available, naval gunfire support should be provided for all convoys. Engineer personnel should accompany all convoys to assist in clearing roads and obstacles. Local civilian traffic should not be allowed in the convoy formation.

Deceptive tactics with helicopters improve the security of airmobile operations, increases chances of success, and helps gain surprise.

## **MISCELLANEOUS**

All military civic actions should be accomplished through established local officials. In areas where local leaders are weak or nonexistent, effort should be made to establish a responsive local government first.

The plastic canteen in the army supply system has proven decidedly superior to the metal canteen. It is lighter, it reduces the individual load, and completely eliminates metallic noises.

Supplementing artillery fire commands with warning orders giving direction (azimuth), use of direction (azimuth) markers, and panoramic telescope markers are beneficial when maintaining a 6400 mil firing capability.

In airmobile operations one problem is the coordination of aircraft flights and artillery fires. If the size of the operation permits, a solution is for all units in the landing zone and all aircraft entering or leaving the zone to operate on a common air-ground radio frequency controlled by a pathfinder team. Mutual clearance of artillery fires and aircraft is obtained, and resupply aircraft are directed to their proper holding area.

---

## **TERMS USED IN RVN**

**NO FIRE AREA (NFA)** — A specific, designated area into which no fire support means will deliver fires or permit the effects of their fires to penetrate. Exceptions are when —

- a. The establishing agency requests fires in the area.
- b. A target is located in the NFA, the nature of which is a major threat to the security of US (Allied) forces.

**POPULAR FORCES (PF)** — A nationally administered military force organized and operated at the village level, consisting of light infantry squads and platoons. The PF units are commanded by their own noncommissioned officer leaders who are responsible, through their village chiefs, to the district chiefs. PF members are full-time volunteers recruited within their native villages and hamlets to protect their own families, property, and community. Because of the small size, light arms, and limited training of PF units, their combat capability is restricted to local defensive and counterattack operations. The basic concept of employment is for village platoons and hamlet squads to defend their own area with the inter-village platoons responsive reinforcement.



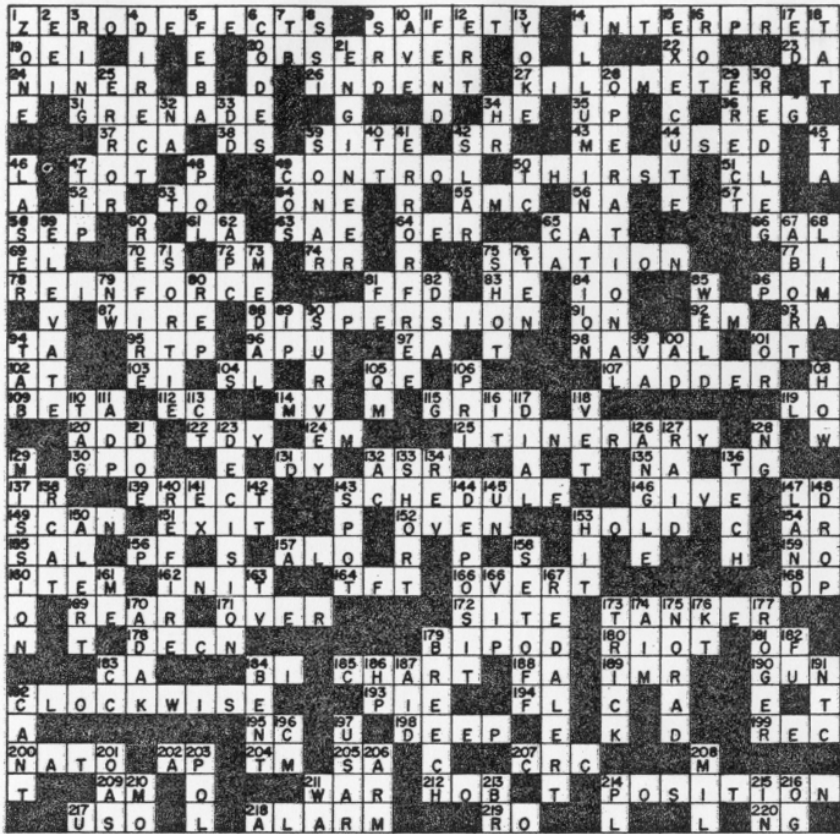

### TERMS USED IN RVN

BASE CAMP — The semi permanent administrative and logistical installation within an area of responsibility from which US or other units conduct operations.

CORPS TACTICAL ZONE (CTZ) — The major military subdivision of Vietnam which is delineated by boundaries corresponding to provincial boundaries. The four CTZ's comprise 5 to 15 provinces. Although the CTZ is primarily a military subdivision, it performs many civil administrative functions.

DISTRICT/SUBSECTOR — Identical terms. District is the major subprovincial political subdivision roughly equating to a US county or parish. The district chief, more than any other governmental official, has direct contact with the populace. In addition to his civil administrative duties, the district chief is the subsector commander of the district paramilitary forces. He is usually an ARVN officer.