

ARTILLERY

TRENDS

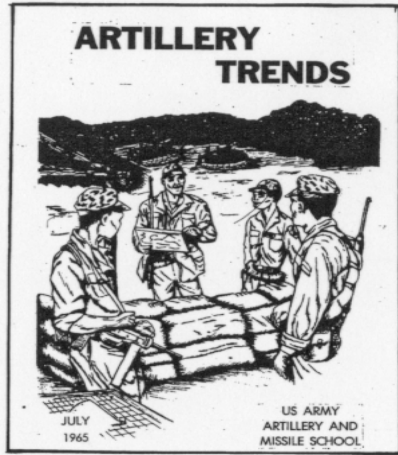



Instructional Aid Number 34

● COVER

In counterinsurgency operations, artillery, and other combined arms, advisors are faced with many day-to-day problems concerning artillery employment, mobility, etc. "Guidelines for Success" on page 17 provides documented ideas and concepts to help the advisor find solutions to these problems.

Also featured are "Instructional Department Notes" which provide items of an instructional nature from the USAAMS, on page 2.

● INSTRUCTIONAL DEPARTMENT NOTES

Instructional Items from the USAAMS	2
---	---

● ARTICLES

Managing Your Maintenance	6
Guidelines for Success—artillery advisor in counterinsurgency operations	17
Surety—the army's new insurance policy	28
Nuclear Firepower	30
Shoot Without Shell—the 14.5-mm artillery trainer mount	46
Firepower Plus Mobility—more about air assault artillery	49
USAARTYBD	73
PUFF	79

● RESIDENT COURSES

USAAMS Resident Course Schedule for FY 66	81
---	----

● STATUS OF TRAINING LITERATURE AND FILMS

Training Literature	87
Training Films	87



ARTILLERY TRENDS is an instructional aid of the United States Army Artillery and Missile School published only when sufficient material of instructional nature can be gathered.

Instructional Department Notes

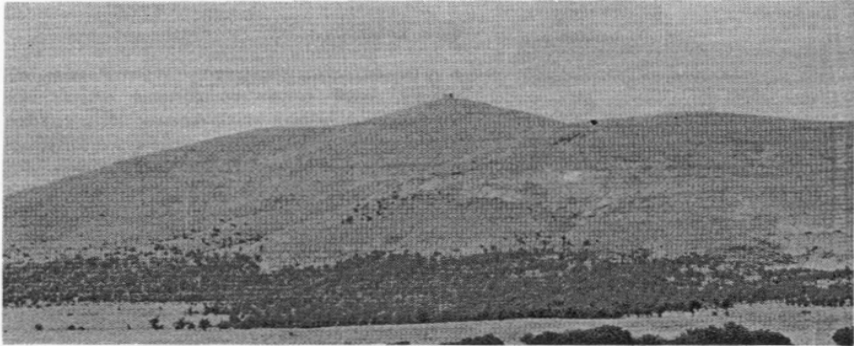

Artillery Transport Department

USAAMS MAINTENANCE INSTRUCTION INCREASED

Recently, the USAAMS has substantially increased its maintenance instruction by implementing major changes in all courses with the heavy emphasis on the student practical work. Additionally, practical exercises have been allocated to preventive maintenance indicators, inspection of Ordnance and Engineer equipment, equipment serviceability criteria readiness reporting and the equipment log book. These changes are a result of command emphasis and correspondence from the field which indicated a need for more and more practical maintenance instruction for the junior officer. Increased hours of maintenance will be implemented as follows:

Field Artillery Officer Candidate Course. Although the total hours of this course will not change in FY 66, the subject matter has been revised to reflect increased instruction in the areas mentioned above. The content of the Officer Candidate Course program of instruction also will be in harmony with the Field Artillery Officer Basic Course.

Field Artillery Officer Basic Course. The largest increase in maintenance subjects was implemented in this course—a 55 per cent increase. Practical exercises were increased by 8 hours in the FY 66 Officer Basic Course program of instruction. The basic student will devote 26 per cent of his maintenance instruction time to practical exercises.

Artillery Officer Career Course. Maintenance instruction in the program of instruction for this course was increased 24 per cent. Because of current emphasis on maintenance, the Artillery Transport Department has completely realigned its hours of instruction for the AOCC. Practical exercises were increased by 8 hours and now command 26 per cent of the total maintenance program of instruction.

Associate Field Artillery Officer Career Course. The increase in maintenance instruction for this course is 12 per cent in total hours with a 7 hour increase in practical exercises. The practical exercises for AFAOCC will require 24 per cent of the total maintenance hours.

The USAAMS feels that these increases will provide better trained officers for company grade assignments. This emphasis on maintenance instruction also will make the future staff officer acutely aware of the importance of proper maintenance, proper maintenance inspection, reporting procedures and materiel readiness.

In addition to the increased hours of maintenance in the courses, the USAAMS has been assigned instructional responsibility for conducting the new nine-week Master Mechanic Course. Seventeen classes are programmed for fiscal year 1966. The purpose of the course is to qualify enlisted personnel to perform as senior mechanics in an organizational maintenance operation for wheeled and tracked vehicles, to include a working knowledge of turret mechanisms and weapons. Prerequisites require that EM be in grade E-4 or above, with a minimum of two years service, and be qualified in MOS 631.1 or 632.1/2 with at least one year of experience.

Particularly noteworthy is the fact that the establishment of the course provides intermediate skill level training for mechanics who reenlist and emphasizes the development of diagnostic skills.

Communication/Electronics Department

REMOTING AN/VRC-12 RADIOS

Staff Sergeant Adam C. Miles, Jr. has submitted to this department that when using the tent extension for the M577 command post carrier, the radio sets of the AN/VRC-12 series must be remoted for use. To save time and avoid setting up of the AN/GRA-39 with WD-1/TT and BA-30 batteries, the following items can be used to accomplish the same purpose:

- one control box, C-2298/VRC
- one cable, special purpose, CX-4723/U

By connecting the CX-4723/U to the J804 connector of one of the C-2298 control boxes in the M577 and the J801 connector of the additional C-2298, the required remote facilities may be provided. A hand mike and a loudspeaker can be attached to the extended C-2298, and the radio sets can be monitored and operated from the tent extension. An added advantage is gained by not having to disconnect this equipment when the tent extension is removed. The cable and control box may be readily stored in the M577 without requiring disconnection.

Since radio equipment issued to units does not require all components under all operating conditions, the required cable and control box should be readily available for the installation described above.

Guided Missile Department

PERSHING MOS

The results of the Pershing service test indicate that an increase in organizational maintenance capability at firing battery level is necessary. In achieving this, additional spare parts have been procured for stockage at the firing battery, and the battery has been assigned certain maintenance tasks formerly performed by ordnance personnel. To provide the technical skills required for organizational maintenance personnel the Pershing Specialist Course has been revised and lengthened to approximately 20 weeks.

These maintenance personnel will be identified by an MOS in the Ballistic Missile Electronic Maintenance Career Group. The new MOS, 21G20, will accurately define their electronic maintenance duties and responsibilities, and will facilitate the identification of these individuals when reassigned. This change in MOS structure will improve the career opportunities for maintenance personnel since they may advance from grade E-4 to E-6 in the same job in an unaugmented battery and to E-7 in an augmented battery. Additionally, it is strongly expected that these individuals will now be able to compete for Proficiency Pay (Specialty) rather than Proficiency Pay (Superior Performance), thus increasing their overall earning capability.

Individuals who demonstrate a high degree of leadership potential may advance into the warrant officer grade as a Field Artillery Missile Systems Technician (Pershing) 214E.

It has been recommended that three positions requiring the new MOS be authorized in the unaugmented firing battery. Two additional positions will require the MOS in an augmented battery. It is anticipated that men now serving in MOS 163.2 positions in units organized under the "T" series TOE will be allowed to convert to the 21G20 MOS at the rate of not more than two per unaugmented battery by on-the-job training. It is expected that the third position will require a school trained maintenance man, and that after the initial conversion, only graduates of the Pershing Specialist Course will be awarded the 21G20 MOS.

Gunnery Department

TARGET PLOTTING GRIDS

Information received by the USAAMS from a unit in Europe indicates that some DA Forms 6-53, Target Plotting Grids, graduated in **yards**, still exist in supply channels. The current Form 6-53 can be readily distinguished by its label "GRADUATED IN MILS AND METERS." While no serious inaccuracies will result from the use of the yard-scaled grid, the new target grid is preferable, particularly when target location is by shift from a known point.

Tactics/Combined Arms Department

FIRE SUPPORT COORDINATION LINE

The U.S. Armed Forces, together with other NATO Armed Forces, recently agreed on principles for fire coordination in the land/air battle. This agreement, the details of which are being included in appropriate Army publications, states that the title Fire Support Coordination Line (FSCL) has been adopted as the name of the control/coordination feature heretofore known as the Bomb Line. FSCL is defined in AR 320-5, "Dictionary of United States Army Terms" or JCS Pub 1, "Dictionary of United States Military Terms for Joint Usage."

The U.S.-NATO agreement also requires two basic changes to the previous fire support coordination line. First, the FSCL is established by the corps commander in consultation with the tactical air commander; previously, it was established by the appropriate ground commander, normally the army commander.

Secondly, the FSCL is applicable to air, ground or sea delivered conventional and nuclear fires; previously, it applied only to air delivered conventional weapons. Therefore, the FSCL is a line established by the corps commander to insure coordination of conventional and nuclear fires which are not under his direct control but which may affect current tactical operations.

A FSCL is not normally required for units lower than corps since the no-fire line and boundaries will provide adequate control measures at lower levels.

Target Acquisition Department

CORPS ARTILLERY METEOROLOGIST

A meteorologist has been added to the Corps Artillery Headquarters and Headquarters Battery, TOE 6-501E. He is an Assistant S3 with the duty of advising the commander and staff on all aspects of ballistic meteorology.

A Metro Quality Control Team (MQCT) also has been added to the corps artillery TOE. The MQCT consists of a warrant officer and two enlisted ballistic meteorologists and provides the corps artillery commander with the means of improving and maintaining the quality of ballistic meteorological data generated in the corps area. The team will check and provide technical assistance to all meteorological sections in the corps.

The USAAMS is preparing a handbook which will provide the corps artillery meteorological staff officer and the MQCT with guidance for the accomplishment of their duties. This handbook will be distributed in the near future to all corps artillery and division artillery headquarters.

Managing Your Maintenance

*Major John F. Geraci
Artillery Transport Department*

MATERIEL READINESS

There is one resource which cannot be saved, stockpiled, augmented or increased—that resource is time. Even in these days of austerity, additional funds can be obtained, if a valid requirement is proven, parts can be stockpiled, personnel can be augmented, and facilities can be expanded, but time alone remains restricted. No one can add an extra hour to a day, not even an extra minute to an hour. Since time cannot be increased, it must be used efficiently.

Of all the many factors which affect the materiel readiness of a unit, time is often the most crucial. As many as 600 man-hours can be required for performing equipment serviceability evaluations on 300 items of equipment. The exact number of required man-hours will depend on many factors but particularly on the state of training of unit personnel. Even if evaluations were required only on a quarterly basis, 2,400 man-hours per year would be used for making these checks. Even in those cases where this time expenditure can be reduced 50 per cent by training (and it can be done), the question remains, "whose time should be used for making these evaluations?"

THE DILEMMA

The technical manuals for equipment serviceability criteria specify that serviceability evaluations will be performed by the equipment operator or crew, assisted as necessary by unit mechanics. Several unit inspections and surveys made throughout the Army have indicated that these instructions are not always followed. These checks revealed that in many cases evaluations were performed only by unit mechanics. Such a practice will defeat either the unit materiel readiness program or its maintenance program.

For example, assume that a 155-mm self-propelled howitzer battery is required to perform equipment serviceability evaluations monthly. The battery commander desires letter-perfect accuracy in his reports and directs his battery maintenance section to perform all evaluations. (The surveys indicated that his situation is not really so unusual; in fact, this situation or similar situations existed in many of the units inspected and probably still exists in many other units.) The battery maintenance section,

at full strength, has three mechanics, including a senior mechanic. For the purpose of this example, we will consider only the howitzers, armored personnel carriers and wheeled vehicles, and we will assume that the battery has 30 of these. Let us also assume that the mechanics are fully trained and that they perform thorough, honest and complete evaluations. On the average, a mechanic will require about an hour per vehicle to perform an evaluation, including most of the attendant paperwork. Therefore, the monthly serviceability evaluation for the battery will require approximately 30 hours, which will mean the loss of one trained mechanic for 30 hours—approximately 3 1/2 working days—each month. Add to this the time required for evaluating generators and the myriad other items that must be evaluated, and the amount of time lost can become so great that maintenance standards will have to be sacrificed, thus defeating the unit maintenance program. At the same time, the mechanics, being saddled with the work of performing evaluations in addition to their regular maintenance duties, may perform slipshod and inaccurate "paper" evaluations, thereby defeating the unit readiness program.

ENTER COMMAND MANAGEMENT

The answer is, of course, proper command management. In the first place, the commander should follow the procedures in the ESC technical manual which specify that the operator or crew will perform the evaluations, calling on a mechanic for assistance only when necessary. Certainly the expenditure of 1 hour of an operator's time or perhaps 20 minutes for a crew of three or four men once a month is no serious time-loss in comparison to the final result. The questions then arise, "Can the equipment operators perform these evaluations in so short a time; can they perform the evaluations with precision, reliability and accuracy; and can they perform them without the assistance of a mechanic?" The answer to each of these questions is "yes."

Serviceability evaluations are not mechanically complex or intricate, although they do demand some technical or mechanical knowledge. It has been demonstrated repeatedly at the U.S. Army Artillery and Missile School that an untrained student, shown how to evaluate a vehicle one time by a mechanic, can thereafter evaluate the item without any appreciable assistance. Furthermore, he can do so with speed, accuracy and a high degree of reliability. In this instance, the word "reliability" is used in the statistical sense to indicate the frequency with which the same result may be obtained or predicted. After one demonstration, a student can completely evaluate a wheeled or a tracked vehicle in well under an hour. Self-propelled howitzers usually require 15 to 30 minutes longer. If several students evaluate the same vehicle or log book, the scores given by each student will habitually be within one or two points of those given by the other students, even on their first evaluation. This is true reliability or uniformity. It also is amazing accuracy, since, on the average, these student evaluations are within one or two points of the value awarded by the highly skilled instructor in his evaluation

of the same item. It is quite logical to predict that with repetitive performance, such as the student will have in the unit, his speed and accuracy can be further improved.

It is recognized that the Army today suffers from great turbulence of personnel, and there is an alarmingly high rate of turnover among maintenance personnel. Therefore, one workable solution to the operator and crew training problem is to have the chiefs of section initially trained by a unit mechanic, a well-qualified platoon sergeant or a junior officer. Then the chief of section should, in turn, be made responsible for training his own operators and crews. This also is a sound leadership technique, since it places the responsibility where it belongs—with the chief of section who has the immediate supervisory responsibility for the equipment.

Following the directions provided in the ESC technical manual, the unit commander will be able to use his time and personnel more efficiently as well as be able to clearly fix responsibility. In the final analysis, it pays to follow instructions.

TIME and TAERP

Of the seven elements that affect maintenance—time, personnel, command emphasis, publications, facilities, training and tools—none is more illusive or more difficult to control than time. If time is not used to an advantage, it is doubtful whether the other elements can be employed effectively.

Two of the chief objections voiced against the current Army Equipment Record Procedures (TAERP) are that maintenance of the equipment log book is too complicated and too time-consuming. These objections are clearly stated in the Baker Board Report. The Procedures can be time consuming and can be complex, but it need not be either if the responsibilities for the preparation, use, maintenance and disposition of the various forms and records are properly assigned to maintenance personnel. If a person is given responsibility for too many different forms or for too many of the same form, then the procedures may become time consuming and complex. The solution to the problem is to assign responsibilities in accordance with the intent of TM 38-750 and good management planning.

Figure 1 lists the forms prescribed by TAERP, indicates the individual(s) it is recommended be responsible for making entries on the forms and shows other information pertinent to maintenance of the forms. Note that the equipment operator need be concerned with a maximum of three forms—DA Form 2404, DA Form 2408-1 (daily and monthly) and DA Form 2409—two of which are log book inserts. All of these forms are simple, easy to understand and easy to use. As far as "paperwork" is concerned (excluding actual maintenance and inspection time), the equipment operator should be able to complete all required entries in 2

to 14 minutes. The actual time required will depend on the equipment—whether he has to replace parts and whether he needs the assistance of a mechanic to correct equipment faults. If his equipment is well maintained, he should be able to complete his paperwork in about 2 minutes. If the equipment is operated an average of 20 days per month, the operator and crew will probably spend from 45 minutes to 4 1/2 hours per month on paperwork, including the time required to maintain the DA Form 2408-1 as a monthly log.

What about the organization mechanics? To illustrate, let us consider a self-propelled, 155-mm howitzer battery operating under normal peacetime conditions. In a unit of this type, a mechanic, either battery or battalion, normally is responsible for making entries on only six forms—DA Forms 2404, 2408-2, 2408-3, 2408-5 (right side only), 2408-14 and 2409. If he is also an equipment operator, then he is also concerned with the equipment daily and monthly log and the equipment log consolidated. In either case, the time required to maintain these records should not exceed several hours in an average month. This does not include the maintenance of DA Forms 2404 used for directed inspections.

How much time is required of the supervisor (chief of section)? Very little, if the records are kept up to date. Again, to illustrate, two log books are required for a towed 155-mm howitzer section—one for the howitzer and one for the prime mover. The chief of section must supervise the maintenance of these records. In addition, he is personally responsible for maintaining the DA Form 2408-4, Weapons Record Data, for the howitzer. He has probably been doing this for years, in the form of a gun book. If both the howitzer and prime mover are operated 20 days per month but the howitzer is fired on only five of those days, the chief of section may have to spend from 1 to 5 minutes supervising records maintenance on nonfiring days and perhaps 5 minutes more to maintain the "gun book" on firing days. Further, he may spend about 5 minutes, once a month, checking the DA Form 2408-1 monthly log. Total paperwork per month will be from 1 hour to slightly more than 2 hours. Paperwork should not be confused with coordination. Figure 1 shows the chief of section coordinating with a number of other people, but this coordination consists primarily of an exchange of information regarding the scheduling of periodic preventive maintenance services, the repair of section equipment, lubrication services, parts replacement, modifications, number of rounds fired, evacuation, etc. It should be obvious that the wealth of essential information made available by TAERP more than justifies the 1 to 2 hours per month expended on TAERP by the chief of section.

TAERP carries no built-in guarantee that it will work effectively with the small expenditure of time, effort and knowledge indicated above. The success of TAERP depends on the commander. A commander who considers TAERP too complex for all but highly specialized experts has to create specialists to operate the system. This might be acceptable if the TOE provided such specialists, but it doesn't. If the commander assigns

Form number	Entries made by	Entries supervised by	Entries coordinated with	Technical assistance given by	Frequency of entries	Average time per entry or completion of form in minutes
DD 314	D	E	B	—	K	2
DA 2404	All	Next senior	—	—	G	1 per entry
(Daily)						
DA 2408-1	A	B	D	C	G	2 per day
(Monthly)						
DA 2408-1	A or B	B	D	C	H	5 per month
DA 2408-2	C	D	A and B	—	K	2
DA 2408-3	C	D	B	—	V	5 per entry
Left side of						
DA 2408-5	D	E	B	—	K-V	2 per entry
Right side of	C and/or					
DA 2408-5	F	D or E	B	F	K-V	1 per entry
DA 2408-6	F	—	D or E	—	NA for unit	—
DA 2408-7	E	—	—	—	K-V	3
DA 2408-8	X	X	X	X	X	X
DA 2408-10	D	E	B	F	K-V	2 per entry
DA 2408-14	C	D	B	D	V	3 per entry
DA 2408-4	B or B ₁	B ₁	—	F	When fired	10 to complete
DA 2408-9	X	X	X	X	X	X
DA 2409	A or C	B, D, or E	B or D	E	V	2 to 5 per entry

LEGEND:

A = Equipment operator and/or crew

B = Chief of section

B₁ = Platoon leader

C = Organization mechanic

D = Motor sergeant

E = Motor officer

F = Support maintenance

G = Daily when operated

H = Monthly

K = Less than monthly

V = Variable

X = Entries not required after form is originally opened

Figure 1. Responsibilities and relationships.

the job of supervising all log books in the firing battery to the chief of firing battery, the chief will be burdened with nearly 1 1/2 hours per day, or 30 hours per month, checking paperwork, even if the weapons are not fired. Likewise, if one mechanic were designated to maintain all TAERP forms for the unit, this pitiful soul would probably die trying to learn the 14 separate forms in detail and working overtime to keep them in shape. Worse yet, the information available from the system would die with him. Under such a system, the commander and his men are serving TAERP; TAERP is not serving them.

MANAGEMENT CONTROL

To many commanders, TM 38-750, The Army Equipment Record Procedures, is apt to be a fearsome, complex and consequently little understood document. Granted, it hardly makes exciting reading but then neither does a 20-volume encyclopedia or an unabridged dictionary, no matter how useful they may be. If the maintenance manager will regard TM 38-750 as a pure reference, just like the encyclopedia and dictionary, and not as reading material in the sense of a novel, he will be able to make a more sensible approach to the use of the Army equipment record procedures and the equipment log book. In the first place, with the infinite number and variety of responsibilities that fill the troop commander's day (and night), what commander can afford the time to become an authority on every minute detail of TM 38-750? There is, however, a solution to the problem. A general understanding of the purposes of the equipment log book as an entity and of its individual component inserts can be acquired in a very short time through the proper use of TM 38-750. By applying this general understanding, along with some good management sense, any commander can derive the benefits inherent in the Army equipment record system.

The equipment log book is primarily a management control. To be effective, any management control must include a collection of data which bears on a management problem, is significant and is in a usable form. This collected data can then be compared with an established or desired standard to determine what difference, if any, exists between management accomplishments and management objectives (standards). The equipment log book, therefore, is the tabulated record of maintenance accomplished to be compared with the command-directed maintenance objectives. Each separate log book insert contains information on a particular area of interest. Mere knowledge of whether a goal has been attained is incomplete management information and is, therefore, inadequate for management control. When it appears that standards are not being met, goal-oriented management needs sufficient data to determine why the standards are not being met, so that prompt corrective action can be taken to raise the level of performance.

DA FORM 2408-5 AS A CONTROL DEVICE

Perhaps the simplest method of illustrating the control principle is to examine the insert, DA Form 2408-5, Equipment Modification Record (fig 2). On the left-hand side of this form are recorded all modifications to be applied to the particular item of equipment. Lists of these modification work orders are published in four sources—DA Pam 310-4 with changes, U.S. Army Equipment Index of Modification Work Orders, Modification Work Order Status Summary (other than selected items), and the weekly bulletin from the St. Louis AG Publications Center. The organization owning the item of equipment is responsible for making entries on DA Form 2408-5 of all required modifications, regardless of who may have physical possession of the equipment. In other words, if an item is listed on a unit property book, that unit has the responsibility for recording the modifications required. The right-hand side of DA Form 2408-5 is used for recording modifications which have been completed. These entries are made by the agency physically applying the modifications, which could be the owning organization, a direct support unit or, in some cases, the depot. If this form is properly maintained, any supervisor can tell at a glance what modifications are required (standard), what has been accomplished to meet the standard and what remains to be done. This data is absolutely essential! AR 750-10 and TM 38-750 specify that failure to immediately apply an urgent modification work order to any item of equipment deadlines that equipment. A normal modification work order, to be applied by the organization, must be applied within six months of the date of publication. This is vitally important from the standpoint of materiel readiness because all equipment serviceability criteria dictate that the failure to apply an urgent MWO to any item must cause that item of equipment to be categorized RED.

How does this apply to the problem of a unit that has some items of relatively old equipment which were received from another unit and which may have "changed hands" many times?

The current owning organization still has the responsibility for recording all required modifications despite the fact that former owning

1. NOMENCLATURE				2. REGISTRATION NUMBER		3. SERIAL NUMBER				
HELICOPTER UH 1A						61-784				
4. MODIFICATIONS REQUIRED				5. MODIFICATIONS COMPLETED						
MWO NUMBER	DATE OF MWO (Day/Mo/Yr)	PRI. ORITY	ECH	MWO TITLE AND KIT NUMBL.	DATE MWO APPLIED (Day/Mo/Yr)	MAN HRS	ORGANIZATION APPLYING MWO	SIGNATURE (Certification of MWO Application)		
a	b	c	d	e	f	g	h	i		
55-1520-207 ²⁰⁷ A	20 Oct 61	U	2	Repl of Starting Fuel Manifold Lines & Clamps	14 Oct 61	1.5	21 st Avn CO.	Signature		
55-1520-207 ²⁰⁷ A	30 Oct 61	N	3	Instl of Drive Actuator # 204-760-1						
55-1520-207 ²⁰⁷ A	29 Dec 61	N	2	Instl. New Overspeed Governor	2 Jan 62	41	21 st Avn CO.	Signature		
55-1520-207 ²⁰⁷ A	4/29 May 62	N	4	Mod of Oil Cooler Fan Drive Sys						

Figure 2. DA Form 2408-5, Equipment Modification Record.

organizations may have failed to keep this data current. In spite of the entries on DA Form 2408-5, indicating modifications applied, a unit mechanic should determine which modifications have actually been accomplished. Mistakes happen, and the alert organization will anticipate and make allowances for such mistakes. Any unit mechanic, given an accurate listing of required MWOs, in a very few minutes, can make an accurate visual inspection of equipment to determine if all modifications have been applied. This is exactly what AGI and CMMI inspectors do. Inaccuracies and errors on DA Form 2408-5 will be spotlighted by other controls, such as DA Form 2406, Materiel Readiness Report and DA Form 2408-3, which is another log book insert. Should a unit report an item in category GREEN, electronic data processing units at higher levels will compare this fact with known data concerning the status of modifications for this item, and if any irregularity is detected, the unit generally is in for one of those "reply by indorsement why . . ." letters. Such discrepancies, which might have been easily avoided, have unintentionally triggered erroneous materiel readiness reporting such as that which has recently been scrutinized by the General Accounting Office, the Army Audit Agency and the Baker Board.

RECOMMENDED PROCEDURES FOR DA FORM 2408-5

The following management procedures are recommended for using DA Form 2408-5 as a control:

- The battalion motor officer should thoroughly research MWO listings for items of each type equipment in the organization. In checking these, he should be especially careful to differentiate between different model numbers of the same basic item. For example, the C model of the M151, 1/4-ton truck incorporates several modifications performed at the factory, such as the battery box cover modification. Careful checking of such information will avoid the possibility of an item being erroneously placed in category RED because of a failure to apply an urgent MWO which, in fact, may have already been applied. In addition, it will insure that the time of the organization mechanics will not be wasted in trying to accomplish something which has already been done.

- The motor officer should then provide each chief of section with a list of required MWOs for each type equipment in his section. For those selected items listed in Appendix IV, TM 38-750, the chief of section should insure that a correct entry is made on the left-hand (required) side of DA Form 2408-5. Nonselected items are a special case to be covered later.

- Each item should receive a one-time inspection by a qualified mechanic, who will determine whether the required modifications have been applied. Each verified modification should then be entered on the MWO accomplished (right-hand) side of the DA Form 2408-5 by the mechanic who performs the inspection (if the modification has not already been recorded). Erroneously recorded modifications should be deleted.

- The battery commander, or his representative, should compare the required MWOs with those accomplished and arrive at a plan of action

to insure that any outstanding MWOs are applied as soon as possible.

- The battery commander should take follow-up action to make certain that his program is carried out for each piece of equipment.

- The battalion motor officer should take continuing follow-up action by reviewing the weekly St. Louis AG Publications Center bulletin and informing the command of the need for any new modifications.

- The battalion commander should periodically spot check DA Forms 2408-5, as his time permits. The following are some common indicators of errors which may be detected by simple checks:

1. The number of required modifications shown exceeds the number of modifications accomplished. The unit or its support maintenance is not keeping modifications current and up to date. The reasons for this may vary, but they warrant a more detailed examination by the staff.

2. There are apparent discrepancies, such as a recorded requirement for, or accomplishment of, obviously inappropriate modifications; for example, a record indicating the accomplishment of MWO G1-W105, "installation of radio power feed kit," on any cargo truck, 2 1/2-ton or larger. Such vehicles normally are not equipped with radios, yet blunders such as this are rather common in log books. An entry indicating the installation of a 100-ampere generator kit on a vehicle which is not equipped with a radio is another typical obvious error. Watch this one—somebody is trying to "snow" the commander.

3. The complete absence of any entries indicating modifications required or accomplished. There are a few items of equipment for which such a condition might exist for a short time. However, it usually is an indication that those responsible are not keeping the records or modifications up to date.

Figure 3 is a reproduction of both sides of an actual DA Form 2408-5 which was in the equipment log book of a vehicle in an artillery battalion and which came to the attention of an inspector. Only the unit designation has been changed. On the face of it, and without further research, how many things can you find in error?

REPRESENTATIVE ERRORS

Block 4, Modifications Required.

1. In lines 4 and 5, side 1, the MWO numbers appear to be known, but if these are modification work orders, why aren't the date, priority, echelon and title listed for each of them? If these are urgent, failure to apply them would deadline the truck and place it in category RED for materiel readiness reporting.

2. The entry on line 6, side 2, indicates a modification requiring the installation of a radio power feed kit. It is most unusual for a 2 1/2-ton cargo truck to mount radio equipment. This particular vehicle does not, so MWO G1-W105 should not be shown as a required modification. This is a good illustration of an obviously inappropriate modification.

1. NOMENCLATURE					2. REGISTRATION NUMBER		3. SERIAL NUMBER	
TRUCK CARGO 2½ TON 6x6 MI35					XXXXXX			
4. MODIFICATIONS REQUIRED					5. MODIFICATIONS COMPLETED			
MWO NUMBER	DATE OF MWO (Day/Mo/Yr)	PRI-ORITY	ECH	MWO TITLE AND KIT NUMB.<RIS1	DATE MWO APPLIED (Day/Mo/Yr)	MAN HRS	ORGANIZATION APPLYING MWO	SIGNATURE (Certification of MWO Application)
a	b	c	d	e	f	g	h	i
G749-W30	14 Mar 56	U	3	Tail Pipe Ext	UNK	.5	UNK	Signature
G749-W34	3 Apr 56	U	3	Neutral Safety Lock	UNK	.5	UNK	Signature
G749-W37	11 Aug 56	N	3	Spare Tire Grease Shield	UNK	.3	UNK	Signature
G1-W69					UNK		UNK	Signature
G1-W78					UNK		UNK	Signature
G749-W22	3 Apr 55	U	3	Stabilizer Bar	UNK	1	UNK	Signature
G749-W23	24 Mar 55	N	3	Flywheel Hsg Drain Plug	UNK	1	UNK	Signature
G749-W25	18 Apr 55	N	3	3d Member Lock Washers	UNK	2	UNK	Signature
G1-W64	19 Mar 55	U	4	Mod. Rear Planetary Unit	UNK	0	UNK	Signature
G1-W70	31 Aug 55	N	4	Trains Data Plate	UNK	.5	UNK	Signature
G1-W104	23 Apr 57	N	2	Alteration of Wiring Harness	UNK	2	UNK	Signature
G1-W35	28 Feb 57	N	2	Polarizing Bracket	UNK	.5	UNK	Signature
G1-W89	5 Oct 56	N	2	Mirror Arm Drain	UNK	.5	UNK	Signature

DA FORM 2408-5, 1 JAN 64 EQUIPMENT MODIFICATION RECORD (TM 38-750)

1. NOMENCLATURE					2. REGISTRATION NUMBER		3. SERIAL NUMBER	
TRUCK CARGO 2½ TON 6x6 MI35					XXXXXX			
4. MODIFICATIONS REQUIRED					5. MODIFICATIONS COMPLETED			
MWO NUMBER	DATE OF MWO (Day/Mo/Yr)	PRI-ORITY	ECH	MWO TITLE AND KIT NUMB.<RIS1	DATE MWO APPLIED (Day/Mo/Yr)	MAN HRS	ORGANIZATION APPLYING MWO	SIGNATURE (Certification of MWO Application)
a	b	c	d	e	f	g	h	i
G1-W96	6 Nov 56	N	3	Hood Handle	UNK	2	UNK	Signature
G749-W2	28 Sep 52	N	2	Deactivate Primer Pump	UNK	.5	UNK	Signature
G749-W11	3 Apr 53	N	2	Cargo Body Drain	UNK	1	UNK	Signature
G749-W28	23 Feb 56	N	3	Spare Tire Heat Shield	UNK	2	UNK	Signature
G1-W46	25 Mar 54	U	4	Control Valve Body	UNK	1	UNK	Signature
G1-W105	8 May 57	N	2	Power Radio Feed Kit		3		
G749-W16	15 May 54	N	4	Clutch Release Spring		15		
G749-W17	24 Aug 54	N	4	Reduction Unit Pump		.5		
G749-W18	25 Apr 55	N	3	Lub. For Reduction Unit		.5		
G749-W19	29 Dec 54	N	3	Oil Pressure Test Hole		.2		
G749-W20	26 Apr 55	N	4	New Clutch Rear Hub		1		
G749-W21	13 May 55	N	4	Mod. Reverse Clutch		1		
G749-W26	10 May 55	N	3	Reduction Clutch Drum				

DA FORM 2408-5, 1 JAN 64 EQUIPMENT MODIFICATION RECORD (TM 38-750)

Figure 3. Completed DA Form 2408-5 (side 1) (top photo).
Completed DA Form 2408-5 (side 2) (bottom photo).

3. The most recent MWO reflected in column b is dated 8 May 1957. It is very doubtful that no MWOs have been published in nearly eight years. In this instance, MWOs have been published since 1957 that are applicable to this vehicle.

Block 5, Modifications Completed.

1. All the unknown entries under columns f and h reflect no irregularities, provided that the application of each of the MWOs was physically verified by inspection.

2. Lines 4 and 5, side 1, under column g are blank. See comment 1.

3. Line 9, column g, side 1, indicates that zero manhours were used to apply the modification. Obviously this is impossible. (Is someone "dummying up" records here?)

4. Lines 6 through 13, side 2, are blank except under column g. If these modifications have not been applied, the vehicle would not be deadlined (throwing out MWO G1-W105 as ridiculous. However, it appears to be about time that they should be. If these MWOs were cancelled by some authority, why are they still reflected on the "required" side of the form?

●

MAINTENANCE CLASSES

In supplementing your unit training on TAERP, try two of the USAAMS class packets—Materiel Readiness (ATD 6105) and Army Equipment Records System (ATD 6167) which provide the necessary manuscripts and vu-graph transparencies for the instructor. To obtain this material, write to: Commandant, U.S. Army Artillery and Missile School, ATTN: AKPSINI/RC, Fort Sill, Oklahoma 73504.

●

LANCE

The Army is currently reviewing the results of the March and April 1965 Lance missile firings at White Sands Missile Range, New Mexico. During the test firings, all test objectives were met and the overall results of the firings were highly successful.

GUIDELINES FOR SUCCESS

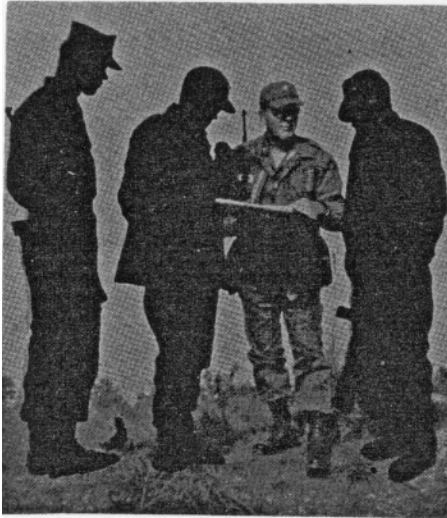

artillery advisor in counterinsurgency operations

How will field artillery be employed? Has artillery doctrine been outmoded by this third form of recognized warfare? Do artillery organizations require changes or modifications for this type environment? What additional training requirements for FA personnel are manifested in counterinsurgency operations? What are some of the problems an artillery advisor may be faced with in a counterinsurgency area of operations?

Very little has been documented concerning the answers to these questions. However, the ideas and conceptual statements expressed in the following article, representing the current thinking of the Artillery Community (USAAMS, USACDCARTYA, USAARTYBD), will provide many guidelines not only for the artillery advisor, but also for other combat arms advisors, who find themselves involved in the planning and execution phases of a counterinsurgency operation in which no American artillery advisor is present.

Note: This article is adapted from a study conducted by the USACDCARTYA.

FA ELEMENTS APPROPRIATE IN COUNTERINSURGENCY

Mission. The mission of artillery remains the same—to provide continuous and timely fire support to the force commander by destroying or neutralizing, in priority, those targets jeopardizing the accomplishment of his mission. Normally, most operations are small scale—from two to three company-size forces to possibly a regiment (-). The important thing to remember here is that no matter how small the supporting or attached artillery unit, the artillery commander is the principal advisor to the force commander on all fire support matters. Similarly, within the advisory structure, artillery officers must assist the advisors of maneuver units at all levels on fire support matters. In many respects this function within the advisory structure assumes an importance equal to that of the advisor-host country commander relationship.

Organization. Artillery in a counterinsurgency environment will probably consist of 4.2-inch mortars and 75-mm, 105-mm and 155-mm howitzers as well as foreign weapons. This artillery normally will be organized into batteries and battalions, and the number of howitzers or mortars within each battalion will vary. There may be differences between host country artillery organization and the organization used by the U.S. Army. Artillery battalions may be organized into a headquarters, headquarters and service battery and three firing batteries. There may be some differences in division and corps artillery headquarters organization. Artillery organization must remain flexible to permit ease in task organization.

Employment. To provide effective fire support in a counterinsurgency environment, artillery is employed to obtain maximum area coverage with available weapons. In addition to supporting tactical operations, artillery may be positioned to provide fire support for towns, hamlets and critical installations. Artillery will usually be employed by platoon rather than battery to obtain greater area coverage. This type of employment is justified by the lack of large targets, as typical targets usually are squads or platoons. The concept of greater area coverage makes it possible for some artillery to be within range of an attacking force at all times. This concept outweighs the need for massing the fires of a battery or battalions against small targets.

During highly decentralized operations in a counterinsurgency environment, there is a requirement for artillery platoons to have a fire direction capability. The term "fire direction" can mean any procedural control ranging from a "hip pocket" type to the far more elaborate and technical procedures normally associated with the FDC. During decentralized operations or in preparation for counterinsurgency actions, it is extremely important that the fire direction and survey personnel be cross-trained. Without adequate training of survey personnel to enable them to function as fire control personnel, the battery may not be able to function at a platoon employment level for long periods of time.

In tailoring artillery organizations, the nature of the terrain in the area must be considered along with enemy tactics and techniques. Platoon

employment may be dictated where relatively few weapons are available and where the size of the area to be supported is quite large. Since this will normally be the case in counterinsurgency operations, it follows that priorities must be established for the use of artillery. The allocation of available artillery is contingent on the priorities established; for example, a single piece may be positioned in a large village for the protection of surrounding hamlets. When, in the opinion of the advisor, there should be a higher priority mission, it is incumbent upon him to convince his counterpart of this change. In counterinsurgency operations, single piece employment is valid if the protection of hamlets and villages is granted a high priority and if no preplanned offensive operations requiring artillery are in progress. It is important to remember that a single piece so employed is not placed "in concrete." It can and should be moved periodically for flexible utilization and to keep the insurgent forces off-balance. If artillery used in this role never fires a round but, by its very presence, discourages guerrilla attack, it has accomplished a mission. This concept may be used in areas where mobility is restricted by a complete lack of roads or intense insurgent activity. Insurgent forces have come to show great respect for the capability of even single artillery weapons. Artillery weapons in a counterinsurgency environment should always be in firing position. It is not uncommon to find the howitzer platoons of an artillery battery separated by as much as 50 to 75 kilometers. Mortar platoons, when employed, may likewise be distributed throughout a large area of operation.

The use of forward observers is vital, especially in areas where map accuracy is questionable, survey is difficult and much of the population is friendly, because of the increased need for discriminating fire. Aerial OPs offer one of the most flexible means of control of fire in remote area operations but do not supplant ground FOs. Defensive concentrations must be fired-in and at periodic intervals refired to check validity since advanced gunnery techniques are rarely employed. There is no substitute for observed fire.

Survey. Inasmuch as artillery operations are varied and widespread, there probably will be little requirement for massing fires and for this reason, little need for survey. Security forces to protect survey personnel against ambush should be provided.

Mobility. Artillery must be as mobile as the supported forces. In marshy, water-covered, or delta terrain, artillery movement may be amphibious or airlifted. In mountainous areas, artillery ideally will move by helicopter. All artillery weapons cannot be used with equally promising results in all types of terrain. Mobility may be the overriding consideration in the selection of both weapons and prime movers in difficult terrain.

Control and Coordination. Artillery commanders at battalion, division and higher echelon exert little or no influence over artillery fire control and maneuver beyond the initial stages of operational planning. This is largely due to the fact that artillery supports many small unit

operations simultaneously with platoons and, in rare instances, with batteries. Additionally, these artillery platoons or batteries are usually far removed from their control headquarters, making higher echelon control difficult and impractical. Once operations are underway, coordination is conducted at battery or platoon level.

Logistics. Logistical support for widely dispersed units imposes demanding requirements and usually differs with each situation. The present logistic concept will remain valid during counterinsurgency operations except during those occasions when platoons are operating semi-independently. Augmentation to platoons may have to be furnished from the battalion organizations. While supply procedures will apply, problems of delivery and distribution become more difficult. Consequently, all methods of surface transportation and air delivery should be exploited.

Maintenance. Maintenance in counterinsurgency operations should receive more than normal emphasis because of the distance between units and normal support and maintenance facilities. Depending on the state of training of host country forces, the advisor must be prepared to devote considerable time to this effort.

Ammunition. In counterinsurgency operations, ammunition basic loads must be tailored to fit the nature of the terrain and the targets to be engaged. VT fuzes provide less effective air bursts when used in jungle areas with high tree canopies. Recent tests have shown that VT fuzes provide good effect when used over inundated rice paddies. White phosphorus shells are effective during the dry season, and illuminating shells play a major role in the defense of hamlets and villages. Ammunition security must be emphasized, because captured shells are frequently used as mines against government forces.

Communications. In the division and province areas, communications are primarily by radio, although wire may be used for internal communications and in some safe areas. Terrain, enemy activity and wide dispersion of units make wire communications impractical, insecure and unreliable in large areas of operations. Fire direction nets above battery level are not utilized in most cases. Practically all radio communications between higher echelons are accomplished over AM radio command nets using CW transmission techniques. Fire control traffic is transmitted over FM sets, such as the PRC-9, and may be augmented with the TR series radios provided by USAID. An artillery platoon in support of an offensive operation usually will be provided an AM radio such as the AN/GRC-9 for communications with higher headquarters.

PROBLEMS

The advisor's problems primarily will result from the background of his host country counterpart; that is, the counterpart's professional level of military education, the degree to which he understands U.S. military tactics, and the U.S. advisor's inability to speak his language. The advisor will encounter several other important problems:

- A tendency on the part of host country commanders to direct artillery or other supporting fires. The commander in his CP may be far removed from the point of contact and unable to evaluate the requirement for fire, much less adjust it. He must allow the forward observer with his maneuver units to call for or adjust fire.

- The frequent use of fire for effect by coordinates with no adjustment. Host country commanders must understand that without survey, meteorological data, VE data and accurate maps, artillery cannot fire with accuracy without observation. Generally, firing data will be computed from outdated maps. Observed fire charts should be used in the majority of cases; this requires a registration (sometimes difficult to accomplish) and the employment of FOs with maneuver elements.

- Since there may be a shortage of forward observers, they may not habitually be allocated to maneuver units but assigned only on the request of the force commander. The advisor, before any operation which includes artillery, should insure that his counterpart has requested forward or aerial observers. This is vital because the use of artillery and/or tactical air without control and direction by a forward observer or forward air controller is both wasteful and dangerous; it is wasteful because it is often inaccurate due to unsophisticated gunnery procedures and map inaccuracies, and it is dangerous because indiscriminate firing into other than "declared free areas" creates an extremely poor environment in which to conduct civic action operations.

- Fire requests must be evaluated from their psychological effect as well as their physical effect. Indiscriminate use of artillery against a village shielding a handful of snipers or an airstrike against an inhabited area, possibly containing a guerrilla platoon, can alienate the population and drive them into supporting the insurgents. Remember that it is quite possible to search an individual personally, and in detail, and fail to discover whether or not he is a guerrilla. Therefore, the difficulty of identifying guerrillas through field glasses or from a speeding plane must be realized. Wherever troops are operating, innocent people may run in fright. They may leap into boats and take up paddles which look like weapons. They may run with farm tools. All these actions will appear incriminating but may only be the frightened actions of innocent people. The U.S. advisor should insure that his counterpart understands these facts.

CAPABILITIES AND CHARACTERISTICS

Weapons. Weapons characteristics have a major impact on artillery employment techniques in counterinsurgency operations (fig 1).

When advising a host country counterpart on a plan for a hamlet or village defense where supporting weapons include 4.2-inch mortars, the minimum range of 800 meters and the lack of a direct fire capability may be severe limitations. Therefore, other weapons, such as 60-mm mortars, M79 grenade launchers, etc., should be considered for close-in protective fires.

The light weight of the 4.2-inch mortar and the 75-mm howitzer, as compared to the 105-mm or 155-mm howitzer, may be the deciding factor in the selection of supporting artillery for mountain and jungle operations or for those areas with few or no roads, inasmuch as both weapons are capable of being lifted in one load by almost all U.S. Army helicopters and several U.S. Army fixed-wing aircraft.

Maximum effective ranges of weapons will be an important consideration when planning artillery support of patrols or surface convoys. Patrols, beyond artillery maximum range, may require artillery displacement or coordination with other artillery units in the area to provide a continuous support capability.

Weapons	Wt (lbs)	Max Rg (km)	Min Rg (HA) ((km)	Max Rate of Fire (rds/min)
M30, 4.2-in Mortar	639	5.1	.8	20
M116, 75-mm How (Pack)	1,440	8.8	2.8	6
M101A1, 105-mm How	4,980	11.0	1.0	10
M102, 105-mm How	3,100	15.0	1.0	10
M114, 155-mm How	12,700	14.0	2.9	4

Figure 1. Weapons characteristics.

Fuzes. Fuze VT is suited for use against personnel in the open, personnel in entrenchments and area targets where neutralization is desired, but it is not suitable for use against targets under heavy tree canopy or dug-in with overhead cover.

Fuze Time is suitable for use against the same type targets as those suitable for VT. The comparative disadvantage of Fuze Time is that it must be adjusted for height of burst. Long times of flight increase fuze probable error.

Fuze Delay allows the projectile either to penetrate and produce mine action or ricochet and produce a low air burst. Mine action will generally occur when the angle of impact is large and where soil composition is very soft. Ricochets, resulting in low air bursts, will generally occur when angle of impact is small. Even in soft ground the projectile may enter the surface and then rise above or to the surface before exploding. Ricochet fire is not as effective as VT and, in addition, must be observed since another fuze must be selected if ricochet action does not result. Fuze Delay may give excellent results when fired against targets under heavy, dense tree canopies and against earth fortifications.

Fuze Quick is suitable for use against personnel in the open, in sparsely wooded terrain where tree bursts give the effect of low air bursts and in hard, rocky ground.

Shell Types. The most commonly used shells are High Explosive, White Phosphorus, HC Smoke and Illuminating.

High Explosive (HE) is the most widely used artillery shell. It produces casualties and structural damage by shell fragmentation, concussion, and spalling on penetration of materiel targets.

White Phosphorus (WP), on detonation, spreads small particles of burning phosphorus outward and upward. Although primarily a marking and screening round, it also has considerable casualty and incendiary capability. For screening effect, it is not as efficient as the HC Smoke Shell. However, because of the high pillar of smoke that it produces, it is a good shell for use when adjusting artillery fire in dense undergrowth and trees which would hide an HE burst. It is also an excellent target marker for tactical air strikes.

Colored Smoke and HC shells are used to produce smoke of various colors for spotting and screening purposes. The projectile is filled with one of five types of smoke producing canisters—HC (white), yellow, red, violet, and green. Smoke shells are used to screen enemy observation, to aid in the adjustment of fire (help the observer locate his rounds), to signal, to mark targets for air observation or air strikes, and as a navigational aid. Projectiles should be fuzed to burst approximately 100 meters above the target, where they base eject smoke canisters which ignite and fall to the ground. The shell should not be used in inundated areas.

The illuminating shell is designed to be fired at a predetermined point approximately 750 meters above the area to be illuminated. At that point a pyrotechnic device is ejected from the shell and parachuted to the ground, thereby providing illumination for approximately 60 seconds. These shells can be placed with the accuracy and flexibility inherent in the weapon from which they are fired. After the parachute opens, its horizontal movement is affected by the force and direction of the wind. By considering wind, visibility, terrain relief and target reflectivity, the proper point of burst for illumination of any desired target normally can be determined by adjustment.

TECHNIQUES

As a minimum, artillery must be as mobile as the supported force. In addition to normally associated prime movers, many other means of mobility are available, and the advisor must use imagination and ingenuity in those cases where normal methods are either unworkable or unavailable.

Operations conducted over large inundated areas or areas bisected by many navigable streams and rivers, can be supported by artillery through the use of boats as prime movers. If available, the LCVP (fig 2) is an excellent mode of transport for artillery up to and including the 105-mm howitzer. The howitzer should be loaded muzzle end first in order to facilitate unloading. In most cases the crew will be able to manhandle the weapon into and out of the boat, using the handbrakes for control. If it is necessary to beach on a steep bank, the weapon may have to be extracted by means of a block and tackle or winch.

The 4.2-inch mortar, 75-mm howitzer and 105-mm howitzer can be lifted by helicopter. This affords the planner the opportunity to use artillery in almost any operation where terrain and the enemy situation are a deterrent to normal ground mobility. Depending on the type of helicopter

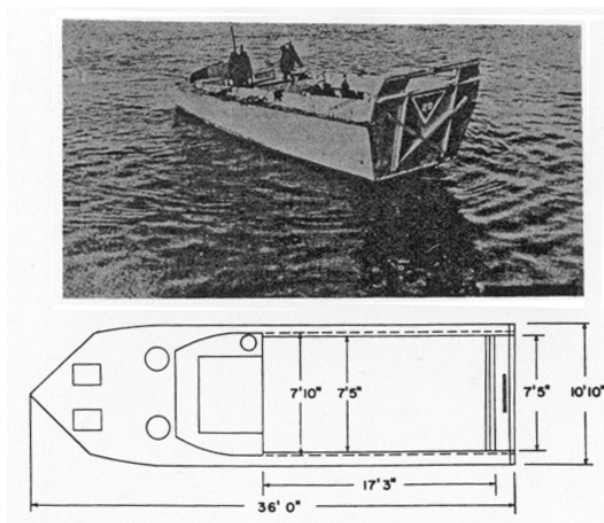

Specific Data:

- Length—36 feet
- Beam—10 1/2 feet
- Draft—2 feet, forward
3 feet, aft
- Speed—7 knots, loaded
9 knots, light
- Weight—9 short tons, light

Cargo Capacity:

- One 5,000-pound vehicle or
8,100 pounds of cargo

Troop Capacity:

- 36 combat equipped soldiers

Sample Loading:

- One 105-mm howitzer plus 15 men
- One 1/4-ton truck and trailer
plus 17 men
- One mechanical mule with
mounted 106-mm rifle-plus crew

Figure 2. LCVP (Personnel and Vehicle Landing Craft) diagram and data.

utilized, it may be necessary to disassemble the M101A1, 105-mm howitzer into several loads:

1. Carriage less cannon and shield—2,600 pounds
2. Cannon —1,240 pounds
3. Wheels — 575 pounds

This mode of transportation increases artillery flexibility in areas where trafficability is poor or where enemy control precludes passage by ground routes. Whenever possible, position reconnaissance should be made. Provisions for ammunition resupply should be granted priority when utilizing helicopters as a mode of artillery transport.

The 4.2-inch mortar or the 75-mm howitzer can be internally transported by the M113 or M59 armored personnel carrier. In marshy, inundated areas it affords the commander an excellent means of positioning artillery.

A simple technique by which hamlet and village defenders can request artillery fire should be devised. The method must be easy to explain to villagers and easy to transmit over the district communications system. One such technique is the "colored quadrant." Essentially, it is a round board with each quadrant painted a different color; for example, red in the first quadrant, white in the second quadrant, blue in the third quadrant and yellow in the fourth quadrant. The round board is then permanently mounted in the village and oriented on a north-south line, and hamlet defenders can call for fire with a color direction. This technique requires close coordination with artillery units, and as many prefire concentrations as possible. More sophisticated methods can be devised, depending on the time allowed for training and the receptability of instruction. Any technique will require reliable and responsive communications.

Active patrolling in a counterinsurgent area is mandatory. Whenever possible, artillery support of patrols should be provided. Such support must be carefully coordinated before the patrol begins. The supported commander must provide the artillery unit such information as the size of the patrol, the times of departure and return, its mission, routes and any other special instructions. Prearranged fires may be planned on prominent or easily identified terrain features from which the patrol leader may reference calls for fire.

Artillery fire, because of its great psychological effect on insurgents, should be utilized to the maximum in the Harassing and Interdiction (H&I) role. Targets for H&I fires can be obtained from many sources to include map inspection of insurgent controlled areas, informers and patrol reports. Infantry commanders and district leaders should be advised to

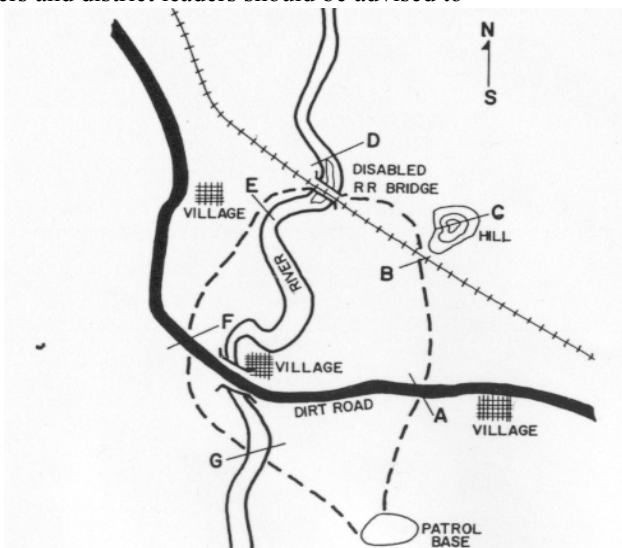

Figure 3. An example of indexing a patrol route.

stress the importance of having patrols locate and record suspected insurgent routes and installations. Patrols should be ordered to record coordinates of deserted camps or villages or areas which give the obvious appearance of insurgent training areas. Such locations should be fired on from time to time to curb insurgent movement, deny their use of the area and lower insurgent morale. Targets for H&I fires must be carefully selected to insure the safety of the local inhabitants.

To the maximum extent possible, artillery positions should be selected to afford a 6,400-mil firing capability. Care should be taken not to mask artillery when positioning it in or near built-up areas. Although position security is a primary consideration, the ability to perform the mission is always paramount. It is important to insure that continued improvement of position does not result in a gun parapet which would preclude the ability to conduct direct fire.

Alternate position areas should be selected throughout the area to add flexibility to the employment of artillery. Such position areas should in no way be prepared, in order to deny the insurgents advance knowledge and thus the opportunity to mine or make plans for ambush. Periodic movement of artillery to within range of areas in which insurgents feel secure (out of normal artillery range) will do much to throw them off balance and disrupt their activities.

Coordination between the supported force and the supporting artillery is vital. In most cases, in counterinsurgent areas of operation, artillery will be attached to the supported force. As minimum communications are established, call signs are arranged, artillery range capabilities are explained to the supported force commander, forward observers are assigned and fire planning is accomplished.

Control of fire is the inherent responsibility of the force commander. Authority to control fire is further delegated to the artillery commander who has knowledge of the schemes of maneuver, the disposition of friendly forces and who by virtue of close liaison with the force commander is able to render quick decisions on requests for fire. Requests for fire must be answered as quickly as possible. Restrictions imposed by force commanders that unduly delay requests for artillery fire should be examined and explained to host country counterparts immediately upon discovery in an effort to have such restrictions removed. It may be advisable to arrange firing demonstrations to prove the worth of artillery to your counterpart and to build mutual confidence.

CONCLUSION

When advising a host country counterpart in the planning of an operation that includes artillery, insure that after the mission is received, the following requirements posed by the seven inherent field artillery responsibilities are satisfied. The advisor must determine—

- From whom calls for fire will be answered.
- With whom communications will be established.
- With whom liaison will be established.

- To whom forward observers will be furnished.
- What will be the zone of fire.
- On whose order the artillery will be displaced.
- By whom the artillery fires will be planned.

We in the field artillery have a tested doctrine, good equipment and a sound organization—all capable of contributing to success in a counterinsurgency area of operation.

The primary differences in counterinsurgency operations will be that of attitude and stress rather than major changes themselves. Attachment of artillery will become much more commonplace; this, and the large area of operations and far-flung units, may negate a portion of the artillery's ability to mass its fires throughout the operating area. Ammunition expenditures may be larger with inferior results in comparison with conventional warfare. Additional and greater responsibility will be placed upon junior officers and NCOs. The needs of decentralization will require additional emphasis on cross-training within our fire direction/survey system to insure a complete fire direction capability when platoon operations are mandatory. An increased emphasis on infantry small unit tactics will be required. Local security personnel must be cross-trained in basic infantry tactics in addition to their normal positions as cannoneers, communicators, drivers and wiremen.



COUNTERINSURGENCY OPERATIONS CLASSES

To provide commanders with information concerning tactics and techniques for counterinsurgency operations, the USAAMS has available six classes, with necessary material for instructors, for issue upon request. These classes are Civic Actions in Counterinsurgency Operations (T1010); Special Forces and Psychological Warfare in Counterinsurgency Operations (T1012); Insurgency Operations (T1014); Fundamentals of Military Operations in Counterinsurgency Operations (T1020); Survival, Escape and Evasion (T2071); and Unconventional Warfare (T1017). These can be obtained by writing to: Commandant, U.S. Army Artillery and Missile School, ATTN: AKPSINI/RC, Fort Sill, Oklahoma 73504.



WHAT IS A STANAG?

STANdardization **AG**reements are subjective Details of Agreement concurred in by the NATO Armed Forces. One of the first STANAGs to be implemented in a field artillery doctrinal field manual will be STANAG #2047, "Emergency Warnings of Hazard or Attack" which will appear in FM 6-140, "Field Artillery Battalions and Batteries."

The requirement for national/service identification within the NATO metro message structure has been deleted by Amendment Number 6 to NATO Standardization Agreement (STANAG) Number 4061, dated 18 December 1964.

DA Form 6-57 is presently being revised to eliminate the three digits (USL) and should be available in the near future.

SURETY

the Army's new insurance policy

Captain Kelvin H. Hunter, Jr.

Guided Missile Department

"Army Nuclear Weapon Explodes—Hundreds Killed and Injured." When the implications of an occurrence as this headline depicts are considered, the need for continual caution and care when dealing with nuclear weapons becomes self evident. With the advent of new nuclear weapons systems and the growing number of nuclear delivery units, the Army has expanded its already operational nuclear weapons safety program into a more inclusive and definite program—the Nuclear Weapon Systems Operational Surety Program, also known as the Surety Program. The objective of this Surety Program is to assure that Army nuclear weapons detonate only at an authorized time, and throughout their careers, artillerymen will find themselves closely and inevitably associated with the Army's atomic capability and related Surety Program.

The Army's Surety Program, which is the first to be definitely established by any service, includes areas of interest involving not only pure nuclear weapons safety but also the fields of national security, personnel selection and assignment, training, materiel development and use, and human reliability. All materiel, personnel and procedural aspects of our nuclear weapons program fall in the area of surety.

Implementation and management of the Program is in the hands of the Nuclear Weapon Systems Surety Group, located at Fort Belvoir, Virginia, which operates under the direction of the assistant Chief of Staff for Force Development.

Since being established more than a year ago, programs in several areas have been implemented:

- One area involves a proposed surety newsletter, which will be published to keep all commanders informed of current trends, activities and problem areas involving surety. These newsletters will supplement the already established "Surety of Nuclear Weapons" messages which are sent to units world-wide upon discovery of any unsafe condition involving a nuclear weapon system. These messages would prohibit any further operations in the unsafe area until proper corrective action can be taken.
- The feasibility of an electro-magnetic handbook is being explored by the Group. The prototype will contain distances that a type nuclear weapon system should be displaced from type emission sources. This will give the commander factual and realistic information with which he can act concerning any problem areas in this field.
- Since daily staff actions involving personnel, intelligence, operations and logistics are often directly related to the Surety Program, the assignment of an additional duty as the Nuclear Weapons Surety Staff Officer to an appropriate member of specified staffs is under study.

Effective direction and coordination of a command Surety Program and advising and informing the commander concerned of any matters involving nuclear surety would be one of the prime duties of such a staff member.

- The Group is presently compiling and evaluating all current technical proficiency inspection reports which have been submitted by major Army headquarters world-wide through the Inspector General, Department of Army. The results of this effort will disclose any trends and weak areas in all nuclear weapons systems technical operations. Corrective action can then be taken to insure that no problems develop to the point of becoming surety hazards and that no errors which might cause accidents or unwanted detonations are allowed to occur. Results of these analyses promise to become one of the most important and beneficial results of the Surety Program.

- In the implementation of the Surety Program at the USAAMS, a 1-hour presentation entitled "Nuclear Weapons Surety" is being included in all programs of instruction which involve nuclear weapons. The objective and major areas involved in the Surety Program are discussed to include peacetime safety rules, personnel selection and retention criteria, security of nuclear weapons and the duties of a surety staff officer. Currently, major emphasis is being placed on the personnel aspects of surety, particularly AR 611-15 and its ramifications.

All of these efforts, however, can only complement the most im-important area of nuclear surety—command effort. The Surety Program has focused attention on areas which have existed since the advent of nuclear weapons. None of the fields involved are new; the Surety Program merely ties them together and emphasizes them. Surety is a day to day effort which must be integrated with our operations and mission accomplishment in all fields which deal with or touch our nuclear capability.

Actions of the Surety Group are objective only, and the program document precludes the Group from censuring a command or individual or otherwise aiding in any punitive or liability actions. To best achieve the goal of the program, all commanders are authorized direct communications with the Surety Group to report dangerous conditions or to seek advice in any matter involving nuclear weapons surety. Commanders utilizing this avenue should take steps to notify their appropriate chain-of-command of actions taken and their results.

Every artillery assemblyman, weapon security guard, platoon leader, battery commander and battalion commander whose duties involve nuclear weapons are the crux of our real surety effort. Conscientious compliance with security regulations and personnel reliability program, an unwavering effort to correctly follow technical procedures and safety rules involving our nuclear weapons, and continuous awareness and quest for improvements in all surety areas of effort are the only real guarantees for the program's success.

The Army has never had a nuclear accident. Let's maintain that proud record by helping our new "insurance policy" pay off.

NUCLEAR FIREPOWER

combat operations nuclear support

Colonel Richard A. Crecelius and

Major Henry A. Pedicone

Tactics/Combined Arms Department

Total Army combat power, as applied in the conduct of land operations, stems from two major sources—maneuver and firepower. These sources are complementary, each reinforcing the other, and their balanced and integrated employment is the key to success in battle.

The firepower aspect of total combat power is provided with a wide variety of tactical nuclear weapons and delivery systems currently in the Army's inventory. This nuclear firepower, in support of ground combat operations, is employed with selected concepts and techniques in mind—coordination and integration of fire support on surface targets; the enemy target array and the capability of the Army to acquire and attack enemy targets; the operational factors affecting the application of Army firepower, particularly nuclear firepower; the optimum procedures for the employment of very small yield nuclear weapons; Army employment requirements for air-delivered nuclear weapons; and employment of artillery units in nuclear warfare.

The framework for the coordination and integration of all supporting fires is provided by a fire support structure, which extends from company to corps. At the company level, fire support is provided by 81-mm mortars and 106-mm recoilless rifles; at the maneuver battalion level, by 4.2-inch mortars; at the brigade level, by the direct support artillery battalion; and at division and corps levels, by the division artillery and corps artillery.

FIRE SUPPORT COORDINATION AND INTEGRATION

Firepower, to be truly effective, must be properly coordinated, for this is a basic requirement of ground combat operations. Not only must the capabilities of the various fire support means available be coordinated for maximum effect and efficiency, but also the total fire support effort itself must be coordinated with and integrated into the scheme of maneuver. Over the years, during and since World War II, a rather extensive body of fire support coordination doctrine has been developed and crystallized by the pressures of experience, and a rather formal organization has been evolved to carry out this doctrine. The principles governing the coordination of fire support are simple and logical. They are:

- Employ all fire support available in accordance with its capabilities and limitations.

- Primary consideration is given to furnishing the type of fire support requested, on the premise that the originator of the request is the most competent judge of what it takes to deal with the target. Though this cannot always be done, it does serve as a starting point to determine exactly what type of fires to place on a given target.

- Fire missions are assigned to, or requested of, the agency that can deliver the most effective fire within the required time.

- Rapid coordination is essential in attacking targets in order that the fire may not be delayed.

- Fire support is accomplished at the **lowest** level having the necessary means available.

- Measures are provided to safeguard friendly troops and installations from our own fires. This is one of the important basic functions of fire support coordination.

- A common system of target designation is required—one target on one piece of real estate should have a single target designation, known to all echelons concerned with its attack.

- Avoid unnecessary duplication. Don't waste fire support resources by having two means attack a target, resulting in over-kill, when one can do the task effectively.

As the pace and complexity of combat and combat support operations increased, and the range, variety and responsiveness of fire support means became greater, the need for a rather formal organization to control and coordinate such activities at corps and division levels became apparent; thus the Tactical Operations Center (TOC) was invented. The function of the TOC is to provide an integrated central facility within the force command post wherein representatives of the general and special staffs are grouped together to assist the commander in the tactical control of current operations. Briefly, the Tactical Operations Center contains:

- **G2 Element:** Provides the focal point for intelligence pertaining to the current situation. It originates intelligence missions and prepares the intelligence annexes, estimates and summaries for use in current operations.

- **G3 Element:** Coordinates and prepares operation orders, directives and frag orders pertaining to current tactical operations.

- **Chemical, Biological and Radiological Element (CBRE):** Coordinates chemical and biological activities with other operations, predicts fallout from the employment of both friendly and enemy nuclear weapons, evaluates CBR contamination data, and prepares the chemical fire plan if one is required.

- **Engineer Element (ENGRE):** Provides a central facility through which requests for engineer combat support are processed and coordinates engineer effort in current operations.

- **Communications-Electronics Element (CEE):** Coordinates the use of the electromagnetic spectrum, coordinates electronic warfare with other combat support operations, and integrates Army Security Agency support in electronic warfare operations.

- **Air Defense Element (ADE):** Coordinates Army air defense operations with current operations.
- **Army Aviation Element (AAE):** Coordinates Army aviation operations and serves as a central facility through which requests for aviation support are processed.
- **Tactical Air Support Element (TASE):** Serves as a central facility through which requests for tactical air support are processed. The G2 Air Group advises the elements of the TOC on the capabilities and employment of air reconnaissance and insures that air reconnaissance support is integrated with current tactical operations. The G3 Air Group advises on the capabilities and employment of close air support.
- **Fire Support Coordination Element (FSCE):** Coordinates all available supporting fires on surface targets and coordinates the fire support effort with other operations.

These last two elements—the TASE and the FSCE—are of primary interest because it is by and between these two, or their equivalents at the lower echelons, that the bulk of the fire support available to the command is coordinated and processed. At each level of command from company to corps, a fire support coordinator (FSCOORD) normally is designated. This fire support coordinator, usually the command artillery officer, operates under the general staff supervision of the G3 (S3). He performs the following functions:

- Advises the commander and staff on all fire support matters concerning the delivery of fires on surface targets.
- Coordinates all supporting fires on surface targets.
- Studies and evaluates enemy fire support capabilities.
- Coordinates fire support deception operations.
- Prepares the fire support plan annex to operation plans and orders and coordinates and integrates the air, artillery, nuclear, chemical and other fire plan appendixes to the fire support plan annex.
- Recommends the allocation of nuclear weapons and other special ammunition and the special ammunition loads for units, supply points and depots, as appropriate.
- Provides for target analysis and damage assessment of nuclear fires employed on surface targets by own forces.

The fire support coordination structure (fig 1) begins at company level where the coordination of fire support is fairly simple. At this level the company commander is his own fire support coordinator, assisted by his weapons platoon leader and the artillery forward observer assigned to support his company. If Naval gunfire support is provided, a spotting team from the Marine Corps Air and Naval Gunfire Liaison Company (ANGLICO) also will be available. At the higher echelons, the volume, variety and formality of fire support coordination activities increase and more individuals become involved in their execution. At maneuver battalion and brigade, the Fire Support Coordination Center (FSCC) is the focal facility for the coordination of fire support, and the artillery liaison officer or the commander of the direct support artillery battalion usually

ECHELON	ORGANIC	ARTILLERY	AIR FORCE
COMPANY	CO CMDR* WPNS PLAT LDR	ARTY FO	
BATTALION	S3 AIR HUY MORT LO	FSCC ARTY LO*	TACP (ALO FAC)
BRIGADE	S3 AIR	FSCC DS BN CO* ARTY LO	TACP ALO
DIVISION	G 3 AIR G 2 AIR	DTOC FSCE DIV ARTY CO*	TASE TACP ALO
CORPS	G 3 AIR G 2 AIR	CTOC FSCE CORPS ARTY CG*	TASE / DASC

* Fire Support Coordinator

Figure 1. Fire support coordination structure.

is designated the fire support coordinator. At division and corps, the Tactical Air Support Element and the Fire Support Coordination Element within the TOC function "knee-to-knee" to coordinate and employ the variety of powerful fire support available to those levels. The division artillery and corps artillery commanders normally are designated the fire support coordinators; however, the detailed staffwork is performed by a lieutenant colonel or colonel, assistant fire support coordinator, assisted by a small group drawn from the artillery headquarters battery to staff the FSCE.

NUCLEAR FIREPOWER VERSUS TYPICAL AGGRESSOR TARGET ARRAYS

To energize this powerful fire support system, targets must be acquired. It is axiomatic that before we can shoot, we must have a target; before we can plan and coordinate fires, we must have suitable targets to plan fires against. An analysis of a typical target array presented by an aggressor motorized rifle division shows that 80 per cent of the targets presented are within the brigade area of influence, and 20 per cent are beyond the brigade but within the division area of influence.

The current family of nuclear weapons and delivery systems within the division is fully able, at least qualitatively, to deal decisively and economically with these targets. The **quantitative** ability to deal with the targets depends upon two factors—the number of nuclear weapons available and the ability to acquire the targets. In exploring this second factor, the ability to acquire targets, a little further, it is frequently mentioned that Army target acquisition capabilities have failed to keep pace with increases in the range and power of Army weapons. This short-fall seems to be more apparent in regard to the longer-range missiles, Sergeant

and Pershing, and to a lesser degree in regard to the Honest John and 175-mm gun. However, a recent Combat Developments Command study of target acquisition capabilities has shown that, although there is certainly room for improvement (and improvements are being programmed), the Army corps and divisions, with equipment presently in the inventory, have a pretty fair capability against a sophisticated enemy to acquire targets to a depth of approximately 15 kilometers, within which approximately 80 per cent of the targets in the division area of influence are found.

Accepting the fact that we have the equipment to do the job, some concepts and procedures that could be applied to enhance our target acquisition capabilities need to be discussed. The procedures offered are founded on two basic premises. The first of these premises is that a commander requires two categories of intelligence—**target** intelligence to feed his fire support system and **decision-oriented** intelligence to provide the basis for his tactical assessments and decisions. Of the two, target intelligence is the more rigorous requirement; it is more stringent in terms of time, in terms of precision of location and in terms of detail regarding composition and disposition of target elements. The production of target intelligence contributes materially to the requirement for decision-oriented intelligence. However, the production of decision-oriented intelligence rarely, and then only coincidentally, satisfies the requirements for battlefield targeting.

The second premise is that target acquisition is not an end in itself. It is an integral and essential part of the field artillery fire support system, the other elements of which are weapons, ammunition, command and control, survey, meteorology, communications and logistics. The degree to which the artillery fire support system contributes its full combat potential to the accomplishment of the commander's mission depends upon the success with which the elements of this system are integrated and coordinated. Unity of effort and singleness of purpose, made possible by common training and central direction, are essential. The target acquisition function, as presently practiced, falls somewhat short of the ideal in this field. Target acquisition agencies external to the field artillery have not satisfactorily been integrated, in terms of direction and responsiveness, into the fire support system. This failure is largely doctrinal and procedural. No clear doctrine has been enunciated upon which to build the organization, techniques and procedures needed to optimize the employment of **all** target acquisition agencies as integral parts of the fire support system.

Presented below is an outline of a doctrine designed to improve the effectiveness of the overall target acquisition effort. The doctrine is founded upon these three concepts:

Concept Number One. Target intelligence, being the more stringent and inclusive of the two categories of combat intelligence, should be the end goal of all information gathering and intelligence processing. It should be centrally directed at each command echelon for unity of effort and singleness of purpose.

Concept Number Two. Target acquisition, being an essential element of the fire support system, should be fully integrated into that system. The planning and focus of the totality of target acquisition effort, the tasking of target acquisition means, the processing of information into target intelligence, and the application of firepower to the targets acquired should be unified into a single, integrated activity at brigade, at division and at corps levels.

Concept Number Three. The fire support coordinator, acting for the force commander, is the logical individual to be vested with the responsibility for this unification. He is the logical individual because by training and professional interest he is target-oriented; because being a "consumer" of targets, he is vitally concerned with their timely and efficient production; and because if he is also the artillery commander, as is usually the case, he already controls all the other elements of the artillery fire support system since they are organic to the artillery.

To execute these concepts, an integrated target intelligence center (TIC) could be established using essentially the personnel and physical resources presently available (fig 2). The current Military Intelligence Detachment is the nucleus, providing a physical facility and the trained AIS personnel required. To this nucleus is added the G2 air group, artillery intelligence representatives from the fire support coordination element, and the necessary clerks and communicators to support the activity.

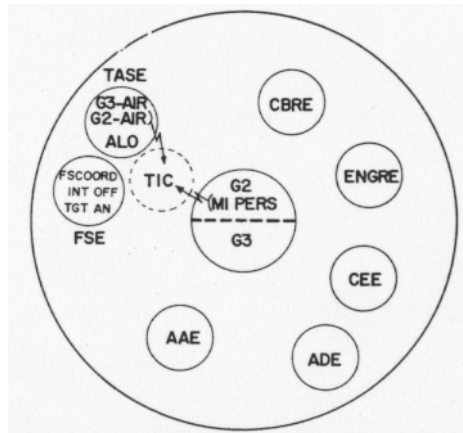

Figure 2. The target intelligence center (TIC).

The target intelligence center would function under the general staff supervision of the G2, with the fire support coordinator providing the daily operational guidance and direction needed for integration of its target acquisition activities into the total fire support operation. The facility would perform the following tasks:

- Prepare, based upon the commander's guidance and priorities, an integrated plan for the employment of available target acquisition agencies.

- Task appropriate target acquisition agencies (aerial surveillance and target acquisition platoon, Air Force tactical reconnaissance, field artillery target acquisition battalion, supporting Army Security Agency, etc.) on a mission basis in execution of the plan.

- Collect, collate, evaluate and synthesize into targets, information from all available sources and agencies that pertain to the area of influence of the command.

It is recognized that this facility also can, and should, contribute materially to producing the decision-oriented "headline intelligence" needed by the G2 and the commander for overall tactical operations. However, it must be stressed that the operations of the activity must be **target** oriented, and that the production of **target** intelligence, because of its perishable nature and stringent requirements for precise location and internal detail of disposition and composition, must be the goal it constantly pursues.

As many readers may recognize, this is not a new nor an original idea. It has been used in some form for several years in 7th Army in Europe, and no doubt exists in some other commands in varying degrees of formality and effectiveness. It does, however, represent a specific, concrete, attainable step that can be taken by field commanders to alleviate present weaknesses in the production of viable targets for attack by the nuclear weapons systems now available within our corps, divisions and brigades. Within the past two years, three major studies and one worldwide conference on target acquisition have been produced by special boards and agencies of Combat Developments Command, analyzing the situation, isolating the problems and recommending what should be done. The results of these studies will begin to appear in the 1966-1970 time frame. In the meantime, if improvement is to be achieved, it must be sought through more efficient use of the target acquisition capabilities currently available.

OPERATIONAL FACTORS AFFECTING THE APPLICATION OF ARMY NUCLEAR FIREPOWER

Turning now to the operational factors affecting the application of Army nuclear firepower, several areas will be considered. These are: Formulation of commander's guidance for nuclear weapons employment; allocations and special ammunition loads; operational ramifications of preinitiation, induced radiation and fallout; and integration of maneuver and fires.

The magnitude and nature of nuclear weapons effects have a profound influence on ground operations. Therefore, proper command guidance to the staff at the start of its planning is vital. Damage criteria and troop safety considerations are normally matters of SOP, and command guidance in these respects is appropriate only when departure from the SOP is desired. As a minimum, the commander's guidance should include:

- The type targets to be attacked.
- What nuclear weapons are supposed to achieve in conjunction with the overall plan; for example, achieve nuclear fire superiority, cause

the initial rupture of the enemy defenses, seal off a critical pass or defile, destroy bridges, neutralize enemy reserves, etc.

- Allocation policy and desired nuclear reserve to be retained for the attack of targets of opportunity.
- Restrictions or restraints which may be imposed by the current tactical situation and/or higher headquarters.

The tactical management of nuclear weapons is carried out through allocation of weapons and prescription of special ammunition loads (SAL). These two terms have specific, precise meanings in Army terminology. A knowledge of precisely what these terms mean, and what they do **not** mean, is essential to the proper appreciation of Army tactical management of nuclear weapons. Given adequate numbers of weapons, they should, in accordance with Army doctrine, be **allocated** to those commanders that require them and can effectively employ them. Each commander receiving an allocation should consider employing a portion to attack targets in furtherance of his tactical plan, suballocating a portion to subordinate commanders for support of their tactical plans, and retaining a suitable weapons reserve for employment as the action progresses. SALs should, if the delivery units are present, equal or exceed the allocation in order to provide the commander the physical wherewithal to execute his employment decisions.

In considering the distribution of nuclear fires within the battle area, the commander and his staff are concerned with preinitiation, induced radiation, and fallout because of the influence these effects have upon the scheme of maneuver.

- **Preinitiation.** In order to achieve surprise, it may be desirable to fire all weapons at the same time or as close together as possible. However, the radiation from one round may cause another to be detonated prematurely, which may result in reduced or undesirable effects. Thus, preinitiation as a factor may influence the selection of certain weapons and also may require adjustment of the plan of maneuver. Procedures for minimizing the possibility of preinitiation through separation of nuclear bursts in time and space are contained in FM 101-31-2 and must be incorporated into the planning and scheduling of nuclear fires. An additional, and unpredictable, preinitiation hazard is introduced when an enemy nuclear weapon is detonated in the vicinity of a nuclear delivery unit. The resultant increase in the surrounding radiation level may cause a nuclear fizzle or a dud round from that unit, if it fires a nuclear weapon before the non-sustaining chain reaction induced within the fissile material of the warhead expires.

- **Induced Radiation.** Whenever a nuclear attack is planned, the nuclear weapons employment officer estimates the area and intensity of induced contamination and informs the commander and the staff of the induced hazard. It is extremely hazardous for troops to enter and stay in an area of induced contamination. However, because of the great destruction near ground zero, which is where the induced contamination is found, there is seldom a requirement for troops to enter the area. Because this radiation decays rapidly, troops in tanks and armored personnel

carriers may pass through ground zero within 30 minutes after burst without undue risk, if they do not stop or dismount. In contrast to fallout, induced contamination is relatively limited in area; therefore, minor adjustments in the tactical plan can normally avoid any serious effects.

- **Fallout.** In comparison with induced radiation, the large areas contaminated by fallout pose an operational problem of considerable importance. Although the height-of-burst calculations performed by the nuclear weapons employment officer are designed to provide 99 per cent assurance of no significant fallout, the statistical probability of obtaining an inadvertent surface or near-surface burst must always be kept in mind. Command decisions in a fallout situation must weigh two opposing factors—the demands of the tactical situation and the hazards due to radiation. The location and extent of resultant militarily-significant fallout must be predicted, and total dose versus stay-time calculations must be performed to assist the commander in arriving at a decision as to whether, in the event of an inadvertent surface burst, to change his plan of maneuver, continue as planned and accept the risk of increased casualties, or to delay his movement until the pattern has decayed to an acceptable level. These data are, of course, prepared by the CBR element of the Tactical Operations Center and presented to the commander as part of the fire support coordinator's recommendation concerning attack of the target. While we are on the subject of fallout, we must not overlook the fact that the commander may elect to use **intentional** surface bursts whenever such employment contributes to the accomplishment of the mission in a manner better than air burst effects. However, because of the large areas covered by fallout patterns, the deliberate use of surface bursts may be closely controlled by higher authority.

It is axiomatic that to achieve decisive results, the effects of tactical nuclear fires must be exploited by maneuver. This integration of maneuver and fires must be as detailed and specific as time and the situation permit. Too often it has been assumed that this integration is automatically provided for by the issuance of an operation order and a nuclear fire plan. However, really effective integration occurs only when a concerted effort is made between the G3 and the fire support coordinator, during the conception and planning of an operation, to weld maneuver and fires together into a single, cohesive entity. To do this effectively it requires that:

- The commander's guidance be clear and explicit as to what each of these components of combat power is expected to accomplish.
- Allocations and SALs be established that provide nuclear weapons of appropriate yields to the combat echelon able to control, employ and exploit them to the best advantage.
- The risks and limitations to maneuver imposed by unwanted obstacles, induced radiation and inadvertent fallout be evaluated, and their adverse effects provided against in coordinating instructions and control measures disseminated to the troops **before** the maneuver forces launch their exploitation.

OPTIMUM PROCEDURES FOR EMPLOYMENT OF VERY SMALL YIELD NUCLEAR WEOPANS

As with any firepower means, the employment of very small yield (2 KT and below) nuclear weapons is optimized by giving these weapons to the commander who habitually requires them and can effectively employ them in the accomplishment of his mission. In judging at what level this capability lies, one must consider: The ability to acquire suitable targets; the relationship of the acquired targets to the mission of the force (target capability); the relationship of weapon R_d to target size; ready availability of the delivery systems associated with the nuclear weapons under consideration; and system response times, speed of friendly maneuver, and duration of opposing targets.

These factors will be considered as they apply at the brigade level; thereby demonstrating the capability of the brigade to coordinate and employ these very small yield weapons. It has already been stated that the brigade and its direct support artillery have the ability to acquire suitable targets within the brigade area of influence. The damage (coverage) of the Davy Crockett, 155-mm, 8-inch, and small Honest John and Little John weapons effectively match the target sizes. It would appear that these weapons, in a nuclear war, would be habitually needed for employment in furtherance of the brigade mission. Of the four delivery systems involved, the Davy Crockett is, of course, within the brigade. The other three are in the division artillery and can readily be made responsive to brigade fire delivery requirements through the use of appropriate artillery tactical missions and fire request channels.

It should be clear that, in any fluid operation, time is of the essence in the target acquisition—mission processing—weapon delivery cycle. The nature of opposing targets and the range and speed of the acquisition and delivery means call for decentralized firing authority and streamlined processing procedures. This factor will be considered in the light of: Allocations and SALs; analysis, processing and coordination procedures; warning procedures; and post-strike reconnaissance and analysis requirements.

Given adequate numbers, very small yield nuclear weapons should be allocated to brigade level, at least to the brigade making the main effort in the attack or garrisoning the most vulnerable area in the defense. In mechanized and armored divisions, the SAL of the supporting direct support artillery battalion should contain at least the number of 155-mm nuclear weapons allocated the brigade, in order to permit delivery by that unit in response to brigade fire requests. In the infantry division, the 155-mm batteries of the general support cannon battalion should be positioned to reinforce the respective direct support battalions by responding to nuclear fire requests originating at the brigade and relayed through the direct support battalion FDC. This can be done by attaching a 155-mm battery to each committed direct support battalion, or by modifying the general support battalion's tactical mission to make that unit responsive to calls for nuclear fires coming directly from the direct support battalions. Similar arrangements would be suitable for the 8-inch howitzer and for the Honest John.

Due to the essence of time and absence of specifics on the composition and precise internal disposition of most targets, target analysis would probably be done using either the coverage index or the visual method, with proper attention to troop safety and a quick determination of the side effects of induced radiation, tree blowdown and fallout (in the event of an inadvertent surface burst) as they may affect maneuver. This analysis would be performed in the brigade FSCC by the artillery liaison officer, who has a Prefix 5. Upon decision by the brigade commander to fire, the mission would be processed through artillery fire control channels (fig 3) to the delivery unit capable of responding. Notification of intent to fire would be transmitted to the division tactical operations center using either operational (G3) or fire support coordination communications channels, and to adjacent brigades through lateral communication or by relay from the division TOC.

Warning messages, in addition to the above, must be transmitted to subordinate units. USAF and Army aviation agencies must be warned to enable friendly aircraft to avoid the over-pressures and risk of flash blindness (dazzle) resulting from the burst. These warnings can be transmitted directly from the brigade command post to the Air Force direct air support center (DASC) and to Army flight operations center (FOC) or flight control center for rebroadcast to airborne aircraft. Troop warning is accomplished through command channels, backed up by the division warning net. The complete notification and warning process is shown in figure 4. It is recognized that this procedure does not guarantee that every individual within sight of the burst will get the word. However, it does provide for those elements that would be directly affected, including aircraft in the area, to receive warning in time to react.

Because these very small yield nuclear weapons are not in themselves decisive, exploiting maneuver is an essential adjunct to their employment. Post-strike reconnaissance and damage assessment, **before the maneuver units are committed**, is essential in order to provide the commander information that is vital to his operation. Briefly, the brigade commander must know the location of actual ground zero, the

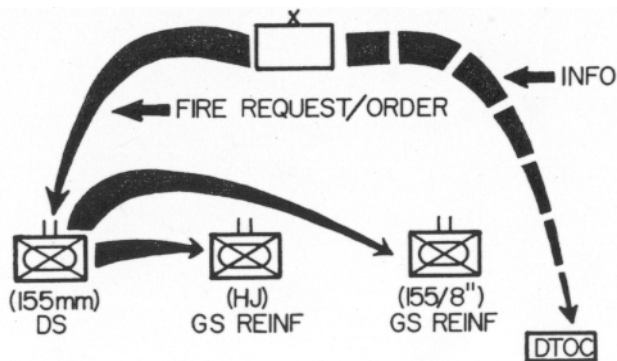

Figure 3. Fire request channels.

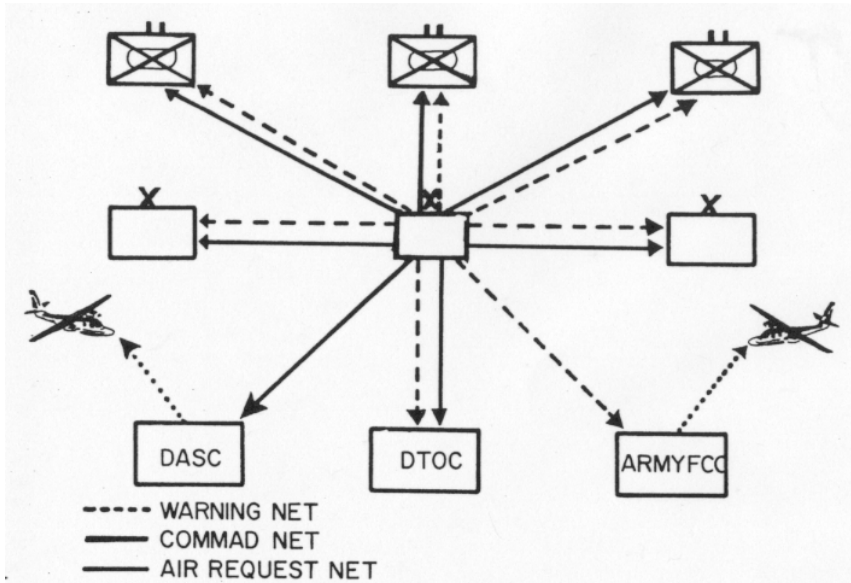

Figure 4. Warning channels.

height-of-burst (air to surface), the order of yield (normal or low-order burst), and whether obstacles were created. This information, which is obtainable by brigade and supporting artillery observation and surveillance means, will enable the commander to launch his exploitation as planned or, if needed, to modify his maneuver plans to accommodate the changed situation. The laying on of the post-strike reconnaissance would be the responsibility of the brigade FSCC.

ARMY EMPLOYMENT REQUIREMENTS FOR AIR-DELIVERED NUCLEAR WEAPONS

In addition to surface fire support, the Army has a definite need for USAF-delivered nuclear weapons to support the ground commander's operations. There are three bases for this requirement:

- **Extensional.** To attack targets within the ground commander's area of interest that cannot be effectively attacked by Army delivery systems. An example would be a deep target requiring accurate placement of a small yield weapon.
- **Supplemental.** To provide quantitative augmentation of Army-delivered nuclear firepower. This need would arise in situations wherein the divisions and corps were confronted with many remunerative nuclear targets but had only relatively small numbers of ground-delivered nuclear weapons available.
- **Substitutional.** To fill in for absent Army weapons systems. For example, the absence of the Sergeant missile system on Joint Exercise DESERT STRIKE created the need for air-delivered nuclear weapons in order to strike targets beyond the reach of the Honest John.

Experience in major joint exercises has shown that for air-delivered nuclear weapons to be of maximum benefit to the ground component, joint doctrine and procedures governing their employment in support of the Army component should provide:

- Assurance that they will be available when needed. This assurance can be provided by the JTF commander suballocating to the Army component commander a suitable portion of the air-delivered nuclear weapons allocated to the JTF.
- Responsiveness to Army requests for employment. This requires good communication between the Army component and Air Force component command posts, agreed format and procedures for transmitting the requests, and a TOT reaction time, hopefully at least, equal to that achieved with conventional ordnance.

TACTICAL EMPLOYMENT OF ARTILLERY UNITS IN NUCLEAR COMBAT

Since the bulk of the nuclear fire support of the division and corps is provided by artillery, a brief discussion of the deployment of artillery units in the nuclear environment is appropriate. In a general war, particularly during Phase I, nuclear firepower can be expected to exert a predominant influence. Because of the massive destructive power of nuclear weapons, maneuver of large forces during this phase probably would not be feasible. However, ground combat elements must still be deployed to maintain the integrity of the battle area. Therefore, the artillery, while participating in the struggle to gain nuclear fire superiority, must still be able to accomplish its traditional mission of providing support to the maneuver forces, even though the greater dispersion of units required as a passive measure against nuclear attack would result in increased zonal frontages and depths.

With these considerations in mind, let us look at a concept of artillery employment at the division level—a mechanized division in the defense (fig 5). The first thing to be noted is the width and depth of the division zone—50 km wide by 20 km deep. Note also the disposition of the maneuver battalions, with substantial elements deployed in depth. It would seem at first glance that this deployment would be difficult for the division artillery to support adequately. However, the current family of weapons can, with the deployment shown, provide the required support over these frontages with only slight modifications to present standard methods of employment. The most significant departure from nonnuclear deployment is illustrated by the positioning of the artillery supporting the 3d Brigade so deep as to be nearly out of range of the forward edge of the battle area. This is done to provide depth and continuity to the artillery deployment, to avoid undue concentration of artillery units in the forward brigade areas, and to provide artillery support of the rearward units in the event of sudden enemy penetration or massive infiltration.

In addition to dispersion **between** artillery battalions, dispersion **within** battalions can also be utilized to increase survivability in a nuclear environment. Figure 6 depicts the degree of dispersion that can be performed

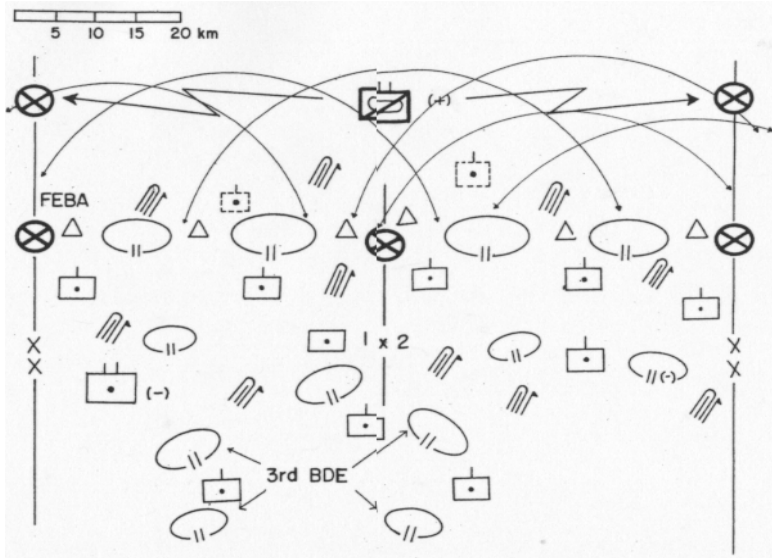

Figure 5. Schematic of mechanized division in the defense.

within the M109 155-mm howitzer direct support battalion without sacrificing fire support capabilities. This is made possible by the advent of extended range ammunition and by the improved gunnery capabilities offered by FADAC, faster survey, and improved communications systems. The diagram shows a concept of deployment of a field artillery battalion in direct support of a brigade in a defensive posture under the threat of nuclear war. Because of this threat, the brigade is dispersed over a relatively large area, approximately 20 km wide by 12 km deep. To enhance security and increase survivability, the batteries of the direct support battalion are deployed as shown. As can be seen, this can be done and still retain an excellent capability to mass the fires of the battalion when and where necessary. Because of the 6,400-mil traverse of the M109, fires of the battalion can be massed on targets to the flanks and rear as readily as on targets to the front.

CONCLUSION

Throughout this article, it has been shown that many selected concepts and techniques are involved in nuclear fire support operations. To reiterate, the following points stand out:

- Army target acquisition means and nuclear weapons systems are inherently adequate to detect, locate and destroy key enemy targets within the brigade and division zones of influence.
- The proliferation of target acquisition agencies outside the artillery fire support system calls for added attention and effort to unifying the efforts of these agencies to improve target acquisition coverage and the production of target intelligence.

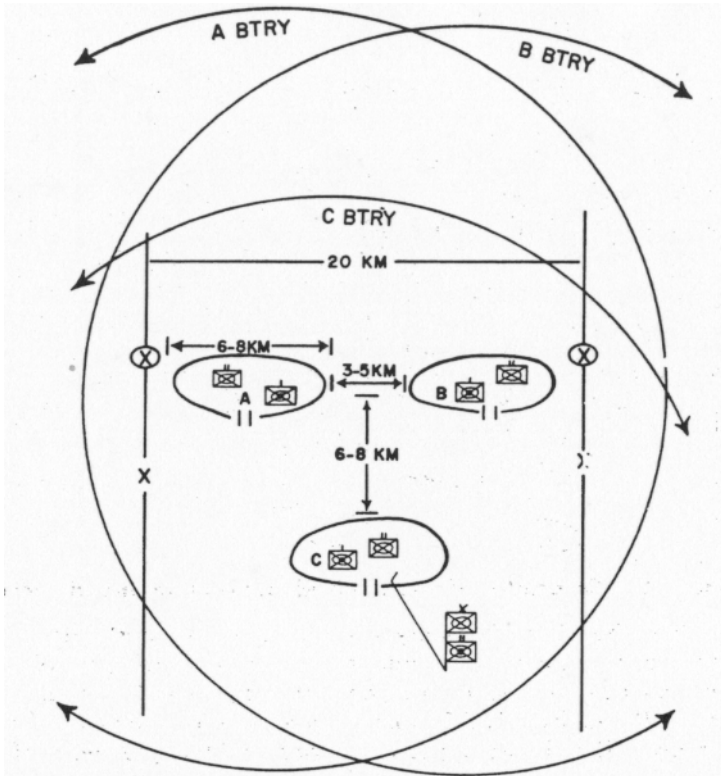

Figure 6. Schematic depicting intrabattalion dispersion capability.

- Awareness of the interaction of fires and maneuver must be ever foremost in the minds of the commander, his G3 and his fire support coordinator. The need for close coordination and detailed integration of these two forms of combat power must never be slighted by the nuclear tactician.
- Very small yield nuclear weapons can be effectively coordinated, employed and exploited by the brigade and should be allocated habitually in a nuclear operation.
- The Army has a definite need for air-delivered nuclear weapons. To be of maximum value to the ground commander, these weapons should be allocated to him, and procedures governing their request and delivery should match the time parameters of the mobile, shifting target array against which the Army force is pitted.
- The extended range of the present family of artillery weapons together with improved gunnery capabilities makes it possible to provide the required support over the extended frontages envisioned in a nuclear war with only minor modifications to present standard methods of employment.

Whether the needed fire support consists of a couple of volleys of 105s or a nuclear catastrophe, the Army's fire support system—the Artillery—can provide it. The effective and efficient employment of this powerful combat resource on tomorrow's battlefield will continue to engage the professional skill and judgment of the artilleryman, the general staff officer and the combined arms commander alike.

NUCLEAR EMPLOYMENT CLASSES

Your unit instruction concerning nuclear weapon employment can be supplemented with three USAAMS classes—Command and Staff Responsibilities on the Employment of Nuclear Weapons (T5260); Operations in Residual Radiation Areas (T5232); and Initial Effects (T5220). The necessary instructional material for these classes may be obtained by writing to: Commandant, U.S. Army Artillery and Missile School, ATTN: AKPSINI/RC, Fort Sill, Oklahoma 73504.

FSC CLASS

To provide a general knowledge of the FSCC and TOC, the USAAMS offers a 2-hour class on Fire Support Coordination, FSCC and TOC (T3200).

FIELD MANUAL INFORMATION

The revised FM 6-161, Radar Set AN/MPQ-4A, dated 17 February 1965, has recently been distributed. The most significant change in the manual is a new procedure for radar gunnery. This revised manual will be the reference for some of the questions on the MOS Evaluation Test for MOS 156.0, scheduled for November 1965. Therefore, any unit with personnel in MOS 156.0 should obtain this manual through normal publication supply channels.

FM 6-39, Field Artillery Battalion Pershing, classified SECRET, was published in January 1965. Addendum Chapter 10, currently in draft form, will be revised and published for inclusion into this manual as soon as all necessary data is available.

SHOOT WITHOUT SHELL

14.5-mm artillery trainer mount

*Captain James E. Fox
2d Battalion, 83d Artillery*

The 2d Battalion, 83d Artillery has designed a mount to convert the 14.5-mm artillery trainer to a subcaliber device for the 8-inch howitzer. Use of this mount increases the training value of the 14.5-mm artillery trainer by including the howitzer crews in the firing of the 14.5-mm trainer. The mount places the trainer on the saddle above the trunnions, slaving the trainer to the 8-inch tube (fig 1). This permits the use of the 8-inch fire control instruments to lay the trainer for deflection and quadrant, which, in turn, serves as a means of improving the speed and proficiency of 8-inch crew drill. A mount has been tested by this battalion on several occasions and has proved successful each time. In addition to integrating the howitzer crews with the firing, the mount provides for more stability than the tripod.

The mount is installed by retracting the tube and removing the bolts which secure the gun removing eye to the saddle. The bolts are then used to bolt the mount to the saddle. **Caution: Block the tube in the retracted position to insure that the tube does not return to battery, crushing the hands of personnel working under the saddle.**

After the mount has been bolted in place, the base of the trainer is secured to the mount with the screw from the tripod mount, using a short section of 3/4-inch pipe as a spacer. The trainer and howitzer are then boresighted together, to bring their axes of fire parallel to one another, by one of the following methods:

Aiming Circle and Gunners' Quadrant Method.

1. Boresight the howitzer, using the normal distant aiming point or test target method.
2. Boresight the trainer, using the distant aiming point method.
3. Level the howitzer tube, using the gunners' quadrant.
4. Using the gunners' quadrant with the same setting as in 3 above, level the trainer by placing the quadrant on the flat surface on the top of the trainer barrel.
5. Have the gunner give a referred reading to the aiming circle.
6. Set this referred reading on the aiming circle, using the upper motion.
7. With the lower motion, swing back to the howitzer sight. This will put the 0-3200 line of the aiming circle parallel to the howitzer tube.
8. Using the aiming circle, lay the 14.5-mm trainer. This will bring the trainer barrel parallel to the howitzer tube.

Distant Aiming Point Method.

1. Level the howitzer and trainer tubes in the same manner as that described in steps 3 and 4 above.
2. Install the boresighting crosshairs on the howitzer tube.
3. Remove the firing pin from the 14.5-mm trainer.
4. Open the firing lock of the howitzer.
5. Aline the howitzer and trainer tubes on a distant aiming point by looking through the firing lock and bolt.

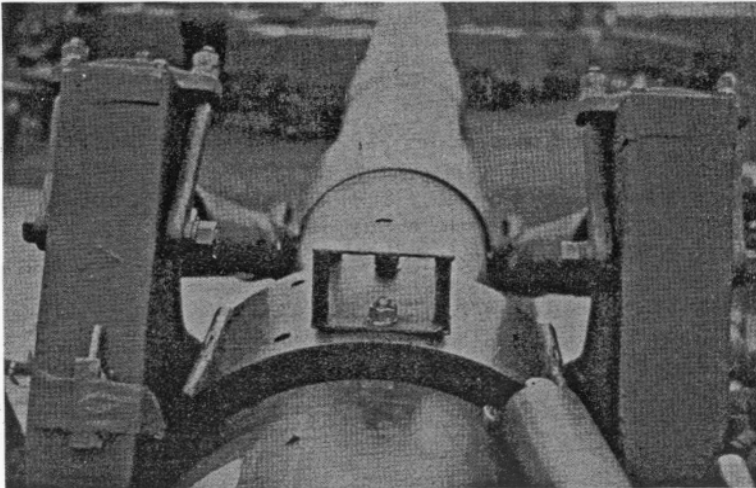
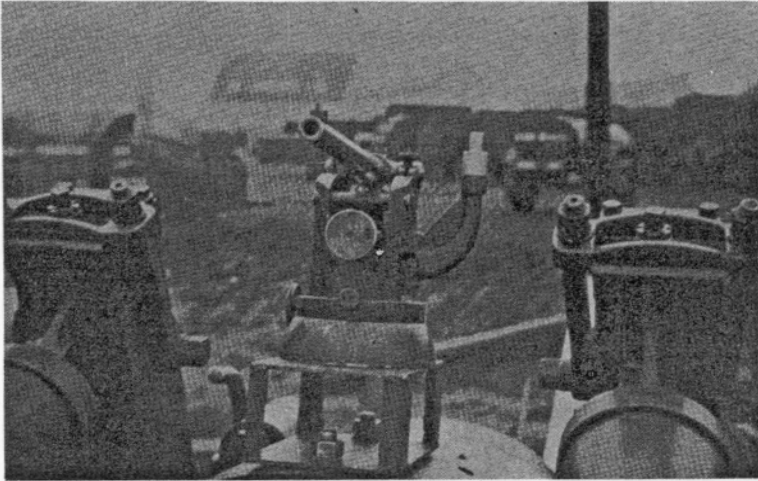

Figure 1. The 14.5-mm artillery trainer mounted on an 8-inch howitzer tube.

6. Aline the howitzer sight on the same distant aiming point. The mount shown in figure 2 was manufactured from salvage material. The dimensions and the materials required are as follows:

Dimensions

Length—12 inches
 Width—10 inches
 Height—5 inches

Materials Required

Two 1/4-inch steel plates, 10 by 12 inches
 Four 2-inch angle irons, 5 inches long
 One 1/16-inch metal strip (copper, brass, aluminum), 10 by 12 inches
 One 3/4-inch pipe, 2 1/4-inches long

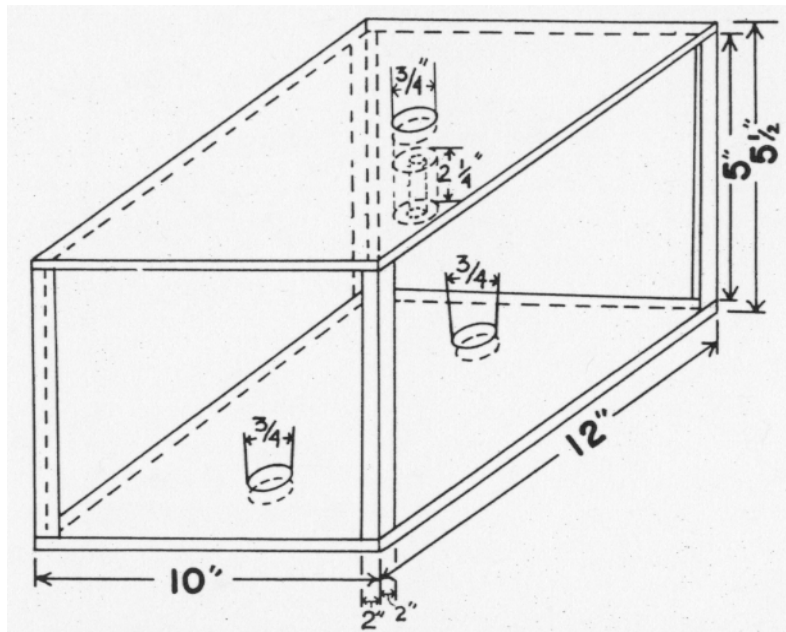

Figure 2. Diagram of dimensions for 14.5-mm artillery trainer mount. The bottom holes are 8 inches apart, center to center. The top of the mount should be covered with a thin sheet of brass, copper or aluminum to protect the brass base of the trainer.

CV-7A STOL AIRCRAFT

The Army has accepted the first CV-7A transport airplanes from DeHavilland Ltd. and will begin extensive service, engineering and climatic tests in the next year. The Army will receive four of the aircraft for testing purposes. The CV-7A (Buffalo) is a STOL—short take-off and landing—airplane developed from the CV-2B (Caribou). The aircraft weighs 38,000 pounds, has a speed of 232 knots and can land in less than 1,000 feet over a 50-foot barrier while carrying nearly 4 tons of payload.



More About Air Assault Artillery

MM-I for FDC

*Major Dan A. Hillsman and
Captain B. L. Jervell
Division Artillery Headquarters*

A question that is as basic as war itself—"can our fires hit the enemy's targets"—can be answered by the most elementary of tools—the prick of a pin. On this premise, and upon the peculiarities of FDC operations in the air assault division artillery, the MM-I, a firing capabilities computer, was evolved. MM-I is a term designated by the air assault division artillery.

The main function of the division artillery fire direction center in the 11th Air Assault Division is similar to that of any other division artillery—that of coordinating and controlling the fires of the division. In the performance of that function, much is repetitive in nature; hence, programmable to automatic solution.

In the process of coordinating and controlling fires, several basic items of information must be continuously available: the positioning of

firing units, the range and capabilities of those units, the locations of targets, the general tactical situation, the scheme of maneuver, and applicable control measures.

In arriving at a determination of what unit could fire on a particular target, the various steps a fire direction officer (FDO) might go through in collating that information into a decision would run something like this: the target is located, the firing batteries are located, distances from the batteries to the target are noted or measured, and firing capabilities of the various type units are considered and compared with the ranges. From this, a determination is made as to which units can fire. Subsequently, it is further determined which units will fire. For each separate target, the process is the same. However, many mental shortcuts may be taken in the process.

This is the purpose MM-I was designed to fulfill. It was to serve as a shortcut and, in its most ideal configuration, was to be such that all information would be presented to the FDO in one step—that of locating the target.

In coordinating and controlling fires, little time is required to analyze the control measures and the tactical situation. The time factor is largely represented in the process of locating and measuring distances between available firing units and the target.

The firing capabilities of weapon systems are constant with regard to maximum and minimum ranges except for meteorological changes. The positions of the units, once established, and the location of a target are not of themselves variable quantities. Hence, if MM-I were programmable such that the range capabilities of the weapon were superimposed upon the battery position, the relative positioning of the target thereto is such that it would or would not be in range of a firing unit. In other words, the basic function of MM-I is to provide a simple "yes" or "no"—yes, a unit can fire or no, a unit cannot fire. A yes/no situation, such as this, is particularly adaptable to an electric circuit, since an electric circuit is either on or off. The indicator used is a light bulb: on, the target is in range and off, the target is out of range. MM-I, therefore, presents a graphical display of desired data (control measures, tactical situation) with automatic electric readout of fire capabilities information.

Electric circuitry (fig 1) performs this function. One terminal of the power source, the ground, is connected to a sheet of conductive material that covers the entire under surface of the map. Disks of conductive material, patterned to scale in the shape of the firing capabilities of the unit, are attached through a light bulb to the other terminal of the power sources. Hence, if contact is made between the two sheets of conductive material (continuity light sheet and ground sheet), the indicator will light. A 12-volt DC power source and a small metal pin are used to complete the circuit. One such circuit is made for each firing unit, each circuit being hooked in parallel.

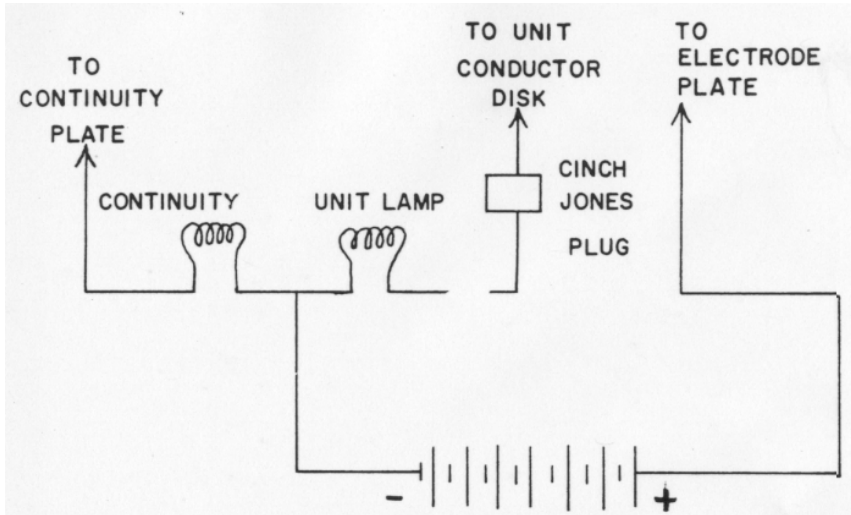

Figure 1. Basic circuitry in MM-I.

Depending on the positioning of the various capability disks when pierced by the pin, one or several or no indicators might appear. Several problems are thereby apparent—if no indicators appear, does it in fact mean that no units can fire? Or, if several lights appear, is the operator certain that all firing units have been considered? And, for any given situation can the operator be certain that there is no malfunction of the power source?

In getting from the topmost capability disk to the bottommost, the pin must pierce all between. The lighting of an indicator, when the bottommost disk is pierced, is a positive indication that all disks were considered and that the power source is functioning properly. Hence, any reading which MM-I presents may be assumed valid.

It has been necessary to incorporate yet another safety circuit into MM-I. If no indicators light, the possibility exists that the light bulb has burned out. Therefore, a circuit was devised to test the light bulbs.

The fabrication of the conductive disks is, singularly, the most auspicious engineering triumph of the project. Aluminum grid sheets were tried in the pilot model of MM-I, but these were quickly rejected because the operator must wield a sledge to penetrate more than two layers.

Aluminum foil insulated by sticky acetate also was tried but was not sufficiently durable. Upon being penetrated by a pin, because of insufficient resilience of the sticky acetate, the foil would protrude from the pin hole shorting the system.

The disks were finally fabricated by sandwiching household aluminum foil between clear acetate and sticky acetate. It was discovered that the clear acetate has sufficient resilience after being penetrated to

return partially to its original position—sufficiently far, in any event, to contain the aluminum foil and prevent shorting.

The electrical circuits, as discussed, give but one half of the desired information. The other half necessary is the graphical display of information—the tactical situation, control measures, boundary lines, etc. Electrical circuits can be made to any desired size. Therefore, in the fabrication of MM-I, the amount and size of the data to be presented and the maximum space available for that presentation determine the ultimate size of the unit.

In any large scale operation and particularly in airmobile operations, the map display of the total situation becomes a problem of acute size. Firing capabilities charts of the areas in which the division operates—even on a scale of 1:100,000—are huge, cumbersome and totally unmanageable when made into a rigid display as in MM-I. For our use, a scale of 1:250,000 is selected, so that the face of MM-I covers an area of 100,000 by 140,000 meters in a space of 18 × 24 inches.

MM-I now has two separate functions—to provide electrical readout of firing capabilities and to indicate the tactical situation. The tactical situation is presented on a battle map and is maintained manually; the electrical portion is undisplayed and is automatic upon MM-I being programmed. Therefore, in the construction of the container, positive correlation of the displayed and undisplayed data was necessary. This was done by keying the battle map grid and the fire capabilities grid together.

In its final configuration (fig 2), the continuity light sheet and the ground sheet are mounted on a cork board and covered by a sheet of plastic grid. On top of this are placed the firing battery capability disks, centered over the battery positions. The tactical display fits over this entire assembly, and when in operating condition, MM-I appears as in figure 3.

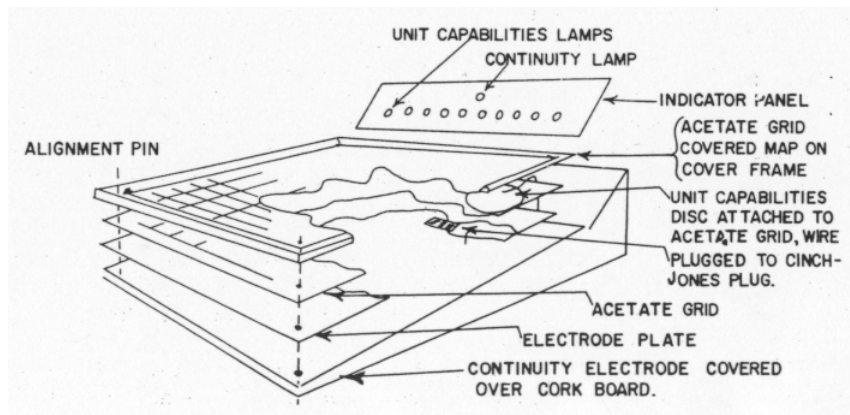

Figure 2. Cutaway of basic elements of MM-I.

Two features of MM-I are worthy of particular mention:

- In airmobile operations, helicopter movement is the method by which division artillery advance elements displace. MM-I is sufficiently light and compact to mount in a UH-1B helicopter for use in an airborne FDC. Since it has an internal power supply, it remains continuously operational without outside appurtenances.

- MM-I is easily programmable. To change firing capabilities, one merely removes the cover and changes the appropriate disks. Less time is required to shift disks upon displacement of a unit than to erase capability lines of a battle map.

MM-I has been purposely subjected to considerable abuse to determine the durability of the electrical circuitry and the capability disks. For example, pins were repeatedly placed through the same hole, and each time the appropriate indicators would appear; additionally, pin holes were gouged out and still continued to function.

MM-I serves our needs far beyond our initial expectations and will continue to serve the division artillery FDC. MM-I is slated to remain in use as the jump FDC facility. Another version, MM-II is currently being built. It contains the same basic circuitry as MM-I but is somewhat more sophisticated and, as a further improvement on our operations, presents a unitized system that will contain all items used in the FDC. It will measure roughly twice the size of a footlocker (fig 3) and will remain with the main CP.

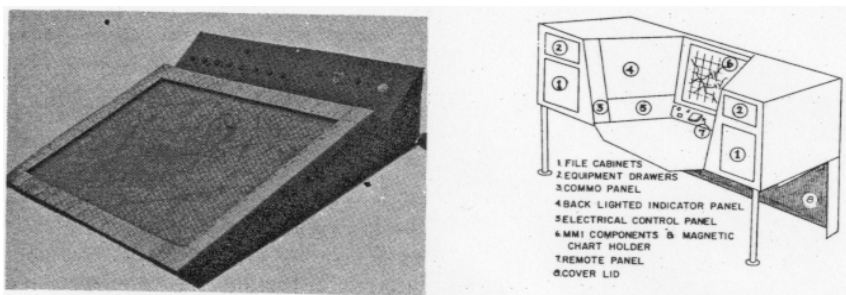

Figure 3. MM-I (left). Diagram of MM-II console (right).

In its brief existence so far, MM-I has attained a certain acclaim all its own. For example, it is one item in Army use today that gives a clearcut "yes" or "no" answer. It is totally incapable of "maybe."

MM-I and its successor MM-II have their unique place in the air assault division artillery. They serve their time-saving function. We feel their use might be of some value to any unit—division artillery or higher—where large scale operations are conducted and where tactical rather than technical FDC control is necessary.

We commend it to your consideration.

Expanded Communications

*Major Floyd B. Lyerla
Division Artillery Headquarters*

The operational concepts and the composition of some organizations within the air assault division artillery are a radical departure from any previously conceived. Never before has the division artillery commander been able to employ varying sizes of tactical elements with such rapidity and, as field testing has proven, selectivity and overall effectiveness. Truly, the "King of Battle" now emerges as a well proportioned, fast moving force capable of overcoming its adversary by initiating any one of several employment-of-fire-methods or modifications thereto. However, the prime essentials involved in any artillery organization have changed only in their method of application and response time. By prime essentials, I refer to moving, locating, shooting and communicating.

The following is quoted from FM 6-10, March 1962: "The ability of artillery to render effective fire support depends on efficient communications. The artillery commander must rely on his communication system in controlling elements of his command, in gathering information and distributing intelligence, and in coordinating the fires of his units." "In the establishment of artillery communication systems, priority of installation is given to elements of the system concerned with fire support and fire direction. During movements and in the initial phase of position occupation, reliance is placed on radio, but wire circuits are installed to parallel radio channels as soon as the situation permits."

The previous quotes are applicable to the air assault division artillery with the exception of the last sentence quoted. Because of the reduced size of individual tactical elements employed, great areas in which operations are involved (width or depth or both) and limitations of equipment within wire sections, paralleling radio channels with wire circuits was not generally accomplished during exercises. The four-channel, radio-wire integration system (radio relay system AN/TRC-122, formerly referred to as AN/MRC-101 which replaced the AN/MRC-69 and AN/MRC-73) was established within the division but did not extend to the brigades. Only division artillery, as an alternate division command post designate, and support command were habitually tied in with division via this radio-wire integration means. Testing has proved there is a requirement for additional AN/TRC-122s so that the brigades also can be tied into the system. Inasmuch as the complete set in an operational configuration, to include personnel, weighs less than 5,500 pounds, the advantages to be gained greatly outweigh the disadvantages. If "Canadian Type" equipment such as the F-1530 are incorporated into the TRC-122, the weight, cube and size can be further reduced. Additional TRC-122s will allow installation of a division system which will normally afford the opportunity to connect artillery units by wire.

During field exercises, it was possible to link the artillery organizations with wire only when in corps reserve (base area). Assuredly, personnel and equipment necessary to provide heretofore normal wire means

in the forward area could be provided from the Army's resources. However this would require additional air transport, which would require additional pilots, which would require additional administrative, maintenance and operational personnel which in turn would require additional equipment. This effect is similar to the magic beanstalk which must be chopped off to stop its growth and is not in keeping with the lean concept of the air assault division in its present structure. Only the separate aviation battery and, infrequently, the Little John battalion are connected with division artillery by wire in the forward area.

Radio is the primary, and usually the only, means of communication. It is imperative that each functioning staff member have access to a radio. Since the number of vehicles in the division artillery are greatly reduced as compared to other divisions, practically every vehicle becomes a radio vehicle (all of these radios can be mounted in 1/4-ton vehicles). In addition, expanded use of portable radios is necessary. In maneuvers, the new family of FM radios (AN/VRC-12 series) has exceeded all expectations. Time and again it was proved that complete and continuous control of fire direction operations was possible within division artillery via radio only. It was learned that the number of antennas AT-791 (RC-292) authorized must be doubled if complete operation (coverage of all division and division artillery FM nets) is to be maintained during periods of displacement.

The AN/MRC-95 was the only ground AM transceiver utilized during maneuvers except for AN/VRC-24s employed in the spot report net. The MRC-95, which has radio-teletype capability, has proved very reliable over heretofore prohibitive distances. However, the absence of a tape cutter and transmitter-distributor has created periodic message backup (saturation) on the AM-single sideband net within division artillery. Assignment of proper precedence to messages requiring RATT transmission is the only, but not completely satisfactory, solution. Occasionally, routine messages were passed as much as 8 to 10 hours subsequent to their origination.

The communication central AN/ASC-5 proved its worth beyond a doubt. Included in the equipment is a lighted map board extending the width of a UH-1 helicopter; three AN/VRC-46 radios; one AN/VRC-24; and provision for mounting a single sideband transceiver T-618, currently a component of the AN/MRC-95. With this equipment the commander is able to remain abreast of the situation as it develops and implement timely command and control directives. Through manipulation of switching and keying devices, one to four frequencies (nets) can be monitored, or one frequency can be used for transmissions from any one of six stations provided.

The portable radio set AN/PRC-25 can be used to monitor critical nets when the helicopter is not airborne. The antenna systems provided with the ASC-5 are used in conjunction with PRC-25s.

Headquarters and Headquarters Battery, Division Artillery began the field exercises using two full-time FM nets—fire direction (F) and command/fire

direction (CF)—and one "as required" FM net (survey). It readily became apparent that these nets were insufficient because of the volume of command, control, fire direction, fire planning, intelligence and administrative traffic. To eliminate communication failures encountered, the following nets were established: command (C), fire direction (F), operations/fire direction (O/F) and survey (S). Breakdowns in FM communications were few and short-lived subsequent to reorganizing the nets. It is anticipated that the FM frequency for a survey net can be eliminated upon receipt of appropriate AM sets throughout the division artillery.

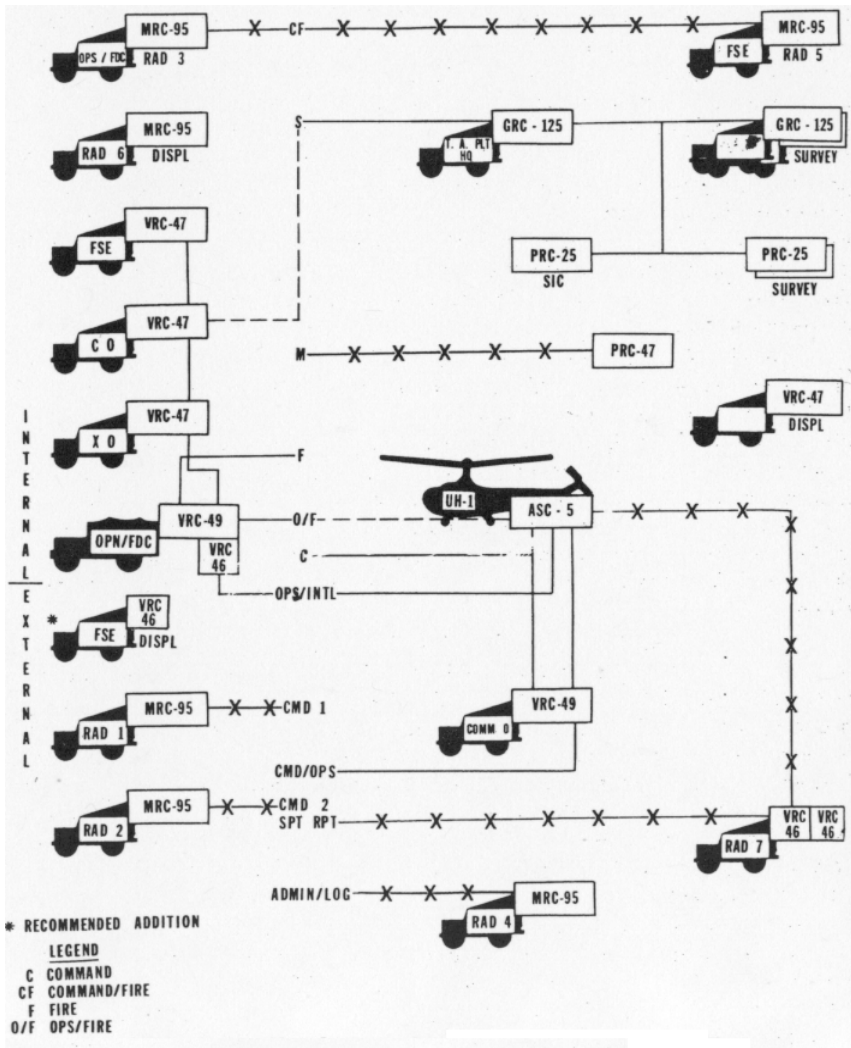

Figure 4. Headquarters and headquarters battery.

As with communicators everywhere, we are still striving to find better ways to communicate over the distances common for air assault operations. Nothing but the maximum effectiveness will suffice in our operations. As we work with the equipment we now have, we are looking forward eagerly to new and better radios and the challenge which will accompany them.

Many pages would be required to verbally describe the radio systems as they exist in air assault division artillery. Since it is well known that a picture is worth several thousand words, the systems have been reduced to diagrams (figs 4 through 8).

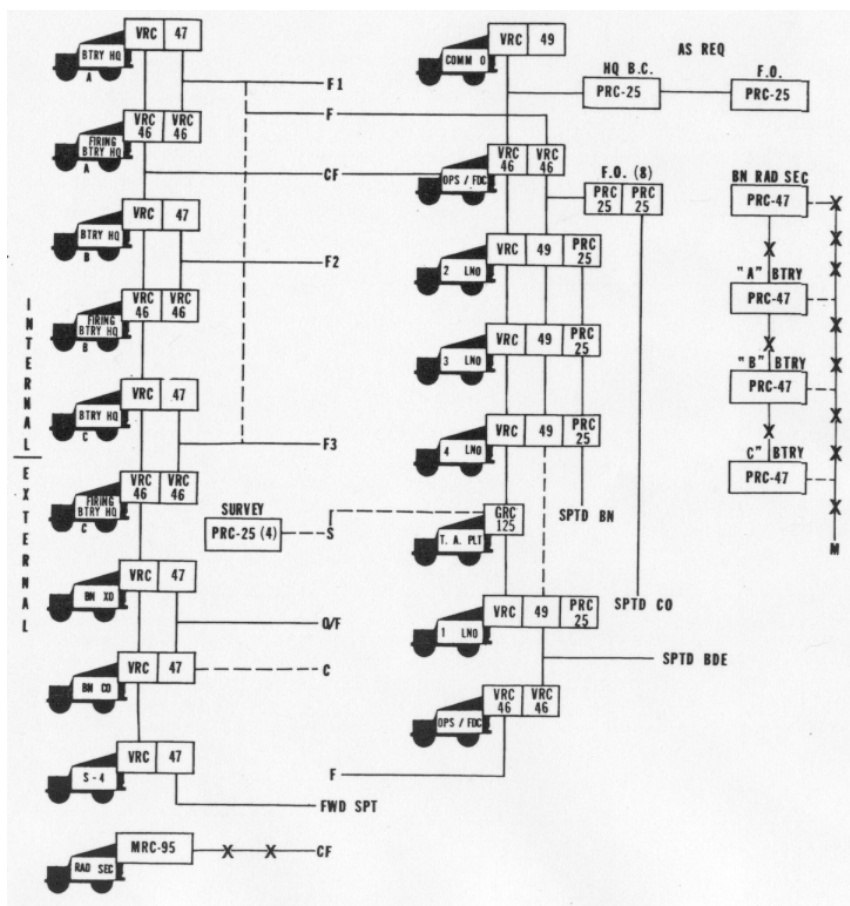

Figure 5. 105-mm battalion.

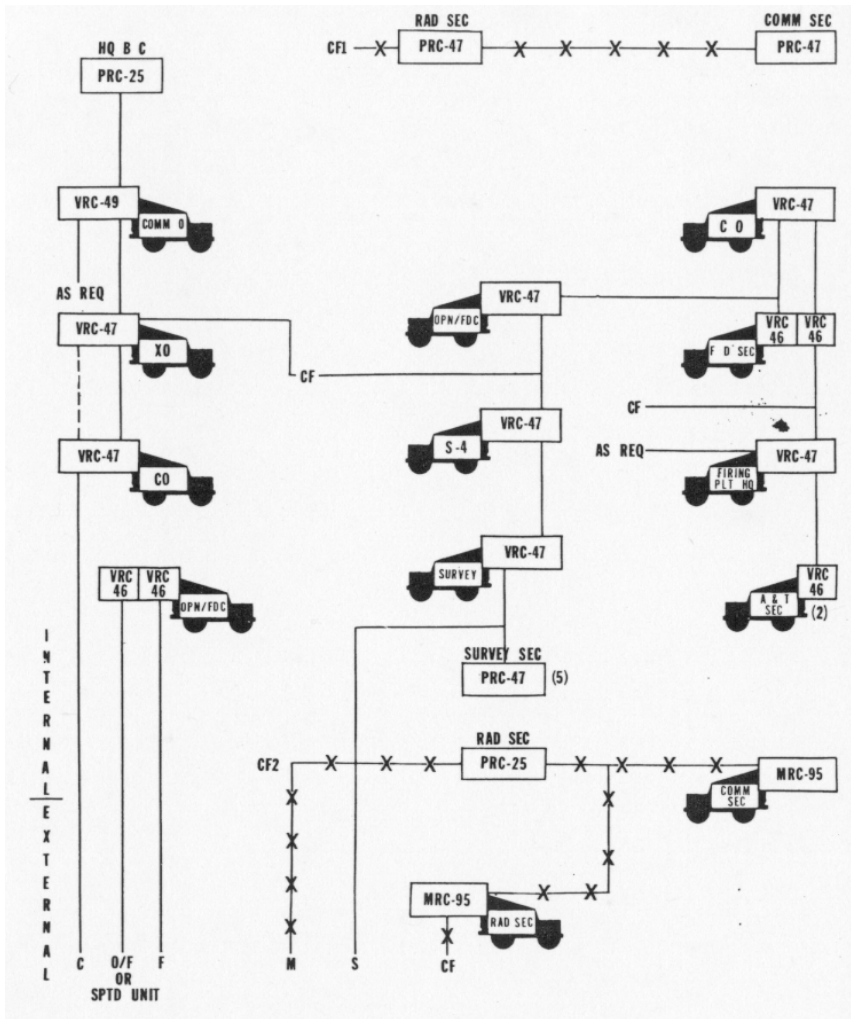

Figure 6. Little John battalion.

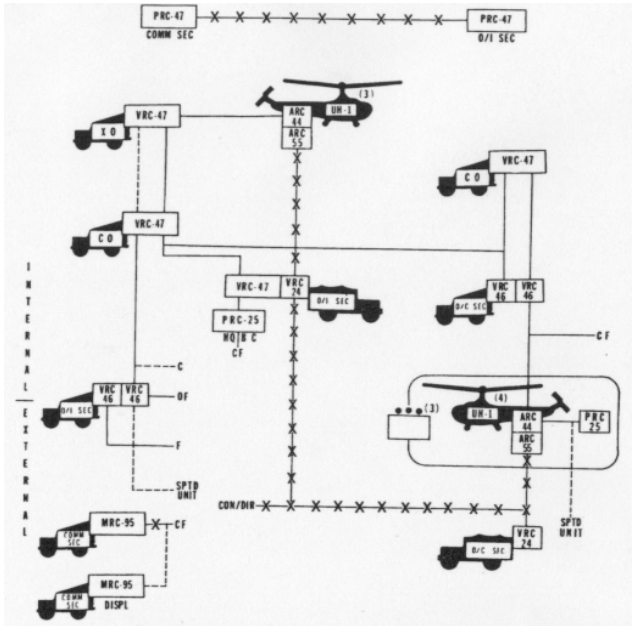

Figure 7. Aerial rocket battalion.

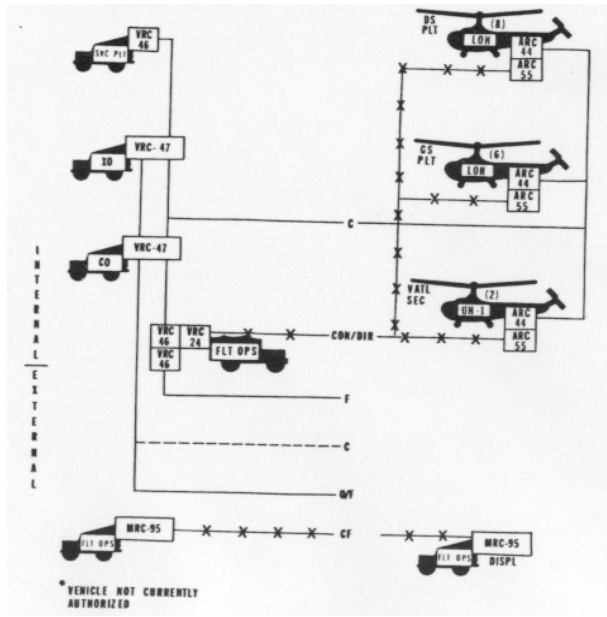

Figure 8. Aviation battery.

The Old and The New

*Captain William H. Goodspeed
3d Battalion, 377th Artillery*

Using the air assault division's new aerial rocket artillery (ARA) in conjunction with old, standard principles of artillery position area defense, our ARA battery was faced with two problems affecting the defense of a position area—the vulnerability of the helicopter and the questionable effectiveness of the M3 rocket system when fired from a static ground position. Even with these problems, our battery, combining the old and the new, conducted a successful position area defense.

PRIOR TO OCCUPATION

The defense began prior to the occupation of position. Site selection was based on mission, proximity of the area to the FEBA, proximity of friendly units, establishment of warning nets and capability to monitor both friendly and enemy situations. Any source of information which afforded maximum warning of attack while in the position area was fully utilized. During reconnaissance, defense was further considered, and the location selected was chosen from extensive map, air and ground study. Alternate areas were provided as well as planning surveillance to preclude surprise attack. Reconnaissance was continuous in order to find additional usable sites. In all cases, occupation of a position area was planned and organized in a manner which attempted to preclude attack since an attack would detract from the unit's ability to perform its mission of fire support. The light, lean TOE of the ARA battery immediately illustrated the need to train battery personnel to fight as infantry when necessary. However, the mobility of ARA and the fact that it does not fire missions from its battery area, facilitate rapid displacement with simultaneous support of an operation. Mission accomplishment was achieved while relocating; therefore, when an attack was imminent, displacement was preferable to defense.

PASSIVE DEFENSE

Passive defense measures are the key factor in undetected operations. In the position area, the structure of the ARA battery consisted of 12 UH-1B helicopters equipped with the M3 system, augmented by seven crew-served 7.62-mm machineguns and riflemen armed with M14s. In planning the position area defense, maximum use of cover and concealment enabled the battery to operate undetected by the enemy. Natural barriers were used not only in locating defilade and limiting avenues of approach but also in gaining maximum cover and concealment. Terrain provided for protection of air vehicles against detection by ground elements, and friendly routes of approach were planned for low flying aircraft rather than ground vehicles. The lack of ground avenues of approach to the position area was very desirable and could be coupled

with the fact that a route of withdrawal sustained only light vehicle traffic. This enabled a battery to locate immediately to the rear of a stream or creek bed in an area where road trafficability was poor.

During an operation in an air assault battle area, there was a lack of time and personnel to prepare field fortifications. Therefore, cover and concealment was augmented by camouflage when possible. As an aid, air assault division aircraft were painted with lusterless OD paint. Because of weight restrictions, standard Army camouflage nets were replaced by much lighter camouflage parachute material (fig 9). Aircraft are parked in shade areas and repositioned during the day to utilize the best available terrain at any given time.



Figure 9. Camouflaged helicopter.

All unnecessary activity in the area was eliminated. To accomplish this, rear base areas were established to perform maintenance. This necessitated only the fighting elements of the battery moving forward. Maintenance in the forward area was confined to what could be accomplished from the mechanic's tool box. In many cases, vehicle traffic in the forward area could (when used) be restricted to night hours, reducing noticeable movements. Light and noise discipline were excellent. Portable battery operated helipad lights were turned on only on call of approaching aircraft, and well trained air crews habitually landed under minimum light conditions.

Aviation POL resupply to battery areas was scheduled only during daylight hours because large aircraft were forced to turn on landing lights during resupply operations. At times aviation fuel and rocket resupply were accomplished at centralized locations instead of by unit distribution. For example, on one such operation, batteries used false locations, i.e., laagering (parking aircraft in a secure place) aircraft in a position other than the actual battery area. Deception was achieved because the first landing in the battery area occurred after dark. Deception continued by varying the false locations periodically. Passive defense measures contributed to both accomplishment of the unit mission and defense of the battery area.

ACTIVE DEFENSE

Active defense measures were based upon weapons of aircraft available during an attack. The aircraft's primary role was to become airborne and counterattack. If fire missions were in progress, the number of aircraft available to aid in the defense fluctuated with mission load. Although positioned separately, sister batteries supported each other during an attack, and aircraft acted as observation posts adjusting friendly fires. Preplanned concentrations of ground artillery were used. Integration of co-located unit's small arms fires increased effectiveness when the battery perimeter was established. The basis of the perimeter defense was listening posts, augmented by crew-served weapons, whose main function was providing warning. The battery perimeter, while not heavily manned, was augmented by a system of reserve squads.

The response to any attack varies with warning time. The success of defense is keyed to an alert warning system that begins with friendly surveillance well forward of the position area. Flight crews vary approaches to position areas providing continual surveillance of avenues of approach. Every means available is utilized to provide early warning.

Although the defense force attempts to deceive the enemy as to its location, an attack may occur and such an attack did occur (fig 10) during testing. At the time, two firing batteries and the battalion headquarters were deployed in an area surrounded by heavy forest with only one access road entering the area. A road block had been established on this road. Forest density and the rolling nature of the terrain prohibited complete observation of the area from any one point. The aggressor could not determine the size of the defending force or see aircraft take off to counterattack. Close monitoring of the situation had revealed aggressor activity in the area, and at the time of the attack many of the battery's ground elements had already departed to safer locations. With fire missions in progress at the time, only three firing sections were in the position area. The attacking aggressor force consisted of 10 1/4-ton trucks with mounted machineguns and 106-mm recoilless rifles, accompanied by approximately 30 personnel. Ample warning was given by a listening post near the road block and this resulted in six UH-1 aircraft, carrying 48 rockets each, departing unobserved. As the aggressor bypassed the road block and began to enter the area, the aircraft that had become airborne were in position to immediately engage the aggressor force with rocket fire (usually rockets are fired from a range of about 1,500 meters).

This engagement illustrates the need for early warning and the effectiveness of the aerial rocket battery when warned. The combination of both passive and active defense measures gave the unit not only protection but also time to react. While the aerial rocket battery position area may be difficult to defend, strict adherence to basic position area defense procedures can achieve desired goals.

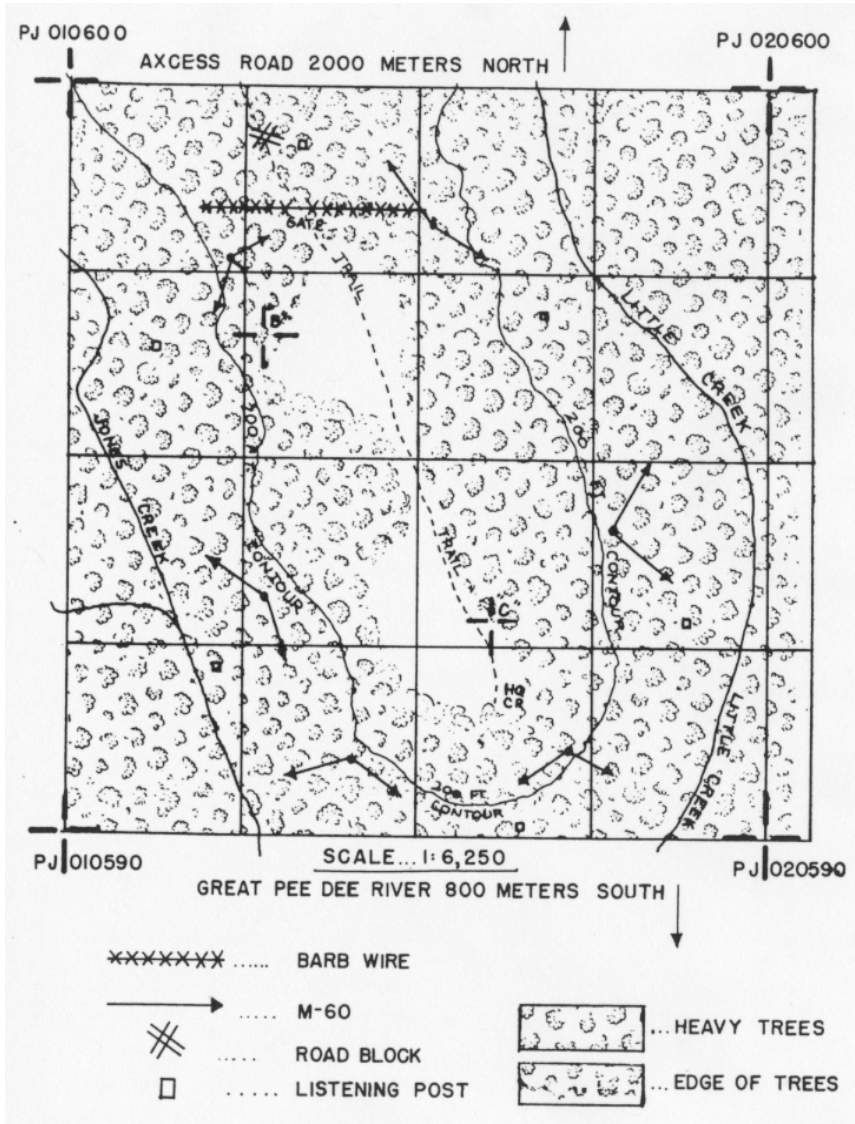

Figure 10. Schematic of defended position area.

LONG DISTANCE SURVEY

*Captain Carl D. Taggart
Division Artillery Headquarters*

Survey elements of the air assault division are faced with two main problems: the distances involved between installations and transportation to accomplish timely survey. Elements of the division artillery may be spread from 10 to 100 kilometers from the division artillery CP. The division artillery survey parties are equipped with angular and distance measuring devices (fig 11) capable of supporting this concept. However, a combination of air and ground transportation is required to provide the mobility necessary for extending timely survey control over these distances.

The primary means of getting the division artillery on a common direction is through the use of a simultaneous observation station established by personnel from the survey information center, using a T2 theodolite from one of the survey parties. Coordinate control is extended to the battalions as time permits, with priority going to the Little John battalion.

The Little John battalion is normally in general support, requiring a firing battery to be capable of covering with fire a brigade zone of action. To insure a rapid reaction time and the ability to cover required zones, a "belt" of well located firing points must be selected and surveyed. The battalion also must cover its zone of responsibility in depth. To cover his zone of responsibility in depth as well as width, each battery commander selects an additional "belt" of firing points 5 to 10 kilometers either forward or to the rear of the previous "belt," depending on the tactical situation. The battalion survey section consists of three

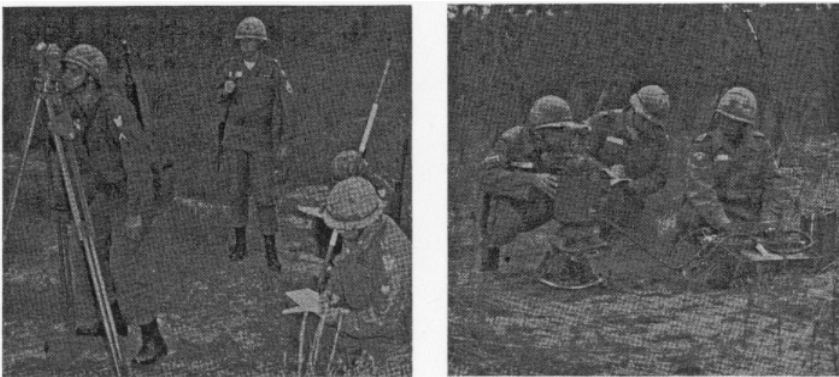

Figure 11. Survey parties utilize various items of equipment to perform their assignment.

survey parties permitting one party to be attached to each firing battery, operating under the control of the battery commander. This makes the survey party immediately responsive to the needs of the battery which it supports. The Little John battalion is provided three battery survey control points instead of a single battalion control point because of the distance between batteries, which may be 5 to 50 kilometers, and because of a lack of electronic distance measuring equipment within the battalion.

Since moves by both battery and battalion size units are frequent, it is necessary to have a method for the battalion survey elements to request survey control by electronic means. This is accomplished through the use of a pre-arranged message form (fig 12). Data are transmitted referencing the line number and pertinent information. No reference is made to the line title. This form contains all information needed by the requesting or receiving party in order to furnish the requested survey control or to furnish information concerning survey control available in the area.

REQUEST FOR CONTROL DATA
(COPPER REQUEST)

SECTION I

1. DATE/TIME _____ UNIT _____

2. UNIT _____

3. LOCATION WHERE CONTROL DESIRED _____

SECTION II

4. DATE/TIME _____

5. MARKER NUMBER _____

6. COORDINATES _____

7. HEIGHT _____

8. AZIMUTH MARK _____ Miles, Blanket _____ Meters

9. DESCRIPTION OF MARKER _____

MESSAGE # _____ SENT BY _____

*Use Check Point System or Map Numerical Code

NOTE: When transmitting requests and/or data by electronic means, only line numbers and necessary information will be transmitted. Line titles will not be used.

Figure 12. Survey message form.

To provide the necessary survey control, the division artillery survey section uses one OH-13 and two UH-1D helicopters. This provides the reconnaissance/survey officer with a rapid, long-range reconnaissance means and transportation for each of the survey parties and necessary equipment (fig 13). It is important that the survey officer be thoroughly familiar with the capabilities and limitations of the aircraft to prevent significant delay of the survey operation. The reconnaissance element must land on or near each station to insure intervisibility between stations, using extreme caution on exceptionally long legs to insure reciprocal intervisibility. A night survey involving the use of helicopters requires more careful pre-selection of landing areas and much more coordination between the pilot and survey personnel, than does a survey during daylight hours.

The chief of party has a systematic loading plan to insure that the proper personnel and equipment are on-board prior to moving from one station to another. The party should be capable of providing three distance measuring equipment (DME) teams (six personnel) and one theodolite team (two personnel) in addition to two computers. Use of the UH-1D makes it possible to transport the 10-man survey party with three DMEs, one theodolite, four tripods, two computer bags, five range poles and sleepers, one portable radio, and additional station marking equipment such as panels and beacon lights.



Figure 13. UH-1D transports survey crew and equipment.

If the use of helicopters is terminated prior to completion of the survey, the survey section is augmented with ground vehicles from the unit in order to accomplish the survey. This fact is considered when picking the stations to insure that all stations are accessible by ground vehicle.

It has been very beneficial to perform a night survey because a light may be seen at night when the instrument operator may not be able to see the range pole during daylight because of haze, sparse trees and underbrush, and when heat waves are prominent. It is extremely critical to make a thorough reconnaissance during daylight hours in order to accomplish a timely night survey.

A survey utilizing helicopters for transportation is not limited to the air assault division, but it can be performed by any unit equipped with long-range survey equipment and may reduce the time required for survey by 25 to 50 per cent.

AVIATION BATTERY ROLE

Major Benjamin F. Harden

Battery E, 26th Artillery

The mission of the aviation battery (fig 14) in the 11th Air Assault Division is to increase the combat effectiveness of the air assault division artillery by providing its headquarters and subordinate elements with immediately responsive aviation support. Compared to the division artillery aviation section of a ROAD division, the mission is the same, and the type of aviation support each is capable of rendering is similar. However, a great difference is found in the amount of support required by the concept of tactical employment of the air assault division. In the widespread battle zone inherent to the air assault division, commanders and staffs must rely on air transportation to accomplish a majority of tasks usually performed by ground vehicles.

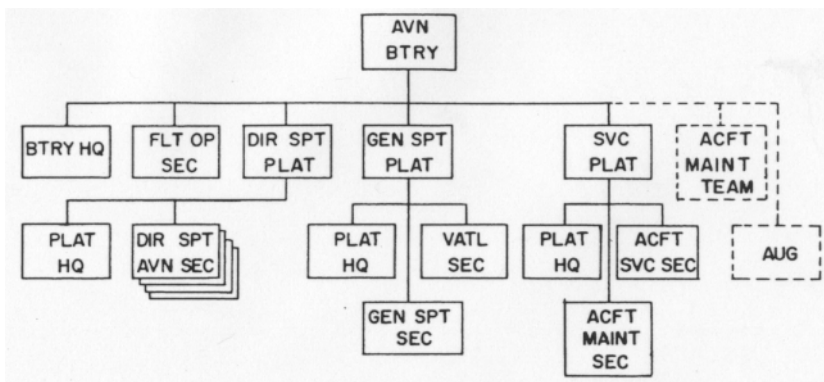

Figure 14. Organization of the aviation battery.

PLATOON FUNCTIONS

In telling you how we accomplish the aviation battery's mission, we will discuss the functions of the individual platoons.

The primary missions of the operations platoon are flight scheduling, flight following, dissemination of flight information, liaison with division artillery operations, compiling data for reports, maintenance of a current situation and flight planning map and operation of internal and external radio and wire communications. To efficiently accomplish these requirements, it is necessary to establish an operations facility at the forward and rear CP, both capable of functioning on a 24-hour basis. The forward operations element is composed of an operations sergeant, three flight operations specialists and radio operators, a 1/4-ton vehicle with trailer and necessary radios to operate as NCS of the battery command net and operate in the division artillery CF net. The battery commander or executive officer usually is located at the forward CP. In addition to accomplishing the requirements listed above, these personnel establish the division artillery main helipad and control air traffic in the vicinity. The rear area operations element serves as a communication link between the forward and rear areas. An additional responsibility is the operation of an AM radio in the division artillery command AM net. Flight following is furnished for necessary organic aircraft movement between forward and rear areas. Flight following is conducted on the battery FM command net for all aircraft except those of the direct support platoon which are followed by the supported artillery battalions.

The direct support platoon is the real "workhorse" of the aviation battery. The utilization and tactical employment of the platoon helicopters is dependent upon the missions which are assigned to the supported artillery battalions. Normally, each of the sections in the direct support platoon are assigned to fly support for a particular battalion. This assignment is followed whenever possible, and experience has indicated that the "habitual association" idea is advantageous for all concerned.

The platoon leader coordinates and directs all functions of the platoon, acts as a stand-by/relief pilot and operates from the battery forward CP.

The primary mission of the general support platoon is to provide continuous aircraft support to the division artillery commander and staff and furnish the support required by the aviation battery for internal control. In addition, the platoon provides back-up support for the direct support platoon when additional aircraft or crews are required on a replacement or supplemental basis. For example, continuous aircraft support for the division artillery commander requires one UH-1B, with a command radio console and map display installed and one backup UH-1B, which is utilized part time by the division artillery executive officer and for utility missions when available. On occasion, the division artillery commander will relinquish the command aircraft to provide an airborne FDC during displacement or deep penetration operations where reliable communications are difficult. Another example of using helicopters on a replacement or supplemental basis concerns the use of observation helicopters in the platoon. Because of maintenance problems encountered in sustained operations, the number of OH-13s available for the platoon will vary from none to three. When available, one OH-13 is utilized to support the division artillery staff remaining in the rear area. This helicopter provides the division artillery S1 with a courier capability and transportation for the S4 to coordinate and expedite the flow of supplies. The division artillery S2 utilizes the OH-13s available in the forward area to collect information and for target acquisition. The S3 uses the observation helicopters for distributing operations plans and orders and for courier missions.

The major mission of the service platoon is to coordinate, schedule and supervise aircraft maintenance within the battery. The tactical deployment of the battery and the supporting aircraft maintenance and supply battalion require the service platoon to remain in the rear area for performance of its mission. During tactical phases, aircraft operating in the forward area requiring scheduled maintenance are flown to the rear area. Non-flyable aircraft in the forward area require the maintenance officer and/or mechanics to move forward to the site of the aircraft. An aircraft usually must be diverted from a tactical mission for this purpose.

The supported battalions may use the assigned helicopters in various ways depending upon the individual commander. Generally, it can be stated that the aircraft from the aviation battery are under operational control of the battalion S3. If two or more aircraft are supporting the battalion, one of the helicopters is used almost exclusively by the battalion commander.

The observation helicopter is invaluable in air assault operations for command-control purposes. The other helicopter(s) assigned or attached to the battalion are used primarily for surveillance, target acquisition, screening, aerial observation and reconnaissance missions. The fact that all the battalions utilize the assigned helicopters extensively for reconnaissance

is particularly significant. Because of the long range and fast moving operations inherent to the air assault division, there is a need for continuous and rapid reconnaissance and survey. Without the aircraft afforded by the direct support platoon, units can not accomplish many requirements in a timely manner.

Since the helicopters working with the artillery battalions are separated from the aviation battery by a considerable distance, several problems might be experienced which adversely could affect their availability. One of these problems is required maintenance and/or scheduled inspections on the aircraft. Although one crew chief normally accompanies each direct support section to its respective battalion, his duties are limited to preventive or pre-flight and post-flight inspections. More extensive maintenance requires the helicopter to be returned to the battery service platoon or evacuated to a higher echelon maintenance activity. Unless a replacement aircraft is immediately available from the general support platoon, this situation leaves the artillery battalion without sufficient support. Another problem is the lack of an adequate refueling capability. Close coordination with supported and adjacent units is constantly required to insure that adequate forward refueling sites are established at an early hour after an operation begins. Still another problem is the unsuitability of the OH-13 for night and marginal weather operation. Only limited operations can be conducted at night even with those aircraft equipped with basic instrument kits. The light observation helicopter presently being tested should significantly enhance the capability of the direct support sections.

The assignment of helicopters to the direct support platoon is on the basis of two for each of the 105-mm and Little John battalions in division artillery. It is often necessary to adjust or shift the helicopter assignment between the supported units. The criteria are mission requirements as influenced by the tactical situation. If sufficient aircraft are not available to permit normal assignment, the division artillery S3. establishes the priority. If several of the observation helicopters are down for extensive maintenance during sustained air assault operations, the direct support platoon reverts to a general support role with few aircraft assigned directly to the artillery battalions. Float aircraft are obtained when available to replace those down for extensive maintenance.

The aviation battery in its present status is organized on a sound functional basis. Experience to date indicates a need for some additional aircraft and crews to enable the unit to provide division artillery and its assigned battalions with aerial vehicles for transportation of commanders, LOs, survey parties, reconnaissance parties and essential messengers, plus providing the aerial platform from which to conduct surveillance, target acquisition and adjustment of artillery fire.

LOLEX

*Major Buford W. Brannon
Division Artillery Headquarters*

An Army Caribou makes a low-level pass over the drop zone (DZ); a parachute balloons to the rear of the aircraft; and a pallet of 105-mm ammunition slides smoothly out of the plane, falls forward and down, and lands right side up with a slight thump.

This is LOLEX (low-level extraction) and to the observers, a sight they have seen many times. What made this particular LOLEX of interest was the fact that the ammunition used was the real thing, not a washed gravel or sand substitute. Thirty-two rounds of 105-mm HE, without fuze, packed in standard ammunition boxes, had been strapped to a flat wooden pallet, loaded into and extracted in flight from a CV-2 aircraft without any special preparation to protect it from the full force of the landing impact. An ammunition inspector from Fort Bragg inspected the ammunition and found it fully serviceable.

The 11th Air Assault Division Artillery had been eyeing LOLEX for some time as a means for delivery of ammunition. The division artillery was aware that experiments with LOLEX had been carried out in various places but had little information on results of the experiments or suitability of the system for ammunition delivery. In the summer of 1964, with the help of the 10th Air Transport Brigade which furnished aircraft and technical advice and the 11th Air Assault Division Support Command which furnished air equipment and load masters and assisted in the preparation of the loads, feasibility tests began. Token loads of sand-filled ammunition boxes were delivered using LOLEX during brigade and division command post and field training exercises in the Fort Benning area. Those initial steps seemed to hold promise, but final judgment on the system's worth had to await a chance to test it on a larger scale.

That opportunity came in a five-day test exercise. Of 596.87 tons of simulated ammunition (washed gravel packed in ammunition boxes and palletized) delivered to units of the 11th Air Assault Division Artillery, 177.80 tons, or almost one-third, was delivered by LOLEX. Most of that was delivered in a two-day period. Delivery by LOLEX by day was as shown on this chart:

DAYS	LOLEX TONNAGE RECEIVED
First	32.80
Second	79.00
Third	64.00
Fourth	2.00
	<hr/>
Total Tonnage:	177.80

Certainly, this was impressive evidence that LOLEX can be an extremely valuable supplement to other means of ammunition delivery.

To receiving units, receipt of ammunition by LOLEX is simplicity itself. All that is required is a DZ approximately 400 feet long and clear enough to permit a CV-2 to fly level with the ground below normal treetop level. Almost any surface is useable provided obstacles do not protrude high enough above the prevailing terrain to endanger the aircraft. Since the aircraft makes the pass as low as 3 to 5 feet off the ground with wheels down (fig 15), the main danger is that the aircraft might strike its wheels against protrusions of rock or tall shrubbery. Should pioneer work be required, it is generally limited since the width of the zone need not be much wider than the 96-foot wing span of the aircraft. When multiple deliveries are being made, the zone must be wider because delivered cargo itself creates a hazard for following aircraft. The zone, having been selected or prepared, is completed by placing a cargo release marker approximately 200 feet from the desired point of impact.

The artillery unit selects the drop zone and stands by to talk the pilots into the correct approach. The request system used by the air assault division requires artillery units to include a contact frequency on all requests, so no special type of request form is required for LOLEX delivery. The requirements for resupply are transmitted to the 11th Air Assault Division Support Command forward support elements who pass the requirements to the log base, and then monitor the delivery schedules until delivery to the unit is made.

Recovery of ammunition from the drop zone presents no peculiar problems. Since no special packaging is used, the ammunition requires no special handling, and the straps with which the ammunition is fastened to the pallets are equipped with quick release catches. Air items can be left in place for later recovery or recovered by the unit for rear shipment on the next available aircraft leaving the unit area for any element of the Division Support Command.

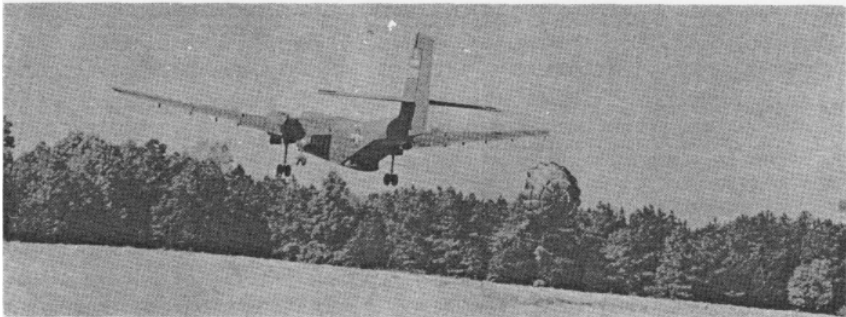

Figure 15. A parachute opens and the LOLEX has begun. The Caribou is much closer to the ground than it appears to be because of the angle at which the camera was being held. Normally, LOLEX takes place with the wheels of the aircraft 3 to 5 feet above the ground.

The only disadvantages of the LOLEX as a method of delivery is that more lead time is required to prepare LOLEX than is required to prepare ammunition for sling loading. This disadvantage can be overcome to some extent by preparing LOLEX pallets in advance and by establishing a positive control over air items used so they can be available for LOLEX preparation well in advance of generated requirements.

A minor drawback is the requirement to provide a drop zone. Heavily wooded terrain and rocky hills might not provide enough zones near battery locations to permit large scale LOLEX operations. However, it is probable that any terrain in which artillery will operate for any extended period will provide enough drop zones to make LOLEX a valuable adjunct to other means of ammunition delivery.

●

WRONG DIAGRAM!

On Page 43 of the April 1965 ARTILLERY TRENDS, the incorrect message form was used in figure 1. For your use, we have provided the correct "Hopscotch Message Form" below.

(CLASSIFICATION)			
HGPOSCOTCH			
A. Objective:	ALICE CJ 2932		
B. H-Hour	011400		
C. Landing Sites:	TANGO - CJ2530, SIERRA CJ2831		
D. Flight Routes:			
	(1) IP	AB1541	Time - 14
	(2) ACP 6	CD4213	Time - 10
	(3) ACP 9	CE1724	Time - 6
	(4) ACP 14	CJ0514	Time - 4
	(5) ACP		Time
	(6) ACP		Time
	(7) RP	CJ1025	Time - 2
E. Little John			
(1) (A) TOT	- 2	(B) #Rds - 1	(C) TGT CJ2530(T)
(2) (A) TOT	- 2	(B) #Rds - 1	(C) TGT CJ2831(S)
F. Aerial Rocket			
(1) (A) TOT	- 1/2	(B) Length of Prep - 1/2	(C) #PRS 24 (D) TGT CJ2530(T)
(2) (A) TOT	- 1/2	(B) Length of Prep - 1/2	(C) #PRS 24 (D) TGT CJ2831(S)
G. 105 Howitzers			
(1) (A) TOT	- 2	(B) Length of Prep - 1	(C) #VOL 4 (D) TGT CJ2530(T)
(2) (A) TOT	- 2	(B) Length of Prep - 1	(C) #VOL 4 (D) TGT CJ2831(S)
H. Zipcode:	(1) CJ 2019	(2) CJ 1025	(3) CJ 4018
	(4) CJ 4916	(5) CJ 0015	(6)
I. Special Instructions:	CHANNEL 71		
(CLASSIFICATION)			

USAARTYBD

*Lieutenant Colonel Donald J. LeMonier
U.S. Army Artillery Board*

Throughout its history, the Army has achieved unparalleled success on the battlefield. These achievements did not happen by accident; they happened because the Army always has been superbly led, properly trained, and equipped with the most advanced weapons that science and industry can produce. This unbeatable combination of leadership, training and equipment in today's Army has produced a global fighting force that would not have been considered possible a few short years ago.

What made this possible? The answer is not simple. Today's Army is the product of many things—the will of a free people to remain free; a national economy with the capacity to support the desires of the people; dedicated professional soldiers who have excellence as their only goal; and a scientific and industrial base capable of producing superior military hardware. The purpose of this article is to examine the part played by the U.S. Army Artillery Board (USAARTYBD) in assuring that the U.S. Army remains the most superbly equipped force in the world.

For a more complete understanding of the factors that lead to the fielding of a new item of equipment, let us briefly examine the current organization for developing and testing equipment.

The mission of the U.S. Army Combat Developments Command (USACDC) includes determining "the kinds of forces and materiel needed" for the conduct of land warfare and making "appropriate recommendations to the Department of the Army." In the case of new materiel this need is ultimately expressed as a Qualitative Materiel Requirement (QMR). The QMR not only identifies the pertinent military engineering characteristics for new materiel but also establishes the organizational and operational concepts for its employment. The USACDC element concerned with field artillery equipment is the U.S. Army Combat Developments Command Artillery Agency located at Fort Sill. (See ARTILLERY TRENDS, December 1964.)

The U.S. Army Materiel Command (AMC) is the Department of the Army agency charged with the research for, and the development of, materiel after the requirement has been established by USACDC.

The U.S. Army Test and Evaluation Command (USATECOM), which is a major subordinate command of AMC, has the basic mission of providing an independent evaluation of the materiel for which AMC has developmental responsibility. This evaluation is provided by means of engineering tests, service tests or combinations of both. Certain other tests also are conducted; for example, military potential tests which are conducted to ascertain the military worth of a developmental item and check and confirmatory tests which are conducted to insure the satisfactory correction of deficiencies discovered during previous testing.

SERVICE TEST

The U.S. Army Artillery Board is the USATECOM agency concerned with the testing of field artillery equipment, and the most important function performed by the Board is the service test. The service test, however, is not an end in itself; it is just one phase of the research, development and production process. It provides the basis for type classification decisions, and when necessary, it serves as the basis for a product improvement program.

As one might imagine, a test does not start with the delivery of a piece of military hardware to the Board. It starts very early in the developmental cycle. Once the QMR for a piece of equipment has been approved and contracts have been let to build equipment to these specifications, test planning begins. A coordinated test plan is written which delineates the responsibilities of the various agencies that have interests in the equipment. This test plan often provides for Board participation in the contractor's design testing, assuring early user inputs to the particular program. During all phases of testing, the one paramount consideration that overrides all others is the ability of the soldier or the Army unit to use the end item to obtain the appropriate effect in either offensive or defensive combat. This axiom dictates the environment in which tests are conducted. It requires that tests be conducted under conditions that closely duplicate those that would be expected during military operations. It also requires that the operators of the equipment be average-trained troops and not experts. The total testing to which military equipment is subjected provides a factual basis for modification of doctrine and continuing equipment improvement. This total testing includes an evaluation of technical publications, an appraisal of maintenance plans and procedures and a most important safety confirmation.

The Pershing service test is an example of how the Board conducts a test of a complete system. An analysis of this test reveals that integrated testing can provide other dividends. As an illustration, aspects of engineer-design testing, engineering testing and troop testing were threaded throughout the service test of the Pershing weapon system.

Test planning began with the receipt of a test directive. The Board received the Pershing test directive in 1959 assigning a mission "to determine the suitability of the Pershing weapon system for Army combat use." A coordinated test plan was written which provided for an engineering evaluation and the monitoring of engineer-design testing done by the contractor and culminated in a service test conducted by the U.S. Army Artillery Board. This test program was divided into four distinct phases.

The first phase of testing began in May 1961, when Board personnel were stationed at the contractor's facility. These individuals learned the Pershing from backboard wiring to system operation. It was at this stage that the collection of data started. Tests conducted by the developer and the contractor were monitored, and usable data were included in the final report of the test.

The transition from engineer-design testing to service testing, the second phase, began in April 1963 when an artillery unit, Battery A, 2d Missile Battalion, 44th Artillery, was stationed at Cape Kennedy. This unit assumed the firing duties that previously had been performed by the contractor. It was at this stage that technical writers also were integrated into the test program. The soldiers from the field artillery unit, the design engineers and the contractor's authors produced the manuals that prescribed system operation. This procedure enabled the contractor to furnish concurrently the necessary software and the test hardware.

In the summer of the same year, testing moved to Fort Sill where the third phase began. Here, for the first time, all types of equipment in the battalion were integrated into the test program. All echelons of maintenance performed by the military also became part of the test. At this point, test objectives were geared to accomplishing appropriate military missions for the system. All Board test objectives were translated into tactical plans and executed by the unit under simulated combat conditions. The Board observed these operations and collected and analyzed data on the performance of the materiel but did not influence tactical operations except to correct unsafe conditions which might have caused accidents. All operations were conducted on a 24-hour schedule and included blackout, camouflage and security operations.

In general, during these types of operations, the number of variables encountered cannot be isolated to the degree desired by the engineers without sacrificing the realism necessary to accomplish the major objectives of a service test. To assist the engineer in determining system trouble spots, all maintenance and troubleshooting procedures were monitored. The data collected from this monitoring operation were analyzed, and significant engineering facts were channeled to the developer.

The final phase of the test was the firing operations conducted during the last quarter of calendar year 1963. This was the payoff phase of testing. All firings were conducted using the artillery battalion as the test unit under the operational control of the Board. Several changes in existing procedures were required to make this test workable. For example, missiles were fired from remote sites, over populated areas, into the White Sands Missile Range (WSMR) impact areas. This necessitated mobile instrumentation emplaced in remote areas by WSMR personnel.

A continuing effort was made throughout this entire test to duplicate the environment in which the system would be employed during combat operations. Until this was done, test results could not be considered relevant. The ability to "predict" what any system will do in a battle situation is dependent on the rigid control of the test environment. In this test, however, certain tactical compromises were required to satisfy the safety requirements of live firings. At the conclusion of the firing phase, the Board analyzed the massive data accumulated over the several years of development and testing. The final report of the test was submitted at the close of 1963.

The U.S. Army Artillery Board uses several methods to arrive at its evaluations. These include, but are not limited to, a comparison of like items of equipment, comparison against a standard (the military characteristics enumerated in the QMR or the technical characteristics defined in the contract), and in the case of new types of equipment, evaluations to establish performance characteristics. This latter method was used to great success in the military potential test of the LASER rangefinder.

Persons familiar with military equipment realize that while a new piece of equipment may be far superior to its predecessor, it still may have areas in which improvements are desirable. One might ask this question: "With all the careful planning and rigid application that goes into a service test, how can military hardware enter the Army's inventory and still have a degree of unreliability?" As previously mentioned, part of the test is a comparison of the new equipment with the item that will be replaced. Often, the measured coefficient of improvement is sufficiently high so that a significant military advantage can be accrued by fielding the new piece of equipment, even though all the pertinent characteristics have not been satisfied.

There are other considerations which affect these decisions. Much of our modern equipment represents enormous investments on the part of the developer. Modern equipment with its inherent complexities is fantastically expensive to create. Many companies could not economically survive if a production decision were not made early in a program. The supporting base—an important part of the national economy—keeps the Army alive. Additionally, concepts for modern weaponry have taxed the



Figure 1. The Lance weapon system. The Lance is designed as a division support system. It marks the first use of prepackaged liquid propellants by the Army. When fielded, it will have all the reliability and simplicity of free rockets and an increased range and accuracy normally associated with guided missiles.

"state of the art" to the limit. It is virtually impossible for current technology to stay abreast of advanced military thinking and still keep costs reasonable. As a result, occasionally the military may be forced to accept something less than is desired, and a carefully evaluated decision to go into production may be made even when certain shortcomings have been identified. However, a concurrent product improvement program is usually initiated which provides for the retrofitting of fielded hardware after the initial production.

Currently, the Board is testing various pieces of new equipment and several improvements to existing hardware (fig 1 through 6).

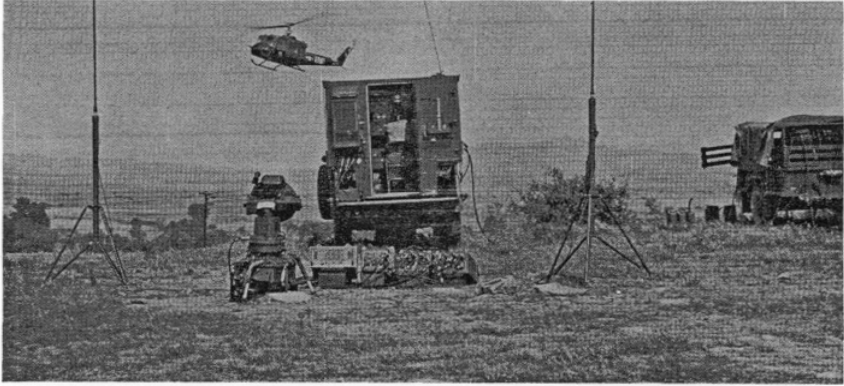

Figure 2. Visual Airborne Target Locator System (VATLS). As with LASER, the Board also developed a technique to connect the target area and position area on a system of false coordinates. This enables the massing of fires from several units prior to the completion of normal survey procedures.

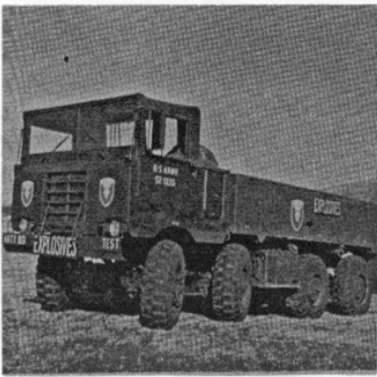

Figure 3. M656 cargo truck.

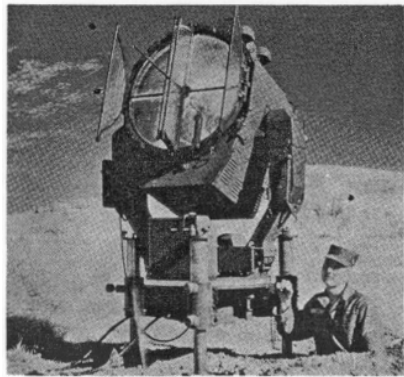

Figure 4. The 30-inch searchlight.

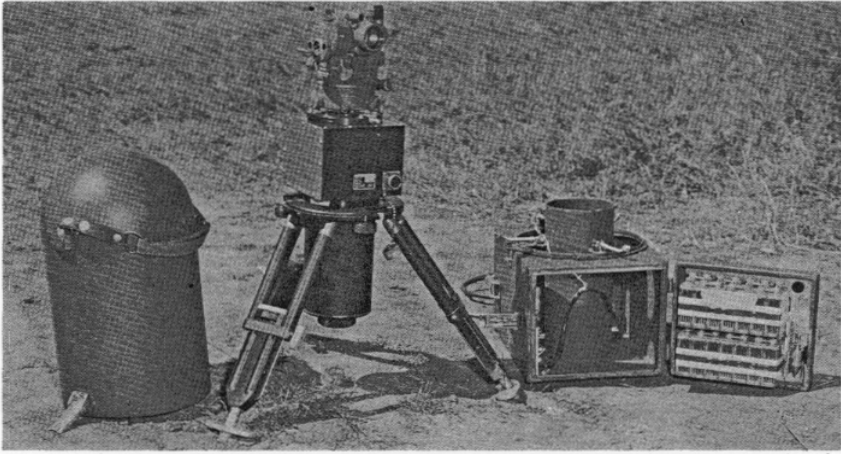

Figure 5. Lightweight surveying instrument azimuth gyro.

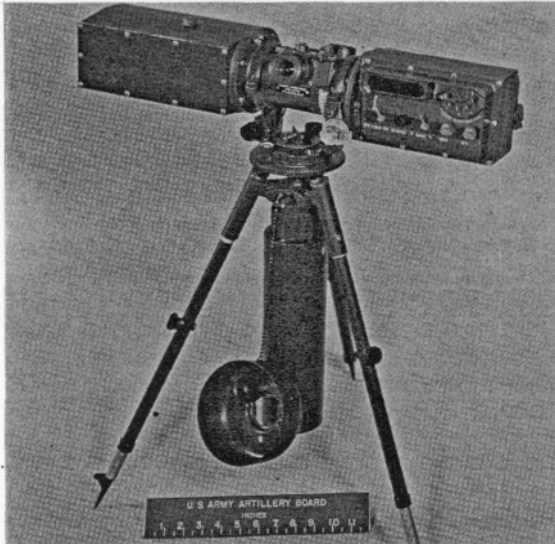

Figure 6. LASER rangefinder. The LASER is a classic example of how the testing agencies affect doctrine. The military standards required that the equipment be able to determine polar coordinates from the forward observer to the target. The test was designed to determine the LASER's ability to perform this function. During the conduct of this test, simple procedures also were developed to provide a self-survey capability for the equipment, using the same technique. This procedure was incorporated in the test report and should become a normal operating procedure.

PUFF

*Lieutenant Colonel Charles W. Montgomery
Tactics/Combined Arms Department*

The word "PUFF" is well established in the vocabulary of the field artilleryman. PUFF represents the smoke rising from an impacting artillery round, or it may represent a PUFF board which is a training device that simulates artillery bursts. In this article, we will consider still another meaning for PUFF; that is, a memory device or check list, using the letters of PUFF, to determine the validity of an artillery organization for combat.

In demonstrating the use of PUFF as a check list, we will use an example of a tactical situation for a division (fig 1). The division will attack the objective using the 1st and 2d Brigades abreast with the 1st Brigade making the main effort. The 3d Brigade, in reserve, will move forward in the sector of the 1st Brigade and will be prepared to assume the mission of the 1st Brigade, if necessary.

The division artillery organization for combat will be as follows:

1/1 Arty (155-mm) (SP):	DS 1st Bde; on order Reinf 1/3 Arty
1/2 Arty (155-mm) (SP):	DS 2d Bde
1/3 Arty (155-mm) (SP):	Reinf 1/1 Arty; on order DS 3d Bde
1/4 Arty (155-mm/8-in) (SP):	GS
1/5 Arty (HJ) (SP):	GS

THE LETTERS OF PUFF

To begin checking the validity of our artillery organization for combat, the first letter of PUFF represents the statement, **Provide Adequate Support**. Each of the committed brigades (1st and 2d) has a battalion of 155-mm howitzers in direct support. A direct support battalion will be provided for the reserve brigade (3d) when committed. The 1st Brigade is making the division's main effort and the 1/3 Arty will reinforce the direct support battalion, 1/1 Arty. This, in effect, makes two artillery battalions immediately responsive to the needs of the main attack force. In addition, the 1/3 Arty will be in an appropriate location if a direct support mission is ordered. Flexibility has been provided in the organization for combat by placing the 1/4 Arty and 1/5 Arty in general support. The fires of these two battalions can be utilized by the division commander anywhere within the division zone of action.

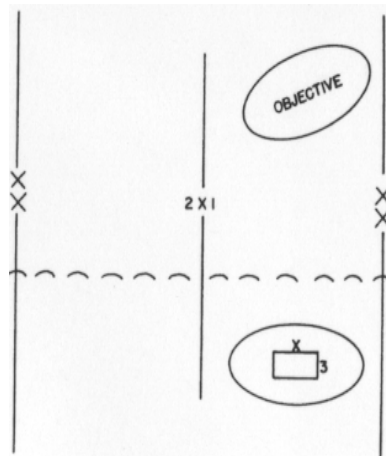

Figure 1. Division in the offense.

Next, using the letter U for the statement, **Use Weapons According To Their Capabilities**, our organization for combat is again valid. In the situation presented, there was little challenge. The 155-mm battalions were assigned direct support roles. This is correct for these battalions are organized and equipped to provide forward observers and liaison personnel to the maneuver force to fulfill the inherent responsibilities of a direct support mission. The 1/4 Arty and 1/5 Arty are not designed to perform this mission. Perhaps better examples of using weapons according to their capabilities are:

- Providing self-propelled artillery weapons to support armored and mechanized forces. This allows the supporting artillery to "keep up" with supported formations maneuvering over difficult terrain which is questionable for towed artillery.

- Providing howitzers in lieu of flat trajectory guns to support operations in mountainous terrain.

- Providing lightweight artillery weapons for airborne and airmobile operations.

The first letter F of the word PUFF is used to "point up" the need to **Furnish Massed Fires Where Required**. The fact that two battalions are responsive immediately to the main attack, while two are retained at division level, establishes the validity of this organization. The general support artillery can be positioned so their fires can be massed with the appropriate direct support artillery.

The second F of the word PUFF denotes the statement, **Facilitates Future Operations**. The validity of the organization shown is verified in two instances. The first is covered by the "on order" missions assigned to the 1/1 Arty and the 1/3 Arty. Each battalion has been alerted to future tasks if and when the 3d Brigade is committed. Through the use of "on order" missions each battalion can develop plans for the future. This saves time and insures a smooth transition and efficiency if the order is given. The second instance which verifies the validity of the organization is the amount of general support artillery available. As was previously mentioned, it affords flexibility in the use of these fires and makes available to the division commander additional artillery with which to influence the action, if needed.

So we see that PUFF means more to the artilleryman than just the smoke from an impacting round. It serves to remind him of the four essentials of a good artillery organization for combat. It can key his thinking on how best to organize in order to—

Provide adequate support.

Use weapons according to their capabilities.

Furnish massed fires.

Facilitate future operations.

When all four of the essentials are met it usually results in combat soldiers sitting on the prescribed objective at the appropriate time.

RESIDENT COURSES

U. S. Army Artillery and Missile School

A complete summary of the purposes and prerequisites for all courses conducted at the USAAMS is published in DA Pam 20-21, "Army School Catalog." All courses which exceed 20 weeks are attended in a permanent change of station (PCS) status and those 20 weeks or less in length are attended in temporary duty (TDY) status.

OFFICER SELECTION/APPLICATION

Active Army. Career active duty artillery officers are selected to attend USAAMS officer career courses by the Artillery Section, Officers Assignment Division, DCSPER, Department of the Army. Applications for admission to resident courses should not be sent to the School. Officers of the active army who desire to attend specialist (MOS) resident courses at the USAAMS may apply through channels.

Reserve. Army Reserve officers not on active duty may make application for attendance for any course (providing they meet all prerequisites) in accordance with the provisions of AR 135-200. Only active status members of the Army Reserve are eligible for selection.

National Guard. National Guard officers not on active duty should make application on National Guard Bureau Form 64 for admission to USAAMS resident courses to the Chief, Army National Guard Bureau, ATTN: Schools Division, Washington 25, D.C.

LETTER INDICATES CATEGORY OF STUDENTS	
A—commissioned officers B—commissioned and warrant officers D—commissioned and enlisted N—warrant officers and enlisted R—enlisted	
6	A
C-23	
Digit indicates branch: 6—FA course 5—engineer course 7—infantry course	Courses within a school: C—officer career course 23—associate career course

Figure 1. Explanation of the digits and letters comprising a typical course number. The example shown is the Associate Field Artillery Officer Career Course.

CURRENT RESIDENT COURSE SCHEDULE

Listed are the officer and enlisted resident courses scheduled to be taught at the USAAMS during the period 1 July 1965 to 30 June 1966. This list includes the entire schedule of courses for FY 66.

OFFICER COURSES

Course	Class No.	Report	Start	Close	Input
FA Officer Basic (6-A-C20) (9 Weeks)	1-66	8 Jul 65	12 Jul 65	10 Sep 65	97
	2-66	2 Sep 65	7 Sep 65	5 Nov 65	97
	3-66	29 Sep 65	1 Oct 65	3 Dec 65	97
	4-66	27 Oct 65	29 Oct 65	14 Jan 66	97
	5-66	25 Nov 65	30 Nov 65	11 Feb 66	97
	6-66	6 Jan 66	10 Jan 66	11 Mar 66	97
	7-66	3 Feb 66	7 Feb 66	8 Apr 66	96
	8-66	4 Mar 66	8 Mar 66	6 May 66	96
	9-66	31 Mar 66	4 Apr 66	3 Jun 66	96
	10-66	28 Apr 66	2 May 66	1 Jul 66	96
	11-66	25 May 66	27 May 66	29 Jul 66	96
	12-66	23 Jun 66	27 Jun 66	26 Aug 66	96
Artillery Officer Career (6-A-C22) (32 Weeks)	1-66	1 Jul 65	6 Jul 65	1 Mar 66	104
	*2-66	4 Oct 65	7 Oct 65	3 Jun 66	104
	3-66	7 Feb 66	10 Feb 66	23 Sep 66	104
	4-66	2 May 66	5 May 66	20 Dec 66	104
Associate FA Officer Career (6-A-C23) (19 Weeks)	1-66	6 Jul 65	8 Jul 65	19 Nov 65	115
	2-66	13 Sep 65	15 Sep 65	10 Feb 66	115
	3-66	11 Jan 66	13 Jan 66	26 May 66	115
	4-66	18 Apr 66	20 Apr 66	1 Sep 66	115
FA Officer Refresher (6-A-C6) (2 Weeks)	1-66	1 Aug 65	2 Aug 65	13 Aug 65	40
	2-66	12 Sep 65	13 Sep 65	24 Sep 65	40
	3-66	6 Feb 66	7 Feb 66	18 Feb 66	40
	4-66	24 Apr 66	25 Apr 66	6 May 66	40
Division Artillery Staff Officer Refresher (6-A-F5) (1 Week)	1-66	11 Jul 65	12 Jul 65	17 Jul 65	20
	2-66	3 Apr 66	4 Apr 66	9 Apr 66	20
Senior Officer (6-A-F6) (2 Weeks)	1-66	18 Jul 65	19 Jul 65	30 Jul 65	25
	2-66	9 Jan 66	10 Jan 66	21 Jan 66	25
	3-66	10 Apr 66	11 Apr 66	22 Apr 66	30
**Nuclear Weapons Employment (6-A-F19) (3 Weeks)	1-66	9 Sep 65	10 Sep 65	30 Sep 65	30
	2-66	19 Nov 65	22 Nov 65	10 Dec 65	30
	3-66	10 Feb 66	11 Feb 66	4 Mar 66	30
	4-66	26 May 66	27 May 66	17 Jun 66	30
Nuclear Weapons Employment (Res Comp) (6-A-F20) (2 Weeks)	1-66	22 Aug 65	23 Aug 65	3 Sep 65	30
	2-66	16 Jan 66	17 Jan 66	28 Jan 66	30
	3-66	24 Apr 66	25 Apr 66	6 May 66	30
Nuclear Weapons Employment (6-A-F26) (4 Weeks, 3 Days)	1-66	22 Aug 65	23 Aug 65	23 Sep 65	20
	2-66	2 Jan 66	3 Jan 66	2 Feb 66	20
	3-66	20 Mar 66	21 Mar 66	20 Apr 66	20
Communications Officer (6-A-0200) (10 Weeks, 5 Days)	1-66	29 Jul 65	30 Jul 65	15 Oct 65	40
	2-66	29 Sep 65	30 Sep 65	17 Dec 65	40
	3-66	3 Feb 66	4 Feb 66	22 Apr 66	40
	4-66	31 Mar 66	1 Apr 66	17 Jun 66	40
	5-66	2 Jun 66	3 Jun 66	19 Aug 66	40

* Includes 28 Non-US Students.

** The above course (6-A-F19) is conducted for selected graduates of each Associate Field Artillery Officer Career class.

Course	Class No.	Report	Start	Close	Input
Artillery Target Acquisition Officer (6-A-1154) (12 Weeks)	1-66	6 Jul 65	8 Jul 65	29 Sep 65	16
	2-66	22 Sep 65	24 Sep 65	17 Dec 65	16
	3-66	10 Jan 66	12 Jan 66	5 Apr 66	16
	4-66	7 Apr 66	11 Apr 66	1 Jul 66	16
Artillery Survey Officer (6-A-1183) (8 Weeks)	1-66	25 Aug 65	26 Aug 65	21 Oct 65	35
	2-66	19 Jan 66	20 Jan 66	17 Mar 66	35
	3-66	6 Apr 66	7 Apr 66	2 Jun 66	35
Sergeant Officer (6-A-1190D) (5 Weeks, 4 Days)	1-66	18 Aug 65	19 Aug 65	29 Sept 65	25
	2-66	16 Feb 66	17 Feb 66	30 Mar 66	25
	3-66	17 May 66	18 May 66	28 Jun 66	21
Pershing Officer (6-A-1190E) (8 Weeks)	1-66	12 Sep 65	13 Sep 65	5 Nov 65	30
	2-66	28 Nov 65	29 Nov 65	4 Feb 66	30
	4-66	18 May 66	19 May 66	15 Jul 66	30
Pershing Officer (Non-US) (6-A-1190EX) (8 Weeks)	1-66	15 Mar 66	16 Mar 66	10 May 66	18
	2-66	8 Jun 66	9 Jun 66	4 Aug 66	15

OFFICER/ENLISTED COURSES

FA Officer Candidate (6-N-F1) (23 Weeks)	1-66	11 Jul 65	19 Jul 65	17 Dec 65	78
	2-66	8 Aug 65	16 Aug 65	1 Feb 66	78
	3-66	5 Sep 65	13 Sep 65	1 Mar 66	78
	4-66	3 Oct 65	11 Oct 65	29 Mar 66	78
	5-66	31 Oct 65	8 Nov 65	26 Apr 66	78
	6-66	28 Nov 65	6 Dec 65	24 May 66	78
	7-66	9 Jan 66	17 Jan 66	21 Jun 66	78
	8-66	6 Feb 66	14 Feb 66	19 Jul 66	78
	9-66	6 Mar 66	14 Mar 66	16 Aug 66	79
	10-66	3 Apr 66	11 Apr 66	13 Sep 66	79
	11-66	1 May 66	9 May 66	11 Oct 66	79
	12-66	29 May 66	6 Jun 66	8 Nov 66	79
	13-66	26 Jun 66	5 Jul 66	6 Dec 66	79
FA Officer Candidate (Res Comp) (6-N-F2) (11 Weeks)	1-66	11 Mar 66	16 Mar 66	28 May 66	101
	2-66	3 Jun 66	8 Jun 66	20 Aug 66	101
FADAC Operator (6-D-F28) (1 Week)	1-66	11 Jul 65	12 Jul 65	16 Jul 65	17
	2-66	24 Oct 65	25 Oct 65	29 Oct 65	17
	3-66	23 Jan 66	24 Jan 66	28 Jan 66	17
	4-66	24 Apr 66	25 Apr 66	29 Apr 66	18
FADAC Maintenance (6-D-F29) (2 Weeks, 1 Day)	1-66	12 Aug 65	13 Aug 65	27 Aug 65	15
	2-66	6 Jan 66	7 Jan 66	21 Jan 66	15
	3-66	5 May 66	6 May 66	20 May 66	15
Master Mechanics (6-D-F38) (9 Weeks)	1-66	2 Jul 65	6 Jul 65	3 Sep 65	38
	2-66	23 Jul 65	26 Jul 65	24 Sep 65	38
	3-66	13 Aug 65	16 Aug 65	15 Oct 65	38
	4-66	3 Sep 65	7 Sep 65	5 Nov 65	38
	5-66	24 Sep 65	27 Sep 65	26 Nov 65	39
	6-66	15 Oct 65	18 Oct 65	17 Dec 65	39
	7-66	5 Nov 65	8 Nov 65	21 Jan 66	39
	8-66	26 Nov 65	29 Nov 65	11 Feb 66	39
	9-66	2 Jan 66	3 Jan 66	4 Mar 66	39
	10-66	21 Jan 66	24 Jan 66	25 Mar 66	39
	11-66	11 Feb 66	14 Feb 66	15 Apr 66	39
	12-66	4 Mar 66	7 Mar 66	6 May 66	39
	13-66	25 Mar 66	28 Mar 66	27 May 66	39
	54-66	15 Apr 66	18 Apr 66	17 Jun 66	39
	15-66	6 May 66	9 May 66	8 Jul 66	39
	16-66	27 May 66	31 May 66	29 Jul 66	39
	17-66	17 Jun 66	20 Jun 66	19 Aug 66	39

Course	Class No.	Report	Start	Close	Input
Artillery Ballistic Meteorology (6-H-103.1) (9 Weeks, 4 Days)	1-66	9 Jul 65	12 Jul 65	17 Sep 65	34
	2-66	6 Aug 65	9 Aug 65	15 Oct 65	34
	3-66	10 Sep 65	13 Sep 65	19 Nov 65	34
	4-66	8 Oct 65	11 Oct 65	17 Dec 65	34
	5-66	7 Jan 66	10 Jan 66	18 Mar 66	35
	6-66	4 Feb 66	7 Feb 66	15 Apr 66	35
	7-66	11 Mar 66	14 Mar 66	19 May 66	35
	8-66	8 Apr 66	11 Apr 66	17 Jun 66	35
		REPORT PHASE I	REPORT PHASE II		
FA Radar Maintenance (6-N-211A/211.3) *** (Phase I, 12 Wks, 2 Days) (Phase II, 14 Wks, 1 Day) (Total: 26 Wks, 3 Days)	1-66	12 Jul 65	6 Oct 65	1 Feb 66	23
	2-66	15 Nov 65	24 Feb 66	7 Jun 66	21
	3-66	28 Mar 66	22 Jun 66	4 Oct 66	21
Sergeant Missile Battery (6-N-161.2) (6 Weeks, 2 Days)	1-66	9 Aug 65	10 Aug 65	23 Sept 65	28
	2-66	4 Oct 65	5 Oct 65	18 Nov 65	28
	3-66	7 Feb 66	8 Feb 66	24 Mar 66	28
	4-66	4 Apr 66	5 Apr 66	18 May 66	30
Pershing Specialist (6-N-214E/6-N-163.2) (19 Weeks, 3 Days)	1-66	7 Jul 65	8 Jul 65	24 Nov 65	52
	2-66	19 Sep 65	20 Sep 65	18 Feb 66	51
	3-66	30 May 66	31 May 66	17 Oct 66	51
Pershing Specialist (Non-US) (6-N-163.2X) (17 Weeks, 3 Days)	1-66	23 Jan 66	24 Jan 66	26 May 66	32
	2-66	17 Apr 66	18 Apr 66	19 Aug 66	32

ENLISTED COURSES

Artillery Survey Specialist (6-R-153.1) (5 Weeks, 2 Days)	1-66	6 Jul 65	7 Jul 65	12 Aug 65	70
	2-66	3 Aug 65	4 Aug 65	10 Sep 65	70
	3-66	31 Aug 65	1 Sep 65	8 Oct 65	70
	4-66	28 Sep 65	29 Sep 65	4 Nov 65	70
	5-66	26 Oct 65	27 Oct 65	6 Dec 65	70
	6-66	4 Jan 66	5 Jan 66	10 Feb 66	70
	7-66	1 Feb 66	2 Feb 66	11 Mar 66	70
	8-66	23 Feb 66	24 Feb 66	1 Apr 66	70
	9-66	22 Mar 66	23 Mar 66	28 Apr 66	70
	10-66	19 Apr 66	20 Apr 66	26 May 66	70
	11-66	10 May 66	11 May 66	17 Jun 66	70
Artillery Sound Ranging Adv (6-R-155.2) (8 Weeks)	1-66	13 Jul 65	15 Jul 65	8 Sep 65	20
	2-66	28 Sep 65	30 Sep 65	24 Nov 65	20
	3-66	4 Jan 66	6 Jan 66	2 Mar 66	20
	4-66	3 May 66	5 May 66	29 Jun 66	20
Radar Operations (6-R-156.1) (8 Weeks, 3 Days)	1-66	30 Jul 65	3 Aug 65	30 Sep 65	32
	2-66	27 Aug 65	31 Aug 65	28 Oct 65	32
	3-66	24 Sep 65	28 Sep 65	26 Nov 65	32
	4-66	29 Oct 65	2 Nov 65	14 Jan 66	32
	5-66	19 Nov 65	23 Nov 65	3 Feb 66	32
	6-66	14 Jan 66	18 Jan 66	17 Mar 66	32
	7-66	4 Feb 66	8 Feb 66	7 Apr 66	32
	8-66	18 Mar 66	22 Mar 66	18 May 66	33
	9-66	8 Apr 66	12 Apr 66	9 Jun 66	33
	10-66	20 May 66	24 May 66	22 Jul 66	33

***Phase I is basic electronic instruction

Course	Class No.	Report	Start	Close	Input
Pershing Missile Battery (121-163.1 formerly 6-R-163.1) (6 Weeks, 4 Days)	1-66	23 Jul 65	24 Jul 65	13 Sep 65	72
	2-66	24 Sep 65	25 Sep 65	12 Nov 65	71
	3-66	5 Jan 66	6 Jan 66	25 Feb 66	35
	4-66	13 Feb 66	14 Feb 66	1 Apr 66	35
Pershing Missile Battery (Non-US) (6-R-163.6X) (8 Weeks, 3 Days)	1-66	10 Mar 66	11 Mar 66	10 May 66	11
	2-66	5 Jun 66	6 Jun 66	4 Aug 66	11
Weather Equipment Maintenance (198-205.1 formerly 6-R-205.1) (14 Weeks)	1-66	16 Jul 65	19 Jul 65	25 Oct 65	7
	2-66	3 Jan 66	4 Jan 66	12 Apr 66	7
	3-66	18 Mar 66	21 Mar 66	27 Jun 66	6
Tracked Vehicle Mechanic (6-R-632.1/6-R-632.2) (7 Weeks)	1-66	5 Jul 65	6 Jul 65	20 Aug 65	39
	2-66	11 Jul 65	13 Jul 65	27 Aug 65	39
	3-66	18 Jul 65	20 Jul 65	3 Sep 65	39
	4-66	25 Jul 65	27 Jul 65	10 Sep 65	39
	5-66	1 Aug 65	3 Aug 65	17 Sep 65	39
	6-66	8 Aug 65	10 Aug 65	24 Sep 65	39
	7-66	22 Aug 65	24 Aug 65	8 Oct 65	39
	8-66	29 Aug 65	31 Aug 65	15 Oct 65	39
	9-66	5 Sep 65	7 Sep 65	22 Oct 65	39
	10-66	12 Sep 65	14 Sep 65	29 Oct 65	39
	11-66	19 Sep 65	21 Sep 65	5 Nov 65	39
	12-66	26 Sep 65	28 Sep 65	10 Nov 65	39
	13-66	10 Oct 65	12 Oct 65	24 Nov 65	39
	14-66	17 Oct 65	19 Oct 65	3 Dec 65	39
	15-66	24 Oct 65	26 Oct 65	10 Dec 65	39
	16-66	31 Oct 65	2 Nov 65	17 Dec 65	39
	17-66	21 Nov 65	23 Nov 65	21 Jan 66	39
	18-66	28 Nov 65	30 Nov 65	28 Jan 66	39
	19-66	5 Dec 65	7 Dec 65	4 Feb 66	39
	20-66	9 Jan 66	11 Jan 66	25 Feb 66	39
	21-66	16 Jan 66	18 Jan 66	4 Mar 66	40
	22-66	23 Jan 66	25 Jan 66	11 Mar 66	40
	23-66	30 Jan 66	1 Feb 66	18 Mar 66	40
	24-66	6 Feb 66	8 Feb 66	25 Mar 66	40
	25-66	13 Feb 66	15 Feb 66	1 Apr 66	40
	26-66	27 Feb 66	1 Mar 66	15 Apr 66	40
	27-66	6 Mar 66	8 Mar 66	22 Apr 66	40
	28-66	13 Mar 66	15 Mar 66	29 Apr 66	40
	29-66	20 Mar 66	22 Mar 66	6 May 66	40
	30-66	27 Mar 66	29 Mar 66	13 May 66	40
	31-66	3 Apr 66	5 Apr 66	20 May 66	40
	32-66	17 Apr 66	19 Apr 66	3 Jun 66	40
33-66	1 May 66	3 May 66	17 Jun 66	40	
34-66	8 May 66	10 May 66	24 Jun 66	40	
35-66	15 May 66	17 May 66	1 Jul 66	40	
36-66	22 May 66	24 May 66	8 Jul 66	40	
37-66	5 Jun 66	7 Jun 66	22 Jul 66	40	
38-66	12 Jun 66	14 Jun 66	29 Jul 66	40	
AN/TRC-80 Operations (Pershing) (6-R-F24) (9 Weeks)	1-66	15 Jul 65	16 July 65	17 Sep 65	15
	2-66	23 Sep 65	24 Sep 65	29 Nov 65	15
	3-66	3 Dec 65	6 Dec 65	18 Feb 66	15
	4-66	4 Mar 66	7 Mar 66	6 May 66	10
Communications Chief (6-R-F31) (12 Weeks)	1-66	8 Jul 65	9 Jul 65	1 Oct 65	38
	2-66	25 Aug 65	26 Aug 65	19 Nov 65	38
	3-66	6 Jan 66	7 Jan 66	1 Apr 66	38
	4-66	4 Mar 66	7 Mar 66	27 May 66	39
	5-66	27 Apr 66	28 Apr 66	22 Jul 66	39
Artillery Survey NCO (6-R-F34) (4 Weeks, 2 Days)	1-66	15 Nov 65	16 Nov 65	16 Dec 65	70
	2-66	31 May 66	1 Jun 66	30 Jun 66	70

Course	Class No.	Report	Start	Class	Input
FA Operations and Intelligence Assistant	1-66	1 Jul 65	2 Jul 65	21 Sep 65	38
	2-66	13 Sep 65	14 Sep 65	2 Dec 65	38
(6-R-F37) (11 Weeks, 1 Day)	3-66	5 Jan 66	6 Jan 66	25 Mar 66	37
	4-66	19 Apr 66	20 Apr 66	8 Jul 66	37

NEW COURSE NUMBERS

The Department of Army has published an advance document which changes the course numbers for the USAAMS resident courses. The converted numbers will become effective either upon publication of a revised DA catalog or as course revisions are approved by USCONARC, whichever comes first. Converted course numbers, when implemented, will be as follows:

Course Title	Former Nr	Revised Nr
FA Officer Refresher	6-A-C6	2-6-C6
FA Officer Basic	6-A-C20	2-6-C20
Artillery Officer Career	6-A-C22	2-6-C22
Associate FA Officer Career	6-A-C23	2-6-C23
FA Officer Candidate	6-N-F1	2G-F1
FA Officer Candidate (Res Comp)	6-N-F2	2-6-F2
Division Artillery Staff Officer Refresher	6-A-F5	2G-F1
Senior FA Officer	6-A-F6	2E-F4
Nuclear Weapons Employment	6-A-F19	2E-F12
Nuclear Weapons Employment (Res Comp)	6-A-F20	2E-F14
AN/TRC-80 Operations	6-R-F24	101-F2
Nuclear Weapons Employment	6-A-F26	2E-F13
FADAC Operator	6-D-F28	2F-F1 or 121-F1
FADAC Maintenance	6-D-F29	4B-F1 or 121-F2
Communications Chief	6-R-F31	101-F4
Artillery Survey NCO	6-R-F34	412-F1
FA Operations & Intelligence Assistant	6-R-F37	250-F1
Communications Officer	6-A-0200	4C-0200
Artillery Target Acquisition Officer	6-A-1154	2E-1154
Artillery Survey Officer	6-A-1183	2G-1183
Sergeant Officer	6-A-1190D	2F-1190-D
Pershing Officer	6-A-1190E	2F-1190-E
FA Radar Maintenance	6-N-211A	4C-211A
Pershing Specialist	6-N-214E	4F-214E
Artillery Ballistic Meteorology	6-H-103.1	5B-F1 or 420-103.1
Artillery Survey Specialist	6-R-153.1	412-153.1
Artillery Sound Ranging Advanced	6-R-155.2	412-155.2
FA Radar Operation	6-R-156.1	221-156.1
Sergeant Missile Battery	6-N-161.2	4F-F4 or 121-161.2
Pershing Missile Battery	6-R-163.1	121-163.1
Weather Equipment Maintenance	6-R-205.1	198-205.1
FA Radar Maintenance	6-N-211.3	104-211.3
Tracked Vehicle Mechanic	6-R-632.1	611-632.1
Tracked Vehicle Mechanic	6-R-632.2	611-632.2

STATUS OF TRAINING LITERATURE AND FILMS

TRAINING LITERATURE

1. The following training literature is under preparation or revision by the U.S. Army Artillery and Missile School or the U.S. Army Combat Developments Command Artillery Agency:

- A. FIELD MANUALS (FM):
- | | |
|--------------|--|
| FM 6-3-2 | Operations of Gun Direction Computer M18 (FADAC), Free Rocket Application. |
| FM 6-3-2A(S) | Gun Direction Computer M18, Cannon Application with Nuclear Ammunition. |
| FM 6-115 | Field Artillery Searchlight Battery. |
| FM 6-140 | Field Artillery Battalions and Batteries. |
| FM 6-141 | Doctrine for Effective Use of Nonnuclear Artillery Weapons, Part II. |
- B. ARMY SUBJECT SCHEDULES (ASUBJSCD):
- C. ARMY TRAINING PROGRAMS (ATP):

2. Training literature submitted for publication:

- | | |
|------------------|---|
| FM 6-2 | Artillery Survey. |
| FM 6-10 | Field Artillery Communications. |
| FM 6-15 | Field Artillery Meteorology. |
| FM 6-20-1 | Field Artillery Tactics. |
| FM 6-39 | Field Artillery Battalion, Pershing. |
| FM 6-60 | Field Artillery Rocket, Honest John with Launcher M289. |
| FM 6-161 | Radar Set, AN/MPQ-4A. |
| ASubjScd 6-50 | Air Movement. |
| ASubjScd 6-142.1 | (SRD) Nuclear Weapons Assembler(U) |
| ATP 6-100 | Field Artillery Cannon Units. |
| ATP 6-302 | Field Artillery Missile Units, Honest John and Little John. |
| ATP 6-555 | Field Artillery Battalion, Sergeant. |
| ATP 6-575 | Field Artillery Target Acquisition Battalion. |
| ATP 6-615 | Field Artillery Battalion, Pershing. |

TRAINING FILMS

1. The following training films are currently under production and scheduled for release during calendar year 1965:

- Communication Systems of the Direct Support Artillery Battalion.
- Weapons of the Field Artillery (Color TF 6-2804).
- Measuring Distance with DME, MC-8.
- Pershing Missile Assembly—Mounted.
- Helicopter Artillery RSOP—Part I and II.
- Fire Support Coordination for the Infantry Division.
- Operation of the Gun Direction Computer, M18.

2. Training films requested for production and release during fiscal year 1966:

Radiotelephone Procedure for Conduct of Artillery Fire.
Field Artillery Ammunition and Fuzes.
On-Carriage Fire Control Equipment.
Artillery Through the Ages.

3. Training films requested for revision during fiscal year 1966:

TF 6-3184, The AN/TPS-25 Ground Surveillance Radar, Moving Target Detection.

TF 6-1991, Service of the Piece, 105-mm Howitzer.

4. Training films recently released to Audio Visual Communications Center:

TF 6-3558, The Sergeant Artillery Guided Missile System.

TF 6-3609, The Pershing Missile Azimuth Laying Procedure.

TF 6-3515, Defense of the Field Artillery Battery (Active and Passive).

TF 6-3517, Pershing Missile System—Air Transported and Truck Mounted Operations.