

ARTILLERY TRENDS

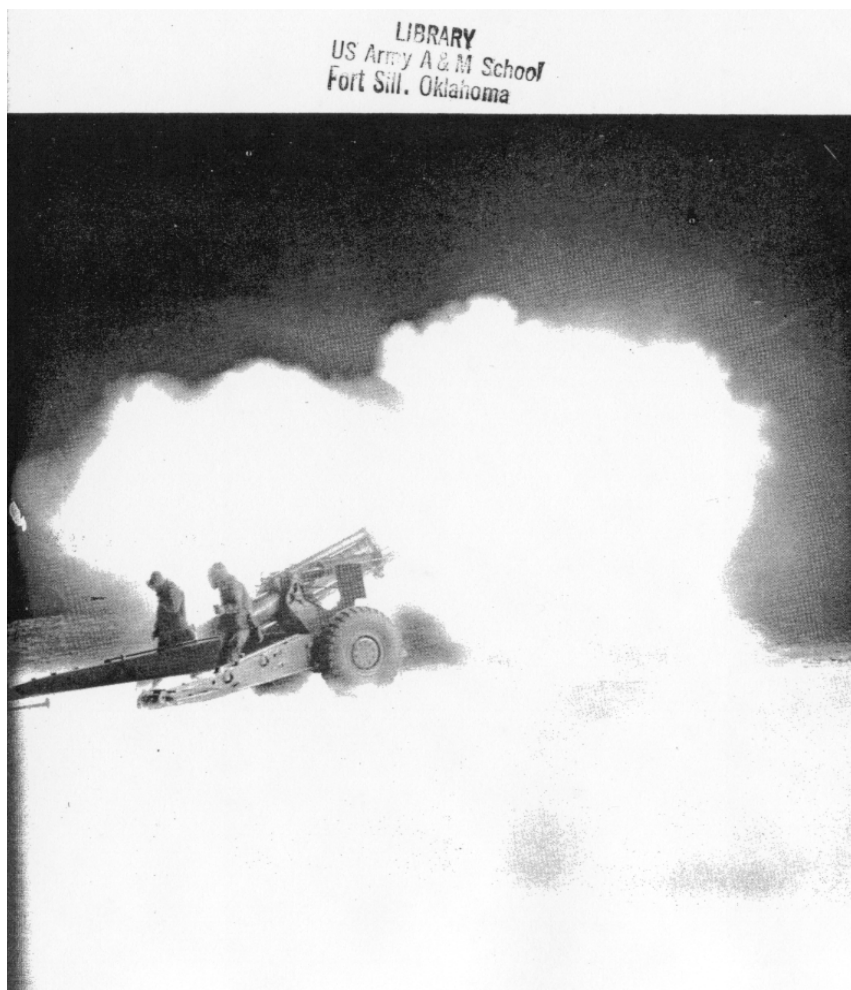

January
1963

U. S. ARMY ARTILLERY
AND MISSILE SCHOOL

ARTILLERY TRENDS

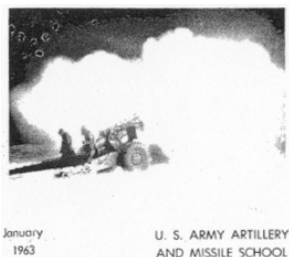

Instructional Aid Number 25

● COVER

A 155-mm howitzer fires at night in subzero temperature—and one of the results is ice fog. This howitzer is being fired under conditions described in **ARTILLERY TRENDS'** feature article, **COLD WEATHER OPERATIONS**, page 6.

● ARTICLES

MET MESSAGE INTERPOLATION	3
Northern area artillery—COLD WEATHER OPERATIONS	6
Better antenna mountings to—IMPROVE YOUR COMMUNICATIONS Part I	23
Part II	25
Latest status Charts—GRAPHICAL FDC EQUIPMENT	29
Field artillery's newest missile—PERSHING	36
AERIAL OBSERVATION: "Nap of the Earth Style"	41

● NEWSNOTES

News of, for, about the Artillery World	43
---------------------------------------------------	----

● ARTILLERY BULLETINS

Late Gunnery Information	46
------------------------------------	----

● RESIDENT COURSES

Current Resident Course Schedule	48
--------------------------------------------	----

● TRAINING LITERATURE

Status of Training Literature	50
-----------------------------------------	----

● SUBJECT INDEX

Subject Index for 1962 ARTILLERY TRENDS	52
---------------------------------------------------	----

ARTILLERY TRENDS is a publication of the United States Army Artillery and Missile School appearing only when sufficient material of instructional nature can be gathered.

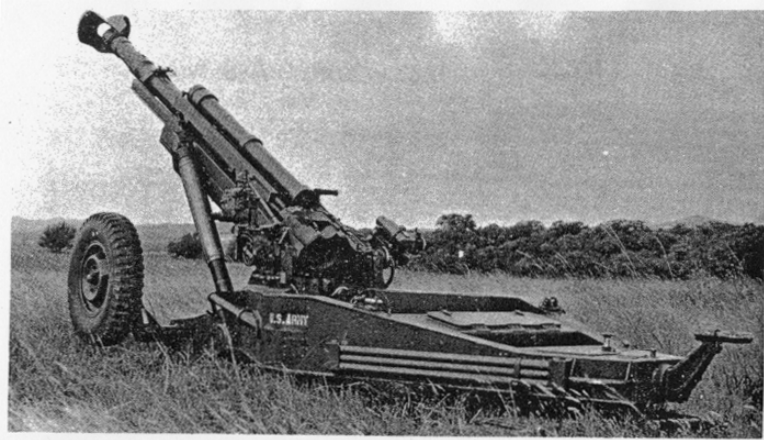

KEEP CURRENT
For the Latest in Artillery,
Subscribe to ARTILLERY
TRENDS

SUBSCRIPTION ORDER

TO: Book Department, USAAMS
For Sill, Oklahoma

Please enter my subscription for copy/copies of each issue of
ARTILLERY TRENDS for issues. Start subscription with:

Current Issue () (check one) (Next Issue ()

Mail to the following address:

NAME

RANK & SERVICE NO

ADDRESS

.....

This material will not be resold or otherwise released to individuals not
assigned to the military establishment or to agencies not connected with the
military establishment.

(RATES: 25c per copy. MINIMUM ORDER: 4 Issues.)

.....

(signature)

MET MESSAGE INTERPOLATION

ABSOLUTE VE's BY GRAPHICAL INTERPOLATION OF MET RANGE CORRECTIONS

Lieutenant Jerry L. Bradshaw
Lieutenant Wiley W. Dover
Gunnery Department

This article presents a rapid, accurate method of calculating Met Range Correction and, subsequently, Velocity Error from fall of shot absolute calibration data. A graphical plot of Met Range Correction as a function of met message time is used to determine the Met Range Correction for each mission. This procedure increases the accuracy of the Met Range Correction, which in turn increases the accuracy of calculated VE's for missions fired at times other than met balloon release time.

The ideal situation for calculation of absolute VE requires a meteorological message taken concurrently with the calibration firing. However, if an entire battery, or battalion, of weapons is being calibrated, it is apparent that most of the weapons will be firing between times of meteorological flights. Because meteorological effects normally vary from hour to hour, a more accurate method for obtaining the Meteorological Range Correction for weapons firing met messages would be interpolation between the messages bracketing the firing. For example: suppose a calibration firing was performed at 0930 hours with meteorological messages available at 0900 and 1000. Which message should be used to calculate the weapon's VE? It is evident that an average between the two mets should be better. However, instead of averaging the meteorological data, a complicated and tedious process, it is much simpler to calculate and average its end result, Met Range Correction. If the above example had been fired at 0915 the averaging process becomes slightly more complicated. Since 0915 is closer to 0900 than 1000, an interpolation should be used. 0915 is 25% of the difference between 0900 and 1000; therefore, the interpolated value would be the 0900 value plus 25% of the difference between the 0900 and 1000 values. The interpolated value could be calculated, but a simpler method for its determination is by graphical interpolation. A plot of Met Range Correction as a function of time, for a given charge, quadrant elevation, and entry range can be made and the Met Range Correction determined directly. Following is a step by step procedure for determining the Met Range Correction by graphical interpolation.

PROCEDURE:

1. Calculate the CI range and vertical interval for each weapon. This may be accomplished using Form DA 6-1.
2. Calculate site, adjusted elevation, and adjusted range for each mission.

3. Calculate the Total Range Correction for each mission.
4. Calculate the entry range for each mission and round to the nearest one hundred meters. In a battalion calibration of one charge there will normally be only two or three entry ranges. Determine the predominant entry range.
5. Using the predominant entry range, calculate the Met Range Correction (DA Form 6-15) for each met message.
6. Calculate the Met Range Correction for one met message at each entry range other than the predominant one.
7. Plot Met Range Correction as a function of met release time for the predominant entry range and connect succeeding points with straight lines. (See Figure 1).
8. Plot the point for Met Range Correction versus time for the other entry ranges, and through each point draw straight lines parallel to the graph from 7 above. (See Figure 1).

MET RANGE CORRECTION VS TIME

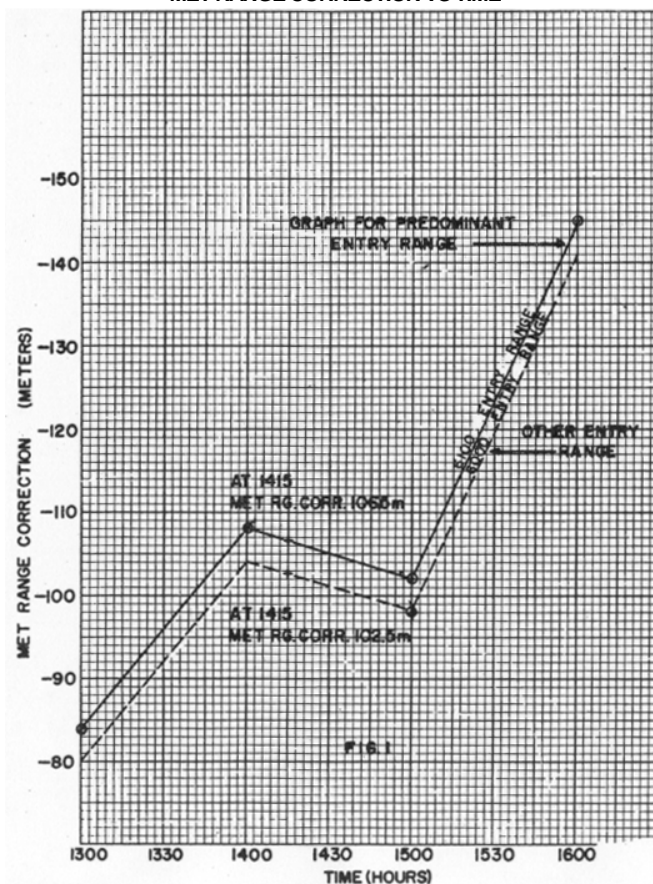

9. Determine the Met Range Correction for each mission from its appropriate graph (the one corresponding to the correct entry range), entering at the time the mission was fired.

PROBLEM EXAMPLE:

The following example is from a calibration performed by the Gunnery Department.

Predominant Entry Range	6100 meters
Other Entry Ranges	6000 meters
Met Range Correction	
at 6100 meters Entry Range	—84 meters at 1300 —108 meters at 1400 —102 meters at 1500 —145 meters at 1600
at 6000 Entry Range	—98 meters at 1500
Met Range Correction at 1415 hours from Graphs (Fig. 1):	
Entry Range 6100	(—106.5 meters)
Entry Range 6000	(—102.5 meters)

After determination of the Met Range Corrections, the VE for each weapon can be calculated using DA Form 6-15 (Met Data Correction Sheet). Actually, the only part of this form required for the VE calculation is the last portion (Computation of VE).

This method of absolute VE calculation has been used for several months by the Research and Analysis Division of the Gunnery Department and has proven successful by actual firings on battery and battalion tests. When calibrating several weapons, plotting met range correction versus time reduces the number of met messages that must be solved, thereby reducing calculating time.



FREE ROCKET FIRING DATA REPORT

Despite a marked improvement in recent months, many inaccurate and incomplete Free Rocket Firing Data Reports are received by the US Army Artillery and Missile School. The most frequent omissions and errors are:

- Failure to provide a complete computer's record.
- Failure to indicate low level wind procedure used and data used to compute final low level wind corrections.
- Failure to indicate height of burst miss distance.

These reports are a very important source of information for system improvement. They are the instrument by which you, the user, can increase the effectiveness of your rocket system. Please fill out your reports completely and accurately.



northern area artillery . . .

Cold Weather Operations

Lieutenant Colonel Theodore J. De Franco

1st Howitzer Battalion, 37th Artillery

Lieutenant Colonel Thomas O. Morrow

U. S. Army Arctic Test Board

History is filled with the records of winter military operations that ended in failure. The cold weather campaigns of both Napoleon and Hitler resulted in failure due to lack of preparations for severe winter weather. Comparatively few US Army artillerymen have had the opportunity to live and train in severe winter weather. This opportunity can be found in Alaska; the lessons learned there apply to similar areas in other parts of the world.

ENVIRONMENT

Artillery units operating in northern areas are faced with two main problems—mobility and survival. Because of the spring thaw, mobility is a greater problem during the warmer months of the year than during the colder months. Fluctuations in temperature cause daytime thaw and nighttime freeze. Continued melting conditions cause the spring breakup which, in addition to the spring rains, floods the lakes and streams and turns the surrounding plains into quagmires. Summer brings maximum daylight and a decrease in precipitation. These climatic factors cause drying conditions with extensive growth of vegetation, increased dust problems, and an abundance of insects in the low-lying areas.

In northern areas, the year can be divided into winter and summer, with these seasons being defined by thermometer readings instead of calendar dates. Winter occurs when the average daily temperature falls and remains below freezing, and summer occurs when the average temperature remains above freezing. A period of transition with wide temperature variations precedes each season.

The authors' contributions for this article have been supplemented with material extracted from draft field manuals and other material provided by the United States Army Combat Developments Agency, Alaska.

The deep cold of winter can make men numb and indifferent and cause them to neglect essential tasks. In addition, essential tasks require more time and effort. Under some conditions, even when the temperature is several degrees above the freezing point, a man in excellent physical condition can die from exposure in a matter of minutes. Frostbite can occur even in relatively warm temperatures if the wind removes the insulating layer of warm air close to the body and the body tissue is exposed. As an example, if the temperature is -30° F. and there is no wind, the windchill factor (fig 1) is 1,000, or very cold. But if the temperature is -30° F. and there is a wind of 3 miles per hour, the windchill factor is 1,400, and exposed flesh will freeze.

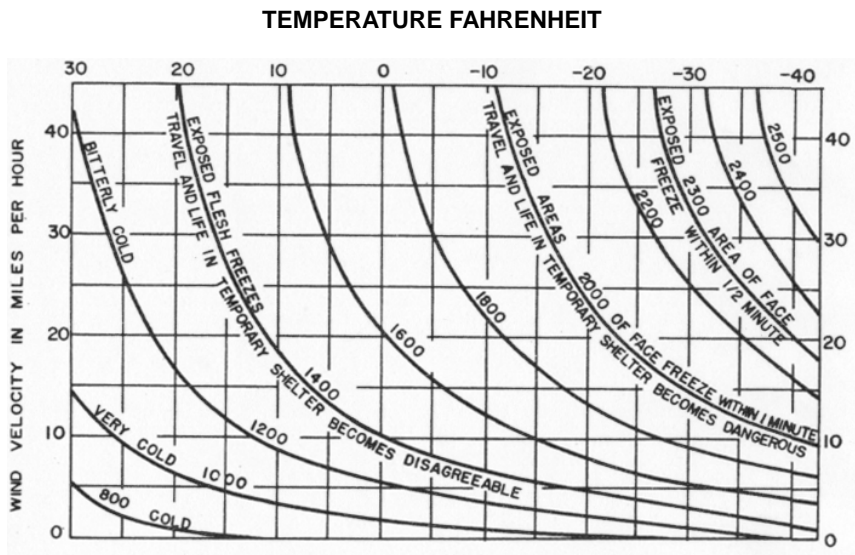

Figure 1. Windchill chart.

Another problem in northern areas is exposure to water which might occur in a fording operation. Since water has a cooling capability 23 times that of air, immersion of a person in water at $+42^{\circ}$ F. can produce shock or serious injury. If the immersion is continued, numbness develops. Death can occur within 5 to 10 minutes after immersion in water at $+36^{\circ}$ F.

TERRAIN

The terrain of northern latitudes consists of exposed bedrock, plains and plateaus covering this rock, and rugged mountains. Much of the area is within earthquake belts, with active volcanoes and glaciers present. This terrain is greatly varied and heavy vegetation, steep mountains, deep defiles, chasms, deep snow, ice-covered rivers, and running streams

are often found in close proximity to each other. The plains have numerous shallow glacial depressions, sloughs, swamps, ponds, and lakes. The plateaus have relatively smooth upland, many rolling hills, and broad sweeping valleys. Scattered rock outcroppings are present. Mountain elevations range from 1,500 meters to more than 5,500 meters within a distance of a few kilometers. Streams often have swift currents and extremely rocky bottoms. The many glacial rivers are silt-laden with numerous sandbars, shifting channels, and undercut banks. Mountains present special problems. Their varied and steep terrain places additional demands upon the skill of a skier and makes movement on snowshoes very difficult. Slopes which are easy to cross in summer often become difficult and dangerous to cross in winter because of deep snow cover and possible avalanches. Large drifts and snow cornices are dangerous obstacles. Snow cover on glaciers obscures crevasses and makes their crossing hazardous.

Perennially frozen ground, or permafrost, is found in most of the subarctic and arctic region. It varies in thickness from a few centimeters to several hundred meters in loosely defined continuous, discontinuous, and sporadic zones. The presence of permafrost affects drainage because of its impervious nature. If the permafrost thaws, the material changes to muck due to the large water content.

The heavily forested areas, with dense coniferous tree stands, are found where little or no permafrost is present. Certain broad-leaved trees will mix with narrow-leaved trees in zones of sporadic permafrost. As the area of permafrost becomes more continuous, vegetation becomes more stunted and is replaced by sedges, grasses, and mosses. In addition to thick forests, vegetation areas include dense brush, swamps, and numerous lakes and rivers. Skiing and snowshoeing are relatively easy on frozen, snow-covered rivers, lakes, and swamps. In wooded areas, concealment is best, but movement is hampered by vegetation and soft snow.

PHYSICAL PHENOMENA

Many seemingly weird conditions are common in arctic areas. In most areas, visibility is either very good or very poor, with average visibility considered uncommon. Fog, blowing snow, and variations in air density impair visibility. Light, reflected at various angles in air of changing density, produces mirages which confuse details of the landscape. Often, flat terrain features appear to be upended, objects far below the true horizon appear to be close and in sharp relief, and objects above the true horizon completely disappear.

Sound transmission depends on wind, temperature, and surface conditions. Normally, with an increase in elevation, windspeeds increase and temperatures decrease, resulting in supernormal sound intensity downwind. Normal conversation has been carried on between persons as distant as 2.4 kilometers and shouted words have been heard as far away as 4 kilometers.

Maximum windspeed occurs during periods of changing temperatures and prolonged velocities above 160 kilometers per hour have been recorded. Snow and silt begin drifting with winds above 16 kilometers per hour. With moderate winds, it is often difficult to determine whether snow is falling or being swirled up from the surface. Under conditions of no wind and low temperatures (-20° F. or lower), a phenomenon known as ice fog is common (fig 2). Ice fog results when water vapor is introduced into clear, calm air of low temperatures. Ice fog occurs at

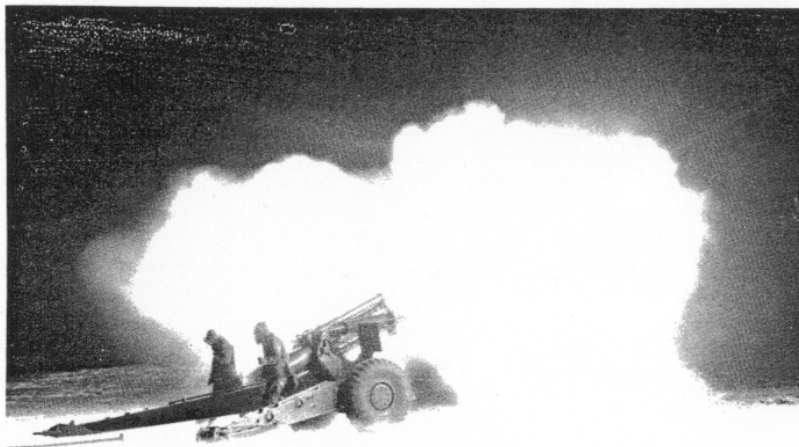

Figure 2. Ice fog shown around artillery piece firing at night.

the gun position and in the impact area on a calm cold day. At the gun position, the ice fog forms around the gun and obscures the view of the aiming posts. Likewise, lack of observation into the impact area because of ice fog can cause delays in firing until it lifts. Under certain conditions, this fog can last for hours or even days.

ARTILLERY OPERATIONS

Artillery units and artillerymen are confronted with many problems in addition to survival and mobility in arctic operations. Artillery fire is affected by the lack of accurate maps and by difficult conditions for observation. Position areas must be carefully reconnoitered to preclude bogging in deep snow or becoming stuck in muskeg (poorly-drained organic terrain covered with a thick, resilient, carpet of mosses and underlain by a high water table, peat of variable thickness, and often permafrost). Local defense becomes a serious problem because the open terrain makes positions more vulnerable to enemy observation, attack, and fire. Ice fog caused by firing of weapons, operation of vehicles, and personnel stoves reveals positions and limits observation. Severe cold adversely affects weapons seals and the recoil of weapons and hampers the activities

of gun crews. Meteorological data changes with rapid changes of temperatures and density. Since maps may be poor or unavailable, registration is critical. In many instances, Army aircraft must be used for spotting and adjusting fires, reconnaissance, locating friendly troops, marking targets for airstrikes, air delivery of supplies and messages, and as radio relay or control in the artillery radio net. All means of target acquisition must be employed.

Ground fog, haze, and brilliant snow reflection make adjustment difficult. Survival gear must be carried by observers at all times. Observers must be qualified to ski and snowshoe and must be in excellent physical condition. Cannoneers must wear their complete arctic clothing to prevent frostbite and frozen extremities of the body. While wearing the cumbersome arctic mitten set, the cannoneer finds it difficult to open fuze containers and prepare rounds, as his manual dexterity and sensitivity are severely reduced. The frequent rotation of troops from gun positions and observation posts to warming tents during the extreme cold is necessary unless troops can be furnished a suitable stove.

Observer parties must be equipped with track vehicles. Observers equipped with wheeled vehicles must expect to leave these vehicles in rear areas because of their inability to negotiate the terrain. Checkpoints, known locations, and appropriate terrain features are few and observers must use initiative and ingenuity. Extensive use of air observation is required. The air observer using Army aircraft must forward information on deep targets and observe all fire missions beyond the visual range of ground observers. In some instances, the attention of ground observers can be quickly directed to targets located by the observers in Army aircraft. The H-13- and HU-1-series helicopters (see page 64 for new numbering of helicopters) should be utilized extensively by commanders and their staff in gathering additional enemy information. Target restitution from aerial photographs is a highly accurate method of locating targets in arctic regions. Photo inspection is of great value in selecting routes and future positions.

AMMUNITION AND WEAPONS

Many problems are encountered in the storage, use, and performance of artillery ammunition at low temperatures. Behavior of propellants for artillery weapons at low temperatures is not consistent. In addition, increased amounts of carbon are generated by the burning of propellants at low temperatures, with resulting increased maintenance problems. When ammunition containers are opened to remove projectiles and propellants, the adhesive-backed cloth sealing tape breaks and is difficult to remove. In storage, the cloth facing separates from the adhesive at temperatures below 0° F. At temperatures below —25° F., approximately 90 percent failure of this tape occurs.

Fuzes present a special problem at low temperatures. Dud rates for point detonating fuzes are excessively high at low temperatures. Proximity fuzes (VT fuzes) do not perform effectively at low temperatures (below

—20°F.) and must be kept in warm storage. Under field conditions this is difficult and often impossible. VT fuzes are designed for use at temperatures between 0° F. and +120° F. and should be stored at temperatures between —20° and +130° F. If these fuzes are fired outside the temperature limits, their performance may be severely reduced, although firing safety will not be affected. An airburst with either a variable time (VT) or mechanical time fuze is most effective against personnel in the open. Although VT fuzes are adversely affected by conditions of the extreme cold and there is an increase in the number of malfunctions, it is one of the most effective fuzes for the arctic.

For most effective performance of ammunition, it should be placed on dunnage during storage. Ice and snow should be removed from ammunition prior to repacking. Containers and components must remain closed during temperature conditioning to prevent condensation. Only the ammunition required for the mission should be unpacked.

The distribution of fragments of high-explosive projectiles is greatly reduced when shells are detonated under snow. Test results at the US Army Arctic Test Board have indicated a smothering factor as high as 80 percent, when shells are detonated under only 4 inches of snow. Deep snow has an adverse effect on chemical shells. The canister from a base ejection shell may be smothered in the snow. The phosphorous shell produces the desired smoke but leaves phosphorous particles buried in the snow. These may remain as a possible hazard for several days.

Artillery weapons are also affected adversely by low temperatures. Maintenance of the weapons becomes a major problem. Care must be taken in assembly and disassembly as the parts may freeze, making reassembly impossible. Seals, for example, must be replaced with unusual frequency due to leakage caused by extreme cold and changing temperatures. Between rounds on howitzers using separate-loading ammunition, the breech must be swabbed with solvent instead of water, which freezes at 32° F. Special care must be taken in maintaining the weapon because of the presence of glacial dust, which sifts into the most intricate mechanisms. Equilibrators must be carefully exercised during extreme cold and the handwheels require excessive effort. Often, the handbrake fails to hold. Recoil systems may fail to return the piece to battery after prolonged exposure in temperatures from —40° to —68° F. Several warmup rounds are normally required to insure proper weapon functioning. The rate of fire is necessarily slow until weapons have been warmed; this is especially true for weapons having a hydropneumatic type of recoil.

Sights and other optical parts present special problems of their own. All sighting equipment should be kept at outside temperatures to prevent fogging. The gunner must be especially careful not to breathe on the sight lens, as this will cause the lens to fog. If it becomes necessary to take optical instruments into a warm shelter, they should be wrapped in heavy blankets prior to entering the shelter to allow gradual warmup. They should be kept wrapped **at least** 4 hours to prevent moisture damage. Another problem encountered on all weapons is the leveling

of bubbles. Bubbles become enlarged and sometimes separate. Vigorous rubbing of the level vial with the fingers will usually bring the bubble back together again.

Rocket units must protect their ammunition from extreme cold, as current propellants are not capable of withstanding extreme temperatures.

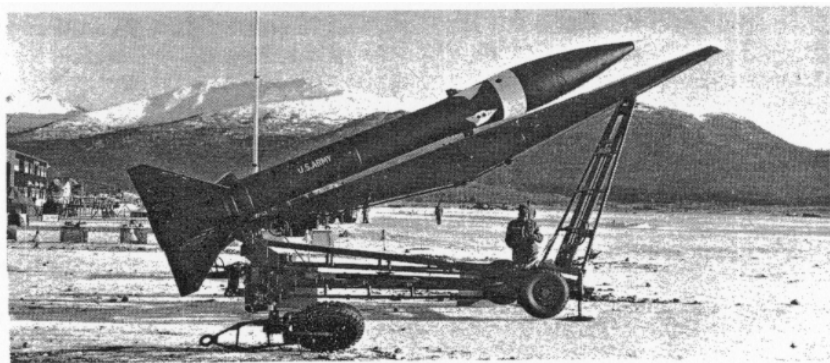

Figure 3. Honest John on display in Alaska.

Insulating and heating blankets or conditioning kits are required to maintain the propellant at safe firing temperatures. These items, in turn, require generators; petroleum, oils, and lubricants; and spare parts. This further complicates the supply system, increases the personnel and transportation requirements, decreases mobility, and contributes to the problem of camouflage and security by generating ice fog and noise and by adding definite identification characteristics to the rocket artillery unit.

During extremely cold periods and periods when temperature changes are sudden, ballistics are severely affected. During these periods, a K factor of 100 meters or more per thousand meters is not uncommon. During firing operations, frequent meteorological reports are required because of abrupt changes in the weather conditions. Corrections must be applied to firing data to compensate for the changes in weather during all firing of artillery pieces.

COMMUNICATIONS

Communications are both a vital necessity and a critical problem in northern areas. Radio is the primary means of communication in the arctic, particularly in areas of extremely low temperatures and in areas covered with deep snow. However, difficulties are experienced with limited range capabilities and with the operation of power supplies at very low temperatures. The use of all types of relay, particularly Army aircraft relay, is necessary. Both dry and wet cell batteries are affected by extreme cold in storage and in operation. The efficiency and life of a battery decrease in direct ratio to the cold. Low temperature, winter

batteries, distinguished by 2000-series type numbers, must be used. An example is the battery BA-2279 for the radio set AN/PRC-9. The 2000-series batteries should be stored at 0° F. Other batteries should be carried inside the operator's clothing whenever possible, to keep them warm. A spare set of batteries for field telephones should also be carried on the operator's person and exchanged with the batteries in the telephone at frequent intervals. Batteries other than the 2000-series can be reactivated by warming them thoroughly at temperatures not exceeding 100° F. These batteries perform best when operated at +70° F.

During extremely cold weather, the warmup time required for radios before operation is excessive. At —40° F. and below, when a radio set has been thoroughly exposed to the air and is "cold soaked," a warmup time of 4 to 6 hours is required. If a radio set is turned on before the warmup is completed, fuzes in receivers and teletype equipment blow out, and the tubes in transmitters burn out and sometimes shatter. Radio communication is also impaired by ice forming on whip antenna bases, causing arcing from antenna to ground. In emplacing antenna systems, it is nearly impossible to drive stakes manually into the frozen ground. Air-hammers, shaped charges, and rocket stakes must be used. Figure 4 shows Radio Set AN/GRC 50 with its antenna emplaced.



Figure 4. Radio Set AN/GRC-50.

Wire communication in the arctic is very difficult. The wire itself is difficult to lay and service. It is easily lost in the snow. At —20° F.,

current issue wire must be warmed prior to laying. At -30° F., wire becomes brittle and breaks. Laying wire on the ground is undesirable because it is subject to damage from tracked vehicles. However, when overhead construction is attempted at low temperatures, the wire breaks. Wire lines are normally restricted to existing trails and roads and are vulnerable to all existing hazards. Poles are broken by storms or uprooted by frost heaves. Wire laying by light aircraft is economical and may be employed when practicable. A tracked vehicle is another suitable means of transport while installing wire on a cross-country route. It is usually less time-consuming to lay new lines than to attempt repair of old ones. Wire must be stored in a warm place up to the time of laying. Hand-splicing of wire must be accomplished with bare hands, which is difficult if not impossible at low temperatures. The adhesive quality of electrical tape decreases in the cold and the tape becomes stiff and unworkable; as a result, poor splices are formed.

At -30° F. all grease must be removed from telephone generators or they will freeze. At -30° F. the telephone handset will freeze even when a deicer is used. Likewise, telephone repeaters do not function properly at low temperatures.

LOGISTICS

Logistics are a great problem in the arctic. All supply movement to forward elements generally must be accompanied by tracklaying vehicles. In connection with this, one concept currently undergoing study is that of a tracked-train. It is believed that this concept will afford a flexible, high-volume supply transport capability. The supply problem in northern latitudes is increased during extreme cold weather due to the high usage rate. Usage factors during spring, summer, and fall afford no basis on which to stock parts that become critical during extreme cold. One unit in Alaska used as many tires during an extremely cold 2-week period in December as it had used during the preceding months of the year.

SURVEY

Survey in snow and extreme cold is slow and tedious. Lenses quickly become fogged. Computation of data will be expedited if temporary shelter is provided. Control points are difficult to locate and will normally be found only along well-established roads and railroads. Because of deep snow, crevasses, and other obstacles natural to arctic terrain, it is often simpler and faster to run a survey by following existing roads and trails even though the cross-country distance is considerably shorter. The use of electronic equipment, such as the tellurometer, makes survey more feasible. Helicopters and/or tracked vehicles are often employed to transport the survey teams to new positions.

ARTILLERY TACTICS

Artillery position areas must be carefully chosen. Supply difficulties greatly influence the selection of position areas. Positions must be considered for tactical utility and for protection from the elements. Prior to occupation of a position, the terrain should be carefully reconnoitered and gunpits, traffic lanes, and snow parapets should be prepared. Direct Support artillery should, when the situation permits, be located adjacent to or within the perimeter of infantry elements. Under winter conditions, it is impossible to dig in a position, although parapets of snow and ice can be built. In extreme cold, some type of heated shelter is required for personnel whose duties must be performed in the open.

Camouflage discipline must be strictly enforced. Limited camouflage can be provided by painting equipment. Tracks left in the snow cannot be effectively covered except by a fresh snowfall, and even in the arctic there are many periods without snowfall. Therefore, vehicles and troops must move only by designated trails and roads to maintain camouflage. Personnel should use white clothing in snow-covered areas (fig 5) for maximum camouflage.



Figure 5. Use of white clothing by an infantry ski patrol.

The large areas of maneuver which are typical of northern operations afford freedom for guerrilla activities and increase the proportion of total effort which must be diverted for effective counter-guerrilla operations. Winter affords the most favorable conditions for counter-guerrilla operations in northern areas. Swamps are accessible to regular combat organizations when they are frozen. Vegetation cover is minimal in winter and affords limited concealment; snow betrays trails; and the cold weather helps to separate guerrillas from their support.

During winter months, good observation is limited to a few hours a day because of the short periods of daylight. Snow cover reduces depth perception and obscures ground features and landmarks. Glare of the sun upon snow is intense and unless personnel wear dark glasses, continued exposure will cause painful snow blindness. Amber filters for observing instruments are required to reduce eyestrain. Personnel operating observing instruments must be relieved frequently or provided with shelter. Forward observer teams should be well trained in the use of over-the-snow equipment and in rock-climbing techniques.

A hot meal should be served to troops prior to the start of the day's operations if possible. Cold rations should be issued only as a matter of necessity. All ration components should be eaten as the complete balanced ration is designed to meet body requirements.

Cold weather clothing should be kept clean and dry, inside and outside. This type of clothing should be worn in loose layers, as weight does not mean warmth but layers do. Clothing should be loosened before the body begins to perspire to avoid overheating. Troops must wash daily, since the multiple layers of clothing can cause serious rashes and skin diseases.

LIGHT ARTILLERY WEAPONS

Because the standard towed artillery does not have sufficient flotation for movement over snow and breaks down rapidly when moved cross country over hard, frozen ground, much of the artillery used in northern areas is self-propelled. Organization and equipment of a unit may vary from standard due to the unique environment. The weapons of one battalion stationed in Alaska consist of a battery of 105-mm self-propelled howitzers and a battery of 75-mm pack howitzers with M59 armored personnel carriers as prime movers (fig 6). The 75-mm pack



Figure 6. Howitzer, inside armored personnel carrier, ready for movement.

howitzers are carried inside of the personnel carriers during movement (see ARTILLERY TRENDS, August 1961, page 51).

The 75-mm howitzer is well suited for the existing tactical and logistical situations in the arctic and for airlift. Compatibility with available airlift (fig 7) is very important, as the supported infantry units utilize Army helicopters as often as possible. The deep snow, subzero temperatures,



Figure 7. Airlift of 75-mm pack howitzer.

and vast areas of isolated, desolate arctic terrain severely restrict all but special purpose, over-snow vehicles. This situation demands air mobility for rapid movement to engage the enemy at a time and place of our choosing.

The 75-mm howitzer battery of this particular battalion participates in air-mobile training exercises from 30 to 40 times a year. Normally, 12 H-21 airlifts are required for a complete movement of the battery, including one lift of 80 to 100 rounds of 75-mm ammunition. The hookup (fig 8) for the airlift takes place in the old position area. The section equipment and from 4 to 8 rounds of ammunition are strapped on the trails of the piece. These items add approximately 350 lb to the 1,400-lb weight of the howitzer. Each cannoneer with his arctic pack and individual weapon is considered to weigh 250 pounds. The load that can be lifted with the H-21 varies with the weather and aircraft conditions, but the normal maximum load is 3,000 pounds. After the battery has displaced, further ammunition airlifts (fig 9) are carried by sling load or inside the helicopter. After the last battery load has been lifted, the prime movers prepare to move forward on order.

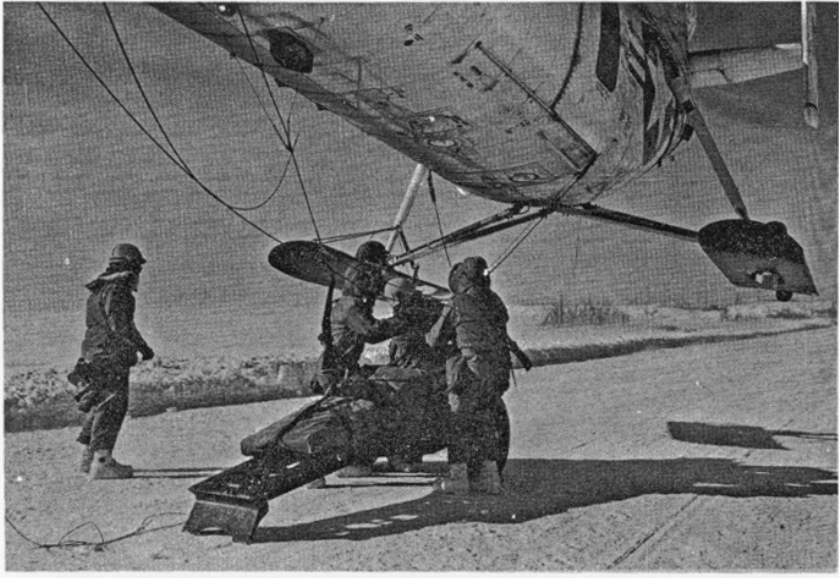

Figure 8. Attaching sling to 75-mm howitzer in preparation for airlift.



Figure 9. The H-21 helicopter carrying ammunition by sling.

HIGH ANGLE

Many tactical situations in arctic forests and mountains necessitate high angle fire, but the 75-mm pack howitzer has no on-carriage high angle capability due to its lack of split trails. A very successful system

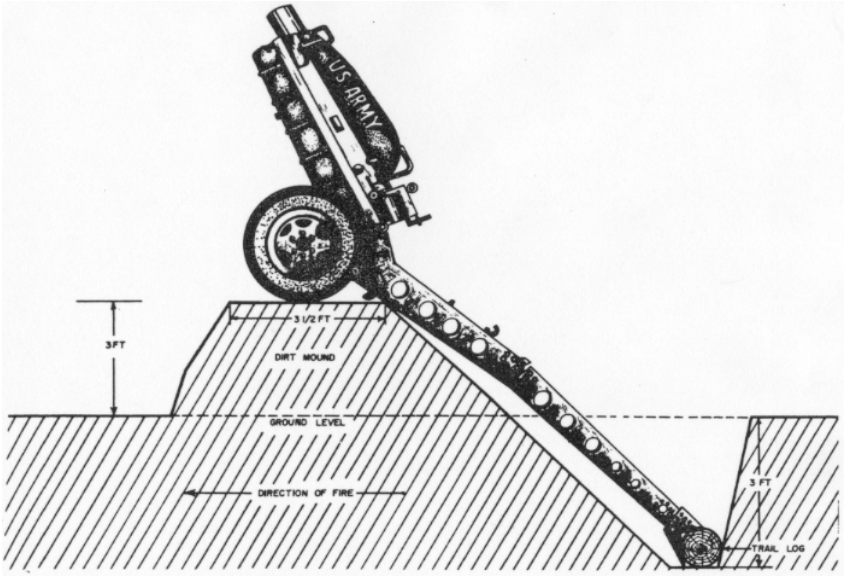

Figure 10. Side view of high angle pit for 75-mm pack howitzer.

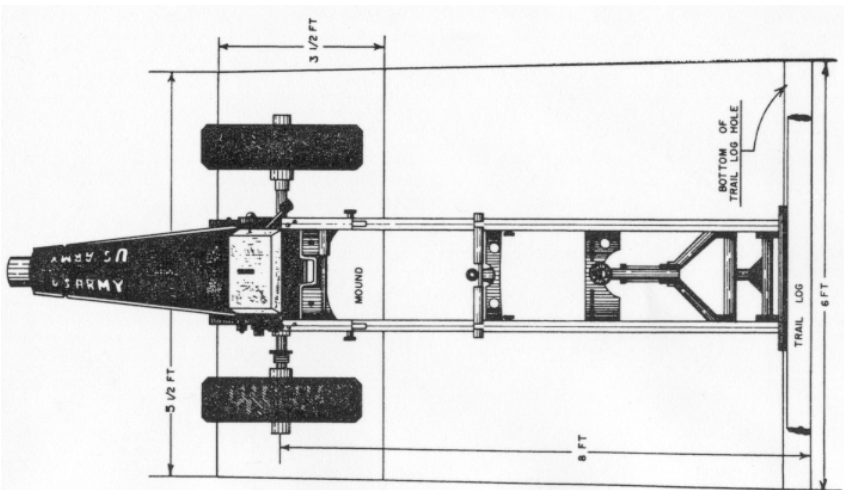

Figure 11. Top view of high angle pit.

(fig 10 and 11) which involves digging high angle pits adjacent to the primary position was developed. The major problems encountered with this method are the length of time required to dig these high angle positions and the difficulty involved in accomplishing large deflection shifts during the mission. After the pit is constructed, the weapon is lowered into the pit and layed at elevation 1150.

AVIATION

Army aviation, as shown above, is very useful in northern latitudes. However, many peculiar problems are presented by cold weather. An example of the effect of cold weather on aircraft components is the following: At temperatures below -30° F., conventional lubricants have the following consistencies—1100 engine oil, frozen solid; 1100 aircraft engine oil with maximum dilution, very thick (like peanut butter); OES and 10-weight oil, thicker than molasses. Aircraft engine oil must be drained and preheated prior to operation. Extreme cold greatly increases the amount of time required to perform a given task and reduces the scope of maintenance that can be performed. All metals become very cold through exposure, making work with bare hands nearly impossible, even when local heat is available.

Another operational problem is that of reduced visibility due to snow. Downwash from helicopter rotor blades and propwash from fixed-wing aircraft create snow blizzards during landing and takeoff on snow-covered surfaces. The pilot cannot see and loses his reference to the ground. A similar loss of ground reference occurs during a "whiteout," when the sky is overcast, visibility is restricted, and the ground is covered with snow.

MAINTENANCE OF VEHICLES AND EQUIPMENT

Maintenance is a difficult and critical activity in northern latitudes. Often, excessively cold temperatures freeze vehicle components instantaneously. When temperatures drop to -40° F., the wind chill factor may produce equivalent temperatures as low as -80° F. Use of arctic lubrication, constant monitoring of vehicles, and consistent and aggressive performance of first- and second-echelon maintenance is necessary. The rapid changes of temperature experienced in the far north within a limited period of time cause a serious engine lubrication problem. Lubrication of equipment in accordance with temperature changes would require multiple changes of oil (OES to OE10, to OE20, to OE30) in short periods of time. One post in Alaska reported a temperature rise of 110° F. within a 48-hour period in December 1961.

Starting becomes a major problem at low temperatures. At -40° F. and lower temperatures, the available starting current from a lead-acid battery is sharply decreased, while at these temperatures the cold-soaked engine needs the highest output from the battery during cranking. Cold-soaked

batteries are slow to take a charge. These batteries are also very vulnerable to damage through handling, particularly when being removed for warming.

Excessive wear occurs on engines during starting and warmup in extreme cold weather. All engines at temperatures of -20° F. and below require engine heaters. Piston engines are inherently difficult to operate at very low temperatures. Operating difficulties begin to appear long before extremely low temperatures are reached. Ice forms in carburetors and air cleaners and causes air starvation resulting in erratic engine performance or causing the engine to stop. In some cases, fuel lines freeze or become clogged with ice while the vehicle is in operation. During extreme cold, the paraffin base in diesel fuel separates and clogs the fuel filter and stops the engine. Abnormally high rates of engine failure occur not only during starting and warmup but also during operation. Typical engine failures are seized engines, burned out connecting rod bearings, a rod thrown through the engine block, scarred cylinder walls and burned rings, broken starter housing, broken gear trains, and scarred shafts. At temperatures below freezing, carburetor intakes, fuel lines, and air breathers often ice and require on the spot operational maintenance. Wheel bearings are very susceptible to burning out in cold weather. Fuel filters must be replaced more often due to icing and resultant strain on the interior parts. Fan belts and flexible cables become stiff, crack, and break during cold weather and are high-usage items. Vehicle instrument panels freeze, and controls and gages fail to operate after prolonged exposure to cold.

Tires and tracks on vehicles become heated through flexing and friction during movement. Then, when the vehicle is parked for any length of time, the heat causes the surface to thaw where the vehicle is parked, and subsequent freezing bonds the tire or track to the surface. This problem may be solved by parking on a bedding of dry branches or other available material which is not susceptible to freezing. If the vehicle does freeze to the surface, it should either be thawed loose with a blower heater

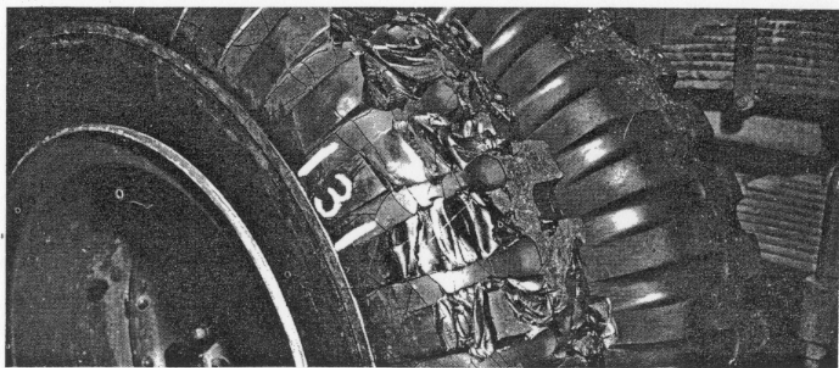

Figure 12. Tire failure at low temperatures.

or chipped loose. Tire failure (fig 12) is a major problem in extreme cold. Truck tires freeze and shatter at -50° F. Tread will break off in chunks while vehicles are running on roads at -60° F. Tire damage at extremely low temperatures is affected by tire loadings; however, the tires of 3/4-ton trucks are affected less than the tires of 1/4-ton trucks and 2 1/2-ton and larger trucks. Replacement tires which have been exposed to cold weather for long periods of time should be flexed slowly and carefully to minimize breakage.

The metal parts of a vehicle which are under continuous stress during operation, such as shock absorbers, springs, road wheels, and idler arm/link assemblies, become brittle in extreme cold and break at high rates. Power trains stiffen and brake bands freeze to brake drums. To help alleviate these problems, vehicles should be warmed every hour. At the temperature range of -25° to -45° F., all vehicles which do not have auxiliary heaters must be fast idled 10 minutes each hour. At the temperature range of -45° to -80° F., all vehicles must be fast idled 5 minutes then exercised 10 minutes each hour. During these warming periods, an alert, licensed operator must be present to observe the vehicle's instruments. Vehicle engines with auxiliary heaters should be prewarmed with this heater when the temperature is below -25° F. After starting, vehicles should be operated at reduced speed long enough to thoroughly warm up the chassis components after prolonged shutdown. Snow, slush, and other materials should be cleaned out of tracks and suspension immediately after stopping the vehicle.

ROAD CONSTRUCTION

An additional requirement for units operating in northern areas is constructing expedient roads, as there are few existing roads in vast sections of the arctic. Routes for winter roads should avoid heavily timbered areas, and lakes and river surfaces should be used whenever possible. Grades must be kept to a minimum and the radius of curves must be greater than 50 meters and preferably more than 100 meters. On many occasions the simplest road is constructed by removing the existing snow cover and allowing the ground to freeze sufficiently, if not already frozen. In areas of deep snow, snow roads can be constructed. One type of snow road can be built by moving tracked vehicles over the snow and allowing this surface to freeze.

* * * * *

The artillery must be prepared to perform its mission under all conditions of terrain and weather. Presented above are some of the problems with which artillery units are confronted in northern operations. Equipment and techniques have been and are presently being developed to overcome many of these problems. In the final analysis, however, it is the determination, ingenuity, and resourcefulness of the individual soldier which permits the successful accomplishment of the traditional mission of fire support under these adverse conditions.

better antenna mountings to . . .

Improve Your Communications

PART I--COMMUNICATIONS IN JUNGLE AND MOUNTAINOUS TERRAIN

Captain Eugene A. Reverse
Communication/Electronics Department

The counterinsurgency operations in Viet Nam have focused the spotlight on the difficulties of radio communication in jungle and mountainous terrain. To point out the progress in this area, we quote from a letter received from an advisor stationed in Viet Nam: "The artillery is seldom without communications when the field expedient RC-292 antenna is used by the battery and the half-rhombic antenna is used by the forward observer." The impact of this statement is best realized when the statement is compared to one taken from a letter written previously by the same advisor: "There have been numerous times that the forward observer could observe large numbers of enemy but could not send fire missions."

Through the use of the antennas mentioned above, Viet Nam units are communicating 15 to 18 kilometers through the heavy jungle cover, across mountainous terrain, and are attaining even greater ranges in open areas. Of significance is the fact that these ranges are attained using radio set AN/PRC-9, which has a rated range of 8 kilometers. In order that all artillerymen can profit from this advisor's experiences, the construction details and diagrams of each of these antennas follow.

Similar to the issue antenna, the field expedient RC-292 (fig 1) is an elevated, ground plane, omnidirectional antenna using a one-quarter-wave radiating element and three downward-pointing counterpoise, or ground plane, sections. Construction is simple and any tall pole or tree serves as a mast for the antenna. Of course, the higher the mast, the better the line of sight. The radiating section is simply the long AN/PRC-9 tubular antenna tied to the uppermost portion of the mast. The ground plane sections are part of the three field wire mast guys which are cut and retied after insulators have been placed in the sections of wire. These insulators are tied in the guys at a distance equal to the length of the radiating section, measuring from the point where the guys connect

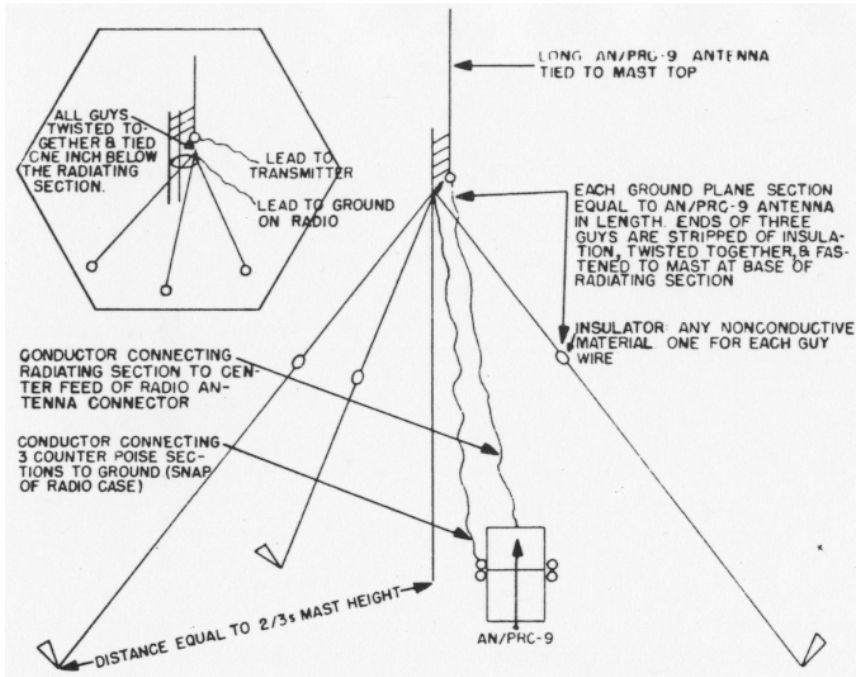

Figure 1. Field expedient RC-292 antenna.

to the mast. These guys must be long enough to be tied to stakes which are placed at a distance of two-thirds the length of the mast from the mast base. Conductors taken from a length of field wire serve to connect the antenna to the radio. One conductor connects the radiating section to the center portion (transmission feed) of the antenna connector on the radio, and the other connects the ground plane sections to the ground on the radio set.

The half-rhombic antenna (fig 2), when properly erected and adjusted, radiates the major portion of the signal fed to it in the direction the antenna is pointing. For reception, this antenna receives best the signals originating in the area toward which it is directed. In constructing this antenna, a length of field wire, 100 feet long, is raised in the center to a height of 30 feet. Lance poles lashed together, small masts, or a tree may be used for this support. A field wire counterpoise, 80 feet long, is then laid on the ground beneath the wire. At the radio end of the installation, the conductors of the wire forming the antenna are twisted together and inserted in the coaxial antenna connector of the radio set. The conductors of the counterpoise are then twisted together and connected to the ground, or outer portion of the antenna connector. At the opposite end of the antenna, the antenna wire is connected to the counterpoise wire through a 500-ohm resistor. Remember that this antenna is highly directional and must be pointed toward the station with which you are operating.

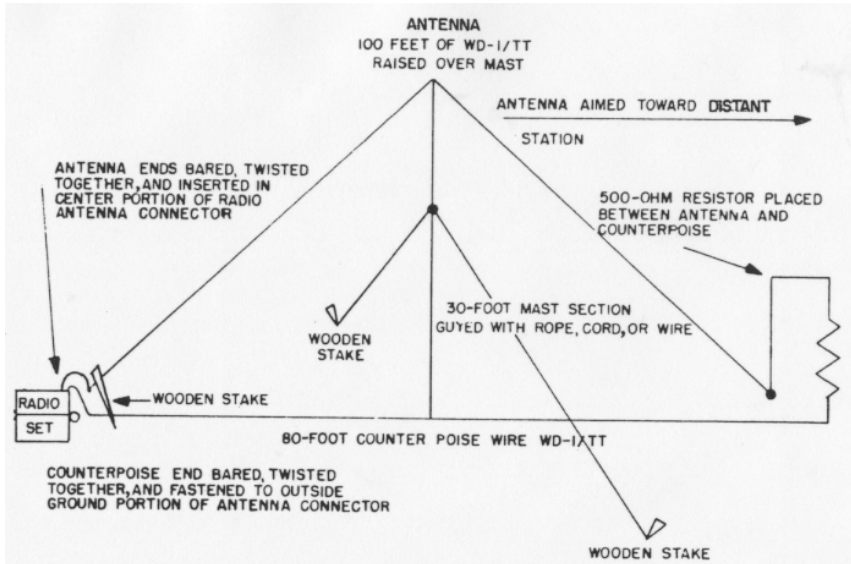

Figure 2. Half-rhombic antenna.

Extensive testing has proven that the proper use of these antennas will significantly increase the range of our tactical FM radios in all types of terrain and under all weather conditions.

PART II--ANTENNAS FOR ARTILLERY APC'S

1st Lieutenant Harry R. Spitz, Jr.

Battery B, 5th Howitzer Battalion (105-mm/155-mm) (SP), 82d
Artillery

1st Cavalry Division Artillery

Has your armored artillery unit ever suffered from poor communications when using vehicular antennas? Have you frantically attempted to establish communication while fire direction center personnel assembled the sections of the RC-292 antenna, measured the distances for the pegs (precisely 120° apart), struggled to drive the pegs into frozen or rocky ground, attached guy lines, and, finally, erected the antenna shakily? **Has an incident of this nature ever happened in your unit?**

If so, you may be interested in the progressive thinking and initiative which one unit has shown in tackling this problem. Recognizing the need for rapid communications when terrain or distance prohibits the use

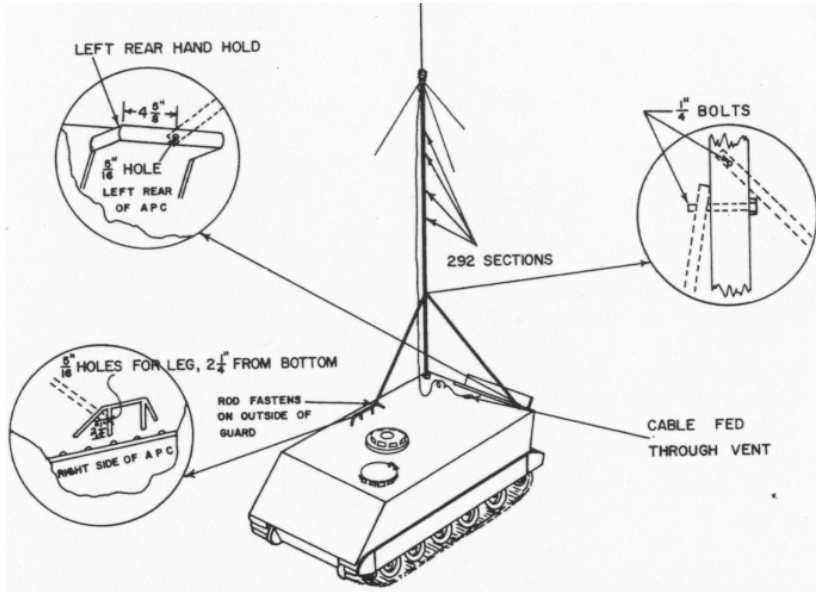

Figure 3. RC-292 antenna mounted on M113 armored personnel carrier.

of vehicle antennas, this unit devised a system of permanent mountings on the FDC armored personnel carrier (fig 3). These mountings enable two men to erect the RC-292 and have it operational within 1 minute.

Here are the construction details. First, fabricate the bracket shown in figure 4. This bracket should be mounted under the outside retaining bolts of the right rear lifting ring (fig 5). Next, attach a 14-foot length of 1 1/2-inch iron pipe to this bracket by drilling holes as shown in figure 6. In the final installation, this pipe will extend straight up from the right rear of the armored personnel carrier (APC). To support this pipe, two braces are needed—one from the left rear handhold bracket and the other from the right front antenna guard. The two braces are lengths of 1/2-inch concrete reinforcing rod, one section 11 feet long (lateral brace) and the other 10 feet 2 inches long (fore and aft brace). These rods should be drilled as shown in figure 7. To mount these rods, drill a 5/16-inch hole in the left rear handhold bracket, 45/8 inches from the outside edge, and a similar 5/16-inch hole in the antenna guard, 21/4 inches from the bottom. After the pipe and braces have been mounted as shown in figure 3, the RC-292 antenna can be erected.

In raising the antenna, first assemble the five sections of the antenna and pin them together with 1/4-inch stove bolts. This assembly will slide firmly but easily over the 1 1/2-inch pipe. Next, attach the standard RC-292 head and cable (taping the cable only to the RC-292 sections). Feed the cable through the troop compartment air vent at the rear of the APC and connect the cable to the radios. The antenna is

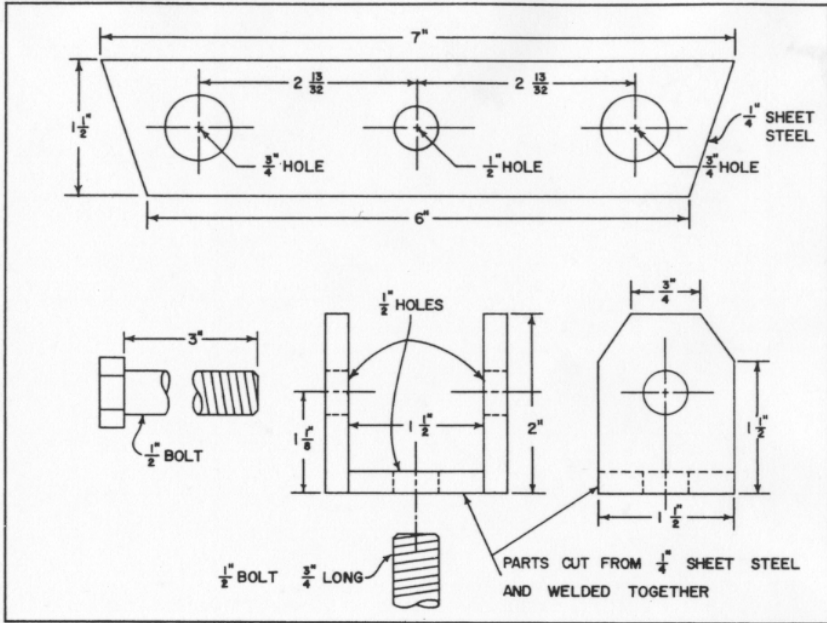

Figure 4. Mounting bracket.

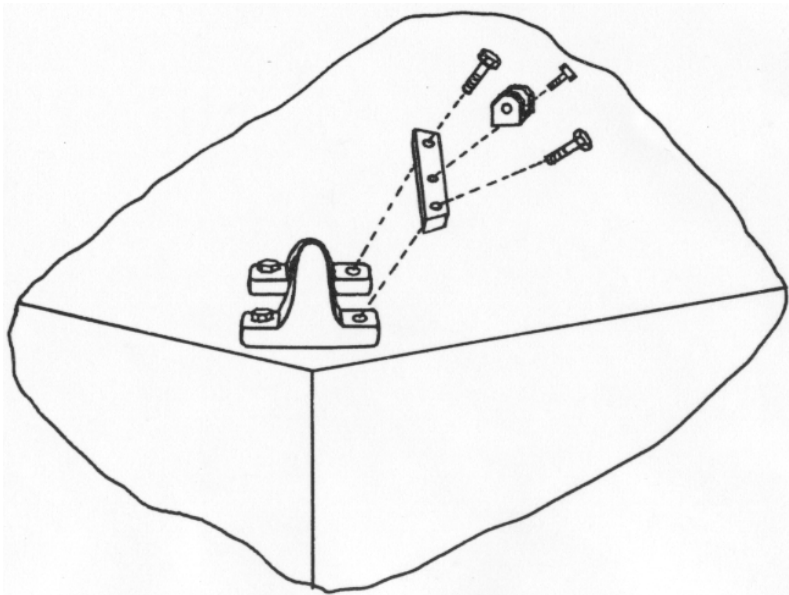

Figure 5. Bracket mounted under lifting ring.

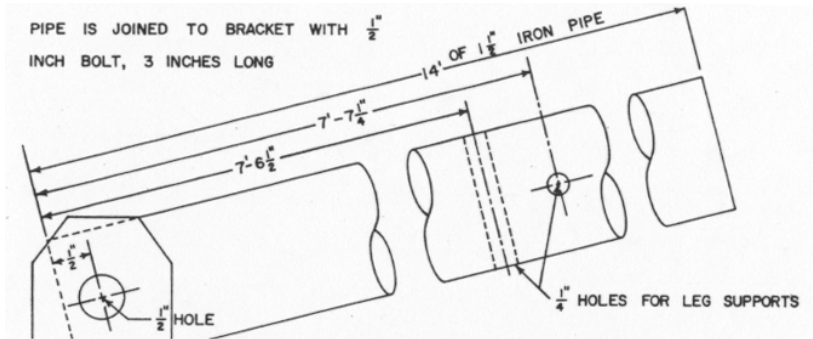

Figure 6. Method of mounting pipe.

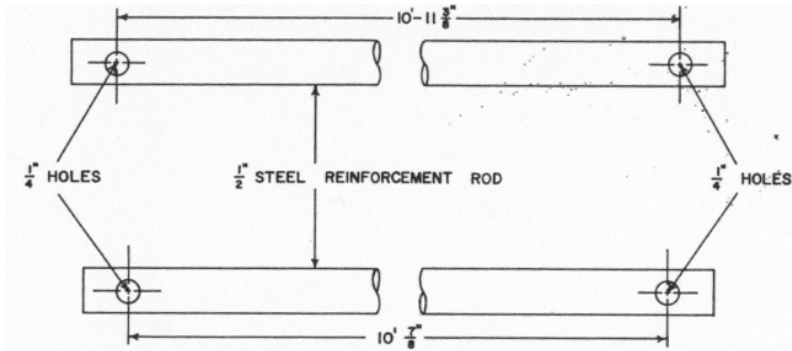

Figure 7. Holes drilled in braces.

now operational. Two men can erect this antenna as follows:

- Number one screws the antenna sections into the head and slides the complete assembly over the 11/2-inch pipe.
- Number two lifts the antenna and "walks" it up to a vertical position.
- Number one positions the braces, first the lateral brace and then the longitudinal one. He secures these braces with 1/4-inch stove bolts.

The parts needed for this system are few: a bracket, as shown in figure 2; a 14-foot length of iron pipe; two lengths of steel reinforcing rod; five sections of the RC-292 antenna with the complete head and cable; eight 1/4-inch stove bolts 3 inches long; a 1/2-inch bolt 21/2 inches long; and a 1/2-inch bolt 1 inch long.

Try this antenna in your unit; it could easily mean the difference between timely, effective fire support and ineffective firepower due to poor communications.

latest status charts . . .

GRAPHICAL FDC EQUIPMENT

1st Lieutenant Milton S. Newberry
Gunnery Department

Once again, ARTILLERY TRENDS presents handy, removable charts (fig 1) containing the latest information concerning graphical fire direction equipment. To retain the latest status of graphical equipment and a list of the pertinent Federal Stock Numbers, you may wish to remove figure 1 from the center of this issue and place it on your bulletin board, desk, or clipboard.

GRAPHICAL FIRING AND SITE TABLES

Newly designed graphical equipment has been developed for all of the recently published tabular firing tables based on the International Civil Aviation Organization (ICAO) atmosphere and the metric system. Graphical equipment based on FT 155-Q-3 for the 155-mm howitzer, published in January 1960, was the first to appear with a change in size and design (ARTILLERY TRENDS, May 1960). Firing tables for the 8-inch howitzer and 105-mm howitzer have also been published, and the associated graphical equipment has been produced: FT 8-J-3 was published in January 1961; FT 8-O-3 was published in August 1961; FT 105-H-6 was published in November 1961; and changes 2 to FT 105-H-6 (FT 105-H-6 C2) were published in April 1962.

Shipment to ordnance depots of graphical equipment for use with FT 155-Q-3—including scale, graphical firing, M64 (formerly GFT); scale, graphical firing, site, M67 (formerly GST); and scale, graphical firing, M70, for use with illuminating projectile M118, MODS—was completed during February 1962.

Graphical equipment for use with FT 8-J-3—scale, graphical firing, M71, and scale, graphical firing, site, M72—was also sent to ordnance depots during February 1962 for issuance to user units. Graphical equipment for use with FT 8-O-3 (ARTILLERY TRENDS, August 1961)—scale, graphical firing, M85, and scale, graphical firing, site, M86—has been produced. Shipment of this equipment to ordnance depots is scheduled to begin during November 1962 for issue to troops during December 1962. As an interim measure, a limited quantity of graphical equipment for use with FT 8-O-3 was sent gratuitously to all active Army 8-inch howitzer units during December 1961 to fulfill minimum requirements.

Graphical equipment for use with FT 105-H-6 (ARTILLERY TRENDS, March 1961 and February 1962)—scale, graphical firing, M82, and scale, graphical firing, site, M83—has also been produced. It is expected that shipment of this equipment to ordnance depots will begin during November 1962 for issue to troops during December 1962. As an interim measure, a limited quantity of graphical equipment for use with FT 105-H-6 was sent to all active 105-mm howitzer units during May and July 1962. A scale, graphical firing, projectile illuminating, for use with FT 105-H-6 C2 has been developed and is currently being produced by the Book Department, US Army Artillery and Missile School (USAAMS). Pilot models of scale, graphical firing, subzone, and scale, graphical firing, site, subzone, for use with FT 105-H-6 C2 are presently being developed. The subzone ammunition with the propelling charge M89 (green bag) has a low muzzle velocity primarily designed for a minimum-range, high-angle capability.

Graphical fire direction equipment for use with FT 105-H-7 and equipment for use with FT 155-Q-4 will be developed as soon as data is available from the Ballistic Research Laboratories (BRL), Aberdeen Proving Ground, Maryland. These firing tables are to be published soon and are for the standard ammunition fired from the new self-propelled weapons (M108, 105-mm, and M109, 155-mm).

REQUISITIONING GRAPHICAL EQUIPMENT

THE REQUISITIONING OF GRAPHICAL EQUIPMENT THROUGH NORMAL SUPPLY CHANNELS WILL BE CONSIDERABLY EXPEDITED IF FEDERAL STOCK NUMBERS OF THE EQUIPMENT ARE INCLUDED WITH THE REQUISITION. At publication time, all of the latest metric equipment (with the possible exception of equipment for the subzone ammunition) should be available through normal supply channels. Graphical fire direction equipment may also be purchased in limited quantities from the Book Department, US Army Artillery and Missile School. Scales, graphical firing, based on FT 105-H-6, FT 155-Q-3, and FT 8-J-3, may be purchased for \$2.75 per set. Scale, graphical firing, based on FT 8-O-3, may be purchased for \$1.50. Scales, graphical firing, site, for all weapons may be purchased for \$2.50.

In the past, there has often been a considerable delay between the issue of a new firing table and the issue of associated graphical firing tables and graphical site tables. To reduce this delay, changes have been made in the administrative and funding procedures for these graphical items. These changes, when implemented fully, will provide for the concurrent issue of graphical firing and site tables with tabular firing tables. One of these changes is the use of the Army Stock Fund for the funding of graphical firing tables and graphical site tables. Graphical "sticks" will continue to be requisitioned, using the Army Stock Fund, with DA Form 1546. However, ordnance will require reimbursement as for other equipment currently funded by the Stock Fund. The relatively small cost of graphical firing tables and graphical firing site tables should place no burden on the units requiring this equipment.

Figure 1. Current status of graphical equipment (December 1962).

105-mm Howitzer

	FT 105-H-4 Yds-OSA	FT 105-H-6 M-ICAO	FT 105-H-6 C2 M-ICAO (ILLUM & SUB ZONE)	FT 105-H-7# M-ICAO
Range and Deflection	PROTRACTOR, FAN, RG DF (Aluminum) 16,500 yds SN 1290-266-6894 (Obsolescent)***	PROTRACTOR, FAN, RG DF (Aluminum) 15,000 meters SN 1290-266-6890 (Standard)	PROTRACTOR, FAN, RG DF (Aluminum) 15,000 meters SN 1290-266-6890 (Standard)	PROTRACTOR, FAN, RG DF (Aluminum) 15,000 meters SN 1290-266-6890 (Standard)
	GFT FAN M1 (Plastic) 15,000 meters SN 1220-335-4970 (Obsolescent)*	GFT FAN (Aluminum) 17,000 meters To be developed	GFT FAN (Aluminum) Not to be developed	GFT FAN (Aluminum) 17,000 meters To be developed
Elevation	GFT M39A1 Rule 1 and 2 (Obsolescent)***	SCALE, GRAPHICAL FIRING, M82 (GFT) Rule 1 and 2 SN 1220-815-6192 (Standard)****	SCALE, GRAPHICAL FIRING, (GFT, Proj Illuminating) Rule 1 and 2 SN 1220-978-9585 (Standard) In Production SCALE, GRAPHICAL FIRING, (GFT Sub Zone) Pilot Model being developed	SCALE, GRAPHICAL FIRING To be developed
Site	GST M53A1 (Obsolescent)***	SCALE, GRAPHICAL FIRING, SITE, M83 (GST) SN 1220-815-6190 (Standard)****	SCALE, GRAPHICAL FIRING, SITE, (GST, SUB ZONE) Pilot Model being developed	SCALE, GRAPHICAL FIRING, SITE, To be developed

* Metric paper ballistic scales based on FT 105-H-6 and FT 155-Q-3 will be pasted on obsolescent plastic ballistic scales and sent to 105-mm and 155-mm howitzer units.

** One standard aluminum GFT Fan with interchangeable aluminum ballistic scales to be developed for 105-mm, 155-mm, and 8-Inch Howitzers. Pilot models of ballistic scales based on FT 155-Q-3 and FT 8-J-3 have been completed and will be tested by the USAAB FY 63.

*** Present graphical equipment should be used until receipt of new graphical equipment.

**** In process of being issued to troops. Equipment based on FT 155-Q-3 and FT 8-J-3 in use by troops. Equipment based on FT 105-H-6 and FT 8-O-3 in use by troops in limited amounts.

Standard ammunition fired from M108 (105-mm) and M109 (155-mm) weapons.

155-mm Howitzer

	FT 155-Q-2 Yds-OSA	FT 155-Q-3 M-ICAO	FT 155-Q-4# M-ICAO
Range and Deflection	PROTRACTOR, FAN, RG DF (Aluminum) 16,500 yds SN 1290-266-6894 (Obsolescent)***	PROTRACTOR, FAN, RG DF (Aluminum) 15,000 meters SN 1290-266-6890 (Standard)	PROTRACTOR, FAN, RG DF (Aluminum) 15,000 meters SN 1290-266-6890 (Standard)
Elevation	GFT FAN M2 (Plastic) 15,000 meters SN 1220-335-4971 (Obsolescent)*	GFT FAN (Aluminum) 17,000 meters To be evaluated by USAAB**	GFT FAN (Aluminum) 17,000 meters To be developed
Site	GST M54 (Obsolescent)***	SCALE, GRAPHICAL FIRING, M64 (GFT) Rule 1 and 2 SN 1220-789-2985 (Standard)**** SCALE, GRAPHICAL FIRING, M70 (GFT, Proj Illuminating) Rule 1 and 2 SN 1220-898-4212 (Standard)****	SCALE, GRAPHICAL FIRING, (GFT) To be developed
		SCALE, GRAPHICAL FIRING, SITE M67 (GST) SN 1220-789-2986 (Standard)****	SCALE, GRAPHICAL FIRING, SITE To be developed

*
**

#

See Key for 105-mm Howitzer

8-Inch Howitzer

	FT 8-J-2 M-ICAO	FT 8-J-3 M-ICAO	FT 8-O-2 M-ICAO	FT 8-O-3 M-ICAO
Range and Deflection	PROTRACTOR, FAN, RG DF (Aluminum) 25,000 meters SN 1290-266-6891	PROTRACTOR, FAN, RG DF (Aluminum) 25,000 meters SN 1290-266-6891 (Standard)	PROTRACTOR, FAN, RG DF (Aluminum) 25,000 meters SN 1290-266-6891	PROTRACTOR, FAN, RG DF (Aluminum) 25,000 meters SN 1290-266-6891 (Standard)
Elevation	GFT FAN Not to be developed	GFT FAN (Aluminum) 17,000 meters To be evaluated by USAAB**	GFT FAN Not to be developed	GFT FAN 17,000 meters To be developed
Site	GFT Rule 1 and 2 (Obsolescent)***	SCALE, GRAPHICAL FIRING, M71 (GFT) Rule 1 and 2 SN 1220-898-4213 (Standard)****	GFT Not developed	SCALE, GRAPHICAL FIRING, M85 (GFT) Rule 1 SN 1220-876-8572 (Standard)****
	GST (Obsolescent)***	SCALE, GRAPHICAL FIRING, SITE M72 (GST) SN 1220-898-6786 (Standard)****	GST Not developed	SCALE, GRAPHICAL FIRING, SITE M86 (GST) SN 1220-876-8573 (Standard)****

**
*** See Key for 105-mm Howitzer

175-mm Gun

Range and Deflection	FT 175-A-1 M-ICAO
	PROTRACTOR, FAN, RG DF (Aluminum) 50,000 meters Scale 1:50,000 To be developed
Elevation	PROTRACTOR, FAN, RG DF (Aluminum) 25,000 meters SN 1290-266-6891
	SCALE, GRAPHICAL FIRING (GFT) Awaiting BRL Data
Site	SCALE, GRAPHICAL FIRING, SITE (GST) Awaiting BRL Data

**FREE ROCKETS
762-mm and 318-mm**

See FTR Categories Below M-ICAO
SCALE, LOW LEVEL WIND M78 FTR 762-A-2 SN 1220-884-7757 (Standard)****
SCALE, LOW LEVEL WIND M80 FTR 762-B-2 SN 1220-884-7755 (Standard)****
SCALE, LOW LEVEL WIND M79 FTR 762-C-1 SN 1220-884-7756 (Standard)****
SCALE, LOW LEVEL WIND M74 FTR 762-D-1 SN 1220-862-2294 (Standard)****
SCALE, LOW LEVEL WIND M81 FTR 762-E-1 SN 1220-884-7754 (Standard)****
SCALE, LOW LEVEL WIND M73 FTR 762-F-1 SN 1220-898-4214 (Standard)****
SCALE, LOW LEVEL WIND FTR 762-G-0 (Rev) Undergoing Field Testing
SCALE, LOW LEVEL WIND FTR 762-H-0 (Rev) Undergoing Field Testing
SCALE, LOW LEVEL WIND FTR 318-A-1 Undergoing Field Testing

**** See Key for 105-mm Howitzer

GFT FAN

The GFT fan, aluminum, with ballistic scales based on FT 155-Q-3 and FT 8-J-3, has been produced. Tests of this fan by the US Army Artillery Board should begin before the end of FY 63. Ballistic scales based on FT 105-H-6 are presently being developed by Frankford Arsenal. As an interim measure, paper ballistic scales based on FT 105-H-6 and FT 155-Q-3 will be pasted to obsolescent plastic ballistic scales for use with the present plastic GFT Fan. Once this has been accomplished, an attempt will be made to send these ballistic scales gratuitously to all active Army 105-mm howitzer units and 155-mm howitzer units.

LOW-LEVEL WIND SCALES

The low level wind scales for the 762-mm Rocket, M31 (Honest John) were shipped to ordnance depots during May 1962. As with other graphical equipment, this equipment should be requisitioned by federal stock number.

The low-level wind scales for the XM50 rocket and the 318-mm (Little John) rocket are undergoing further field tests to determine their usefulness.

SOVIET ARTILLERY WEAPONS

Corrective information has been received from the US Army Foreign Science and Technology Center regarding the article on Soviet artillery weapons which appeared in the July 1962 issue of ARTILLERY TRENDS. This information is as follows:

- Figure 1 on page 34 illustrates the Soviet 160-mm mortar M43 rather than the 160-mm mortar M160 as stated in the figure title. The rate of fire of the M160 is two to three rounds per minute.
- On page 36, the road weight of the 122-mm field gun, D-74, should read 14,500 pounds (estimated) and the projectile weight should read 55 pounds (estimated).
- On page 37, the projectile weight of the 152-mm gun howitzer round should read 90 pounds (estimated).
- On page 37, the rate of fire for the 203-mm gun howitzer, M55, should read three rounds in four minutes (estimated) and the projectile weight should read HE-225 pounds (estimated) and CP-240 pounds (estimated).
- On page 38, the road weight of the 140-mm rocket launcher, BM 14, with rockets, should read 18,000 pounds (estimated).
- On page 39, the size designation of the 280-mm rocket launcher should read 250-mm rocket launcher.
- Figure 12 on page 41 illustrates the SS-4 SANDAL missile rather than the SS-3 SHYSTER as stated.

field artillery's newest missile . . .

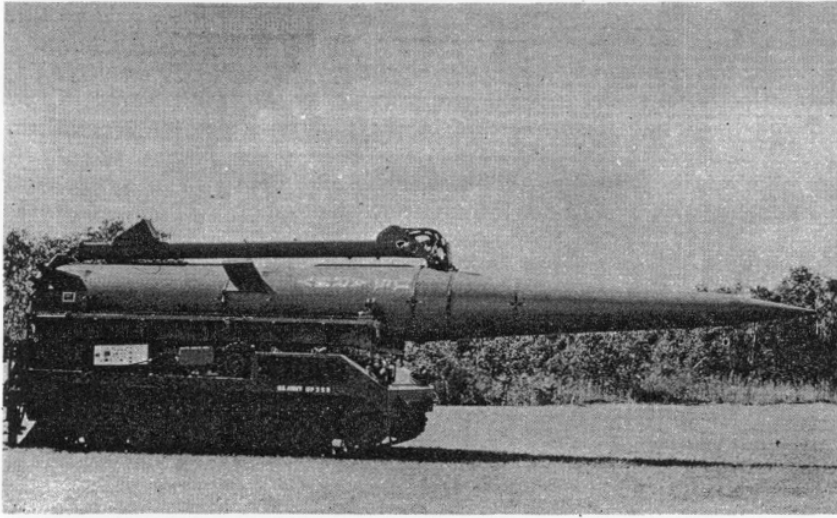

Lieutenant Colonel Fred A. Tupper
Captain E. E. Hausburg
Guided Missile Department

The Pershing program, which began in 1958, is rapidly approaching successful completion. Nearly all system design requirements have been met satisfactorily. As has been reported in ARTILLERY TRENDS, the Pershing test series was more successful than any previous series of its kind to be conducted at the Cape Canaveral Test Facility.

CHARACTERISTICS

Pershing is a two-stage, solid-propellant missile with an inertial guidance system. The use of a solid propellant contributes to the short reaction time of the Pershing, since no fueling operations are required during countdown. The missile measures slightly more than 34 feet in length and just over 3 feet in diameter. Although smaller and lighter than the Redstone missile, the Pershing can be fired at a far greater range. When fired, Pershing weighs 10,000 pounds. The inertial guidance system, using the ST-120 (stable table) as a space-fixed reference, is invulnerable to all known electronic countermeasures.

The Pershing system can be air transported by cargo aircraft; fourteen C-123 or ten C-130 loads are required. The system, less track vehicles, can also be transported to a position area in fourteen HC-1B Chinook cargo helicopter loads.

EQUIPMENT

The equipment necessary to fire the Pershing missile is transported

on four XM474E2 track vehicles. The XM474E2 vehicle is shown in figure 1.

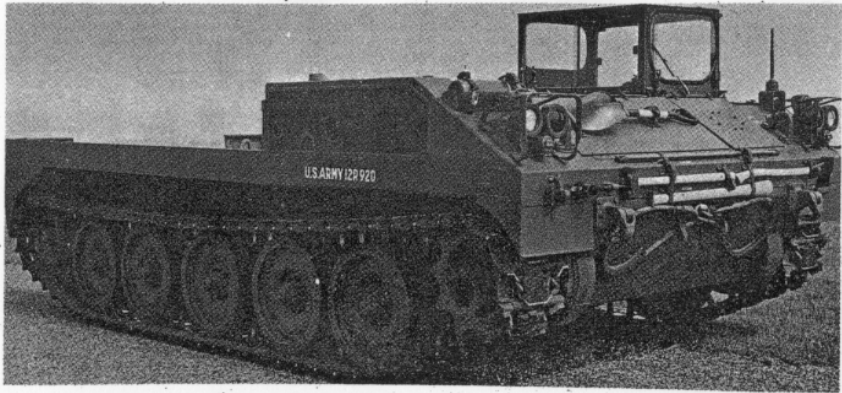

Figure 1. XM474E2, cargo version of the M113 armored personnel carrier.

The XM474E2 is a lightweight, unarmored, low-silhouette vehicle, which can operate at 40 miles per hour on improved roads and highways. Over rough terrain it is capable of extended travel and can ford to a maximum depth of 42 inches. Figure 2 shows the four XM474E2 vehicles loaded with Pershing equipment. These four basic Pershing prime

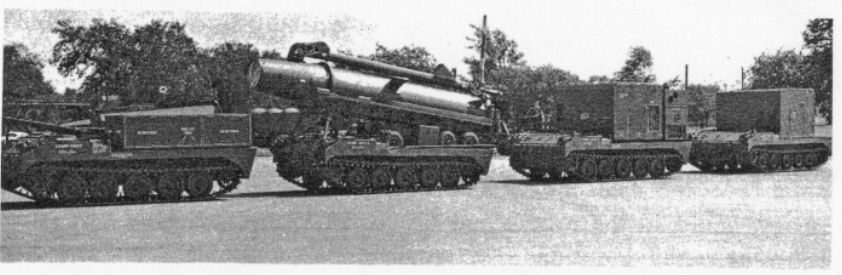

Figure 2. Pershing system transported by four XM474E2 track vehicles.

movers transport the warhead section and azimuth laying equipment; erector-launcher and missile (less warhead section); programmer test station, including a digital computer and power station; and the radio terminal set AN/TRC-80 (see ARTILLERY TRENDS, Feb 62, page 4). The programmer test station and the power station are shown in figure 3. Five wheeled vehicles are also organic to provide transportation for missile crewmen, to act as buffer vehicles for the warhead section carrier, to carry spare parts and tools, and to carry command and on-line cryptographic equipment.

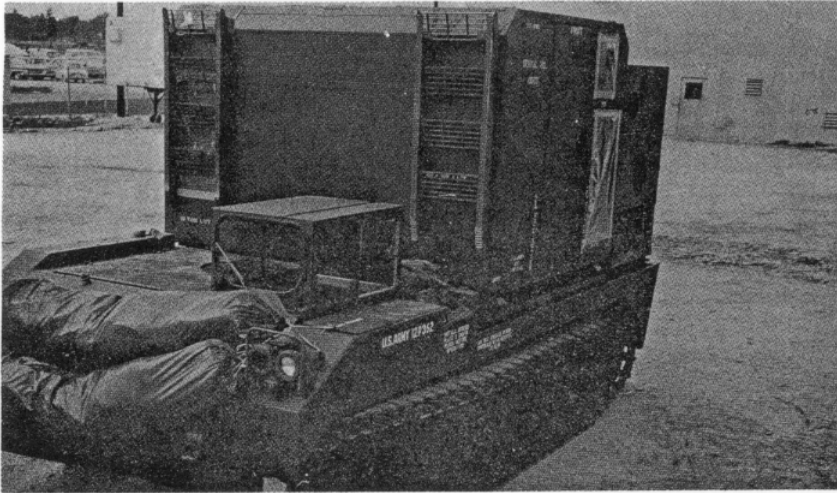

Figure 3. Programmer test station and power station.

Upon arrival at the firing position, warhead mating, missile checkout, azimuth laying, and the establishment of communications occur concurrently. Missile checkout and erection are accomplished as part of the countdown. Near the end of the countdown, control is passed from the programmer test station to a remote firing panel 500 feet from the launcher. It is at this panel that two firing buttons are simultaneously depressed to ignite the rocket motor.

On first-stage ignition, the missile rises vertically. A short time later, the pitch program is begun, causing the missile to tilt toward the target. At this time, the attitude of the missile is controlled by air fins and jet vanes in the exhaust nozzle on the first-stage motor. After the first-stage motor burns out, the missile coasts intact until a signal from the guidance system causes separation and second-stage ignition. The attitude of the missile is then controlled by the air fins and jet vanes on the second stage.

When the proper velocity and displacement from the launcher are attained, a second signal from the guidance system causes the warhead section to separate from the second stage (fig 4). The warhead section follows a ballistic trajectory to the target and the second-stage motor section and the guidance section (still joined) fall short of the target. An ablative coating protects the warhead section during reentry.

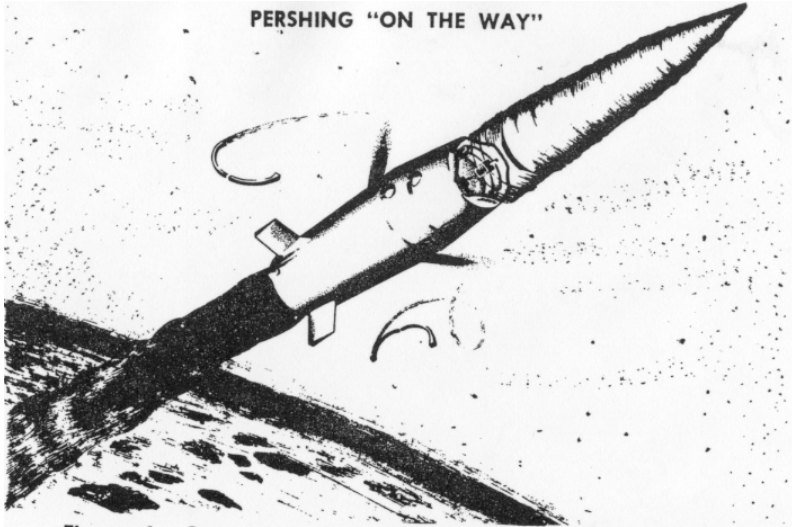

Figure 4. Separation of warhead section from second stage.

AZIMUTH LAYING

Pershing, the Army's longest range missile, presents to the artillery a new challenge in the field of azimuth laying. The Pershing system is designed for extreme accuracy, and accuracy in azimuth becomes more critical as range increases. Therefore, greater accuracy in azimuth laying than heretofore required with any other artillery weapon is necessary. Full utilization of Pershing's inherent capabilities depends upon the artilleryman's skill in laying the missile.

The Pershing missile is laid on its firing azimuth using the "lathe bed" method of azimuth laying. This method of laying, developed jointly by the US Army Artillery and Missile School, the Army Missile Command, and the Martin Company, permits the ST-120 to be laid on the firing azimuth before erection and permits the lay of the ST-120 to be verified after erection, just prior to firing.

Preliminary firing position survey includes the establishment of an orienting line (OL) and markers for positioning the erector-launcher (EL) vehicle. The OL may be established either by conventional survey or by use of the ABLE orientor which is organic in the Pershing battery. The following equipment is used to lay the missile: three Wild T2 theodolites (two of which are mounted on special tripods with translation bars called lathe beds), an aiming circle M2, and a remote torque control box, which is used to rotate the ST-120.

The theodolite without the lathe bed is emplaced on the OL. This instrument is called the orienting station theodolite (OST). A second theodolite, with its lathe bed tripod, is emplaced near the window on the side of the missile to permit optical viewing of the porro prism on

the ST-120. This prism is a mirrorlike device which is mounted so that a reflection can be seen at exactly 90° from the heading of the ST-120. The second theodolite is called the horizontal laying theodolite (HLT). The control box is initially located at the HLT. A vertical laying theodolite (VLT), also equipped with a lathe bed, is positioned by use of the aiming circle which is located at the center of the launcher position. The OST, by reciprocal collimation, transfers azimuth control from the OL to the HLT and the aiming circle. Positions of the instruments used in azimuth laying are illustrated in figure 5. When the HLT has been oriented

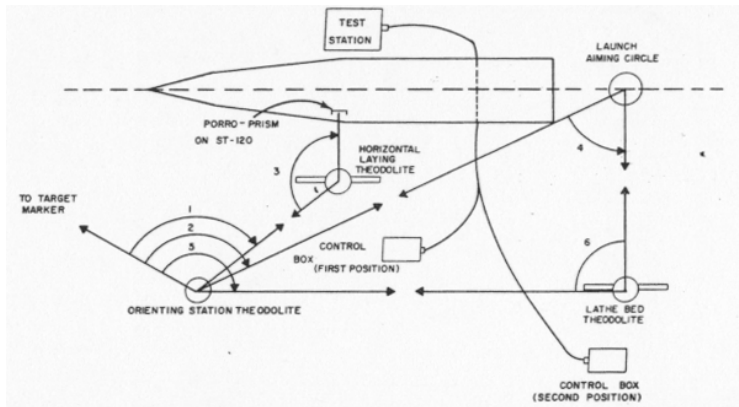

Figure 5. Positions of instruments for laying the Pershing missile.

by the OST, the HLT operator turns the HLT to a direction which is perpendicular to the firing azimuth. He then moves the HLT along the horizontal lathe bed until he can again see into the window on the side of the missile. To insure accuracy, the HLT operator then relevels and requalifies his instrument by again referring to the OST. Following this step, he uses the control box to electrically position the ST-120 until the HLT is autocollimated on the porro prism. The heading of the ST-120 is then coincident with the firing azimuth.

At the proper time in the countdown, the missile is erected and automatically rotated on the launcher until it is aligned with the inertial platform. Prior to this time, the VLT was roughly positioned by the aiming circle and exactly oriented by the OST. Therefore, the VLT operator can acquire the porro prism immediately after the missile is erected. After the missile has been raised to a vertical position and rotated to the firing azimuth, the laying procedure used earlier with the HLT is repeated for the VLT and thus a doublecheck on the laying is accomplished. Monitoring to correct for drift is continued until the area is vacated at the last moment before firing. This quick and accurate method of laying the Pershing, combined with the inherent accuracy of the missile system, enables the battlefield commander to influence the tactical situation with swiftness and accuracy never before possible.

AERIAL OBSERVATION:

"Nap of the Earth" Style

Captain Edwin C. Riley
Gunnery Department

One of the primary missions of Army aviation over the years has been aerial observation and the adjustment of artillery fire from the air. The requirements which prompted this mission still exist and will continue to exist. The most common system employed for accomplishing this mission has been a trained pilot in an L-19 or other observation aircraft, carrying a trained observer and flying at a given altitude in the old familiar racetrack pattern. This pilot-observer combination may be referred to as the Army aviation observation team (AAOT).

With the development of more sophisticated antiaircraft weapons systems, particularly the development of advanced techniques in electronic guidance and acquisition by air defense artillery, continued employment of the racetrack technique may leave our aircraft unprotected, making them simple targets for enemy antiaircraft fire. However, as was previously stated, the requirements for observation and adjustment of artillery fire from the air still exist and have multiplied with the increasing complexity and fluidity of modern mobile warfare.

The intelligence gathering capability of the AAOT, coupled with its ability to request and adjust large volumes of artillery fire, makes the AAOT a vital part of the modern combined arms team. Obviously, these capabilities are lost if the aircraft are shot down by enemy fire. When enemy air defense weapons are prevalent, about one turn around the racetrack is all a pilot can be expected to fly his aircraft without being detected and downed.

How, then, can we fulfill the artillery adjustment and surveillance mission and still not lose a prohibitive number of pilots, observers, and aircraft? "Nap of the earth" flight techniques offer a solution to the artillery portion of the problem.

As part of the curriculum of the Officer's Primary Utility Transport/Observation Rotary Wing Aviator's Course at Camp Wolters, Texas, the final 4 weeks are spent at Fort Sill, Oklahoma. During the first of these 4 weeks, in conjunction with training in the adjustment of artillery fire and aerial observation, students receive training in the "nap of the earth" flight techniques necessary to support these functions. The course covers some 33 hours, 12 in the classroom and 21 devoted to service practice.

The methods employed in the adjustment of artillery fire using "nap of the earth" flight techniques are no different from those used in the

past—volleys are successively adjusted to the gun-target line and range changes are made until effective fire is placed on the adjusting point. Similarly, no change has been made in observation and surveillance techniques. The big change is in the flight technique, particularly when employing helicopters.

The new technique is to fly as near the ground as possible, within the limits of flying safety, thus making use of all available cover and defilade and keeping exposure time to an absolute minimum. The observer must be able to see the rounds to adjust them; therefore, some exposure is necessary for him to accomplish his mission. For a well-trained observer, however, this time need not exceed 10 seconds per volley. The flight path of the aircraft must be planned so that the exposure time will be limited to that necessary for the aircraft to clear the mask, the observer to sense and correct the rounds, and the aircraft to disappear again behind the mask without being shot down. This technique is difficult and challenging. It requires maximum proficiency in both flying and adjustment skills, but it is being accomplished successfully.

Pilots are presently being trained in observation as well as in the flying techniques described above in order that they may better accomplish the overall mission. A skillful pilot can accomplish the entire mission of the AAOT by himself when necessary, thus freeing a trained observer for other important duties.

After the completion of thorough classroom courses—conferences in basic observation procedures and practical work on numerous classroom exercises—the student pilot attends three service practices, one conducted from the ground and two from the air. The ground shoot is intended to familiarize the student with the actual adjustment of artillery fire. In the first of the two aerial service practices, the student adjusts his fire as a regular air observer, while an instructor pilot flies the helicopter; in the second, the student not only adjusts his fire but also pilots the helicopter. By this time, he has an appreciation of "nap of the earth" flight techniques, giving him a firm base upon which to build his proficiency when he returns to his unit.

The need for aerial surveillance and rapid and accurate aerial adjustment of artillery fire is a continuing one, which is complicated with difficult problems. One of these problems, that of providing a system whereby observation and adjustment of artillery fire may be conducted with the greatest possible safety from enemy counteraction, has been at least partially solved by applying modern flight techniques to established observation techniques. With this combination, Army aviation will continue to support the field artillery and all parts of the combined arms team in the manner to which they have become accustomed.

"It was evident from the volume of artillery fire that we would not go very far. We were astonished by the flexibility and precision of the American artillery."

Field Marshal Rommel



THE ARTILLERY WORLD

AN/MPS-30 RADAR

The AN/MPS-30 ground surveillance radar (fig 1), currently being evaluated by the US Army Artillery Board, is a combination of the AN/TPS-25 radar and the XM106 (T257E1) mortar carrier. The AN/MPS-30

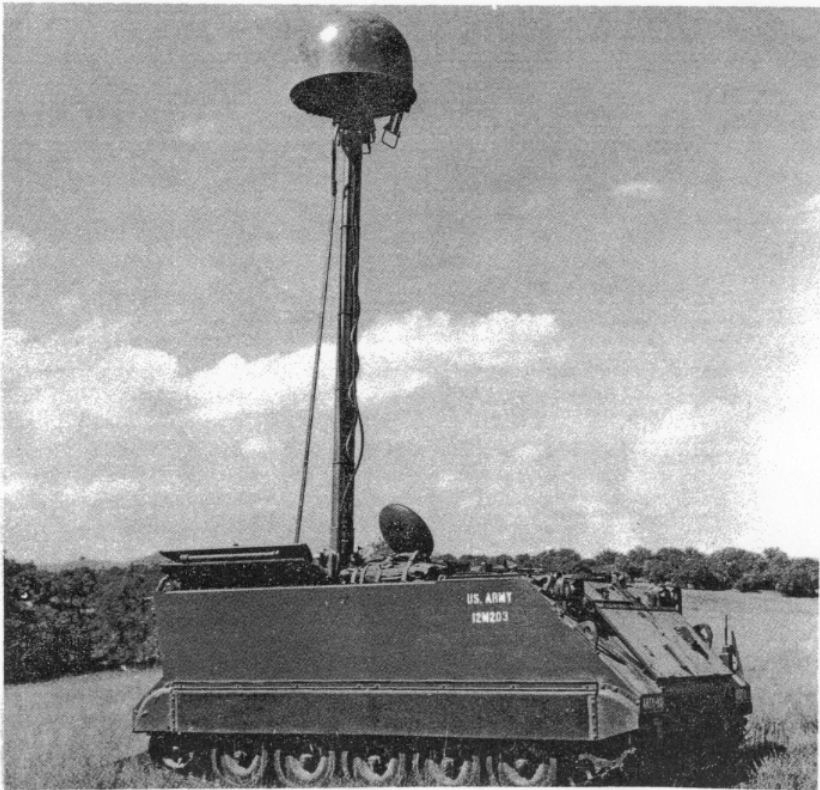

Figure 1. The AN/MPS-30 ground surveillance radar.

was developed in an effort to increase mobility, reduce the time required for emplacement and march order, and to provide protection for the radar operators from small arms fire and shell fragments.

The XM106 was selected for this system because it was the only available tracked vehicle whose top hatch was large enough to allow for entrance and exit of the AN/TPS-25 radome without modification. The generator of the XM106 was replaced by an alternator and inverter, permitting operation of the radar from the vehicular power supply. Equipment for the mortar installation was removed and appropriate components for the radar were added.

All components of the standard AN/TPS-25, except the shelter and the plotting board, were retained in the new installation. The major additional items required were an electrically-driven telescoping mast and a leveling system for the antenna. These additions permit the antenna to be raised to its maximum height of 23 feet and leveled within 3 minutes after the vehicle is halted.

HOWITZER FLOTATION KIT

Currently undergoing tests at the US Army Artillery Board is a flotation kit for the Army's new armored self-propelled 155-mm and 105-mm howitzers. The kit is comprised of inflatable rubberized bags (fig 2), an air blower system, and splash boards. The air blower system is

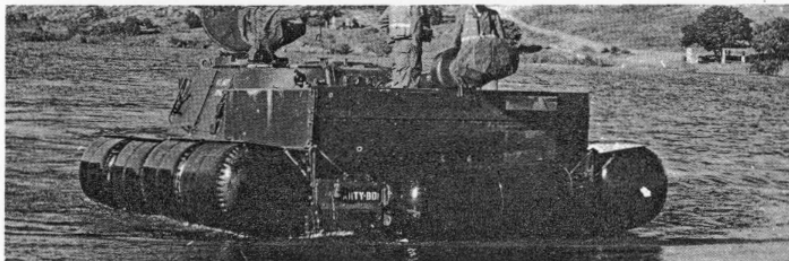

Figure 2. 155-mm howitzer with air bags inflated.

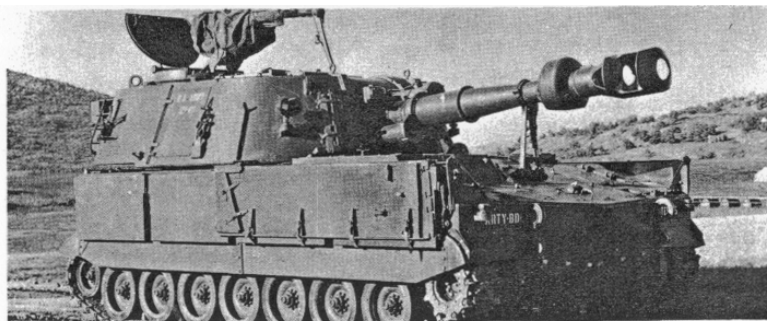

Figure 3. Float bags in stowed position.

mounted permanently within the vehicle, but the bags and splash boards with mounting components can be removed for storage. While the vehicle is in the water, the inflated bags are almost completely submerged, presenting a difficult target for small arms fire, blast, and fragmentation. When not in use, the bags are protected by aluminum plates (fig 3), which fold over the deflated bags.

ARMY AIRCRAFT DEVELOPMENTS

Many recent innovations in the field of Army aircraft are of interest to artillerymen. Among these developments are the mounting of various weapons systems on the UH-1 series helicopters (figures 4 & 5), and the testing of the XV-4A Hummingbird, a jet-powered, vertical take-off and landing (VTOL) research aircraft.



Figure 4. XM-153 (7.62-mm) quadruple machine-gun kit on UH-1B.



Figure 5. UH-1B helicopter with SS-11 missiles.

NEW LITTLE JOHN LAUNCHER

A new launcher (fig 6) for the Little John is being tested by the US Army Artillery Board. The new launcher, designated XM34E1, offers many improvements over the current launcher, XM34. The new launcher has a tread width of 74.5 inches (comparable to a 3/4-ton truck), whereas the current launcher has a tread width of 62 inches (comparable to a 1/4-ton truck). The increased tread width permits the new launcher to

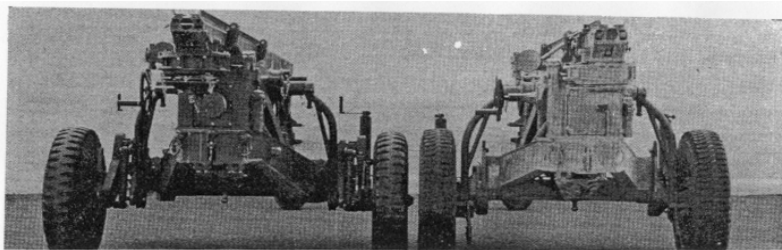

Figure 6. Rear view of Little John launchers, XM34E1 at left and XM34 at right.

be employed sideways on slopes up to 38° without tipping over, whereas the current launcher is limited to 27°. The improved suspension of the XM34E1 features better brakes, torsion bars, shock absorber suspension arms, and a suspension pivot point for raising the wheels when emplacing the launcher. The weight increase (from 1317 pounds to 1385 pounds, without rocket and tool kit) of the new launcher has been held to a minimum through the use of magnesium wheels and lightweight tires.

MISSILE B REDESIGNATED

With the award of a 100 million dollar contract to Chance-Vought Division of Ling-Temco-Vought for development and initial production, the Missile B system has been redesignated as the Lance missile system. The Lance will have both nuclear and non-nuclear capabilities and will be the first Army missile to use pre-packaged liquid fuel for its propulsion system. Planned as a simple, low-cost, rugged, and reliable weapon system, the Lance will use a new guidance concept.

ARTILLERY BULLETINS

155-MM M4A1 WHITE BAG PROPELLANT

155-mm howitzer units should note that charges 3 and 4 of the M4A1 white bag propellant are **unstable**. Publication of changes to TM's 9-331A, 9-331B, 9-7004, and 9-1300-203 is pending. Neither of these two charges of this propellant should be used when precision firing data or reliable calibration data is desired.

REVISED VERTICAL DISPLACEMENT TABLES FOR FM 6-75 AND FM 6-77

The vertical displacement tables in FM 6-75 and FM 6-77 relate information pertinent to Shell, 105-mm, HEAT, now type classified Standard B. The revised vertical displacement table data (fig 1) should be used when firing Shell, 105-mm, HEP-T or Shell, 105-mm, HE, M1. The correct procedures for using HEP-T ammunition with current fire control equipment are contained in Changes 1, FM 6-75, dated 15 May 1962.

SHELL HEP-T		REMARKS	SHELL HE, M1 CH 7	
RANGE (Meters)	ELEVATION (Mils)		DISPLACEMENT (Feet)	ELEVATION RANGE (Meters)
100	1.6	Start firing using 400 meter range setting.	1.0	2.3
200	3.3		1.5	4.7
300	5.1		2.5	7.1
400	7.0		3.0	9.6
500	8.9			
600	10.9	Start firing with estimated range. Increase or decrease by multiples of 50 or 100 meters. Bracketing not necessary.	4.0	12.0
700	13.0		5.0	14.7
800	15.2		6.0	17.3
900	17.5		7.0	19.9
1000	20.0	Bracket target (bursts over and short) to obtain hit.	8.0	22.6
1100	22.5		9.0	25.4
1200	25.1		10.0	28.2
			11.0	31.0
1300	27.9	Firing at moving targets at this distance is inaccurate.	12.0	33.9
1400	30.7		13.5	36.9
1500	33.7		14.5	39.9
1600	36.8		16.0	43.0
Over				Over
1600				1600

Figure 1. Vertical displacement (feet) per 100 meter range change with corresponding elevations for night firing.

CURRENT RESIDENT COURSE SCHEDULE

Listed below are the courses to be begun at the US Army Artillery and Missile School during the period 1 March through 30 June 1963.

Course	CI No.	Report	Start	Close	Input
Field Artillery Officer Orientation (6-A-C20)	14-63	6 Mar 63	11 Mar 63	10 May 63	90
	15-63	20 Mar 63	25 Mar 63	24 May 63	90
	16-63	3 Apr 63	8 Apr 63	7 Jun 63	89
	17-63	17 Apr 63	22 Apr 63	21 Jun 63	89
	18-63	1 May 63	6 May 63	5 Jul 63	89
	19-63	28 May 63	3 Jun 63	2 Aug 63	89
Artillery Officer Career (6-A-C22)	20-63	12 Jun 63	17 Jun 63	16 Aug 63	89
	4-63	30 Apr 63	3 May 63	17 Dec 63	154
Associate Field Artillery Officer Career (6-A-C23)	4-63	21 Apr 63	23 Apr 63	29 Aug 63	115
Field Artillery Field Grade Officer Refresher (Reserve Component) (6-A-C11)	3-63	2 Jun 63	3 Jun 63	14 Jun 63	58
Division Artillery Staff Officer Refresher (6-A-F5)	3-63	7 Apr 63	8 Apr 63	13 Apr 63	46
Senior Field Artillery Officer (6-A-F6)	3-63	12 May 63	13 May 63	24 May 63	26
Senior Field Artillery Officer (Non-US) (6-A-F6X)	1-63	14 Apr 63	15 Apr 63	26 Apr 63	10
Nuclear Weapons Employment (Reserve Component) (6-A-F20)	2-63	21 Apr 63	22 Apr 63	4 May 63	100
	3-63	16 Jun 63	17 Jun 63	29 Jun 63	100
Nuclear Weapons Employment (6-A-F26)	3-63	17 Mar 63	18 Mar 63	19 Apr 63	61
Field Artillery Radar Officer (6-A-0140)	2-63	4 Apr 63	5 Apr 63	27 May 63	16
Artillery Target Acquisition Officer (6-A-1154)	3-63	16 May 63	20 May 63	6 Aug 63	15
Lacrosse Officer (6-A-1187)	2-63	21 Apr 63	22 Apr 63	25 May 63	18
Sergeant Officer (6-A-1190D)	4-63	20 May 63	22 May 63	2 Jul 63	21*
Pershing Officer (6-A-1190E)	3-63	29 Mar 63	1 Apr 63	24 May 63	29*
	4-63	28 Jun 63	1 Jul 63	26 Aug 63	28**
Sergeant Officer (Non-US) (6-A-1190DX)	2-63	18 Mar 63	20 Mar 63	6 May 63	17
Artillery Communications Officer (6-A-0200)	3-63	8 May 63	9 May 63	15 Aug 63	34
Field Artillery Officer Candidate (6-N-F1)	5-63	24 Mar 63	1 Apr 63	3 Sep 63	56
	6-63	19 May 63	27 May 63	29 Oct 63	56
Field Artillery Officer Candidate (Reserve Component) (6-N-F2)	2-63	13 Jun 63	17 Jun 63	31 Aug 63	113
Nuclear Projectile Assembly (6-D-142.1)	2A-63	10 Mar 63	11 Mar 63	15 Mar 63	27
	3-63	31 Mar 63	1 Apr 63	5 Apr 63	27
	3A-63	12 May 63	13 May 63	17 May 63	27
	3B-63	9 Jun 63	10 Jun 63	14 Jun 63	28

Rocket Nuclear Warhead Assembly (6-D-147.2)	8-63	3	Mar 63	4	Mar 63	11	Mar 63	19
	9-63	24	Mar 63	25	Mar 63	1	Apr 63	19
	10-63	28	Apr 63	29	Apr 63	6	May 63	19
Artillery Ballistic Meteorology (6-H-103.1)	6-63	24	Mar 63	25	Mar 63	10	Jun 63	37
	7-63	28	Apr 63	29	Apr 63	17	Jul 63	38
Weather Equipment Maintenance (6-N-201A/205.1)	6-63	4	Apr 63	5	Apr 63	12	Jul 63	15
Field Artillery Radar Maintenance (6-N-211A/211.3)	3-63	13	Mar 63	18	Mar 63	29	Oct 63	12
LaCrosse Fire Control System Maintenance (6-N-217.1)	2-63	31	Mar 63	2	Apr 63	18	Sep 63	11
AN/TRC-80 Transition (Pershing) (6-D-F21)	2-63	14	Mar 63	15	Mar 63	22	Mar 63	3
	3-63	13	Jun 63	14	Jun 63	20	Jun 63	7
Field Artillery Operations and Intelligence Noncommissioned Officer (6-R-152.6)	3-63	7	Apr 63	9	Apr 63	25	Jun 63	30
	4-63	23	Jun 63	25	Jun 63	11	Sep 63	30
Artillery Survey Advanced (6-R-153.1)	7-63	21	Mar 63	26	Mar 63	17	May 63	70
	8-63	3	Apr 63	8	Apr 63	31	May 63	70
	9-63	28	May 63	3	Jun 63	26	Jul 63	70
Artillery Flash Ranging (Advanced) (6-R-154.1)	3-63	16	May 63	17	May 63	28	Jun 63	24
Field Artillery Radar Operation (6-R-156.1)	7-63	20	Mar 63	22	Mar 63	29	May 63	35
	8-63	25	Apr 63	29	Apr 63	9	Jul 63	35
	9-63	26	Jun 63	28	Jun 63	6	Sep 63	35
Sergeant Missile Battery (6-N-161.2)	3-63	5	May 63	7	May 63	20	Jun 63	28*
		*	Includes 2 Non-US Input					
Sergeant Missile Battery (Non-US) (6-N-161.2X)	2-63	3	Mar 63	5	Mar 63	19	Apr 63	25
Pershing Specialist (6-N-163.2)	2-63	1	Mar 63	4	Mar 63	2	Jul 63	28
	3-63	31	May 63	3	Jun 63	2	Oct 63	28
Pershing Missile Battery (163.6 Pending) (6-R-F23)	5-63	22	Mar 63	25	Mar 63	23	May 63	34*
	6-63	21	Jun 63	24	Jun 63	23	Aug 63	34*
		*	Includes 1 Non-US Input					
Corporal Mechanical Material Maintenance (6-R-164.3)	2-63	3	Mar 63	5	Mar 63	26	Apr 63	15
AN/TRC-80 Operations (Pershing) (6-R-F24)	4-63	3	Apr 63	4	Apr 63	6	Jun 63	15
	5-63	24	Apr 63	25	Apr 63	27	Jun 63	15
Artillery Radio Maintenance (6-R-313.1)	17-63	8	Mar 63	11	Mar 63	17	Jun 63	45
	18-63	22	Mar 63	25	Mar 63	1	Jul 63	45
	19-63	5	Apr 63	8	Apr 63	16	Jul 63	45
	20-63	19	Apr 63	22	Apr 63	30	Jul 63	45
	21-63	3	May 63	6	May 63	13	Aug 63	45
	22-63	17	May 63	20	May 63	27	Aug 63	45
	23-63	31	May 63	3	Jun 63	10	Sep 63	45
	24-63	14	Jun 63	17	Jun 63	24	Sep 63	45
Artillery Communication Supervisors (6-R-313.6)	3-63	24	May 63	27	May 63	11	Sep 63	27
Artillery Track Vehicle Maintenance (6-R-632.1)	12-63	1	Mar 63	5	Mar 63	23	May 63	45
	13-63	15	Mar 63	19	Mar 63	6	Jun 63	45
	14-63	29	Mar 63	2	Apr 62	20	Jun 63	45
	15-63	12	Apr 63	16	Apr 63	5	Jul 63	45
	16-63	26	Apr 63	30	Apr 63	18	Jul 63	44
	17-63	10	May 63	14	May 63	1	Aug 63	44
	18-63	24	May 63	28	May 63	15	Aug 63	44
	19-63	7	Jun 63	11	Jun 63	29	Aug 63	44
20-63	21	Jun 63	25	Jun 63	12	Sep 63	44	

STATUS OF TRAINING LITERATURE

1. The following training literature is under preparation or revision by the US Army Artillery and Missile School or the US Army Artillery Combat Developments Agency (ACDA):

A. FIELD MANUALS (FM):

- FM 6-3 Operation and Field Application of Gun Direction Computer, M18.
- FM 6-20-2 Field Artillery Air Assault Techniques (ACDA) (Supplement)
- FM 6-() Field Artillery Battalion, Aerial Rocket (ACDA)
- FM 6-30 Field Artillery Battalion, Corporal (ACDA) (Changes 1)
- FM 6-39 Field Artillery Battalion, Pershing (ACDA)
- FM 6-125 Qualification Tests for Specialists, Field Artillery
- FM 6-300-64 The Army Ephemeris

B. ARMY TRAINING PROGRAMS (ATP):

- ATP 6-700 Air Assault Field Artillery Units

C. ARMY TRAINING TESTS (ATT):

- ATT 6-() Field Artillery Battalion, Aerial Rocket
- ATT 6-() Field Artillery Battery, Aerial Rocket
- ATT 6-() Air Assault Field Artillery Missile Battalion, Little John
- ATT 6-() Air Assault Field Artillery Missile Battery, Little John
- ATT 6() Air Assault Field Artillery Howitzer Battalion, 105-mm
- ATT 6-() Air Assault Field Artillery Howitzer Battery, 105-mm

D. ARMY SUBJECT SCHEDULES (ASUBJSCD):

- ASubjScd 6-9 Countermortar Operations (TO BE RESCINDED)
- ASubjScd 6-161 MOS Technical Training of the Field Artillery Missile Crewman (Sergeant)

2. Training literature submitted for publication:

- FM 6-20-2 Field Artillery Techniques (ACDA) (Changes 1)
- FM 6-75 105-mm Howitzer, M2 Series, Towed (Revision)
- FM 6-79 105-mm Howitzer, M108, Self-Propelled
- FM 6-88 155-mm Howitzer, M109, Self-Propelled
- FM 6-300-63 The Army Ephemeris. (Changes 1)
- ATT 6-137 Field Artillery Gun or Howitzer Battery, Heavy, Towed or Self-Propelled
- ASubjScd 6-8 Counterbattery Operations

- ASubjScd 6-24 Organization and Duties of Operation Section,
(Changes 1) Field Artillery Target Acquisition Battalion
- ASubjScd 6-50 Air Movement
- ASubjScd 6-156 MOS Technical Training of the Radar Crewman.

3. Training literature at the Government Printing Office:

- FM 6-57 Field Artillery Rocket, Little John,
(Changes 1) (Launcher XM34)
- FM 6-75 105-mm Howitzer, M2 Series, Towed
(Changes 1)
- FM 6-90 8-Inch Howitzer, M2, Towed
- FM 6-94 8-Inch Howitzer, M110, Self-Propelled and
175-mm Gun, Motor Carriage, M107
- FM 6-121 Field Artillery Target Acquisition (ACDA)
- FM 6-135 Adjustment of Artillery Fire by the Combat
Soldier
- ATT 6-16 Field Artillery Battalions, Gun or Howitzer, Heavy
- ASubjScd 6-11 Defense of Artillery Position Areas

4. Training literature recently printed:

- FM 6-81 155-mm Howitzer, M1, Towed
- ATP 6-615 Field Artillery Missile Battalion, Pershing
- ATT 6-5-1 Field Artillery Howitzer Battalion, Light and
Medium, Towed and Self-Propelled, for Reserve
Component Units
- ATT 6-325-1 Field Artillery Rocket/Howitzer Battalion,
Armored Division, for Reserve Component Units
- ATT 6-576 Headquarters and Headquarters Battery, Field
Artillery Target Acquisition Battalion
- ATT 6-615 Field Artillery Battalion, Pershing

"I can assure you that the infantry of this Division have complete and utter confidence in you to a degree that I personally have never seen before. You in your gun-pits never see them and they never see you. But they know you are always there. They see the worst side of war, and they need something to depend on, something to lean against. They one and all lean against you, because you have saved them over and over again—and they know you will go on doing so."

Brigadier Pasley
1st British Infantry Division Artillery Commander
During the battle of Anzio
ANZIO by Vaughan-Thomas

ALPHABETICAL SUBJECT INDEX for ARTILLERY TRENDS 1962

ISSUES OF FEBRUARY, MAY, JULY, AND OCTOBER

SUBJECT AND ARTICLE	ISSUE	PAGE
ABLE ORIENTOR		
Weapons System: 1970	May	24
A Home for Able	Oct	50
AC-1 CARIBOU		
Weapons System: 1970	May	13
Advanced STOL Caribou II (Newsnote)	Oct	55
AFAOCC		
AFAOCC - AOCC SUCCESS	Oct	27
AIMING POST T6		
Infinity Aiming Reference Collimator	Jul	3
AIRBORNE ARTILLERY		
Airborne Divarty Reorganization	Feb	19
ALTIMETER		
Weapons System: 1970	May	25
AMMUNITION		
Direct Fire	Jul	27
AN/GRA-6		
Battalion Communication Systems	Feb	46
AN/GRC-46		
Battalion Communication Systems	Feb	46
AN/GRC-106		
Weapons System: 1970	May	20
AN/GRC-107		
Weapons System: 1970	May	20

AN/GRC-108		
Weapons System: 1970	May	20
AN/GRR-5		
Battalion Communication Systems	Feb	45
AN/GXC-5		
Facsimile Set (Newsnote).....	Jul	60
AN/MRC-83		
Weapons System: 1970	May	20
AN/MSC-37		
Weapons System: 1970	May	14
AN/PRC-8		
Battalion Communication Systems	Feb	44
AN/PRC-10		
Battalion Communication Systems	Feb	44
AN/PRC-25		
AN/PRC-25 Production Started (Newsnote)	Feb	62
Weapons System: 1970	May	19
AN/TRC-80		
Track-80	Feb	4
Weapons System: 1970	May	19
AN/TSC-15		
Weapons System: 1970	May	20
AN/URC-40		
Weapons System: 1970	May	14
AN/USC-3(V)		
Weapons System: 1970	May	14
AN/VRC-8		
Battalion Communications Systems.....	Feb	44

AN/VRC-9		
Battalion Communications Systems	Feb	46
AN/VRC-10		
Battalion Communications Systems	Feb	44
AN/VRC-12		
Weapons System: 1970	May	17
AN/VRC-47		
Weapons System: 1970	May	17
AO-1 MOHAWK		
Weapons System: 1970	May	13
AOCC		
AFAOCC - AOCC SUCCESS	Oct	27
ARMOR VEST		
Improved Armor Vest (Newsnote)	Feb	61
ARTILLERY SUPPORT, MECHANIZED DIVISION		
Artillery Tactics of the New Divisions.....	Oct	40
ARTILLERY TACTICS		
Artillery Tactics of the New Divisions (Parts I and II). Jul		9
Artillery Tactics of the New Divisions (Part III).....	Oct	40
ARTILLERY TRENDS		
Instructional Material for Active Duty Artillerymen....	Oct 3	
AUTOMATIC DATA PROCESSING		
Weapons System: 1970	May	31
AUTONETICS BASE LINE EQUIPMENT (ABLE ORIENTOR)		
A Home for ABLE	Oct	50
AVIATION, ARMY		
New Division Artillery Aviation.....	Feb	12
BOOK DEPARTMENT		
Instructional Material for Active Duty Artillerymen....	Oct	4

CANNON		
Soviet Artillery Weapons.....	Jul	34
See "Howitzer"		
CARIBOU (AC-1)		
Weapons System: 1970	May	20
Advanced STOL Caribou II (Newsnote).....	Oct	55
CHINOOK (HC-1)		
Chinook (Newsnote)	Feb	61
Weapons System: 1970	May	13
COLD WEATHER INJURY		
Cold Weather Injury (Filler).....	Feb	31
COMMUNICATIONS SYSTEMS		
Battalion Communication Systems	Feb	44
COMPUTER, GUN DIRECTION, M18		
Computer, Gun Direction, M18.....	Oct	16
DEADSPACE		
Deadspace	Oct	29
More Deadspace—Electrical Analyzers.....	Oct	37
DIRECT FIRE		
Direct Fire	Jul	25
EAR PROTECTOR		
New Electronic Ear Protector (Filler)	Oct	36
ELECTRICAL ANALYZERS		
More Deadspace—Electrical Analyzers.....	Oct	37
ENGINEER REFERENCE DATA PAMPHLET		
Engineer Reference Data Pamphlet (Filler)	Oct	36
EXPLOSIVES		
Explosives for Nuclear Units (Filler)	Jul	32
New Demolition Kit (Newsnote)	Jul	60
EXTENSION COURSES		
Instructional Material for Active Duty Artillerymen....	Oct	3
Air Defense Extension Courses Transferred (Filler)....	Oct	36

FADAC (FIELD ARTILLERY DIGITAL AUTOMATIC COMPUTER)		
Progress Report: FADAC	Feb	54
Weapons System: 1970	May	32
Computer, Gun Direction, M18	Oct	16
FIELD ARTILLERY DATA COMPUTER AUTOMATIC LOGIC TESTER (FALT)		
Computer, Gun Direction, M18.....	Oct	17
FIRE CAPABILITIES ANALYZER		
More Deadspace—Electrical Analyzers	Oct	39
FIRE DIRECTION		
Graphical Stick and Fan Status	Feb	39
FIRE PLANNING		
Missile Fire Planning	Feb	28
FIRING TABLES		
FT 105-H-6 (Filler)	Oct	28
FUZES AND FUZE SETTERS		
Universal Fuze Setter (Newsnote)	Oct	56
GAS		
Toxic Roxic—115-mm Multiple Rocket Launcher	Oct	12
GB		
Toxic Roxic—115-mm Multiple Rocket Launcher	Oct	12
GEM (GROUND ENVIRONMENT MACHINE)		
Weapons System: 1970	May	14
GOER		
Weapons System: 1970	May	7
8-ton GOER to be Evaluated (Newsnote)	Oct	54
GUN, 175-MM, M107		
Weapons System: 1970	May	6
H-13		
New Division Artillery Aviation	Feb	18

H-21		
	The H-21C in Artillery Employment	Jul 42
HC-1 (CHINOOK)		
	Chinook (Newsnote)	Feb 61
	Weapons System: 1970	May 13
HELICOPTERS		
	The H-21C in Artillery Employment	Jul 42
	See "H-13," "H-21," "HC-1," "HU-1," "LOH"	
HONEST JOHN		
	Battalion Communication Systems	Feb 49
	New Free-flight Rocket—XM50	Oct 5
	Deadspace	Oct 34
HOWITZER, 105-MM		
	Weapons System: 1970	May 5
	The H-21C in Artillery Employment	Jul 42
	105-mm in the Jungle	Oct 19
HOWITZER, 105-MM, M108		
	New Weapons Designations (Newsnote)	Feb 60
	Weapons System: 1970	May 5
HOWITZER, 105-MM, T195E1		
	See M108, above	
HOWITZER, 105-MM, XM102		
	See "XM102"	
HOWITZER, 105-MM, XM104		
	See "XM104"	
HOWITZER, 105-MM, XM124		
	See "XM124"	
HOWITZER, 155-MM		
	Weapons System: 1970	May 5
HOWITZER, 155-MM, M109		
	New Weapons Designations (Newsnote)	Feb 60
	Weapons System: 1970	May 5

HOWITZER, 155-MM, M1A2E3		
155-mm Howitzer, M1A2E3 (Newsnote)	May	59
HOWITZER, 155-MM, T196E1		
See M109, above		
HOWITZER, 155-MM, XM123		
See "XM 123"		
HOWITZER, 8-INCH		
Deadspace	Oct	33
HOWITZER, 8-INCH, M110		
See "M110"		
HU-1 (IROQUOIS)		
HU-1D Development (Newsnote)	Feb	60
Weapons System: 1970	May	11
INFINITY AIMING REFERENCE COLLIMATOR		
Infinity Aiming Reference Collimator	Jul	3
INSTRUCTIONAL MATERIAL		
Instructional Material for Active Duty Artillerymen ..	Oct	3
IROQUOIS (HU-1)		
HU-1D Development (Newsnote)	Feb	60
Weapons System: 1970	May	11
JUNGLE - MOUNTAIN EXERCISES		
105-mm in the Jungle	Oct	19
L-19		
New Division Artillery Aviation	Feb	18
L-20		
New Division Artillery Aviation.....	Feb	12
LASER		
Laser Rangefinders (Newsnote)	Jul	63
LAUNCHER, MULTIPLE ROCKET, 115-MM		
Toxic Roxic—115-mm Multiple Rocket Launcher	Oct	8

LEAR		
	New Survey Instruments (Newsnote)	Oct 53
LIMITED WAR		
	Limited War Lab (Newsnote)	Jul 66
LITTLE JOHN		
	PADA Concept for Little John	Feb 57
	Weapons System: 1970	May 6
	Deadspace	Oct 34
LOH (LIGHT OBSERVATION HELICOPTERS)		
	New Division Artillery Aviation	Feb 12
	Weapons System: 1970	May 11
M107 175-MM GUN		
	Weapons System: 1970	May 6
M110 8-INCH HOWITZER		
	Weapons System: 1970	May 6
M113 ARMORED PERSONNEL CARRIER (APC)		
	M113 APC Production (Newsnote)	May 58
M114 RECONNAISSANCE VEHICLE		
	Weapons System: 1970	May 9
M116 AMPHIBIOUS CARGO CARRIER		
	Weapons System: 1970	May 9
MABLE (MINIATURE ABLE)		
	New Survey Instruments (Newsnote)	Oct 53
MAP TACKS		
	Map Tack Procurement (Filler)	May 60
METEOROLOGY BALLOONS		
	New Balloon—Faster Metro (Filler)	Oct 52
METEOROLOGY		
	Weapons System: 1970	May 26
	Meteorology Meeting (Newsnote)	Feb 63

MISSILE B		
Missile B Begins to Stir (Newsnote)	Oct	53
MISSILES		
Missile Fire Planning	Feb	28
Missile Markings (Filler)	Feb	70
MOHAWK (AO-1)		
Weapons System: 1970	May	13
MOUNTAIN - JUNGLE EXERCISES		
105-mm in the Jungle	Oct	19
MUSKRAT		
Muskrat (Newsnote)	Jul	62
MX 155/GT		
Battalion Communication Systems	Feb	47
NUCLEAR WARHEADS		
Nuclear Warhead Safety (Filler)	Oct	39
NUCLEAR WEAPONS EMPLOYMENT COURSE		
Nuclear Weapons Employment Course (Reserve Component) (Filler)	Oct	59
OPERATION TAPER		
See "Taper"		
OPERATIONS AND INTELLIGENCE NONCOMMISSIONED OFFICERS COURSE		
School Offers New Course for NCO's	Oct	52
PERSHING		
Track-80	Feb	4
Weapons System: 1970	May	6
First Pershing Missile Battalion Activated (Newsnote)	Oct	57
PROGRAMS OF INSTRUCTION		
Instructional Material for Active Duty Artillerymen ..	Oct	4

RADAR		
Small Arms Radar (Newsnote).....	May	58
RADIO		
Battalion Communication Systems	Feb	44
Tuning (Gem).....	Jul	57
See "AN/——"		
RANDOM ACCESS SYSTEM		
Weapons System: 1970	May	20
RECENT CONTRACTS		
Recent Contracts in Newsnote Section of Issues		
REDSTONE		
Redstone Reorganized	Feb	28
RESERVE COMPONENT CLASSES		
Instructional Material for Active Duty Artillerymen ..	Oct	4
RESIDENT COURSES		
Resident Courses	May	49
RIFLE		
AR-16 Rifle (Newsnote)	Jul	62
ROCKETS		
Soviet Artillery Weapons	Jul	36
See "Honest John," "Little John," "Launcher, Multiple Rocket, 115-mm"		
SERGEANT		
Sergeant Completes Tests (Newsnotes)	Feb	62
Weapons System: 1970	May	6
First Sergeant Missile Battalion Activated (Newsnote)	Jul	66
SERGEANT TRAINER		
Missiles in the Classroom	Feb	7
SLIDE RULE		
Military Slide Rule Lubrication (Filler)	Oct	18
Artillery Weapons Effects Slide Rule (Newsnote)	Oct	56

SOVIET ARTILLERY

Direct Fire	Jul	25
Soviet Artillery Weapons	Jul	33

SURVEY

With Helicopters—New Division Artillery Aviation ..	Feb	13
For Survey Personnel (Gem)	Jul	59

SWITCHBOARD

For the Switchboard SB-86/P Operator (Gem)	Jul	32
--------------------------------------------------	-----	----

TA-341

Weapons System: 1970	May	23
----------------------------	-----	----

TAPER (OPERATION TAPER)

Operation TAPER (Filler)	Feb	80
Operation TAPER	May	38
The Army's Equipment Record System	Jul	49

TELEPHONE

See "Wire"

TELLUROMETER

Weapons System: 1970	May	24
----------------------------	-----	----

TOXIC ROCKET

Toxic Roxic—115-mm Multiple Rocket Launcher	Oct	8
--------------------------------------------------	-----	---

TPI (TECHNICAL PROFICIENCY INSPECTION)

TPI	May	40
-----------	-----	----

TS-352/U

For the Electronic Technician (Gem)	May	61
-------------------------------------------	-----	----

TURRET BEARING

New Turret Bearing (Newsnote)	Feb	60
-------------------------------------	-----	----

US ARMY ARTILLERY AND MISSILE SCHOOL (USAAMS)

USAAMS Reorganized (Filler)	Oct	7
-----------------------------------	-----	---

VX

Toxic Roxic—115-mm Multiple Rocket Launcher	Oct	13
--------------------------------------------------	-----	----

WEAPONS SYSTEM

Weapons System: 1970 May 4

WIRE

Battalion Communication Systems Feb 44

XM50 (HONEST JOHN ROCKET)

New Free-flight Rocket—XM50 Oct 5

XM70

XM70 Series Rapid-Fire Weapon (Newsnote) Oct 58

XM100

PADA Concept for Little John Feb 57

XM102

Weapons System: 1970 May 5

XM104

Weapons System: 1970 May 5

XM104 Being Tested (Newsnote) Oct 54

XM123

New Weapons Designations (Newsnote) Feb 60

XM124

Auxiliary-Propelled 105-mm Howitzer (Newsnote) .. Oct 55

XM437E1

Weapons System: 1970 May 9

XM474

Track-80 Feb 6

XM520E1

Weapons System: 1970 May 8

XM559

Weapons System: 1970 May 8

XM561

Weapons System: 1970 May 5

XM577

Weapons System: 1970	May	10
New Fire Direction Center Vehicle (Newsnote)	Jul	64

X-RAY EXPOSURE

X-Ray Exposure (Filler)	Feb	18
-------------------------------	-----	----

ARMY AIRCRAFT REDESIGNATED

The model number designations of Army aircraft have been changed to conform to a standard Department of Defense system. To provide a ready reference for its readers, ARTILLERY TRENDS has extracted the following information from AR 700-26, dated 18 September 1962.

FORMER DESIGNATION	CURRENT DESIGNATION	FORMER DESIGNATION	CURRENT DESIGNATION
Helicopter Series			
HU-1	UH-1	H-21B	CH-21B
HU-1A	UH-1A	H-21C	CH-21C
HU-1B	UH-1B	H-23B	OH-23B
HU-1D	UH-1D	H-23C	OH-23C
HO-4	OH-4A	H-23D	OH-23D
HO-5	OH-5A	H-23F	OH-23F
HO-6	OH-6A	H-34A	CH-34A
H-13E	OH-13E	H-34C	CH-34C
H-13G	OH-13G	H-37A	CH-37A
H-13H	OH-13H	H-37B	CH-37B
H-13K	OH-13K	YH-41	NH-41A
H-19C	UH-19C	HC-1A	CH-46C
H-19D	UH-19D	HC-1B	CH-47A
Utility Series			
U-1A	U-1A	L-23F	U-8F
L-20A	U-6A	L-26B	U-9B
L-23D	U-8D	L-26C	U-9C
RL-23D	RU-8D	RL-26D	RU-9D
VTOL & STOL Series			
AO-1A	OV-1A	—————	XV-3A
AO-1B	OV-1B	VZ-10	XV-4A
AO-1C	OV-1C	VZ-11	XV-5A
AC-1	CV-2A	VZ-12	XV-6A
AC-1A	CV-2B	AC-2	CV-7A
Observation Series			
L-19A	O-1A	L-19E	O-1E
TL-19D	TO-1D		