

ARTILLERY

TRENDS

USAAMS LIBRARY

LIBRARY, USAAMS

RECD: 63 APR 29

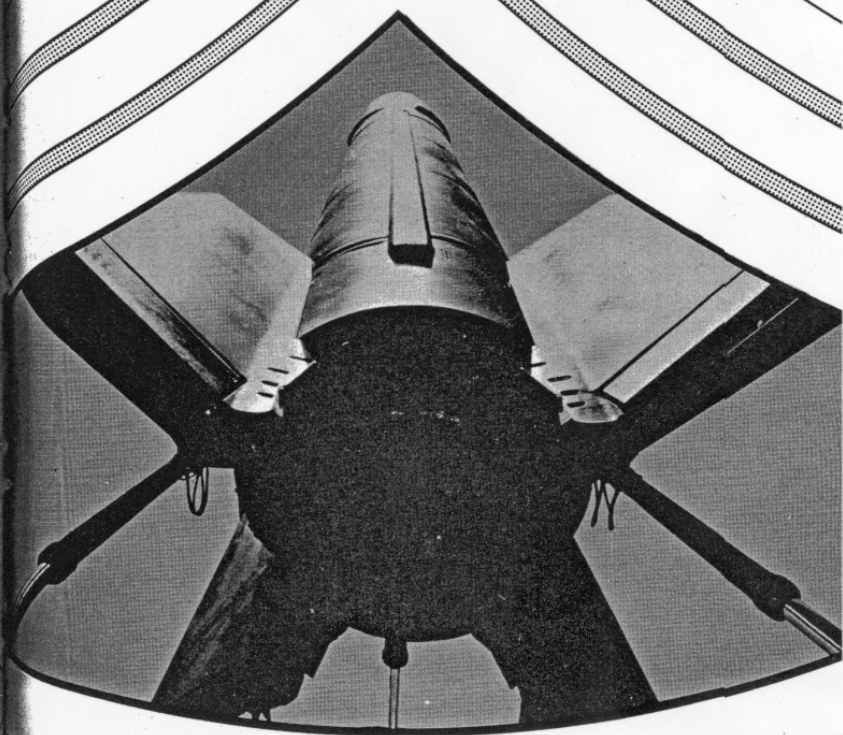

U S ARMY ARTILLERY AND MISSILE SCHOOL

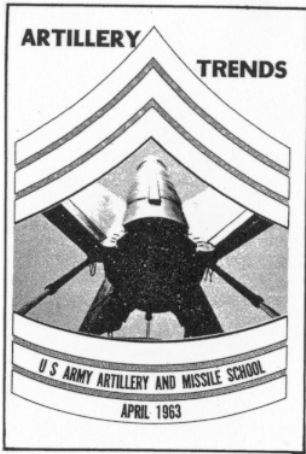

Instructional Aid Number 26

● COVER

Master Sergeant chevrons surround the Sergeant guided missile, poised on its launcher. An up-to-date article on the newly operational Sergeant begins on page 6. The inside front cover shows the production model FADAC; for the latest FADAC information, see page 30. On the back cover is provided a slow-motion look at the fast-moving XM3; for details, see page 2.

● ARTICLES

Aerial artillery—UH-1B/XM3	2
SERGEANT	6
OBJECTIVE: SYMBOL SAVVY	20
Better tactical communications—SINGLE SIDEBAND RADIOS ...	25
FADAC	30
ARMY TRAINING TESTS	46
New dimension for field artillery—AIR ASSAULT	49
How accurate?—FLASH RANGING	55
Fiscal year 1964—RESIDENT COURSES USAAMS	57

● NEWSNOTES

News of, for, about the Artillery World	67
---	----

● TRAINING LITERATURE

Status of Training Literature	71
-------------------------------------	----

ARTILLERY TRENDS is a publication of the United States Army Artillery and Missile School appearing only when sufficient material of instructional nature can be gathered.

aerial artillery . . .



UH-1B/XM3

Major James H. Merryman
Aviation Officer, USAAMS
Captain Robert L. Graham
Artillery Combat Developments Agency

The field artillery's newest means of furnishing fire support to the ground-gaining arms combines modern mobility (UH-1B) and modern firepower (XM3). The XM3 weapons system will be found in the aerial rocket battalion of the air assault division (see page 49). There will be a total of 39 UH-1B helicopters mounting the XM3 weapons system in the aerial rocket battalion—3 in headquarters battery and 12 in each of the three firing batteries.

The armament subsystem XM3 is the result of the aircraft area rocket weapon system program. The XM3 is designed to fire 2.75-inch folding fin aerial rockets (FFAR) against personnel or area targets. The 2.75-inch FFAR, originally developed for the United States Air Force, has a redesigned nozzle which imparts a slow rotation to compensate for thrust malalignment. As the rockets leave the firing tubes, the fins snap into position to provide in-flight stability. Each rocket weighs 18 pounds and has a 6.5-pound warhead with a quick fuze. The warhead contains 1.25 pounds of high explosive. The XM3 has a 15-mil dispersion pattern and is normally employed at ranges from 750 to 2,000 meters. Maximum range of the rocket is 9,000 meters.

THE LAUNCHER

The 2.75-inch rockets are fired from open-breech tubes mounted in clusters on either side of the UH-1B. Each cluster is composed of 4

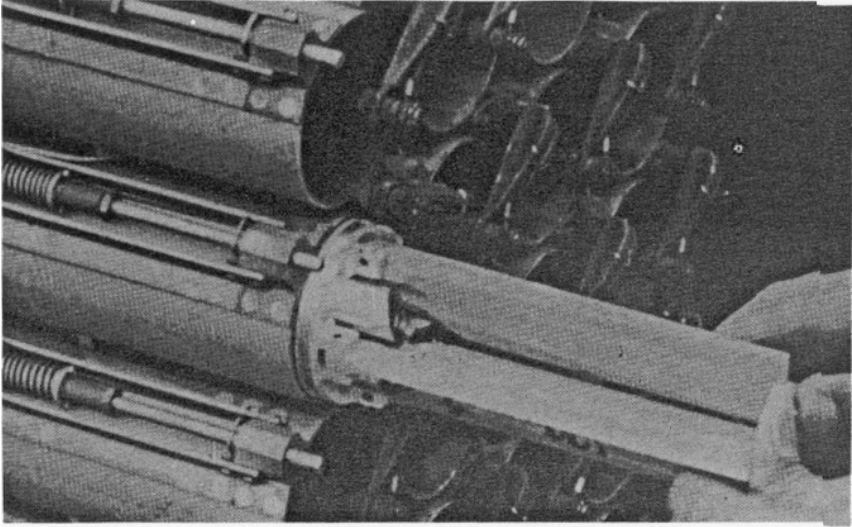

Figure 1. Loading a rocket into the open-breech tube.

stack modules with 6 tubes each, or a total of 48 tubes on each helicopter. The rocket clusters are fixed; therefore, elevation and traverse must be changed by changing the attitude of the helicopter. The rocket pods may be jettisoned by means of explosive bolts. The system is designed to fire ripples of 1, 2, 3, 4, 6, or 24 pairs of rockets; only 4 seconds are required to fire all 24 pairs.

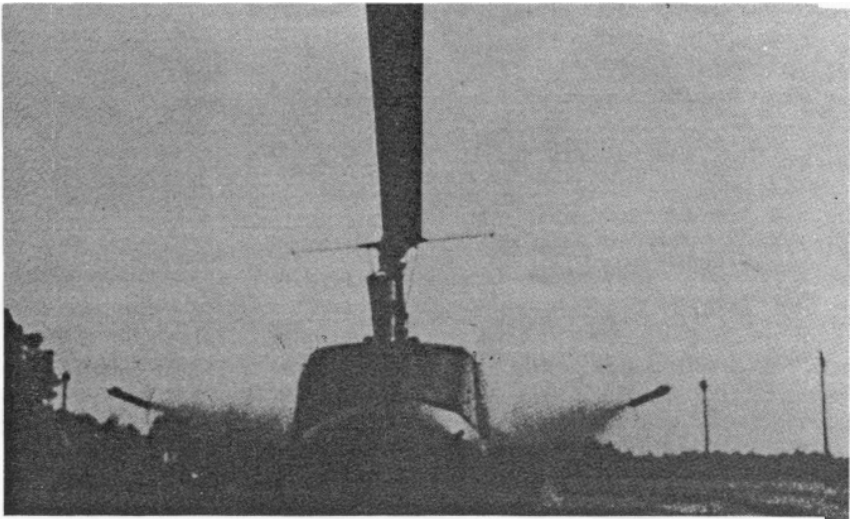

Figure 2. Front view of one pair of rockets firing.

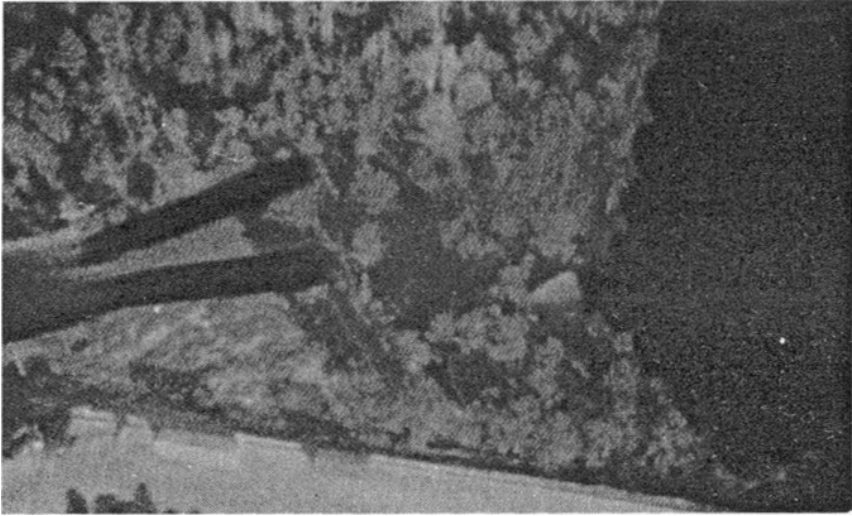

Figure 3. Aerial firing of the XM3; the fins on the first rocket begin to unfold as the next rocket emerges.

The fire control system for the XM3 is composed of three subsystems:

- Illuminated sight Mark VIII. This sight is an optical instrument based on the collimator principle with a reticle display projected on a clear reflector, appearing to be at infinity without appreciable parallax. Sight settings for range and airspeed, obtained from a range card, are made on the sight reflector.
- Firing system. This system consists of a junction box with the circuitry for firing the rockets and jettisoning the two pod assemblies, and an intervalometer assembly with the controls and indicators required for selecting the number of rounds to be fired and for arming the firing circuit. This system also has a counter to record the number of pairs of rounds fired.
- Jettison control panel assembly. This assembly consists of controls and indicators necessary to jettison the two pod assemblies and the system power switch.

The XM3 system is simple and rugged. It is operable by direct current at 28 volts, and incorporates no vacuum tubes or other complex electronic circuitry. Test and checkout procedures for the XM3 system are rapid and positive. A number of component parts are interchangeable, and only one special tool is required for assembly and disassembly of the entire system. System safety precautions are few in number:

- The rockets require handling procedures similar to any solid propellant rocket.
- The firing system must be deenergized prior to loading and unloading.

- During aircraft ground handling, the jettison circuit (to the explosive bolts) must be removed from the separating device and the squib grounded with a ground spring.

Although the field artillery has had much experience with rocket weapons systems and aircraft, the UH-1B/XM3 marks the first time that the two have been combined into an aerial field artillery weapon. This combination, necessary because the mobility of the field artillery must equal or exceed that of the supported force, promises to add a new dimension to the concept of timely, accurate, and decisive field artillery fire support.

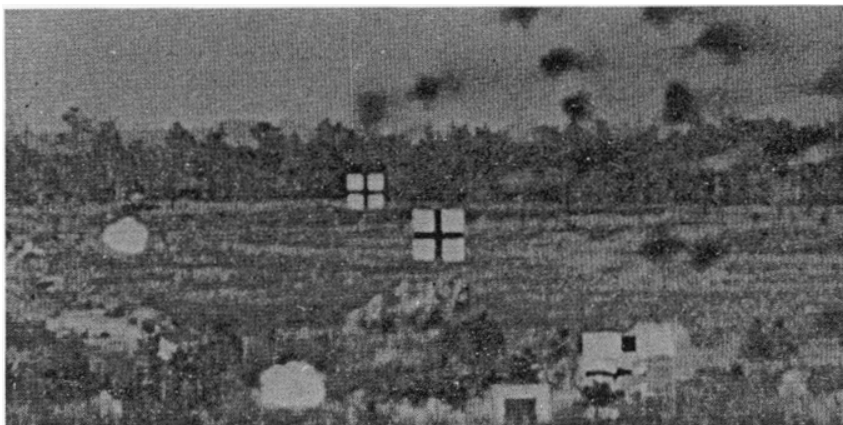

Figure 4. First rockets strike in impact area during test firing; black puffs of smoke in upper right are other rockets "on the way."



Figure 5. Area target neutralized.

CORRECTION

In the January 1963 issue of ARTILLERY TRENDS, credit was erroneously given to Lieutenant Colonel Thomas O. Morrow for the US Army Arctic Test Board's portion of the article entitled "Cold Weather Operations." Credit for the USAATB's portion of the article should have been given to Major Boyde A. Allen, US Army Arctic Test Board.

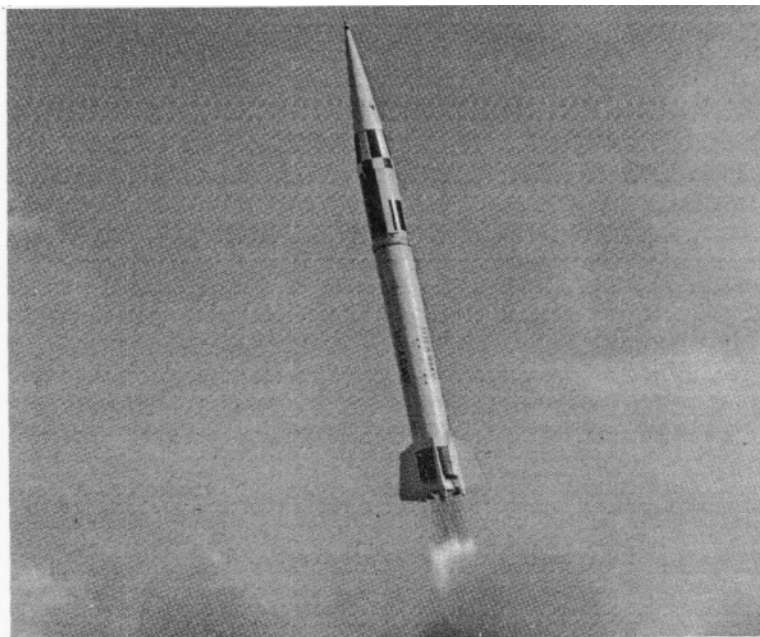

SERGEANT

PART I--PAST AND PRESENT

Major William S. Monsos
Guided Missile Department

The Sergeant missile system described two years ago in ARTILLERY TRENDS as "an up and coming system" is now fully operational. Sergeant's attainment of operational status not only signifies a substantial increase in field artillery capabilities but also illustrates the Army's ability to plan, describe, and bring into being the precise types of weapons it requires.

MISSILE DEVELOPMENT

More than a decade ago, with the Corporal practically in its "incubation period," planners began establishing the criteria for a second-generation replacement. This approach deviated from the normal missile system development, because detailed military characteristics were submitted before a project had been initiated, before feasibility studies had been made, and before preliminary design information had been submitted. The success of the approach employed can be attributed to the ability of the Army to forecast requirements accurately and to tremendous

strides made in the missile field by industry, research, and engineering.

The early submission of Sergeant requirements pushed missile "state of the art" to its maximum limits. The Sergeant designers faced difficulties similar to those faced by a caveman trying to select a club. Should the "club" be heavy and powerful or light and easy to carry? The requirements of air transportability, automatic checkout, simplicity of operation, ruggedness, reliability, etc., for the Sergeant were not always mutually compatible. Numerous problems were encountered. The development of aerodynamic dragbrakes to control range and the design of the firing set were two such challenges requiring exceptional engineering.

The appearance and operation of the present Sergeant system are very much like its earliest model. Early missiles fired during feasibility studies of the Sergeant (fig 1) appear to have been modified Corporals used as test vehicles for certain Sergeant components.

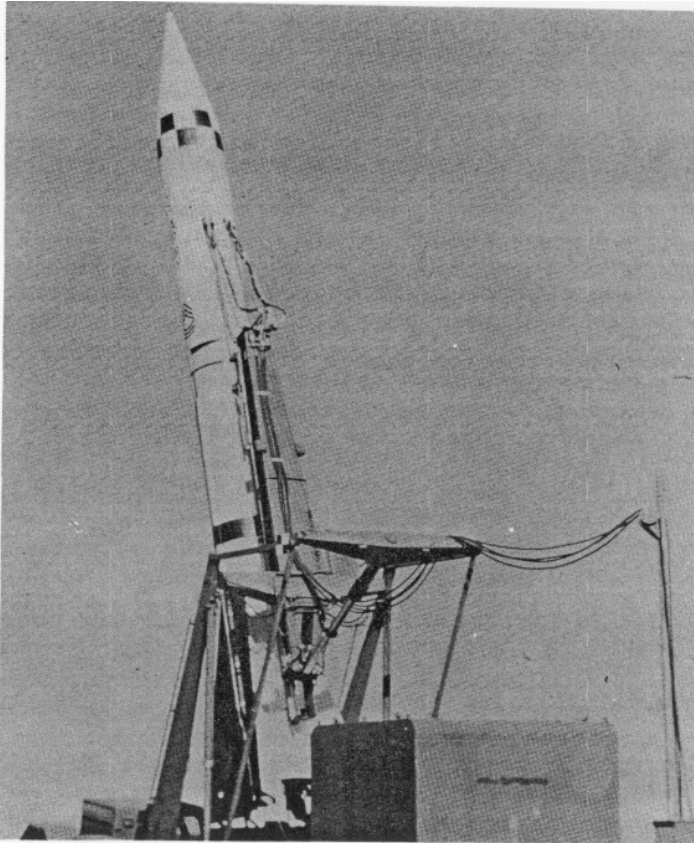

Figure 1. Early Sergeant missile.

The experimental model launching station (fig 2) is remarkably similar to the present configuration. Except for the location of the door on the firing set enclosure, there is little visible difference between the experimental and the production models of launcher equipment.

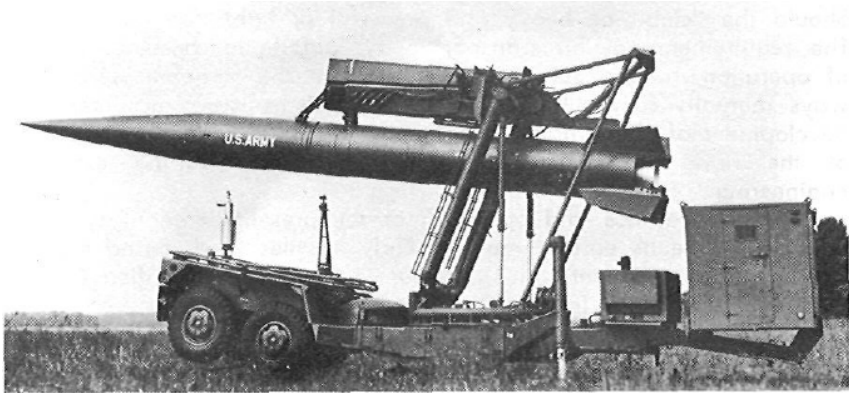

Figure 2. Experimental model launching station and missile.

CHARACTERISTICS AND CAPABILITIES

The characteristics and capabilities of the present-day Sergeant system provide many marked advantages over those of its predecessor, the Corporal. Through inertial guidance, solid propellant, and reduced ground support equipment, the delivery of corps and field army general support fires has been greatly improved in both speed and reliability.

The Sergeant battalion can rapidly move its two firing batteries into position. Within minutes after entering their prepared firing positions, the batteries can have launchers emplaced and the missiles assembled, presenting a deterrent threat to any enemy within 75 nautical miles.

To accomplish its mission, the Sergeant battalion depends on relatively few special purpose vehicles (fig 3-5).



Figure 3. Launching station: length 31 feet 3 inches; weight 17,000 pounds. Used to assemble, erect, program, orient, and automatically launch the missile.

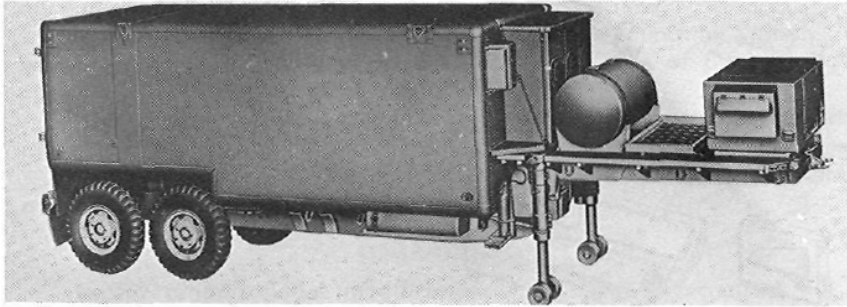
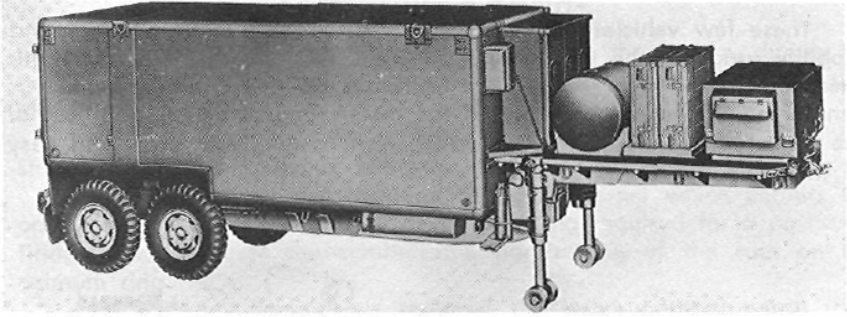

Figure 4. Organizational maintenance test station (OMTS) (top): length 31 feet 6 inches; weight 14,810 pounds. Used to perform missile checkout and maintenance of the electronic assemblies of the missile, firing set, and OMTS. Field maintenance test station (FMTS) (bottom): length 31 feet 6 inches; weight 15,500 pounds. The external appearance is similar to the OMTS, but the internal components are considerably different. Used to perform ordnance maintenance of electronic components of firing set, OMTS, missile, and FMTS.

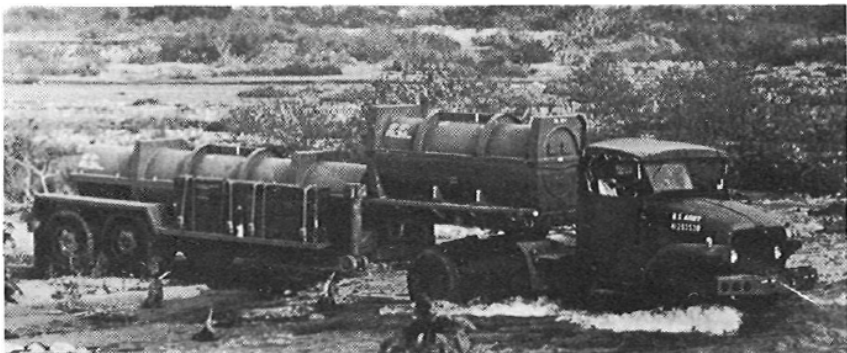
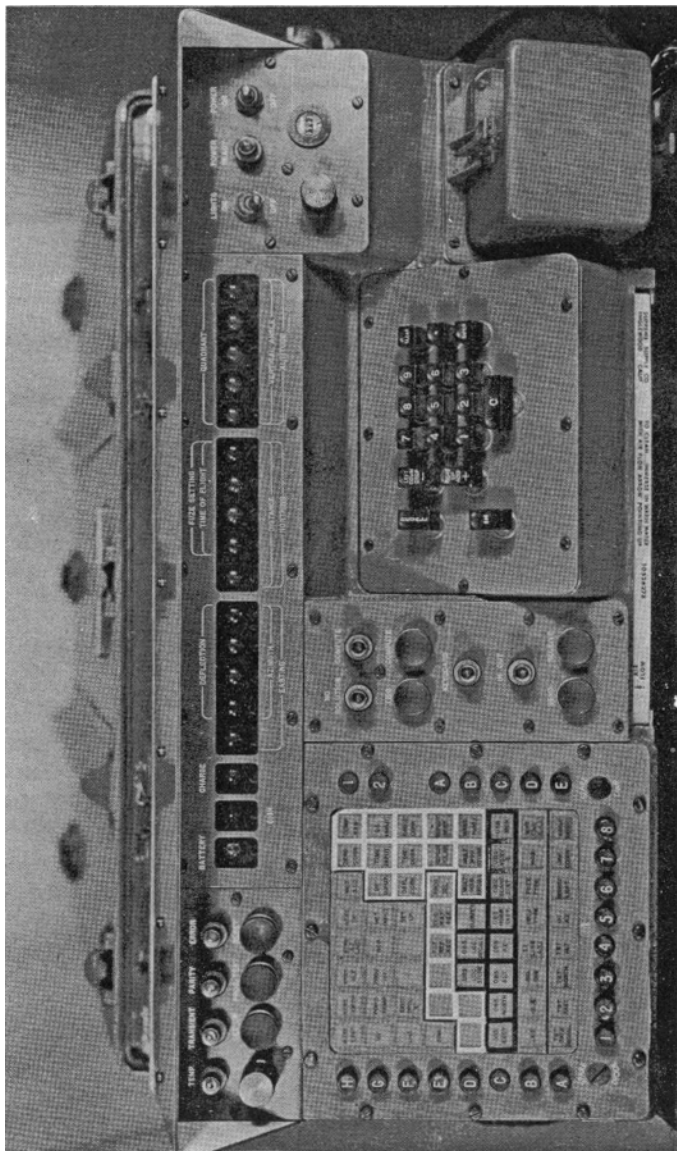

Figure 5. Transporters: length 31 feet 6 inches; weight 15,810 pounds (when loaded). Used to transport the rocket motor section, the guidance section, and four control surface assemblies.



FADAC--SEE PAGES 30-45

These few vehicles allow quick reaction time, provide good ground mobility, and can be air transported by C-130 aircraft. The automatic checkout capability of the system decreases operator training time. Its simple maintenance concept takes the meters and soldering irons out of the artilleryman's hands. The missile, itself, is relatively small and easy to assemble (fig 6).

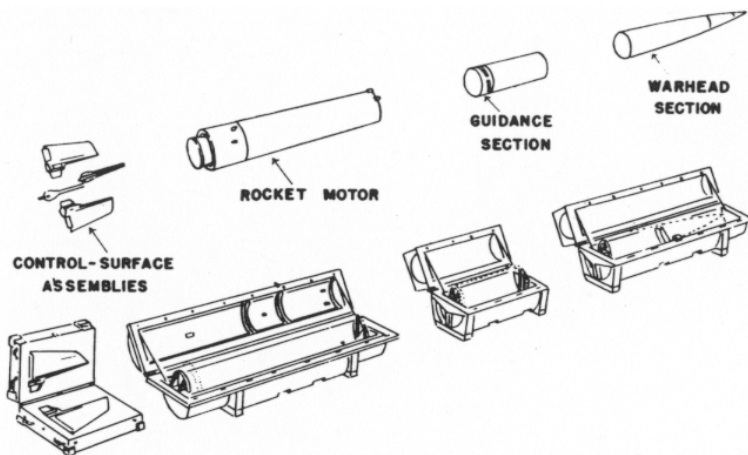

Figure 6. Missile: length 34 1/2 feet; weight 10,000 pounds. Transported in individual section containers. All sections are interchangeable between missiles and can be quickly mated with eight bolts.

MAINTENANCE

Maintenance of the Sergeant, as compared to that of the complex Corporal, has been greatly simplified through the Sergeant automatic checkout system. The OMTS provides the battery missile test section with the ability to test the Sergeant guidance section and control-surface assemblies in their containers and to isolate malfunctioning electronic assemblies. The checkout time for the Sergeant is decidedly less than that for the Corporal because the Sergeant test equipment indicates only GO or NO GO for system components, whereas testing for the Corporal involves reading dials, meters, and gauges to determine malfunctions. If a malfunction is detected during the checkout of a Sergeant component, the entire component can easily be replaced with a new one.

A faulty Sergeant assembly is sent to the battalion ordnance missile maintenance platoon where the FMTS is used to determine the defective electronic subassembly within the faulty component. The OMTS and FMTS with their automatic checkout and programmed test sequences have reduced the amount of maintenance training required, because personnel are concerned only with simple troubleshooting techniques rather than with the detailed circuit analysis.

SYSTEM IMPROVEMENTS

Numerous modifications have been made to the system, during the period of its development, to improve ground handling equipment and reduce reaction time:

- New hydraulic motors have been installed on the launching station to provide smoother operation of the launcher.
- A dial has been installed in the firing set which permits the operator to make the necessary azimuth setting required for a particular firing. This replaces the cumbersome handsetting of the cam on the azimuth ring.
- Hydraulic jacks have replaced the hand-operated winch used on earlier models to raise and lower the blast shield.
- A hoist brake has been installed on the launching station. This will prevent the dropping of missile sections in case of power failures, operator errors, and/or other malfunctions.
- The change from a 2 1/2-ton to a 5-ton truck tractor as a prime mover for the launching station has increased the mobility of the system.
- Air conditioning has been added to the firing set, the OMTS, and the FMTS for better environmental control.

ORGANIZATION

Recent organizational modifications have greatly increased the efficiency of today's Sergeant system over earlier organizational versions. The present basic organization of the Sergeant battalion consists of a headquarters and headquarters battery and two firing batteries (fig 7).

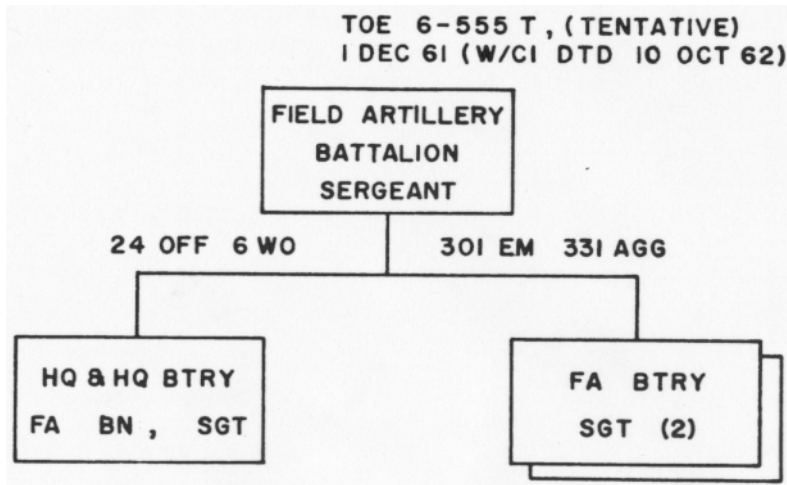

Figure 7. Field artillery missile battalion, Sergeant.

The ordnance missile maintenance platoon, presently organic to the headquarters battery, was a detachment in earlier organizational concepts (fig 8).

The tentative organization for the firing battery consists of a battery headquarters, a battery detail, and one firing platoon (fig 9).

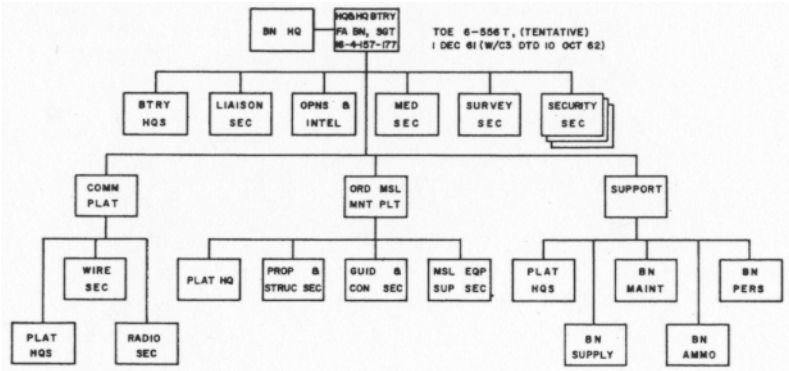

Figure 8. Headquarters and headquarters battery, field artillery missile battalion, Sergeant.

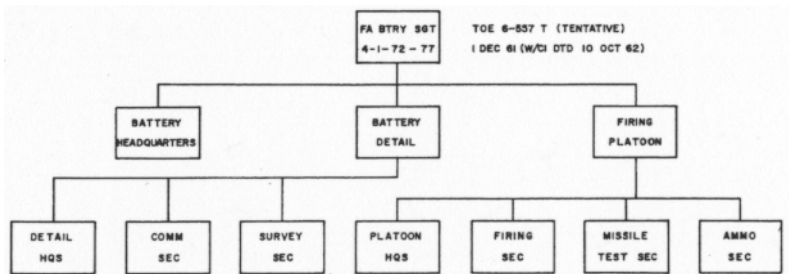

Figure 9. Field artillery missile battery, Sergeant.

PART II--SERGEANT TRAINING

Major William S. Monsos
Guided Missile Department

Under the supervision of the 1st Field Artillery Missile Brigade at Fort Sill, Oklahoma, several Sergeant battalions have been activated,

organized, trained, equipped, and deployed. The systems training concept is being employed in the Sergeant activation training program (fig 10).

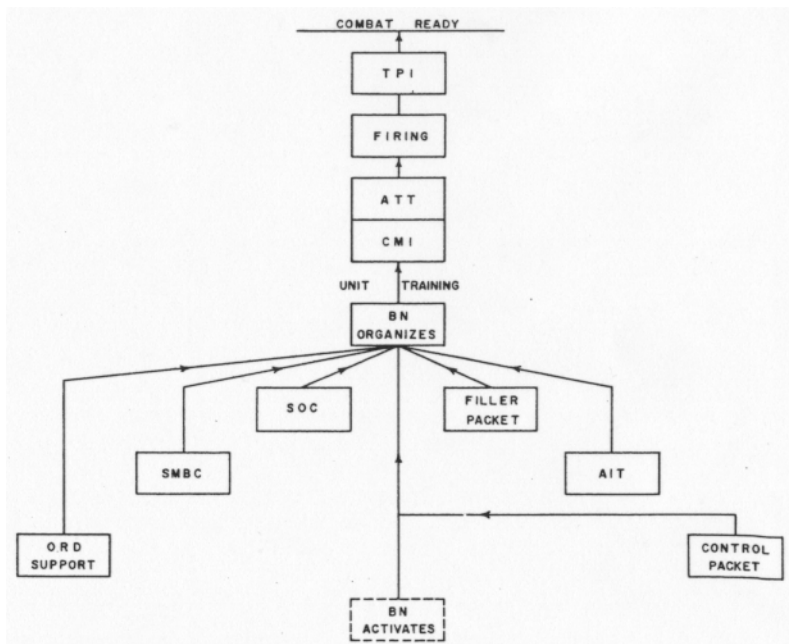

Figure 10. Activation training program for Sergeant.

Personnel for a newly activated Sergeant battalion are provided from several different sources:

- Personnel for a control packet are assigned, providing a skeleton battalion framework.
- School-trained specialists are furnished by USAAMS from the Sergeant Officer (SOC) and Missile Battery Courses (SMBC).
- Personnel for the ordnance direct support platoon are furnished and trained by the Ordnance Guided Missile School, Redstone Arsenal, Alabama.
- The necessary cooks, administrators, survey, communication, and maintenance specialists are provided by an assigned filler packet.
- The remaining battalion personnel are provided from advanced individual training courses conducted by the 1st Field Artillery Missile Brigade.

After receiving the required equipment, the battalion begins a 13-week training phase followed by a command maintenance inspection (CMI) and an Army training test (ATT). The battalion then moves to White Sands Missile Range, New Mexico, for graduation firings. Upon completion of the firings, the unit returns to Fort Sill for a technical proficiency inspection and prepares to move overseas.

TRAINING PLAN DEVELOPMENT

Prior to the activation of the first battalion, agencies concerned with the Sergeant spent many months planning a suitable training program for the system. Training plans to include training aids and equipment, instructor training, and facilities had to be coordinated with equipment delivery schedules.

USAAMS planning for the Sergeant training program covered several years. In the initial phases, USAAMS participation consisted mainly of general monitoring of the system, liaison visits, general coordination, and submission of early requirements. Preliminary requirements for the two major training devices for the Sergeant program, the 3G52 missile trainer (fig 11) and the 3G100 ground support equipment trainer, were submitted long before the beginning of the actual training program, to insure timely availability.

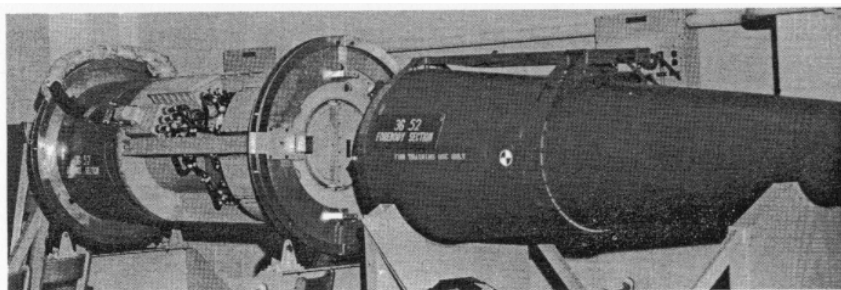

Figure 11. 3G52 Sergeant missile trainer.

The present Sergeant program of instruction (POI) closely resembles the POI developed for initial planning, in which estimates of required equipment, instructors, facilities, training aids, and number, length, and frequency of courses were determined.

The Sergeant missile system POI is a radical change in specialist training as compared to other missile system POI's. Sergeant specialists receive no electronic training, and the longest course of instruction is 6 weeks; a significant reduction from the 8-month specialist courses required for some, more complex missile systems.

Instructors attended new equipment training (NET) programs before preparing their lesson plans and classes. Ordnance and artillery personnel received primary NET courses on the overall system at the Sperry Utah Company in Salt Lake City, Utah. New equipment training courses were also conducted on the 3G52 missile trainer and the 3G100 ground support equipment trainer at Fort Sill, and on the gas turbine generator set (Sergeant's primary power source) at Fort Belvoir.

The scheduling, preparation, and finalization have helped the Sergeant training to proceed smoothly and properly, a tribute and testimonial to hard work, complete planning, proper vision, and foresight (fig 12 and 13).

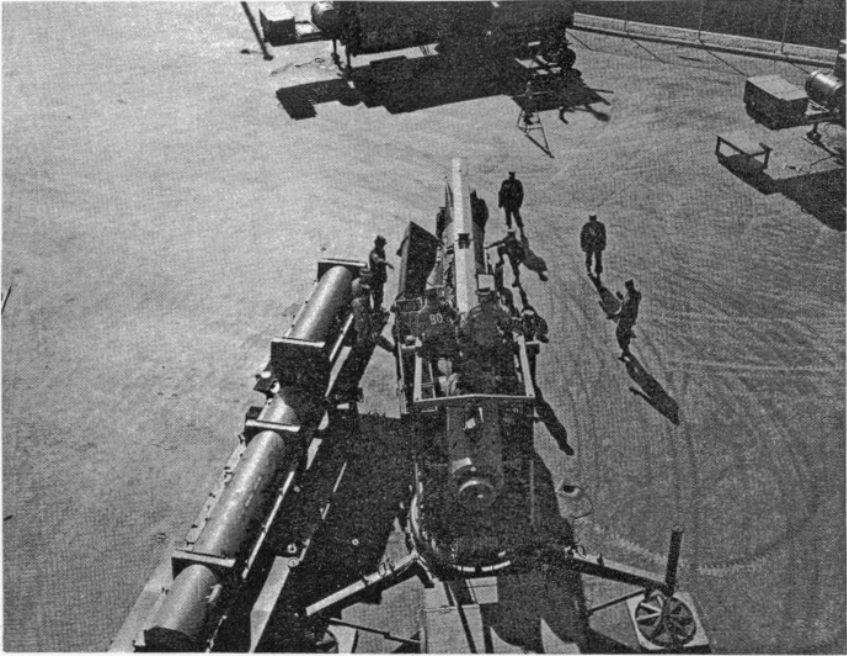

Figure 12. Sergeant personnel receive realistic rocket assembly practice with the 3G52 missile trainer.

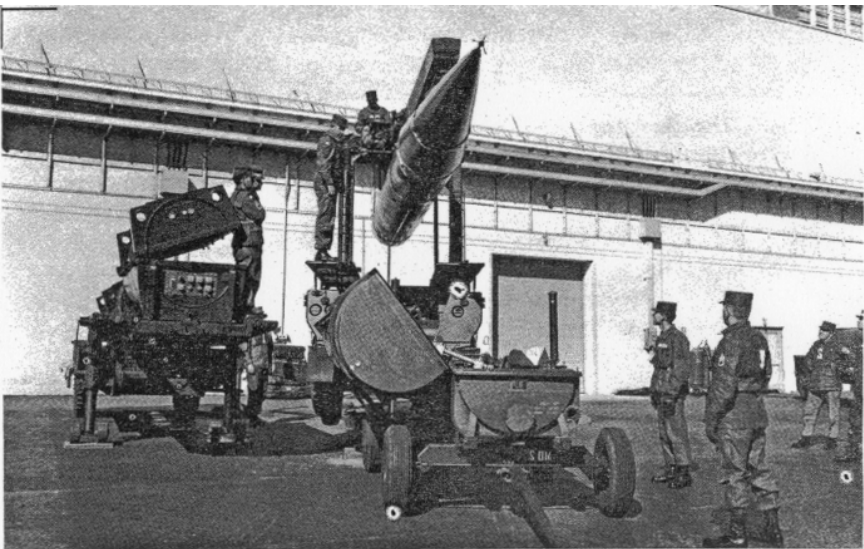

Figure 13. Sergeant trainees demonstrate the mating of the warhead to the rocket motor with the 3G52 missile trainer.

PART III--SERGEANT TESTING PROGRAM

Major Wendell E. Phillips

US Army Artillery Board

The Sergeant guided missile system has nearly completed the Joint Engineer-Service Troop Test which will determine how well the missile system meets its approved military characteristics and how the Sergeant equipment can best be utilized under tactical conditions by troops with average training. The test is a combined effort, involving the Artillery Board, Fort Sill, Oklahoma, and the Army Missile Test and Evaluation Directorate, White Sands Missile Range, New Mexico.

More realistic results can be achieved during missile system tests if a tactical troop unit provides support for the test. Consequently, the first tactical Sergeant battalion, the 3d Battalion, 38th Artillery, and 23d Ordnance Direct Support Detachment have been placed under the control of the Artillery Board in support of the Sergeant test.

The Sergeant Joint Engineer-Service Troop Test began in the late spring of 1962 with a series of intensive tactical type, nonfiring field problems at Fort Sill, Oklahoma (fig 14-24).



Figure 14. The Sergeant can be assembled and fired from a predetermined position with nine crew members. The launching station can be emplaced in an area as small as 20 meters in diameter.



Figure 15. The power generator of the Sergeant is started, and then the outrigger jacks are lowered on the station, which provides the assembly and firing platform for the missile.



Figure 16. The launching station is leveled, and the boom is unfolded to the loading position. Left.



Figure 17. The rocket motor of the missile is removed from its container and raised to its "hooked" position on the boom. Right.



Figure 18. The guidance section of the Sergeant is removed from its container and attached to the rocket motor with four bolts.



Figure 19. The warhead section is hoisted from its container and attached to the rocket motor with four bolts. Left.



Figure 20. The fins or control surface assemblies are snapped onto the missile. Right.

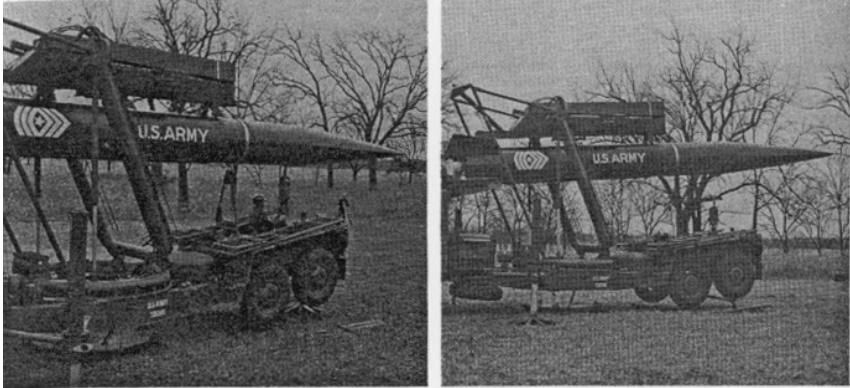

Figure 21. The Sergeant azimuth orientation unit (AOU) operator sights on the reference theodolite to accurately align the missile guidance platform. Left.

Figure 22. At X—6 minutes in the countdown, all firing section personnel except the firing set operator leave the firing position. Right.

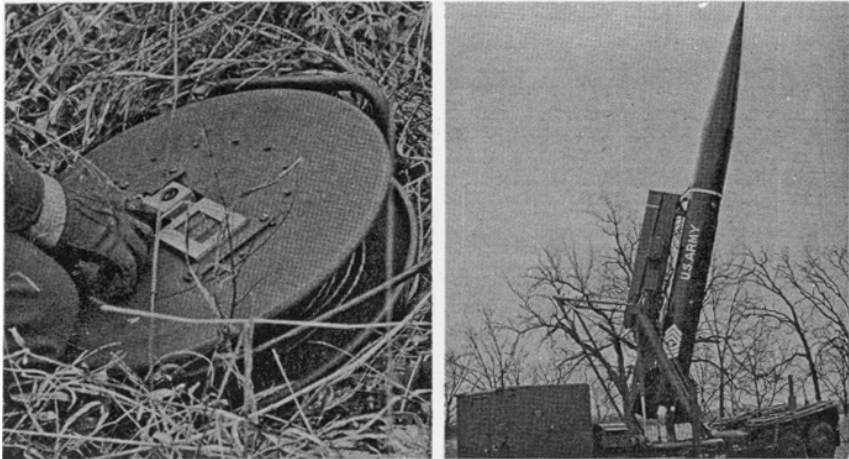

Figure 23. The operator continues to monitor countdown progress until X—3 minutes when he leaves the firing set and proceeds to a remote firing pit where he continues to monitor countdown with a portable firing box. Left.

Figure 24. At a certain time in the countdown, the missile is elevated and traversed to the proper firing position. Right.

Upon completion of the nonfiring tests, the 3d Battalion was road marched to White Sands Missile Range where it joined the Ordnance crew for additional nonfiring exercises and for the firing of 27 Sergeant missiles. The first of these 27 missiles was launched in mid-July 1962 (fig 25). All firing and nonfiring tests will be completed in early May, and the Artillery Board's service test report will be submitted about 1 June 1963.

The results of the Sergeant tests to date show that the system is more reliable, more accurate, and more rugged than its predecessor, the Corporal.

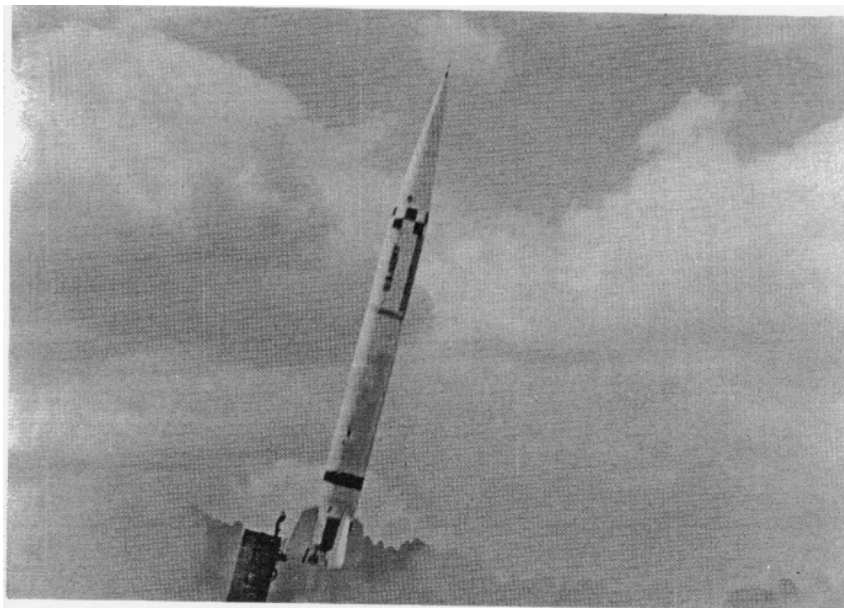
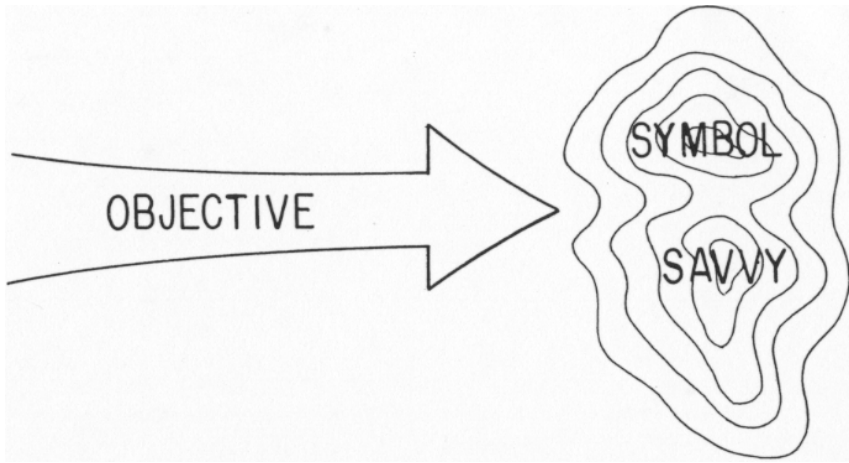

Figure 25. The Sergeant missile system is continually demonstrating its capabilities and readiness.

BACK ISSUES OF ARTILLERY TRENDS

Due to storage space limitations, varying numbers of copies of the following issues of ARTILLERY TRENDS must be disposed of by 31 May 1963: February, March, and June 1959; November 1960; March, June, August, and November 1961; October 1962; and January 1963. Units or individual members of the Armed Services who desire any or all of these issues may obtain them by request to the following address prior to 31 May 1963:

Commandant
US Army Artillery and Missile School
ATTN: AKPSIPL - ARTILLERY TRENDS
Fort Sill, Oklahoma



An understanding of operation overlays and situation maps is essential to all artillerymen involved in combat planning. This understanding can only be obtained through a knowledge of the meanings of various military symbols. To envision the entire situation pertinent to a particular combat operation, the artilleryman must be able to interpret not only those symbols in common artillery usage but also the symbols peculiar to other combat arms and services. The standardized symbols employed are simple enough to be accurate and understandable and yet detailed enough to leave no doubt as to what is being portrayed. Military symbols tell even the lowest unit commander when his unit will attack, what artillery fires will be planned to support him, and what terrain the enemy has occupied.

GENERAL SITUATION

Figure 1 shows the various symbols used on an operation overlay pertaining to a general combat situation.

Clearly defined on the ground and on the map are the locations of restrictive limits, such as the bomb line "B", short of which friendly aircraft may not attack without prior clearance from the ground forces, and the no-fire line "C", short of which no artillery unit may fire without prior clearance from the direct support artillery which established it. This operation overlay also designates the approximate location of friendly "D" and enemy "A" frontlines and patrols, straggler lines "E", main supply routes "H", and light lines "I".

Operation overlays indicate immediate or permanent boundaries by means of solid lines and future or proposed boundaries by means of broken lines, labeled with the time they are to be effective "F". One symbol is placed on a boundary to show the units having the boundary in common; but, if the units are of unequal size, the number and symbol of the higher unit are shown and the complete designation of the lower unit is given to show its size "G". Boundaries between allied units are identified by national distinguishing letters.



Figure 1. Operation overlay symbols pertaining to a general combat situation.

OFFENSIVE SITUATION

Figure 2 portrays various symbols used on an operation overlay pertaining to the control measures, tactical employment, and objectives inherent in an offensive combat situation.

The "jumpoff" phase of an offensive maneuver may be controlled by means of the forward edge of the battle area "B" and the line of departure "A". Both are approximately perpendicular to the direction of attack.

In order that all attacking elements may strike their objectives at the proper time, forward movement may be controlled by phase lines "D", where attacking units make nonstop reports, and checkpoints "C", prominent terrain features used by subordinate commanders as references for reporting their locations rapidly and accurately.

The manner in which an approach to an objective is designated depends on the amount of control a commander wishes to exercise. An axis of advance "E" is a general direction of attack which allows subordinates to choose their exact approach. A direction of attack "F" is an exact route designated by the commander to be rigidly followed by attacking elements.

Main objectives "H" may be assigned entirely to one subordinate unit or may be divided "G" with each area numbered separately. The sequence of numbering does not indicate a priority of seizure or importance. Every objective is identified with the abbreviation "obj" followed by the assigned number, letter, or unit designation.

DEFENSIVE SITUATION

Figure 3 shows various symbols used on an operation overlay pertaining to the security, forward, and reserve areas involved in a defensive combat situation.

In the security area, necessary designations include outpost lines established to provide early warning and to delay, disorganize, and deceive the enemy. The general outpost line (GOPL) "A" is normally designated by corps, controlled by division, and manned with troops assigned by division. Coordination points for the combat outpost line (COPL) "B" are designated by division.

The forward edge of the battle area "C" indicates the locations of friendly frontlines. A "goose egg" designates the visual outer limits of a frontline unit's primary "D" and supplemental "E" positions.

In the reserve area, the exact location of supply point "G" and command post "F" installations are indicated by placing a staff on the symbol.

SITUATION MAPS

Situation maps employ symbols identical with those described in the foregoing paragraphs concerning operation overlays of general, offensive, and defensive situations. Operation overlays graphically portray orders and instructions to subordinate units, whereas situation maps provide up-to-date information concerning tactical and administrative

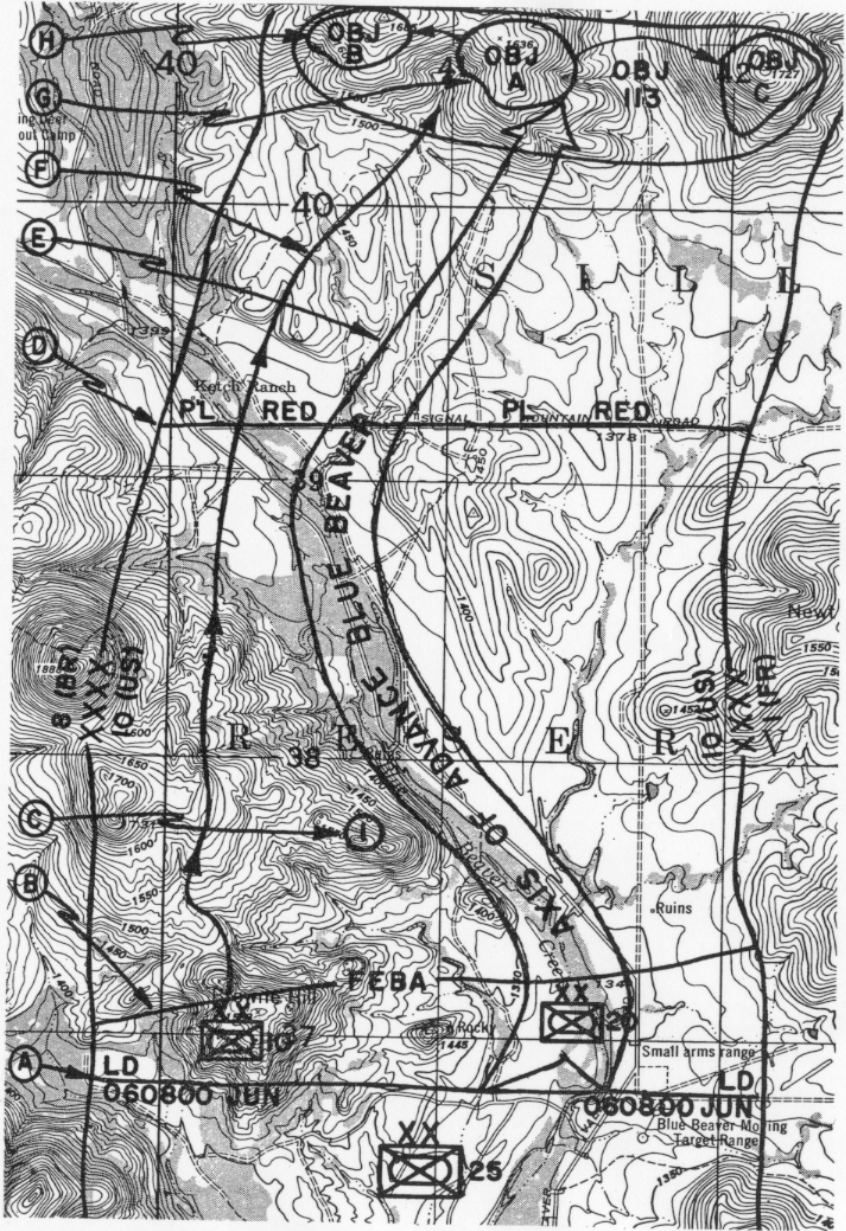

Figure 2. Operation overlay symbols inherent in an offensive combat situation.

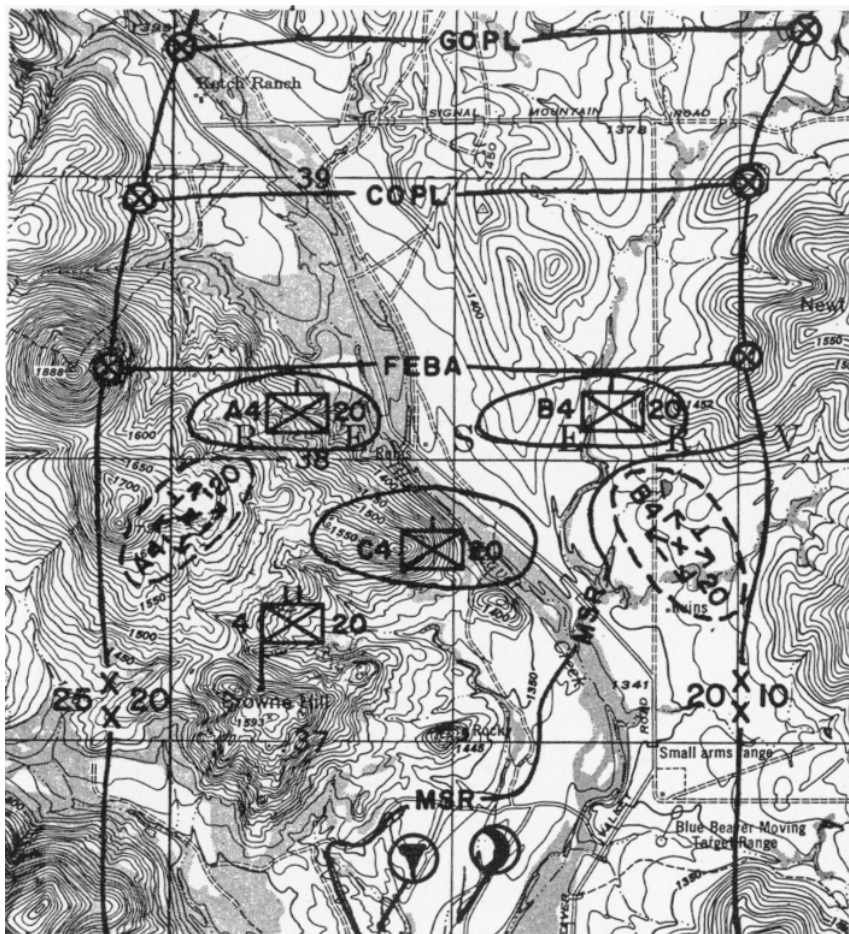

Figure 3. Operation overlay symbols pertaining to a defensive combat situation.

situations, to include traffic handling, supply operations, and medical evacuation. Situation maps may also be used in staff studies or in staff reports.

The ability to recognize and immediately understand conventional symbols is the key to formulating and interpreting graphical representations of combat information. The skill of artillerymen in the art of map reading is traditional. The intent of this article has been to provide a means of reviewing some of the symbols most commonly used in combat planning.

Single Sideband Radios

Lieutenant Leslie T. Jones
Communication/Electronics Department

The requirement for greater mobility, operational flexibility, and dispersion on the nuclear battlefield will place an ever-increasing demand on communication systems. The increased distances between tactical units will make it necessary to rely more than ever on radio communication. The number of frequencies available for use by the field artillery is limited; therefore, the problem of frequency allocation is extremely complex. The range of future radios must be increased considerably over that of our present tactical amplitude modulated (AM) sets. The 40- to 100-mile range is of particular interest to the field artillery. AM radios are capable of providing reliable communication up to 40 miles and in the range beyond 100 miles, but the problem of communicating in the 40- to 100-mile range throughout a 24-hour period has not been satisfactorily solved to date. One solution to problems of frequency spectrum crowding and increased distances between tactical units is the single sideband radio (SSB). This article will explain some of the history of SSB and some of the advantages of its use over the present AM radios used by the artillery.

The possibility of single sideband transmission as a communication method was discovered in 1915. In 1918, the SSB concept was used in commercial wire carrier telephone equipment. The first transatlantic SSB signal was transmitted in 1923. Further experimentation with SSB transmission resulted in the first transoceanic SSB radiotelephone service between New York and London in 1927. Starting in 1936, SSB equipment was available in the high frequency spectrum for long distance radio communication and was put to use in transoceanic radiotelephone service. During World War II, the military found wide use for SSB in intercontinental communication. At the present time, improved SSB radio and radio telegraph sets are available for military, commercial, and amateur users. The single sideband system is recognized as the standard for extremely long range, point-to-point communication systems and is appearing in its new role of providing greater utilization of the frequency spectrum in high frequency, portable, vehicular, and avionic applications. The US Air Force, Navy, and Marine Corps, as well as some foreign armies, are presently using tactical SSB equipment.

Since the single sideband principle is a form of amplitude modulated radio, let's examine the transmission of our present AM sets and compare it to SSB transmission.

AMPLITUDE MODULATION

Modulation is the process of superimposing audio-frequency intelligence on a radio frequency (RF) carrier. This method of modulation is readily understood by an examination of an amplitude modulated wave. There are three components of an AM wave; the carrier component, the upper sideband, and the lower sideband (fig 1). The carrier component is steady in amplitude, conveys no intelligence, and is constant in frequency. The frequencies of the upper sideband are equal to the carrier

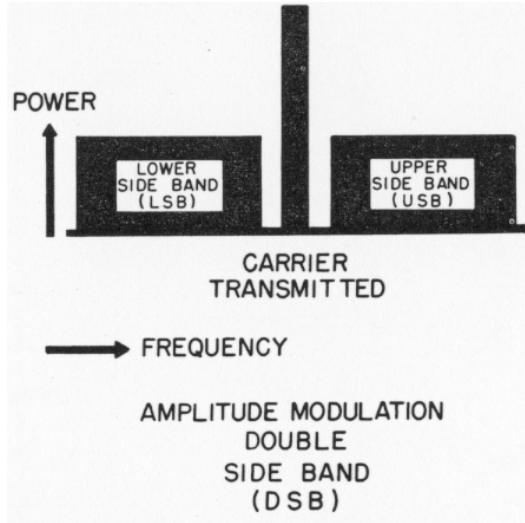

Figure 1. AM radio wave.

frequency plus the signal frequencies; the frequencies of the lower sideband are equal to the carrier frequency minus the signal frequencies. The sidebands carry all intelligence and are mirror images of each other. The term "signal" is used to represent the speech or basic intelligence being transmitted.

The intelligence bandwidth for voice communication is generally considered to be from 300 cycles per second (cps) to 3,000 cycles per second. A characteristic of amplitude modulation is that the radio signal requires a bandwidth twice that of the original signal. As an example, if the original signal contains frequencies from 300 cps to 3,000 cps, the total bandwidth requirement of an amplitude modulated wave would be 2 times 3,000 or 6,000 cps.

A major disadvantage of AM receiving equipment is that it cannot discriminate between natural electrical disturbances and the transmitted signal. Another disadvantage is that power is required to transmit the carrier even when no intelligence is being transmitted.

SINGLE SIDEBAND

Let us now investigate the single sideband radio and see how it can reduce some of the problems confronted by the artillery in its longer range communication systems. The SSB radio wave is similar to an AM wave except that only one sideband is transmitted (fig 2). The other sideband is filtered out and the radio frequency carrier is balanced out or suppressed. Since it is necessary to have a complete wave at the receiver in order to obtain the intelligence from the radio wave, the carrier

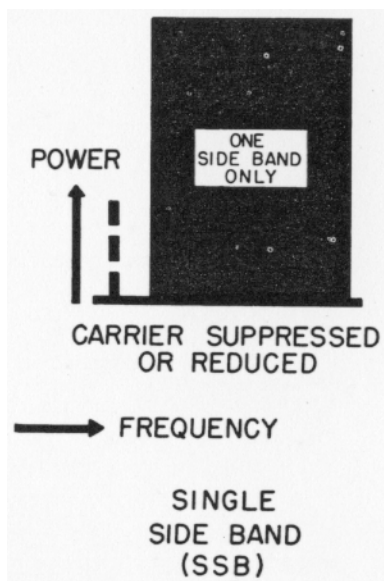

Figure 2. Single sideband wave.

must be reinserted at the receiver, and the other sideband must be reproduced. The carrier at the receiver must be of exactly the same frequency as the original carrier. This requires a very stable frequency generator and has been one of the main problems in adapting SSB for the mobile stations required by the artillery. However, in recent years, great strides have been made in overcoming this problem.

Single sideband radios offer economy both in frequency spectrum utilization and power consumption. This reduction of power required from the vehicle battery or other power supply is a very important aspect in the application of SSB for mobile applications. A single sideband system has considerably greater transmitted power output than that of a conventional AM system of equivalent power consumption. The reason for this increased power output is that no power is dissipated in transmitting the carrier and the unused sideband. All of the power is used to transmit the audio intelligence on only one sideband. An even greater power reduction results during the absence of transmission of

intelligence. During These periods of no transmission, a SSB radio set consumes considerably less power than a conventional AM radio set, due to the absence of a continuously transmitted carrier. SSB is not as susceptible to electrical interference as an AM set because of the decreased bandwidth of the transmitted signal and because of a stronger received signal at a given distance from the transmitter. A comparison of bandwidth requirements for the various modulation methods used in radio communication today shows a significant advantage in the use of SSB. AM systems require approximately 7 kilocycles (kc), and single sideband systems require approximately 3.5 kc for voice transmissions. Therefore, a single sideband system can provide approximately twice as many channels as an equivalent AM system.

Now that we are acquainted with SSB and some of its advantages, let us see what is being done to provide operational sets in the high frequency tactical communication systems of the field army. The Army has programs for the development and production of two single sideband radio sets—the 50-mile tactical radio set AN/GRC-106 and the 100-mile tactical radio set AN/GRC-107—and two radio teletypewriter sets—the 50-mile tactical radio teletypewriter set AN/GRC-122 and the 100-mile tactical radio teletypewriter set AN/GRC-108. It is anticipated that these sets will provide reliable communication in the 40- to 100-mile range.

The radio set AN/GRC-106 is a vehicular-mounted (can be mounted in a 1/4-ton truck), single sideband radio set weighing approximately 70 pounds that will provide voice and continuous wave (CW) communication. Its frequency coverage is from 2.0 megacycles to 30.0 megacycles in 1 kc locked steps with vernier tuning between steps. This radio set operates from a 24-volt direct current, 25-ampere vehicular generating system. It will be used primarily in forward area tactical command, warning, meteorological, and administrative nets. It is presently planned to replace the radio set AN/GRC-19 with the AN/GRC-106.

The radio set AN/GRC-122 uses the same receiver-transmitter as the AN/GRC-106 and has all of the characteristics described for the AN/GRC-106 except that it is mounted in a shelter designed to be transported on a 3/4-ton truck. In addition to these characteristics, the AN/GRC-122 includes teletypewriter equipment which enables this radio set to provide voice, teletypewriter, and CW operation in single sideband radio nets in the 2 to 30 megacycle range. This radio set will replace some of the current radio teletypewriter equipment.

The radio set AN/GRC-107 is a high frequency radio set, weighing approximately 400 pounds, which can be mounted in the 3/4-ton truck shelter. It provides one voice or one CW channel in the frequency range of 2.0 megacycles to 30.0 megacycles in 1-kc locked steps with vernier tuning between steps. The transmission range of the AN/GRC-107 is 100 miles, and it operates from a 115/230-volt alternating current, single-phase, 60- or 400-cycle power source. The AN/GRC-107 will be

used primarily as a tactical radio set in conjunction with other high frequency, single sideband radio sets in division, corps, and army communication systems.

The radio teletypewriter set AN/GRC-108 utilizes the radio set AN/GRC-107 as a component part and has all the characteristics of the radio set AN/GRC-107 described above. In addition to these characteristics the radio set AN/GRC-108 includes radioteletypewriter equipment which gives this radio set a full duplex voice, teletypewriter, and CW capability in the 2 to 30 megacycle range. This set will be used in high frequency, single sideband radio teletypewriter nets in the division, corps, and army.

Single sideband radios will make more economical use of the radio frequency spectrum. They will be smaller and lighter than the sets they replace and yet will offer greater capabilities (both in terms of frequency coverage and range). Modular construction will reduce maintenance requirements. They will provide greater reliability, will reduce the number of major components in the high frequency (HF) family of radios, will provide for component standardization throughout the HF family of radios, and will feature a higher degree of compatibility between the different HF radio sets. These radios will enhance mobility and communication flexibility on the battlefield. The radio sets AN/GRC-106 and -122 are expected to be available for issue in 1965, and the radio sets AN/GRC-107 and -108 are expected to be available for issue in 1967.

Although single sideband radios may not completely replace all present AM radio sets in the field army, it is certain that single sideband will play an ever increasing role in the communication systems of the artillery. The change from AM to SSB is necessitated by the requirement for greater range and reliability from tactical radios on a nuclear battlefield. The single sideband radio has been used with great success by the Marine Corps and the Navy shipboard communication systems. Tests substantiate the belief that the artillery will have the same success and that single sideband radios will be the backbone of future long range artillery communication systems.

●

AN/GRC-106 NEARS PRODUCTION

The Army has recently announced completion of development and testing of the AN/GRC-106. This two-way, transistorized set weighs 100 pounds and provides dependable 50-mile voice communications. Although half the size and weight of the set it replaces, the AN/GRC-106 provides ten times the effective signal power and twice the range through the use of advanced single sideband circuitry. This set operates on any one of 28,000 high frequency channels spaced one kilocycle apart. Tuning is simplified by the use of a digital tuning system in which a channel is selected by setting a series of knobs to prescribed numbers.

F A D A C

Part I--Maintenance Problems of the FADAC User

Mr. Michael Moss
Communication/Electronics Department

The arrival of the computer, gun direction, M18 (FADAC) in the field is imminent, and the receipt of new and different equipment usually brings new problems in user-equipment relationships. This is particularly true of the FADAC, the introduction of which will mark the first digital computer to be used in a field where manual techniques have been predominant for many years. An example of a FADAC problem area is revealed by the question: how does the user (operator, supervisor, commander, or technician) know when the computer is working properly?

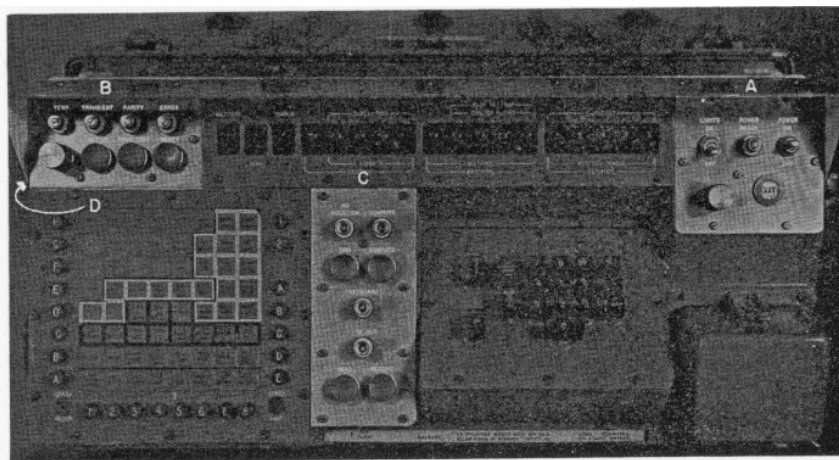

Figure 1. FADAC main control panel (divided into four areas for reference purposes).

Another question is: in the event of improper functioning of the FADAC, how does the user separate a legitimate malfunction from an operator-generated trouble?

To answer these questions and to provide information and user guidance, this part will outline proper computer checkout procedures and good operating habits. Computer checkout and malfunction recognition are the principal problem areas in the user-FADAC relationship and are therefore discussed separately.

COMPUTER CHECKOUT

The computer checkout procedure is used to determine that the computer is functioning properly and that it is ready for problem-solving. The initial step in checkout is the application of power to the computer by operation of the POWER ON-OFF switch, shown in area A of figure 1. This is a momentary contact, center-return switch. In the ON position, this control actuates the power control circuits in the computer, thereby energizing in proper sequence the power supply, cooling blowers, and computer memory. After a delay of approximately 20 seconds, the POWER READY indicator (area A, fig 1) lights. When this indicator lights, the computer is ready to be checked for proper functioning. (CAUTION: If the POWER ON-OFF switch is accidentally triggered again after the POWER READY indicator lights, the computer will not function. This condition is indicated when the POWER READY light goes out. The correct procedure to reestablish power is to place the POWER ON-OFF switch in the OFF position, thereby deenergizing the computer. Then the switch is placed in the ON position again, and the computer is ready when the POWER READY indicator light comes on.)

Checkout of the computer is accomplished primarily by program tests and computation of sample problems. The program tests are normally run before the sample problems are computed. The permanent storage program test is a check of the program in the permanent portion of the memory. In this test, all the numbers in the program are added and the result is subtracted from a given number in the memory. The result should be a Nixie display of a specific number, as indicated in the manual accompanying the program tape. If the display is incorrect, the NO SOLUTION light (area C, fig 1) will blink continuously. In the event of a NO SOLUTION indication, it is important to insure that the test has been properly conducted. Since the possibility also exists that the computer has not had sufficient warm up time (even if the POWER READY indicator is lit), the operator should wait a reasonable length of time and rerun the program test. If the NO SOLUTION indication persists after the rerun, the maintenance technician should be summoned.

A second program test is the temporary storage program test, which determines if the program is properly transferring information into the temporary portions of the memory. The correct indication for this test is a display of the address of the highest numbered channel in the memory being used for temporary storage. For all programs, the user should consult the appropriate manual for the specific address to be displayed.

The sample problems are contained in the FM 6-3-() series, such as FM 6-3-1, "Operation of Gun Direction Computer M18 (FADAC)—Cannon Applications." If the sample problems produce correct answers in the computer, the machine may be considered to be functioning properly. If the computer produces incorrect answers, it is possible that one or more items of information may have been improperly entered in the

computer memory or that the operator may have failed to remove nonstandard data (ballistic, meteorological, or registration) from the computer memory before running the sample problem. After a careful check has been made to insure the removal of all nonstandard data from the computer, the sample problem should be rerun by another operator. It is essential at this point in the procedure to insure that incorrect answers are not being caused simply by oversight or by the insertion of incorrect data. If, after checking all inputs and establishing standard conditions, the rerun does not provide correct answers, troubleshooting procedures may be begun.

A valuable supplement to the sample problems may sometimes be available in the form of "did hit" data from previously fired missions. However, care must be exercised in the use of these missions, because all nonstandard data that applied to the original firing must also be used as inputs in running the mission through the computer for checkout purposes.

Another important element of computer checkout is the marginal test. This test is performed when the equipment is first installed or whenever the user believes that the equipment is not operating properly. The marginal test is conducted by running a program test with the MARGINAL TEST switch (area D, fig 1) in each of its five positions. This switch varies the power supply voltages in the computer, thus intentionally forcing any marginal subassembly within the machine which might cause an intermittent malfunction into a steady state malfunction. Then the steady malfunction can readily be located, isolated, and repaired. Whenever the MARGINAL TEST switch is in any position other than OFF, the POWER READY indicator light will blink to indicate that the computer is in the marginal test mode. The marginal test will also detect aging components by forcing them to malfunction at a time when such malfunction can be readily repaired. It is important to remember that if the computer generates correct answers in the normal mode but incorrect answers in the marginal test mode, it can still be used with confidence. Of course, the maintenance technician should be called at the earliest convenient moment to replace the aging components. Thus, the marginal test not only is a powerful tool for accomplishing computer checkout but also serves as a confidence builder for the user.

MALFUNCTION RECOGNITION

One of the most important aspects of operator training in the use of FADAC is the prompt and accurate recognition of computer malfunction. Experience to date clearly indicates that computer reliability is considerably higher than was anticipated and that many so-called troubles are generated by operator error rather than by equipment malfunction. As field experience is gained by the user, it will become apparent that the thoroughness with which operator procedures are followed will eliminate most of these troubles. Many minor troubles can be analyzed and corrected by the user, thereby removing a considerable burden from the maintenance technician and eliminating many needless

calls for his services. Recognition of these minor troubles, as well as the legitimate malfunctions which lie beyond the scope of user repair, can be expedited by proper use of the trouble indicators (area B, fig 1) on the computer main control panel.

The TEMP indicator, which is normally lighted, blinks when the computer internal operating temperature falls outside the operating range (-40° F to +125° F). Although the temperature is not likely to fall below the lower operating limit, the upper limit may be exceeded through carelessness; for example, by exposing the computer to the summer sun in many climates (not necessarily tropical). Appropriate measures, such as the use of a suitable cover, can alleviate high temperature conditions and keep the computer operable.

The TRANSIENT indicator is normally lighted when line voltage is correct. The indicator blinks when there is a line voltage transient or when the input 3-phase power is not within tolerance. If the input voltage (normally 120 volts) falls to 108 volts or rises to 132 volts, the indicator blinks continuously. If the input voltage falls outside the 100- to 140-volt range, the power supply to the computer is automatically stopped. If a power failure occurs, there are certain other indications which govern whether a maintenance technician should be called. The power failure may be a one-time condition, in which case the RESET button may be pushed and the computations repeated to correct the condition. If the power failure persists, the power generator should be checked before maintenance personnel are called. A slight adjustment of output frequency or voltage may be all that is required to correct a persistent deficiency. Also, when power is being applied to the computer, the operator should insure that the cooling blowers are operating. If the TRANSIENT error persists, the maintenance technician should be called.

The PARITY indicator blinks as a result of the failure of an internal parity check. The parity check determines whether information is being correctly transferred from an input device to the memory and from the memory to an output device. Again, the operator should push the RESET button and restart computations. If the parity error persists, the maintenance technician should be called.

The ERROR indicator, which is normally on, blinks when an internal overflow has occurred or when a verification process fails to give correct results. In the event of an error indication, the best procedure is to start the problem again from the beginning. Operator error is always a possibility and careful checking of all inputs used in computing problem solutions is required. If checking procedures rule out operator error, a sample problem from the field manual may be solved to determine whether there is a computer malfunction. If the sample problems produce correct answers, the computer is **probably** working properly; if the sample problems produce incorrect answers, maintenance personnel should be summoned.

The PROG TEST control initiates the program tests during checkout of the computer. When this pushbutton is momentarily depressed and

a 1 is entered through the keyboard, the permanent storage program test will be entered into the computer. When the pushbutton is depressed and a 2 is entered through the keyboard, the temporary storage program test is initiated. During the computation of either of these program tests, the COMPUTE indicator (area C, fig 1) lights. The COMPUTE indicator goes out when the test is completed.

The RESET switch is a momentary-push switch which may be operated and released to clear an error indicated by a blinking PARITY, TRANSIENT, or ERROR indicator. When this switch is operated, the computations in process are cleared, the blinking indicator ceases to blink, and the operator may restart computations. If reset and restart procedures do not eliminate the blinking, appropriate troubleshooting procedures are started.

The NO SOLUTION indicator blinks when an out-of-range solution occurs or if some input parameter is omitted prior to beginning computations. This indicator will automatically reset itself when the SAMPLE MATRIX pushbutton is activated and the missing piece of information is supplied or when the parameters are recalled for a check of the inputs.

Because of the close user-machine relationship, the FADAC operator must be well trained. Avoidance of "cockpit trouble" will be in direct proportion to the thoroughness and care with which the operator is trained. Although this training teaches correct procedures and instills good maintenance habits, only constant attention to these procedures and habits will insure reliable functioning and trouble-free operation. A well-trained FADAC operator, constantly on the alert and using good operating procedures, is one of the strongest links in the chain between the artillery weapon and its target.

Part II--FADAC Publications

Captain Douglas B. Stuart
Gunnery Department

With the forthcoming issue of FADAC to artillery units, many new field manuals (FM's) and technical manuals (TM's) will be required for its proper operation and maintenance. A brief glance at the FADAC-related field manuals and their organization was provided in ARTILLERY TRENDS (October 1962, p 18). To reiterate this information briefly, the basic field manual, FM 6-3, describes the non-program associated computer operator's duties and a series of supplemental manuals, the FM 6-3-() series, describes in detail the computer operator's procedures with a particular program entered in the computer's memory (for example, FM 6-3-1 pertains to the cannon trajectory program).

The technical manuals describing the computer are the TM 9-1220-221 series. Non-program associated first-echelon maintenance and operator procedures will be contained in TM 9-1220-221-10/1, and program associated procedures will be found in the remaining manuals of the

	Divisional 8-Inch Howitzer Battery	Divisional Honest John Battery	Divisional Little John Battery	Hq Btry, Howitzer or Gun Battalion	Hq Btry, Honest John Battalion	Hq Btry, Little John Battalion	Hq Btry, Lacrosse Battalion	Hq Btry, Redstone Battalion	Hq Btry, FATAB	Hq Btry, Division Artillery	Hq Btry, Field Artillery Group	Hq Btry, Corps Artillery
FIELD MANUALS												
FM 6-3	X	X	X	X	X	X	X	X	X	X	X	X
FM 6-3-1 (Cannon)	X			X						X	X	X
FM 6-3-2 (Honest John)		X			X					X	X	X
FM 6-3-() (Little John)			X			X				X	X	X
FM 6-3-() (Lacrosse)							X				X	X
FM 6-3-() (Redstone)								X				X
FM 6-3-() (Survey)									X	X		X
TECHNICAL MANUALS												
TM 9-1220-221-10/1	X	X	X	X	X	X	X	X	X	X	X	X
(Cannon)												
TM 9-1220-221-10/2	X			X						X	X	X
(HJ)												
TM 9-1220-221-10/()		X			X					X	X	X
(LJ)												
TM 9-1220-221-10/()			X			X				X	X	X
(Lacrosse)												
TM 9-1220-221-10/()							X				X	X
(Redstone)												
TM 9-1220-221-10/()								X				X
(Survey)												
TM 9-1220-221-10/()									X	X		X
TM 9-1220-221-20				X	X	X	X	X	X	X	X	X
TM 9-1290-326-12										X	X	X
TM 9-1290-326-20P										X	X	X
TM 9-4931-204-12										X	X	X
TM 9-4931-204-20P										X	X	X

Figure 2. Distribution pattern for FADAC manuals.

TM 9-1220-221-10/() series. There will be a manual for each program to be entered into the computer memory, for example, TM 9-1220-221-10/2 is used with the cannon program. Although the organization of the first-echelon technical manuals varies little from that of the field manuals, the field manuals are oriented toward operator duties and the technical manuals give a technical description of the materiel, providing only sufficient operator procedures to enable the operator or maintenance personnel to determine that the equipment is operating properly.

The technical manual describing the second-echelon maintenance procedures for the FADAC will be TM 9-1220-221-20. Since there will be several diagnostic tapes for use in checking the computer, this second-echelon manual will be organized similarly to the first-echelon manual, and there will be a supplemental manual for each diagnostic tape. In addition, TM 9-1220-221-20P will list and describe the spare parts available at second-echelon level.

Third- and fourth-echelon maintenance procedures are described in TM 9-1220-221-34, and fifth-echelon procedures are given in TM 9-1220-221-50. The spare parts available at third- through fifth-echelon levels will be described and listed in TM 9-1220-221-35P.

MLU AND FALT

The signal data reproducer AN/GSQ-64 (memory loading unit) (MLU) and the computer logic test set AN/GSM-70 (FALT) will be issued to division artillery headquarters, artillery group headquarters, and corps artillery headquarters. For the memory loading unit, the first- and second-echelon maintenance procedures will be contained in TM 9-1290-326-12, and the second-echelon spare parts will be listed in TM 9-1290-326-20P. TM 9-4931-204-12 will describe the first- and second-echelon maintenance procedures for the FALT, and TM 9-4931-304-20P will describe the second-echelon spare parts.

The manuals described in this article will be issued through normal publications channels to the units that need them. In addition, TM 9-1220-221-10/1 will be issued with the computer, and a copy of the appropriate FM 6-3-() series manual and the TM 9-1220-221-10/() series manual will be issued with the programs as a part of the program package (ARTILLERY TRENDS, October 1962).

The last type of FADAC publication is the supply bulletin. Through this medium, units in the field will be kept informed of the latest program tapes to be used. Although not initially a problem, it is felt that confusion could develop as changes and new tapes are generated. Each program tape will be marked with its applicable caliber(s) of weapon(s) and with the date the tape was made. This information will identify the tape and assure the units that the latest program has been entered into the computer memories.

Part III--FADAC FDC Organization

Captain Douglas B. Stuart
Gunnery Department

To be effective, an FDC organization must allow its unit to process fire missions accurately and rapidly under all conditions. This principle has worked well in our present FDC organizations and is being carried over into the FDC organization planned for use with the gun direction computer M18 (FADAC). The new organization not only will allow the computer to be used to best advantage but also will give the S3 maximum flexibility in the processing of fire missions.

In both personnel and equipment, the cannon battalion FADAC FDC organization is very similar to the present organizations which do not employ the computer. The only change in personnel is the substitution of a computer operator for the horizontal control operator. The only change in the equipment issued to the FDC is the addition of the computer and its supporting generators and program package. The graphical FDC equipment will be retained to allow the S3 to process missions manually as well as with the FADAC. However, because of the superior accuracy of the FADAC, it will be the primary means of generating firing data. The FADAC is expected to be highly reliable—no excessive computer or generator malfunction is anticipated. The fact that the manual capability is being retained stresses the fact that the artilleryman must always provide an alternate means of computing data and delivering fire.

BATTALION LEVEL			BATTERY LEVEL	
FULL SHIFT			FULL SHIFT	
REDUCED SHIFT				
1	S3 (OR REPRESENTATIVE)	1	ASST EXEC OFFICER	1
1	CHIEF OF FIRE DIRECTION	0	COMPUTER OPERATOR	1
1	COMPUTER OPERATOR	1	VERTICAL CONTROL OPERATOR	1
1	VERTICAL CONTROL OPERATOR	1	RADIO-TELEPHONE OPERATOR	2
			TOTAL 1 OFF, 4 EM	
3	COMPUTER/RECORDER	3	* NOT MEMBER OF FDC	
2	RADIO-TELEPHONE OPERATOR	0		
1*	SWITCHBOARD OPERATOR	1		
1 OFF, 8 EM		1 OFF, 5 EM		
TOTALS				

Figure 3. Typical FADAC fire direction center shifts.

CANNON BATTALION FDC

The members of a full FADAC battalion FDC shift in cannon units and their duties are as follows:

- **Battalion S3**—Is responsible for overall supervision of FDC.
- **Chief of fire direction**—Acts as the chief enlisted assistant to the S3. The title has been changed from its former designation of chief fire direction computer to avoid confusion.
- **Computer operator**—Operates the FADAC.
- **Vertical control operator (VCO)**—Determines the target altitude and announces it to the computer operator, and maintains the chart for a manual backup in the event of computer malfunction. If it becomes necessary to revert to the manual system, the VCO will compute the site.
- **Computer/recorder**—Records and transmits fire commands to their particular batteries. If the computer becomes inoperable, the computer/recorder computes fire commands, using the graphical firing table. There will be one computer/recorder in each firing battery, as in present FDC's.
- **Switchboard operator**—Operates the FDC switchboard (a member of the communications platoon who trains with the FDC).
- **FDC vehicle driver**—Operates and maintains the generator for the computer as an additional duty.
- **Radiotelephone operator (RTO)**—Receives command fire requests and maintains contact with the target acquisition agencies, if necessary.

During periods of reduced activity, the number of personnel on duty may also be reduced. As an example, the computer/recorders may monitor incoming transmissions, and the chief of fire direction may perform the duties of the VCO. By using this organization, the FDC can operate with six enlisted men and one officer. If the FDC is to be placed in a command post vehicle, such as the XM577, it will be necessary to use this type of organization because of space limitations of the vehicle.

The battalion S3 has considerable flexibility in processing fire missions. He may use the FADAC to compute all firing data, since the production model computer allows considerable flexibility in processing multiple missions. In addition, when processing multiple missions, the S3 has the option of processing some missions with the computer and processing other missions manually. Also, the option of forwarding a mission to a battery FDC for processing still exists.

The FADAC FDC organization has been designed for ease of transition, in the event of computer malfunction, from the FADAC to manual processing. To manually process a fire mission, the vertical control operator announces ranges and deflections, and the computer/recorders use the graphical firing table to compute firing data as in the present system. During short periods of computer malfunction, the computer operator would probably assist the maintenance personnel who are working on the computer. However, during extended periods of computer malfunction, when it is necessary to use a full "manual" FDC, the computer operator will assume the duties of the horizontal control operator (HCO).

PROCESSING FIRE MISSIONS

In the table in figure 4, the numbers in the left column indicate the steps in processing a fire mission and the duties of the FDC personnel are listed in sequence under the appropriate column headings. Blank areas in the table indicate that a member of the FDC has no particular duties in the processing of the mission at that time. Duties listed for several members of the FDC on the same sequence line indicate that these functions are completed simultaneously. Duties listed inside parentheses are performed individually by the appropriate member of the FDC; processing of the mission progresses without regard to whether these duties have been completed.

	RTO's (2)	S3	Chief of Fire Direction	Computer Operator	VCO	Computer/Recorders (3)	Swbd. Op.
1	Receive fire mission	*	*				**
2				Enter target	Plat target	Record target on computer's record	
3		Issue fire order					
4	Send message to Obsvr.				Announce altitude	Alert batteries: give fire commands through method of fire; record on computer's record.	
5				Enter altitude	(Computes site and prepares for manual backup, if necessary.)		
6				Enter fuze type & other overrides.			
7				Computes firing data using computer.			
8				Announce firing data for batteries to fire. Precede data by battery to which they apply.			
9						Transmit chg. DF, fuze setting, QE to btry (record on computer's record.)	
10						Receive "On the Way" from battery.	
11	Transmit "On the Way" to Obsvr.						
12	Receive subsequent corrections			Enter QT AZ if not previously entered		Record on computer's record	
13				Enter correction	Plot correction		
(Return to step 6)							
* Duties include overall supervision of FDC.							
** Operates switchboard as required.							

Figure 4. Duties of personnel and sequence of events, using a full FDC shift to process a fire mission.

If a unit is operating with a reduced shift (fig 5), the computer/recorders will also perform the duties of radiotelephone operator and maintain contact with the observers as well as with the batteries. The chief of fire direction serves as VCO.

	COMPUTER/RECORDERS (3)	S3	COMPUTER OPERATOR	VCO	SWBD. OP.
1	Receive fire mission; record on computer's record	*			**
2			Enter Target	Plot Target	
3		Issue Fire Order			
4	Alert batteries; give fire commands through method of fire. Record on computer's record.			Announce altitude (Computes site and prepares for manual backup if necessary)	
5	Send Msg to Obsvr.		Enter Altitude		
6			Enter Fuze Types and other overrides		
7			Compute firing data using computer		
8			Announces firing data for batteries to fire. Precede data by battery to which they apply.		
9	Transmit, Chg, Df, Fuze Setting, QE to batteries to fire. Record on computer's record.				
10	Receives "On the Way" from battery.				
11	Transmits "On the Way" to Obsvr.				
12	Receives subsequent correction		Enter OT AZ if not previously entered.		
13	***		Enters Correction	Plots correction	
(Return to step 6) * Duties include overall supervision of FDC. ** Operates switchboard as required. *** Breakdown of duties of Computer/Recorders other than transmission of data to batteries: 2—Act as RTO's to target acquisition agencies. 1—Could operate switchboard for further reduction of shift.					

Figure 5. Duties of personnel and sequence of events, using a reduced FDC shift to process a fire mission.

BATTERY FDC ORGANIZATION

The FDC shift for a battery equipped with the FADAC is organized as follows:

- An officer, normally the assistant executive officer, to supervise the FDC.
- A computer operator to operate the FADAC.
- A VCO to determine altitudes and maintain a manual backup capability.
- Two radiotelephone operators, one to receive the fire mission and the other to transmit fire commands to the battery executive officer.
 - A vehicle driver, who is also responsible for operating the generator which furnishes power for the computer.

The procedure for processing a fire mission, except for the reduced number of personnel, is practically identical to that of the battalion FDC

(fig 4). In a battery FDC, one of the RTO's assumes the duties of the computer/recorder and the other RTO performs the functions listed in figure 4. If it becomes necessary to revert to a manual system, the VCO determines the range and deflection, using the range-deflection protractor, and the site, using the GST. The RTO transmitting fire commands to the executive officer determines elevations and fuze settings, using the GFT.

FDC TRAINING

It is apparent that the FADAC will not decrease the training requirement of the fire direction center. Although the computer itself is relatively easy to operate, personnel must still be trained to perform the manual FDC solution. This dual training requirement is recognized in contemplated changes to the Army training test (ATT) for units equipped with the FADAC. These contemplated changes state that one-third of the fire missions will be fired with commands generated by the FADAC, one-third will be fired with data computed manually, and the remaining third will be fired with either FADAC computed or manually computed data, at the discretion of the chief umpire. Additionally, at least one fire mission will be started with personnel using the FADAC and then will be interrupted by the chief umpire, who will declare the computer to be inoperative and require the mission to be completed using the manual backup. Additional time will be given for missions interrupted in this manner.

Rocket artillery unit FDC's will generally follow the same principles outlined for cannon FDC's—the FDC vehicle driver will also act as the generator operator, one of the FDC computers will operate the FADAC, and no change will be made in the personnel involved in the communications or supervision areas of the FDC. The backup will consist of personnel trained to compute manually, with firing tables and appropriate forms, in the event of computer malfunction.

In conclusion, it is reemphasized that none of the manual FDC capability is being given up with the introduction of the FADAC. This does not imply a lack of confidence in the FADAC and its capabilities; it simply means that the artilleryman is not going to put all of his eggs in one basket—regardless of how good that basket is.

Part IV--FADAC Meteorological Messages

Captain Henry E. Callaghan
Communication/Electronics Department
Captain Douglas B. Stuart
Gunnery Department
CWO Garland C. Goodman
Target Acquisition Department

One of the elements of data required by the FADAC computer during the solution of the gunnery problem is accurate, timely meteorological

data. Transmission of a computer-type meteorological message from the meteorological section to the using unit may be accomplished by the manual method or by the teletypewriter perforated tape method.

The manual method requires that the computer meteorological message be transmitted by voice or teletypewriter page printer and entered into the FADAC through the FADAC keyboard. This method requires no change from present procedures; however, it is time consuming and subject to transmission error.

The teletypewriter perforated tape method requires that the computer meteorological message be transmitted by perforated tape (fig 7) and that the information on the tape be entered directly into the FADAC through the FADAC tape reader (fig 10). This method insures that the user will receive the message as soon as possible after preparation, that the perforated tape can be proofread by the meteorological section before transmission, and that the message is received at the artillery unit in a form that is immediately usable.

COMPUTER METRO MESSAGE									
FM 4-13									
IDENTIFICATION	OCTANT	SOURCE		LOCATION		DATE	VALID TIME (GMT)	STATION HEIGHT (FT/MB)	MOP PRESSURE (% OF STD)
METCM	Q	BB	C	XXX	XXX	YY	G ₀ G ₁ G ₂ G ₃	hmb	P ₀ P ₁ P ₂
METCM	1	US	L	344	988	10	0911	036	987
TRUE VALUES									
ZONE HEIGHTS (METERS)	LINE NUMBER	WIND DIRECTION (10°/10°)		WIND SPEED (KNOTS)	TEMPERATURE (1/10° K)	DENSITY (1/1000 M ³)			
		ddd	ddd	FFF	TTTT	Δ	Δ	Δ	Δ
SURFACE	00	320	009	2775	1231				
200	01	365	013	2784	1214				
500	02	396	019	2806	1166				
1000	03	398	036	2833	1100				
1500	04	385	031	2830	1035				
2000	05	404	032	2806	0980				
2500	06	415	024	2792	0927				
3000	07	430	020	2773	0877				
3500	08	464	007	2732	0836				
4000	09	431	008	2692	0797				
4500	10	421	014	2658	0755				
5000	11	448	013	2622	0718				
6000	12								
7000	13								
8000	14								
9000	15								
10000	16								
11000	17								
12000	18								
13000	19								
14000	20								
15000	21								
16000	22								
17000	23								
18000	24								
19000	25								
20000	26								
### 3rd Division Artillery				DATE AND TIME (GMT)		RECORDER			
				10 Feb 63 1000		CWO G.C. GOODMAN			

Figure 6. DA Form 6-59, Computer Meteorological Message.

When the teletypewriter perforated tape method is used, the meteorological message is prepared by the meteorological section on DA Form 6-59, Computer Meteorological Message (fig 6). This form is delivered to the radio teletypewriter operator who cuts the meteorological message on perforated tape for transmission to the using unit. The preparation of this tape must follow the procedure discussed in this article, because any deviation will cause the FADAC at the using unit to reject the meteorological message. The carriage return and line feed instructions on the perforated tape must appear on the tape in exactly the sequence and number prescribed.

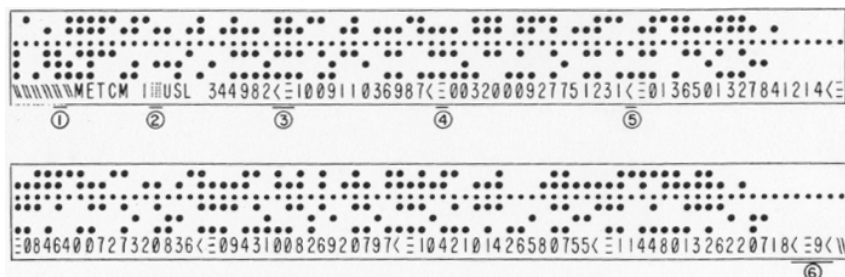

1. Symbol for tape advance.
2. Symbol for print letters instruction.
3. Break after location item in identification line.
4. Symbol for line feed instruction.
5. Symbol for carriage return instruction.
6. Series of symbols and digit which indicate the end of the meteorological message.

Figure 7. Taped meteorological message.

The radio teletypewriter operator cuts the normal address on the tape. After the last item of the address, he cuts one carriage return and one line feed instruction and advances the tape by means of the tape advance lever until 4 or 5 inches of tape have been fed out of the tape cutter. He then begins to cut the identification line of the meteorological message. Immediately after the location item in this line (fig 7), the operator cuts one carriage return and one line feed instruction on the tape and then continues to cut the identification line. At the end of the identification line and at the end of each succeeding line from line 00 to the line before the last line of the message, the operator cuts one carriage return and one line feed instruction. The last line of the message is ended with one carriage return instruction, one line feed instruction, the digit 9, and one carriage return instruction. This series of instructions is the signal to the computer that the meteorological message is ended. Any information on the tape which follows this series will not be accepted by the computer.

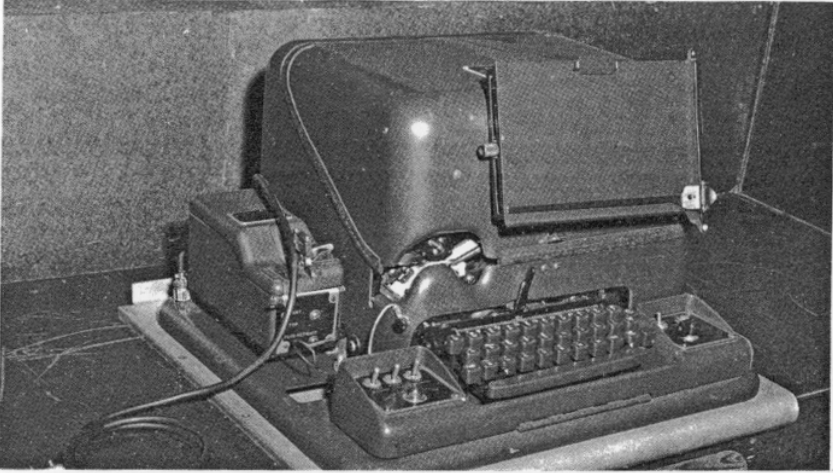

Figure 8. Tape cutting machine, Teletypewriter Reperforator Transmitter TT/76.

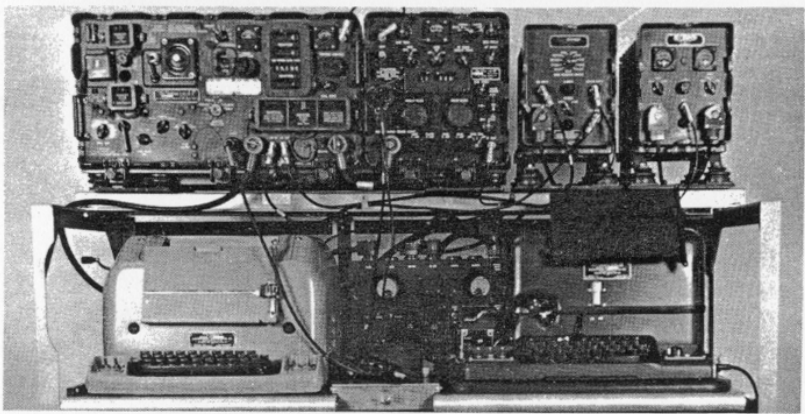

Figure 9. AN/GRC-46A radio teletypewriter set.

If the operator makes an error while cutting the tape, the error can be corrected. This is accomplished by back spacing the number of digits, carriage return instructions, and line feed instructions to and including the error. The operator then hits the LETTERS key on the tape cutter the number of times he back spaces, hits the FIGURES key, corrects the error, and recuts the tape from the error to the end of the message.

The teletypewriter tape should be proofread by the personnel of the meteorological section before it is transmitted to the users. On the teletypewriter tape prepared in the radio teletypewriter set AN/GRC-46, the message is printed in alpha-numeric characters on the bottom of the tape. The machine instructions, such as carriage return, line feed, and print letters, are indicated by symbols on the tape (fig 7).

When the teletypewriter tape has been proofread and approved by the meteorological section, it is transmitted to the using unit, and the receiving radio teletypewriter set automatically cuts an identical tape. This tape is removed from the radio teletypewriter set, and the address, including the carriage return and line feed instructions immediately following the last item of the address, is removed from the tape. The operator must insure that at least 4 inches of blank tape remain at the beginning of the meteorological message after the removal of the address so that the tape can be easily fed into the FADAC tape reader (fig 10).

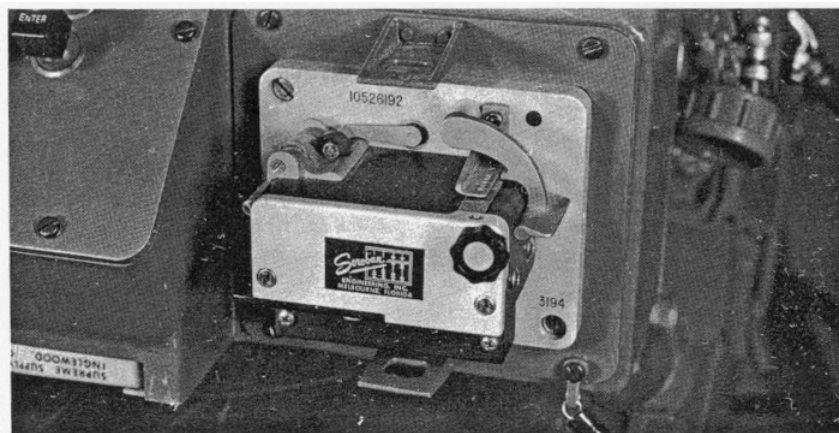

Figure 10. FADAC tape reader.

Through the use of these procedures, timely, accurate meteorological messages can be made available to artillery units in usable form requiring no complicated procedures on the part of the user. This information, when entered into FADAC, will enhance FADAC's inherent accuracy.

Reserve Component Class Number AC 1 is a 2 hr class on the Application of FADAC to the Gunnery Problem. For further information pertaining to the above class or to obtain a catalog containing a complete listing of available classes, write to:

Commandant
U.S. Army Artillery and Missile School
Nonresident Instruction Department
ATTN: Reserve Component Division AKPSINI/RC
Fort Sill, Oklahoma

Army Training Tests

Captain William J. Le Clair
Office of Artillery Policy and Literature

Maintaining a high state of training is a challenge to every commander and a problem of vital concern to all artillerymen from the artillery commander to the chief of section. The state of training of a unit will certainly be reflected in the unit's ability to accomplish its combat mission. Short of combat, an evaluation of the unit's performance and state of training can best be determined through the administration of the Army training test (ATT). Realizing the importance of ATT's to every artilleryman, ARTILLERY TRENDS presents the following information to keep its readers abreast of the most recent ATT changes.

Army training test objectives as stated in USCONARC Directive 310-11, dated 2 October 1961, indicate that ATT's are designed to ascertain the degree of individual and unit combat readiness, provide realistic instruction, stimulate and sustain training interest, insure uniformity in training, and facilitate a basis for evaluation of operational readiness training. Pursuant to the attainment of these objectives, commanders receive an evaluation of unit test performance. Previously, these evaluations were in the form of a numerical grade; but effective 8 November 1962, changes 2 to USCONARC Directive 310-11 requires that only the adjectival evaluations unsatisfactory, satisfactory, or excellent appear as entries on umpire checklists. Further, the unit's final evaluation will reflect a summation of all checklist evaluation ratings; e.g., unsatisfactory, satisfactory, or excellent as appropriate. Units engaged in the operational readiness phase of training will receive ratings combat ready or not combat ready.

Concurrent with the implementation of the above change, the USAAMS, the proponent of artillery ATT's, has been conducting an extensive revision of howitzer and missile unit ATT's to bring them up to date as new equipment and organizations are standardized and to improve realism. To comply with changes 2 to USCONARC Directive 310-11, the School revised its checklists, substituting the adjectival ratings for the weighted numerical score; and, in addition, it conducted a complete review of all checklists to insure that the most comprehensive guidance would be provided the individual umpires.

1. In general, the new tests will consist of the following areas of interest:
 - a. Tactics.
 - b. Communications.

- *c. Gunnery.
 - d. Survey.
 - e. Nuclear and CBR (chemical, biological, and radiological) defense.
 - f. Military intelligence.
 - g. Code of conduct.
 - h. Organizational maintenance.
- *Operations in firing (missile ATT's).

2. All checklists are written as guides for the umpires in arriving at adjectival ratings and are not restrictive in nature. Furthermore, mere unit accomplishment of all checklist items does not necessarily constitute a rating of excellent.

3. No attempt has been made to assign weights to the checklist items or the individual checklists; however, the new ATT does indicate that failure to accomplish the primary mission (accurate and timely fire) will result in an overall rating of unsatisfactory.

4. The test directs that umpire evaluation, other than satisfactory, must be justified by narrative reports. Also, an unsatisfactory evaluation in any of the areas tested would eliminate the possibility of an overall rating of excellent.

5. The new tests provide increased emphasis in the area of maintenance in that the maintenance checklist is used in the formulation of the overall adjectival evaluation. An unsatisfactory maintenance evaluation will require a retest of that ATT area within 60 days (USCONARC Directive 750-8).

What effect will the new tests have upon the unit taking the test? First, to attain an overall rating of excellent, the unit must attain ratings of excellent or satisfactory in all areas. Prior to changes 2, a unit could have attained a superior rating (over 95 percent) and yet have failed in one area, such as CBR or code of conduct. Therefore, the ATT objective—to stimulate and sustain training interest—is satisfied, if not enhanced, inasmuch as unit training must be broad in scope with emphasis on the aspects of the primary mission (tactical movement, communications, and ability to shoot). Secondly, justification of ratings, other than satisfactory, should make the test an excellent teaching vehicle and, at the same time, reduce any tendency toward overrating or underrating a unit because of the personal whims of individual umpires.

What effect will the change have upon umpire personnel? Since no weighted values are available to the individual umpire, his evaluation of the unit's performance must be based upon mature judgment and experience. Also, the change will require that the chief umpire establish clearly defined guidance for the individual umpires in the event that special situations require test modification or preclude an accurate evaluation of unit performance in a particular area. It is incumbent upon the umpire to ascertain whether the unit is engaged in operational readiness training, because this information is imperative in formulating his evaluations. Units in the operational readiness phases of training (having completed

their formal phases of training and been assigned the responsibility for continuous readiness for deployment) must be rated either combat ready or not combat ready. In arriving at an overall evaluation of combat ready, the umpires must consider the individual mission of the unit and realize that even though the unit attains an overall rating of satisfactory certain unit weaknesses could preclude a status of combat ready.

Each of the new tests has been staffed prior to forwarding for publication. Part of this staffing procedure was an actual field test of certain ATT's by units at Fort Sill, Oklahoma. The new ATT's are expected to be published in the first or second quarter of fiscal year 1964.

INTERCHANGEABLE SUBCHASSIS FOR LACROSSE

The Lacrosse external guidance equipment, or Missile Guidance Central (MGC), requires a large amount of maintenance, due in large part to the interaction between subchassis and the fact that each subchassis is not a functional entity. Presently, it is not possible to aline a subchassis, take it forward to a Missile Guidance Central, insert it into an operating mainframe, and then expect the MGC to function. Rather, the major component or operating mainframe must be taken to an Ordnance van and alined using third and fourth echelon test equipment. Because of this situation, a requirement was placed on Martin Company, the prime contractor, to produce subchassis which are completely interchangeable.

The objective of the Lacrosse Interchangeability Program is to eliminate the undesirable mechanical and electrical characteristics which prohibit free interchangeability of the major MGC components and their subchassis. Undesirable mechanical characteristics include tolerance accumulations and dimension errors which prevent the subassemblies from fitting properly into their mainframe positions. Undesirable electrical characteristics include circuit instability, improper application of components, inadequate adjustment controls, and poor impedance matching.

Interchangeable subchassis have been engineered and tested, and interchangeability modification kits are now available for application. The modification program has started at Fort Sill and is being implemented by four Ordnance teams from Letterkenny Depot. Modification of a single MGC to the interchangeability configuration will require from three to four weeks. Interchangeability will result in less down time for the external guidance equipment and should increase Lacrosse reliability. MGC operator procedures will be relatively unaffected by interchangeability modification, but the modification will necessitate new second echelon maintenance procedures.

CORPORAL MISSILE SPECIALIST TRAINING

On 1 February the US Army Artillery and Missile School stopped all Corporal training except warhead assembly training (Corporal Nuclear Warhead Assembly Course).

new dimension for field artillery ...



Air Assault

The Army has recently activated a division to test and further develop the air assault concept for ground combat. The test division, designated the 11th Air Assault Division (Test), was activated in mid-February 1963, at Fort Benning, Georgia. Initial test units activated include an air assault infantry battalion (a lighter version of the conventional infantry battalion) and a composite artillery battalion. The weapons of the composite artillery battalion consist of 105-mm howitzers, Little John rockets, and the XM3 weapon system (UH-1B helicopter armed with 2.75-inch folding fin aerial rockets) (see page 2).

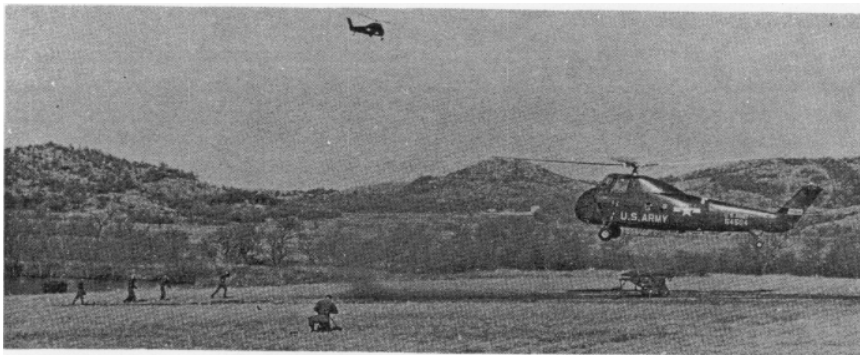

Figure 1. CH-34 transporting Little John rocket and launcher.

An aviation group with a variety of aircraft and aircraft support

equipment has been formed to provide helicopters as prime movers for the 105-mm howitzer and Little John rocket batteries, surveillance, troop transport in the battle area, and air transport for supply and support functions. Other supporting elements activated are an air cavalry troop for reconnaissance, a support group for administrative and logistical needs, a signal company, and an engineer company. These test units, together with the artillery and infantry units mentioned above, are being grouped into a test model of an air assault division.



Figure 2. CH-37 helicopters transporting 105-mm howitzers.

The test division will be supported by a test version of an air transport brigade, using both helicopters and fixed-wing aircraft. In addition to its ability to transport combat units, the brigade also has the capability of "retailing" supplies to divisional units in the battle area. These supplies would be delivered to "wholesale" distribution points by the United States Air Force.

AIRMOBILE CONCEPT

The airmobile concept calls for movement and support of combat units in the battle area by simple, rugged helicopters and fixed-wing aircraft capable of operating with primitive base facilities in the environment of the soldier. Ground combat units are provided the capability



Figure 3. UH-1 (Iroquois) firing antitank missile.

to relocate immediately by air whenever it is tactically desirable to do so. This concept, therefore, provides improved battlefield mobility to Army combat forces in their traditional role of sustained land combat.

The air vehicles used to provide high mobility to airmobile units will become as much a part of such units as the corresponding trucks, armored vehicles, cannon, and other ground equipment in conventional organizations. The aircraft used for these purposes are designed to fly low over the battle area and to "live" with and be maintained in the same environment as the combat soldier. Their survival depends on maneuverability, armament, ability to make movements conform to the terrain, and on a highly coordinated pattern of tactical operations. The primary role of these aircraft is to contribute to combat superiority on the ground by providing improved battlefield mobility for ground combat forces.

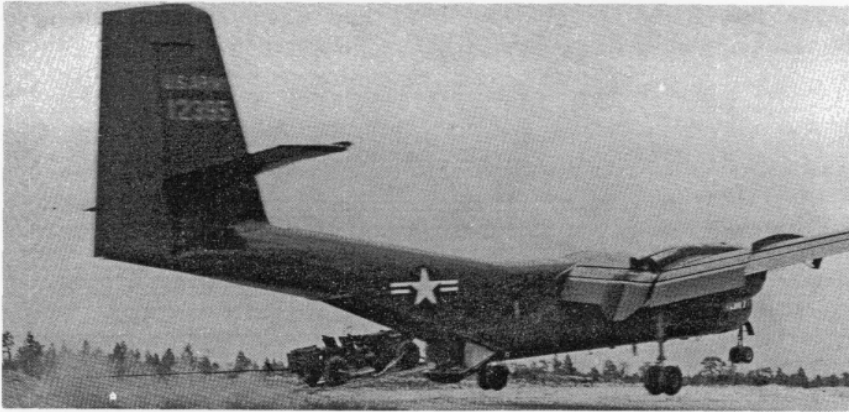

Figure 4. CV-2 (Caribou) delivering cargo by touch-and-go system.



Figure 5. XM3 (UH-1 helicopter with 2.75-inch rocket pods attached).

The airmobile concept and tactics to be tested are the result of studies ordered by Secretary of Defense Robert S. McNamara and conducted by a board headed by Lieutenant General Hamilton H. Howze. The concepts and tactics have become feasible through the advances made in light aviation technology over the last several years. The new tactics take full advantage of experience gained in counterinsurgency operations. Also, these tactics will increase the capability to fight on the widely dispersed frontages and depths that may be expected to develop in any tactical operations involving nuclear weapons.

TEST PROGRAM

Although some of the units to be used in the tests are already in existence, additional personnel and material resources must be provided and the personnel must be trained in the special skills required for airmobile operations. In addition, basic and advanced unit training of the test units must be completed before field testing starts.



Figure 6. Experimental "sky crane": 8,000 horsepower, 10-ton lift capacity.

The Army training and test program will be essentially a test of tactical teams. The program will involve a series of field exercises designed to determine the combat capability of air assault units under a wide range of warfare types and terrain conditions. The maneuvers will begin with small unit problems (squad and platoon) and progress through company- and battalion-size problems to larger unit exercises. The field exercises will be designed to evaluate the ability of the airmobile units to accomplish their combat missions and will determine the effectiveness of Army rotary- and fixed-wing aircraft as proper means of transporting, supporting, and resupplying this type of unit, if actively engaged in combat.

ARTILLERY AND ARMY AVIATION

The joint role of Army aviation and artillery operations began in World War I, when balloons and aircraft were used extensively for the adjustment of artillery fires. This relationship continued, with great success,

throughout World War II and the Korean Conflict. The new airmobile concept will capitalize upon the success of earlier years and may greatly increase the mobility and flexibility of field artillery. The results of the test program scheduled for the 11th Air Assault Division (Test) will establish the capability of the artillery and Army aviation team to add a new dimension to the tactical employment of field artillery. In the new organization, 105-mm howitzer and Little John rocket units will be displaced by air, and the third dimension will be further emphasized by the employment of aerial rocket batteries (page 2). ARTILLERY TRENDS will publish additional details on the activities of the 11th Air Assault Division (Test) as they become available.

TENTATIVE TOE's

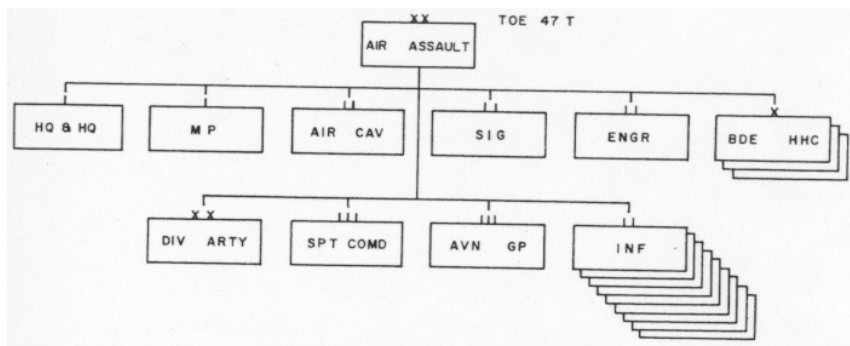

Figure 7. Air assault division.

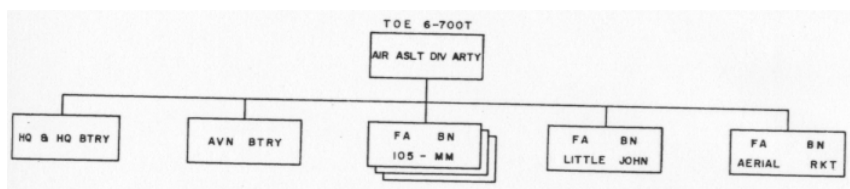

Figure 8. Air assault division artillery.

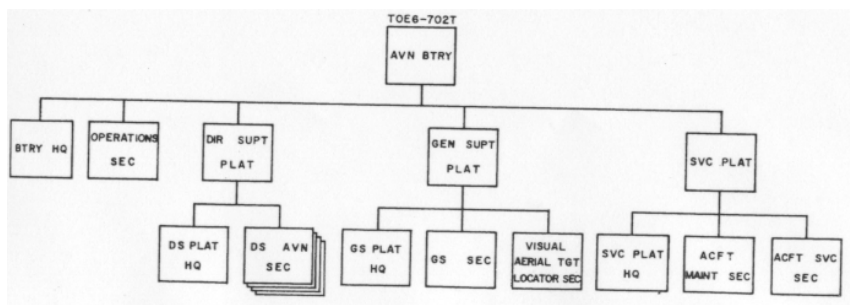

Figure 9. Aviation battery.

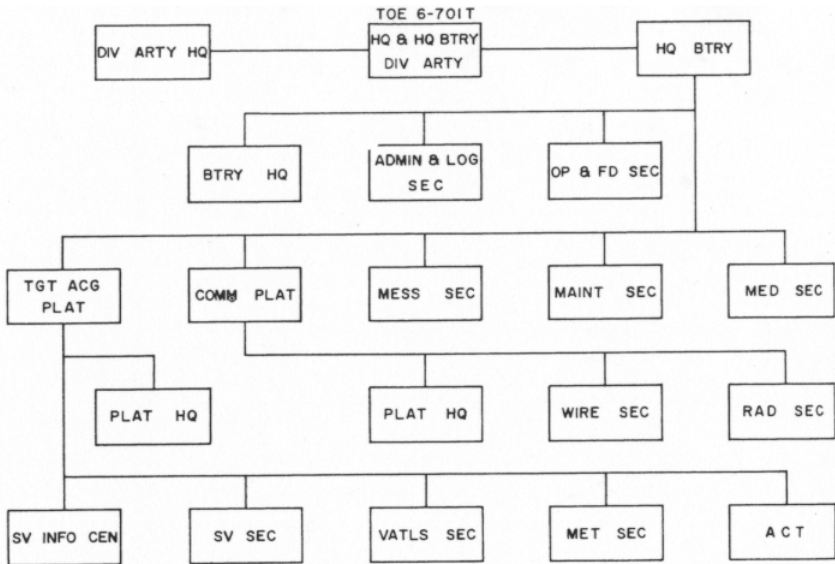

Figure 10. Headquarters and headquarters battery, division artillery.

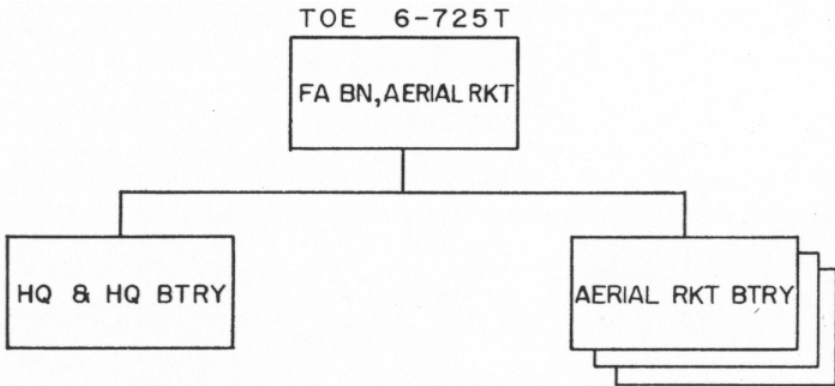

Figure 11. Field artillery battalion, aerial rocket.

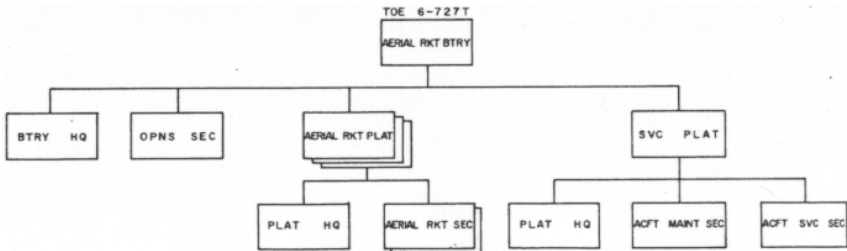

Figure 12. Aerial rocket battery.

how accurate? ...

Flash Ranging

Lieutenant Gerald V. Varsoke
US Army Artillery and Missile School

How good is flash ranging? The answer to this question is of special interest to the personnel of those units whose ATT fire-for-effect is graded by flash ranging. The US Army Artillery and Missile School (USAAMS) has recently conducted a field experiment on target location accuracy achieved by flash observation techniques. This experiment was conducted by firing into an effects field at targets located by survey to an accuracy of 1:3,000.

METHODS EMPLOYED

Two methods were used to determine the displacement of the center of impact (CI) of each volley from the intended target point. One method employed five flash observation teams using BC scopes to determine the center of impact. The flash observation posts were also located by survey with an accuracy of 1:3,000, and the distances from these posts to the intended CI varied from approximately 1,700 meters to 3,600 meters. An alternate method was employed to determine the physical location of each crater on the ground. Upon completion of each fire mission, survey crews entered the impact zone and determined the locations of the craters with respect to the surveyed target positions.

A comparison of the results of these two methods provided a valid evaluation of flash ranging accuracy. Flash location dispersion was measured by comparing the flash CI with the actual CI as determined by measurement in the impact zone. Figure 1 shows a sample of the type of data used in evaluating flash ranging. Battery volleys are listed by date of firing and mission number. The "actual miss distances" listed are the surveyed distances of the actual center of impact from the intended center of impact; the "flash base miss distances" are the distances of the flash centers of impact from the intended center of impact, as recorded by the flash ranging teams. By comparing the two sets of data the flash error in range and deflection was determined for each volley. For example, on the fifth mission(*) fired on 1 March, the flash error was determined to be 8 meters over in range (53-45) and 9 meters left in deflection (L7-R2) with respect to the center of impact as determined by measurement on the ground.

Probable errors for flash location accuracy were computed based on the above comparisons. The flash ranging location probable errors were determined to vary from 3 to 13 meters in range and from 4 to 11 meters in deflection. By the use of statistical methods, the circular probable

Meteorological and Velocity Error Analysis 155-mm Howitzer—Shell HE, Fuze PD, charge 4, range, 5,050 meters, met age—1 to 2 hours.							
Date	Btry Msn No	No of Rds	ACTUAL MISS DISTANCE (Meters)		FLASH BASE MISS DISTANCE (Meters)		Elevation
			Range	Deflection	Range	Deflection	
1 Mar	1st	6	+61	19L	+57	13L	326
	2d	6	+47	15L	+47	10L	318
	3d	6	+59	14L	+63	17L	318
	4th	6	+65	5L	+69	2L	316
	*5th	6	+45	2R	+53	7L	316
	6th	6	+81	14R	+86	5R	320
	7th	6	+98	7R	+100	4R	320
2 Mar	1st	6	+9	2L	+13	13L	316
	2d	6	+63	11R	+66	4R	314
	3d	6	+77	6R	+77	7R	314
	4th	6	+50	14R	+50	11R	311
	5th	6	+77	14R	+65	3R	311
	6th	6	-24	5R	-27	4R	306
	7th	6	-50	0	-50	5R	306
3 Mar	1st	6	+36	5R	+24	9L	317
	2d	6	+36	5L	+33	4L	318
	3d	6	+28	3L	+23	5L	318
	4th	6	-14	5L	-14	11L	317
	5th	6	-14	14R	-16	2R	317
	6th	6	-5	9R	0	4R	317
	7th	6	+36	18R	+41	11R	316
	8th	6	+21	13R	+20	8R	316
	9th	6	+63	14R	+59	12R	316
	10th	6	+59	23R	+55	19R	314
	11th	6	+36	24R	+39	20R	314
	12th	6	+14	39R	+17	36R	312
	13th	6	+20	39R	+24	36R	312
4 Mar	1st	6	+27	23R	+32	19R	318
	2d	6	+14	29R	+18	22R	317
	3d	6	-7	25R	-12	17R	317
	4th	5	+9	27R	+7	21R	317

Figure 1. Flash ranging accuracy data.

error for the entire set of firing series (265 battery volleys) was determined to be 14 meters. This excellent result indicates the accuracy that can be achieved with well-trained flash ranging crews.

fiscal year 1964...

Resident Courses

U.S. Army Artillery and Missile School

Mr. Harold E. Earley
Office of Director of Instruction

More than 10,000 students are presently scheduled for resident courses at the US Army Artillery and Missile School (USAAMS) for fiscal year 1964. The USAAMS schedule of classes includes 46 courses of instruction with a total of 210 classes scheduled. Course lengths are approximately the same as in fiscal year 1963. Course changes are as follows:

NEW COURSES

Course No.	Course Title	Length
6-A-F20	Nuclear Weapons Employment (Reserve Component)	2 weeks
6-A-F26	Nuclear Weapons Employment	5 weeks
6-R-152.6	Field Artillery Operations and Intelligence Noncommissioned Officer	11 weeks, 1 day

COURSES DROPPED PERMANENTLY

6-A-1191	Corporal Maintenance Officer	33 weeks
6-A-1190A	Corporal Officer	8 weeks, 4 days
6-N-215.1	Corporal Fire Control System Maintenance	31 weeks
6-N-214.1	Corporal Electronic Materiel Maintenance	29 weeks
6-H-F8	Corporal Handling Equipment Maintenance	4 weeks
6-R-164.3	Corporal Mechanical Materiel Maintenance	8 weeks

The Artillery Officer Career Course will be conducted jointly at Fort Sill and Fort Bliss, with 24 weeks of field artillery instruction presented by the USAAMS and eight weeks of air defense instruction presented at Fort Bliss.

SCHEDULE OF CLASSES

The USAAMS FY 1964 schedule of classes has been forwarded to United States Continental Army Command (CONARC) for approval. Based upon this schedule and those from other agencies, the United States Continental Army Command annually publishes a "Detailed Schedule of Classes, Army Service Schools." This schedule provides course titles, class numbers, reporting dates, close dates, and class capacities. It is distributed throughout the Army.

Career active duty artillery officers are selected to attend the officer career courses by the Artillery Section, Officers Assignment Division,

DCSPERS, Department of the Army. Applications for admission to resident courses should not be sent to the School. Officers of the Active Army who desire to attend specialist (MOS) resident courses at the USAAMS may apply through channels. Army Reserve officers not on active duty may make application for attendance for any course (providing they meet all prerequisites) in accordance with the provisions of AR 140-220. Only active status members of the Army Reserve are eligible for selection. National Guard officers not on active duty should make application on National Guard Bureau Form 64 for admission to USAAMS resident courses to the Chief, Army National Guard Bureau, ATTN: Schools Division, Washington 25, D. C. Warrant officers and enlisted personnel of the National Guard and the Army Reserve, not on active duty, should submit application for attendance at Army service schools in the same manner as commissioned officers of their respective components who are not on active duty.

Listed below are the officer and enlisted resident courses scheduled to be taught at the USAAMS during FY 64. All courses which exceed 20 weeks are attended in a permanent change of station (PCS) status and those 20 weeks or less in length are attended in temporary duty (TDY) status. A brief summary of all courses, except non-US courses, is also provided.

OFFICER CAREER COURSES

1. FA OFFICER ORIENTATION (FAOOC) (6-A-C20) (9 weeks).
To provide basic branch orientation and training in field artillery for newly commissioned officers. Class capacity: 113; FY 64 classes: 18.
2. ARTILLERY OFFICER CAREER (AOCC) (6-A-C22) (32 weeks).
To train regular army and career reserve officers (with 3 to 8 years commissioned service) in Field Artillery and Air Defense Artillery command and staff duties and responsibilities of artillery officers. This course is conducted jointly by the US Army Artillery and Missile School and the US Army Air Defense School. Officers are selected for attendance by DA. The MOS prefix digit 5 is awarded upon successful completion of the nuclear weapons employment phase of course. Class capacity: 160; FY 64 classes: 4.
3. ASSOCIATE FA OFFICER CAREER (AFAOCC) (6-A-C23) (18 weeks).
To provide branch training in the duties and responsibilities of active duty and reserve component field artillery officers. Active duty officers are selected for attendance by DA. Reserve officers not on active duty may make application through channels to attend the course. The MOS prefix digit 5 is awarded upon successful completion of the nuclear weapons employment phase of the course during mobilization only. Class capacity: 120; FY 64 classes: 4.
4. FA OFFICER FAMILIARIZATION (FAOFC) (6-A-C21) (8 weeks).

To provide familiarization with field artillery tactics and techniques for officers transferred to field artillery from other branches or assigned to field artillery duties without prior formal field artillery training. Class capacity: 75; FY 64 classes: 3.

LETTER INDICATES CATEGORY OF STUDENTS A—commissioned officers B—commissioned and warrant officers D—commissioned and enlisted N—warrant officers and enlisted R—enlisted		
6	A	C-23
Digit indicates branch: 6—FA course 5—engineer course 7—infantry course	Courses within a school: C—officer career course 23—associate career course	

Figure 1. Explanation of the digits and letters comprising a typical course number. The example shown is the Associate Field Artillery Officer Career Course.

5. FA FIELD GRADE OFFICER REFRESHER (Reserve Component) (FAFGORC) (6-A-C11) (2 weeks).

To provide refresher training in tactics, techniques, and materiel appropriate to field artillery field grade reserve component officers not on active duty. Class capacity: 60; FY 64 classes: 3.

OFFICER FUNCTIONAL COURSES

6. DIVISION ARTILLERY STAFF OFFICER REFRESHER (DASORC) (6-A-F5) (1 week).

To provide refresher training as a team (minimum of 6 officers) to National Guard and USAR division artillery or artillery group commanders and principal staff officers. Class capacity: 60; FY 64 classes: 1.

7. SENIOR FA OFFICER (SFAOC) (6-A-F6) (2 weeks).

To provide refresher training for senior artillery officers on field artillery tactics, techniques, organization, and equipment in current employment, and to provide orientation on trends proposed for the future. Class capacity: 50; FY 64 classes: 2.

8. NUCLEAR WEAPONS EMPLOYMENT COURSE (Reserve Component) (NVEC) (6-A-F20) (2 weeks).

To qualify students as nuclear weapons employment officers. The prefix digit 5 (nuclear weapons employment) is added to current MOS upon successful completion of both nonresident and resident phases. Class capacity: 130; FY 64 classes: 4.

9. NUCLEAR WEAPONS EMPLOYMENT COURSE (NVEC) (6-A-F26) (5 weeks).

To qualify commissioned officers for duty as nuclear weapons employment officers. The prefix digit 5 is added to current MOS. Class capacity: 150; FY 64 classes: 3.

10. FA RADAR OFFICER (FAROC) (6-A-0140) (7 weeks, 2 days).

To train captains and lieutenants of the active army and reserve components to supervise field artillery radar operation, maintenance, and employment, including target acquisition, fire direction, position fixing and vectoring of light army aircraft. Class capacity: 25; FY 64 classes: 2.

11. ARTILLERY TARGET ACQUISITION OFFICER (ATAOC) (6-A-1154) (11 weeks).

To train active army and reserve component officers in counterbattery and countermortar, drone target acquisition, sound and flash ranging techniques, and to provide them with a general knowledge of corps and division target acquisition functions, field artillery radar operations, production and dissemination of ballistic meteorology data and airborne target location techniques. Class capacity: 30; FY 64 classes: 3.

12. ARTILLERY SURVEY OFFICER (ASOC) (6-A-1183) (8 weeks).

To train active army and reserve component captains and lieutenants in reconnaissance and survey procedures. Class capacity: 35; FY 64 classes: 3.

13. REDSTONE OFFICER (ROC) (6-A-1190B) (5 weeks, 3 days).

To train active army officers in the characteristics, operating principles, capabilities and limitations of the Redstone missile and associate equipment. Class capacity: 20; FY 64 classes: 1.

14. SERGEANT OFFICER (SOC) (6-A-1190D) (5 weeks, 4 days).

To train active army officers in the characteristics, tactical employment, system maintenance and general operating procedures of the Sergeant missile system. Class capacity: 25; FY 64 classes: 3.

15. PERSHING OFFICER (POC) (6-A-1190E) (8 weeks).

To train active army officers in the characteristics, tactical employment, system maintenance and general operating procedures of the Pershing missile system. Class capacity: 30; FY 64 classes: 2.

16. LACROSSE OFFICER (LOC) (6-A-1187) (5 weeks).

To train active army officers in the characteristics, operating principles, fire direction procedures, tactical employment, and capabilities of the Lacrosse missile system. Class capacity: 20; FY 64 classes: 1.

17. ARTILLERY COMMUNICATIONS OFFICER (ACOC) (6-A-0200) (13 weeks, 3 days).

To train active army and reserve component officers in the grade of major or below in the supervision and coordination of the installation, operation and maintenance of artillery communication equipment and systems. Class capacity 40; FY 64 classes: 3.

18. ARTILLERY MOTOR TRANSPORT (AMTC) (6-B-0600/631A) (9 weeks).

To train active army and reserve component company grade officers and warrant officers in the supervision of organizational maintenance, to include

artillery turret maintenance, and operation and recovery of automotive equipment in artillery units. Class capacity: 40; FY 64 classes: 3.

OFFICER/ENLISTED COURSES

19. FA OFFICER CANDIDATE (FAOCC) (6-N-F1) (23 weeks).

To train selected warrant officers and enlisted men to be reserve second lieutenants. Class capacity: 100; FY 64 classes: 13.

20. FA OFFICER CANDIDATE (Reserve Component) (FAOCC) (6-N-F2) (11 weeks).

To train National Guard and USAR personnel to be second lieutenants. ARNG personnel are selected by the State Adjutant General for attendance. USAR personnel must meet requirements of AR 140-50. Class capacity: 140; FY 64 classes: 1.

21. NUCLEAR PROJECTILE ASSEMBLY (NPAC) (6-D-142.1) (1 week).

To train active army officers and enlisted men in the mechanical assembly, disassembly, and prefiring preparation of nuclear projectiles. EM receive MOS 142.1. Class capacity: 30; FY 64 classes: 10.

22. ROCKET NUCLEAR WARHEAD ASSEMBLY (RNWAC) (6-D-147.2) (1 week, 1 day).

To train active army officers and enlisted personnel in prefiring procedures, storage and logistical considerations of nuclear warheads for the 762-mm and 318-mm rockets. EM receive MOS 147.2. Class capacity: 20; FY 64 classes: 10.

23. ARTILLERY BALLISTIC METEOROLOGY (ABMC) (6-H-103.1) (9 weeks, 4 days).

To train commissioned officers, warrant officers, and enlisted personnel in the installation and operation of an artillery meteorological station. Enlisted personnel receive MOS of 103.1. Class capacity: 37; FY 64 classes: 7.

24. WEATHER EQUIPMENT MAINTENANCE COURSE (WEMC) (6-N-201A/205.1) (12 weeks, 4 days).

To train warrant officers and enlisted personnel in the organizational maintenance of electrical and electronic meteorological equipment used in artillery ballistic meteorology sections. Warrant officers receive MOS 201A; enlisted personnel receive MOS 205.1. Class capacity: 15; FY 64 classes: 10.

25. FA RADAR MAINTENANCE (FARMC) (6-N-211A/211.3) (32 weeks, 2 days).

To train warrant officers and enlisted personnel in the operation, adjustment and organizational maintenance of field artillery radar equipment. Warrant officers receive MOS of 211A; enlisted personnel receive MOS 211.3. Class capacity: 25; FY 64 classes: 4.

OFFICER/ENLISTED FUNCTIONAL COURSES

26. AN/TRC-80 TRANSITION (PERSHING) (6-D-F21) (1 week, 1 day).

To provide communication officers (in the grade of major or below) and communication chiefs (grade E-5 or above) with a working knowledge

of the operation, maintenance and employment of the Radio Terminal Set AN/TRC-80 and associated equipment. Class capacity: 9; FY 64 classes: 2.

27. FIELD ARTILLERY OPERATIONS AND INTELLIGENCE
NONCOMMISSIONED OFFICER (FAOINCO) (6-R-152.6) (11 weeks, 1 day).

To train enlisted personnel to assist command and staff officers in appraisal of intelligence, operation and training; and to provide personnel with a working knowledge of all phases of fire direction, intelligence and liaison in cannon units. Receives MOS 152.6. Class capacity 30; FY 64 classes: 4.

28. ARTILLERY SURVEY ADVANCED (ASAC) (6-R-153.1) (8 weeks).
To train enlisted personnel to supervise, coordinate, and participate in operations of an artillery survey party, battery detail, or survey information center; to assist in establishment of observation. Receives MOS 153.1. Class capacity: 70; FY 64 classes: 9.

29. ARTILLERY FLASH RANGING ADVANCED (AFRAC) (6-R-154.1) (6 weeks).
To train enlisted personnel in the installation, operation and organizational maintenance of a field artillery flash ranging unit. Receives MOS 154.1. Class capacity 30; FY 64 classes: 3.

30. ARTILLERY SOUND RANGING ADVANCED (ASRAC) (6-R-155.2) (8 weeks).
To train enlisted personnel in the installation, operation and organizational maintenance of a field artillery sound ranging unit. Receives MOS 155.2. Class capacity: 30; FY 64 classes: 3.

31. FA RADAR OPERATION (FAROC) (6-R-156.1) (10 weeks).
To train enlisted personnel in the operation, tactical employment and utilization of field artillery radar. Receives MOS 156.1. Class capacity: 35; FY 64 classes: 9.

32. SERGEANT MISSILE BATTERY (SMBC) (6-N-161.2) (6 weeks, 2 days).
To train warrant officers and enlisted personnel, grade E4 or above, of the active army, in the assembly, checkout, maintenance and operation of the Sergeant missile and associated ground handling equipment. Warrant officer receives MOS to be announced. Enlisted personnel receive MOS 161.2. Class capacity: 32; FY 64 classes: 2.

33. PERSHING SPECIALIST (PSC) (6-N-163.2) (17 weeks).
To train warrant officers and enlisted specialist personnel, grade E5 or below, of the active army, in the detailed assembly, checkout, maintenance, and operation of the Pershing missile and associated ground support equipment. Warrant officer receives MOS of FA Msl System Technician, Pershing (to be determined), enlisted personnel receive MOS 163.2, or other skill level digits as appropriate. Class capacity: 30; FY 64 classes: 2.

34. PERSHING MISSILE BATTERY (PMBC) (6-R-163.6) (8 weeks, 4 days).

To train noncommissioned officers, E4 or above, of the active army, in the assembly, checkout, maintenance, and operation of the Pershing missile and associated ground support equipment. Receives MOS of 163.6 or other skill level digits as appropriate. Class capacity: 35; FY 64 classes: 2.

35. AN/TRC-80 OPERATIONS (6-R-F24) (9 weeks).

To qualify enlisted personnel, grade E5 or below, of the active army, in the operation and operator maintenance of the Radio Terminal Set AN/TRC-80 and associate equipment. MOS for which trained to be determined. Class capacity: 18; FY 64 classes: 6.

36. ARTILLERY. RADIO MAINTENANCE (ARMC) (6-R-313.1) (14 weeks).

To train enlisted personnel of grade E5 or below to install, operate and perform organizational maintenance on communication equipment used in artillery communication systems or units employing similar equipment. Receives MOS of 313.1. Class capacity: 45; FY 64 classes: 23.

37. ARTILLERY COMMUNICATION SUPERVISORS (ACSC) (6-R-313.6) (15 weeks).

To train enlisted personnel of grade E4 or above to supervise, coordinate, and participate in the operation of a communication section of an artillery unit. Receives MOS of 313.6. Class capacity: 40; FY 64 classes: 2.

38. ARTILLERY VEHICLE MAINTENANCE SUPERVISORS (AVMSC) (6-R-631.7/632.7) (9 weeks).

To train enlisted personnel of grade E5 or above to supervise artillery turret maintenance, organizational maintenance and recovery of vehicles used in the artillery. Receives MOS of 631.7 or 632.7. Class capacity: 20; FY 64 classes: 3.

39. ARTILLERY TRACK VEHICLE MAINTENANCE (ATVMC) (6-R-632.1) (11 weeks, 4 days).

To train enlisted personnel of the active army or a reserve component to perform organizational maintenance on artillery track vehicles, self-propelled mounts, associated accessories and equipment, to include turret maintenance. Receives MOS 632.1. Class capacity: 64; FY 64 classes: 17.

40. LACROSSE FIRE CONTROL SYSTEM MAINTENANCE (LFCSMC) (6-N-217.1) (24 weeks).

To thoroughly ground warrant officers and enlisted personnel in organizational maintenance operation and procedures of Lacrosse fire control and associated equipment. Receives MOS 217.1. Class capacity: 12; FY 64 classes: 1.

CURRENT RESIDENT COURSE SCHEDULE

Listed below are the courses to be begun at the US Army Artillery and Missile School during the period 1 July 1963 through 31 December 1963.

Course	CI No.	Report	Start	Close	Input
Field Artillery Officer	1-64	10 Jul 63	15 Jul 63	12 Sep 63	104
Orientation	2-64	24 Jul 63	29 Jul 63	26 Sep 63	104
(6-A-C20)	*3-64	12 Aug 63	15 Aug 63	24 Oct 63	140

	4-64	5 Sep 63	9 Sep 63	7 Nov 63	104
	5-64	18 Sep 63	23 Sep 63	21 Nov 63	103
	6-64	1 Oct 63	4 Oct 63	5 Dec 63	103
	7-64	15 Oct 63	18 Oct 63	19 Dec 63	103
	8-64	13 Nov 63	18 Nov 63	30 Jan 64	103
	9-64	26 Nov 63	2 Dec 63	13 Feb 64	103
	* Reserved for USMA Graduates and DMG s.				
Field Artillery Officer Familiarization (6-A-C21)	1-64	15 Jul 63	16 Jul 63	11 Sep 63	56
	2-64	7 Oct 63	8 Oct 63	5 Dec 63	57
Artillery Officer Career (6-A-C22)	1-64	2 Jul 63	8 Jul 63	6 Mar 64	165
	*2-64	8 Oct 63	11 Oct 63	9 Jul 64	177
	*Includes 59 non-US.				
Associate Field Artillery Officer Career (6-A-C23)	1-64	1 Jul 63	3 Jul 63	7 Nov 63	117
	2-64	7 Oct 63	9 Oct 63	28 Feb 64	117
Field Artillery Field Grade Officer Refresher (Reserve Component) (6-A-C11)	*1-64	4 Aug 63	5 Aug 63	16 Aug 63	60
	2-64	22 Sep 63	23 Sep 63	4 Oct 63	40
	*For US Marine Corps Personnel Only.				
Division Artillery Staff Officer Refresher (6-A-F5)	1-64	25 Aug 63	26 Aug 63	31 Aug 63	41
Senior Field Artillery Officer (6-A-F6)	1-64	14 Jul 63	15 Jul 63	26 Jul 63	23
Senior Field Artillery Officer (Non-US) (6-A-F6X)	1-64	15 Sep 63	16 Sep 63	27 Sep 63	7
Nuclear Weapons Employment (Reserve Component) (6-A-F20)	1-64	29 Sep 63	30 Sep 63	11 Oct 63	26
Nuclear Weapons Employment (6-A-F26)	1-64	11 Aug 63	12 Aug 63	14 Sep 63	40
	2-64	17 Nov 63	18 Nov 63	21 Dec 63	40
Field Artillery Radar Officer (6-A-0140)	1-64	8 Aug 63	12 Aug 63	1 Oct 63	15
Artillery Target Acquisition Officer (6-A-1154)	1-64	10 Sep 63	12 Sep 63	27 Nov 63	10
Artillery Survey Officer (6-A-1183)	1-64	3 Jul 63	9 Jul 63	29 Aug 63	29
	2-64	19 Sep 63	24 Sep 63	15 Nov 63	28
Lacrosse Officer (6-A-1187)	1-64	29 Sep 63	1 Oct 63	1 Nov 63	22
Redstone Officer (6-A-1190B)	1-64	7 Jul 63	8 Jul 63	14 Aug 63	15
Sergeant Officer (6-A-1190D)	1-64	21 Jul 63	23 Jul 63	31 Aug 63	25
	2-64	4 Dec 63	6 Dec 63	28 Jan 64	25
Pershing Officer (Non-US)	1-64	22 Oct 63	24 Oct 63	20 Dec 63	20
Sergeant Officer (Non-US) (6-A-1190DX)	1-64	18 Sep 63	20 Sep 63	6 Nov 63	17
Artillery Communications Officer (6-A-0200)	1-64	1 Jul 63	2 Jul 63	7 Oct 63	25
	2-64	28 Oct 63	29 Oct 63	17 Feb 64	26
Artillery Motor Transport (6-B-0600/6-B-631A)	1-64	5 Jul 63	8 Jul 63	6 Sep 63	20
	2-64	7 Nov 63	8 Nov 63	24 Jan 64	20

Field Artillery Officer Candidate (6-N-F1)	1-64	14 Jul 63	22 Jul 63	20 Dec 63	95
	2-64	11 Aug 63	19 Aug 63	4 Feb 64	95
	3-64	8 Sep 63	16 Sep 63	3 Mar 64	95
	4-64	6 Oct 63	14 Oct 63	31 Mar 64	95
	5-64	3 Nov 63	12 Nov 63	28 Apr 64	95
	6-64	1 Dec 63	9 Dec 63	26 May 64	95
Nuclear Projectile Assembly (6-D-142.1)	1-64	21 Jul 63	22 Jul 63	26 Jul 63	30
	2-64	18 Aug 63	19 Aug 63	23 Aug 63	30
	3-64	15 Sep 63	16 Sep 63	20 Sep 63	30
	4-64	20 Oct 63	21 Oct 63	25 Oct 63	30
	5-64	17 Nov 63	18 Nov 63	22 Nov 63	30
Rocket Nuclear Warhead Assembly (6-D-147.2)	1-64	9 Jul 63	10 Jul 63	17 Jul 63	20
	2-64	6 Aug 63	7 Aug 63	14 Aug 63	20
	3-64	3 Sep 63	4 Sep 63	11 Sep 63	20
	4-64	8 Oct 63	9 Oct 63	16 Oct 63	20
	5-64	5 Nov 63	6 Nov 63	14 Nov 63	20
Artillery Ballistic Meteorology (6-H-103.1)	1-64	1 Jul 63	2 Jul 63	10 Sep 63	37
	2-64	16 Aug 63	19 Aug 63	25 Oct 63	36
	3-64	4 Oct 63	7 Oct 63	16 Dec 63	34
	4-64	29 Nov 63	2 Dec 63	20 Feb 64	37
Weather Equipment Maintenance (6-N-201A/6-N-205.1)	1-64	19 Jul 63	22 Jul 63	25 Oct 63	10
	2-64	25 Oct 63	28 Oct 63	17 Feb 64	10
Field Artillery Radar Maintenance (6-N-211A/211.3)	1-64	7 Aug 63	12 Aug 63	9 Apr 64	14
	2-64	6 Nov 63	12 Nov 63	10 Jul 64	14
LaCrosse Fire Control System Maintenance (6-N-217.1)	1-64	25 Sep 63	26 Sep 63	27 Mar 64	13
AN/TRC-80 Transition (Pershing) (6-D-F21)	1-64	12 Sep 63	13 Sep 63	20 Sep 63	8
Field Artillery Operations and Intelligence Noncommissioned Officer (6-R-152.6)	1-64	8 Jul 63	9 Jul 63	25 Sep 63	33
	2-64	30 Sep 63	1 Oct 63	19 Dec 63	33
Artillery Survey Advanced (6-R-153.1)	1-64	18 Jul 63	23 Jul 63	13 Sep 63	64
	2-64	1 Aug 63	6 Aug 63	27 Sep 63	64
	3-64	1 Oct 63	4 Oct 63	27 Nov 63	64
	4-64	16 Oct 63	21 Oct 63	13 Dec 63	64
Artillery Flash Ranging (Advanced) (6-R-154.1)	1-64	11 Sep 63	13 Sep 63	23 Oct 63	23
Artillery Sound Ranging (Advanced) (6-R-155.2)	1-64	11 Jul 63	15 Jul 63	6 Sep 63	13
	2-64	22 Oct 63	24 Oct 63	19 Dec 63	13
Field Artillery Radar Operation (6-R-156.1)	1-64	26 Jul 63	30 Jul 63	7 Oct 63	35
	2-64	30 Aug 63	4 Sep 63	12 Nov 63	35
	3-64	4 Oct 63	8 Oct 63	17 Dec 63	30
	4-64	8 Nov 63	13 Nov 63	3 Feb 64	30
Sergeant Missile Battery (6-N-161.2)	1-64	8 Jul 63	10 Jul 63	21 Aug 63	32
	2-64	18 Nov 63	20 Nov 63	16 Jan 64	32
Sergeant Missile Battery (Non-US) (6-N-161.2X)	1-64	3 Sep 63	5 Sep 63	22 Oct 63	25
Pershing Specialist (Non-US)	1-64	6 Nov 63	8 Nov 63	31 Jan 64	28
Pershing Missile Battery (Non-US)	1-64	16 Oct 63	18 Oct 63	20 Dec 63	20
AN/TRC-80 Operations (Pershing) (6-R-F24)	1-64	3 Jul 63	5 Jul 63	6 Sep 63	15
	2-64	25 Jul 63	26 Jul 63	27 Sep 63	15

Artillery Radio (Maintenance) (6-R-313.1)	1-64	5 Jul 63	8 Jul 63	14 Oct 63	40
	2-64	19 Jul 63	22 Jul 63	28 Oct 63	41
	3-64	2 Aug 63	5 Aug 63	12 Nov 63	41
	4-64	16 Aug 63	19 Aug 63	26 Nov 63	41
	5-64	30 Aug 63	3 Sep 63	11 Dec 63	41
	6-64	11 Sep 63	12 Sep 63	20 Dec 63	41
	7-64	27 Sep 63	30 Sep 63	21 Jan 64	41
	8-64	11 Oct 63	14 Oct 63	4 Feb 64	41
	9-64	25 Oct 63	28 Oct 63	18 Feb 64	41
	10-64	8 Nov 63	12 Nov 63	4 Mar 64	41
	11-64	22 Nov 63	25 Nov 63	17 Mar 64	41
	12-64	6 Dec 63	9 Dec 63	30 Mar 64	41
	Artillery Communication Supervisors (6-R-313.6)	1-64	26 Aug 63	27 Aug 63	12 Dec 63
Artillery Vehicle Maintenance Supervisors (6-R-631.7/632.7)	1-64	6 Sep 63	9 Sep 63	3 Nov 63	20
Artillery Track Vehicle Maintenance (6-R-632.1)	1-64	5 Jul 63	9 Jul 63	27 Sep 63	63
	2-64	26 Jul 63	30 Jul 63	18 Oct 63	63
	3-64	16 Aug 63	20 Aug 63	8 Nov 63	63
	4-64	6 Sep 63	10 Sep 63	29 Nov 63	63
	5-64	27 Sep 63	1 Oct 63	20 Dec 63	63
	6-64	18 Oct 63	22 Oct 63	24 Jan 64	63
	7-64	7 Nov 63	12 Nov 63	14 Feb 64	63
	8-64	29 Nov 63	3 Dec 63	6 Mar 64	63

●

NUCLEAR WEAPONS EMPLOYMENT REFRESHER TRAINING

Under the provisions of a recent Department of the Army directive, all officers with an MOS prefix digit 5 must successfully complete a Refresher Training Course at least once every two years in order to maintain a rated proficiency in the tactical employment of nuclear weapons. Effective 1 June 1963, refresher training may be accomplished through resident courses conducted in the various Army areas or, effective 1 September 1963, through an extension course administered by the Nonresident Instruction Department of the US Army Artillery and Missile School (USAAMS).

Instructional packets will be furnished by the USAAMS for the conduct of resident refresher training. This training will be conducted at the lowest major unit or installation level which is able to provide qualified instructors and adequate facilities. A standardized proficiency test will be provided with the instructional packets and will be administered at the conclusion of the refresher training. The prefix digit 5 will be withdrawn from the MOS of any officer who fails to pass the test.

For those officers who do not have access to resident instruction, nonresident refresher training will be provided by the USAAMS through an unclassified extension course. This extension course will encompass twenty-eight hours of study followed by a four-hour examination. As in the resident training, the prefix digit 5 will be withdrawn from the MOS of any officer failing to pass the examination. When it becomes available, enrollment for this course may be made on DA Form 145, through appropriate channels, to the Commandant, ATTN: Nonresident Instruction Department, United States Army Artillery and Missile School, Fort Sill, Oklahoma.



THE ARTILLERY WORLD

175-mm GUN UNITS ACTIVATED

Two 175-mm gun battalions, the 2d Gun Battalion, 32d Artillery and the 6th Gun Battalion, 9th Artillery, were activated at Fort Sill in January. These are the first U. S. Army units to be equipped with the M107 175-mm self-propelled gun (fig 1). Each battalion will consist of a headquarters battery, a service battery, and three firing batteries. The personnel strength of a 175-mm gun battalion will be 30 officers, three warrant officers, and 507 enlisted men.



Figure 1. Test configuration of the M107 175-mm self-propelled gun.

The M107 weighs 31 tons and fires a 147.3 pound projectile to a range of 32,800 meters. The M113 tube is 428 inches long (60 calibers) and has a rifling twist of one turn in 20 calibers. This weapon is capable of traversing 30° right and 30° left of center, and may be elevated from +2° to +65°. The M107 is 10 feet 4 inches wide, 8 feet 11 1/2 inches high, and is 42 feet long in firing position. With the tube retracted for traveling, the overall length is reduced to 37 feet 3 inches. The 175-mm gun employs pneumatic puller equilibrators and a hydro-pneumatic recoil mechanism.

Graphical firing tables based on FT 175-A-O (Rev) have been developed by the US Army Artillery and Missile School (USAAMS). This equipment, based on the provisional firing tables, may be used until the final firing tables are published. The graphical firing table, complete except for 10 mil site for high angle fire, will be gratuitously issued to all 175-mm gun units as they are activated. A graphical site table is currently being developed.

PERSHING-CHINOOK TESTS

The Pershing missile is shown below undergoing a post-flight countdown during the conduct of recent tests. The tests, known as the Pershing-Chinook



Figure 2. Pershing missile receiving post-flight countdown.

systems compatibility tests, were conducted by an Army-Industry team at Orlando, Florida. All elements (less tracked vehicles) of the Pershing system were airlifted by the Chinook, then mated at the site. A total of fourteen helicopter loads are required to transport the entire system. In the photograph above, the fire control equipment is housed in the large shelter at the left, with the power supply adjacent to it.

CANADIAN ARTILLERY AIMING POSTS

Artillery units of the Canadian Army are making interesting modifications to a historic item of field artillery equipment, the aiming post. Steel steps have been welded to the lower portions of posts, to facilitate firm emplacement. Each post is marked with prominent stripes on the quadrant seen by the gunner, and the remaining quadrants are covered with camouflage paint. The Canadian Army is also experimenting with the use of phosphorescent paint on the striped quadrants, to supplement their lighting equipment in night firings. The modified aiming posts can still be easily stored in regular carrying cases.

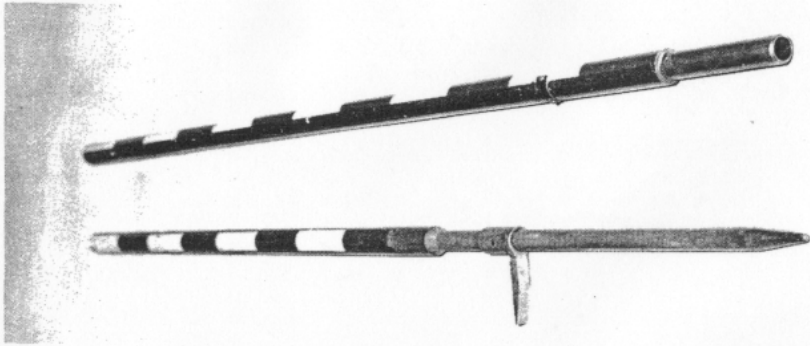

Figure 3. Canadian artillery aiming posts.

IMPROVED DEVELOPMENTAL CYCLE FOR GFT'S AND GST'S

A new streamlined developmental cycle is expected to reduce by two-thirds the time required to manufacture and issue graphical firing and site tables to troops (fig 4). The new procedures shown are considered the necessary minimum to insure an adequate supply of quality graphical equipment for troop use. The streamlined cycle is expected to average seven months as compared to an average of more than 1 1/2 years for what has been the standard developmental cycle.

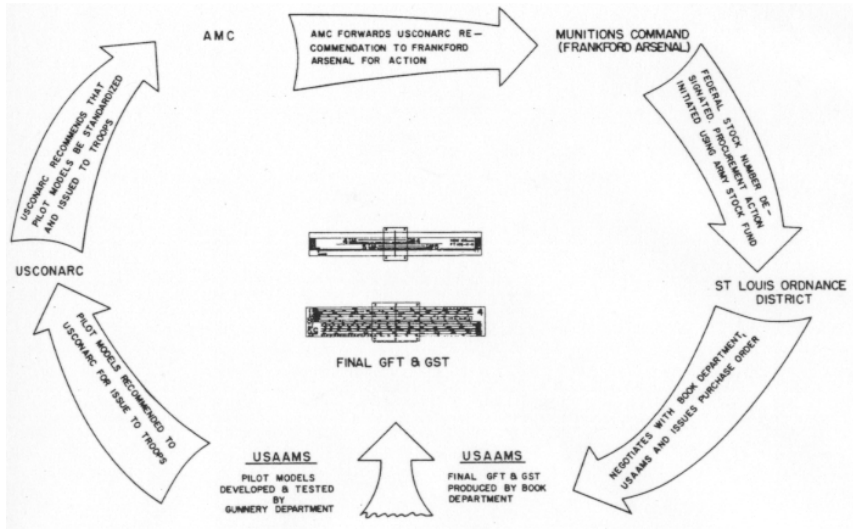

Figure 4. GFT and GST streamlined developmental cycle.

In the past, the major items of equipment were developed through procedures which delayed the manufacture of graphical equipment until after the firing tables were issued. Several significant changes in the new cycle include the elimination of testing by the US Army Artillery Board, the elimination of the formal standardization requirement, the use of the Army Stock Fund, and the issuing of a purchase order to replace the formal contract. The new standardization and procurement procedures should provide for concurrent issue of firing tables and associated graphical equipment.

LANCE MISSILE

An artist's concept of the Lance missile (described in the Newsnote section of the January 1963 issue) has been made available to ARTILLERY TRENDS by the Public Information Office at Redstone Arsenal, Alabama.

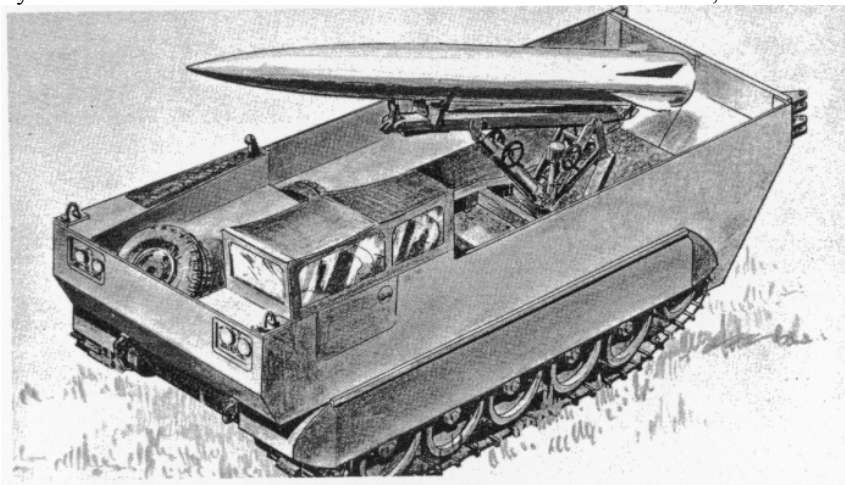

Figure 5. Artist's concept of Lance missile and Launcher.

FAMSEG

An important element of the US Army 1st Field Artillery Missile Brigade (Fort Sill) is the Field Artillery Missile Systems Evaluation Group (FAMSEG). The primary mission of FAMSEG is to render technical assistance to field units in the emplacement, checkout, and firing of guided missiles, nuclear warheads, and nuclear projectiles. This assistance is rendered by teams of personnel who are highly trained in technical operating procedures. FAMSEG contains a division for each field artillery guided missile and nuclear weapons system. Personnel of the group have received extensive military and civilian schooling and have had considerable practical experience in the field artillery unit(s) of their particular specialty. FAMSEG personnel travel extensively, visiting units throughout the United States and making annual visits to units in USAREUR and USARPAC. The services of FAMSEG may be obtained upon request; for complete instructions, see paragraph 5, USCONARC circular 350-7.

STATUS OF TRAINING LITERATURE

1. The following training literature is under preparation or revision by the US Army Artillery and Missile School or the US Army Artillery Combat Developments Agency (ACDA):

- A. FIELD MANUALS (FM):
 - FM 6-30 Field Artillery Battalion, Corporal (ACDA).
(Changes 1)
 - FM 6-37 Field Artillery Battalion, Sergeant.
 - FM 6-38 Field Artillery Battery, Sergeant.
 - FM 6-44 Field Artillery Missile, Lacrosse.
 - FM 6-44A Field Artillery Missile, Lacrosse.
 - FM 6-54 Area Toxic Rocket.
 - FM 6-300-64 The Army Ephemeris.
 - FM 6-545 Field Artillery Battalion, Corporal.
 - FM 6-545A Field Artillery Battalion, Corporal.
 - B. ARMY TRAINING PROGRAMS (ATP):
 - ATP 6-700 Air Assault Field Artillery Units.
 - C. ARMY TRAINING TESTS (ATT):
 - ATT 6-115 Field Artillery Battalion, 105/155, Towed, Self-Propelled, Infantry Division.
 - ATT 6-325 Field Artillery Rocket/Howitzer Battalion, Armored Division.
 - ATT 6-585 Field Artillery Missile Battalion, Lacrosse.
 - ATT 6-635 Field Artillery Battalion, Redstone.
 - ATT 6-705 Air Assault Field Artillery Howitzer Battalion, 105-mm.
 - ATT 6-707 Air Assault Field Artillery Howitzer Battery, 105-mm.
 - ATT 6-715 Air Assault Field Artillery Missile Battalion, Little John.
 - ATT 6-717 Air Assault Field Artillery Missile Battery, Little John.
 - ATT 6-725 Field Artillery Battalion, Aerial Rocket.
 - ATT 6-727 Field Artillery Battery, Aerial Rocket.
 - D. ARMY SUBJECT SCHEDULES (ASUBJSCD):
 - ASubjScd 6-9 Countermortar Operations (to be rescinded).
 - ASubjScd 6-161 MOS Technical Training of the Field Artillery Missile Crewman (Sergeant).
 - ASubjScd 6-163 MOS Technical Training of the Field Artillery Missile Crewman (Pershing).
- 2. Training literature submitted for publication:**
- FM 6-3 Operation and Field Application of Gun Direction Computer, M18.
 - FM 6-75 105-mm Howitzer, M2 Series, Towed (Revision).
 - FM 6-79 105-mm Howitzer, M108, Self-Propelled.
 - FM 6-88 155-mm Howitzer, M109, Self-Propelled.
 - FM 6-125 Qualification Tests for Specialists, Field Artillery.
 - FM 6-300-63 The Army Ephemeris.
(Changes 1)
 - ATT 6-137 Field Artillery Gun or Howitzer Battery, Heavy, Towed or Self-Propelled (Revision).
 - ATT 6-175 Field Artillery Missile Battalion and Battery, Honest John and Little John.

- ATT 6-415 Field Artillery Battalion, Heavy.
 ATT 6-615 Field Artillery Battalion, Pershing (Revision).
 ASubjScd 6-8 Counterbattery Operations.
 ASubjScd 6-24 Organization and Duties of Operations Section,
 (Changes 1) Field Artillery Target Acquisition Battalion.
 ASubjScd 6-50 Air Movement.
- 3. Training literature at the Government Printing Office:**
 FM 6-35 Field Artillery Missile, Redstone.
 (Changes 1)
 FM 6-36 Field Artillery Missile, Redstone,
 (Changes 2) Firing Procedures
 FM 6-57 Field Artillery Rocket, Little John,
 (Changes 1) (Launcher XM34).
 FM 6-75 105-mm Howitzer, M2 Series, Towed.
 (Changes 1)
 FM 6-90 8-Inch Howitzer, M2, Towed.
 FM 6-135 Adjustment of Artillery Fire by the Combat Soldier.
 ATT 6-16 Field Artillery Battalion, Gun or Howitzer, Heavy.
 ATT 6-555 Field Artillery Battalion, Sergeant.
- 4. Training literature recently printed:**
 FM 6-20-2 Field Artillery Techniques (ACDA).
 FM 6-39 Field Artillery Battalion, Pershing (ACDA) Draft, Service Test
 Use.
 FM 6-81 155-mm Howitzer, M1, Towed.
 FM 6-94 8-Inch Howitzer, M110, Self-Propelled and 175-mm Gun,
 Motor Carriage, M107.
 FM 6-121 Field Artillery Target Acquisition (ACDA).
 FM 6-137 Field Artillery Gun or Howitzer Battery, Heavy, Towed or
 Self-Propelled.
 ATP 6-615 Field Artillery Missile Battalion, Pershing.
 ATT 6-576 Headquarters and Headquarters Battery, Field Artillery Target
 Acquisition Battalion.
 ATT 6-615 Field Artillery Battalion, Pershing.
- 5. Training literature rescinded:**
 ATT 6-5-1 Field Artillery Howitzer Battalion, Light and Medium.
 ATT 6-116-1 Field Artillery Howitzer Battalion 105/155.
 ATT 6-135-1 Field Artillery Rocket/Howitzer Battalion, Infantry Division.
 ATT 6-325-1 Field Artillery Rocket/Howitzer Battalion, Armored Division.

ARTILLERY INFORMATION LETTERS

The following artillery information letters containing items of technical nature have been recently published by the US Army Artillery and Missile School. Distribution is made only to the units and their controlling headquarters which are authorized the equipment discussed in these letters:

ARTILLERY INSTRUCTORS LETTER NUMBER 20

dated 6 December 1962

HONEST JOHN-LITTLE JOHN INFORMATION LETTER NUMBER 2

dated 24 January 1963

ARTILLERY INSTRUCTORS LETTER NUMBER 21

dated 26 February 1963