

xx

ARTILLERY

TRENDS

JULY 1962

US ARMY ARTILLERY and MISSILE SCHOOL

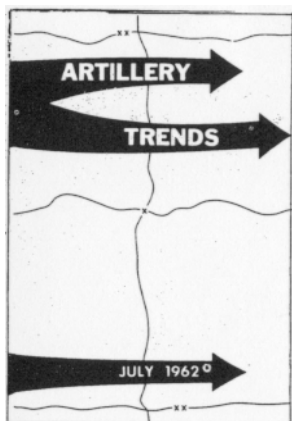

Instructional Aid Number 23

● COVER

The overlay and attack arrows on this issue's cover introduce an article on the combined arms tactics and techniques of the new organization. "Artillery Tactics of the New Divisions" begins on page 9, with introduction on page 8.

● INSIDE COVER

A peek through a chink in the iron curtain at Soviet Artillery Weapons on page 33.

● ARTICLES

Infinity Aiming Reference Collimator	3
Two illustrative examples of—	
ARTILLERY TACTICS OF THE NEW DIVISIONS	
Part I	9
Part II	17
Doctrine and Capabilities—DIRECT FIRE	25
SOVIET ARTILLERY WEAPONS	33
Heliborne operations—The H-21C in Artillery Employment. . .	42
Operation TAPER—The Army Equipment Records System . .	49

● RESIDENT COURSES

Current Resident Course Schedule	58
--	----

● NEWSNOTES

News of, for, about the Artillery World	60
---	----

● TRAINING LITERATURE

Status of Training Literature	67
---	----

***HOW IS YOUR
ARTILLERY SIGHT?***

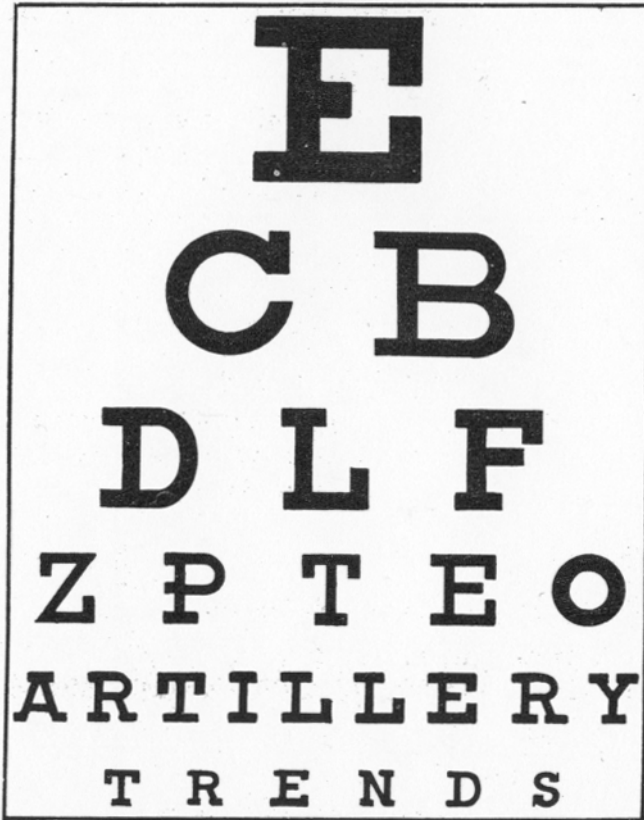

THIS IS NOT A REFERENCE TO THE PANORAMIC TELESCOPE ON THE GUNS. HOW IS YOUR ARTILLERY VISION? ARE YOU KEEPING UP WITH THE "EXPLOSIVE" DEVELOPMENTS IN ARTILLERY TODAY? ARTILLERY TRENDS IS THE LENS THROUGH WHICH YOU CAN FOCUS YOUR EYE ON THE ARTILLERY SCENE.

BE AWARE! with **ARTILLERY TRENDS**, published 3 to 5 times yearly . . . minimum order—4 issues, .25c each. Mail your check, postal or money order for personal copies to the Book Department, USAAMS, Fort Sill, Oklahoma.



INFINITY AIMING REFERENCE COLLIMATOR

"Aiming point, aiming post, deflection 2800, refer." No longer will this catch phrase signal the beginning of the number 5 cannoneer's 100-pace relay dash with two candy-striped aiming posts for batons. Instead, a device resembling an aiming circle (fig 1) will be set up within whispering distance of the gunner. It's the new infinity aiming reference collimator T6E1, shortened to the "aiming post T6."

This optical instrument may be used for indirect laying of field artillery weapons by establishing an optical reference from which weapon deflection angles can be measured. The aiming post T6 is essentially an optical collimator equipped with a special reticle (which can be illuminated), so that the instrument functions as an optical projection system simulating a target at infinity. The device works on the same principle as the old distant aiming point method, but affords greater accuracy.

ADVANTAGES

The advantages of the T6 are immediately obvious. It can be set up quite close to the weapon, eliminating the hand signal system and the time-consuming method of emplacing aiming posts with the gunner and number 5 man. Beyond that, it is unaffected by poor visibility. With its interior illuminating system (the bulb is located at the rear of the cylindrical barrel), the T6 operates in rain, snow, and fog, and at night as well as on the brightest day.

Another important advantage is its automatic correction for weapon displacement (weapon jump). The reticle is numbered so that further "zeroing" is unnecessary; matching the numbers of the panoramic telescope with corresponding digits on the T6 reticle corrects for displacement. The accuracy of this method, when compared with the gunner's visual "splitting the difference" of the old aiming posts with the vertical hairline of the panoramic telescope, is the real advantage of the infinity aiming reference collimator.

Because the T6 can operate within the relatively close distance of 12 to 48 feet, it can usually be placed under the camouflage net—or even in a gun pit—and still function. Maximum difference in height between the T6 and various weapon telescopes is 13 feet.

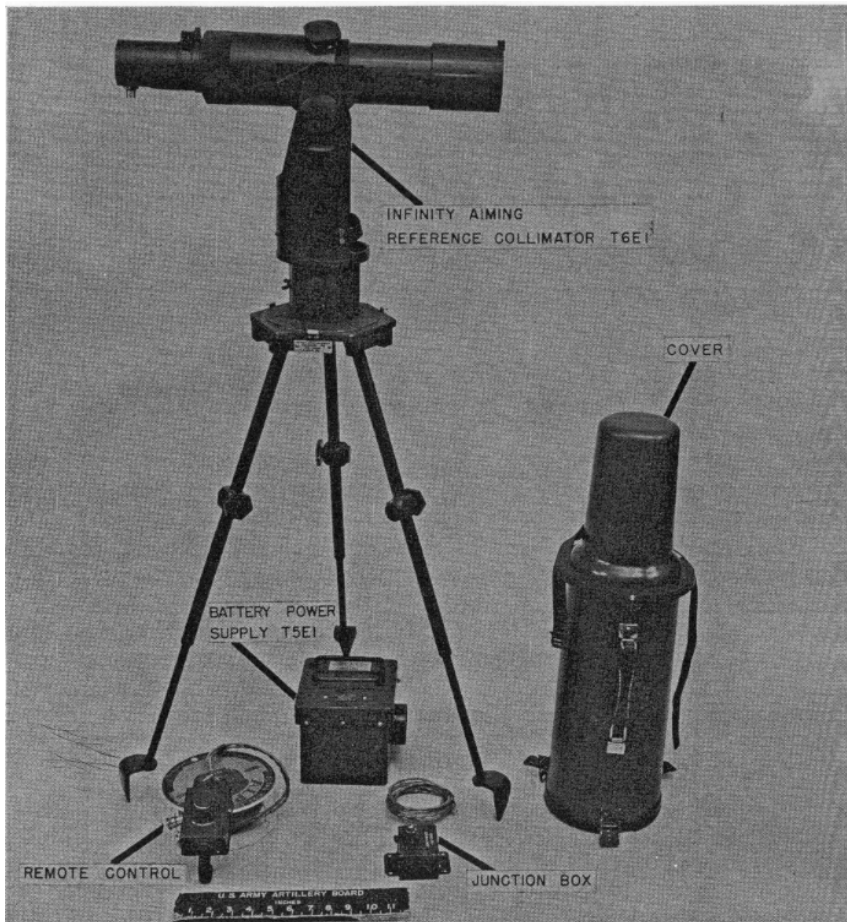

Figure 1. The infinity aiming reference collimator T6E1, and associated equipment.

Finally, although it has the optical instrument's natural disadvantage of fragility, it is less so than the aiming circle and can be taken anywhere.

COMPONENTS

The complete T6 system (fig 1) is comprised of (1) the infinity aiming reference collimator, (2) battery power supply T5E1, (3) light source remote control with connecting cables, (4) instrument covers, and (5) junction box.

The desired weapon deflections are obtained by matching appropriate symbols (numbers) of the panoramic telescope reticle with those of the

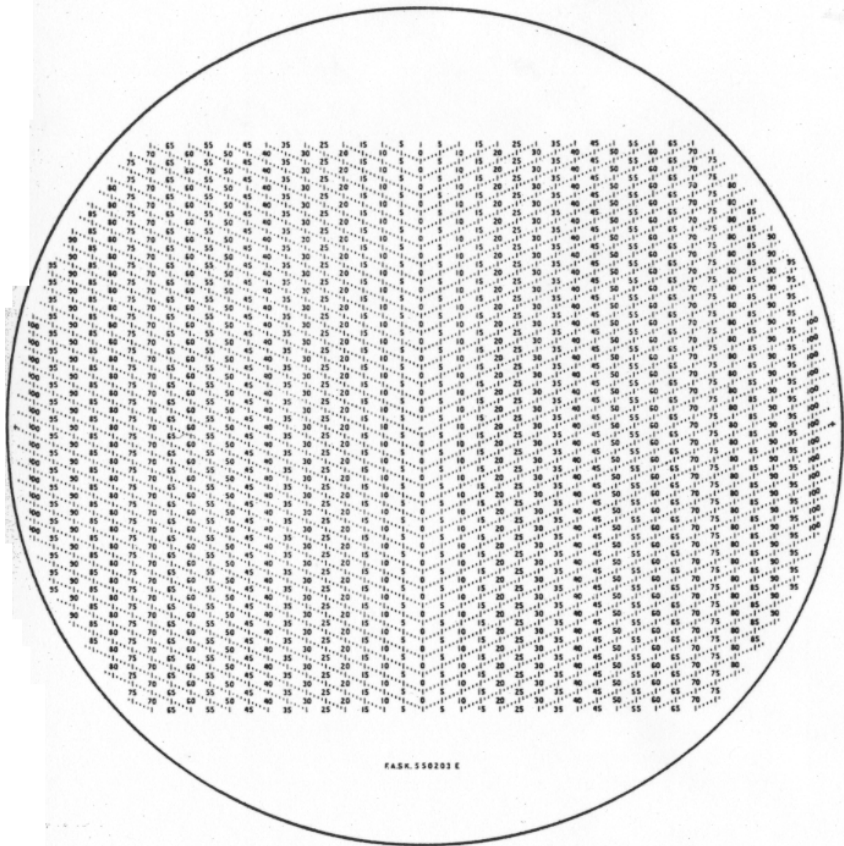

Figure 2. The reticle of the infinity aiming reference collimator T6E1.

aiming post reticle (fig 2), deflecting the weapon telescope through the desired angle, and traversing the weapon until reticle match is again obtained. Accurate angular deflections can be obtained even though the observing telescope is displaced, as well as rotated, when the weapon is

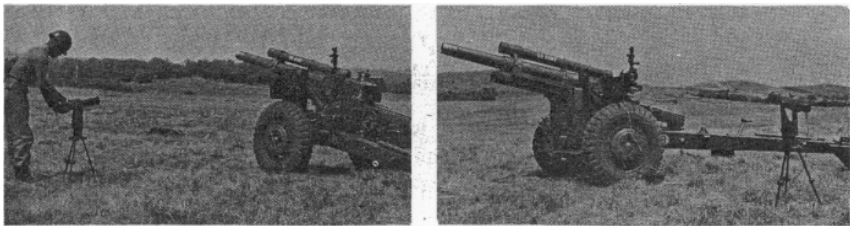

Figure 3. Photographs of the T6 in action.

traversed. The aiming post must be firmly stationed and approximately level for operation.

The weapon is laid by conventional procedures, and the aiming post is simultaneously set at the proper distance and height and is levelled (fig 3). After this is done, the panoramic telescope reticle is alined (matched) with the reticle of the T6 (fig 4). When a new deflection is set on the scales of the telescope, the weapon is traversed until mil graduations are again matched.

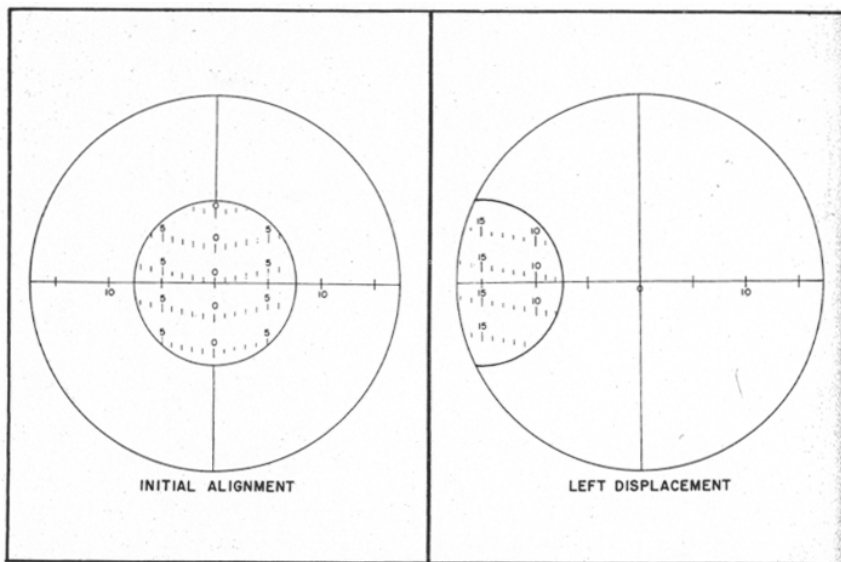

Figure 4. Matching the reticle of the panoramic telescope and the T6—both before and after weapon jump (displacement).

POWER AND COST

The reference collimator reticle has two sources of electrical power for illumination. If it is to be used with a towed weapon, the battery power supply T5E1 is attached to the power input cable of the remote light source control. This remote control contains a PUSH-TO-USE switch which is shaped to fit comfortably into the hand of the gunner; or, if he prefers, it can be hung on the shield of the weapon during operation.

When the aiming post is used with a self-propelled weapon, however, the internal electrical power of the vehicle itself can be fed through a junction box to the power input cable of the remote control.

The infinity aiming reference collimator will cost approximately \$85.00. The battery power supply, which is necessary for towed units,

will cost an additional \$80.00. However, even at the approximate \$165.00 figure, the cost of the T6 will not be prohibitive, since the current aiming posts with night lighting equipment cost \$55.00, and the newly authorized standard equipment, including radioactive reflectors, runs over \$300.00 a set. And, considering that the greater accuracy of the new aiming post will waste fewer rounds than the older equipment, the T6 will pay for itself.

The T6E1 is being tested in the field by the US Army Artillery Board, and is scheduled for further testing at the US Arctic Board in its next test period. Since tests may indicate a need for minor changes, no production date, and thus no projected date of issue, can be predicted at this time.

A GEM FOR FDC PERSONNEL

A procedure has been developed for achieving an adjusted deflection in those cases where an adjusted quadrant elevation has been arrived at prior to the adjusted deflection. This situation occurs mainly when a large angle T is encountered, causing difficulty in establishing a positive deflection bracket because of doubtful FDC deflection sensings. FM 6-40, par 293 e, f, and g, states the action to be taken in general terms. This new procedure, however, will allow a positive FDC deflection sensing to be obtained with a minimum amount of rounds. Assuming that an adjusted quadrant elevation has been arrived at prior to achieving an adjusted deflection, the time registration will begin immediately. The observer will be told to sense, in meters, all *graze* bursts as to range and deflection. If the next two (2) *graze* bursts produce doubtful FDC deflection sensings, the following procedure will be followed:

The HCO will place the range deflection protractor (RDP) on the chart with the notch in the base on the pin representing the battery firing. The deflection arc is rotated until the last deflection fired is over the deflection index for the battery firing. The target grid should remain centered over the registration point and oriented on the azimuth given by the observer in his fire request. The HCO should then select an intersection of grid lines (on the target grid) that falls directly under the left edge of the RDP. This procedure is not absolutely necessary but will assist in plotting observer sensings more conveniently. The two *graze* bursts will be plotted on the target grid using the grid intersection (or any other location) as a starting point. This will result in two rounds plotted in relation to the GT line:

- a. If the rounds plot on *opposite* sides of the GT line, the deflection is considered acceptable.
- b. If the rounds plot on the *same* side of the GT line, the deflection is changed 1/2S in the appropriate direction or the existing deflection bracket, if any, will be split. The smaller of the two will be used.

continued on p. 66.

What are the organizational features of the new divisions that will require significant modifications of combined arms tactics and techniques? The major tactical units of the new infantry, mechanized, airborne, and armored divisions will be the three brigades. Like the combat commands of the present armored division, the brigades will be composed of various groupings of attached infantry and tank battalions. The brigades may often be "triangular," but they are designed to control from two to five battalion or task force size units. (For detailed organizational information, see supplement to ARTILLERY TRENDS, August 1961.)

Significant weapons changes are found within the maneuver battalions of the new divisions. The battalions' mortar/Davy Crockett platoons will contain four 4.2-inch mortars and three nuclear-firing Davy Crockett weapons. The antitank platoons will contain three ENTAC (see ARTILLERY TRENDS, Aug 61, p. 59) missile squads.

The three divisional 105-mm howitzer battalions, which will normally support the brigades, will each contain a headquarters battery, three howitzer batteries, and a service battery. Each of these battalions will have 5 liaison sections and 10 forward observers to work with the supported maneuver units, compared to one liaison section and five forward observers in the old battalion. An AN/MPQ-4 radar will be found in the target acquisition platoon of each headquarters battery, rather than in the division artillery headquarters battery.

Tactical concepts for employment of the new brigades envision greater mobility in the attack, but smaller frontages in the defense, if a nonnuclear situation exists. Frontages for infantry companies should not exceed 1,500 meters (compared to 2,000 meters under the old concept), and frontages for battalions should not exceed 3,000 meters, even on "ideal terrain." In the first phase of an all-out nuclear war, however, units may have to increase their frontages and depths two to four times in order to survive the initial massive exchange of nuclear weapons. Under these conditions, the additional frontages assigned would be accepted as gaps between battalions and/or between brigades.

The return of the battalion task force echelon to the infantry and airborne divisions emphasizes the role of the artillery liaison officer with these maneuver headquarters. These battalion liaison officers (LO's 2, 3, 4, and 5) become key men in the combined arms pattern. The battalion liaison officer is the fire support coordinator (FSCOORD) for that force, whereas the brigade liaison officer (LO 1) is the assistant brigade FSCOORD. (The direct support artillery battalion commander is the brigade FSCOORD). The battalion liaison officer will prepare the fire plan for the maneuver battalion and will supervise the activities of the forward observers with the companies within that battalion. This is in contrast to the present system in which the forward observers send their target lists directly to the artillery battalion S3.

Parts I and II of ARTILLERY TACTICS FOR THE NEW DIVISIONS illustrate, by narrative situations, the employment of divisional artillery battalions in support of the new infantry and mechanized brigades. Two contrasting situations are depicted: defense in a nonnuclear war and offense on a nuclear battleground.

two illustrative examples of . . .

ARTILLERY TACTICS *of the* *NEW DIVISIONS*

Major R. M. Jennings
Tactics/Combined Arms Department

PART I

ARTILLERY SUPPORT OF AN INFANTRY BRIGADE IN THE DEFENSE—NONNUCLEAR ENVIRONMENT

KOREA, May 19—. At 260700 May, the battalion commander of the 1st Howitzer Battalion (105-mm) (towed), 23d Artillery, reports to the command post of the 1st Brigade, 21st US Infantry Division, near the town of POCHON. A planning conference begins between the artillery commander, his S3 and S2, the brigade liaison officer, and the infantry brigade commander and his staff.

The preceding day, Aggressor Satellite forces had violated the truce agreement and launched a major offensive into South Korea. The Aggressor forces, employing modern weapons, have succeeded in making numerous penetrations of the initial UN defensive positions. Now, as UN forces are fighting a stubborn delaying action, the 21st Infantry Division is moving up from a training area in the vicinity of UIJONGBU to establish an area defense in the POCHON sector. Both Aggressor and UN forces have indicated that nuclear weapons will not be employed.

The 1st Brigade will man the right defensive sector of the division, with the 2d Brigade on its left and the 17th US Infantry Division on its right. The 1/23 Artillery has been given the tactical mission of direct support (DS) of the 1st Brigade. The 9/7 Artillery, another towed 105-mm howitzer battalion, will be in general support-reinforcing of the 1/23 Artillery, after the 3d Brigade that the 9/7 normally supports has withdrawn from the general outpost line (GOPL) and become the division reserve. The division artillery commander has directed that the artillery battalions move into position after the end of evening nautical twilight (EENT) on the 26th and be ready to fire by 2200. The liaison officers and forward observers of the direct support battalion have joined their supported infantry units, but have not yet occupied their defensive positions.

INFANTRY PLAN OF DEFENSE

Now, briefing the artillery officers from the brigade situation map, the brigade S3 outlines the plan of defense. The brigade, with three infantry

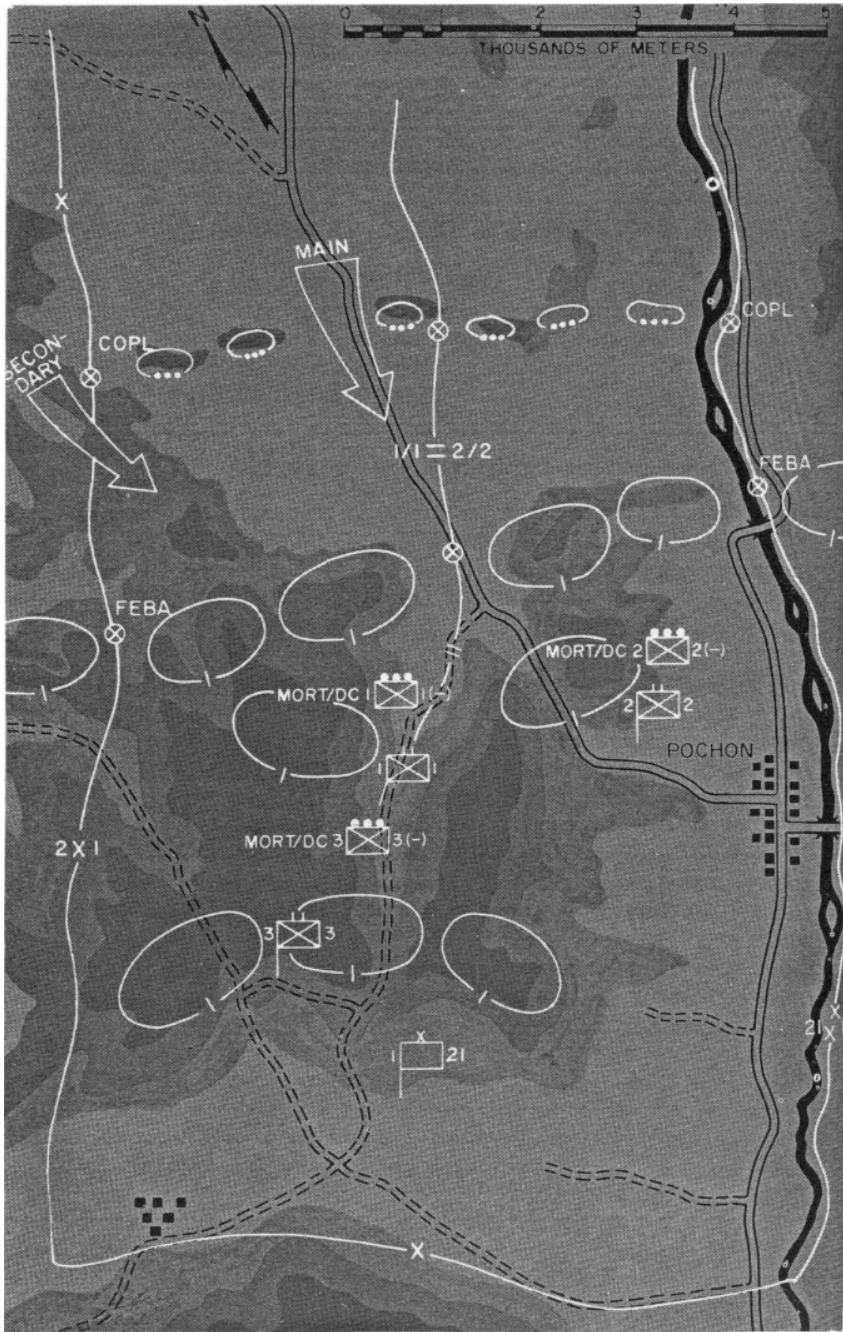

Figure 1. Infantry organization for defense.

battalions and one tank company attached, will organize the defensive area with two battalions on line and one in reserve, as shown on attached map (fig 1). The Davy Crockett weapons of the mortar/Davy Crockett platoons will be held in the brigade trains area in the rear until intelligence indicates a nuclear threat is imminent. A combat outpost line (COPL) will be manned by the reserve companies of the forward battalions, supported by tanks. The main and secondary avenues of approach of the enemy are shown. The division general outpost line (GOPL) is approximately 10,000 meters forward of the forward edge of the battle area (FEBA). The infantry companies of the brigade will be in position by 1800. Aggressor forces are not expected to contact the GOPL until the next day at 1300 (271300).

After the infantry briefing, the artillery battalion commander informs the brigade commander of the artillery situation. With his S3, reconnaissance and survey officer, and communication officer, he then begins a reconnaissance for a suitable position area, leaving the S2 behind to brief the battery reconnaissance parties on the situation. At 1000 hours, having selected a battalion position area and tentative battery positions and determined the azimuths of fire, the battalion commander issues his orders to the battery commanders and staff officers, and the detailed reconnaissances and preparations begin. As the battery commanders organize their position areas, the survey officer begins his survey plan, the communication officer supervises the installation of the wire and radio nets, and the radar officer, with the guidance of the S2, selects a location for the battalion's AN/MPQ-4 countermortar radar. Later in the afternoon, the liaison officers with the infantry battalions report that the infantry companies are in position, and the forward observers send their locations to the S2-S3 operations section in the artillery battalion FDC. The liaison officers with the infantry battalions monitor these reports, and the S2 begins studying the need for battalion OP's to supplement the observation coverage of the FO's.

ARTILLERY POSITION AREAS

The locations of the artillery battalion headquarters, the three firing batteries, the radar set, and the forward observers are shown in figure 2. The battalion service battery is located approximately 10 kilometers to the rear with the brigade trains. Also shown is the position for the general support-reinforcing battalion (9/7 Arty), which was positioned by division artillery on the recommendation of the direct support artillery battalion commander. Note that the firing battery positions are echeloned in depth to enable continuous fire during displacements necessitated by enemy penetrations. More depth in positioning within a battalion is possible than under the old organization with two firing batteries.

Forward supplementary positions have been selected to enable batteries to take the enemy under long-range fire and then fall back to the primary position. Alternate positions would also be selected for occupancy if the primary position becomes untenable. The radar set has been located in slight defilade to provide protection, reduce clutter, and minimize

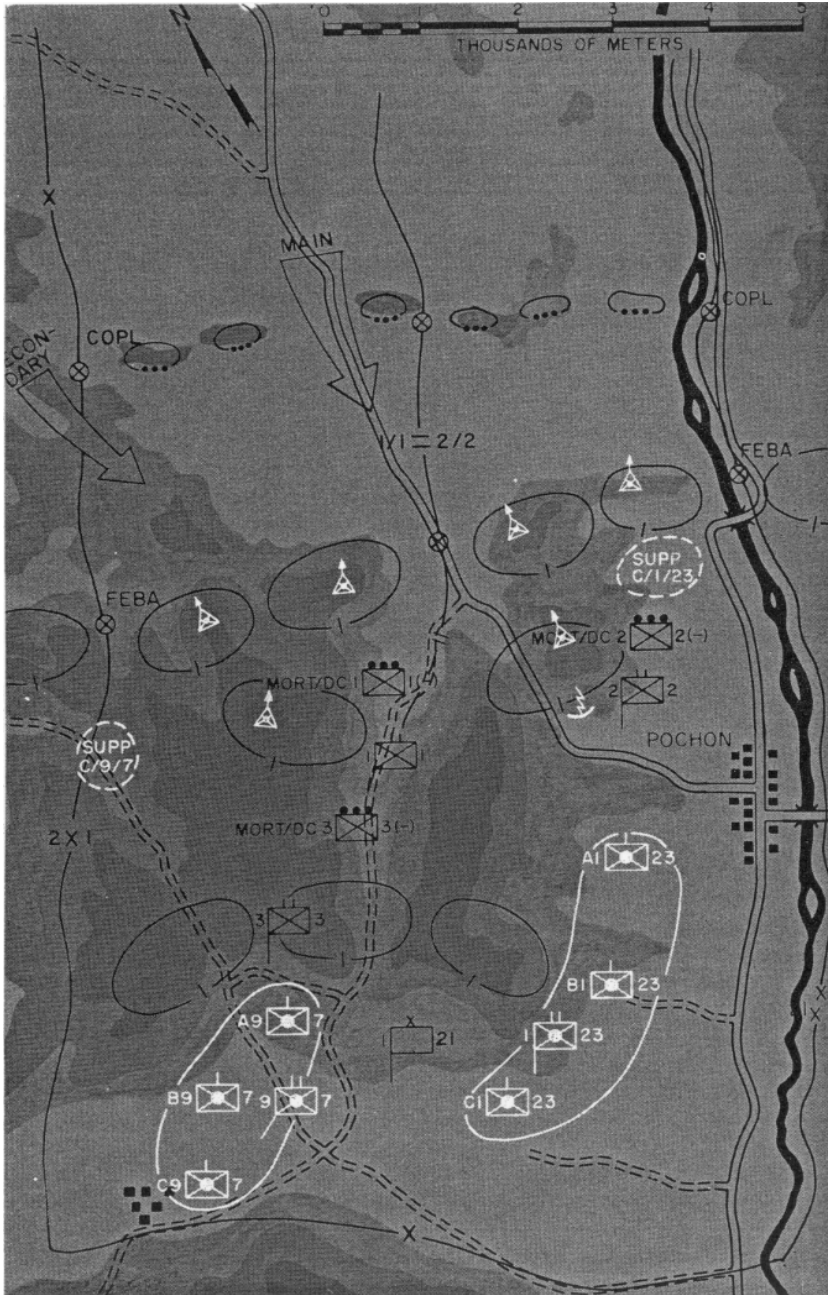

Figure 2. Position areas, radar location, and observation posts.

electronic countermeasures. The forward observer teams that would be with the tank company and the companies of the reserve battalion are not shown.

In coordinating the artillery observation for the brigade sector, the artillery battalion S2, after analyzing the visibility diagrams sent back by the FO's, arranges for the establishment of a centralized battalion OP. This OP will supplement forward observer OP's and add depth to the observation plan. It will be prepared by LO 5 and his party and later be manned by the reconnaissance and survey officer, when survey is completed. When relieved from the OP mission, LO 5 (not needed in his normal mission as LO to a fourth maneuver battalion) will assist the S3 in fire planning, fire direction, and liaison with the brigade. Observation is furnished the COPL force by the artillery and mortar FO's with the reserve companies manning that position.

FIRE PLANNING, REGISTRATION, AND THE NO-FIRE LINE

Meanwhile, fire planning is conducted at all echelons. Forward observers select possible targets in coordination with the rifle company commanders and send their target lists to the battalion liaison officers. The liaison officers assign concentration designations and forward the fire plans to the FDC, where the S3 consolidates the artillery fire plan for the brigade. A barrage will be furnished by each battery of the 1/23 Artillery, and division has directed that the 9/7 Artillery furnish one battery barrage to the brigade, giving a total of four barrages to the brigade sector. After allocation by the brigade commander, the exact locations of these barrages are selected by the rifle company commanders and forwarded by the FO's through the LO's to the fire direction center. The concentrations and barrages are plotted on the firing charts at the FDC, and the locations are also stored in the field artillery computer (FADAC), which has recently been received by the battalion.

Though the FADAC gives the unit the capability of delivering accurate fire without registration, the S3 decides to shoot-in registrations and barrages initially, since time and ammunition are available. The S3 has designated three points in the area as precision registration points. He plans initially to register the base piece of the center battery immediately after occupation by firing a high-burst registration at a chart location beyond the COPL. After daylight, he plans to register the base pieces of all three batteries on registration point 1 and to fire-in each of the barrages. As a manual backup for the FADAC, GFT settings will be computed for the other two registration points, using them as meteorological (met) check points. Arrangements are made with the infantry to coordinate this firing with troops on, and forward of, the FEBA.

During this firing, the FADAC will be checked and subsequent fire missions on enemy targets will be handled by the computer. The S3 receives from the LO's at the infantry battalion and brigade CP's the exact locations of the friendly forward elements on the COPL and the FEBA and designates recommended no-fire lines for these two positions, to become effective upon withdrawal of the security forces. (See figure 3 for

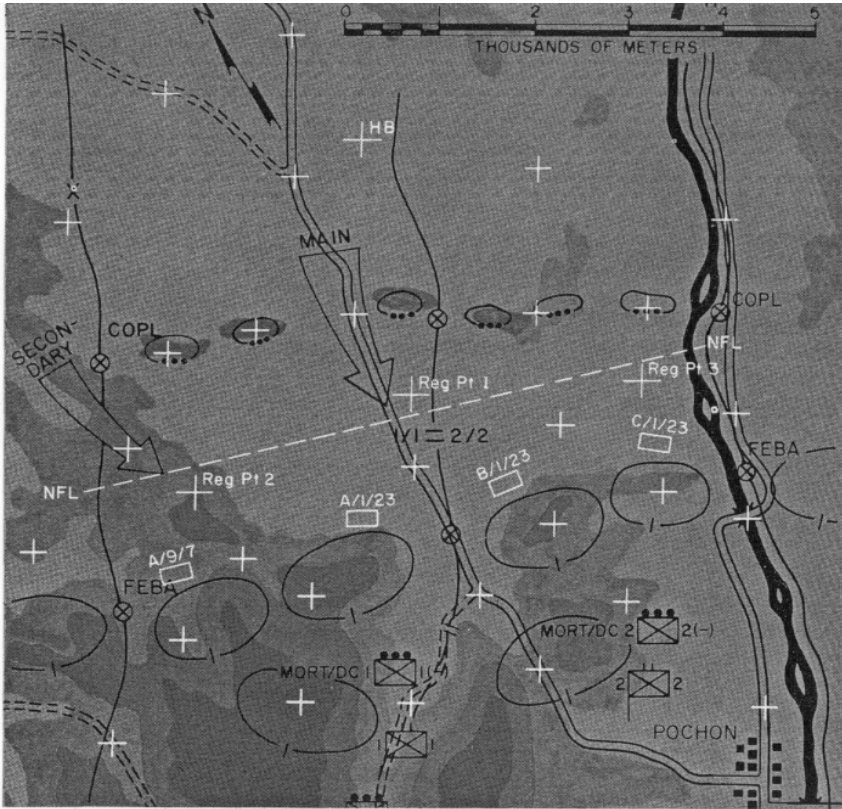

Figure 3. Concentrations, registration points, barrages, and no-fire line.

the no-fire line that will be in effect upon withdrawal of the COPL). The no-fire lines are approved by the direct support artillery battalion commander after coordination with the brigade commander and then forwarded to the division artillery FDC.

At 2130, the 1/23d Artillery arrives at the battalion release point under the control of the battalion executive officer and occupies its position. By 2155, the batteries report ready to fire, and Battery B begins the high-burst registration. The first met message is received from division artillery at 2220 over the AN/GRR-5 radio receiver.

SURVEY AND COMMUNICATIONS

The high-burst registration is observed from the 01-02 target area base. These OP's have been surveyed in by the battalion survey section, who completed the battalion survey during the afternoon (fig 4). The survey

section was split into two 8-man survey parties, one party completing the position area and target area surveys and the second party performing the connection survey, to include the radar, the supplementary position, and the mortar/Davy Crockett platoons of the 1/1 and 2/2 Infantry battalions. Assumed control was used initially, obtaining starting coordinates and height by map inspection and starting direction by gyro-azimuth instrument. Division artillery had established a survey control point within the area at 1815, and data was converted to common control. Later, as time permits, control will be carried to all observation posts and the mortar/Davy Crockett platoon of the reserve battalion.

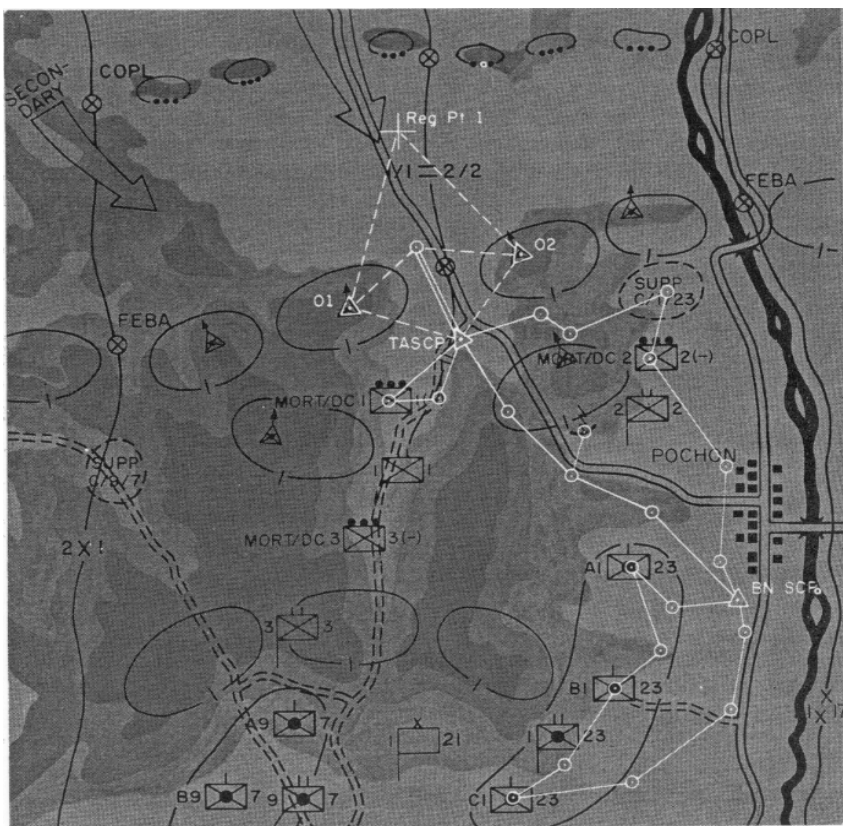

Figure 4. Battalion survey.

The battalion wire crews completed the installation of the priority wire lines prior to the arrival of the battalion. In addition to the command switchboards at the battalion and battery CP areas, switchboards are located in the battalion FDC and with the liaison officers at the maneuver battalions. Forward observers, with their 1 mile of wire, lay

into the infantry company switchboard and assist the liaison section or battalion wire crews in establishing the line from their OP to the LO's switchboard. A trunkline is laid by the artillery battalion from the battalion command switchboard to the brigade switchboard, and this line is simplexed to provide a circuit between LO 1 and the battalion FDC. (The artillery battalion's radio and wire nets are the same as those outlined in the February issue of ARTILLERY TRENDS.) The general support-reinforcing battalion will lay wire to the 1/23 Artillery command and FDC switchboards, and will send a liaison officer with a radio to the direct support battalion FDC.

AGGRESSOR ATTACK REPULSED

The next day, at 271400 May, as the GOPL withdraws before the leading elements of the Aggressor force, Aggressor troops are taken under fire by the batteries of the 1/23 and 9/7 Artilleries in the forward supplementary positions. Adjustment of fire is conducted from light observation helicopters of the division artillery aviation section. When the Aggressor forces move forward, they are met by massed artillery concentrations, as the artillery battalions skillfully maneuver their fires to critical areas of the battlefield. The confused enemy force disperses and while the remainder of the artillery batteries and the tank guns keep the enemy under fire, the forward batteries move back to their primary positions. Shortly thereafter, the COPL force, having accomplished its mission, withdraws behind the FEBA. The enemy's all-out attack smashes into the FEBA at 272300. Most of the Aggressor units are stopped there with heavy casualties by the final protective fires and barrages. But the momentum of the attack enables enemy elements to penetrate the right portion of the sector. At dawn, the howitzer sections of Battery A, 1/23 Artillery, destroy five medium tanks on the outskirts of POCHON with direct fire. The brigade reserve is committed at 280700 and, supported by massed fires from the mortars and artillery, eliminates the Aggressor penetration and restores the FEBA.

MAIN POINTS

Although artillery units will not always employ the tactics and techniques described in this situation, several important points were brought out.

1. Rifle company frontages in the defense will normally be 1,500 meters or less.
2. Elements of the forward companies or the reserve company of the forward infantry battalions will man the COPL.
3. The three firing batteries of the light artillery battalions should be echeloned in depth in the defense.
4. Service battery will normally be located in the rear, usually with the brigade trains.
5. Artillery liaison officers at supported maneuver battalions are the fire support coordinators for the maneuver battalions and will supervise the activities of the forward observers with the maneuver companies.

6. The battalion liaison officers will be given blocks of numbers and will assign designations to the targets planned by the forward observers.

7. A direct support artillery battalion should, if the situation permits, have a battalion observation post and a target area base (they may be combined) in addition to its forward observers.

8. Since the divisional light artillery battalions are single-caliber, registration by one piece will give satisfactory corrections if comparative VE's are known.

9. The direct support artillery battalion will furnish survey to, and integrate communications with, the several (2 to 5) 4.2-inch mortar platoons in its sector to the extent practicable.

10. The location of on-call fires (up to 100 targets) may be stored in the field artillery computer and firing data quickly computed when called for.

PART II

ARTILLERY SUPPORT OF A MECHANIZED BRIGADE IN THE OFFENSE—NUCLEAR ENVIRONMENT

CENTRAL EUROPE, AUGUST 19—. Following defeats of Aggressor Satellite forces in Asia in the spring of 19—, the Aggressor nation prepared for total war. In late July, while conducting maneuvers near the German zonal border, Aggressor, supported by her satellites, suddenly launched a major offensive preceded by massed nuclear missile strikes on Western Europe and the United States. The enemy attack was countered by a massive retaliatory nuclear bombardment by US and NATO forces.

NATO ground forces had been alerted prior to the attack and had taken a dispersed defensive posture in the field that enabled them, though severely damaged, to maintain a limited tactical effectiveness. During the all-out nuclear exchange, the US army corps had spread out in sectors 40 miles or more in width and depth, keeping their tank, infantry, and nonnuclear artillery protected, while the nuclear artillery units fought the deadly nuclear duel.

By 1 August, NATO forces had achieved nuclear fire superiority and had stopped the Aggressor with a mobile defense east of the RHINE River. Then, having virtually wiped out Aggressor's nuclear stockpiles, NATO forces, reinforced by STRAC units from CONUS, counterattacked eastward in hardhitting, mobile division- and brigade-size units to exploit the nuclear success. One of these reinforced brigades, the 2d Brigade, 10th Mechanized Division, is attacking north-eastward in southern Poland on an independent-type mission.

The 2d Brigade has as its major tactical units three mechanized infantry battalions, a tank battalion with four tank companies, and a combat engineer company. Attached from division artillery are the 7th How Bn (105-mm) (SP), 4th Arty; Btry A (155-mm) (SP), 8th How Bn, 18th Arty; and 1st Plat, Btry D (8-in) (SP), 8th How Bn, 18th Arty.

Three light observation helicopters (LOH) with air observers from the division artillery aviation section have been attached, and the four FO's who normally support the tank battalion, although from another artillery battalion, have also been attached for this operation. Other attached artillery elements are a survey team from the 155-mm/8-inch battalion and an electronic meteorological section from corps artillery.

The 155-mm howitzer battery, the 8-inch howitzer platoon, the LOH aircraft, and the other artillery personnel were attached by division artillery to the 105-mm howitzer battalion for this operation, enabling one artillery commander to direct the employment of the artillery and serve as brigade fire support coordinator. The brigade commander has given the commander of the artillery battalion (+) the mission-type order to "support the brigade." The artillery commander has placed the 105-mm battalion in direct support and the 155-mm and 8-inch howitzers in general support of the brigade.

Having crossed the TILICA River, the forward elements of the brigade have been held up by a secondary Aggressor defensive line holding the high ground northeast of the river (fig 5). Aggressor units in this area appear to be about a regiment in size, but at approximately 70 percent strength. The mission of the 2d Brigade is to penetrate the Aggressor position, capture the town of LEWICE, and continue the attack to the northeast.

The brigade commander issues his concept of the operation to his subordinate commanders and the artillery commander at 141200 Aug. Following a nuclear and nonnuclear preparation, Task Force 1/10 and Task Force 1/11 will seize objectives 1 and 2, respectively. Each of these task forces will consist of a mechanized infantry battalion and a tank company. After the capture of objectives 1 and 2, Task Force 1/12, consisting of a mechanized infantry battalion and a tank battalion (—), penetrates by mounted attack, captures objective 3, and prepares to continue the attack to the northeast. Task Force 1/10 will become the brigade reserve upon commitment of Task Force 1/12. For the 72-hour period 15-17 Aug, the brigade is allocated three 8-inch howitzer nuclear weapons and six Davy Crockett weapons. H-hour is 150400 Aug.

FIRE SUPPORT

Having received the concept of the operation, the artillery commander, liaison officer 1, the brigade S3 air, and the brigade assistant S2 begin the fire support planning. The preparation will begin with 8-inch howitzer nuclear strikes on objectives 1 and 2 from H—10 to H—8 minutes. From H—7 to H+5, the nonnuclear preparation will be fired, hitting the enemy artillery batteries early in the preparation. An airstrike is requested on the enemy tank company at H+10 minutes. The remainder of the nuclear weapons will be held in reserve for on-call targets or targets of opportunity. The artillery commander, based on guidance from the brigade commander, designates the line of contact (LC) as a nuclear safety line (NSL), with the specification that no friendly troops be beyond this line from H—30 to H—5 minutes.

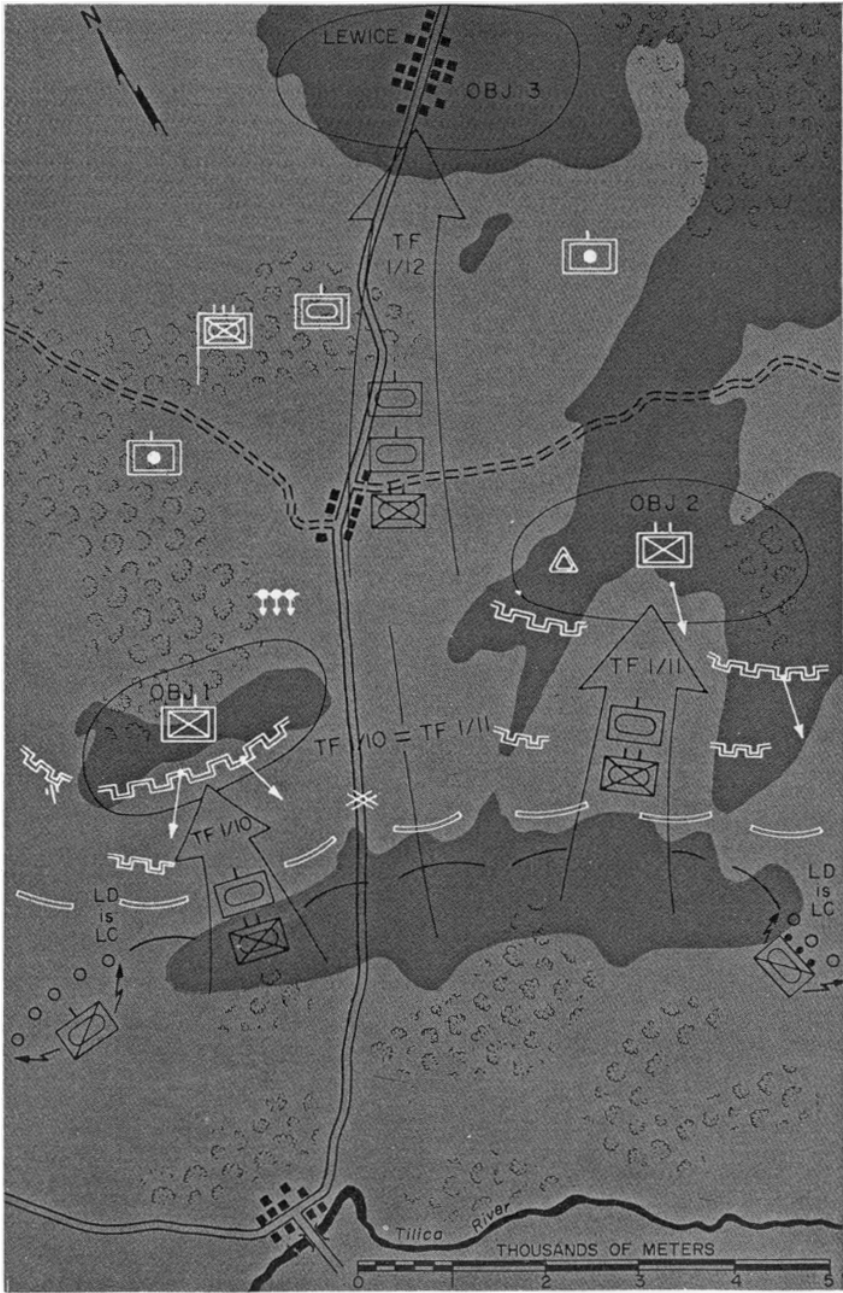

Figure 5. Brigade attack plan.

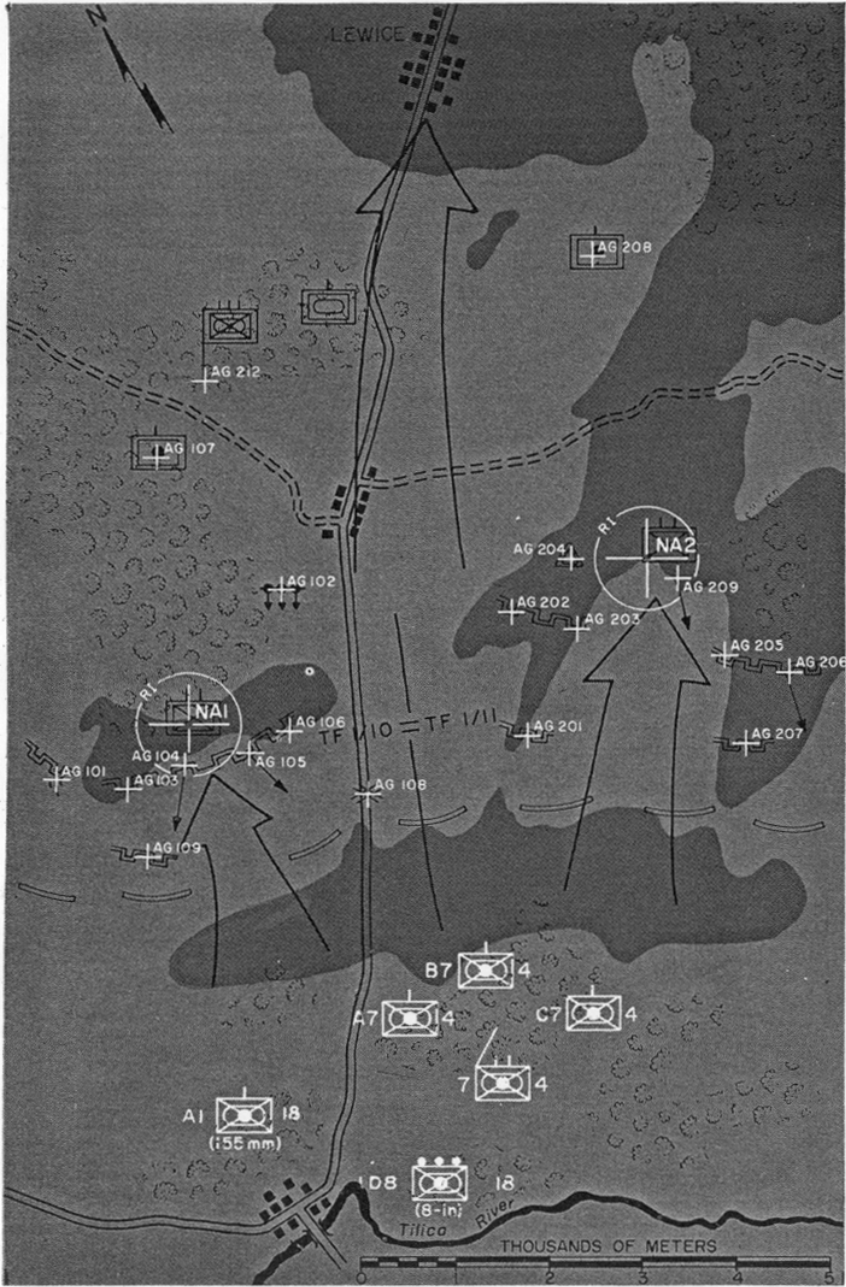

Figure 6. Artillery positions and fire support.

The artillery commander considers that the present positions of the artillery batteries (not shown, about 6,000 meters to the rear of the LC) are too far to the rear and orders that the batteries be brought up to positions well forward, after EENT (fig 6).

The enemy will be hit by surprise preparatory fires from the new artillery positions. Since accurate muzzle velocities of the artillery howitzers have been obtained by the radar chronograph during previous fire missions and the FADAC and electronic meteorological messages are available, registration is not considered necessary prior to the attack.

The fire support planners strive for maximum integration of the nuclear and nonnuclear fires with the plan of maneuver. A radius of integration (RI) is figured for each nuclear strike at the R.30 effects distance from desired ground zero. Targets on this circle will have at least a 30 percent probability of being neutralized; those within the circle will have a much higher probability of being neutralized. Some nonnuclear concentrations are planned on-call within the radius of integration (fig 6) but are not scheduled to be fired in the preparation.

	H-10	-8	-6	-4	-2	H	+2	+4	+6
V1/D/8/18	NA 1 -KT								
2/1/D/8/18	NA 2 -KT								
A/7/4			AG107 18		AG212 18			AG107 30	
B/7/4			AG107 18		AG212 18		AG 204 12 HC SMOKE		
C/7/4			AG 102 30		AG212 18			AG102 24	
A/1/18			AG 208 30		AG107 18			AG 208 30	
MORT 1/10			AG109 24		AG101 24			AG 105 32	
MORT 1/11			AG 207 32			AG 205 32		AG206 32	
MORT 1/12			AG108 16		AG106 24			AG 105 32	
MORT-TK			AG201 32		AG203 32			AG 202 32	

Figure 7. Preparation Schedule of fires.

The preparation planned included targets to be fired by the 4.2-inch mortars of the four battalions (fig 7). The mortar/Davy Crockett FDC's coordinated the target lists of the mortar FO's and forwarded the consolidated target lists to the artillery liaison officers at the battalion CP's. The liaison officers, working with the mortar/Davy Crockett platoon leaders, coordinated the artillery and mortar fires and included them in the fire plans forwarded to the direct support battalion FDC. The artillery fire planning channels are shown in figure 8.

Division artillery FDC is shown, although it is not applicable in this independent operation. When the preparation schedule is completed, firing data for the concentrations to be fired by the 105-mm and 155-mm howitzers are computed by the FADAC and sent to the firing batteries. The 8-inch howitzer platoon will compute its own data.

USE OF AIRCRAFT

Of the three light observation helicopters (LOH) attached to the 7/4 Artillery, one will be used to enable the artillery commander to reconnoiter

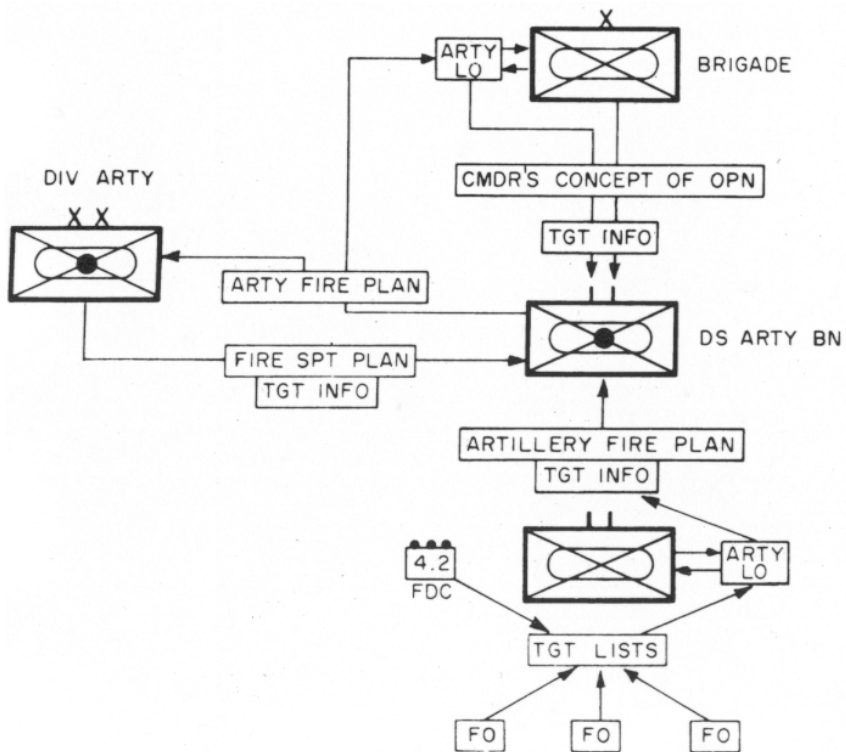

Figure 8. Artillery fire planning channels.

position areas and control the artillery units. The other two LOH's will be used primarily for observation and adjustment of fire, one LOH on station at a time. At H—5 minutes, one LOH will be dispatched to assess the damage and survey the radiation caused by the nuclear bursts and radio this information to the brigade FSCOORD.

THE ATTACK

At 150350, the early morning light is split by the fireballs of the two nuclear weapons, fired by the 8-inch howitzers, erupting over the Aggressor positions. After the blast wave passes the positions of the artillerymen in the 155-mm and 105-mm howitzer batteries, they quickly check the settings on their self-propelled howitzers and at 0353 fire their high explosive shells on the enemy. At 0400, the tanks and armored personnel carriers of Task Forces 1/10 and 1/11 cross the line of departure under the whistling shells of the artillery preparation. Upon nearing their objectives, the infantrymen dismount from their carriers and assault on foot. Eight fighter-bombers conduct the airstrike on the Aggressor tank reserves at 0410 and destroy nine tanks with napalm and rockets. By 0500, objectives 1 and 2 are secure, and the brigade commander orders the commitment of Task Force 1/12.

Task Force 1/12 passes through friendly troops and rolls forward against sporadic enemy resistance. Artillery FO's, riding in tanks and armored carriers furnished by the maneuver units, adjust fires on disorganized Aggressor elements and succeed in completing the destruction of the two enemy artillery batteries. The CO, 7/4 Artillery, begins moving the artillery units forward by echelon, starting with the 105-mm batteries. In each echelon there are fire direction personnel, to maintain continuous fire support.

On the outskirts of LEWICE, Task Force 1/12 is stopped by heavy antitank fire from the town and by tank and mortar fire from a large enemy force on the wooded high ground 3,000 meters south of the objective. The task force commander, on the recommendation of the FSCOORD, informs the brigade commander that he intends to fire two Davy Crockett weapons on the enemy force in the south. Friendly mortar and artillery fire keep the enemy pinned down in his position. The nuclear weapons are delivered on the target, and the tank-infantry teams of Task Force 1/12 are sent to mop up the area. Task Force 1/11 is committed around the northern flank and, following an intense artillery preparation, captures the objective.

MAIN POINTS

1. Though centralized control of artillery is maintained when practical to provide massed fires, attachment may be necessary to support an independent-type operation.
2. The division's 155-mm/8-in howitzer battalion is normally employed as a unit, but it may be attached in battery/platoon-size units as in this action.

3. The mission-type order of "support" may be used.
4. Nuclear and nonnuclear fires must be integrated with the plan of maneuver.
5. Nuclear weapons may often be allocated from divisions to brigades but, with the exception of Davy Crockett subkiloton warheads, are not normally allocated to battalion level.
6. In a nuclear situation, infantry and tank battalion commanders have the authority to employ Davy Crockett weapons to accomplish their mission. However, such fires are coordinated by the fire support coordinator, and higher headquarters must be notified.
7. The artillery commander establishes the nuclear safety line (NSL), based on guidance from the force commander.
8. Fires of the 4.2-inch mortars may be integrated into the artillery fire plan.
9. In a mechanized/armored attack, artillery forward observers should ride in a tank or armored carrier and have the capability to adjust fires while moving.
10. Light observation helicopter aircraft from the division artillery aviation section may be attached to, or placed in support of, an artillery battalion.
11. When a field artillery computer (FADAC), a chronograph, and electronic meteorological messages are available, registration is not necessary.
12. The FADAC can compute firing data for batteries of two different calibers, using the same program.

* * * * *

In the preceding situations, typical examples of the employment of field artillery in support of the new brigades have been depicted—both in offense and defense, in nuclear and nonnuclear environments. A discussion of division artillery level tactics, to include employment of the new 155-mm/8-inch howitzer and Honest John battalions, has been reserved for a later article. In reading through the above situations, the experienced artilleryman has probably found that, though certain new equipment and techniques have been adopted, the fundamental principles of artillery tactics still apply.

Class Number T3100, concerning tactics of the new divisions, is available from the address on this issue's inside back cover.

QUALIFICATION BADGE AWARD

Commanders! Have you taken action yet to ensure that your men get the Qualification Badges they deserve? If not, see the back cover of the previous issue (May 1962) of ARTILLERY TRENDS.

doctrine and capabilities . . .



Captain Thomas P. Rametta
Office of Combat Development and Doctrine

In North Africa in World War II, Rommel's advance was thwarted by a *single battery* of US field artillery firing direct fire offensively. In Aachen, the defending German commander, whose sole remaining stronghold was his command post, surrendered with the words, "There is no use in continuing when you are faced with Long Toms (155-mm guns) firing at you pointblank." During its attack on the Rhine in March 1945, the Ninth US Army assigned artillery units the mission of ". . . direct fire on objects on the Rhine River . . .," and in Korea, too, roving platoons of medium and heavy howitzers often occupied forward positions from which they attacked bunkers and caves, thus sealing the apertures.

The significance of these isolated instances of direct fire in offensive employment is that direct fire can be effective in that role. This article will discuss the doctrine of direct fire as it is understood by US artillery and by the Soviets; it will also show the capabilities of current US and Soviet materiel in this role. This article, coupled with the article, "Direct Fire," in ARTILLERY TRENDS, June 1961, page 17, which puts forth the latest information on direct fire techniques, represents current information on this subject. All units concerned—and that includes all cannon units—would do well to keep this information at hand.

SOVIET DOCTRINE AND MATERIEL

Soviet artillery actively employs direct fire techniques both in offense and defense. The Soviets probably advocate its use because of the conviction of its tactical usefulness and advantages, reasoning that with direct fire, targets can be defeated in less time with less ammunition than with indirect fire. Generally, they use smaller calibers in defense and to accompany tanks and infantry in the attack; large caliber weapons are employed in offensive operations against fortifications and are then assigned specific targets to destroy. Thus, artillery is often carefully sited to maximize the direct fire capability. It is not uncommon for the Soviets to site their weapons at ranges not exceeding 1,000 to 1,500 meters from targets. Against stationary targets the Soviets use antitank artillery and regimental artillery guns. These weapons are normally emplaced at a

maximum range of 1,000 meters, although 500 meters is the preferred range. Against moving targets the same general principles are applied by both the Soviets and the US; i.e., considerations for direction, speed, angle of approach, and pointblank range.

In the execution of direct fire missions, the Soviet *weapon commander* is in control and adjusts the mission from a vantage point. The person in direct charge of the weapon is the *layer*, who sets off data as announced by the *weapon commander* and fires. The *gunner* loads and unloads while other crew members prepare ammunition.

If the first round misses a moving target laterally by less than the length (width) of the target, the command "To the Right (Left)" is given; the *layer* does not alter his settings, but merely changes his sight picture; i.e., he uses "Kentucky windage." If the lateral miss exceeds one length (width), the *weapon commander* specifies new settings.

When engaging roadbound targets, the Soviets attempt to occupy the most advantageous sites; if possible, exact distances to checkpoints are determined, and check rounds are fired. The lead vehicle is attacked first; if more than one weapon is available, the weapon which is to attack the lead vehicle will be predetermined.

The Soviets and their satellites currently employ weapons of at least eight different calibers in the direct fire role. These weapons range in caliber from 45-mm to 203-mm (see page 33), and nearly all are mounted in one or both of two configurations, towed and unarmored or self-propelled and armored. They consist of antitank, assault, and field guns; howitzers; and gun/howitzers.

Soviet sighting devices are characterized by simplicity of design and relative ease of manufacture. Although these devices are generally of World War II vintage, one cannot overlook the fact that the Soviets have had access to modern German sights and, via Lend-Lease, to modern US and UK sights. Soviet sights are of good workmanship and are adequate for normal field artillery purposes. New tanks and self-propelled artillery may possibly employ a type of gyro-stabilized direct fire sight, although these devices were not used during World War II. Known tanks and self-propelled artillery vehicles are equipped with direct fire telescopes which are excellent, but are not considered the equal of modern US fire control devices for tanks. The three basic types of on-carriage sights are all copies of adaptations of French and German World War I designs, and none are modern by US standards.

- German Gortz-type dial sight—this is their best direct fire sight. It is used with 45-mm and 57-mm antitank weapons for direct fire against armor and fortifications.

- Schneider-type quadrant sight—this sight is an adaptation of a French design used by the US in World War I but abandoned by us in 1928. The panoramic telescope has no capability for complete cant compensation: this correction is determined in the FDC, adding to computational complexities and seriously handicapping rapid fire capability.

- German-type (match-the-pointer) quadrant sight—this sight uses a simple panoramic telescope similar to the US panoramic telescope. It

is laid in elevation by matching two pointer arms, one of which is fixed to the weapon and the other to the sight mount. This sight is their best for indirect fire, as it automatically compensates for trunnion cant when cross-leveled. Although not particularly adaptable for use in direct fire, it is so used in consonance with Soviet doctrine.

US TECHNIQUE AND EQUIPMENT

US artillery employs three methods for direct laying: two men using two sights, two men using one sight, and one man using one sight. Regardless of the system, the US applies a "continuous tracking" technique against moving targets. All US howitzers and guns, from 105-mm through 175-mm, are capable of being laid for direct fire. Some, due to mounting of fire control equipment, are limited as to which technique may be used; i.e., one-man, one-sight system, two-man, two-sight system, etc; others can be employed with either technique.

Optical devices used for direct fire sighting by US artillery are of high quality and are precision-made. The two basic types of sights, modified for specific weapons are: the panoramic telescopes, M-12, M-100, and T-177 (click), primarily designed for horizontal laying in indirect fire. However, by applying a zero setting and changing the line of sight by traversing the tube, the vertical hairline can be used for horizontal laying in direct fire. All panoramic telescopes are similar in the possession of single vertical and horizontal graduated hairlines which cross in the center of the reticle. The M12A2, used with the current towed 105-mm howitzer M2A2, possesses a gridded reticle allowing for range as well as azimuth sighting. The T-177, to be utilized in the T195E1 (M108, 105-mm) and T196E1 (M109, 155-mm) armored, self-propelled howitzers, is unique because of the click feature in its micrometer knob which permits the gunner to set off lead in 5-mil increments by sound or feel without removing his eye from the eyepiece.

There are four models of direct fire telescopes which are currently employed by artillery; however, all have relatively similar reticle patterns. All have a NORMAL range line or ZERO range tickmark; all are graduated in regular range increments up to the maximum effective direct fire ranges of the weapons with which they are used; all are graduated for horizontal laying. The latest model, T176E1, to be utilized with the armored, self-propelled howitzers T195E1 and T196E1, is an improved version allowing for cant compensation.

The US currently utilizes point- and base-detonating and concrete-piercing fuzes in ammunition suitable for direct fire missions against materiel targets. These fuzes are used in combination with the following projectiles:

High explosive (HE)—the high explosive shell is the artillery workhorse among munitions and is used in many roles against personnel as well as medium materiel targets. Its greatest limitation is against armor, in which case it is effective merely as a harassing agent, forcing tank crews to button up inside their turrets. It is available in all calibers and accepts both point-detonating and concrete-piercing fuzes.

High explosive antitank (HEAT)—this shell is available only in the 105-mm caliber. It possesses a tracer element, utilizes a shaped charge based on the Munroe principle of jet formation, and functions with a base-detonating fuze. The penetration capability of these rounds is relatively independent of impact velocity, and through our better understanding of the shaped charge phenomenon and wave-shaping, the effectiveness of this type of round has steadily increased since World War II.

Traditionally, the US artillery regards direct fire as a technique to be used in the defense of a battery position or as a special technique, such as a section or two taking enemy strongpoints, e.g. pillboxes, under fire.

Targets which are taken under direct fire are normally the hard, point type, requiring penetration and destruction; e.g., tanks, armored personnel carriers, bunkers, bridges, buildings, and command posts. However, on the future battlefield the scope of targets which may be attacked by direct fire may be widened. For example, the concept of mission-type forces of the future, on a battlefield where dispersion is significant, calls for sharp and violent local actions involving personnel with and without armor protection. Cannon artillery may find itself on, or near, the forward edge of the battle area (FEBA) more often than in past wars. Such operations will result in greater dispersion of units, greater fluidity of operations, and less clearly defined lines of contact. With the increased tempo of the future battlefield, the requirement for an effective direct fire capability exists more than ever before. Fleeting targets which must be taken under fire immediately may appear; attacking forces may be required to breach enemy strongpoints or road blocks by utilizing the low trajectories afforded only by direct or assault fires. Thus it is apparent that artillery must be prepared to employ direct fire not only in protection of battery positions, but also in offensive situations under special conditions. This may involve single gun or platoon actions covering roads, fields, etc.

Artillery in support of guerrilla forces would also participate in operations without the clear distinction between offense and defense. Guerrilla operations are characterized by fluidity, and supporting artillery must be capable of supporting such actions by offensive fires as well as by defensive barrages and direct fire against hard-charging counterattacks.

It is appropriate to note that direct fire is often confused or considered synonymous with assault fire. This is not so. True, the same types of targets are generally attacked with both methods, and both methods take maximum advantage of high velocities, the use of the highest propellant charges, and low trajectories. The difference lies in control. In direct fire, the observer is in direct communication with the gunner (often, the chief of section is the "observer"). It is the gunner who lays directly on the target through sights mounted on the weapon. In assault fire, the forward observer (FO) communicates with the fire direction center (FDC). The FDC then computes gun data and transmits this data to the gun crew. The weapon is laid using indirect fire techniques with the exception of horizontal laying for which a deflection

board is mounted on the near aiming post. This board is graduated in 1/4-mil increments; it is depicted in figure 31, page 50, FM 6-40.

In view of the many precedents for use of direct fire techniques set in World War II and Korea, and particularly the anticipated application of such techniques in future warfare, it would be well to realize the importance and the emphasis that should be given in the training of US field artillerymen in direct fire methods. The fourth edition (August 1960) of the USAAMS "Notes for the Battery Executive" states that the battery that is called upon to fire direct fire and is unable to do so effectively is probably lost. Although US cannonners quickly learned to deliver effective fire *in combat* in the past, the battlefield should *not* double as a training ground and the tempo of future battle will not allow us the luxury of "learning while doing."

There has been a divergence of opinion among US and Allied artillerymen as to which of several techniques for delivering direct fires is most effective. Basically, the divergence resolves into two areas: the use of one man and one sight versus two men and two sights (the two-man, one-sight system is generally not satisfactory) and tracking moving targets continuously versus laying the tube statically ahead of the target and firing when the target has "reached" the proper lead. The US is the only Tripartite member which advocates the two-man, two-sight system. In addition, the US prefers to track moving targets continuously, whereas the UK uses the static laying technique. In these respects, the UK and USSR techniques are similar. The US Army Artillery Board, Fort Sill, has recently completed an exhaustive study on the relative merits of direct fire techniques, and the results of this study (fig 1) have strengthened the US conviction that the two-man, two-sight, continuous track technique is best.

In future war we will face an enemy aggressive in the use of artillery, who utilizes mechanization and "breakthrough" tactics to the utmost. Machines will compete with men as primary targets, and the rate of travel of targets will radically reduce the reaction time afforded weapon systems. Artillery must not be limited to support of the maneuver forces by missiles fired from great distances, but rather must render all-purpose fire support to the maneuvering arms, to include effective and timely fire against all types of targets.

Interchangeable sights are available for the different types of ammunition. These sights are precise optical instruments, and, once range and lead estimates are determined, the tubes can be accurately laid. However, the artilleryman must still estimate ranges to targets without mechanical or computational aids. His only aids are the skill and proficiency he attains in his training and the valuable experience he has received in the past.

It was recognized that a requirement existed for a device to determine accurate initial range data for ground targets. A very lightweight visual rangefinder has been proposed. It will measure accurate slant ranges from 300 to 3,000 meters, and will be small, easily maintained, and capable of operation by one man—a high degree of technical skill will

(1) One series fired at targets moving down a steep slope 500 yards from the weapon gave the following results:

<i>Sight system</i>	<i>Charge</i>	<i>Percent of hits</i>	<i>Initial time to lay</i>	<i>Average time between rounds</i>
One-man, one-sight	7	59	14.8 sec	15.1 sec
Two-man, two-sight	6	82	21 sec	11.8 sec

(2) Close in fires, conducted at a range from 500 yards to 50 yards gave the following results:

<i>Sight system</i>	<i>Charge</i>	<i>Percent of hits</i>	<i>Initial time to lay</i>	<i>Average time between rounds</i>
One-man, one-sight	7	69	18.4 sec	13.1 sec
Two-man, two-sight	6	100	22.4 sec	11.0 sec

(3) A series of problems conducted with 24 gunners from tactical units gave the following results:

<i>Sight system</i>	<i>Charge</i>	<i>Percent of hits</i>	<i>Initial time to lay</i>	<i>Average time between rounds</i>
One-man, one-sight	7	36	9.7 sec	15.5 sec
Two-man, two-sight	6	60	8.1 sec	16.6 sec

(4) A series fired at 1,200 yards gave the following results:

<i>Sight system</i>	<i>Charge</i>	<i>Percent of hits</i>	<i>Initial time to lay</i>	<i>Average time between rounds</i>
One-man, one-sight	7	0	15.5 sec	15.9 sec
Two-man, two-sight	6	21	25.7 sec	21.8 sec

(5) The fifteenth series, fired with charge 6 at targets with lead and ranges known to be correct (with no restriction on number of rounds to be fired) gave the following results:

<i>Sight system</i>	<i>Rounds fired</i>	<i>Number of Hits</i>	<i>Initial time to lay</i>	<i>Average time between rounds</i>
One-man, one-sight	122	79	23.9 sec	18.1 sec
Two-man, two-sight	189	156	20.4 sec	13.6 sec

Figure 1. The statistical results of the direct fire study.

not be required. This proposed very lightweight rangefinder will be satisfactory for use in direct artillery fire.

The advent of automatic data processing with small computers may lead to the application of such a computer for direct fire. Coupled with an accurate rangefinder device, a computer could process input data such as range, lead, azimuth, etc., and display firing data on the weapons. This capability might even eliminate the need for optical tracking devices such as are now used. Such a system, however, may prove to be too unwieldy and costly if developed solely for direct fire. However, if a direct fire capability could be incorporated into a system primarily developed for indirect fire, automatic data processing could well serve the artilleryman in direct fire.

Despite a limitation in the capability to determine accurate range data to the target, we can, with binoculars, panoramic and elbow (direct fire) telescopes, determine horizontal lead, and our weapon can be laid accurately and quickly. Range is determined visually, and accuracy depends wholly on the experience and judgment of the person who happens to be tracking the target. Beyond flat trajectory range (approximately 500 meters for most weapons) fire must be adjusted onto the target by an independent observer. This is necessary because of trajectory characteristics of howitzers and because of the inability to "range" a target accurately. After the initial round has been fired, subsequent rounds are "bracketed" on the target in much the same manner as adjustment of fires in indirect techniques. As an example, using the two-man, two-sight system, gun crews were able to hit 100 percent of the close-in targets (50-500 meters) but they hit only 21 percent of the targets at a range of 1,200 meters. The situation will be rare which will afford the gun crew the luxury of three- or even two-round adjustments against targets at direct fire ranges. If the target is not destroyed with the first round, the crew itself will be in grave danger of annihilation.

SUMMARY

Considering the characteristics of direct fire targets, the traditional use of direct fires in all wars in which the United States has participated, the future battlefield situations, and the current availability of direct fire equipment and munitions, employment of cannon artillery in the direct fire mode as an alternate method of employing the assault fire technique becomes increasingly important. Weapons employed in this special manner may fire in their primary indirect fire role as required. Self-propelled cannons will be particularly adaptable to this role, and their fires will be particularly effective against hard targets, such as fortified positions, caves, bunkers, and vehicles. Additionally, greater firing accuracy may be achieved with direct fire than with indirect laying techniques.

US field artillery units can be expected to have a secondary role of anti-APC and antitank defense, consisting primarily of defense of positions and defense against attack during displacement by hostile armor and/or APC's. It would be feasible to employ cannon artillery in direct

fire as an alternate method of employing the assault fire technique. Utilizing current materiel, direct fire laying techniques appear to be adequate.

* * * * *

What does all this mean? Simply this—research and development has recognized a dire need for new equipment to improve US artillery in the direct fire role. But that doesn't mean that cannon units are without direct fire capability today! On the contrary, US guns, ammunition, and optical equipment offer an adequate direct fire capability—to that cannon unit which recognizes its ability and exploits it through training. Future equipment will only add icing to the cake. It will make direct fire easier, faster, and more accurate. It will not create the direct fire capability! That has already been done. Before "pan scopes," direct fire was the only capability. It will be no less important in the future.

●

GEM FOR THE SWITCHBOARD (SB-86/P) OPERATOR

To prevent accidental signaling of the Manual Telephone Switchboard (SB-86/P) while the wire line is being laid, and to prevent possible damage to the switchboard during the initial line check, *all* line selector switches should be placed in the "M" position and should remain in this position until each wire line has been connected and tested using local battery operation. After each line is connected, the installer should then indicate to the switchboard operator which type of operation is required for the particular instrument. The line selector switch on the switchboard and the circuit selector switch on the telephone should then be placed in the desired position.

—submitted by Major (Ret) Lawrence E. Keene
Communications/Electronics Department

●

EXPLOSIVES FOR NUCLEAR WEAPONS UNITS

Some field artillery missile battalions have not been able to acquire the demolition materials they need to carry out their mission. During the next change or revision of the applicable TOEs, the following addition will be made: "Demolition equipment set, explosive initiating, electric and nonelectric," line item No. 411785, one per company, battery, detachment, or similar unit having a nuclear delivery or storage capability and mission.

Meanwhile, TA 20-2 (scheduled for revision in early summer) will contain authorization for TOE units to obtain and temporarily retain a demolition equipment set, explosive initiating, nonelectric, for training purposes. Major Items Supply Management Agency (MISMA) has been informed and TOE units may use AR 725-5 as authorization for requisitioning until TA 20-2 is revised.

СОВЕТСКИЕ
(SOVIET)

Артиллерийские
(ARTILLERY)

Орудия
(WEAPONS)

Captain Alden C. Walsh
Office of Combat Development and Doctrine

A recent article in ARTILLERY TRENDS ("Soviet Armor and Artillery," November 1961, page 29) discussed Soviet artillery in its conjunctive efforts with armor, primarily from a tactical standpoint. More recent developments in Russian artillery and a greater understanding on our part of Russian trends in artillery tactics prompts this latest informational effort.

It is generally recognized that the Soviets, true to their unswerving belief in the tactic of MASS, attach at least as great a significance to *massed* artillery as they do to *massed* infantry or *massed* armor. The very fact that Russian artillerymen have substituted the term "artillery attack" for the traditional "artillery preparation" manifests the emphasis placed on artillery.

ARTILLERY A DOMINANT FORCE

Today, as in World War II, approximately one-third of the Soviet combat forces wears the artillery insignia. Since World War II, Soviet artillery has experienced a rate of growth and development unequaled by any power in modern times. It is, modestly speaking, the very backbone of defense and the striking force of the attack.

The concept of MASS in artillery is not new to the Russians. It has proven itself in the past, when with large numbers of cheap, unrefined, and relatively simple cannon and multiple rocket launchers, often employed "hub-to-hub," the Soviets were able to place effective massed fires on their enemies. Today, the weapons are not so unrefined, inaccurate, and cumbersome. Indeed, they are sophisticated and highly mobile weapons

rivaling the best artillery of other nations. And with this new equipment, the concept of massed fires has taken on added importance.

THE SHOWCASE

The Soviet artillery-consciousness is evidenced twice each year in Moscow parades. These are the ominous occasions on which the newest military equipments are flaunted before the public. Each of the past several years has revealed at least one completely new or radically-improved weapon.

Generally, tactical Soviet field artillery weapons may be classified as cannon, small and large free-flight rockets, and guided missiles. Cannon includes all tube weapons such as mortars, guns, gun/howitzers, and howitzers. Rockets are either the smaller varieties fired from multiple launchers or the larger versions similar to the Honest John. Tactical guided missiles are classified as those with maximum ranges up to 700 nautical miles.

THE DICTIONARY OF CANNON

The 160-mm mortar M160 (fig 1) was first placed in the Soviet military structure in 1953. It is currently found in the motorized rifle division artilleries. It is an improvement over older mortars of the same caliber in that it features a greater range capability and a more rugged mount.

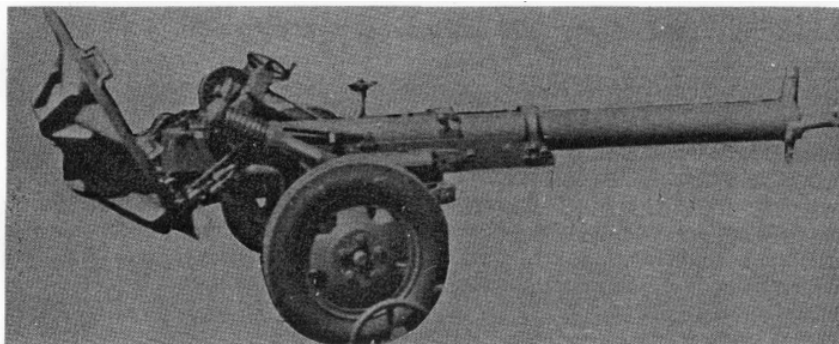

Figure 1. Soviet 160-mm mortar M160.

Road weight—3,240 lb. Rate of fire—3 to 4 rd/min.
Maximum horizontal range—8,070 meters.
Projectile weight—90 lb.

The weapon is muzzle-towed by an armored personnel carrier. It is breech-loaded and trigger-fired with the wheels attached.

The 240-mm mortar (fig 2) is distinguished from other Soviet mortars by its great bulk and extremely long tube. Like the 160-mm mortar, it is breech-loaded and trigger-fired. This weapon is found only in artillery divisions.

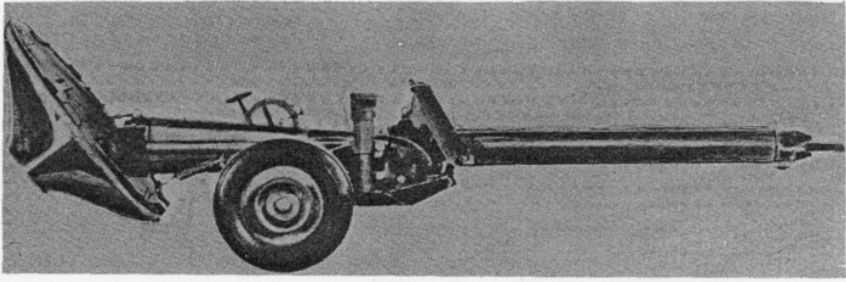

Figure 2. Soviet 240-mm mortar.

Road weight—9,150 lb. Rate of fire—1 rd/min.
Maximum horizontal range—9,700 meters.
Projectile weight—288 lb.

Any discussion of Soviet mortars would be incomplete without mentioning the 420-mm self-propelled mortar (fig 3). This weapon was first displayed in 1957. It apparently represents initial Soviet efforts to produce a self-propelled weapon capable of firing nuclear ammunition. Very

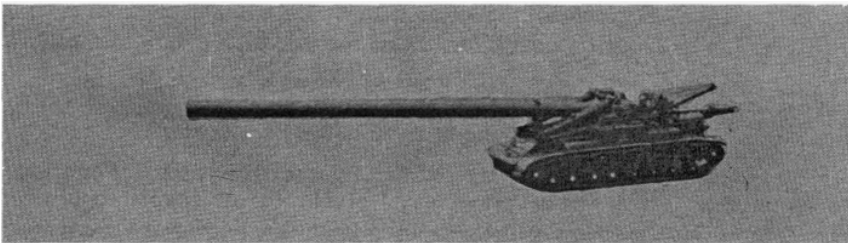

Figure 3. Soviet 420-mm self-propelled mortar.

Road weight—60 tons. Rate of fire—1 rd/min.
Maximum horizontal range—18,280 meters.
Projectile weight—1,700 lb.

little information has been obtained on which to base estimates of the numbers of these weapons available or where they are found in the Soviet military structure.

The 122-mm field gun D74 (fig 4) appears to be the workhorse of the Soviet artillery branch. This weapon is found at all echelons from the artillery division down to division artillery. It is a modern, conventional weapon and is superior in mobility and performance to older versions of the same caliber. Although it is primarily a field artillery weapon, it performs important missions in the antitank, direct fire role.

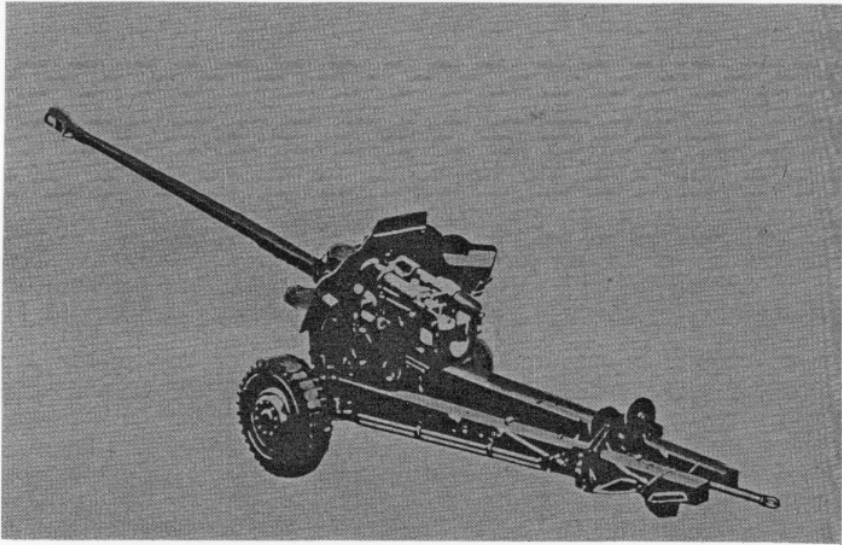

Figure 4. 122-mm field gun D74.

Road weight—6,575 lb. Rate of fire—6 rd/min.
Maximum horizontal range—21,900 meters.
Projectile weight—90 lb.

Mounted on the same carriage as the 122-mm D74 is the 152-mm gun/howitzer D20 (fig 5). The prominent feature that distinguishes it from the 122-mm gun is the shorter and thicker tube. Both weapons feature a circular firing pedestal. In the travelling position the pedestal is secured to the underside of the tube; in the firing position the pedestal serves as a pivot on which to traverse the piece.

The 203-mm howitzer M1931 is a fine example of the modernization of Soviet weapons that has taken place since World War II. Marking the improvement of this weapon, the Soviets now have the 203-mm gun/howitzer M55 (fig 6). This piece is very light and mobile for a weapon of its caliber and size and may have an atomic capability. It is normally towed by a heavy-tracked vehicle.

SMALL FREE-FLIGHT ROCKETS

The multiple artillery rocket launcher has been a favorite weapon of the Soviets since early in World War II. Although almost all world powers have used these weapons at one time or another, the Soviets are the only ones who still maintain them in appreciable quantities. The large numbers of these weapons in their military structure gives them tremendous

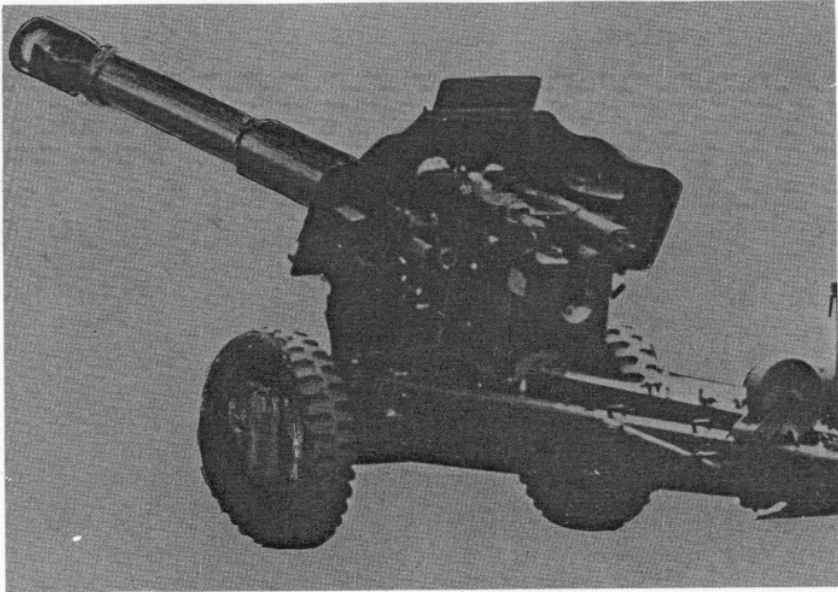

Figure 5. 152-mm gun/howitzer D20.

Road weight—12,610 lb. Rate of fire—4 rd/min.
Maximum horizontal range—17,200 meters.
Projectile weight—107 lb.

volumes of firepower. This type of weapon is found in four calibers: 140-mm, 200-mm, 240-mm, and 280-mm.

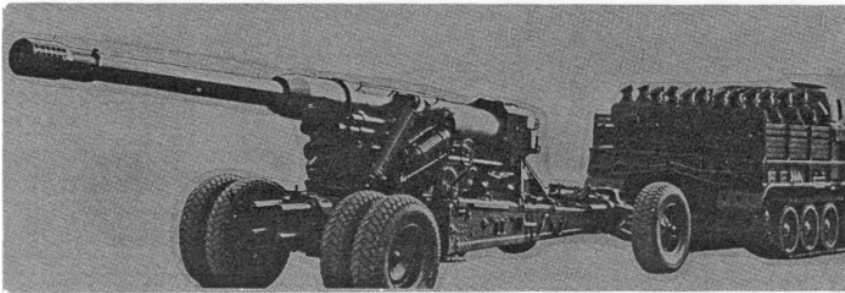

Figure 6. 203-mm gun/howitzer M55.

Road weight—45,000 lb. Rate of fire—3 to 4 rd/min.
Maximum horizontal range—29,250 meters.
Projectile weight—325 lb.

The 140-mm rocket launcher (fig 7) has been shown in two versions. A light general purpose truck is used in both cases to mount 16 or 17 tube launching assemblies. This particular weapon is found in the division artillery and is used for placing large volumes of fire on area targets.

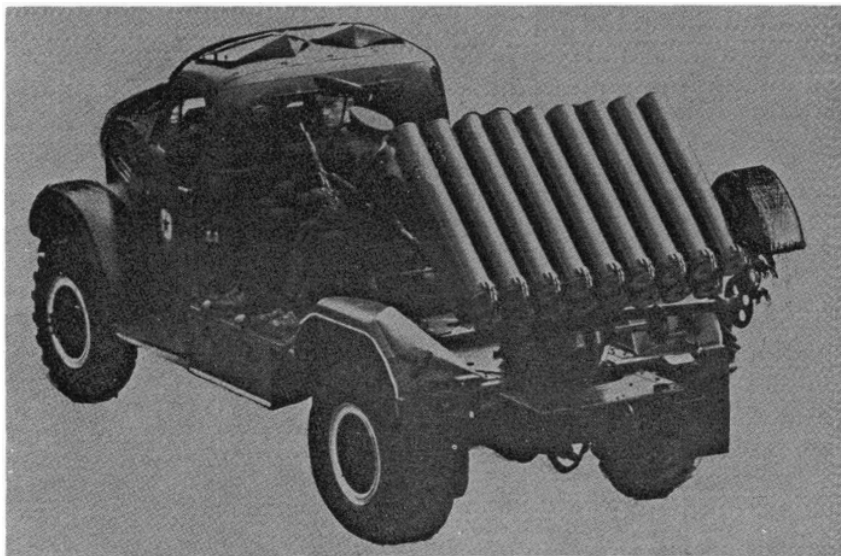

Figure 7. 140-mm rocket launcher, BM-14.

Road weight with rockets—10,000 lb.

Reload time—3 to 4 minutes. Rocket weight—70 lb.

Maximum horizontal range—9,000 meters.

In contrast to the small 140-mm rockets, the Soviets have a 280-mm free-flight rocket (fig 8). The six-rail launcher is mounted on a general purpose vehicle. The open crate type launching frames impart a one-third turn initial spin to the rockets for correction of thrust malalignment. This weapon is found only at higher artillery echelons.

LARGE FREE-FLIGHT ROCKETS

The class of Soviet free-flight rockets comparable to the Honest John has been nicknamed "FROG" by US intelligence agencies. FROG means "free rocket-over-ground." The first rocket of this type to appear was the FROG-1 in 1957 (fig 9). The launcher is a monorail-type, mounted on a full-tracked carrier. The launcher incorporates a cylindrical housing composed of large segments which clamp together. This housing protects

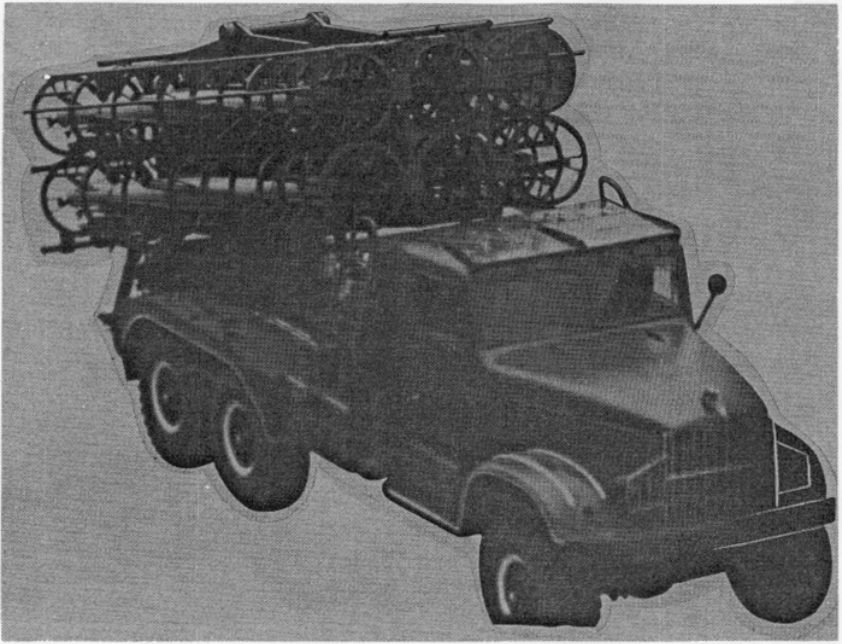

Figure 8. 280-mm rocket launcher.

Road weight with rockets—20 tons.
Reload time—unknown. Rocket weight—1,000 lb.
Maximum horizontal range—23,000 meters.

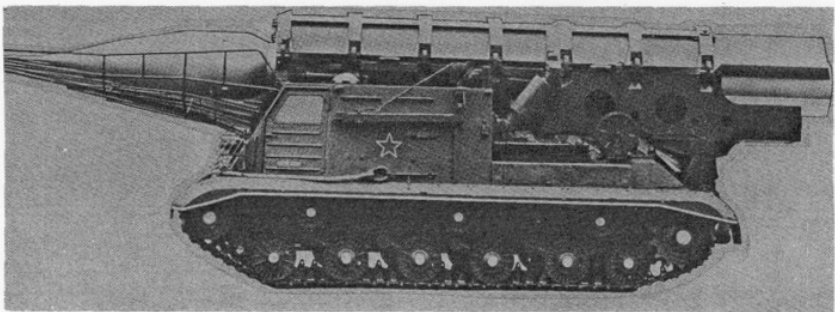

Figure 9. Soviet FROG-1 rocket.

Road weight of vehicle and rocket—36.5 tons.
Weight of rocket—7,000 lb. Length—33.4 feet.
Weight of warhead—1,500 lb. Range—64,000 meters.

the rocket, provides rigidity for cross-country travel, and serves as a warming jacket to prevent cold-weather damage to the rocket's solid-propellant motor. The six-finned rocket is spin-and-fin stabilized. The size of the warhead indicates a nuclear capability. All types of FROGs are found at Soviet artillery echelons comparable to our corps artillery.

The development of the FROG-1 has progressed to the FROG-4 (fig 10) which was first seen in 1960. This rocket is carried on a single-rail launcher mounted on an amphibious tank chassis. The FROG-4 is quite different from its earlier counterparts. The rocket consists of a booster motor and a sustainer motor with a much more streamlined warhead. At the base of both motors is a large venturi surrounded by 12 nozzles, which impart a slow rotation to the rocket for increased stability and accuracy. It is believed that this rocket has no means of guidance after it leaves the launcher.

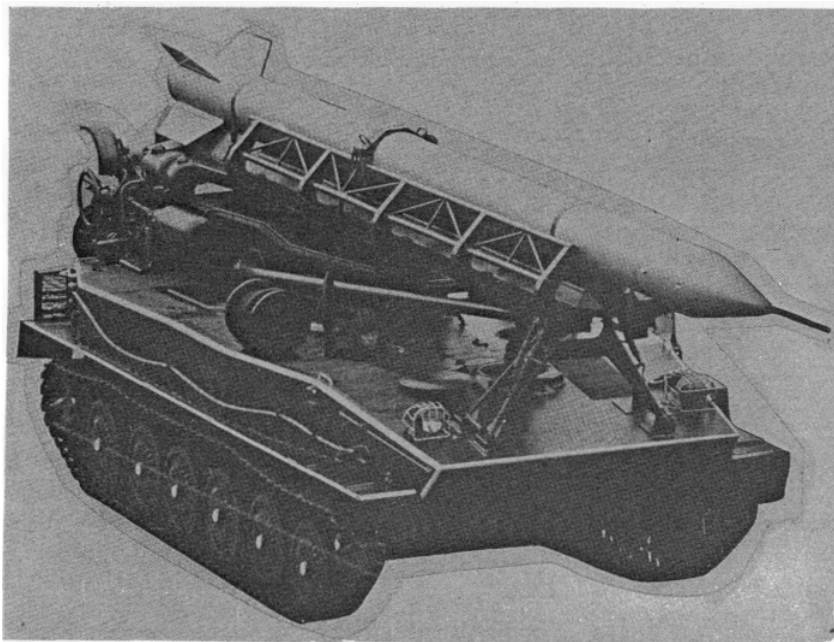

Figure 10. Soviet FROG-4 rocket.

Road weight of rocket and launcher—15.7 tons.
Weight of rocket—4,800 lb. Length—33.6 feet.
Weight of warhead—800 lb. Range—45,720 meters.

GUIDED MISSILES

The Soviets have displayed a rather impressive array of tactical guided missiles for the past several years. One of the most significant is

the SS-1 or "SCUD" (fig 11) as it is called. The SCUD is a single-stage missile capable of carrying a nuclear warhead. The missile has a solid-propellant motor and is guided by command and/or inertial means. As with many other types of Soviet rockets and missiles, this weapon is

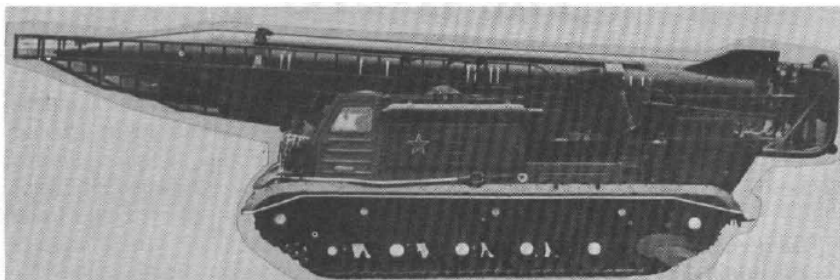

Figure 11. Soviet SS-1 "SCUD" missile.

Road weight of launcher and missile—41.5 tons.
Weight of missile—11,000 lb. Length—35 feet.
Weight of warhead—1,600 lb.
Maximum range—100 nautical miles.

transported on a full-tracked vehicle which incorporates an on-carriage erection and launching capability. The tactical control of this missile is retained at a high level comparable to our Army headquarters.

The largest Soviet tactical guided missile is the SS-3 "SHYSTER" (fig 12). Like the SCUD, its control is retained at high level. It is a liquid-propelled missile guided by command and/or inertial means.

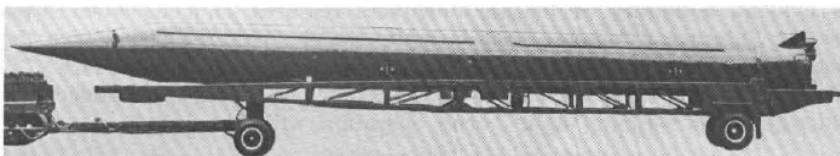

Figure 12. Soviet SS-3 SHYSTER missile.

Missile weight—66,000 lb. Length—70 feet.
Warhead weight—3,000 lb. Range—700 nautical miles.

With such a variety of equipment and weapons systems, there can be little doubt of the Russian Army's emphasis on, and faith in, artillery support for its ground-gaining arms. It would be safe to say that the recent Soviet nuclear testing will have a further developmental effect on the artillery. At any rate, the Soviet artillery bears watching; it is a versatile, aggressive, and formidable force. And as such, we must remain aware of its progress.

The H-21C In Artillery Employment

Lieutenant R. N. Tredway
Headquarters and Headquarters Battery, 7th/11th
25th Infantry Division

How to take a battery of 105-mm howitzers 25 miles across a jungle, emplace it, and fire it 1 1/2 hours after alert? It can be done and is being done every day with the H-21C Shawnee helicopter. When confronted with the underdeveloped areas of Southeast Asia and other jungle and difficult terrain, the sophisticated equipment which we have developed is sometimes overshadowed by simpler equipment. The accomplishment of the H-21C helicopter is an example of what can be done in certain situations with equipment not specifically designed for that situation. Although this helicopter has a severe lift limitation (3,000 pounds), a little organization and forethought can satisfactorily carry the mission to completion. Figure 3 shows the breakdown of battery equipment into approximately equal loads of a weight which the H-21C can handle. As is evident, a battery of 105-mm howitzers requires 24 loads when lifted by the Shawnee. Compare this with the six or seven loads in which the battery can be carried by the H-37 helicopter (see ARTILLERY TRENDS, May 1960) and the disadvantage becomes obvious. There are added considerations in planning a heliborne operation with the H-21C.

WEIGHT

The H-21C Shawnee is basically a light cargo helicopter. The largest single item in the battery to be airlifted is the 105-mm howitzer carriage which, when stripped, still weighs in excess of 3,000 pounds. As a result, fuel requirements must be juggled, since it has been found that the H-21C cannot lift the 3,000 pound 105-mm carriage and its own 1,800 pound load of fuel. The fuel load must be calculated as closely as possible to permit the greatest lift capability.

Terrain is a second consideration. Difficult terrain (mountains or other terrain involving elevation changes) requires additional fuel and, therefore, limits the lift capacity. Directly related to the terrain limitation is the route of movement. The safest, most tactically-cogent route to the drop point may not be the shortest; hence, more fuel—less lift.

WHO? WHAT? WHEN?

Once the characteristics of the H-21C Shawnee are understood, three important questions are raised. Who goes? What goes? And in what order does everything go?

Several factors must be considered here: namely, speed, safety, and appropriate distribution of equipment and personnel. Speed must be the primary consideration for traditional reasons—artillery is never out of action. The guns must be moved, reassembled, emplaced, and prepared for action in the shortest possible time. At the same time, however, personnel must be made aware of safe operating procedures when working with helicopters. Well-trained personnel will observe all the safety precautions, thereby adding to the all-important factor of speed. Finally, similar items of equipment and personnel should be distributed among all the available helicopters; then, if one or more helicopters are lost during the movement, the battery will still be able to function in the new position area.

LOADING

External loading using a sling or a 12- by 17-foot cargo net is the primary means of carriage. This is true again for reasons of speed and safety. It takes less time to attach and detach a sling load to the helicopter than to load and unload the items inside. On the safety side of the ledger, a damaged or defective helicopter can make an emergency drop of the sling load and thereby afford a margin of safety to the passengers.

Carrying the 105-mm howitzer is the biggest problem. The method (fig 1) found to be most successful for movement with the H-21C is to lift the tube and recoil mechanism as one unit and the carriage as another. The shields and breechblock should always be removed when transporting the howitzer by helicopter.

The sequence of disassembly is:

- a. Remove shields and place on prime mover.
- b. Remove breechblock and place in section chest.
- c. Remove tube and place on ground (requires 10 personnel).
- d. Remove recoil mechanism and replace on tube.
- e. Complete rigging of tube and recoil mechanism as a unit, including the timbers used for handling the tube and recoil mechanism.
- f. Complete rigging of carriage.

During reassembly, the recoil mechanism is removed from the tube and placed on the carriage. The tube is then placed on the carriage. This system requires fewer personnel, shorter timbers (less awkward to use), and shorter time to complete preparation.

Figure 2 shows the specifications for lifting bars. They act as "timbers" which are relatively permanent in nature, are not susceptible to damage, are easier to work with, and are more efficient. The poles are made of 3-inch iron pipe approximately 12 feet long. Brackets are welded in position to aid in handling.



Figure 1. The H-21C bringing in a 105-mm howitzer in two loads.

LOAD BREAKDOWN

Figure 3 shows a breakdown of loads for the air movement of a 105-mm battery by H-21C helicopter.

The reconnaissance party—the battery commander with a radio set AN/PRC-9—utilizes a reconnaissance-type helicopter. The helicopter should be armed. If the situation does not permit an aerial reconnaissance, aerial photos and maps can be utilized. The reconnaissance could also be conducted for the battery by higher headquarters.

A pathfinder and security party follows the battery commander. This party provides local security in the area until the battery arrives. In addition, it includes personnel trained in the techniques for guiding the helicopters.

The two loads listed above were not given number designations since they would normally displace before the main body. The personnel selected for the pathfinder and security party are those who are not needed at the battery rear or in the firing battery during air movement.

The following firing battery loads are designed to fall within the capabilities of the H-21C light cargo helicopter when operating at or near sea level.

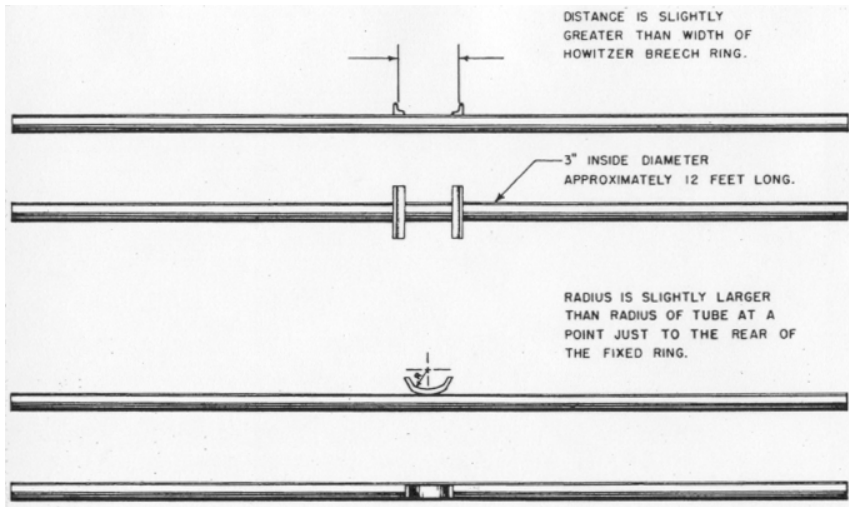

Figure 2. Lifting bars for disassembling the 105-mm howitzer.

Load 1. The assistant executive officer takes the chief of firing battery and the communication chief forward to organize the new position area. The cannoneers and gunners are shown their respective howitzer locations in order to expedite the laying of the battery. If time permits, the chief of firing battery could at this time refer deflections to each of the six sections to assist in orienting the howitzers upon their arrival. The location for the battery FDC could be selected at this time and the local wire net started.

Load 2. The fire direction center (FDC) personnel, upon arrival, report to the FDO and prepare the FDC for operation. Certain items of the executive officer's report are completed at this time. In load 2 are sufficient wiremen and equipment to complete the local wire net. Erection of the RC-292 antenna should be started. The chief of section is the chief of the first howitzer to be lifted, usually the base piece.

Note. Each chief of section precedes his howitzer to the position area. For example, the chief of the section providing the base piece comes in on load 2; his howitzer components come in on loads 4, 5, and 6. The next chief of section comes in on load 4; his howitzer components come in on loads 7, 8, and 9.

Load 3. This load consists of the battery commander's 1/4-ton vehicle, with VRC-17 mounted, and the driver-RTO. The purpose of bringing a vehicle on this load is twofold: First, it can serve as a prime mover for the howitzers when they arrive; second, it gives the battery commander better communication capability. It would be desirable for both 1/4-ton vehicles (second 1/4-ton—load 22) to be equipped with a winch for use in jungle operations.

	PERSONNEL	No	PERSONNEL WEIGHT	EQUIPMENT	EQUIPMENT WEIGHT	TOTAL WEIGHT
Reconnaissance Party	Battery Commander			Reconnaissance type helicopter, armed		
				AN/PRC-9 radio		
Pathfinder and Security Party.	First sergeant	11	2,750	H-21C helicopter	230	2,980
	Wire team chief			MG cal .30, 2 ea		
	Sr switchboard operator			MG ammo, 6000 rd		
	Wheel vehicle mechanic			Antenna RC-292		
	Four ammo handlers					
	Three cannoneers					
Load 1 (small items in 12' x 17' paulin)	Asst XO	10	2,500	Aliming circle	480	2,980
	Ch of fir btry			3.5-in rkt launcher		
	Comm chief			3.5-in ammo (3 rd)		
	Wireman			MG .30 cal, 2 ea		
	Cannoneer (2d section)			MG ammo, 6000 rd		
	Cannoneer (4th section)					
	Cannoneer (6th section)			TA-312/PT phones, 4 ea		
	Gunner (1st section)			Aliming posts, 6 ea		
	Gunner (3d section)			DR-8 w/wire, 3 ea		
	Gunner (5th section)			Pioneer tools, 4 sets		
Load 2 (small items in 12' x 17' paulin)	Instr operator	9	2,250	Aliming circle	730	2,980
	Chief sec (from 1st how lifted)			CP tent		
	Chart oper			FDC equipment		
	Computer			3.5-in rkt launcher		
	Sr wireman			3.5-in ammo, (3 rd)		
	Wireman			Pioneer tools, 2 sets		

	Gunner (2d section)		DR-8, 6 ea		
	Gunner (4th section)		TA-312/PT phone, 7 ea		
	Gunner (6th section)		MG .30 cal, 2 ea		
			MG ammo, 6000 rd		
			5-gal water can, filled, 2 ea		
Load 3	Driver-RTO	1	250	Truck, 1/4-ton, w/VRC-17 radio	2,750 3,000
Load 4, 7, 10, 13, 16, and 19	Chief of sec (except load 19)	6	1,500	Howitzer tube and recoil mech	1,500 3,000
	Asst gunner			Section equipment in chest	
	Cannoneer			Night lighting chest	
	Cannoneer			Timbers, 1 set	
	Cannoneer				
	Cannoneer				
	Arty mechanic (load 19 only)				
Load 5, 8, 11, 14, 17, and 20	None			Howitzer carriage	3,000 3,000
Load 6, 9, 12, 15, 18, and 21	None			105-mm howitzer ammo, 52 rds (or 26 boxes at 2 rd/box)	3,000 3,000
Load 22	Driver-RTO	1	250	Truck, 1/4-ton, w/VRC-9 radio	2,750 3,000
Load 23 (small items packaged in 12' x 17' paulin)	Executive officer	6	1,500	3.5-in rkt launcher	1,500 3,000
	Wireman			RL-159 w/axle/RL-29, 1 ea	
	Swbd operator			Rations, 2 days, 32 cases	
	Recorder			5-gal water can, filled, 6 ea	
	Aid man			MG .30 cal, 2 ea	
	Ammo sergeant			3.5-in ammo, 3 rd	
				M-1 and carb ammo, (if available)	
				MG .30 cal ammo, 6000 rd	

Figure 3. Equipment and personnel breakdown for H-21C loads in moving a 105-mm howitzer battery.

Loads 4, 7, 10, 13, 16, and 19. The chief of section listed here (load 4) is from the second howitzer to be lifted in order that he might arrive in the new position early enough to receive additional instructions from the chief of firing battery before his section arrives. All section chiefs arrive early for this purpose. It might be noted, however, that on load 19 there would be no chief of section since all six would be in the new position area. The tube and recoil mechanism are dropped in the vicinity of the section to which they belong; the personnel immediately remove the recoil mechanism from the tube so that once the carriage is brought into position, reassembly can begin without delay. (The timbers used for handling the tube and recoil mechanism are carried on the tube and recoil mechanism load.)

Loads 5, 8, 11, 14, 17, and 20. The howitzer carriage is brought in immediately after its tube and recoil mechanism.

Loads 6, 9, 12, 15, 18, and 21. A load of ammunition for each section follows immediately behind the howitzer carriage of that section.

Load 22. This load consists of the executive officer's 1/4-ton vehicle, with VRC-9 mounted, and the driver-RTO. This vehicle may be used as a prime mover for the howitzers and as a general purpose vehicle, leaving the battery commander's vehicle as a communications base.

Load 23. The executive officer rides the last load. He remained in the old position, since the battery commander had gone forward. He was responsible for maintaining a fire direction capability until all the howitzers were sent forward. Included in load 23 are the remaining personnel and sufficient rations to feed the forward elements until resupply can be effected. The executive officer is also responsible for taking care of the personnel and equipment left behind. Normally, the personnel remaining after the battery's displacement (i.e., drivers, clerks, cooks, etc.) will come under the control of headquarters battery until it becomes feasible for them to rejoin the battery. If, due to tactical considerations, only a portion of the battery can be displaced, the type loads can be adjusted to meet the situation.

Some advantages of loading as shown in figure 3 are: (1) The use of nets for external loading reduces the time for displacements, (2) the 1/4-ton truck serves as a prime mover in the forward area and provides additional radio capability, (3) the duplicate FDC equipment remains in the rear to provide a fire direction capability for the battery (—), (4) key personnel and essential items have been distributed in such a manner that the battery can still function if one or more loads are lost.

Although H-37 helicopters are the preferred prime movers in heliborne operations, they are not always available, and other types, such as the H-21C, may have to be employed. The artillery has moved on the ground in strange ways in the past; it can continue to do so in the air in the future. And this employment of a light cargo helicopter to move a battery, though unwieldy, is an example of this ingenuity and field expediency.

It is just such original thinking which lies at the basis of the well-founded and time-proven boast: "... no place the artillery won't or can't go."

operation taper . . .

The Army Equipment Records System

Mr. H. A. Howell
Artillery Transport Department

Operation TAPER—the Army project launched to revise the equipment records system for the purpose of ultimately providing simple, effective, standard procedures for producing essential maintenance information and better control at the forward echelons—has now been completed. Armywide implementation of the new standardized records system for all categories of equipment will begin 1 August in the Continental United States (CONUS). This standard system, described in TM 38-750 (May 1962), is to be known as the Army Equipment Records System and Procedures.

After its implementation, there will be a continuing requirement for refining the system. Even more important, all personnel concerned must be trained and educated so that maximum use can be made of the command "tools" provided by the new system. To aid in this training effort, a special edition of "PS Magazine" (1 June 1962) was published and distribution was increased 50 percent.

When Operation TAPER was initiated a year and a half ago, one of the first tasks accomplished was to analyze and review all current equipment records, forms, and directives on an individual and collective basis. In connection with this review, the records of a hypothetical "battle brigade" were examined. Field army mobile missile units were added to the hypothetical brigade to insure a complete representation of all categories of equipment. A command below division level was deliberately selected so that the forms, records, and reporting procedures applicable to the first and second echelons would be highlighted. It was determined that revision of the equipment records should be oriented to the environment of the battlefield, but with the realization that the system would have to be applicable to peacetime garrison situations in which the same organizations would be required to operate under the Army's Command Management System.

The review of the forms, records, and directives required in the battle brigade for the control of equipment operation and maintenance (first and second echelon), resulted in the discovery that 84 forms and 20 directives were being used (fig 1). Over the years, new forms and directives had been added to the list of those already in use, resulting in a great

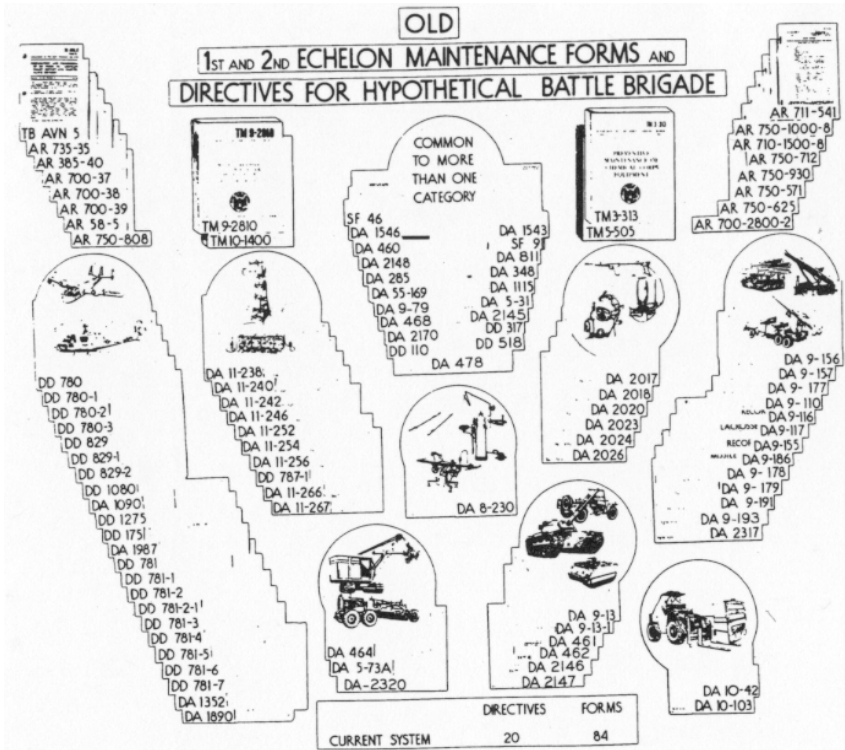

Figure 1. Old forms and records.

deal of duplication. It was apparent that if progress was to be made toward devising a streamlined, effective records system, a common denominator—standardization—was needed. Standardizing and streamlining the records system eliminated 51 forms and records and 15 directives. All of the forms, records, and directives (fig 2) in the new Army Equipment Records System will be applicable to all categories of equipment. Furthermore, some of the forms and records will be used by the support echelons in the field.

The Army Equipment Records System consists of three key elements—the Equipment Log, the Equipment Inspection and Maintenance Worksheet, and the Maintenance Request. In addition to the three key elements, operator qualification cards, maintenance rosters, dispatch records, accident reports, equipment status and deadline reports, and requisition forms for repair parts supply will be used in the new system. Some of the forms from the old system will be retained, but all forms were reviewed to determine if improvement was needed. If improvement was warranted, it was accomplished on an individual form basis.

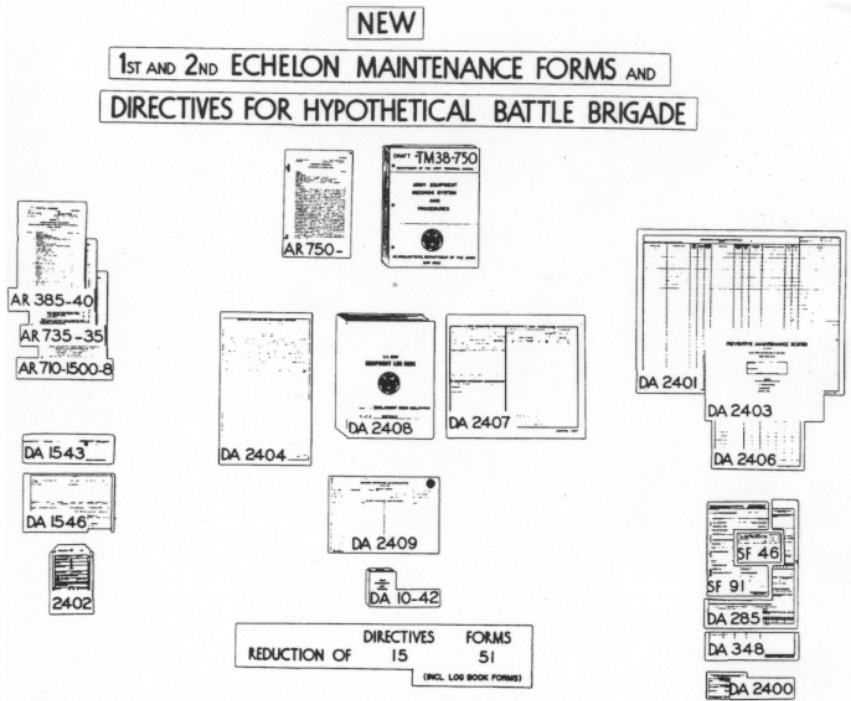

Figure 2. New forms and records.

EQUIPMENT LOG

The first key element—the Equipment Log—comes in three styles: a single-card log, a bound logbook, and a looseleaf logbook. The single-card log is the Equipment Maintenance Log (consolidated), which will be used for items of equipment generally less complex in design but for which maintenance data must be kept; for example, a 1/4-ton trailer. The bound logbook is the Army Parachute Log Record. This log has been in use by the Army for a number of years and has been retained in the new Army Equipment Records System. The looseleaf logbook, a three-ring, vinyl plastic binder, 8 × 10 inches in size, will be used for more complex items of equipment, such as vehicles, artillery weapons, and missile systems.

The looseleaf logbook will contain a series of color-coded card inserts. These inserts will be used to record essential maintenance and historical data for each item of equipment. Recording certain maintenance and processing events which occur during the life cycle of an item of equipment is mandatory (fig 3). The record begins with salmon-colored card inserts. These cards will show equipment acceptance and proof acceptance information and will be filled out when the equipment enters the Army inventory. The blue card inserts will be used for recording

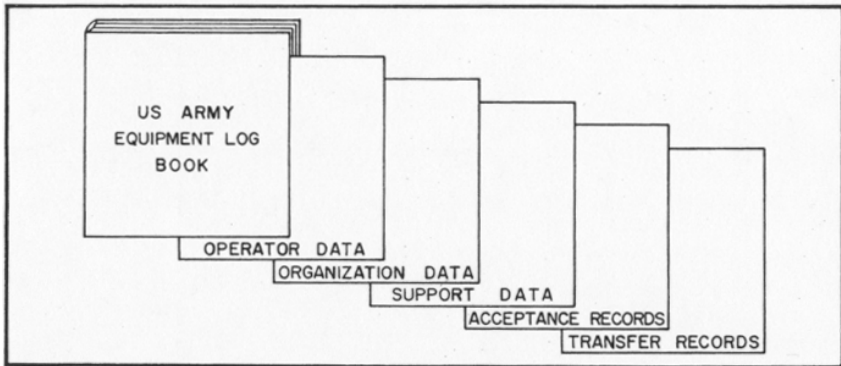

Figure 3. Information in equipment logbook.

any retrofit, repair or any processing event which occurs at the third, fourth, or fifth echelon of maintenance.

The white card inserts are for use by the equipment operator, crew, or second-echelon maintenance personnel to record events which occur at the using organization level. One of the most important white card inserts will be the Equipment Modification Record, DA Form 2408-5. Although equipment modification may be accomplished by the support echelons, the using echelon is responsible for listing all modifications. It is worthy of note that modifications that are required and those that have been accomplished will now be recorded in the same place. The using organization will be vitally concerned with this information.

Two card inserts (fig 4) are of particular interest to artillerymen, as they will replace the familiar artillery gun book. These inserts are the white DA Form 2408-4, Weapon Record Data, and the salmon-colored Proof Acceptance Record, DA Form 2408-9.

The other white card inserts represent daily and periodic "logs" of oil and fuel consumption, miles or hours accumulated, status of equipment readiness, preventive maintenance actions completed, lubrication accomplished, rounds fired, etc. Thus, a commander or supervisor can at any time examine the logbook white card inserts and at a glance determine equipment readiness and whether the required preventive maintenance, repair, or services are being accomplished. Moreover, by using various combinations of 17 standard card inserts, an Equipment Logbook can be "tailored" to meet the requirements for storing operational and maintenance data for almost any end item of equipment in the Army inventory.

Equipment logs provide a means for the mandatory recording of events which occur during the life cycle of an item of equipment. They are activated when an item of equipment is first delivered by the manufacturer and they remain with that item until it finally leaves the Army inventory. Equipment logs have been referred to as permanent "health records" of factual data and maintenance information pertaining to the

1. CANNON TUBE SERIAL NUMBER		2. TYPE				3. ORGANIZATION		
2536		105 mm How M101A1				A Btry 1 st FA BN		
DATE	CHARGE OR ZONE	PROJECTILE TYPE AND ROUNDS FIRED	ACCUMULATIVE ROUNDS FIRED	RECOIL EXERCISE	GAGE OR VELOCITY MEASURE	ESTIMATED REMAINING LIFE (EFC Rounds)	REMARKS	SIGNATURE
1-7-62			2,500	RE Jan 61	4,165 Jan 61	15,000	Carried forward from previous page	H. C. Johns
5-8-62	7	10 rounds HE, M1 21 rounds blank	2,531			14,969		W. L. Payne
10-10-62				RE				
12-11-62	7	60 rounds HEAT-T M 67 40 rounds CSTA, TIRE	2,631			14,869		H. E. Allen
3-12-62					4,175	12,000		P. J. Smith
4-12-62	TO	BE CONDEMNED					Abnormal transverse cracks across bands (4) and grooves (3), 21 inches forward of commencement of rifling. Possible cause: Over heating from extended firing. 12 Nov 62 P. J. Smith	
WEAPON RECORD DATA (TM 38-750)						4. PREVIOUS PAGE TOTAL (Rounds) 2,500	5. THIS PAGE TOTAL (Rounds) 131	6. ACCUMULATIVE TOTAL (Rounds) 2,631

PROOF ACCEPTANCE CERTIFICATE			
WEAPON NOMENCLATURE AND NUMBER			
TUBE NUMBER	MOUNT		
PROOF TESTED AND ACCEPTED (Authority)			
ROUNDS	DATE		
ABOVE ROUNDS			
TEX	STD	115%	
COMMENTS			
REMARKS			
SIGNATURE OF CHIEF, INSPECTION BRANCH			

PROOF ACCEPTANCE RECORD (TM 38-750)	
PASTE PROOF ACCEPTANCE CERTIFICATE HERE	

Figure 4. DA Forms 2408-4 and 2408-9.

equipment's complete history. The most important use of the logs will be to provide a ready, accurate means of determining the operational or battle readiness of equipment and to assess equipment reliability. They are specifically designed to assist commanders at all levels in this respect.

EQUIPMENT INSPECTION AND MAINTENANCE WORKSHEET

The second key elements of the Equipment Records System is the Equipment Inspection and Maintenance Worksheet, DA Form 2404 (fig

5). This form is a simplified worksheet to be used while performing inspection and maintenance services on all categories of equipment. It becomes peculiar to a specific item of equipment when the nomenclature of

EQUIPMENT INSPECTION AND MAINTENANCE WORKSHEET (TM 28-750)																													
1. ORGANIZATION				2. NOMENCLATURE AND MODEL																									
3. REGISTRATION/SERIAL/FSN		a. USAGE	b. MILES	c. HOURS	d. ROUNDS FIRED	e. DATE	6. TYPE INSPECTION																						
7. APPLICABLE REFERENCE																													
TM NUMBER			TM DATE		TM NUMBER			TM DATE																					
<p>INSTRUCTIONS - Perform each check listed in the TM applicable to the inspection performed. Following the sequence listed in pertinent TM, complete form as follows:</p> <p>COLUMN a - Enter TM item number.</p> <p>COLUMN b - For Army aircraft, enter condition status. For other equipment enter "DL" if condition deadlines equipment.</p> <p>COLUMN c - Enter deficiencies and shortcomings.</p> <p>COLUMN d - Show corrective action for deficiency or shortcoming listed in Column c.</p> <p>COLUMN e - Individual ascertaining completed corrective action initial in this column.</p> <p>For Command Materiel Readiness Inspections enter scoring codes as follows: D - Deficiency; S - Shortcoming; R - Materiel Readiness Rating; O - Organizational Maintenance Rating; F - Field Maintenance Rating.</p>																													
ALL INSPECTIONS AND EQUIPMENT CONDITIONS RECORDED ON THIS FORM HAVE BEEN DETERMINED IN ACCORDANCE WITH DIAGNOSTIC PROCEDURES AND STANDARDS IN THE TM CITED HEREON.																													
SIGNATURE (Person(s) performing inspection)					SIGNATURE (Maintenance Supervisor)			8. MANHOURS REQUIRED																					
TM ITEM NO.	STATUS	DEFICIENCIES AND SHORTCOMINGS			CORRECTIVE ACTION			INITIAL WHEN CORRECTED																					
a	b	c			d			e																					
<table border="1"> <tr> <td>CMRI SCORE</td> <td></td> <td>R</td> <td></td> <td>O</td> <td></td> <td>F</td> <td></td> <td colspan="2">TOTAL SCORING POINTS</td> </tr> <tr> <td>SUB TOTAL</td> <td>D</td> <td>S</td> <td>O</td> <td>S</td> <td>D</td> <td>S</td> <td></td> <td colspan="2"></td> </tr> </table>										CMRI SCORE		R		O		F		TOTAL SCORING POINTS		SUB TOTAL	D	S	O	S	D	S			
CMRI SCORE		R		O		F		TOTAL SCORING POINTS																					
SUB TOTAL	D	S	O	S	D	S																							
CONTINUED ON REVERSE SIDE																													

DA FORM 2404
1 APR 62

Figure 5. DA Form 2404.

the item, the appropriate technical manual (TM), and the date are entered on the form heading. This form *must* be used in conjunction with the maintenance standards and procedures prescribed in the pertinent equipment technical manual. Checks and services will be performed as directed by the technical manual sequence for preventive maintenance services. Faults discovered will be recorded and the technical manual item number (or page and paragraph) noted in the left column ("a") of the form. This procedure will force the use of appropriate technical manuals during the course of servicing and repairing equipment, thus taking the guesswork out of such maintenance actions. Benefits will also accrue from the requirement for each technical manual to contain complete, explicit, and logical inspection and servicing procedures. The

Equipment Inspection and Maintenance Worksheet will be used by equipment operators, maintenance personnel, and inspectors at *all* echelons for *all* inspections for *all* items of equipment. It is the source document from which the initiation of all maintenance actions will stem. This form is an excellent example of the standardization that has been achieved in the new Equipment Records System.

MAINTENANCE REQUEST

The third key element of the Army Equipment Records System is the Maintenance Request, DA Form 2407 (fig 6). This form will have the effect of standardizing and simplifying the method of requesting, recording, and reporting maintenance services and repairs. It was engineered to provide maximum information which will facilitate better control and management at all echelons of maintenance and is designed for machine processing or manual processing as the situation demands.

The Maintenance Request is similar to the old Work Request and Job Order, DA Form 811. The Maintenance Request will be submitted when work is beyond the capability, skill, or tool authorization of the requesting organization. Section I of this form provides information on the environment and conditions under which a failure or malfunction occurred. Describing the deficiency or symptom provides the support activity with the information needed to evaluate the equipment failure and to correct the deficiency.

Section II is completed by the supporting echelon as work is completed. The reason for component failure and removal of parts is shown by selecting and recording the appropriate number from the standard failure code and Army action code. These codes are printed on the reverse side of the Maintenance Request and are primarily for use by the national echelon (equipment design and engineering level). However, they can be used to evaluate care, services, maintenance, and utilization of equipment by the owner organization or by intermediate commanders.

It is mandatory that an equipment improvement recommendation (EIR) be included on the Maintenance Request when repairs or services are due to abnormal wear or conditions. Thus, maintenance personnel are now required to submit equipment improvement recommendations during the course of repairing the defect. Providing this information to the national agency responsible for equipment engineering and improvement will result in a better, more reliable equipment product for the using organization.

The Maintenance Request is also used to report the accomplishment of modification work orders (MWO). This information will provide for better control of application of MWO's at all echelons.

Section I of the Maintenance Request, together with either section II or III, or a combination of all three provides the total information required for product improvement or for control of maintenance. This vital information, generated during maintenance and repair of equipment, is preserved and transmitted on a selective basis by mailing one copy of the maintenance request to the appropriate National Maintenance Agency.

I		<input type="checkbox"/> WORK REQUEST	<input type="checkbox"/> SEPARATE EIR	
1. DATE OF REQUEST (Day - Month - Year)	2. UNIT OR ORGANIZATION	STRAC <input type="checkbox"/>	3. WORK REQUEST NO. <input type="checkbox"/>	17. JOB ORDER NUMBER
4. SERIAL NUMBER		5. REGISTRATION NUMBER		
6. NOMENCLATURE AND MODEL		7. FSN		
8. DATE MFG/LAST OVERHAUL	9. MANUFACTURER OR OVERHAUL ACTIVITY	10. <input type="checkbox"/> HOURS <input type="checkbox"/> MILES <input type="checkbox"/> ROUNDS		
11. FAILURE DETECTED DURING		12. FIRST INDICATION OF TROUBLE		
<input type="checkbox"/> SCB MAINTENANCE CODE A <input type="checkbox"/> INSPECTION/TEST CODE C <input type="checkbox"/> HANDLING CODE B <input type="checkbox"/> NORMAL OPERATION CODE D		<input type="checkbox"/> INOPERATIVE CODE 008 <input type="checkbox"/> LOW PERFORMANCE CODE 387 <input type="checkbox"/> NOISY CODE 008 <input type="checkbox"/> OUT OF ADJUSTMENT CODE 790 <input type="checkbox"/> OVERHEATING CODE 258 <input type="checkbox"/> OTHER CODE 009		
13. DESCRIBE DEFICIENCIES OR SYMPTOMS ON THE BASIS OF COMPLETE CHECK OUT AND DIAGNOSTIC PROCEDURES IN THE EQUIPMENT TM. (Do not prescribe repairs)				
14. SUBMITTED BY (Signature)		15. RECEIVED BY (Signature)		16. DATE RECEIVED (Day-Month-Year)
III EQUIPMENT IMPROVEMENT RECOMMENDATION (EIR)				
<input type="checkbox"/> EMERGENCY <input type="checkbox"/> URGENT <input type="checkbox"/> ROUTINE				
29. <input type="checkbox"/> NORMAL REPLACEMENT		30. FAILED OR DEFECTIVE PART FSN		
31. RECOMMENDATION				
a. <input type="checkbox"/> IMPROVE DESIGN b. <input type="checkbox"/> MODIFY c. <input type="checkbox"/> REVISE PROCEDURE d. <input type="checkbox"/> OTHER (Specify)				
32. OPINION OR REMARKS (Relate to block selected. Describe conditions under which failure occurred. Attach photos or sketches, if available)				
33. SIGNATURE		34. ORGANIZATION		35. CONTROL NUMBER
DA FORM 2407, 1 APR 62		REPLACES DA FORM 468, 1 OCT 55; DA FORM 811, 1 DEC 58; DA FORM 1278, 1 AUG 55; DA FORM 1987, 1 JUN 57; DA FORM 2170, 1 OCT 58; AND DA FORM 2407 (Trans), 1 JUN 61, WHICH		MAINTENANCE REQUEST (TM 38-750)

Figure 6. DA Form 2407.

This is accomplished with no additional effort on the part of troops other than tearing off the designated copy and mailing it.

To summarize the major benefits to be derived from the new Army Equipment Records System, it should be noted that there is one technical manual, TM 38-750, which describes the use, preparation, and disposition of equipment records for all categories of equipment; one "maintenance language" will be spoken; and procedures will be standardized throughout the entire Army. In addition to this, the Equipment Records System will provide a greatly improved means for determining the operational or combat readiness of equipment. The new system was designed to be fully compatible with both the old and the new Army division organizations.

During the past decade the Army has become more and more equipment-oriented. Commanders have had to adjust their thinking to consider the man-weapon-machine team when planning a tactical mission. Maintaining equipment in a state of combat readiness has thus become a major problem for commanders and their staffs. The Army Equipment Records System is specifically directed toward easing this problem. However, the success of the system as an equipment maintenance management tool depends greatly on the emphasis the commanders at all levels place on diligent, accurate recording and transmitting of maintenance data by all personnel concerned.

Reserve Component Class Number ATD 6167 covers TAPER (the Army Equipment Records System) in detail. The inside back cover, this issue, tells how to get it.

GEM FOR THE COMMANDER

Too many times, unqualified or unknowing personnel interchange radios and vehicles, either forgetting or not caring that all mounted radioes must be tuned to their vehicular antennas. It is estimated that 40% or more of all FM communication "trouble" experienced in the field can be traced to this oversight.

Remember:

- All radio sets *must* be tuned to the *particular* antenna on the vehicle in which it is mounted.
- Don't allow the "grab-bag" method of issuing radio sets. Have each set assigned to a particular vehicle and issue that set only to that vehicle. This system eliminates the need for tuning each time the set is issued and installed.
- A qualified individual should tune the set every time a substitution or swap of the transmitter-receiver is made.

—submitted by Capt Paul R. Harper
Communication/Electronics Department

CURRENT RESIDENT COURSE SCHEDULE

Listed below are the courses to be begun at the US Army Artillery and Missile School during the period 1 September 62 through 30 November 62.

Course	CI Nr	Report	Start	Close	Input
Field Artillery Officer Orientation (6-A-C20)	4-63	5 Sep 62	10 Sep 62	9 Nov 62	98
	5-63	19 Sep 62	24 Sep 62	23 Nov 62	99
	6-63	17 Oct 62	22 Oct 62	20 Dec 62	99
	7-63	31 Oct 62	5 Nov 62	18 Jan 63	99
	8-63	14 Nov 62	19 Nov 62	1 Feb 63	99
	9-63	28 Nov 62	3 Dec 62	15 Feb 63	99
Field Artillery Officer Familiarization (6-A-C21)	2-63	15 Oct 62	16 Oct 62	13 Dec 62	62
Artillery Officer Career (6-A-C22)	2-63	2 Oct 62	5 Oct 62	31 May 63	192
Associate Field Artillery Officer Career (6-A-C23)	2-63	23 Sep 62	25 Sep 62	12 Feb 63	115
Field Artillery Field Grade Officer Refresher (6-A-C11)	1-63	23 Sep 62	24 Sep 62	5 Oct 62	58
Nuclear Weapons Employment (6-A-F26)	2-63	12 Nov 62	13 Nov 62	11 Dec 62	60
Division Artillery Staff Officer Refresher (6-A-F5)	1-63	4 Nov 62	5 Nov 62	10 Nov 62	45
Senior Field Artillery Officer (6-A-F6)	2-63	9 Sep 62	10 Sep 62	21 Sep 62	25
Artillery Target Acquisition (6-A-1154)	1-63	13 Sep 62	17 Sep 63	3 Dec 62	15
Artillery Survey Officer (6-A-1183)	2-63	23 Oct 62	26 Oct 62	20 Dec 62	35
Corporal Officer (6-A-1190A)	2-63	10 Sep 62	12 Sep 62	16 Nov 62	15
	3-63	18 Nov 62	20 Nov 62	7 Feb 63	15
LaCrosse Officer (6-A-1187)	1-63	16 Sep 62	17 Sep 62	20 Oct 62	19
Sergeant Officer (Non-US) (6-A-F—X)	1-63	29 Oct 62	31 Oct 62	19 Dec 62	17
Field Artillery Officer Candidate (6-N-F1)	2-63	23 Sep 62	1 Oct 62	19 Mar 63	55
Nuclear Projectile Assembly (6-D-142.1)	1-63	16 Sep 62	17 Sep 62	21 Sep 62	22
Rocket Nuclear Warhead Assembly (6-D-147.2)	3-63	9 Sep 62	10 Sep 62	17 Sep 62	20
	4-63	7 Oct 62	8 Oct 62	15 Oct 62	20
	5-63	25 Nov 62	26 Nov 62	3 Dec 62	20
Artillery Ballistic Meteorology (6-N-103.1)	2-63	16 Sep 62	17 Sep 62	4 Dec 62	37
	*3-63	28 Oct 62	29 Oct 62	5 Feb 63	9
*Non-US officers only (extended one week).					
Weather Equipment Maintenance (6-N-201A/205.1)	3-63	10 Oct 62	11 Oct 62	31 Jan 63	9
Field Artillery Radar Maintenance (6-N-211A/211.3)	1-63	12 Sep 62	17 Sep 62	13 May 63	25
AN/TRC-80 Transition (Pershing) (6-D-F21)	1-63	4 Oct 62	5 Oct 62	12 Oct 62	4
Artillery Survey Advanced (6-R-153.1)	3-63	3 Oct 62	8 Oct 62	30 Nov 62	70
	4-63	17 Oct 62	22 Oct 62	14 Dec 62	70

Field Artillery Radar	3-63	3 Oct 62	5 Oct 62	14 Dec 62	35
Operation (6-R-156.1)	4-63	7 Nov 62	9 Nov 62	1 Feb 63	35
Sergeant Missile Battery	1-63	14 Oct 62	16 Oct 62	4 Dec 62	25
(Non-US) (6-N-F—X)					
Pershing Specialist	1-63	16 Nov 62	19 Nov 62	2 Apr 63	25
(6-N-F22)					
Pershing Missile Battery	2-63	23 Sep 62	25 Sep 62	26 Nov 62	20
(6-R-F23)	3-63	21 Oct 62	22 Oct 62	21 Dec 62	20
Artillery Radio	6-63	14 Sep 62	17 Sep 62	21 Dec 62	45
Maintenance (6-R-313.1)	7-63	28 Sep 62	1 Oct 62	22 Jan 63	45
	8-63	12 Oct 62	15 Oct 62	5 Feb 63	45
	9-63	26 Oct 62	29 Oct 62	19 Feb 63	45
	10-63	9 Nov 62	13 Nov 62	6 Mar 63	45
	11-63	23 Nov 62	26 Nov 62	18 Mar 63	45
Artillery Communication	1-63	31 Oct 62	1 Nov 62	4 Mar 63	27
Supervisors (6-R-313.6)					
Artillery Track Vehicle	6-63	14 Sep 62	18 Sep 62	29 Nov 62	60
Maintenance (6-R-632.1)	7-63	28 Sep 62	2 Oct 62	13 Dec 62	60
	8-63	12 Oct 62	16 Oct 62	20 Dec 62	60
	9-63	26 Oct 62	30 Oct 62	24 Jan 63	60
	10-63	9 Nov 62	13 Nov 62	7 Feb 63	60
	11-63	23 Nov 62	27 Nov 62	21 Feb 63	60

●

A GEM FOR SURVEY PERSONNEL

A system of rapid position area survey has been developed which will greatly facilitate the massing of a light artillery battalion from unprepared positions. This type of survey may be used when an entire battalion is in a march column and a fire mission is received. The lead battery will leave the road and prepare to fire the mission. When the two other batteries arrive, they will take positions flanking the lead battery.

After the XO of the lead battery has laid his pieces, a survey instrument (theodolite or aiming circle) is set up at battery center. Survey personnel sight on the instrument with the recording motion of the XO's aiming circle, being careful not to disturb the lower motion. The azimuth of fire is added to this reading and the result is the azimuth from the XO's aiming circle to the survey instrument at battery center. The addition or subtraction of 3200 mils then gives the azimuth from the survey instrument to XO's aiming circle.

Using the XO's aiming circle as a rear station, the azimuth to which is known, and the battery center of the center battery as the starting point, all the prerequisites for initiating a survey exist. The coordinates of the battery center are determined by map inspection. Survey is then simultaneously extended to the two flank batteries, which will be relaid by orienting angle. Thus, all batteries are on common coordinates and a common direction within a very short time. The registration of the center battery may be accurately applied to the flank batteries and the battalion may be effectively massed. As more time passes, the survey will be improved and true control will be established.

—Submitted by 1st Lt David C. Hogan
Survey Officer
2d How Bn, 27th Arty
APO 39



THE ARTILLERY WORLD

NEW DEMOLITION KIT

Picatiny Arsenal has announced the development of a demolition kit, blasting, XM175. This kit was designed specifically to provide a means of blasting holes to anchor the Little John launcher in frozen ground. It contains four "shaped" demolition charges XM106 (fig 1) with priming accessories, and weighs 28 lb. The kit is versatile, easy to operate, and

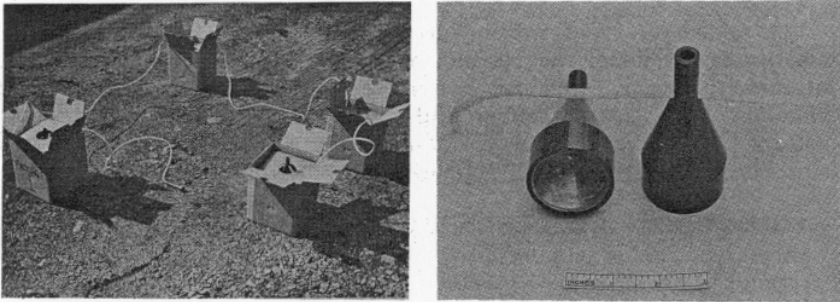

Figure 1. Demolition charge, XM106.

can be used to blast holes in frozen ground for other stake-driving operations, for emergency destruction of vehicles and equipment, as an antipersonnel weapon when fired horizontally, and to blast pilot holes for the emplacement of dynamite or other explosives.

FACSIMILE SET AN/GXC-5

A new lightweight device that can flash battle sketches and pictorial data by radio directly from the front lines of combat has been developed through inter-service cooperation. The experimental unit (Facsimile Set AN/GXC-5) is the first of its kind small enough to be carried on a soldier's back and was designed by US Army scientists in cooperation with the US Marine Corps.

In engineering tests the new facsimile set transmitted battle maps from a radio-equipped jeep, even while the vehicle was in motion. All



Figure 2. Jeep-Mounted Facsimile Set AN/GXC-5.

electrical power was supplied by the vehicular electrical system. The set, which weighs only 27 lb., will transmit graphical information to a distant receiver through most standard portable combat radios or through a telephone line.

The system is designed to send written messages, maps, pencil sketches, and other graphical data. It can handle pictorial data up to 8×11 inches and transmit it in less than six minutes. At the receiving end many miles away, graphical information is instantly reproduced on a similar unit. To transmit, the operator merely slips the copy into the unit and presses a button. The sheet is automatically wound around a roller where it is scanned electronically and its content converted to electrical signals. At a distant location, the receiver unit re-converts these signals into an immediately usable facsimile by employing a newly developed carbon paper printing technique.

The Facsimile Set AN/GXC-5 can be used to send back detailed sketches of terrain, maps marked with combat data, printed foreign-language text, drawings of captured equipment, and other vital military data that is best handled in visual form. The print as received can be used directly as a master for standard multiple-copy duplicating machines.

AR-16 RIFLE

The development of a new rifle (fig 3), AR-16, has been announced by ArmaLite, Inc. The AR-16 is gas-operated, fires the standard 7.62-mm NATO cartridge from a 20-round magazine, and is capable of semiautomatic and full-automatic fire (650 rounds per minute). The overall length of



Figure 3. AR-16 experimental rifle.

this new rifle is just under 37 inches and the buttstock may be folded and locked to the left side of the receiver to reduce the length to 27 inches. The production weapon will weigh approximately 7 1/2 pounds empty.

This lightweight, compact weapon is well suited to special missions and counter guerrilla operations. The open action is notable for the absence of numerous close tolerances in operating parts. This feature enables the AR-16 to actually ingest mud, sand, and dirt and spew it out without interrupting the firing cycle. A weight reduction is achieved by employing a multiple-lug bolt which is firmly locked in a barrel extension during firing. Because the receiver is required to withstand only the relatively light loads of recoil and action cycling, it is fabricated from sheet-metal stampings welded into a rigid frame.

MUSKRAT

Based on the Army's "Mover" study, the artillery is considering and testing various prototype vehicles in the weight classes of 1/4-ton, 1 1/4-ton, 2 1/2-ton, and larger. Pictured below is a 3/4-ton prototype version of one of the competitive entries in the 1 1/4-ton class (XM561)—the MUSKRAT.

MUSKRAT has all-round increased performance features, particularly in the areas of cross-country mobility and swimming. Some of its other features are: individual wheel suspension, aluminum body, spark ignition engine, 4 × 4 drive system. The 1 1/4-ton version will be capable of

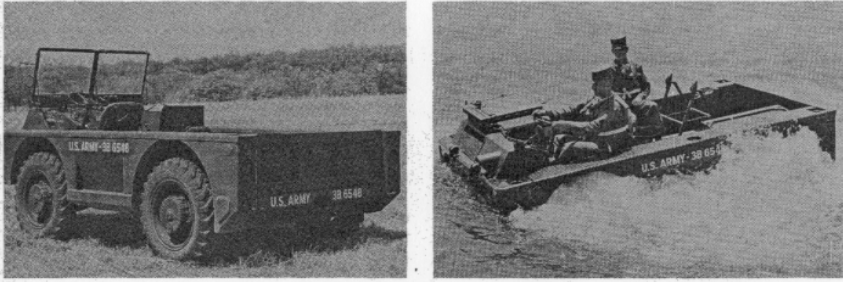

Figure 4. The MUSKRAT.

transporting 10 men, including driver. It will have 53 sq. ft. of cargo space.

The XM561 has the projected missions of towing the future lightweight XM102 towed howitzer, or the Little John rocket. It will also act as a radio vehicle, survey vehicle, and possibly as a fire direction vehicle. MUSKRAT has already proved itself as an excellent wire laying vehicle in early US Army Artillery Board testing.

LASER RANGEFINDERS

The word "LASER," which is a shorter way of saying, "Light Amplification by Stimulated Emission of Radiation," has become an important word to the artilleryman, particularly the Forward Observer.

Rangefinders (fig 5 and fig 6), utilizing the technique that "LASER" describes, are under development to meet the classic artillery requirement,

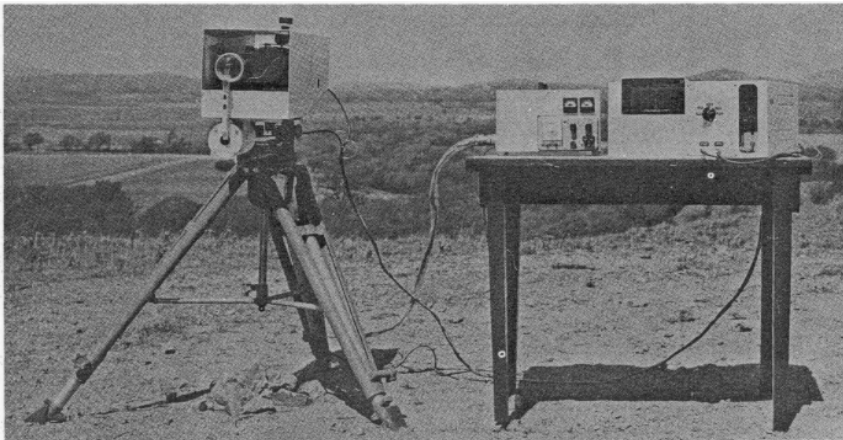

Figure 5. Developmental LASER rangefinder demonstrated by Ordnance Corps.

"A means by which an observer can accurately and rapidly determine the range to a target so that every fire mission can be 'Fire for Effect'." By the LASER technique, range is determined by measuring the transit time of a ray of light.

In the past month both Ordnance and Signal Corps developmental agencies have demonstrated laboratory "breadboard" models of "LASER" rangefinders at Fort Sill.

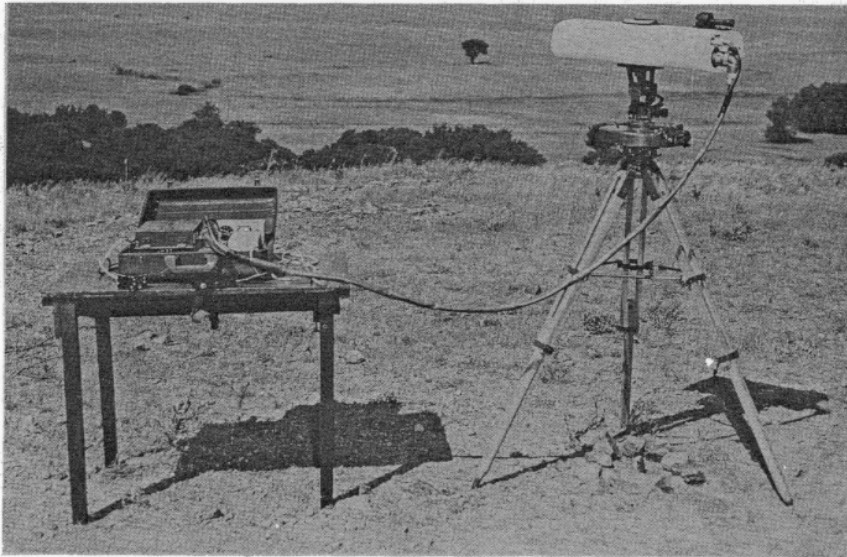

Figure 6. Developmental LASER rangefinder demonstrated by Signal Corps.

Of particular interest were the types of targets the "LASERS" were able to range upon. In addition to the usual "materiel objects," so familiar to the student officer, the "LASERS" were able to range upon clumps of grass, trees, bushes, mounds of dirt, personnel, roads, sand bag emplacements, and bare ground.

The pictures shown are of the "breadboard" models demonstrated at Fort Sill. As part of its development, the "LASER" rangefinder will be designed to meet the FO's environmental requirements for accuracy, size, weight, and configuration.

NEW FIRE DIRECTION CENTER VEHICLE

The Command Post and Fire Direction Center Vehicle, light tracked XM577 (fig 7), was evaluated by the US Army Artillery Board in April 1962 to determine its suitability as a field artillery FDC vehicle. The XM577 was developed to provide command post facilities for uses requiring

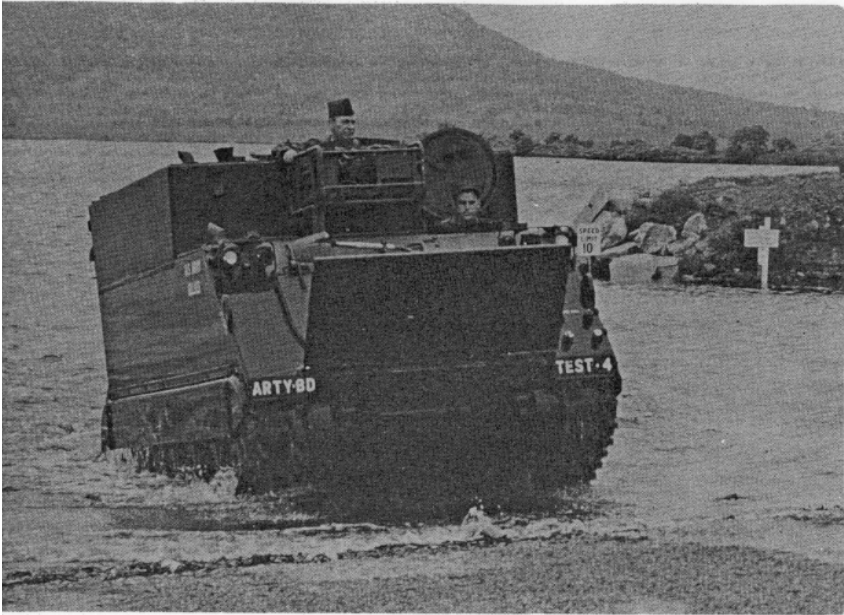

Figure 7. The XM577 FDC vehicle.

armor protection and high mobility. The vehicle is a modification of the M113 armored personnel carrier. The raised hull roof provides an interior height of 75 inches in the crew compartment. In the fire direction application the XM577 will make armored and mechanized field artillery units more responsive and will facilitate the timely delivery of supporting fires.

The FDC configurations evaluated included: (1) a battalion FDC employing present manual techniques; (2) a battalion FDC with a single Computer, Gun Direction M18 (FADAC); (3) a battalion FDC utilizing the FADAC System currently undergoing user tests at the Board; and (4) an Honest John battery FDC with a single FADAC. The XM577 does provide adequate space and facilities for the fire direction equipment, communications media, and personnel required in each configuration. In addition, a specifically designed command post tent attaches to the vehicle allowing for the rapid expansion of work space.

The XM577 is adaptable to any fire direction center application, manual or electronic. Sufficient racks will be built-in to provide for various radio combinations. A 20-pair capacity terminal strip will connect incoming wire lines to the fire direction center.

Permanently installed tables allow adequate work space and a secure base for mounting electronic equipment. Adjustable interior wall brackets permit flexibility in attachment of miscellaneous items.

A 28-volt, 150-ampere auxiliary engine generator provides power for white interior lights, blackout lights, and tent lights. This generator is normally mounted on the hull but can be removed for operation in a remote location.

The swimming performance of the vehicle was tested to determine its inland waterways traverse capability. Under loads representing all the aforementioned fire direction configurations, the swimming performance was satisfactory.

This fire direction vehicle should begin to become available to the artilleryman in the field during CY 63. The employment of this vehicle with artillery units will better enable the artillery to deliver on the enemy rapid destructive fires, essential to victory.

FIRST SERGEANT MISSILE BATTALION ACTIVATED

The Army's first Sergeant battalion, the 3d Missile Battalion, 38th Artillery, was presented its "colors" at Fort Sill as part of Armed Forces Day events. The 3d/38th consists of a Headquarters and Headquarters Battery plus A and B firing batteries, each with one launcher. Each battery has its own survey, communications, maintenance, and administrative personnel and can perform its tactical mission in locations widely separated from the battalion headquarters.

The 3d/38th will initially support the US Army Artillery Board in further testing of the Sergeant system. Later, it will support the US Army Artillery and Missile School. Two additional Sergeant Battalions, the 3d Msl Bn, 81st Arty, and 5th Msl Bn, 77th Arty, will be activated early this summer. Deployment of Sergeant units overseas is expected to begin early next year.

LIMITED WAR LAB

A new Limited War Laboratory, at Aberdeen Proving Ground, is being initiated by the Army to research and provide weaponry and other materiel for use in such fields as guerrilla and counterinsurgency operations.

The staff will consist of approximately 70 military and civilian personnel in a wide variety of scientific fields—chemists, physicists, electronic scientists, natural scientists, analysts, and engineers.

continued from p. 7

Firing is continued until a positive FDC deflection sensing is obtained or the situation in a and b above occurs. The appropriate deflection change will be made at this time and the procedure will be continued until the adjusted deflection has been obtained.

—submitted by Lt Col Theodore J. DeFranco

Commanding Officer, 1st How Bn, 37th Arty

STATUS OF TRAINING LITERATURE

1. The following training literature is under preparation or revision by the US Army Artillery and Missile School:

- A. FIELD MANUALS (FM):
 - 6-90 8-inch Howitzer, M2, Towed
 - 6-135 Adjustment of Artillery Fire By The Combat Soldier
 - 6-() Howitzer, 8-inch, M110, SP, and Gun, 175-mm, M107, SP
 - 6-() Operation and Field Artillery Application of Gun Direction Computer, M18
- B. ARMY TRAINING PROGRAMS (ATP):
 - None
- C. ARMY TRAINING TESTS (ATT):
 - 6-16 FA Battalions, Gun or Howitzer, Heavy
 - 6-137 FA Howitzer Battery, 8-inch, Infantry Division
 - 6-() Field Artillery Missile Battalion, Pershing

2. Training literature submitted to USCONARC or DA:

- FM 6-121 Field Artillery Target Acquisition
- FM 6-() 115-mm Multiple Rocket Launcher M91, and Toxic Rocket M55
- ATP 6-545 Field Artillery Missile Battalion, Corporal
- ATP 6-585 Field Artillery Missile Battalion, Lacrosse
- ATP 6-615 Field Artillery Missile Battalion, Pershing
- ATP 6-635 Field Artillery Missile Battalion, Redstone
- ATT 6-4 Field Artillery Target Acquisition Headquarters and Headquarters Battery
- ATT 6-117 Field Artillery Howitzer Battery, Light or Medium
- ATT 6-() Field Artillery Target Acquisition Battery
- ATT 6-() Field Artillery Missile Battalion, Sergeant

3. Training literature at the Government Printing Office:

- FM 6-15 Artillery Meteorology
- FM 6-40 Changes 1, Field Artillery Gunnery
- FM 6-45A Field Artillery Missile Battalion, Lacrosse Gunnery
- FM 6-75 Changes 1, 105-mm Howitzer, M2 Series, Towed
- FM 6-81 155-mm Howitzer, M1, Towed
- FM 6-92 155-mm Howitzer, M44, SP
- FM 6-140 The Field Artillery Battery

4. Training literature recently printed:

- FM 6-25 FA Missile Battalion, Redstone (U)
- FM 6-36 Changes 1, FA Missile, Redstone Firing Procedures
- FM 6-37 FA Missile Battalion, Sergeant (U)
- FM 6-38 FA Missile, Sergeant (U)

FM 6-56A FA Missile Battalion (Battery), Little John Rocket
(U)
FM 6-162 Radar Set, AN/TPS-25
ATP 6-555 FA Missile Battalion, Sergeant

5. Status of Army Subject Schedules (MOS):

A. UNDER PREPARATION OR REVISION BY THE US ARMY
ARTILLERY AND MISSILE SCHOOL:

ASubjScd 6-104 MOS Technical Training of the Field
Illumination Crewman
ASubjScd 6-161 MOS Technical Training of the FA Missile
Crewman (Sergeant)
ASubjScd 6-166 MOS Technical Training of the FA Missile
Crewman (Lacrosse)
ASubjScd 6-167 MOS Technical Training of the FA Missile
Fire Control Crewman (Lacrosse)

B. SUBMITTED TO USCONARC:

ASubjScd 6-141 MOS Technical Training of the Light and
Medium FA Crewman
ASubjScd 6-156 MOS Technical Training of the Radar
Crewman

C. AT GOVERNMENT PRINTING OFFICE:

None

D. RECENTLY PRINTED:

None

6. Status of Army Subject Schedules (Non-MOS):

A. UNDER PREPARATION OR REVISION BY THE US ARMY
ARTILLERY AND MISSILE SCHOOL:

None

B. SUBMITTED TO USCONARC:

ASubjScd 6-1 Care and Handling of Ammunition

C. At Government Printing Office:

ASubjScd 6-5 Communications training for sections and
platoons

D. Recently Published:

None

ARTILLERY INFORMATION LETTERS

The following artillery information letter containing items of technical nature has been published by the US Army Artillery and Missile School since the MAY 1962 issue of ARTILLERY TRENDS. Distribution is made *only* to the units and their controlling headquarters which are authorized the equipment discussed in this letter:

Metro Information Letter Number 9, dated 13 June 1962