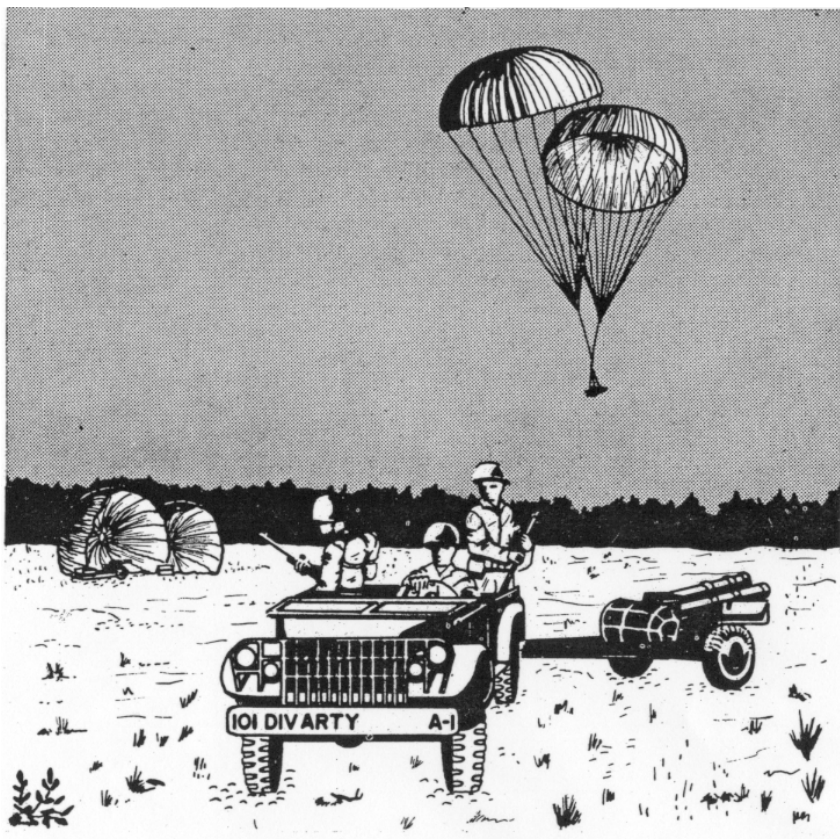


# ARTILLERY TRENDS



**U S Army Artillery and Missile School**



**March 1961**

PROPERTY OF U. S. ARMY

MORRIS SWETT TECHNICAL LIBRARY.

# ARTILLERY TRENDS

---

March 1961

Instructional Aid Number 17

---

## In This Issue

### ● ARTICLES

Artillery's Candid Camera—The SD-1 Drone . . . . .	3
The WHITE PLAN . . . . .	10
"Anytime to Anyplace and Fight!"—The Airborne Division . . .	13
Sea-Going Survey—Artillery's Helping Hand. . . . .	36
Tactical Redstone Employment . . . . .	42
Status of FDC Graphical "Tools" . . . . .	47
FT 155-Q-3 Published—New Firing Tables Format. . . . .	51
The Intelligence Chain—Strong As Its Weakest Link . . . . .	54
Safety Limits By FADAC . . . . .	67
Safety "Stops" for Traverse and Elevation. . . . .	70

### ● NEWSNOTES

Newsnotes for Artillerymen . . . . .	72
--------------------------------------	----

### ● TRAINING LITERATURE

Status of Training Literature . . . . .	75
---	----

### ● RESIDENT COURSES

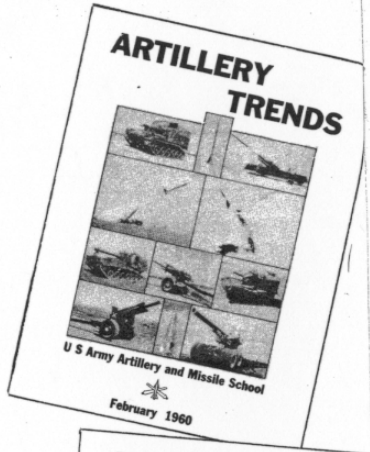
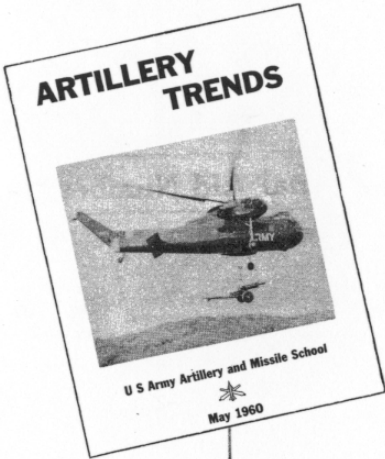
Current Resident Course Schedule. . . . .	79
---	----

### ● 1960 SUBJECT INDEX

Alphabetical Subject Index . . . . .	81
--------------------------------------	----

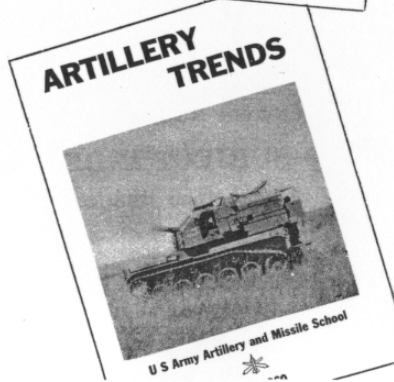
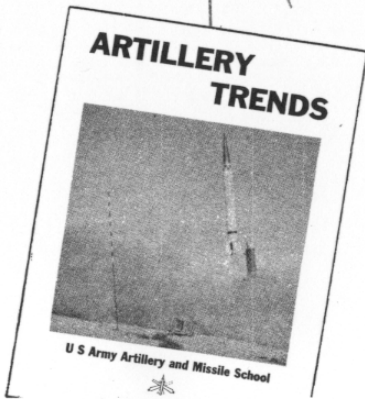
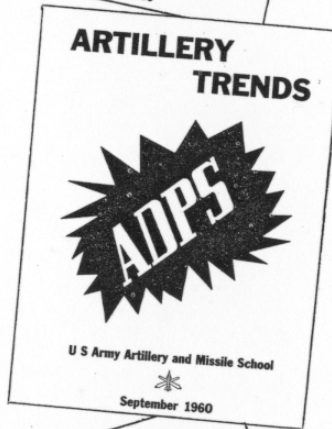
### ● COVER

While other equipment is still in the air, this 105-mm howitzer is being pulled into position to "shoot." See the Airborne Division, pages 13 to 35.

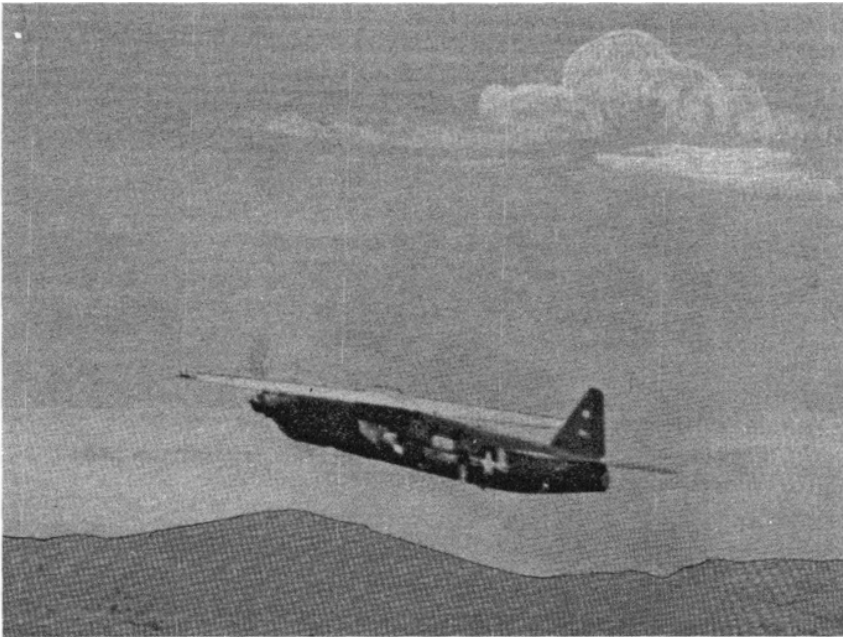


**1960 in Review...**

**ARTILLERY TRENDS'**  
**SUBJECT INDEX . . . SEE**  
**PAGES 81 TO 96 IN THIS**  
**ISSUE.**



## artillery's candid camera



# THE SD-1 DRONE

1/Lt Francis San Pietro  
Target Acquisition Department

The AN/USD-1 surveillance drone system is a recent addition to the artillery's growing means for acquiring targets. The "eyes" of this system—a photographic sensor—can provide general target locations in the battle area. The photographs taken on SD-1 drone missions give the artilleryman a better means for target analysis and, indirectly, more effective weapons employment.

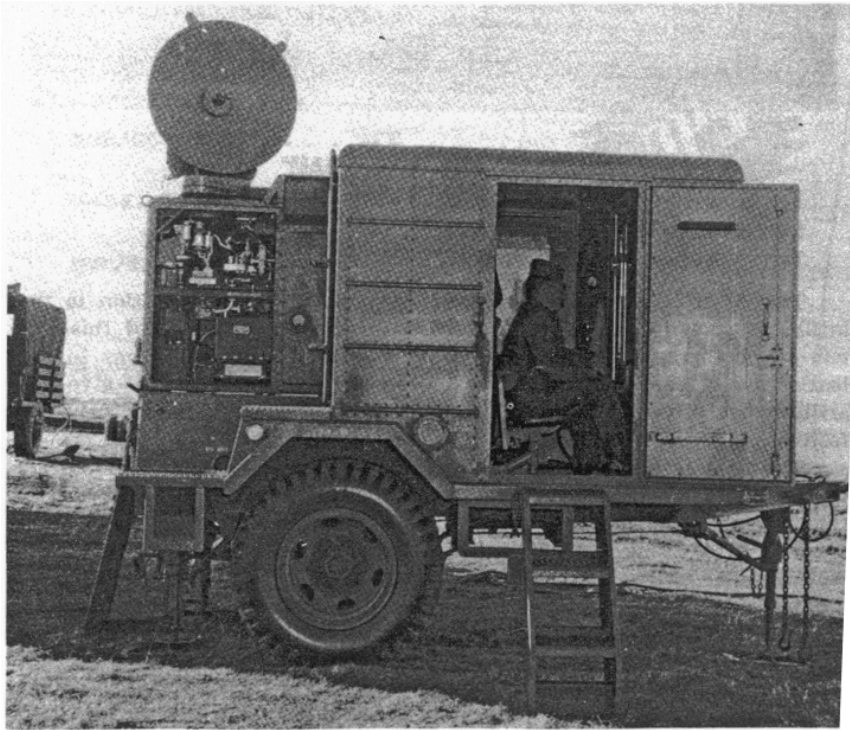
The SD-1 drone system is organic to the drone platoon, headquarters battery, field artillery target acquisition battalion (FATAB) at corps artillery and at the missile command (medium).

The SD-1 drone system used by the artillery includes support, control, and operating equipment; the system consists of 12 drones, two ground-control stations, three zero-length launchers, ground-handling equipment, and necessary test and checkout equipment. Two AN/MPQ-29 tracking and plotting radars, a mobile photographic darkroom (ES-29), and complete maintenance facilities are organic to the drone platoon, but are not included in the drone system. The drone platoon has sufficient organic vehicles for 100 percent mobility.





**Figure 1. The SD-1 drone ready for takeoff on its zero-length launcher.**



**Figure 2. The AN/MPQ-29 tracking and plotting radar.**

The SD-1 drone (fig 1) is a small high-wing monoplane designed to carry lightweight sensory devices. It was adapted from the OQ-19 radiocontrolled aerial target (RCAT). In comparison to the RCAT drone, the SD-1 has a much improved control and recovery system. Controlled out-of-sight flights are possible through use of the AN/MPQ-29 radar (fig 2). These improvements permit a greater operating range for the SD-1 and enable it to overcome recovery failures that were common to the OQ-19. In addition, gyros have been built into the SD-1 system to provide roll and pitch stabilization, which is necessary for aerial photography. Flight maneuver of the drone is controlled by ailerons and elevators; therefore, a rudder is not required and the vertical stabilizer is fixed.

The SD-1 drone is launched from its zero-length launcher by the thrust of two jet assisted takeoff (JATO) bottles. When the drone is airborne and has attained flying speed, the JATO bottles are dropped and the drone continues under the power of its gasoline engine-driven propeller. Since the SD-1 drone uses a zero-length launcher and is parachute recoverable, it does not depend upon an airstrip or base airfield.

### **CAPABILITIES OF THE SD-1 DRONE**

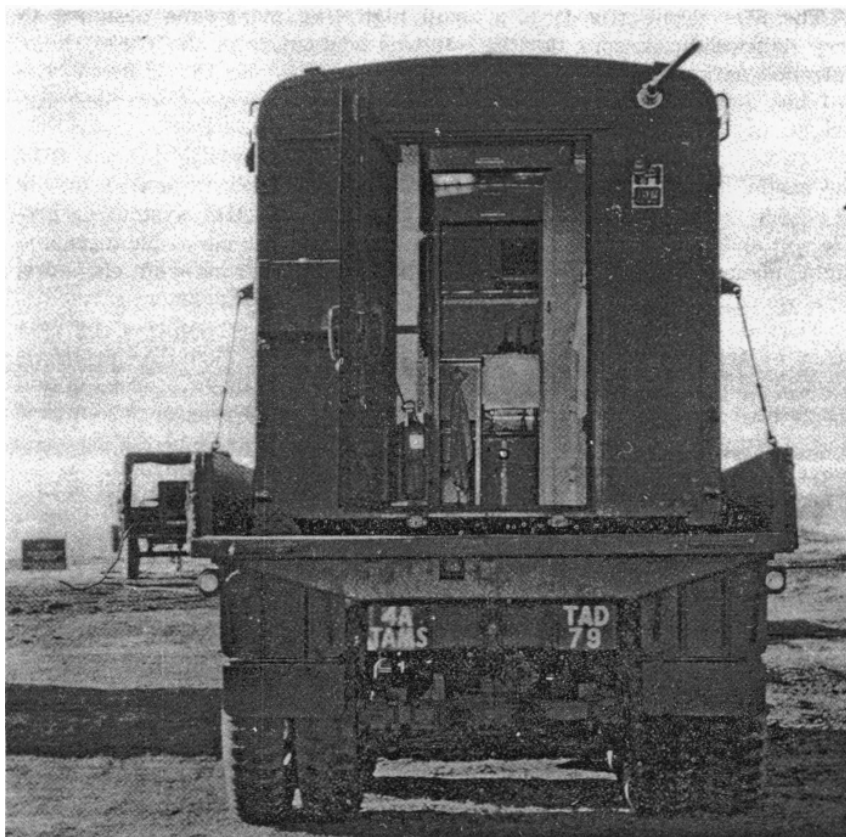
Some operational capabilities of the drone system are—

<b>Speed</b>	160 knots
<b>Range (one way)</b>	74 kilometers
<b>Endurance</b>	30 minutes
<b>Sensor payload weight</b>	60 pounds
<b>Effective range with minimum masking (limitation imposed by camera)</b>	30 kilometers

**Figure 3. Operational capabilities of the AN/USD-1 drone system.**

The SD-1 drone is designed for day or night operation in all types of weather. However, it has been necessary to establish an operational minimum visibility environment in which the drone can be flown during inclement weather. A 700-foot cloud ceiling and 1,000-meter range visibility are the minimums established at Fort Sill, Oklahoma. It has been determined in practice that these visibility environment figures allow an experienced drone controller sufficient maneuver area to launch and fly the drone overhead until the aircraft is trimmed and stabilized, and radar lock-on is achieved. After radar lock-on, visibility is of no concern until return of the drone to the recovery area, except for air safety during training flights.

Presently, the SD-1 system is capable of performing only day photo missions, since the KA-20A camera furnished with the system has only a daylight photographic capability. In the future, it is expected that the KA-39A camera, which has a day *and* night capability, will be issued to replace the present camera. The mobile photo developing plant for the SD-1 drone is shown in figure 4.

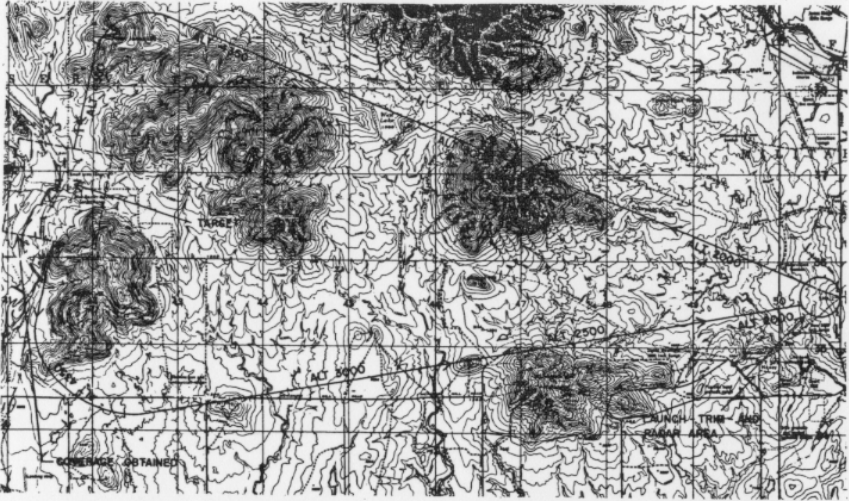


**Figure 4. The mobile photographic darkroom for the SD-1 drone system.**

### **DRONE VERIFIES SUSPECT TARGET LOCATIONS**

As with weapons systems, the terrain, weather, tactical situation, and the commander's desires and mission will dictate how the SD-1 is employed. The SD-1 drone is *not* normally employed by the artillery as a surveillance device, but is flown on specific target acquisition missions for verifying suspect target locations. The map coordinates of the target's location are determined by restituting the photographs obtained from the drone flight. A typical drone mission controlled by personnel of the US Army Artillery and Missile School, Fort Sill, is shown on the map in figure 5. This mission had the road junction at the small arms range as its target area (fig 6).

Drone launching and recovery, photograph processing, photo interpretation and target restitution, and rehabilitation of recovered drones for future flights should all occur within the same general area to minimize

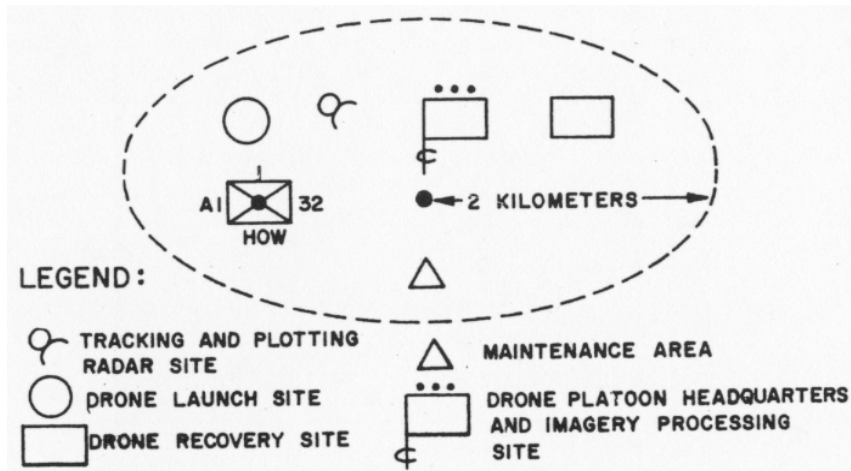


**Figure 5. A typical drone mission.**



**Figure 6. This aerial photograph reveals the target of the drone mission in figure 5.**

reaction time. This area (fig 7) is called the "drone area"; it is generally circular in configuration, with a two-kilometer radius. The drone area is not necessarily exclusive for the drone platoon. For example, the drone area in figure 7 is located with an artillery battery.



**Figure 7. A representative drone area.**

The drone operating area is normally positioned as far forward as possible to exploit the maximum effective range of the drone, which in turn provides maximum target area coverage. The location of the AN/MPQ-29 radar effects the employment of the drone. The radar must be situated to provide line-of-sight tracking of the drone to and from the target area, and while the drone is in flight over the target area. However, until radar lock-on, the drone is tracked by the ground-control station (fig 8). To prevent visual detection of the drone launching and at the same time afford radar lock-on, a defiladed launch site is usually selected about 500 meters from the radar site.

### **TWO TYPES OF DRONE MISSION**

Based on requirements of the supported force, missions for the FATAB drone platoons are normally assigned by corps and division artillery, or the missile command (medium). There are two types of drone mission—preplanned and immediate.

For a preplanned mission, requests for target locations are made by higher, lower, and adjacent units, and staff sections, and are submitted daily to the corps artillery or missile command G2 through artillery intelligence channels for integration into the target acquisition plan. Mission priorities are established by the artillery G2 in coordination with the artillery G3. The missions are then assigned to FATAB, which exercises command and operational control of the drone platoon.

An immediate mission request may be submitted at any time through artillery intelligence channels to the corps artillery or missile command G2 at the artillery fire support coordination center (FSCC). Mission requests are coordinated with the G3 and are then assigned to the drone platoon. An immediate mission assignment is monitored by the FATAB operations center; if for valid reasons the mission cannot be flown, it will be placed in a "hold" status until it can be accomplished. If the FATAB operations center is silent, concurrence is denoted and the mission is flown immediately.



**Figure 8. The ground-control station for the SD-1 drone.**

The SD-1 drone, complete with the equipment necessary for a maximum capability flight, costs \$14,500. This may seem expensive for such a small aircraft, but when the cost of a conventional aircraft is considered, not to mention the life of a pilot, this cost is comparatively small.

The SD-1 drone system is being field tested in several commands. Informal comments concerning these tests would be of value to the Artillery and Missile School in revising and improving tactics and techniques of operation of the drone system; comments would also be of assistance in the preparation of training literature. Address comments to the Assistant Commandant, USAAMS, Attn: Director, Target Acquisition Department, AKPSITA, Fort Sill, Oklahoma.

---

"Doctrine is indispensable to an army—or to any military organization, for that matter. This is true because doctrine provides a military organization with a common philosophy, a common language, a common purpose, and a unity of effort. Doctrine influences, to a major degree, strategic thinking as well as the development of weapons, organization, training, and tactics. Doctrine is the cement that binds a military organization into an effective fighting unit."

General George H. Decker

---

"The Artillery is the blocking back for the Infantry ball carrier."

Major General Terry M. Allen



# THE WHITE PLAN

Colonel Jack F. Diggs  
Office of Combat Development and Doctrine

The Artillery *can* use computers successfully. The WHITE PLAN, a joint Artillery-Signal Corps demonstration held last fall at the United States Army Electronic Proving Ground (USAEPG), Fort Huachuca, Arizona, proved the feasibility of automating procedures in certain field artillery areas ("Decisions in the Saddle" to ADPS, ARTILLERY TRENDS, September 1960).

A 105-mm howitzer battery and a 155-mm howitzer battery, without registering, showed that the artillery can obtain "first-round accuracy" on targets of known location when a computer is used to prepare firing data. An IBM 709 laboratory computer simulated a FIELDATA computer of the type which may be issued to troop units. It applied unweighted meteorological data to the ballistic solution, sensed the weather conditions at many levels through which the projectiles were to pass, and corrected for weather at each level, thus producing rapidly a true solution for the trajectory.

A highlight of the WHITE PLAN was the demonstration of the preparation of artillery fire plans by computer. The computer considered a list of 127 targets and prepared a complete nonnuclear fire plan in about 6 minutes. The fire plan took into account, among other factors, the type of target, effect desired on the target, ammunition, and number and type of fire units. It will be possible in a tactical environment to have fire plans reproduced at the firing battalions by means of print-out devices almost as fast as the plan is made at division artillery or group fire direction centers.

The use of computers for fire planning is expected to improve the quality of fire support through a great increase in the speed of preparation and dissemination of fire plans and through a more efficient use of available fire units. In addition, it should be possible to obtain better use of available artillery through a more scientific application of required lethal effects.

The computer analyzed a number of nuclear targets and prepared a complete nuclear fire plan in about 10 minutes. The results of this operation indicate that computers will possess significant operational value in situations in which nuclear weapons are employed.

### **COMPUTER USED IN VARIOUS ROLES**

The value of computers was demonstrated also in roles other than fire direction and fire planning. Complicated survey problems were solved with great speed, and an ammunition status report was prepared. These operations are among the 14 functional areas proposed for automation in the Fire Support Subsystem of the field army Command and Control Information System (CCIS), formerly known as ADPS (Automatic Data Processing System), which were discussed in ARTILLERY TRENDS, September 1960.

A communications demonstration was presented in which digital data was transmitted by radioteletype at the rate of 100 words per minute, while voice transmissions of fire missions were being conducted on the same channel.

The project of creating an automatic data processing system for artillery is complex. First, it is necessary to determine which artillery functions can be performed more efficiently and more rapidly by computers than by soldiers. A number of studies have been made in this area, and it has been concluded that computers are required for fire direction, survey, fire planning, and ammunition status accounting. Other studies are under way at the present time.

After the general functional areas are selected, the next problem is to define all the artillery tasks which must be accomplished within an area. For example, in fire direction, a statement of all possible inputs of data, computations required, and outputs of fire commands and information desired is a necessity. When these have been prepared, it is possible to draw up flow charts that diagram the sequences in which various items of data must be considered by the computer to reach a solution. A program of instructions to be stored in the computer is then prepared.

### **WHITE PLAN SERVED AS TOOL**

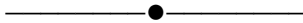
It may be easily seen that some sort of a laboratory tool was required to check the validity of the various prepared programs before militarized hardware was procured. The WHITE PLAN served as this tool. By preparing a limited number of computer applications and demonstrating the use of a computer to put "iron on the target," the joint Signal Corps-Artillery-Industrial team was able to gain experience in the building



of the subsystem while awaiting the development of field equipment. Benefits were also gained in the drive to produce the overall field army CCIS system which embraces operations, intelligence, administrative, and logistical subsystems in addition to the fire support subsystem.

The next step in development after the WHITE PLAN will be known as Field Exercise Number 1; it is scheduled for the USAEPG in November 1961. This exercise will make use of computers in a field environment. The ORANGE PLAN, for which the use of completely militarized hardware is being planned, is slated for early 1962 at Fort Huachuca. The RED PLAN, scheduled for mid-1962 at Fort Sill, Oklahoma, is expected to present a problem using a division artillery headquarters and two artillery battalions.

The WHITE PLAN was a significant step forward in the development of automatic data processing for the Artillery. Observers from the US Army Artillery and Missile School, Fort Sill, believe the plan, while only a simulative test, showed that CCIS will be of great value to the field artillery commander.



## **PREPARED CLASS MATERIAL IS AVAILABLE**

Complete instructional material for both instructor and students is available at no charge to all artillery units except the National Guard. The classes are listed in the *Catalog of Instructional Material*.

Each class is up-to-date and is based upon the latest instruction at the US Army Artillery and Missile School, Fort Sill. The current Catalog (FY 62) lists 193 classes covering communications, gunnery, materiel, artillery transport, and tactics and combined arms.

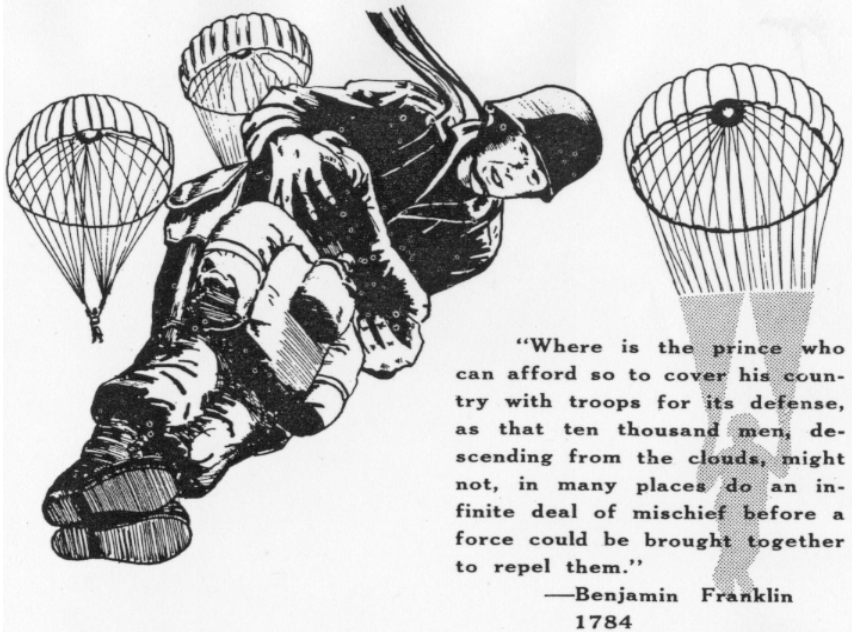
The material includes the instructor's manuscript; training aids such as maps, transparencies, and overlays; and demonstration-size forms and records, such as grid sheets, target grids, computer's records, computation forms, cutout models and photos. The student equipment consists of illustrative problems, instructional writs, half-grid sheets, target grids, instructional notes, forms and records, cutout models of sights and aiming circles, checklists, maps, and other necessary items.

The Catalog contains instructions for ordering classes. Funding procedures for National Guard units are also outlined in the Catalog. Address requests for the Catalog and material to: Commandant, US Army Artillery and Missile School, Fort Sill, Oklahoma, Attn: AKPSINI/RC.



The transition to maps of 1/50,000 scale is expected to be completed in both resident and nonresident instructional material during 1962. Maps with a 1/25,000 scale will be issued until the supply is exhausted.

## “Anytime to Anyplace and Fight!”



# THE AIRBORNE DIVISION

Major William C. Wood  
Captain Robert W. Douglass, III  
Tactics and Combined Arms Department

Wait a minute! Don't turn the page. If you are airborne qualified, you may be saying to yourself, "I know the airborne division. Let someone who is not airborne qualified read this article." Or perhaps you are saying, "Why should I be interested in the airborne division? I am not airborne qualified and I do not intend to become qualified. I'll never be working with this organization." You may be wrong. Let us see why.

The Army has a military force known as STRAC—the Strategic Army Corps. It is a high contender as the forerunner of a major force that may be initially employed if our nation is plunged into war. The headquarters of STRAC is the 18th Airborne Corps at Fort Bragg, North Carolina. The Corps has one infantry division and two airborne divisions as its major divisional units. The infantry division is the 4th Infantry Division at Fort Lewis, Washington. The airborne divisions are the 82d Airborne Division at Fort Bragg and the 101st Airborne Division at Fort

Campbell, Kentucky. These three divisions constitute roughly 50 percent of the total STRAC forces. The other units are *supporting logistical and tactical units*. An example of an artillery STRAC unit that is in support of the divisional forces is the 11th Field Artillery Battalion, a 155-mm howitzer battalion, at Fort Campbell.

Your next troop assignment may be as a member of a STRAC unit. If you are airborne qualified, you might be assigned to the 101st or 82d Airborne Division. If you are not airborne qualified, you could be assigned to a nonairborne STRAC unit whose primary mission is that of supporting an airborne division of the STRAC force. Therefore, all Active Army, Reserve, and National Guard officers should have a clear understanding of the general organization of the current airborne division.

To better understand the airborne division, let us compare its mission with the mission of the infantry division. The mission of the infantry division in offensive combat is to close with, destroy, or capture an enemy force. The mission of the airborne division is to *move by air*, to close with, destroy, or capture an enemy force. The airborne division does this by exploiting all available aircraft.

If the United States were to engage in an overall military effort, air lift would initially be at a premium. In a theater of operations, there would be many "first priorities." The airborne division, to engage in tactical operation, would have to receive its fair share of air force troop carrier aircraft. It would use these aircraft to overcome great distances and major geographical barriers and to bypass major enemy defenses.

### **SURPRISE, RAPID DELIVERY IN AIRBORNE LANDING**

The landing of an airborne force is characterized by surprise and rapid delivery of troops and equipment into an airhead, deep in enemy territory.

Normally, airborne operations are conducted in an area where there are few enemy defenses and organized combat troops and few or no enemy armor and antiaircraft weapons. If there is opposition and resistance, it must be neutralized before the airborne assault.

The airborne division is trained and equipped to enter combat by parachute, by assault aircraft, or, in some cases where the objective area or the proposed airhead is relatively shallow or not too deep into enemy territory, by helicopter. The airborne division is equipped and trained to land in unprepared areas and to engage the enemy alone or as part of a larger force. This division has a highly mobile strategic and tactical airlift capability. However, this strategic and tactical capability has been purchased at a cost which limits ground mobility and heavy weapon and equipment support.

The airborne division cannot operate for an extended period of time without additional combat and logistical support. For this reason, the airborne division should not be employed on a mission which can be accomplished by an infantry or armor division more effectively or economically.

When you think of the airborne division, you may visualize an operation like that portrayed in figure 9.



**Figure 9. Streaming from the sky, these troops were transported to the objective area by the Air Force.**

The troops have been transported to the objective area by Air Force troop carrier aircraft. When an airborne operation is performed using airborne troops and troop carrier aircraft from the Air Force, it is known as a joint-type operation.

#### **CURRENT INVENTORY OF TROOP CARRIER AIRCRAFT**

Since the availability of aircraft determines the extent of airborne operations, let us first examine the current inventory of troop carrier

aircraft which the Air Force has that could be used by the airborne division for both strategic and tactical movement. Under the category of medium transport is the C-119 (fig 10). This aircraft is a twin-engine, high-wing monoplane-type aircraft. The recognizable characteristic of this aircraft is its twin tail boom. The C-119 can be used for parachute operations, evacuation of casualties and equipment from an airhead, aerial resupply, and aerial delivery of heavy equipment into the airhead. This aircraft has an allowable cargo load of 16,000 pounds and can carry this load for 1,500 nautical miles. It is capable of carrying 62 troops or 42 jumpers.



**Figure 10. The C-119 can carry 62 troops or 42 jumpers.**

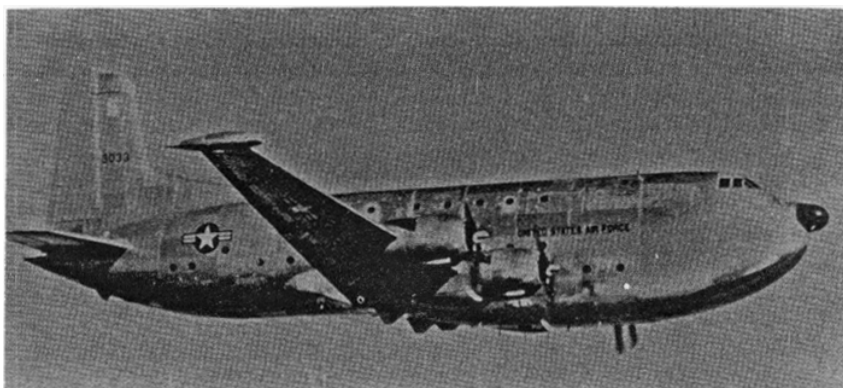
The C-130 is another medium transport aircraft (fig 11). It is a high-wing monoplane and has four turboprop-type engines. It can be used for parachute operations, evacuation, and the delivery of heavy-drop loads. The C-130 has an allowable cargo load of 25,000 pounds; this load can be carried 2,500 nautical miles. The C-130 can carry 92 troops or 64 jumpers.

The C-124 "Globe Master" (fig 12) comes under the category of heavy transport. Incidentally, this is the principal heavy transport aircraft within the Military Air Transport Service (MATS). It is currently considered the principal aircraft for a STRAC strategic move. The C-124

is a four-engine, long-range monoplane. It can be used for parachute operations, evacuation, and the carrying of cargo. The C-124 has an allowable cargo load of 43,000 pounds. It can carry this weight 1,500 nautical miles. It can carry 200 troops or 112 jumpers. In recent years, airborne forces have not used this aircraft for parachute operations in training, because the dispersion of troops on the ground is too great. Representative loads are three 2½-ton trucks, one M41 light tank, or four H-13 helicopters.

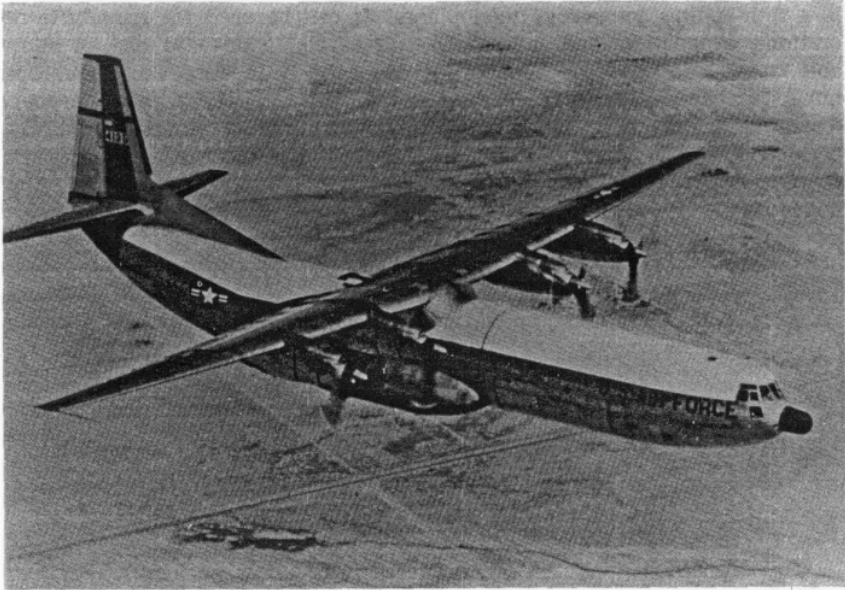


**Figure 11. The C-130 aircraft has four turboprop-type engines.**



**Figure 12. The C-124 is the principal heavy transport aircraft used by the Military Air Transport Service.**

The C-133 is another heavy transport aircraft (fig 13). It is relatively new and there are few within the Military Air Transport Service. The C-133 is a high-wing, four-engine aircraft and is classified as a long-range monoplane. It is designed for transporting a large number of troops or a heavy cargo load a great distance. The rated allowable cargo load of this aircraft is 50,000 pounds; it can transport this load 2,500 to 3,000 nautical miles. The C-133 is capable of transporting 200 troops from the United States to Europe without refueling. Its gross "fly away" weight exceeds one quarter of a million pounds.



**Figure 13. The C-133 is the newest heavy transport aircraft.**

The C-123 medium assault aircraft is an excellent aircraft for airborne operations (fig 14). It is a twin-engine, high-wing monoplane and can be used for parachute operations, heavy-drop operations, transporting of cargo into the airhead, and evacuation of wounded and equipment from the airhead. The allowable cargo load for the C-123 is 13,000 pounds; it can transport this load for an average radius of operation of 250 nautical miles. It carries 60 troops or 42 jumpers. The C-123 can land on any improvised or improved landing facility within an airhead. If the boulders and stumps are cleared from a relatively level area, the C-123 has a landing strip. This aircraft can land in approximately 1,200 feet and take off fully loaded in 2,100 feet.

This, then, is the current inventory of aircraft that the airborne division could use for a strategic or a tactical operation.

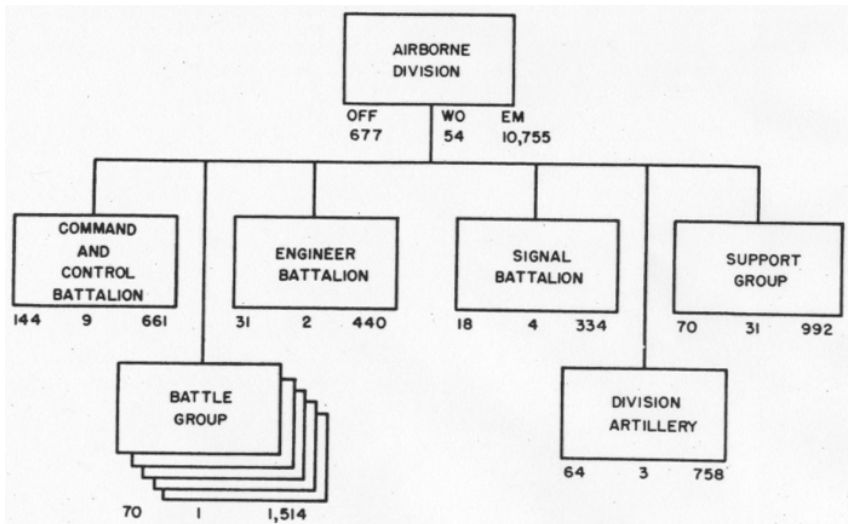
### **COMPARISON OF AIRBORNE, INFANTRY DIVISIONS**

The overall structure of the infantry division, by comparison to the airborne division, appears to be quite "weighty." The infantry division has a great deal of equipment—tanks, armored personnel carriers, and engineer equipment. Remember, the airborne division (fig 15) must maintain its capability of strategic and tactical mobility and has been kept lean with respect to heavy-type equipment. The airborne division has 11,475 men as compared to 13,748 in the infantry division. However, the foxhole strength, or the number of men assigned to the rifle squads in the airborne division, *exceeds the infantry division by about 1,000 men.* Why? The airborne division's rifle company has four platoons

rather than the three platoons found in the infantry division rifle company. This will be discussed in more detail later in the article.



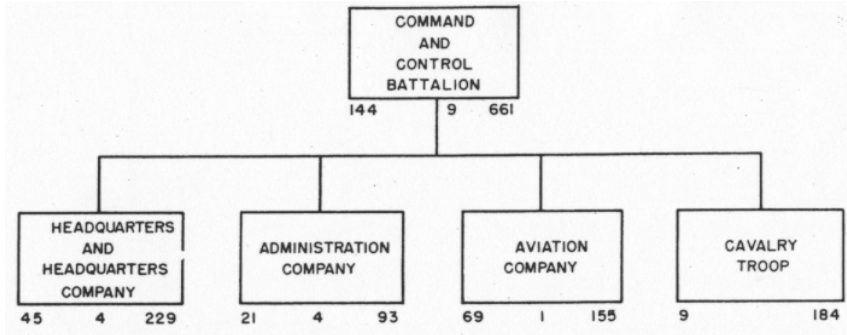
**Figure 14.** The C-123 can land in a span of 1,200 feet.



**Figure 15.** The current airborne division.

The current infantry division, to be self-sufficient, contains the necessary elements to satisfy this self-sufficiency. They are a reconnaissance element, a combat element, a command element, and a service element (ARTILLERY TRENDS, March 1959). Similarly, the pentomic airborne





**Figure 16. The command and control battalion.**

division has all these elements to enable it to be self-sufficient for a limited period of time.

The following paragraphs describe the organization, mission, and normal employment of the major subordinate units within the airborne division.

First, there is a command and control battalion (fig 16). The following units are within the battalion: A headquarters and headquarters company, an administration company, an aviation company, and a cavalry troop. The battalion is commanded by a lieutenant colonel. During tactical operations, he has operational control over only the headquarters and headquarters company in his capacity as headquarters commandant of the division. During tactical operations, the division adjutant general has operational control over the administration company. The G3 has operational control over the aviation company, and the G2 has operational control over the cavalry troop for reconnaissance missions. If the cavalry troop is given a tactical mission the G3 will normally exercise staff supervision. The headquarters and headquarters company contains the personnel who provide command, control, staff planning, and supervision of administration and operation within the division.

The administration company (fig 16) has those administrative personnel of the division that are found in the inspector general, adjutant general, judge advocate, and special services sections and in other administrative units of the division.

The aviation company (fig 16) resembles the aviation company of the infantry division. It has 52 aircraft, both fixed-wing and rotary, as compared to 49 in the infantry division. The mission of the aviation company is to provide the division with aerial observation, surveillance, reconnaissance, movement of limited quantities of supply, and the transportation of limited tactical forces. It may also be used for medical evacuation within the airhead and for other aerial support-type missions. Remember, this unit is under the general staff supervision of the division G3 during tactical operations.

The last unit within the command and control battalion is the cavalry troop—the aerial and ground "eyes and ears" of the division (fig 16). In addition to a troop headquarters, this unit has five identical reconnaissance platoons. The reconnaissance platoons in the cavalry troop of the infantry division have light tanks and armored personnel carriers along with a 1/4-ton vehicle for reconnaissance work. This is not true in the airborne division. As previously mentioned, to retain maximum airlift capability, heavy-type equipment was eliminated wherever possible. The largest vehicle within the airborne reconnaissance platoon is the 1/4-ton truck. The mission of this unit is to conduct reconnaissance through

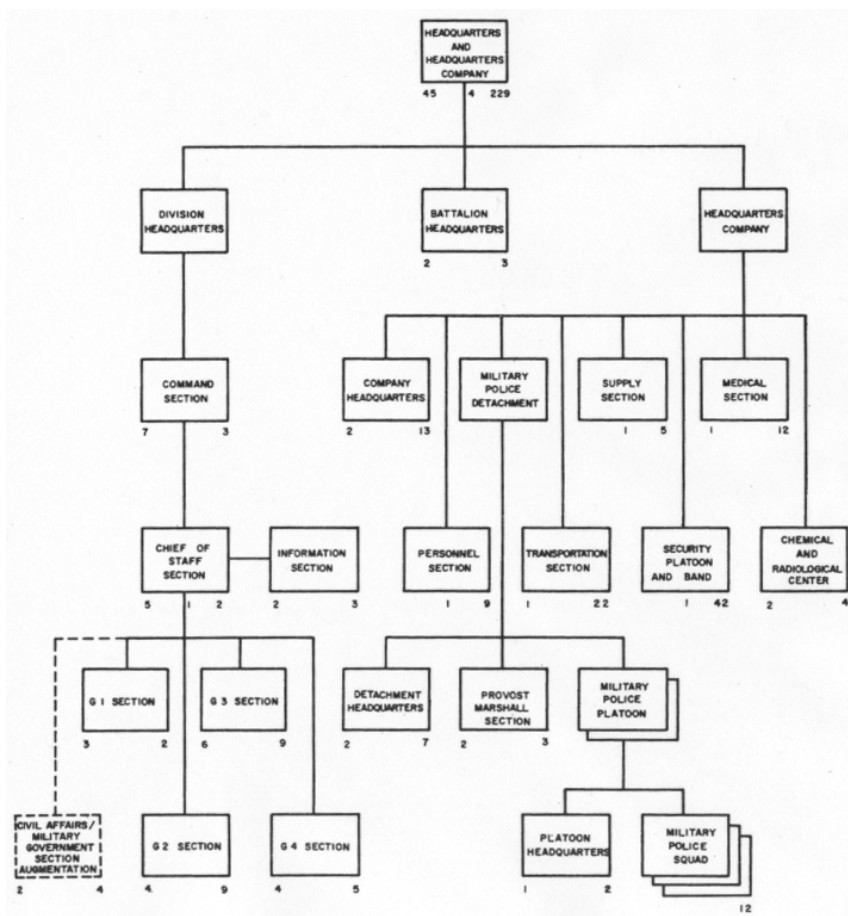


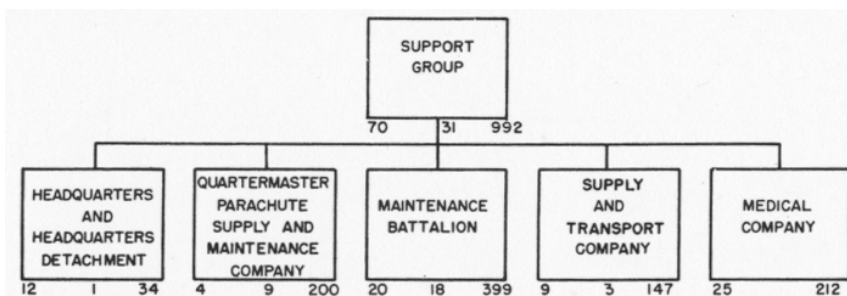
Figure 17. The division headquarters and headquarters company.

the use of, combined air and ground elements. This reconnaissance can be made over a wide front and for extended distances. During tactical operations, this unit normally operates beyond the battle group security echelons and in areas between the battle groups on security-type missions.

### DIVISION HEADQUARTERS

The division headquarters (fig 17) has two assistant division commanders compared to one in the infantry division. One of the assistant division commanders normally supervises the administrative and logistical operations for the commanding general. The second assistant division commander supervises tactical training and operations. The airborne division does not have a brigade headquarters as does the infantry division. Many airborne officers believe that the airborne division needs a brigade headquarters and that it will appear in the airborne tables of organization and equipment (TOE) in the future. If the airborne division were authorized a brigade headquarters headed by one of the assistant division commanders, this headquarters could be used as a separate staff to plan operations scheduled for several weeks in the future, as an alternate division command post (this is most important when considering employing the division on the nuclear battlefield), or as a command headquarters for a division task force.

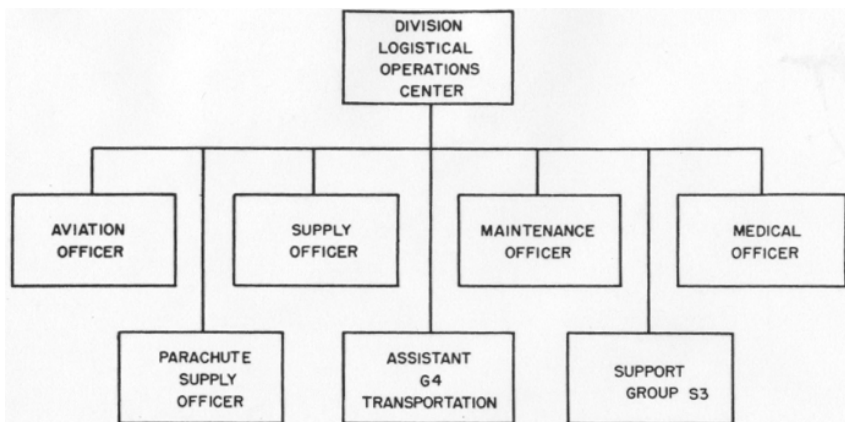
An organization that is not only peculiar to the airborne division but also reflects a new concept in logistical operations is the support group (fig 18).



**Figure 18. The support group of the airborne division.**

This group is responsible for all logistical operations and activities except for procuring and distributing engineer construction material and supplying maps and water. The latter two functions are still performed by the division engineer battalion. The support group is commanded by a colonel, who is normally a combat arms officer. He has a unit staff and a logistical staff to assist him. As the division logistical "operator," both he and his logistical staff work in close coordination with the division G4, the logistical "planner" and "policy maker" of the division.

The division logistical operations center (DLOC) is composed of personnel of the logistical staff of the support group (fig 19). The DLOC



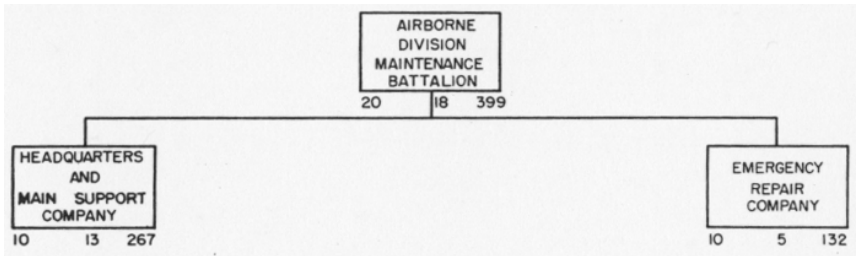
**Figure 19. The division logistical operations center.**

provides a single agency to which all units of the division may direct requests for other than routine support of medical supplies. The DLOC is normally headed by the deputy commander of the support group. It is normally staffed by the following personnel, who advise the support group commander on matters within their field of interest: An Army aviation representative to advise the support group commander, or his deputy, on the availability of Army aircraft within the airhead which could be used for the movement of limited quantities of supplies or small tactical forces from one portion of the airhead to another; a parachute supply officer, who advises the commander on the status of quartermaster air items, such as parachutes and heavy-drop kits; the division surgeon; the division supply officer; and the division maintenance officer. The assistant G4 for transportation habitually works within the DLOC. He advises the support group commander, or his representative, on the availability of this very limited ground transportation for the movement of supply and small tactical forces within the airhead. In practice, the support group S3 is normally the operations officer of the DLOC. The functions of the units in the support group are as follows:

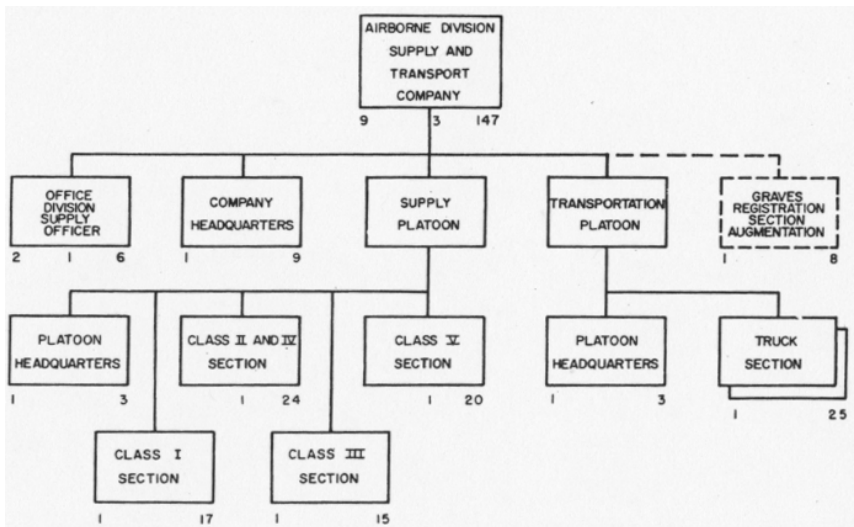
The headquarters detachment performs the normal mission of any headquarters company or detachment; that is, administration, intelligence, communications, and other necessary activities.

The airborne division counterpart of the ordnance battalion in the infantry division is the maintenance battalion (fig 20). It is termed a maintenance battalion because it performs all types of maintenance—engineer, ordnance, signal, transportation. Its subordinate units are the headquarters and main support company and the emergency repair company. The operations of the headquarters and main support company are fixed shop-type maintenance. This unit is seldom sent into the tactical airhead as a complete unit. Only those elements of the company

needed for a specific task are sent. The company's primary mission is to give backup support to the emergency repair company. The emergency repair company has five support platoons. During tactical operations, one platoon is placed in support or attached to each of the five battle groups. They perform "on-the-spot" emergency second-echelon and limited third-echelon maintenance work. If the work is beyond their capability, it is evacuated from the airhead to the headquarters and main support company.



**Figure 20. The airborne division maintenance battalion.**

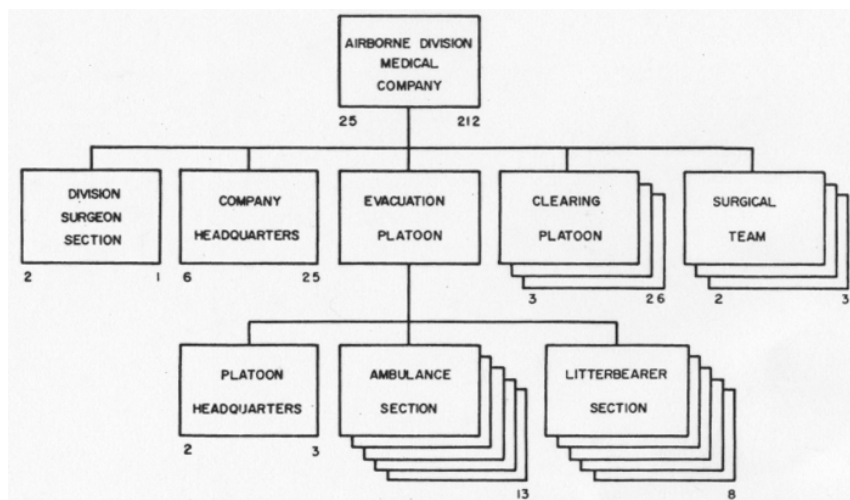


**Figure 21. The supply and transport company.**

### SUPPLY AND TRANSPORT COMPANY

A supply and transport company within the support group contains the support vehicles and supply activities that pertain to the various classes of supply within the company (fig 21).

The transportation platoon has thirty 2½-ton trucks compared to the eighty 2½-ton trucks found within the infantry division truck company. Here again, heavy weight has been "sliced off" to give the airborne division its strategic and tactical airlift capability. The supply platoon in this company handles all the procurement and distribution of class I, II, III, IV and V type supplies. Incidentally, the airborne division has class VI supplies—repair parts. The maintenance battalion procures and distributes these repair parts to divisional units.

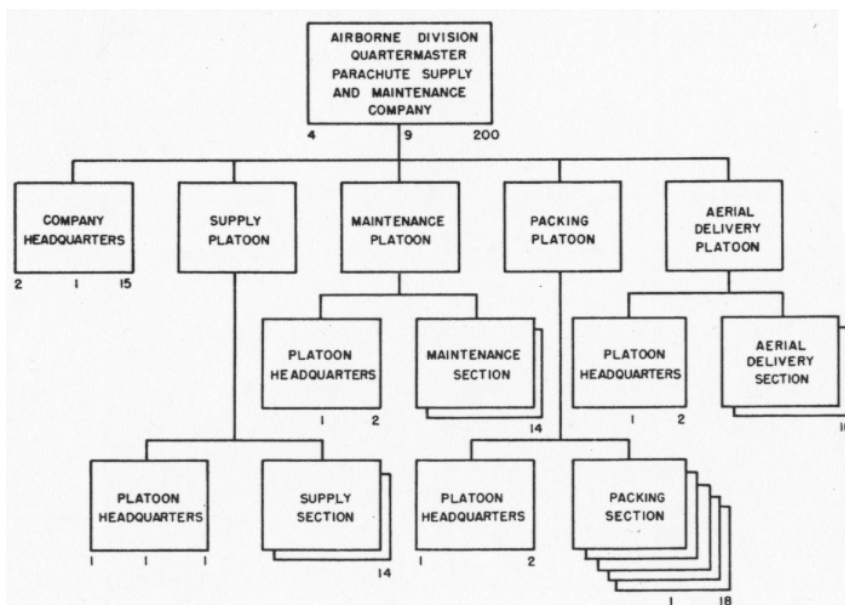


**Figure 22. The airborne division medical company.**

The medical company is responsible for all medical activities (fig 22). Its basic organization, in addition to a company headquarters, is an evacuation platoon and three clearing platoons. During tactical operations, it is normal to attach or place in support an evacuation section from the evacuation platoon to each battle group. This evacuation section assists the battle group by evacuating casualties from the battle group aid station to a clearing platoon. The clearing platoon, normally located near an air landing facility, is staffed with surgical teams trained to perform surgical treatments. Why is it that the airborne division has surgical teams and the medical battalion of the infantry division does not? Compare the missions of the two units. The mission of the medical battalion in the infantry division is to give emergency treatment to prepare the casualties for further evacuation to the rear. If evacuation aircraft cannot fly into the airhead, the airborne medical company must be prepared to perform the mission of administering surgical treatment. To do this, it has organic surgical teams.

The parachute supply and maintenance company gives "wings" to the airborne division (fig 23). The mission of this unit is to pack, store,

maintain, and issue quartermaster items required for aerial delivery of personnel, supplies, and equipment into the airhead. To give you an idea of the amount of equipment within this company, there are approximately 1,800 tons of quartermaster air items; for example, parachutes and heavy-drop platforms. The maintenance platoon is responsible for maintaining this great quantity of quartermaster air items. The packing platoon's responsibility is to pack personnel parachutes and to supervise the recovery of air items used during an airborne assault. The third operational platoon is the aerial delivery platoon. The personnel within this platoon are trained to give technical advice and to supervise the rigging of various types of equipment by the tactical units of the division for heavy-drop into an airhead during tactical operations. How long does it take for a battle group to prepare that equipment which will be heavy-dropped into the airhead? Experience shows that approximately 135 loads will be prepared for heavy drop, and it takes about 72 hours for a battle group to completely rig these loads. The last major unit of the company is the supply platoon. These personnel "ride herd" on the quartermaster air items that are issued to the tactical units of the division.

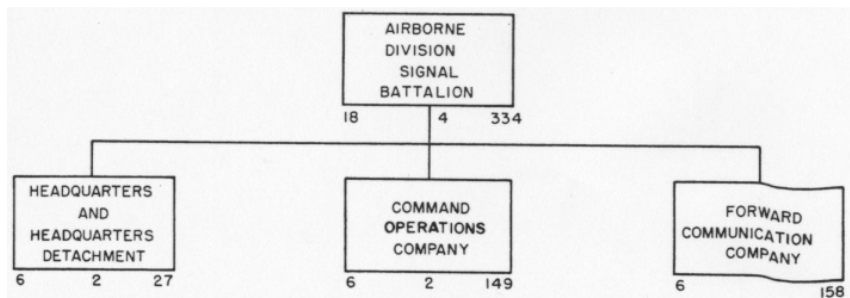


**Figure 23. The parachute supply and maintenance company.**

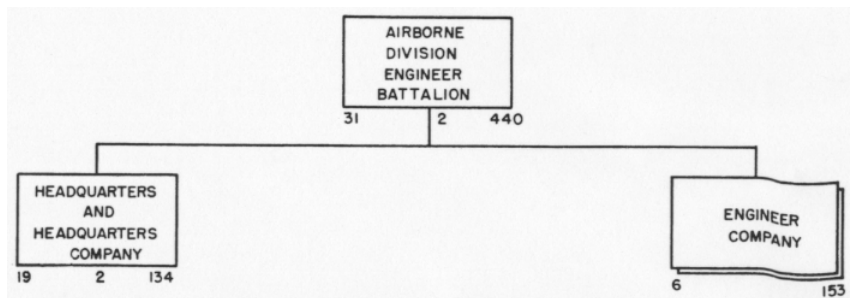
### **DIVISION SIGNAL BATTALION**

Signal activities and operations are centered in the division signal battalion (fig 24). This battalion is similar in organization to the signal

battalion of the infantry division. It has a headquarters and headquarters detachment, a command operations company, and a forward communication company. These units perform the same mission as their counterparts in the infantry division by establishing an area communications system and providing signal center support to the major tactical units of the division. The command operations company provides communications for the division command post, division artillery, engineer battalion support group, or those units that are normally found in the central portion of an airhead. The forward communication company focuses its effort on providing communications to the airborne battle groups.



**Figure 24. The signal battalion of the airborne division.**



**Figure 25. The engineer battalion.**

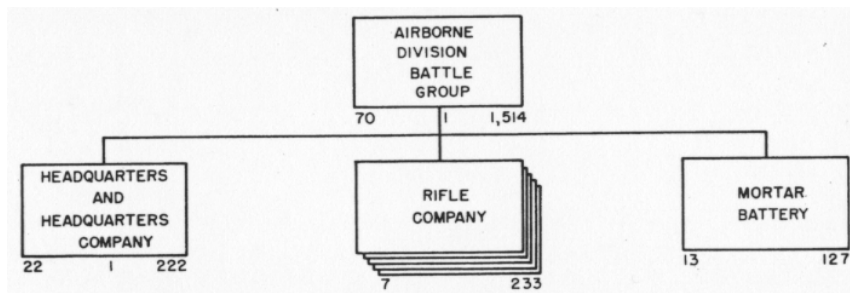
The airborne division also has an engineer battalion (fig 25). This battalion has, in addition to the headquarters and headquarters company, two engineer companies as compared to the five operating companies in the infantry division. You may ask yourself, "Why is it that the airborne division has two companies and the infantry division has five?" Again, compare the difference in missions of the two battalions. The infantry division engineer battalion provides general engineer support to improve the combat effectiveness of the division. This is done by repairing, maintaining, and building roads and bridges and performing other engineer work. In the airborne division engineer battalion, the first priority mission is to construct, maintain, or rehabilitate air landing facilities.



The task of maintaining and building roads and bridges has second priority. It has been determined that two operating companies are sufficient to accomplish the first priority job. Also, by reducing the number of engineer companies, considerable tonnage has been reduced in engineer equipment. Great strides have been taken to reduce to a minimum the size and weight of the earth-moving equipment within the battalion.

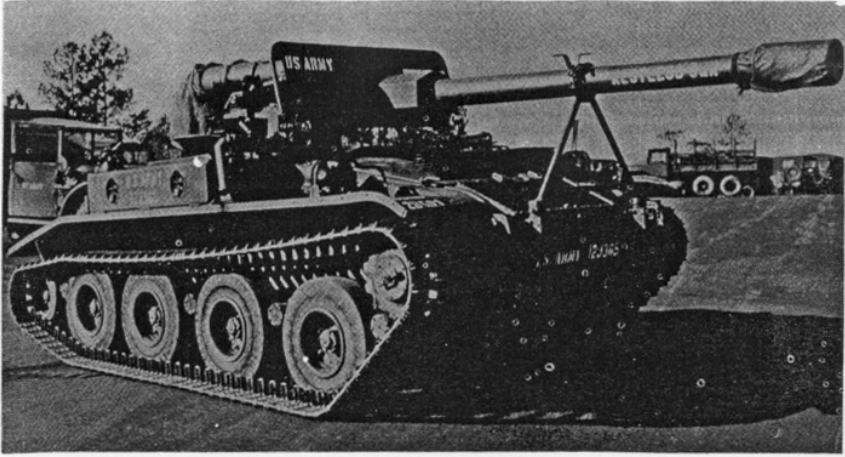
### AIRBORNE BATTLE GROUP

The basic combat element of the airborne division consists of five battle groups—the "iron fist" of the airborne division (fig 26). The battle group is a self-sufficient unit and can operate independently or with the division. The strength of the airborne battle group is 1,585 men compared to the battle group within the infantry division of 1,356 men. The airborne battle group has a headquarters and headquarters company, five rifle companies, and a mortar battery. The mortar battery is an artillery unit commanded by an artilleryman. However, even though it is an artillery unit, it comes under the direct command of the airborne battle group commander.



**Figure 26. An airborne division battle group.**

The headquarters and headquarters company provides the battle group with command and staff planning, administrative support, and supervision of operations. Units within the company provide reconnaissance, communications, assault gun and antitank support, terminal guidance for Army aircraft, and medical service. The airborne battle group does not have a combat support company. Some functions contained within the combat support company of the infantry division are found within the airborne headquarters and headquarters company; for example, the assault gun platoon. The airborne battle group assault gun platoon is equipped with six full-tracked, self-propelled antitank weapons, the M56, each mounting a 90-mm gun. Known as the "Scorpion," (fig 27), the M56 provides the battle group with the same gun as found on the M48 medium tank within the tank battalion of the infantry division. The M56 weighs 16,000 pounds and can be delivered by parachute, thus being capable of participating in the assault phases. When properly employed, it will add considerable strength to the battle group antitank defense and reduce vulnerability to enemy armor action immediately after the airborne assault landing.



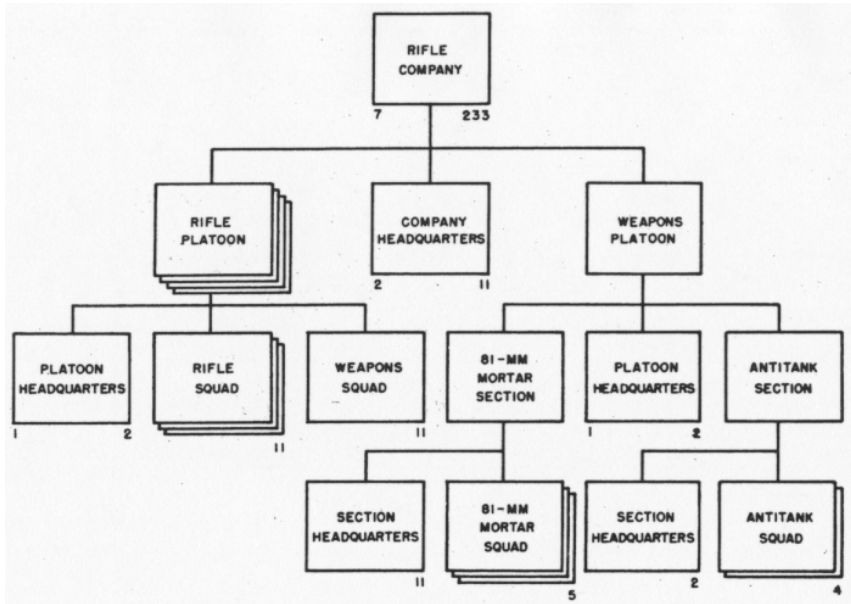
**Figure 27. The M56, commonly referred to as the "Scorpion."**

The communications platoon, in addition to providing the normal communication function of message center service and inter-battle group communications, has an electronic devices section with two medium radar teams and five light radar teams. The primary mission of the radar section is to provide ground radar surveillance for the battle group. The light teams are each equipped with an AN/PPS-4 portable radar set, and the medium teams are each equipped with an AN/TPS-21 radar set. Both sets can detect moving individuals and moving vehicles.

The headquarters and headquarters company also has a reconnaissance platoon. A major difference between this platoon and the platoon in the infantry division battle group is that its largest organic vehicle is the 1/4-ton truck. It has no armored personnel carriers and no light tanks.

### **AIRBORNE RIFLE COMPANY**

The rifle company normally fights as part of the battle group. It may operate under the direct control of the battle group commander or as part of a task force under the deputy battle group commander. The airborne rifle company (fig 28) has four rifle platoons as compared to three platoons in the infantry division rifle company. Because of this additional platoon, the airborne division exceeds the infantry division in "foxhole" strength by approximately 1,000 men. Why does the airborne division need this added strength? Because, during an airborne operation, there is an immediate need for a 360° defense once the assault force gets on the ground. Experience also shows that during the airborne assault phase, more than the average number of casualties can be expected. Since there is an absence of heavy fire support, especially early in an airborne assault, there is more reliance on individual weapons fires.



**Figure 28. A rifle company of the airborne division battle group.**

Except for the difference in the number of platoons, the organization of the airborne rifle company is similar to that of the rifle company in the infantry division. Each airborne rifle company does have, however, 12 M274 carriers (mechanical mule), a light infantry 1/2-ton 4 x 4, which alleviates, to a degree, the problem of ground mobility within an airhead. This vehicle, weighing only 900 pounds, has a payload of 1,000 pounds, and, fully loaded, can be heavy-dropped. The carrier is essentially a platform mounted on two axles and four wheels with a four-cylinder, four-cycle, air-cooled, opposed type, gasoline, 17-horsepower engine (fig 29).

Now, consider the artillery units within the airborne division. The mortar battery (fig 30) is organic to the airborne battle group; however, it is an artillery unit manned by artillerymen. It is 100 percent air transportable, but when using organic transportation, the battery is only 50 percent ground mobile. The capabilities of the mortar battery are as follows:

(1) To provide close and continuous fire support, to include observation, liaison, communication, and survey, for the airborne division battle group.

(2) To augment the fires of other artillery.

(3) To give continuous fire support during displacement.



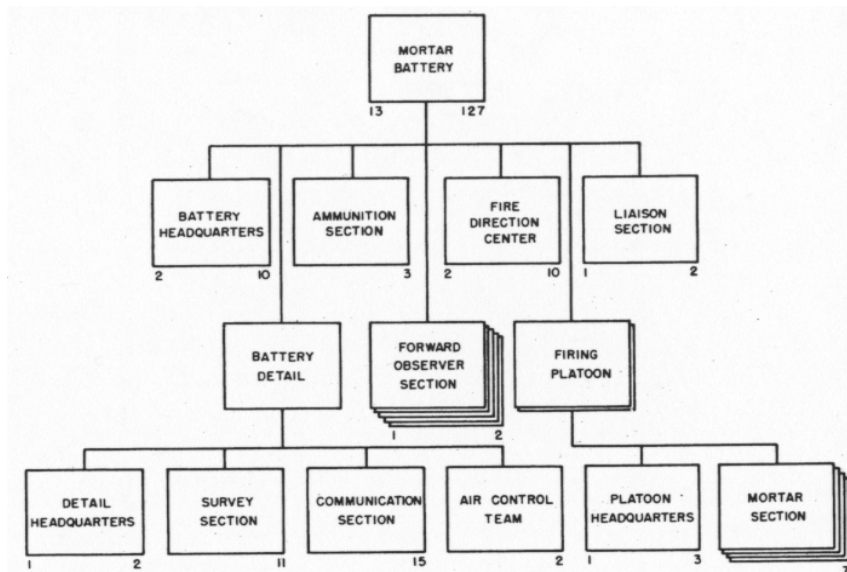
**Figure 29. The M274 carrier has a payload of 1,000 pounds.**

### **THE BATTERY HEADQUARTERS**

The battery headquarters is the same as in any artillery battery and performs the normal functions of command and administration. One difference does exist, however. The executive officer is in the battery headquarters since there is no firing battery. Because the mortar battery must furnish close and continuous fire support to each rifle company of the battle group, there are five forward observer sections. These sections are similar to those in the infantry division artillery except that they have no vehicles.

The firepower capability is found in the two firing platoons, each consisting of a platoon headquarters and four mortar sections with one 4.2-inch mortar each. This gives a total of eight 4.2-inch mortars in the battery. Normally, these mortar platoons will operate separately rather than as a combined unit. The mortar battery commander, as the senior artilleryman in the battle group, is the fire support coordinator. A liaison officer provided by the TOE, represents the battery commander at battle group headquarters and advises the battle group commander on fire support matters. This section contains a liaison officer, a liaison

specialist, a radiotelephone operator, and a 1/4-ton truck with two radios, an AN/VRC-9 and an AN/VRC-10.



**Figure 30. The mortar battery of the airborne battle group.**

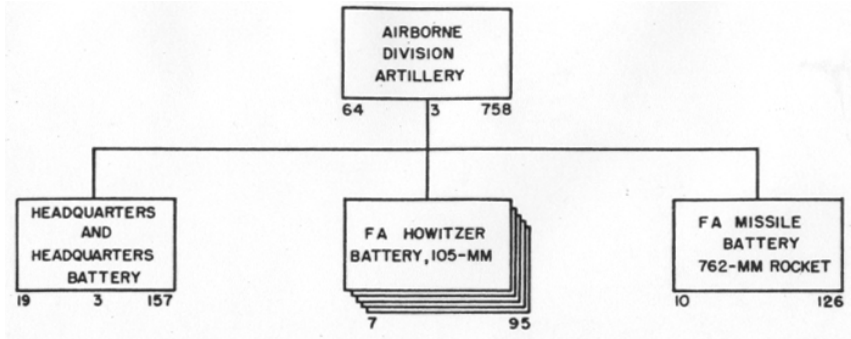
The battery fire direction center (FDC) operates directly under battery control and has two officers and 10 enlisted men. The FDC not only can operate as one unit, but is capable of being split into two sections to operate with the two firing platoons when they are firing independently.

The ammunition section contains three enlisted men and three infantry light weapons carriers, the M274, to transport ammunition with the battery.

The battery detail is organized to accomplish its normal function of communication and survey. The survey section has two 5-man teams operating under the chief of survey. The communication chief supervises the employment of his two 7-man wire teams. An item not normally found in a battery detail is the air control team. Since this is an airborne unit, there will be many close support aircraft operating in the area to support the division. As a result, there is a need for forward air controllers. A 1/4-ton truck and an AN/VRC-30 radio set are available to provide the forward air controller with communications and transportation.

### THE DIVISION ARTILLERY

The division artillery (fig 31) differs from all other division artillery organizations in that it has no organic battalions. It consists of a headquarters and headquarters battery, five 105-mm howitzer batteries, and a field artillery missile battery (Honest John).



**Figure 31. The airborne division artillery.**

The division artillery is commanded by a colonel. The headquarters and headquarters battery has a normal command and control element; a staff consisting of an S1, S2, S3, and S4; and a headquarters for the administration and operation of the battery. The battery is capable of performing the necessary communications, survey, and meteorological functions associated with a division artillery. In addition, there are operations and intelligence personnel to assist the staff in their duties. This unit has those administrative and logistical functions normally associated with a battalion headquarters, such as ammunition, supply, and personnel sections. Since the division artillery commander is the fire support coordinator for the division, there is a need for a fire support coordination center (FSCC). The TOE provides the personnel for this FSCC, and this section is capable of performing those functions associated with the FSCC. Again, as in the mortar battery, there are air control teams. Three of these teams are organic to the division artillery headquarters and headquarters battery, and they perform the same duties as those in the mortar battery.

The major tactical element of the division artillery is the 105-mm howitzer battery. This battery is organized similarly to other 105-mm howitzer batteries, with a battery headquarters for command and control, a battery detail to perform survey and communications, and a firing battery composed of an FDC, an ammunition section, and five howitzer sections. The elimination of one howitzer section has helped to lighten the airlift requirements of the division artillery.

### **HOWITZER BATTERY REINFORCES MORTAR BATTERY**

Current artillery doctrine dictates that whenever a battle group is committed, its organic mortar battery will be reinforced by the fires of at least one 105-mm howitzer battery. This can be accomplished by assigning to the 105-mm howitzer battery a reinforcing or a general support-reinforcing mission. In either case, it is necessary for the howitzer battery to have a representative at the mortar battery headquarters. A liaison section has been provided by the TOE for this purpose. The mortar battery might also request forward observer assistance, so a for

ward observer section has been provided. If the mortar battery does not require an additional forward observer, the division artillery S2 may use this observer to establish an artillery observation post.

The nuclear punch of the division is the Honest John battery. It is organized much the same as its counterpart in the infantry division, except for additional firing sections. The Honest John battery has a battery headquarters for command and control, a battery detail for survey and wire functions, an FDC for computation of firing data, an assembly section, and two firing platoons of two sections each. The battery is completely air transportable and 100 percent ground mobile with its organic transportation.

Figure 32 sums up the capabilities of the artillery with the division. First is the ability of the artillery units with the division to move. The mortar battery is 50 percent ground mobile with its organic transportation. The 105-mm howitzer battery is 60 percent ground mobile and the Honest John battery is 100 percent ground mobile. All divisional artillery units are completely air transportable.

	<b>MORTAR BATTERY</b>	<b>105-MM HOWITZER BATTERY</b>	<b>HONEST JOHN BATTERY</b>
MOVE			
Mobility	50%	60%	100%
SHOOT			
Fire direction	FDC section	FDC section	FDC section
Firing	Eight 4.2-inch mortars	Five 105-mm howitzers	Four Honest John launchers
Survey	Survey section	Survey section	Survey section
Observation	Five forward observers	One forward observer	None
Liaison	One liaison officer	One liaison officer	None
Ammunition	Ammunition section	Ammunition section	Assembly section
COMMUNICATE			
Communications	Communication section	Communication section	Communication section
	Air control team		
PLUS	Battery headquarters for command and control		

**Figure 32. Capabilities of the airborne division artillery.**

Next is the ability to shoot. Each battery has an organic FDC section for the computation of firing data. There are eight 4.2-inch mortars in each mortar battery, a total of 40 in the division. Each 105-mm howitzer

battery has five howitzers, a total of 25 in the division, and the Honest John battery has four launcher sections.

Each battery has survey personnel. There are five forward observers in the mortar battery and one in each 105-mm howitzer battery, or a total of 30 artillery observers in the division. There is a liaison section in each mortar battery and 105-mm howitzer battery. Each battery also has an ammunition or assembly section.

Last is the ability to communicate. Communications personnel are in each battery. In addition, there is an air control team in each mortar battery and three of these teams in the division artillery headquarters and headquarters battery. Each battery has a battery headquarters for command and control.

There you have it, the "lean and mean" airborne division. Although its fire support capability and ground transport is less than that of the infantry division, this loss is compensated, to a large degree, by an increase in "fighting soldier" strength. The pentomic airborne division is organized, equipped, and trained to move by land, sea, or air—*anytime to anyplace*—and FIGHT.



## **THE 'ART' OF WARFARE—MAPS**

The need for maps has been recognized by every commander since armies have fought in strange lands. General Washington once said, "The want of accurate maps . . . has been of grave disadvantage to me. I have in vain tried to procure them, and have been obliged to make-shift with such sketches as I could trace out from my own observations and that of gentlemen around me . . ."

It cannot be claimed that maps are the most important tool of modern war, but modern warfare cannot be carried on without them. Today there is not a single branch of the Armed Services which does not use maps.

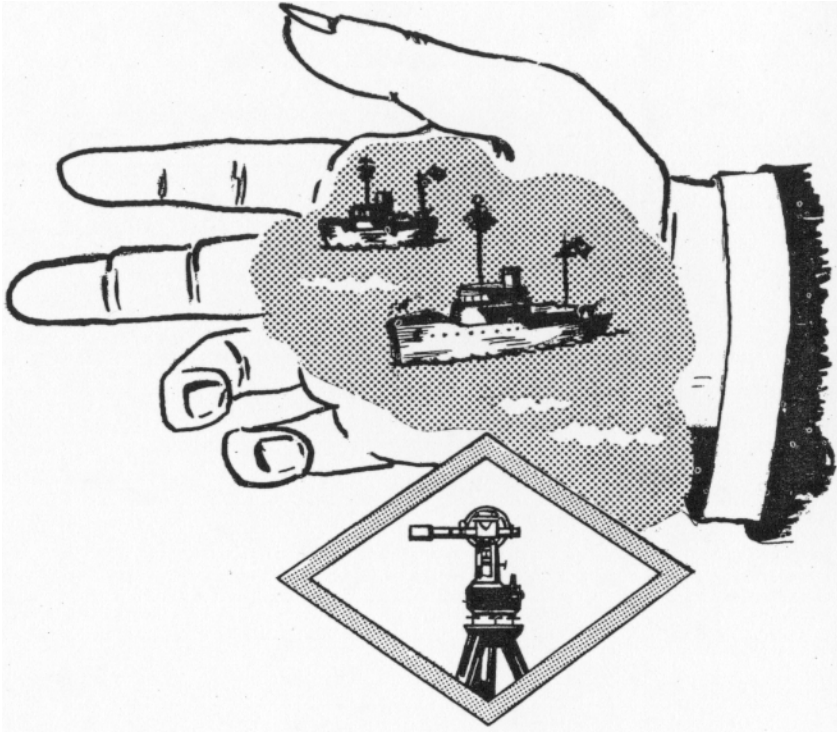
Progress in map making has been somewhat slower than for other tools of war. Perhaps the most far-reaching development in modern military maps was the adoption of the universal transverse mercator grid (commonly called Military Grid or UTM) by all North Atlantic Treaty Organization (NATO) forces in 1952. It is now possible to shoot from a battery position on one map to a target on another map.

As a result of this standardization, the commander has more *usable* maps. The main source of supply is still the Army Map Service; however, the same map correction factors and tables will apply to those of other organizations. If the commander receives a map from an ally, it will have the UTM grid. This is also true in the United States. To facilitate the use of maps by Civil Defense personnel and others, the UTM grid is shown on all quadrangle maps prepared by the Geological Survey. This standardization increases the availability of maps for an emergency.

The adoption of the UTM by many map makers, along with advances in acquiring, interpreting, and reproducing chart information, aids the commander who sorely needs the "art" of warfare—maps.



## sea-going survey



## Artillery's Helping Hand

Lieutenant Commander John O. Boyer  
US Coast and Geodetic Survey  
Liaison Officer, USAAMS

One hundred and fifty-four years ago a neophytic agency known as Coast Survey was created by an Act of Congress. The Act directed President Thomas Jefferson to use this agency "to cause a survey to be taken of the coasts of the United States and to undertake such matters in connection therewith as he may deem proper for completing an accurate chart of every part of the coasts thereof." Destined to become the government's oldest scientific bureau, the former Coast Survey exists today as the US Coast and Geodetic Survey (the Survey), one of the United States' seven commissioned services.

The Survey is a major source of assistance to the Army in the field of survey. The modern artillery surveyor must take into account factors he considered insignificant a few years ago; for example, the world

wobbling as it spins about its axis. Also, an azimuth used to be THE azimuth, but now it must be known whether it is a magnetic, geodetic, astronomic, plane grid, or geodetic grid azimuth. All differ significantly. Although it is a relatively small organization the Survey has contributed significantly to the complicated science of the earth and is recognized as a world leader in the practice and theory of geodetic surveying. With the increased sophistication necessary in survey for the accurate fire prediction essential with today's modern weapons systems, artillerymen should become better acquainted with this small but unique service.

The title Coast Survey was changed to Coast and Geodetic Survey in 1878, reflecting the added responsibilities in geodetic surveying. In 1807 the Coast Survey's responsibility included only the few thousand miles of the new country's coastline. The United States and her possessions grew until the Survey was responsible for over 100,000 miles—four times the distance around the world—of coastline. Now, several million square miles of coastal areas are included which must be surveyed repeatedly for safe navigation. The wisdom of undertaking a survey of the coast has become increasingly evident through the years from the benefits to commerce, industry, engineering, and national defense.

### **COAST AND GEODETIC SURVEY RESPONSIBILITY**

The basic responsibility of the Survey is to provide accurate nautical and aeronautical charts of the United States and her possessions. An enormous amount of technical data is required to produce modern charts. The government's responsibility for many of these related investigations has been delegated to the Coast and Geodetic Survey. One major responsibility of the Survey is the execution of all first- and second-order, formerly called primary or precise, geodetic control surveys. This requires a constant study of the size, shape, and motion of the earth and involves astronomy, gravity, geomagnetism, seismology, and most branches of physical earth sciences. In addition to hydrographic surveys, nautical charts require the study of tides, currents, magnetics, and the broad field of oceanography that encompasses so many subjects about which the world knows relatively little. The requirement to show topography on charts caused the Coast and Geodetic Survey to pioneer and become a leader in the development of photogrammetry.

The Coast and Geodetic Survey is a bureau of the Department of Commerce; it is headed by a director and a deputy director, both of whom are rear admirals. Most of the operations of the Survey are directed by commissioned officers who are graduates in engineering and hold ranks similar to those in the Navy. Officers and enlisted personnel man the Survey's ships, and civilian engineers, scientists, and technicians participate in field and office operations. The Survey's present staff numbers about 2,200, of which 185 are commissioned officers.

The work of the Coast and Geodetic Survey is carried on chiefly in the interests of commerce and industry, though considerable work and guidance is supplied the military, state and local governments, and foreign nations. With the advent of war, all activities are channeled to

concentrate on projects essential for war purposes. Commissioned officers, without option on their part, are subject to transfer to combat duty in the Armed Forces or to duty with the Survey in areas of military hazard. The possibility of assignment to combat units is the same for Coast and Geodetic Survey officers as for officers of the Armed Forces.

### **SURVEY OFFICERS TRANSFERRED TO ARMED FORCES**

During World War II, 94 of the 171 commissioned officers in the Survey were transferred to the Armed Forces—48 to the Army and 46 to the Navy and Marines. Officers transferred to the Army served principally with the Air Corps, Field Artillery, and Corps of Engineers. In the Air Corps, they engaged in mapping isolated regions of Africa, Asia, Alaska, and South America and in the development of electronic methods for determining distance. The Army Air Corps Chart Plant at St. Louis, Missouri, now the Aeronautical Chart and Information Center, was commanded by the present Director of the Survey.

Survey officers assigned to Army and Marine artillery forces generally served in observation units, some in command of battalions. Their work included development of methods and instruction of personnel in surveying and map construction. One officer was head of the survey department at the Field Artillery School, Fort Sill, Oklahoma, during the war; two Coast and Geodetic Survey officers served as his assistants. Coast and Geodetic Survey officers at Fort Sill did much to change or rewrite survey manuals, teach survey instructors, and improve methods for field work and computations in artillery survey so that good surveys were possible under battlefield conditions. Good surveys made possible the massing of artillery fires, a decisive factor in World War II. Most of the officers transferred to the Corps of Engineers were engaged in amphibious landing operations, including development of methods and equipment for navigation, instruction of personnel, and actual landings on enemy shores.

The majority of the officers on duty with the Navy served on Coast and Geodetic Survey ships (fig 33), which were transferred to the Navy, and on other naval survey ships. Some were assigned as commanding officers, others as executive officers or survey officers. Their duties included performance of survey in combat, preparation of preliminary charts for immediate use, establishment of aids and removal of dangers to navigation, piloting ships, conducting salvage operations, and laying out anchorages.

The preceding enumeration of duties performed by officers transferred to the military is not intended to minimize the importance of the war time work done by the personnel who remained with the Survey. Rather, the duties are shown as a guide to the future commander who might someday have a Coast and Geodetic Survey officer assigned to his unit.

After the war, several branches of the Army and Air Force requested the continued assignment of Survey officers for special duties; for

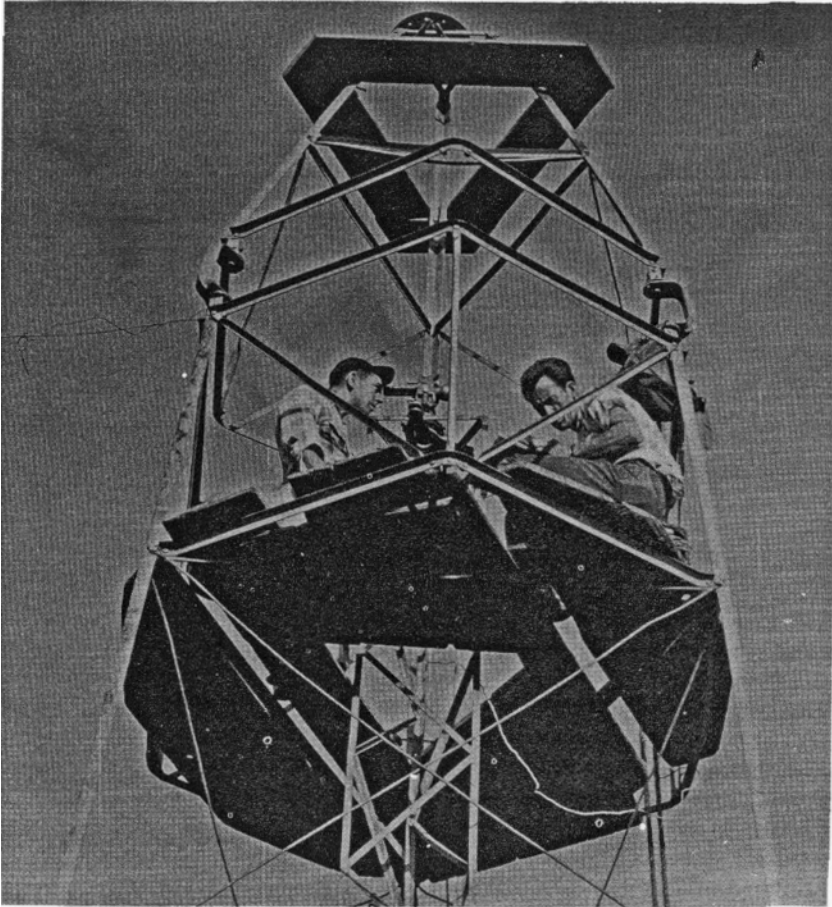


**Figure 33. The Coast and Geodetic Survey Ship SURVEYOR, completed in April 1960, is the world's most modern and best-equipped survey vessel.**

example, as survey experts and consultants, instructors in artillery survey schools, and in connection with the development of survey instruments. Such assignments prove mutually beneficial since officers on these assignments render valuable technical assistance to the military and at the same time receive training in military procedure. Coast and Geodetic Survey officers are now stationed at the Air Force Missile Center, Patrick Air Force Base, Florida; Cape Canaveral, Florida; Orlando Air Force Base, Orlando, Florida; Naval Amphibious School, Norfolk Virginia; and the US Army Artillery Board and the US Army Artillery and Missile School, Fort Sill.

#### **SURVEY PERFORMS UNUSUAL AND PRECISE SURVEYS**

A commander with an unusual survey problem might well find it advantageous to consult the Coast and Geodetic Survey (fig 34). The Survey has been called on by military services to execute many unusual and precise surveys for a wide variety of purposes. These have ranged from a small ultra-accurate survey of about 200 feet at Cape Canaveral to a 250-mile triangulation scheme for the Navy off the California coast. Most of the projects were concerned with observational control of various types of test missiles in flight. One such project was a triangulation survey at White Sands Proving Ground, where 10 times the minimum length accuracy for first-order work was reached. Another project, at the Navy's David Taylor Model Basin, involved the problem of obtaining unusually accurate alinement. A precision of 0.02 inch was obtained over a line 2,000 feet long.



**Figure 34. Survey being performed from the top of a steel tower.**

The greatest known accuracy ever accomplished by geodetic survey was recently attained by the Coast and Geodetic Survey on a project carried out for the Air Force. This project entailed the precise location of nine ballistic camera sites spread out over an area of about 4,050 square miles for photographing space missiles or flares against a background of stars. The average probable error of the positions of the camera sites was calculated to be about 0.2 feet, the average correction to geodimeter baseline lengths measured in the operation was 1 part in 1,200,000, and the average probable error in direction was only 0.18 seconds (0.0009 mils). Precision achieved in this project was ten times greater than the Survey's rigid requirements for first-order triangulation.

Most of the work and products of the Survey are directed toward, and for the use of, air and ship navigation; however, the Coast and

Geodetic Survey is ever mindful of its engineering responsibilities in many different fields. Its accumulated data, together with its technical procedures as set forth in numerous reports, manuals, and special publications, constitute a vast reservoir of precise facts of immediate and potential value to the engineer, surveyor, and scientist. Because of its unique organization, its technically trained personnel, and its specialized equipment, the Survey forms an effective reserve for service to the country in times of national emergency.

As ranges are extended and survey becomes more complex, the assistance which the Coast and Geodetic Survey can give the Artillery becomes increasingly important.

---

●

### **A GEM FOR ELECTRONIC WARFARE TRAINING**

To simulate enemy jamming during field exercises, a standard FM radio will make an acceptable jammer. To use an FM radio as an expedient jammer, connect a loudspeaker to one of the audio receptacles on control box C-375/VRC. If a control box is not being used with the set, connect the loudspeaker to the audio receptacle on the receiver-transmitter. Connect a handset to the other audio receptacle. Turn the set on to maximum volume and tune to the frequency you wish to jam. Press the PUSH-TO-TALK switch on the handset and hold the microphone an inch or two from the speaker. Feedback will cause a whistle or squeal which will change tone as you move the handset. With a little practice, you can produce a jamming signal similar to the stepped-tone or "bagpipes" sometimes used by jamming stations. You might have to try several combinations of receiver-transmitter, speaker, and handset for best effect.

A sound similar to modulated continuous wave (CW) can be produced by using the RING switch on the receiver-transmitter. Voice jamming is produced by chattering into the microphone. In each case, the vehicle can be moved about to provide the desired signal strength and degree of interference. The strength of the jamming signal should allow receiving operators to work through the jamming by using proper procedures.

Although these jamming methods should be continued only for relatively short periods, such procedures will make operators conscious of jamming and afford training in anti-jamming techniques and reporting procedures.

—Submitted by Capt Charles C. Wieland  
Dept of C & E, USAAMS

---

"The artillery saved my arm (infantry) from utter destruction and sacrificed itself to cover the retreat."

Frederick the Great

# Tactical Redstone Employment

Captain George M. Rodgers  
Tactics/Combined Arms Department

. . . . Five, four, three, two, one, A, B, C, D, E . . . . a blinding flash, a mighty roar, a cloud of dust, and the largest and longest range tactical operational field artillery guided missile in the Army—the Redstone—is on its way. The Redstone provides the Army with a missile that supplements and extends the firepower of artillery cannon and missiles, provides long-range fire support for ground forces, and compensates for the expanding dimensions of the battle area.

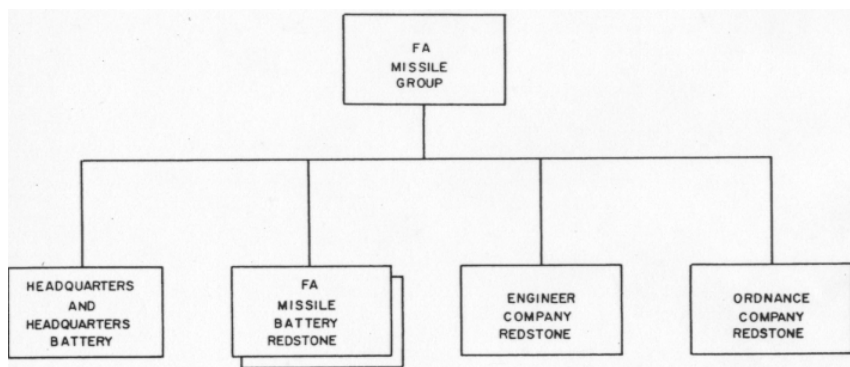
The Redstone was named for its place of development—Redstone Arsenal, Huntsville, Alabama. The United States' first successful developmental firing of an inertially guided Redstone ballistic missile was accomplished in December 1955. In December 1956, the Redstone was the first operational prototype, long-range ballistic missile to be fired in the western hemisphere, to a range of over 400 nautical miles. In January 1958, when the first United States satellite, Explorer I, was placed into orbit by a Jupiter C missile, a Redstone missile was used for the first stage of the Jupiter C missile system. A Redstone missile was also used in the Jupiter C missile system which placed Explorer IV into orbit. The Redstone was first successfully fired by troops in May and June of 1958. These historic firing tests were accomplished in May by Battery A of the 40th Field Artillery Missile Group, Redstone, at Cape Canaveral, Florida, and in June by Battery B, 40th Field Artillery Missile Group, Redstone, at White Sands, New Mexico.

The first Redstone unit to be organized was the 217th Field Artillery Missile Battalion, Redstone, which was activated in April 1956 at Redstone Arsenal. The battalion was composed of a headquarters and service battery, two firing batteries, and a medical section. Ordnance and engineer support was furnished by a separate ordnance company, Redstone, and a separate engineer company, Redstone. However, certain weaknesses were found in testing this battalion, and the unit was reorganized in September 1957 as the 40th Field Artillery Missile Group, Heavy, Redstone.

## **REDSTONE GROUP REORGANIZED IN MARCH 1958**

The Redstone group, heavy, was composed of a group headquarters and headquarters battery, a field artillery missile battalion, Redstone, an

ordnance company, Redstone, and an engineer company, Redstone. Field experience indicated that the field artillery missile battalion headquarters and service battery, Redstone, was not necessary for effective employment of the group, heavy; thus, the unit was reorganized in March 1958 as the 40th Field Artillery Missile Group, Redstone. This field artillery missile group, Redstone, is typical of the present-day organization. It consists of a headquarters and headquarters battery, two missile batteries, an engineer company, Redstone, and an ordnance company, Redstone (fig 35).



**Figure 35. The present-day organization of the field artillery missile group, Redstone.**

The Army has three Redstone groups. The 40th Field Artillery Missile Group, Redstone, and the 46th Field Artillery Missile Group, Redstone, which was activated in October 1957 at Fort Sill, Oklahoma, have taken their place at the forefront of the armed might of the North Atlantic Treaty Organization (NATO) in Europe. The 209th Field Artillery Missile Group, Redstone, which was activated in September 1958 at Fort Sill, is the third group. Its mission is to support the US Army Artillery and Missile Center, the US Army Artillery and Missile School, and to provide equipment support for Advanced Individual Training for the 1st Field Artillery Missile Brigade.

Figure 36 lists the characteristics of the Redstone missile system. These characteristics influenced the organization of the present-day Redstone group.

The mission of the field artillery missile group, Redstone, is to provide nuclear missile fires in general support of the field army; one Redstone group is normally assigned per field army. The supported or higher headquarters commander and his staff must be familiar with several considerations to accomplish this mission.

### **COORDINATION OF FIRE SUPPORT**

The coordination of fire support of the Redstone group must be considered. Under the concept of the field army tactical operations center



(FATOC), coordination of the fires of the Redstone group is accomplished by the fire support element (FSE) of the field army tactical operations center. The fires of the group are planned, coordinated, and integrated with other fires in accordance with principles for the employment of fire support in FM 6-20. Another factor that must be considered is the detailed analysis of potential nuclear targets to determine their suitability for attack. This is done in the FSE after a target area has been evaluated by the commander and the G3. The commander's guidance is given to the FSE; then the target analyst performs the detailed analysis and makes a recommendation to the commander on the method of attack, yield, height of burst, and expected condition of the target area after attack.

<b>Length</b>	21.1 meters (69 ft, 4 in)
<b>Diameter</b>	1.8 meters (70 in)
<b>Loaded weight</b>	61,700 pounds
<b>Empty weight</b>	16,300 pounds
<b>Range (maximum)</b>	330 kilometers (200 statute miles)
<b>Propellants:</b>	
— <b>Oxidizer</b>	Liquid oxygen, 25,000 pounds
— <b>Fuel</b>	75 percent alcohol plus 25 percent water, 19,000 pounds
— <b>Steam source</b>	Hydrogen peroxide, 854 pounds
<b>Thrust</b>	78,000 pounds for 96 to 121 seconds
<b>Guidance</b>	Inertial
<b>Warhead</b>	Nuclear, 7,900 pounds total nose section weight
<b>Mobility</b>	100 percent

**Figure 36. Characteristics of the Redstone missile system.**

The supported or higher headquarters is responsible for the surveillance of fire, which is accomplished through the field army tactical operations center. The surveillance of fire of the Redstone group may be performed by Army aviation through the Army aviation element, by the tactical air support element, by artillery controlled equipment and personnel through the FSE, or by other means available to the commander through the G2 or G3 element.

The next consideration is, what targets are available for the Redstone? The Redstone can be used against troop concentrations, such as general reserve units; command installations, corps or higher; missile firing positions; air fields; communication centers; logistic centers; and critical terrain defiles. After a target has been selected, the supported or higher headquarters commander and his staff must consider the mobility and transportability of the Redstone group to move it to a position where the mission can be accomplished. The Redstone group is 100 percent mobile with its organic vehicles; it is air transportable in current aircraft of the United States Air Force (C-124's and C-133's), with the exception of the liquid oxygen generating plants, whose space requirements

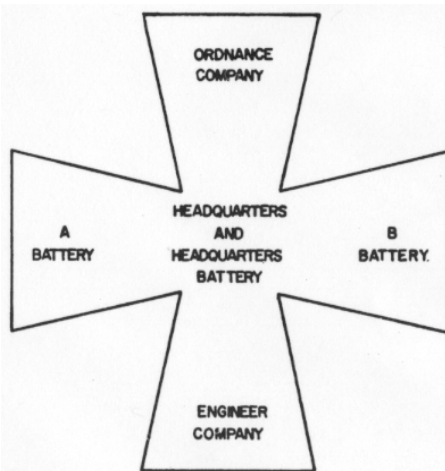
and excessive weight prevent air travel. The Redstone can be moved at road speeds comparable to heavy cannon artillery. For deception purposes, movement will be conducted during darkness or under conditions of reduced visibility by multiple routes or by infiltration.

The Redstone is considered invulnerable to known electronic countermeasures.

How is the Redstone group tactically employed? First, you must understand the relationship between the Army artillery officer and the Redstone group. The fires of the Redstone group are controlled by the artillery officer; this control includes the selection of a general position area for the group. A preliminary map and aerial reconnaissance of the possible position areas should be made by the artillery officer or his representative before a general area is assigned to the Redstone group. The artillery officer will notify the group commander of his selection of position area. The group commander will then make a thorough map reconnaissance of the designated area followed by an air reconnaissance. Aircraft requested for the reconnaissance by the group commander must come from the Army air section, since aircraft are not authorized by the Redstone group's tables of organization and equipment. Then, a more detailed reconnaissance is made. The reconnaissance of a Redstone group position area is time consuming because of the large area required for the entire group—an area 13 to 16 kilometers in diameter. During his reconnaissance, the group commander may select the position areas for the elements within the group, placing them in what is known as a "Maltese cross" formation (fig 37).

The Redstone group commander uses this formation for simplification of command, administration, communication, survey, and local security problems. A major advantage of the Maltese cross formation is the time saved in resupplying the missile batteries with missiles, fuel, and components.

When selecting position areas for the company- or battery-size units, the group commander must ask himself several questions. Is the terrain firm enough to support the missile when it is fully serviced and ready for firing? Are there good access roads and communication routes leading into and out of the area? Are natural cover and concealment used to their best advantages? After he has answered these questions, the commander must consider security,



**Figure 37. A diagram of the "Maltese cross" formation.**

since the personnel and equipment organic to the group are not adequate for ground and air defense of the Redstone group. Security is a major factor that the Army commander and artillery officer must also consider in selecting the Redstone group position areas. The position areas should be located, when possible, in an existing air defense framework. Because the nuclear capability of the Redstone missile makes each position area of the Redstone group a high priority target for attack, additional personnel and equipment may be required for position area defense.

The most effective way for an enemy to counteract the effectiveness of missile fire is to prevent a unit from firing its missiles; therefore, it can be expected that the enemy will focus his countermissile intelligence efforts on locating the Redstone group position areas. It can also be expected that the enemy will attack the position area with every means at his disposal. The group commander must insure that all active and passive security measures are fully implemented, so that the Redstone group can accomplish its mission. The principle of tactical mobility must be practiced, since this principle is the key to successful employment of missiles. Keep this in mind; *fixed missile sites are dead sites*. The commander must make a continuous reconnaissance and study of the situation, and have several firing positions preselected and prepared to minimize the time required when a mission is assigned.

The Redstone system is an extremely hard-hitting, reliable system which is immediately responsive to the requirements of the Army commander. By applying the principles of tactical employment, the mission of the Redstone group can be and will be accomplished. The Redstone can influence the actions on the battlefield to a depth and degree never before possible.



## **WHEN IS A METER A METER?**

The conversion of maps and linear measurements to the metric system has made quite an impact on the field artillery. It has altered particularly the tools and thinking in fire direction techniques.

Do you really know what constitutes "one meter?"

By an Act of Congress, the meter is the base of American linear measurement, as well as in countries using the metric system, and in all scientific laboratories in the world. Since 1889, the world standard meter has been a platinum-iridium bar kept in France. In the past, meter bars were sent to France for calibration against the standard. However, despite the extreme care taken in calibration, some of the secondary standards were often of different length than others. But now, these annoying errors have been overcome.

The international meter is now the length of 1,650,763.70 wave lengths of the orange-red line of light emitted by krypton 86. The new standard replaces the platinum-iridium bar in France. It is immediately accessible anywhere and should simplify scientific work.

# Status of FDC Graphical "Tools"

1/Lt David A. Hufnagel  
Gunnery/Cannon/Rocket Department

Calling all battalion commanders, battery commanders, and executive officers . . . here, in the form of handy, removable status charts (figures 38 and 39), is the answer to your inquiries concerning new graphical fire direction equipment.

Newly designed graphical equipment was developed with the advent of new tabular firing tables. Graphical equipment based on the new firing tables (FT 155-Q-3) for the 155-mm howitzer was the first to appear with a change in size and design (ARTILLERY TRENDS, May 1960). These rules, which are the forerunners of graphical equipment for the new 105-mm and 8-inch howitzer firing tables, include the Scale, Graphical Firing, M64 (formerly GFT); Scale, Graphical Firing, Site, M67 (formerly GST); and the Scale, Graphical Firing, M70. This last graphical device is designed for use with the illuminating shell, M118, Mods (ARTILLERY TRENDS, November 1960).

Graphical equipment for use with FT 8-J-3, the new tabular firing tables for the 8-inch howitzer, was issued in December 1960. This equipment was developed by the US Army Artillery and Missile School (USAAMS), Fort Sill, Oklahoma, and recommended by the US Army Artillery Board (USAAB), Fort Sill, for issue to 8-inch howitzer units. These graphical items include the Scale, Graphical Firing, M71; and Scale, Graphical Firing, Site, M72; they will replace the GFT and GST paper scales for FT 8-J-2, which were mailed to active and reserve units in March and July 1960, respectively.

Ordnance contracts are presently in progress to procure graphical fire direction equipment based on FT 155-Q-3 and FT 8-J-3 for appropriate howitzer units.

## **BALLISTIC DATA FOR FT 105-H-6 TO BE AVAILABLE SOON**

The ballistic data needed to develop graphical equipment for FT 105-H-6, the new firing tables for the 105-mm howitzer, should be available to the Artillery and Missile School from Ballistic Research Laboratories (BRL), Aberdeen Proving Ground, Maryland, in April 1961. This will be approximately six months prior to publication of the tabular firing tables. In addition to the Scale, Graphical Firing, and Scale, Graphical Firing, Site, a graphical device for the illuminating shell will be developed which will be identical in operation to the M70 device for the 155-mm howitzer illuminating shell.

New graphical equipment has also been developed for the Honest John (762-mm Rocket) (fig 39). The Scale, Graphical Firing, M73, based on FTR 762-F-1, resembles a GST in appearance and provides a rapid solution for low level wind corrections. The status of other graphical scales for low level wind corrections and their appropriate tabular firing

DATA SOURCE			
DATA OBTAINED	105-MM Howitzer		155-MM Howitzer
	Range And Deflection	FT 105-H-4 Yds-OSA	FT 105-H-6 M-ICAO
PROTRACTOR, FAN, RG, DF (Aluminum) 16,500 yds SN 1290-266-6894* (Standard)		PROTRACTOR, FAN, RG, DF (Aluminum) 15,000 meters SN 1290-266-6890*	PROTRACTOR, FAN, RG, DF (Aluminum) 15,000 meters SN 1290-266-6890* (Standard)
Elevation	GFT FAN MI (Plastic) 15,000 meters SN 1220-335-4970 (Standard)	GFT FAN (Aluminum) To be evaluated by USAAB (Project Nr 2253-2)**	GFT FAN M2 (Plastic) 15,000 meters SN 1220-335-4971 (Obsoloescent)
	GFT M39A1 Rule 1 and 2 (Limited Standard)	SCALE, GRAPHICAL FIRING (GFT) Awaiting BRL data SCALE, GRAPHICAL FIRING (GFT, Sb, Illuminating) Awaiting BRL data	SCALE, GRAPHICAL FIRING, M64 (GFT) Rule 1 and 2*** (Standard) SCALE, GRAPHICAL FIRING, M70 (GFT, SL, Illuminating) Rule 1 and 2*** (Standard)
Site	GST M53A1 (Standard)	SCALE, GRAPHICAL FIRING, SITE (GST) Awaiting BRL data	GST M54 (Obsoloescent)*** Awaiting Ord contract for troop issue

	FT 8-J-2 M-ICAO	FT 8-J-3 M-ICAO	FT 8-O-2 M-ICAO	FT 8-O-3 M-ICAO
<b>Range And Deflection</b>	PROTRACTOR, FAN, RG, DF (Aluminum) 25,000 meters SN 1290-266-6891*	PROTRACTOR, FAN, RG, DF (Aluminum) 25,000 meters SN 1290-266-6891* (Standard)	PROTRACTOR, FAN, RG, DF (Aluminum) 25,000 meters SN 1290-266-6891*	PROTRACTOR, FAN, RG, DF (Aluminum) 25,000 meters SN 1290-266-6891 (Standard)
	GFT FAN Not to be developed	GFT FAN (Aluminum) To be evaluated by USAAB (Project Nr not yet assigned)**	GFT FAN Not to be developed	GFT FAN Not to be developed
<b>Elevation</b>	GFT Rule 1 and 2 (Obsolescent)*** Paper scales mailed to active and reserve units in March and July 1960, respectively	SCALE, GRAPHICAL FIRING, M71 (GFT) Rule 1 and 2 (Standard) Awaiting Ord contract for troop issue	GFT Not to be developed	SCALE, GRAPHICAL FIRING, (GFT) Experimental pilots to be developed at USAAAMS
<b>Site</b>	GST (Obsolescent)*** Paper scales mailed to active and reserve units in March and July 1960, respectively	SCALE, GRAPHICAL FIRING, SITE, M72 (GST) (Standard) Awaiting Ord contract for troop issue	GST Not to be developed	SCALE, GRAPHICAL FIRING, SITE (GST) Experimental pilot to be developed at USAAAMS
<p>* Logistical responsibility for the PROTRACTOR, FAN, RG, DF, was transferred from Engineers Corps to Ordnance Corps in April 1960.</p> <p>** One standard aluminum GFT Fan with interchangeable ballistic scales to be developed for 105-mm, 155-mm, and 8-inch howitzer. Pilot completion by Ordnance anticipated in April 1961.</p> <p>*** Present graphical equipment should be used until receipt of new graphical equipment.</p> <p>**** Awaiting Ordnance contact for troop issue.</p>				

**Figure 38. The current status of cannon graphical fire direction equipment (1 March 1961).**

<b>Free Rockets (762-MM and 318-MM) M-ICAO</b>	
SCALE, GRAPHICAL FIRING (Low Level Wind) FTR 762-A-2 Awaiting Ord "M" Nr and troop issue	SCALE, GRAPHICAL FIRING (Low Level Wind) FTR 762-D-1 Awaiting Ord "M" Nr and troop issue
SCALE, GRAPHICAL FIRING (Low Level Wind) FTR 762-B-2 Being developed at USAAMS	SCALE, GRAPHICAL FIRING (Low Level Wind) FTR 762-E-1 Being developed at USAAMS
SCALE, GRAPHICAL FIRING (Low Level Wind) FTR 762-C-1 Awaiting Ord "M" Nr and troop issue	SCALE, GRAPHICAL FIRING M73 (Low Level Wind) FTR 762-F-1 Awaiting Ord issue to troops (Standard)
	SCALE, GRAPHICAL FIRING (Low Level Wind) FTR 318-A-1 Awaiting BRL data

**Figure 39. The current status of graphical equipment for the Honest John (762-mm) and Little John (318-mm) Rockets (1 March 1961).**

tables are also shown in figure 39. There will be no graphical equipment developed to compute initial firing data for the Honest John and Little John (318-mm Rocket).

Other new graphical equipment will be the development of experimental pilots for the Scale, Graphical Firing, and Scale, Graphical Firing, Site, based on FT 8-0-3. This tabular firing tables is scheduled for publication in April 1961. If approved at the Artillery and Missile School, the graphical devices will be forwarded to the USAAB for additional evaluation and possible recommendation for issuance to 8-inch howitzer units.

The US Army Ordnance at Frankford Arsenal, Philadelphia, Pennsylvania, is currently developing one standard aluminum Graphical Firing Tables (Rizza) Fan for the 105-mm, 155-mm, and 8-inch howitzers. Pilots of the metal fan and ballistic scales are expected to reach the USAAB for testing and evaluation in April 1961. Both the GFT fan and ballistic scales will be constructed of aluminum, and the same fan can be used with any of the three howitzers by using appropriate ballistic scales.

It is expected that in the future all graphical fire direction equipment costing less than ten dollars will be categorized as expendable "mission-type" items. This means that most graphical equipment, although listed in unit TOE's, will be purchased through self-service facilities.

To show the transition from old to new graphical equipment, you might wish to remove figures 38 and 39 from this issue and put them on your bulletin board, clipboard, or desk.

# **New Firing Tables Format**

Major K. H. Bailey, Jr.  
Gunnery/Cannon/Rocket Department

A new firing tables, FT 155-Q-3, containing data based on ballistic reductions with respect to certain parameters yielding more accurate ballistic coefficients, has been published for the 155-mm howitzer. Marked advantages gained through the use of analog and digital automatic computers have made the reductions possible. Subsequent firing tables for all caliber cannon will reflect the new format, for example, FT 8-J-3 and FT 105-H-6, due for publication in February and September 1961, respectively.

In addition to standardizing the format of firing tables for all cannon, the new firing tables will eliminate double interpolation, express range in meters, and use the North Atlantic Treaty Organization (NATO) meteorological (met) message.

It appears that the NATO met message (ARTILLERY TRENDS, page 72, May 1960), which is based on the International Civil Aviation Organization (ICAO), is not likely to be available until after July 1961, the date originally scheduled for its adoption by all NATO countries. For this reason, a change 1 (C1) will be issued concurrently with each new firing tables up to and including FT 105-H-6. This change, as seen in C1 to FT 155-Q-3, will provide the necessary conversion tables and instructions to make the United States met message, which is based on the Ordnance Standard Atmosphere, applicable to the new firing tables. Clear and pertinent examples of conversions are given. When the NATO met message is officially adopted by the US Army, change 1 will be rescinded.

To present clarifying background information, the advent of two-dimensional firing tables, for example, the FT 280-B-1 for the 280-mm gun and FT 8-J-2 for the 8-inch howitzer, created a new approach to gunnery techniques involving time-consuming double interpolation. Instead of listing unit effects to be used for any departure from standard conditions, one set of unit corrections was provided for an increase from standard conditions and another set for a decrease from standard conditions. Such provision increases accuracy of firing data because second-order errors are reduced or eliminated. However, such unit corrections are expressed in mils or seconds as functions of range and height of burst and are applied to the computed quadrant elevation (QE) and the computed time of flight. The procedures involved normally required double interpolation for each unit correction. By accepting a slight decrease in accuracy for increased speed in computation, later 8-inch



howitzer gunnery procedures permitted unit corrections to be determined at the appropriate range and 0 height of burst, regardless of the actual height of burst desired. Although actual firings proved such an assumption valid for most conditions likely to be encountered in the field, this procedure was not an ideal solution to the problem of double interpolation.

### **NEW FORMAT DOES NOT SACRIFICE ACCURACY**

The new firing tables format eliminates double interpolation and reduces single interpolation without a sacrifice in accuracy. Before explaining further, complementary range should be defined. It is that range corresponding to the complementary angle of site; the range rather than the angle must be used, as unit corrections in the new firing tables are expressed in meters, not in miles. The complementary range corresponding to the chart range and desired height of burst is determined from the firing tables. The complementary range is added to the chart range; the sum is rounded off to the nearest 100 meters and referred to as the entry range. The entry range is then used as the argument with which to enter the ground data table to obtain unit corrections. Since the nearest tabular entry is to the nearest 100 meters, no interpolation for range is required; since the ground data table is based on a 0 height of burst, no interpolation for height of burst is required. Thus, double interpolation is not required in using the new firing tables format.

Other changes in the new firing tables are—

<b>Change</b>	<b>Purpose of Change</b>
(1) Met line numbers are printed as functions of both range and QE.	Met line numbers can be determined from either a given QE or a given range.
(2) Corrections rather than effects are listed in wind components table.	Maintains consistency in solving for corrections rather than effects with the new firing tables format.
(3) Negative numbers are printed in red; unit corrections for a decrease from standard conditions are printed in brown.	Reduces errors in computations.
(4) Rotation corrections tables are listed for all caliber cannons.	The magnitude of rotation corrections can be determined for any cannon.
(5) Maximum ordinates are listed for every 500 meters of range.	Maximum ordinates can be determined more easily than with old-type firing tables; only one table is entered and only single interpolation is required.
(6) Cotangents of angles of fall are listed.	Useful in determining corrections to be applied for C1's located at different altitudes, as in calibration firing.

- |  |   |
|--|---|
| (7) Tables listing change in range and height of burst for increase of 10 mils in elevation are included.  | The difference in terminal coordinates of two standard trajectories having initial elevations of 10 mils apart and terminating at the same time of flight can be determined.                            |
| (8) Tables listing change in range and height of burst for increase of 1 second in time of flight are included.  | Remaining velocity of a projectile at any point along the trajectory and the trajectory angle can be computed.  |
| (9) Trajectory charts are included.  | Studies of standard trajectories can be made. Although the charts in FT 155-Q-3 are small and indistinct, future firing tables will include trajectory charts of larger dimensions, that is, fold outs. |
| (10) Abbreviations for probable errors (PE) are standardized as follows:<br>$PE_r$ = range to impact<br>$PE_R$ = range to burst<br>$PE_T$ = Time to burst<br>$PE_H$ = height of burst<br>$PE_d$ = deflection | Preserves continuity when using different firing tables, thereby avoiding confusion in terminology.   |

In addition to clarifying the problems involving each type technique presented in the introduction to each new firing tables, the consonance of the new format with the 1960 edition of FM 6-40 provides a relatively easy transition from the old procedures to the new. Basic procedures in the techniques of registration, K-transfer, and met plus VE remain unchanged, but are much less complex.

The principal advantage of a standard format for all firing tables is that all cannon problems, regardless of caliber, can be solved in an identical, or a very similar fashion. This will simplify instruction at service schools and in unit training and insure maximum flexibility in techniques.



"The cannons have their bowels full of wrath,  
 And ready mounted are they to spit forth  
 Their iron indignation."

Shakespeare, "King John," Act II



# **THE INTELLIGENCE CHAIN-- STRONG AS ITS WEAKEST LINK**

Captain Lucius L. Daugherty  
Captain Horace L. Hunter  
Tactics/Combined Arms Department

Much progress is being made in the development of artillery materiel. Methods and techniques for getting the round on the target have become increasingly more reliable and sophisticated. Considerable effort, time, and funds are being expended on the development of computers—all for the purpose of accuracy and of saving valuable time. However, these efforts are of no avail if targets cannot be located rapidly and accurately. So—enter the artillery S2! Long an honored, but sometimes misused member of the artillery commander's staff, the S2 assumes an even greater role on today's battlefield. The following article discusses target acquisition, the chief function of the howitzer battalion S2 and the division artillery S2 in the infantry division.

At each level of command, the efforts of an artillery S2 are directed principally toward the acquisition of suitable artillery targets. Other activities of the battalion S2—security responsibilities, reports, maintenance of a situation map, keeping the commander informed of the enemy situation, and other normal duties—will not be considered in this article. Unit SOP's will, in most cases, dictate the manner in which these functions are performed. The initial portion of this article will concern the battalion S2 and target acquisition.

The battalion S2 has an intelligence sergeant as his principal enlisted assistant; they must be located

close to the S3 operations. The S2 and the S3 must work together; the efforts of each complement and supplement the other. The S2 also works closely with the battalion reconnaissance and survey officer, who is the platoon leader of the target acquisition platoon in the headquarters and headquarters battery. Most of the target locating agencies of the battalion are within this platoon. The battalion communications officer and the S2 are closely associated, too; communication is an essential requirement of target acquisition.

### **TARGET LOCATING AGENCIES MUST BE COORDINATED**

The target locating agencies of the battalion must be coordinated for targets to be acquired efficiently, rapidly, and continuously. The S2 is responsible for coordination of observation. Four essentials establish a framework within which the S2 coordinates observation. These are—

(1) Maximum coverage. The battalion S2 must exert every effort to obtain maximum observation coverage of the zone of the supported unit. The ideal situation is one in which complete observation coverage of the zone is obtained.

(2) Continuous observation. The observation agencies must be coordinated and organized so that there will be continuous observation of the zone of the supported unit.

(3) Competent observers. The S2 must be assured that the observation agencies are qualified to perform their mission. The training of the agencies is a function in which the S2 must work with the S3.

(4) Communications. The ability to communicate is a requisite for the efficient functioning of each observation agency. This is where the S2 works closely with the communications officer. As time permits, alternate and lateral lines of communications are established to insure adequate communications.

A brief description of the most important observation agencies available to the battalion S2 is necessary before discussing the methods used to coordinate these agencies. Each artilleryman is a potential observation agency and each individual can contribute to the observation plan. However, only the formalized agencies will be mentioned below.

Five forward observer (FO) sections are organic to each of the howitzer battalions. One section is organic to the rocket/howitzer battalion. In each battalion, the sections are organic to the target acquisition platoon in the headquarters and headquarters battery. Since the howitzer battalion is designed specifically to perform a direct support mission, it is provided with five forward observer sections—one to work with each of the five rifle companies of the battle group. Each forward observer section is composed of an FO, a reconnaissance sergeant, and a radiotelephone operator. The main items of section equipment include an AN/VRC-9 radio, an AN/PRC-10 radio, two compasses, one pair of field glasses, one observation telescope, two field telephones, and a 1/4-ton truck and trailer.

## **PRINCIPAL DUTIES OF THE FORWARD OBSERVER**

When a howitzer battalion is assigned a mission of direct support of a battle group, an FO section is sent to each rifle company. The principal duties of the FO are to adjust fire, plan fires to support the company, advise the company commander on all matters relating to artillery support, and report combat information factually and rapidly.

The activities of the FO section are supervised by the S3. However, the FO and his section are essentially on their own. They displace on their initiative as the situation requires, keeping the S3 informed of their plans for displacement. The FO selects an observation post which permits him to accomplish his primary mission of providing close and continuous artillery support to the rifle company. He must communicate with the supported commander and the battalion fire direction center at all times.

Although the S3 supervises the activities of the FO sections, the S2 has considerable interest in their activities. This will be brought out in the methods used by the S2 to coordinate observation.

The battalion observation post (OP) is another observation agency used by the battalion S2. Each artillery battalion in the division artillery, regardless of its mission, will normally establish a battalion observation post.

The purpose of a battalion OP is to provide wider and deeper observation coverage of the zone of the supported unit than that provided by the forward observers. If possible, the battalion OP is located on more dominant terrain than the forward observer. This position also provides a measure of security for the battalion. The OP may be positioned so that it can maintain surveillance over gaps and lightly defended areas between units.

### **S2 LOCATES, DISPLACES BATTALION OP**

The battalion S2 will establish one or more battalion OP's, depending upon the personnel available, terrain, width of the front, and other tactical considerations. The S2 controls closely the location and displacement of the battalion observation post(s). As mentioned earlier, an FO displaces on his own initiative. The observer at the battalion OP will be notified by the S2 when and where to move. The S2 must plan for the timely displacement of the battalion OP to provide continuous observation. In the offense, the S2 should position the battalion OP well forward. In the defense, if there is more than one battalion OP, the S2 should echelon them in depth to provide continuous observation in the event of displacement.

The battalion observer is as concerned with observation as the forward observer. However, since he is not necessarily in contact with the supported units, his duties will vary from those of the forward observer. The battalion observer adjusts fires, conducts surveillance of fires, and reports combat information. He does no fire planning and does not advise a unit commander.

Personnel for a battalion OP are not listed on the tables of organization and equipment (TOE) of the battalion. Where, then, does the S2 obtain the personnel? A minimum of three people, with the necessary radio equipment, observation equipment, and transportation, are required for continuous operation. The S2 may be able to use one of the organic FO sections if for some reason it is not required by the supported battle group. One or more FO sections may be requested from a reinforcing or a general support-reinforcing battalion. With the latter, however, permission must be obtained from division artillery before the FO sections may be obtained. Frequently, the S2 will use the reconnaissance officer and survey section personnel. This would occur only after survey work has been accomplished. In the operation of target area survey bases, survey personnel are prime sources of target information. The target area base stations often can and will be designated battalion observation posts. Personnel from the firing batteries may be used in some instances. However, this is not likely. The battalion OP may sometimes consist entirely of enlisted personnel.

Another observation agency used by the battalion S2 is aerial observation. When authorized by Department of the Army, the battalion will be augmented with two air observers. Aerial observation is perhaps the most versatile of all the observation agencies; because of the air observer's altitude and mobility, he can observe sectors of the battle zone which cannot be seen by a ground observer.

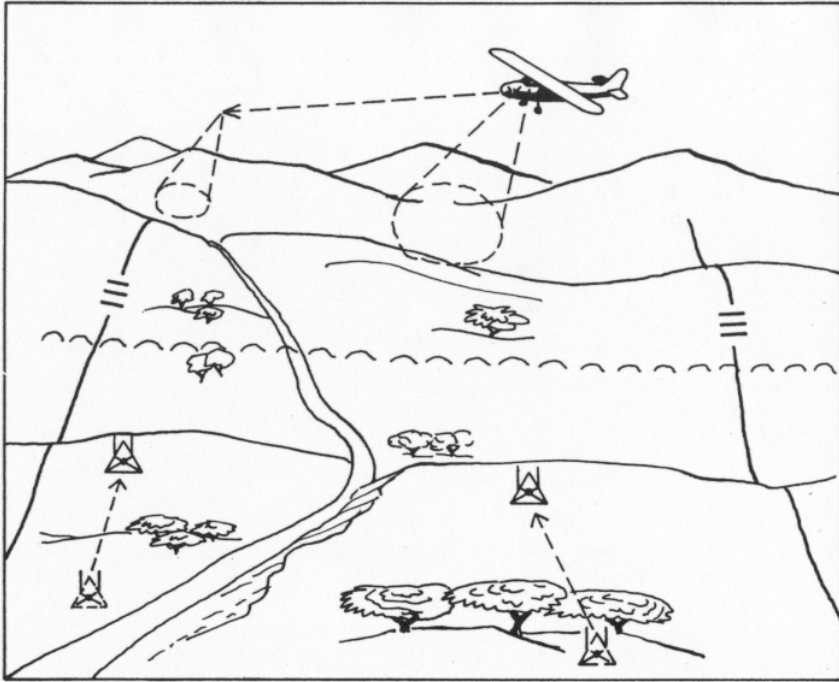
#### **AIRCRAFT FROM DIVISION AVIATION COMPANY**

The aircraft in which the air observers fly are organic to the artillery support section of the division aviation company. The section has eight L-19 fixed-wing light observation aircraft and two H-13 single-engine helicopters, which is the Army's standard observation helicopter. This flight operates in support of the division artillery. Frequently, one or more aircraft will be placed in support of a direct support battalion. When this occurs, the battalion S2 will control the aerial observation, just as he controls the employment of the battalion observation posts (fig 40).

The duties of the air observer are the same as those of the battalion observer. He adjusts fires, conducts surveillance of fires, and reports combat information. Aerial observation is used to supplement ground observation, not to replace it.

The S2 will coordinate the battalion observation agencies, then coordinate the observation capabilities of the battalion with those of the supported unit, and, finally, effect coordination with adjacent and higher artillery units.

When a direct support battalion is reinforced by another artillery unit, the S2 of the direct support battalion has the responsibility of coordinating the observation of the reinforcing unit. He will displace and position the battalion OP of the reinforcing battalion. In some cases, the same battalion OP will be used for both battalions.



**Figure 40. Positioning and maneuvering of the battalion observation post and air observation post by the S2.**

### **COORDINATION OF OBSERVATION FOR GS, GS-REINF MISSIONS**

For division artillery units with a mission of general support or general support-reinforcing, coordination of observation agencies will usually be controlled by the division artillery S2. Coordination of observation agencies will be effected within the battalions by the battalion S2 consistent with the observation plan of the division artillery S2. This may or may not amount to a great degree of control by the division artillery S2. Units with a mission of general support are not concerned with supporting a specific maneuver element of the force but, rather, with supporting the force as a whole. To a lesser extent, this is also true for a unit whose mission is general support-reinforcing. Units with these missions have their fires and positioning controlled by division artillery. Thus, the observation capabilities of these units will be used to a greater extent in the observation plan for the division than will those of direct support and reinforcing units. A direct support unit may obtain observation agencies from a general support-reinforcing unit, subject to approval of division artillery headquarters.

It was previously mentioned that the activities of the FO are supervised by the battalion S3; also, that the FO displaced on his own initiative

and positioned his observation post so that he could carry out his mission of providing close and continuous artillery support to the rifle company. The zone of observation for an FO is inherent in his mission; that is, it corresponds to the zone of the company. What, then, does the S2 have to do with a forward observer? Working with and through the S3, the S2 can require certain items from the forward observer, specifically, visibility diagrams and information reports. The portion of the FO procedure in conduct of observed fire which requires him to estimate the effectiveness of his rounds was also designed to fulfill an S2 requirement. Visibility diagrams illustrate the observation coverage of the forward observer. They may be made from maps or photomaps, or they may be sketched. The positioning of other observation agencies will be based primarily on the observation coverage obtained by the forward observers. The S2 will also require information reports from the forward observers. Again, this will be accomplished in conjunction with the S3. Information reports contain at least four elements—who, where, when, and what. These reports must be as factual as possible. The S2 may require these reports at stated intervals.

This leads to the methods used by a direct support battalion S2 in coordinating his observation agencies. These methods include the positioning and maneuvering of certain agencies and the assignment of zones of observation and primary areas of responsibility to certain observation agencies.

## **S2 CONSOLIDATES VISIBILITY DIAGRAMS**

The first method used by the S2 to coordinate observation is primarily brought about as a result of the observation coverage of the forward observers. The S2 receives the visibility diagrams from the forward observers with the committed rifle companies (fig 41). Then, he consolidates these diagrams into one visibility diagram. He is now able to determine where to position his other observation agencies. If the S2 has personnel available for only one battalion OP, he will position this OP so that it can eliminate as much of the area in defilade to the FO's as possible. If there is reinforcing artillery, the battalion OP of this unit may be positioned by the direct support battalion S2. If personnel are available to form two battalion observation posts, so much the better. Visibility diagrams are made by the observers at the battalion OP and forwarded to the S2.

If a portion of the artillery support section from the aviation company has been placed in support of the battalion, the S2 will position these aircraft so as to eliminate areas in defilade to the ground observers. As previously stated, in the offense the S2 will position the battalion OP's well forward. In the defense, if more than one battalion OP has been established, they will be echeloned in depth as much as possible to provide for continuous observation in event of displacement. The S2 will maneuver the battalion observers and the air observers as the situation requires. In a static situation, if it becomes necessary for an FO to be displaced to another position to conform better to the observation



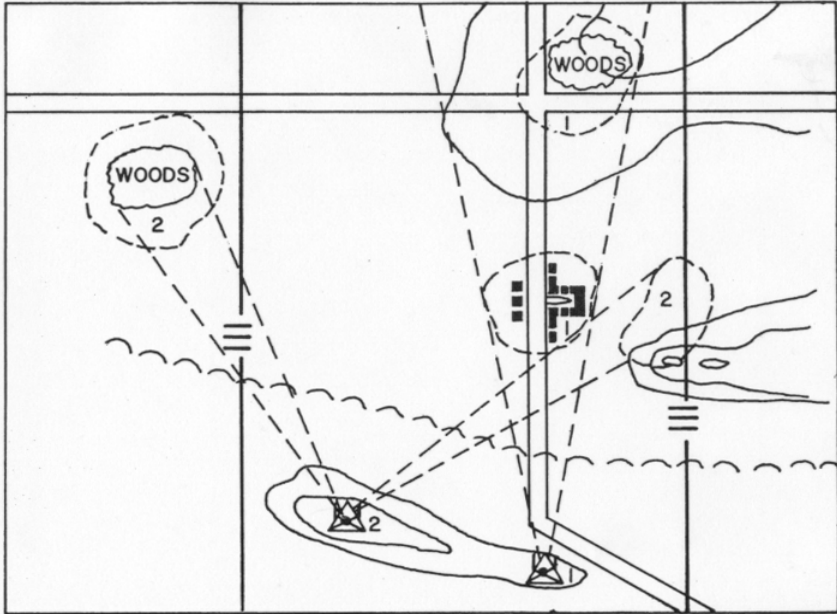
plan of the battalion, this would be accomplished by the S2 working through the S3. Ordinarily, the FO is on his own and is not subject to positioning and maneuvering by the S2 or the S3.



**Note.** The clear areas are in defilade to the forward observer; the shaded areas can be observed by the forward observer.

**Figure 41.** A visibility diagram submitted to the S2 by a forward observer.

The second method used by the battalion S2 to coordinate observation within the battalion is to assign zones of observation and one or more primary areas of responsibility to certain of the observation agencies—specifically the battalion OP's and the organic air observers (fig 42). The S2 will assign zones of observation to each of these agencies, in which they will maintain general surveillance. Within the zones of observation, the S2 may assign one or more primary areas of responsibility in which a closer surveillance will be maintained. These primary areas may include terrain features, such as crossroads, hilltops, or areas between maneuver elements. Usually, the FO will not be given primary areas of responsibility. However, this may occur in a static situation; in such an instance the S2 would effect this through the S3. The FO is normally occupied with observing in the zone of the supported company.



**Note.** In this example, the S2 has assigned a zone of observation to each of the battalion observation posts which includes the entire zone of the battle group. In addition, the S2 has assigned two primary areas of responsibility, as indicated, to each of the battalion observation posts.

**Figure 42. Zones of observation and areas of primary responsibility.**

After positioning the battalion OP's, the battalion S2 will make up a consolidated visibility diagram. This diagram will include the observation coverage obtained by all observation agencies, including air observers. It will be forwarded to the division artillery S2.

**ARTILLERY S2, BATTLE GROUP S2 WORK TOGETHER**

Coordination with the supported battle group is also effected by the battalion S2. The battle group has certain organic observation agencies, and the battle group S2 has the responsibility for coordinating these agencies. The direct support battalion S2 will coordinate his own observation capabilities with those of the battle group S2. This will be accomplished through a direct working relationship. The artillery liaison officer at battle group headquarters may assist in this coordination. There must be a constant exchange of information between the two S2's. Each must be continually informed of the observation capabilities and plans of the other. For example, the location of the battle group surveillance radars may enable the artillery battalion S2 to position his battalion OP in a different location from that originally planned. On the other

hand, the battalion S2's observation plan may enable the battle group S2 to employ his observation agencies differently.

Coordination with adjacent and higher artillery units will also be effected by the direct support battalion S2. Adjacent S2's, insofar as possible, should coordinate their observation capabilities. Normally, higher artillery will authorize this direct working relationship. For example, a direct support battalion may select a location for a battalion OP so that a critical area of the zone of the adjacent battle group can be observed. With direct liaison between the two artillery battalion S2's, it becomes a simple matter for this observation coverage to be coordinated. Coordination with higher artillery headquarters is essential for the direct support battalion S2. Location of the surveillance radar from division artillery may result in a different employment of the battalion S2's observation agencies.

### **HUB OF TARGET ACQUISITION AT DIVISION ARTILLERY**

The hub of target acquisition activity within the division is found at division artillery level. Many of the means by which target information can be gained are found there. Here also is the center of the artillery collection web which funnels information from both organic and nonorganic sources to the individual who must coordinate, assess, and convert all the diversified bits and pieces of target and possible target data into usable form. This individual is the *division artillery S2*.

At first glance, there would seem to be an unusually strong organization to assist the S2, but as a greater appreciation of the employment of the various sections falling under the purview of the S2 is gained, it can be seen that this is not the case. A target acquisition platoon at this level furnishes the personnel required to perform the various tasks associated with the countermortar surveillance, survey, meteorological, and air control tasks of the division artillery S2.

This platoon consists of a platoon headquarters, containing the assistant S2 who is platoon leader, the radar officer and assistant radar officer, the intelligence and assistant intelligence sergeants, and a radiotelephone operator; a survey information section of four enlisted men; a survey section of 27 enlisted men; a meteorological section of one warrant officer and 14 enlisted men; three countermortar radar sections each of eight enlisted men; a surveillance radar section of seven enlisted men; and an air control team of two enlisted men.

The radar sections are the primary source of target information available to this platoon, but the surveyors, both in their role as surveyors and in their frequent assignment to ground observation posts, must also be included in any listing of target acquisition means. The air control team may also be a good source of information.

### **DIVISION ARTILLERY S2 MUST BE AGGRESSIVE**

This does not exhaust the means used by the S2 in his search for information. Actually these sections provide only a small portion of the total target acquisition picture. The greatest quantity of usable information will

come from the direct support battalion S2's. The division artillery S2 must be aggressive to insure that the battalions pass on all information received. In training, this necessary flow of information has a tendency to be slow moving due to the difficulty usually met in realistically portraying the intelligence picture. In the early days of combat, this flow of information may be slow due to habits acquired in training, the likely confusion of inexperienced units when first committed to action, and the possible lack of appreciation of the urgency of passing on information as it is received.

The S2's close liaison with the division G2 will also supply target information that is not obtainable elsewhere. Such information may come from—

- (1) Photographic interpretation.
- (2) Target data developed by the Air Force.
- (3) General intelligence information, for example, intelligence reports and daily intelligence summaries.
- (4) Results of prisoner of war interrogations.

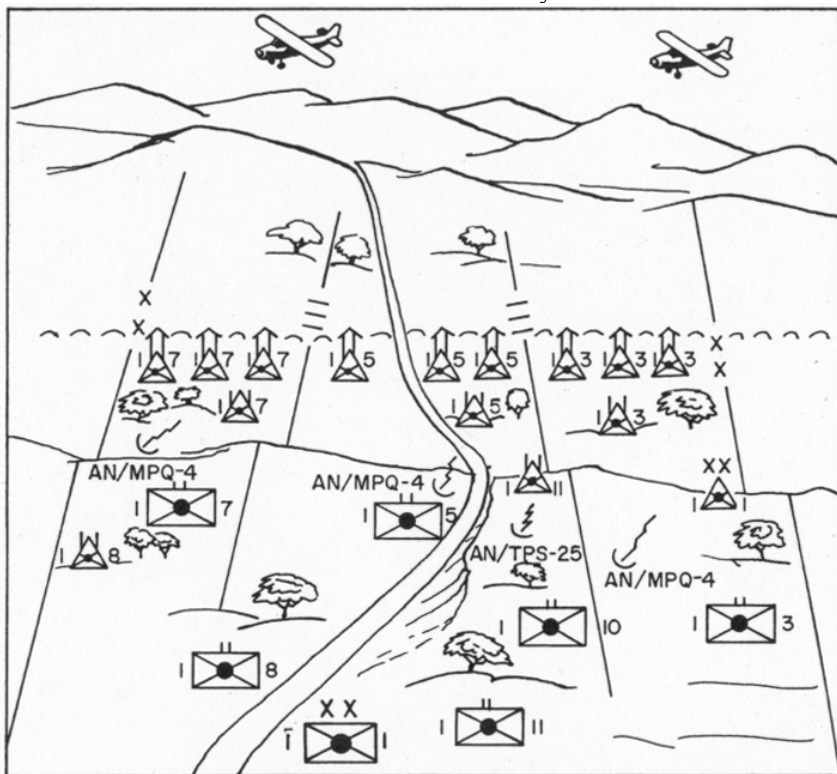
Requests for additional aviation support for intelligence missions will be made through the G2. This aviation support is becoming more and more important as the capabilities of the division aviation company have been, or are being, expanded. Additional photographic coverage can now be obtained either by aircraft or drone and airborne radar. These means, coupled with Air Force reconnaissance flights, both visual and photographic, which are also requested through G2 (air), will be the principal means of obtaining deep target information.

The corps artillery S2, another artilleryman who is primarily interested in target acquisition, has an appreciation of the division artillery S2's problem which insures his cooperation in their common task. It is a case of mutual dependence. From division artillery, the corps artillery S2 can expect prompt action in reporting counterbattery information that the division's agencies (fig 43) may have developed, and he, in turn, will furnish any information of targets of interest to the division artillery S2.

### **S2 WANTS COMPLETE COVERAGE OF DIVISION ZONE**

The techniques of ground and aerial observation were considered at battle group level. These techniques are also applicable at division artillery level. The division artillery S2 is interested in insuring complete coverage of the division zone of observation, which is usually the division zone out to the 0-0 line. To do this, the direct support battalions, and, in fact, all battalions will be required to forward a copy of their consolidated visibility diagrams to division artillery. The S2 will consolidate these and come up with a fairly accurate picture of the ground observation in his zone. If this coverage is spotty, he must then evaluate the terrain and recommend new locations for ground observation posts. It is conceivable that these recommendations may include the maneuver of the general support and general support-reinforcing unit's OP's, as well as the establishment of OP's by division artillery. Personnel for

these installations are as much a problem at division artillery as elsewhere and must be solved by using available qualified personnel. If their primary duties permit it, the survey personnel are ideal for this job. In siting these OP's, the S2 must make sure that boundaries are well covered by observation.



**Note.** The illustration shows forward observers with committed rifle companies, battalion observation posts established by direct support battalion S2's, counter mortar radars and surveillance radar, and a division artillery observation post established by the division artillery S2 and assistant S2. Two observation aircraft from the artillery support section of the aviation company are also depicted.

**Figure 43. The principal observation agencies of the infantry division artillery.**

When the ground observers are positioned for optimum utilization, the S2 will use aircraft to complete his visual coverage of the zone of observation. The S2 will insure that air observers are assigned areas of responsibility that will augment and deepen the ground observation. The exact mechanics of assigning these areas and scheduling flights will depend

on the method of employment of the available aircraft. The problem is greatly simplified if aircraft have been retained under division artillery control, but if controlled by the direct support battalions, the S2 must coordinate their activities through the battalion S2's. This again stresses the necessity for artillery S2's to be a smooth operating team, all primarily interested in their own unit but also realizing the absolute dependence of their success or failure on the S2 team.

It is in electronic target acquisition that the division artillery S2 excels, for he has under his thumb, so to speak, the entire division artillery's capability in this area.

### **RADAR SECTION HAS AN/TPS-25 RADAR**

The surveillance radar section, presently equipped with the AN/TPS-25 radar (ARTILLERY TRENDS, November 1960), is employed under the operational control of the S2. It may be used either in the combat surveillance role or for target acquisition. This radar must be positioned according to its line of sight characteristics. It is a flexible piece of gear useful in covering areas not covered by patrols, in maintaining surveillance of avenues of approach into the position, in furnishing warning to friendly patrols of enemy activities in their vicinity, and in locating targets. Since other surveillance means can perform the tasks of the AN/TPS-25 in daylight and due to its obvious configuration when in operation, this radar is most effectively employed during periods of reduced visibility. When carefully sited and accurately surveyed in, it makes possible the deadly delivery of fires on targets that would otherwise be relatively secure from attack and considerably improves the effectiveness of harassing and interdiction fires.

The AN/MPQ-4 radar sets of the countermortar radar sections also are invaluable pieces of equipment. Accurate and fast in operation, they give the division artillery the ability to be the scourge of enemy mortars and provide much needed life insurance to the infantry.

These radars should be employed under the operational control of the assistant S2 acting in his role as countermortar intelligence officer (CMIO). He will be the officer who will assign primary and contingent sectors of scan to these sections and who will pick out general position areas for them. The radar officer, operating within these limitations, will select the exact location for each set, based on the tactical and technical considerations. To exploit the range of these sets and still give them protection, they should be positioned from 2,000 to 4,000 meters behind the front and spaced laterally across the division zone to give as complete coverage as possible. To increase the rapidity with which the hostile mortars may be engaged, it is desirable to locate the AN/MPQ-4 radars close to one of the firing elements of the division artillery. Wire communication can easily be established between the radar and a nearby fire direction center. By establishing a short direct line, reaction time is decreased considerably due to the elimination of the necessity for using trunk lines and thereby making line maintenance simpler and faster. Other benefits derived from such positioning are—

- (1) Ease of obtaining survey control.
- (2) Provision for greater security for the radar.
- (3) Ease in obtaining food, water, gasoline, and other supplies.

The division artillery SOP must prescribe the responsibilities of the direct support battalions in whose areas the sets operate. The battalions should be responsible for providing survey control and establishing wire communications; other arrangements will be a matter of local choice. If it is decided to attach the sections to the battalions, it is essential that control of the assignment of sectors of scan be retained by the division artillery S2 if a coordinated countermortar program is to be effected.

Radar sets and shelling reports will furnish the CMIO with most of his countermortar information; the information from the radars should be the fastest, most reliable, and most accurate source.

### **TASKS OF THE S2**

To sum up, the S2 must insure complete coverage of the zone of observation. To achieve this, he must use visibility diagrams, have a precise knowledge of the terrain, and use judgment in positioning and maneuvering his observation agencies. In addition, he must assign primary and secondary zones of observation or sectors of scan and be sure that the observers—air, ground, and electronic—supplement and complement each other. The S2 must be certain that there is adequate relief for personnel and maintenance time for equipment, and that displacements are timely and as carefully coordinated as the displacement of a battalion. Continuous observation demands that OP's be displaced by echelon. The S2's coordination job is enhanced when all agencies participating are well trained and disciplined. This points up the necessity for the S2's supervision of intelligence training for the entire command, if he is to be sure that reliable tools for accomplishing the tactical mission are at hand.

In the future, the timely and accurate location of targets might well spell the difference between victory and defeat. The increased range capabilities of the newer artillery weapons give the S2 an area of interest which now extends much further into enemy territory. An increased reliance must be placed on the use of Army Aviation and Air Force photo, visual and electronic reconnaissance, for the deeper zone. It can also be expected that drones will replace manned aircraft in long range observation efforts. The use of "stay behind" and long range patrols is another proven technique that has acquired a renewed emphasis with the appearance of nuclear weapons on the battlefield and the necessity for locating them before they can be employed. Information obtained from such patrols and friendly guerrilla forces will be of assistance in the preparation of counternuclear programs.

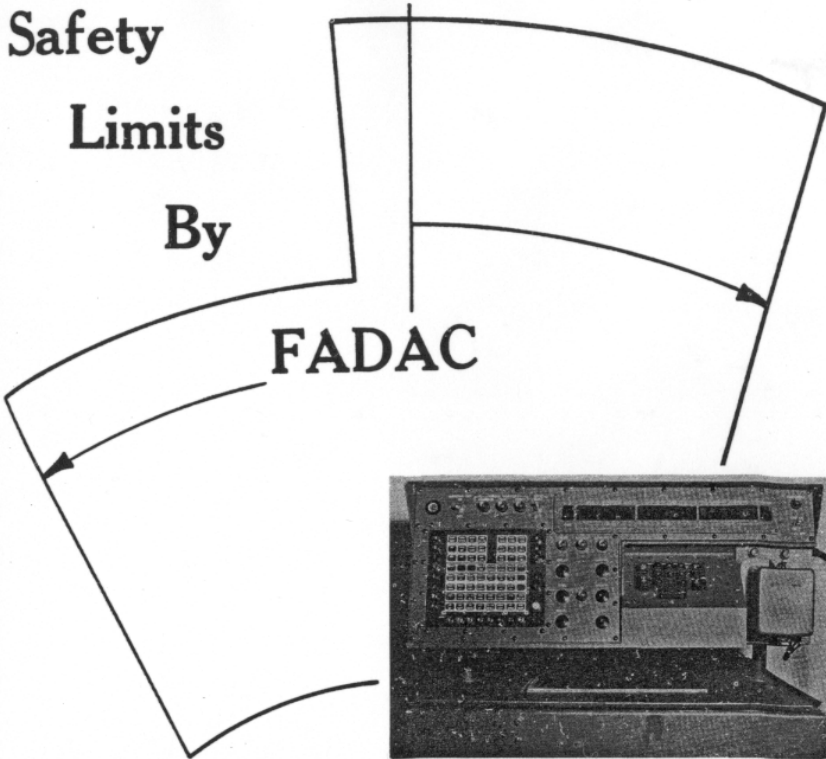
The importance of target acquisition is recognized and programs are being developed which will provide a target acquisition capability commensurate with the ranges of the newer weapons. The effectiveness of these means depends on the ability, imagination, and aggressiveness of the S2.

**Safety**

**Limits**

**By**

**FADAC**



Major Fred E. Wagoner, Jr.  
Major K. H. Bailey, Jr.  
Gunnery/Cannon/Rocket Department

The September 1960 issue of ARTILLERY TRENDS explained in general terms the description and function of the Field Artillery Data Computer (FADAC). The FADAC is now being tested at the US Army Artillery Board, Fort Sill, Oklahoma. If the tests prove satisfactory, the FADAC may be in the hands of user units by 1962.

This small scale electronic digital computer seems to offer many applications. It is the problem of the artilleryman to search for these applications and further define the requirements. Until the computer can be told what to do, by means of a program, the FADAC remains nothing more than an ignorant automaton full of wires, transistors and buttons.

Accuracy has always been the artillery's foremost requirement and the FADAC promises to effectually accommodate this need. When the FADAC is given accurate inputs for gun and target location, raw weather measurements, and weapon-ammunition performance data, it will determine firing data to an accuracy that may permit elimination of registrations, transfer limits, and time-consuming computational techniques.



Now, as the capabilities of the FADAC are evaluated, it is realized that there are other applications that will eliminate scratch pad computations and firing tables "groping," each of which provides an opportunity for error at every step. An application such as this can certainly be applied to safety. The FADAC *is* able to compute safety limits and even signal an unsafe fire command. Thus, another step can be taken to free the S3 and battery executive officer for other important functions, such as timely decisions and supervision of operations.

### **FIRE DIRECTION OPERATIONS WITH FADAC**

The FADAC is prepared initially for fire direction operations by entering the battery coordinates, altitude, azimuth of fire, and aiming post deflection into the computer. The battery executive officer reports the highest angle of site and the piece-mask range to the fire direction center (FDC). Assuming that the FADAC has been programmed to solve the safety problems, the data are entered in the FADAC memory by a simple keyboard input. The FADAC now has all the necessary inputs which it needs to solve automatically the battery executive officer's minimum quadrant elevation (QE).

Next, the FADAC determines the altitude of the mask, adds 5 meters vertical clearance for fuze quick, adds 2 forks, and then computes the QE required to safely clear the mask. The FADAC stores this value for later reference.

The responsibility of the FDC to determine the minimum QE's to intervening crests that are not visible from the battery position is quickly fulfilled by the Field Artillery Data Computer. The ranges and altitudes of critical masks are determined from the battlemap and the appropriate vertical clearances and 2 forks are added; the FADAC then computes the QE to clear each mask. The FADAC now compares the battery executive officer's minimum QE stored in the computer and the minimum QE's determined for each intervening mask and selects the largest value. This value is displayed as the correct minimum QE for the battery.

The FADAC can also compute, for peacetime range firing, data with which to construct the safety diagram from the safety card. The minimum range, the maximum range, and the safety limit azimuths are entered in the FADAC memory. The highest altitude on the minimum range line and the lowest altitude on the maximum range line, as selected from the battlemap, are also entered into the FADAC memory. At this point, all inputs required to solve the safety diagram have been entered into FADAC.

### **FADAC COMPUTES DEFLECTION LIMITS**

Using the appropriate stored data, the FADAC now determines the safe maximum QE, the safe minimum QE, and the safe minimum time. By searching its memory for drift corrections and applying the left-add right-subtract (LARS) rule in micro-seconds with zero mils accuracy, the FADAC can compute left and right deflection limits.

The FADAC will also give several "bonuses." Assume that the computations discussed so far are for charge 1. The FADAC will repeat the entire sequence automatically for higher numbered charges; a simple instruction programed in its memory will add 1 to the charge and compute again, up to the limit of the charge constants stored. To conduct the entire sequence again for fuze VT, it is only necessary to "override" the fuze quick entry: then the FADAC will apply 80 meters or other appropriate factor instead of 5 meters for vertical clearance at the piece mask range, minimum arming range, or range to intervening mask, as appropriate. All data can be corrected for changes in weather as meteorological messages are received. The FADAC can also be wired to a high-speed printer that can turn out any number of neat hard copies of all data computed.

The artillery's "mechanical friend" can be instructed to perform one more service. As the safety limits are computed and stored, subsequent computation of firing data will be checked automatically against these limits. If a fire command is unsafe to fire, the FADAC can be programed to warn the operator by a flickering of the lights displaying the fire commands of deflection, time, and quadrant elevation.

The FADAC solution for safety limits is but one of many feasible applications for a digital computer. When the present 4,096-word memory size is expanded, as is indicated in the latest research developments, the problem of the artilleryman will be to weigh all possible applications in terms of the additional capabilities. He must then decide which applications offer the greatest gains in accuracy, simplicity, and conservation of time. "Let FADAC do it" is the order of the day.



## **FUZE M520 TO REPLACE FUZE M500**

The Mechanical Time Super Quick (MTSQ) fuze M520 consists of the M501A1 fuze with the M125 booster; it is being issued to replace the fuze M500. All characteristics and procedures applicable to the fuzes M501A1 and the M500A1 pertain to the fuze MTSQ M520. The same rounds that utilized the M500 and M501 fuzes can use the M520 fuze.

The essential difference between the M500A1 and the M520 is in the arming time of the booster rotor. The booster used with fuze M500 is capable of arming immediately when the projectile leaves the muzzle of the weapon. However, with the M125 booster the arming process cannot begin until a rotational velocity of 2,000 revolutions per minute (rpm) has been attained. This occurs anywhere between 90 and 220 feet from the muzzle (arming distance).

The lowest normal spin of a projectile fired at the lowest charge in the 155-mm howitzer is 3.220 rpm, but in a worn tube the spin may be less than the 2,000 rpm necessary to arm the M520 fuze. Therefore, some duds can be expected when the M520 fuze is used in the 155-mm howitzer at the lowest charge in a worn tube.

# Safety "Stops" for Traverse and Elevation

PFC Billy Ray Weeks, US 55 683 135  
Headquarters and Training Company  
1st Battle Group, 1st Infantry  
United States Military Academy, West Point

When a unit fires live ammunition, whether during a service practice or an Army Training Test, all known safety procedures and methods must be employed at the firing site and the impact area.

However, regardless of detailed safety checks by crew members, the battery executive officer, and safety officers, the danger of the human error cannot be denied.

Two suggested devices have been made to *supplement* other safety practices and to provide a mechanical stop at the safety limits of both deflection and elevation. The devices can be used for artillery firing in small and restricted impact areas. The following account explains how the devices are installed.

## TRAVERSING SAFETY STOP

The device to confine the traverse within safety limits (fig 44 ①) is installed on the bottom auxiliary shield bracket. The cutaway in the device fits over the shield bracket. The head of the locking bolts should be faced downward and the head of the adjusting bolt turned toward the lower strut latch assembly. The locking bolts are tightened until the device is locked firmly to the shield bracket. The locknuts are loosened and the adjusting bolt is screwed in until the head of the bolt is firmly against the lower strut latch assembly. The aiming posts are then rechecked. If the aiming posts are still aligned, the locknuts are tightened.

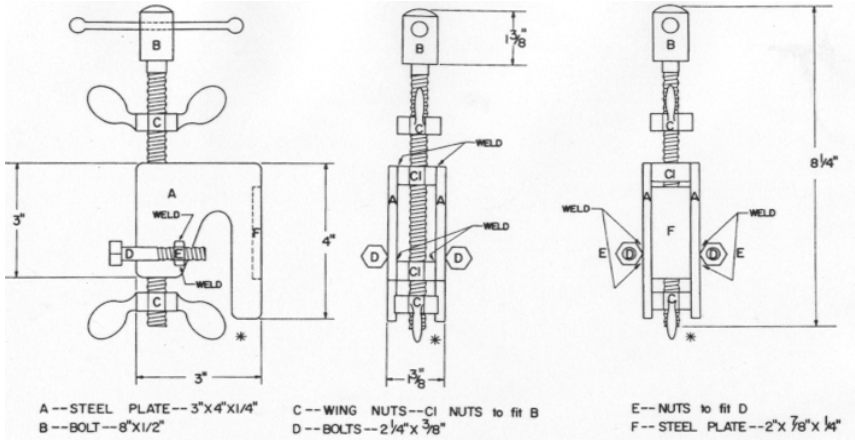
Periodic checks should be made to determine whether any shifting has occurred during firing.

## ELEVATING SAFETY STOP

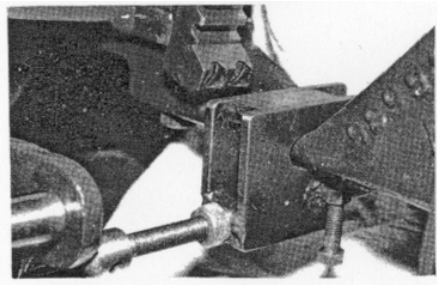
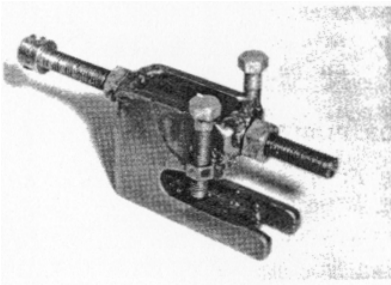
The tube is elevated to the maximum safe elevation. The safety device (fig 44 ②) is placed on the elevating arc as close as possible above the elevating worm shaft housing (shown in fig 65, TM 9-3007). The tube may then be depressed to facilitate installation of the device. It is installed so that the flanges lock around the elevating arc and the bolt passes between the teeth on the arc. The locknuts are then tightened.

The same procedure is followed for safe minimum elevation, except that the device is installed *below* the elevating worm shaft housing.

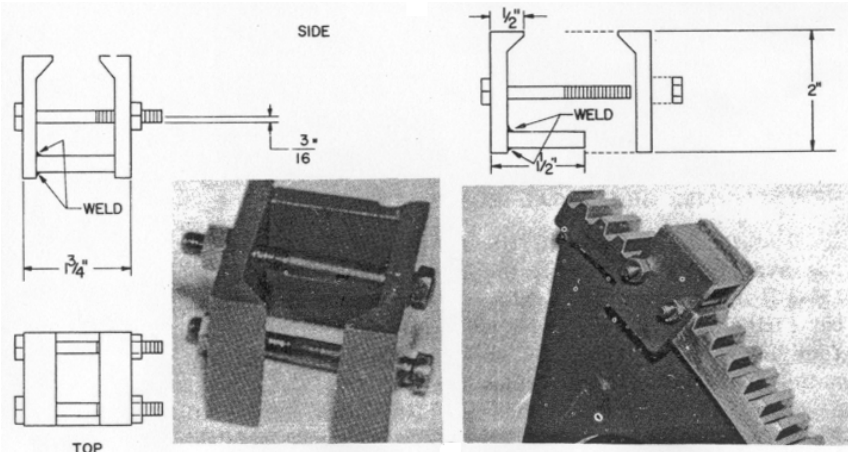
Employment of the traversing and elevating stops can materially assist in establishing additional safety features for small impact areas.



\*A wing nut or standard nut may be used.



①



②

Figure 44. ① The traverse stop for the 105-mm howitzer.  
 ② The elevation stop for the 105-mm howitzer.

# NEWS NOTES FOR ARTILLERYMEN

## FADAC HAS SUCCESSFUL DEBUT

The artilleryman's biggest gain with the digital computer is its ability to determine rapid and accurate predicted fire data. In December 1960, the Field Artillery Data Computer (FADAC) was given an opportunity to prove itself in a firing demonstration at Fort Sill.

The current weather data and the measured weapon-ammunition data for four howitzer batteries (two 105-mm, one 155-mm, and one 8-inch) were entered into the computer in about three minutes time. Data for targets selected at random were also entered into the computer. The FADAC then computed and displayed predicted fire gun settings, which were sent to the guns. The effect on the targets was impressive.

The demonstration also displayed the capability of the computer to conduct multiple missions with three batteries, compute registration corrections, and compute survey data from traverse and triangulation field notes. The coordinates for ten targets can be stored and recalled as desired.

## NEW FIELD MANUALS APPROVED FOR PUBLICATION

Two new Field Manuals, FM 6-10, *Field Artillery Communications*, and FM 6-121, *FA Target Acquisition*, have been approved for publication by USCONARC, and are now under preparation by the US Army Artillery and Missile School.

Field Manual 6-10 will consolidate artillery communication information presently found in portions of fourteen manuals. It will also include communication data which is unavailable in current literature.

Field Manual 6-121 will consolidate all phases of Field Artillery Target Acquisition formerly found in FM 6-20, *FA Tactics and Techniques*, to include duties of the S2, and the coordination, acquisition and processing of artillery target information.

## NEW 155-MM GRAPHICAL EQUIPMENT AVAILABLE

The Book Department, US Army Artillery and Missile School, now has available for purchase the latest graphical equipment based on FT 155-Q-3, including metric scales. This equipment includes: Table, Graphical Firing, M64 (two 15-inch rules for \$2.50); Table, Graphical Site, M67 (one 14-inch rule for \$2.25); and Table, Graphical Firing, M70 for illuminating shell (two 15-inch rules for \$2.50).

The Department also has the November 1960 edition of FM 6-40, *Field Artillery Cannon Gunnery* (\$2.50 postpaid) available for immediate purchase. Mail your check, postal or money order payable to the USAAMS Book Department, Fort Sill, Oklahoma.

## **NEW SLIDE RULE DEVELOPED**

The field artillery's new slide rule is a three-piece (indicator, case, and data strip), double-faced rule made of aluminum alloy. A new feature is the inclusion of log log scales on the back of the rule. This rule will be a future item of issue.

## **TELLUROMETER REQUIRES NEW SYSTEM OF SURVEY TOLERANCES**

A recent exercise using the tellurometer was conducted at Fort Carson, Colorado. The purpose of the exercise was to determine the capabilities of this instrument in traverse operations. A 3rd order traverse was performed by the 32d Engineer Combat Battalion, 2d US Army Missile Command (medium), from Fort Carson to Fort Bliss, Texas (Oro Grande Range), a distance of 540 miles. Although the exercise was conducted in conjunction with the scheduled firing of a Corporal battalion of the Missile Command, it was not planned that the survey would control the firing. It did, however, provide certain time factors and a check on the organization of the proposed engineer survey support company.

Six survey parties equipped with either a master or remote tellurometer unit and a Wild T2 Theodolite were used to extend the control. Thirty-two stations were established along the route with an average of 14 miles between stations. Five stations were controlled each day. Three of the occupied stations were known stations, and the accuracies attained were:

Station 6	Position 1:21,000	Height —.5 meters
Station 16	Position 1:11,000	Height —.5 meters
Station 20	Position 1: 9,000	Height —3.5 meters
Station 32	Position 1:11,000	Height +2.2 meters

The closing accuracy of 1:11,000 was based on a total error of 79 meters over the 540 miles. For a 3rd order (1:5,000) survey over this distance, the total allowable error was 179 meters. It becomes evident that certain specifications must be changed for tellurometer traverse if units are to achieve results with errors which can be tolerated, regardless of accuracy. For example, the allowable closing error might be stated as 1:5,000 or as 25 meters, whichever is smaller.

The length of lines before closure could be limited to 100 miles and the number of stations in any 100-mile segment could be limited to 12 stations, thereby assuring an azimuth closure not to exceed 60 seconds (5 seconds probable error per station).

Helicopters were used extensively throughout the exercise to transport personnel and equipment. Although the exercise lasted only five days, the traverse parties could have continued as a separate unit for an additional three weeks before requiring administrative, logistical or technical support.

## **PINPOINT ACCURACY SURVEY INSTRUMENTS IN PRODUCTION**

Autonetics Division, North American Inc., was awarded a contract in October 1960 to produce the 101 azimuth-gyro-artillery survey instrument.

Rigid specifications enable this device to read azimuths to an accuracy of 0.148 mils (30 seconds) or better at mid-northing latitudes. Excluding instrument set-up time, this extreme accuracy can be accomplished in 20 minutes.

The first production model will be delivered in 13 months after contract date, with subsequent deliveries scheduled so that 36 instruments will be available in 18 months. Full shipment should be completed in approximately 24 months. This delivery schedule indicates that some units authorized the azimuth-gyro-artillery instrument in their TOE's will be equipped with the device by the end of FY 1962.

#### **SECOND LACROSSE FIRING COMPLETED AT FORT SILL**

The Army's Lacrosse missile was put through its second phase of Army Training Tests at Fort Sill in January 1961. The 4th Missile Battalion, 41st Artillery, launched the first of six missiles fired in a two-day period. The first missile traveled at a speed of about 1,500 feet per second to an impact area 8.8 miles from the firing point. The initial phase of the tests was conducted at Fort Sill in October 1960.

#### **FIRST LITTLE JOHN BATTALION ACTIVATED**

The 1st Missile Battalion, 18th Artillery, is the designation of the new Little John battalion which was activated at Fort Sill in January 1961. This battalion is the first Little John unit outside of Strategic Army Corps. A second Little John battalion, the 1st Missile Battalion, 57th Artillery, is expected to be activated at Fort Sill later this year.

#### **RESULTS OF FIELD ARTILLERY INDUSTRIAL CONFERENCE**

The strengthening of the all-important relationship between the artillery and industry was in the spotlight last November at the Field Artillery Industrial Conference, sponsored by the US Army Artillery and Missile School (USAAMS), Fort Sill. The purpose of the conference was to acquaint representatives of industry with the status of field artillery, its problems, techniques, concepts, and future developments.

Representatives from industrial organizations throughout the United States attended the conference. They came from many industries; for example, electronics, missiles, infrared, vehicles (ground and airborne), data processing, computers, radar, television, communications, research institutes, and electronic warfare. In addition, several military agencies not from Fort Sill were present.

The scope of the conference presentations included tactical organization, gunnery, communications, target acquisition, field artillery rockets and missiles, artillery radars, survey, meteorology, transportation and future materiel. The conference concluded with a panel discussion, after which the conferees visited individual departments of the School.

The conferees were enthusiastic about the conference and it was agreed that future meetings would prove beneficial to both parties.

## STATUS OF TRAINING LITERATURE

### 1. The following training literature is under preparation or revision by the US Army Artillery and Missile School:

#### A. FIELD MANUALS (FM):

- 6-10 Field Artillery Communications
- 6-15 Artillery Meteorology
- 6-16 Tables for Artillery Meteorology
- 6-20 FA Tactics and Techniques
- 6-45A FA Missile Battalion, Lacrosse, Gunnery
- 6-56 FA Missile Battalion (Battery), Little John Rocket
- 6-57 The FA Rocket, Little John, w/Launcher XM34
- 6-120 FA Target Acquisition and Batteries
- 6-121 FA Target Acquisition
- 6-200 Artillery Survey
- 6-( ) Field Artillery Graphical Firing Equipment
- 6-( ) Radar Set, AN/MPQ-4
- 6-( ) US Army Missile Command
- 21-13 The Soldiers Guide

#### B. TECHNICAL MANUALS (TM):

- 6-( ) Logarithmic and Mathematical Tables

#### C. ARMY TRAINING PROGRAMS (ATP):

- 6-100 Field Artillery Unit
- 6-302 FA Rocket Units (Honest John, Little John)
- 6-545 FA Missile Battalion, Corporal
- 6-575 FA Target Acquisition Battalion
- 6-630 FA Missile Battalion, Redstone

### 2. Training literature submitted to USCONARC:

- ATP ( ) Training Program for non-unit obligors

### 3. Training literature at the Government Printing Office:

- FM 6-44A FA Missile, Lacrosse
- FM 6-75 105-mm Howitzer, M2 Series, Towed
- FM 6-81 155-mm Howitzer, M1, Towed
- FM 6-90 8-inch Howitzer, M2, Towed
- ATT 6-10 Change 1, FA Missile Battalion, Corporal

### 4. Training literature recently printed:

- FM 6-35 FA Missile, Redstone
- FM 6-36 FA Missile, Redstone Firing Procedures
- FM 6-40 FA Cannon Gunnery
- FM 6-44 FA Missile, Lacrosse
- TM 6-300 Army Ephemeris for 1961
- ATT 6-630 FA Missile Group, Redstone

### 5. Artillery training films currently under production and scheduled for release during calendar year 1961:

- 318-mm Rocket
- Part I. Introduction to the system



- Part II. Description of equipment
- Part III. Loading, preparation for action, firing, and march order
- Field Artillery, RSOP
  - Part I. Deliberate
  - Part II. Rapid
- Ground Surveillance Radar, AN/TPS-25
  - Part I. Theory, installation and operation
  - Part II. Moving target detection
- The 762-mm Rocket
  - Part I. Introduction to the system
  - Part II. Mechanical assembly and electrical checkout
  - Part III. Loading, preparation for action, firing, and march order
- Countermortar Radar AN/MPQ-4A
  - Part II. Preparation and performance checks

**6. Artillery training films currently under production and scheduled for release during calendar year 1962:**

Laying the Field Artillery Battery

**7. Artillery training films production completed and scheduled for release in calendar year 1961:**

Countermortar Radar, AN/MPQ-4A

Part I. Operation (TF 6-3096) (25 minutes)

Lacrosse Battalion Guidance Section

Part I. Duties in prepare for action and march order (25 minutes)

Lacrosse Battalion Assembly Section—Crew duties in prepare for action, checkout and assembly, and march order (25 minutes)

Lacrosse Battalion—Firing Section—Crew duties in prepare for action, firing, and march order.

Lacrosse Battalion—RSOP

Extension of Direction for Artillery by Simultaneous Astronomic Observation (25 minutes)

**8. Artillery training films scheduled for production and release during calendar year 1962:**

Field Artillery Sound Ranging

Field Artillery Target Acquisition Battalion

Introduction to Flash Ranging

**9. Artillery training films recently released:**

Artillery Battalion Survey

Part II. Planning and Execution (TF 6-2875) (25 minutes)

**10. Status of Army Subject Schedules (MOS):**

A. UNDER PREPARATION OR REVISION BY THE US ARMY ARTILLERY AND MISSILE SCHOOL:

- ASubjScd 6-103 MOS Technical Training of the Ballistic Meteorology Crewman
- ASubjScd 6-104 MOS Technical Training of the Field Illumination Crewman
- ASubjScd 6-152 MOS Technical Training of the FA Operations and Intelligence Assistant
- ASubjScd 6-153 MOS Technical Training of the Artillery Surveyor
- ASubjScd 6-154 MOS Technical Training of the FA Flash Ranging Crewman
- ASubjScd 6-155 MOS Technical Training of the Sound Ranging Crewman
- ASubjScd 6-156 MOS Technical Training of the Radar Crewman
- ASubjScd 6-164 MOS Technical Training of the Field Artillery Missile Crewman (Corporal)
- ASubjScd 6-165 MOS Technical Training of Field Artillery Fire Control Crewman (Corporal)
- ASubjScd 6-166 MOS Technical Training of the FA Missile Crewman (Lacrosse)
- ASubjScd 6-168 MOS Technical Training of the FA Missile Crewman (Redstone)
- B. SUBMITTED TO USCONARC:
  - ASubjScd 6-142 MOS Technical Training of the Heavy and Very Heavy FA Crewman
  - ASubjScd 6-147 MOS Technical Training of the FA Rocket Crewman
- C. RECENTLY PRINTED:
  - ASubjScd 6-141 MOS Technical Training of the Light and Medium FA Crewman

**11. Status of Army Subject Schedules (Non-MOS):**

A. UNDER PREPARATION OR REVISION BY THE US ARMY ARTILLERY AND MISSILE SCHOOL:

- ASubjScd 6-2 FA Air Observer Training
- ASubjScd 6-3 Cannoneer and Rocketeer Instruction
- B. SUBMITTED TO USCONARC:
  - ASubjScd 6-4 Combat Intelligence
  - ASubjScd 6-6 Communication Exercise for Artillery Units
  - ASubjScd 6-12 Field Exercises
  - ASubjScd 6-16 FA Instruction and Duties of Instrument Operator
  - ASubjScd 6-24 Organization and duties of Operations section, FA Observation Battalion
  - ASubjScd 6-29 Artillery Survey
  - ASubjScd 6-41 Organization, Mission and Employment of Armored and Infantry Units

C. RECENTLY PUBLISHED:

A Subj Scd 6-10      Countermortar and counterbattery radar

**ARTILLERY INFORMATION LETTERS**

The following artillery information letters containing items of technical nature have been published by the US Army Artillery and Missile School since the NOVEMBER 1960 issue of ARTILLERY TRENDS. Distribution is made *only* to the units and their controlling headquarters which are authorized the equipment discussed in these letters:

- CORPORAL INFORMATION LETTER NUMBER 21 dated 15 November 1960
- CORPORAL INFORMATION LETTER NUMBER 22 dated 9 January 1961
- CORPORAL INFORMATION LETTER NUMBER 23 dated 27 January 1961 (S)
- LACROSSE INFORMATION LETTER NUMBER 7 dated 28 October 1960 (C)
- LACROSSE INFORMATION LETTER NUMBER 8 dated 25 November 1960 (C)
- LACROSSE INFORMATION LETTER NUMBER 9 dated 6 December 1960 (C)
- LACROSSE INFORMATION LETTER NUMBER 10 dated 6 January 1961 (C)
- LACROSSE INFORMATION LETTER NUMBER 11 dated 10 January 1961
- LACROSSE INFORMATION LETTER NUMBER 12 dated 19 January 1961 (C)
- LACROSSE INFORMATION LETTER NUMBER 13 dated 9 February 1961



"We soldiers share a deeply rooted faith in the indispensability and in the permanency of the land combat function. We realize that the means to perform this function will change in the future as they have in the past. But we have an unshakable faith that as long as there is land, and people on the land, the land combat function itself will remain a decisive element in any future conflict."

General George H. Decker



"In many situations that seemed desperate, the artillery has been a most vital factor."

General Douglass MacArthur



"The first duty of artillery is to hit, the second duty is to hit, and the third is to hit."

Hohenlohe

## CURRENT RESIDENT COURSE SCHEDULE

Effective with this issue, ARTILLERY TRENDS will publish a schedule of US Continental Army Command approved classes to be conducted at the US Army Artillery and Missile School, Fort Sill. The schedule will cover a period of approximately three months and is subject to change.

Complete details of the school courses, including prerequisites, are listed in Department of the Army Pamphlet 20-21, *The Army School Catalog*, and changes 1 through 140; and the July 1960 issue of ARTILLERY TRENDS.

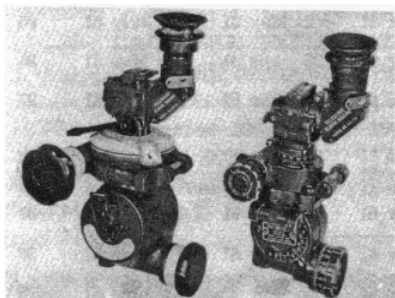
The officer and enlisted resident courses listed below are scheduled to be taught at the US Army Artillery and Missile School the latter part of April through 30 June 1961:

Course	Class Nr	Report	Start	Close	Input
FA Officer Orientation (6-A-C20)	17-61	17 Apr 61	21 Apr 61	14 June 61	100
	18-61	1 May 61	5 May 61	28 June 61	99
	19-61	28 May 61	2 June 61	26 July 61	99
	20-61	12 June 61	16 June 61	9 Aug 61	99
FA Officer Familiarization (6-A-C21)	4-61	16 Apr 61	17 Apr 61	2 June 61	50
Associate FA Officer Career (6-A-C23)	5-61	15 May 61	17 May 61	20 Sept 61	96
FA Field Grade Officer Refresher (6-A-C11)	2-61	11 June 61	12 June 61	23 June 61	63
Artillery Communication Officer (6-B-0200)	4-61	30 Apr 61	2 May 61	26 July 61	30
Lacrosse Officer (6-A-1187)	2B-61	23 Apr 61	25 Apr 61	27 May 61	20
Artillery Vehicle Maintenance Supervisors (6-R-631.7/632.7)	3-61	25 June 61	27 June 61	10 Aug 61	27
Artillery Track Vehicle Maintenance (6-R-632.1)	16-61	23 Apr 61	26 Apr 61	7 July 61	63
	17-61	7 May 61	10 May 61	21 July 61	63
	18-61	21 May 61	24 May 61	4 Aug 61	63
Artillery Survey Advanced (6-R-153.1)	9-61	24 May 61	29 May 61	21 July 61	67
Artillery Flash Ranging Advanced (6-R-154.1)	3-61	11 May 61	15 May 61	23 June 61	30
Field Artillery Radar Operations (6-R-156.1)	4A-61	10 Apr 61	12 Apr 61	23 June 61	33
	5A-61	15 May 61	17 May 61	1 Aug 61	33
	6-61	21 June 61	23 June 61	31 Aug 61	34
Corporal Mechanical Materiel Maintenance (6-R-164.3)	6-61	26 Apr 61	28 Apr 61	22 June 61	14
Artillery Radio Maintenance (6-R-313.1)	19-61	16 Apr 61	18 Apr 61	25 July 61	36
	20-61	30 Apr 61	2 May 61	8 Aug 61	36
	21-61	14 May 61	16 May 61	22 Aug 61	36
	22-61	4 June 61	6 June 61	12 Sept 61	36
	3-61	31 May 61	5 June 61	15 Sept 61	29
Artillery Communication Supervisors (6-R-313.6)	3-61	31 May 61	5 June 61	15 Sept 61	29
Nuclear Projectile Assembly (6-D-142.0)	10-61	30 Apr 61	1 May 61	6 May 61	29
Artillery Ballistic Meteorology (6-N-103.1)	8-61	14 Apr 61	19 Apr 61	30 June 61	32
FA Radar Maintenance (6-N-1121/211.1)	2A-61	16 May 61	19 May 61	18 Jan 62	28
Corporal Electronic Materiel Maintenance (6-N-1192A/214.1)	4B-61	18 May 61	22 May 61	14 Dec 61	15

Course	Class Nr	Report	Start	Close	Input
Corporal Fire Control System Maintenance (6-N-1186/215.1)	5-61	14 June 61	16 June 61	10 Feb 62	14
Artillery Target Acquisition Officer (6-A-1154)	2-61	10 May 61	12 May 61	21 July 61	25
Artillery Motor Transport (6-B-0600/0606)	3-61	4 June 61	7 June 61	1 Aug 61	29
FA Officer Candidate (6-N-F1)	6-61	24 Apr 61	1 May 61	3 Oct 61	40
FA Officer Candidate (Reserve Component) (6-N-F2)	7-61	19 June 61	26 June 61	28 Nov 61	40
FA Officer Candidate (Reserve Component) (6-N-F2)	1A-61	18 June 61	21 June 61	2 Sept 61	102
Rocket Nuclear Warhead Assembly (6-D-147.2)	13-61	16 Apr 61	17 Apr 61	24 Apr 61	20
	14-61	7 May 61	8 May 61	15 May 61	20

### **XM53 SIGHT UNIT TO BE TESTED**

The extensively redesigned M34 sight unit, now the XM53 (fig 45) will be service-tested at the US Army Artillery Board, Fort Sill, in the near future. The redesign of the M34 sight unit began in 1957 after engineering tests showed that the M34A2 sight unit could not withstand the shock of firing when mounted on the 4.2-inch mortar, M30.



**Figure 45. The redesigned sight unit (Left) and the existing sight unit M34 (Right).**

Some of the improvements in the redesigned M34 are as follows: the cost and weight of materials have been reduced; crevices and corners have been eliminated; durability and accuracy have been increased by eliminating the azimuth worm throwout feature; an integral light projector has been added, thus eliminating the standard night lighting instrument M14; fast-slewing cranks have been added for speed of operation (not shown in figure); the telescope magnification has been increased to four power; scales and indexes have been rearranged for better readability; and the azimuth mil scale has been numbered from 0 to 6400 mils.

"Artillery which cannot march is useless and a burden upon the lines of supply; Artillery which cannot maintain itself soon falls by the wayside, and artillery which cannot shoot, becomes not only useless, but a positive menace to its own associates."

Colonel Henry W. Butner  
Field Artillery School 1923

# ALPHABETICAL SUBJECT INDEX

## FEBRUARY 1960 THROUGH NOVEMBER 1960

SUBJECT	ISSUE	PAGE
<b>Abacus</b>		
The Original Computer—The Abacus (Newsnote).....	Sept 60	88
<b>Adjustment of Artillery Fire</b>		
Adjustment of Artillery Fire by Radar .....	Feb 60	3
A New Bracket Method of Fire.....	Nov 60	3
<b>Advanced Individual Training (Artillery)</b>		
US Army Training Center, Field Artillery.....	Feb 60	28
<b>Airborne Artillery</b>		
Airborne Target Identification .....	Sept 60	64
<b>Aircraft</b>		
An Important Friend of Artillerymen—Army Aviation .....	July 60	59
Grumman Mohawk Models Tested (Newsnote) .....	Nov 60	58
New Helicopter Planned (Newsnote).....	Nov 60	59
<b>Air Defense Artillery</b>		
Air Defense Artillery in the Field Army .....	May 60	39
<b>Ammunition</b>		
Death by Radio—The CVT Fuze .....	Feb 60	7
<b>Amphibious Vehicles</b>		
LARC-5—Lighter, Amphibious, Resupply, Cargo (Newsnote).....	Feb 60	73
<b>AN/GRA-6 Remote Control Equipment</b>		
Fast and Reliable Remoting .....	Feb 60	58
<b>AN/GRR-5 Radio Receiver</b>		
Gem for Communication Personnel (Improvised antenna for AN/GRR-5).....	Nov 60	28
<b>AN/MRC-69 Radio Terminal Set</b>		
Air Defense Artillery in the Field Army .....	May 60	48
<b>AN/MSG-4 Missile Monitor</b>		
Air Defense Artillery in the Field Army .....	May 60	45
<b>AN/MSQ-18 (Fire Distribution System)</b>		
Air Defense Artillery in the Field Army .....	May 60	46
<b>Antiradiation Pill</b>		
Antiradiation Pill is Expected (Newsnote).....	Nov 60	59
<b>Armored Cavalry Regiment</b>		
"Horseshoes to Iron Tracks"—Armored Cavalry Regiment .....	July 60	26

SUBJECT	ISSUE	PAGE
<b>Armored Division</b>		
The Armored Division—Its Employment and Future.....	May 60	49
<b>Armor Protection</b>		
Lightweight Armor Protection (Newsnote).....	Feb 60	71
<b>Armored Division Artillery</b>		
The Armored Division—A Combined Arms Team.....	Feb 60	42
<b>Armored Infantry Battalion—Armored Division</b>		
The Armored Division—A Combined Arms Team.....	Feb 60	42
<b>Armored Mortar Carrier, M84</b>		
The Armored Division—A Combined Arms Team.....	Feb 60	42
<b>Armored Organization and Tactics</b>		
See Organization and Tactics—Armored.....		
<b>Armored Personnel Carrier, M59</b>		
The Armored Division—A Combined Arms Team.....	Feb 60	42
<b>Armored Personnel Carrier, M113</b>		
The Armored Division—Its Employment and Future.....	May 60	56
"Horseshoes To Iron Tracks"—Armored Cavalry Regiment .....	July 60	32
<b>Army Aviation</b>		
An Important Friend of Artillerymen—Army Aviation .....	July 60	59
<b>Army Ballistic Missile Agency</b>		
Missile Responsibilities Realigned (Newsnote).....	Nov 60	59
<b>Army School Catalog</b>		
Under Revision—The Army School Catalog (Newsnote) .....	Nov 60	56
<b>Army Training Test Grading</b>		
New ATT Grading for FFE .....	Nov 60	16
<b>Artillery Board</b>		
A New Artillery Trainer for Gunnery Practice.....	July 60	9
"Light and Mobile"—The Italian 105-mm Howitzer.....	July 60	69
<b>Artillery Development</b>		
See Development		
<b>Artillery Information Letters</b>		
Artillery Information Letters (Newsnote).....	May 60	79
Artillery Information Letters (Newsnote).....	July 60	76
Artillery Information Letters (Newsnote).....	Nov 60	63
<b>Artillery Instructors Conference</b>		
Fort Sill to Host Artillery Instructors Conference (Newsnote) .....	July 60	71

<b>SUBJECT</b>	<b>ISSUE</b>	<b>PAGE</b>
Results of Artillery Instructors Conference (Newsnote) .....	Nov 60	57
<b>Artillery Officer</b>		
US Army Reserve Schools and Staff Training Program .....	Feb 60	54
Gem for the Communication Officer (Directional antennas) .....	Feb 60	65
Gem for the Survey Officer (Range pole container) .....	Feb 60	79
Gem for the Artillery Battery (Lantern box) .....	Feb 60	80
Battery Executive Officer Now Controls Fire Direction .....	May 60	70
<b>Artillery Trainer, 14.5-mm</b>		
A New Artillery Trainer for Gunnery Practice .....	July 60	9
<b>Artillery Weapons (Foreign)</b>		
See Foreign Artillery Weapons		
<b>Artillery Weapons (General)</b>		
Weapons of the Artillery—8 (Redstone) .....	Feb 60	2
Weapons of the Artillery—9 (Lacrosse) .....	May 60	2
"Light and Mobile"—The Italian 105-mm Howitzer .....	July 60	69
A Bizarre 155-mm Howitzer .....	Nov 60	50
<b>Automatic Data Processing</b>		
Entire Subject Covered in One Subject Issue .....	Sept 60	
<b>Automatic Radiological Monitoring Equipment</b>		
Automatic Radiation Alarm Being Tested (Newsnote) .....	July 60	37
<b>Aviation Army</b>		
An Important Friend of Artillerymen—Army Aviation .....	July 60	59
Grumman Mohawk Models Tested (Newsnote) .....	Nov 60	58
New Helicopter Planned (Newsnote) .....	Nov 60	59
<b>Basic Unit Training</b>		
US Army Training Center, Field Artillery .....	Feb 60	28
<b>Battery and Battalion Tests</b>		
New ATT Grading for FFE .....	Nov 60	16
<b>Battery Display Unit</b>		
Pushbutton Fire Control .....	Sept 60	53
<b>Battery Executive Officer</b>		
Gem for the Battery Executive Officer (Checking that tubes are parallel) .....	Feb 60	12
Gem for the Battery Executive Officer (Laying in center of traverse) .....	Feb 60	35
Protect Your Gun Book .....	Feb 60	79
Battery Executive Officer Now Controls Fire Direction .....	May 60	70
Handbook for Battery Executive Now Available (Newsnote) .....	Nov 60	58



SUBJECT	ISSUE	PAGE
<b>Binary Numbering System</b>		
Computer Code—By the Numbers .....	Sept 60	89
<b>Binoculars, Lightweight</b>		
Lightweight Binoculars (Newsnote) .....	May 60	74
<b>Bookstore</b>		
New Publications for Radar Mechanic Instruction (Newsnote) .....	May 60	76
Handbook for Battery Executive Now Available (Newsnote) .....	Nov 60	58
<b>Bracket Method of Fire</b>		
A New Bracket Method of Fire .....	Nov 60	3
<b>Bridge, Armor, Self-Propelled</b>		
The Armored Division—A Combined Arms Team .....	Feb 60	42
<b>British Artillery</b>		
Allied Artillery Missiles .....	Feb 60	16
<b>Cargo Truck, M125, TM</b>		
New Technical Manual for M125 Cargo Truck (Newsnote) .....	Nov 60	58
<b>Cathode-ray Tubes</b>		
Gem for the Radar Technician (Handling of cathode-ray tubes) .....	Nov 60	13
<b>Chronographs</b>		
The T7 Field Artillery Chronograph .....	May 60	35
<b>Combat Arms Conference</b>		
Combat Arms Conference Held at Fort Sill (Newsnote) .....	Feb 60	66
<b>Communication Converter</b>		
Computer Code—By The Numbers .....	Sept 60	92
<b>Communication Defense Measures</b>		
Communication Defense Measures in Electronic Warfare .....	Nov 60	10
<b>Communications in the New Division Artillery</b>		
New Radiotelephone Procedure for the New FD System .....	Feb 60	21
<b>Communication Personnel</b>		
Gem for Communication Personnel (Synchronization of Autotune Mechanism) .....	Nov 60	36
<b>Communications Systems</b>		
New Radiotelephone Procedure for the New FD System .....	Feb 60	21
Fast and Reliable Remoting .....	Feb 60	58

SUBJECT	ISSUE	PAGE
Gem for Communication Personnel (Radio/wire integration system) .....	July 60	76
"Real-Time" Communication Capability for ADP (Newsnote) .....	Sept 60	15
Computer Code—By The Numbers .....	Sept 60	89
<b>Computers</b>		
"First Round Hits" with FADAC .....	Sept 60	8
Road to Good Decision Through Computers .....	Sept 60	16
The Computer Story—Speed and Accuracy .....	Sept 60	30
How FIELDATA Computers Achieve Tactical Capabilities (Newsnote) .....	Sept 60	42
Speeding Nuclear Response Via ADP .....	Sept 60	59
Pinpoint Survey Control With Computers .....	Sept 60	80
The Original Computer—The Abacus .....	Sept 60	88
Computer Code—By The Numbers .....	Sept 60	89
<b>CVT Fuze</b>		
Death by Radio—The CVT Fuze .....	Feb 60	7
<b>Deployment of Artillery</b>		
The Armored Division—A Combined Arms Team .....	Feb 60	42
<b>Development</b>		
Project Metro Precision .....	Feb 60	36
New Shipping Container for STRAC Units (Newsnote) .....	Feb 60	66
Missile-Borne TV Camera (Newsnote) .....	July 60	71
Tougher Helmet Liner May Be Near Reality (Newsnote) .....	July 60	72
New Helicopter Planned (Newsnote) .....	July 60	72
Army Has New Tear Gas (Newsnote) .....	July 60	72
<b>Digital Data Terminal AN/TYC-1</b>		
Computer Code—By The Numbers .....	Sept 60	92
<b>Distance Measuring</b>		
T16 Theodolite—Speed, Accuracy, Economy .....	Nov 60	14
<b>Electronics</b>		
Growing Pains in the Electronics Field (Newsnote) .....	Feb 60	73
Electronic Troubleshooting (Newsnote) .....	May 60	75
<b>Electronic Tactical Map</b>		
Pushbutton Fire Control .....	Sept 60	51
<b>Electronic Warfare</b>		
Communication Defense Measures in Electronic Warfare .....	Nov 60	10
<b>Emergency Gunnery Procedures</b>		
The Modern "Minuteman"—A New Fire Direction Center Computer .....	May 60	3

SUBJECT	ISSUE	PAGE
<b>Engineer Topographic Company</b>		
Topographic Company to Aid Artillery (Newsnote).....	Nov 60	59
<b>Enlisted Evaluation System</b>		
The Enlisted Evaluation System (Newsnote) .....	Feb 60	74
<b>Extension Courses</b>		
Milestone for Artillery Extension Courses .....	Feb 60	15
Training By Mail—Extension Course Division .....	Nov 60	52
<b>Field Artillery Automatic Data Computer (FADAC)</b>		
"First Round Hits" With FADAC .....	Sept 60	8
<b>Field Artillery Data Computer Automatic Logic Tester (FALT)</b>		
"First Round Hits" With FADAC .....	Sept 60	12
<b>Field Artillery Weapons (General)</b>		
See Artillery Weapons (General)		
<b>Field Expedients</b>		
Gem for the Survey Officer (Range pole container) .....	Feb 60	79
Protect Your Gun Book .....	Feb 60	79
Gem for the Artillery Battery (Lantern box) .....	Feb 60	80
Gem for Communication Personnel (Improvised antenna for AN/GRR-5) .....	Nov 60	28
<b>Field Message</b>		
How To Write A Field Message .....	July 60	13
<b>Fire Direction</b>		
New Radiotelephone Procedure for the New FD System .....	Feb 60	21
The Modern "Minuteman"—A New Fire Direction Center Computer .....	May 60	3
Battery Executive Officer Now Controls Fire Direction .....	May 60	70
Gem for the Fire Direction Center (Charge selector) .....	May 60	80
Inside An Automated FDC .....	Sept 60	39
<b>Fire Distribution System</b>		
Air Defense Artillery in the Field Army .....	May 60	39
<b>Fire Planning</b>		
Future Shooting—Automated Artillery .....	Sept 60	56
<b>Firing Panel Box, M35</b>		
M35 Firing Box (Newsnote) .....	Feb 60	67
<b>Firing Tables</b>		
New Firing Tables for Cannon Artillery (Newsnote) .....	May 60	73
<b>First Field Artillery Missile Brigade</b>		
The 1st Field Artillery Missile Brigade .....	May 60	66

SUBJECT	ISSUE	PAGE
<b>Flip-flop Circuit (Digital Computer)</b>		
Road To Good Decision Through Computers .....	Sept 60	18
<b>FM 6-20</b>		
Status of Training Literature (Newsnote) .....	Feb 60	75
Status of Training Literature (Newsnote) .....	May 60	77
Status of Training Literature (Newsnote) .....	July 60	73
Status of Training Literature (Newsnote) .....	Nov 60	60
<b>FM 6-40</b>		
Status of Training Literature (Newsnote) .....	Feb 60	75
Status of Training Literature (Newsnote) .....	May 60	77
Status of Training Literature (Newsnote) .....	July 60	73
Status of Training Literature (Newsnote) .....	Nov 60	60
<b>FM 6-140</b>		
Status of Training Literature (Newsnote) .....	Feb 60	75
Status of Training Literature (Newsnote) .....	May 60	77
Status of Training Literature (Newsnote) .....	July 60	73
Status of Training Literature (Newsnote) .....	Nov 60	60
<b>Foreign Artillery Weapons</b>		
Allied Artillery Missiles .....	Feb 60	16
"Light and Mobile"—The Italian 105-mm Howitzer .....	July 60	69
<b>Forward Observer</b>		
Gem for the Forward Observer (Determining range from 106-mm recoilless rifle) .....	May 60	71
Gem for the Forward Observer (Reference brochure for forward observer) .....	Nov 60	49
<b>French Artillery</b>		
Allied Artillery Missiles .....	Feb 60	16
<b>Fuzes and Fuze Setters</b>		
Death by Radio—The CVT Fuze .....	Feb 60	7
<b>GOER Vehicles</b>		
The Armored Division—Its Employment and Future .....	May 60	57
<b>Graphical Equipment, 8-inch howitzer</b>		
New 8-Inch Howitzer Graphical Equipment (Newsnote) .....	May 60	72
<b>Graphical Firing Tables</b>		
Honest John Gunnery—Solution by Graphic Methods .....	July 60	38
"Artillery Lamplighter"—A New GFT .....	Nov 60	47
<b>Gun, 155-mm (SP) (T245)</b>		
Lightweight Armor Protection (Newsnote) .....	Feb 60	71
<b>Gun, 175-mm (SP) (T235)</b>		
Lightweight Armor Protection (Newsnote) .....	Feb 60	71

SUBJECT	ISSUE	PAGE
<b>Gun, 280-mm</b>		
280-mm Gun Publications Distributed .....	Nov 60	9
<b>Gunnery (General)</b>		
Adjustment of Artillery Fire by Radar .....	Feb 60	3
Death by Radio—The CVT Fuze .....	Feb 60	7
Project Metro Precision .....	Feb 60	36
The Modern "Minuteman"—A New Fire Direction Center Computer .....	May 60	3
A Darned Site Better .....	May 60	29
The T7 Field Artillery Chronograph .....	May 60	35
Simplified Site .....	May 60	60
Battery Executive Officer Now Controls Fire Direction .....	May 60	70
New 8-Inch Howitzer Graphical Equipment (Newsnote) .....	May 60	72
NATO to Have Standard Met Message (Newsnote) .....	May 60	72
New Firing Tables for Cannon Artillery (Newsnote) .....	May 60	73
Gem for the Fire Direction Center (Charge selector) .....	May 60	80
Honest John Gunnery—Solution by Graphic Methods .....	July 60	38
A New Bracket Method of Fire .....	Nov 60	3
"Artillery Lamplighter"—A New GFT .....	Nov 60	47
<b>Hawk</b>		
Air Defense Artillery in the Field Army .....	May 60	41
<b>Helicopters (General)</b>		
Helicopter Industry Looks at the Future (Newsnote) .....	May 60	75
<b>Helicopter RSOP</b>		
The Army's Forward Look—"The Flying Artillery" .....	May 60	19
<b>Helicopter Transportation Company (light and medium)</b>		
The Army's Forward Look—"The Flying Artillery" .....	May 60	12
<b>Honest John Rocket</b>		
M35 Firing Panel Box (Newsnote) .....	Feb 60	67
Honest John Gunnery—Solution by Graphic Methods .....	July 60	38
The XM33—Honest John's New 'Cousin' .....	July 60	57
<b>Howitzer, 105-mm</b>		
"Horseshoes To Iron Tracks"—Armored Cavalry Regiment .....	July 60	34
"Light and Mobile"—The Italian 105-mm Howitzer .....	July 60	69
<b>Howitzer, 155-mm</b>		
Information For 155-mm Howitzer Units .....	Feb 60	79
A Bizarre 155-mm Howitzer .....	Nov 60	50
<b>Howitzer, 8-inch</b>		
Lightweight Armor Protection (Newsnote) .....	Feb 60	71
New 8-Inch Howitzer Graphical Equipment (Newsnote) .....	May 60	72

SUBJECT	ISSUE	PAGE
<b>Howitzer, 8-inch, Self-propelled (T236)</b>		
New 8-Inch Howitzer Graphical Equipment (Newsnote) .....	May 60	72
<b>IBM 709 (Computer)</b>		
Pinpoint Survey Control With Computers .....	Sept 60	83
<b>Integrated Communication</b>		
Gem for Communication Personnel (Radio/wire integration system) .....	July 60	76
<b>Introduction to Automatic Data Processing</b>		
"Decisions in the Saddle" to ADPS .....	Sept 60	3
<b>Italian Artillery</b>		
Allied Artillery Missiles .....	Feb 60	16
"Light and Mobile"—The Italian 105-mm Howitzer .....	July 60	69
<b>Laboratory Work</b>		
Growing Pains in the Electronics Field (Newsnote) .....	Feb 60	73
<b>Lacrosse Missile</b>		
Lacrosse Battalions Due to Fire (Newsnote) .....	Feb 60	73
Weapons of the Artillery—9 (Lacrosse Missile) .....	May 60	2
New Lacrosse Battalion Formed (Newsnote) .....	May 60	74
Two Lacrosse Battalions Sent to Germany (Newsnote) .....	July 60	71
Another Training Triumph—Lacrosse Trainer .....	Nov 60	37
<b>LARC-5</b>		
LARC-5—Lighter, Amphibious, Resupply, Cargo (Newsnote) ....	Feb 60	73
<b>Laying Artillery Weapons</b>		
Gem for the Battery Executive Officer (Checking that tubes are parallel) .....	Feb 60	12
Gem for the Battery Executive Officer (Laying in center of traverse) .....	Feb 60	35
Artillery's 'Topkick' Missile—Sergeant .....	Nov 60	26
<b>Little John Rocket</b>		
Production Started on Little John Rocket (Newsnote) .....	May 60	74
Little John—The Mighty Mite .....	July 60	20
<b>M35 Fire Control System</b>		
"First Round Hits" With FADAC .....	Sept 60	8
<b>Maintenance</b>		
New Equipment Technical Publication System .....	Feb 60	39
Electronic Troubleshooting (Newsnote) .....	May 60	75
No 'Magic'—Still FITCAL .....	Sept 60	93
<b>Mauler (Surface-to-Air Missile)</b>		
Air Defense Artillery in the Field Army .....	May 60	42

SUBJECT	ISSUE	PAGE
<b>Message Entry Device (MED)</b>		
Pushbutton Fire Control .....	Sept 60	43
<b>Meteorological Balloons</b>		
Commercial Hydrogen for Meteorological Balloons? .....	Feb 60	64
<b>Meteorology</b>		
The Little Known Front .....	Feb 60	13
Project Metro Precision .....	Feb 60	36
Commercial Hydrogen for Meteorological Balloons? .....	Feb 60	64
Weather Forecast By Rocket .....	Sept 60	85
<b>Meteorological Message</b>		
NATO to Have Standard Met Message (Newsnote) .....	May 60	72
<b>Missile Systems Evaluation Group</b>		
The 1st Field Artillery Missile Brigade .....	May 60	66
<b>Missiles (general)</b>		
Weapons of the Artillery—8 (Redstone) .....	Feb 60	2
Weapons of the Artillery—9 (Lacrosse) .....	May 60	2
Allied Artillery Missiles .....	Feb 60	16
The Pershing Missile—The Army's "Blackjack" .....	May 60	30
New Lacrosse Battalion Formed (Newsnote) .....	May 60	74
Economic, Realistic Training—The Redstone System .....	July 60	42
Artillery's 'Topkick' Missile—Sergeant .....	Nov 60	21
Another Training Triumph—Lacrosse Trainer .....	Nov 60	37
A Redstone Milestone (Newsnote) .....	Nov 60	57
Pershing System Tested (Newsnote) .....	Nov 60	58
Missile Responsibilities Realigned (Newsnote) .....	Nov 60	59
<b>Missiles (surface-to-air)</b>		
Air Defense Artillery in the Field Army .....	May 60	41
<b>Mission Monitor Panel</b>		
Pushbutton Fire Control .....	Sept 60	47
<b>MOS System</b>		
The Enlisted Evaluation System (Newsnote) .....	Feb 60	74
<b>Nike Ajax</b>		
Air Defense Artillery in the Field Army .....	May 60	41
<b>Nike Hercules</b>		
Air Defense Artillery in the Field Army .....	May 60	41
<b>Nomographs, HE</b>		
Graphic Guide for HE Effects .....	Nov 60	29
<b>Nuclear Subjects</b>		
Division Staff Procedures—Nuclear Weapons		
Employment .....	July 60	3
Speeding Nuclear Response Via ADP .....	Sept 60	59

SUBJECT	ISSUE	PAGE
<b>Numbering System of Technical Publications</b>		
New Equipment Technical Publication System .....	Feb 60	39
<b>Occupation of position</b>		
Gem for the Battery Executive Officer (Laying in center of traverse) .....	Feb 60	35
<b>OCS</b>		
Officer Candidate School Today .....	Feb 60	61
<b>Officer Information</b>		
US Army Reserve Schools and Staff Training Program .....	Feb 60	54
Career Courses Revised (Newsnote) .....	May 60	73
New Publications for Radar Mechanic Instruction (Newsnote) .....	May 60	76
<b>Organization and Tactics of the Field Artillery</b>		
The Armored Division—A Combined Arms Team .....	Feb 60	42
<b>Organization and Tactics—Armored</b>		
The Armored Division—A Combined Arms Team .....	Feb 60	42
The Armored Division—Its Employment and Future .....	May 60	49
<b>Pershing Missile</b>		
The Pershing Missile—The Army's "Blackjack" .....	May 60	30
Pershing System Tested (Newsnote) .....	Nov 60	58
<b>Proficiency Testing</b>		
The Enlisted Evaluation System (Newsnote) .....	Feb 60	74
<b>Project Metro Precision</b>		
Project Metro Precision .....	Feb 60	36
<b>Radar Fire Adjustment</b>		
Adjustment of Artillery Fire By Radar .....	Feb 60	3
<b>Radar</b>		
Adjustment of Artillery Fire by Radar .....	Feb 60	3
New Information on the AN/MPQ-4A Radar .....	Feb 60	38
Airborne Target Identification .....	Sept 60	64
Gem for the Radar Technician (Handling of cathode-ray tubes) .....	Nov 60	13
An Electronic FO—The AN/TPS-25 Radar .....	Nov 60	44
<b>Radar Instruction</b>		
New Publications for Radar Mechanic Instruction (Newsnote) .....	May 60	76
<b>Radar Processing Center (Missile Monitor)</b>		
Air Defense Artillery in the Field Army .....	May 60	45
<b>Radar Set AN/MPQ-4A</b>		
New Information on the AN/MPQ-4A Radar .....	Feb 60	38



SUBJECT	ISSUE	PAGE
<b>Radar Set AN/MPQ-10</b>		
Adjustment of Artillery Fire by Radar .....	Feb 60	3
<b>Radar Set AN/TPS-25</b>		
An Electronic FO—The AN/TPS-25 Radar .....	Nov 60	44
<b>Radio Communication</b>		
New Radiotelephone Procedure for the New FD System .....	Feb 60	21
Fast and Reliable Remoting .....	Feb 60	58
Gem for the Communication Officer (Directional antennas) .....	Feb 60	65
Gem for Radio Maintenance Personnel (Hemostatic forceps) .....	May 60	59
Gem for Radio Maintenance Personnel (Safety stand for AN/PRC-8, -9, and -10 radio sets) .....	May 60	65
<b>Radio Nets</b>		
New Radiotelephone Procedure for the New FD System .....	Feb 60	21
<b>Radio Relay Equipment</b>		
Radio Relay Equipment for Artillery Units .....	May 60	47
<b>Radio Sets</b>		
Fast and Reliable Remoting .....	Feb 60	58
Air Defense Artillery in the Field Army .....	May 60	48
Don't Get Caught Short With the AN/GSA-7 .....	May 60	64
Gem for Communication Personnel (Interchangeability directory for vacuum tubes) .....	July 60	56
<b>Radiotelephone Procedure</b>		
New Radiotelephone Procedure for the New FD System .....	Feb 60	21
<b>Radioteletype (AN/GRC-46)</b>		
Weather Forecast by Rocket .....	Sept 60	87
<b>Rations</b>		
"Quickserve" Meals (Newsnote) .....	May 60	75
<b>Rawin Sets</b>		
Project Metro Precision .....	Feb 60	36
<b>Rawin Set AN/GMD-1</b>		
Project Metro Precision .....	Feb 60	36
<b>Receiver-Transmitter RT-70/GRC</b>		
Gem for the Communication Section (Receiver-transmitter RT-70/GRC) .....	July 60	19
<b>Redeye (Man-Portable)</b>		
Air Defense Artillery in the Field Army .....	May 60	42
<b>Redstone Missile</b>		
Weapons of the Artillery—8 (Redstone) .....	Feb 60	2

SUBJECT	ISSUE	PAGE
Boost for the Spaceman (Newsnote) .....	Feb 60	69
A Redstone Milestone (Newsnote) .....	Nov 60	57
<b>Redstone Trainer</b>		
Economic, Realistic Training—The Redstone System .....	July 60	42
<b>Remote Control Equipment</b>		
Fast and Reliable Remoting .....	Feb 60	58
<b>Resident Courses</b>		
Career Courses Revised (Newsnote) .....	May 60	73
Resident Courses—US Army Artillery & Missile School .....	July 60	49
Resident Course Duration Changes (Newsnote) .....	Nov 60	56
<b>ROCID-ROCAD-ROTAD</b>		
The Armored Division—A Combined Arms Team .....	Feb 60	42
<b>Rocketsonde</b>		
Weather Forecast by Rocket .....	Sept 60	85
<b>Safety Officer</b>		
Death by Radio—The CVT Fuze .....	Feb 60	7
Gem for the Safety Officer (Reduced safety diagram card) .....	July 60	25
<b>Sergeant Missile</b>		
Artillery's 'Topkick' Missile—Sergeant .....	Nov 60	21
<b>Shipping Container (STRAC)</b>		
New Shipping Container for STRAC Units (Newsnote) .....	Feb 60	66
<b>Site</b>		
A Darned Site Better .....	May 60	29
Simplified Site .....	May 60	60
<b>Spotting Instrument (T9)</b>		
T9 Spotting Instrument (Newsnote) .....	Feb 60	72
<b>SS10 Antitank Guided Missiles</b>		
The Armored Division—Its Employment and Future .....	May 60	58
<b>Staff Training Program</b>		
US Army Reserve Schools and Staff Training Program .....	Feb 60	54
<b>Survey</b>		
Gem for the Survey Officer (Range pole container) .....	Feb 60	79
Gem for the Survey Section (Carrier for taping pins) .....	May 60	69
Pinpoint Survey Control With Computers .....	Sept 60	80
'Gimrada' Formed (Newsnote) .....	Nov 60	58

SUBJECT	ISSUE	PAGE
<b>Survey Instrument, Azimuth, Gyro, Artillery</b>		
Pinpoint Survey Control With Computers .....	Sept 60	82
<b>Swiss Artillery</b>		
Allied Artillery Missiles .....	Feb 60	16
<b>Switchboards</b>		
Replacement for Switchboard SB-18/GT (Newsnote) .....	May 60	74
<b>Switching Kit</b>		
Gem for the Communications Section (Plastic bag for MX 155 switching kit) .....	May 60	11
Gem for the Firing Battery (Substitute communications switching device) .....	May 60	38
<b>Tank Company—Armored Division</b>		
The Armored Division—A Combined Arms Team .....	Feb 60	42
<b>Tank, M41</b>		
The Armored Division—A Combined Arms Team .....	Feb 60	42
"Horseshoes To Iron Tracks"—Armored Cavalry Regiment .....	July 60	32
<b>Tank, M48</b>		
The Armored Division—A Combined Arms Team .....	Feb 60	42
<b>Tank, M60</b>		
The Armored Division—Its Employment and Future .....	May 60	55
"Horseshoes To Iron Tracks"—Armored Cavalry Regiment .....	July 60	33
<b>Tank, 'STA 2' Light</b>		
'STA 2' Light Tank (Newsnote) .....	May 60	75
<b>Target Acquisition</b>		
Adjustment of Artillery Fire by Radar .....	Feb 60	3
New Information on the AN/MPQ-4A Radar .....	Feb 60	38
T9 Spotting Instrument (Newsnote) .....	Feb 60	72
Airborne Target Acquisition .....	Sept 60	64
T16 Theodolite—Speed, Accuracy, Economy .....	Nov 60	14
An Electronic FO—The AN/TPS-25 Radar .....	Nov 60	44
<b>Target Compiler</b>		
Aid To Decision—Target Compiler .....	Sept 60	67
<b>Technical Publication System</b>		
New Equipment Technical Publication System .....	Feb 60	39
<b>Tellurometer</b>		
Pinpoint Survey Control With Computers .....	Sept 60	81

SUBJECT	ISSUE	PAGE
<b>Theodolite</b>		
T16 Theodolite—Speed, Accuracy, Economy .....	Nov 60	14
<b>Training</b>		
US Army Training Center, Field Artillery .....	Feb 60	28
Lacrosse Battalions Due to Fire (Newsnote) .....	Feb 60	73
Gem for the Firing Battery (Buckets for aiming stakes).....	July 60	8
A New Artillery Trainer for Gunnery Practice .....	July 60	9
Economic, Realistic Training—The Redstone System .....	July 60	42
Another Training Triumph—Lacrosse Trainer .....	Nov 60	37
<b>Training Literature</b>		
New Equipment Technical Publication System .....	Feb 60	39
Status of Training Literature (Newsnote) .....	Feb 60	75
Status of Training Literature (Newsnote) .....	May 60	77
New Publications for Radar Mechanic Instruction (Newsnote) .....	May 60	76
Status of Training Literature (Newsnote) .....	July 60	73
Status of Training Literature (Newsnote) .....	Nov 60	60
New Policy in Publications Processing (Newsnote) .....	Nov 60	62
<b>Training Literature and Nonresident Instruction, Department of</b>		
Milestone for Artillery Extension Courses .....	Feb 60	15
<b>Truck, 1/4-ton, M151</b>		
A New Jeep—The M151 (Newsnote) .....	Feb 60	69
<b>US Army Air Defense School</b>		
Air Defense Artillery in the Field Army .....	May 60	46
<b>USAAMS</b>		
Milestone for Artillery Extension Courses .....	Feb 60	15
Combat Arms Conference Held at Fort Sill (Newsnote).....	Feb 60	66
Growing Pains in the Electronics Field (Newsnote) .....	Feb 60	73
Career Courses Revised (Newsnote) .....	May 60	73
School Has Two New Buildings (Newsnote) .....	July 60	71
Resident Courses—US Army Artillery & Missile School .....	July 60	49
Fort Sill to Host Artillery Instructors Conference (Newsnote) .....	July 60	71
Training by Mail—Extension Course Division .....	Nov 60	52
US Army Artillery and Missile School Reorganized (Newsnote) ....	Nov 60	55
Resident Course Duration Changes (Newsnote) .....	Nov 60	56
Results of Artillery Instructors Conference (Newsnote) .....	Nov 60	57
Handbook for Battery Executive Now Available (Newsnote) .....	Nov 60	58

SUBJECT	ISSUE	PAGE
<b>US Army Training Center, Field Artillery</b>		
US Army Training Center, Field Artillery .....	Feb 60	28
<b>USAR</b>		
US Army Reserve Schools and Staff Training Program .....	Feb 60	54
<b>USAR Schools</b>		
US Army Reserve Schools and Staff Training Program .....	Feb 60	54
<b>Weather</b>		
The Little Known Front .....	Feb 60	13
Commercial Hydrogen for Meteorological Balloons? .....	Feb 60	64
Weather Forecast By Rocket .....	Sept 60	85
<b>Weather Fronts</b>		
The Little Known Front .....	Feb 60	13
<b>Wheeled Vehicles</b>		
A New Jeep—The M151 (Newsnote) .....	Feb 60	69
LARC-5—Lighter, Amphibious, Resupply, Cargo (Newsnote) .....	Feb 60	73
<b>Wind Measuring Set, AN/MPQ-6</b>		
Little John—The Mighty Mite .....	July 60	23
<b>Wire Communications</b>		
New Radiotelephone Procedure for the New FD System .....	Feb 60	21
Gem for Communication Personnel (Lance pole (P02)) .....	May 60	63
Battery Executive Officer Now Controls Fire Direction (type battery wire system) .....	May 60	70
<b>Wire System</b>		
New Radiotelephone Procedure for the New FD System .....	Feb 60	21
<b>Worldwide Combat Arms Conference</b>		
See Combat Arms Conference		
<b>XM33 (Honest John Rocket Launcher)</b>		
The XM33—Honest John's New 'Cousin' .....	July 60	57
<b>XM474 Track Vehicle</b>		
The Pershing Missile—The Army's "Blackjack" .....	May 60	32



"The battlefield achievements of the artillery arm have enhanced the prestige of the entire American Army as well as its own reputation."

Major General Harry F. Hazlett