

ARTILLERY TRENDS

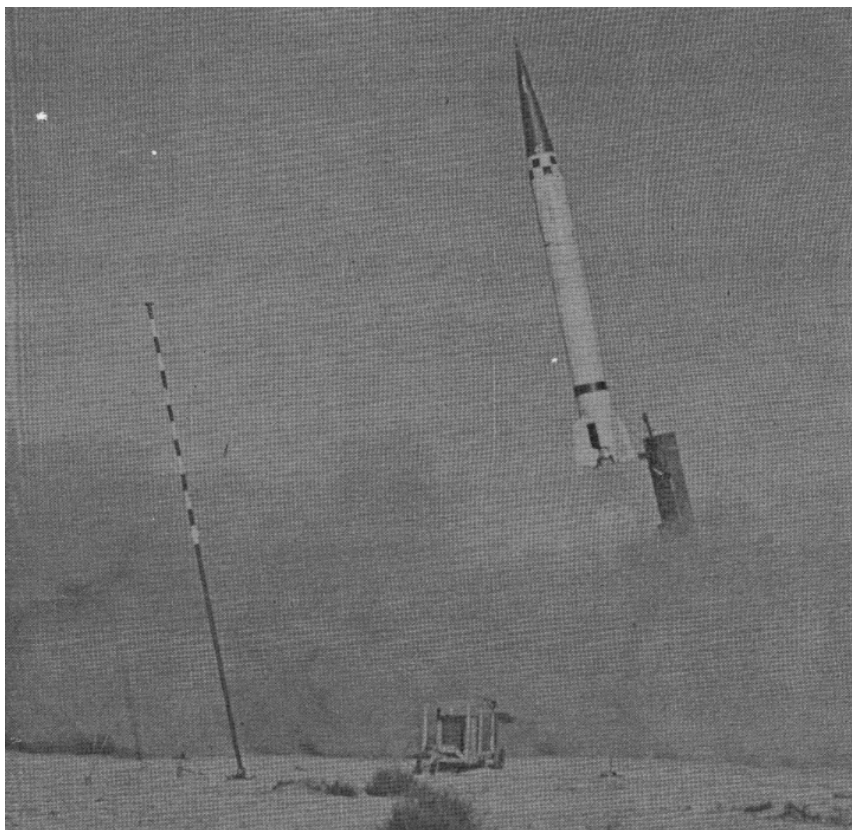

U S Army Artillery and Missile School

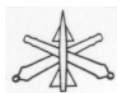

November 1960

ARTILLERY

TRENDS

November 1960

Instructional Aid Number 16

In This Issue

● ARTICLES

A New Bracket Method of Fire	3
Communication Defense Measures In Electronic Warfare	10
T16 Theodolite—Speed, Accuracy, Economy	14
New ATT Grading for FFE	16
Artillery's 'Topkick' Missile—Sergeant	21
Graphic Guide For HE Effects	29
Another Training Triumph—Lacrosse Trainer	37
An Electronic FO—The AN/TPS-25 Radar	44
"Artillery Lamplighter"—A New GFT	47
A Bizarre 155-mm Howitzer	50
Training By Mail—Extension Course Division	52

● NEWSNOTES

Newsnotes for Artillerymen	55
--------------------------------------	----

● TRAINING LITERATURE

Status of Training Literature	60
---	----

● COVER

The Sergeant missile firing from its launcher. See the article starting on page 21 for this "up and coming" guided missile—the Artillery's 'Topkick.'

**"And where e'er we go
You will always know..."**



Now, for your convenience—personal copies of **ARTILLERY TRENDS** mailed direct to you . . . Published 3 to 5 times yearly, **ARTILLERY TRENDS** IS .25c an issue; minimum order—4 issues . . . the USAAMS Book Department will handle your subscription order . . . see page 64.

Be In The Know With ARTILLERY TRENDS

A NEW Bracket Method of Fire

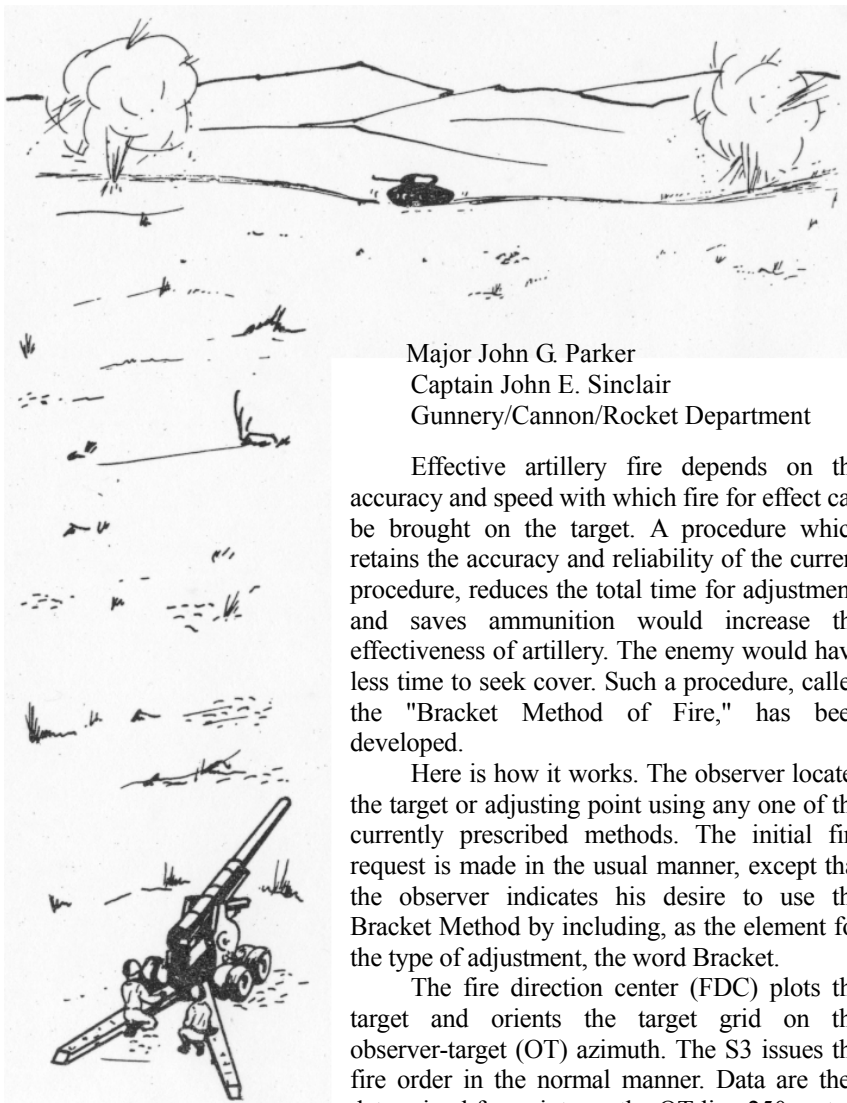

Major John G. Parker
Captain John E. Sinclair
Gunnery/Cannon/Rocket Department

Effective artillery fire depends on the accuracy and speed with which fire for effect can be brought on the target. A procedure which retains the accuracy and reliability of the current procedure, reduces the total time for adjustment, and saves ammunition would increase the effectiveness of artillery. The enemy would have less time to seek cover. Such a procedure, called the "Bracket Method of Fire," has been developed.

Here is how it works. The observer locates the target or adjusting point using any one of the currently prescribed methods. The initial fire request is made in the usual manner, except that the observer indicates his desire to use the Bracket Method by including, as the element for the type of adjustment, the word Bracket.

The fire direction center (FDC) plots the target and orients the target grid on the observer-target (OT) azimuth. The S3 issues the fire order in the normal manner. Data are then determined for points on the OT line 250 meters over and 250 meters short of the observer's initial target location.

One of the adjusting pieces will fire with the data for the far point; the other piece, with data for the near point. The method of fire for the adjusting pieces is SALVO LEFT (RIGHT) AT 5-SECONDS with the piece which is to fire on the far point firing first.

PROCEDURES WHEN FIRST SALVO BRACKETS TARGET

The observer will see the initial salvo as two rounds 500 meters apart on the OT line, or on a line parallel to the OT line. If the observer's initial target location has been reasonably accurate, the initial salvo should bracket the adjusting point for range. Assuming that the initial salvo does bracket the adjusting point for range, the observer will give one of the following sensings: BRACKET, BRACKET FAR, or BRACKET NEAR.

BRACKET: The sensing of BRACKET indicates that the adjusting point is bracketed by the salvo and the observer is unable to determine which round of the salvo is closer to the adjusting point. When the FDC receives a sensing of BRACKET for the initial salvo, data are determined for points 50 meters over and 50 meters short of the initial target location, and the second salvo is fired.

BRACKET FAR: The sensing BRACKET FAR indicates that the adjusting point is bracketed by the initial salvo and that the adjusting point appears closer to the *far* round than to the near round. When the FDC receives a BRACKET FAR sensing for the initial salvo, data are determined for points 50 meters and 150 meters beyond the initial target location. These points are 100 meters and 200 meters short of the far round of the initial salvo. The second salvo is fired at these points.

BRACKET NEAR: The sensing BRACKET NEAR indicates that the adjusting point is bracketed by the initial salvo and that the adjusting point appears closer to the near round than to the far round. When the FDC receives a BRACKET NEAR sensing for the initial salvo, data are determined for points 50 meters and 150 meters short of the initial target location and the second salvo is fired. These points are 100 and 200 meters beyond the near round of the initial salvo.

ACTION WITH SUBSEQUENT SALVOS

The second salvo is fired with a 100-meter range spread. If the second salvo brackets the adjusting point for range, the appropriate sensing is BRACKET, and the data for the next volley is determined for the center of the established 100-meter range bracket. It is normally appropriate to enter fire for effect if the second salvo brackets the adjusting point.

If both rounds of the second salvo are beyond the adjusting point, the sensing is OVER, and the observer will transmit the command NEAR, DROP 50, FIRE FOR EFFECT, or NEAR, DROP 100, whichever is appropriate. The FDC will plot the location of the next salvo(s) 50 or 100 meters short of the near round of the last salvo fired. The command DROP 50, FIRE FOR EFFECT, is appropriate if the near rounds of the first and second salvos established a 100-meter bracket. Otherwise the

command DROP 100 is appropriate and should result in enclosing the adjusting point in a 100-meter range bracket. Fire for effect is usually fired when a 100-meter range bracket is split.

If both rounds of the second salvo are short of the adjusting point, the observer will transmit the command FAR, ADD 50, FIRE FOR EFFECT, or FAR, ADD 100, whichever is appropriate. The FDC will determine data to fire a volley 50 or 100 meters beyond the far round of the second salvo.

If any round of a salvo is sensed as range correct, the observer's next command should identify the round sensed as range correct and should include the command REPEAT RANGE; for example, FAR, REPEAT RANGE, FIRE FOR EFFECT.

In the Bracket Method, deviation is measured to the center of the salvo and is corrected in the normal manner. The deviation correction, if any, precedes the range command; for example, LEFT 50, BRACKET NEAR.

PROCEDURES WHEN FIRST SALVO FAILS TO BRACKET TARGET

When the first salvo fails to bracket the adjusting point, possible sensings and actions that may be taken are as follows:

OVER: Both rounds of the initial salvo land beyond the target. If the observer estimates that the adjusting point is within 400 meters of the near round, he will transmit the command NO BRACKET, DROP. The FDC will determine data for points 100 meters and 400 meters short of the near round of the initial salvo and fire a second salvo. If the second salvo brackets the adjusting point, the observer transmits the command BRACKET, and the FDC will determine data for points 100 and 200 meters beyond the near round of the second salvo, and fire the third salvo. After the third salvo, the adjusting point will normally be enclosed in a 100-meter range bracket, and fire for effect can be fired at the center of that bracket. If the second salvo is short of the adjusting point, the sensing is SHORT and the adjusting point is within the 100-meter bracket established by the near round of the first salvo and the far round of the second salvo. The observer will then send the command FAR, ADD 50, FIRE FOR EFFECT. If the second salvo is also beyond the adjusting point, the observer should return to using normal observer procedures prescribed in FM 6-40. To return to normal observer procedures, the command must indicate which round of the last salvo fired is the point from which the shift is being made, the shift, and the control element; for example, NEAR, LEFT 40, DROP 600, WILL ADJUST.

SHORT: Both rounds of the first salvo are short of the target. The procedure to be followed is similar to that described above for an OVER sensing.

OVER DOUBTFUL and DOUBTFUL SHORT: If only one round of a salvo can be sensed positively for range, the observer senses both rounds, the far round first. The possible sensings in such a situation are OVER DOUBTFUL or DOUBTFUL SHORT. The observer will then send a command designating the round sensed as doubtful followed by

the words FIRE BRACKET; for example, ON NEAR, FIRE BRACKET The FDC will then determine data to fire the second salvo at points 150 meters beyond and short of the round of the initial salvo that was sensed as doubtful. If the second salvo brackets the adjusting point, a third salvo is fired at points 50 meters beyond and short of the doubtful round of the initial salvo. The adjusting point will be enclosed in a 100-meter bracket after the third salvo. If the second salvo, fired 150 meters over and short of the doubtful round of the initial salvo, does not bracket the adjusting point, the observer should return to normal observer procedure.

FIRE COMMANDS FOR BRACKET METHOD OF FIRE

When the FDC has determined the data for the far and near rounds of the salvo, fire commands must be transmitted to the battery. The piece which fires at the far point must fire first. Therefore, if the method of fire is SALVO RIGHT, the right piece must fire with data to the far point. An example of initial fire commands for the Bracket Method of Fire follows:

BATTERY ADJUST
 SHELL HE, LOT Y
 CHARGE 5, FUZE QUICK
 CENTER RIGHT AT 5 SECONDS, BATTERY 4 ROUNDS IN
 EFFECT
 NUMBER 3, DEFLECTION 2655, QUADRANT 340
 NUMBER 4, DEFLECTION 2628, QUADRANT 303.

Whenever a salvo is to be fired with a range spread along the OT line, the FDC will habitually notify the observer of the size of the spread; for example, ON THE WAY, 500- (300 or 100) METER BRACKET.

SAMPLE MISSIONS

Mission 1: First salvo brackets the target (fig 1).

Initial fire request: BANKSHOT 9, THIS IS BANKSHOT 31
 FIRE MISSION
 COORDINATES 3658 4793, AZIMUTH 3850
 30 ENEMY DIGGING IN
 BRACKET
 FUZE VT
 WILL ADJUST.

Salvo number	Sensing/Command	Action
1	BRACKET NEAR.	FDC determines data and fires second salvo at points 100 and 200 meters beyond the near round of the initial salvo.
2	OVER (not transmitted) NEAR, DROP 50, FIRE FOR EFFECT.	FDC determines FFE data for point midway between the near rounds of the first and second salvos.

- 3 END OF MISSION, Mission is terminated.
ESTIMATE 12
CASUALTIES.

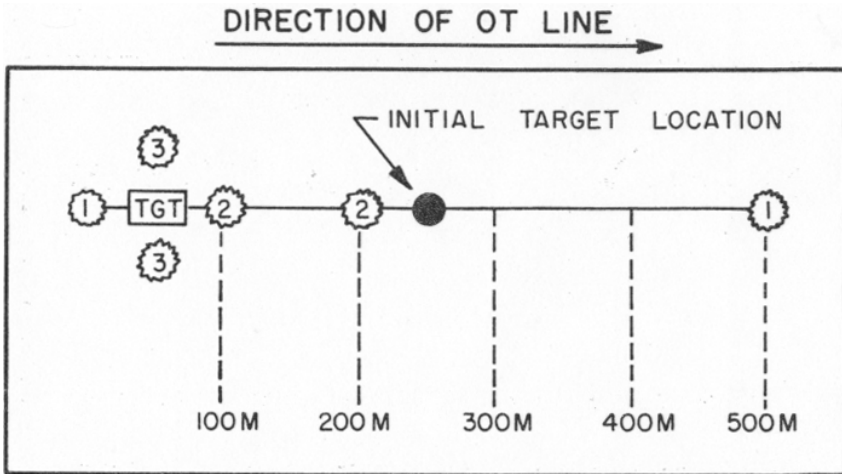

Figure 1. Adjustment of fire mission where the first salvo brackets the target.

Mission 2: First salvo fails to bracket the target (fig 2).

Initial fire request: CURLIE 9, THIS IS CURLIE 31,
FIRE MISSION
FROM REGISTRATION POINT 1,
AZIMUTH 2760
LEFT 350, UP 20, ADD 600
OBSERVATION POST
BRACKET
FUZE VT
WILL ADJUST.

Salvo number	Sensing/Command	Action
1	SHORT (not transmitted) NO BRACKET ADD.	FDC determines data and fires second, salvo at points 100 and 400 meters beyond the far round.
2	BRACKET.	FDC determines data and fires third salvo at points 100 and 200 meters beyond the near round of the second salvo.
3	BRACKET, FIRE FOR EFFECT.	FDC determines FFE data for point midway between the rounds of the third salvo.

- 4 END OF MISSION, The mission is terminated.
OP NEUTRALIZED.

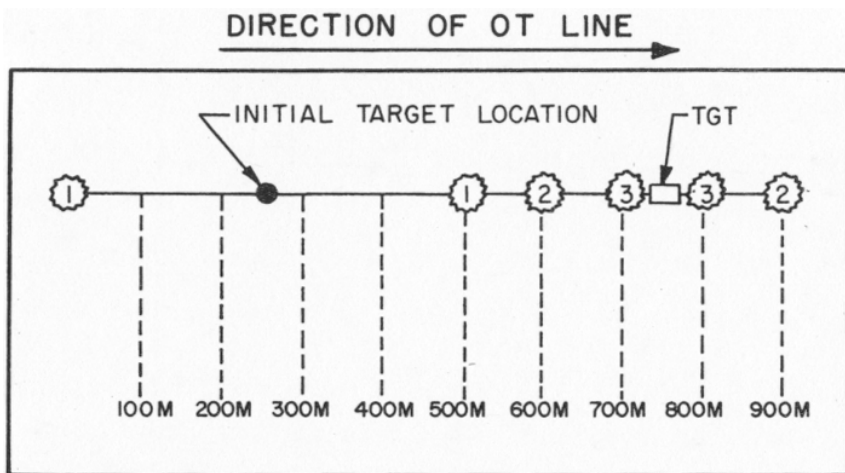

Figure 2. Adjustment of fire mission where the first salvo fails to bracket the target.

Mission 3: First salvo fails to bracket the target. Bracket Method replaced by normal observer procedures (fig 3).

Initial fire request: BANNER 9, THIS IS BANNER 31,
FIRE MISSION
COORDINATES 3847 6219, AZIMUTH 2600
INFANTRY ASSEMBLY AREA
BRACKET
FUZE VT
WILL ADJUST.

Salvo

Salvo number	Sensing/Command	Action
1	OVER (not transmitted) NO BRACKET DROP.	FDC determines data and fires second salvo at points 100 and 400 meters short of the near round.
2	OVER (not transmitted) NEAR DROP 800 WILL ADJUST.	FDC plots indicated shift from the near round of the second salvo and the mission is continued using normal observer procedures.

The Bracket Method of Fire provides a procedure for obtaining a range bracket of the adjusting point with the first salvo if the location of the target is reasonably accurate. It also prescribes procedures for

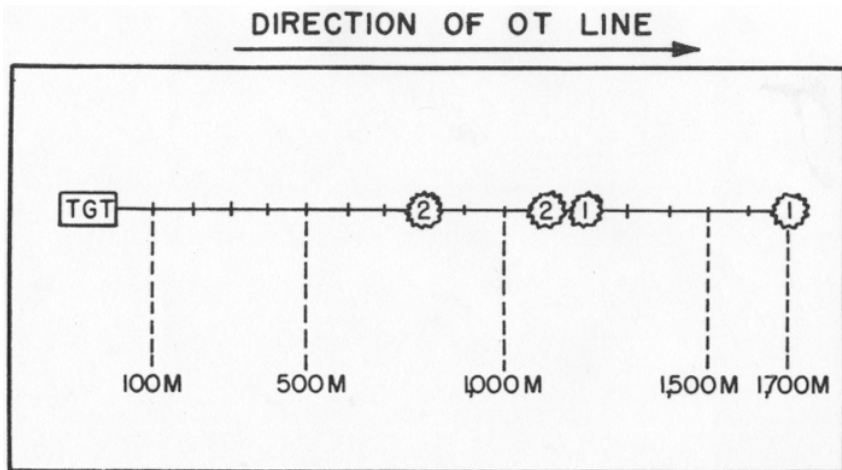

Figure 3. First salvo fails to bracket the target. Bracket Method replaced by normal observer procedures.

quickly enclosing the adjusting point in a 100-meter bracket. If at any time during the mission the observer desires to use normal observer procedures, he needs only to make a shift from one of the rounds of the last salvo fired and state a method of control; for example, FAR, ADD 600, WILL ADJUST; NEAR, RIGHT 10, ADD 50, FIRE FOR EFFECT.

The Bracket Method of Fire is not intended to replace the tried and true procedure in FM 6-40, but is being tested as an alternate procedure to be used on favorable terrain by an observer who is confident that he has located the target within plus or minus 250 meters in distance along the OT line.

280-MM GUN PUBLICATIONS DISTRIBUTED

Initial distribution of the following publications was recently completed by the US Army Adjutant General Publications Center, St. Louis, Missouri: TOE 6-535D, 13 July 1960, *Field Artillery Gun Battalion, 280-mm*; TOE 6-536D, 13 July 1960, *Headquarters and Headquarters Battery, Field Artillery Gun Battalion, 280-mm*; TOE 6-537D, 13 July 1960, *Field Artillery Gun Battery, 280-mm*.

"The basic principle of all training is so familiar that people still fail to appreciate how much it means: *Men do in combat exactly what they have been in the HABIT of doing in training.*"

General Bruce C. Clarke
Commanding General, USCONARC

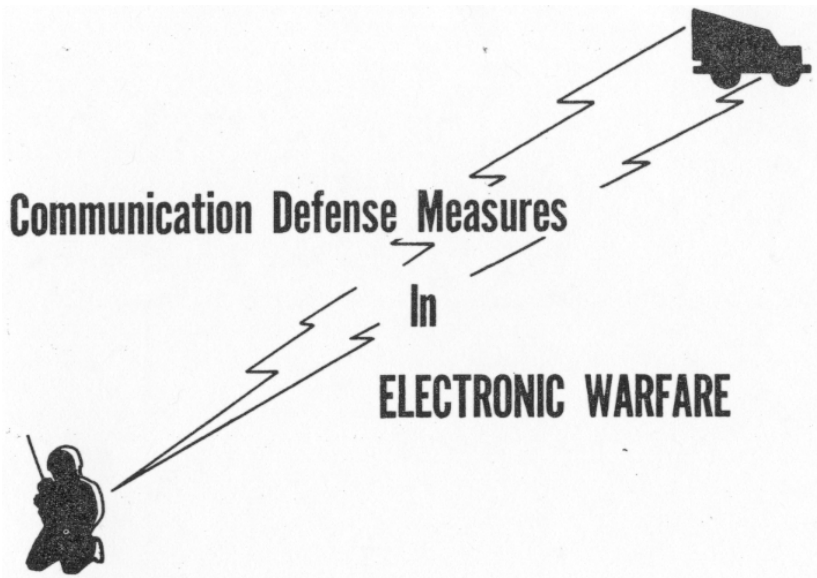

Captain Charles C. Wieland
Communication/Electronics Department

If our nation were to be involved in war tomorrow, our Army would be employed in a manner only dreamed of a few years ago. Units would be required to move rapidly in highly coordinated maneuvers over great distances. Troops would employ sophisticated weapons with tremendous firepower and "unheard of" accuracy. All this could be accomplished only with the use of effective communication and electronic systems. With so much reliance on communication and electronics, a new dimension has been added to the battlefield—electronic warfare.

Electronic warfare includes all actions taken to reduce the effectiveness of radiated electromagnetic energy used by the enemy and to insure the effectiveness of friendly radiated electromagnetic energy. The important role electronic warfare can play in future wars is easily appreciated if you will visualize what would happen if an enemy could, at critical moments, completely wipe out our Army's radio communication, navigational aids, radar, missile guidance, and projectile fuze control. A complete stroke is unlikely; however, a vital advantage can often be won even by a partially successful application of the tactics and techniques of electronic warfare.

Electronic warfare is divided into two functions. The first of these, electronic countermeasures (ECM), is the military use of electronics to reduce the effectiveness of military electronic equipment and tactics. This includes passive measures, for example, communication intelligence, and active measures such as jamming and deception. Radio jamming is

the transmission of interfering radio signals which obscure the reception of other signals, thereby nullifying the effectiveness of radio equipment. Personnel and agencies outside the artillery perform this function.

Artillerymen are directly concerned with the second function of electronic warfare. This function is known as electronic counter-countermeasures (ECCM) or, more simply, all the measures taken to insure the effective use of friendly electromagnetic radiations *despite* the enemy's use of electronic countermeasures. These measures include transmission security to protect transmissions from interception and traffic analysis and, equally important, antijamming measures to reduce or nullify the effect of jamming.

ALL COMMANDERS RESPONSIBLE FOR TRANSMISSION SECURITY

Commanders at all echelons are responsible for transmission security. All users of communication systems must be aware of the need for transmission security and the means by which it is achieved. The following rules must be practiced not only by assigned radio operators but by all military personnel:

(1) The number of radio transmissions must be kept to a minimum and as short as possible. Make only authorized transmissions and transmit at a speed that will preclude unnecessary repetition.

(2) Classified material will be sent in the clear only when specifically authorized. Identification of units, locations, and individuals must be avoided.

(3) Station and message authentication should be used to prevent deception by the enemy. Voice and style recognition may be used to augment authentication but will not serve as a substitute for an authorized authentication system.

Antijamming measures start with the design of the electronic equipment, but it cannot stop there. Commanders and staff officers must realize the enemy's ECM capability and provide for appropriate defensive measures in their orders, plans, and SOP's. Antijamming measures for tactical radio communication include station siting, diversity of frequencies, alternate frequencies and call signs, and a system to implement their use when necessary. The Signal Operation Instructions should make alternate frequencies and call signs available for timely use when an operating frequency is jammed, but the unit SOP must provide for the implementation of the antijamming measures. The unit SOP should include procedures for:

(1) Siting radios prior to jamming to provide maximum operating efficiency and protection from potential jamming.

(2) Changing to an alternate frequency, including the method of disseminating the order to change frequencies. Call signs of all stations in the net must be changed simultaneously with the shift to alternate frequency.

(3) Continued operation on a jammed frequency to keep the jammer occupied on that frequency

(4) Reporting jamming or other ECM activity. The SOP should indicate when and to whom to report and what information is required.

MOST IMPORTANT STEP—OPERATOR TRAINING

All plans and procedures are ineffective unless they are followed up with the most important step of all—adequate operator training. Inadequate training would increase the likelihood of surprise and confusion of communication personnel. The operator must learn to accept the inevitability of jamming. He must be subjected continuously to jamming during all phases of training. This experience teaches him to operate his equipment to counteract the effects of jamming in some cases and, at least, to increase the effectiveness of his equipment under jamming conditions. Operators must be taught to adhere to the following fundamental defensive practices:

(1) Transmission discipline must be employed. The shortest possible transmission time is important to successful antijamming measures. Excessive transmission invites enemy jamming and even shelling. The transmitter should be adjusted for the lowest radiated power required to maintain good communication. Unnecessary testing and checking of communication should be avoided.

(2) Jamming must be recognized. Disturbances are not always caused by external sources. If the disturbance is not eliminated by grounding or disconnecting the antenna, the trouble is internal; if it is eliminated, the trouble is external to the radio. If external interference is indicated, a further check must be made to determine whether the cause is enemy jamming or accidental interference. Jamming is of two basic types—spot jamming of a specific frequency and barrage jamming on a wide band of frequencies. Spot jamming can usually be distinguished from unintentional interference, since the intensity of spot jamming drops sharply when the receiver is tuned slightly off the operating frequency. Barrage jamming is not so easily distinguished, and a search of the area should be made to eliminate the possibility of interference from other radios, radar, or other electrical devices. Recognition is easier if the operator is familiar with the sound of jamming signals used by the enemy.

(3) The radio operator is responsible for getting the message through. Several techniques are available to radio operators for avoiding or combating the effects of jamming. Siting and antenna orientation are important factors in obtaining maximum station efficiency. In some cases, positioning the antenna so that hill formations, buildings, or other obstructions are between the antenna and the enemy will reduce or eliminate the effectiveness of enemy jamming. It is often advisable to use a directional antenna oriented so that maximum energy is radiated and received in the direction of the friendly station, minimum energy in the jamming station's direction. Even if the desired signal is blanketed by jamming, the operator must continue to operate, as a sudden halt indicates to the enemy that his jamming was successful. The transmitter

should be switched to full power and receiver controls should be manipulated in an attempt to improve reception.

(4) Prompt, accurate, and complete reporting of enemy jamming is important, since an enemy jamming attack is usually part of a well-organized plan and frequently precedes important tactical maneuvers. A detailed report of jamming is made to the commanding officer immediately after the jamming starts. This report must be forwarded promptly.

ECCM TRAINING MUST BE CONTINUOUS

Training in ECCM must be a continuous process. It is taught to officers and communication specialists at the US Army Artillery and Missile School, but this alone does not insure proficiency. The specialist training of communication personnel in all artillery units should include ECCM. It must be made a part of unit proficiency tests, field exercises, communication exercises, and command post exercises. Jamming and other ECM can usually be provided by supporting electronic warfare units. If necessary, one of the unit radios may be pressed into service as a jammer. Exposure to simulated jamming and deception under field conditions develops the skill and confidence needed by communication personnel and operational familiarity of commanders and their staffs. Further information on this subject is contained in FM 11-151, *Defense Against Electronic Jamming*, and FM 24-150, *Electronic Warfare (U) (C)*.

All equipment using electromagnetic radiation is subject to ECM. Radio communication is extremely vulnerable to enemy jamming. Jamming must be anticipated, provisions for antijamming measures must be included in all planning, and these activities must be controlled and coordinated. Whether or not enemy ECM tactics are effective will depend to an important degree upon the attitude and training of personnel.

A GEM FOR THE RADAR TECHNICIAN

Careful handling of cathode-ray tubes (CRT) is a "must" for the radar technician. The glass envelope of the CRT is evacuated to a high degree, subjecting the tube to considerable atmospheric pressure. For example, the total force exerted on a 10-inch CRT is approximately 3,750 pounds, almost two tons. For this reason, great care should be taken to avoid breaking the glass envelope.

Do not hold the tube by the narrow neck. When placing the CRT on the bench, stand it on its face, preferably on a felt pad, or something similar. Even if rough handling doesn't cause explosion, it might displace the element inside the tube, possibly affecting normal operation of the CRT. Care should also be exercised in disposing of a broken CRT, as the material used for coating the face of the CRT may be extremely toxic.

—Submitted by Mr. Baldwin G. Sullivan
Communication/Electronics Department

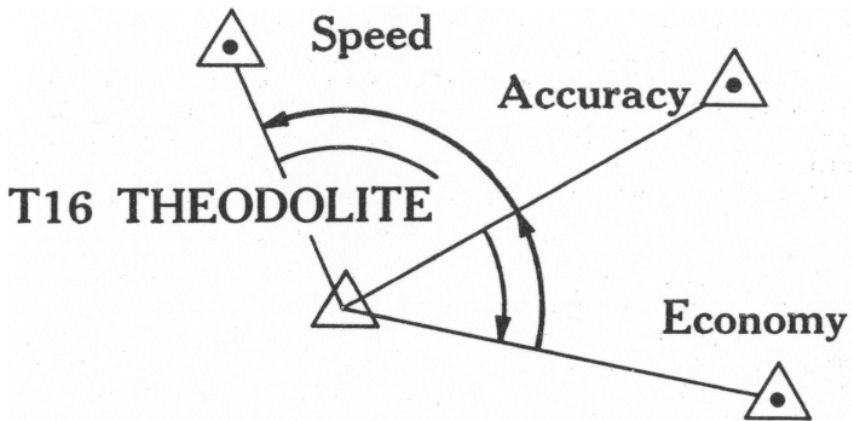

Mr. Chris E. O'Connor, Jr.
Target Acquisition Department

With the artillery's adoption of microwave distance measuring equipment last year, its surveying capability has been substantially increased. Today, continuing to keep pace with developments offering speed, accuracy, and economy, the artillery is being issued a new angle-measuring instrument. Designated the "Wild T16" (fig 4) by the manufacturer and the "Theodolite, 0.2 mil" by the Army, this instrument replaces the transit in field artillery battalions and batteries.

The speed and precision made possible by this instrument will allow the survey section to complete and close battalion survey in considerably less time than formerly required. Artillerymen familiar with the Wild T2 Theodolite, used at division artillery and the corps observation battalion, will find the T16 Theodolite similar in construction and operation.

The T16 Theodolite is a compact, lightweight, dust-proof, optical-reading, direction type instrument with a repeater clamp for measuring vertical and horizontal angles. The scales, graduated in mils, may be read directly to 0.2 mil and, by estimation, to the nearest 0.1 mil. The scales are completely enclosed and are read through a scale-reading microscope. The Theodolite is issued complete with cover, case, tripod, and accessory kit. The instrument with cover weighs 13¾ pounds, and the tripod, 12½ pounds. The accessory kit contains cleaning and adjusting equipment, eyepiece prisms and filters, and the circular compass. The instrument is centered over a desired point by means of an optical plummet.

In artillery survey, the T16 Theodolite is used as a directional instrument; that is, the size of a horizontal angle is determined by comparing the mean of direct and reverse pointings on one station with the mean of direct and reverse pointings at another station. Vertical scale readings are reduced to vertical angles by comparing the scale reading

with 1,600 mils and 4,800 mils when the telescope is in the direct and reverse positions, respectively.

T16 THEODOLITE A PRECISION INSTRUMENT

The T16 Theodolite is a delicate precision instrument and must be given appropriate care and maintenance if consistently accurate and dependable service is expected. The operator is responsible for the before-, during-, and after-operation inspection and cleaning as described in TM 5-6675-200-15. The operator also performs the following adjustments: tripod legs, plate level, horizontal collimation, vertical collimation, and optical plummet.

Since the T16 Theodolite replaces the transit, it will be used in artillery surveys performed to fifth-order accuracy (1:1,000). In divisional field artillery battalions, T16 Theodolites will be used for position area and connection survey. If the situation and terrain permit, they may also be used for the target area survey.

Instruction on the use of the T16 Theodolite began at the US Army Artillery and Missile School in March 1960; T16 Theodolite training will be incorporated in Army training programs as the instruments become available for issue to US Army Artillery Training Centers. Upon receipt of the T16 Theodolite, commanders should modify appropriate training programs to include Theodolite instruction.

Detailed operating instructions in the form of an Information Letter, (Wild T16 Theodolite, dated 12 April 1960) have been furnished commanders of units scheduled to be issued the Theodolite. The letter serves as interim training literature pending the 1961 revision of TM 6-200, *Artillery Survey*. Maintenance instructions are included in TM 5-6675-200-15, published in May 1960. Also, instruction on the T16 Theodolite will be included in the Extension Courses Division subcourse 501 (formerly 17), *Artillery Survey*, to be published in early 1961.

To appreciate its characteristics and advantages, artillerymen should take steps to familiarize themselves with this new piece of survey equipment. Thorough knowledge and understanding of this instrument and its capabilities will contribute to success in combat by providing more timely and effective massed artillery fires.

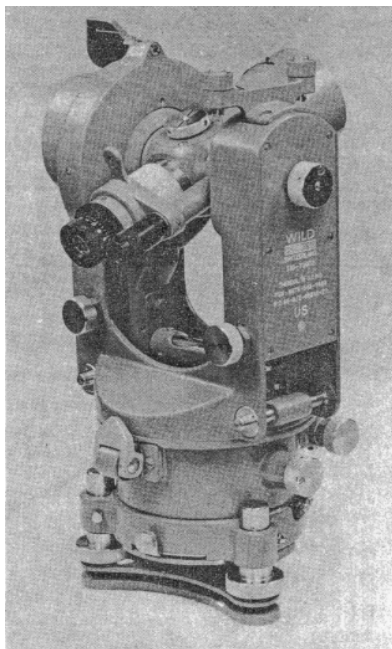
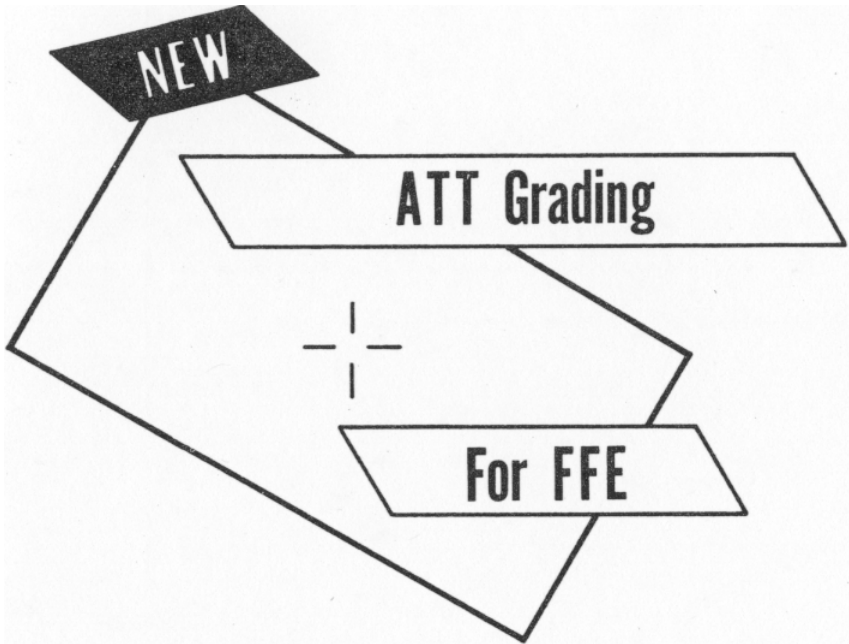

Figure 4. The Theodolite 0.2 mil—"Wild T16."



Major K. H. Bailey
Gunnery/Cannon/Rocket Department

The culmination of the battery and battalion training cycle is the training test that the unit or organization must undergo annually. Every "redleg" from the battalion commander and battery commander to the lowest numbered cannoneer realizes that all phases of the test are important, but the phase that concerns everybody is the fire-for-effect (FFE) portion of the test. This is the factor on which the "shooting reputation" of the unit will be established.

The manner and method of grading the "effects" have been mysterious to many artillerymen. Now, a new method of grading FFE has been prescribed in Army Training Tests 6-116 (November 1959), 6-117 (December 1959), 6-135 (April 1960), and 6-137 (May 1960). A rectangle or "box" is used to compute the grade for FFE. The box is designed to give the tested unit credit for every round that is fired accurately, with allowances for dispersion and other factors beyond the control of human abilities. Sound gunnery techniques should permit *all* rounds fired to land in the box.

The type of gun or howitzer with which the unit is equipped determines the rectangle for purposes of grading. The center of the target rectangle is placed over the surveyed coordinates of the target. The dimensions of the rectangle are determined by adding the values of the following factors:

Rectangle Width (Perpendicular to Direction of Fire).

(1) Battery front: The battery front cannot be greater than that recommended by FM 6-40.

(2) Six probable errors in deflection: 96 percent of all rounds fired should land within this area in deflection.

(3) 30 meters: Approximate sum of the unknown factors that may cause a round to land outside the tolerances thus far included; for example, 4 percent of rounds that may fall outside the six probable errors in deflection described in factor 2.

(4) Number of meters subtended at the target by an angle of 3 mils at the gun-target (GT) range. This is an allowance for unknown errors in observer azimuth that may occur despite the adherence to sound gunnery procedures. For example, the target grid can only be oriented to the nearest 10 mils.

(5) Quantity $(40 \text{ meters} \times \sin T)$ (fig 5). This quantity is derived from the possibility that the observer, although following good observer procedures, may have requested FFE with a shift of 50 meters in the appropriate direction from the last rounds fired in adjustment, when, in fact, the last rounds were very close to the target; for example, 10 meters beyond. If maximum dispersion is encountered in FFE under these conditions, the FFE rounds *could* land more than 50 meters from the target. It can be argued that a good observer would not request a range change of 50 meters if the last rounds in adjustment were within 10 meters of the target. However, such a solution is more easily determined by hindsight than by the observer "shooting for pay" and following proven gunnery techniques. Since the fork is frequently less than 50 meters in firing 8-inch howitzers, this quantity $(40 \text{ meters} \times \sin T)$ is changed to $(20 \text{ meters} \times \sin T)$ on the 8-inch howitzer tests.

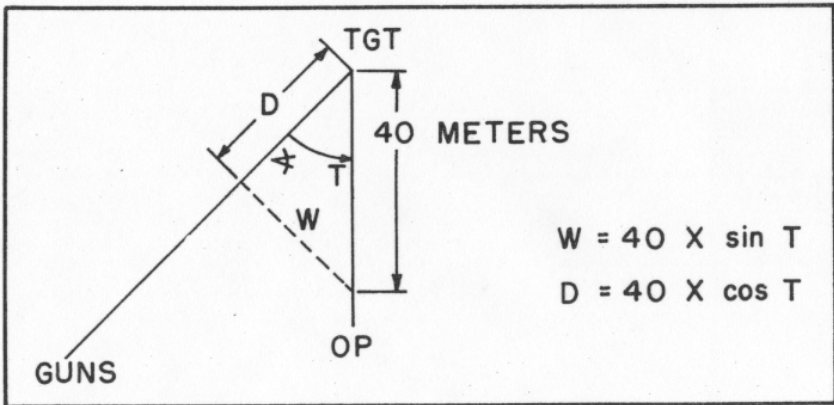

Figure 5. Factors to be added after registration.

CIRCUMVENTING DAMAGE TO A TESTED UNIT

To circumvent the damage to a tested unit when conditions as described above occur, the umpire will, after registration, add the quantity concerned to that side of the rectangle which is reached by the deflection fired in effect. Since the observer adjusts along the observer-target (OT) line, and rounds are fired along the GT line, the 10 meters that the rounds were beyond the target in the situation described above is equal to $10 \sin T$ meters in deflection on the GT line. Likewise, the 40 meters that the observer will actually cause the rounds to move short of the target, ignoring dispersion, becomes $40 \sin T$ meters in deflection on the GT line. This quantity is added to the rectangle for will-adjust missions only and is not included in the grading rectangle for FFE missions.

Rectangle Depth (in Direction of Fire).

(1) Battery depth: Cannot be less than an amount assumed to be the maximum from a sound tactical and gunnery viewpoint.

(2) Six probable errors in range: Same reason as described for rectangle width.

(3) 30 meters: Same reason as described for rectangle width.

(4) Quantity ($40 \text{ meters} \times \cos T$) (fig 5): Same reason as described for rectangle width, with the exceptions that 40 meters on the OT line is equal to $40 \cos T$ meters on the GT line and the quantity is added to the end of the rectangle which is closest to that point reached by the range corresponding to the elevation fired in effect.

A close comparison between grading by rectangle and by radial distance of center of impact (CI) from prescribed circles will show the advantages of the rectangle system. The judgment of umpires in deciding which rounds are obviously in error is not necessary. There is no exclusion of those rounds from further computations, with subsequent loss of points to the tested unit. Units are not penalized for dispersion and other errors not attributed to deficiencies on their part.

The circular grading pattern assumes that deflection and range probable errors are equal. This is a specious assumption that could either penalize the superior unit or reward the poorly trained unit. Furthermore, the circular grading method does not take into consideration that, if the target area includes hilly terrain, single rounds may fall outside prescribed limits, not due to errors made by the tested unit, but to the resultant difference in site between the guns and the points of impact of each round fired. The rectangle method of grading *does* consider the site problem and the unit is graded fairly in that situation.

EACH ROUND LOCATED AND ANALYZED

A possible disadvantage in the rectangle method of grading appears to be from the umpire's point of view. The umpire must determine the point of impact of each round fired and must analyze each round to grade properly. The radial technique of grading, on the other hand, uses the determination of the CI of all rounds fired in the FFE portion of each mission, and the grading of this CI alone against prescribed circular dimensions, or "miss" distances.

SAMPLE PROBLEM

- (1) **Given:**
- a. 155-mm howitzer battery.
 - b. Battery front—230 meters.
 - c. Battery depth—25 meters.
 - d. Angle T—600 mils.
 - e. Surveyed data to target:
 1. Deflection—2652 mils.
 2. Range—6,500 meters.
 - f. Fire-for-effect data to target (obtained by adjustment):
 1. Charge—5.
 2. Deflection—2666 mils.
 3. Elevation—346 mils.
- (2) **Find:** Dimensions of target grading rectangle for ATT 6-117.

(3) **Solution:**

Width of rectangle (perpendicular to direction of fire)	Depth of rectangle (parallel to direction of fire)
*Battery front = 230 meters	Battery depth = 25 meters
Constant factor = 30 meters	Constant factor = 30 meters
6 PE (deflection)	6 PE (range)
$6 \times 2 = 12 = 12$ meters	$6 \times 27 = 162 = 162$ meters
Meters subtended by 3 mils	
3×6.5 (range in thousandths) = <u>20 meters</u>	
Total = 292 meters	Total = <u>217 meters</u>
40 meters $\times \sin T = 40 \times 0.56$ or 22 meters	40 meters $\times \cos T = 40 \times 0.83$ or 33 meters

*Maximum frontage expressed in ATT 6-116 and ATT 6-117 (table III), 150 meters for 105-mm howitzer battery and 250 meters for 155-mm howitzer battery.

The center of the target grading rectangle, measuring 292 meters in width and 217 meters in depth, is placed over the surveyed coordinates of the target (fig 6). Then, since the FFE chart deflection plots to the left of the surveyed chart deflection to the target (deflection 2666 being greater than deflection 2652), the left side of the grading rectangle is extended 22 meters.

FFE CHART RANGE IS GREATER

Since the range corresponding to the FFE elevation of 346 mils is 6,600 meters, the FFE chart range is greater than the surveyed range to the target of 6,500 meters. Therefore, 33 meters (40×0.83) is added to the end of the target grading rectangle that is farthest from the guns.

Note that in grading each round in FFE, the first round to fall outside the target rectangle is cut only a slight amount as indicated by the

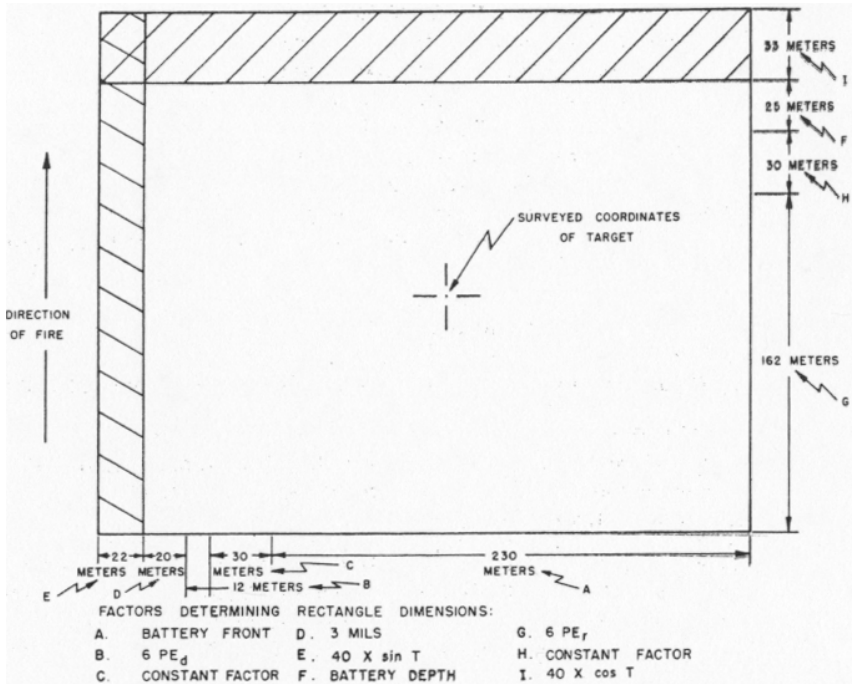

Figure 6. The target grading rectangle, which is placed over the surveyed coordinates of the target. See sample problem on page 19.

grading scale in table III of ATT 6-117 and ATT 6-116. This is because of the slight possibility that a round may fall more than six PE's from the expected point of impact.

With the advent of Field Artillery Digital Automatic Computers (FADAC) (ARTILLERY TRENDS, September 1960) the 90 to 100 rounds that an umpire will have to analyze under the rectangle method of grading will become a simple problem. The location of each round can be determined within seconds by FADAC after the observed azimuth, height, and distances are entered in the computer as inputs. The use of FADAC will eliminate the only known disadvantages of grading by the rectangle method.

As current Army Training Tests are revised and new ones are written, this system of grading FFE will be included.

●

"An Infantryman's best friend
Is not his mother
It's the Artillery, Brother!"
A range sign at Fort Benning, Georgia

Artillery's 'Topkick' Missile -- **SERGEANT**

Captain Norman B. Hopkins, Jr.
Guided Missile Department

"You can depend on Brown, sir. He has all the qualities that should help him to be highly successful if he is promoted to sergeant." Similar words can be spoken for the "up and coming" Sergeant missile system (ARTILLERY TRENDS, February 1959). Possessing all the outstanding features for which it is designed—reliability, ruggedness, simplicity of operation, accuracy, range, immunity to known countermeasures, mobility, and safety—the Sergeant is being developed and promoted to replace the Corporal.

A program was initiated in 1955 to replace the Corporal system. The Jet Propulsion Laboratories (JPL), that developed the Corporal, were called on to develop the Sergeant system. The vast experience gained by the JPL made this agency the logical choice for the Sergeant's development. In 1956, Sperry Utah Engineering Laboratory of Salt Lake City, Utah, was brought into the picture to act as the prime contractor for production of the Sergeant system and to work hand in hand with the developing contractor. System responsibility has now passed completely to the Sperry Utah Engineering Laboratory.

Although meeting the impressive characteristics mentioned above, the Sergeant is extremely simple to operate and maintain. As a field artillery guided missile system, Sergeant has several advantages and major improvements over the Corporal system. It employs an inertial guidance system and a solid-propellant propulsion system. These two features are significant because they greatly reduce the amount of ground-handling equipment, training, and reaction time required of command guidance and liquid-fueled systems.

Besides the missile, the main components of the Sergeant system are a launching station, the organizational maintenance test station (OMTS), the field maintenance test station (FMST) for ordnance use, and transport semitrailers.

COMPONENTS OF THE SERGEANT MISSILE

Assembled, the Sergeant is 34½ feet long with a diameter of 31 inches. This makes it 10 feet shorter than the Corporal. The missile, which weighs about 5 tons, is capable of delivering several types of warheads, and consists of three sections plus a set of four control surface assemblies (fig 7). The sections include the forebody, guidance, and rocket motor sections. Each missile section is interchangeable; for example, any rocket motor can be replaced with any other Sergeant rocket motor. Any control surface assembly can be interchanged with any

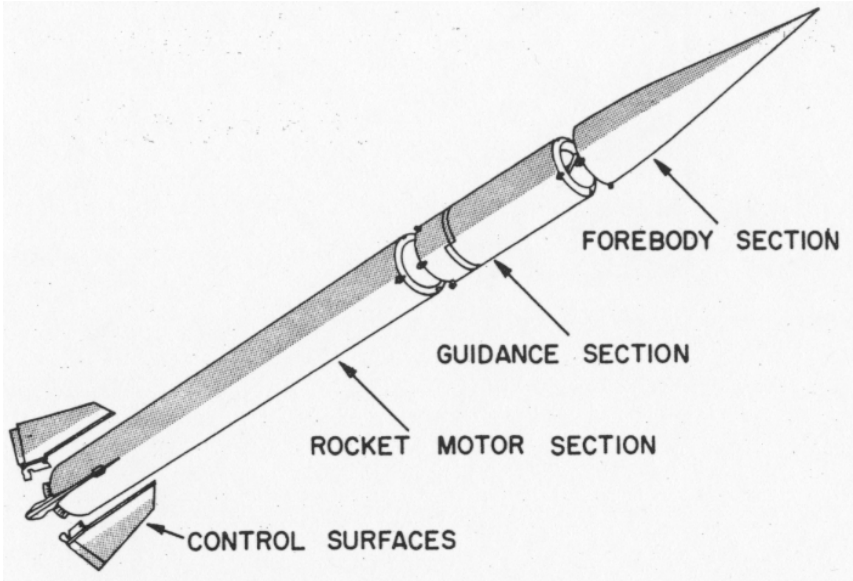

Figure 7. The three missile sections and three (shown) of the four control surface assemblies of the Sergeant missile.

other Sergeant control surface assembly. All sections, except the fore-body section (warhead section), are normally carried in containers aboard trailer transporters. A standard cargo vehicle transports the forebody section.

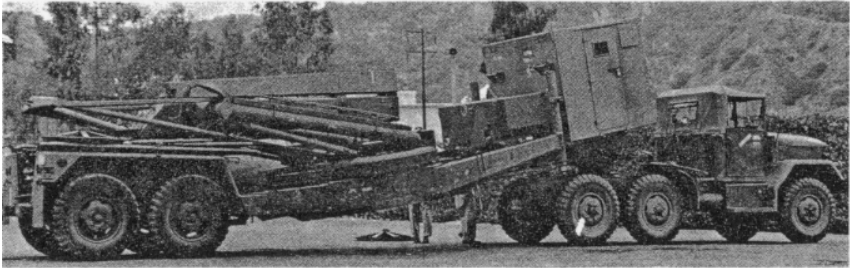

Figure 8. The Sergeant launching station on its modified semitrailer chassis; the prime mover is a 2 1/2-ton truck-tractor with a fifth wheel.

The heart of the ground support equipment is the launching station. All of the ground support equipment is mounted on trailers pulled by standard 2½-ton truck-tractors. This provides great mobility and flexibility for the Sergeant. The entire system is air transportable in C-103 and C-133 aircraft.

The launching station is composed of a launcher, firing set, azimuth orienting unit (AOU), and the required power equipment. The launching station provides equipment to remove major missile sections from their containers on the transport vehicles. Prior to this operation, however, the launching station must be emplaced—an operation which takes approximately 5 minutes. The Sergeant launching station is transported on a modified semitrailer chassis, its prime mover being a 2½-ton truck-tractor with a fifth wheel (fig 8). The launcher boom is operated like a wrecker boom for assembling the missile. Electro-hydraulic equipment mounted on the chassis is used for emplacing and leveling the launching station, assembling the missile sections on a launcher boom (fig 9), traversing the missile to the target azimuth, and elevating and firing the missile. The launcher boom can traverse over the missile containers, pick up missile sections, and support them during the assembly operation. Three tapered hooks on the rocket motor fit into receptacles on the underside of the boom and support the completed missile (fig 10). It takes only about 10 minutes to assemble the Sergeant.

The azimuth orienting unit (AOU) (fig 11) is located on the launching station. The AOU is used to orient the missile on a computed firing azimuth. The sight for the Sergeant missile is a modified theodolite and is an integral part of the AOU.

ROLE OF THE FIRING SET

The firing set, being an integral part of the launching station, is capable of computing the fire mission, automatically inserting firing parameters into the missile, and monitoring missile functions by "go-no-go" checks. All computer operations are automatic once target data are inserted into the control panel. When firing set operations are finished, the missile is traversed to its firing azimuth, elevated to its firing angle, and automatically fired (fig 12). The reaction time for this unit system is drastically reduced from that for the Corporal system.

The organizational maintenance test station (OMTS) consists of a semitrailer chassis, on which is mounted an enclosure housing automatic electronic test equipment (fig 13). After a self-test of its checkout equipment, the OMTS is capable of testing the missile guidance section, control surface assemblies, and the forebody section while these sections are still in their sealed containers. A faulty guidance section can be removed from its container and placed in the van for isolation and replacement of malfunctioning parts. The maintenance concept for this system is the replacement of faulty components with spares.

At the ordnance direct support level, a field maintenance test station (FMTS) is used to check out the missile, firing set, and OMTS components returned to ordnance by the artillery.

Actually, only limited piece-part repair, as such, is planned to be performed by third-echelon maintenance personnel who, using the same concept as the field maintenance test station, will replace faulty subcomponents.

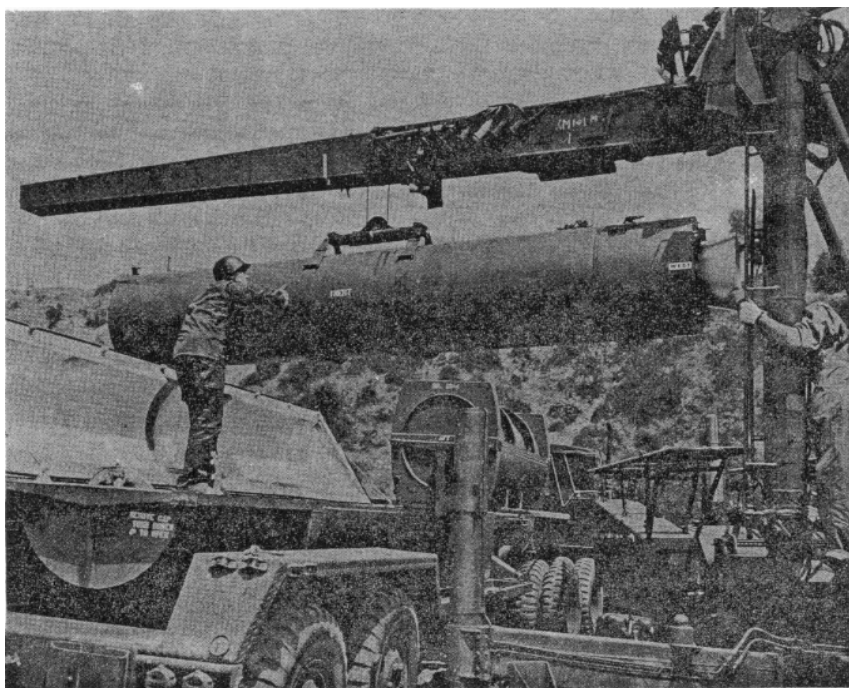

①

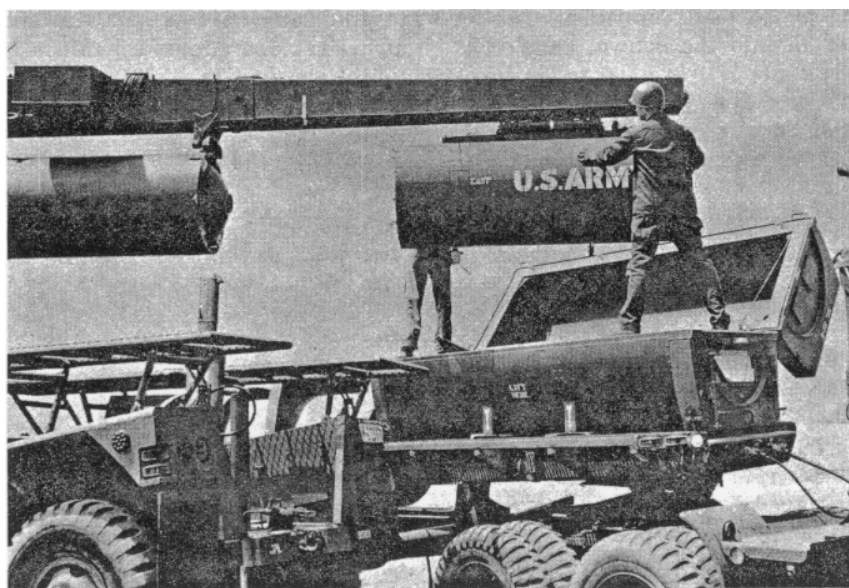

②

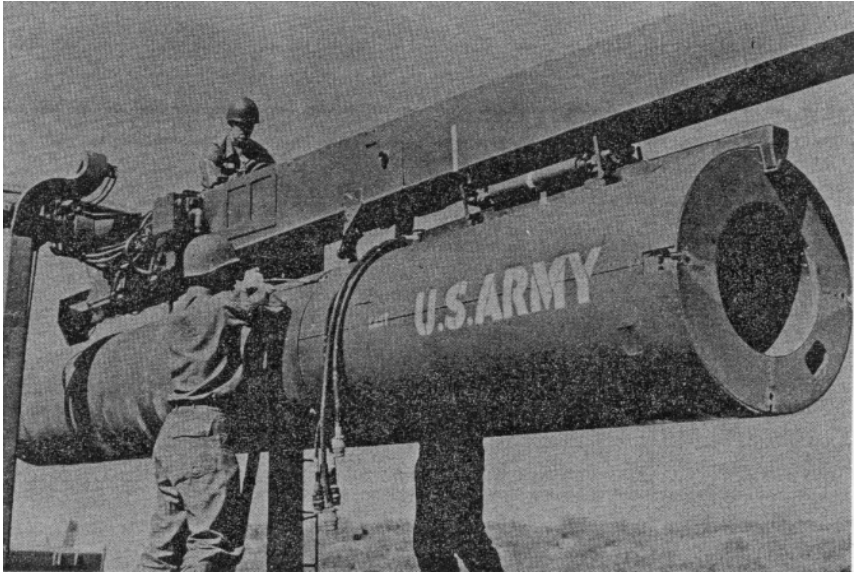

③

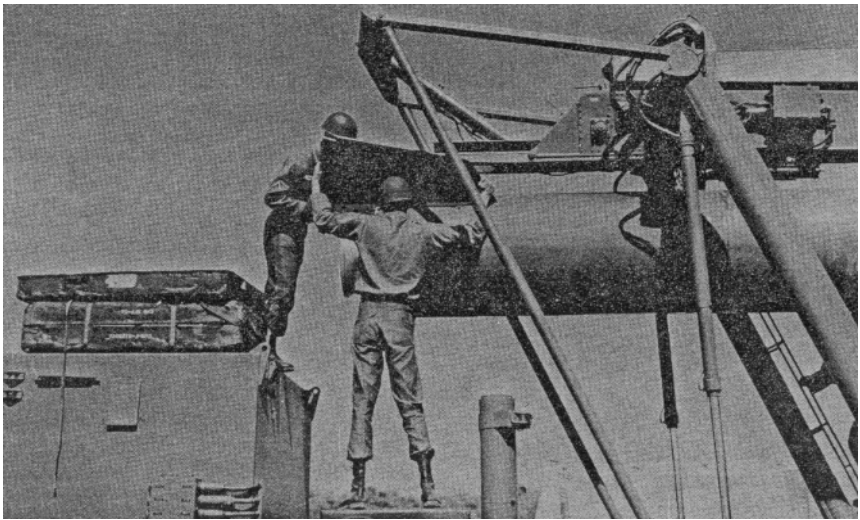

④

Figure 9. The missile assembly sequence.

① Shows the rocket motor being slung under the boom. Two of the three tapered hooks can be seen. ② The guidance section is being lifted by the boom prior to connection to the rocket motor. ③ Guidance section being connected to the motor section. ④ The interchangeable control surface assemblies are being attached.

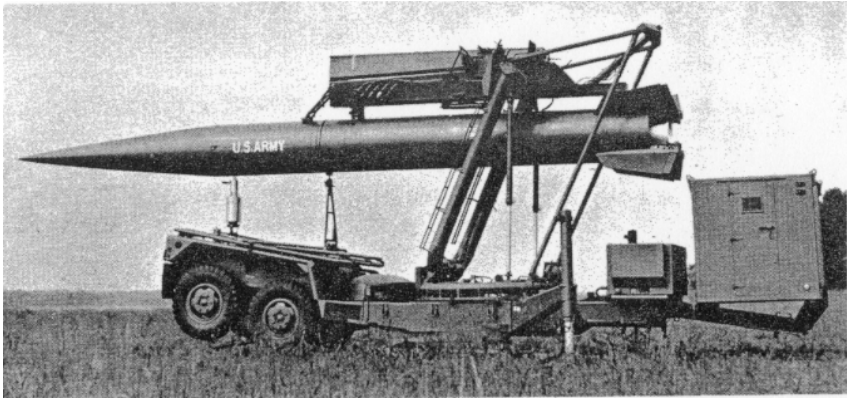

Figure 10. The missile completely assembled on the launcher.

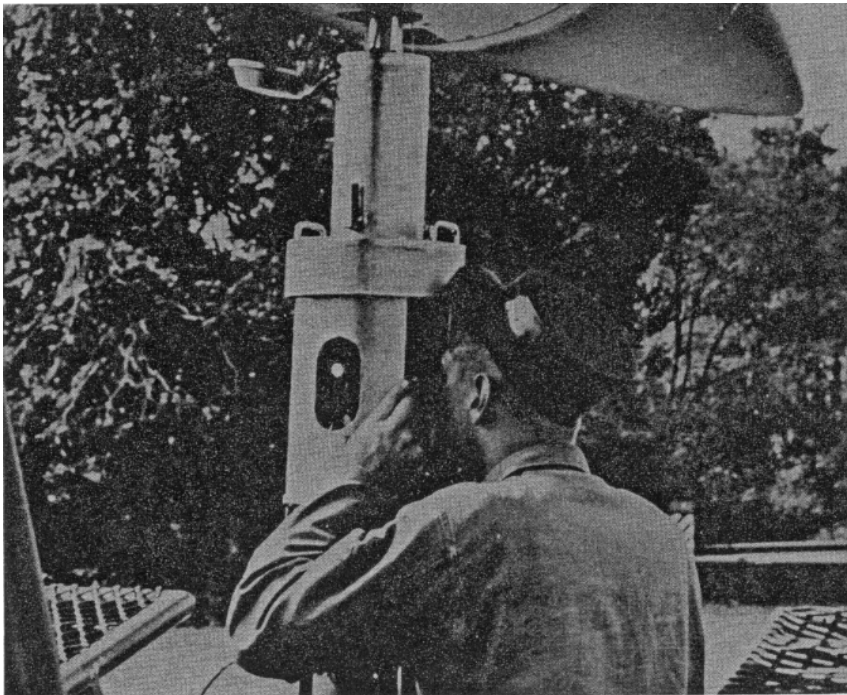
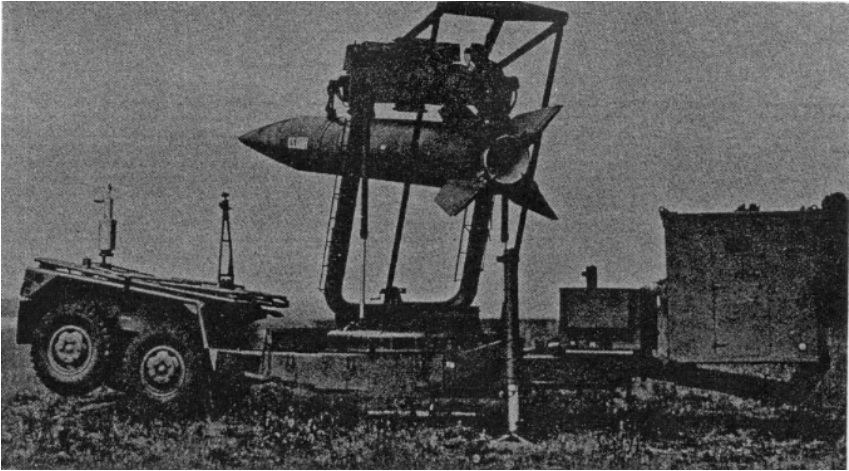
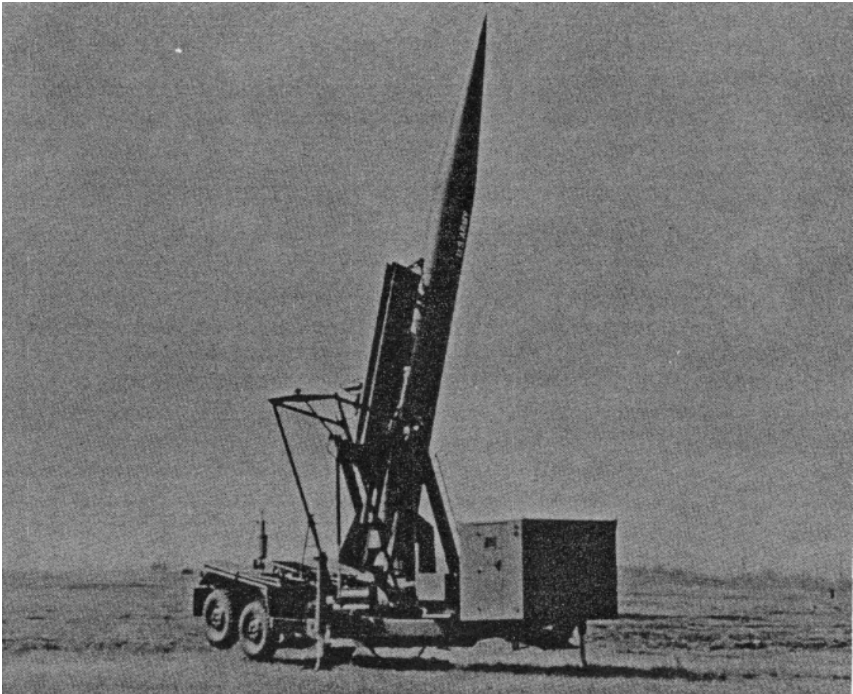

Figure 11. The Sergeant missile is laid similarly to cannon artillery.

Artillery training for the Sergeant system will consist of special courses conducted by the US Army Artillery and Missile School for officers and selected key enlisted personnel. Individual crewmen will be trained by the 1st Field Artillery Missile Brigade at Fort Sill. The maintenance concept and the reliability of this system eliminates the need for



①



②

Figure 12. The Sergeant missile firing sequence.

- ① Shows the missile being traversed for azimuth.
- ② The missile is elevated to the firing position.

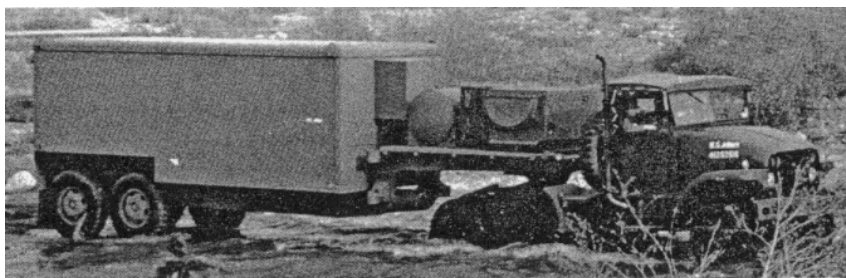

Figure 13. The OMTS towed by its prime mover.

detailed technical training for any of the personnel assigned to the Sergeant artillery battalion. The battalion organization, pending Department of the Army approval, will consist of a headquarters and headquarters battery and two missile batteries. Each battery will have one complete set of Sergeant equipment.

The Sergeant will be a mainstay in the ranks of the field artillery in the near future—a capable replacement for the Corporal missile system. It will provide the field army with a potent, highly mobile system that extends the range of cannon artillery and supplements the fires of corps artillery.



A GEM FOR COMMUNICATION PERSONNEL

The AM radio receiver AN/GRR-5 is used in artillery units down to battery level to monitor the division warning net and, in some cases, the corps artillery metro net. The AN/GRR-5 is usually operated in the operations or fire direction center (FDC) tent using a dry battery pack as a source of power. It may be operated on 115-volt alternating current or 6-, 12-, or 24-volt direct current. One of the problems involved in using the radio in a tent is that the roof is too low to permit use of the whip antenna issued with this equipment.

A method for solving this problem is to place a jumper wire between the antenna binding post of the radio receiver AN/GRR-5 and one of the binding posts of the nearest telephone connected with the command switchboard. This causes one side of the telephone line between the FDC and the command switchboard to act as an antenna. Since wire lines within a command post area are usually overhead and the distance to the command switchboard is usually in excess of 50 yards, this improvised antenna is more efficient and more readily available than other expedients.

—Submitted by Capt Henry Callaghan
Communication/Electronics Department

Graphic Guide For HE Effects

Major John G. Parker
Lt Robert Lee Hickerson
Gunnery/Cannon/Rocket Department

"How much fire should I place on this area target?" A familiar question? It has been one that has plagued S3's for years. The answer to the question will be influenced by many factors. Among them are the ammunition supply rate, the proximity of the ammunition supply point, the road net, and the tactical situation. No guide has existed to indicate to the S3 the amount of fire necessary to achieve a specified effect. In the war of the future, characterized by swift, self-contained task forces, the economic expenditure of ammunition will be a necessity. The S3 must have some "yardstick" that will enable him to fire a minimum number of volleys to achieve the effect desired.

Studies have been made of the effectiveness of high explosive (HE) ammunition against troops. The key to the effectiveness of HE fire is the "lethal area" of the projectile. Many factors affect the size of the lethal area of a projectile of a given caliber. These factors include the angle of fall, the height of burst, the terminal velocity of the projectile, the nature of the terrain (cover available, slope and hardness of the ground), and the posture of the troops being fired upon (standing, prone, or in uncovered foxholes). There is no single lethal area for a given projectile, but as many different lethal areas as there are conditions under which the projectile may burst.

In determining the effectiveness of an HE volley against an area target, the lethal area of the projectile is only one factor. Other factors are the number of rounds in the volley, the size of the area occupied by the target, and the probability that the rounds will burst within the limits of the target.

A graphical representation of the basic equation on effects computation is shown in figure 14.

The value of X for any volley is computed using the formula in figure 15.

NEW NOMOGRAPHS SIMPLIFY COMPUTATION

To simplify HE effects computation, the US Army Artillery and Missile School has developed the HE effects nomographs shown in figures 17 and 19. The effects nomographs provide solutions valid only for the following assumed conditions:

- (1) The target is at a medium range. Because computations are made for a fixed medium range, the value of p and the angle of fall are constant for each cannon.
- (2) The terrain is open and gently rolling.

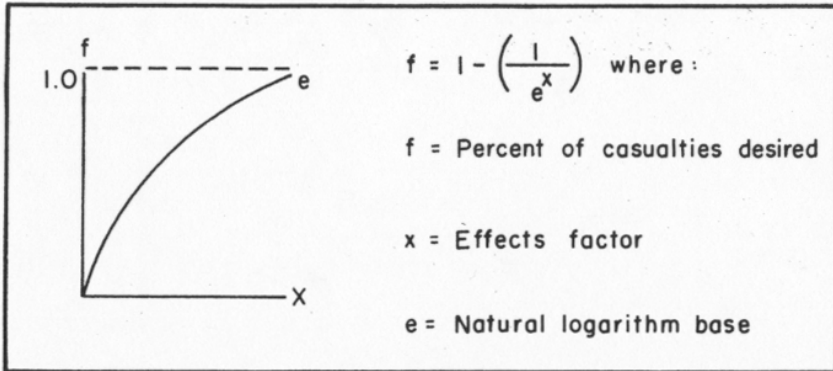

Figure 14. Graph of the basic equation in target effects computation.

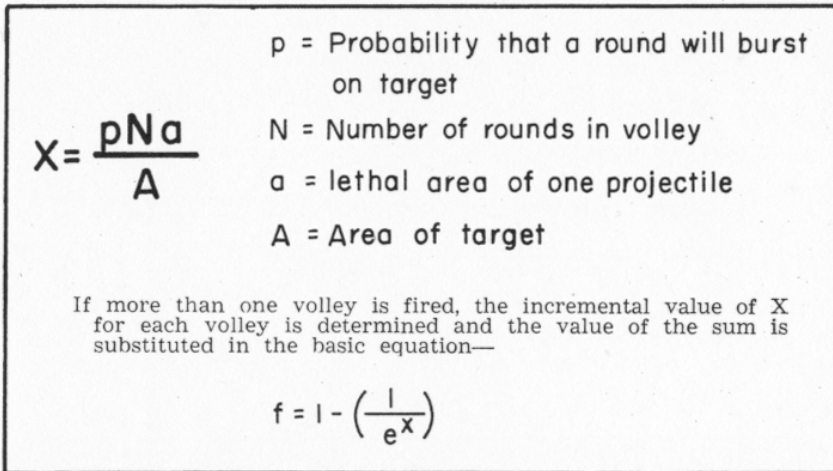

Figure 15. Formula for computing value of X for any volley.

(3) Fuze quick is fired for the first volley and fuze VT for subsequent volleys.

(4) Troops are in one of two general situations:

a. Class I: troops in the open, troops in the offense (no shelter available).

b. Class II: troops near shelter, troops in defense.

(5) Troops will seek and find more cover as additional volleys are fired.

It is assumed that troops in the offense are standing for the first volley, and are prone for all subsequent volleys; also that troops on the defense are standing for the first volley, prone for the second volley, and in uncovered foxholes for all subsequent volleys.

(3) The target is assumed to be 120 meters in depth (dimension parallel to the direction of fire). If the width of the target is less than the front covered by an open sheaf, the sheaf will be adjusted to the width of the target. A target more than 120 meters deep or greater than 300 meters wide should be treated as more than one target.

THREE SCALES INDICATE TARGET SIZE

Because the observer can rarely determine the exact dimensions of an area target, three scales have been standardized to indicate the approximate size of the target. Scale 0 denotes targets up to 100 meters in width. For effects computations, a scale 0 target is assumed to be 75 meters wide. Scale 1 denotes targets from 101 to 200 meters wide. A scale 1 target is assumed to be 150 meters wide for effects computations. Scale 2 denotes targets from 201 to 300 meters wide. For effects computations, scale 2 targets are assumed to be 250 meters wide. All target scales are considered to be 120 meters deep.

The lethal area of any projectile will vary with each of the three troop postures—standing, prone, and in uncovered foxholes. Two different sets of figures are needed, one to give a measure of the effect of fire against troops in the open (Class I) and one to give a measure of the effect against troops near shelter (Class II). The effects equations on which the nomographs are based are shown in figure 16.

$\text{CLASS I } X = \frac{pNa_1}{A} + \frac{pNa_2}{A} (n-1)$
$\text{CLASS II } X = \frac{pNa_1}{A} + \frac{pNa_2}{A} + \frac{pNa_3}{A} (n-2)$
<p>Where: a_1 = lethal area of a projectile against troops standing in open a_2 = lethal area of a projectile against troops prone in the open a_3 = lethal area of a projectile against troops in uncovered foxholes n = total number of volleys</p>

Figure 16. Effects equations on which nomographs are based.

There are three scales on an effects nomograph (figures 17, 19). The percent of casualties (f) is plotted on the right vertical scale. The target size is plotted on the horizontal scale that extends from the bottom of the right vertical scale to the top of the left vertical scale. The left vertical scale represents the volume of fire. To the left of the left vertical scale is shown the number of volleys from a number of cannon systems corresponding to the volume of fire represented on the left vertical scale.

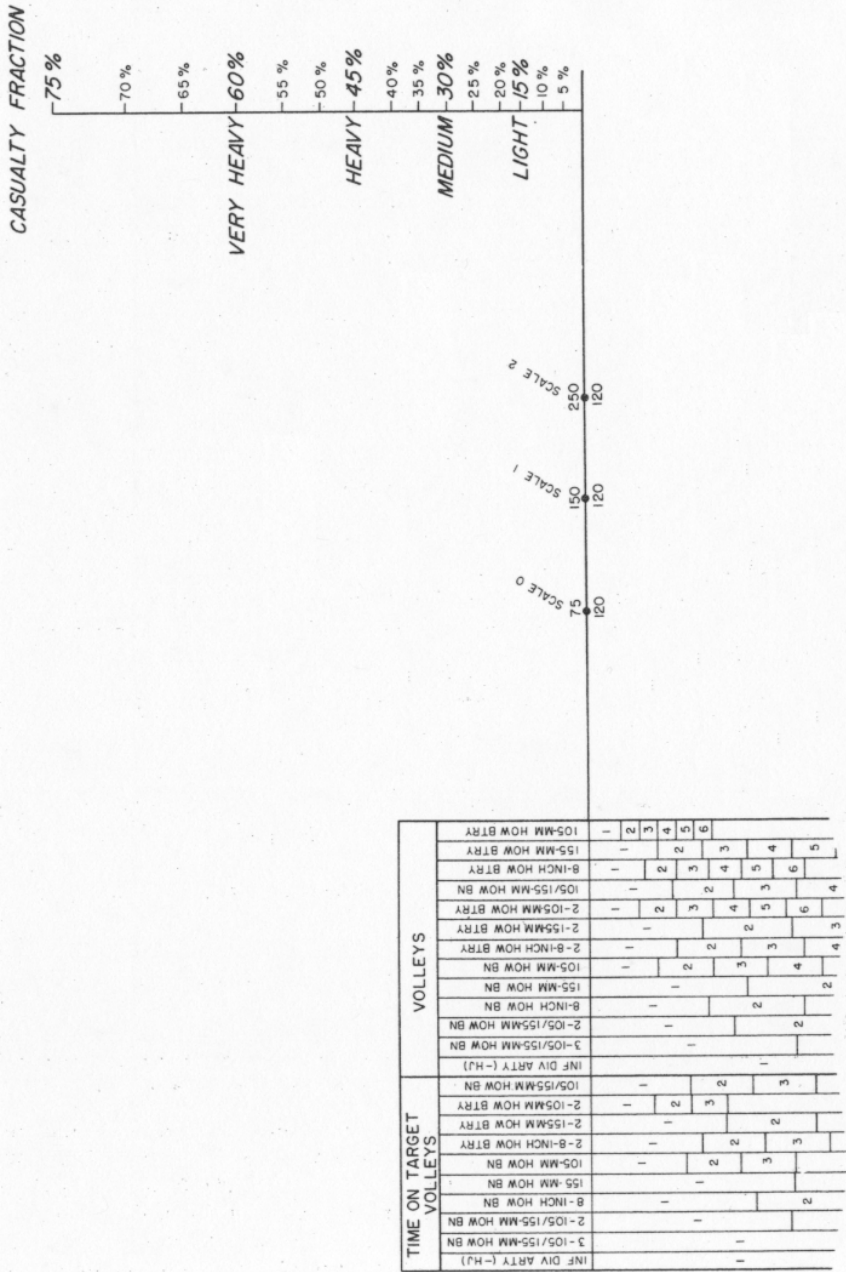
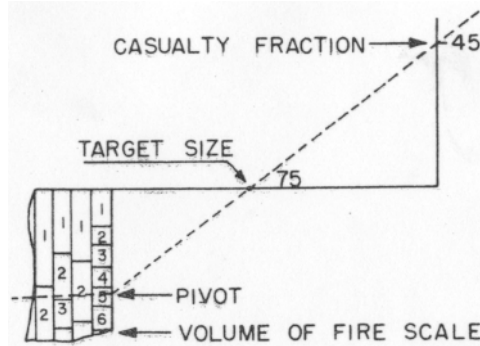

Figure 17. HE Effectiveness Table (HEFT) for use against personnel in open (Class D).

SAMPLE PROBLEM

- (1) An observer reports a Scale 0 target consisting of personnel in the open.
- (2) The S3 of a 105/155-mm howitzer battalion desires 45 percent casualties.
- (3) Solution:



- a. Place a straightedge so that it passes through 45 percent on the casualty fraction scale and Scale 0 (75×120) on the target size scales.
- b. Note the point at which the straightedge intersects the volume of fire scale.
- c. Read directly to the left to determine the number of volleys from the available systems.

1.	105-mm howitzer battery	5 volleys
2.	155-mm howitzer battery	2 volleys
3.	105/155-mm howitzer battalion	2 volleys
4.	105/155-mm howitzer battalion TOT	1 volley
- d. Select the most appropriate system.

Figure 18. Portion of Class I effects nomograph and sample problem.

SAMPLE PROBLEM

An observer has requested fire on troops in the defense and has reported the size of the target as scale 1. The S3 decides that a casualty fraction of 30 percent should be achieved. On the Class II nomograph (fig 19), he places a straightedge so that it passes through 30 percent on the casualty fraction scale and scale I (150×120) on the target-size scale to intersect the volume of fire scale. Directly to the left of the point at which the straightedge intersects the volume of fire scale, the S3 reads the number of volleys from each cannon system required to achieve 30 percent casualties, as in figure 21.

The nomographs deal in whole volleys only. Therefore, some of the systems shown above will produce a casualty fraction in excess of the requested 30 percent. The figure obtained from the nomograph is the minimum whole number of volleys from each system required to produce the specified casualty fraction. The S3 must then select, based on availability, ammunition requirements and tactical requirements, the most appropriate system.

From the HE effectiveness nomographs, several facts become apparent. First, the 155-mm howitzer unit is more effective against personnel than any other cannon unit. For example, the 155-mm howitzer battery

SAMPLE PROBLEM

- (1) An observer reports a Scale 0 target consisting of personnel.
- (2) The S3 of a 105/155-mm howitzer battalion desires 30 percent casualties.
- (3) Solution:

- a. Place a straightedge so that it passes through 30 percent on the casualty fraction scale and Scale 0 (75 × 120) on the target size scale.
- b. Note the point at which the straightedge intersects the volume of fire scale.
- c. Read directly to the left to determine the number of volleys from the available systems.
 1. 105-mm howitzer battery 5 volleys
 2. 155-mm howitzer battery 1 volley
 3. 105/155-mm howitzer battalion 1 volley
- d. Select the most appropriate system.

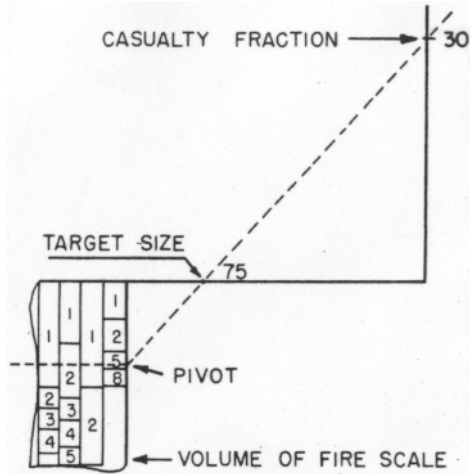

Figure 20. Portion of Class II effects nomograph and sample problem.

is more effective than an 8-inch battery against troops in an area 120 meters deep for two reasons. One, there are six howitzers in the 155-mm howitzer battery and only four in the 8-inch howitzer battery. Two, the small probable error of the 8-inch howitzer works to its disadvantage in firing against area targets because it reduces the area covered by multiple volleys.

System	Volleys (Non-TOT)	Volleys (TOT)
One 155-mm how btry	2	0
One 8-inch how btry	8	0
One 105/155-mm how bn	5	2
Two 155-mm how btry	1	1
Two 8-inch how btry	4	2
One 105-mm how bn	0	2
One 155-mm how bn	1	1
One 8-inch how bn	3	1
Two 105/155-mm how bn	3	1
Three 105/155-mm how bn	2	1
Inf div arty (-HJ)	1	1

Figure 21. The number of volleys from each cannon system required to achieve 30 percent casualties, for the sample problem.

A second point that should be obvious is that when multibattery systems are fired, the added effect from volleys after the first volley is small. The reason is that for non-time on target (TOT) firing, the enemy are prone (Class I) or in uncovered foxholes (Class II) for all multibattery volleys after the first. For this reason, the number of volleys (non-TOT) considered on the nomographs is limited to six for Class I targets and eight for Class II targets.

TIME ON TARGET GIVES GREATER EFFECT

A third point to notice is the vastly greater effect derived from a TOT. Why? All rounds from the system are assumed to burst at the same time, against virtually all standing troops. In a non-TOT mission, only the initial volley from the first battery to impact will find the troops standing.

Although the computations from which the effects nomographs were derived are based on the assumptions listed earlier, conditions different from those assumed will not materially affect the relative effectiveness of the several cannon systems shown. Variations from the percentages shown will result from changing conditions. Experience will give commanders and staff officers an appreciation for this variation. The solution is to change the casualty fraction sought; that is, change the point of entry into the nomograph. The nomograph will still serve to present comparative volumes of the fire required from different cannon systems to achieve a single effect.

This, then, gives the battalion, group, or division artillery S3 a "yardstick" for the development of his offensive and defensive supporting fires.

A GEM FOR COMMUNICATION PERSONNEL

If the PRESET CHANNEL SELECTOR SWITCH of the T-195 transmitter is operated with the locking bars of the BAND SELECTOR or the TUNING CONTROL loosened, there is a chance that the multiturn head or single turn head of the autotune mechanism will become unsynchronized. Should this occur, tightening the locking bars of the controls will not lock the mechanism.

A quick method of synchronizing the mechanism is to loosen both locking bars, turn the PRESET CHANNEL SELECTOR SWITCH to a different channel, and, as the BAND SELECTOR CONTROL and TUNING CONTROL start to rotate, quickly tighten both locking bars. Upon completion of the autotune cycle, the controls should then be locked, and the autotune mechanism should be in synchronization.

—Submitted by Mr. Jonathan P. Cornelius
Communication/Electronics Department

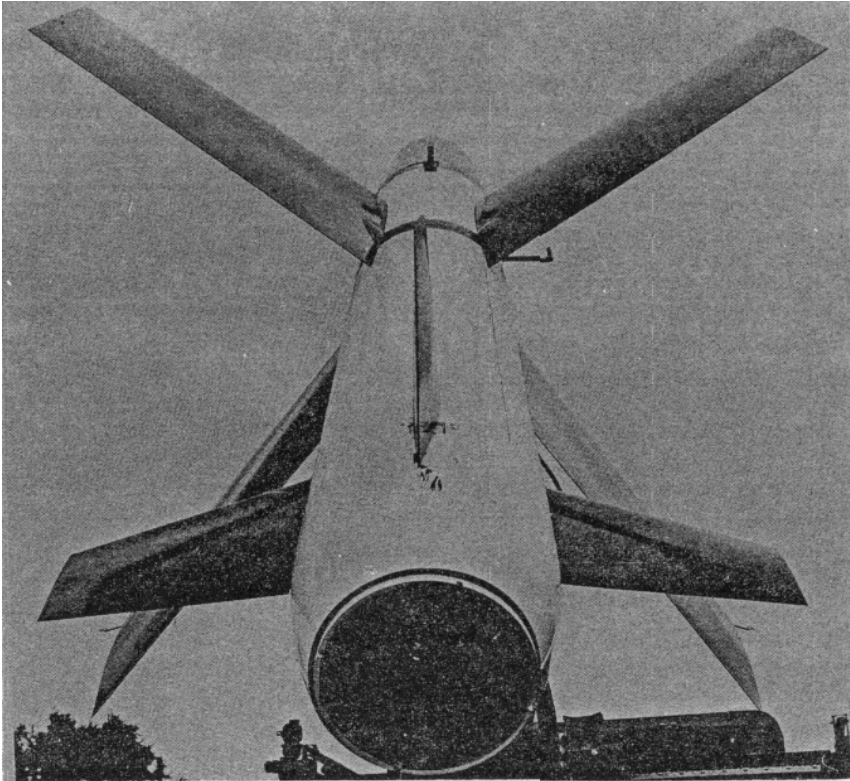

Another Training Triumph – – LACROSSE TRAINER

1/Lt Lawrence E. Stockett
1/Lt Frank Powell
Guided Missile Department

Poised as if ready for firing, the "ground bound" Lacrosse missile trainer impresses the viewer with the awesome potential of the actual weapon. With the aid of "brother" training equipment, the hard hitting, far-reaching Lacrosse has retained its keynote of simplicity as the newest operational guided missile in the US Army Artillery today. The Lacrosse training equipment permits mastering the Lacrosse operation and maintenance techniques so that the simplicity of the system can be appreciated.

Initially, it was decided that tactical Lacrosse equipment (ARTILLERY TRENDS, December 1959 and May 1960) would be used in training artillerymen. However, early in the Lacrosse program the US Army Artillery and Missile School realized that training Lacrosse crewmen by using tactical equipment created two problems. One, guidance central

personnel can be trained in making settings and in operation of the equipment, but confidence in the operation of the equipment and complete operational checkout can be obtained only by guiding missiles. Cost and range restrictions limited this type of training. Two, tactical missiles and guided missile test sets were not designed for continuous training use. Valuable training time was lost because of breakdowns in the equipment. Personnel at the Artillery and Missile School, working with the Army Rocket and Guided Missile Agency, solved these equipment problems by developing the Lacrosse handling and checkout trainer and the missile trajectory simulator.

LACROSSE HANDLING AND CHECKOUT TRAINER

The Lacrosse handling and checkout trainer has three major components—a simulated missile, a simulated guided missile test set, and an instructor's console. Externally, the trainer is a "double" for tactical equipment that it simulates (fig 22). The same first- and second-echelon operation and maintenance functions required in assembling and preparing a tactical missile for firing can be performed with the trainer; the trainer is used to train assembly and firing sections. The trainer was designed so that the electrical power required for operation can be furnished by 110 volts alternating current or 28 volts direct current. The trainer's capability to use several types of power provides versatility in that the trainer can be operated in a classroom or in the field by using the generator mounted on a launcher or the 28-volt generator of the assembly section.

The heart of the Lacrosse handling and checkout trainer is the instructor's console (fig 23). With this console, the instructor can monitor many of the procedures followed by the crewmen in preparing for and checking out the missile. Lights on the console indicate to the instructor that all cables within the missile are properly connected, what dive angle is set into the flight controller, when the gyroscope is caged, and when battery power is supplied to the missile. It also allows the instructor to insert any one of 126 malfunctions into the trainer. By the use of three rotary switches located on the front panel of the console, a malfunction can be set into the simulated missile, the simulated guided missile test set, or the comparator at each of the 42 steps used in checkout of the Lacrosse missile. The programmed malfunction is identical in appearance and operation to that which will occur when the tactical equipment malfunctions. After programming the malfunction, the instructor observes the reaction of the students to determine if proper corrective action is taken. One cable from the right side of the guided missile test set cabinet connects the instructor's console to the test set. This is the only special and nontactical cable required in the trainer. The instructor's console and its cable have been designed so that they do not interfere with the use of the trainer simulating the tactical equipment in assembly and checkout while following approved procedures. The use of the instructor's console enables the instructor to test students in ways which are not possible with the tactical equipment.



Figure 22. The Lacrosse missile trainer at high elevation.

The trainer guided missile (fig 24) is a full-scale, laminated plastic replica of the tactical Lacrosse missile. The trainer missile airframe is reinforced with fiberglass and is weighted to provide the identical weight and center of gravity of the tactical missile, so that it will duplicate the handling characteristics of the tactical missile. Realistic reproductions of the first- and second-echelon replaceable guidance and power components are within the guidance and power section of the trainer missile. These include the flight controller, transponder, beacon, battery, motor-generator, and hydraulic power control unit. Installation and removal of these components are identical to that of the tactical missile; however, because of their realistic appearance, the simulated components have been designed with a mechanical stop, so that interchange with components of a tactical missile is impossible. A spare set of these components in tactical containers is included with the missile trainer to provide realism of storage, transportation, and replacement of the components. A horn and four lights located within the nozzle of the rocket motor function when the two fire buttons are depressed. The trainer missile contains an inert tactical igniter. The trainer is designed so that this igniter must function properly and be properly armed to get the visual and aural indication when the fire buttons are depressed. Tactical handling equipment



Figure 23. The instructor's console, heart of the Lacrosse handling and checkout trainer.

used in assembly and assembly procedures are the same for the trainer as for the tactical missile.

The trainer guided missile test set (fig 25) is also a full-scale replica of its tactical counterpart. It is composed of a simulated electronic command signals programmer, guidance checkout unit, distribution box, and radio-frequency detectors. The guided missile firing panel, the prelaunch checkout indicator, and all cables except the instructor's console cable are tactical. The trainer test set completely simulates all performance characteristics of the tactical test set. It provides the same 42-step test sequence and simulates the automatic checkout of the simulated guidance and power components of the trainer missile. Malfunctions are localized to either the trainer test set or the trainer missile on a go-no-go basis, as with the tactical test set. Signals necessary to produce a "go" signal in the test set, causing the test set to step to the next step, are supplied by the trainer missile's simulated guidance and power components. If the guidance and power components have not been installed, connected, or properly adjusted, a malfunction will appear on the programmer of the trainer test set during the appropriate step. Also, improper cabling of

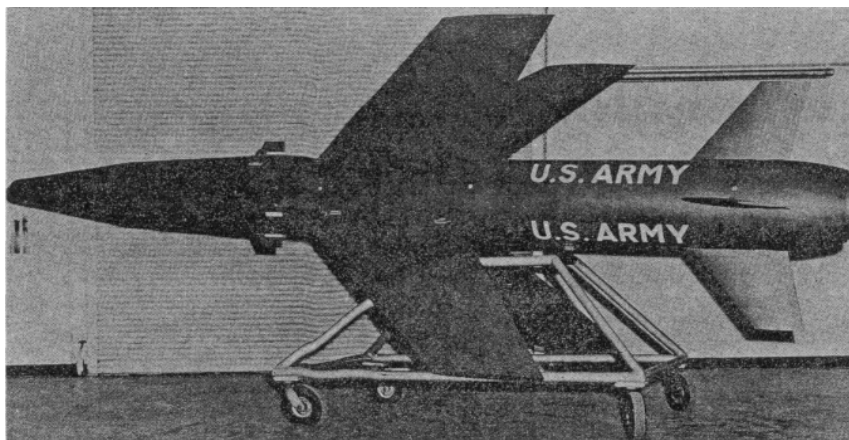

Figure 24. A side view of the Lacrosse trainer guided missile.

the trainer missile and test set will cause a malfunction on the proper step. From the malfunction indication, personnel may determine the cause of the malfunction and take corrective action.

MISSILE TRAJECTORY SIMULATOR

As the name implies, the missile trajectory simulator simulates the trajectory of the Lacrosse missile. The missile guidance components are installed in a piloted L-19E aircraft. The guidance components convert the commands from the missile guidance central into the visual indications. An omni-instrument landing system (ILS) indicator and a series of lights on the instrument panel of the aircraft are used to display the commands to the pilot. The pilot will correct the flight path of the aircraft until the commands that are displayed on the indicator show that the aircraft is on the proper course or trajectory.

The components of the missile trajectory simulator (fig 26) are a rack assembly, a beacon, a transponder, a motor-generator, a beacon antenna, a transponder antenna, a junction box, and the pilot's panel.

The L-19E aircraft must be modified slightly to include the installation of a 100-ampere generator, in place of the aircraft's own generator, and the insertion of a circuit breaker. The 100-ampere generator is required to provide the necessary power to operate the missile guidance components, and the circuit breaker is a safety device to prevent the overloading of the circuits and endangering the pilot's life. A cross pointer indicator (omni-ILS indicator) and a series of lights are located on the pilot's panel. The yaw commands from the missile guidance central will cause the vertical needle of the indicator to deflect from the center position. This is an accurate indication of the aircraft's position with respect to the proper trajectory in the yaw plane. The pilot will "fly the needle" to cause the vertical needle to return to the center position. The horizontal needle is used in the same manner to indicate

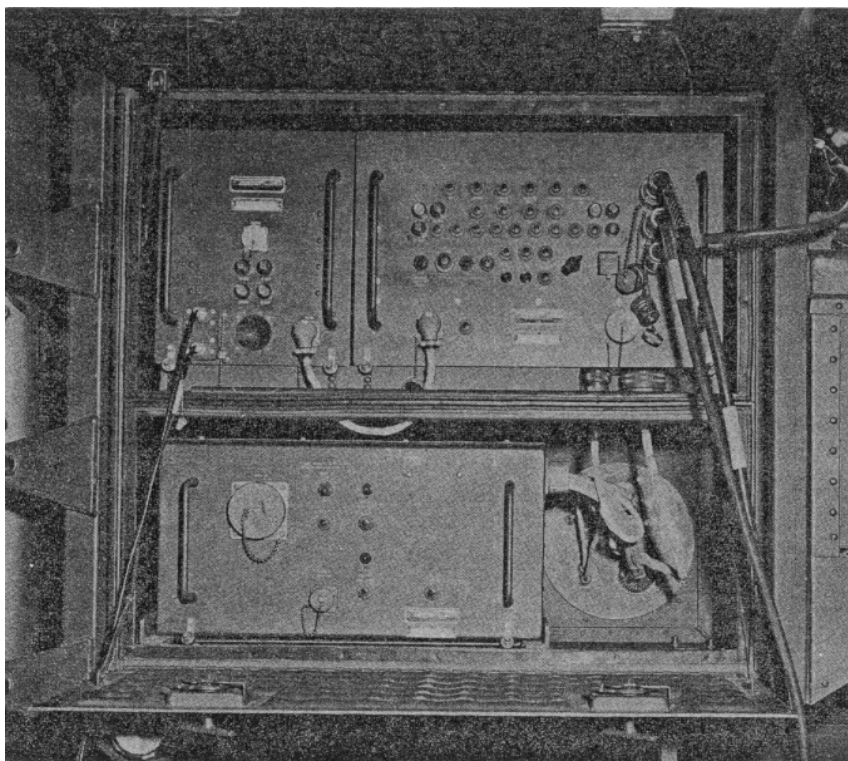

Figure 25. The Lacrosse trainer guided missile test set, a full-scale replica of its tactical counterpart.

the pitch commands. The three lamps on the pilot's panel indicate when the yaw-transfer, pitch-transfer, and warhead arming commands are sent from the missile guidance central to the missile trajectory simulator.

Approximately 30 hours are required to install the components and modify the aircraft. A special rack assembly is placed in the observer's compartment to secure the missile guidance components, and the junction box provides the necessary connections to connect the guidance components to the aircraft's electrical circuits. The beacon antenna is then mounted on the tip of the aircraft's right wing, and the transponder antenna is mounted on the under side of the fuselage. When the beacon and the transponder antennas have been mounted, the guidance simulator can be easily removed and reinstalled in the aircraft in a minimum amount of time.

OPERATION OF MISSILE TRAJECTORY SIMULATOR

The operation of the simulator is simple. The pilot is given an altitude at which to fly, a starting point or initial point, and a heading. The pilot is informed through radio communications to begin his run. By flying

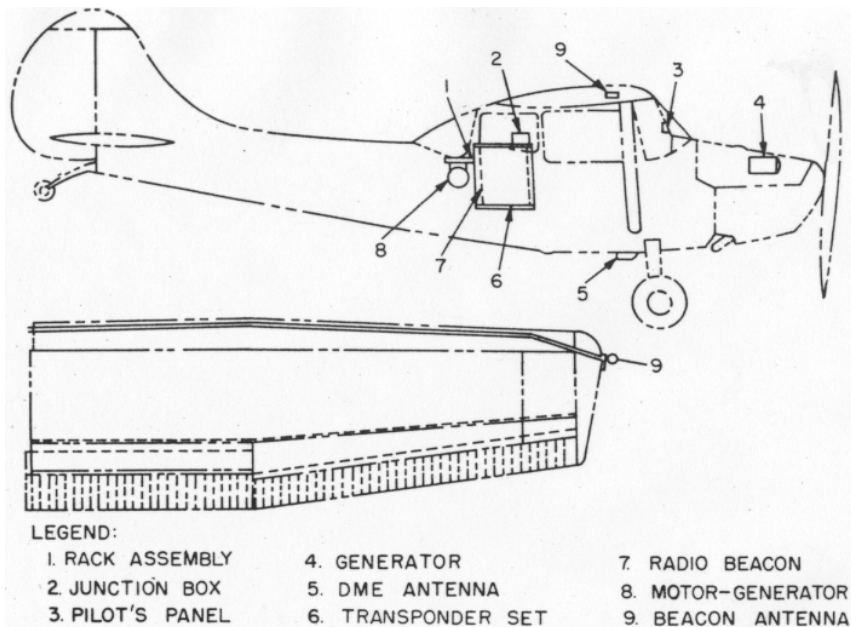

Figure 26. A sketch of the missile trajectory simulator.

along the indicated trajectory, the missile guidance central will acquire the aircraft and guide it accurately to the target. This enables the guidance central personnel to check the accuracy of the settings they have placed in the guidance central components. The simulator also provides an accurate indication of the proper operation of these components and can be used to calibrate the missile guidance central equipment. As the pilot approaches the target, in the terminal dive, he will pull the aircraft up at a safe altitude in the vicinity of the target.

The missile trajectory simulator gives the guidance section personnel a chance to observe their equipment under actual conditions without actually firing a missile. Proper use of the simulator aids in measuring the operational effectiveness of the guidance section personnel and equipment and provides immediate indications as to the success or failure of a simulated mission.

Besides keeping Lacrosse operation and maintenance techniques simple, the use of the Lacrosse training equipment greatly assists in training by allowing section personnel to perform operation and maintenance functions which cannot be performed when the tactical equipment is used for training. By the use of these items of training equipment, the Lacrosse unit commander can be assured that his personnel are properly trained to deliver Lacrosse fires with pinpoint, one-shot accuracy.

An Electronic FO --

THE AN/TPS-25 RADAR

Captain James N. Heath
Captain Billy G. Hensley
Target Acquisition Department

The time . . . 0103 . . . the place . . . inside a shelter mounted on a two-wheel trailer. A small dot of light is shining through a location on a battle map, around which two men are huddling. Two minutes later, at a point about 10,000 meters from the darkened shelter, an enemy tank is obliterated by the fires of a 105-mm howitzer battery. Stealthily, quietly, the darkened trailer and its supporting components are march ordered—readied to "see" another mission.

The darkened shelter houses the AN/TPS-25 radar (ARTILLERY TRENDS, March 1959), one of the first radar sets issued to troops that has been specifically designed for ground surveillance of moving targets. Originally, radars were used to determine distance and direction of objects. Near the end of World War II it was discovered that radar could be used effectively as a battlefield surveillance device during periods of darkness or poor visibility. Two major difficulties initially encountered were that the equipment was too bulky and complex to be moved as often as this mission required, and the radar had to be withdrawn from its primary mission to perform the surveillance role. Since then, however, methods have been devised to adapt several radar sets for battlefield surveillance.

The AN/TPS-25 (fig 27) is a transportable battlefield surveillance radar of the noncoherent Doppler type, designed to detect and locate moving ground targets at ranges between 450 and 18,280 meters. Normally, it is able to spot a moving man at ranges up to 4,500 meters and a moving vehicle at ranges up to a maximum of 18,280 meters. This radar will be used to supplement artillery observation of the battlefield during periods of reduced visibility. It is particularly useful for adjusting effective harassing and interdicting fires on a road junction or avenue of approach.

RADAR SET TRANSPORTED IN OPERATING SHELTER

The entire radar set, except its spare generator, is transported inside an operating shelter (fig 28), which is normally mounted on a 1½-ton, two-wheel trailer. The power requirements of the AN/TPS-25, including the shelter, are furnished by a 115-volt, 400-cycle, single-phase 'AC, 1.5-kilowatt power unit PU-450/G. A spare power unit is issued with each radar. The shelter, with all the radar components except the spare generator stored inside, weighs 2,960 pounds.

The antenna can be installed directly on the receiver-transmitter or

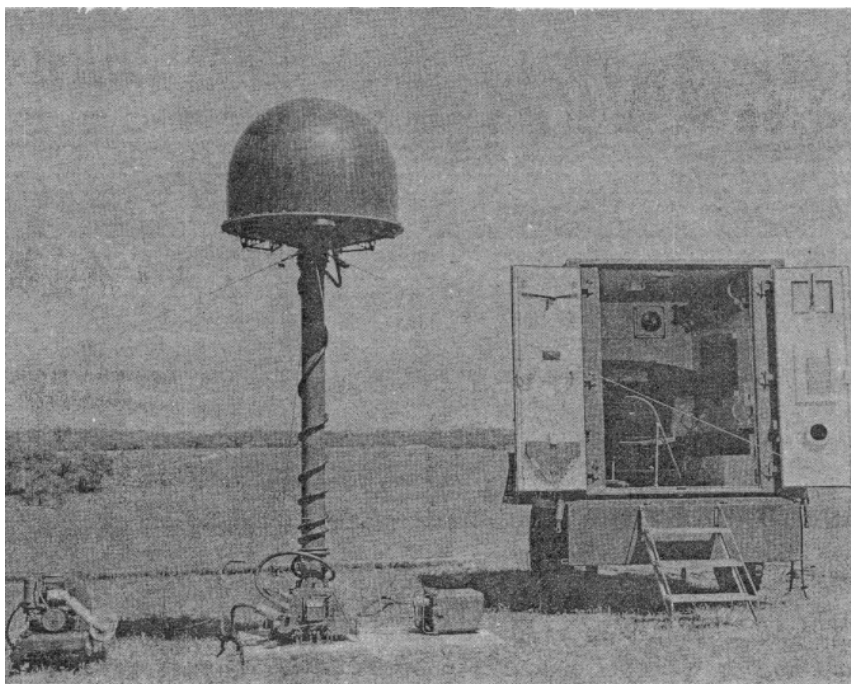

Figure 27. The AN/TPS-25 radar complete with power unit, antenna, and operating shelter.

on one, two, or three mast sections. When installed on three mast sections, the antenna height reaches to approximately 25 feet. A crew of four trained men can install the radar in 15 to 45 minutes, depending on the number of mast sections used. Since the AN/TPS-25 requires line of sight to the target area, it will be visible from the target area. If the equipment is used only during darkness or periods of poor visibility as intended, this will not be a problem. However, if the radar is left in position during periods of improved visibility, camouflage and concealment will become an important and difficult problem. A radar site must be carefully chosen to give the required line of sight to the target area without presenting an unnecessarily difficult camouflage problem.

There are two means of target indication on the AN/TPS-25; these are visual presentation on a cathode-ray tube and audible presentation from a loudspeaker and/or earphones. Target locations are presented in polar data—range, azimuth, and angular elevation counters—and in Cartesian coordinates—on X and Y counters. Target location is also indicated on a battle map by a dot of light shining through the map at the target location, a presentation which is especially useful in tracking a moving target. By observing the direction and speed of the target, the operator can predict its time of arrival at a point on which fire can be delivered.

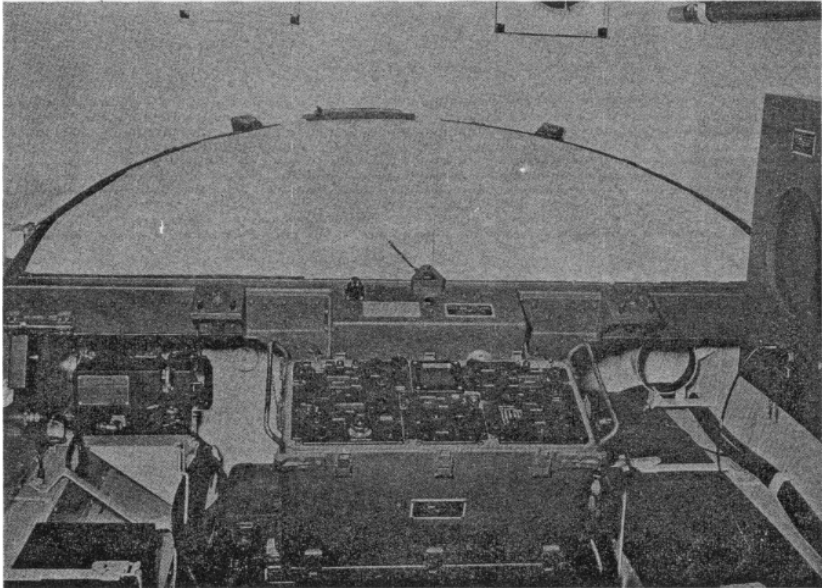

Figure 28. The interior of the AN/TPS-25 radar operating shelter.

PRINCIPLES OF AN/TPS-25 OPERATION

When radiated radio-frequency energy is reflected from an object moving toward or away from the stationary source of radiation, the apparent frequency of the reflected energy at the source is changed slightly due to the target movement. The amount of apparent frequency change depends on the velocity of the object. This apparent change in frequency due to the motion of the object is known as the Doppler effect. To detect this change in frequency, the return signal must be compared with a signal at the original frequency. Coherent Doppler systems, like those used to detect speeders on the highway, generate a reference signal inside the radar. Noncoherent systems, such as that in the AN/TPS-25 radar, use the return from stationary objects (clutter) as a reference. The difference between the two signals is detected and, after amplification, applied to earphones and/or a loudspeaker, where it is converted into sound. It is primarily from this sound that the operator is able to detect and identify moving targets.

One AN/TPS-25 radar section is organic to the Target Acquisition Platoon of Headquarters and Headquarters Battery, Division Artillery, in both the Infantry and Armored Divisions.

Although not a prime target locator, the AN/TPS-25 radar does provide a capability that no previous item of equipment could fulfill within the division artillery. During periods of darkness and poor visibility, it is, in effect, an electronic forward observer.

"Artillery Lamplighter" – –

A NEW GFT

Major Leon L. deCorrevont
1/Lt David A. Hufnagel
Gunnery/Cannon/Rocket Department

Have you ever had the frustrating experience of being a forward observer with an infantry company commander literally "breathing down your neck" while you were waiting for an illuminating round to be fired? If so, you probably realize that graphical equipment has never been issued specifically for the illuminating shell. Illuminating shell firing data are contained in a separate portion of the tabular firing tables. Because this portion differs in format from the rest of the firing tables and is seldom used, more time is required to produce firing data. Consequently, fires may not be as effective and the supported unit may not receive maximum artillery support.

The delay could be lessened if graphical firing tables (GFT) for the illuminating shell were available. Such an item *does* exist now, for use with FT 155-Q-3.

With a previous model design as a guide and using new ballistic data for FT 155-Q-3, the US Army Artillery and Missile School has developed pilot models of GFT's for illuminating shell, charges 3, 4, 5, and 7.

Basically, the GFT (fig 29) displays quadrant elevation and fuze setting as a function of height of burst and range. Height of burst is displayed in 50-meter increments from 600 to 1,000 meters and range is shown in 20-meter increments. Using ballistic data for the ascending and descending branch of the trajectory for charge 3 and for the descending branch only of the remaining charges, it is possible to provide firing data from a minimum range of 1,000 meters to the maximum range capability of the weapon system.

DETERMINING FIRING DATA

To determine firing data, the hairline of the cursor is placed over the range to the target. The quadrant elevation is read on the appropriate height of burst scale. Optimum height of burst for the 105-mm and 155-mm illuminating shell is 750 meters, plus or minus the difference in altitude between the piece and the terrain over which the round is to burst. The fuze setting is determined by interpolating between appropriate fuze setting lines to the point of intersection of the hairline and height of burst line. In the example shown in figure 29 for charge 5, assume that the height of burst is 800 meters and range is 7,200 meters. By visual interpolation, the quadrant elevation is 665 mils and the fuze setting is 34.2 seconds.

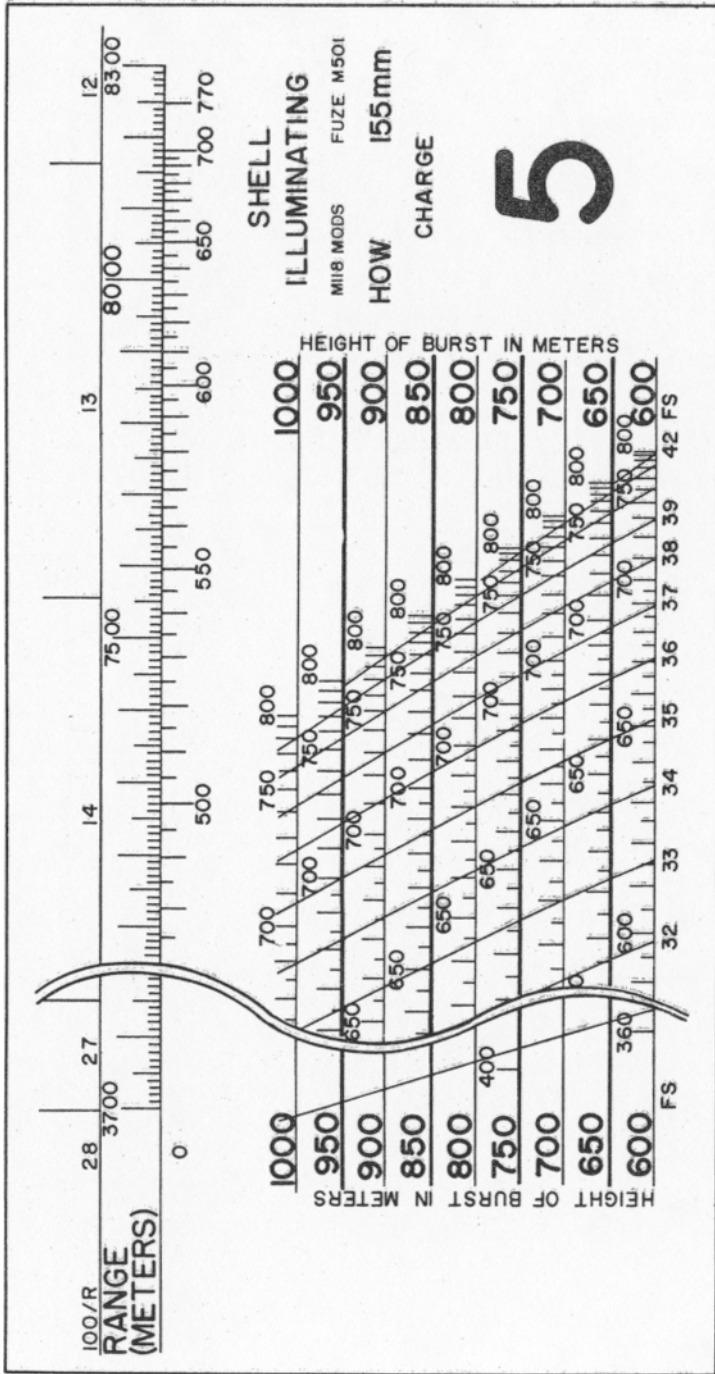

Figure 29. The new graphical firing tables for the illuminating shell.

The GFT also has a 100/R scale, which may be used to plan the location of the various rounds in a two or four gun mission. A zero height of burst scale assists the safety officer in determining the point of impact if the time fuze fails to function.

The Artillery and Missile School believes that these GFT's will greatly increase speed and accuracy of the 155-mm howitzer illuminating shell. The GFT's have been approved by the US Army Artillery Board, Fort Sill, and it is anticipated that they will become items of issue late this year or early in 1961. The GFT's are now available at the School Book Department for \$2.50 per set postpaid.

A GEM FOR THE FORWARD OBSERVER

Since a forward observer (FO) has many additional duties to perform during the time he is not "on the hill," he is prone to forget procedures. In our unit, a handy reference file, or brochure, has been set up to give the FO quick answers to his queries concerning observed fire procedures.

The brochure consists of a large manila folder with pertinent information appended to it. All material is held in place by fasteners and compressors. Items included in the folder are listed in order from top to bottom for both the left and right sides of the folder. For example: Right side

- (1) Extract from battalion SOP for combat pertaining to intelligence.
- (2) Conduct of fire forms.
- (3) Gunnery data booklet.
- (4) Observer report forms.
- (5) Artillery counterfire information forms.
- (6) Atomic burst report forms.
- (7) Chemical, biological, and radiological warfare report forms.
- (8) Terrain sketch (sample).
- (9) Protractor (plastic).
- (10) Coordinate scale (plastic).
- (11) OF fan.

Left side

- (1) Instructional Notes OF 1.
- (2) Instructional Notes OF 2.
- (3) Instructional Notes OF 4, 5.

We also insert in the folder an FO checklist, which includes jobs to be done in the battery area, a list of items of information and equipment to be obtained at command post, and a procedure after reaching the observation post. The checklist is mounted on cardboard and covered with acetate.

—Submitted by Capt Nehemiah E. Richardson
Btry A, 3rd How Bn, 13th Arty
APO 25, San Francisco, Calif.

A Bizarre 155-mm Howitzer

Imagine a cannoneer sitting comfortably on a seat located on the left trail of a 155-mm howitzer . . . then, with a casual flick of two hand levers he begins to maneuver the weapon out of its emplacement—on its own power! Amazing, but true. This weapon is a reality, it's the auxiliary-propelled 155-mm howitzer carriage M1A2 (fig 30).

The weapon received the name "auxiliary-propelled" rather than "self-propelled" because it can assist its prime mover when traveling over soil of limited trafficability and over steep slopes. It can also act independently as a self-propelled weapon with a degree of maneuverability at speeds of 3 to 9 miles an hour. Because of the weapon's added tractive effort, the 2½-ton truck can be considered for use as the prime mover.

Advantages of the auxiliary-propelled howitzer are: It enables the elimination of the prime mover in phase I airborne operations; it can be readily maneuvered in and out of an emplacement; and it can move through ditches, broken terrain, mud, and heavily forested areas not negotiable by standard prime movers capable of towing the howitzer. Tractive effort is sufficient to tow an ammunition trailer over less difficult terrain. A power source can be used to seat the spades for firing and to pull them out of the ground when march ordering the weapon.

The weapon has an internal combustion engine, hydraulic drive, and wheels. Each large wheel of the weapon is driven by an independent hydrostatic propulsion system which provides steering control and vehicle propulsion. An engine on each trail drives a variable displacement piston pump through a gear reduction. High pressure is transmitted from the pump through the tubing on top of the trails to two variable displacement motors located adjacent to the large driving wheel.

The auxiliary-propelled 155-mm howitzer propulsion system shown in figure 30 weighs approximately 2,300 pounds. The propulsion system was assembled from commercial components available for a feasibility test.

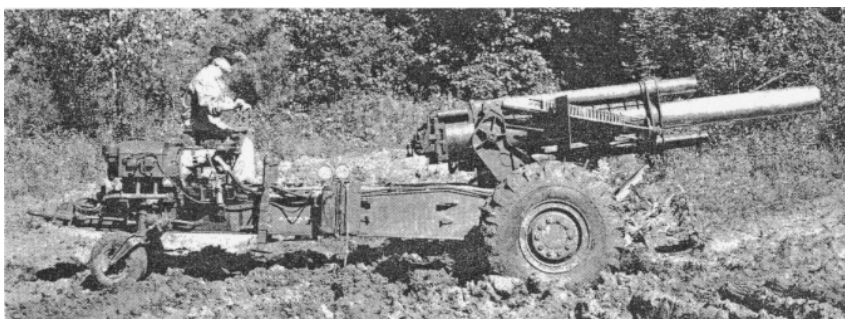

Figure 30. The auxiliary-propelled 155-mm howitzer M1A2 in the traveling position.

The prototype will weigh about 1,200 pounds and will be smaller and more compact in design. Firing of this howitzer is not hindered by the propulsion system (fig 31).

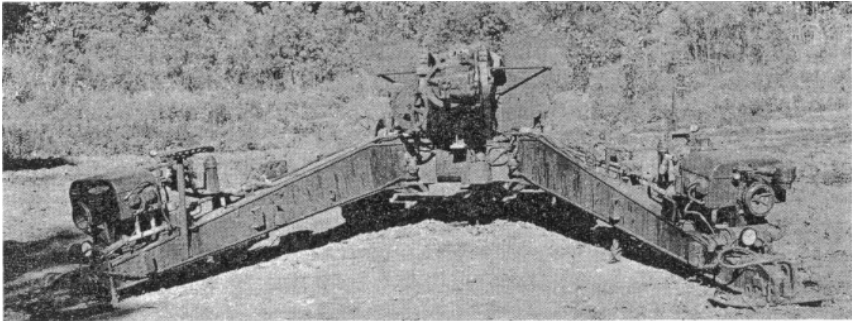

Figure 31. A rear view of the auxiliary-propelled 155-mm howitzer in the firing position.

DRIVER OPERATES TWO HAND LEVERS

Each of the two hand levers operated by the driver are connected to the hydrostatic transmission furnishing the power to the wheel on that side. When the hand levers are in a central position the transmission is in neutral, allowing the pump to idle at very low pressure and providing positive braking of the weapon. Moving both hand levers forward from the neutral position causes the weapon to move forward, moving them to the rear causes the weapon to go backward. Moving one hand lever forward and the other back will cause the howitzer to turn about its own center by reversing the drive of one wheel. The weapon speed attained, within the limits of the propulsion system, is directly proportional to the amount the hand levers are moved.

The weapon has a two-shift drive, high and low. The mechanical linkage between the hydraulic motors and the driving wheels can be declutched for normal towing operations. Ground clearance with respect to the transmission driving wheel is low. This, however, is to be corrected in the prototype.

A caster wheel at the end of each trail aids in spreading the trails. The wheels are pivoted into the horizontal position when the weapon is fired. A detachable jack at the end of each trail is used to support the trail when the caster wheels are pivoted and is used to raise and lower the trails during emplacement and displacement of the weapon. The jacks also offer the advantage of a spade puller when the weapon is being displaced.

Observers from the US Army Artillery and Missile School and the Artillery Board, Fort Sill, who saw the auxiliary-propelled 155-mm howitzer demonstrated at Rock Island Arsenal, Illinois, consider it to be a promising weapon. Development on the prototype model is being continued at the Rock Island Arsenal and further tests can be expected in the near future.

TRAINING BY MAIL --

Extension Course Division

Over 22,000 artillerymen presently are enrolled in the extension courses program of the US Army Artillery and Missile School. These self-study courses provide an effective progressive military education. This method of learning is of particular value to persons who are not able to attend a resident course and persons who want to stay up-to-date in the artillery. The courses are conducted by mail at no cost to the student.

In the period between World War I and World War II, extension courses provided the primary means by which a reserve officer could maintain his military proficiency. There were few periods of active duty, service school attendance was limited, and few organized reserve units were in existence. The National Guard, because of its organized units and established drill periods, fared better; however, extension courses still played an important role in furthering the military education of the National Guard officer. Prior to World War II, a large number of individuals in both components obtained their commissions through extension course study. As a result of their peacetime military education, personnel of the reserve components comprised the major portion of the officers of the wartime Army.

Since World War II, the position of world leadership acquired by the United States has necessitated the maintenance of larger active and reserve armed forces. Organizational changes, new weapons, and methods of employment have increased training problems, and because of the number of military personnel involved, resident schooling cannot be provided for everyone. A solution to this schooling problem lies in increased participation in the extension course program, which provides a means of keeping abreast of the latest changes in weapons, doctrine, and techniques. In addition to furthering his individual job proficiency, the National Guard and the Reserve officer may meet educational requirements for promotion, and the Reserve officer may obtain additional retirement points through extension courses.

Since new units are being organized and new weapons developed, the extension course program is equally important to members of the active Army. Improved extension courses are designed to provide instruction in these new developments for the individuals who cannot attend a resident course. In addition, certain selected subcourses, or special extension courses, may be taken in preparation for attendance at a resident course.

WARRANT OFFICERS AND ENLISTED MEN

Warrant officers and enlisted men of all components are eligible to enroll for extension course study. They may take selected subcourses pertaining to their job or special extension courses in a particular subject

area. The advantages of extension course study to officers are equally applicable to warrant officers and enlisted men. Warrant officers and enlisted men also may enroll in the Battery Grade Extension Course if they have completed the Army Precommission Extension Course, which is offered by the US Army Infantry School. When he has completed the battery grade series, the individual is eligible to take the Advanced Extension Course. Other courses of interest to enlisted men are the special courses for enlisted personnel in key jobs in artillery units.

The artillery extension course program at present is composed of the Battery Grade Extension Course, the Advanced Extension Course, a number of special extension courses, a transition course, and preparatory courses for resident instruction. The Battery Grade and Advanced Extension Courses parallel the corresponding associate resident courses previously offered by the resident school. The special extension courses present related instruction in a specific field such as survey, gunnery, and missile. Students may enroll in any of these courses, or in selected subcourses according to their need for instruction.

Recent changes in resident instruction (ARTILLERY TRENDS, July 1960) will necessitate a major change in the organization of the extension course program for fiscal year 1962. Present plans indicate the new program will consist of an Orientation Extension Course, a Familiarization Extension Course and a Field Artillery Officers Career Extension Course. Special and preparatory extension courses will also be included. The three basic courses will be designed to present instruction which is parallel to that offered by corresponding resident courses.

Those titles shown in the *Extension Course Catalog 1960-61* under Field Artillery Preparatory Courses (page 17) and Air Defense Artillery Preparatory Courses (pages 27 to 29) no longer apply. The *new* resident course titles and numbers are shown in parenthesis below, following the appropriate preparatory extension course:

(1) **Field Artillery Preparatory Course 1** (Field Artillery Officer Orientation Course (FAOOC)), (6-A-C20).

(2) **Field Artillery Preparatory Course 2** (Field Artillery Officer Familiarization Course (FAOFC)), (6-A-C21).

(3) **Field Artillery Preparatory Course 3** (Associate Field Artillery Officer Career Course (AFAOCC)), (6-A-23).

(4) **Air Defense Artillery Preparatory Course 1** (Associate Air Defense Officer Career Course), (44-A-C23).

(5) **Air Defense Artillery Preparatory Course 2** (Air Defense Officer Orientation Course), (44-A-C20).

(6) **Air Defense Artillery Preparatory Course 3.** (No change).

(7) **Air Defense Artillery Preparatory Course 4** (Nike Universal Officer Course), (44-A-F4) and/or (Nike Hercules Officer Transition Course), (44-A-F7).

(8) **Air Defense Artillery Preparatory Course 5** (Nike Ajax Fire Control System Maintenance Course), (44-N-1178A/44-N-224.1) and/or (Nike Ajax Missile Electronic Maintenance Course), (44-N-1182A/44-N-223.1).

(9) **Air Defense Artillery Preparatory Course 6** (Nike Ajax Missile Mechanical Maintenance Course), (44-R-172.1).

(10) **Air Defense Artillery Preparatory Course 7** (no change).

(11) **Air Defense Artillery Preparatory Course 8** (no change).

Generally, any member of an Army component is eligible to enroll in the extension course program. Specific categories of eligibility and specific enrollment procedures are covered in AR 350-60, 26 June 1956, *Education and Training, Army Extension Courses*, and DA Pamphlet 350-60, *Announcement of Army Extension Courses*, January 1960. Copies of the booklet, *Extension Courses for Artillery*, are available by writing to: Commandant, US Army Artillery and Missile School, Fort Sill, Oklahoma, ATTN: Extension Courses Division.

The subcourse is the basic instructional unit in an extension course. It covers a single phase of instruction and contains from 3 to 9 lessons and an examination. Each lesson has a study assignment and practical exercises to develop the subject. Necessary training aids and devices such as graphical firing tables, protractors, coordinate squares, and firing charts are supplied to the student with the subcourse.

SUBCOURSES MUST BE UP TO DATE

The ever changing organization and equipment of the artillery requires that existing subcourses be periodically examined to keep them up to date. If necessary, existing subcourses are revised and new ones prepared. Approximately six months are required to rewrite or prepare a new subcourse. Illustrations are prepared, the lesson is edited, and the final copy is printed.

A new or revised subcourse is "service tested." The first 100 students who enroll in a new subcourse are given a questionnaire requesting their reaction and opinion of the subcourse. These comments are used to improve the subcourse.

A specific number of credit hours is allowed the student for the successful completion of each lesson and examination. These credit hours, ranging from 12 to 27 hours, are based on the average time needed to study the text and solve the exercises. For retirement determination, 3 credit hours are equivalent to 1 retirement point.

The rapid expansion of the extension courses program necessitated the conversion from manual to machine methods of processing answer sheets. Since 1958, answer sheets are machine graded and on the way back to the student within 24 hours. To facilitate this rapid processing system, each student must place his assigned student number on all answer sheets and on all correspondence with the school.

The student counseling service is available to give the student a prompt and personal reply to any question relative to the course.

Are *you* one of the more than 22,000 artillery extension course students?

NEWS NOTES FOR ARTILLERYMEN

US ARMY ARTILLERY AND MISSILE SCHOOL REORGANIZED

The US Army Artillery and Missile School, Fort Sill, completed a reorganization (fig 32), effective 15 July 1960, which created three new departments and consolidated the materiel, gunnery, instructional, and research aspects of its guided missile and rocket systems.

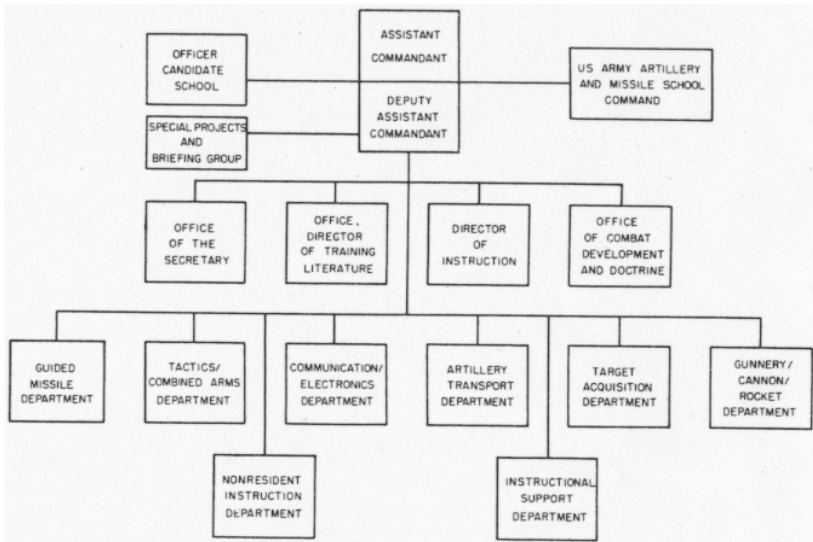

Figure 32. The reorganization of the Artillery and Missile School.

This reorganization was the result of a long and deliberate study that was pointed toward a plan of organization that would create a clearer line of control and coordination between the School's agencies and departments to keep themselves current on the development of the various guided missile and rocket systems in all areas of interest.

The Department of Training Literature and Nonresident Instruction (TL&NRI) was dissolved. A former division of TL&NRI was redesignated the Office, Director of Training Literature. The remaining divisions were formed into two new departments—the Instructional Support Department and the Nonresident Instruction Department.

The old Department of Materiel now is the Guided Missile Department and the well-known Department of Gunnery is now known as the Gunnery/Cannon/Rocket Department. As the new departments' names indicate, each has sole responsibility for either all of the guided missile systems or all of the rocket and cannon weapons systems.

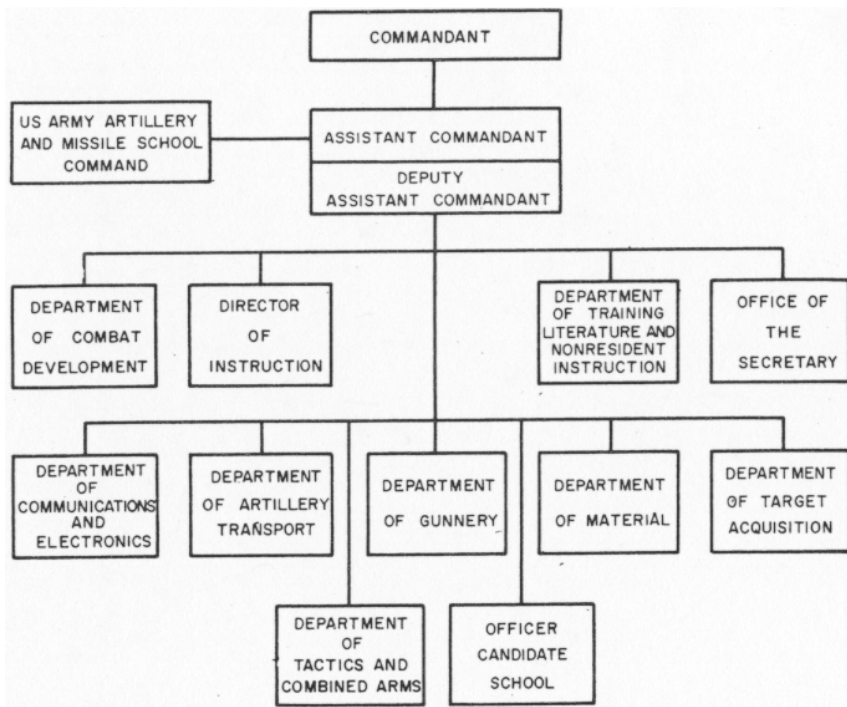

Figure 33. The Artillery and Missile School before its reorganization.

A new group, the Special Projects and Briefing Group, was created and will be under the direct supervision of the Deputy Assistant Commandant.

UNDER REVISION—THE ARMY SCHOOL CATALOG

Department of the Army Pamphlet 20-21, *The Army School Catalog*, is presently under revision to incorporate accumulated changes. It is contemplated that the revised edition will be published early in 1961. Specific information on starting dates and duration of courses can be obtained from the USCONARC course schedule.

RESIDENT COURSE DURATION CHANGES

Changes in the duration of four resident courses (ARTILLERY TRENDS, July 1960) taught at the US Army Artillery and Missile School were recently announced. These are:

The FA Radar Officer Course (FAROC) (6-A-0140) has been extended from 7 weeks to 7 weeks and 2 days.

The Corporal Fire Control System Maintenance Course (CFCSMC) (6-N-1186/215.1) has been extended from 19 weeks and 2 days to 21 weeks and 3 days.

The Corporal Electronic Materiel Maintenance Course (CEMMC) (6-N-1192A/214.1) has been extended *from* 23 weeks *to* 29 weeks.

The Redstone Electronic Materiel Maintenance Course (REMMC) (6-N-218.1) has been extended *from* 20 weeks *to* 20 weeks and 2 days.

RESULTS OF ARTILLERY INSTRUCTORS CONFERENCE

Seventy-five Army and Marine officers attended the Artillery Instructors Conference held at the US Army Artillery and Missile School, Fort Sill, Oklahoma, from 22-26 August 1960. The majority of the conferees were artillery instructors from other service schools and colleges. Other representatives were from research and development agencies concerned with artillery equipment and materiel; the Artillery and Missile School, and Fort Sill troop units.

The purpose of the conference was to insure the standardization of artillery doctrine taught in the service schools and colleges. Artillery and Missile School presentations brought the conferees up to date on current doctrine in primary areas of interest to the field artilleryman; gave them a look at future trends in materiel, equipment, organization, tactics and techniques of field artillery; and acquainted them with the School's position concerning field artillery for the field army of 1965-1970.

From the viewpoint of the Artillery and Missile School, the conference was very successful. Material was provided to assist the artillery instructors at their respective schools; also, the School gained a better insight into their individual and collective problems.

A final report of the Artillery Instructors Conference will be distributed to the participants and other interested agencies in December 1960.

A REDSTONE MILESTONE

The US Army's highly reliable Redstone rocket engine has passed another milestone in its brief but colorful career. The delivery of the last of the liquid propellant rockets to the Army by the manufacturer marked the end of eight years of production which started early in 1952. During that period the Redstone has chalked up a record of accomplishments and reliability that is unique in the field of missiles, rockets, and space exploration. Of 61 attempted firings, 59 have been successful. A Redstone boosted the Army's Explorer I, America's first space satellite, into orbit. Subsequently, it boosted two of the next three successful US satellite launchings.

Although production has ended, the operational life of the Redstone is far from finished. United States Army Redstone units will continue to stand guard in Europe until eventually replaced by the newer solid propellant Pershing missile units.

A Redstone is scheduled to boost the capsule in which the first US Astronaut will be transported out of the earth's atmosphere into space. The 78,000-pound thrust Redstone engine was the predecessor to the H1 engine, which, in a cluster of eight units will provide the first stage lift for the 1.5-million-pound thrust Saturn space vehicle.

'GIMRADA' FORMED

Artillery surveyors and topographic engineers work closely in the field army to accomplish the expeditious extension of survey control. Equipment used by all military surveyors has been introduced through the efforts of the US Army Engineer Research and Development Laboratories (ERDL) at Fort Belvoir, Virginia.

As of 1 August 1960, the topographic engineering activities of ERDL were combined with the Army Map Service research and development activities within the field of geodesy, intelligence, and mapping. The merger is known as the US Army Engineer Geodesy, Intelligence and Mapping Research and Development Agency (GIMRADA) with offices at Fort Belvoir.

HANDBOOK FOR BATTERY EXECUTIVE NOW AVAILABLE

The Fourth Edition of *Notes for the Battery Executive*, published by the US Army Artillery and Missile School, is for sale at the School Book Store. The Booklet costs 35c.

NEW TECHNICAL MANUAL FOR M125 CARGO TRUCK

A new Technical Manual (TM), TM 9-2320-206-12 dated 4 February 1960, covers the 10-ton M125 cargo truck with the single and dual winch, and the M123 truck tractor. The new TM supersedes the TM 9-8002 (1 November 1955) and Section I of ORD 7 SNL G792 (31 January 1958).

The February 1960 issue of ARTILLERY TRENDS included an article *New Equipment Technical Publications System* which explained the numerical sequence of the numbering system.

PERSHING SYSTEM TESTED

The Army recently fired its Pershing ballistic missile successfully from the system's integrated transporter-erector-launcher mounted on a tracked vehicle (ARTILLERY TRENDS, May 1960). The entire Pershing system is transported on XM474 vehicles, which will give the weapon a true battlefield mobility.

As of 30 June 1960, the two-stage missile had been fired successfully five times. This was the first time that a new research and development missile achieved five successes on its first five flights. Moreover, the missile was programed through a mid-air zig-zag to test its structure and control systems under the severe stress imposed by changes in direction.

The Army Ballistics Missile Agency, an element of the Army Ordnance Missile Command, is developing the solid-fuel Pershing as a replacement for the liquid-fueled Redstone which is already in the hands of troops.

GRUMMAN MOHAWK MODELS TESTED

Five models of the Grumman Mohawk, the US Army's first medium weight observation aircraft (all weather), began official trial flights the past summer. The five models are being put through their paces to test the basic airplane and its all-weather photography and radar equipment.

The Mohawk is designed to "live in the field" with tactical troops, takeoff from small unprepared fields, and provide all-weather tactical observation for field forces.

TOPOGRAPHIC COMPANY TO AID ARTILLERY

A new table of organization for the Engineer Topographic Company (Corps) recently developed by the Army Engineer School has been approved for field tests. This company is to support artillery and missile units.

The strength of the company is increased to provide four survey parties. The control, rapid development, and resupply of the survey parties is facilitated by an aviation section of three helicopters. A multiplex section and a topographic mapping set have been added for the extension of ground control by photogrammetric methods and to increase map revision ability.

NEW HELICOPTER PLANNED

The US Army has invited aircraft manufacturers to compete in the design of a new lightweight helicopter to replace the L-19 observation plane, and the H-13 Sioux and H-23 Raven helicopters (ARTILLERY TRENDS, July 1960).

The testing of at least two designs will be conducted in 1963. These tests will provide the basis for selection of a final design to be produced and procured, probably in 1964 or 1965. Characteristics of the proposed helicopter include a turbine engine, a cruising speed of approximately 126 miles per hour, a capability to operate for three hours without landing, and a payload of 400 pounds in addition to the pilot.

MISSILE RESPONSIBILITIES REALIGNED

The Army Ballistic Missile Agency (ABMA), a subordinate agency of the Army Ordnance Missile Command, has taken over from the Army Rocket and Guided Missile Agency (ARGMA) all research, development, and industrial relations in connection with Honest John, Little John, Corporal, Sergeant, the light antitank weapon (LAW), and Missile A and B weapons systems and the necessary personnel.

The ABMA will continue to be in charge of the Redstone, Jupiter, and Pershing missile programs, which gives it all the Army missiles with fixed trajectories. The ARGMA retains the missiles that can be redirected in flight, which includes the Lacrosse and Shillelagh, and all surface-to-air missiles—Hawk, Mauler, Nike Zeus, Nike Hercules, Nike Ajax, and Redeye.

ANTIRADIATION PILL IS EXPECTED

Additional details recently made available disclose that research now being conducted by Army scientists to counter the harmful effects of exposure to radioactivity is expected to produce a usable antiradiation pill within the next two years. The pill is expected to protect an individual from the immediate effects of radiation as well as long-term genetic damage. It may have certain undesirable side effects, such as nausea and vomiting, but these would not impair its effectiveness.

STATUS OF TRAINING LITERATURE

1. The following training literature is under preparation or revision by the US Army Artillery and Missile School:

A. FIELD MANUALS (FM):

- 6-15 Artillery Meteorology
- 6-16 Tables for Artillery Meteorology
- 6-20 FA Tactics and Techniques
- 6-44A FA Missile, Lacrosse
- 6-45A FA Missile Battalion, Lacrosse, Gunnery
- 6-81 155-mm Howitzer, M1, Towed
- 6-120 FA Target Acquisition Battalion and Batteries
- 6-200 Artillery Survey
- 6-() Radar Set, AN/MPQ-4
- 6-() US Army Missile Command
- 6-() FA Missile Battalion (Battery), Little John Rocket
- 6-() The FA Rocket, Little John, w/Launcher XM34
- 21-13 The Soldiers Guide

B. TECHNICAL MANUALS (TM):

- 6-() Logarithmic and Mathematical Tables

C. ARMY TRAINING PROGRAMS (ATP):

- 6-302 FA Rocket Units (Honest John, Little John)
- 6-575 FA Target Acquisition Battalion
- 6-630 FA Missile Group, Redstone

2. Training literature submitted to USCONARC:

- FM 6-90 8-inch Howitzer, M2, Towed
- TM 6-300 Army Ephemeris for 1961
- ATP () Training Program for non-unit obligors
- ATT 6-10 Change 1, FA Missile Battalion, Corporal

3. Training literature at the Government Printing Office:

- FM 6-35 FA Missile, Redstone
- FM 6-35A FA Missile, Redstone Firing Procedures
- FM 6-40 FA Cannon Gunnery
- FM 6-44 FA Missile, Lacrosse
- FM 6-75 105-mm Howitzer, M2 Series, Towed
- ATT 6-630 FA Missile Group, Redstone

4. Training literature recently printed:

- FM 6-25 FA Missile Group, Redstone (U)
- FM 6-45 FA Missile Battalion, Lacrosse (U)(C)
- FM 6-58 The FA Rocket, Honest John, w/Launcher XM33
- FM 6-59 FA Rocket, Honest John w/Launcher M386
- FM 6-140 The FA Battery
- ATP 145-1-6 Program of Instruction for FA Reserve Officer Training Corps
- ATT 6-11 Change 1, FA Missile Battalions and Batteries, 762-mm
- ATT 6-135 FA Rocket/Howitzer Battalion, (Infantry Division)
- ATT 6-137 FA Howitzer Battery, 8-inch, Infantry Division

ATT 6-585 FA Missile Battalion, Lacrosse

5. Artillery training films currently under production and scheduled for release during calendar year 1960:

Counter mortar Radar AN/MPQ-4A (25 minutes)

6. Artillery training films currently under production and scheduled for release during calendar year 1961:

Lacrosse Battalion Guidance Section

Part I. Duties in prepare for action and march order (25 minutes)

Lacrosse Battalion Assembly Section—Crew duties in prepare for action, checkout and assembly, and march order (25 minutes)

7. Artillery training films production completed and scheduled for release in calendar year 1960:

Extension of Direction for Artillery by Simultaneous Observation (25 minutes)

Artillery Battalion Survey

Part II. Planning and Execution (25 minutes)

8. Artillery training films scheduled for production and release during calendar year 1961:

Field Artillery Sound Ranging

Field Artillery Target Acquisition Battalion

Introduction to Flash Ranging

Lacrosse Battalion—RSOP

Lacrosse Battalion—Guidance Section

Part II. Duties in firing Lacrosse

Lacrosse Battalion—Firing Section—Crew duties in prepare for action, firing, and march order.

9. Artillery training films recently released:

Weapons of the Field Artillery (TF 6-2804)

10. Army Subject Schedules (MOS) under preparation by the US Army Artillery and Missile School:

ASubjScd 6-103 MOS Technical Training of the Ballistic Meteorology Crewman

ASubjScd 6-104 MOS Technical Training of the Field Illumination Crewman

ASubjScd 6-141 MOS Technical Training of the Light and Medium FA Crewman

ASubjScd 6-142 MOS Technical Training of the Heavy and Very Heavy FA Crewman

ASubjScd 6-147 MOS Technical Training of the FA Rocket Crewman

ASubjScd 6-152 MOS Technical Training of the FA Operations and Intelligence Assistant

ASubjScd 6-153 MOS Technical Training of the Artillery Surveyor

ASubjScd 6-154 MOS Technical Training of the FA Flash Ranging Crewman

- ASubjScd 6-155 MOS Technical Training of the Sound Ranging Crewman
- ASubjScd 6-156 MOS Technical Training of the Radar Crewman
- ASubjScd 6-166 MOS Technical Training of the FA Missile Crewman (Lacrosse)
- ASubjScd 6-168 MOS Technical Training of the FA Missile Crewman (Redstone)

11. Army Subject Schedules (Non-MOS):

A. UNDER PREPARATION OR REVISION:

- ASubjScd 6-2 FA Air Observer Training
- ASubjScd 6-3 Cannoneer and Rocketeer Instruction
- ASubjScd 6-4 Combat Intelligence
- ASubjScd 6-6 Communication Exercise for Artillery Units
- ASubjScd 6-12 Field Exercises
- ASubjScd 6-16 FA Instruction and Duties of Instrument Operator
- ASubjScd 6-29 Artillery Survey
- ASubjScd 6-41 Organization, Mission and Employment of Armor, Infantry and Airborne units.

B. SUBMITTED TO USCONARC:

- ASubjScd 6-10 Countermortar and counterbattery radar
- ASubjScd 6-24 Organization and duties of Operations section, Field Artillery Observation Battalion

C. RECENTLY PUBLISHED:

- ASubjScd 6-1 Care and Handling of ammunition
- ASubjScd 6-5 Communications training for sections and platoons
- ASubjScd 6-13 Operation of the Fire Direction Center
- ASubjScd 6-18 Mobility Training
- ASubjScd 6-23 Operation, Adjustments, and Maintenance of Sound Ranging Set GR-8
- ASubjScd 6-25 Construction of Sound Ranging plotting chart
- ASubjScd 6-32 Command Post Exercises
- ASubjScd 6-50 Air movement

NEW POLICY IN PUBLICATIONS PROCESSING

A recent USCONARC publication announced a policy change in the processing of certain official branch training literature. A step to reduce processing time of selected publications was taken to eliminate Hq USCONARC staff review time in the sequence of events.

The affected publications so far that are the responsibility of the US Army Artillery and Missile School include:

- FM 6-16 Tables for Artillery Meteorology
- FM 6-59 The FA Rocket HONEST JOHN w/Launcher M386
- FM 6-60 The FA Rocket HONEST JOHN w/Launcher M289
- FM 6-61 FA Missile Battalion, HONEST JOHN Rocket
- FM 6-81 155-mm Howitzer, M1, Towed

FM 6-90 8-inch Howitzer, M2, Towed
FM-6() Artillery Survey
TM 6-230 Logarithmic and Mathematical Tables
TM 6-240 Rule, Slide, Military, Field Artillery

ARTILLERY INFORMATION LETTERS

The following artillery information letters containing items of technical nature have been published by the US Army Artillery and Missile School since the JULY 1960 issue of ARTILLERY TRENDS. Distribution is made *only* to the units and their controlling headquarters which are authorized the equipment discussed in these letters:

HONEST JOHN INFORMATION LETTER NUMBER 22 dated 22 August 1960 (SRD)
HONEST JOHN INFORMATION LETTER NUMBER 23 dated 22 September 1960
CORPORAL INFORMATION LETTER NUMBER 17 dated 6 May 1960 (C)
CORPORAL INFORMATION LETTER NUMBER 18 dated 20 July 1960
CORPORAL INFORMATION LETTER NUMBER 19 dated 11 August 1960
CORPORAL INFORMATION LETTER NUMBER 20 dated 4 October 1960
LACROSSE INFORMATION LETTER NUMBER 1 dated 30 June 1960
LACROSSE INFORMATION LETTER NUMBER 2 dated 11 July 1960 (C)
LACROSSE INFORMATION LETTER NUMBER 3 dated 11 August 1960
LACROSSE INFORMATION LETTER NUMBER 4 dated 16 August 1960
LACROSSE INFORMATION LETTER NUMBER 5 dated 18 August 1960
LACROSSE INFORMATION LETTER NUMBER 6 dated 25 August 1960 (S)
METRO INFORMATION LETTER NUMBER 6 dated 3 October 1960

CORRECTION

An error appeared on page 73 of ARTILLERY TRENDS, July 1960. Under paragraph 2 of Status of Training Literature, ATT 6-10, Change 1, FA Missile Group, Redstone, should read, ATT 6-10, Change 1, *FA Missile Battalion, Corporal*.

"No army is efficient unless its field artillery is efficient."
Major General William J. Snow

The *Catalog of Instructional Material* is published as a service to you. It contains material applicable to staff training, unit training, and section training. Based on the material taught in resident courses, the Catalog is revised every year. To insure the use of the most recent instructional material, all classes should be reordered annually from the current Catalog (FY 1962). Address your requests for Catalogs and material to: Commandant, US Army Artillery and Missile School, Fort Sill, Oklahoma, ATTN: AKPSINI/RC.

"The life of the American soldier is too precious to be measured in money. The life of our country is too precious to be measured in men. Continuous combat readiness is the only measure that can safeguard both."

General Bruce C. Clarke
Commanding General, USCONARC

ARTILLERY TRENDS SUBSCRIPTION ORDER

TO: **Book Department, USAAMS**
Fort Sill, Oklahoma

Please enter my subscription for () copy/copies of each issue of ARTILLERY TRENDS for issues. Start subscription with:

Current Issue () one

Next Issue ()

I enclose payment of \$

Mail to:

Name

(please print)

Rank and Service Number

Address

This material will not be resold or otherwise released to individuals not assigned to the military establishment nor to agencies not connected with the military establishment.

(Rate: .25c a copy; minimum order: 4 issues.
Payable to USAAMS Book Department by
check, postal or money order).

L 1136 ARMY-FT. SILL, OKLA.