

ARTILLERY TRENDS



U S Army Artillery and Missile School



May 1960

ARTILLERY TRENDS

May 1960

Instructional Aid Number 13

In This Issue

● ARTICLES

Weapons of The Artillery—9	2
The Modern "Minuteman"—A New Fire Direction Center Computer	3
The Army's Forward Look—"The Flying Artillery"	12
A Darned Site Better	29
The Pershing Missile—The Army's "Blackjack"	30
The T7 Field Artillery Chronograph	35
Air Defense Artillery in The Field Army	39
Radio Relay Equipment for Artillery Units	47
The Armored Division—Its Employment and Future	49
Simplified Site	60
Don't Get Caught Short With The AN/GSA-7	64
The First Field Artillery Missile Brigade	66
Battery Executive Officer Now Controls Fire Direction	70

● NEWSNOTES

Newsnotes for Artillerymen	72
--------------------------------------	----

● TRAINING LITERATURE

Status of Training Literature	77
---	----

● COVER

The H37 helicopter brings in a 105-mm howitzer as part of a helicopter RSOP. This modern method of delivery of artillery for timely artillery fire is covered in the "Flying Artillery" starting on page 12.

WEAPONS of the ARTILLERY - - - 9

Lacrosse Missile

MISSILE CHARACTERISTICS

Length—19' 2"
Diameter—20"
Weight—2,360 lbs.
Guidance—Command
Warhead—Shaped Charge
Mobility—100 percent, and
air transportable
Time required to emplace
weapon and
fire—approximately 5
minutes
Fire control
equipment—Aiming
Circle M2, Panoramic
Telescope M12A7

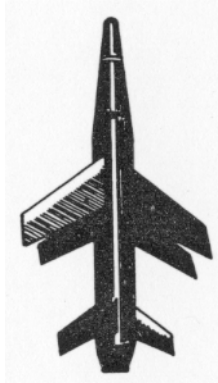

LAUNCHER CHARACTERISTICS

Height—10'
Width—8'
Length—22'
Weight—16,000 lbs.
Elevation limits—5° to 70°
or 88 mils to 1244 mils
Traversing limits—15°
right/left or 266 mils
right/left

TRAINING REFERENCES

FM 6-44, Field Artillery Missile, Lacrosse
FM 6-45, Field Artillery Missile Battalion, Lacrosse
FM 6-(), Warhead Section, XM13, XM16, and XM55, Lacrosse

TABLES OF ORGANIZATION

6-585 Field Artillery Missile Battalion, Lacrosse, self-propelled

ARMY TRAINING TEST

ATT 6-585 Field Artillery Missile Battalion, Lacrosse

THE MODERN "MINUTEMAN" - -



A New Fire Direction Center Computer

"The Redcoats are coming . . . the Redcoats are coming." These words bring back all the excitement and exuberance of a fledgling nation about to embark on her quest for independence. Think back . . . it's a pleasant night . . . dark . . . late . . . but quiet . . . then . . . "The Redcoats are coming . . . the Redcoats are coming." These words hang heavy in the air. The hoofbeats of a sweaty, straining horse thunder in your ears, and disappear as quickly as they came. But the phrase lingers . . . "The Redcoats are coming." All the young men in earshot of this swift horseman are now out of bed . . . scurrying into their clothes . . . their hearts beating wildly . . . the blood pounds heavily in their heads . . . their entire beings flushed with the feeling of liberty. Now the young Americans, muskets in hand, are in the street . . . running to the Village Green . . . Who are they? THE MINUTEMEN.

Romantic . . . perhaps. But who will deny the effectiveness of the Minuteman some 190 years ago. The modern "Minuteman" is not a man at all, but a fire direction device which has been demonstrated to the US Army Artillery Board at Fort Sill.

Coincidentally as the original "Minuteman," today's version comes from the ranks of the citizen soldier and was born in the same locale as the historic patriots. Second Lieutenant David Webster of Bravo Battery of the 2d Howitzer Battalion, 101st Artillery, Massachusetts National Guard, is the developer of this unusual and provocative fire direction device. In the following paragraphs Lieutenant Webster tells the story of his "Minuteman."

The device is designed to determine firing data in an emergency situation when the normal fire direction procedures cannot be used. It can be operated by one man who can determine initial and subsequent firing data in a matter of seconds. The "Minuteman" device also can be converted to an observed or surveyed firing chart by the addition of a section of a grid sheet or map.

OTHER EMERGENCY PROCEDURES

There are various other emergency fire direction procedures presently being used. ARTILLERY TRENDS has presented three different emergency techniques—in October 1957, June 1958, and June 1959. The latter article discussed the M10 plotting board method which is taught by the US Army Artillery and Missile School. A comparison of the M10 plotting board and "Minuteman" techniques is presented later in this article.

As an introduction to the "Minuteman," consider first the characteristics. The "Minuteman"—

- (1) Employs an abbreviated chart system.
- (2) Can be hand carried and will not be in the way at the executive officer's command post (XOCP).
- (3) Requires only one man to operate it efficiently.
- (4) Requires no computation other than normal site calculations.
- (5) Requires no deviation from standard plotting techniques after the initial orientation of the north index.
- (6) Requires less prefire setup time than any present method.
- (7) Can be developed into an observed or a surveyed firing chart.
- (8) Can be used without a map (observer's location does not need to be known).

The device (fig 1) has the following elements:

- (1) Plotting board (A).
- (2) Sliding deflection arc (B).
- (3) Range deflection arm (C).
- (4) Target grid (D).
- (5) Ballistic plate with cursor (graphical firing table (GFT) can be substituted) (E).

The computer is constructed as follows: A 1/4-inch plywood board, 15 inches wide by 26 inches long, is covered with a strip of battleship linoleum (approximately 1/8-inch thick), with the exception of the top of the board which is covered with a strip of plastic 3½ inches long, 15 inches wide, and 1/8-inch thick. A movable arc, approximately 1½ inches wide, is built into the plastic portion of the board. The range deflection

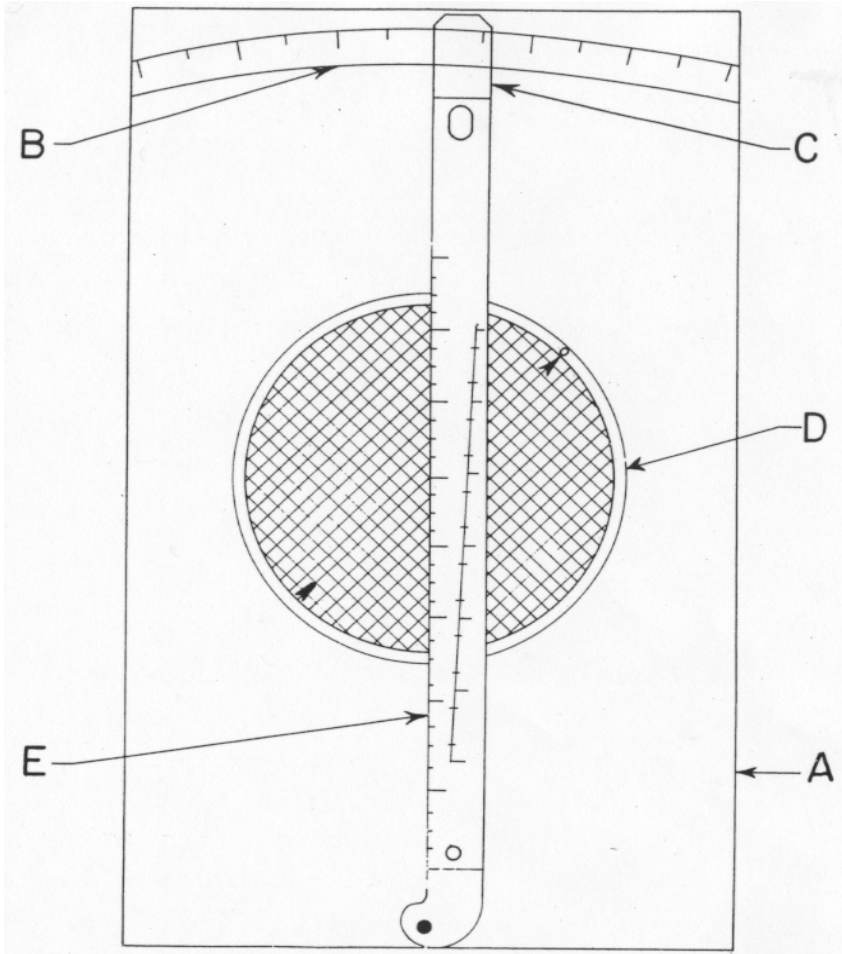

Figure 1. The "Minuteman" fire direction device.

arm is plastic and is mounted at the base of the board on a pivot screw. The range deflection arm is graduated from 0 to 16,400 yards. Two connection points on the arm permit a ballistic scale to be superimposed upon it.

PREFIRE PROCEDURES

The basic prefire procedures (fig 2) in readying the device for a hasty occupation of position are—

(1) Determine the initial azimuth and distance from the battery position to the target from the battlemap, using the following procedures:

(a) Place the protractor over the battery position parallel to a north-south gridline.

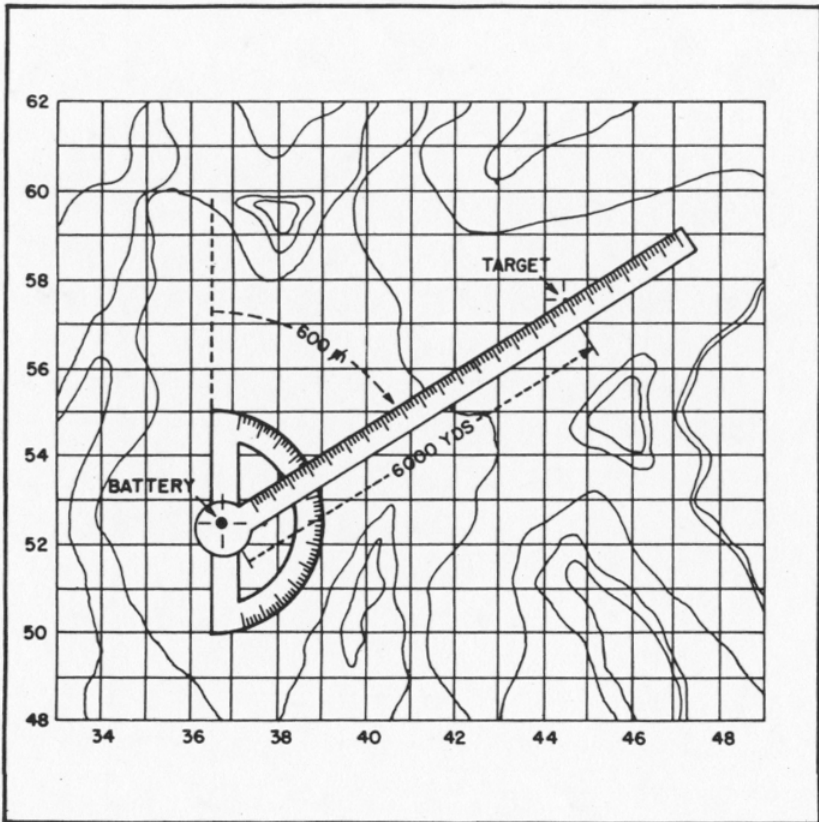

Figure 2. Basic prefire procedures.

(b) Place the battery position end of the range deflection arm on top of the protractor over the battery position and rotate the arm until it contacts the plotted target position.

(c) Read the azimuth to the target on the protractor where the deflection arm intersects the protractor scale. This is the azimuth of fire on which the executive officer will lay the battery.

(d) Read the gun-target (GT) range on the scale etched on the range deflection arm.

(2) Place the range deflection arm on the pivot screw at the base of the board (permanent (plotted) battery position).

(3) Slip the target grid under the range deflection arm and place the center of the target grid at the plotted range of the target.

(4) Place a plotting needle in the center of the target.

(5) Orient the target grid with the arrow parallel to the range deflection arm and pointing to the top of the board.

(6) Draw a north index opposite the proper azimuth graduation on the target grid (azimuth of target from battery position).

(7) Rotate the target grid until the forward observer's azimuth, determined from the observer's fire request, appears under the north index.

Here is a sample problem using the "Minuteman" in a hasty occupation situation. The 105-mm howitzer battery is in march column advancing toward a new firing position. A fire request is received from the forward observer

—CITRINELLA 21,
THIS IS CITRINELLA
31, FIRE MISSION . . .
COORDINATES
4468-5748
AZIMUTH 1400
INFANTRY IN THE
OPEN, FUZE VT,
WILL ADJUST.

Upon acknowledging and receipting for this fire request, the battery executive officer selects a position and the battery executes a hasty occupation. The executive plots his battery position and the coordinates of the target on his battlemap.

Following the steps outlined in the basic prefire procedures, he prepares the "Minuteman" for operation. After measuring the azimuth to the target the executive instructs the chief of firing battery to lay the

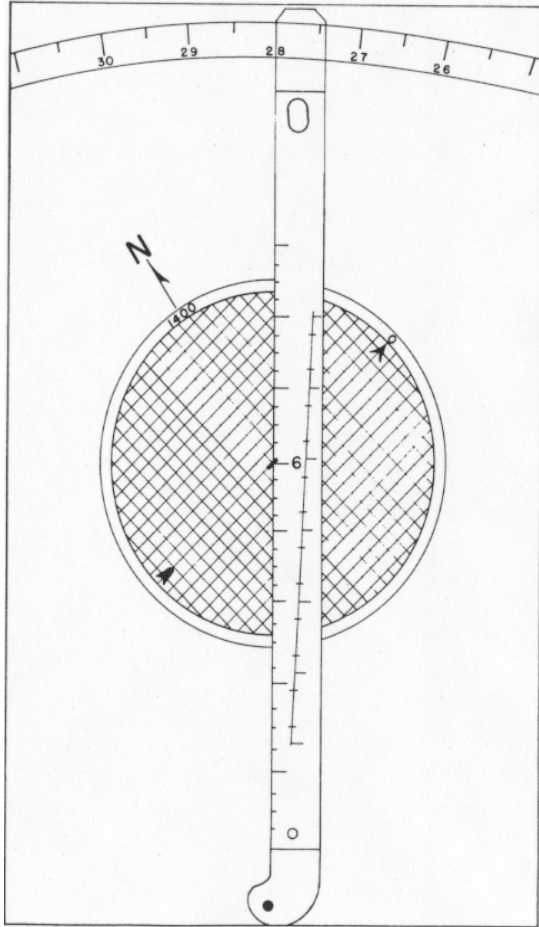

Figure 3. The "Minuteman" is ready to give initial firing data.

battery on azimuth 600 mils. This is the angle read on the protractor where the deflection arm intersects the protractor scale. Opposite 600 mils on the target grid, a north index is drawn. The target grid then is rotated to place the observer's announced azimuth (1400 mils) under the north index (fig 3).

Reading the gun-target range from the scale scribed on the range deflection arm at the plotted target location, the executive determines that the range is 6,000 yards. Comparing this range to the ballistic plates, he selects charge 6. Then he places the cursor on the selected ballistic plate with the manufacturer's hairline over the measured range and determines that the elevation is 278. Assuming that site is "0," quadrant elevation would be announced as—QUADRANT 278. Before the initial round is fired, the executive officer moves the sliding deflection arc so that the appropriate deflection (for example 2800 for the towed 105-mm howitzer) is opposite the index (left side) of the range deflection arm. This, then, makes the previously measured azimuth, 600 mils, now read deflection 2800 mils. The executive officer now is ready to conduct the mission. He issues the fire order—BATTERY ADJUST, SHELL HE, CHARGE 6, FUZE QUICK, CENTER ONE ROUND, DEFLECTION 2800, QUADRANT 278. As soon as the center platoon is ready, the first volley is fired.

TARGET GRID METHOD

Using the standard target grid method, the executive officer plots the observer's correction—LEFT 50, ADD 400 (fig 4). After plotting this correction, the executive reads the deflection by placing the left edge of the deflection arm against the plotting needle and announces—DEFLECTION 2762. The deflection on the sliding deflection arc increases from right to left as in the LARS (Left Add, Right Subtract) rule. Reading the range—6,324 yards—to the target (plotting pin), he announces the elevation from the ballistic scale—QUADRANT 299.

Throughout the remainder of the mission, the executive officer continues to use the same procedure for the determination of firing data.

To convert the "Minuteman" to an observed or surveyed firing chart, a grid intersection is polar plotted and oriented on the board with respect to the north index which was drawn during the prefire procedure. This is accomplished by first labeling the gridlines on the chart. A grid intersection with coordinates known to be within range of the battery is selected. With a map, the azimuth and range from the battery to the selected position is determined. From the measured azimuth, the deflection is computed and set off by rotating the range deflection arm along the sliding deflection arc. With the range deflection arm in this position, the selected grid intersection is moved along the arm until it coincides with the range of the grid intersection from the battery. A plotting needle is placed at the grid intersection in this position. The chart is rotated around the plotting needle until the north-south grid lines on the chart are parallel to the north index on the plotting board.

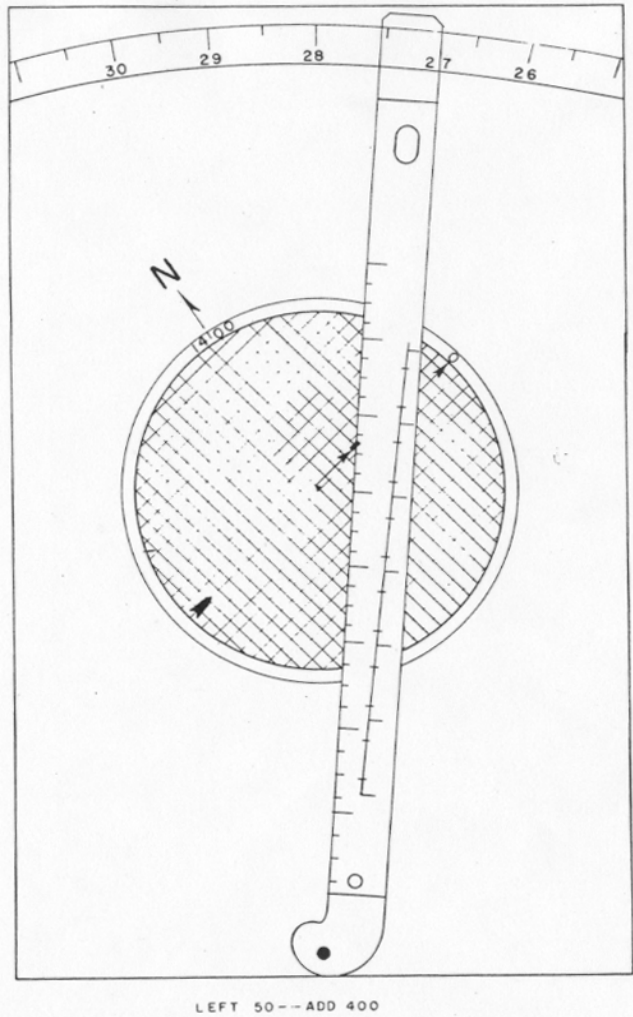

Figure 4. The correction is—LEFT 50, ADD 400.

An example of this procedure (fig 5) uses the grid intersection of 4658. The azimuth and range from the battery to the selected grid intersection is 720 mils and 7,300 yards respectively. With the azimuth of 720 mils, the deflection is computed to be 2680. Therefore, with the range deflection arm positioned over 2680 on the sliding deflection arc, the 4658 grid intersection is placed under the 7,300-yard mark on the range scale of the range deflection arm. The chart is then rotated around this point until the north-south gridlines are parallel to the north index on the plotting board. The board now can be used as an observed firing chart.

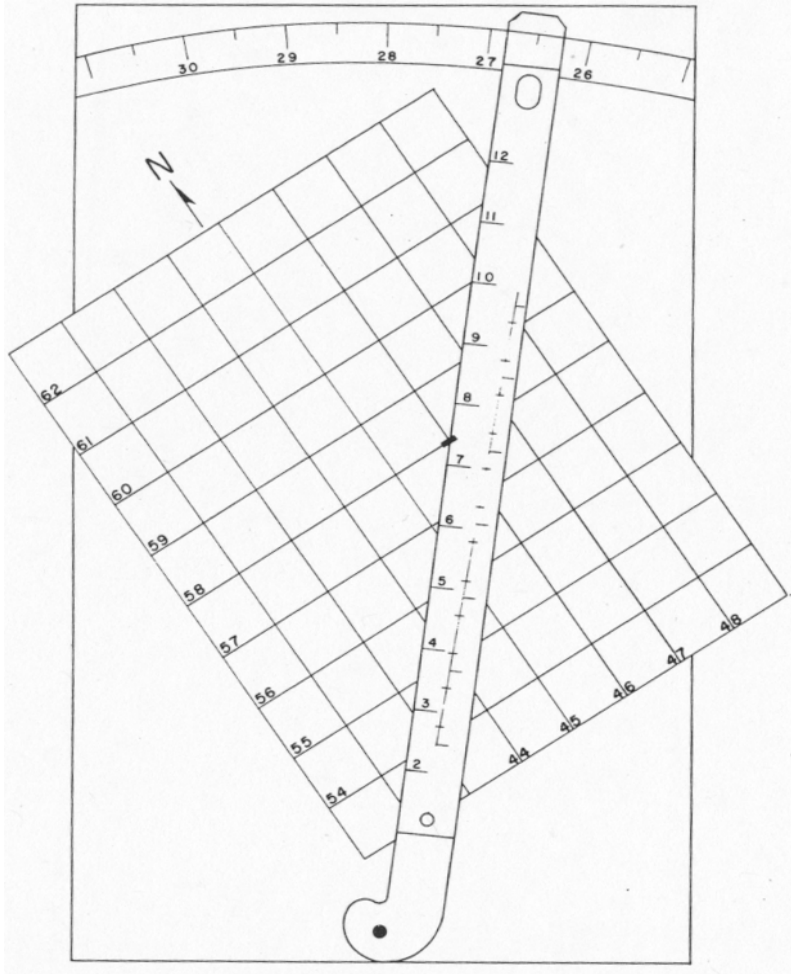

Figure 5. The polar plot method.

Using normal fire direction procedures, the temporary deflection index is erased and the corrected deflection index is drawn in. Using the "Minuteman" the corrected deflection index is constructed by rotating the deflection arc.

THE M10 AND "MINUTEMAN"

Now that the "Minuteman" has been covered, a comparison may be drawn between the M10 plotting board and "Minuteman" techniques. The M10 is smaller, its method is proved and accepted, and can be used successfully in all situations. The "Minuteman" can be used effectively

if the executive desires to have one constructed. The following are the basic steps involved in each method:

M10 method of converting corrections to firing data

Deflection

1. Plot the correction.
2. Rotate the disk to the angle T.
3. Multiply the value of each square by the number of squares from the GT line.
4. Multiply the 100/R factor by the shift in hundreds of yards to get mils.
5. Apply the deflection shift algebraically to the deflection previously fired.

Elevation

1. Multiply the value of each square by the number of squares the plotted point is above or below the horizontal center line.
2. Apply the product to the last range fired.
3. Move the cursor to the new range.
4. Read the elevation under the hairline.

"Minuteman" method of converting corrections to firing data

Deflection

1. Plot the correction.
2. Move the range deflection arm to the correction.
3. Read the deflection on the deflection arc under the manufacturer's hairline on the range deflection arm.

Elevation

1. Read the range on the range deflection arm opposite the plotted correction.
2. Place the cursor of the GFT or ballistic plate at the plotted range.
3. Read the elevation under the hairline.

The artillery continually seeks emergency fire direction techniques that can be used under all conditions with maximum speed and accuracy and a minimum number of trained personnel. Also there should be as little variation from standard procedures as possible. These requirements are met by the "Minuteman."

With the modern "Minuteman" on duty, the artillery moves forward with another fast, simple device that can be used when normal fire direction procedures cannot be employed. Today's rallying phrase for the artillery might well be—"The Redlegs are coming."

A GEM FOR THE COMMUNICATIONS SECTION

During wet weather the MX 155 switching kit seems to give the executive officer trouble by shorting out. One way to overcome this is to use a plastic bag that dry cell batteries are shipped in. First insert all plugs, then slip the bag over the switching kit.

—Submitted by Capt Lenwood A. Smith
Dept of C & E, USAAMS

THE ARMY'S FORWARD LOOK --

"THE FLYING ARTILLERY"

History offers many examples of the effectiveness of surprise and timely combat power applied judiciously and, at times, with reckless gamble. The latest and most prominent classic examples of American military surprise maneuvers were the timely movement of General Patton's Third Army during the Battle of the Bulge and General MacArthur's memorable behind-the-line landing at Inchon.

Long acknowledged as the "Sunday-punch" of the ground-gaining arms, the artillery often has been the deciding factor in influencing the success of an offensive or defensive action.

The Army today has developed the "flying artillery" forward look. The artillery commander at higher headquarters now has the means and power to wield the "big stick" at the enemy in a minimum of time by air-lifting a 6-piece, 105-mm howitzer battery using H37 medium cargo or H34 light helicopters for prime movers.

Among the many things in which the artillery redleg prides himself is speed of action, which is vital for the delivery of timely and accurate firepower. The speed that a helicopter-borne 105-mm howitzer battery can reconnoiter and occupy a position, fire one or more missions, and then evacuate the position is analogous to a bolt of lightning.

Thousands of artillerymen have seen a 105-mm battery demonstrate the techniques and tactics of a helicopter-borne operation at the US Army Artillery and Missile School. To maximize the effect of this operation, whether it be in a peacetime demonstration, a training objective, or actual combat, the artillery unit commander must be well grounded in his knowledge of the helicopter operation. As the halfback on a football team must know the capabilities of the tackle who will block for him, so then must the artillery commander know the capabilities of the agency that will work for him in a helicopter-borne operation—the transportation company (medium helicopter) or transportation company (light helicopter). There are many liaison and administrative details confronting the commander in both the technical and tactical aspects of the planned operation. In the following discussion, primary emphasis is placed on the H37 helicopter. However, a commander might find himself using the less desirable H34; therefore, critical information about this aircraft also is presented.

THE TRANSPORTATION COMPANY

The mission of the transportation company (medium helicopter) is to provide air transport to expedite tactical operations and logistical support within a combat zone.

The medium helicopter transportation company (fig 6) (TOE 55-58T) has a company headquarters, an operations platoon, a service platoon, a communications section, two helicopter platoons, and a field maintenance

detachment that is available to the company for third echelon support. The H37 company has two reconnaissance helicopters and sixteen H37 medium cargo helicopters that furnish the necessary flying support. A typical H37 crew includes a pilot, co-pilot, flight engineer, and crew chief.

TRANSPORTATION MEDIUM HELICOPTER COMPANY

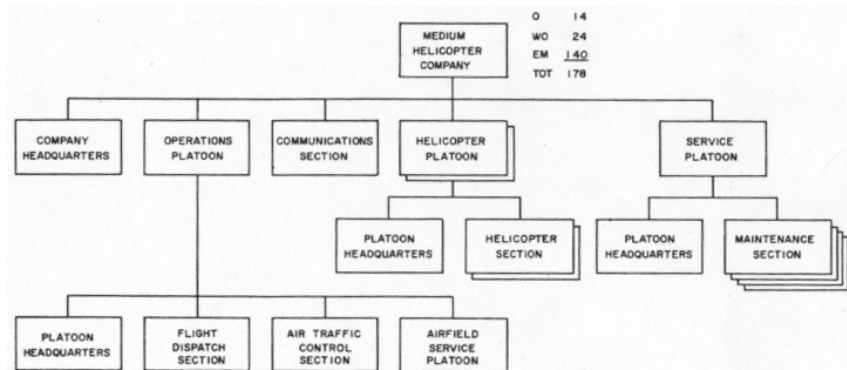

Figure 6. The transportation company (medium helicopter).

The organization and mission of the H34 light helicopter transportation company (TOE 55-57C) is similar to the medium company, except that it has more helicopters. The H34 company has two reconnaissance helicopters, and twenty-one H34 light cargo helicopters. A typical H34 crew includes a pilot, co-pilot, and crew chief.

Under normal conditions, the H37 helicopter can ascend and descend at a relatively steep angle, enabling operation from confined and unimproved areas. While the helicopter is hovering, troops and cargo can be loaded or unloaded. Cargo can be transported as an external load and delivered to areas otherwise inaccessible.

The H37 possesses a speed range of 0 to 120 knots and has a maximum range of 250 nautical miles. It can fly horizontally in any direction—forward, backward, sideways, or obliquely. It can fly safely and efficiently at low altitudes using the terrain and vegetation for cover and concealment.

The H34 is as maneuverable as the H37, although its lift capability is not quite as great. The H37 has two engines and the H34 has only one. The maximum speed of the H34 is over 110 knots, and it has a range of 250 nautical miles.

LIMITATIONS

Knowledge of helicopter limitations is essential to the artillery commander. To accomplish a safe autorotation landing if power fails, the H37 must either have sufficient altitude or sufficient forward speed. An autorotation can be accomplished above 500 feet with a minimum speed or below 300 feet if the forward speed is 60 knots or more. A helicopter unit has a relatively high deadline factor during extended operation because of increased technical maintenance problems. The fuel consumption is high—approximately 200 gallons per hour—limiting range and allowable cargo load. Since weight and balance affect flight control, loads must be distributed properly to keep the center of gravity within allowable limits. Hail, sleet, icing, heavy rains, gusty winds (20-knot gust spread), and winds above 50 knots preclude operation of the H37. The H34 cannot operate if the winds are above 40 knots. Engine and rotor noise compromise secrecy.

Pilot fatigue is a great factor in the operation of the helicopters. The inherent instability of all helicopters gives the pilot no relief.

The maximum lift capability of the H37 helicopter company is 368 fully equipped troops, based on 240 pounds per individual; 50.1 cargo tons; or 384 litter patients. This is assuming that all 16 helicopters are used and the operation is restricted to a 50-mile radius at elevations between sea level and 5,000 feet. The load capability decreases with an increase of elevation and temperature.

The helicopter company commander or his representative establishes liaison with the supported unit. He acts as the technical adviser in matters pertaining to helicopter operations. Upon receipt of the implementing directive, the two commanders make concurrent detailed planning. They consider—

(1) The mission to determine the number of helicopters and special equipment needed.

(2) Communication between the helicopters and the supported unit.

(3) Navigational aids.

(4) Maintenance support (to include additional maintenance personnel and facilities that may be needed at the loading area, refueling point, or landing zone).

(5) Intelligence concerning detailed weather information.

(6) Enemy ground and air capabilities.

(7) Nature of terrain in loading areas.

(8) Flight routes and landing zones.

Refueling facilities normally will be located in the loading area. This permits the helicopter unit to maintain the highest lift capability throughout the operation. Normally, helicopters carry a minimum amount of fuel in addition to a reserve, but they are refueled frequently.

LOADING AND UNLOADING AREAS

The artillery unit commander must know the techniques and tactics in establishing the procedures and requirements for the location of

loading and unloading areas for both the H34 and H37 operations. A possible solution for the H37 operation is presented in figure 7; a solution for the H34 is presented in figure 8.

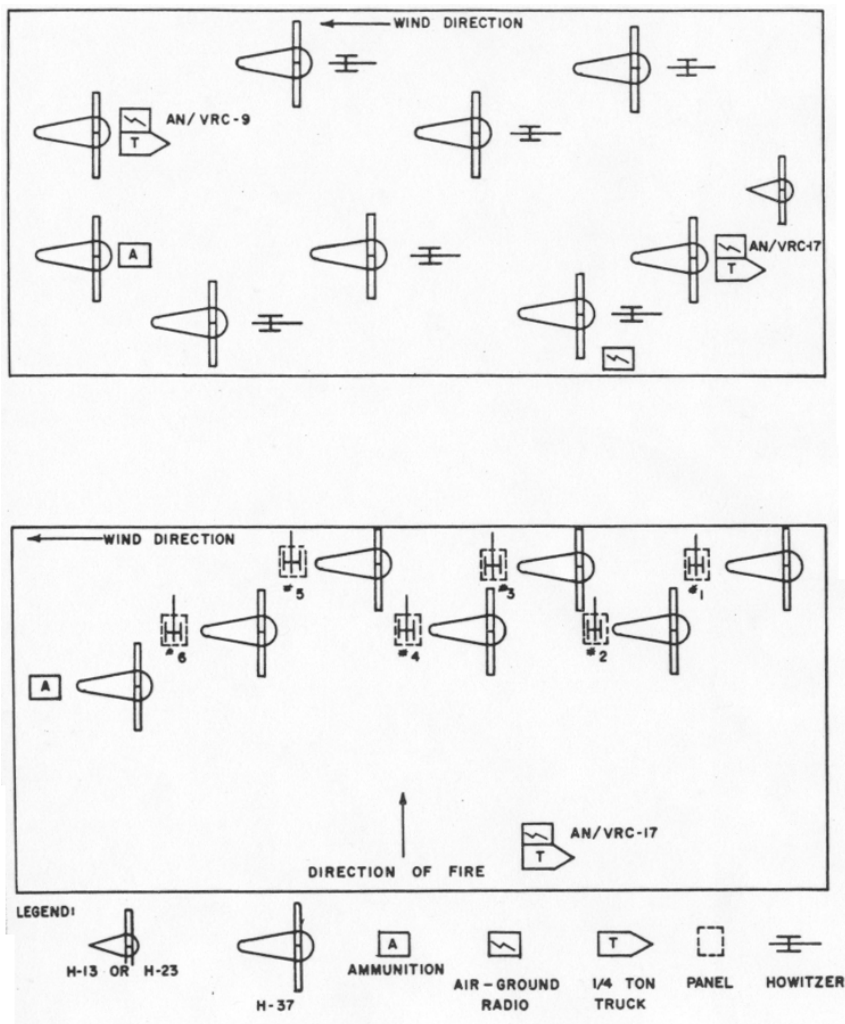

Figure 7. A possible loading (top) and unloading (bottom) area for the H37 operation.

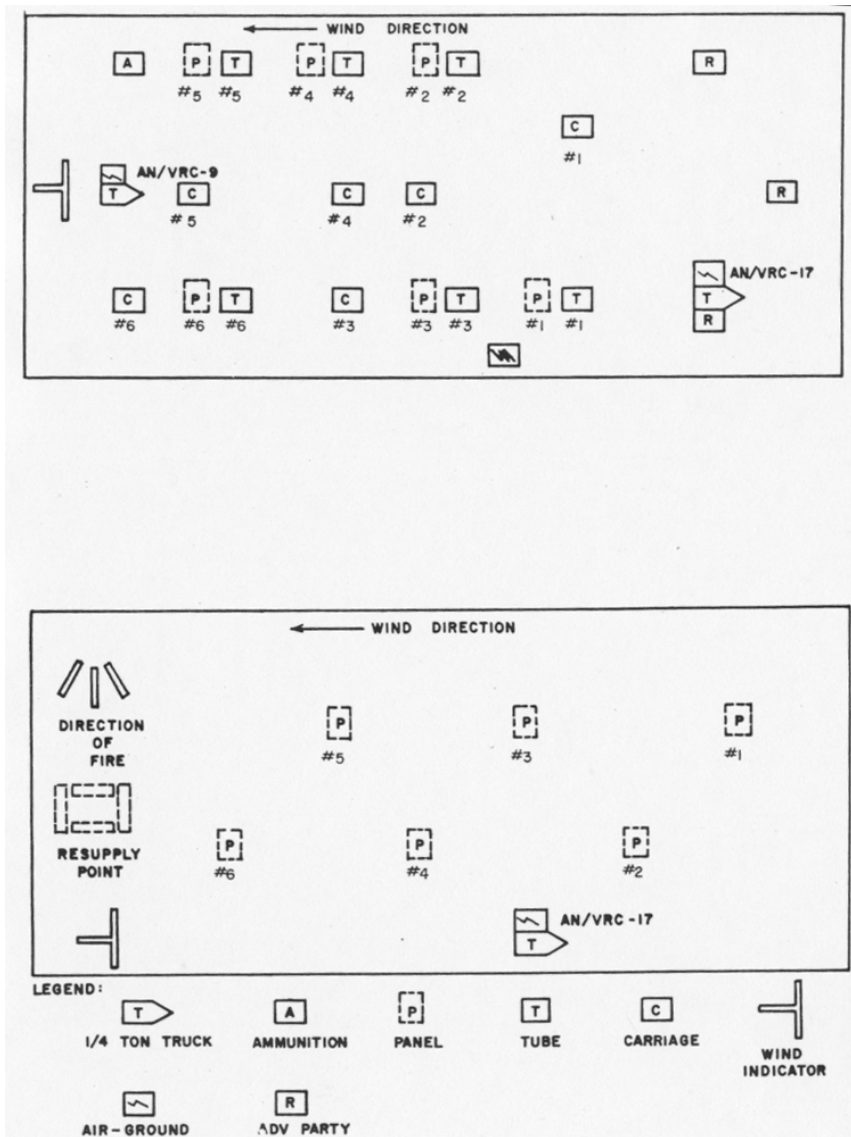

Figure 8. A possible loading (top) and unloading (bottom) area for the H34 operation.

The helicopter unit commander assists in selecting loading sites to insure that they meet the loading requirements. He advises and assists the supported unit in preparing loading plans based on the helicopter lift capability. He insures that the lift capability is not exceeded, and that the loads are properly loaded and lashed so they will not be a hazard during flight. Equipment which cannot be fitted inside the cargo compartment may be transported by an external sling for aerial delivery. The helicopter unit also is responsible for the establishment of air traffic control facilities at the loading area.

An example of an H37 loading plan for a 105-mm howitzer battery which has a direct support mission for a limited period is shown in figures 9, 10, 11, 12, and 13. Loads 3, 4, 5, 6, and 7 are identical except that the fire direction computer, chart operator, and recorder each occupy a space in separate helicopters.

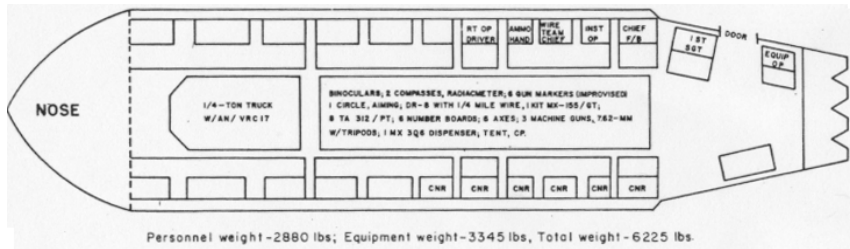

Figure 9. H37 LOAD NUMBER 1 carries the advance party.

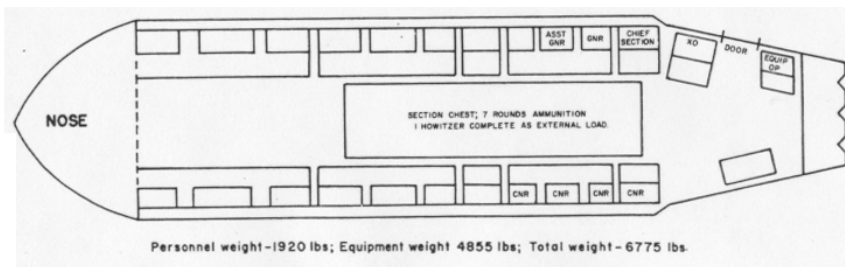

Figure 10. H37 LOAD NUMBER 2 carries the battery executive officer and one howitzer section.

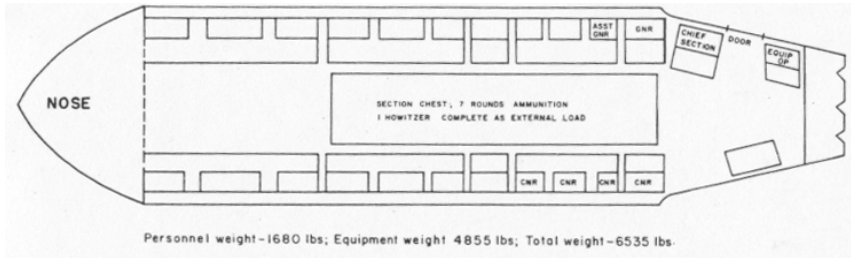

Figure 11. H37 LOADS NUMBER 3, 4, 5, 6, and 7; each carries one howitzer section.

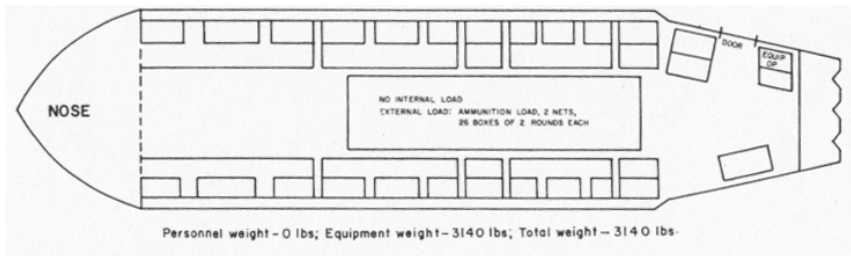

Figure 12. H37 LOAD NUMBER 8 carries an external load of 52 rounds of 105-mm ammunition.

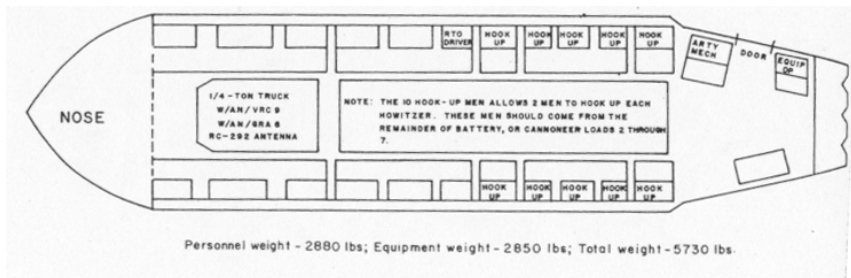

Figure 13. H37 LOAD NUMBER 9 carries the hookup crew.

If the battery is to be air-lifted by H34 helicopters, 16 helicopters are needed compared to 9 H37's. A loading plan that can be used to accomplish the mission with H34's is shown in figure 14. Because seven additional helicopters are needed, there is increased helicopter activity, and there is a need for more air and ground traffic control.

Other problem areas include the additional training required for the battery personnel; increased time required to disassemble the howitzer for pickup and then reassemble it in the forward position area; the time lost because of the split load; and the additional lift equipment needed, such as slings for tubes and lifting bars.

THE HELICOPTER RSOP

The helicopter-borne artillery operation with the H37 or H34 requires split-second timing, close coordination, and extensive training. A well-trained unit can deliver a volume of smashing surprise effective firepower in a matter of minutes. The operation follows the guidelines of a normal hasty reconnaissance, selection, and occupation of position (RSOP).

An important consideration in the selection and occupation of a position is that the reconnaissance be as thorough as time permits. In a helicopter RSOP, this consideration acquires added significance. The battery commander reconnoiters in the reconnaissance H13 (Bell) or H23 (Hiller) helicopter. From the viewpoint of the helicopter pilot, if the area is relatively level and is free from large boulders, trees, large bushes, or tall obstructions—and enemy—the area is satisfactory. The traffic patterns are finalized during this reconnaissance because they may materially affect the battery commander's occupation plan. From the viewpoint of the battery commander, specific requirements must be met. He must—

- (1) Be able to accomplish his mission from the position.
- (2) Seek defilade from ground observation and direct fire.
- (3) Seek natural concealment.

The reconnaissance party, designated as LOAD NUMBER 1 (fig 9) may accompany the battery commander on his reconnaissance, may meet him at a predesignated location, or remain in the assembly position until either called for or brought forward by the battery commander. When the position area has been selected, the H37 carrying the advance party lands, and is assembled and given instructions by the battery commander. They include—

- (1) Direction of fire.
- (2) Location of howitzers.
- (3) Direction from which the helicopters will approach.
- (4) Location of the executive officer's command post (XOCP).
- (5) Location of the aiming circle.
- (6) Positions for local security.

During the reconnaissance phase, the battery commander also alerts and march orders the remainder of the battery, using the radio in the reconnaissance helicopter, the radio on the 1/4-ton truck that came

		PERSONNEL		EQUIPMENT		TOTAL	
		Nr	LBS	EQUIPMENT	WEIGHT	WEIGHT	WEIGHT
Load #1-Advance Party	1st Sgt; Chief, Firing Btry; Instrument Operator; Wire Team Chief; 6 Cannoneers; Ammo Handler.	11	2,640	Binoculars; 2 Compasses, Radiometer; 6 Gun Markers 1 Aiming Circle, DR-8 w/ 2 Mile Wire; 1 MX-155/GT; 1 MX 306 Dispenser; 2 Guns Machine, 7.62-mm w/Tripod; 8 TA 312/PT; 6 Panel Sets, and Axes.	390	3,030	
Load #2-Advance Party	Radio/Telephone Operator-Driver; Wireman.	2	480	1/2-Ton Truck w/AN/VRC-17; Control Group AN/GRA-6; Tent, CP; Gun, Machine, 7.62-mm w/Tripod.	2,955	3,435	
Loads #3, 4, 5, 6, 7 and 8		0	0	Howitzer Carriage w/2 Lifting Bars and Less Tube.	3,500	3,500	
Load #9	Radio/Telephone Operator-Driver; Arty Mechanic.	2	480	1/2-Ton Truck w/AN/VRC-9, Control Group AN/GRA-6; Gun, Machine, 7.62-mm w/Tripod; 3.5 Rocket Launcher; RG-292 Antenna; Mechanic Tool Set.	2,895	3,375	
Load #10	Exec O; Chief Section; Gunner; Ass't Gunner; 4 Cannoneers.	8	1,920	Tube; Section Chest w/Breech Block; 7 Rds Ammunition.	1,395	3,315	
Load #11	Chief Section; Gunner; Ass't Gunner; 4 Cannoneers; FDC Computer.	8	1,920	Tube; Section Chest w/Breech Block; 7 Rds Ammunition, FDC Equipment.	1,435	3,355	
Load #12	Chief Section; Gunner; Ass't Gunner; 4 Cannoneers; Chart Operator.	8	1,920	Tube; Section Chest w/Breech Block; 7 Rds Ammunition.	1,395	3,315	
Load #13	Chief Section; Gunner; Ass't Gunner; 4 Cannoneers; Recorder	8	1,920	Tube; Section Chest w/Breech Block; 7 Rds Ammunition.	1,395	3,315	
Load #14	Chief Section; Gunner, Ass't Gunner; 4 Cannoneers.	7	1,680	Tube; Section Chest w/Breech Block; 7 Rds Ammunition.	1,395	3,075	
Load #15	Chief Section; Gunner, Ass't Gunner; 4 Cannoneers.	7	1,680	Tube; Section Chest w/Breech Block; 7 Rds Ammunition.	1,395	3,075	
Load #16		0	0	26 Boxes of 2 Rds Each-Ammunition	3,140	3,140	
		61	114,640		21,290 LBS	35,930 LBS	

Figure 14. H34 helicopter personnel and equipment loading plan.

with the advance party, or he can relay the message through the H37 which carried the advance party. As soon as possible after briefing his advance party, the battery commander reconnoiters for alternate positions.

PANELS USED

Under the supervision of the chief of firing battery, panels for each howitzer are placed on the ground by the six cannoneers who are part of the advance party. These panels mark the howitzer locations for the helicopter pilots. Guidance is not difficult. The pilots are simply guided over the panel and signaled when to release the load.

The 1/4-ton truck that arrives with the advance party has a radio which makes it possible for the battery to receive fire missions from the ground observer with the supported unit, air observers on surveillance missions; and to maintain communication with higher headquarters as directed.

In preparing the piece for action, each member of the section has specific duties. The entire procedure must be a team effort with no lost motion. Experience has shown that after a helicopter occupation, the pieces are seldom out of boresight by more than five miles. This compares favorably with normal towed or self-propelled operations.

To graphically portray this lightning-like, impressive operation, the story of the helicopter RSOP is told in pictures beginning on page 22.

Because of the nature of this operation, and the demand for speed and accuracy, the well-trained battery using a good flexible standing operating procedure (SOP) has other factors to consider. They include the possibility of laying wire to the supported unit either by backpack or helicopter, the possibility of establishing airborne radio relay stations for communication with the supported unit and higher headquarters, and the formulation and implementation of the defense plan.

A unit conducting this operation is expected to operate and sustain itself at peak efficiency for 72 hours. Emergency rations are carried by the personnel making the initial occupation. If possible, meals will be prepared in the rear area and delivered to the forward area by the most expeditious means available.

If the operation is extended for a longer period, the rear echelon will link up with the main body if the situation permits. If it is not possible to link up, the rear echelon continues to draw supplies normally and has the added responsibility of supporting the forward echelon by airborne resupply.

In this day of space and missile technology, progress is more important to the artillery than ever before. The commander who has the helicopter-borne artillery available for employment has flexibility and an increased capability to move, shoot, and communicate. By striving for perfection, the artillery continues to live up to the motto—"There is nothing the artillery won't or can't do; no place the artillery won't or can't go."

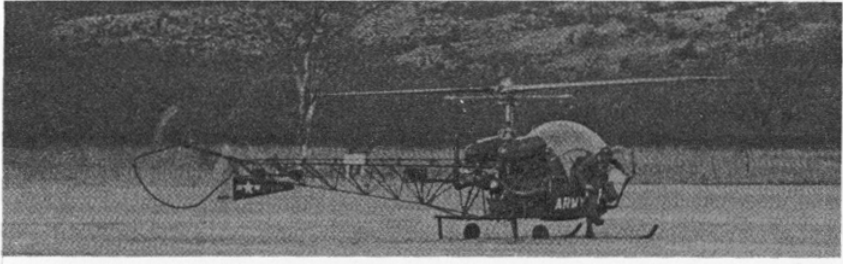

Battery commander, having completed his aerial reconnaissance, dismounts from the H13 reconnaissance helicopter at the position area.



The advance party unloads from LOAD NUMBER 1 ship. Part of the party is setting up the perimeter defense while the 1/4-ton truck is being unloaded. The truck has a radio which gives the battery commander communication with the remainder of the battery.



The advance party is assembled to receive instructions from the battery commander. The helicopter which carried them to the area has departed.



After the chief of firing battery receives his position area instructions, he directs each howitzer guide to stake a panel at the position to guide in the helicopters.

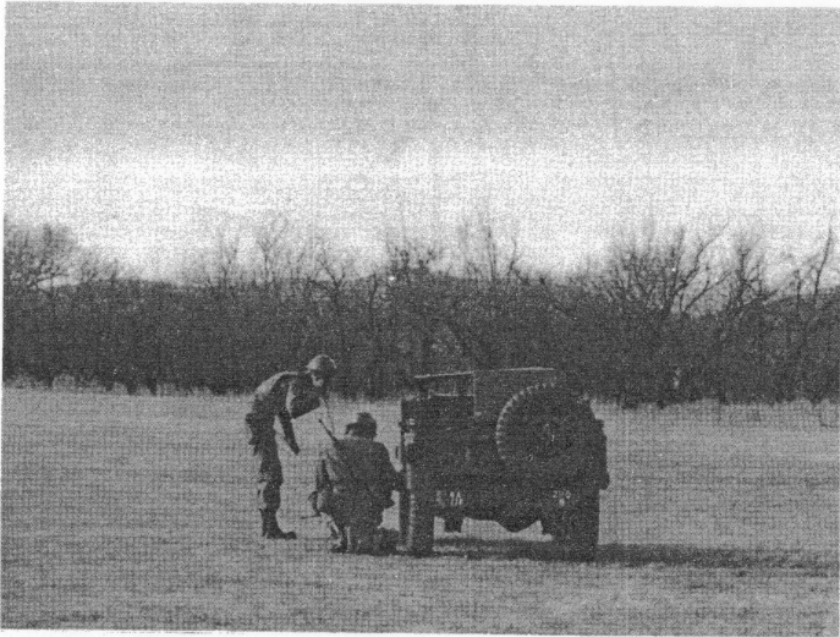

The battery commander uses the radio to tell his airborne battery executive to "bring 'em in."

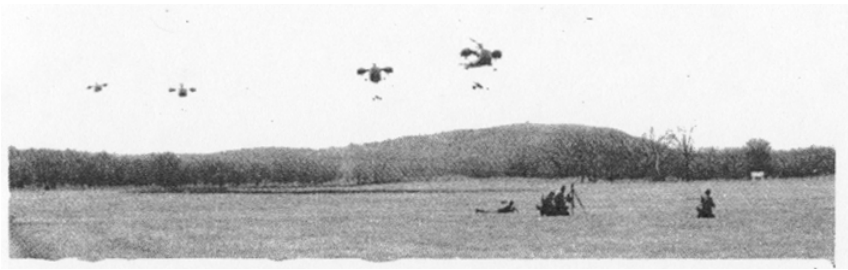

"Prime movers" with the flying artillery making their approach to the position area. Four of the six howitzers are visible. The chief of firing battery is standing by at the aiming circle ready to lay the battery.



The howitzer guide directs the pilot over the position panel. Once the howitzer has been released from its carrying sling, the crew unloads and the helicopter is again airborne. This is accomplished in approximately 30 seconds.

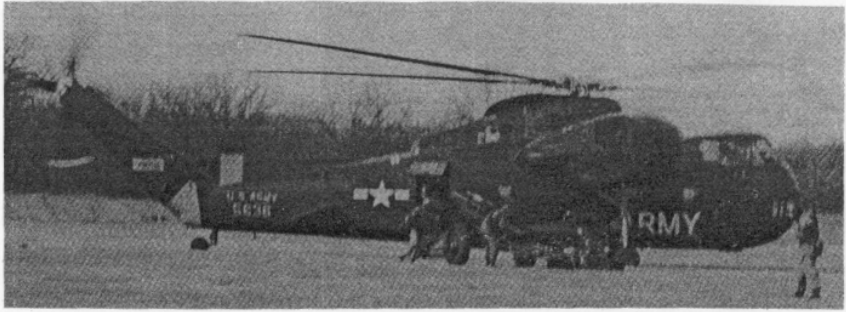

The howitzer crew unloads from the helicopter. The guide stands in view of the pilot ready to give the signal to "move out."



Activity is fast, furious, and efficient. One "prime mover" already is moving out, while another has just received the signal to move out.

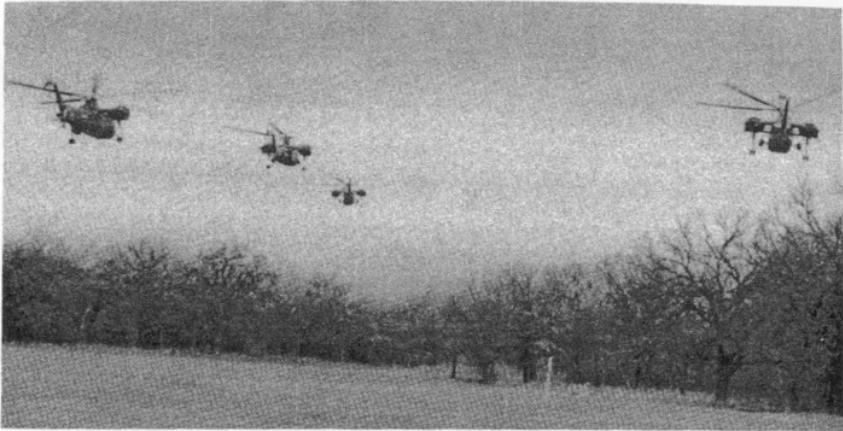

Four of the six prime movers head back to the assembly area.



The fire direction team consisting of the assistant executive officer, chart operator, and radiotelephone operator receives and plots the fire mission.

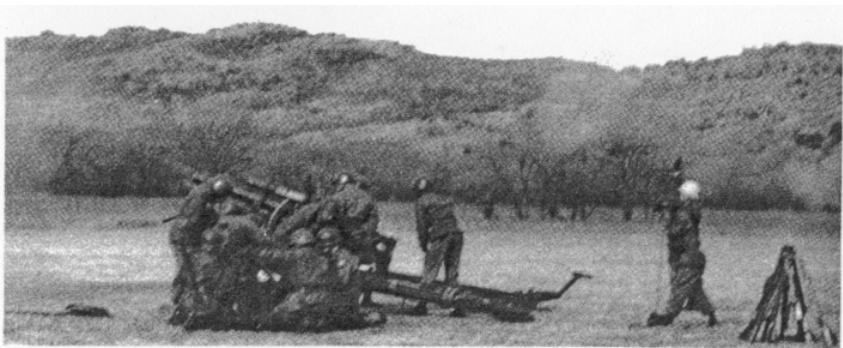

First round on the way! About 2 minutes have elapsed since the howitzer was touched down by the helicopter.



Battery firing for effect . . . 3 minutes have elapsed since "touch down."



Close station—march order. The advance party loads on its helicopter while the howitzer crews prepare the weapons for pickup by the "prime movers."

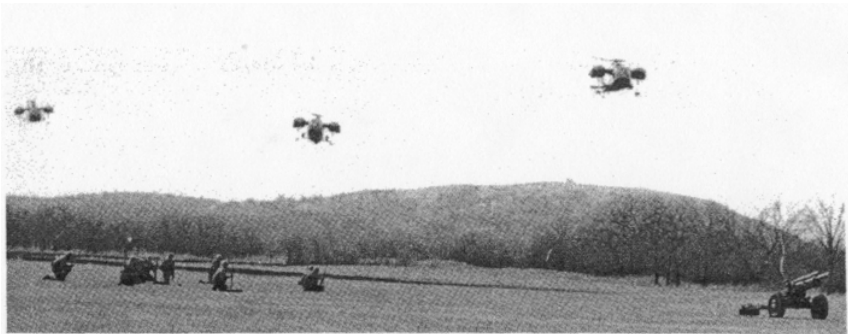

Employing hit and run tactics, the battery has march ordered, prime movers are approaching the position, and the hookup crew (one man from each section) is standing by to hook the howitzer sling to the helicopter. This crew hooks up all howitzers simultaneously, then they load on the last helicopter.



The howitzer crew loads on the "prime mover."



The hookup man signals the pilot that the howitzer is secure in the sling and ready to move out.



The last helicopter loads the 1/4-ton truck and the hookup crew is on board. The occupation is over . . . less than 5 minutes has elapsed since the first howitzer landed . . . mission accomplished.

A Darned Site Better

If one considers the mountainous terrain encountered in Korea, the fact that nuclear rounds may be burst high in the air, and the requirements for a high-burst registration, it should be apparent that a requirement exists for a new GST to rapidly determine site for higher heights of burst than is possible with the standard GST. However, cannon artillery still will be required to fire conventional ammunition and hence the need for the standard graphical site table (GST).

Rather than encumber a fire direction center (FDC) with two different methods of determining site, the US Army Artillery and Missile School studied the possibility of designing one GST that would give accurate site for both low and high heights of burst and would look and operate like the conventional GST.

Standard GST's are based on a complementary angle of site factor (CSF) for a 25-mil angle of site. These GST's give accurate data from approximately 0 mils to 50 mils angle of site but are not accurate for angles in excess of 50 mils. The ideal solution is a GST with a complementary angle of site factor that provides accurate site for both low and high angles of site.

The first product of research for such a GST is the GST for FT 8-J-2. It gives accurate site for heights of burst to approximately 1,000 meters, if the user does not exceed a quadrant elevation of 500 mils for charges 1 through 6 and 560 mils for charge 7. The GST also provides accurate site for bursts 0 to 400 meters below the piece.

Having successfully developed a GST that appears and operates similarly to any conventional GST and that provides accurate site for any target likely to be attacked by an 8-inch howitzer, the School is working on GST's to accompany new firing tables. These tables, which are expected to be issued during calendar year 1960, will contain new ballistic data for the 155-mm and 105-mm howitzers.

"Combat knows no distinction between components of the Army. There is no difference whatsoever between combat-ready units or individuals of the Active Army, the National Guard, and the Army Reserve. To achieve combat readiness, the same training and the same principles for guiding training must be applied to all. Granted that there is a difference in the degree of readiness appropriate to the mission of an Active Army unit. *Never has the difference been so small!*"

General Bruce C. Clarke
Commanding General, USCONARC

"The great artillery masses decided the result of battle, Napoleon's enemies were compelled to imitate him before they could master him."

Prince Kraft Hohenlohe

THE PERSHING MISSILE - -

The Army's "Blackjack"

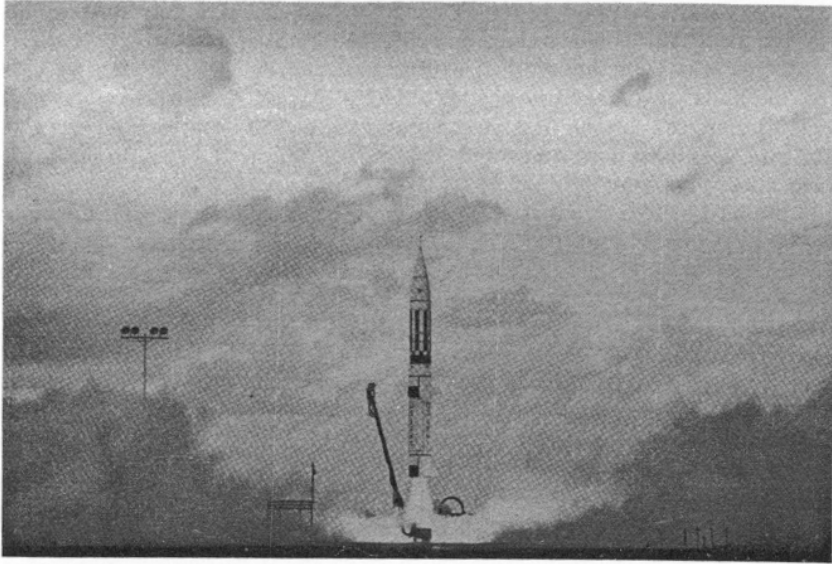

Bearing the proud name of General John J. "Blackjack" Pershing, the Army's newest second generation missile roared skyward recently at Cape Canaveral, Florida. The Pershing missile made its debut on schedule in late February at the Atlantic Missile Range (fig 15), less than two years after the Army awarded initial contracts for the project in March 1958.

Development of the Pershing has been on an accelerated basis. It is designed to eventually replace the Redstone as the field artillery's longest range surface-to-surface weapon. The missile now has officially entered the research and development stage. Only the first stage of the missile has been fired in early tests.

In its tactical version, the 32-foot Pershing is smaller and lighter than the Redstone (69 feet 4 inches). It is a two-stage, solid propellant, ballistic missile, with a selective range reported to be up to 500 miles. Its inertial guidance system is immune to known electronic jamming devices.

The transporter-erector-launcher (TEL), which carries the missile (less warhead), is transported on one XM474 (fig 16). The TEL is an electro-mechanical system and part of the ground handling equipment.

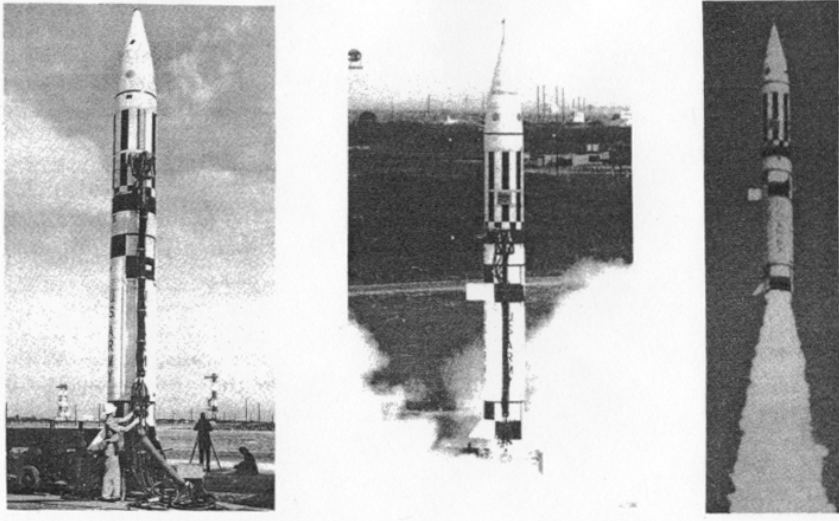

Figure 15. The Pershing in three stages of its initial firing at Cape Canaveral, Florida. The missile is being prepared at left, is lifting off its launcher in the center, and is on its way down range at right.



Figure 16. The Pershing on its transporter-erector-launcher which is mounted here on the XM474 track vehicle. Note the launching platform already on the ground at the rear of the vehicle.

Its function is to mount and erect the missile into its firing position, supporting it accurately at the proper azimuth until the missile lifts off.

The TEL is designed so that it can be transported easily by air as well as on the XM474 vehicle. It has four wheels and pneumatic tires that enable it to be towed short distances, and to be maneuvered into the firing position.

The TEL includes a dual-track erector supported on the transporter chassis. The launching platform is mounted at the rear of the transporter and is pivoted so that it can be rotated to the ground, where it is supported by leveling jacks (fig 16).

MISSILE CARRIED HORIZONTALLY

During transport the missile is carried in a horizontal position on the erector, which is also pivoted at the rear of the transporter. At the firing position, after the launch pad is rotated to the ground and leveled, the erector raises to the vertical position, placing the missile on the launcher (fig 17).

In keeping with the Army's approach to developing this system, all aspects of the Pershing program are being conducted in parallel rather than in series. For example, engineering test firings and Army test firings are scheduled concurrently rather than consecutively.

The joint Army-industry team is keeping the system as tactical as possible throughout its development phase. This means an early introduction of tactical ground-support equipment in the flight test program.

The primary goals of the Pershing system are to develop a highly reliable weapon with a short reaction time. The Pershing's solid propellant is an important factor in obtaining its light weight and high mobility. There is no need for the heavy and cumbersome propellant generating and transporting equipment associated with liquid propellant missiles. Since there is no requirement for loading propellant at the firing position, the Pershing system's reaction time will be considerably shorter.

GROUND-SUPPORT EQUIPMENT

High mobility is further enhanced by the prime mover and the ground-support equipment required to prepare and fire the missile. The ground-support equipment includes the TEL, primary power pack, communication equipment, fire control equipment (computers, azimuth laying equipment, and other system components), test and checkout equipment through all levels of maintenance, plus the necessary huts and shelters. The Pershing system is both ground and air transportable.

All of the ground-support equipment will be carried on lightweight, full-track vehicles capable of moving cross country on all terrain. The prime mover for the missile and all of its equipment is the XM474, a lightweight, low silhouette track vehicle. The use of one type vehicle in the unit should greatly reduce maintenance problems.

The XM474 has a gross weight of about 11,000 pounds. It has an overall length of 16 feet 10 inches, a height of 6 feet 4 inches, and a

width of 8 feet 4 inches. The ground clearance of the XM474 is 16 inches, and it can ford a depth of 42 inches of water. The maximum speed of the vehicle is about 40 miles per hour.

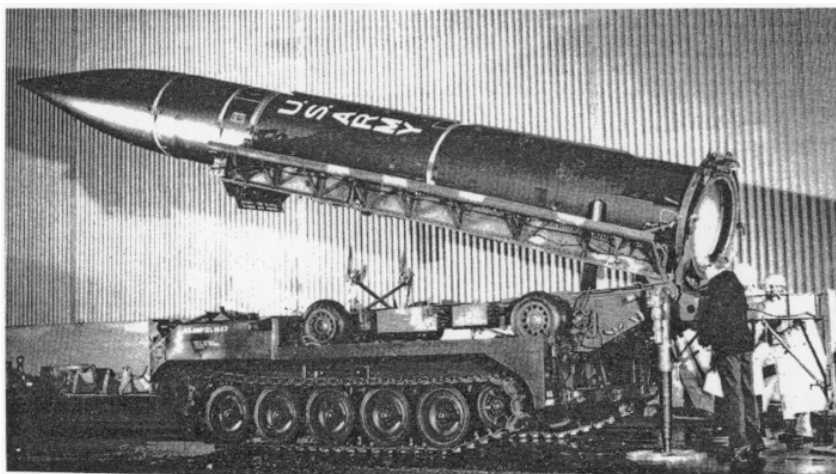

Figure 17. The Pershing being raised by the erector to the vertical position.

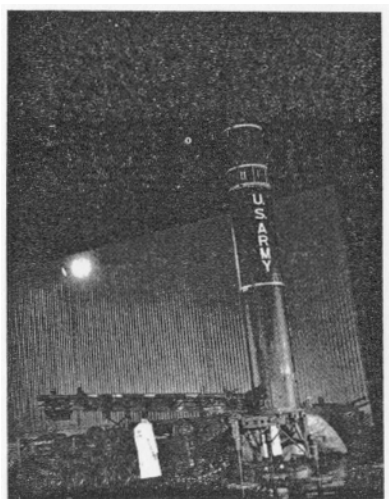

Figure 18. The missile now is in the vertical position and is resting on the launching platform. Note that the erector has dropped away from the missile and returned to the horizontal position.

The erector then returns to the horizontal position (fig 18), leaving the missile resting in a vertical position on the azimuth ring of the launcher. Under command of the fire control unit, the azimuth position of the missile is adjusted accurately before firings.

Control cables, air ducts, and high-pressure air lines necessary to precondition, checkout, and fire the missile are mounted in a cable mast. The lower end of the cable mast is mounted in a bracket attached to the launcher azimuth ring, and the upper end is engaged with electrical and air connections in the missile. During the firing procedure, prior to ignition, the upper end of the cable mast is automatically ejected from engagement with the missile. One of the features of the TEL is that the cable mast is not damaged or destroyed during firing. While the upper end of the mast is ejected a sufficient distance from the missile to provide clearance for firing, a brake in the bracket at the lower end quickly stops the movement of the mast and holds it in a near vertical position. Since the mast is prevented from falling to the ground it is not damaged and may be used repeatedly as a permanent part of the TEL.

Test and checkout equipment, located in the tracked vehicle (XM474) transported fire control hut, accomplishes most of the prefire checkout, and can isolate faults within the missile and ground equipment. The countdown and launch equipment, also in the fire control hut, accomplishes the prefire countdown sequencing and provides for monitoring the same. The portable remote fire control box, which fires the missile, also is a part of this equipment.

The Army Ballistic Missile Agency (ABMA) has technical supervision of the Pershing program. The prime contractor for the complete missile system is the Martin Company.

Through a careful analysis of the Army's needs and by consistently using the latest advances in guided missile technology, the Pershing missile is intended to provide the Army with a truly modern weapon. The mobility, flexibility, and rapid reaction time which will be characteristic of the Pershing system should add considerably to the Army's capability for accurate application of firepower to highly selective targets.



Don't get caught in a "bind" each spring for retirement points or qualification for promotion—continue your Extension Course work during the summer and fall.



If you enjoy reading ARTILLERY TRENDS and it assists you in keeping up to date—keep your Extension Course enrollment active to insure receipt of the next issue.

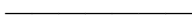

" . . . Our massed fire technique was one of the decisive factors of our ground campaigns throughout the world."

General Dwight D. Eisenhower

THE T7 FIELD ARTILLERY CHRONOGRAPH

First Lieutenant Richard P. Parten

Department of Gunnery

The field artillery has long sought a rugged, portable chronograph which would enable units to determine the muzzle velocities of their howitzers for any given weapon-ammunition combination and would be organic to the division artillery. The T7 radar doppler chronograph can do this.

The T7 chronograph (fig 19) is a continuous-wave doppler radar system that operates on a frequency of 10,500 megacycles. It has two main components—the receiver-transmitter and the electrical counter. The power source is a 0.75-kilowatt (kw), 400-cycle generator. The two main components and the generator can be operated either on a jeep or on the ground. A tripod assembly is provided for the receiver-transmitter for ground operation.

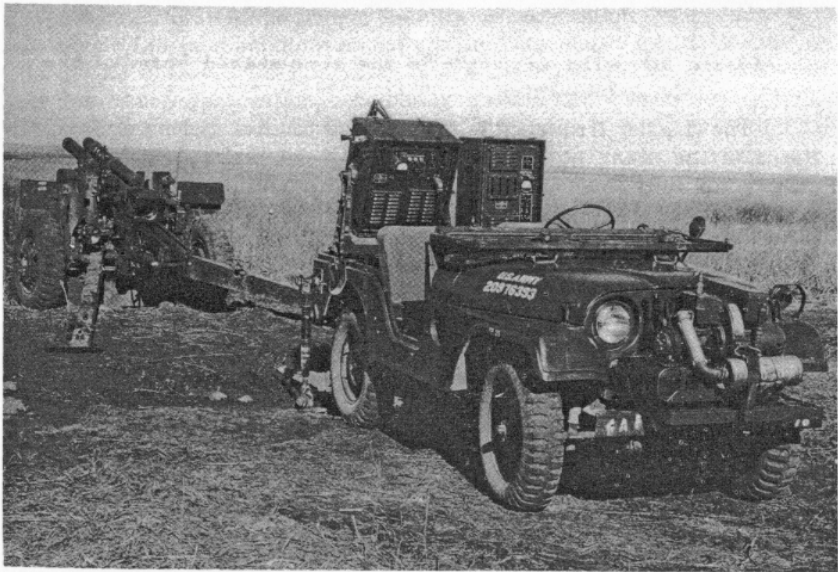

Figure 19. T7 radar doppler chronograph in operating position.

The receiver-transmitter unit emits a continuous wave of radio energy in the form of a small, cone-shaped beam. The operators orient the unit for deflection and quadrant elevation so that the transmitted beam will enclose the ascending branch of the trajectory being fired. When the howitzer fires, the projectile enters the beam and a portion of the transmitted energy bounces off the moving projectile and reflects

back to the receiver-transmitter unit (fig 20). The reflected energy differs in frequency from the transmitted energy because of the velocity of the projectile. This difference in frequency is called the doppler frequency and is proportional to the velocity of the projectile.

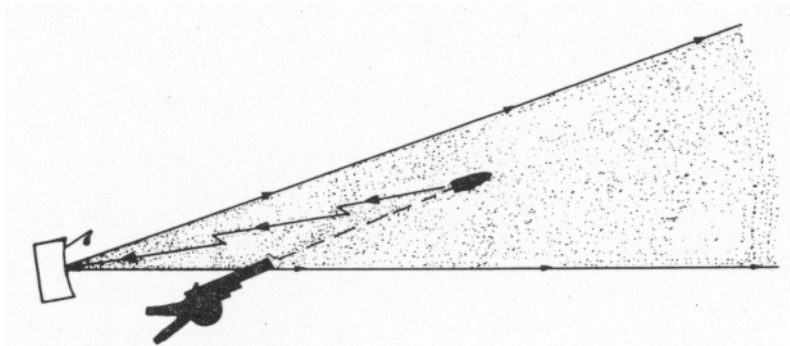

Figure 20. The projectile in the cone-shaped beam of the receiver-transmitter.

The doppler frequency is fed into the counter as long as the projectile is in the beam; however, the counter is interested in the doppler frequency for only a short time. A gating circuit is opened at a predetermined time after the gun blast, and the velocity of the projectile is measured over a 0.05-second time interval. The projectile's velocity at the midpoint of the 0.05-second time interval then is displayed in lights on the front panel of the counter.

DETERMINING MUZZLE VELOCITY

The velocity reading on the counter is the velocity of the projectile at a known point on the trajectory. The muzzle velocity is determined by correcting for the retarding effects of drag and gravity which have acted upon the projectile during the imposed time delay. These corrections are obtained from an extrapolation booklet. Corrections are applied for nonstandard powder temperature and projectile weight. The corrected velocity is the muzzle velocity for the given weapon-ammunition combination corrected to standard conditions of projectile weight and propellant temperature.

The operation of the T7 can be taught in approximately 8 hours. Radar repairmen (MOS 211) can become proficient in maintenance after approximately 40 hours of instruction and familiarization.

The advantages of the T7 over other current chronographs are as follows:

- (1) It will be organic to the field artillery.
- (2) It operates at a convenient distance (normally 3 to 10 meters) to the rear or side of the howitzer.

- (3) It requires no survey.
- (4) It provides all-weather day and night operation.
- (5) It requires only 5 minutes to emplace and prepare for operation.
- (6) It remains mounted in the vehicle unless ground operation is desired.
- (7) It requires only two persons to operate.
- (8) It measures velocities while a howitzer is engaged in any type mission.
- (9) It measures velocities with an accuracy of plus or minus 2 f/s or 0.1 percent, whichever is greater.

Three T7 chronographs presently are being used at Fort Sill by the US Army Artillery Board and by the US Army Artillery and Missile School for research and howitzer calibration. The Board has completed the user test of the T7 and has recommended standardization for use with howitzers. The production model should be available for issue to the field artillery in 1962.

The organic field artillery chronograph will give the artillery commander accurate muzzle velocity data when he needs it. A change in ammunition lot will no longer require re-registration. The muzzle velocity for the new ammunition lot can be determined by the chronograph during an observed mission prior to the depletion of the old ammunition lot for which registration corrections were determined. The change in velocity resulting from the change in ammunition can then be applied to the registration corrections.

The field artillery chronograph will serve as a data source for the electronic digital gun data computer being tested by the Artillery Board. The gun data computer, using chronograph velocity data and unweighted meteorological data, will give the field artillery the capability of placing effective fire on a known target *without* adjustment or prior registration.

The rugged T7 is an important technological advance for the field artillery. It brings to the division artillery level a simple instrument to determine muzzle velocity. This leads to faster, more accurate artillery fire.

The *Catalog for Instructional Material*, formerly called the *Staff Training Catalog*, was distributed in July 1959. The material listed reflects the latest organization and current artillery procedures. Address requests for this catalog: Commandant; US Army Artillery and Missile School; Fort Sill, Oklahoma; ATTN: AKPSIDA-TP/RC. (ARTILLERY TRENDS, December 1959).

Additional copies of ARTILLERY TRENDS are available at 15 cents each, postpaid. All orders must be accompanied by a check or money order payable to the Book Department. Address correspondence to: Book Department, US Army Artillery and Missile School, Fort Sill, Oklahoma.

A GEM FOR THE FIRING BATTERY

During a period when a unit did not have an MX 155/GT switching kit, this substitute communications switching device was developed. It consists of two ammunition rods (105-mm howitzer) and a wood cover to protect the cross bars from inclement weather.

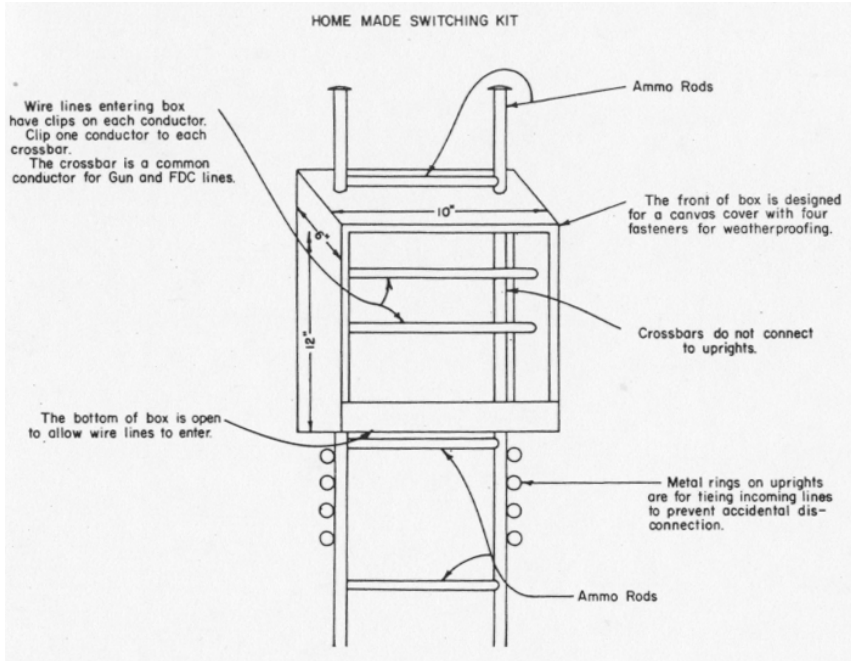

Alligator clips are attached to the ends of the wire lines which come in from the individual howitzer sections. These clips are available through self service supply centers.

—Submitted by Sgt James K. Rushing
2d How Bn, 28th Arty
Fort Bragg, North Carolina

DO YOU HAVE A GEM?

Do you have a practical idea on how to better accomplish an artillery task than the device or technique currently used? Send your "GEMS" to:

ARTILLERY TRENDS

Department of Training Literature and Non-resident Instruction
Fort Sill, Oklahoma

Air Defense Artillery In The Field Army

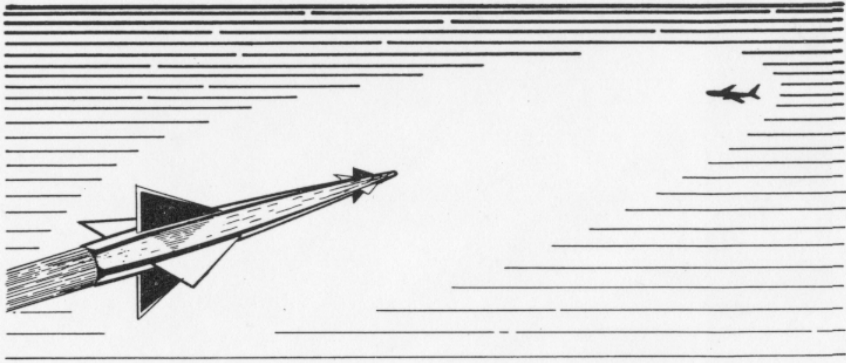

The artillery mission of supporting the ground-gaining arms with firepower is not limited to ground fire support. The artillery also must protect the vertical flank of the ground forces from attack by airborne weapons. Air defense artillery (ADA) operations include all measures designed to destroy, nullify, or reduce the effectiveness of enemy attack by aircraft and cruise or ballistic type missiles after they are airborne. The air defense artillery goal is command of the air.

Command of the air is the capability of one antagonist to conduct military air operations without prohibitive interference from the aerial weapons of the opposing force. Command of the air is broader than "air superiority." Nuclear weapons and increased use of guided missiles for nuclear delivery emphasize the importance of command of the air. Complete command of the air can be attained and maintained only by total destruction of the enemy's aviation, guided missiles, and artillery. Since this is seldom practicable, offensive counterfirepower operations and air defense operations must be conducted continuously. The term "offensive counterfirepower" includes the application of artillery, guided missiles, and air force power against similar hostile means on the surface prior to their being airborne.

The combat operations of the active air defense means are directed to—

- (1) Destroy hostile aircraft and missiles after they are airborne.
- (2) Nullify or reduce the effectiveness of hostile air attack by using electronic warfare against electromagnetic radiations used by the enemy for communications, navigation, fire control, identification, electronic warfare, fuzing, or other purposes.
- (3) Assist in the accomplishment of the basic tasks of offensive counterfirepower means through use of the active air defense means in their secondary role.

EMPLOYMENT AND APPLICATION

Knowledge of the capabilities and limitations of the active air defense means is prerequisite to the sound employment and application of air defense forces. Active air defense operations may precede or occur concurrently with the initial contact of ground forces. The orderly mobilization and strategic concentration of military field forces and their ability to move into combat will be influenced by the success of both offensive counterfirepower and active air defense operations. The nature of active air defense operations, the innate characteristics of targets for attack, and the characteristics of modern, effective, active air defense weapons (Army surface-to-air missiles) dictate separate organizations for active air defense and offensive counterfirepower means.

Maximum integration and flexibility of forces and the coordination and control of both are essential to the attainment of command of the air. They require that the offensive counterfirepower means and the active air defense system and their commanders be provided with—

(1) Intelligence systems capable of high-speed data gathering and production.

(2) Command control facilities for rapid coordination and direction of force employment and operations.

(3) Reliable, high-speed communications for the execution of the above functions.

The immense power of nuclear weapons and the development of highly efficient and sophisticated carriers dictate that field forces receive near absolute assurance of defense from air attack. Successful defense of field forces will be enhanced if the organization of the active air defense system—

(1) Is instantly responsive to the enemy threat and to the direction of the responsible commanders.

(2) Provides for maximum decentralization of execution, while providing for centralization of supervision essential to effect coordination of operations.

(3) Provides for integration and full use of the effective weapons, modern techniques, and intrinsic capabilities of each of the services.

(4) Insures mutual understanding and confidence between agencies using the same airspace.

THEATER COMMANDER RESPONSIBLE

The theater commander is responsible for final determination of air defense priorities and the allocation of air defense means. The theater commander normally establishes a unified air defense command whose commander is assigned responsibility for defense against air attack and who would exercise the authority of the theater commander to coordinate all air defense forces.

In the area of the field army, the field army commander has the responsibility for defense against all forms of attack, subject to the operational procedures directed by the theater commander. He will be provided with means and authority commensurate with this responsibility,

including weapons and forces, to defend against air attack. The field army commander is responsible for control and regulation of the airspace over the field army area, which includes enemy-held territory to a depth designated by higher headquarters. The field army air defense artillery brigade commander is designated the field army air defense commander.

The changing nature of combat operations and characteristics of active air defense weapons require organizational changes to meet the demands for adequate air defense. All air defense units assigned or attached to the field army and not otherwise assigned or attached to subordinate units will be considered organic to the air defense artillery brigade. Long-range surface-to-air missile battalions are employed to provide a highly effective integrated air defense in depth for the entire army area. Short-range surface-to-air missile (or possibly air defense tube artillery until sufficient missiles are available) battalions are employed to augment the air defense of the longer range surface-to-air missile units, providing point defenses of critical units, terrain, and installations.

WEAPONS

The present surface-to-air missiles are the Hawk (fig 21), the Nike Ajax (fig 22), and the Nike Hercules (fig 23).

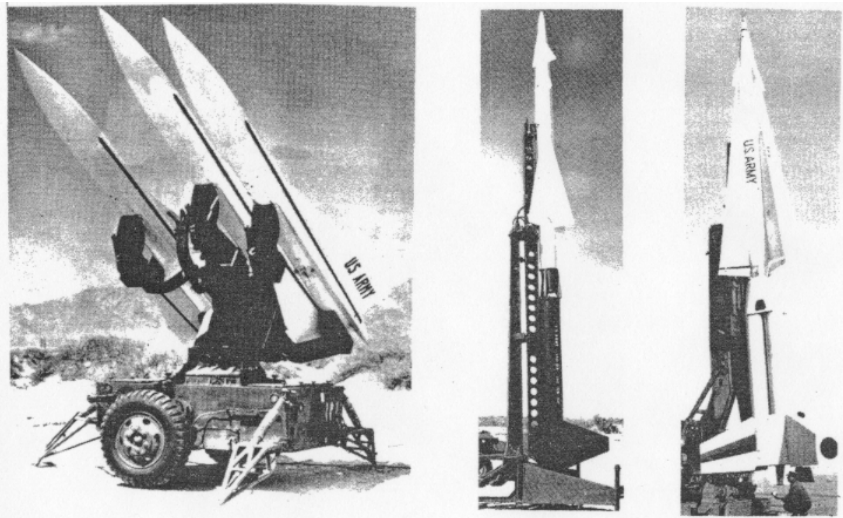

Figures 21, 22, 23. The left photo shows three Hawk missiles on launcher. Center, Nike Ajax missile erected for firing. Right, Nike Hercules poised for the kill.

The Hawk system is designed to destroy low-flying attackers (fig 24), while the Nike Hercules protects against higher altitude aircraft and aerodynamically supported missiles. The Nike Ajax, which has been

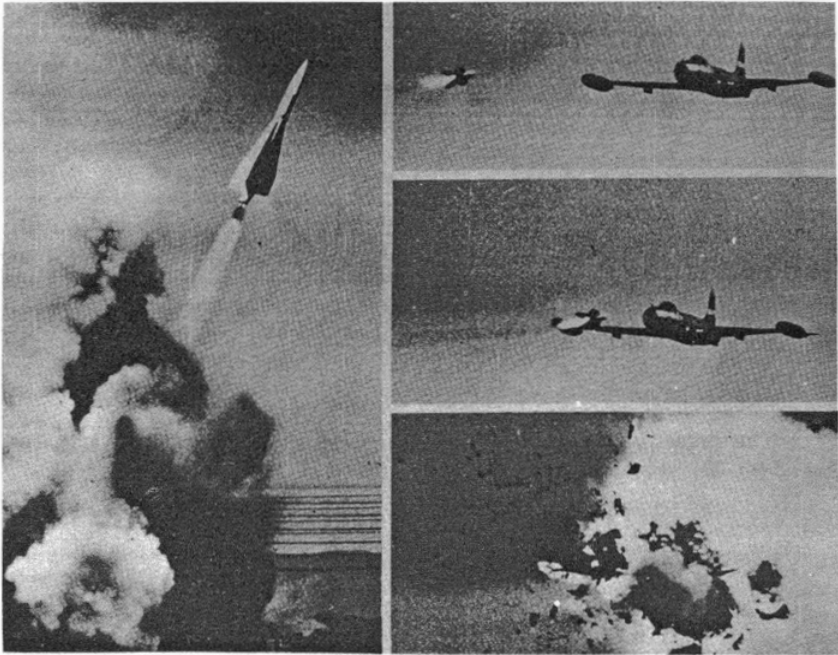

Figure 24. Hawk missile attacking and destroying a low-flying QF80 drone target.

operational since 1953, is in the process of being replaced by Nike Hercules (fig 25). In addition, the Nike Hercules is being improved to give it greater range capability. It has a greater range and altitude capability than its forerunner, the Nike Ajax.

Several weapons are being considered to replace the current twin 40-mm air defense artillery gun as a forward area air defense weapon. The Mauler is a full-tracked, self-propelled, guided surface-to-air missile system. The Redeye is a man-portable, shoulder-fired homing missile planned for use by the combat arms as an organic air defense weapon.

The tactical deployment of air defense artillery weapons within the field army is based on the capabilities and mobility of the weapons. Generally, weapons are deployed in a dispersed pattern in depth throughout the army area with mutual support distances maintained between weapons. The less mobile weapons normally have the greatest range and can be sited well away from exposed perimeters. The lack of cross-country

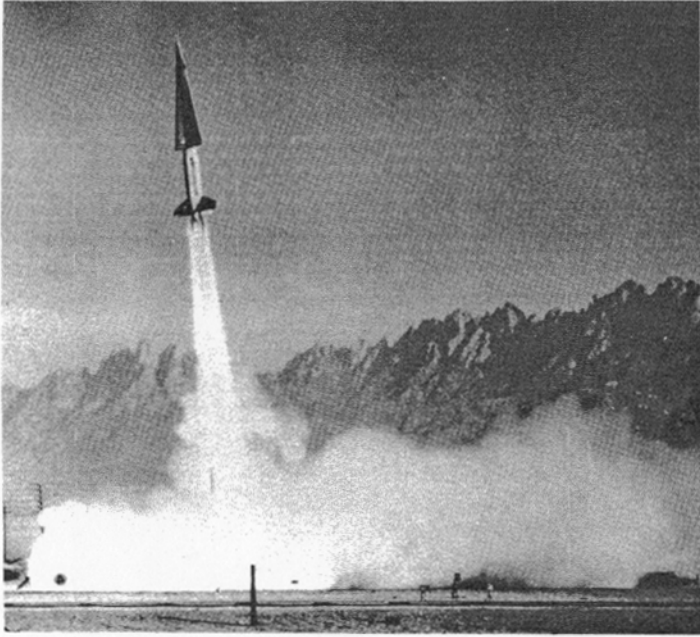

Figure 25. Nike Hercules, with booster attached, shortly after firing.

mobility is compensated for by their great range and high-kill potential. Weapons with greater mobility (fig 26), but usually shorter

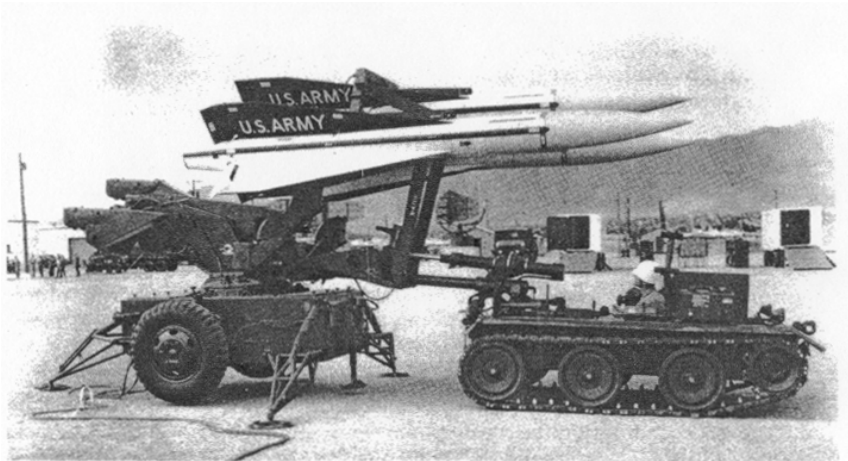

Figure 26. Hawks being loaded on launcher. This system features mobile equipment.

range, are deployed forward in the battle area. These weapons provide the necessary low-altitude, close-in coverage of the forward element of the field army. The forward area weapons, presently the twin 40-mm gun, mounted on a full-tracked chassis, may be deployed to defend critical units, terrain, and installations (nuclear delivery systems, avenues of approach, nuclear weapon storage sites) within the army area. These point defenses would augment the area defense-in-depth established throughout the army area.

PLANNING FACTORS

Determination of the level of air defense effectiveness required for the army area or critical points within the area must be based on thorough consideration of the following primary interrelated factors:

(1) The importance of the area concerned to the strategic or tactical plan of military operations.

(2) The capability of enemy offensive firepower means to attack the area and the possible enemy tactics and weapons for such attacks.

(3) The capabilities and limitations of the available air defense and offensive counterfirepower means to attain and maintain command of the air over the area.

Nuclear weapons and improved delivery means have increased the capability to attack and devastate large area targets. The required level of active air defense effectiveness has increased correspondingly. Thus, it is more necessary to determine the priorities of various areas (and their critical subportions) for active air defense and to insure that the required air defense means are available.

After the priorities for air defense are determined, the means are allocated—

(1) In accordance with one plan.

(2) On the basis of availability.

(3) To exploit weapon capabilities and to minimize the effect of any limitations.

FIRE DISTRIBUTION

To assure that the full potential of the air defense artillery weapons are realized once priorities are established and weapons are deployed, effective fire distribution must be provided. Fire distribution in air defense artillery simply means placing a sufficient amount of fire on the appropriate target to assure destruction of all hostile airborne objects. A close corollary is the required timely identification of friendly aircraft to assure no inadvertent destruction of friendly forces.

Since the time permissible for active air defense operational decisions is measured in minutes and seconds, it is paramount that most matters of coordination be anticipated and published as standing operating procedures. Instantaneous transmission of air defense intelligence, command control instructions, and data to effect coordination must be provided by reliable high-speed communication and display equipment. Electronic fire distribution systems for field army use, such as the

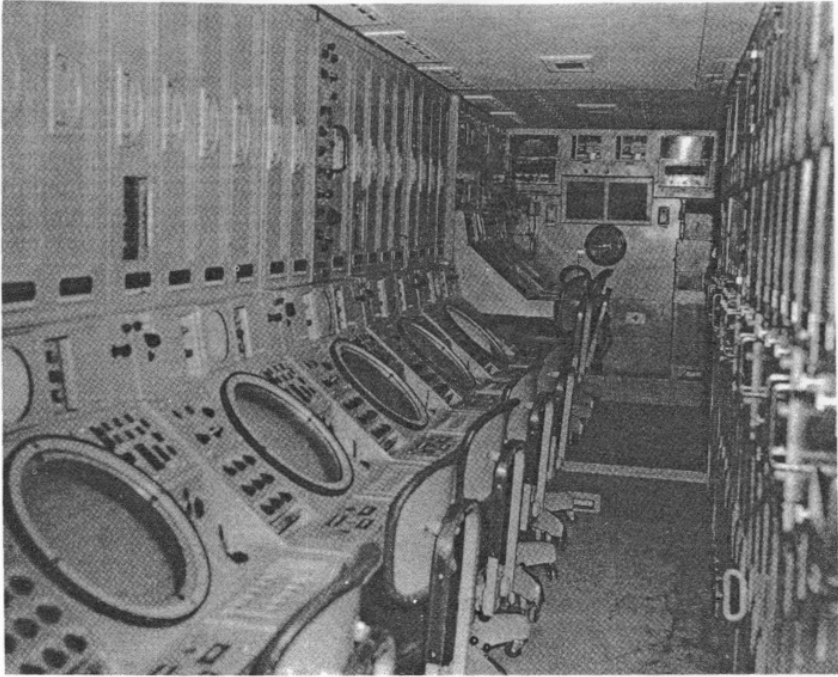

Figure 27. The Radar Processing Center (RPC) of the Missile Monitor. The basic system consists of four major components—the Army Air Defense Command Post (AADCP), frequency scan radar, operations center, and coder-decoder group.

AN/MSG-4 Missile Monitor (fig 27), used at air defense artillery group level, and the AN/MSQ-18 (fig 28), which is the battalion level fire distribution system, provide the air defense artillery organizations with the necessary fire distribution data. The AN/MSQ-18 is one of the four major components (operations center) of the Missile Monitor.

The data that may be interchanged and displayed throughout the field army air defense system by automatic electronic means are—

- (1) Location of known friendly aircraft.
- (2) Location of hostile aircraft.
- (3) Targets under attack by each air defense artillery battery.
- (4) Readiness condition of each battery.
- (5) Command data.
- (6) Data from other air defense agencies (adjacent defenses, US Air Force control centers).

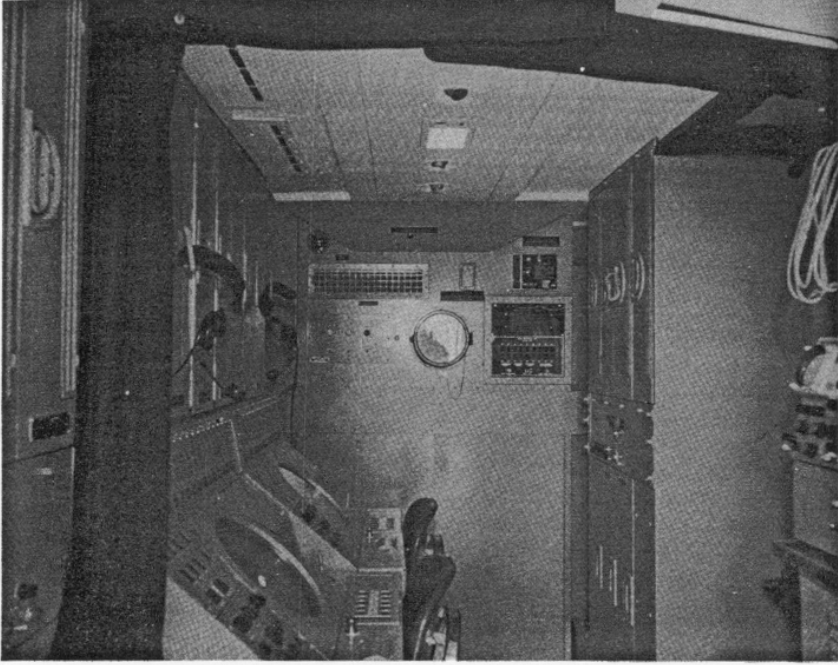

Figure 28. The AN/MSQ-18 is the battalion level fire distribution system.

The defense-in-depth concept of air defense for the entire field army area presents many advantages. It permits every element of the field army to concentrate upon its mission without undue concern of possible attack from the skies. The area defense concept also reduces the requirements for the determination of priorities for air defense of the various emplacements and units of the field army. Only in forward area weapons employment must major consideration be given to priorities of critical point defenses. On the battlefield, every element of the field army will be given the best possible protection from air attack. Field artillery missile units, infantry in bivouac or on the move, armor in the attack or deep reserve, and the many other units and services that support the combat elements have the same top air defense priority. (This article was prepared by the US Army Air Defense School, Fort Bliss, Texas.)

RADIO RELAY EQUIPMENT FOR ARTILLERY UNITS

Major John T. Beaver, Jr.
Department of Communication and Electronics

For several years artillery units have used radio relay equipment in various parts of the world with success. In Europe, equipment modification lists authorize radio relay equipment for corps artillery, field artillery groups, and various other artillery units. This equipment supplements, and in many cases completely replaces, long wire lines. During operations over extended distances and during rapidly moving situations, this radio relay equipment often has been the difference between having and not having necessary communication to command and control subordinate units and to receive vital reports.

The need for radio relay equipment in artillery units has been recognized by artillerymen for many years. The US Army Artillery and Missile School has studied the problem, determined requirements, and recommended that radio relay equipment be included in tables of organization and equipment (TOE) of certain artillery units.

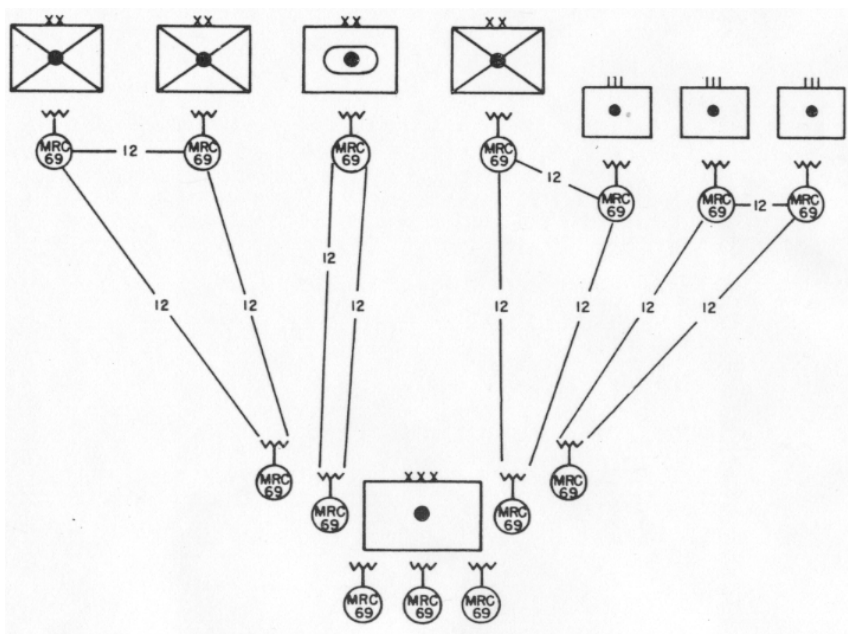

Figure 29. The AN/MRC-69 radio terminal set connected for operation.

Radio relay equipment should appear on the corps artillery TOE for the first time in the third quarter of fiscal year 1960. The equipment authorized will be the AN/MRC-69 radio terminal set (fig 29). This equipment will provide 12 radio telephone channels in two different directions, or it will provide 24 radio telephone channels in one direction. The AN/MRC-69 operates in the 50- to 600-megacycle frequency range and has a rated transmission range, limited by line of sight, of 30 miles or 48 kilometers. Installation time for the equipment is approximately one hour. Most of this time is spent erecting antennas and initial channeling the equipment.

The corps artillery headquarters battery will be authorized 14 AN/MRC-69 sets. The AN/MRC-69's provide both ends of a radio link and may be employed in various ways. Figure 30 shows a possible, although not necessarily typical, method of employment.

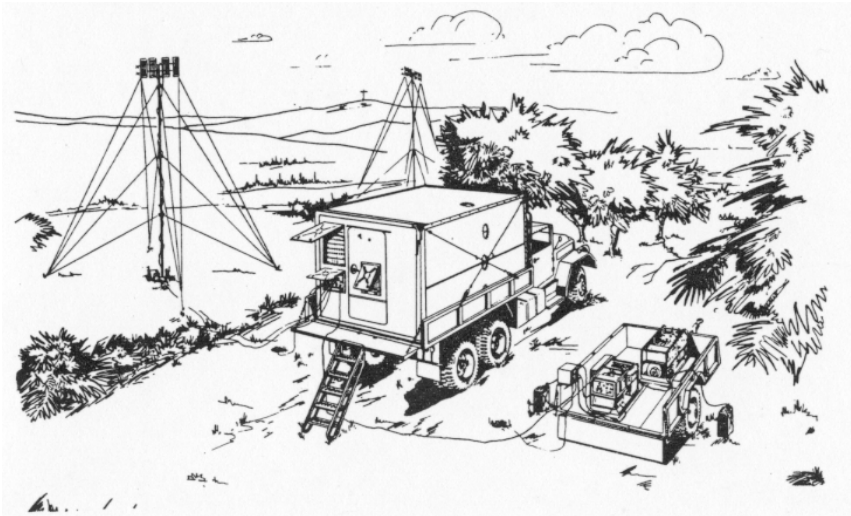

Figure 30. A possible method of employing the AN/MRC-69.

In figure 30, three AN/MRC-69's are not in use. This arrangement may not always be possible since terrain may prevent working two distant units with a single AN/MRC-69. Additional sets must be used to offset this difficulty. However, as few sets as possible should be used. Sets saved can be used for displacement, relay, special missions, or for equipment failure.

The AN/MRC-69 radio terminal set should give the corps artillery commander the reliability needed in his communication system and should eliminate problems in maintaining long wire lines.

THE ARMORED DIVISION - -

Its Employment and Future

Major John C. Burney, Jr.

Department of Tactics and Combined Arms

If the armored division were a commercial enterprise, it might advertise its products like this—"Does your unit suffer from lack of momentum when you strike for deep objectives? Is that tired, depressed feeling getting you down? To clear up this offensive problem, try ARMOR. Only ARMOR provides the products for fast, *Fast, FAST* relief for run-down attacks. ARMOR contains not just one vital ingredient, but a combination of firepower, mobility, and shock action . . ."

As discussed in the February 1960 issue of ARTILLERY TRENDS, these ingredients make the armored division particularly well-suited for the modern nuclear battlefield. In both offense and defense, armor is a versatile, hard-striking arm of mobile, mounted combat. This smoothly functioning team of tanks, armored infantry, and armored artillery is the corps' main striking force—the combat arm of decision.

In the February issue the organic structure of the armored division was discussed. The combat command's separate battalion organization permits maximum flexibility and enables the commander of each echelon to tailor his elements so that each is organized to best perform its mission.

In organizing for combat, the guiding principle followed by each commander is "form combined arms teams." The various elements of the armor team are employed in close coordination with each other so that the limitations of one member of the team balance with the capabilities of others. The tank, for example, is vulnerable to short-range, hand-held antitank weapons when it is passing through wooded areas. In such a situation, the tank, with its restricted visibility, cannot easily detect concealed enemy infantrymen. Tanks could fall easy prey to rocket launchers under these conditions. However, the armored infantrymen can easily eliminate such threats; when wooded areas are reached, the infantrymen dismount and provide close-in protection for the tanks. However, in other situations the infantrymen become vulnerable to other weapons, machineguns for example. But the tank can easily crush these weapons. Tanks and infantry, working in close coordination with each other, supported by artillery, form an unbeatable team. As General Karl von Clausewitz said, "The results will be greatest when combat elements unite themselves in one great battle."

COMMANDER'S CONSIDERATIONS

How does the commander know what proportions of tanks and infantry to use in his combined arms teams? At each level, the commander considers his assigned mission, the enemy confronting his force, the

available troops, and the terrain. With these factors in mind, he makes a reconnaissance and looks for indications that tell him whether to form his force tank-heavy, infantry-heavy, or balanced. Examples of tank-heavy indications are a mission requiring speed and shock action, an enemy strong in tanks, and terrain with few obstacles. Examples of infantry-heavy indications are a mission requiring a zone to be cleared, strong enemy antitank defenses (such as minefields), and cities that restrict the maneuverability of tanks. In some situations, tank-heavy indications will balance the infantry-heavy indications, and balanced forces will be appropriate. After considering these indications, the commander decides what groupings of tank, armored infantry, armored

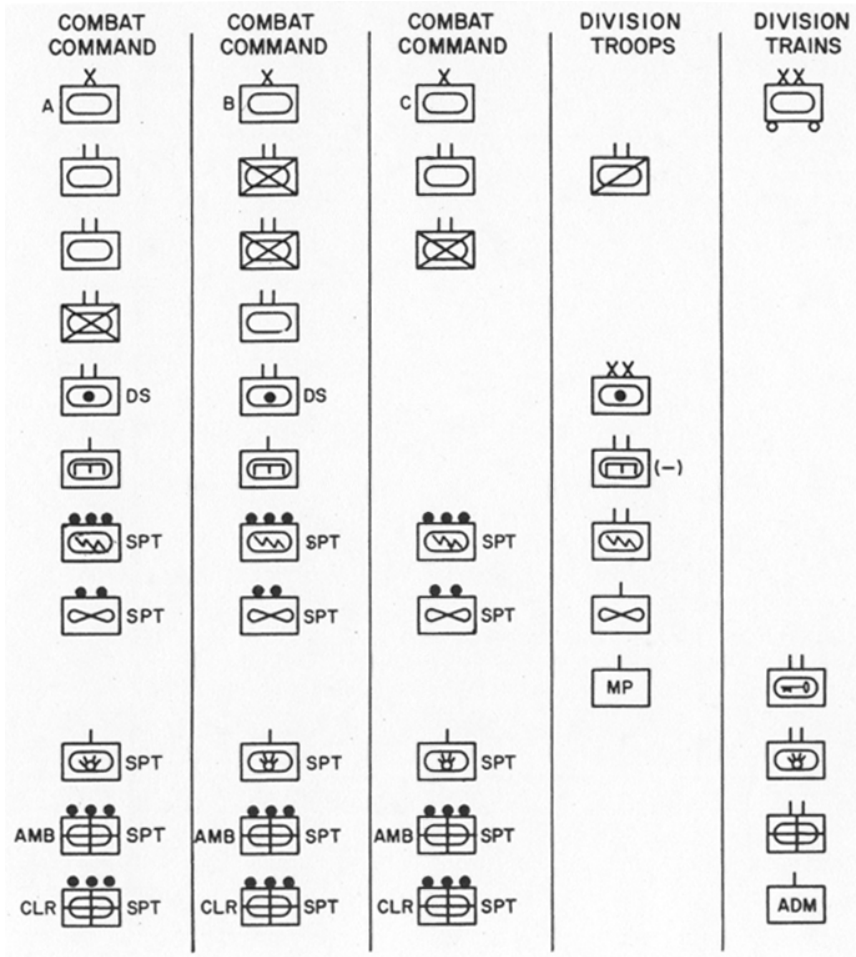

Figure 31. Typical armored division organization for combat.

cavalry, artillery, engineers, and other elements will best accomplish his mission.

The division commander organizes for combat by attaching or placing in support of each combat command the necessary combat, combat support, and service elements needed to perform a specific mission. The result might be a division organized as shown in figure 31. In this example, the commander made combat command "A" (CCA) tank-heavy with two attached tank battalions and one armored rifle battalion. In contrast, combat command "B" (CCB), with two armored rifle battalions and one tank battalion, is infantry-heavy; and combat command "C" (CCC) is balanced. To each committed combat command the division commander attached an engineer company. Combat command "C," the reserve, would receive an attached engineer company when committed. In this example, a 105-mm self-propelled howitzer battalion was placed in direct support of each committed combat command. Combat command "C" normally would receive a direct support howitzer battalion when committed. Meanwhile, its supporting artillery remains in general support, prepared to provide direct support to combat command "C" on order.

Division artillery and elements of the engineer battalion not attached to the combat commands are included in the tactical grouping called "division troops." Division troops are employed directly under the control of the division commander. Other elements in this category normally include the armored cavalry squadron, the signal battalion, the aviation company, and the military police company. An area support platoon from the signal battalion and a combat support section from the aviation company usually are placed in support of each combat command. The armored cavalry squadron and military police company normally are employed intact under division control.

DIVISION TRAINS

All units not attached to the combat commands or retained in division troops are attached to the division trains. The trains normally include the quartermaster battalion, ordnance battalion, medical battalion, and administration company. From these elements, an ordnance forward support company, an ambulance platoon, and a clearing platoon normally are placed in support of each combat command. The quartermaster battalion and administration company usually operate intact.

The combat command commander also forms combined arms teams. He uses the headquarters of his attached tank and armored rifle battalions as control headquarters and cross-attaches tank and armored rifle companies between these battalions to tailor each battalion for its mission. When organized for combat, the battalions are known as "task forces." The combat command commander normally places an engineer platoon in support of each committed task force. The combined arms teams are completed by making artillery available through liaison officers who accompany each task force headquarters.

The task force commander organizes his elements for combat by

using the headquarters of his attached tank and armored rifle companies as control headquarters and cross-attaching tank and rifle platoons between the companies to tailor each company for its mission. The companies are then known as "teams." Engineer support for these teams is available on call, and artillery is available through forward observers who accompany each company headquarters. Below this level, tank and rifle platoons usually are not split.

The foregoing examples represent typical organizations for combat at each echelon within the armored division. This is not to imply that these exemplary tactical groupings are rigidly adhered to. On the contrary! Originality in thought and flexibility of organization are heartily encouraged. Commanders organize their forces for specific missions and tailor their subordinate elements so that each is best organized for most effective employment.

EMPLOYMENT

After armor forces have been organized for combat, they must be employed in a manner to maximize their mobility, firepower, flexibility, and shock action. It is not enough simply to have an organization that features these characteristics. To apply these attributes effectively, the commander himself must be mentally mobile and flexible. The fluidity and increased dispersion of the nuclear battlefield demand that the commander react rapidly to unforeseeable developments. Flexibility of mind, blended with imagination, boldness and aggressiveness, are the keys to armor success!

Successful armor action is based on rapid and thorough estimates and flexible plans. Commanders issue mission-type orders, which are as brief as possible and include a minimum of detail. They must allow considerable freedom of action so that subordinates can act freely without requesting instructions from their commanders. In this same vein, restrictive control measures are meticulously avoided. For example, units are seldom required to stay within boundaries because boundaries restrict maneuver. When minimum restraint is imposed, a commander can take immediate advantage of a favorable change in the situation. As General Patton stated, "Plans must be simple and flexible. Actually, they only form a datum plane from which you build as necessity directs or opportunity offers."

The planning of armor operations is followed by bold, violent execution. Armor is primarily an offensive arm. As part of a type corps, the armored division is the principal mobile combat force and usually makes the corps main attack toward deep, decisive objectives. Every effort is made to get the division into the enemy's vulnerable rear areas.

Armor can be placed in the hostile rear either by enveloping the enemy's position or by penetrating his defenses. Usually it is preferable to envelop; however, this may not be possible if the enemy has no assailable flanks, or if time does not permit an envelopment. In such cases, a penetration must be effected. In a nonnuclear situation, it is preferable to use the infantry to make the penetration and then commit the

armored division through the area of the penetration into the exploitation. Using this technique, the armored division can enter the decisive phase of the operation fresh. If nuclear weapons are available, these can be used to breach the enemy's forward defenses. With its armor protection, the armored division can be poised close to ground zero. With its mobility, it can exploit the nuclear blast with lightning-like speed.

THE EXPLOITATION

A successful penetration or envelopment is followed by the decisive phase of offensive operations—the exploitation. This is the type of operation in which armor excels. The exploitation offers armor the finest opportunity to capitalize on its mobility, tremendous firepower, and devastating shock action. With its flexible organization and extensive communication system, the armored division can react swiftly to friendly success, plunge into the exploitation at the decisive time and place, and readily adapt itself to changing conditions as the exploitation continues. The exploitation truly might be termed "armor's finest hour."

In the exploitation, commanders must do everything possible to reach their objectives as rapidly as possible. Speed is all important! A few minutes might mean the difference between success and failure. This was vividly demonstrated during World War II by the 9th Armored Division in its exploitation toward the Remagen Bridge. The unexpected seizure of this bridge had an incalculable effect on the European campaign. Its seizure averted the necessity of a costly forced crossing of the Rhine, the most formidable terrain barrier in Central Europe, and surely saved thousands of lives. Yet, this critical bridge was captured *only ten minutes* before it was scheduled to have been destroyed by the Germans. Only ten minutes saved many thousands of lives! Speed is of the utmost importance in the exploitation!

But how does one attain this speed? First, speed is attained by properly organizing columns for the exploitation. Tank-heavy forces are placed in the lead to maintain the momentum of the attack. Commanders must be well forward where they can make instantaneous decisions and insure swift, uninterrupted progress. It is extremely important that artillery be placed well forward within the columns so that fire support can be obtained at a moment's notice.

Next, speed is attained by taking the proper action when enemy forces are encountered. These forces must be either destroyed or bypassed. It usually is preferable to bypass the enemy because this course of action normally is faster and results in minimum losses to exploiting forces. Bypassed pockets of enemy resistance are later destroyed by infantry divisions which normally follow and support armor in the exploitation. Sometimes it may be faster to attack and destroy enemy forces. If this is necessary, the attack is launched suddenly, without stopping; terse fragmentary orders are issued over the radio, and units swing into the attack from the march.

BOTH DAY AND NIGHT

Speed is achieved by continuing the attack day and night. Units are pushed relentlessly to the limit of endurance of both men and equipment. Night attacks keep the enemy off balance, confuse him, and have an adverse psychological effect on his soldiers.

The speed and momentum of an exploitation are maintained by committing reserves to exploit successes. Armor commanders must aggressively seek opportunities to commit reserves. As B. H. Liddell Hart said in his book, *The Defense of Britain*, "For mobile operations, the risks of pushing too far and committing reserves prematurely are minor compared with the cumulative risks of delay."

In the offense, armor operations are characterized by aggressiveness, boldness, speed, violence and decisiveness!

Although the armored division is primarily an offensive weapon, it can be effectively employed in the defense. The division may be used initially to delay the enemy forward of the battle area and allow the infantry divisions of the corps the time needed to organize a defense. The division subsequently may be employed as the corps reserve to add depth to the battlefield and act as a decisive striking force to destroy major enemy penetrations. It also may occupy a sector of the battle position covering major avenues of approach for enemy armor. In the defense, as in the offense, armor is vital to the corps.

The armored division is particularly well suited to conduct aggressive delaying actions because of its complete mobility, large volume of long-range fires, and extensive communications. These characteristics enable the division to cover a much wider front than the infantry division. In a delaying action, armor forces take every opportunity to inflict maximum destruction on the enemy with minimum risk to delaying units. They maintain continuous contact with the enemy and delay on and between carefully selected positions. Bold counterattacks are frequently launched to gain time and to assist the disengagement of elements that have become closely engaged.

MOBILE DEFENSE

If required to defend a sector of the battle area, the division normally adopts a mobile defense. The mobile defense is an active and aggressive defense that is accomplished by a combination of offensive and delaying action. Forward defensive positions are organized with the minimum forces necessary to warn of impending attacks, to delay and disorganize the advancing enemy, and to canalize his attack. The larger portion of the division is retained as the striking force, which is used to destroy the enemy by offensive action.

Even in defensive and retrograde operations, armor achieves its greatest potential by stressing offensive tactics and techniques.

Even though armor is well-suited for nuclear war, every possible organizational concept and piece of equipment which might improve its capabilities is being explored.

In the field of organization, armor's combat development groups have been particularly active. A pentagonal structure, such as that employed in the infantry and airborne divisions, has been under constant consideration. An armored division with pure tank groups and pure armored infantry groups has been compared with a division including groups in which the tanks and armored infantry were integrated. Organizational and operational concepts for airborne armor have been developed. Several "SKYCAV" (air reconnaissance) theories have been investigated thoroughly; and an aerial reconnaissance and security troop, equipped with armed helicopters, recently has been developed. In the field of administrative support, functionalized supply and maintenance have been tested during a field exercise. Unfortunately, security classification prohibits a detailed discussion of these developments.

NEW EQUIPMENT

Evidence of armor's progress in new equipment is ever present. By April 1960, tank crewmen should be enjoying the increased, longer range firepower and greater operational range of the new M60 tank (fig 32). This tank mounts a British-developed 105-mm gun and is powered by a diesel engine. The use of the diesel minimizes fire hazards and substantially

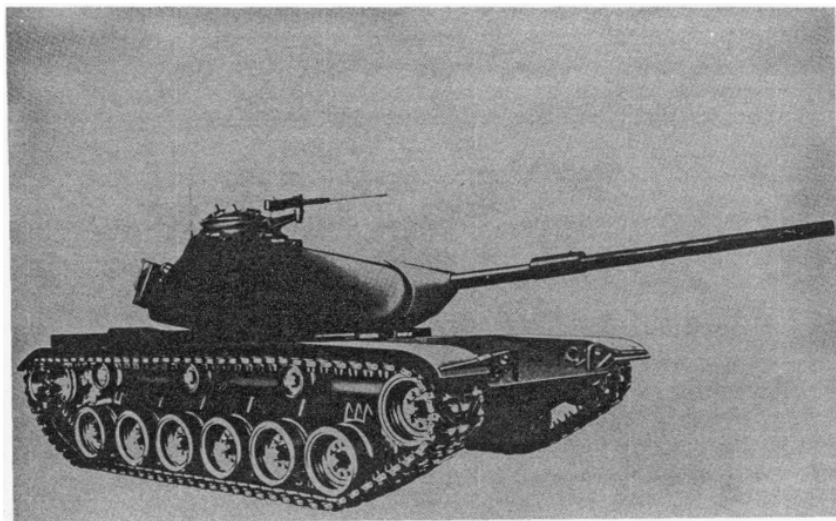

Figure 32. The new M60 tank.

increases operational ranges. Recently standardized is a new, lightweight armored personnel carrier, the M113 (fig 33). Versions of



Figure 33. The M113 armored personnel carrier.

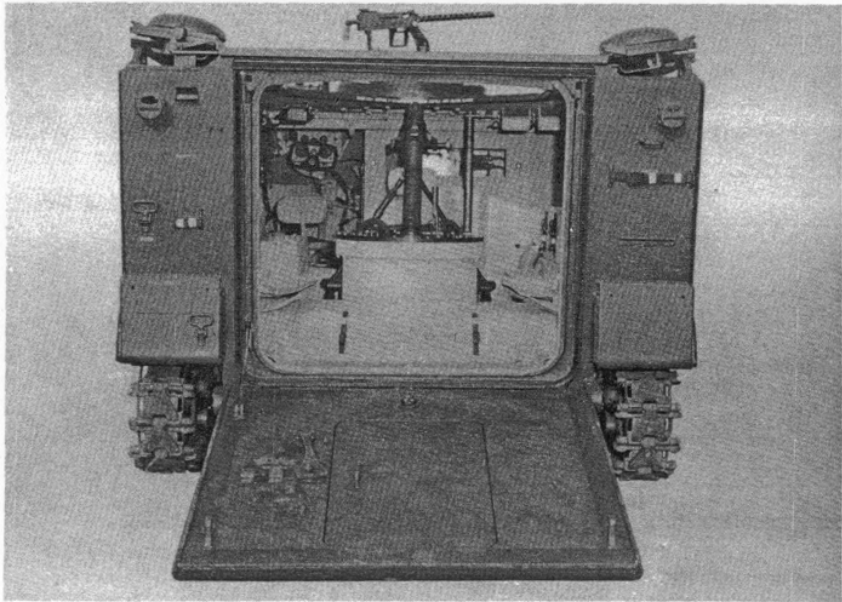

Figure 34. Modified M113 mounting an 81-mm mortar.

the M113 which mount 81-mm (fig 34) and 4.2-inch mortars are under development. The logistical support of these vehicles will be facilitated by a promising family of radically new transports called the "Goer" vehicles (fig 35). These carriers incorporate the "big wheel" concept characteristic of commercial earth-moving equipment. Their high payload-to-weight ratios may answer armor's logistic problems. In other

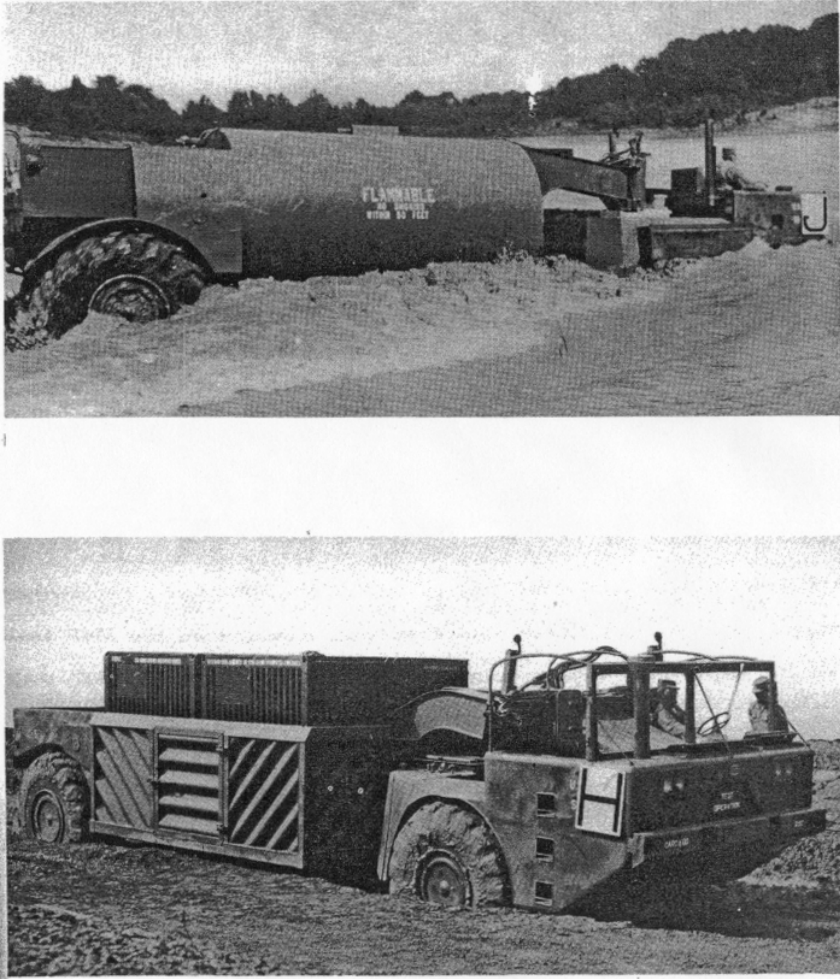

Figure 35. The XM438 5,000-gallon "Goer" tank truck (top photo) is a highly mobile vehicle (bottom photo).

developments, progress has been made in the firing of SS10 antitank guided missiles from tanks (fig 36) and armored personnel carriers, in the development of multifuel engines, and in the perfection of equipment for the night firing of tank guns.



Figure 36. SS10 antitank guided missiles mounted on the M48 tank.

Armored artillerymen can rest assured that their "tanker" teammates are doing everything possible to keep pace with the swiftly changing requirements of this period of rapid, dramatic changes.

In an article, one can discuss only briefly the highlights of armor organization, organization for combat, and employment. To function effectively as a member of the armor team, the artilleryman must know not only the highlights but also many of the details. For further detail, Field Manual 17-100, *The Armored Division*, is recommended.

THE ARMORED ARTILLERYMAN

The armored artilleryman faces a true challenge. As the provider of fire support to his armor teammates, he has perhaps the most difficult job on the team. His support must be continuously available to fast-moving units that may speed hundreds of miles in several days. He faces an ever-changing situation that demands the utmost in skill, ingenuity, and imagination. A direct support artillery battalion commander may find that the combat command that he is supporting is infantry-heavy

in the morning and tank-heavy that same afternoon. In the morning it might be slowly and savagely slugging its way through strong enemy defenses and in the afternoon be hurtling at breakneck speed in the exploitation. At one moment it might be attacking east to seize a vital bridge and minutes later might have swerved north to seize a guided missile site. The armored artilleryman must have a deep appreciation of the flexibility, mobility, and aggressiveness characteristic of the armored division.

To exploit these characteristics of armor, the artilleryman must understand the capabilities of the other elements in the division. He must understand how forces are tailored for each particular mission, and he must understand armor tactics, both in the offense and defense. These requirements enlarge the challenge facing the artilleryman.

However, by meeting these requirements he will be fully rewarded. He will have the satisfaction of knowing that he is a vital member of a team that represents the "Sunday Punch" of today's combined arms forces. He will be a part of a team that encourages originality and flexibility of mind, allows considerable freedom of action, and demands close coordination and teamwork. He'll enjoy the esprit de corps that General MacArthur referred to as, "the invincible esprit which . . . carries him to the vanguard of every advance, an irresistible force toward victory."

●

CORRECTION

An error appeared on page 52 of ARTILLERY TRENDS, February 1960. The diagram of the armored division artillery (figure 26) indicates one 155-mm howitzer battery in the rocket/howitzer battalion. There are *two* 155-mm howitzer batteries as correctly stated in the text on page 50.

A GEM FOR RADIO MAINTENANCE PERSONNEL

A handy tool for use by the radio or radar repairman in those "hard to get at places" is the hemostatic forceps, a surgical instrument. This instrument usually can be obtained from an aid station or hospital when it is discarded as unserviceable because of minor stains, rust, or wear. This versatile tool, which looks like a combination of scissors and long nose pliers, provides a means of reaching into small places that are inaccessible to the repairman using standard tools. The locking grip of the forceps makes it valuable as an aid in assembling small components or as a holding tool when soldering.

—Submitted by Maj Harry F. Sanborn
Dept of C & E, USAAMS

Moved recently? Been promoted? Unit re-designated? Advise the Extension Course Division, US Army Artillery and Missile School of any change in your status. Help the School to better serve you.

Simplified Site

Captain Frank J. Murray, USMC
US Marine Corps School
Quantico, Virginia

To reword a familiar phrase—"A second saved is a second earned." Seconds are important in the artillery, and when a second can be saved it helps. Much of this precious commodity is lost in the fire direction center when to figure site the vertical control operator (VCO) must determine from a map the altitude of a target in feet, then convert the feet to yards (meters) in order to determine the vertical interval (VI). Only after the VI is known can the VCO use the graphical site table (GST).

If the following suggested method is used the conversion from feet to yards (meters) is not necessary and there is no need for algebraic subtraction to determine the VI. The GST is prepared as follows:

(1) Place the target altitude scale on the upper (blank) portion of the GST.

(a) Set the "3" on the C scale directly over the "1" (left end) on the D scale. This places the index of the C scale over 3.33 on the D scale (3.33 yards = 10 feet and 33.3 yards = 100 feet).

(b) Move either edge of the cursor over the index of the C scale.

(c) Mark a vertical line along the upper portion of the edge of the cursor upon the blank portion of the GST. This vertical line corresponds to a target altitude greater than (or less than) the battery altitude in the amount of either 10 or 100 feet.

(d) Repeat the above process by placing the "3" on the C scale over the "1.1," "1.2," "1.3," etc., through "1.9," and "2.0" through "2.9" on the D scale. In the next position of the slide (3.0 on C scale over 3.0 on D scale), mark a vertical line over both indexes of the C scale. Continue graduating the target altitude scale, marking a line above the left C index with the "3" on the C scale over the "4.0," "5.0," "6.0," "7.0," "8.0," and "9.0" in turn on the D scale.

(2) Paste a strip of frosted acetate over the upper portion of the GST.

(3) Label the target altitude scale, using the altitude of the battery as a reference.

(a) The scale for targets below the battery is labeled with red pencil. Label the first vertical line which was determined previously in paragraphs (a), (b), and (c) of (1) for an altitude 10 feet below the battery. Then, label the next line to the right for an altitude 11 feet below the battery, the third line for an altitude 12 feet below, etc. This continues until the last line to the right has been labeled with an altitude of 30 feet below the battery. This first row of altitudes should be placed

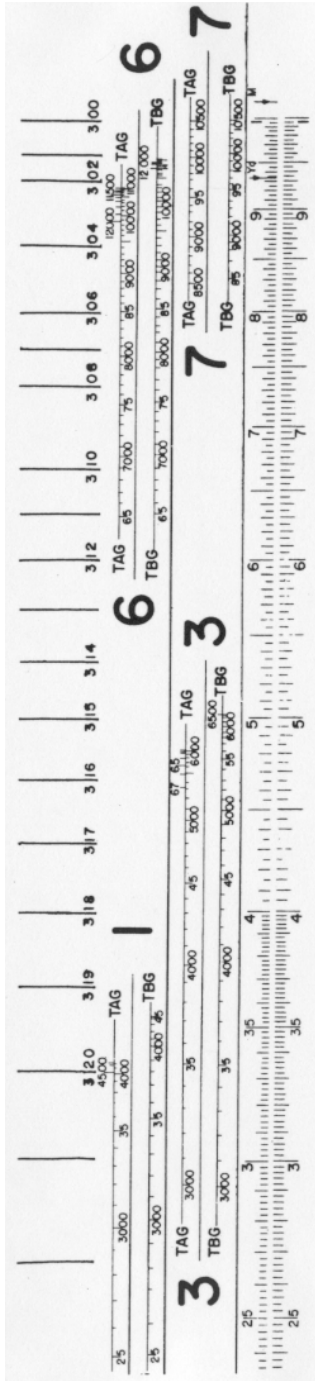

Figure 37. Right hand portion of scale reading 320 to 300.

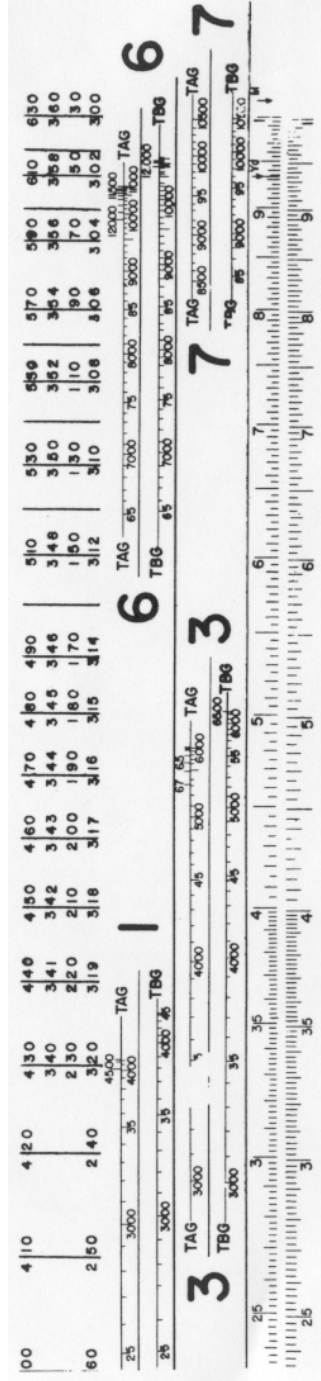

Figure 38. Entire reading from 30 below to 630 above.

near the bottom of the acetate, leaving enough room for three more rows of numbers above this set. Figure 37 has an illustration using a hypothetical battery "B" altitude of 330 feet. Thus, in this particular example, the scale should now read from 320 to 300. Next, label the vertical line on the left end of the acetate with the same altitude as on the right end of the scale—30 feet below the battery. Then, label the next line to the right for the altitude 40 feet below that of the battery, the next line for 50 feet below the battery, and continue to the right until all the lines have been labeled. The last line labeled should have an altitude of 90 feet below the battery. Continue labeling to the right with these new numbers written above the previous set. This second row of numbers on the right half of the scale will be for altitudes of 100 feet below the battery, 110 feet below, 120 feet below, and so forth until the line farthest to the right is reached with an altitude of 300 feet below the battery.

(b) The scale for targets above the battery is labeled with black pencil. The same procedure as described above is used for targets below the battery, however the word "above" is substituted for the word "below" in all cases. Thus, a line that has been labeled in *red* for an altitude at a particular distance *below* the battery should now further be labeled with *black* pencil for an altitude at the same distance *above* the battery.

(c) The target altitude scale now should read from an altitude of 300 feet below the battery to an altitude of 300 feet above the battery. Thus, in the example illustrated in figure 38, in which the battery is at an altitude of 330 feet, the numbers on the target altitude scale read from 30 feet to 630 feet.

(d) For two or more batteries at different altitudes, the computer must apply a correction. This is done by penciling a notation at the right end of the acetate to indicate the altitude of the reference battery and the altitude corrections for the remaining batteries (Altitude of B is 330—A+14, C-20). The computer would then add 14 feet to the announced target altitude when computing for battery "A" since it is 14 feet lower than battery "B."

The following steps are followed when computing angle of site:

(1) Set the hairline over the announced target altitude found on the acetate.

(2) Slide the range on the C scale under the hairline.

(3) Read the angle of site on the D scale opposite the YD gauge point.

To compute site—

(1) Set the hairline over the announced target altitude found on the acetate.

(2) Set the proper range (TAG or TBG) for charge desired under the hairline.

(3) Read the site on the D scale opposite the YD gauge point. The penciled altitudes are valid only for one position area. If the batteries move, the penciled altitudes on the acetate must be changed. If greater accuracy is desired, intermediate lines can be drawn on the

acetate between the longer vertical lines to aid in interpolating. The setup of the GST described in this article is for map altitudes given in feet. However, the same general technique can be used when map altitudes are given in yards or in meters with the following modification. With the VI in yards or meters dividing by 3 (to convert feet to yards) is unnecessary. Therefore, the vertical lines for the target altitude scale are drawn directly above the major graduations on the D scale. Then the leftmost line on the target altitude scale is labeled for 10 yards (meters) below the battery, the next line to the right as 11 yards (meters) below, etc. Thus, instead of beginning the target altitude scale near the middle of the GST, the scale is begun on the left end of the GST, eliminating the shift for converting feet to yards.

This method of "simplified site" is a time saver. It may only be minutes or seconds saved, but—"A second saved is a second earned."

●

A GEM FOR COMMUNICATION PERSONNEL

A handy field expedient for overheading field wire or cable in wooded areas can be made by using a lance pole (PO2) with a slingshot stock taped to one end. This aids in lifting a line to a limb or overhang.

The lance pole has several advantages over the pike pole. The lance pole is five feet longer than the pike pole and is in one section; the pike pole is in two sections and requires assembly. Also the lance pole can withstand more pressure.

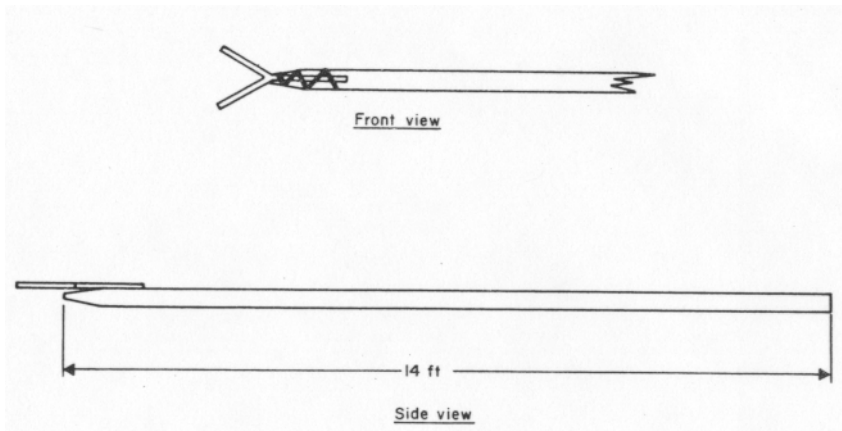

If you have experienced difficulty with broken wire lines in the ground, start collecting slingshot stocks and lay the wire overhead.

—Submitted by Sp5 J. L. Tate

Dept of C & E, USAAMS

DON'T GET CAUGHT SHORT WITH THE AN/GSA-7

Artillery units should be receiving the AN/GSA-7 radio set control (ARTILLERY TRENDS, December 1959) in the near future. One of the first things that must be done after receiving it is to verify the output of the 1,600-cycle ring on all RT66, RT67, and RT68 receiver-transmitters. The AN/GSA-7 will not ring through the telephone equipment if the ringer circuit on the receiver-transmitter is off frequency. Some receiver-transmitters will require adjustment so that the proper ringing signal will be emitted.

The following is a suggested procedure for this check:

(1) Assemble the equipment and prepare for operation as in the system illustrated in figure 39.

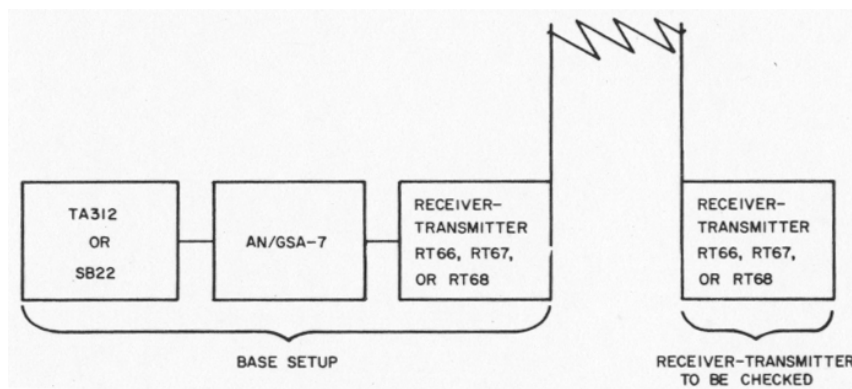

Figure 39. A system using the AN/GSA-7.

(2) Check the tuning of the receiver-transmitters with the vehicular antenna system.

(3) Set the volume controls to NORMAL (not maximum or minimum).

(4) Set the squelch control to OFF.

(5) Set the common frequency on the receiver-transmitters so that they net.

(6) Turn on the AN/GSA-7 and check the wiring.

(7) Hold the DIAL LIGHT (off-on) RING switch in the RING position on the receiver-transmitter to be checked. The telephone or switchboard should ring. If the telephone does not ring, tag the receiver-transmitter and continue checking the remaining receiver-transmitters until all have been verified.

(8) If the receiver-transmitter will not ring a telephone or switchboard through the AN/GSA-7, it must be adjusted by technically qualified personnel (field radio mechanic) to insure that the proper ringing signal is emitted (TM 11-289, December 1953, par 28b(3)).

(9) Recheck the adjusted receiver-transmitter as indicated above.

When this checkout procedure is followed, communication personnel in artillery units will not be caught short with equipment that will not work in a wire-radio integrated system.

A GEM FOR RADIO MAINTENANCE PERSONNEL

A safety stand for AN/PRC-8, -9 and -10 radio sets, for use when the set is removed from the case for repair, may be made from foam rubber and plywood. The stand provides an important safety feature—reduction of the electrical shock hazard, particularly when the repairman is working at a metal work bench. The cut in the edge of the stand provides a passage for wires from the test socket to a multimeter or other test instrument. It also reduces the possibility of breaking test cables, connectors, battery leads, and test probes.

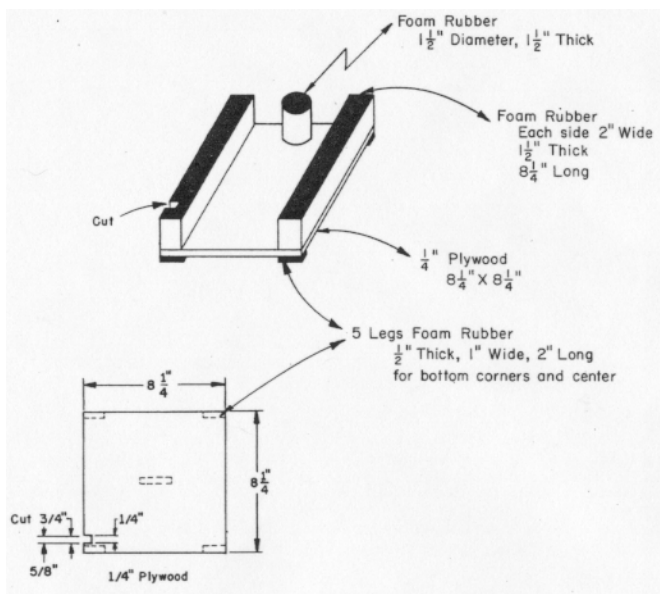

The stand may be constructed with one piece of 1/4-inch plywood, 8 1/4 inches square, with foam rubber attached as shown on the sketch.

—Submitted by Capt Alfred I. Rohler
Dept of C & E, USAAMS

The First Field Artillery Missile Brigade

Major Karl R. Liewer
1st Field Artillery Missile Brigade
Fort Sill, Oklahoma

All functions connected with the activation, training, and deployment of field artillery missile units now are grouped under one headquarters at Fort Sill—the 1st Field Artillery Missile Brigade.

To trace briefly the background of the Brigade, in October 1945, the 1st Guided Missile Battalion was activated at Fort Bliss. Its purpose was to insure that trained Army troops would be available when Army missile units became operational. In March 1952, the first field artillery guided missile units were activated and equipped with Corporal missiles. Later in 1952, the 2d Guided Missile Group was formed at Fort Bliss with the mission of supervising the training and deployment of surface-to-surface missile units. In 1957, the 3d Guided Missile Battalion of this group was moved to Fort Sill so that surface-to-surface missile training could be consolidated. This unit was redesignated the Field Artillery Missile Training Command at Fort Sill and, in August 1958, the name was changed to the 1st Field Artillery Missile Brigade.

Today, the principal functions of the Brigade are—

1. To supervise the activation, training, testing, and deployment of field artillery missile and warhead support units.
2. To conduct advanced individual training (AIT) programs in field artillery missile systems to provide fillers and replacements for US missile units.
3. To provide field artillery missile support for the US Army Artillery and Missile Center and School.
4. To support the annual service practice of field artillery missile units.
5. To provide troop participation in engineer-user tests and firings of field artillery missile units.
6. To operate telemetry and in-flight safety systems for field artillery missile firings as required.
7. To operate the US Army Missile Systems Evaluation Group.

The present organization of the brigade reflects its mission. The major elements of the command are a Headquarters and Headquarters Battery, the Missile Systems Evaluation Group, the 52d and 209th Artillery Groups, and the 1st and 2d Field Artillery Missile Training Battalions. In addition, separate warhead support groups are attached to the brigade during their period of training at Fort Sill. Two such groups have been activated and deployed.

The functional organization of the command is further reflected in the primary missions of its subordinate elements. For example, the 1st and 2d Field Artillery Missile Training Battalions conduct advanced individual training; the 52d Artillery Group supervises the activation, training, testing, and deployment of Lacrosse and Honest John Units;

and the 209th Artillery Group performs a similar mission for Corporal, Redstone, and other related missile systems. Both the 52d and 209th Artillery Groups provide support to the US Army Artillery and Missile School in the missile systems under their jurisdiction. Separate warhead support groups direct and coordinate the training and employment of subordinate field artillery detachments. The functions of the Missile Systems Evaluation Group are unique and will be discussed separately.

CENTRALIZED AIT

Past experience has shown that there is less interference with unit training programs and increased unit effectiveness when AIT is conducted centrally rather than by table of organization and equipment (TOE) units. The 1st and 2d Field Artillery Missile Training Battalions are organized into batteries, each of which teaches basic crewmen in a specific missile system. At present, there are Corporal, Redstone, Lacrosse, and Honest John instructor batteries. Little John, Sergeant, and Pershing will be added later. After eight weeks of instruction, graduating students are awarded the MOS for basic crewmen appropriate to their missile fields. On the basis of a survey of individual aptitude and demonstrated capability, certain students are trained according to their interest and aptitude and the needs of the service for a particular skill. For example, the Corporal program of instruction is subdivided into four separate fields—assembly and test, ground guidance, firing section and servicing section. Using Army-wide system requirements as a basis approximately one-third of each class receives instruction in assembly and test, one-fourth in firing section and servicing respectively, and the remainder in ground guidance.

Since the program began at Fort Sill two years ago, more than 2,350 (as of 30 January 1960) trained Corporal crewmen have been provided as replacements for the 12 active units. Although the Honest John, Redstone, and Lacrosse AIT programs are more recent, their output has been sufficient to meet Army requirements for newly activated units and for replacements in existing units. The Lacrosse AIT program has been the only source of trained filler personnel for newly activated units. A similar situation will be true for the Sergeant and Pershing systems.

Since the Lacrosse system was integrated into the artillery, eight Lacrosse battalions have been activated at Fort Sill and placed under the supervision of the 52d Artillery Group. The activation to deployment cycle normally is 6 to 7½ months, depending on the complexity of the missile system involved.

During the first six to eight weeks, key personnel are assigned to the battalion, equipment is drawn and checked out, and preparation for unit training is begun. In succeeding weeks, the battalion receives filler personnel from three sources—graduates of the appropriate missile courses conducted by either the 1st or 2d Missile Training Battalions, school-trained specialists from the Artillery and Missile School, and common specialists from Department of the Army resources. Unit training normally

begins about six to ten weeks after activation and lasts 13 weeks or more depending on equipment availability and serviceability.

BASIC AND ADVANCED PHASES

Training is broken down into basic and advanced unit training phases conducted according to the Army training program (ATP). As in other unit training programs, the culmination of the training is the Army training test (ATT). Nonfiring portions of the test are conducted at Fort Sill. Firing portions of the test are conducted at Fort Sill if the characteristics of the weapons system permit; otherwise, they are held at White Sands Missile Range, New Mexico. After having successfully completed the Army training test, the battalion returns to Fort Sill and prepares to assume its assigned role in the active Army.

Another important responsibility of the Brigade is the support of annual service practice at White Sands Missile Range (ARTILLERY TRENDS, October 1958). This is the sixth year in which annual surface-to-surface missile service practices have been conducted at White Sands. The Brigade provides both equipment and personnel support for these firings.

Firing tests for newly-activated Lacrosse battalions currently are being conducted at Fort Bliss, Texas, with unit equipment. After the installation of a Lacrosse in-flight safety system, these firings will be conducted at Fort Sill.

The Brigade and the US Army Artillery Board have participated jointly in the conduct of Redstone engineer-user tests at White Sands. The Brigade has provided personnel to render technical assistance from the Missile Systems Evaluation Group and tactical elements from the 209th Artillery Group. The experience gained from participation of a fully-equipped tactical unit in the engineer-user testing program has been one of the significant factors in cutting down the lead time from the start of the program until the system becomes operational. Continuation of the program in testing the Sergeant and Pershing is expected to contribute to the early readiness of these two new Army missile systems.

MISSILE SYSTEMS EVALUATION GROUP

The Missile Systems Evaluation Group consists of teams of specialists for each of the field artillery missile systems. Each team is qualified to give technical assistance to field artillery missile units "on-call" and worldwide. These teams monitor firings during training tests and annual service practices and conduct technical proficiency inspections of field artillery units as a part of Fourth Army inspection teams and for other Armies on request.

As a part of its mission of improving present missile systems techniques, the Missile Systems Evaluation Group records, collates, and evaluates data secured during training exercises and firings for use in later studies on the reliability, accuracy, and complexity of the systems. It also provides timely recommendations to the Artillery and Missile School for procedure changes and improvements in the various systems.

Since 1954, the Group's Corporal section has performed telemetry functions for all Corporal firings at White Sands. The purpose of these operations is to check the in-flight functioning of Corporal missiles and ground station. After careful study and evaluation, the telemetry data secured from each firing are used to determine the reliability of the system and to suggest areas for possible improvement.

The Lacrosse In-flight Safety Section is conducting studies which will enable tactical units to fire Lacrosse missiles at Fort Sill. This will simplify the conduct of Lacrosse unit training and later may be adapted for use at other artillery ranges where Lacrosse units are stationed.

The 1st Field Artillery Missile Brigade provides the US Army Artillery and Missile Center with a command headquarters to insure centralized supervision over a wide variety of related training and support activities in the missile field. As a result of its wide-spread operations, the 1st Field Artillery Missile Brigade is in the unique position of influencing the doctrine and techniques of all field artillery missile units and of helping to improve and refine the capabilities of field artillery missile organizations stationed throughout the world.

●

A GEM FOR THE SURVEY SECTION

A handy carrier for taping pins used by the survey party's front and rear tapemen permits free use of both hands. The carrier is simple in design and is constructed using an old taping pin mounted on a board. The reverse of the board has a loop of sufficient width to allow it to be attached to the pistol cartridge belt. A coat hanger, or wire of sufficient strength may be used in place of the old taping pin.

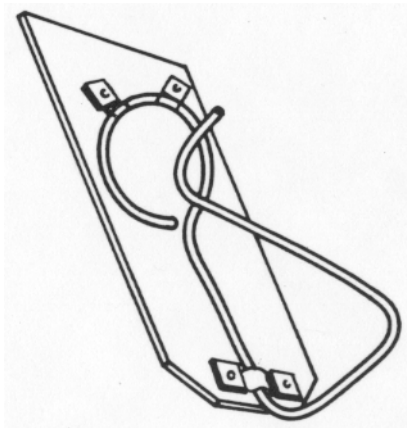

—Submitted by 1st Lt William J. Spradley
23d Missile Detachment
Fort Sill, Oklahoma

BATTERY EXECUTIVE OFFICER NOW CONTROLS FIRE DIRECTION

"This is Bunker 9, send your fire mission, over" . . . then just seconds later—"Battery, three rounds . . . Fire!" Normally the battery executive officer would have been directly concerned only with the latter command. Now, however, besides maintaining complete supervision over his gun sections, he controls fire direction within the battery. The executive officer's command post (XOCP) is the firing battery headquarters with established communications (ARTILLERY TRENDS, June 1959).

The fire direction officer has been deleted from tables of organization and equipment, and the terms "Exec's Post" and "Battery FDC" are being eliminated in FM 6-140, *The Field Artillery Battery*, currently under revision and due to be submitted to USCONARC in June 1960.

The XOCP is normally comprised of the fire direction computer, chart operator, recorder, radiotelephone operator (if required), and the executive or his authorized representative. Communications include radio or wire contact with battalion FDC, wire lines from the MX 155 switching kit to each gun and, as time permits, a wire line to the battery switchboard.

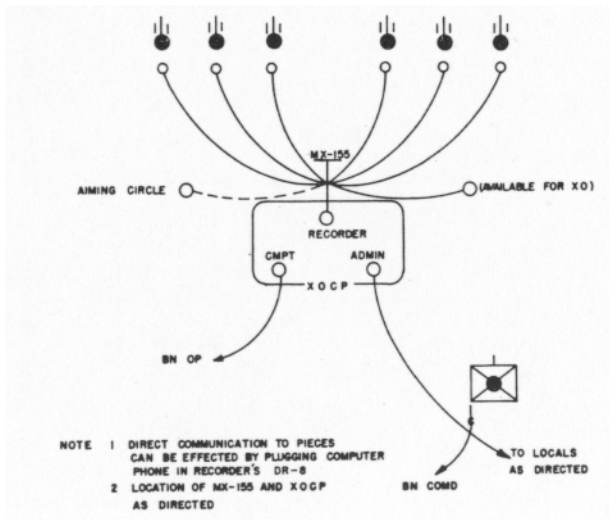

Figure 40. Type battery wire system.

The executive officer maintains control of the firing battery from his command post (CP) or elsewhere, as necessary. If he carries a head-and-chest set that can be plugged into any gun phone, his flexibility is increased. Physical location of personnel and equipment can be varied to meet changing conditions. The XOCP is usually located about 50 meters to the rear of the guns.

The XOCP permits flexibility in the use of personnel. If the state of training permits, fire commands can be transmitted directly to the guns from battalion FDC. This direct transmission results in greater speed in delivering fire on targets. If the battalion commander feels that his battalion FDC is sufficiently trained and capable of rapid computation and transmission of accurate fire commands, he will probably prefer that the battalion FDC transmit fire commands direct to the guns in a battalion mission, with battery personnel monitoring. If the battalion commander prefers that the battery relay commands from battalion to its guns, or produce its own fire commands, the XOCP provides this capability, as shown by the solid lines in figure 40.

An advantage of the XOCP is that the battery executive officer can control the firing of his firing battery, and maintain close supervision over fire direction activities. Also, one installation is substituted for two installations. This reduces the number of transmissions required to fire a mission, saves time, and eliminates the chance for error. Communications are simplified and more easily installed, too.



A GEM FOR THE FORWARD OBSERVER

The rifle company in the Infantry Division has two 106-mm recoilless rifles. The M92D sight on the 106-mm recoilless rifle permits the determination of the range to targets hit by the rifle or the spotting rifle that is a component of the weapon. Range may be determined from firing the recoilless rifle up to 2,200 yards and from firing the spotting rifle up to 1,200 yards. The forward observer should seek range data from any 106-mm recoilless rifle squad near his observation post. This range data can be a great aid in determining observer-target distance.

—Submitted by 2d Lt Cosmo M. Barone, Inf
Company C, 3rd Battle Group
1st Brigade
Fort Ord, California

Review gunnery and tactics through enrollment in selected sub-courses of the Artillery Extension Course Program.

Are you an *active* member of the 21,000 extension course students of the US Army Artillery and Missile School?

NEW NOTES FOR ARTILLERYMEN

NEW 8-INCH HOWITZER GRAPHICAL EQUIPMENT

The US Army Artillery and Missile School has developed graphical firing tables (GFT) and a graphical site table (GST) for use with FT 8-J-2, the new 8-inch howitzer tabular firing table published in February 1958. The GFT's and GST have been evaluated and recommended by the US Army Artillery Board for issue to 8-inch howitzer units.

Paper scales of the GFT's and GST were distributed to 8-inch howitzer battalions and to 8-inch howitzer divisional artillery batteries. The scales can be mounted on present GFT's and GST's with rubber cement or a similar adhesive that will not "bleed" through the paper.

When the scales are mounted, the GFT's and GST, together with the aluminum range deflection protractor, provide the 8-inch howitzer unit with a complete set of graphical equipment to match FT 8-J-2.

When FT 8-J-3 is published (scheduled for calendar year 1960), the School anticipates that the new GFT's and GST will be issued concurrently with the firing tables. The new GFT's will be of the same size

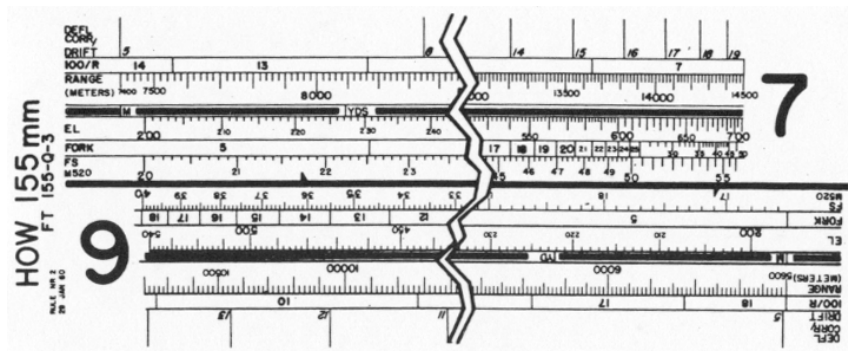

Figure 41. Cutout portion of new 155-mm howitzer GFT. Note the differences from current GFT's.

(15" × 2½") and format as GFT's being developed for the new FT 155-Q-3 (fig 41). The new GST will be of current design (size 14½" × 2").

Users of the graphical equipment are cautioned to be certain that the equipment matches the tabular equipment which it was designed to supplement.

NATO TO HAVE STANDARD MET MESSAGE

The North Atlantic Treaty Organization (NATO) countries have agreed on a standard meteorological (met) message, its principal advantage

being that a message produced by any NATO met station can be used by any NATO artillery unit. Proposed implementation date for the new message is 1 July 1961.

The NATO met message will provide essentially the same ballistic data as the current met message, except that wind speed will be given in knots, and temperature will be given in percent of standard temperature. The NATO met message is based on the International Civil Aviation Organization (ICAO) atmosphere instead of the Ordnance standard atmosphere currently used for the US met message.

The NATO met message, with the ICAO atmosphere and the conversion to the metric system (ARTILLERY TRENDS, June 1959), will necessitate publication of new firing tables. The new firing tables will contain a complete description of the NATO met message.

NEW FIRING TABLES FOR CANNON ARTILLERY

The advent of the NATO meteorological message has necessitated the publication of new firing tables for cannon artillery. To insure that the firing tables are in the hands of units when the NATO met message is implemented, publication of new firing tables has been initiated. The first firing tables, FT 155-Q-3 (155-mm how) is expected to be issued to units in July 1960.

Use of firing tables for high explosive ammunition should be initiated with new GFT's and GST's, which are expected to be issued concurrently with the new firing tables.

New firing tables will be printed in a simple, one-dimensional format and will be based on the NATO met message, the ICAO atmosphere, and the metric system. The tables will give unit range corrections in meters. The introduction to the tables describes in detail the use of the firing tables.

Since the firing tables are based on the NATO met message, which will not be implemented until 1 July 1961, a problem is created: "How can we use the US message with the new firing tables?" A change 1 to be issued with each new firing tables published prior to 1 July 1961 will solve this problem. This change contains instructions and tables that convert US met data to NATO data.

Change 1 does not replace any pages or information in the new firing tables but will supplement the tables during the transition period.

CAREER COURSES REVISED

The titles and basic structure of officer career courses at the US Army Artillery and Missile School have been changed for fiscal year 1961.

The Field Artillery Officer Basic Course will be cut from 12 weeks to eight weeks and will be known as the Field Artillery Officer Orientation Course. The course still is designed for newly commissioned reserve second lieutenants (ARTILLERY TRENDS, June 1959).

The Field Artillery Officer Familiarization Course is a new course which will run nine weeks. It is designed for branch transfers.

The regular Officer Advanced Course will be extended to 42 weeks and will be called the Artillery Officer Career Course.

The title of the Associate Field Artillery Officer Advanced Course has been changed to Associate Field Artillery Officer Career Course (AFAOCC).

NEW LACROSSE BATTALION FORMED

The 5th Missile Battalion, 33d Artillery, was activated at Fort Sill in March 1960. The Army's 7th and newest Lacrosse battalion is attached to the 1st Field Artillery Missile Brigade.

Other Lacrosse missile battalions formed here this year were the 5th Missile Battalion, 40th Artillery in January, and the 5th Missile Battalion, 39th Artillery in February.

PRODUCTION STARTED ON LITTLE JOHN ROCKET

The Army Rocket and Guided Missile Agency (ARGMA) has released the Little John rocket for industrial production. The system was developed by ARGMA with the assistance of industry and other Army ordnance installations.

The Little John is only 14 feet long and 12.5 inches in diameter, but it can deliver either a nuclear or conventional warhead to ranges beyond 10 miles.

A crew of nine men demonstrated the mobility of the Little John system last December at Fort Sill, Oklahoma. Employing two H34 helicopters under simulated battlefield conditions, the rocket was emplaced, fired, and displaced in 10 minutes.

The system was flight tested at White Sands Missile Range, New Mexico, and parachute delivery operations were successfully conducted at Fort Bragg, North Carolina.

REPLACEMENT FOR SWITCHBOARD SB-18/GT

The luminous dots on the plugs in the SB-18/GT switchboard are a radiation hazard to operating personnel. To aid in removing the radioactive items from the field and from the supply system, nonluminous replacements have been authorized. Nomenclature for the nonradioactive, nonluminous replacements was established as follows:

- (1) Switchboard, telephone, manual SB-993()/GT replacing SB-18/GT.
- (2) Adapter, connector U184()/GT replacing U4/GT.
- (3) Case, switchboard CY-2589()/GT replacing CY-229/GT.
- (4) Holder, adapter, connector MT-2156()/GT replacing MT-313/GT.

LIGHTWEIGHT BINOCULARS

Two new military binoculars have been developed by an ordnance-industry team composed of the Research and Development Group of Frankford Arsenal and the Farrand Optical Company. The new instruments fulfill three important functions. They satisfy an important military

need for small-size and lightweight binoculars, provide a basis for interservice binocular standardization, and can be included in the Modern Army Maintenance System (MAMS) concept of simplified maintenance and supply. The two new binoculars are designated the T13 and T14. The T13 weighs approximately 10 ounces and has 6-power magnification; the T14 weighs approximately 25 ounces and has 7-power magnification. A limited number of each instrument has been produced, and presently are undergoing field tests by the US Continental Army Command.

ELECTRONIC TROUBLESHOOTING

Electronic equipment working much like a doctor's stethoscope to pinpoint sources of malfunctions and potential breakdowns may revolutionize methods of inspecting motor vehicles. Now being studied by ordnance at Frankford Arsenal, Philadelphia, Pennsylvania, the new method of troubleshooting engines and electrical systems could result in large savings in money and manpower by eliminating unnecessary maintenance and servicing. Concept of the system calls for a digital computer which would receive information from transducers or microphones attached to various components. The information received would be matched against predetermined standards and tolerances to provide a basis for judging the working condition of the vehicle.

'STA 2' LIGHT TANK

The Japanese have developed a 35-ton light tank which mounts a high velocity 90-mm gun plus two machineguns. The STA 2 is only 79 inches high and is equipped with a 550 horsepower air-cooled diesel engine. Operated by a four man crew, it affords up to 75-mm of armor protection.

"QUICKSERVE" MEALS

A family of 21 "quickserve" meals is under development by the quartermaster corps and is slated for taste-testing in 1961, according to the Materiel Development Section of US Continental Army Command. The section is engaged in determining the kind of food a combat soldier needs and can carry with the least inconvenience. One result from these studies is a "6-in-1" precooked, dehydrated meal served on a disposable tray. It will contain, for example, hot chicken slices or fried pork chops, hot salted lima beans, onion soup, pasteurized bread, and cake. Several variations have been devised.

HELICOPTER INDUSTRY LOOKS AT THE FUTURE

An 8-inch howitzer or 280-mm gun carried by a helicopter? Preposterous! Maybe not. Speeds up to 350 miles an hour and payloads up to 50 tons are within the capabilities of today's helicopter industry. Expanded research and development activity is the main prerequisite for creating such aircraft.

Such a development in the helicopter industry would go a long way toward meeting the Army's requirements for a low-flying, slow-moving tactical aircraft with high payload capabilities.

A Sikorsky Aircraft spokesman was quoted in *Armed Forces Management*, February 1960. He said, "Research results indicate that the helicopter can be designed to achieve speeds from 200 to 300 miles an hour by various means . . . these include greatly increasing negative blade twist to delay blade stall on the helicopter's retreating blade; increasing rotor solidity by adding more blades; and using such auxiliary forward propulsion as turbine engines with conventional airplane propellers."

He said that fixed wings provide added lift and promise greater speeds and that helicopters will be able to carry 50-ton payloads by 1970. The spokesman said that design work already is in progress on a craft which can carry 20 tons a range of 50 miles.

NEW PUBLICATIONS FOR RADAR MECHANIC INSTRUCTION

A new series of instructional notes containing circuit diagrams and illustrations will be used as the primary reference for radar mechanic instruction at the US Army Artillery and Missile School.

The following publications are available for purchase at the School Book Department: Radar Set AN/TPS-25 Circuit Diagrams; RM 500, Principles of Operation, AC and DC Distribution Systems, and Low Voltage Power Supplies; RM 510, Transmitting, RF, and Receiving Systems; RM 520, Range, Audio, and Indicating Systems; and RM 530, Antenna Positioning and Computer Systems.

●

THINK!

Yes, think! Then share your valuable ideas and experience with artillerymen worldwide by putting your knowledge in writing and sending it to the US Army Artillery and Missile School, Attn: ARTILLERY TRENDS.

Who reads ARTILLERY TRENDS? Seven copies go to each artillery battalion and five issues are sent to each division artillery headquarters, artillery group headquarters, and corps artillery headquarters.

NOTICE

The stock of 1957 and 1958 issues of ARTILLERY TRENDS is depleted.

STATUS OF TRAINING LITERATURE

1. The following training literature is under preparation or revision by the US Army Artillery and Missile School.

A. Field Manuals (FM):

- 6-20 FA Tactics and Techniques
- 6-25 FA Missile Group, Redstone (U)
- 6-35 FA Missile, Redstone
- 6-35A FA Missile, Redstone, Missile Technical Firing Operations
- 6-40 FA Gunnery
- 6-45 FA Missile Battalion, Lacrosse
- 6-75 105-mm Howitzer, M2 Series, Towed
- 6-81 155-mm Howitzer, M1, Towed
- 6-90 8-inch Howitzer, M2, Towed
- 6-120 FA Target Acquisition Battalion and Batteries
- 6-140 FA Battery
- 6-() The Field Artillery Rocket, Honest John w/Launcher XM 33
- 6-() Radar Set, AN/MPQ-4

B. Technical Manuals (TM):

- 6-200 Artillery Survey
- 6-241 Meteorology Tables for Artillery
- 6-242 Meteorology for Artillery

C. Army Training Tests (ATT):

- 6-585 FA Missile Battalion, Lacrosse
- 6-630 FA Missile Group, Redstone

2. Training literature submitted to USCONARC:

- FM 6-33 Warhead Section, M34 and M35 (Corporal) (U)
- FM 6-97 Change 1, Projectile: Atomic, M366; and Atomic Training, M369; 280-mm Gun (U)
- FM 6-98 Change 1, Projectile: Atomic, T317E1; Atomic Training, T349E1; and T347; 8-inch Howitzer (U)
- FM 6-156 Warhead Section, M24, M25, M26 and M29 (Honest John) (U)
- FM 6-() Warhead Section, XM13, XM55 and XM16 (Lacrosse) (U)
- FM 6-() Warhead Section, XM18, XM30, XM31 and XM33 (Redstone) (U)

ATP 145-1-6 Program of Instruction for FA Reserve Officer Training Corps

ATP () Training Program for non-unit obligors

ATT 6-() FA Howitzer Battery, 8-inch, Infantry Division

3. Training literature at the Government Printing Office:

- ATT 6-11 Change 1, FA Missile Battalions and Batteries, 762-mm
- ATT 6-135 FA Rocket/Howitzer Battalion (Infantry Division)
- FM 21-13 The Soldiers Guide
- FM 6-() FA Rocket, Honest John w/Launcher M386

4. Training literature recently printed:
 - FM 6-21 Division Artillery (includes infantry, armored and airborne)
 - FM 6-40 Change 2, FA Gunnery
 - FM 6-44 FA Missile, Lacrosse
 - FM 6-60 The FA Rocket, Honest John w/Launcher M289
 - FM 6-61 FA Missile Battalion, Honest John Rocket
5. Artillery training films currently under production and scheduled for release during calendar year 1960:
 - Artillery Battalion Survey
 - Part II. Planning and Execution (25 minutes)
 - Extension of Direction for Artillery by Simultaneous Observation (25 minutes)
 - Countermortar Radar AN/MPQ-4A (25 minutes)
 - Lacrosse Battalion Guidance Section
 - Part I. Duties in prepare for action and march order (25 minutes)
 - Lacrosse Battalion Assembly Section—Crew duties in prepare for action, check-out and assembly, and march order (25 minutes)
6. Artillery training films production completed and scheduled for release in calendar year 1960:
 - Artillery Battalion Survey
 - Part I. Methods (TF 6-2800) (25 minutes)
7. Artillery training films scheduled for production and release during calendar year 1960:
 - Field Artillery Sound Ranging
 - Field Artillery Target Acquisition Battalion
 - Introduction to Flash Ranging
 - Lacrosse Battalion—RSOP
 - Lacrosse Battalion—Guidance Section
 - Part II. Duties in Firing Lacrosse
 - Lacrosse Battalion—Firing Section—Crew duties in prepare for action, firing, and march order.
8. Artillery training films recently released:
 - Weapons of the Field Artillery (TF 6-2804) (30 minutes)
 - Artillery Orientation by Sun and Star
 - Part I. Altitude Method (TF 6-2850) (30 minutes)
9. MOS. Army Subject Schedules under preparation by the US Army Artillery and Missile School:
 - ASubjScd 6-103 MOS Technical Training of the Ballistic Meteorology Crewman
 - ASubjScd 6-141 MOS Technical Training of the Light and Medium FA Crewman
 - ASubjScd 6-152 MOS Technical Training of the FA Operations and Intelligence Assistant
 - ASubjScd 6-153 MOS Technical Training of the Artillery Surveyor

- | | |
|---|---|
| ASubjScd 6-155 | MOS Technical Training of the Sound Ranging Crewman |
| ASubjScd 6-156 | MOS Technical Training of the Radar Crewman |
| 10. Non MOS Army Subject Schedules submitted to USCONARC: | |
| ASubjScd 6-1 | Care and Handling of Ammunition |
| ASubjScd 6-5 | Communications training for sections and platoons |
| ASubjScd 6-7 | Duties of the Battery Recorder and Computer |
| ASubjScd 6-13 | Operation of the Fire Direction Center |
| ASubjScd 6-18 | Mobility |
| ASubjScd 6-23 | Operation, adjustments, and maintenance of Sound Ranging Set GR-8 |
| ASubjScd 6-24 | Organization and duties of Operations section, FA Observation Battalion |
| ASubjScd 6-25 | Construction of Sound Ranging plotting chart |
| ASubjScd 6-31 | Visibility Diagram (Charts) |
| ASubjScd 6-42 | Difficult traction and field expedients |
| ASubjScd 6-50 | Air movement |

ARTILLERY INFORMATION LETTERS

The following artillery information letters containing items of technical nature have been published by the US Army Artillery and Missile School during calendar year 1960. Distribution is made *only* to the units and their controlling headquarters which are authorized the equipment discussed in these letters:

- HONEST JOHN INFORMATION LETTER NUMBER 16 dated 17 January 1960
- HONEST JOHN INFORMATION LETTER NUMBER 17 dated 11 February 1960
- HONEST JOHN INFORMATION LETTER NUMBER 18 dated 12 February 1960
- CORPORAL INFORMATION LETTER NUMBER 15 dated 25 February 1960
- CORPORAL INFORMATION LETTER NUMBER 16 dated 6 April 1960
- METRO INFORMATION LETTER NUMBER 4 dated 21 January 1960
- REDSTONE INFORMATION LETTER NUMBER 1 dated 4 March 1960
- 8-INCH AND 280-MM GUN NUCLEAR PROJECTILE ASSEMBLY SPECIALIST dated 24 March 1960
- WILD T16 THEODOLITE dated 12 April 1960

A GEM FOR THE FIRE DIRECTION CENTER

The ideal charge to be used in firing a particular mission can be determined conveniently and rapidly by using a CHARGE SELECTOR.

By extracting the ideal charge ranges from appropriate 105-mm howitzer graphical firing tables (GFT), a selector can be constructed by using transparent material as shown below. The scale to be used is

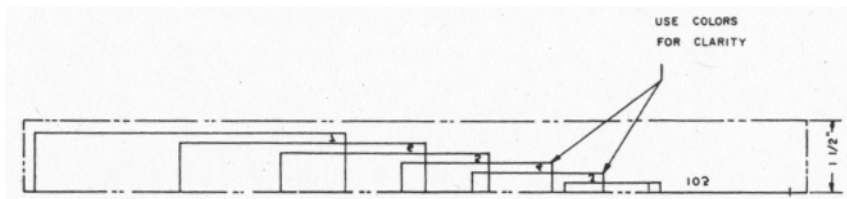

100 yards of range equal to 0.144 inches. The scale is placed on the reverse side of the plastic protractor fan, with the tick mark centered on the vertex of the fan. The scale is secured to the protractor with scotch tape or glue, and then the edges are trimmed. The numbers 1 through 7 are drawn backwards so they will appear in the proper perspective on the under side of the fan.

For composite battalions, a similar selector can be constructed for the 155-mm howitzer battery. One selector can be placed on the HCO fan and the other on the VCO fan.

By placing the vertex of the fan on the battery center and the arm against the plotting needle in the target location, the ideal charge is easily determined as shown below.

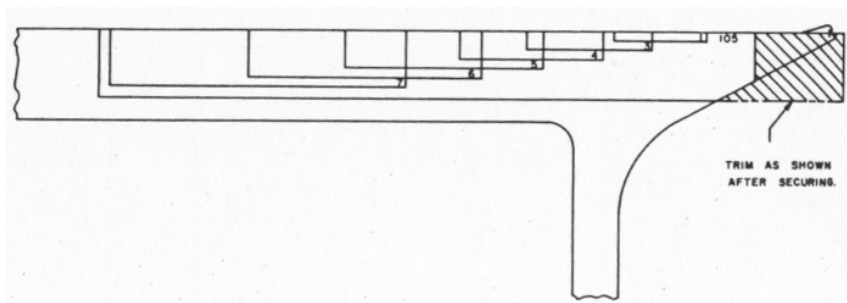

—Submitted by 1st Lt John E. Ballweg
5th How Bn, 20th Arty
102d Inf Div