

# ARTILLERY TRENDS

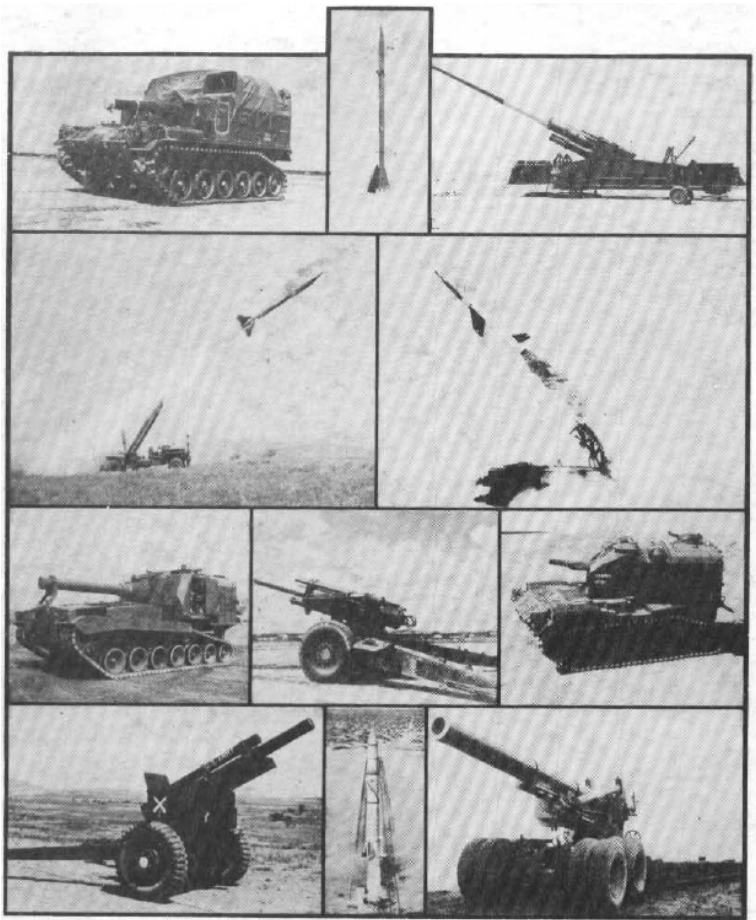

U S Army Artillery and Missile School



February 1960

# ARTILLERY TRENDS

<u>Contents</u>	<u>Page</u>
Weapons of the Artillery--8 -----	2
Adjustment of Artillery Fire by Radar-----	3
Death by Radio--The CVT Fuze-----	7
The Little Known Front -----	13
Allied Artillery Missiles -----	16
New Radiotelephone Procedure for the New Fire Direction System -----	21
US Army Training Center, Field Artillery -----	28
Project Metro Precision-----	36
New Equipment Technical Publication System-----	39
The Armored Division--A Combined Arms Team-----	42
US Army Reserve Schools and Staff Training Program -----	54
Fast and Reliable Remoting -----	58
Officer Candidate School Today -----	61
Commercial Hydrogen for Meteorological Balloons -----	64
Newsnotes for Artillerymen-----	66



**INSTRUCTIONAL AID NUMBER 12**

# WEAPONS of the ARTILLERY---8

## Redstone Missile

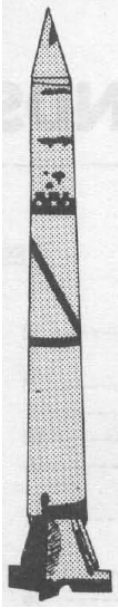

### MISSILE CHARACTERISTICS

Length--fully assembled 21.1 meters (69' 4")

Diameter--1.8 meters (70")

Loaded weight--28,000 KG (61,700 pounds)

Empty weight--7,420 KG (16,300 pounds)

Range (maximum)--320 KM (200 statute miles)

Propellants:

Oxidizer--liquid oxygen, 11,370 KG (25,000 pounds)

Fuel--75 percent alcohol plus 25 percent water, 8,650 KG (19,000 pounds)

Steam source--hydrogen peroxide, 359 KG (854 pounds)

Thrust--35,200 KG (78,000 pounds) for 96 to 121 seconds

Guidance--inertial

Warhead--nuclear, 3,590 KG (7,900 pounds) total nose section weight

Mobility--100 percent, and air transportable

Vulnerability--considered invulnerable to any presently known electronic countermeasures

Time required to emplace weapon and fire--approximately 6½ hours

Fire control equipment-- T2 Theodolite and missile porro prism

### TRAINING REFERENCES

FM 6- ( ), Warhead Section, XM18, XM30, XM31, and XM33, Redstone

FM 6-25, FA Missile Group, Redstone

FM 6-35, FA Missile, Redstone

FM 6-35A, FA Missile, Redstone, Missile Technical Firing Operation

Tables of Organization:

6-630T, FA Msl Gp (Red) (21 May 58)

6-631T, Hq & Hq Btry, FA Msl Gp (Red) (21 May 58)

6-634T, FA Msl Btry (Red) (21 May 58)

5-464T, Engr Co (Red)(3 Mar 58)

9-217T, Ord Co (Red)(3 Mar 58)

NOTE: Revised TOE's have been submitted to USCONARC for approval.

Army Training Test:

ATT 6-630 FA Msl Gp, 28 Oct 58

# ADJUSTMENT OF ARTILLERY FIRE BY RADAR

First Lieutenant Allen W. Brown, Jr., USMC  
Department of Target Acquisition

Since the days of the catapult the plight of the artilleryman has been to obtain accurate artillery fire during periods of little or no visibility and under conditions where targets are not within the scope of identification by an observing agency.

The artillery always has sought ways and means to overcome this problem, however, it was not until the Korean conflict that a real advancement was made--the development of the AN/MPQ-10 radar. The AN/MPQ-10 radar not only could locate targets during periods of poor visibility, but it also provided a means for adjusting fire on enemy positions. This bright spot was made brighter by the fact that the relative locations of gun positions and the radar position did not have to be established by survey.

Two inherent limitations in the established procedure must be considered. To insure maximum destruction of the unobserved target, a large volume of fire must be used during fire for effect. Also, the procedure is time consuming. Normal corrections take several minutes from the time the projectile is tracked by the radar until corrections are sent to the fire direction center (FDC). This article discusses a procedure to minimize this latter limitation.

Range corrections are relatively simple in that the corrections are computed or measured by taking the difference between the burst range and the radar-target (OT) range. Under current doctrine (FM 6-160), subsequent corrections in deflection are computed mathematically, based on the value of the angular variation between the target azimuth and the burst azimuth. By using the value of this angle with the radar-target (OT) distance and the mil-relation formula ( $W/RM$ ), a deflection shift is computed, This takes time and introduces a possible mathematical error, or a "shift error" (reporting corrections in the wrong direction).

More accuracy in deflection shifts and fewer "grocery store" arithmetic errors will result from a procedure using the target grid. The target location determined by the radar is plotted on a grid sheet in the radar operations center. The radar position already has been plotted and azimuth indexes have been drawn. The target grid is centered over the target. Orientation of the target grid is accomplished by placing the range-deflection protractor (aluminum) over the target grid with the vertex at the plotted location of the radar and the straight edge against the pin in the target location. The target grid is then rotated until the arrow lies along the straight edge of the range deflection protractor with the arrow pointed



away from the radar position. The target grid now is oriented; it is secured to the grid sheet with masking tape.

The location of the adjusting round burst is determined by the radar. Range and azimuth to the burst are plotted with the range-deflection protractor, and a plotting needle is used to mark the burst location. Corrections are read from the target grid. These corrections are the required changes in range and deflection to move the subsequent burst to the target as seen by the observer--the radar. Corrections in meters can be sent directly to the FDC by using a metric target grid, thereby eliminating the time spent in conversion.

### Illustrative Problem

- SITUATION: (a) A radar section of an observation battalion lettered battery will adjust the fires of a 105-mm howitzer battery.
- (b) The relative locations of the radar and the firing battery have not been established by survey. The battery FDC

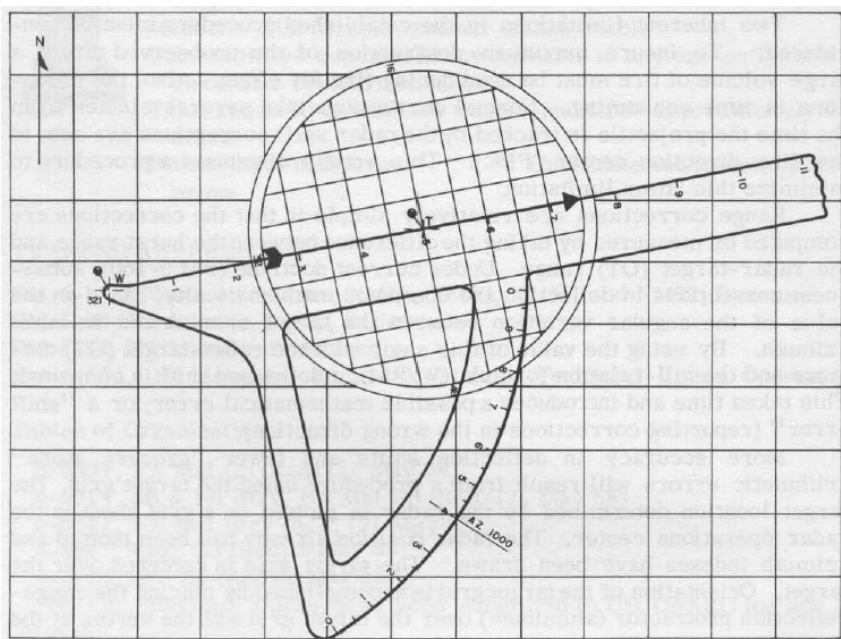

Figure 1. The target grid oriented.

has notified the radar of the general positions of the firing battery and target areas.

- (c) A hostile weapon has been located at azimuth 1400 mils at a distance of 5,000 yards (4,550 meters) from the radar.

DETERMINATION OF PICK-UP DATA:

When the hostile weapon is located, the following report is made to the FDC: THIS IS RADAR, FIRE MISSION, AZIMUTH 1400, DISTANCE 4,550 METERS, ENEMY

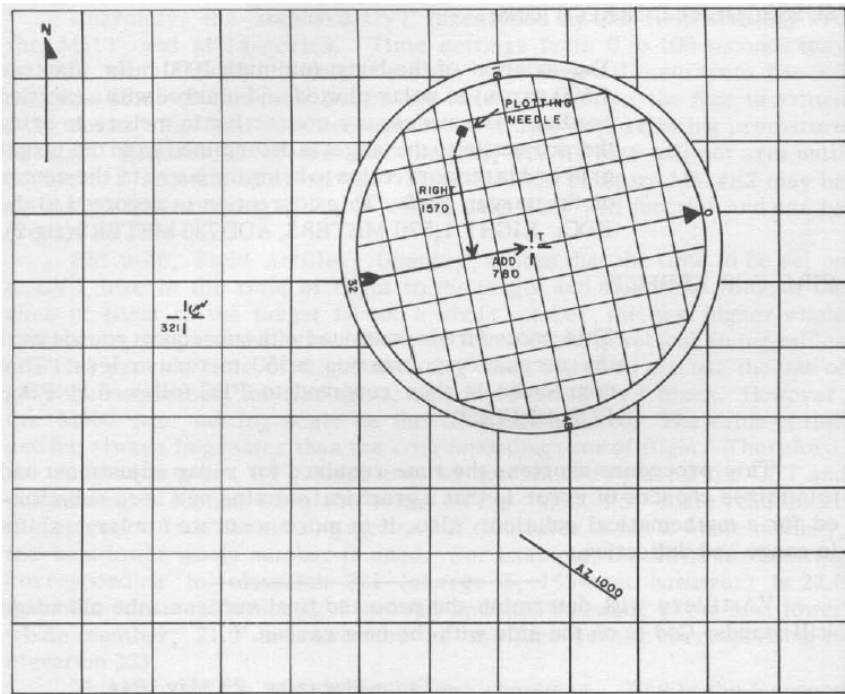

Figure 2. Determining corrections (target at range 5,000 yards, azimuth 1400 mils; round lands at range 4,500 yards, azimuth 1000 mils).

WEAPON, ONE ROUND AT MY COMMAND, WILL ADJUST. Simultaneously with the report, the radar control unit operator places the azimuth handwheel in the sector scan position, and the plotter plots the target and orients his target grid (fig 1). The adjusting battery reports READY and the radar officer commands FIRE. The control unit operator detects the projectile on the B-scope and determines the pickup data to the projectile. The radar officer then reports to FDC: REPEAT RANGE. Upon the report of READY, the radar officer alerts the control unit operator and then commands FIRE. The projectile is tracked. By extrapolating the plot, the plot reader determines the burst location of azimuth 1000 mils and range 4,500 yards.

#### SUBSEQUENT CORRECTIONS:

The location of the burst (azimuth 1000 mils, distance 4,500 yards) is polar plotted and marked with a plotting needle. The necessary correction in meters to bring the projectile to the target is determined from the target grid and is the correction to bring the burst to the center of the target grid. This correction is reported to the FDC: RIGHT 1,570 METERS, ADD780 METERS (fig 2).

#### FIRE FOR EFFECT:

This procedure is continued with subsequent rounds until the necessary correction is 50 meters or less. This correction is then reported to FDC followed by FIRE FOR EFFECT.

This procedure shortens the time required for radar adjustment and minimizes chances of error in that a graphical solution has been substituted for a mathematical solution. Also, it is more accurate for large shifts in range and deflection.

---

"Artillery will determine the pace and final success...the old adage still stands; God is on the side with the best cannon."

--Time Magazine, 22 May 1944

"Our artillery played a huge part all through the Mediterranean fighting."

--Ernie Pyle

# Death by radio----

## THE CVT FUZE

Major John G. Parker  
Department of Gunnery

Inquiries from the field indicate that there are questions concerning the use of the controlled variable time (CVT) fuze. The major problems with CVT fuzes are determining the proper fuze setting, computing the executive's minimum elevation (ME), and computing the minimum safe time for the fuzes.

Currently, the standard CVT fuzes used by the field artillery are the M513- and M514-series. Time settings from 0 to 100 seconds may be set on all fuzes of these series. The fuze will arm from 2 to 5.5 seconds prior to the time set on the fuze. Therefore, the fuze is armed only during the final few seconds of its trajectory, reducing premature bursts. Regardless of the fuze setting, a CVT fuze will not arm until at least 2 seconds after firing. Fuze M513E2 and fuze M514E2 may be set on point detonating (PD), in which case they will function and can be treated as fuze quick.

FM 6-40, Field Artillery Gunnery, states that the time to be set on a CVT fuze is the time of flight to the target and that if the value of the time of flight to the target is not a whole number, the next higher whole number is set on the fuze. None of the current graphical firing tables (GFT's) provide time of flight data nor does FM 6-40 discuss the use of graphical equipment for finding the time to be set on CVT fuzes. However, the M500 fuze setting scale on the GFT can be used. The value of this setting always is greater than the corresponding time of flight. Therefore, the fuze setting for CVT fuzes can be determined by using the GFT and subtracting 1 second from the value on the "M500 FS" scale read under the elevation (not the time) gageline. If this value is not a whole number, the next lower whole number is used. For example, the M500 fuze setting corresponding to elevation 331 (charge 5, 155-mm howitzer) is 22.6 seconds. After subtracting 1 second and then rounding to the next lower whole number, 21.0 is announced as the fuze setting corresponding to elevation 331.

This procedure may bring up two questions. Why is the 1 second subtracted and why is the elevation gageline used instead of the time gageline? The 1 second is subtracted because experience has shown that this procedure reduces the number of impact bursts. The elevation gageline is used because time of flight is being sought, and time of flight is a function of elevation. The time gageline is merely a portrayal of the correction to fuze settings for a particular lot of M500 fuzes.

### Minimum Elevation

The executive always computes minimum elevation (ME) for impact and time fuzes which will cause a projectile to clear the visible mask vertically by 5 yards. If CVT fuzes are to be fired, the executive also must compute another ME to be used whenever the time set on the CVT fuze is equal to or less than the sum of the time of flight to the mask plus 5.5 seconds. If the time set on the CVT fuze is greater than the sum of the time of flight to the mask plus 5.5 seconds, the ME computed for impact and time fuzes is applicable.

When the time set on the CVT fuze is equal to or less than the sum of the time of flight to the mask plus 5.5 seconds, it is possible that the fuze may be armed as it passes over the mask. Therefore, the executive's ME must be large enough to insure that the projectile will clear the mask by a vertical distance that will guarantee that a reflection from the mask will not activate the fuze. It also must be great enough that a random burst will be ineffective and cause no harm to the friendly occupants of the mask. The prescribed minimum clearances are listed in table 1.

<u>WEAPON</u>	<u>VERTICAL CLEARANCE</u>
<b>105-mm howitzer</b>	<b>80 yards</b>
<b>155-mm howitzer</b>	<b>100 yards</b>
<b>8-inch howitzer</b>	<b>150 yards</b>
<b>280-mm Gun</b>	<b>150 yards</b>

Table 1. Prescribed Minimum Clearances of the Mask.

Computing ME is sometimes complicated and time-consuming and has several areas where "grocery store" arithmetic errors are common. Therefore, a device (ME card) has been developed which will simplify ME computation. For comparison, the long method of computation will be reviewed first.

The first step in the computation of the executive's ME for CVT fuzes is to determine the range. If the time of flight to the mask is 2 seconds or greater, all computations are made at the mask range. However, if the time of flight to the mask is less than 2 seconds, the fuze is not armed when it passes over the visible crest. If this is the case, the executive makes all computations at a range corresponding to 2 seconds time of flight (arming time range). Arming time range is always short enough that it is assumed that it is shorter than the range to the frontlines. By computing at the arming time range, an ME that will clear any crest at a range which might be obscured by the visible crest is determined. Arming time range

is determined by entering the firing table at the appropriate charge and going down the time of flight column to the value 2.0 (or the next higher value if 2.0 is not listed) and then reading the range corresponding to that time of flight. Expressed another way, the range to the mask or the arming time range, whichever is greater, is used in computing the executive's ME for CVT fuzes.

### Five Angles

To compute the executive's ME, the following angles must be determined and added:

- (1) The greatest angle of site to the mask reported by the chiefs of section.
- (2) The vertical angle corresponding to the prescribed vertical clearance. The angle is computed by using the mil relation formula (mils =  $W/R$ ), where  $W$  is the vertical clearance, and  $R$  is the range (mask or arming time) divided by 1,000.
- (3) The complementary angle of site (comp site) determined by multiplying the sum of (1) and (2) above by the comp site factor for mask or arming time range.
- (4) Elevation for mask or arming time range.
- (5) Two forks at mask or arming time range.

If the sum of angles in (1) through (5) is not a whole number, it is rounded to the next higher whole number. That number is the value of the executive's ME to be used when a CVT fuze is fired with a fuze setting equal to or less than the sum of the time of flight to the mask plus 5.5 seconds.

For example, the chiefs of section have reported the following angles of site to the mask: +18, +20, +19, +19, +18, +19. The range to the mask is 500 yards and charge 5 is being used. The time of flight to the mask (from the firing table at range 500) is 1.5 seconds. The arming time range is 700 yards (corresponds to 2.1 seconds; 2.0 is not listed). The executive's ME is to be computed at arming time range, 700 yards, because that range is greater than mask range, 500 yards.

(1) Greatest angle of site reported	+20.0 mils
(2) Vertical clearance ( $m/ = 80/.7$ )	+114.3 mils
(3) Comp site ( $134.3 \times 0.0$ )	0.0 mils
(4) Elevation for 700 yards	+33.8 mils
(5) Two forks at 700 yards	+2.0 mils
Total	+170.1 mils

Therefore, the executive's ME to be used when the fuze setting on a CVT fuze is equal to or less than 7.0 seconds (time of flight to the mask. 1.5 seconds, plus 5.5 seconds) is +171 mils. When the fuze setting on a

**MINIMUM ELEVATION (Less angle of site)  
105-mm Howitzer, Fuze M513 Series**

Range to mask	CHARGE 3		CHARGE 4		CHARGE 5		CHARGE 6		CHARGE 7	
	El	Ti	El	Ti	El	Ti	El	Ti	El	Ti
200	203	6.3	175	6.2	151	6.1	130	6.0	105	5.9
400	203	7.1	175	6.9	151	6.7	130	6.5	105	6.3
600	187	7.8	175	7.6	151	7.3	130	7.0	105	6.7
800	174	8.6	155	8.3	141	7.9	130	7.5	105	7.1
1000	171	9.4	150	9.0	131	8.5	117	8.1	105	7.6
1200	177	10.3	151	9.7	128	9.1	112	8.6	96	8.0
1400	188	11.1	158	10.5	129	9.8	110	9.2	92	8.5
1600	201	11.9	167	11.2	137	10.4	111	9.8	90	8.9
1800	216	12.8	176	11.9	142	11.0	114	10.3	90	9.4
2000	233	13.6	189	12.7	148	11.7	118	10.9	91	9.9
2500	282	15.9	224	14.6	171	13.3	137	12.4	98	11.2

**Instructions:**

(1) Enter the table at range to mask, or the next lower listed range if the range to mask is not listed, and at the appropriate charge (s).

(2) To obtain the ME, add the greatest angle of site reported by the chiefs of section to the value listed in the table under El.

(3) The ME determined using this table is used when the fuze setting is equal to or less than the value listed in the table under Ti. If the fuze setting is greater than the time listed in this table, use the ME determined for fuze M500 and M51.

Figure 3. An ME card can be made for any caliber cannon.

CVT fuze is greater than 7.0 seconds, the ME to be used is that computed for fuze M500 and M51 (+56 mils). If the ME for CVT fuzes had been computed using the range to the mask, instead of arming time range, it would have been +206 mils. The lower value determined at arming time range is more desirable, since the fuze is unarmed when it passes over the visible portion of the mask.

The "ME card"

Determining the executive's ME can be simplified by using an ME card (fig 3). To determine the ME, it is only necessary to enter the table at the mask range and under the appropriate charge determine the value listed in the column headed EI. Add to that value the greatest angle of site reported by the chiefs of section. The ME thus determined is used only when the fuze setting on a CVT fuze is equal to or less than the value listed in the column headed Ti for the mask range and charge. This value may not be as accurate; however, it is safe.

A similar card can be made for any caliber cannon. The value listed in the column headed EI is the sum of the following angles:

- (1) The vertical angle corresponding to the prescribed vertical clearance, computed at the mask range or the arming time range, whichever is greater.
- (2) The complementary angle of site for a 300-mil angle of site determined by multiplying 300 by the comp site factor for mask range or arming time range, whichever is greater.
- (3) Elevation corresponding to mask range or arming time range, whichever is greater.
- (4) Two forks at mask range or arming time range, whichever is greater.

When the sum of these elements is not a whole number, the value is rounded to the next higher whole number. The value listed under Ti is the time of flight to the mask plus 5.5 seconds.

The last of the three problem areas concerns the determination of the minimum safe time for CVT fuzes by the safety officer. Prior to registration, the minimum time is determined. Two forks are added to the elevation to the minimum range. The time of flight corresponding to this elevation is determined. Then 5.5 seconds is added to that time. The result is the minimum safe time. For example, if the minimum range is 2,000 yards, the minimum safe time for CVT fuzes prior to registration for 105-mm howitzer, charge 4, is computed as follows:

Elevation for range 2,000 yards .....	136.5
Two forks at 2,000 yards .....	<u>6.0</u>
	142.5 mils



Time of flight corresponding to elevation 142.5 ..... 7.5 seconds  
+5.5

Minimum safe time for fuze M513 ..... 13.0 seconds

After registration, a GFT setting is determined and the minimum elevation is determined using that setting. The minimum safe time for CVT fuzes is determined by adding 5.5 seconds to the time of flight corresponding to the new minimum elevation.

Continuing the example, a registration is conducted and the following GFT setting is determined: GFT A, charge 4, lot X, range 3,900, elevation 300. The minimum safe time for CVT fuze is determined as follows:

Elevation for range 2,000 yards (GFT) ..... 139 mils

Time of flight corresponding to elevation 139 ..... 7.3 seconds  
+5.5

Minimum safe time for fuze M513 ..... 12.8 or 13.0  
seconds

The effects of a CVT fuze action are devastating. However, it is as lethal to friendly elements as it is to the enemy. Therefore, to insure safety and to gain the maximum effect of the fuze, the user must know how to use it.

A GEM FOR THE BATTERY EXECUTIVE OFFICER

After quadrant elevation has been announced, the executive visually checks the line of fire to assure himself that the tubes are parallel. This may be accomplished by one of the following methods:

- (1) If there is a hill mass at a great distance, all tubes will appear to point at the same object on the hill mass when they are parallel.
- (2) Assuming that the tubes were laid in center of traverse, the relationship of the cradle to the trails will be the same on all pieces if the tubes are parallel.

To aid in determining that the proper quadrant is set, the executive may use one of the following visual checks:

- (1) If the pieces are on level terrain, large errors in elevation will be obvious by looking at the angle at which the tubes are pointing.
- (2) If the terrain is rough or uneven, errors may be detected by observing the movement of the tubes in relation to the change in quadrant elevation.

--Submitted by 1st Lt Robert A. Lewis  
Dept of Gunnery, USAAMS  
Fort Sill, Oklahoma

# The Little Known Front

Captain David A. Winters  
Department of Target Acquisition

During the first and second world wars the term "front" became popular. All's Quiet on the Western Front became a best seller in the years following World War I. During World War II, the Eastern Front, the Western Front, and other military "fronts" were covered daily in the news media. In any battalion, the morning briefing always pointed out the "front lines." They were and will remain a very conscious part of the military no matter what they are called.

The term "front" also can be applied to meteorology. "Front" as used by civilian meteorologists has the same meaning as the military term "front" and, in fact, evolved from it. In 1915, the Norwegian meteorologist, J. Bjerknes, discovered a war that has been going on for centuries between giants who far outstripped the puny armies of mankind. These giants were air masses.

These air masses, classified under the two general terms "warm" and "cold," build up over a large, nearly uniform geographical area of the earth. During the build-up process, the air mass takes on the physical characteristics of the area (hot and dry, cold and moist, or any of the permutations). Having mustered their strength (physical characteristics) they advance. In the Northern Hemisphere, cold air masses move southward and eventually are turned in an easterly direction; warm air masses move north and are turned to the east. Eventually, the two meet. Since they have different physical characteristics, the air masses do not mix but retain their individuality. The cold air pushes underneath the warm air and lifts it up and over the cold dome of air (fig 4). The boundary layer between the two air masses is called a front. To illustrate, consider oil and water confined in a vessel. If the fluids are allowed to reach the equilibrium state, the water will underlie the oil, which is the lighter of the two. So it is with air masses. The colder, heavier air mass will tend to underlie the warmer, lighter air mass. This boundary is usually narrow and abrupt, but it can be gradual. The interaction between these two air masses creates energies which are far greater than any nominal nuclear detonation.

## The Common Fronts

The cold front, the warm front, and the stationary front are the most common fronts. In a cold front, the motion is such that the cold air replaces the warm air at the surface. Conversely, in a warm front, the motion is such that the warm air replaces cold air at the surface (fig 5). A stationary front is one which may oscillate with little apparent motion.

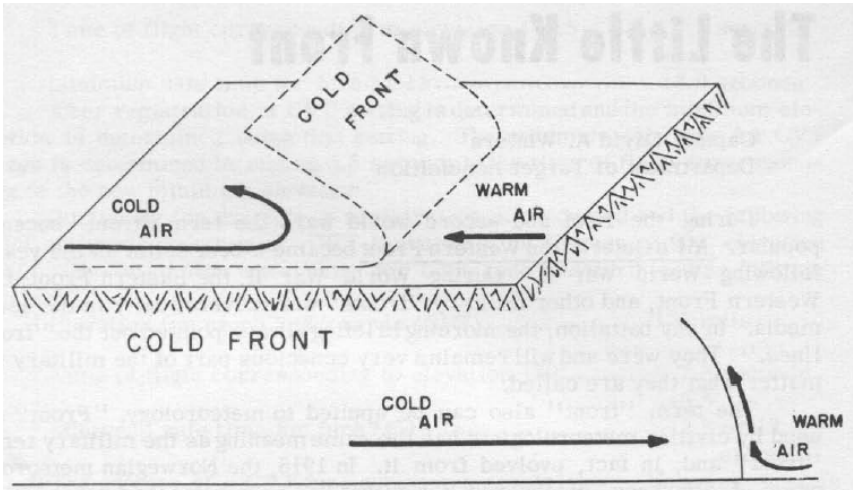

Figure 4. Simplified diagram of a cold front.

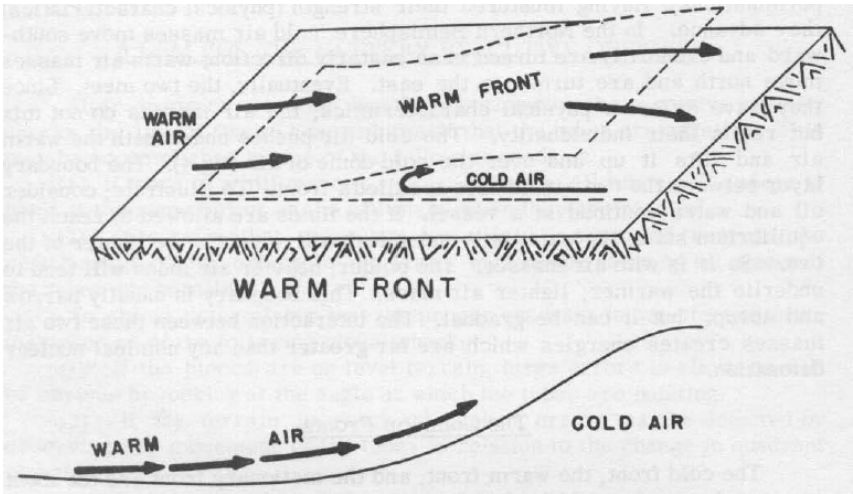

Figure 5. Simplified diagram of a warm front.

Artillerymen should know the effects of a front when it moves through their area. When a front passes, the weather, ballistic meteorological corrections, and sound ranging meteorological corrections change. Sound rangers should request meteorological messages more often than the normal 2-hour frequency, and unobserved fires may not be as effective because ballistic meteorological corrections are not as valid as during a stable weather period.

When a warm front passes, the temperature rises, the wind direction changes (less than 45°), there is increased moisture in the air, and foul weather can be expected for a few days. The cold front is characterized by an abrupt temperature fall, a wind shift of as much as 180°, a decrease in the amount of moisture in the air, and probable fair weather until the next front moves through.

A knowledge of these frontal characteristics does not make one a forecaster. However, a forecaster is not always available, and a unit commander may have to make his own weather estimates. In such cases, even a slight knowledge of fronts will take some of the "guess" factor out of an estimate.

Usually, a forecast from the Air Weather Service is available. These forecasts normally will predict the occurrence of a front. Since a front produces weather changes, calibration or test firings should not be scheduled during a front passage. An artillery registration fired after a front has passed will be more valid than one fired just prior to, or during, a front passage. Unobserved fires, fired after a front has passed, will be more effective than those fired during a passage.

Two fronts must be considered daily. Knowledge of the "weather" front helps the artillery on the "tactical" front.

## **MILESTONE FOR ARTILLERY EXTENSION COURSES**

On 11 December 1959 the US Army Artillery and Missile School processed its 1,000,000th extension course document for calendar year 1959. The document was a "Notice of Subcourse Completion" for Artillery Subcourse Number 22 issued to Major Rodney K. Berg (USAR), 104th Infantry Division, Everett, Washington. A special certificate was sent to Major Berg to commemorate the occasion.

This milestone is representative of the increase in extension course participation by members of the active Army and the reserve components during the past few years. As a comparison, a total of 700,000 documents were processed during 1958. The current enrollment in the artillery extension course program is in excess of 21,000 students and it is increasing steadily.

# ALLIED ARTILLERY MISSILES

Standing ready to deter any aggression against the free world is a deadly arsenal of missiles in the hands of the United States and her allies. In previous issues of ARTILLERY TRENDS, some allied artillery pieces have been covered. In ARTILLERY TRENDS, December 1959, the first of two installments on missiles was presented. It covered the artillery missiles of the Soviet Union. This second installment covers artillery missiles of allied nations. In the future, ARTILLERY TRENDS will continue to present information on foreign weapons systems as it becomes available.

## Great Britain

### Blue Streak

The Blue Streak is the only long-range British missile project. It is an intermediate-range ballistic missile designed to carry a thermonuclear warhead over distances up to 2,000 miles. The Blue Streak is more than 60 feet long and 10 feet in diameter. It compares favorably to the US Air Force Thor missile. The Blue Streak is intended to be a "hard-based" missile, launched from underground bombproof silos.

### Thunderbird

A surface-to-air missile for use by both the Royal Army and the Royal Air Force, the Thunderbird (fig 6) is similar in performance and operational use to the Nike-Hercules. It is designed for mobility and ease of handling and is fired from a compact wheeled launcher. The solid-fuel Thunderbird is 21 feet long and has a wing span of 5 feet 3 inches. The center section is 21 inches in diameter. The missile is in production.

### Bloodhound

Another British surface-to-air weapon, the Bloodhound (fig 7) is boosted by a solid-propellant rocket to a velocity of 1,500 feet per second and is sustained on the remainder of its flight by two Bristol 16-inch Thor ram-jets delivering 15,000 pounds of thrust. The Bloodhound is 15 feet long and 16 inches in diameter. It is guided by a semiactive homing system. It is in production.

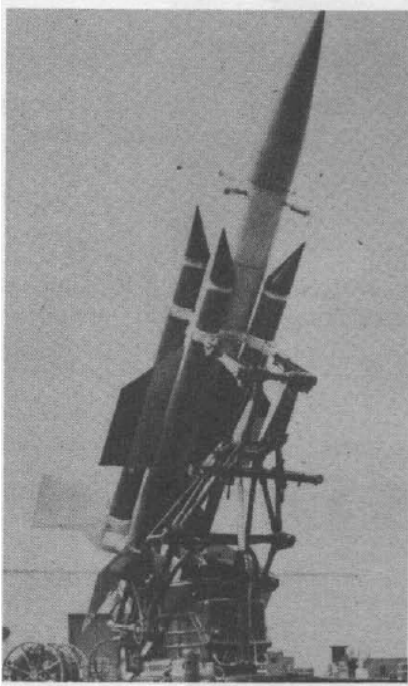

Figure 6. The Thunderbird on its mobile launcher.

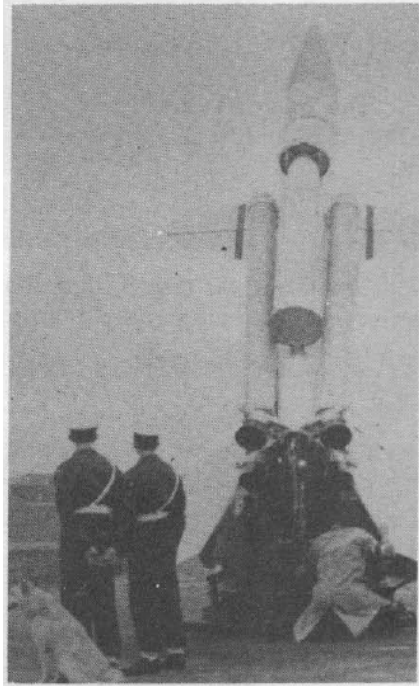

Figure 7. The Bloodhound is 15 feet long.

### Vigilant

An Army short-range battlefield missile, the Vigilant has a pistol-like firing mechanism which guides it toward its target. Primarily an antitank weapon, it is carried in a portable launching cannister which weighs 45 pounds. The missile and cannister can be handled by one man. The missile is 53 inches long, has a wing span of less than 1 foot, and has a solid-fuel engine.

### France

#### SS10, SS11

This versatile missile, developed by France, has been accepted by the US Army for use in the infantry division as an antitank weapon. It can be launched from vehicles (as small as a 1/4-ton truck), conventional aircraft and helicopters. These two missiles (the SS11 is an advanced version) are

short-range, wire-guided, and use a solid-fuel propellant. Eight countries besides the United States have ordered the missiles.

### Entac

The Entac is similar in use and nearly identical in range and velocity to the SS10 and SS11. It also is wire-guided and uses a solid-fuel propellant.

### SE 4200

The SE 4200 (fig 8) is a short-range winged missile. It is launched from a truck-mounted ramp by solid boosters which drop off after launching.

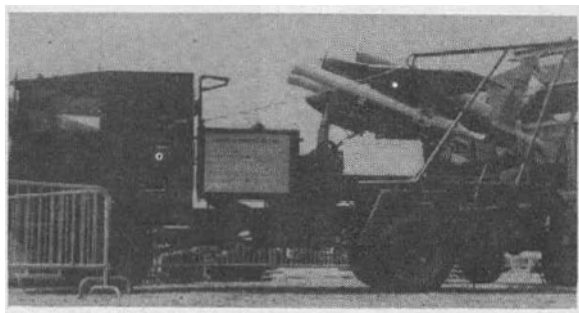

Figure 8. Two French Army battalions are armed with the SE 4200.

The range is about 60 miles. The high explosive charge is carried in a pod beneath the missile.

### Parca

Now in production, the Parca (fig 9) is a surface-to-air weapon with a maximum speed near Mach 2 and a range of 14 miles. It is a beam rider and has a proximity fuze. Power is supplied by a liquid-fuel rocket plus four solid boosters. The missile weighs slightly more than 1 ton.



Figure 9. Firing of the surface-to-air Parca.

### SE 4300

A surface-to-air weapon which is similar in principle to the Nike, the SE 4300 is used as a training missile by the French Army. It is subsonic and has a range of 12 miles. It has a liquid-fuel engine and weighs 1 ton.

### Masurca

The Masurca is a large surface-to-air weapon. It is supersonic and has a 15-mile range. It is 18 feet 8 inches long with a span of 3 feet 3 inches. It weighs slightly more than 1 ton with boosters and has a solid-fuel engine.

### Matra R. 422

Capable of speeds over Mach 2, the Matra R. 422 is a two-stage surface-to-air missile fired from a mobile launcher-transporter. It has a solid-fuel booster, and a solid-fuel sustainer in the second stage, and a command guidance system. It has been built and tested in limited numbers. An advanced "B" version has a range of 30 miles.

### BB10

The BB10 is a guided bomb and features cruciform fins, an annular shroud wing, and canard surfaces. It is radio-controlled.

## Italy

### Airone

Airone is a short-range surface-to-surface weapon. It uses a solid-fuel propellant, is unguided, and has a range of about 6 miles.



## Orione Sar

The Orione Sar is a winged limited-range surface-to-air weapon. It has a 15-foot wing span and is about 6 feet long.

## Robotti

The Robotti is the name for a family of battlefield rockets now under development. The basic rocket is supersonic, but unguided. The rocket is 16 feet long and 4 feet in diameter.

## Switzerland

### Type 54

A surface-to-air weapon, the Type 54 (fig 10) is 20 feet long, is 16 inches in diameter, and weighs about 800 pounds. It has a 2,000-pound

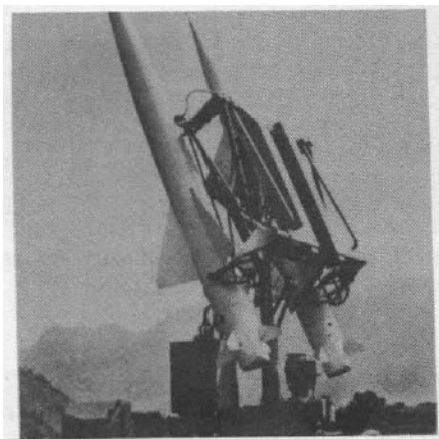

Figure 10. An Alpine Setting for the big Type 54.

thrust liquid-fuel rocket. Guidance is by beam riding, and the warhead has a proximity fuze. Advanced versions, known as types 56 and 57, are in development, while Type 54 presently is in production.

(All information on the missiles included in this article is reprinted from MISSILES AND ROCKETS MAGAZINE, Copyright July 20, 1959, American Aviation Publications, Inc.)

# New Radiotelephone

## Procedure for the

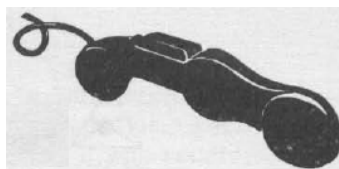

## New FD System

Second Lieutenant Richard J. Torretto  
Department of Communication and Electronics

ARMFUL 9, THIS IS ARMFUL 31, FIRE MISSION, OVER. . . These probably are the most important words of the artillery. It is the "curtain raiser" of the job the artillery is established to do--put fire on a target. This transmission means that a forward observer needs some artillery fire. This transmission immediately sets the fire direction center into motion. In a few minutes, cannoneers are methodically and swiftly preparing their weapon to belch out destruction to the enemy. The story doesn't end with that transmission, however. The FDC must have more information to place fire on the target; then they must communicate this same information, converted to different terms, to the gun position. Unless correct radiotelephone procedure is used, precious time may be lost--time that may take my life, or yours.

With the passing of the check-chart system and the establishment of the new infantry division concept, a fire direction procedure has been developed (ARTILLERY TRENDS, June 1959) which requires some radical changes and simple modifications of radiotelephone procedure used in the conduct of fire.

The battalion FDC is the controlling agency for the conduct of fire. The battery FDC is little more than a link in the communication system. The US Army Artillery and Missile School considers the battery FDC and the executive's post as a single installation, referring to it as the executive officer's command post (XOCP) (ARTILLERY TRENDS, June 1959).

There are three frequency modulated (FM) channels allotted to a howitzer battalion of the infantry division. One channel is used for command (C). The remaining two channels are assigned as a primary fire direction channel (F1), and a secondary fire direction channel (F2) (fig 11). The command channel is not primarily intended for fire direction and will not be discussed further.

The wire system generally parallels the radio system (fig 12).

A fire mission may be conducted by radio and/or wire communication. The stations normally concerned with the conduct of fire are:

- (1) Each forward observer and air observer.
- (2) The liaison officer.
- (3) The base sets in the battalion FDC.
- (4) Each battery XOCP.

## FORWARD OBSERVERS

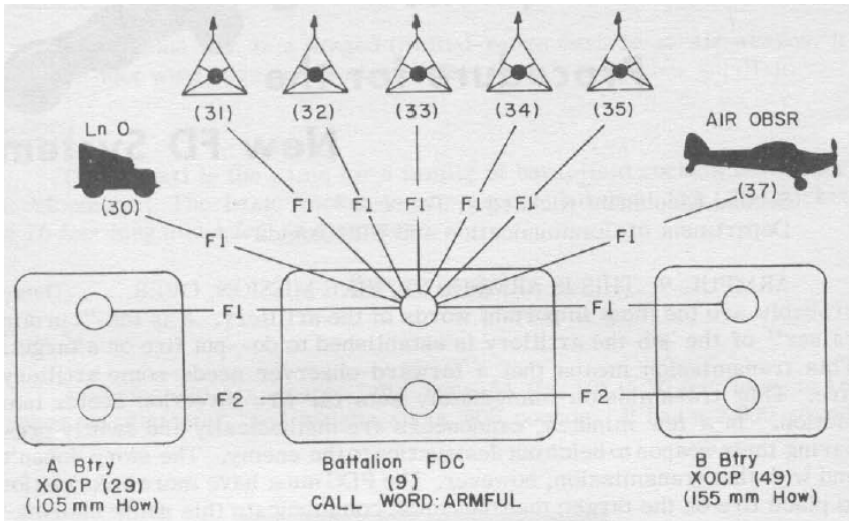

Figure 11. Radio net organization for conduct of fire. Numbers in parenthesis are call sign suffix numbers.

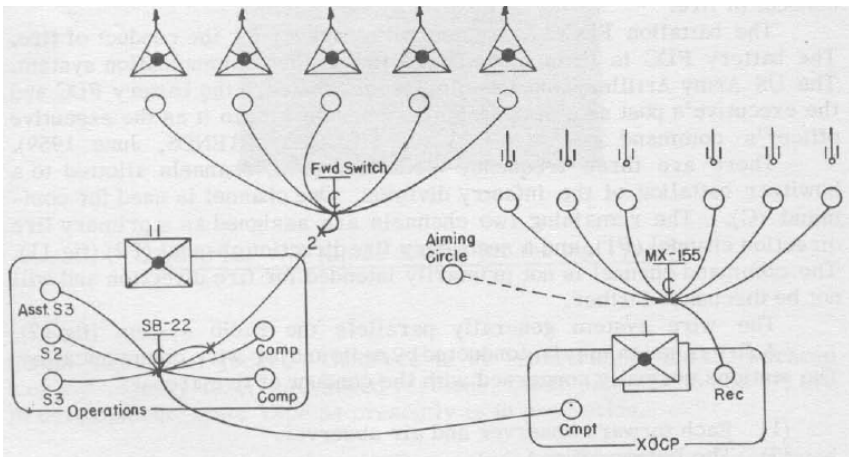

Figure 12. The wire system generally is set up like the radio system.

## Short Phrases

Transmissions are made in short phrases to facilitate the transmission of firing data and to minimize requests for repetition. Each phrase is repeated by the receiving operator exactly as it was received. The length of each phrase or the number of elements of firing data included in each transmission should be determined by established procedure and the training and experience of the individuals. Operators must be familiar with the sequence of elements of firing data.

In the example presented here, a fire mission is conducted by radio between the forward observer and the battalion FDC. Wire is used between the battalion FDC and each firing battery (fig 13).

The radiotelephone operator for a forward observer (ARMFUL 31) calls the primary base set operator (ARMFUL 9) in the battalion FDC. This call is made on the primary fire direction channel (F1) to inform the battalion FDC that the observer has a fire mission.

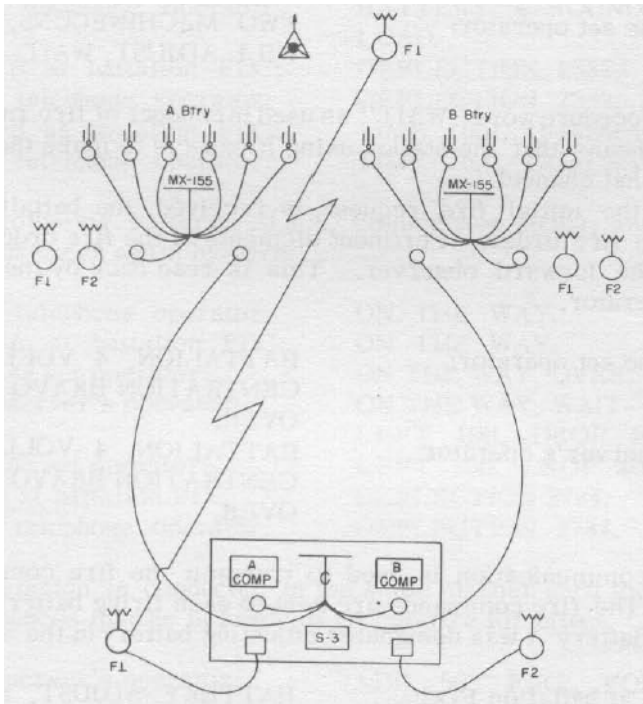

Figure 13. Communication system used between forward observer, battalion FDC and firing battery.

Forward observer's operator:        ARMFUL 9, THIS IS ARMFUL 31,  
    FIRE MISSION, OVER.  
 Primary base set operator:         ARMFUL 31, THIS IS ARMFUL 9,  
    SEND YOUR MISSION OVER.

If the primary fire direction channel is being used for another mission, the battalion S3 may direct the forward observer to change to the secondary fire direction channel. Having been directed to send his mission, the radiotelephone operator for the forward observer transmits the initial fire request in short phrases. Call signs are omitted only when one mission is being sent on a particular channel.

Forward observer's operator:        COORDINATES 4322, OVER.  
 Primary base set operator:         COORDINATES 4322, OVER.  
 Forward observer's operator:        3445, OVER.  
 Primary base set operator:         3445, OVER.  
 Forward observer's operator:        AZIMUTH 800, OVER.  
 Primary base set operator:         AZIMUTH 800, OVER.  
 Forward observer's operator:        TWO MACHINEGUNS, FUZE VT,  
    WILL ADJUST, OVER.  
 Primary base set operator:         TWO MACHINEGUNS, FUZE VT,  
    WILL ADJUST, WAIT--

The procedure word "WAIT" as used in conduct of fire radiotelephone procedure means that the station using it expects to make the next transmission on that channel.

After the initial fire request is received, the battalion S3 issues the battalion fire order. Pertinent elements of the fire order are transmitted to the forward observer. This is read back by the forward observer's operator.

Primary base set operator:         BATTALION, 4 VOLLEYS,  
    CONCENTRATION BRAVO JULIET  
    387, OVER.  
 Forward observer's operator:        BATTALION, 4 VOLLEYS,  
    CONCENTRATION BRAVO JULIET  
    387, OVER.

Wire communication is used to transmit the fire commands to the batteries. The fire commands are sent to each firing battery as they are produced. Battery A was designated adjusting battery in the S3 fire order.

Computer A at battalion FDC:        BATTERY ADJUST, SHELL HE, LOT  
    HOTEL, CHARGE 5, FUZE QUICK.  
 Battery A telephone operator:      BATTERY ADJUST, SHELL HE, LOT  
    HOTEL, CHARGE 5, FUZE QUICK.

Computer A at battalion FDC:	CENTER RIGHT, BATTERY 4 ROUNDS, VT IN EFFECT.
Battery A telephone operator:	CENTER RIGHT, BATTERY 4 ROUNDS, VT IN EFFECT.
Computer A at battalion FDC:	DEFLECTION 2765.
Battery A telephone operator:	DEFLECTION 2765.
Computer A at battalion FDC:	QUADRANT 381.
Battery A telephone operator:	QUADRANT 381.

While these commands are being sent, commands also are sent to the nonadjusting battery.

Computer B at battalion FDC:	BATTERY ADJUST, SHELL HE, LOT XRAY YANKEE, CHARGE 4, FUZE VT.
Battery B telephone operator:	BATTERY ADJUST, SHELL HE, LOT XRAY YANKEE, CHARGE 4, FUZE VT.
Computer B at battalion FDC:	BATTERY 4 ROUNDS, DO NOT LOAD.
Battery B telephone operator:	BATTERY 4 ROUNDS, DO NOT LOAD.
Computer B at battalion FDC:	DEFLECTION 2582.
Battery B telephone operator:	DEFLECTION 2582.
Computer B at battalion FDC:	TIME 16.0, QUADRANT 230.
Battery B telephone operator:	TIME 16.0, QUADRANT 230.

The adjusting battery, ALFA, commences firing, and the battery operator announces again by wire:

Battery A telephone operator:	ON THE WAY.
Computer A at battalion FDC:	ON THE WAY.
Primary base set operator:	ON THE WAY, OVER.
Forward observer's operator:	ON THE WAY, WAIT-- LEFT 100, DROP 400, OVER.
Primary base set operator:	LEFT 100, DROP 400, WAIT--
Computer A at battalion FDC:	DEFLECTION 2784.
Battery A telephone operator:	DEFLECTION 2784.

The mission is conducted in the same manner until the forward observer announces that he is ready to go into fire for effect.

Forward observer's operator:	ADD 50, FIRE FOR EFFECT, OVER.
Primary base set operator:	ADD 50, FIRE FOR EFFECT, WAIT--

Computer A at battalion FDC: FUZE VT, BATTERY 4 ROUNDS,  
DEFLECTION 2778.  
Battery A telephone operator: FUZE VT, BATTERY 4 ROUNDS,  
DEFLECTION 2778.  
Computer A at battalion FDC: TIME 21.0, QUADRANT 369.  
Battery A telephone operator: TIME 21.0, QUADRANT 369.

While fire for effect commands are being sent to the adjusting battery, fire commands are sent to the nonadjusting battery.

Computer B at battalion FDC: BATTERY 4 ROUNDS, DEFLECTION  
2595.  
Battery B telephone operator: BATTERY 4 ROUNDS, DEFLECTION  
2595.  
Computer B at battalion FDC: TIME 15.0, QUADRANT 219.  
Battery B telephone operator: TIME 15.0, QUADRANT 219.

The batteries commence fire for effect.

Battery A telephone operator: ALFA FIRING FOR EFFECT.  
Computer A at battalion FDC: ALFA FIRING FOR EFFECT.  
Primary base set operator: FIRING FOR EFFECT, OVER.  
Forward observer's operator: FIRING FOR EFFECT, OVER.  
Battery B telephone operator: BRAVO FIRING FOR EFFECT.  
Computer B at battalion FDC: BRAVO FIRING FOR EFFECT.  
Battery A telephone operator: ALFA ROUNDS COMPLETE.  
Computer A at battalion FDC: ALFA ROUNDS COMPLETE.  
Battery B telephone operator: BRAVO ROUNDS COMPLETE.  
Computer B at battalion FDC: BRAVO ROUNDS COMPLETE.  
Primary base set operator: BATTALION ROUNDS COMPLETE,  
OVER.  
Forward observer's operator: BATTALION ROUNDS COMPLETE,  
WAIT--END OF MISSION, MACHINE  
GUNS SILENCED, 8 CASUALTIES,  
OVER.  
Primary base set operator: END OF MISSION, MACHINE GUNS  
SILENCED, 8 CASUALTIES, OUT.

Since the concentration number of the target was given to the forward observer over the radio, it is presumed that the batteries did not receive the concentration number. The concentration number and END OF MISSION are sent to the batteries by wire.

Computer A at battalion FDC: END OF MISSION, CONCENTRATION  
BRAVO JULIET 387.  
Battery A telephone operator: END OF MISSION, CONCENTRATION  
BRAVO JULIET 387.

Computer B at battalion FDC:       END OF MISSION, CONCENTRATION  
BRAVO JULIET 387.  
Battery B telephone operator:       END OF MISSION, CONCENTRATION  
BRAVO JULIET 387.

The flexibility of conduct of fire procedure permits its modification to meet special situations. The radiotelephone procedure used in the fire for effect portion of a precision fire mission is similar to that used in area adjustments. Except to avoid possible confusion, the terminating word will be eliminated when transmitting sensings.

Forward observer's operator:       ON THE WAY, WAIT--  
SHORT, LEFT.  
Primary base set operator:         SHORT, LEFT--  
ON THE WAY, OVER.

There are situations in which it is necessary to send two or more fire missions simultaneously on the same radio channel. Under these conditions, it becomes necessary for the forward observers' operators to identify their transmission by preceding it with their stations' call sign suffix numbers. The base set operator directs his transmission to the observer concerned by preceding it with the observer's call sign suffix number.

Forward observer number 2       32, DROP 50, FIRE FOR EFFECT, OVER.  
operator:  
Primary base set operator:       32, DROP 50, FIRE FOR EFFECT, WAIT--  
31, ON THE WAY, OVER.  
Forward observer number 1       31, ON THE WAY, WAIT--  
operator:                         31, ADD 100, OVER.  
Primary base set operator:       31, ADD 100, WAIT--  
32, FIRING FOR EFFECT, OVER.

In May 1946, General Dwight D. Eisenhower said, "The speed, accuracy, and devastating power of American artillery won confidence and admiration from the troops it supported and inspired fear and respect in the enemy." Communication played an important role in gaining this reputation for the artillery. Weapons, procedures and tactics improve constantly, therefore, communication must be improved to keep pace. Today's artillery is fast-moving and highly mobile. To communicate becomes more of a challenge. The new procedure presented here is another step in meeting this challenge.



# U S Army Training Center, Field Artillery



Lieutenant Colonel William B. Lee  
US Army Training Center,  
Field Artillery

The young American who is called to the Colors today is provided the best individual and unit training that the US Army can offer. It is at the training center that the young man sheds his civilian suit, or his overalls, or his high school monogrammed jacket, and learns and lives the life of the honored soldier. Here he is introduced to and gains knowledge in the school of warfare.

The art of military science includes, among many other facets, the proper employment and use of personnel and equipment to insure the accomplishment of an assigned mission and ultimate success on the battlefield.

An important duty of an artillery unit commander is the proper assignment of his personnel to insure that he is getting maximum use of the actual and potential ability available to him. Commanders may rejoice and discard their "crystal ball" and similar unsatisfactory devices formerly used in assigning the right man to a job. Some examples of improper assignments are a potential artillery mechanic assigned as a cook, a surveyor assigned as driver of a wire truck, and a chart operator wondering what a monkey wrench is doing in the tool box. How many artillery commanders have found out too late that points were lost on the unit test because the surveyor, the chart operator, and other personnel were assigned the wrong jobs?

Now, artillery unit commanders can look with confidence at the enlisted qualification record (DA Form 20) and make his assignment based on the recommended military occupational specialty (MOS) with realization that the soldier has received intensive and specialized training in that MOS.

The unit commander should be acquainted with the principles of advanced individual training and the procedures employed by the US Army Training Center, Field Artillery, at Fort Sill.

The Training Center is organized into seven training battalions (fig 14). Five battalions of four batteries each provide cannoneer training. The organization for training is such that each week two cannoneer batteries begin a new training cycle. Another battalion, designated as the specialist training battalion, provides training in fire direction, survey, and flash and sound ranging. One battery is organized to control four survey sections and two sound ranging sections; one battery controls four survey and two flash ranging sections, and two batteries each have four

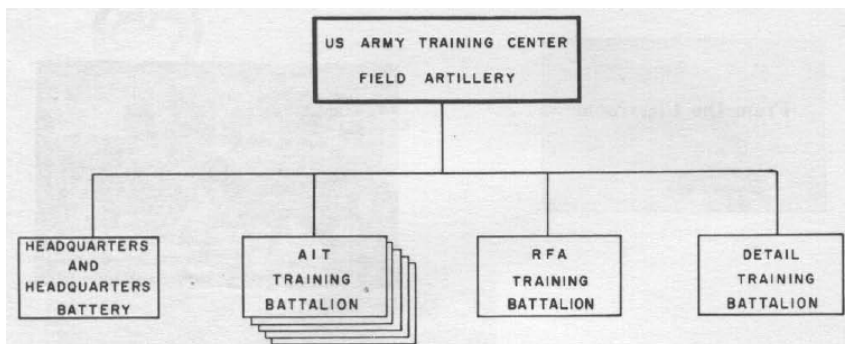

Figure 14. Organization of the US Army Training Center, Field Artillery.

fire direction sections. This section organization of batteries is based upon the weekly input of fire direction and survey personnel and the monthly input of flash and sound ranging personnel. It will accommodate the eight week program for each MOS. The Center also has 1 battalion of 6 batteries which gives basic unit training (BUT) to Reserve Forces Act (RFA) personnel (men having a 6-month active duty obligation).

### Two Types of Training

Upon completion of the basic combat training phase at a basic training center, recruits from all sections of the country start their artillery training at Fort Sill. The Training Center provides two types of training for these recruits--advanced individual training (AIT) in the duties of cannoners, fire direction, survey, and flash and sound ranging; and basic unit training (BUT) for RFA personnel.

The Adjutant General at the Department of the Army advises the Training Center of the arrival of a group of recruits from 4 to 6 weeks before their arrival. An information letter lists the recruits by name and designates the MOS training (cannoneer, fire direction, survey, or flash and sound ranging) that each individual should receive. Using this letter as a basis, individuals are assigned to certain training batteries. MOS training in these batteries include MOS's 140, 152, 153, 154, and 155.

Approximately 440 men arrive each week for the 8 weeks' cannoner, fire direction, and survey specialist training; and about 80 men arrive every 4 weeks for sound and flash ranging training.

When the 8 weeks of AIT is completed, men who have a 2 or 3 year obligation are assigned worldwide. RFA personnel enter the basic unit

# CANNONEER TRAINING - - - - -

**From the Classroom . . . . .**



**. . . . . to "Cannoneers hop"**

**to the real thing . . . . .**



**Learning about  
ammunition is  
important . . . . .**



# - - - FIRE DIRECTION INSTRUCTION

**Elaborate training aids in demonstrations**

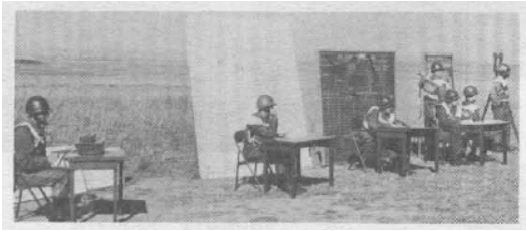
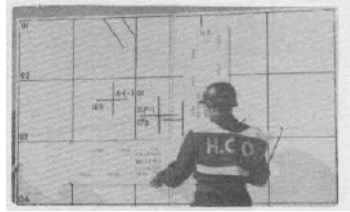

**. . . . . precede practical classroom work . . . . .**



# TRAINING IN - - -

Survey . . . .



Flash  
Ranging . . . . .



Sound  
Ranging . . . . .

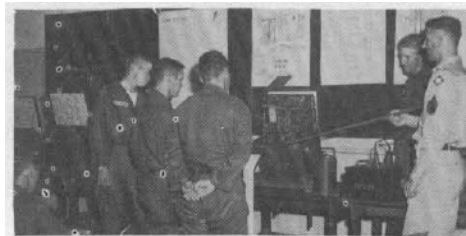

# **- - - THE RESULTS - - -**



**A demonstration team from a Basic Unit Training battery . . . . a few days before, these trainees were in Advanced Individual Training.**



**Graduation . . . . and assignment Worldwide—**

training batteries for a 6-week training cycle, after which they return to their respective National Guard or USAR units.

When the soldier joins an AIT cannoneer battery, he is assigned to a section under the supervision of a noncommissioned officer trainer (section chief). He remains with that section throughout the entire 8-week phase which comprises 352 hours of instruction. The noncommissioned officer trainer is directly responsible to the battery commander for the training, welfare and morale of his section.

### "Unit System"

In contrast to the "committee system" training technique in which a committee instructs all units in a particular phase of training, the "unit system" now is used. Battery officers and noncommissioned officers of each unit are used as instructors, thereby making them responsible for all classroom and field training as well as control of their own unit. Unit training makes the trainee feel more at home, gives him the feeling of belonging to his section and his battery, and closely associates him with the instructor who can give him more personal attention. This system also lends itself to competition between sections. In the specialist training battalion, the "committee system" is used. The organization is designed for committee trainer administration; and trainee housing, mess, and administrative control. The battalion has a headquarters and headquarters battery for administration and training control of committee instructor personnel.

The AIT program of instruction includes 138 hours of general training and 214 hours of specialist training. Each man receives 14 hours of motor vehicle operation and maintenance, 8 hours of map reading, 12 hours of basic artillery communications, and if he has not qualified with the M1 rifle on a known distance (KD) range, he receives 20 hours of advanced rifle marksmanship instruction for ultimate qualification. Of the 127 hours allotted to firing battery instruction for cannonneers, 53 hours are spent in the field firing live ammunition. Joint instruction is conducted for fire direction, survey, and flash and sound ranging personnel during the firing exercises by the cannoneer batteries.

Fire direction, survey, and flash and sound ranging personnel are given weekly examinations to determine the quality of training and their progress. Cannoneer trainees are given written examinations at the end of their second and sixth weeks of training, and a performance type general examination in the fourth and eighth weeks of the cycle.

Examination scores of trainees in fire direction, survey, and flash and sound ranging are scrutinized closely. If an individual is not doing well, he is given additional personal attention. Because of this extra help, the attrition rate in these areas is extremely small. When it is finally decided that an individual cannot make the grade in these areas, he is transferred to a cannoneer battery and receives training in MOS 140.

The BUT battalion conducts training under a modified program as directed by the US Continental Army Command (USCONARC). The program

is modified to a 6-week period including 304 hours of instruction. The 6-battery BUT battalion conducts 175 hours of general training, including service practice, maintenance, camouflage and concealment, and other subjects. Cannoneers and fire direction and survey personnel receive 129 hours of specialist training.

All training at the US Army Training Center, Field Artillery, stresses maximum practical application of the subject to give the individual the best possible working knowledge of the weapons, techniques, and tactics of the field artillery. As new procedures are approved, they are immediately included in the program of instruction at the Center. The end result is that the artillery commander can effectively integrate into his unit the newly qualified artilleryman who can perform duties in the MOS for which he has been trained.

### A GEM FOR THE BATTERY EXECUTIVE OFFICER

"Center of traverse, zero mils sir!!!".

An embarrassing situation for the battery executive officer and his section chiefs is when it becomes necessary to move trails or spade in order to complete or to shoot a fire mission, because during the lay of the pieces, one or more pieces was laid too far off center of traverse. This is particularly true for heavier caliber pieces that can not be man-handled. To effectively combat this and to stimulate section competition, the following solution is tried and true.

The chief of firing battery, having received the azimuth of fire from the battery commander during the reconnaissance and selection portion of the RSOP, along with each section chief or his representative lays 2 stakes (section colored) at each howitzer position with the aiming circle on the azimuth of fire. The section chief then reconnoiters a route from the point of departure on the road using existing roads or trails and guides his prime mover and piece over the 2 stakes. During a lull in firing, the battery executive officer can compute the offset for each piece by having his gunners traverse their piece to center of traverse and reporting the deflection to their aiming posts. Then he compares the reported deflection with the original referred deflection.

Competition is stimulated when the piece with the least offset wins the privilege of being lead piece going back to the base camp, and the piece with the greatest offset being last in line and eating dust in addition to 'humble pie'.

--Submitted by Capt B. M. Berkowick  
Dept of TL & NRI, USAAMS



# PROJECT

## METRO PRECISION

Lieutenant Colonel Robert E. Plett  
Captain Leon L. deCorrevont  
Department of Gunnery

How stale is your meteorological message? How far is the meteorological station from your battery position? What effect do meteorological staleness and meteorological station distance have on the accuracy of your artillery fire? It is anticipated that questions of this nature will be answered by Project MP (metro precision).

Project MP evolved from the efforts of the US Army Artillery and Missile School and other agencies to establish as a routine procedure the calibration of ammunition lots by ordnance at the proving grounds. The ordnance believes that other errors, such as those resulting from invalid meteorological data and inaccurate target location, might reduce the value of lot calibration data to just a marginal improvement in accuracy. The Ordnance Ballistic Research Laboratories (BRL) at Aberdeen, Maryland, recommended that a firing program be conducted to estimate meteorological errors under a variety of conditions. This recommendation resulted in the birth of Project MP.

Project MP is being conducted under the joint supervision of the School, BRL, and the US Army Signal Research and Development Laboratory (USASRD), Fort Monmouth, New Jersey. The project has two primary missions:

- (1) To determine the variability of meteorological data as a function of--
  - (a) Distance taken from the firing site.
  - (b) Staleness (time interval between the time meteorological data was taken and firing time).
  - (c) Different meteorological sections at the same time.
  - (d) The same section at different times.
  - (e) Ambient conditions.
  
- (2) To determine the total error of centers of impact and to isolate individual sources of error to include those errors due to--
  - (a) Meteorological equipment and procedure.
  - (b) Weapon and ammunition data.
  - (c) Firing table computation.

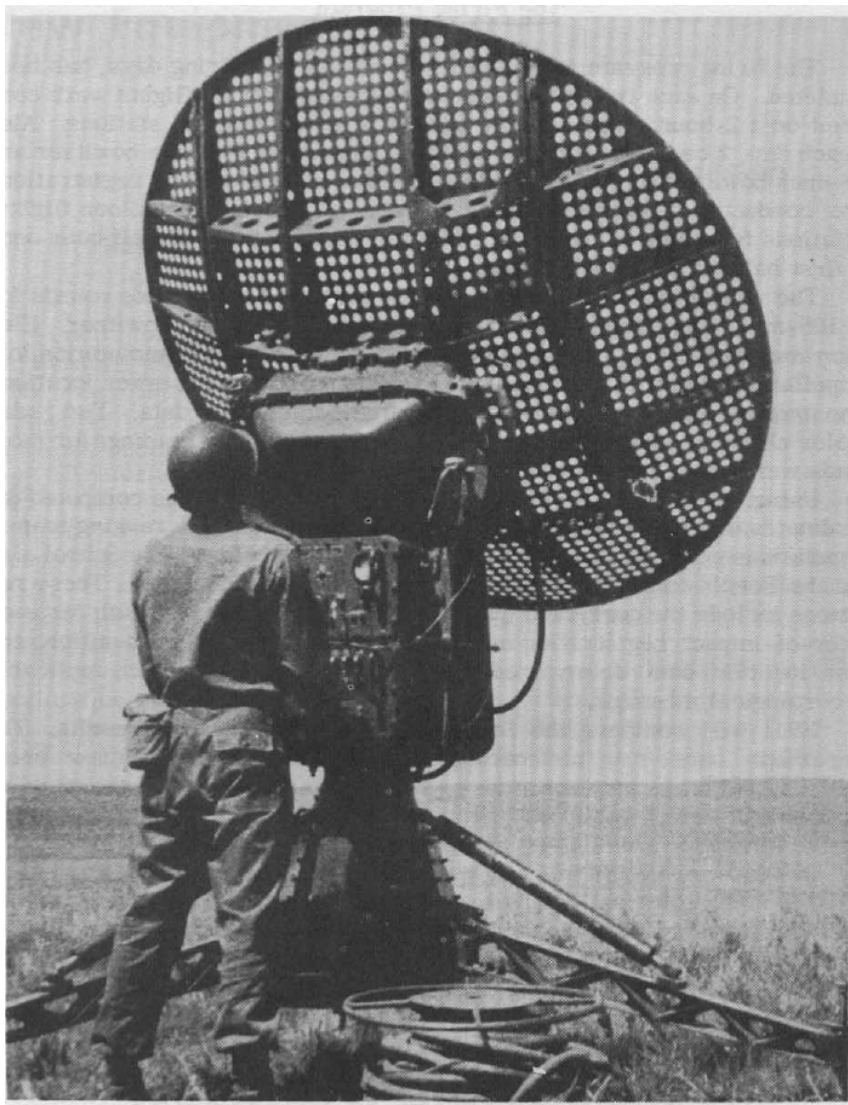

Figure 15. The Rawin set AN/GMD-1.

## The Firing Program

The firing program at Fort Sill, consisting of 8 firing days, has been completed. On each firing day, 4 meteorological balloon flights were conducted on a 2-hour schedule from each of 4 meteorological stations. Also on each day, 2 center-of-impact registrations from a 105-mm howitzer and an 8-inch howitzer were conducted on a 4-hour schedule. The registrations were conducted concurrently with the second and fourth balloon flights. Deviations from this prefixed schedule were kept within one-half hour once the first balloon flights and begun.

The center-of-impact registrations consisted of 8 usable rounds for the 105-mm howitzer and 10 usable rounds for the 8-inch howitzer. Elevation and deflection settings were held constant as were ammunition lots (propellant, projectile, and fuze) for the weapons. Three observer locations were used to fix each burst location for the flash team data. Two radar doppler chronographs were employed and paired velocity readings for most rounds were recorded.

Using the Bendix G-15D digital computer, the School has computed the coordinates of each burst location so the results of the flash ranging teams' computations could be evaluated on the M5 plotting board. The School also used the Bendix computer to determine firing table reductions. These reductions include the corrected quadrant elevation (QE) and azimuth for each center-of-impact registration using firing table, weapon, ammunition, and burst location data determined by the flash teams and each applicable meteorological message.

BRL will compare the School's results with its own results. The comparison uses raw meteorological data, ballistic coefficient computations, and trajectory solutions to show the variability of meteorological functions to time, space, and team as well as the meteorological error relative to weapon ammunition data and computational procedure.

In addition, USASRDL will compare map wind techniques using all available meteorological data with each meteorological message. Its study also includes comparing the data developed from the Rawin set AN/GMD-1 (fig 15) and Rawin set AN/GMD-2 as well as determining an error of wind data from the AN/GMD-1 using the photo theodolite as a primary standard.

In view of the widespread interest and far reaching effects of the study, the final test results will be published in ARTILLERY TRENDS.

## NEW INFORMATION ON THE AN/MPQ-4A RADAR

A new instructional note designated IN R 4000 on the operation of AN/MPQ-4A radar has been published. This 124-page publication containing many illustrations will be used as the primary reference for operator instruction at the US Army Artillery and Missile School. It is available from the School Book Department at 40 cents per copy.

# New Equipment Technical Publication System

Mr. Herschel A. Howell  
Department of Artillery Transport

Good news for artillerymen who are responsible for supervision and maintenance of equipment! Motor sergeants, section chiefs, mechanics, parts specialists, drivers, and other persons who have had to wade through a maze of numbers and thick manuals when seeking information from a technical publication soon will find that this problem has been solved.

The format and numbering system of technical publications have been revised (fig 16). Federal supply classification numbers now are used to identify equipment technical publications. Further, the information is grouped according to the echelon to which it applies and is bound within one cover. A suffix identification number, which shows the echelon to which the manual pertains is assigned, eliminating searching through the manual for specific information.

Prefix letters indicate the type of publication--technical manual (TM), modification work order (MWO), lubrication order (LO). They are followed by a number which identifies the preparing technical service. In figure 16, the four numeral block (2350) represents the federal supply classification group and the class to which the equipment is assigned. The first two digits (23) identify the materiel group to which the equipment belongs (motor vehicle); the last two digits (50) classify the equipment within the materiel group (self-propelled artillery). The three numeral block (213) identifies the end item of equipment to which the manual pertains. Technical manuals are identified with specific items of equipment by using numbers starting with 200. Technical publications for a new item of equipment will carry the next higher number for that particular type of equipment. For example, the number 213 on the manual indicates that it is the 14th technical manual published under the new format for this type equipment. The two numeral block or suffix identification number signifies the echelon(s) of maintenance to which that section of the manual or publication applies. Examples are as follows: 10--a manual for the operator or crew; 20--a manual applicable to organizational maintenance personnel; 30--a manual applicable to direct support field maintenance personnel; 40--a manual applicable to fourth echelon maintenance personnel; 50--a manual applicable to depot maintenance personnel; and 35--a manual applicable to more than one echelon of maintenance. The numeral 35 indicates the manual contains instructions for third, fourth, and fifth echelon maintenance personnel.

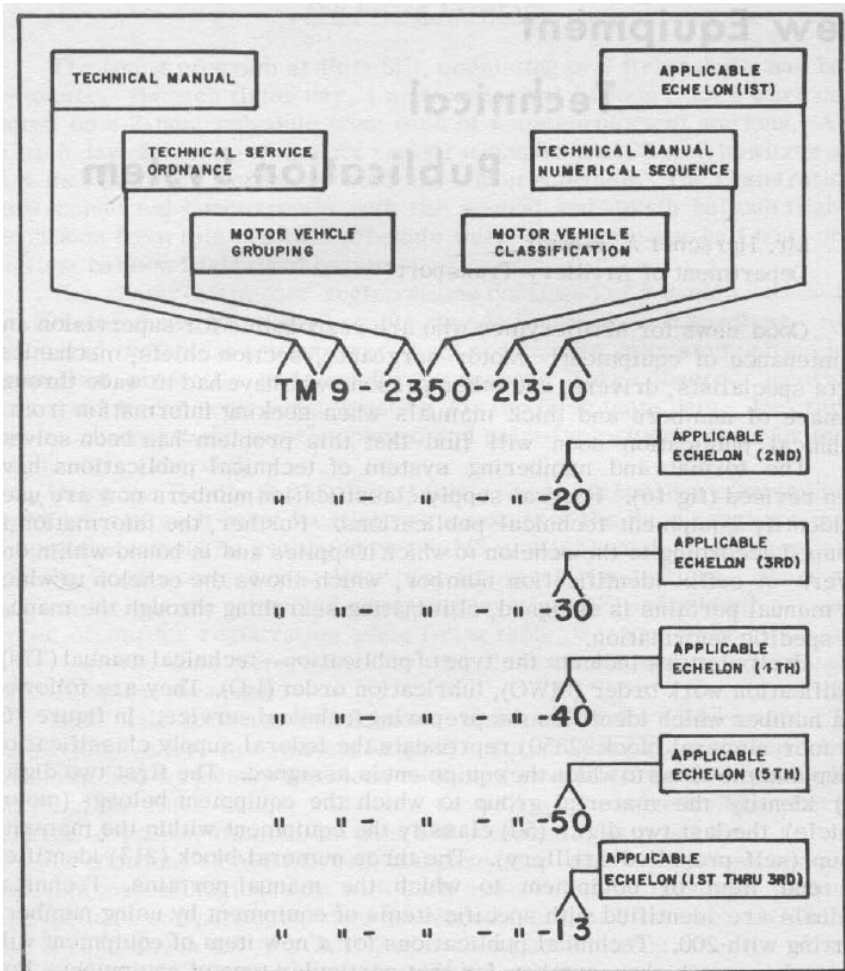

Figure 16. Example of the new technical publication numbering system.

### Parts List

When the suffix identification numbers are followed by the letter "P," that section of the manual is a parts list to be used by the echelon indicated by the suffix identification (fig 17). The parts appendix (20P section) contains pictures of all the items listed. This aids in identifying repair parts authorized the using unit.

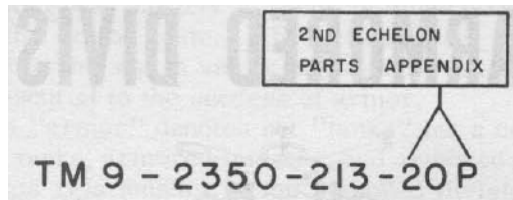

Figure 17. Example of a repair parts list.

Presently, the "P" series publications include the 1/4-ton 2 1/2-ton, M34, and 5-ton wheeled vehicles; the M59 tracked vehicle; and the M44 carriage.

To further simplify identification of technical publications, the basic number used on the technical manual also is used on the lubrication order (LO), technical bulletins (TB), and modification work orders (MWO) applicable to the equipment. For example, a modification work order is assigned the vehicle's identification number, but this number is prefixed with the letters MWO. MWO's are identified with the lowest echelon authorized to perform the work, and are serially numbered (MWO 9-2350-213-20/1). The number following the slash mark on the latest dated MWO indicates the total number published for that echelon. Equipment technical bulletins and lubrication orders are numbered in the same manner.

Maintenance allocation charts are being prepared for all equipment and will be published as appendix II to the "20" section of the revised technical manual. These charts allocate specific maintenance and repair operations to the proper echelon on the basis of time, tools, and skills available to the various echelons in a combat situation. The allocation is influenced by maintenance policy and sound maintenance practices as outlined in AR 750-5 and FM 9-10. The maintenance allocation chart can be used to eliminate guesswork in determining which echelon will perform specific maintenance and repair operations on assigned equipment.

As users become more familiar with the new publications, information will be easier to locate than it has been in the past. This is truly "good news" for artillerymen in supervisory and maintenance jobs.

---

"The Army must be a unified fighting team which draws in full measure upon the characteristics of each arm and service. No single branch of the Army is self-sufficient."

--Wilber M. Brucker  
Secretary of the Army

# THE ARMORED DIVISION

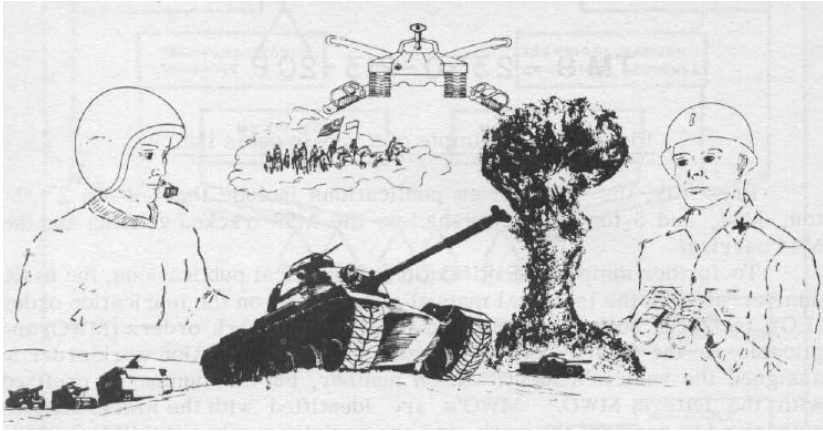

## A Combined Arms Team

Major John C. Burney, Jr., Armor  
Department of Tactics and Combined Arms

There was no Merry Christmas in store for American troops defending the thinly manned Ardennes sector in 1944. Their "holiday season" opened with a sudden, vicious attack by 22 panzer and panzer grenadier divisions. The carefully rehearsed German forces surprised the Americans, broke through the forward defenses, and sped towards the vulnerable port of Antwerp and the lifelines of the Allies.

To stop the assault, General Omar Bradley diverted elements of General George S. Patton's Third Army south of the breakthrough and General Hodge's First Army on the north. From the north, the famous 2d Armored Division, "Hell on Wheels," swept down towards a spearhead of the German attack--the 2d Panzer Division.

Christmas day witnessed a titanic head-on struggle between these two armored Goliaths--the Battle of the Celles Pocket. In this clash, the 2d Armored functioned as a closely knit team. The artillery members of the team understood the fast-moving, fluid tactics of the tankers and were able to provide close, responsive fire support. The result was the complete destruction of the 2d Panzer Division. Every German tank and the complete division artillery of the 2d Panzer was wiped out. As the colorful "Hell on Wheels" commander, Major General Ernest Harmon, reported, "We got in front the the 2d Panzer Division and polished them off."

This victory was largely a result of close coordination between the members of the armor team. The artilleryman had again convincingly demonstrated that he was a vital component of this team and that his fire support was essential to the success of armor.

The word "armor" denotes not "tanks" but a combined arms force, which includes tanks, armored infantry, and armored artillery. A constant reminder of this relationship is the armored division's familiar yellow, blue, and red triangular patch.

To provide effective fire support to his teammates, the artilleryman must understand the organization and employment of armor. As Napoleon stated in his 75th Maxim--"It is the duty of the general of artillery to know the operations of the Army as a whole, since he is obliged to support the divisions of which it is composed."

### Armor Team Not New

Today's armor team is not a new, untried concept. It was developed during World War II and vividly demonstrated its effectiveness during such actions as General Patton's dash across France, the Battle of the Celles Pocket, and the deep exploitation to the Elbe River. As a result of such achievements, armor has become known as "The Combat Arm of Decision."

Since World War II, the armored division has experienced few changes. However, during this time nuclear weapons have become commonplace. This may lead some to ask, "Does the armored division, essentially a World War II organization, meet the requirements of the modern, nuclear battlefield?"

To answer this question, the characteristics and capabilities of today's armored division must be examined. General Maxwell D. Taylor said, "Armor's characteristic ability to move, shoot, and communicate in mounted combat will give a decisive element to the battlefields of the future."

Armor is the arm of mounted combat, a force that can fight while moving. Thus, MOBILITY is one of the dominant characteristics of armor. The entire armored division is mounted. All combat units, including the artillery, are equipped with full-tracked vehicles which give excellent cross-country mobility. This mobility enables armored forces to concentrate swiftly for an attack and to disperse rapidly after the attack before the enemy can strike the concentration with nuclear weapons. Because of its mobility, the armored division can cover extensive fronts and deep zones of action, operate in dispersed formations, and move swiftly to decisive points.

The armored division also is characterized by its tremendous FIREPOWER. This firepower includes 360 tanks, each mounting a high velocity, precision-fire tank gun. In addition to numerous other weapons, the division has more than twice as many machineguns as does the infantry division. All of this firepower is backed up by a division artillery, which provides both nuclear and nonnuclear fires.



## Close Operation to Nuclear Blasts

With the exception of the Honest John, this firepower is armor protected. Armor protection enables forces to fully exploit the use of nuclear weapons; for, with this protection, units can operate close to nuclear blasts and traverse areas that foot troops cannot cross because of nuclear contamination.

Armor-protected firepower combines with armor's mobility to provide SHOCK ACTION. This shock action enables armor to gain and maintain the momentum of the attack, to paralyze the enemy and keep him off balance, and to roll relentlessly to deep, decisive objectives.

To capitalize on its mobility, firepower, and shock action, armor must have the flexibility to enable it to react promptly to the swiftly changing conditions of the nuclear battlefield. This flexibility is afforded by a cellular-type organization; an extensive communications system; and mobile, responsive combat support and service units geared to the needs of fast-moving armor operations.

The characteristics and capabilities of armor coincide with the requirements of a modern, nuclear battlefield, as expressed in field manuals

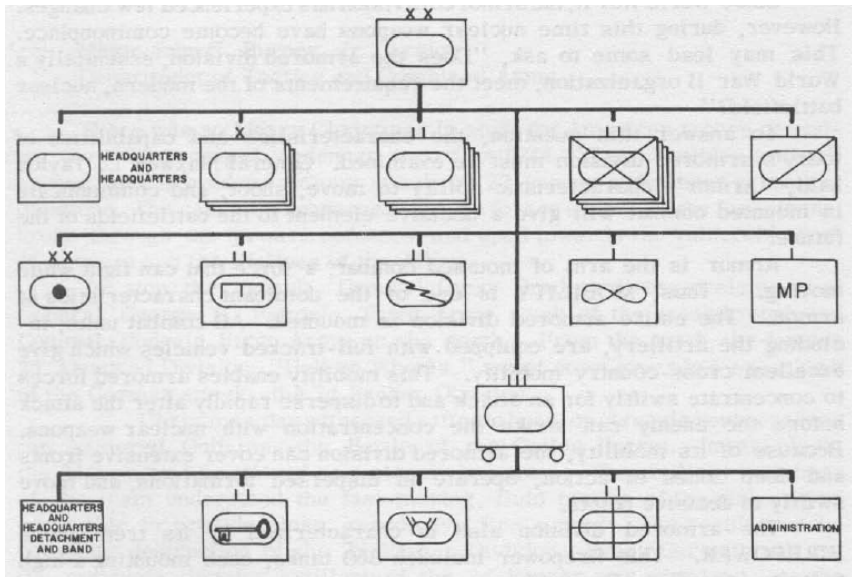

Figure 18. The armored division.

and articles in service journals. The armored division meets the requirements of nuclear warfare. As General James Gavin stated in his book, War and Peace in the Space Age--"We soon learned that the World War II organizations, no matter how packaged, would not adapt themselves to nuclear tactics. The one exception was our armored division."

Armor's unique capabilities make it well suited for a wide variety of combat missions in either nuclear or nonnuclear war. In the offense, the armored division can be used in deep penetrations or wide envelopments to seize decisive objectives, destroy hostile forces, and disrupt enemy rear areas. It can be used effectively to exploit the successes of other units and the effects of nuclear fires. The pursuit and destruction of enemy forces also is a particularly suitable mission for armor. In the defense, the division may be employed as a covering force for a corps. Subsequently, the division may become the corps striking force or reserve. It also might be assigned the defense of a given sector.

### Organization

To help him plan, coordinate, and supervise operations, the division commander has a headquarters and headquarters company. As his major maneuver elements, he has three combat commands. To provide indirect fire support, there is a division artillery; and to provide administrative support, a division trains (fig 18).

A combat command headquarters is a small tactical control headquarters. It has no organic fighting troops. The forces that the commander needs to perform a specific mission are attached to or placed in support

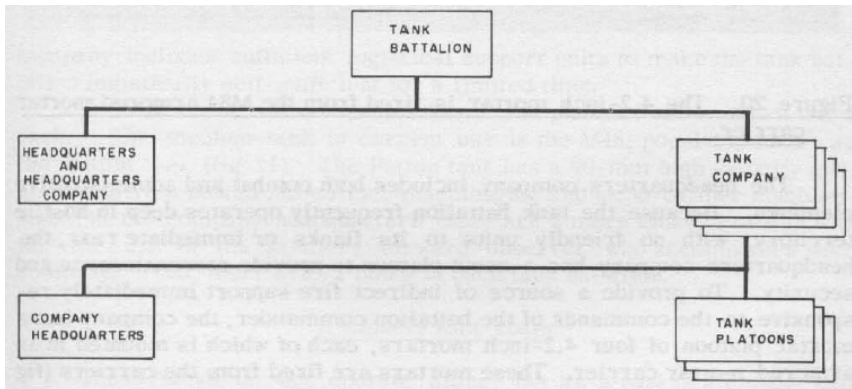

Figure 19. The tank battalion.

of the combat command prior to each operation. The primary forces attached to the combat command are 4 tank battalions and 4 armored rifle battalions.

The tank battalions, also known as armor battalions, have the mission of closing with and destroying the enemy. In addition, these battalions fulfill an antitank role, because the best antitank weapon is a good tank. To perform these tasks, each battalion has a headquarters and headquarters company and four tank companies (fig 19).



Figure 20. The 4.2-inch mortar is fired from the M84 armored mortar carrier.

The headquarters company includes both combat and administrative elements. Because the tank battalion frequently operates deep in hostile territory, with no friendly units to its flanks or immediate rear, the headquarters company has a scout platoon to provide reconnaissance and security. To provide a source of indirect fire support immediately responsive to the commands of the battalion commander, the company has a mortar platoon of four 4.2-inch mortars, each of which is mounted in an armored mortar carrier. These mortars are fired from the carriers (fig 20). The final combat element of the headquarters company is a tank section of four tanks. These tanks are for the use of the battalion commander and his staff, and one is reserved for the artillery liaison officer who accompanies each battalion. As for administrative elements, the headquarters



Figure 21. The M48 medium tank, popularly known as the Patton tank, has a 90-mm high velocity gun.

company includes sufficient logistical support units to make the tank battalion logistically self-sufficient for a limited time.

Each of the 4 tank companies has 3 tank platoons of 5 medium tanks each. The medium tank in current use is the M48, popularly known as the Patton tank (fig 21). The Patton tank has a 90-mm high velocity gun, a coaxially mounted .30-caliber machinegun, and a .50-caliber machinegun. In the company headquarters there are 2 more tanks, 1 of which is for the use of the artillery forward observer who accompanies each company. Thus, there are 72 tanks in each tank battalion.

#### A Closely Knit Team

These tanks do not operate alone, but as a part of a closely knit team. The armored infantry of this team is provided from four armored rifle battalions, also called armored infantry battalions. Each battalion has a headquarters and headquarters company and four armored rifle companies (fig 22). The headquarters company is almost identical to that of

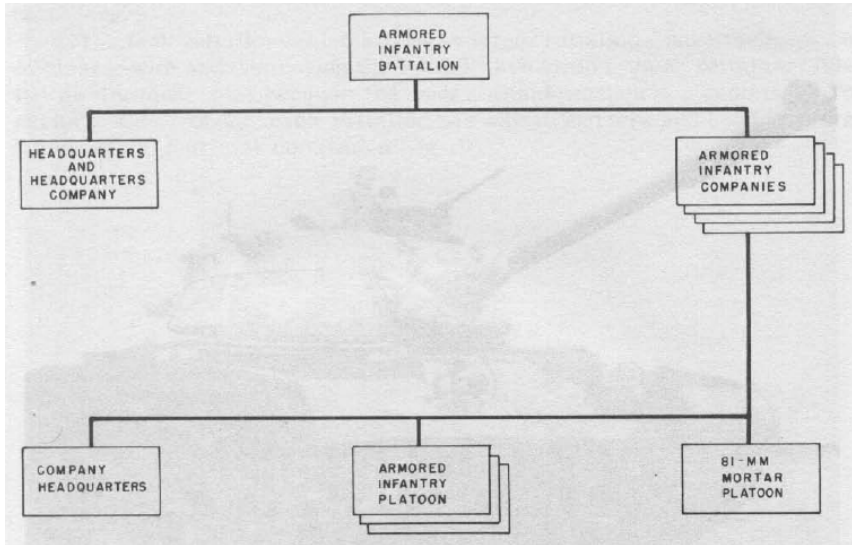

Figure 22. The armored infantry battalion.

the tank battalion. The major difference is that the armored rifle battalion has no tank section. Each armored rifle company has three rifle platoons and an 81-mm mortar platoon. These platoons have their own organic armored personnel carriers. Armored infantry does not depend on an outside source for its mechanization as does the infantry of the battle group. With this organic mechanization, the armored infantry has the speed, mobility, and armor protection to enable it to accompany the tanks and provide that close protection upon which the tanks often depend.

The armored personnel carrier now being used is the M59. The M59 is full tracked, provides all-around armor protection, and is amphibious (fig 23). This latter characteristic is of particular importance. In the past, deep exploitations by armor have frequently been stopped by unfordable rivers. But today, with the M59, the infantry can rapidly cross such rivers, seize a bridgehead, and protect the crossing sites while the engineers either ferry the tanks across or build hasty bridges on which the tanks can cross.

For the same reasons that the tank and armored rifle battalions need scout platoons, the division commander needs a force that can provide reconnaissance and security. Therefore, the division has an armored cavalry squadron, also known as a reconnaissance squadron. This squadron has a headquarters and headquarters troop and four armored cavalry



Figure 23. The M59 armored personnel carrier has all-around armor protection and is amphibious.

troops (fig 24). The headquarters troop is similar in some respects to the headquarters company of the tank battalion. For example, it has a tank section of four tanks. Like the headquarters company, the headquarters troop also has the units needed to make the squadron logistically self-sufficient for a limited time. Unlike the headquarters company, the headquarters troop has no scout platoon. The squadron commander has no need of such a platoon because he has four armored cavalry troops to perform reconnaissance and security. Furthermore, the headquarters troop has no 4.2-inch mortar platoon because one platoon could not cover the wide frontages on which the squadron normally operates.

Each of the 4 armored cavalry troops has 3 reconnaissance platoons. Each platoon is a combined arms team; for in each platoon are tanks, infantry, scouts, and a 4.2-inch mortar.

In the armored cavalry, a light tank is used. The standard light tank is the M41, popularly known as the "Walker Bulldog" (fig 25). The M41's main armament is a 76-mm gun. Mounted coaxially with this gun is a .30-caliber machinegun, and on top the commander's cupola is a .50-caliber machinegun. This light tank gives the armored cavalymen the speed and the agility needed to move swiftly about the battlefield to accomplish their reconnaissance and security missions.

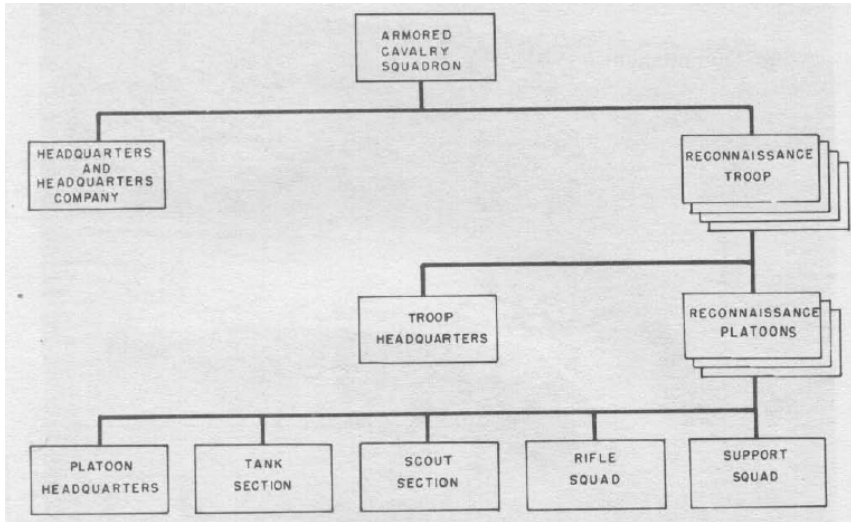

Figure 24. The armored cavalry squadron.

### Fire Support

Fire support for the tank battalions, armored rifle battalions, and armored cavalry squadron is provided by a division artillery (fig 26) of three 105-mm self-propelled howitzer battalions and a rocket/howitzer battalion. Each 105-mm battalion has 3 batteries of 6 "tubes" each. The rocket/howitzer battalion includes 2 self-propelled 155-mm howitzer batteries of 6 weapons each, a self-propelled 8-inch howitzer battery of 4 weapons, and a missile battery equipped with two 762-mm rocket launchers. Both the 8-inch howitzers and the 762-mm rockets can fire nuclear rounds. All of the artillery of the armored division (except the rocket launchers) is equipped with full-tracked, armored-protected vehicles. This mobile, armored equipment enables the artillery to provide close, responsive fires to swiftly moving armor columns.

The engineer battalion assists the advance of the division and delays the enemy's advance. To accomplish this, the battalion has a headquarters company, four engineer companies, and a bridge company. The engineer companies have armored personnel carriers and medium tanks equipped with dozer blades. The bridge company provides hand-erectable float bridging and self-propelled armor bridges (fig 27).

The engineer battalion insures the uninterrupted continuation of the armor attack.

A prerequisite to successful mobile warfare is an extensive and multiple communication system. Supplementing the vehicular radios organic to all units of the division is the signal battalion. This battalion operates a division area communication system. Its command operations



Figure 25. The M41 light tank, or "Walker Bulldog" has a 76-mm gun.

company provides signal communications for the division headquarters and headquarters company, division trains headquarters, and the division rear echelon. The forward communication company provides area signal center service to units in the division forward area. The services of the signal battalion are essential to enable the division to respond to the rapidly changing conditions of the modern battlefield.

The aviation company includes all 50 aircraft of the division. The aircraft are used for command and control, reconnaissance, aeromedical evacuation, resupply, troop transport, and the support of division artillery.

The division also has a military police company which maintains law and order, handles prisoners of war, and controls traffic.



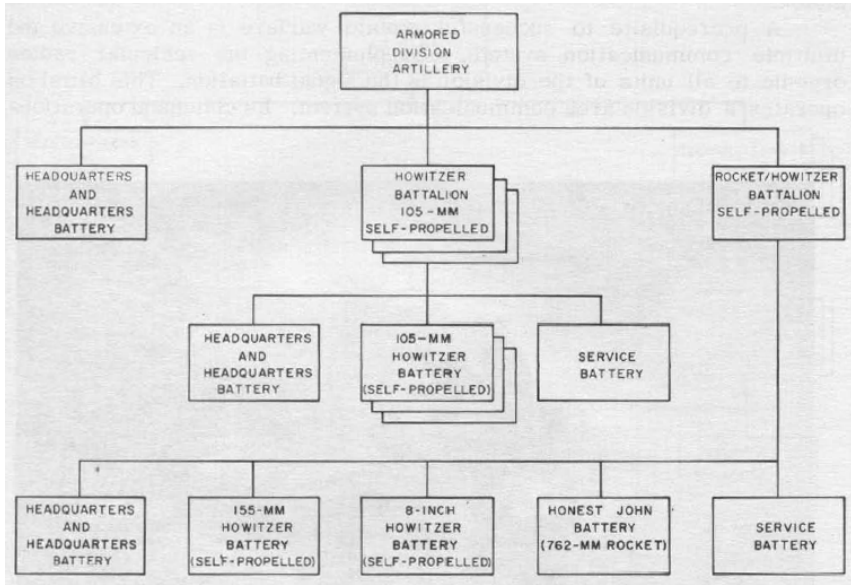

Figure 26. The armored division artillery.

### Logistical Support

Logistical support elements are grouped under a division trains headquarters, the commander of which is responsible for the tactical control, movement, protection, and tactical training of the elements employed under division trains. Division trains include a quartermaster battalion, ordnance battalion, medical battalion, and an administration company.

The quartermaster battalion provides food, gasoline, oils and lubricants, quartermaster clothing and equipment, bath facilities, recovery and disposition service, and supplementary transportation. To perform these tasks, it has a supply company and a service company. This battalion has a challenging task, for approximately 370,000 gallons of gasoline are required to move the division 100 miles.

The ordnance battalion also has a difficult task. It plays a vital role in keeping the 3,400 vehicles of the division rolling. To do this, it has a headquarters and main support company and three forward support companies. Each forward support company provides direct ordnance support for a combat command while the headquarters and main support company services the remainder of the division.



Figure 27. A bizarre piece of equipment, the self-propelled armor bridge.

The medical battalion has an ambulance company and a clearing company, each of which has four platoons. A division clearing station, consisting of a clearing platoon and an ambulance platoon, is established at each combat command and at division trains.

The administration company serves as a carrier unit for personnel of the division special staff who perform personnel and administrative services. During operations, the battalion personnel sections (including artillery) join the administration company to form the division administration center.

The logistical and service elements of the armored division, like the combat support elements, are organized and equipped to provide close, responsive support to swiftly moving combat elements. Even though the division includes all of the elements normally required for combined arms action, it may include additional organizations when needed. Typical reinforcements include the armored cavalry regiment, separate tank battalions, engineer battalions, and elements of corps artillery.

With an understanding of the organization of the armored division and its characteristics and capabilities, one has the basis for acquiring a full understanding of how the division is employed. To appreciate the boldness, aggressiveness, and imagination that are the hallmarks of armor employment and to learn of the challenging problems that armor tactics pose for the artilleryman, read the next issue of ARTILLERY TRENDS for the second of this two-part series on the armored division.

# U S Army Reserve Schools and Staff Training Program

Lieutenant Colonel John F. Keester  
Department of Training Literature and Nonresident Instruction

Since World War II, the United States Army has passed through a revolutionary period. Nuclear weapons have created an immediate need for technological improvements in all related fields. Complicated weapons systems, communication, battlefield surveillance, and transport require personnel who have the knowledge to use these facilities.

This requirement poses no great problem for those who can attend the service schools. However, consideration has been given to reserve component officers whose civilian occupations preclude attendance at army service schools. The US Army Artillery and Missile School administers three programs to assist reserve component officers to maintain branch qualification and to improve their professional backgrounds. They are the US Army Reserve (USAR) school program, staff training program, and the extension course program. The USAR school program and the staff training program will be discussed here. The extension course program will be presented in a subsequent issue of ARTILLERY TRENDS.

The USAR school program, in existence since 1950, is operated by the reservist for the reservist. The artillery portion of this program provides a progressive artillery education for artillerymen who cannot attend resident courses at the US Army Artillery and Missile School. USAR schools meet all military education criteria for promotion and retention of officers of the reserve components.

USAR schools offer courses in all branches throughout the world. Commandants, staffs, faculties, and students are reserve component officers. A typical USAR school organization is shown in figure 28.

The army commander determines the number and location of USAR schools established in his army area. Criteria for establishing a school is contained in Section II, paragraph 7, Annex AL of US Continental Army Command (USCONARC) Training Directive, dated 1 July 1958. To be established, a school must have at least three instructional departments. An instructional department provides instruction in one particular branch or technical service of the Army. A list of 19 possible departments is contained in the training directive. MOS departments which give specialized enlisted training and satellite departments, which are set up in cities in the vicinity of the school, cannot be included as part of the required minimum of three instructional departments. The staff, faculty and student spaces allocated each army area cannot be exceeded.

## Instructional Departments

Instructional departments to be established within the schools also are determined by the army commander. The minimum student enrollment needed to establish an instructional department is 10 students; however, in the artillery, armor, and infantry departments, only 5 students must be from the branch for which the course is established.

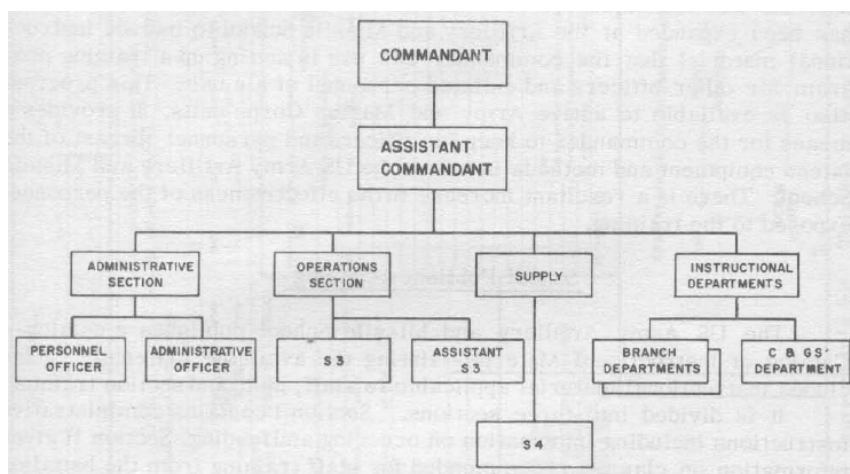

Figure 28. Organization of a typical USAR school. There must be a minimum of three instructional departments.

The US Army Artillery and Missile School offers two artillery courses through the USAR schools system--the USAR Associate Advanced Officers Course and Associate Battery Officers Course. Each course lasts 3 years. In each year, 24 two-hour training periods are given at the home station, and 80 hours of active duty instruction normally are given at the US Army branch service school location. A total of 384 hours of instruction is presented in each course. This figure represents approximately 65 percent of the instruction offered in the comparable resident courses. All "must know" material is included, and "should know" material is excluded.

The US Army Artillery and Missile School supports the USAR schools system with instructional material and training aids. The instructional material is prepared by the resident instructors who teach the same subjects to resident students. Instructional material is reviewed annually to insure that current doctrines, concepts, and procedures are being presented and that resident instruction is being paralleled as closely as possible.

The successful completion of a course entitles the student to a certificate, which is an award of equivalent academic credit to the comparable resident course. Presently, there are 121 artillery departments located in USAR schools throughout the United States. 172 courses are offered in battery and advanced level training. The present enrollment in artillery courses is approximately 2,270 officer students.

The staff training program began operation in 1954. The idea was conceived by USCONARC as a program to provide USAR and National Guard unit commanders with instructional material that reflected current doctrine and techniques of each branch for staff training. This program has been expanded at the Artillery and Missile School to include instructional material that the commander can use in setting up a training program for other officers and enlisted personnel of his unit. This program also is available to active Army and Marine Corps units. It provides a means for the commander to keep his officers and personnel abreast of the latest equipment and methods in use at the US Army Artillery and Missile School. There is a resultant increase in the effectiveness of the personnel exposed to the training.

### School Publishes Catalog

The US Army Artillery and Missile School publishes a catalog--Catalog of Instructional Material--listing the available material. It includes instructional material applicable to staff, unit, and section training.

It is divided into three sections. Section I contains administrative instructions including information on ordering and funding. Section II gives information on classes recommended for staff training from the battalion level up to and including corps artillery. Section III lists the classes recommended for unit and section training.

Each instructional unit offered by the Artillery and Missile School through the staff training program is complete in every detail (fig 29). It includes an instructor's manuscript, instructional notes, illustrative problems, instructional units, Vu-Graph transparencies, and the necessary forms, maps, and overlays to present a complete and well organized class.

An instructional unit includes a packet of material for the instructor and an additional packet containing sufficient material for 10 students. In the last year, over 25,000 units of instructional material have been shipped to organizations and individuals throughout the world.

All instructions for obtaining this material are contained in the catalog which is distributed throughout the Army to artillery units, to include battalion and higher headquarters of the USAR, National Guard, and active Army units. This material also is available to Marine Corps artillery units, military assistance advisory groups, and military missions.

Comments and recommendations from the field are valuable in determining the needs of the user. Comments, recommendations, and requests for material should be addressed to: Commandant, US Army Artillery and Missile School, Fort Sill, Oklahoma, ATTN: AKPSIDA-TP/RC.

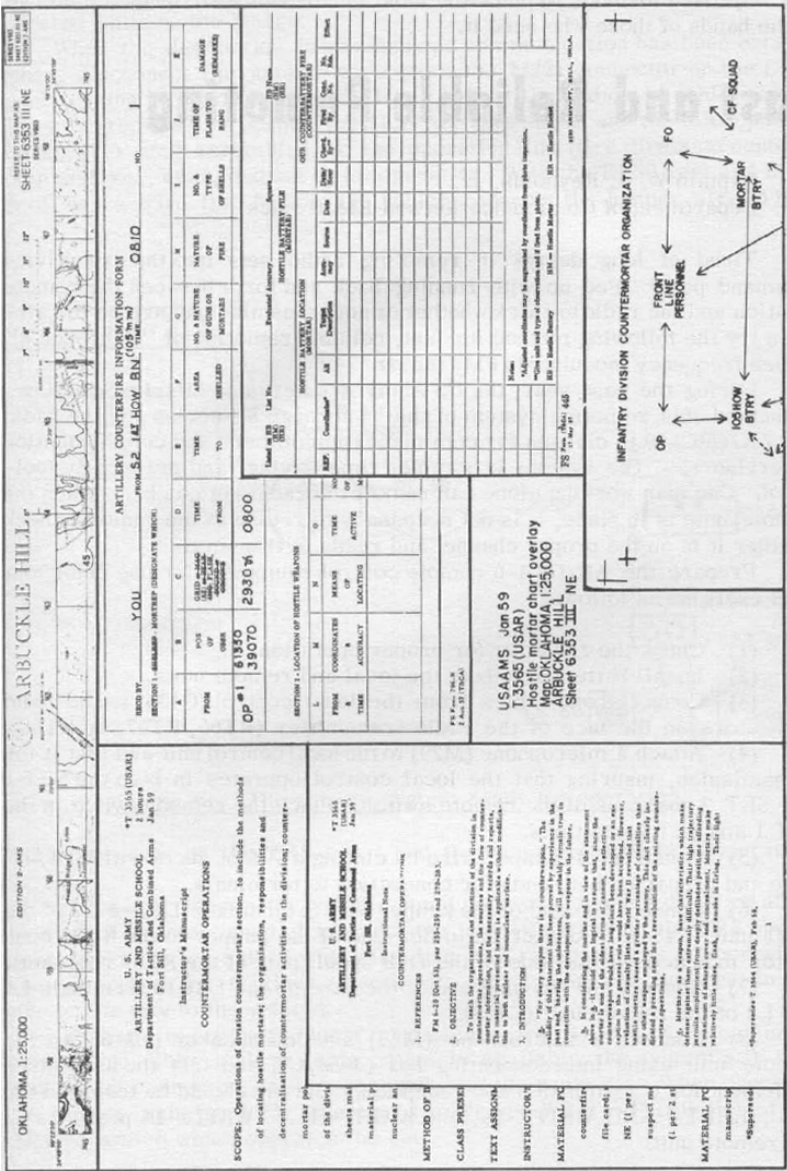

Figure 29. An example of the typical instructor's kit. This kit is for class T3565 (USAR).

The US Army Artillery and Missile School constantly is seeking new and improved methods to place the most up-to-date instructional material in the hands of those who need it.

## Fast and Reliable Remoting

Captain W. A. Reynolds, Jr.  
Department of Communication and Electronics

Tired of long delays in remoting radio sets into the executive's command post? Fed up with running back and forth between the remote position and the radio to check whether or not transmissions are on the air? Then try the following method for fast, reliable remoting of "3 through 8" series frequency modulated (FM) radios.

During the past year, the US Army Artillery and Missile School has presented this remoting system of the "3 through 8" series and the radio set AN/GRC-19 to classes for communication officers and communication supervisors. The system is simple, time saving, and practically foolproof. One man working alone can remote the radio set quickly. When the remote unit is in place, it is not necessary to return to the radio to check whether it is on the proper channel and ready to transmit.

Prepare the AN/GRA-6 remote control equipment for use prior to a field exercise as follows:

- (1) Check the radio set for proper operation.
- (2) Install batteries in both the local and remote units.
- (3) Connect both cables from the local control (C434) to the audio connectors on the face of the radio transmitter (RT66, RT67, or RT68).
- (4) Attach a microphone (M29) to the local control unit and test it for transmission, insuring that the local control operates in both the SET 1 and SET 2 positions of the remote switch. Place the remote switch in the SET 1 and SET 2 positions.
- (5) Construct a jumper wire by cutting a 7-foot section of WD1/TT wire and preparing both ends for connection to terminals.
- (6) Connect one end of the jumper wire to terminals L1 and L2 of the local unit (C434). Connect the other end of the jumper to the M221 connector mounted on the side of the DR8 spool (part of the RL39 reel unit).
- (7) Connect the running end of the wire on the DR8 to terminals L1 and L2 of the remote unit (C433).
- (8) Connect a microphone (M29) and loudspeaker (LS166) to the remote unit using interconnecting box (J654/U), and test the assembled equipment for transmission and reception. The unit should be tested in the TEL, LEFT-HAND WRITE-IN, and RIGHT-HAND WRITE-IN positions on the remote unit.

(9) During testing, defective equipment should be replaced as soon as it is located. When placed in a vehicle, the set as assembled may be operated while on the march.

When the destination is reached and communication has been established, disconnect the jumper wire from the M221 connector on the DR8 spool leaving it connected to the local unit at the radio and vehicle site. Carry the remote unit (C433), the RL39, the DR8 spool, and the microphone and speaker still assembled, to the operating site (fire direction center, command post, etc.), and set up for operation. With the RL39 reel and DR8 spool, lay a wire line back to the vehicle, connect the jumper wire to the

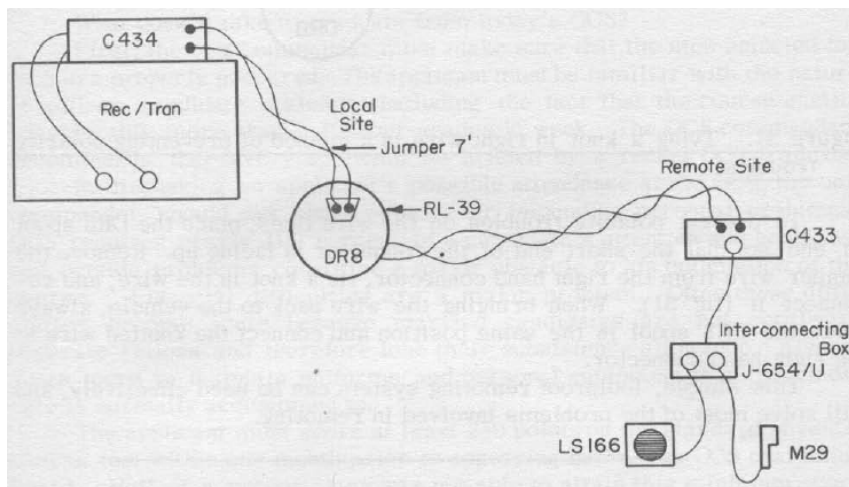

Figure 30. The remote system ready for operation.

M221 connector on the DR8 spool and the remote system is in operation (fig 30).

If for any reason the vehicle must be moved a short distance after the system is established, disconnect the jumper wire from the DR8 spool, move the vehicle, extend the wire line and reconnect the jumper wire. When march order is given, disconnect the jumper wire and reel in the wire on the way to the vehicle.

If, while checking the local control unit (step 4), one of the cables is found to be faulty and no replacement is available, the system still will function by connecting the one good cable to the radio set. When checking the remote unit (step 8), locate and mark the WRITE-IN position of the selector switch which operates the set.



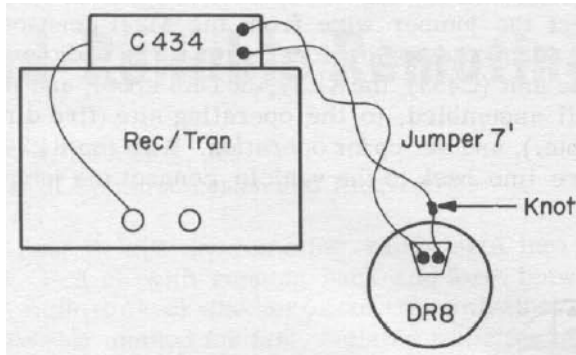

Figure 31. Tying a knot in right wire is a method of preventing polarity troubles.

To prevent polarity troubles on the wire lines, place the DR8 spool on end so that the short end of the connector is facing up. Remove the jumper wire from the right hand connector, tie a knot in the wire, and reconnect it (fig 31). When bringing the wire back to the vehicle, always place the DR8 spool in the same position and connect the knotted wire to the right hand connector.

This simple, foolproof remoting system can be used effectively, and will solve most of the problems involved in remoting.

---

"The importance today of the citizen-soldier to the active Army cannot be overestimated. Since it is impracticable to maintain an active Army of sufficient size to deal with all the possible emergencies which our potential enemies might create, our Army National Guard and Army Reserve must be maintained in a constant state of combat readiness so that they can be deployed as integral parts of our active forces with the least possible delay."

--Wilber M. Brucker  
Secretary of the Army

"The ground combat soldier is not a Guardsman, nor a Regular, nor a Reservist, nor a Selectee--he is simply the American fighting man on the One Army Team."

--General Bruce Clarke  
Commanding General, USCONARC

# OFFICER CANDIDATE SCHOOL TODAY



Captain Talbott Barnard  
US Army Artillery and Missile Officer Candidate School

The US Army Artillery and Missile Officer Candidate School presently has its 100th class in training since the artillery OCS was reactivated in January 1951.

What does it take to graduate from today's OCS?

First, the unit commander must make sure that the men selected for OCS are properly prepared. The applicant must be familiar with the nature of officer candidate training, including the fact that the course entails considerably more than a 40-hour academic week. The OCS commandant recommends that every applicant be briefed by a recent OCS graduate.

In discussing an applicant's possible attendance at the OCS, the unit commander should ask about existing or impending personal problems. OCS requires nearly 100 percent of a candidate's attention and energies, and outside problems constitute a major obstacle to his completion of the course. Financial difficulties are a major problem. Often these difficulties become acute because married candidates are not entitled to separate rations and therefore lose their subsistence allowance. Also, it costs more to maintain uniforms and personal equipment than the candidate is normally accustomed to.

The applicant must score at least 250 points on the standard physical fitness test within one month prior to appearing before the OCS examining board. Half of a recent class was not able to attain this minimum score when they were given the test again during the first week of the school. The school presupposes a certain degree of physical fitness, therefore the course is not designed to raise the physical proficiency of an individual.

### A New Requirement

A recent additional prerequisite for attending OCS is the completion of high school trigonometry or its equivalent. As a minimum standard, the applicant should be familiar with the functions of triangles and the use of logarithms. To meet this requirement, the applicant should complete subcourse 15, "Exercises in Mathematics." Prospective candidates may apply for this and other extension courses by filling out DA Form 145 and mailing it to the Commandant, USAAMS, Fort Sill, Oklahoma.

The unit commander should consider all these points when reviewing an individual's application for OCS. The unit commander should never process this application as a matter of routine.

The OCS area at Fort Sill is called Robinson Barracks. In addition to the normal administrative offices and barracks, the facilities include a mess hall, post exchange, barber shop, visitor's lounge, gymnasium, and classroom buildings. The OCS is organized with a standard headquarters and staff, a headquarters battery to administer the enlisted permanent party, and three lettered candidate batteries. Within this structure, the OCS fulfills the mission of preparing selected individuals for duty as second lieutenants, and serves as a basis for expansion in the event of mobilization.

A class of approximately 50 candidates enters the OCS every 8 weeks and is divided among the three candidate batteries. There are three classes in residence all the time. Consequently, one-third of each of the three classes is in each of the lettered batteries. Thus, each candidate battery has a Lower Class, a Middle Class, and an Upper Class, each separated by 8 academic weeks. A system of command position is used on a weekly rotational basis as part of the leadership instruction. The battery officer positions are filled by the upperclassmen and the noncommissioned officer positions by the middleclassmen while the lowerclassmen serve as "privates." A candidate battalion staff is formed by members of the Upper Class. This staff is responsible for administrative and training activities and occupies its own headquarters building in the OCS area.

#### Honor System

The candidates elect representatives to operate an honor system similar to the one at the United States Military Academy. Any violation or suspected violation of the honor system is reported to the Honor Committee. The committee then conducts an investigation in accordance with Article 32 of the Uniform Code of Military Justice. The committee also conducts a hearing, and the findings are forwarded to the OCS commandant for appropriate action. If a finding of guilty is submitted, the offender, in most cases, is either permitted to resign or relieved from the school.

The OCS is an organic part of the US Army Artillery and Missile School. It shares the responsibility for the instruction of the candidate with the academic departments of the School. The resident School departments teach the candidate those subjects essential to artillerymen. Twenty percent of the candidate's instruction is in gunnery, 25 percent is in tactics and combined arms, 10 percent is in artillery transport and materiel, and 10 percent is in communications and target acquisition.

The remaining one-third of the instruction is either taught or supervised by the OCS tactical staff. This instruction gives the candidate the necessary background to be a junior officer. There are periods of dismounted drill, physical training, and troop information which prepare him to instruct those subjects. The candidate receives familiarization training with small arms and small arms range operations and instruction in the use of the bayonet and hand-to-hand combat. To facilitate the transition from an enlisted to a commissioned status an officer indoctrination program is being expanded.

This full academic program given in a 22-week period exerts a demanding routine upon the candidate, who must satisfactorily complete each of the subcourses as one of the criteria for graduation. Academic achievement is weighted as 65 percent of his overall grade.

#### Other Grading Areas

There are two other areas in which a candidate is graded. The first is an evaluation of the individual by his battery tactical officers. The candidate is observed closely during all phases of his training, and the rating he receives accounts for 25 percent of his overall grade. The final 10 percent of the overall grade is derived from student ratings of the candidate submitted by his classmates.

The overall attrition rate for the past 9 years has remained constant at about 44 percent. Of those not completing the course, approximately 49 percent are relieved for lack of motivation and 12 percent for physical deficiencies while leadership and academic deficiencies account for some 27 percent of the individuals relieved. This figure of 27 percent would be considerably higher were it not for the policy of retaining candidates deficient in these areas by turning them back to a subsequent class. To be retained by being turned back, a candidate must demonstrate sufficient potential to justify his retention. The remaining 12 percent who do not complete the course drop out primarily due to financial hardship, character deficiencies, and security requirements.

The candidate is constantly made aware that his every action is being observed, analyzed, and evaluated. The prescribed standards are intentionally made to seem unattainable; adequate time to perform necessary actions never seems to be available. In this atmosphere, the candidate must learn to function efficiently and concentrate his efforts on the most important of a multitude of "mandatory" requirements. This takes determination, as more than 5,000 past graduates will affirm.

For the future, the Officer Candidate School will strive to continue to produce qualified junior officers from the enlisted ranks.

---

"No member of the Army can afford to compartmentalize his thinking, and consider only his own branch, his own service, or his own component. He must visualize the military picture as a whole--not just his particular part of it--and with that vision as his guide, work in complete harmony with all concerned to achieve a single, positive result. The traditional wall which once separated the various Army branches and components has become completely outmoded."

--Wilber M. Brucker  
Secretary of the Army

## COMMERCIAL HYDROGEN FOR METEOROLOGICAL BALLOONS?

In this age of high taxes a savings to the government of \$121.92 a day is important. It is possible to save Uncle Sam this sum for each day of operation in a meteorological section.

A meteorological section that is assigned a mission of supporting artillery units during a fixed station operation, firing range duty, or on the job training, can use commercial hydrogen in lieu of the issued calcium hydride for inflation of sounding balloons. This is nine times cheaper. Bottled hydrogen also reduces balloon inflation time, allows the section to attain higher altitudes, it is much cleaner and more convenient than calcium hydride. However, because of its bulk weight and space limitation, hydrogen is not practical for use in a tactical situation, except in emergencies.

In order to inflate a sounding balloon (ML391C) with calcium hydride charges, five ML305A calcium charges are required. Each charge costs \$4.42, therefore, the cost of inflating a sounding balloon is \$22.10. Using commercial hydrogen, the cost of inflating the same balloon would be approximately \$1.78. The saving then is about \$20.32 per balloon. Based on a minimum artillery requirement of at least six observations in a 24-hour period, the total saving is \$121.92.

While calcium hydride is a signal corps issue item, commercial hydrogen in cylinders is an engineer technical service item. The federal stock number for a 200-cubic foot capacity hydrogen filled cylinder is FSC 3655-408-4560.

It is possible to obtain commercial hydrogen in other areas of the world. In England, a metro team that was using calcium hydride charges discovered that an English oxygen firm also produced hydrogen. Later, while in Germany, it was found that the meteorological sections were not using commercial hydrogen. By checking with the local military hospital it was found that a German oxygen company produced hydrogen. The result was that all three meteorological sections under this particular command were using commercial hydrogen within one month. Where there is a source of commercial oxygen or nitrogen, there probably is a source of hydrogen.

What are the procedures to obtain the commercial hydrogen? First, consult the local engineer supply officer. Commercial gas, of any type, is procured through engineer supply channels. The next step is to establish comparative costs of the two gases and explain the savings. The engineer supply officer should agree to complete the operations required to change to commercial gas.

The authority for requesting commercial hydrogen and the procedures to be followed are contained in AR 725-5, dated 10 September 1958, with change 1, dated 4 May 1959 (Issues of Supplies and Equipment - Request for Items in Excess of Authorized Allowances). Furthermore, AR 700-8120-1 (Gas Cylinders--Safe Handling, Storing, Shipping, Using, and

Disposing), explains the safety requirements when using commercial gas cylinders.

Are you in a position to save money for Uncle Sam under this operation?

### A GEM FOR THE COMMUNICATION OFFICER

The wave antenna and the vertical half rhombic antenna are two field

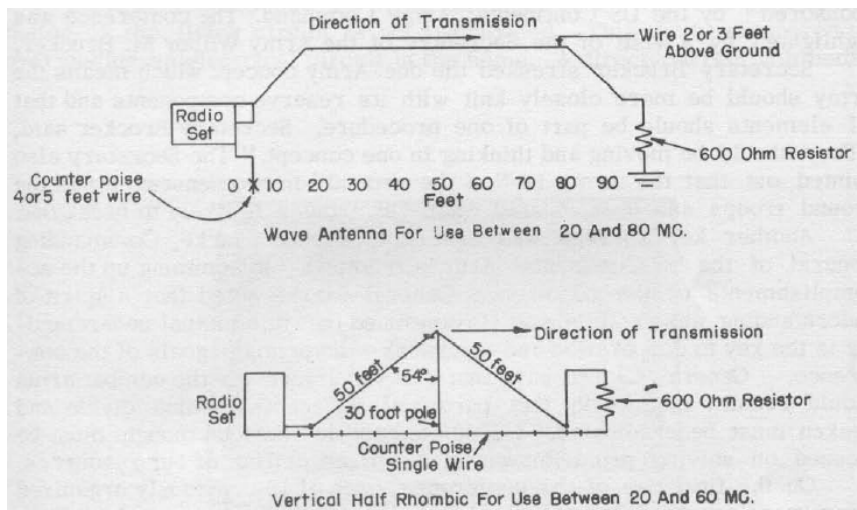

expedient directional antennas that can be used with frequency modulated (FM) radio sets. The antennas can be constructed easily using field wire and lance poles or existing trees as supports. They are directional and will transmit in the direction of the terminating end, and will normally double or triple the rated operating range of the FM sets.

--Submitted by Capt A. J. Podlesny, Jr.  
Dept of C & E, USAAMS  
Fort Sill, Oklahoma

---

"That guns will never be deserted simply because danger threatens is a point of honor around which the artillery has largely built the solid discipline of its corps."

--S. L. A. Marshall

# **NEWS NOTES FOR ARTILLERYMEN**

## **COMBAT ARMS CONFERENCE HELD AT FORT SILL**

Some 93 general officers and 200 other officers met at Fort Sill from 7 to 11 December for the first Worldwide Combat Arms Conference, sponsored by the US Continental Army Command. The conference was highlighted by a visit of the Secretary of the Army Wilber M. Brucker.

Secretary Brucker stressed the one-Army concept which means the Army should be more closely knit with its reserve components and that all elements should be part of one procedure. Secretary Brucker said, "They should be moving and thinking in one concept." The Secretary also pointed out that the Army is "on the ground" in two senses. It has the ground troops and it is located wherever trouble is likely to break out.

Another key speaker was General Bruce C. Clarke, Commanding General of the US Continental Army Command. In summing up the accomplishments of the conference General Clarke noted that a spirit of understanding was established. He continued that this mutual understanding is the key to cooperation and teamwork--the primary goals of the conference. General Clarke said that the watchword for the combat arms should remain teamwork; that parochial differences which divide and weaken must be eradicated. He pointed out that serious thought must be focused on solving problems within the fixed ceiling of our resources.

On the final day of the conference, each of 10 previously organized committees reported their conclusions. The committees covered subjects such as organization; mobility; air space utilization; fire support and fire support coordination; air defense; combat intelligence, surveillance, and target acquisition; divisional administrative support; responsiveness of doctrine to field requirements; communications; and integration of combat arms. The final conference report has been completed and distributed worldwide.

General Clarke, in his closing remarks, promised that the recommendations made by the committees would receive careful attention and necessary action by USCONARC headquarters.

## **NEW SHIPPING CONTAINER FOR STRAC UNITS**

A lightweight, low cost, expendable shipping container has been designed for Strategic Army Corps (STRAC) units. The containers will be prepacked with organizational and individual equipment and stored in readiness for movements on short notice. It is expected that the containers will provide a 60-percent reduction in packing materials as well as a saving in time and weight.

## M35 FIRING PANEL BOX

The M35 firing panel box now is being used to fire the Honest John missile in the M386 system. It replaces the 50-cap blasting machine used with the M289 launcher. The M35 will also be used to fire the Little John missile.

The M35 (fig 32) is 13 inches long, 9 inches wide, 6 inches deep, and weighs 13 pounds. A major advantage is that it uses a 24-volt vehicle storage battery as the primary power source. Any vehicle equipped with a trailer receptacle can use this battery (fig 33). The vehicle's light switch must be in the "blackout" position.

Several rockets can be fired simultaneously with one push of the button if the firing circuit is not overloaded. This can be compared to overloading an electrical circuit in the home. A direct-current voltmeter

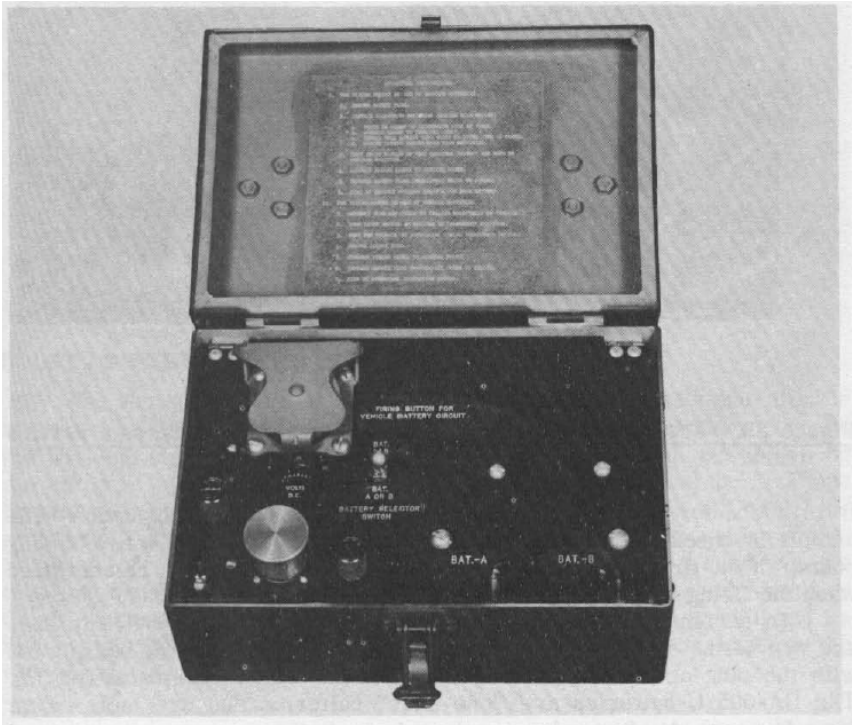

Figure 32. The M35 firing panel box with the lid raised.



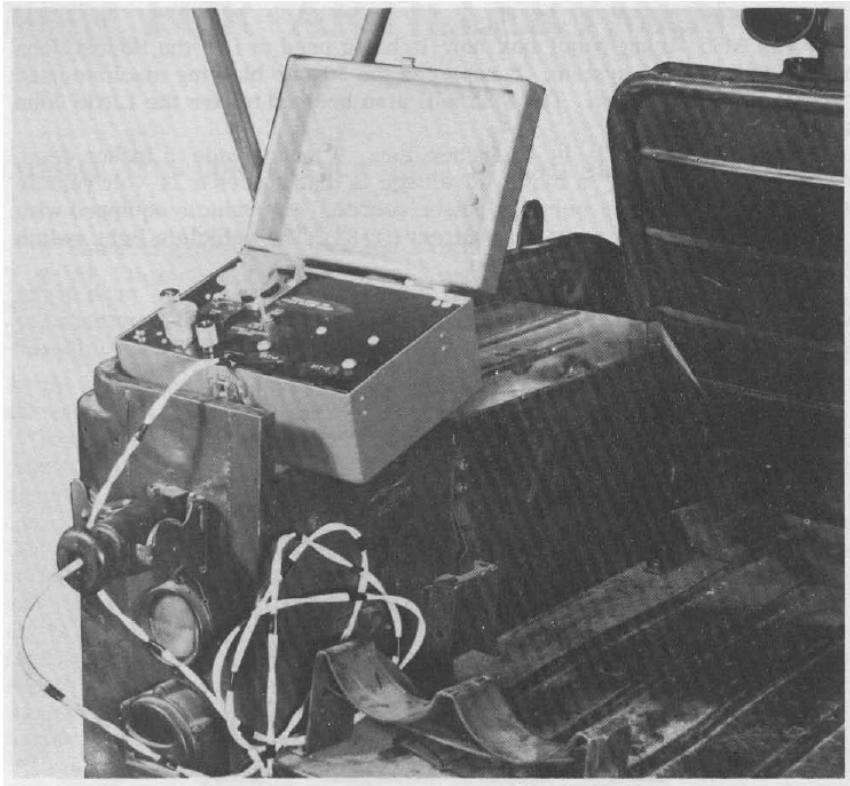

Figure 33. The firing panel box plugged into a receptacle on a 1/4-ton truck.

is provided for checking the circuit to determine if it is overloaded. The circuit is checked before the firing cable is connected to the two binding posts. If the firing circuit is overloaded, the circuit will not be energized when the firing button is depressed.

To accommodate this possible greater load, two BA-605/U batteries are provided. They are located under the hinged panel of the box (fig 34) with the plug and cable which connects to the trailer receptacle (fig 33). The BA-605/U batteries are "one-shot" batteries that are inert except for a few seconds after releasing the trigger firing pin.

The safety feature is a plug which completes the circuit to each binding post. When it is removed from the receptacle, the circuit is open or on "safety," and the rocket cannot be fired.

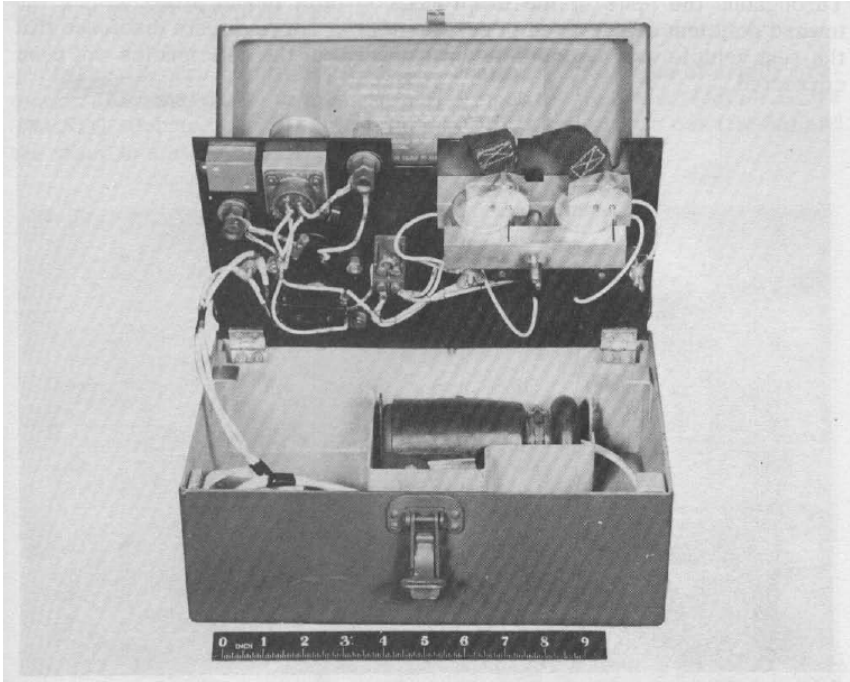

Figure 34. The firing panel box with the panel raised.

### **BOOST FOR THE SPACEMAN**

The Army Ballistic Missile Agency will use eight Redstone missile boosters in the advanced stages of Project Mercury. Present plans of the National Aeronautics and Space Administration, which is sponsoring the effort to put a man into orbit in outer space, are to use the Redstone boosters as power units on manned trainer capsules which will carry the spaceman to an altitude of more than 100 miles. These flights will provide a period of weightlessness of about 5 minutes and test the spaceman's reaction under gravity-free conditions. The Redstone, which has been fired successfully more than 50 times, was selected because of its reliability. Its record is unmatched by any other ballistic missile in the western world.

### **A NEW JEEP—THE M151**

A new version of the 1/4-ton truck the M151 (fig 35), presently is undergoing final tests by the US Army Armor Board at Fort Knox, Kentucky.

Throughout the tests of the preproduction pilot model attention is given toward deficient areas noted in service tests. Service tests disclosed that the test vehicle was not suitable until several of the deficiencies had been corrected.



Figure 35. The M151 presently is undergoing final tests at Fort Knox, Kentucky.

The vehicle is a conventional military tactical wheeled vehicle with a unit body (body and frame are one). The M151 has an independent coil spring suspension which improves the cross-country mobility.

The M151 is considered a standard vehicle and eventually will replace the present 1/4-ton truck. When the Armor Board is satisfied that all deficiencies have been corrected, the vehicle will be produced by the Ford Motor Company.

## LIGHTWEIGHT ARMOR PROTECTION

The US Army Artillery Board is evaluating two types of armor protection for the T236 family of self-propelled weapons (ARTILLERY TRENDS, February 1959). One type cover is the plastic cab (fig 36) and the other is a nylon armor cab (fig 37).

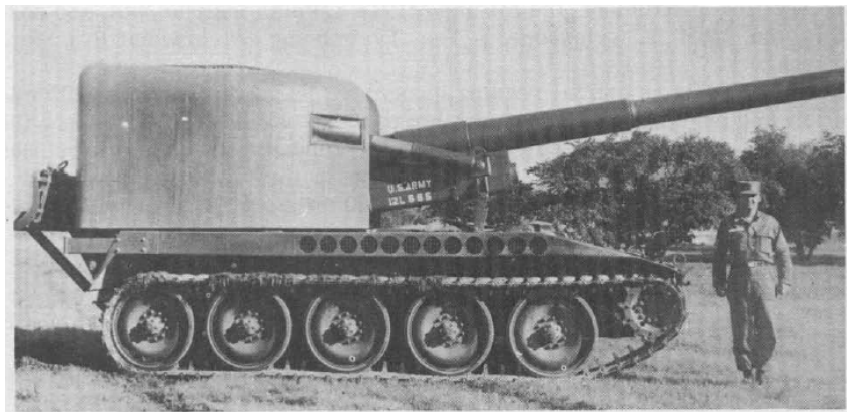

Figure 36. The plastic cab here is installed on the 175-mm gun, T235. It is a mockup of the proposed lightweight armor cover for the T236 family.



Figure 37. The nylon cab is shown on the 155-mm gun, T245. It is being tested concurrently with the plastic cab.

The final version of the lightweight armor cover will incorporate the best features of the two in order to provide the crew with the maximum protection from shell fragments, thermal effects of a nuclear burst, and the weather.

### **T9 SPOTTING INSTRUMENT**

A new spotting instrument, the T9 (fig 38), is designed to replace the M2 spotting instrument, the M1 and M1918 azimuth instruments, and possibly the M65 BC telescope. The T9 is being developed at Frankford Arsenal.

The T9 is an optical reading binocular instrument with night illumination and periscopic features similar to those of the M65 BC scope. The horizontal and vertical scales which are graduated to 1 mil can be seen through the right eyepiece. Magnification in the telescope is selective, either 10-power with a field of view of 100 mils or 20-power with a field of view of 50 mils.



Figure 38. Mockup of the T9 spotting instrument.

The T9 has a selective filter system to permit direct observation of nuclear bursts. Eventually, the instrument will be equipped with an automatic shutter device to protect the observer's eyes from damage from unexpected nuclear bursts. It is expected that the T9 will be issued to units during 1961.

### **LARC-5—LIGHTER, AMPHIBIOUS, RESUPPLY, CARGO**

The LARC-5 is a new lightweight, all aluminum, amphibious truck with a 5-ton capacity, designed to replace the 2½-ton World War II DUKW.

A 270-horsepower engine located aft of the engine compartment powers the vehicle in the water at approximately 10 miles per hour and on highways at 30 to 35 miles per hour. Four large diameter, low pressure tires provide exceptional mobility in sand. The new vehicle also has been designed to negotiate heavy surf. Removable side gates aid in loading and unloading the cargo.

Testing of the first LARC-5 began in July 1959 at Fort Custer, Michigan, and seven additional vehicles are being constructed under a contract awarded during the summer of 1959. A 15-ton capacity vehicle, the LARC-15, also is being developed.

### **LACROSSE BATTALIONS DUE TO FIRE**

Two Lacrosse missile battalions, the 5th Missile Battalion, 41st Artillery and the 5th Missile Battalion, 42d Artillery recently have completed the nonfiring portion of the Army Training Program (ATP).

Both battalions are programmed to conduct the firing phase of the ATP at Fort Bliss, Texas, during early 1960.

Three more Lacrosse battalions are tentatively scheduled for activation in early 1960. They are the 5th Missile Battalion, 40th Artillery in January 1960, the 5th Missile Battalion, 39th Artillery in February 1960. and the 5th Missile Battalion, 33d Artillery in March 1960. This will bring the total of Lacrosse battalions in the active Army to seven. They will be attached to the 1st FA Missile Brigade at Fort Sill.

### **GROWING PAINS IN THE ELECTRONICS FIELD**

Electronics, one of the fastest growing phases of the artillery, is experiencing "growing pains" in the form of a shortage of qualified maintenance personnel. Accordingly, the US Army Artillery and Missile School is expanding its facilities and developing a training program to provide technicians.

An elaborate \$1,500,000 communication and electronics building is under construction. Two 1,000-man messhalls have been converted to electronics laboratories to house the new lab equipment until the new building is finished. Some 30 contract civilian instructors, in addition to military instructors, have been provided.

New construction boards with plug-in components reduce construction time and allow students to build and study more electrical circuits than before (fig 39).

Elaborate facilities are available to train maintenance personnel. However, to take advantage of these facilities, unit commanders must send qualified men to the School. Too often the "spare" man is sent rather than the "best" man, and time and money are invested in one who may never benefit the organization.

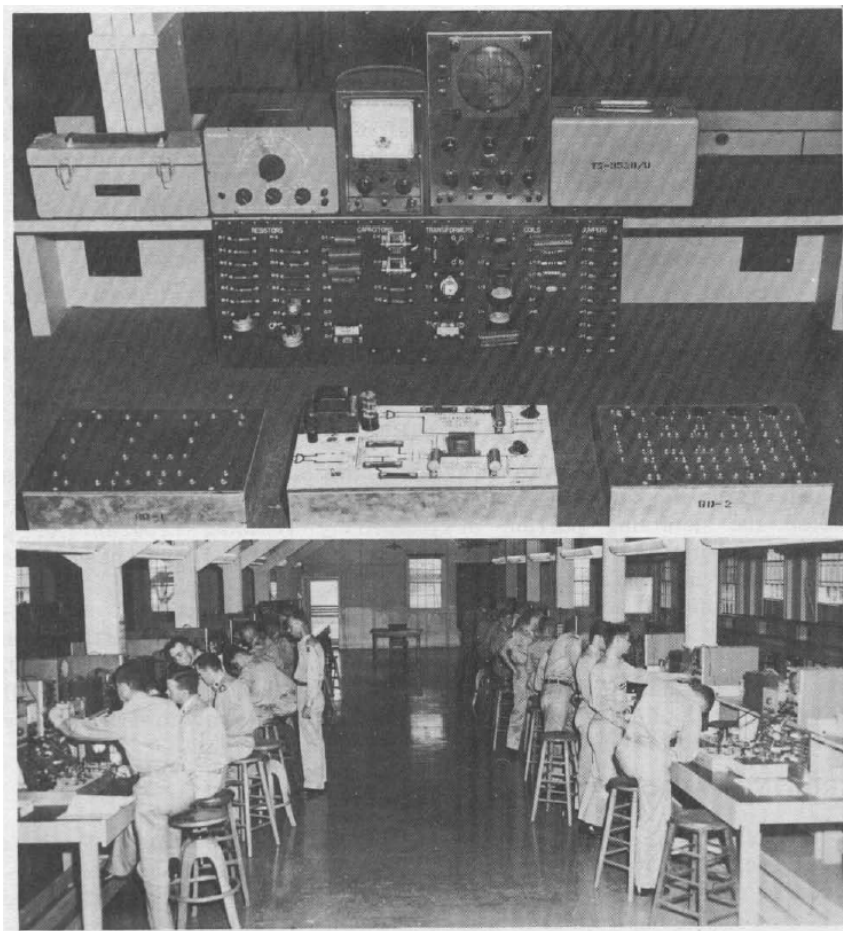

Figure 39. Electronics laboratory work area.

## **THE ENLISTED EVALUATION SYSTEM**

The ever increasing complexity and lethality of the equipment and weapons of modern warfare underscores the need for skilled and highly trained soldiers. To insure the best use of the talents of its enlisted men,

the Army adopted in 1958 its Enlisted Management Program. A vital element of this program is the evaluation system.

The purpose of the evaluation system--as stated in AR 611-205--is "to provide techniques for improving military personnel management through objective evaluation of individual proficiency." This system consists of two major components--MOS proficiency testing and proficiency evaluation.

MOS proficiency tests consist of paper and pencil performance tests which measure the soldier's technical job knowledge. There will be a separate test for each skill level (fourth digit) of each advanced MOS. Each test may cover any position that a soldier is required to fill within the skill level of his MOS.

Proficiency evaluation is a means whereby the soldier's on-the-job performance is evaluated by his immediate supervisor. To accomplish this evaluation, the supervisor uses the Commander's Evaluation Report (DA Form 2166).

Based on the results of the MOS proficiency test and the proficiency evaluation, the Evaluation Center at Fort Benjamin Harrison, Indiana, computes a proficiency score. This score is recorded on proficiency data cards and is maintained in the individual's 201 file. The proficiency score is the individual's standing relative to all other Army enlisted personnel of the same MOS, skill level, and grade. All Army enlisted men, of grade E-4 or higher, are eligible to take the test; however, only enlisted men in the Regular Army are eligible for proficiency pay.

Proficiency pay is not a substitute for promotion but is intended to give recognition to those individuals who have displayed special proficiency in their skill and grade. A Regular Army enlisted man, E-4 or higher, who is classified and serving in a primary MOS for which proficiency payments are authorized (AR 611-208) and who achieves a qualifying proficiency score, may receive proficiency pay.

Recognizing the need for skilled enlisted men, the Army established the enlisted evaluation system as an incentive for enlisted men to do a better job and to recognize those men who have done a good job.

## **STATUS OF TRAINING LITERATURE**

1. The following training literature is under preparation or revision by the US Army Artillery and Missile School.

A. Field Manuals (FM):

6-20 FA Tactics and Techniques

6-25 FA Missile Group, Redstone (U)



- 6-35 FA Missile, Redstone
- 6-35A FA Missile, Redstone, Missile Technical Firing Operations
- 6-40 FA Gunnery
- 6-75 105-mm Howitzer, M2 Series, Towed
- 6-140 FA Battery
- 6-585 FA Missile Battalion (Lacrosse)
- 6-( ) The Field Artillery Rocket, Honest John w/Launcher XM33

B. Technical Manual (TM):

- 6-242 Meteorology for Artillery

C. Training Circular (TC):

- 6-( ) Nuclear Burst Data

D. Army Training Tests (ATT):

- 6-5 FA Battalion, Light and Medium
- 6-585 FA Missile Battalion, Lacrosse
- 6-( ) FA Rocket/Howitzer Battalion (Infantry Division)
- 6-( ) FA Howitzer or Gun Battery (Hvy)

E. Department of the Army Pamphlet:

- 6-1 FA Checklists

2. Training literature submitted to USCONARC:

- FM 6-40 Change 2 FA Gunnery
- FM 6-( ) Division Artillery (includes infantry, armored and airborne)
- FM 6-( ) FA Missile, Lacrosse
- FM 6-( ) Warhead Section, M24, M25, M26 and M29 (Honest John) (U)
- FM 6-( ) Warhead Section, XM13, XM55 and XM16 (Lacrosse) (U)
- FM 6-( ) Warhead Section, XM18, XM30, XM31 and XM33 (Redstone) (U)
- FM 6-( ) FA Rocket, Honest John w/Launcher M386
- FM 21-13 The Soldiers Guide

3. Training literature at the Government Printing Office:

ATT 6-( ) FA Howitzer Battery, 105-mm and 155-mm  
(Infantry Division)  
FM 6-60 The FA Rocket, Honest John w/Launcher  
M289  
FM 6-61 FA Missile Battalion, Honest John Rocket

4. Training literature recently printed:

ATT 6-11 FA Missile Battalions and Batteries, 762-mm  
ATT 6-116 FA Howitzer Battalion, 105-mm and 155-mm  
(Infantry Division)  
FM 6-18 Mortar Battery, Airborne Division, Battle Group  
FM 6-33 Warhead Section, M34 and M35 (Corporal) (U)  
FM 6-97 Projectile: Atomic, M366; and Atomic  
Training, M369; 280-mm Gun (U)  
FM 6-98 Projectile: Atomic, T317E1; Atomic Training,  
T349E1; and T347; 8-inch Howitzer (U)

5. Artillery training films currently under production and scheduled for release during calendar year 1960:

Artillery Battalion Survey  
Part II. Planning and Execution (25 minutes)  
  
Extension of Direction for Artillery by Simultaneous  
Observation (25 minutes)  
Countermortar Radar AN/MPQ-4A (25 minutes)  
  
Lacrosse Battalion Guidance Section  
Part I. Duties in prepare for action and march order (25  
minutes)  
Lacrosse Battalion Assembly Section--Crew duties in prepare for  
action, check-out and assembly and march order (25 minutes)

6. Artillery training films production completed and scheduled for release in calendar year 1960:

Artillery Battalion Survey  
Part I. Methods (TF 6-2800) (25 minutes)  
  
Weapons of the Field Artillery (TF 6-2804) (30 minutes)  
Artillery Orientation by Sun and Star  
Part I. Altitude Method (TF 6-2850) (30 minutes)

7. Artillery training films scheduled for production and release during calendar year 1960:

Field Artillery Sound Ranging  
Field Artillery Target Acquisition Battalion  
Introduction to Flash Ranging  
Lacrosse Battalion-RSOP

Lacrosse Battalion-Guidance Section  
Part II. Duties in Firing Lacrosse  
Lacrosse Battalion-Firing Section--Crew duties in prepare for action, firing, and march order.

8. The following artillery training films pertaining to the Honest John will be revised and have been approved for production in calendar year 1960: TF's 6-2374 through 6-2379 (Parts I to VI inclusive)

NOTE: An Instructor's Film Reference is available with each film issued by the film library. The FR (Film Reference) includes general information, synopsis of film, suggested introductory, use and place of training film in training program, suggested discussion, correlated training aids and publications, and a suggested end of film quiz. The FR is a valuable aid in preparing the instructor outline and lesson plan. Discrepancies in a training film, if any, will be indicated in notes to the instructor on the FR.

9. MOS Army Subject Schedules under preparation by the US Army Artillery and Missile School:

ASubjScd 6-103 MOS Technical Training of the Ballistic Meteorology Crewman  
ASubjScd 6-152 MOS Technical Training of the FA Operations and Intelligence Assistant  
ASubjScd 6-153 MOS Technical Training of the Artillery Surveyor  
ASubjScd 6-155 MOS Technical Training of the Sound Ranging Crewman  
ASubjScd 6-156 MOS Technical Training of the Radar Crewman

10. MOS Army Subject Schedules submitted to USCONARC:

ASubjScd 6-1 Care and Handling of Ammunition  
ASubjScd 6-7 Duties of the Battery Recorder and Computer  
ASubjScd 6-31 Visibility Diagram (Charts)  
ASubjScd 6-141 MOS Technical Training of the Light and Medium FA Crewman

## INFORMATION FOR 155-MM HOWITZER UNITS

155-mm howitzers equipped with a M6A2 recoil mechanism made by the American Locomotive Company are developing nitrogen leaks through the recuperator charging valve. Units equipped with this recoil mechanism have been asked to report the serial number of the recoil mechanism to the Ordnance Weapons Command, Rock Island, Illinois, ATTN: ORDOW-FM

## PROTECT YOUR GUN BOOK

Damp weather can cause damage to equipment. Dampness can cause rust, sticking of parts, fogged up lenses and other damage. Keep your Gun Book container (FSN 1025-339-2109) protected from condensation by drilling two 1/8-inch holes in opposite corners of the bottom of the container about 1/2-inch from each end. Air out the gun book cover (FSN 1015-722-8906) often to prevent condensation. When fording deep water, seal the holes made by drilling.

## A GEM FOR THE SURVEY OFFICER

Do your range poles roll around in the bottom of your truck getting scuffed, dented, and the paint chipped? Here is a field expedient which works and also saves time. Take two shell casings from a 105-mm howitzer shell. Tape them together, slap a little OD paint on them, tie them to the side of your 3/4-ton truck, and you've got a ready made "quiver" in which you can carry your poles already assembled, keeping them off the floor of the truck and readily available to the survey officer or chief of party when he is out on a ground reconnaissance or actually laying out a survey. It looks like this:

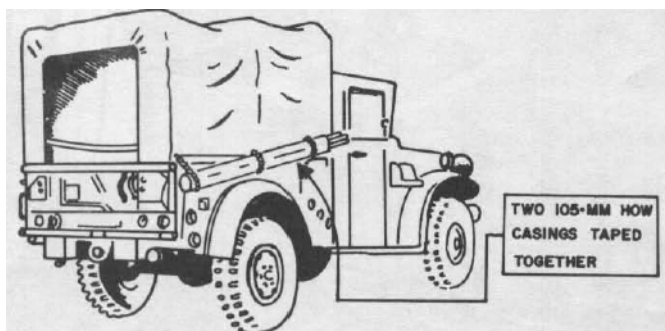

--Submitted by 1st Lt Harry A. Thompson II  
Hq, 1st FA Bn, 34th Arty APO  
29, New York, New York

## A GEM FOR THE ARTILLERY BATTERY

It is difficult to keep the battery's fragile gasoline lanterns operating while in the field. The major problem is breakage. The lantern is issued in a cardboard box which offers no protection once it gets wet. A two section wooden box built from scrap lumber offers adequate protection for the lantern. The box is easy to carry and can be constructed in the battery.

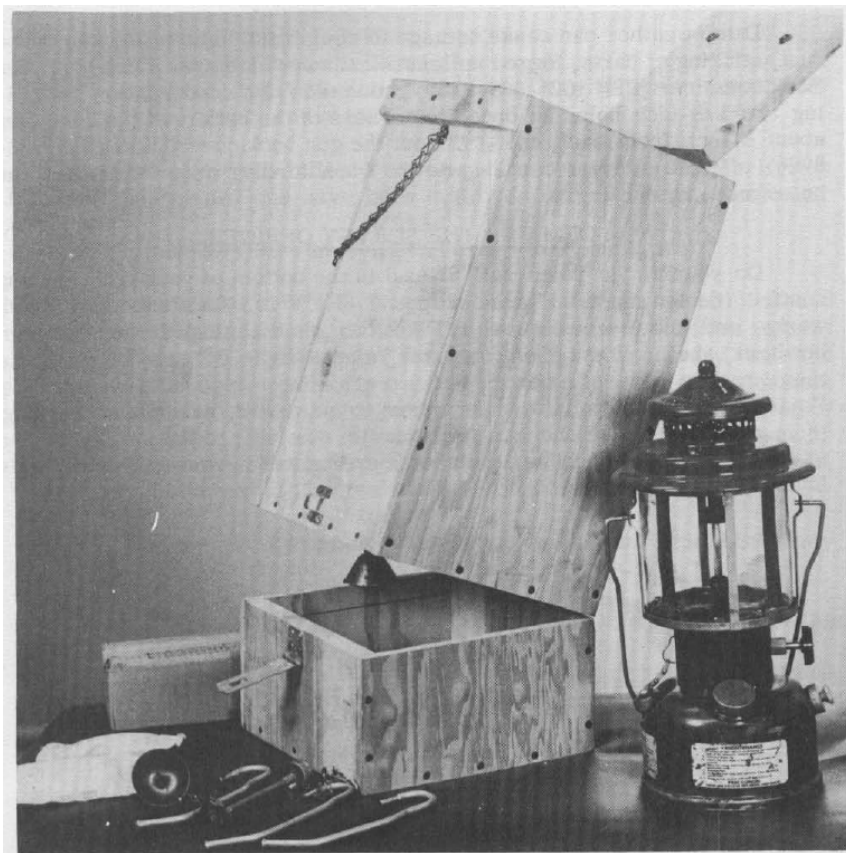

A lower compartment can be added to store repair parts, extra mantles, etc. The compartment shown here is 4 1/4-inches deep. The upper portion is 7-by 7 1/4-inches and is 14 3/4-inches tall. The inside of the upper portion is lined with pieces of scrap sponge rubber.

--Submitted by SFC Bill M. Griffith

2d Howitzer Battalion, 31st Artillery, Fort Sill

5092 ARMY-FT. SILL, OKLA.

# **LOOK FOR IT!**

**WITH** this copy of ARTILLERY TRENDS you should find a copy of the ARTILLERY TRENDS Index. This is a subject index which covers all issues of TRENDS from January 1957 through December 1959.

# An Attractive Addition

*to Your Library*

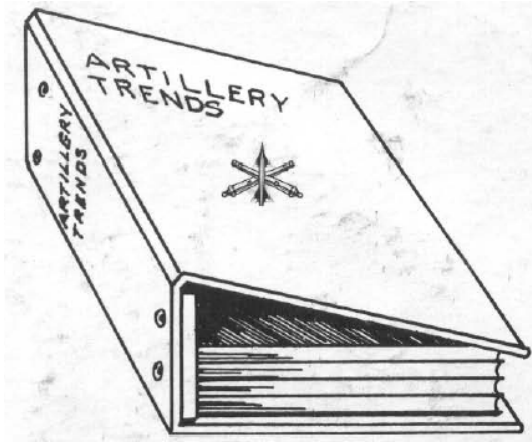

An attractive binder now available for your copies of ARTILLERY TRENDS features . . . . .

- Gold lettering
  - Colorful red cover
  - Sturdy stiff-grained leatherette construction

This compact binder holds **8** issues of ARTILLERY TRENDS and costs only \$1.85 post paid (US and APO's).

## ALSO

*Your name or unit can be stamped in gold on the front cover for an additional 25c.*

All orders must be accompanied by a check or money order payable to . . . .

THE BOOK DEPARTMENT  
US ARMY ARTILLERY AND MISSILE SCHOOL  
FORT SILL, OKLAHOMA