

# ARTILLERY TRENDS

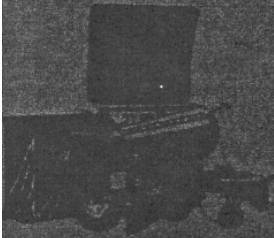

JUNE  
1959

U.S. ARMY ARTILLERY  
AND MISSILE SCHOOL

# ARTILLERY

## TRENDS

<u>CONTENTS</u>	<u>PAGE</u>
Weapons of the Artillery - 6-----	2
New Fire Direction Procedures-----	3
More on the New Infantry Division Artillery-----	14
The Rifle Company, New Infantry Division-----	18
New Emergency Fire Direction Procedure	
Using the M10 Plotting Board-----	30
Reorganized French Infantry Division	
Artillery-----	37
Redstone--The Missile and Its Equipment-----	40
Protection for the Head of the M2 Aiming	
Circle-----	56
Exercise Your Radar -----	58
Artillery Time Savers -----	59
Improved Method of Time Registration-----	63
The US Army Artillery Board -----	64
Resident Courses Taught at the US Army	
Artillery and Missile School-----	69
Newsnotes for Artillerymen-----	77



**INSTRUCTIONAL AID NUMBER 10**

## WEAPONS OF THE ARTILLERY—6

### 8-INCH

### HOWITZER

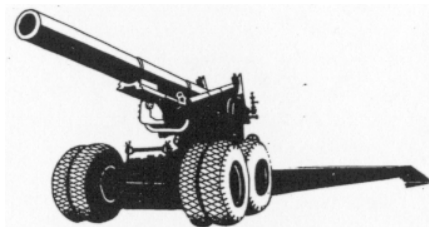

#### HOWITZER CHARACTERISTICS

Weight--29,700 pounds, firing position; 32,000 pounds, traveling position  
Length--36 feet  
Tube length--16.9 feet  
Range--16,930 meters or 18,510 yards  
Elevation-- -36 mils to 1,156 mils  
Traverse--533 mils right and left  
Type of traverse--pintle  
Muzzle velocity--1,950 ft per sec  
Rate of fire--1 rd per min  
Ammunition--HE, dummy, nuclear  
Fire control equipment--panoramic telescope M12A7C and range quadrant M1  
Recoil mechanism--hydropneumatic, variable, independent, using nitrogen gas under 1,500 psi at 70° F  
Length of recoil--29 inches at maximum elevation, 70 inches at minimum elevation  
Breechblock--stepped thread, interrupted screw  
Equilibrator--pneumatic  
Tube life--5,600 rd at maximum charge  
Time to emplace--30 min to 6 hr

#### TRAINING REFERENCES

FM 6-87, 155-mm Gun M2 on Motor Carriage M40 and 8-inch How M2 on Motor Carriage M43 (Jun 53) w/change 1  
FM 6-90, 155-mm Gun M2 and 8-inch How M2, Towed (Apr 53) w/change 1  
FM 6-93, 155-mm Gun M53, SP and 8-inch How M55, SP (Jul 57)  
TM 9-3004, 8-inch How M2, Carriage M1 and Heavy Carriage Limber M5 (Jun 53)  
TM 9-7220, Howitzer, 8-inch, SP, T108 (May 55)  
Tables of Organization:  
6-415D, FA How Bn, 8-inch, Towed or SP (Feb 58)  
6-417D, FA How Btry, 8-inch Towed (Feb 58)  
6-418D, FA How Btry, 8-inch SP (Feb 58)  
6-328D (DRAFT) FA How Btry 8-inch SP  
6-137 D (DRAFT) FA How Btry 8-inch Towed  
Army Training Tests:  
6-1, FA How or Gun Btry w/change 1 (U), 2 (S)  
6-15, FA Bn, ROCID  
6-16, FA Bn, 8-inch How w/change 1 (S)

# NEW FIRE DIRECTION PROCEDURES

Captain Paul Donovan  
Department of Gunnery

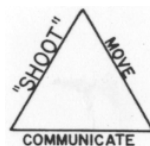

Progress is a key word in current US Army planning. As equipment, organization, and tactics are modernized, so then must methods and procedures be modernized. Several developments in the field artillery have made a reevaluation of the "check chart" fire direction system necessary.

A major development was the adoption of the New Infantry Division artillery (ARTILLERY TRENDS, March 1959). The battalion fire direction center in the howitzer battalions must exercise technical fire direction over batteries of different calibers. In the March issue of TRENDS, a suggested fire direction procedure was presented. The new method follows it closely.

The New Infantry Division artillery tables of organization and equipment (TOE), as well as other new TOE's, authorize few personnel for fire direction duties.

Another development that outdated the "check chart" system is a requirement for frequent and rapid displacement which in turn creates a requirement for small, compact fire direction centers that can be van mounted. Also, the high-speed, electronic, digital computer for fire direction is being developed. It should be in the hands of troops soon. When the field artillery has machine computers there will be a requirement for a simple fire direction system to backup the machine.

Considering these developments, the School has formulated a new system. It is adaptable to modern requirements, can be supported by the new TOE's, and is intended to serve all cannon artillery units, divisional and nondivisional. It is simple, flexible, and can be varied by unit standing operating procedure (SOP). Except for units in which batteries habitually operate alone, the new fire direction system is characterized by centralized control at the battalion fire direction center (FDC).

The new system has been submitted to US Continental Army Command (USCONARC) for approval.

## The Battalion FDC

The battalion FDC is composed of the S3 (assistant S3), a chief fire direction computer, a horizontal control operator, a vertical control operator, a computer for each battery organic or attached to the battalion, and the number of radiotelephone operators needed to monitor and operate the radio and wire communication nets of the battalion. In addition, a switchboard operator, who is a member of the wire section of the headquarters and headquarters battery, is needed to install and operate the battalion FDC switchboard. The S3 is the battalion gunnery officer as well as the operations and training officer. He must plan, coordinate,



and supervise the activities of the battalion FDC and supervise fire direction and firing activities in the batteries. Also, he is responsible for training the fire direction personnel. FM 6-101 contains a detailed discussion of his duties. The assistant S3 must be able to perform the duties of the S3.

In all cannon artillery units, the fire direction officer (FDO) will be eliminated. Artillery operations consist principally of firing. Marches are made to permit the battalion to deliver the maximum effective fire throughout the operation. Therefore, operations and the delivery of fire (fire direction) cannot be divorced. The S3 must retain the full operating responsibility for both.

The chief fire direction computer is the senior enlisted member of the battalion FDC. He must be proficient in both communication and gunnery procedures.

The horizontal control operator (HCO) prepares and maintains the horizontal control firing chart (a grid sheet). Using the aluminum range deflection protractor (fig 1) he determines range and deflection for each battery. In the same order, he announces that data to the computers.

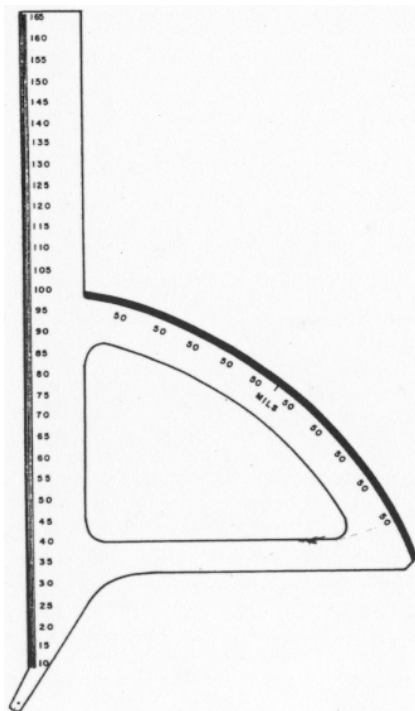

Figure 1. The aluminum range deflection protractor.

The vertical control operator (VCO) prepares and maintains the vertical control firing chart (a battle map), a fire capability overlay, and a situation overlay. In addition, the VCO does the following:

- (1) plots and determines the altitude of targets.
- (2) assists the S3 in selecting the basis for corrections for charge and lot.
- (3) computes site for each battery that is to fire.
- (4) announces site to each computer when it is requested.

He also must be prepared to take over the duties of any other member of the FDC.

The computer, using the graphical firing table (GFT) (fig 2), converts chart data into fire commands and transmits them to the firing battery in

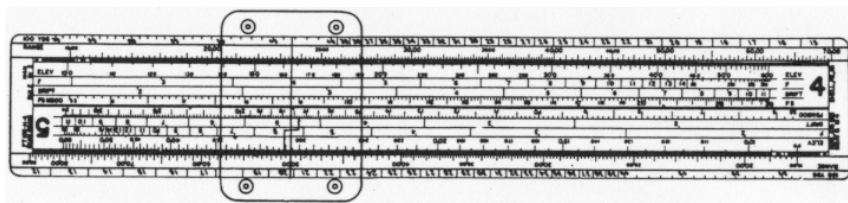

Figure 2. The graphical firing table (GFT).

the proper sequence. Specifically, for simplicity and uniformity of instruction, the US Army Artillery and Missile School will teach the following duties for the computer:

- (1) completes the computer's record.
- (2) computes and transmits total deflection (i. e., chart deflection plus deflection correction) to the battery.
- (3) determines fuze setting (if applicable) and elevation from the GFT.
- (4) computes the height of burst correction (20/R) for fuze VT (variable time) or time (if applicable); adds it, together with the site announced by the VCO, to the elevation read from the GFT; and transmits the sum to the battery as--QUADRANT (so much).
- (5) when computing for the adjusting battery, announces corrections to fuze and height of burst to the nonadjusting battery computers.
- (6) with the assistance of the VCO, determines data for replot.

The switchboard operator is trained in both fire direction and communications procedures. He installs and operates the FDC switchboard.

Radiotelephone operators also must be trained in fire direction and communications procedures. The radiotelephone operators receive and repeat back fire missions received by radio or wire.

## Fire Mission

When a fire mission is received, the radiotelephone operator (or switchboard operator) alerts the FDC by announcing the warning--FIRE MISSION. All computers not actively engaged in another mission record the initial fire request, and the chart operators plot the location of the target.

If the S3 decides to fire the mission, he issues a fire order. Two elements of the fire order have been changed (the previous fire order is printed on page 227 of FM6-40). Altitude has been deleted, and the charge has been combined with the ammunition lot. Inapplicable elements are omitted, but the sequence is followed to avoid errors and confusion. The 12 elements in proper sequence follow:

<u>Element</u>	<u>When Announced</u>
(1) Battery(ies) to fire	Always
(2) Adjusting battery	When applicable
(3) Method of fire of adjusting battery	When different from the observer's request
<u>Note.</u> The standard method of fire for adjustment has been changed from volley to <u>salvo right</u> . If the observer desires any other method, he must ask for it.	
(4) Basis for corrections	When applicable
(5) Use of special corrections	When applicable
(6) Projectile	When different from observer's request
(7) Ammunition lot and charge	When applicable
(8) Fuze	When different from observer's request
(9) Number of volleys	Always, except in precision fire
(10) Range spread or zone	When different from observer's request
(11) Time of opening fire	When different from observer's request
(12) Concentration number	Always

Items (1), (9), and (12) of the fire order, together with any other elements which are different from the observer's initial fire request, are transmitted to the observer. This is a change from the previous system in which the entire fire order was sent to the observer.

If the target is within the limits of a registration point for which corrections are available, the S3 specifies in his fire order--USE REGISTRATION POINT (so and so). If the target is within transfer limits of more than one registration point, the registration point nearest the target is used because it gives the greatest accuracy if the corrections are current.

## Registration Point List

Each computer must have a list of the registration points with the lot numbers and charges fired on each. If the S3 specifies a basis for corrections in his fire order, he omits the lot number and charge. Using the list, each computer determines the lot number and charge for his battery.

If a basis for corrections is not specified by the S3, he must designate the charge to be fired (except in high angle fire) and the lot number. When a "will adjust" mission is to be fired by only one battery, the lot number need not be given by the battalion, but it should be given by the battery so that the howitzer sections will not fire different lots.

If a battalion has different caliber batteries, as in the New Division artillery, the lot number and charge, if announced, are announced for each battery. For example--BATTALION, ALPHA; ALPHA, LOT X, CHARGE 5; BRAVO, LOT XY, CHARGE 4; etc.

The site for each battery to fire is computed and recorded by the VCO. When a computer desires the site for his battery, he requests it by saying--SITE ALPHA? The VCO then announces the site to the computer as requested--SITE ALPHA, PLUS 7. The computer repeats--SITE ALPHA, PLUS 7--to the VCO. This repeat back assures that the correct site has been received.

## HCO Gives Range and Deflection

The HCO, for the first salvo (volley) in a mission, announces the range and deflection (in that order) for each battery to fire. In a "will adjust" mission the data for the adjusting battery is announced first, followed by the data for the nonadjusting batteries in a sequence designated by unit SOP. The order in which the data is read for the batteries in a "fire for effect" mission also is designated by unit SOP. For example, the HCO announces--ALPHA, RANGE 6140....DEFLECTION 2825 ....BRAVO, RANGE 5980....DEFLECTION 2801....CHARLIE, RANGE 6040 ....DEFLECTION 2779.... (the four dots represent a repeat back to the HCO by the computer concerned).

The computer, having already sent the preliminary fire commands (through method of fire) to the firing battery, immediately transmits deflection (deflection correction plus chart deflection).

The fuze setting (if applicable), announced as--TIME (so much), is the next transmission by the computer.

The computer now adds the site (announced by the VCO) to the elevation which he gets using the GFT. If fuze time or VT is to be fired, the height of burst correction (20/R) must be added. The sum (quadrant elevation) is transmitted to the firing battery.

The computer records each command sent to the firing battery as well as the data announced by the HCO and VCO.

### Procedure During Adjustment

On receiving the observer's subsequent fire request, the HCO plots the corrections. The HCO reads the range and deflection (in that order) to the new location of the target needle. Only the chart data for the adjusting battery is announced.

The computer converts the HCO's data into subsequent fire commands, applying the same deflection correction to the chart deflection, and transmits these commands to the firing battery. He also records the observer's subsequent fire request, the HCO's data, and the fire commands. The adjustment proceeds in this manner until the observer transmits--FIRE FOR EFFECT. A typical transmission from an observer who desires to enter fire for effect is--RIGHT 10, ADD 50, FIRE FOR EFFECT. The HCO plots this correction. The adjusting battery computer announces corrections to fuze and height of burst (in meters) to insure that all nonadjusting computers make the appropriate change to fuze and site. For example, if the observer had changed to fuze time and his total height of burst corrections were up 20 meters (this figure does not include the vertical shift made in the initial fire request), the adjusting battery computer announces to the nonadjusting battery computers--CORRECTIONS, FUZE TIME, UP 20. If no corrections to fuze or height of burst were made, the announcement is--CORRECTIONS, NONE.

The HCO announces range and deflection for each battery to fire. These are converted to fire commands and sent to the battery by each computer together with the method of fire specified in the fire order.

### Multiple Missions

The battalion FDC can process two fire missions simultaneously. All fire requests received at the FDC are acknowledged and recorded. When a battalion fire mission is in process and another mission is received, the mission is recorded by a second radiotelephone operator. It is plotted by the VCO for examination by the S3.

When a second mission is received the S3 has a number of courses of action. He may stop firing a mission in order to attack a more important target; he may take the mission but notify the observer that there will be a delay; he may call on attached or reinforcing battalions to fire it; he may request fire through higher headquarters; if the target is suitable for attack by a single battery, he may assign the mission to a battery; or he may decide the target is not sufficiently important to be attacked and will so inform the observer.

Batteries whose mission or employment habitually requires them to determine firing data must organize and operate a battery FDC similar to a battalion FDC. The only change involved is in the number of computers, radiotelephone operators, and supervisory personnel. Examples of such units are the 105-mm howitzer battery of the airborne division and the 8-inch howitzer battery of the New Infantry Division.

A battery organic or attached to a battalion which exercises technical fire direction is required to determine fire commands only when the

battery is operating independently, acting in an emergency, or acting for the battalion during displacements on multiple missions.

Since the emphasis for producing firing data is placed on the battalion FDC, the number of battery fire direction personnel has been reduced. Because of this reduction, the battery FDC is now merged with the executive's post. The combined installation is called the executive's command post. It is located within the firing position.

### Monitors and Relays

When the battalion FDC is processing the fire mission, the executive's command post monitors and relays the fire commands to the howitzer sections. The fire commands are received from the battalion by a radiotelephone operator. They may be relayed to the howitzers by voice or by wire. The recorder normally is designated by the battery executive to transmit the fire commands to the howitzer sections by wire. The executive should not tie himself to the command post, but should organize his personnel so that either the assistant executive, chief of firing battery,

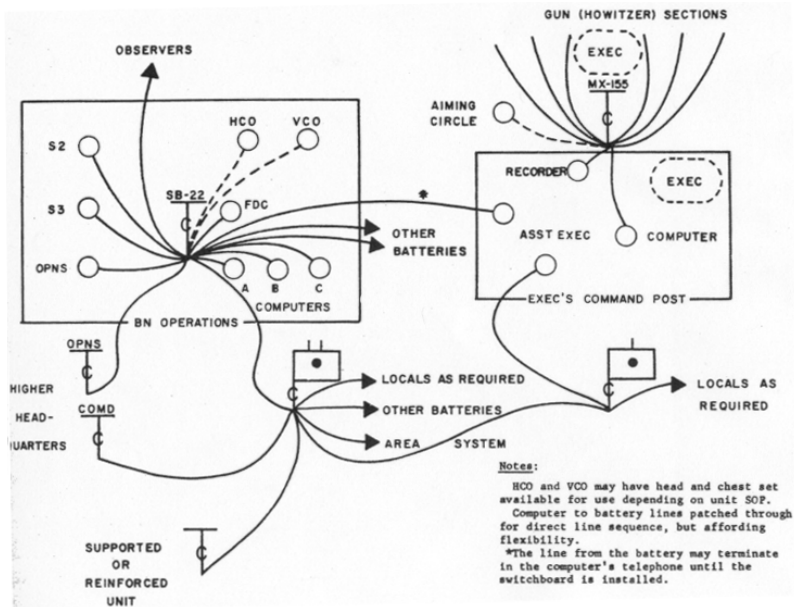
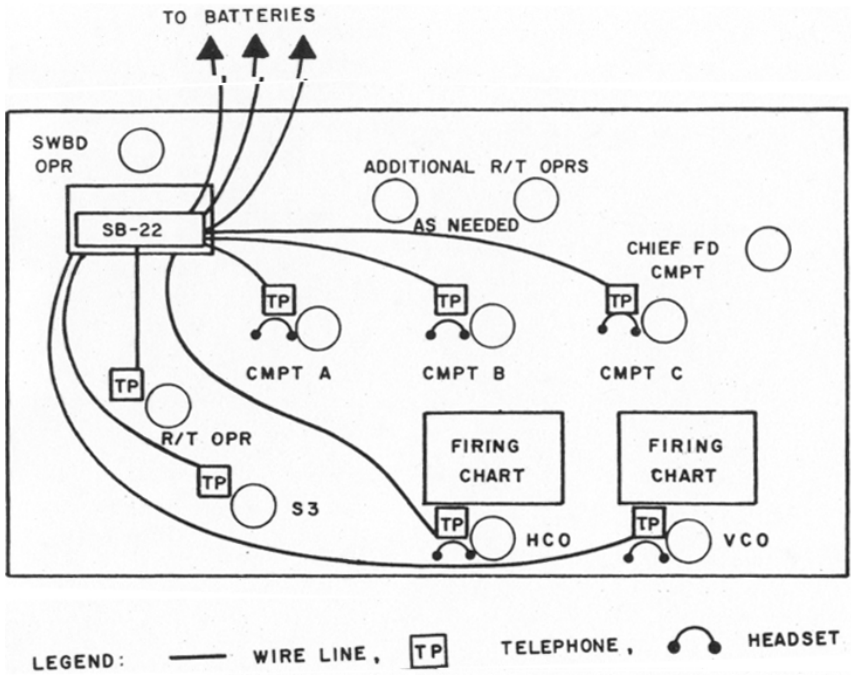

Figure 3. Portions of a typical wire system of a field artillery battalion (3 batteries).



**NOTE: THE TELEPHONES FOR THE HCO AND VCO ARE OPTIONAL.**

Figure 4. Suggested arrangement of a battalion FDC (3 batteries). The S2 and personnel involved in operations are not shown.

or some other responsible individual is able to monitor the fire commands from the battalion FDC. This monitoring system insures that the fire commands are in the proper sequence, consistent with the preceding commands in the mission, and do not contain data that should not be sent to the howitzer sections.

If the commander believes the training level of the battalion permits, fire commands may be sent directly from the computer in the battalion FDC to the howitzer sections in the battery.

During lulls in firing, the battery chart operator or operators and computer receive from the battalion FDC data for the construction of the firing chart, plus current registration and meteorological data. One or two firing charts (the number is left to the discretion of the commander) are maintained. If one chart is kept, it should be a battle map.

GFT settings and deflection correction scales are kept current so that the battery can determine fire commands if the need arises.

When the battery is required to process a fire mission, the members of the executive's command post perform the same duties as their battalion counterparts. The assistant executive officer (or whoever is in charge of the executive's command post at the time) performs the duties of the S3 at battery level. If wire is used, the computer, rather than the recorder, may transmit the fire commands to the howitzer sections.

### System of Checks

The new fire direction system places checking in the normal chain of command. The unit commander or the S3 prescribes a system of checks that begins with the VCO checking the HCO, the chief computer checking the battery computers, and the assistant S3 making checks of the work of the VCO and the chief computer. The tolerances for checking data should be prescribed by individual unit commanders.

To provide the communications necessary for fire direction, separate radio and wire systems are installed. Wherever possible, these systems parallel each other. Thus, an alternate means of communication is provided if either system fails. The radio and wire systems can be adapted to all organizations, regardless of caliber or mission, where fire commands normally are generated at the battalion FDC. All FDC personnel should be trained in both communication and gunnery techniques.

Figure 3 depicts a portion of a typical wire communication system of a field artillery battalion. Figure 4 shows a suggested arrangement of the battalion FDC.

### Other Important Changes

In the New Division artillery it is desirable to have the same referred deflection for the different caliber batteries of the howitzer battalion. In the towed battalion the School will teach that the aiming posts be placed out at a compromise deflection, specifically 2600. In the self-propelled battalion, each battery should place aiming posts out at deflection 800. Then, to achieve the same referred deflection, the counter on the M100 panoramic telescope of the 105-mm howitzer (SP) M52 must not be used. The micrometer and the course azimuth scale of that sight will operate similar to the M12A7 panoramic telescope on the 155-mm howitzer (SP) M44.

The computer now constructs and uses the deflection correction scale. The scale may be constructed in line form as shown in figure 141, FM 6-40.

Another change is that site is no longer a fire command. The towed 105-mm howitzer is the only weapon in the US Army having a site scale. Since, in the New Division artillery, fire commands for the 105-mm howitzer and the 155-mm howitzer batteries are generated at the same FDC, a difference in fire commands would become confusing in the towed



battalion. Therefore, site is added to the elevation and the sum is announced as quadrant, as is the procedure with medium and heavy artillery.

High angle fire procedures are only slightly changed. The computer (using the GFT) selects the charge, and records known registration deflection corrections for each charge on the GFT adjacent to the data for that charge.

### Data for Replot

The new fire direction system dictates different procedures in determining data for replot. In addition, the data for replot procedure is greatly simplified since it is performed in one location. Only those targets requested for replot by the observer or those directed by the S3 are replotted. Replot data consists of the coordinates, altitude, fuze, and concentration number. For point detonating fuze, the adjusting battery computer announces the deflection and range for the initial replot to the VCO. The replot range is the range read under the hairline when the elevation gageline is placed over the elevation fired (quadrant elevation minus site). The replot deflection is the total deflection fired minus the deflection correction at the fire for effect range. The VCO polar plots the target from the adjusting battery pin at the deflection and range announced by the computer. The VCO then determines the map altitude of the replotted target. Using this altitude, he computes a new site, which he announces to the computer.

If the site announced by the VCO is within 1 mil of the site fired, the deflection and range previously announced by the computer are verified. The VCO announces the target coordinates and altitude, and they are recorded on the computer's record.

If the site announced by the VCO is not within 1 mil of the site fired, it is subtracted algebraically from the quadrant elevation fired, and the resulting elevation is used to determine a new replot range. The replot deflection remains the same. The VCO then plots this improved location of the target and determines and announces the new site. This procedure is repeated until the site announced by the VCO is within 1 mil of the site previously computed. When this agreement is reached, the replot data (coordinates and altitude) are announced by the VCO.

Replot of targets attacked with VT (variable time) fuze is accomplished in the same manner as described for point detonating fuze after the height-of-burst correction (20/R) fired has been subtracted from the quadrant elevation fired in effect.

To replot a target in a fuze time mission, the site derived from firing, minus the 20/R computed at fire for effect range, is accepted as correct. The altitude determined from this site and fire for effect range is the altitude assigned to the target. The coordinates of final target needle locations are announced by the HCO as the replot coordinates.

### Graphical Equipment

The new fire direction system requires the use of three pieces of graphical equipment--the range deflection protractor (aluminum), the graphical firing table (GFT), and graphical site table (GST).

The range deflection protractor (aluminum) is available in fire direction sets 3, 4, and 5, which are described in SM 504-1290-S02, 3, and 4 respectively. This series of Department of the Army supply manuals dated 1957, included the range deflection protractors with maximum ranges of 12,500 yards, 16,500 yards, and 26,000 yards all at a scale of 1:25,000. In 1958 the DA supply manuals were changed to include protractor fans with maximum ranges of 12,000 meters, 15,000 meters, and 25,000 meters.

Since current tabular firing tables are in yards, some 105-mm and 155-mm howitzer battalion S3's probably have retained the protractor fans graduated in yards, planning to draw the meter fans when new firing tables (in meters) are issued. It is anticipated that the new tables for the 105-mm howitzer, and 155-mm howitzer based on meters and the ICAO (International Civil Aviation Organization) atmosphere will be distributed during calendar year 1960. There is no current 8-inch howitzer firing table in yards. Therefore, 8-inch howitzer units must have range deflection protractors in meters. The meter fan has federal stock number 6675-266-6891 and is listed in SM 5-1-6600, dated 14 July 1958.

The School will recommend that the GFT again be placed on TOE's. With the exception of the 8-inch howitzer GFT which will be in meters, the GFT's initially issued will be in yards.

The School has prepared a GFT for FT 8-J-2 for charges 4, 5, 6, and 7 and has recommended to USCONARC that this item be added to the 8-inch howitzer TOE's. Meanwhile, the School Book Department is planning to send one free set of these GFT's to each 8-inch howitzer battalion and divisional battery in the active Army in the near future.

### Graphical Site Table

The GST in yards presently is authorized for all units. However in the 8-inch howitzer battalion, the GST is graduated in yards whereas the firing table (FT 8-J-2) is based on meters. The School is preparing a GST in meters to be used with FT 8-J-2. New GST's for the other calibers also are being developed.

An FDC may find itself equipped with a range deflection protractor in meters, a GFT in yards, and a GST in yards. One way to operate with this equipment would be to have the HCO read ranges in meters, and announce them to the computer who automatically will convert the range to yards on his GFT. The computer can then read the elevation corresponding to the range in yards in the normal manner. To convert the range in meters to yards with the GFT it is necessary to use the "M" and "YD" gagelines located at the left of the rule, in the breaks in the heavy

red line separating range and elevation. The hairline is moved to the "YD" gageline. Then a pencil gageline is drawn on the window, over the "M" gageline. Now the gageline just drawn is moved to the range in meters, and the range in yards is read under the hairline. Once the gageline has been drawn on the window, no further change is necessary.

The VCO, as well as the computer, will need the range in yards to compute site. The computer can announce the range in yards, or the VCO can derive his own range in yards from the meters announced by the HCO. The latter system is recommended because the range in yards is never announced aloud and therefore cannot be confused with the range in meters. The VCO has "M" and "YD" gage points on the GST. To convert meters to yards on the GST, the "YD" gage point is placed over the range in meters on the D scale. The range is read in yards opposite the "M" gage point (see paragraph 306e in FM 6-40).

The new fire direction system proposed by the School does not contain any of the disadvantages of the check chart system. The system is simple and flexible and has centralized control. When approved it will be used by all cannon artillery units.

## **MORE ON THE NEW INFANTRY DIVISION ARTILLERY**

Since the publication of the one-subject issue of ARTILLERY TRENDS in March 1959, concerning the New Division artillery, several questions have been asked about different aspects of the new organization. To keep readers informed of the latest doctrine on the New Division artillery, the questions and their answers are presented here. This information supplements ARTILLERY TRENDS, March 1959. Information of this nature also will be covered in subsequent issues of TRENDS.

QUESTION 1: Does the increased amount of division artillery eliminate the need for attachment?

ANSWER: No. The objectives outlined in FM 6-20 on organizing for combat must be achieved.

QUESTION 2: Will there be a cross assignment of batteries in organizing for combat? Will it be common practice to organize with purely towed battalions and purely self-propelled battalions?

ANSWER: The tactical integrity of the field artillery battalion must be maintained whenever possible. However, batteries may be cross assigned within battalions when a tactical situation dictates.

QUESTION 3: In the defense, must the organization for combat be such that the self-propelled artillery will be ready to support the reserves when they are committed?

ANSWER: Self-propelled field artillery, because of its mobility, should support the mechanized forces of the division whenever possible.

QUESTION 4: In the defense, will the division primarily use the self-propelled artillery in support of the general outpost line (GOPL) force?

ANSWER: The general outpost line (GOPL) forces normally are mechanized and therefore should be supported by the self-propelled artillery.

QUESTION 5: In offensive and defensive positioning, what terrain considerations are involved in trafficability requirements of towed and self-propelled artillery?

ANSWER: There is no change to current doctrine; the considerations remain the same.

QUESTION 6: Will artillery units in the defense be "echeloned in depth by caliber" now that the division has light and medium artillery in each battalion and towed and self-propelled artillery are involved?

ANSWER: Artillery units will be "echeloned in depth" as covered in FM 6-20, December 1958.

QUESTION 7: In positioning, the doctrine is that "some artillery is placed forward." Must the commander now specify if he wants towed or self-propelled or both placed forward?

ANSWER: FM 6-20, December 1958, explains the placement of both towed and self-propelled artillery. In positioning units, the oncarriage traverse of the self-propelled artillery should be considered.

QUESTION 8: What size rectangle for barrages should be planned for the 4.2-inch mortar platoon and the 105-mm and 155-mm howitzer batteries?

ANSWER: The infantry heavy mortar platoon, located in the combat support company of the battle group, is divided into 2 sections of 3 mortars each. Each mortar section can fire a barrage 150 meters wide. For instructional purposes, 105-mm barrages will be 200 meters wide and 100 meters deep, and 155-mm barrages will be 300 meters wide and 200 meters deep.

QUESTION 9: If, in organizing for combat, the division artillery ends up with a 155-mm howitzer battalion, will the battalion's mission be direct support or reinforcing? If reinforcing, will it have a barrage allocated?

ANSWER: To maintain battalion integrity, the organization for combat probably will not place a battalion consisting entirely of 155-mm howitzers in the division artillery (note question 2).

QUESTION 10: With the howitzer battalion (direct support) fire support coordinator responsible for fire planning for the infantry mortar platoon, what additional responsibilities, such as collection agencies, collection plan, and observation coverage, does this place on the artillery battalion S2?

ANSWER: The battalion S2 has no responsibility for this, but he may make recommendations through the fire support coordination center (FSCC) to the battle group commander to position the mortar platoon forward observers where they can gather intelligence information.

QUESTION 11: When planning the fires of the mortar platoon, can the fire support coordinator position the mortars?

ANSWER: The fire support coordinator may recommend to the battle group commander the location of the mortar platoons, and they will move on the battle group order.

QUESTION 12: If the 8-inch howitzer battery or the Honest John battery is separated from the parent battalion, who furnishes survey support?

ANSWER: When the firing units of the rocket/howitzer battalion are operating separately or individually, the survey section of the battalion is divided into two survey parties. One party will be attached to each battery. If the platoons or individual pieces of a battery are widely separated, survey control for the platoons or individual pieces will be provided by the nearest artillery unit with a survey capability. The survey parties of the division artillery normally should not be diverted for these purposes.

QUESTION 13: Will the howitzer battalion (direct support) be used to fire the countermortar program?

ANSWER: When available, the howitzer battalion (direct support) will be used to fire the countermortar programs.

QUESTION 14: Can division artillery place requirements on the infantry mortar platoon?

ANSWER: The division artillery can place requirements on the mortar platoon through the howitzer battalion (direct support) which is planning its fires. To do this, however, the battle group commander must concur or the division commander must direct.

QUESTION 15: Will personnel in the mortar platoon fire direction center be trained in artillery procedures and carry an artillery MOS?

ANSWER: Personnel of the mortar platoon fire direction center will be trained in infantry procedures and will have an infantry MOS of 1120.

QUESTION 16: If the battle group commander or the mortar platoon forward observers want a smoke mission, through what channels must the mission be cleared or through what channel is notification made?

ANSWER: Employment of smoke will be coordinated in the fire support coordination centers (FSCC's).

QUESTION 17: Under the New Division artillery organization, is it feasible to use the self-propelled 155-mm howitzers as roving guns?

ANSWER: Self-propelled 155-mm howitzers may be used as roving

guns if the situation dictates. This represents no change to current doctrine.

QUESTION 18: Is there a mortar platoon liaison officer?

ANSWER: There is a lieutenant in the mortar platoon who functions as the liaison officer at the fire support coordination center (FSCC).

QUESTION 19: Is there any significant change in concept concerning control measures and depth of objective?

ANSWER: No changes are anticipated.

QUESTION 20: Where will the infantry battle group's headquarters and support company commanders fit into the fire support coordination picture?

ANSWER: Neither the headquarters company commander nor the support company commander will be integrated into the fire support coordination center (FSCC).

QUESTION 21: How will company-sized units in the New Infantry Division be employed? Why did the division go to five companies per battle group?

ANSWER: The number of companies to be employed either in the offense or defense will depend on the tactical situation. Based on conversations with US Army Infantry School representatives at Fort Benning, Georgia, it is understood that the battle group was increased to 5 companies for basically 2 reasons. First, the number of rifle platoons per company were reduced from 4 to 3. Second, for the battle group to cover the same frontage and accomplish the same mission, it became necessary to add an additional rifle company. The battle group commander with a staff and an added deputy commander can command 5 rifle companies better than a rifle company commander can command 4 platoons without a staff.

QUESTION 22: How will the division artillery radars be employed?

ANSWER: The infantry division artillery countermortar radars normally will support the howitzer battalions (direct support). Normally the radars will be located 2,000 to 4,000 meters behind the forward edge of the battle area (FEBA) and near the direct support artillery battalions, which will provide the radar sections with logistical and mess support. The division artillery assistant S2 (countermortar information officer) will prescribe primary and contingent sectors of search for all radars to insure complete coverage of the division front. Furthermore, the countermortar information officer will prescribe the general areas for radar sites.

QUESTION 23: How will air observation be handled?

ANSWER: The artillery flight of the division aviation company will be placed under the operational control of the division artillery commander. The flight commander will employ the aircraft as directed by

the division artillery commander. Normally, an aircraft will be employed with each artillery battalion assigned a direct support mission for observation and adjustment of fire. Aircraft requirements for artillery units assigned a general support or a general support-reinforcing mission will be coordinated by the flight commander. Normally, aircraft already aloft (observing for direct support battalions) will be used to satisfy these requirements.

QUESTION 24: Will the artillery be positioned by battery or battalion?

ANSWER: It is positioned by battalion in the howitzer battalions (direct support). All efforts will be made to maintain battalion integrity. In the rocket/howitzer battalions (general support), the battalion (batteries) will be positioned as dictated by the tactical situation.

## **THE RIFLE COMPANY—NEW INFANTRY DIVISION**

Captain Leonard S. Wheatley, Infantry  
Captain John B. Yeater, Infantry  
Department of Tactics and Combined Arms

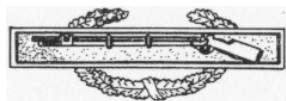

The mission of the infantry is "to close with the enemy by means of fire and maneuver in order to destroy or capture him." The mission of the artillery is to support the infantry by fire. Knowledge of the organization, weapons, and tactics of the rifle company of the New Infantry Division is vital to all artillerymen.

The new rifle company accomplishes its mission by combining fire, maneuver, and shock action. Fire is employed to inflict losses on the enemy and neutralize his combat power while other elements maneuver to close with him. In the shock action phase, his destruction is completed in close combat.

The company normally fights as a part of the battle group. Being capable of only limited independent actions with its own weapons, the company must be supported by other arms, primarily artillery and armor, to achieve the necessary sustained combat power.

Thorough fire planning is necessary to gain the proper control, supervision, and distribution of fire on any target or on several targets simultaneously. Since the artillery forward observer assists in the fire planning (ARTILLERY TRENDS, October 1958) and provides most of these fires, he must know the organization, weapons capabilities, and tactics of the rifle company.

### Organization and Weapons

The rifle company consists of a company headquarters, three rifle platoons and a weapons platoon (fig 5). The rifle platoons are the company's organic maneuver element, and the weapons platoon is the fire support element.

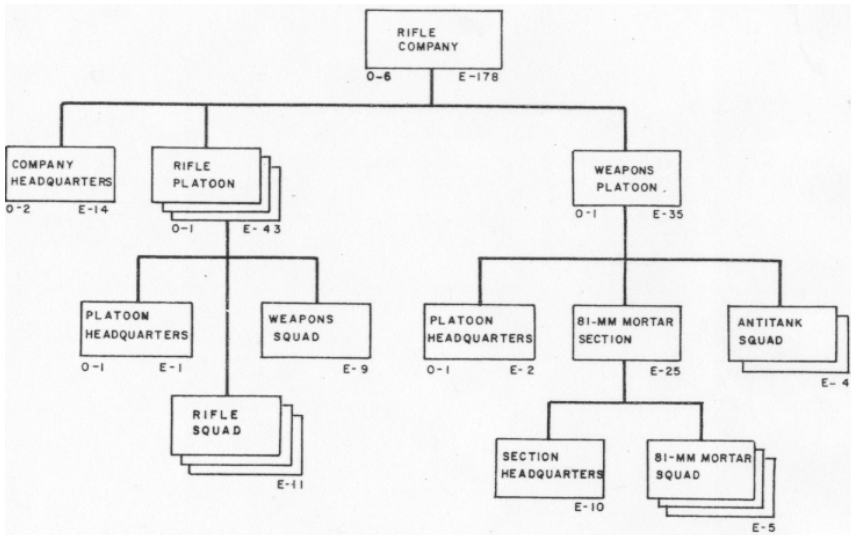

Figure 5. The rifle company of the New Infantry Division.

Each rifle platoon has a platoon headquarters, 3 rifle squads (the maneuver element), and 1 weapons squad (the fire support element). The weapons squad has two machinegun teams, each having an M60 machinegun (fig 9), and a rocket launcher team which has one 3.5-inch rocket launcher (fig 8).

The rifle squad (fig 13) has 11 men organized into two 5-man fire teams and a squad leader. The two fire teams, designated Alpha and Bravo, give the squad the fire and maneuver capability. A fire team consists of a team leader, three riflemen equipped with M14 rifles (fig 7), and an automatic rifleman authorized an M15 rifle (fig 6). The M15 differs from the M14 in that it can deliver automatic or semiautomatic fire, and has a bipod.

The mission of the weapons platoon is to furnish close and continuous fire support and antitank protection for its rifle company. The platoon has a headquarters, a mortar section, and two antitank squads. The mortar section includes a headquarters and three squads. Each of the mortar squads has one 81-mm mortar (fig 11). The section headquarters has a section leader, 3 sergeant (grade E5) forward observers, 2 fire direction computers, and 4 radio-telephone operators. Each antitank squad is authorized one 106-mm recoilless rifle (fig 12) which is transported on a 1/4-ton truck. The rifle may be fired from the vehicle or from the ground.



weight: 12-13 pounds  
maximum effective range: 450  
meters  
maximum effective rate of fire:  
120-150 rounds per minute



Figure 6. The M15 automatic or semiautomatic rifle.



weight: 8.7 pounds  
maximum effective range: 450  
meters  
maximum effective rate of fire:  
40-60 rounds per minute

Figure 7. The M14 semiautomatic light barrel rifle.

weight: 13 pounds  
maximum rate of fire: 12-18  
rounds per minute  
sustained rate of fire: 4 rounds per  
minute  
maximum effective range: 175-275  
meters  
armor penetration: 11 inches



Figure 8. The 3.5-inch rocket launcher.



weight: 23 pounds  
maximum rate of fire: 550-600  
rounds per minute  
maximum effective range: 1,100  
meters

Figure 9. The M60 machinegun.

weight: 49.5 tons  
maximum rate of fire: 8 rounds  
per minute  
sustained rate of fire: 1 round per  
minute  
maximum range: 18,200 meters

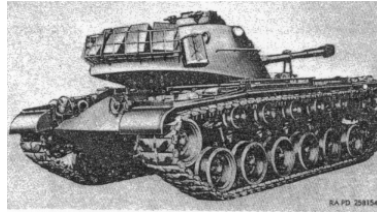
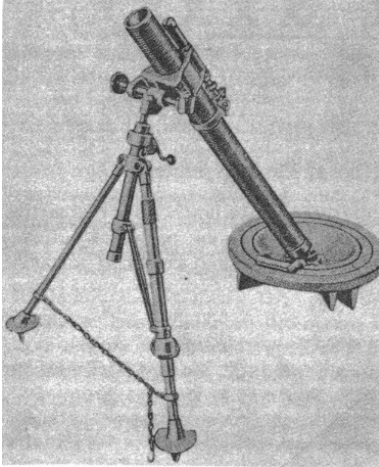

Figure 10. The 90-mm gun tank, M48.



weight: 93 pounds  
maximum rate of fire: 30 rounds  
per minute  
sustained rate of fire: 18 rounds  
per minute  
maximum range: 3,675 meters

Figure 11. The 81-mm mortar.

weight: 483 pounds  
maximum rate of fire: 6 rounds  
per minute  
sustained rate of fire: 1 round  
per minute  
maximum effective range  
(moving target): 1,100  
meters  
maximum effective range (still  
target): 1,400 meters  
armor penetration: 16-18  
inches

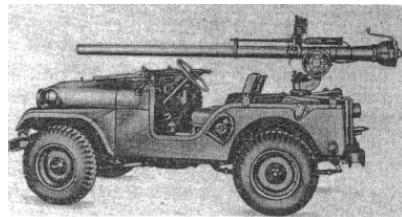

Figure 12. The 106-mm recoilless rifle.

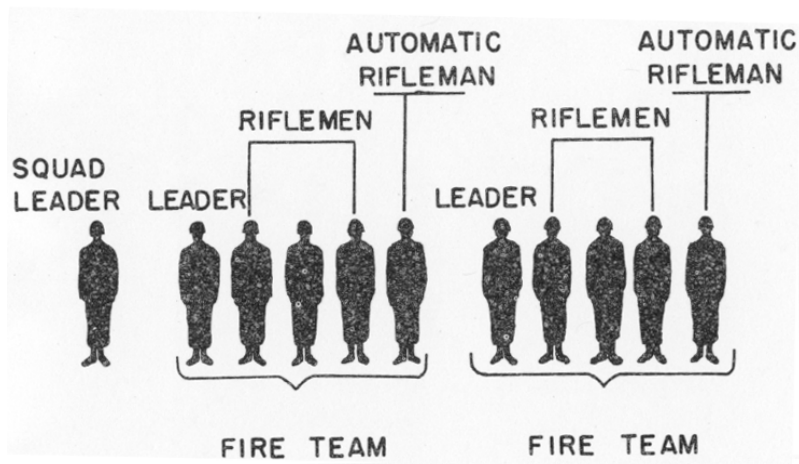

Figure 13. The organization of the rifle squad.

In combat, the rifle company normally will have units from the battle group or division attached or in support. The mobility, shock action, armor protection, and fire power afforded by tanks and armored personnel carriers increases the capabilities of the rifle company in all types of operations.

#### Tank Platoons

The supporting tank platoon from the division tank battalion is both a fire and maneuver element. It consists of five M48 tanks (fig 10). The armored personnel carrier platoon consists of nineteen M59 carriers. One carrier can transport one rifle or weapons squad.

The radio communication system of the rifle company has been expanded. The company commander has a radio set AN/VRQ-3 which operates in the battle group command net. The company command net, using sets AN/PRC-10, links the company commander with the 4 platoon leaders, the 2 antitank squads, and the artillery forward observer. Each platoon has a radio net that enables the platoon leader to control his squads up to 1 mile away. AN/PRC-6 radios are used in this net. In the weapons platoon, the 81-mm mortar section has a fire direction net using AN/PRC-10 radios. A company wire net may be established when the tactical situation warrants. An SB-22 switchboard is authorized for this net.

Artillery forward observers in the New Division artillery are authorized an additional radio, the AN/PRC-10. With this set the forward observer can operate in the rifle company command net. Infantrymen may inform the forward observer of potential targets over this net. The forward observer has a telephone which ties into the company wire net.

## Offensive Operations

The mission of the rifle company in offensive operations remains the same--to close with and destroy the enemy. This mission of the attacking rifle company usually is expressed in terms of terrain objectives to be seized. The company is assigned either a zone of action, an axis of advance, a direction of attack, or a combination of these control measures. The company may have only foot mobility or it may be motorized, mechanized, or transported in helicopters.

A plan of attack is based on a number of factors including the battle group order; a reconnaissance; recommendations from leaders of organic, attached, and supporting units; and an estimate of the situation. Essentially, the plan of attack consists of a plan of maneuver and a fire support plan.

The plan of maneuver is the plan for employing the maneuver elements, i.e., the rifle platoons, attached tank platoons, and other attached units which seize or assist in seizing objectives through movement. Included in the plan of maneuver are control measures, formations, specific missions to subordinate units, the security plan, the plan for reorganization and consolidation, and a plan for continuing the attack.

The company prepares the fire support plan. The plan is defined as "the coordinated plan for employment of all fire support available to the commander." However, unlike the fire support plan at higher levels, it is rarely produced in a written form. The artillery forward observer is the principal assistant to the rifle company commander in fire planning. He sends the artillery fire plan, actually a simple target list, by telephone or messenger to the direct support artillery battalion fire direction center. The forward observer makes recommendations on the use of artillery fires and, if appropriate, on air strikes and naval gunfire. In developing the fire support plan, such items as the nature of the target, effects desired, weapons capabilities, and availability of ammunition are considered. These fires are planned to neutralize known and suspected enemy positions and to permit the rifle platoons to more rapidly seize and consolidate the objective. Control measures may include radiotelephone brevity codes, visual signals such as pyrotechnics, or time schedules to be used in shifting, lifting, or calling for fires.

### Rifle Platoons Have Specific Missions

Rifle platoons are assigned specific missions which are usually terrain objectives to be seized. Normally, a platoon objective is less than 270 meters wide. The number of objectives selected should be no more than the number required to maintain control, insure coordination, and accomplish the mission.

The reserve is that portion of the rifle company that is withheld from action at the beginning of the attack. It is available for employment at a decisive moment to insure success or to maintain momentum.

Appropriate missions for the reserve are to protect the flanks, maintain contact with adjacent units, attack from a new direction, or "mop-up" a position bypassed by the attacking platoons.

The reserve is positioned where it can best perform its assigned mission or missions. The initial location is usually in a covered and concealed area a short distance behind the line of departure. It displaces on order so that it will be immediately available to influence the action.

The weapons platoon is used to provide maximum fire support for the attacking platoons. The 81-mm mortar squads are employed in general support whenever centralized control permits fires in support of the major portion of the company. The antitank squads are employed in general support whenever possible. These 106-mm rifle squads provide antitank protection, and, if appropriate, close fire support for the attacking platoons.

In the attack, one or more tank platoons may be attached to a rifle company to form an infantry-tank team. Normally the attached tank platoon or platoons are employed as a unit under company control. Mutual support and teamwork between tanks and infantry are essential. Tanks assist the infantry by destroying enemy armor and weapons positions and by breaching lanes through barbed wire and antipersonnel minefields. The infantry assists the tanks by locating and destroying enemy antitank weapons and by breaching or locating routes through or around obstacles.

#### Employing the Infantry-Tank Team

There are three general methods of employing the infantry-tank team in the attack: tanks and infantry attacking on the same axis, tanks and infantry attacking on two converging axes, and tanks supporting by fire only (fig 14). One or more of the methods may be used. As the combat situation changes, a method of attack being employed may have to be changed. The attacking company must be able to change to another method as the attack progresses.

Although the methods may change and the techniques of their application may vary, the tank must be employed to make maximum use of its battlefield mobility, armor-protected firepower, speed, and shock action.

A rifle company frequently will be mechanized when rapid movement over long distances is required. In such cases the company will have enough armored personnel carriers attached to mechanize all the rifle platoons. These carriers provide the company with armor-protected mobility and with some additional firepower.

In some cases only enough carriers are available to mechanize a portion of the company. If this is the case, they normally are used with the reserve platoon or platoons. A mechanized reserve provides greater flexibility because it may be moved rapidly to influence the action.

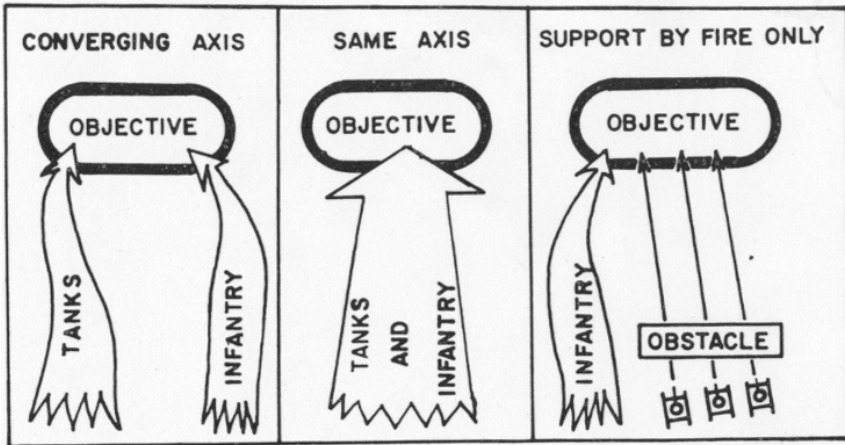

Figure 14. The three general methods of employing the infantry-tank team in the attack.

The attack is characterized by a constant forward movement toward the enemy. Initially, fire support keeps the enemy pinned down and unable to counter the maneuver. When the attacking platoons reach the point that they are so close to the concentrations being fired by friendly fire support weapons that casualties might be inflicted by them, the fire must be lifted and shifted to deeper targets. This point is called the assault line. Here the infantrymen launch their assault. The assault is a single-determined, nonstop, forward movement into and through the enemy position with the riflemen providing their own fire support to keep the enemy pinned down. From the assault line, the attacking elements move forward simultaneously, and each rifleman takes up the fire as he moves. They take 2 or 3 steps, raise their weapons, aim, and fire. They continue to do this as they pass through the objective. The automatic riflemen and the machinegunners also fire and reload on the move. In fact, there is no stop whatsoever until the company has passed through the objective.

#### In the Defense

The defensive mission of the rifle company is to stop the enemy by fire in front of the battle area; to repel his assault by close combat if he reaches the battle area; and to destroy and eject the enemy by counterattack if he penetrates the battle area.

The rifle company defense plan is based on the mission, enemy situation, available troops, and the terrain. Normally, the mission is assigned

in terms of a battle area to be defended. The battle area is defined by boundaries between the forward companies and limiting points which indicate the general trace of the forward edge of the battle area (FEBA).

The rifle company can defend a frontage of up to 2,000 meters. The depth assigned to a company varies, but normally it does not exceed 1,400 meters. The rifle platoon can defend a position up to 750 meters wide. The depth of a platoon position normally does not exceed 200 meters depending on the location of supplementary squad positions.

Rifle platoons are assigned a portion of the company battle area to organize and defend. These platoon areas dominate avenues of approach and protect the critical terrain within the company battle area. The platoon defense area is organized for all-round defense and mutual support with adjacent platoons. The three rifle squads are positioned, taking maximum advantage of the terrain, so that they can place their heaviest volume of fire forward of the battle area. Each squad is assigned overlapping sectors of fire within the platoon. Whenever possible, the sectors of the flank squads overlap the fires of adjacent platoons. The machineguns are placed to cover the most dangerous avenues of foot approach into the platoon area, to cover the gaps between platoons, and to provide mutual support with an adjacent platoon. The machineguns of the forward platoons are assigned sectors of fire and final protective lines. The rocket launcher provides close-in antitank protection. It is positioned within the platoon defense area to cover the most likely avenue of armor approach. The location and principal direction of fire of the rocket launcher is coordinated with other antitank weapons located within the platoon area.

### The Reserve Platoon

The company reserve provides flexibility and adds depth to the defense area. A reserve platoon is assigned a primary position and one or more supplementary positions. These positions are prepared in the rear of the forward platoons on terrain that permits the platoon to accomplish a combination of missions. Appropriate missions for the reserve platoon follows:

- (1) limit penetrations.
- (2) protect the company flanks and rear.
- (3) support the forward platoons by fire.
- (4) perform surveillance in the company's rear area and provide security.
- (5) participate in a counterattack.
- (6) man the combat outpost line.

The reserve platoon position or positions generally are organized the same as the forward platoon, except that final protective lines for the machineguns are not selected. The platoon accomplishes its mission from positions at least 150 meters to the rear of the forward platoons to prevent it from being subject to fire directed at the forward platoons.

The reserve platoon of a forward company rarely will participate as the maneuver element in a counterattack.

The weapons platoon normally is employed in general support. The 106-mm recoilless rifle squads are placed well forward to take maximum advantage of their range. They are positioned to cover dangerous tank approaches into the company battle area. The 81-mm mortar sections provide close and continuous fire support by firing concentrations in support of the combat outpost and in front of and behind the FEBA and by firing barrages. Each mortar can fire a barrage 50 meters wide. The section can fire a barrage 100 meters wide.

### Fires in Support of the Defense

The fires of infantry and artillery weapons are planned and coordinated carefully. Defensive fire plans include fires of organic, attached, and supporting weapons on targets of opportunity and prearranged fires that can be placed under all visibility conditions. The plans also include targets to be fired upon, duration of fire, types of fires, and weapons to be used. Defensive fires should be able to bring the enemy under fire as soon as he comes within ground or air observation (long-range fires). It should hold him under increasingly heavier fire as he approaches the battle area (close defensive fires), and break up his assault by intense fire in front of the battle area (final protective fires). If he penetrates the battle area, he must be destroyed by fire. Defensive fires also should be able to support counterattacks (fires within the battle area). The artillery forward observer recommends the use of artillery fire and sends fire requests to his artillery battalion fire direction center.

The battle group commander designates the general location of the 4.2-inch mortar platoon and supporting artillery barrages. The 4.2-inch mortar platoon can fire two barrages each, 150 meters wide.

The coordinated antitank plan includes the integrated fires of all the antitank weapons organic to and supporting the rifle company. These weapons include the 3.5-inch rocket launcher of the rifle platoon, the 106-mm rifles of the weapons platoon, the assault weapons (SS10) (fig 15) of the battle group combat support company, and tanks of the division tank battalion which are attached to the battle group.

A security and surveillance system is established for maintaining a 24-hour watch over the company area. This system includes listening posts, electronic surveillance devices, and all other means available.

The combat outpost is the security force covering the foreground of the battle area. The combat outpost in front of each forward company usually consists of at least one reinforced rifle platoon including tanks and armored personnel carriers. The primary mission of the combat outpost is to provide an early warning of an enemy advance and to deny the enemy close ground observation of the battle area. Also the outpost delays and disorganizes the enemy and attempts to deceive him as to the true location of the battle area.



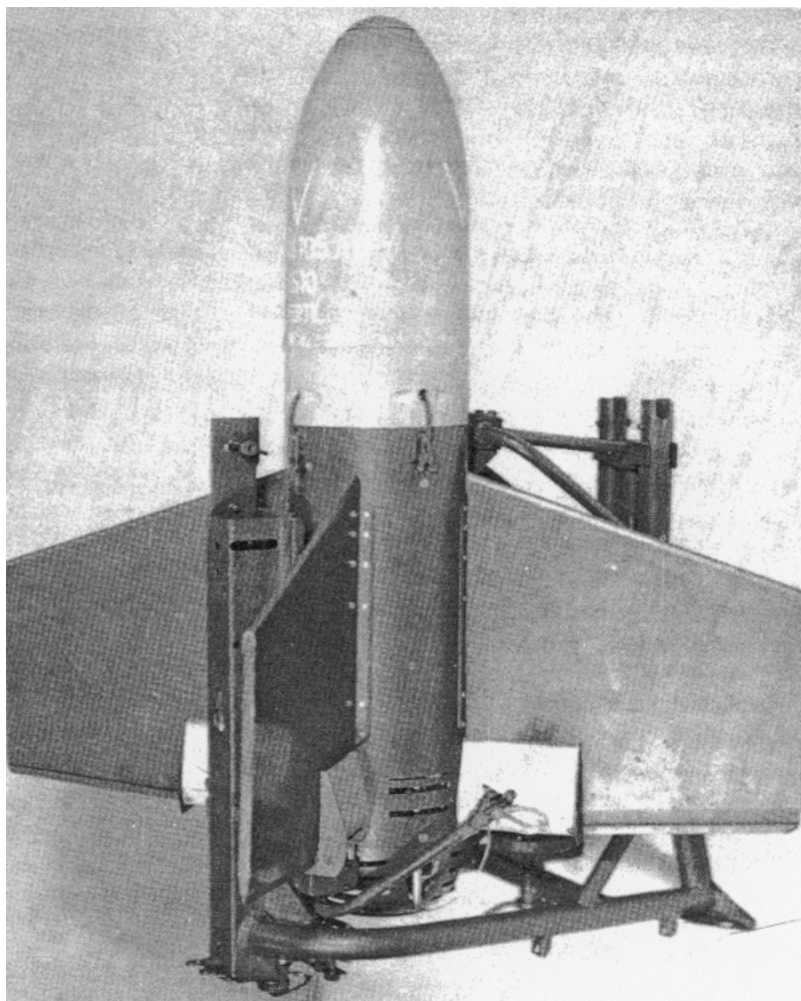

Figure 15. The French-manufactured, antitank missile SS10 has been adopted by the United States. Depending on the warhead, the missile weighs 70 to 90 pounds and has a range of 1,650 meters.

#### Conduct of the Position Defense

The rifle company must hold critical terrain. The enemy must be destroyed in front of the battle area by coordinated fire. His attack must be repelled within the battle area by fire, close combat, and counterattack.

Long-range and close defensive fires are used to destroy the enemy while he is in the attack formation and before he reaches an assaulting

distance. In close defensive fires, flat trajectory weapons are fired at known and suspected targets within their sectors or principal directions of fire. Tanks, assault weapons, and 106-mm rifles not engaging enemy armor are directed at targets such as known or suspected enemy weapon positions, observation posts, and groups of men. If the enemy does not know the true location of the battle area and surprise fire can be gained, all flat trajectory weapons except designated tanks, assault weapons, and 106-mm rifles hold their fires until the enemy is within effective small arms range. Uncontrolled fires may disclose prematurely the the positions of automatic weapons and allow the enemy to avoid or destroy them before they can be used effectively.

If the attack continues through the close defensive fires and the enemy prepares for the assault, final protective fires are delivered forward of the threatened unit. Machineguns fire their final protective fires; artillery and mortars fire their barrages; and other weapons increase their rate of fire against the most threatened targets within their sectors. If the enemy reaches the battle area, forward units repel him by fire and close combat.

Fires planned within the battle area are delivered when called for by the unit whose area has been penetrated. If fire alone fails to destroy the enemy within a penetration, the company commander must decide whether to use his reserve, to block, or to counterattack. Normally the counterattacking force will come from the battle group reserve.

Having sufficient knowledge of how the infantry rifle company is organized, its weapons and concepts of employment; the artilleryman can more efficiently plan and execute the fire mission needed to support this ground gaining unit.

#### A GEM FOR 4.2-INCH MORTAR BATTERIES

Personnel in 4.2-inch mortar units probably have had their nerves shattered time and time again by the tensions involved in clearing misfires caused by the accumulation of excess propellant holders in the tube while firing with extension. A simple gadget will eliminate this headache.

Attach a small magnet to a straight lightweight wooden pole which is about six inches longer than the mortar tube. Without lifting the tube or displacing the mortar, the gunner can insert the pole down the tube and the propellant holders will adhere to the magnet, allowing the holders to be extracted easily.

For best results the propellant holders should be removed each time a fire mission is completed. One extraction pole per firing platoon should be sufficient, as sections can pass the pole from piece to piece.

--Submitted by Lt J. Sam Marler, Jr.  
US Marine Corps School, Quantico, Va.

## **NEW EMERGENCY FIRE DIRECTION PROCEDURES USING THE M10 PLOTTING BOARD**

Major John C. Dove  
Major William W. Madison  
Department of Gunnery

The poet Robert Burns once wrote that "The best laid schemes o' mice and men gang aft' a-glea." Artillery commanders might do well to read that line again. The long established and well-rehearsed standing operating procedure for rapid RSOP's (reconnaissance, selection, and occupation of position) are of no value when the fire direction center is knocked out. The US Army Artillery and Missile School has continually worked to solve this potential problem by developing better methods of emergency fire direction. It has sought a fast and accurate system that would require a minimum amount of equipment and personnel.

ARTILLERY TRENDS presented two different emergency techniques in October 1957 and in June 1958. The School presently is teaching the following procedure and believes it is simpler and faster than previous ones. Another advantage of this procedure is that even though a map is not available or locations are not known, fire still may be delivered quickly. The reader can follow the procedure easier if he has an M10 plotting board and 105-mm howitzer firing tables available.

A forward observer from a 105-mm howitzer unit that is moving with an advance guard is requested to furnish immediate fire support. He calls his battery and transmits the following:

FIRE MISSION  
MARK CENTER OF SECTOR  
AZIMUTH 6040  
ROADBLOCK  
WILL ADJUST

The battery executive receipts for the fire request and immediately selects a position and makes a rapid occupation. While leaving the road, the FDC truck hits a land mine. The FDC personnel become casualties and the equipment is burned. The executive has firing tables, an M10 plotting board, and an M2 compass. He must get fire on the target now.

Since the executive does not have a map, he must estimate the general direction and range to mark center of sector. Using the M2 compass, he reads an azimuth of 100 and lays the battery. He makes a terrain analysis in the direction of fire and decides that a round fired at a range of 3,500 yards will clear the forward observer's position. He transmits the initial fire commands to the battery by voice.

## Using a Map

If the executive has a map, he uses the following procedure. The forward observer sends the same mission as stated above except he omits the mark center of sector request and sends the location of the target--COORDINATES 42578159. This situation will be continued throughout the article.

The executive locates the battery center at coordinates 42157865. The recorder plots the target and battery location on the map. The executive verifies the location of the battery. To determine the azimuth, the executive first constructs a straight line on the map from the plotted battery position through the plotted location of the target. Then he orients the M10 plotting board on the map by removing the center screw and placing the center of the M10 plotting board over the battery position on the map. The right side or the center line of the plotting board is rotated

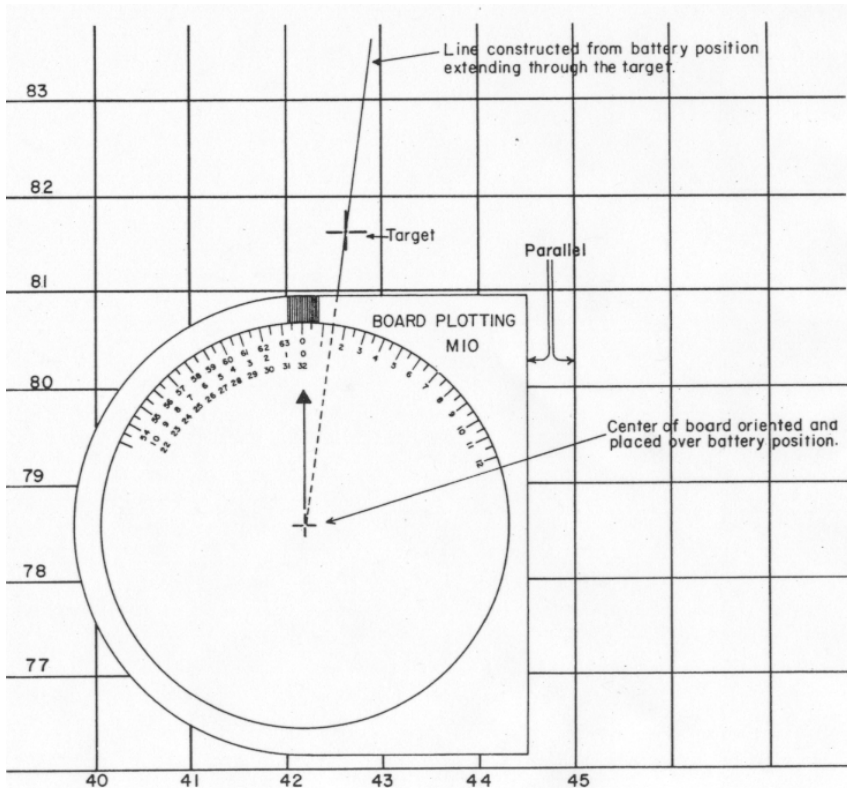

Figure 16. Determining the azimuth on which to lay the firing battery.

until it is parallel to a north-south gridline.

When the plotting board is properly oriented, the executive can determine the azimuth. He rounds it off to the nearest 100 mils and directs the chief of firing battery to lay the battery. In this example (fig 16) the azimuth measured is 140 mils; therefore, the battery is laid on an azimuth of 100 mils. Aiming posts are put out at deflection 2800.

#### Determining the Initial Commands

The executive selects the proper charge and verbally gives the following commands to the battery--BATTERY ADJUST, SHELL HE, CHARGE 4, FUZE QUICK, CENTER RIGHT. The executive now must determine the initial deflection. The battery is laid on an azimuth of 100 mils; aiming posts are out at deflection 2800; and the azimuth to the target is 140 mils. Therefore, the executive determines the initial deflection to be 2760 (the azimuth is increased by 40 mils so the deflection is decreased by 40 mils, i.e., azimuth 100 to azimuth 140 is a change of plus 40 mils; deflection 2800 - 40 mils = 2760 mils). The executive figures the range to be 3,500 yards. To get the range he can use a straightedge or sheet of paper and the appropriate scale in the margin of the map. The range is converted to elevation by using the graphical firing table (GFT) or tabular firing tables.

The 100/R and the C factors for the initial range are recorded. They will be used in computing subsequent deflection and elevation changes. In this case the 100/R factor to the nearest 10 mils is 30 mils, and the C factor to the nearest even number is 8 mils.

Site is not computed since there is no large difference in the altitude of the battery and the target. If it is apparent that site should be determined, and a graphical site table (GST) is not available, the mil relation formula ( $\text{mils} = W/R$ ) can be used.

The executive announces--CORRECTIONS O, DEFLECTION 2760, SITE 300, ELEVATION 256.

Two men are required to efficiently operate the emergency battery FDC. One man (recorder), is needed to operate the M10 plotting board while the other (battery executive) computes and announces the commands to the guns.

#### Preparing the M10 Plotting Board

Now that the initial data has been determined and sent to the guns, the M10 board must be prepared by setting the black 0 (6400) index of the rotating disk opposite the red vernier 0 at the top of the plotting board base. An appropriate scale is selected for the grid on the plastic base of the board. For example, each small square may equal 10, 20, or 50 meters. A tick mark is placed at the number representing the angle T on the appropriate side of the rotating disk (red or black numbers). If the observer is on the right, the angle T tick mark is drawn opposite the

correct mil graduation on the right side of the rotating disk (black numbers). When the observer is on the left, the red numbers are used. The tick mark facilitates shifting the disk rapidly when determining data for the guns and also is a reminder of the location of the observer's position. The initial angle T is used throughout the problem unless it is obviously in error. If there is an error in the angle T, the observer is requested to verify his azimuth and the last azimuth fired. When the angle T is less than 100 mils, the M10 board is not used and the observer adjusts along the gun-target (GT) line.

In this problem, the angle T is 500 mils. The executive arrived at this figure by comparing the azimuth fired (140 mils or, by adding 6400, 6540 mils) with the observer's azimuth to the target--6040 mils ( $6540 - 6040 = 500$  mils).

The plotting board operator constructs a tick mark opposite the black 500-mil graduation on the rotating disk and positions the black 0 (6400) opposite the red vernier 0. The board is now ready for the observer's correction to be plotted.

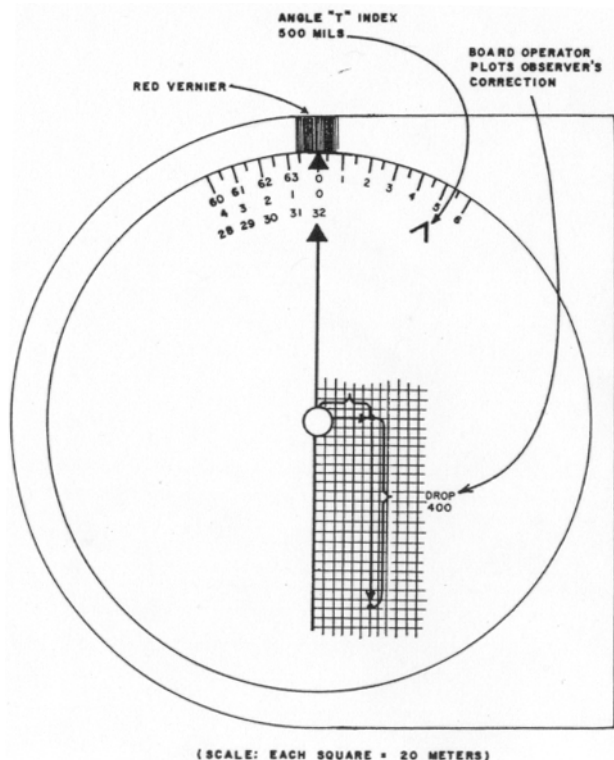

Figure 17. Observer's correction plotted on M10 plotting board. The board is in the original position.

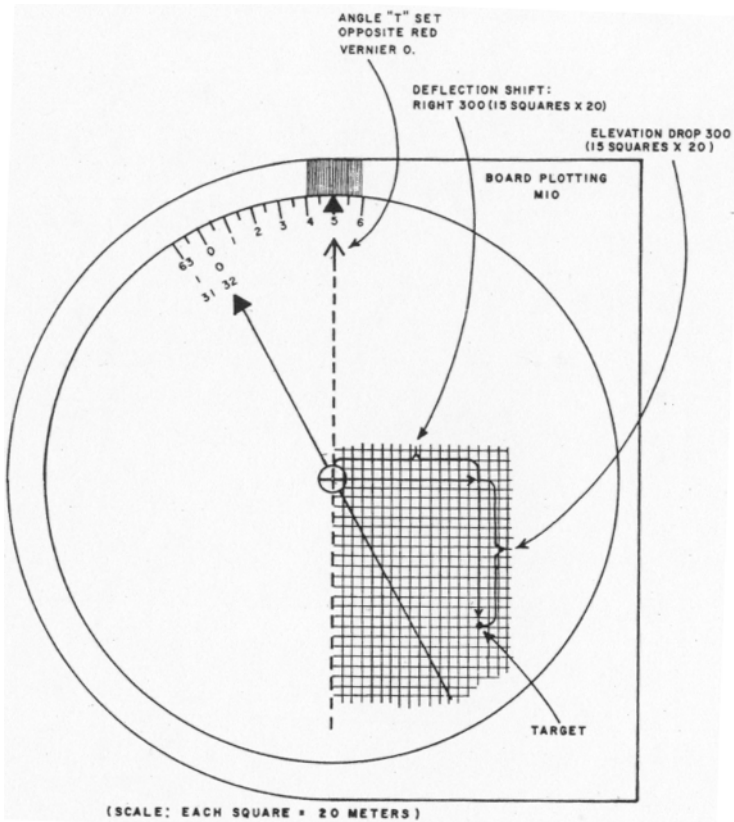

Figure 18. Angle T set off on board shows new position of the plot of the observer's correction.

### The First Round

The first round is fired.

The observer senses the round and sends a correction command to the executive using normal observer procedures. Considering the center of the plotting board as the last round fired and with the 0 (6400) index opposite the red vernier 0, the correction is plotted just as on a target grid except that a pencil instead of a needle is used to mark the plot. After the correction is plotted, the plastic disk is rotated until the tick mark indicating the angle T is set opposite the red vernier 0.

In this case, the observer's correction is--RIGHT 120, DROP 400. Considering the value of each square to be 20 meters, the board operator plots 6 squares right and 20 squares below the center of the board (fig 17).

The plastic disk now is rotated to the left, and the observer's angle T (500 mils) is set opposite the red vernier 0 (fig 18).

The deflection shift is determined by multiplying the 100/R factor by the distance in hundreds of meters from the gun-target line, represented by the vertical center red line on the board base, to the location of the plotted correction. The direction of the plot, left or right of the center vertical red line, indicates the direction of the subsequent shift.

As shown in figure 18, the board operator counts 15 squares to the right of the center vertical red line, multiplies the number by the value of each square (20), and announces--RIGHT 300. The executive then multiplies the 100/R factor (30) by the announced shift of 3 (in hundreds of yards) and determines that the deflection shift to the right is 90 mils. This shift is applied to the last deflection fired (2760 - 90), and the resultant deflection--DEFLECTION 2670--is announced to the battery.

#### Determining Elevation

Elevation is determined by multiplying the value of each square by the number of squares above or below the horizontal centerline and applying the product to the last range fired. Elevation is obtained from the graphical firing table (GFT) or by using the C factor from the tabular firing tables. The location of the plot above or below the center horizontal red line indicates whether the elevation has increased or decreased.

In the problem, the board operator counts 15 squares below the center horizontal red line and multiplies this number by the value of each square (20) and announces--DROP 300. If a GFT is being used, 300 is subtracted from the range used for the previous round and the elevation is read opposite the new range. When using tabular firing tables, the executive multiplies the C factor (8) by the announced range change (3) and determines the range change to be 24 mils. This number is applied to the last elevation fired (256 - 24), and the result is announced to the battery--ELEVATION 232.

The board operator erases the plot and rotates the plastic disk back to the original position. The board is now prepared for the plot of the observer's next command.

The problem continues as follows:

Observer: LEFT 50, ADD 200

Board Operator: LEFT 140 (7 squares left x 20)

Executive: DEFLECTION 2712 (2670 + (1.4 x 30))

Board Operator: ADD 160 (8 squares above center x 20)

Executive: ELEVATION 245 (232 + (1.6 x 8))

ERASE PLOT

Observer: DROP 100

Board Operator: RIGHT 50 (2.5 squares right x 20)

Executive: DEFLECTION 2697 (2712 - (.5 x 30))



Board Operator: DROP 90 (4.5 squares below center x 20)  
Executive: ELEVATION 238 (245 - (.9 x 8))

#### ERASE PLOT

Observer: ADD 50 FIRE FOR EFFECT  
Board Operator: LEFT 20 (1 square left x 20)  
Executive: DEFLECTION 2718 (2712 + (.2 x 30))  
Board Operator: ADD 40 (2 squares above x 20)  
Executive: BATTERY 3 ROUNDS, ELEVATION 241 (238 - (.4 x 8))

#### ERASE PLOT

Observer: END OF MISSION, ROADBLOCK  
NEUTRALIZED, ESTIMATE 10 CASUALTIES.

An emergency fire direction technique is needed to provide for all situations. The advantages of this particular system are:

- (1) It allows the observer to shoot using the observer-target (OT) line.
- (2) The required equipment is issued.
- (3) Initial data, particularly with a map, is accurate, thereby expediting the mission.
- (4) It allows the observer to make shifts from previously fired concentrations.

Like the computed firing data conversion system discussed in ARTILLERY TRENDS, June 1958, this emergency fire direction system may not be the ultimate system, but it can get the job done effectively.

---

The Catalog of Instructional Material will be distributed in the near future. Formerly called the Staff Training Catalog, the publication lists instructional material for unit, section, and staff training. Doctrine based on the New Infantry Division organization is reflected in the material. In addition classes incorporate the latest artillery procedures. The needs of units in all phases of field artillery training are met in the 196 classes offered.

Additional copies will be available after 1 September 1959. Address requests to: Commandant, US Army Artillery and Missile School, Fort Sill, Oklahoma, ATTN: AKPSIDA-TP/RC.

---

Review gunnery and tactics through enrollment in selected subcourses of the Artillery Extension Course Program.

## **REORGANIZED FRENCH INFANTRY DIVISION ARTILLERY**

Major Arthur P. Wade, Artillery  
Army Section, Military Assistance Advisory Group  
(France)

Following the conversion of the United States infantry divisions to the pentagonal pattern in 1957, the French Army began studying the possibility of a similar reorganization. Profiting from the experience of the United States, the French developed an infantry division organization in 1958.

The new French infantry division is part of a long-range organizational plan and is an interim solution. Known tentatively as the Infantry Division, Partially Mechanized (DIPM), its organic units presently are undergoing field tests in Germany.

In general, the DIPM is similar to the ROCID organization. The combat elements of the division include five regiments of infantry, partially mechanized, which are equivalent in strength to the US battle group; a tank unit; a reconnaissance unit; an engineer unit; a signal unit; division artillery; and service support units similar to those found in the ROCID trains.

The division artillery of the DIPM consists of three subordinate elements (fig 19), each traditionally called a "regiment." They provide direct support, general support, and air defense respectively. There is no division artillery headquarters battery. Its normal personnel and functions have been combined with the headquarters and headquarters battery of the direct support regiment. The division artillery commander is a brigadier general with a colonel as deputy.

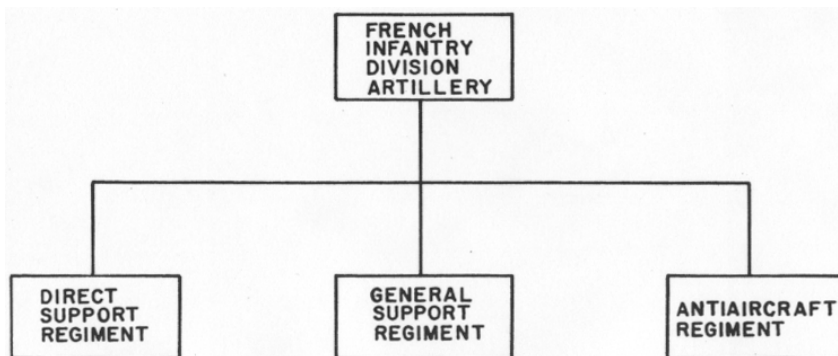

Figure 19. Organization of the French Infantry Division Artillery (DIPM).

## Direct Support

Direct support of the infantry is provided by a light regiment (fig 20) consisting of a headquarters and headquarters battery, a service battery, and 5 small battalions, each containing 2 batteries of 105-mm howitzers. Each battery consists of four self-propelled howitzers. The light battalions furnish direct support to an infantry regiment and normally will train with and support the same regiment. The colonel commanding the direct support regiment also is the division artillery fire direction officer.

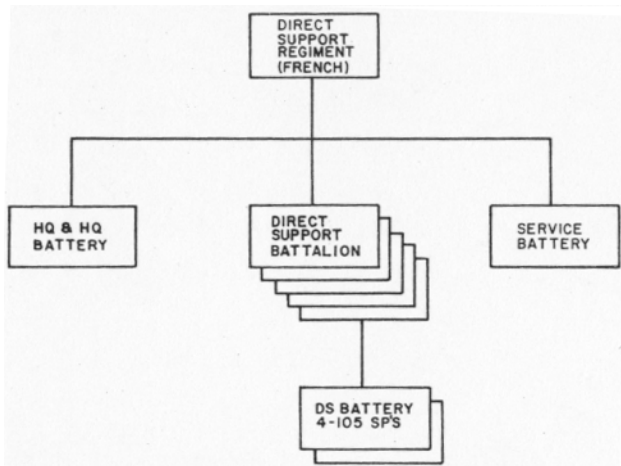

Figure 20. Organization of the direct support regiment (DIPM artillery).

General support for the division is provided by a composite regiment (of battalion size) composed of a two-battery medium battalion and a separate rocket battery. Each battery in the medium battalion has four towed 155-mm howitzers. In the near future, the rocket battery will be equipped with Honest John (762-mm) rockets. The medium battalion is commanded by a lieutenant colonel.

Organic antiaircraft artillery consists of a four-battery battalion of self-propelled weapons, similar in organization and equipment to a US Air Defense Artillery automatic weapons battalion. The battalion is commanded by a lieutenant colonel. This battalion, and a headquarters and operations detachment, are controlled by the division air defense commander who is a colonel.

A particular point of interest in comparing the artillery of the DIPM with the New Infantry Division artillery (ARTILLERY TRENDS, March 1959) is that the French have made all of their direct support artillery self-propelled. The French light self-propelled weapon is a 105-mm howitzer on the light and highly mobile AMX tank chassis (fig 21).

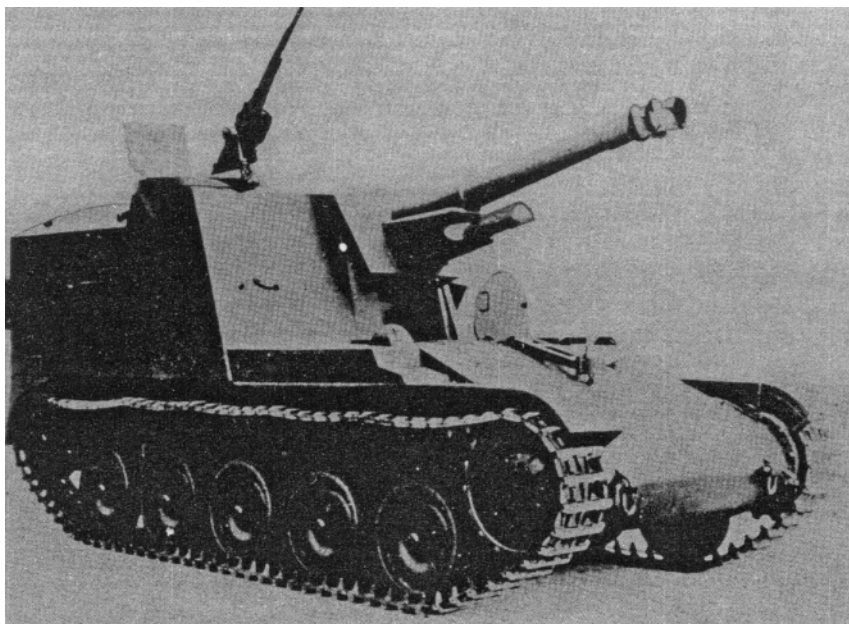

Figure 21. French 105-mm howitzer (SP).

It should be remembered that the organization of the DIPM artillery was finished several months before the adoption of the US New Infantry Division. In effect it represents a completely independent evaluation of the limitations of ROCID as originally organized in 1957. It is a source of satisfaction that two major powers, each with the highest artillery traditions, have independently reached similar conclusions regarding the artillery organization necessary to support a pentomic infantry division.

(The above information was cleared for publication in ARTILLERY TRENDS by the French Army General Staff.)

---

Interested in the Corporal missile?

Enroll now in the special extension course "The Corporal Missile". Write to: Commandant, US Army Artillery and Missile School, Fort Sill, Oklahoma, ATTN: Extension Courses Division.

---

## REDSTONE—THE MISSILE AND ITS EQUIPMENT

Captain Luke A. Vavra  
Department of Materiel

The Redstone is the largest and longest range operational field artillery missile. The missile has a rocket propulsion system and an inertial guidance system. Guidance is set before firing. The system automatically guides the missile to the target, making the necessary corrections in the trajectory to insure accuracy.

The Redstone is 21.1 meters long, 1.8 meters in diameter, and weighs 31 tons when it is prepared for firing. Its range is 200 miles.

The Redstone group (ARTILLERY TRENDS, February 1959) has 2 firing batteries, each containing the equipment and personnel required to prepare and fire one missile at a time; a headquarters and headquarters battery; an Ordnance company; and an Engineer company. The headquarters and headquarters battery provides the normal command, administrative, maintenance, and supply functions. The Ordnance company is responsible for missile supply and maintenance, in addition to supplying the fuel and hydrogen peroxide. The Engineer company manufactures liquid oxygen (LOX) and supplies it directly to the firing battery. The entire Redstone group is 100 percent mobile. Normally one Redstone group is assigned to each field army.

### Three Units

The missile consists of a thrust unit, an aft unit, and a warhead unit (fig 22). The aft and warhead units are known as the body unit when they are assembled. The thrust unit includes the tail section which has fixed stabilizers, movable rudders, and jet vanes. The jet vanes extend into the rocket exhaust and provide control of the missile until its speed is sufficient to make the rudders effective. The rocket engine and a propellant pumping system are located inside the tail section. The pumping system is operated by hydrogen peroxide, a chemical which readily decomposes into steam. Above the tail section is the oxidizer tank which is loaded with 25,000 pounds of liquid oxygen (LOX). Above the oxidizer tank is the fuel tank loaded with 19,000 pounds of an alcohol and water solution.

Various valves of the propulsion system are operated by high-pressure air in fiberglass spheres near the engine. High-pressure air also is used to maintain a slight pressure on the fuel tank; the oxidizer tank is self-pressurized by the evaporation of liquid oxygen.

The aft unit houses the guidance system. At the base of the aft unit are four vanes which control the body unit after separation. The guidance system has a gyro-stabilized platform as a reference, accelerometers to measure the performance, computers to determine corrective commands,

a relay box to apply battery power to the motor actuators which position the rudders as required, and a program device to provide pitch programming and timing signals.

Shortly after thrust termination, the thrust and body units are separated by igniting six explosive bolts which connect the units and by pushing the units apart using two compressed-air-loaded expulsion cylinders. Separation improves the reentry characteristics of the missile.

The rest of the story is told in pictures. The photographs show the equipment needed to get the missile in the air and insure that it hits its target.

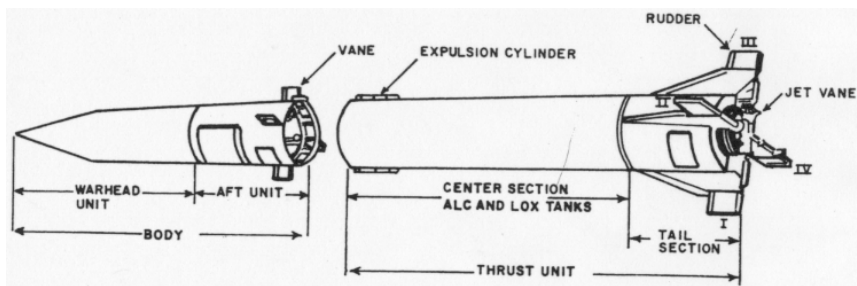

Figure 22. Components and nomenclature of the Redstone missile.

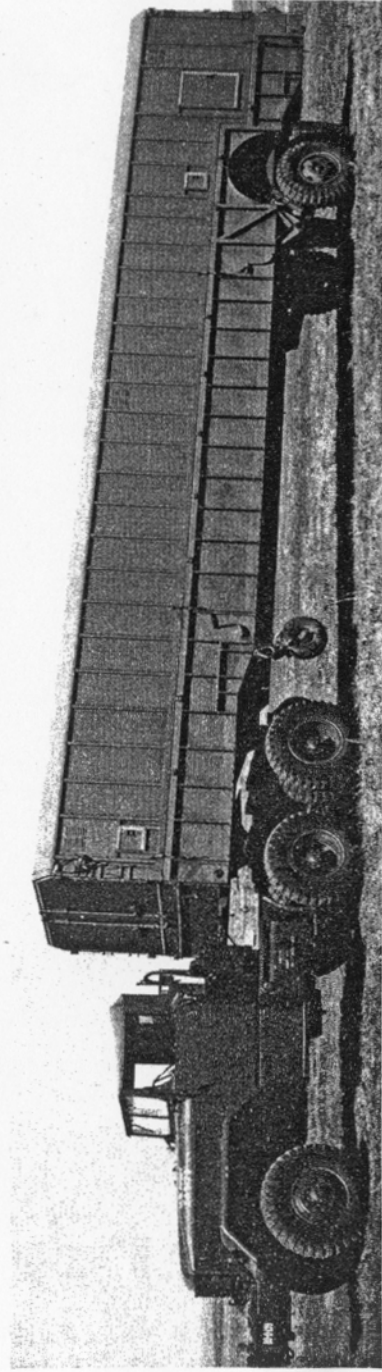
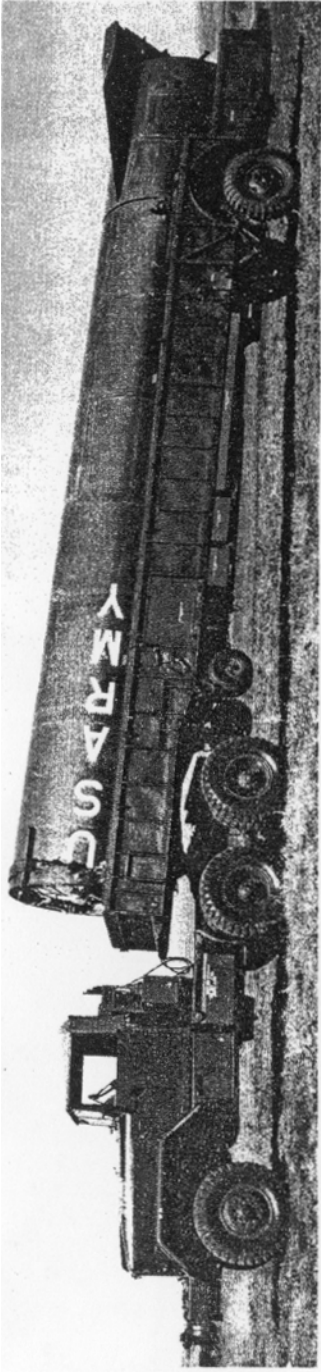

Figure 23. The missile is transported into the battery area as three separate units. The thrust unit is the largest of the three and is carried on the XM482 semitrailer. The cover (shown in bottom photo) is removed prior to

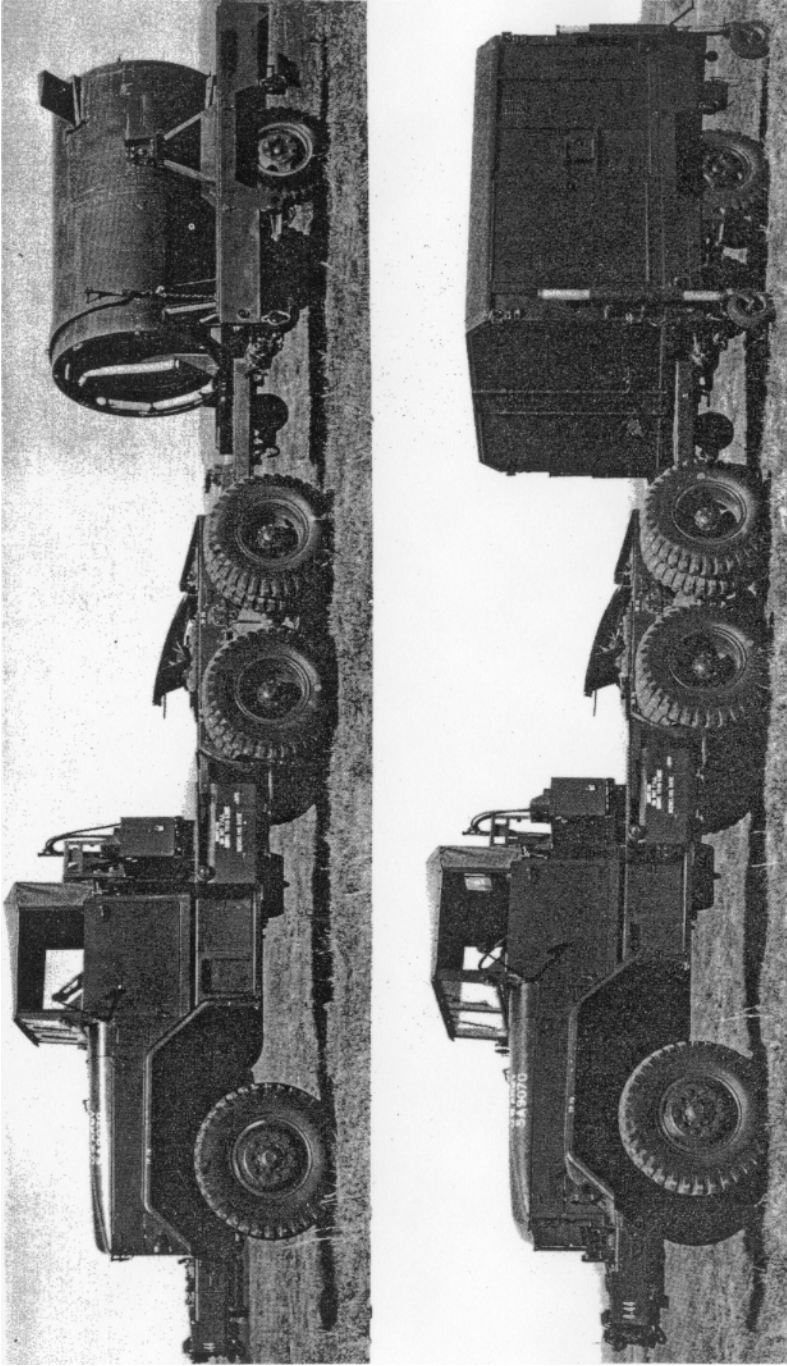

Figure 24. The aft unit is transported on the XM480 trailer. Like the other two trailers, the upper portion or cover of the trailer is removed by lowering a set of four extendable legs (shown in bottom photo). The cover is then elevated by a series of jacks and the entire assembly is pushed to the rear by battery personnel thereby uncovering the aft unit.



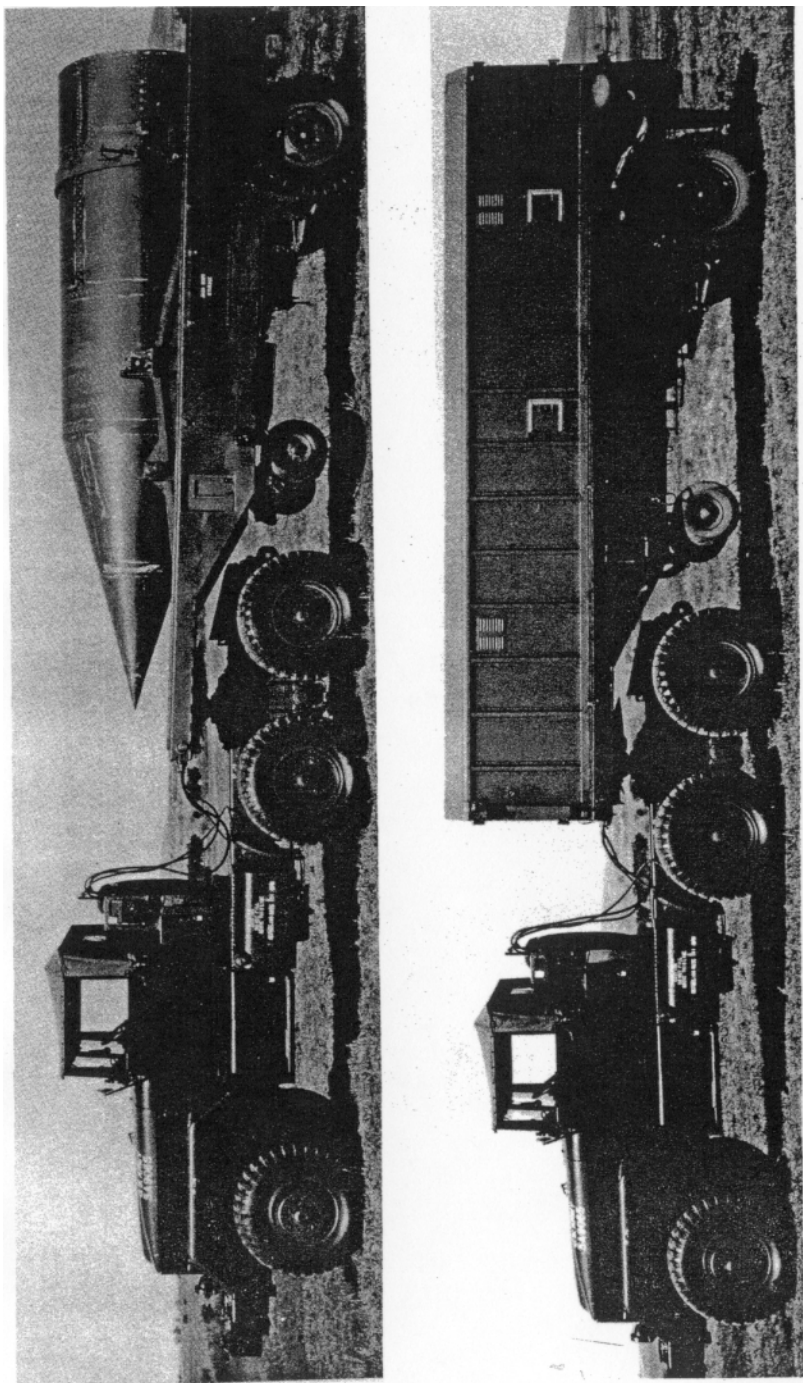

Figure 25. The warhead arrives in the battery area on the XM481 semitrailer. After the warhead and the aft unit have been uncovered, the aft unit is removed from its trailer by a standard 5-ton wrecker and is mated to the warhead. Once mated this portion of the missile is termed the "body." The bottom photo shows the trailer with the cover mounted.

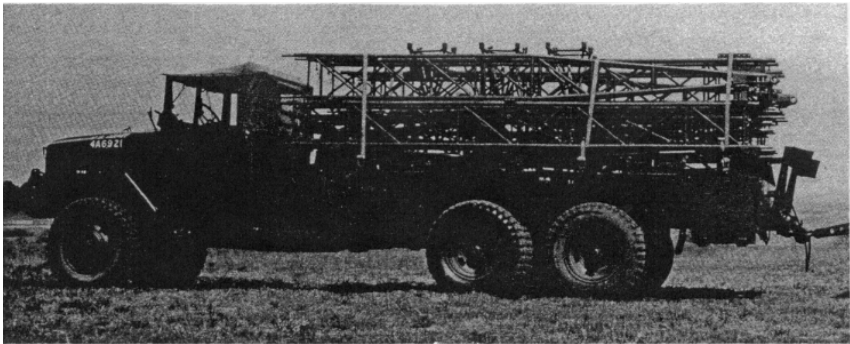

Figure 26. The erector-servicer XM478 consists of a modified 2½-ton truck on which lightweight erection equipment is transported. When a firing position has been selected, the truss sections are unloaded and bolted together to form large "A" and "H" frames, which will be shown in subsequent photographs. This truck normally tows the launcher shown in figure 27.

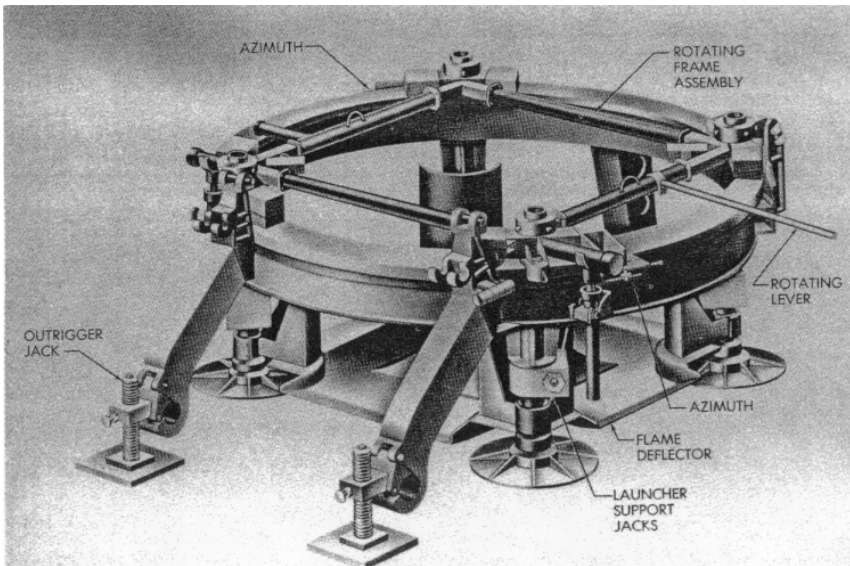

Figure 27. The XM74 launcher is used to orient the missile vertically and to align the selected reference fin toward the target. The wheel and axle assembly is removed when the launcher is emplaced.

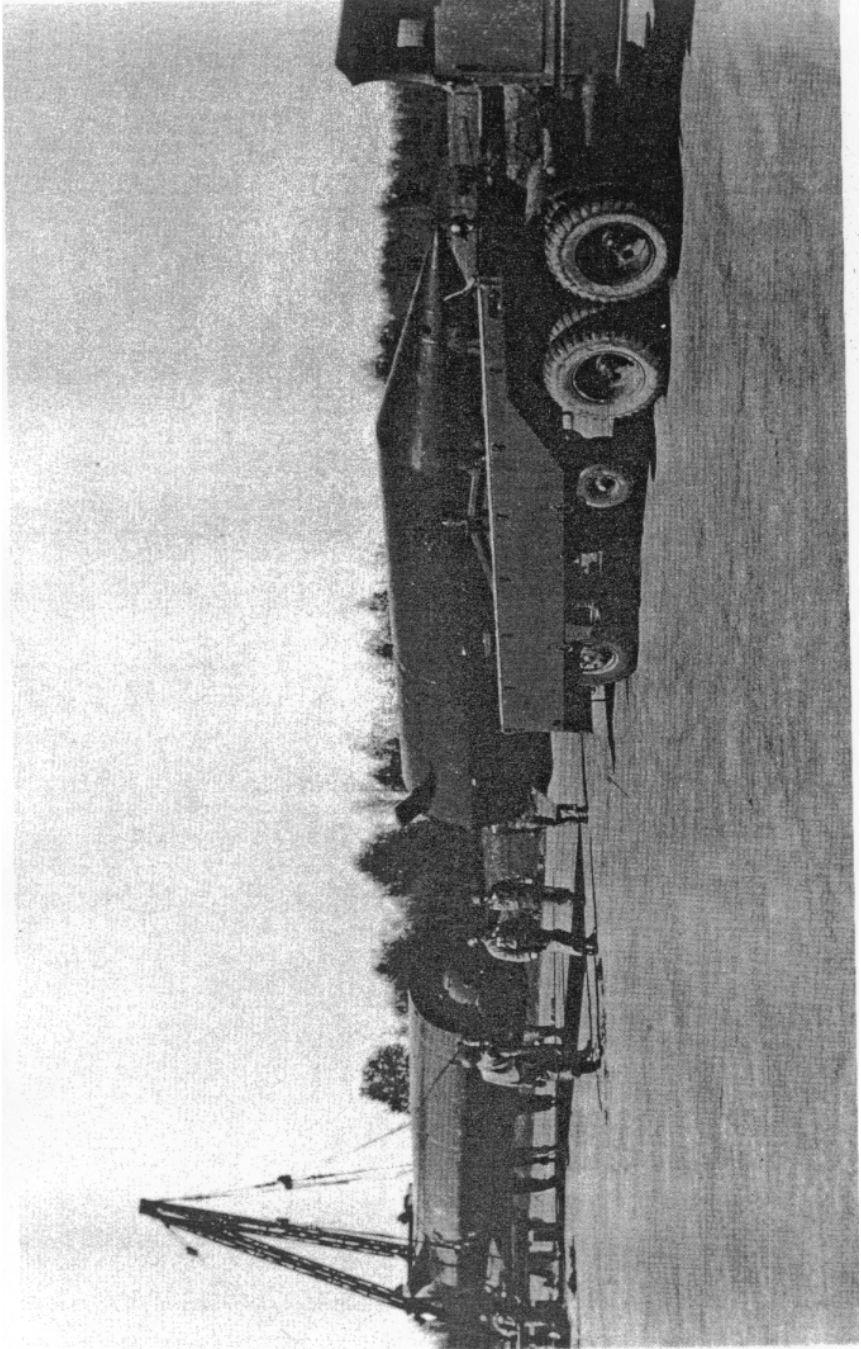

Figure 28. During missile assembly, the erector-servicer holds the missile thrust unit while the body unit is properly positioned by maneuvering the body unit (warhead and aft unit) trailer.

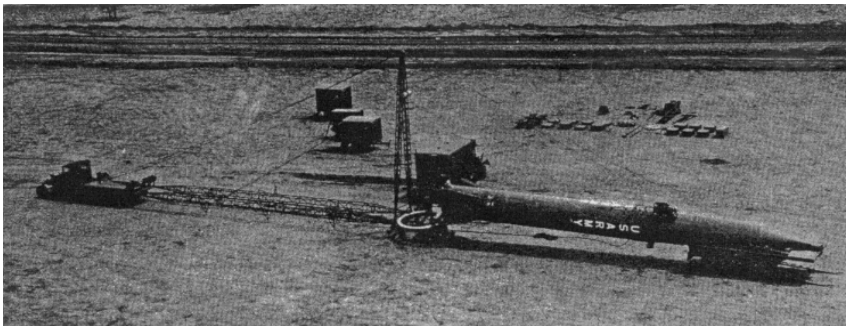

Figure 29. The missile is assembled at the firing position and is first tested in the horizontal position by the firing battery personnel. At this stage the missile also is rigged for erection.

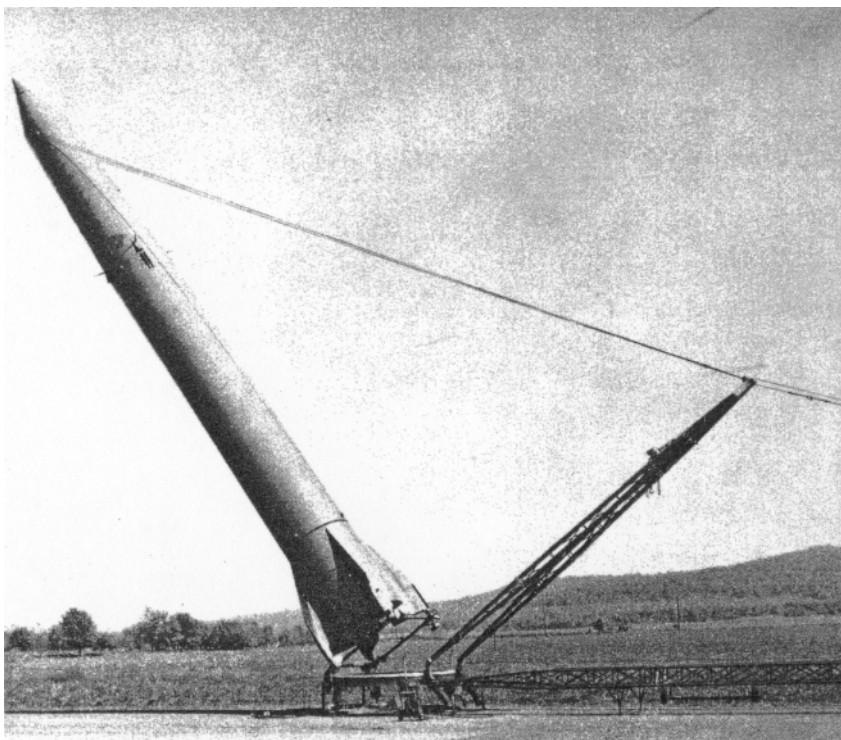

Figure 30. The missile is raised to the vertical position by the erector-servicer. The base of the missile is hinged to the launcher and the nose is raised to the vertical position by steel cables which are attached to the "A" frame.

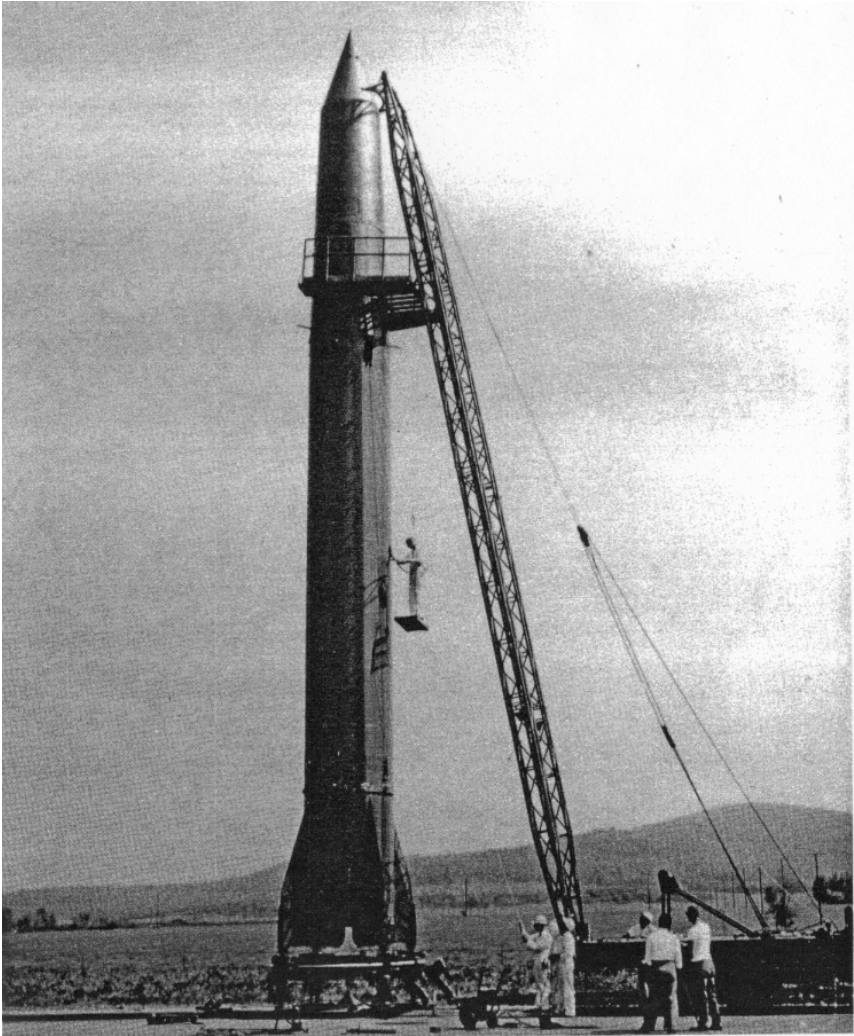

Figure 31. After the missile is raised to the vertical position, the "H" frame of the erector-servicer is used as a boom for positioning and supporting the service platform. Battery personnel perform final checks on the missile from the platform. The platform is raised by a cable assembly which is operated by an electrically powered winch located in the bed of the erector truck.

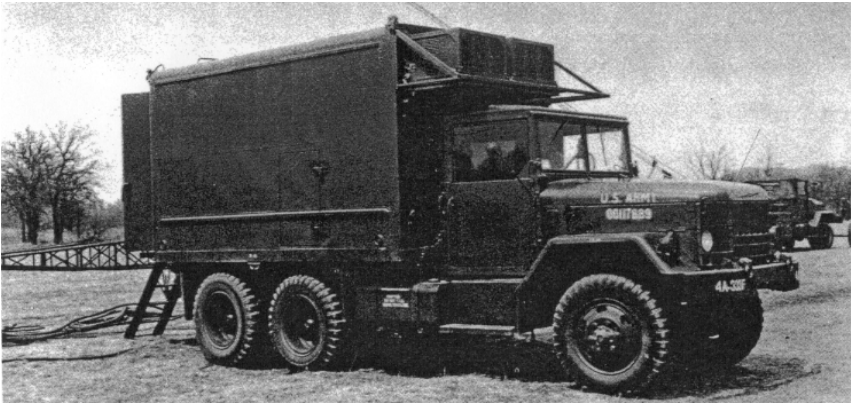

Figure 32. Battery personnel use test equipment in the fire control and test truck during the checkout phase when the missile still is in the horizontal position. This truck also contains equipment used to preset the guidance system with the trajectory data. Some trajectory data is recorded on a magnetic tape. Tapes for different trajectories are selected from a library of tapes in the battery.

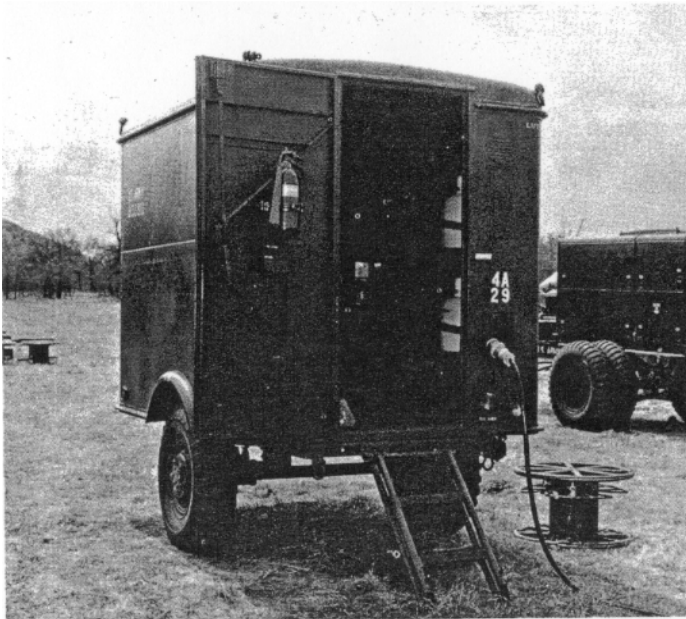

Figure 33. The XM479 battery servicing trailer activates and tests the 28- and 60-volt silver oxide batteries which provide the necessary onboard power to the missile during flight.



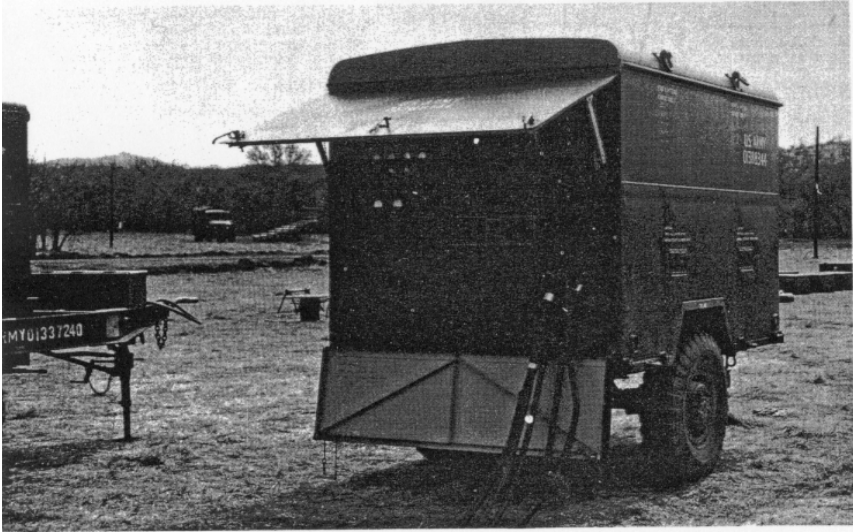

Figure 34. The power distribution station AN/MSQ-27 is used to convert 60-cycle, 208-volt power into 28- and 60-volt direct current power for missile testing and firing.

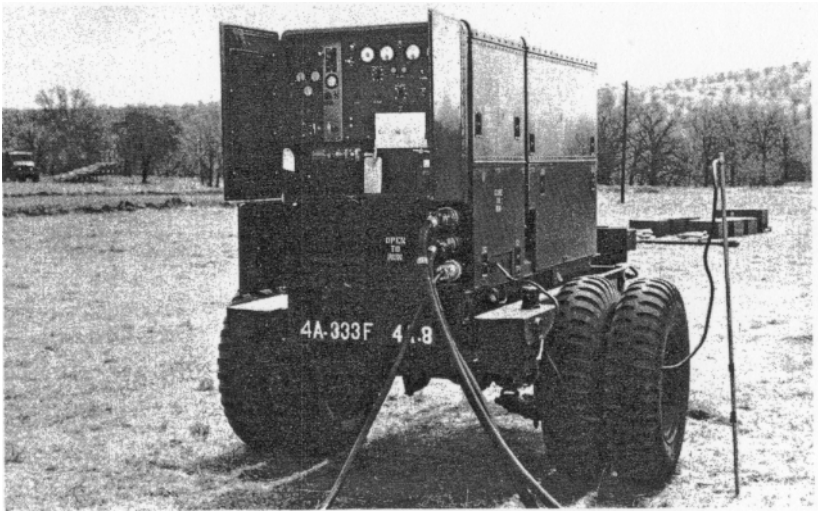

Figure 35. The generator set provides 3-phase, 60-cycle, 208-volts of power to operate the equipment that prepares and fires the missile. This diesel generator develops 60 kilowatts (KW).



Figure 36. The truck-mounted air compressor provides 5,000 pounds per square inch of air pressure. During flight the compressed air, which is stored within the missile, is used to pressurize the alcohol and hydrogen peroxide tanks and to open and close valves in the propulsion system.

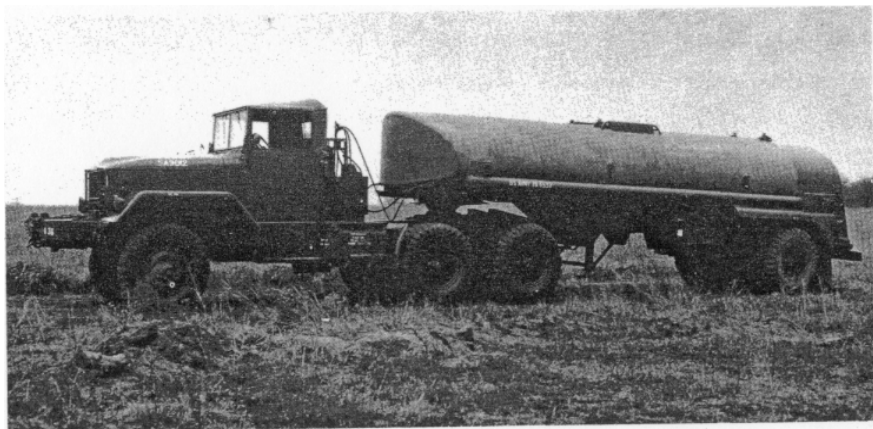

Figure 37. The XM388 alcohol semitrailer has a 3,000-gallon tank and a pumping system to transfer the alcohol-water (75 percent alcohol, 25 percent water) solution to the missile. The alcohol-water solution is the fuel for the Redstone missile. The missile is fueled only when in the vertical position.



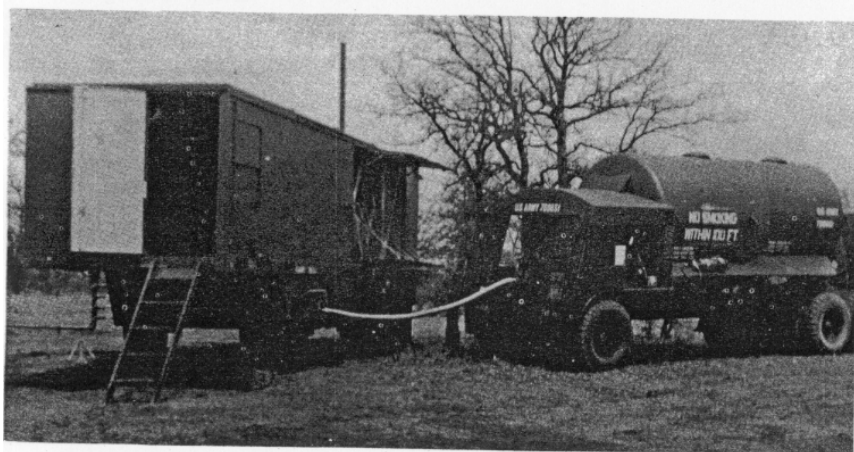
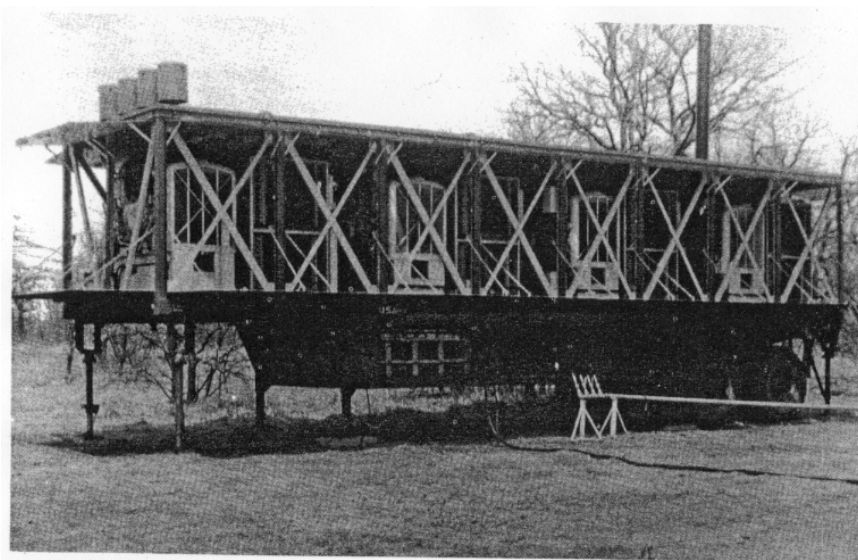

Figure 38. Liquid oxygen (LOX) is produced by the Redstone group's organic Engineer company. The generating plant consists of an air compressor unit (top photo) and an air separation unit (bottom photo) where the major components of atmospheric air, nitrogen and oxygen, are separated. The liquid oxygen is then routed to the liquid oxygen semitrailer (also shown at bottom) for delivery to the missile firing position.



Figure 39. Each firing battery has two liquid oxygen (LOX) semitrailers that carry the oxidizer to service the missile. Each trailer can hold 9 tons of LOX. The trailer has a "thermos bottle" construction to maintain the LOX at a temperature of minus 297 degrees Fahrenheit. The LOX transfer pumps and equipment are mounted in the closed compartment at the rear of the trailer.



Figure 40. The XM387, hydrogen peroxide servicer, carries a 78-gallon drum of concentrated hydrogen peroxide which is used to generate steam to operate the missile's propulsion system. The propellant loading sequence is: alcohol, LOX and hydrogen peroxide.

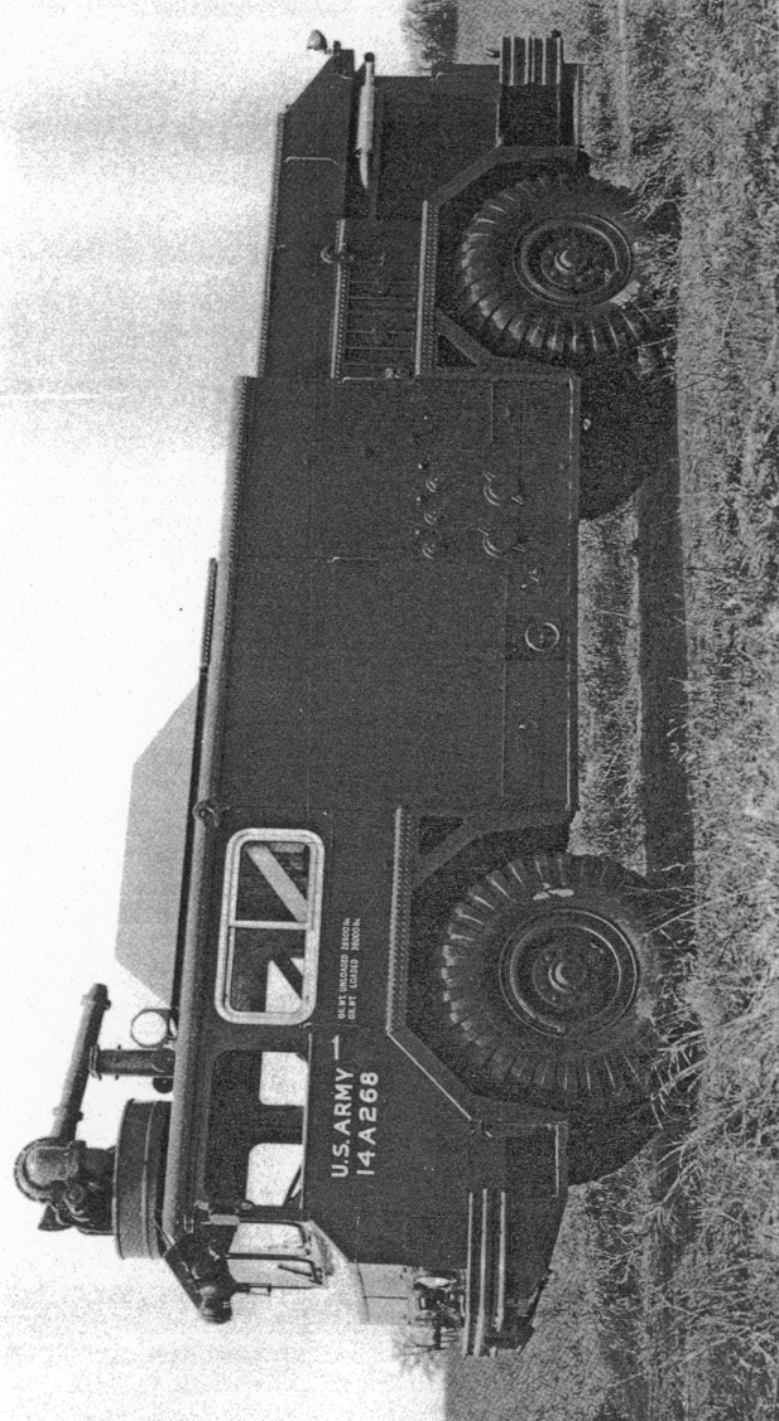

Figure 41. The fire truck carries 1,000 gallons of water and is used to neutralize spilled propellant or to extinguish small fires which may ignite when the missile is fired. The truck normally tows a four-wheeled water trailer which contains a 2,000-gallon reserve.



Figure 42. ON THE WAY!

## PROTECTION FOR THE HEAD OF THE M2 AIMING CIRCLE

Second Lieutenant William J. Spradley  
2d Howitzer Battalion, 31st Artillery, Fort Sill

The M2 aiming circle provides the artillery with a versatile and accurate fire control and survey instrument (ARTILLERY TRENDS, October 1958). As with all new equipment, the user must learn to properly maintain and transport it.

The forerunner of the M2 aiming circle, the M1, had a steel carrying case that provided adequate protection for the instrument. The fragile head of the M2 is stored and transported in a top heavy, dome-shaped, metal container (fig 44) (the tripod for the M2 is fastened together with belts and carried separate from the head). Because of

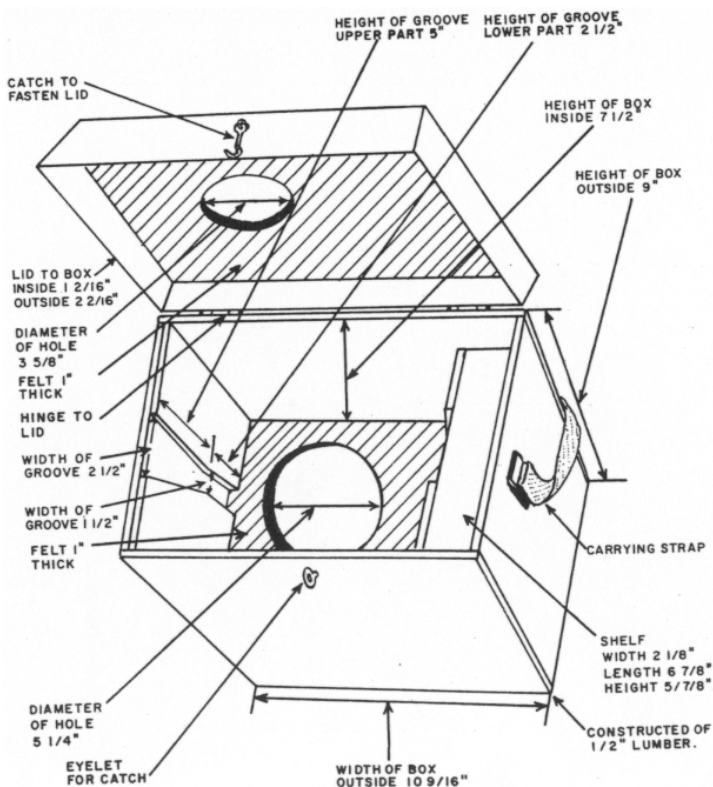

Figure 43. Dimensions of the box designed to protect the M2 aiming circle head.

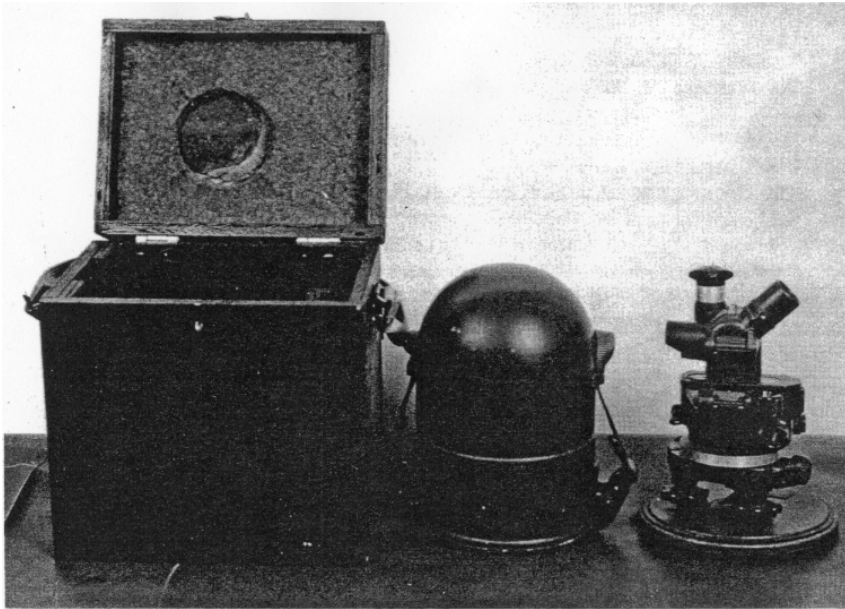

Figure 44. From left to right, the protective box, the dome-shaped container, and the M2 aiming circle head.

the small offset base of the container, it may tip over if a vehicle should sway or go over a slight bump. The instrument probably will be damaged after rolling around the bed of a truck for even a short period of time. Responsible technical services are working on this problem. However, units can use an interim solution. A man could hold the container in his lap whenever the vehicle is in motion, however, a more practical solution is to build a simple wooden box (fig 43) to hold the dome-shaped container snugly, thus preventing it from tipping and rolling around in the truck.

The box shown in figures 43 and 44 can be built easily by battery personnel. Units at Fort Sill have built this box for approximately \$1.50.

Such a box for the head of the M2 aiming circle helps eliminate damage to this rather fragile instrument and provides artillery units with a handy carrying device.

---

Are you an active member of the 20,000 extension course students of the US Army Artillery and Missile School?

---

## EXERCISE YOUR RADAR

Captain W. Thomas Reeder  
Department of Target Acquisition

If you have not exercised your radar 4 days this week, you do not have a combat ready radar section.

The proper use of radar, particularly frequent exercising, will produce the information necessary to destroy enemy mortars and artillery. The location and destruction of mortars is essential considering the fact that over 50 percent of all US Army casualties in World War II resulted from mortar fire.

Commanders can achieve better results from organic radar equipment if the radars are operated frequently. In addition, a radar must be electrically energized so that various electrical components will be kept dry. As with television sets and other electronic equipment, moisture is a prime enemy and can best be overcome by operating the equipment. The more varied the exercising of the radar and the practice given its operators, the more versatile and proficient the radar section will be in performing its combat mission of locating targets.

### Challenge the Radar Section

The usual methods of radar section training, i.e., radar "drill," weapons location and radar gunnery, moving target detection, and aircraft vectoring are all described for the AN/MPQ-10 in FM 6-160. In addition, the following ideas will challenge the radar section, promote section competition, and help maintain combat readiness.

(1) Use radar speed traps. Position the radar for moving target detection and observe a highway at a zero mil aspect. Using a stopwatch, hand-track vehicles along the road and calculate their speed. The speed trap is excellent training for the combat surveillance role. It trains the operators to identify various types of targets.

(2) Automatically track aircraft (AN/MPQ-10 only).

(3) Conduct a "radar RSOP" (reconnaissance, selection, and occupation of position) concurrently with artillery or mortar service practice. Radar sections should occupy two or more surveyed sites, making at least one weapon location from each site. The section determining the most accurate locations is the winner.

Frequent exercise of radar sets and frequent practice for the sections has many desirable results. First, destructive moisture is eliminated and electrical components are heated. Second, the commander is assured that the equipment is being maintained properly. Third, teamwork is developed through on-the-job training of radar operators.

The potential of radar as a means of target acquisition has been recognized. In World War II radar sets were used to locate targets. Since then, improvements have been made to the point that the Army has

progressed through two generations of radar sets. The AN/MPQ-4 (ARTILLERY TRENDS, June 1958) now has replaced the AN/MPQ-10 as the standard countermortar set. The SCR-784 was standard before the AN/MPQ-10. The AN/MPQ-4 represents a major technical advancement. It has a greater range, a first round target acquisition capability, and target location time is reduced to 20 seconds. To fully realize their target acquisition potential, radars should be operated often. Only in this way will the radar sections and the equipment itself be truly combat ready.

## **ARTILLERY TIME SAVERS**

Captain Joseph J. Addison, Armor  
US Army Artillery Board

Servicing a field artillery piece during firing has never been an easy job. This is especially true of the larger weapons. For example, it requires much hard work to keep the 8-inch howitzer (towed or self-propelled) firing. When new weapons are developed, labor saving devices are always considered. For example on the new self-propelled 8-inch howitzer, the T236 (ARTILLERY TRENDS, February 1959), which is now under test, hydraulic assists have been installed wherever possible.

In addition efforts always are made to simplify and make more efficient the effort involved in firing artillery weapons. The US Army Artillery Board has developed two devices that will do this.

When firing separate loading ammunition, the chamber and face of the obturator must be swabbed after each round is fired. Generally, this is done with a bundle of rags tied to the rammer staff.

The Artillery Board has developed a better device shown in figures 45 through 47. The simple tool consists of five sponges clamped between two round plates at the end of a rammer staff section. The entire assembly is screwed onto a rammer staff and makes a lightweight, long-lasting swab. In tests, one set of sponges lasted for more than 200 rounds. Also, the alternate dipping of the sponges first in water and then in bore cleaner produced no harmful effects. Crews on 155-mm and 8-inch howitzers will find the device a valuable assist.

### Dollar per Dozen

The sponges are available through the Army supply system under stock number 7920-240-2553. They cost \$1.00 per dozen through self-service supply centers.

Improvement also is possible in the method of loosening the screw handles on powder bag containers. In the past the containers have been opened with hammers, axes, sledge hammers, smashed fingers, and a



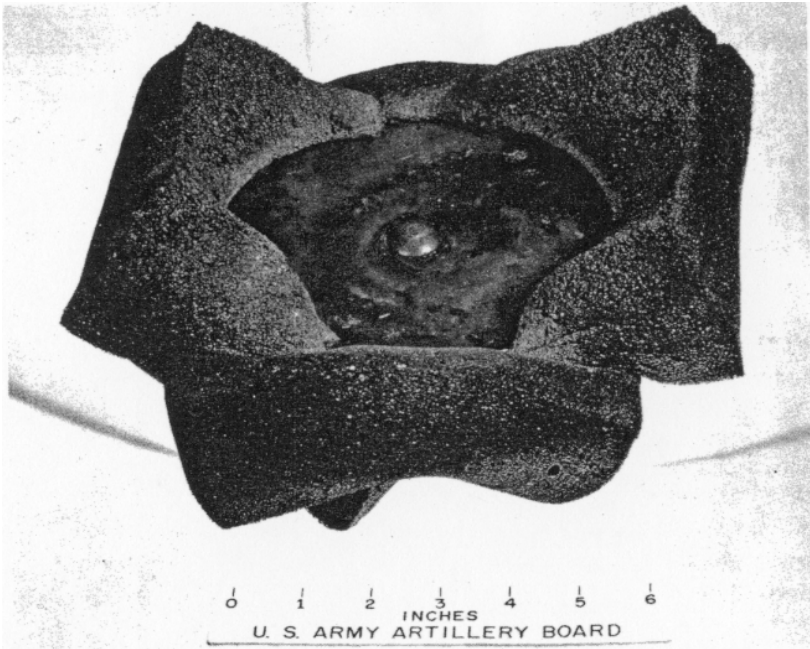

Figure 45. The five sponges are clamped between two round plates on the end of an 8-inch howitzer rammer staff section.

liberal sprinkling of cuss words; always with the danger that a spark might set off the "keg of dynamite."

The Board has devised a simple wrench which has bronzed surfaces to reduce the spark hazard. Figure 48 shows the dimensions and figure 49

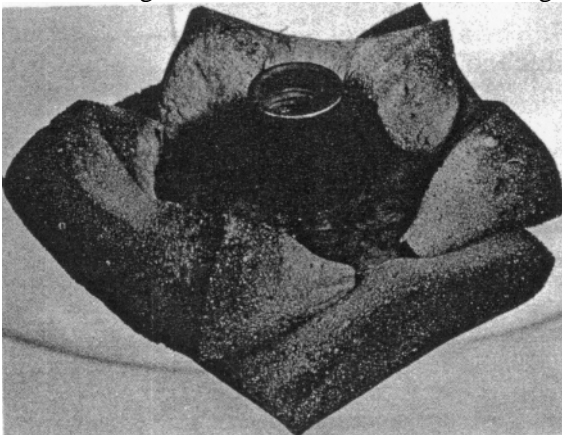

Figure 46. Underside view of the five sponges on end of rammer staff section. This screws onto the rammer staff.

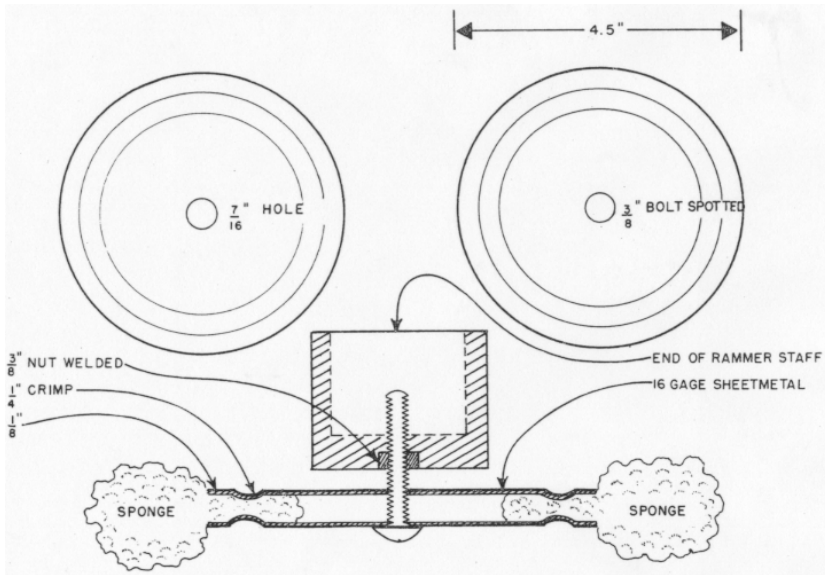

Figure 47. Measurements and method of attaching the sponges on rammer staff section.

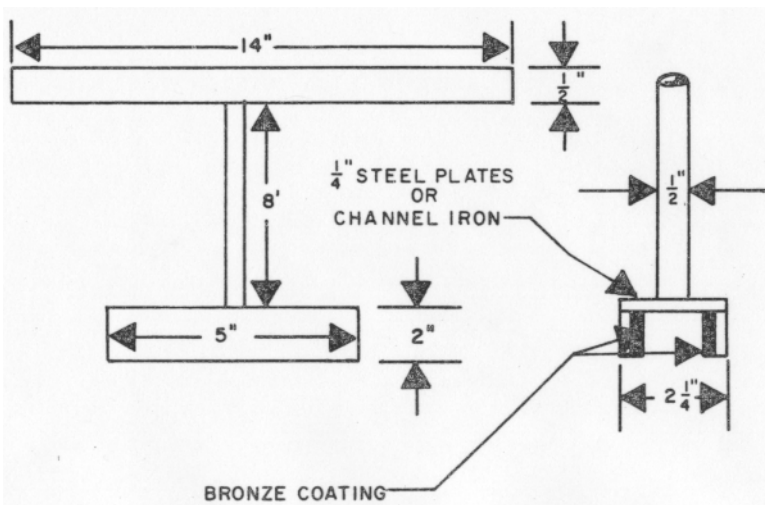

Figure 48. Measurements and material needed for making a wrench to open powder bag containers.



Figure 49. The wrench being used to open an 8-inch howitzer powder bag container.

shows how the wrench is used. This wrench was made from scrap materials and bronzed on the inside with brazing rods.

The wrench can be used on powder bag containers for any caliber weapon. It also can be used to open the canisters which hold 105-mm semi-fixed ammunition.

These devices have been recommended to the appropriate technical service for adoption. In the meantime, battalion and battery commanders can have them made in their own maintenance shops. Their use will reduce physical effort, help the morale of the gun crews, speed the operation, and provide greater safety for the ammunition handlers.

---

Don't be a victim of the "summer slump." Remain active in Artillery Extension Courses.

---

## IMPROVED METHOD OF TIME REGISTRATION

Major William W. Madison  
 Department of Gunnery

An improved method of time registration has been adopted by the US Army Artillery and Missile School. Previously, when the first 3 time-registration rounds fired at the trial time (time obtained by splitting a 0.4-second bracket) resulted in mixed sensings, 3 more rounds were fired at the same fuze setting. This procedure allowed a greater possibility of a 5 and 1 registration (5 airs and 1 graze or vice versa) which in turn could result in an invalid registration.

The new method was proposed by Captain Edward B. Atkeson while attending the advanced course. It makes the undesirable 5 and 1 registration less probable. When the first 3 rounds fired at the trial time result in mixed sensings, 2 more rounds are fired at the last time setting which resulted in a sensing opposite the preponderance of the 3-round group. These 2 rounds plus the round fired at the time setting that established one end of the 0.4-second bracket constitute the second group of 3 rounds to be used in computing the adjusted time.

An example of the new method follows:

<u>Round number</u>	<u>Time</u>	<u>Sensing</u>
*1	16.4	air
2	16.8	graze
3, 4, 5	16.6 (trial time)	graze, graze, air
6, 7, (*1)	16.4	graze, graze, (air*)

\*Used as third round in second group.

$$\text{Mean time} = \frac{\text{three rounds at } 16.6 + \text{three rounds at } 16.4}{2} = 16.5$$

$$\text{Adjusted time} = \text{mean time} \pm \frac{\text{difference in airs and grazes} \times 0.4}{2 \times \text{number of rounds fired}}$$

$$= 16.5 - \frac{(4 \text{ grazes} - 2 \text{ airs}) \times 0.4}{2 \times 6}$$

$$= 16.5 - 0.1 \text{ (rounded off)} = 16.4$$

It must be pointed out that the procedure for determining adjusted time when the first three time registration rounds fired at the trial time result in the same sensing has not changed. The change is when these first three rounds result in mixed sensings.

This new procedure will save at least one round in the time registration. In addition, the method increases the probability of a more accurate adjusted time.

# THE US ARMY ARTILLERY BOARD

Colonel R. W. Fletter  
President, US Army Artillery Board



The artillery, like every other branch of the Army, must keep its equipment up to date. It must have equipment which not only incorporates the latest technical advances, but also has the capabilities required in modern warfare. The mission of the US Army Artillery Board at Fort Sill is to ascertain that the artillery has this equipment.

The overall job of insuring that the artillery has modern equipment consists of several specific tasks. One of those is to conduct field tests on new items of equipment being considered for field artillery use. When these tests are completed, the board must then recommend whether or not the item should be adopted. Another specific task is to furnish user guidance to any agency that is developing a new piece of artillery equipment. The Board also participates in troop tests of equipment and observes and reviews the performance of equipment already in use. Further the Board prepares and reviews the military characteristics for a new piece of equipment for artillery. The Board also assists the US Army Artillery and Missile School in preparing basic training literature and selecting training aids.

A new piece of equipment begins as an idea and materializes through a process called the research and development cycle. How the Artillery Board fulfills its missions can be best explained by examining the Army's research and development cycle to see how the Board functions within it.

The development part of the cycle begins with a requirement which is an idea for a new piece of equipment. It can originate in the field, at the US Army Artillery and Missile School, at the Artillery Board itself, or with an individual, either civilian or military. The requirement is formalized by being evaluated and approved as a qualitative materiel requirement (QMR) through the Combat Developments system, the Continental Army Command and the Department of the Army.

## Determining Military Characteristics

Once the QMR is approved, the Artillery Board determines what military characteristics the new equipment must have to fulfill the requirement. The Board strives to set military characteristics which will reflect a true advance in equipment, thus forcing the developer to produce something genuinely new. If the characteristics set by the Artillery Board are too close to the characteristics of present equipment (too much within the state of the presently known art), nothing new is developed. The result is only an assembly of current on-the-shelf components. However, while

the military characteristics must reflect a true improvement, they must not be impossible for the developer to achieve. Knowledge of the current state of the art in development fields is obtained by Board members from reading, liaison visits, and service on steering committees. Also, in determining military characteristics, the Artillery Board must avoid telling the developer how to do his job and confine itself to stating what is needed.

After military characteristics are approved and forwarded to the appropriate technical service for development, the Artillery Board follows the development by taking part in design conferences, mockup conferences, and preliminary tests until the item is ready for the Board's user test. All artillery items except field artillery missiles and heavy rockets are tested at Fort Sill. These exceptions are tested by the Artillery Board's missile division at Fort Bliss, Texas.

The Artillery Board was moved to Fort Sill in 1954 from Fort Bragg, North Carolina, where it had been since 1922. The purpose of this move was to facilitate the coordination and interchange of ideas and information between the Board and the US Army Artillery and Missile School.

Presently, the board has more than 80 active test projects and some 125 developments to be monitored away from Fort Sill. Table 1 gives an idea of the type of equipment tested by the Artillery Board.

Cannon, towed and self-propelled
Field artillery missiles
Ammunition for artillery weapons
Fire control equipment
Survey equipment
Sound and flash ranging equipment
Countermortar and counterbattery radar
Meteorological equipment
Prime movers for field artillery
Camouflage nets
Searchlights
Ancillary field artillery equipment

Table 1. Types of artillery equipment tested by the Artillery Board.

The User Test

As many as 6 years may elapse between the QMR and the receipt of a test item at the Board. Therefore, the members of the Artillery Board

who wrote the military characteristics usually are not present to administer the user test. This test is based on a plan which is submitted for comment to all interested agencies to insure that the test is comprehensive and meets all foreseeable needs.

The user test begins as soon as a new item reaches the Artillery Board and continues until all the desired facts have been determined. It is not sufficient just to determine whether the military characteristics are met, in whole or part; judgment must be exercised. Such factors as overall performance and value to the service must be considered. If the military characteristics were sufficiently visionary at the time they were formulated, there is every reason to expect a new item to be a true improvement.

Tests by the Artillery Board usually can be accomplished within 3 to 6 months after the materiel arrives. However, the test time is directly proportionate to the quality of the test item. Equipment failures can prolong testing far beyond the time stated above.

In testing, the Board endeavors to discover and report the good features of equipment as well as point out weaknesses. The user test is not intended to destroy the equipment unless destruction is required by the nature of the test itself. Nor does the Artillery Board duplicate engineering tests which already have been performed by the technical service.

After deliberating on all the available facts, the Artillery Board decides whether a tested item should be adopted to replace a standard item, whether it needs modification, or for that matter, whether it has sufficient merit to be kept alive in development. The final decision is made at a formal meeting of the project review board of the Artillery Board. The US Army Artillery and Missile School is represented at this meeting, and formal comments of the School are included in the final report. In this manner a unified artillery position is obtained which is of greater assistance to higher staffs than separate positions would be.

#### An Example of Equipment Development

The new T236 8-inch self-propelled howitzer (ARTILLERY TRENDS, February 1959) offers a specific example of how the Artillery Board functions in the development of new equipment.

In the early 1950's, the US Army Artillery and Missile School drew up qualitative materiel requirements for a new self-propelled artillery weapon in the 8-inch howitzer class. Concept studies also were initiated. The materiel requirements called for a simple, rugged, and durable self-propelled weapon that would be air transportable. The standard self-propelled M55 8-inch howitzer weighed 50 tons combat loaded--too heavy to be carried by aircraft. The contract to build the new artillery piece was awarded to the Pacific Car and Foundry Company.

While plans were being made for the weapon, the Artillery Board together with representatives of the Ordnance and Tank-Automotive Command

and the Continental Army Command participated in design conferences with the company.

The next step was for these same agencies to examine a wooden mockup of the weapon built from the design drawings. The mockup affords a better picture than the drawings of what the howitzer would actually look like when built. From the mockup certain faults which were not evident in the plans were detected and corrected before work continued. Next, a prototype was built and sent to the Yakima, Washington, Firing Center for a preliminary user evaluation test. Yakima was chosen because it was near the manufacturing plant. Two officers and nine enlisted men from the Artillery Board took part in the test. Almost every new piece of equipment has certain deficiencies which do not become apparent until a full-size, working model is tested. This was the case with the T236. For instance, the traversing gear mechanism housing was found faulty and had to be changed.

#### The T236 at Fort Sill

In October 1958, the company sent a pilot model to Fort Sill for the Board's important user test. At this point, the Board's careful examination of the weapon began. The test had been planned and approved before the weapon arrived. The howitzer was checked for accuracy and stability during firing. All on-carriage fire control equipment was tested for dependability. Emplacement and displacement times were checked. The crew's safety and comfort during travel was considered. The location of all on-carriage equipment was checked to see if it was in the best place for protection and convenience. Fuel and oil consumption was measured.

Deficiencies were recorded and some very minor improvements were made. For example, the Board replaced the standard, round drop seats used on other self-propelled weapons with bench type seats and then added railings to improve the crew's comfort and safety. The exhaustive testing was completed in February 1959.

Still more testing will be done before the weapon becomes operational. The Armor Board will give the T236 an extensive automotive test. The weapon will go to the Aberdeen Proving Grounds for an engineer test. Other testing boards will make the T236 prove itself under both desert and arctic conditions before it is finally accepted. The Artillery Board will follow these further tests with extreme interest. It wants to be sure that when the T236 does become operational, the weapon is as effective and reliable as present knowledge and resources can make it.

#### Personnel and Organization

Forty-one officers, 11 warrant officer specialists, 4 civilian engineers, and 238 enlisted men carry out the Artillery Board's work. They are assigned to seven major divisions under the Board president (fig 50). The gunnery and materiel divisions operate at Fort Sill, while the missile division functions at Fort Bliss.



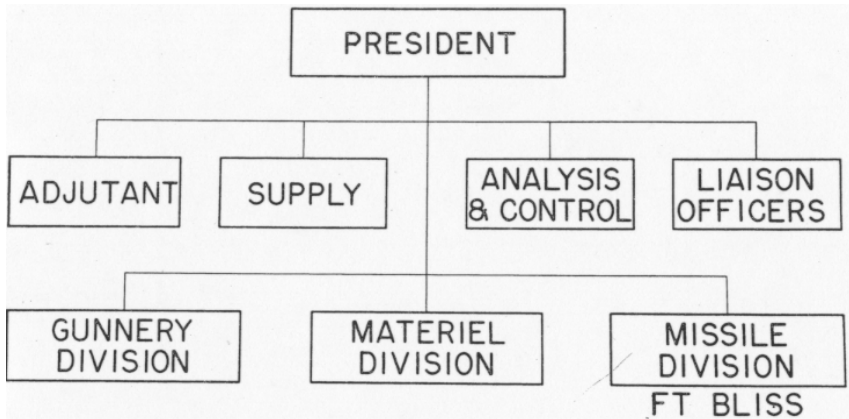

Figure 50. Organization of the Artillery Board.

Testing by the Board is thorough, comprehensive, and requires the best efforts of the project officers. The Board tries to make an item work, assuming that no particular skill would be needed to make any item fail to work. In other words, the Board attempts to give constructive advice to the developing agency on how to correct a faulty item rather than adopting the simple solution afforded by a flat rejection. It is firmly believed that this approach is more economical and fairer to the developing agency and eventually will make the maximum contribution to the overall goal sought by the Artillery Board, namely, to provide the artillery with the best possible combat equipment.

#### CORRECTION

Two errors appeared in the article "Redstone Materiel Courses Now Taught at Fort Sill" (ARTILLERY TRENDS, February 1959). The MOS listed after Redstone Officers' Course should be 1190 instead of 1191. The length of the Redstone Electronic Materiel Maintenance Course should be 22 weeks rather than 9 weeks.

#### DO YOU HAVE A GEM?

Do you have a practical idea on how to better accomplish an artillery task than the device or technique currently used? Send your "GEMS" to:

ARTILLERY TRENDS  
 Dept of TL&NRI, USAAMS  
 Fort Sill, Oklahoma

## RESIDENT COURSES TAUGHT AT THE US ARMY ARTILLERY AND MISSILE SCHOOL



The US Army Artillery and Missile School has dropped several resident courses from its fiscal year 1960 (FY 60) schedule. FY 60 begins on 1 July 1959. In addition, many courses will be shorter. This article incorporates into one reference the latest information on the courses taught at the School. Complete details including prerequisites are in the Department of the Army Pamphlet 20-21, The Army School Catalog and changes 1 through 67.

A significant change has been made to the Field Artillery Officer Basic Course (FAOBC). This course will be 12 weeks long (table 2) beginning with the first class that enters after 1 July. The FAOBC teaches newly commissioned reserve and National Guard lieutenants to be forward observers and assistant executive officers. Officers entering active duty are automatically sent to this course. Graduates will have been taught the fundamentals of field artillery tactics and techniques. However, only after field experience can these officers be considered fully trained artillerymen.

<u>Field Artillery Officer Basic Course</u>	
<u>Department</u>	<u>Periods</u>
Artillery Transport	32
Communications and Electronics	41
Gunnery	178
Materiel	48
Tactics and Combined Arms	181
Target Acquisition	<u>32</u>
	Total: 512
	Processing, Commandants time, etc: <u>84</u>
	Grand Total: 596

Table 2. Periods of instruction by department for the 12-week Field Artillery Officer Basic Course.

The former 33-week Field Artillery Battery Officer Course has been eliminated from the FY 60 curriculum. Many of the students originally programmed for this course will attend, on a temporary duty status, one of the 17-week Associate Battery Officer Courses (table 3). The majority of the students attending this associate course will have served exclusively in air defense artillery units. In turn many field artillerymen will attend

<u>Associate Field Artillery Battery Officer Course</u>	
<u>Department</u>	<u>Periods</u>
Artillery Transport	42
Communications & Electronics	45
Gunnery	276
Materiel	54
Tactics and Combined Arms	232
Target Acquisition	<u>66</u>
	Total: 715
Processing, Commandants time, etc:	<u>72</u>
	Grand Total: 787

Table 3. Periods of instruction by department for the 17-week Associate Field Artillery Battery Officer Course.

one of the Associate Battery Officer Courses at the Air Defense School, Fort Bliss, Texas.

The 2-week Honest John Officer Course also has been eliminated from the FY 60 schedule of classes.

Among the officer courses being shortened are: Corporal Officer from 10 weeks to 9 weeks and 4 days, Redstone Officer from 9 weeks to 7 weeks and 1 day, Communication Officer from 14 to 13 weeks, and Motor Transport Officer from 14 to 13 weeks. Several enlisted courses have been shortened. For example, the Artillery Vehicle Maintenance Supervisors Course has been reduced from 12 to 4 weeks.

All newly commissioned regular Army second lieutenants will attend the 20-week integrated Artillery Officer Basic Course which includes instruction at both Fort Sill and Fort Bliss. Students are assigned to this course by the Department of the Army. The number of students attending the 38-week Artillery Officer Advanced Course during FY 60 will be increased to approximately 388, which about doubles the number attending the class in FY 59.

The School is planning a new career course of 42 to 48 weeks. This course would, if approved, replace the present Artillery Officer Advanced Course and would begin in FY 61. General prerequisites for the course would be: a career officer, regular or reserve; 3 to 8 years of service; a graduate of one of the basic officer courses (or artillery OCS); no other credit for an advanced course. This proposed course is only in the planning stage. As more details become available, they will be published in ARTILLERY TRENDS.

### Schedule of Classes

The US Continental Army Command publishes a detailed schedule of classes taught at the School entitled "Detailed Schedule of Classes, Army Service Schools." The latest edition is dated 15 December 1958 and contains the names of the classes, class numbers, reporting dates, class starting dates, closing dates, and class capacities. The Detailed Schedule of Classes is distributed throughout the Army.

Regular Army and career reserve officers to attend the Artillery Officers Advanced Course are selected by the Artillery Section, Officers Assignment Division, Department of the Army. Officers of the regular Army who want to attend any School resident course other than the basic or advanced may apply through channels.

Army National Guard officers on active duty who want to attend a resident course other than the Artillery Officer Basic or Artillery Officer Advance Course may submit personal applications through channels. National Guard officers not on active duty should submit an application (NGB Form 64) for admission to a US Army Artillery and Missile School resident course to the Chief, Army National Guard Bureau, Washington 25, D.C., ATTN: School Section. All applications should be sent through the Adjutant General of the state or territory concerned.

Reserve officers on extended active duty who desire to attend any resident course other than the Artillery Officer Basic or Artillery Officer Advanced Course may submit personal applications through channels. Those reserve officers not on active duty may apply for admission to a

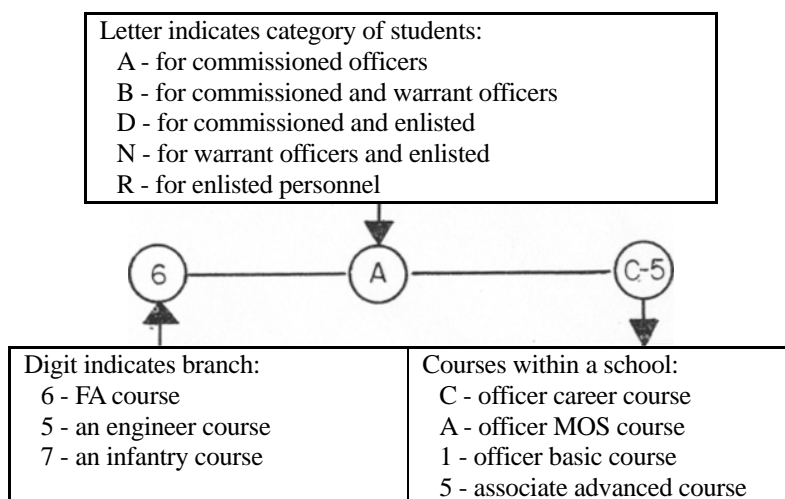

Figure 51. Explanation of the digits and letters comprising a typical course number. The example shown is the Associate Field Artillery Officer Advanced Course.

resident course under the provisions of AR 140-220. Applications for admission to resident courses should not be sent to the School.

### Designation of Courses

Courses conducted at US Army service schools are designated by a series of numbers and letters. Officer and enlisted courses taught at the US Army Artillery and Missile School have an initial digit of "6" which identifies the course as field artillery (fig 51). Those School courses which train personnel in a specific Military Occupational Speciality (MOS) have the MOS number in the course designation. For example, graduates of course 6-A-0140, Field Artillery Radar Officer will receive an MOS of 0140, Enlisted men successfully completing course 6-R-166.6, Lacrosse Firing Battery will receive an MOS of 166.6

Listed below are all of the officer and enlisted resident courses scheduled to be taught at the US Army Artillery and Missile School during FY 60. Of the 41 courses listed, 7 are attended in a permanent change of station status and the remaining 34 are attended in a temporary duty status. A brief scope of each course is given. As mentioned previously, complete information concerning eligibility, prerequisites, and other pertinent data may be found in DA Pamphlet 20-21, The Army School Catalog and changes 1 through 67.

### Officer Career Courses

1. FA Officer Basic (FAOBC) (6-A-C1), 12 weeks. To provide basic FA training to newly commissioned reserve and National Guard lieutenants. Class capacity: 110, FY 60 classes: 18.

2. Artillery Officer Basic (AOBC) (6-A-CIC/44-A-CIC), 20 weeks. To train newly commissioned RA lieutenants (USMA and ROTC honor graduates) in FA and air defense weapons systems. Class capacity: 160, FY 60 classes: 3.

3. Associate FA Battery Officer (AFABOC) (6-A-C3), 17 weeks. To provide training in duties of FA battery commander for RA, career reserve, and reserve component officers above grade of 2d lieutenant. Active duty officers (2 to 5 years commissioned service) may be selected by DA for attendance, or may apply. Officers not on active duty must apply. Class capacity: 95, FY 60 classes: 6.

4. Artillery Officer Advanced (AOAC) (6-A-C4), 38 weeks. To train RA and career reserve officers (with 5 to 12 years commissioned service) in the duties and responsibilities of a field grade officer in FA and air defense artillery. Officers are selected for attendance by DA. Class capacity: 388, FY 60 classes: 1.

5. Associate FA Officer Advanced (AFAOAC) (6-A-C5), 18 weeks. To train active duty and reserve component officers in the duties and responsibilities of a field grade FA officer. Attendance by application. Class capacity: 120, FY 60 classes: 4.

6. FA Battery Officer Refresher (reserve components) (FABOR) (6-A-C10), 2 weeks. To provide refresher training in tactics, techniques, and materiel appropriate to FA battery grade reserve component officers not on active duty. Class capacity: 60, FY 60 classes: 2.

7. FA Field Grade Officer Refresher (reserve components) (FAFGOR) (6-A-C11), 2 weeks. To provide refresher training in tactics, techniques, and materiel appropriate to FA field grade reserve component officers not on active duty. Class capacity: 60, FY 60 classes: 2.

#### Officer Functional Courses

8. Division Artillery Staff Officer Refresher (DASOR) (6-A-F5), 1 week. To provide refresher training as a team (minimum of 6 officers) to National Guard and USAR division artillery commanders, principle staff officers, battalion commanders, and executives. Class capacity: 60, FY 60 classes: 2.

9. Senior FA Officer (SFAO) (6-A-F6), 3 weeks. To acquaint active Army lieutenant colonels and above with new tactics and techniques of FA delivered nuclear weapons. Class capacity: 40, FY 60 classes: 2.

#### Officer MOS Courses

10. FA Radar Officer (6-A-0140), 6 weeks and 2 days. To train active Army and reserve component captains and lieutenants in the tactical employment of FA radar. Class capacity: 30, FY 60 classes: 3.

11. Artillery Observation (6-A-1154), 9 weeks. To train active Army and reserve component captains and lieutenants in sound and flash ranging and observation battalion survey. Class capacity: 45, FY 60 classes: 1.

12. Artillery Survey Officer (6-A-1183), 8 weeks. To train active Army and reserve component captains and lieutenants in artillery surveying. Class capacity: 35, FY 60 classes: 3.

13. Corporal Officer (6-A-1190A), 9 weeks and 4 days. To train active Army officers in the characteristics, operating principles, and capabilities of the Corporal missile system. Class capacity: 15, FY 60 classes: 3.

14. Redstone Officer (6-A-1190B), 7 weeks and 1 day. To train active Army officers in the characteristics, operating principles, and capabilities of the Redstone missile system. Class capacity: 20, FY 60 classes: 1.

15. Lacrosse Officer (6-A-1190C), 4 weeks and 2 days. To train active Army officers in the characteristics, operating principles, and capabilities of the Lacrosse missile system. Class capacity: 20, FY 60 classes: 5.

16. Corporal Maintenance Officer (6-A-1191), 33 weeks. To train active Army captains and lieutenants in the functions, technical operations, characteristics, and maintenance of the Corporal missile system. Class capacity: 18, FY 60 classes: 1.

17. Artillery Communication Officer (6-B-0200), 14 weeks. To train active Army and reserve component majors and below in the techniques and characteristics of artillery communications systems. Class capacity: 45, FY 60 classes: 3.

18. Artillery Motor Transport (6-B-0600/0606), 13 weeks. To train active Army and reserve component captains and below in the supervision of organizational maintenance (including SP turrets). Class capacity: 40, FY 60 classes: 4.

#### Officer/Enlisted Courses

19. FA Officer Candidate (6-N-F1), 23 weeks. To train selected WO's and EM to be reserve 2d lieutenants. Class capacity: 100, FY 60 classes: 6.

20. Nuclear Projectile Assembly (6-D-142.0), 1 week. To train active Army officers and EM in the mechanical assembly of nuclear projectiles. Class capacity: 30, FY 60 classes: 7.

21. FA Officer Candidate (reserve component) (6-N-F2), 11 weeks. To train National Guard and USAR personnel to be 2d lieutenants. Guard personnel are selected by State Adjutant General for attendance. USAR personnel must meet requirements of AR 140-50. Class capacity: 100, FY 60 classes: 2.

22. Honest John Atomic Warhead Assembly (6-D-147.2), 2 weeks. To train active Army officers and EM in the assembly of the Honest John nuclear warhead. EM receive MOS 147.2. Class capacity: 15, FY 60 classes: 8.

23. Corporal Atomic Warhead Assembly (6-D-F13), 2 weeks. To train active Army officers and EM in the mechanical and electrical assembly of the Corporal nuclear warhead. Class capacity: 15, FY 60 classes: 2.

24. FA Radar Maintenance (6-N-1121/211.1), 30 weeks. To train WO's and EM to operate, adjust, and maintain FA radar equipment. WO's receive MOS 1121, EM receive MOS 211.1. Class capacity: 30, FY 60 classes: 3.

25. Artillery Ballistic Meteorology (6-N-103.1), 11 weeks. To train WO's and EM in the operation of a meteorological station. EM receive MOS 103.1. Class capacity: 32, FY 60 classes: 6.

26. Weather Equipment Maintenance (6-N-8219/205.1), 13 weeks and 3 days. To train WO's and EM to maintain meteorological equipment. WO's receive MOS 8219, EM receive MOS 205.1. Class capacity: 15, FY 60 classes: 6.

27. Corporal Fire Control System Maintenance (6-N-1186/215.1), 32 weeks. To train WO's and EM to operate and maintain Corporal fire control equipment. WO's receive MOS 1186, EM receive MOS 215.1. Class capacity: 12, FY 60 classes: 3.

28. Corporal Electronic Materiel Maintenance (6-N-1192A/214.1), 29 weeks. To train WO's and EM to install and maintain Corporal guidance control components. WO's receive MOS 1192, EM receive MOS 214.1. Class capacity: 18, FY 60 classes: 3.

29. Redstone Electronic Materiel Maintenance (6-N-1192/218.1), 22 weeks. To train WO's and EM to install and maintain Redstone guidance control components. WO's receive MOS 1192, EM receive MOS 218.1. Class capacity: 12, FY 60 classes: 4.

#### Enlisted MOS Courses

30. Artillery Survey Advanced (6-R-153.1), 9 weeks. To train qualified artillery surveyors (MOS 153.0) to supervise and coordinate survey operations and conduct fire on artillery targets and to familiarize them with FDC procedures. Class capacity: 60, FY 60 classes: 9.

31. Artillery Flash Ranging Advanced (6-R-154.1), 6 weeks. To train qualified flash ranging crewmen to install, operate, and maintain flash ranging equipment. Class capacity: 30, FY 60 classes: 3.

32. Artillery Sound Ranging Advanced (6-R-155.2), 8 weeks. To train qualified sound ranging crewmen to install, operate, and maintain sound ranging equipment. Class capacity: 30, FY 60 classes: 2.



33. FA Radar Operations (6-R-156.1), 9 weeks. To train personnel in the operation and tactical employment of FA radar. Class capacity: 50, FY 60 classes: 6.

34. Corporal Mechanical Materiel Maintenance (6-R-164.3), 8 weeks. To train E6's and below to install and maintain Corporal on-missile guidance equipment and propulsion and mechanical systems. Class capacity: 16, FY 60 classes: 6.

35. Lacrosse Firing Battery (6-R-166.6), 4 weeks. To train personnel to assemble, test, adjust, operate, and maintain the Lacrosse missile and launcher. Class capacity: 20, FY 60 classes: 5.

36. Lacrosse Fire Control Operation (6-R-167.6), 5 weeks. To train E6's or below to adjust, operate, and maintain the Lacrosse forward guidance station and target survey unit. Class capacity: 12, FY 60 classes: 5.

37. Redstone Mechanical Materiel Maintenance (6-R-169.1), 8 weeks. To train personnel to install and maintain Redstone on-missile guidance and control systems; assemble missiles; and perform mechanical and pneumatic checks. Class capacity: 20, FY 60 classes: 2.

38. Artillery Radio Maintenance (6-R-313.1), 13 weeks. To train E5's and below to perform organizational maintenance on artillery radio equipment. Class capacity: 55, FY 60 classes: 16.

39. Artillery Communication Supervision (6-R-313.7), 15 weeks. To train E4's and above to supervise the communications section of an artillery unit. Class capacity: 30, FY 60 classes: 2.

40. Artillery Vehicle Maintenance Supervision (6-R-631.6/632.6), 4 weeks. To train qualified motor mechanics (E4 and above) in the supervision of organizational maintenance. Class capacity: 30, FY 60 classes: 2.

41. Artillery Track Vehicle Maintenance (6-R-632.1), 13 weeks. To train personnel to perform organizational maintenance of artillery track vehicles including turret. Class capacity: 60, FY 60 classes: 18.

---

Are you up to date? Do you plan to attend a resident course soon? Prepare yourself by enrolling in the special extension course "FA Refresher."

# NEWS NOTES FOR ARTILLERYMEN

## TWO LACROSSE BATTALIONS ACTIVATED

Two field artillery Lacrosse missile battalions are scheduled to be activated at Fort Sill prior to 25 June 1959. The battalions have been designated the 5th Missile Battalion, 41st Artillery, and the 5th Missile battalion, 42d Artillery. The units will be assigned to and will train under the direction of the 1st Field Artillery Missile Brigade.

A Lacrosse battalion consists of a headquarters and headquarters battery and a firing battery. Administrative and support elements such as survey, communications, and supply are located in the headquarters battery. The firing battery contains 4 firing sections, 4 forward guidance sections, and 2 missile assembly sections.

All components of the Lacrosse system--the 19-foot solid propellant missile and the launcher and guidance elements--are mounted on a standard 2½-ton truck. The supersonic Lacrosse is an extremely accurate, all weather, general support missile designed for close support of ground troops.

## ARTILLERY ADVANCED INDIVIDUAL TRAINING PROGRAM MOVED TO FORT SILL

The field artillery advanced individual training (AIT) program has been moved to the US Army Artillery and Missile Center at Fort Sill. This training formerly was conducted at Fort Chaffee, Arkansas, which is being inactivated by the Department of the Army.

The move is expected to increase the strength at Fort Sill by some 5,000 personnel. The first men are scheduled to arrive at Fort Sill in June.

A new unit, similar to the replacement training center used in World War II and during the Korean conflict, will be organized to administer and supervise the training.

Advanced individual training is the second 8 weeks of training a soldier receives after he is inducted into the Army. His first 8 weeks are spent in basic combat training.

## NEW HONEST JOHN HANDLING UNIT

A new Honest John handling unit has been designed to improve the air transportability of the Honest John system. The trailer-mounted M405 (fig 52 and 53) will replace the M329 rocket trailer and, in air transportable operations, it also will replace the 5-ton wrecker.

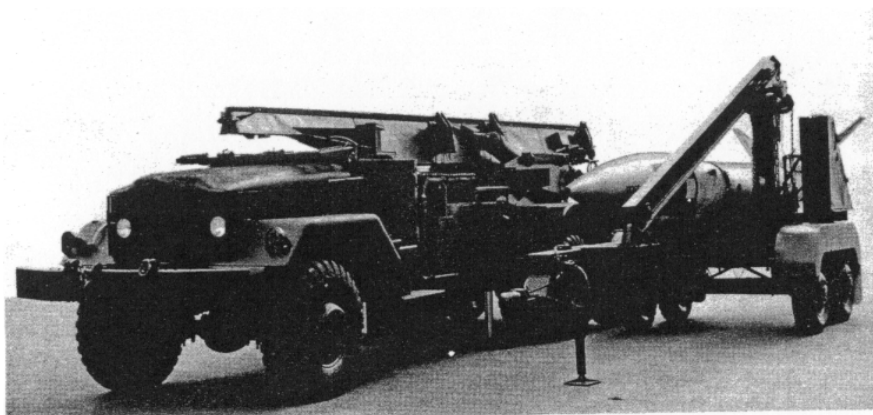

Figure 52. Honest John handling unit, M405 beside the M386 launcher.

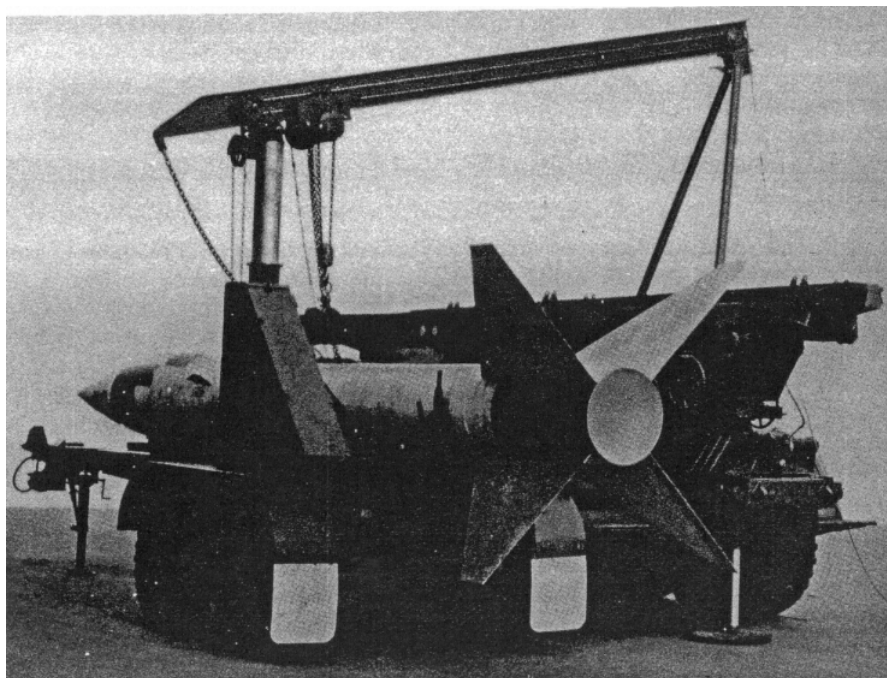

Figure 53. Honest John rocket being transferred from the M405 trailer to an M386 launcher.

The M405 has numerous functions. It can transport a rocket, serve as an assembly platform, and transfer an assembled rocket to a launcher without the 5-ton wrecker. However, when the trailer is used almost twice as much time is required to transfer a rocket to the launcher than when the wrecker is used.

A steel jib crane mounted on a hydraulic column is used to transfer the rocket to the launcher. The hydraulic column is operated by a hand lever and controls the height of the lifting beam. The rocket handling is done manually using chain hoists and guy ropes.

The M405 is issued only to those units which have the M386 launcher. The new unit can be used with both the M31 and XM50 rockets and can be operated at temperatures from minus 40° to 140° Fahrenheit.

The M405 is 12 feet, 8 inches long, and 8 feet wide. Its maximum height is 10 feet, 9 inches and it weighs 8,630 pounds with no rocket.

#### CAMOUFLAGE COVER FOR THE HONEST JOHN

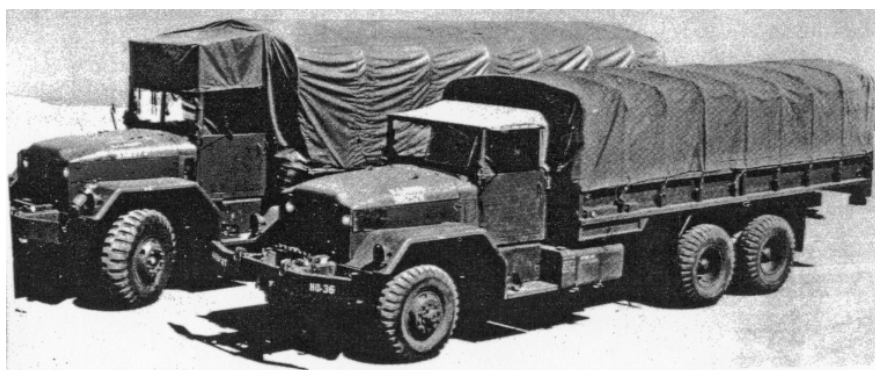

Figure 54. Which truck has the Honest John?

In figure 54 above, the truck on the left has an Honest John rocket under the cover. The truck on the right is an extra-long wheel-base, 5-ton, cargo truck. The camouflage cover is being tested for use with the M386 Honest John launcher (ARTILLERY TRENDS, October 1958). The objective is to conceal the tell-tale silhouette of the launcher in the traveling position, with or without the rocket mounted.

#### INSTRUCTION ON THE NEW DIVISION ARTILLERY

All resident classes at the US Army Artillery and Missile School which begin after 1 July 1959 will receive instruction based on the New

Division Artillery organization (ARTILLERY TRENDS, March 1959). The organizational change has necessitated a revision of most of the lesson plans. The revised lesson plans, map overlays, and student outlines are now being printed.

The nonresident instruction program also is being revised. Extension course students can expect to receive the first of the revised subcourses in early September 1959. The changes will not necessitate any student repeating a course already completed.

#### THE METRIC SYSTEM NOW USED IN GUNNERY

The US Army will convert by 1 January 1966 to the metric system for measuring linear distances (Army Regulation 700-15). To comply with the regulation, the US Army Artillery and Missile School is requiring that linear measurements used in future correspondence, documents, and training publications be expressed in meters.

The School recently has started using meters instead of yards in observed fire instruction. Initial location of targets; determination of distance; and subsequent changes in deviation, vertical distance, and range are now determined in meters. Meters are used in observed fire procedures even though some firing tables and graphical equipment are still graduated in yards.

The transition to the metric system should not be difficult for the observer since the mil relation ( $\text{mils} = W/R$ ) is valid for any unit of linear measure, providing that both the width (W) and the range (R) are in the same units of measure. The observer will send his initial fire request to the fire direction center (FDC) in meters when using a shift from a known point or when polar plotting. The target grid (DA Form 6-53) is now printed in meters and can be used in the FDC when shifting from a known point or in subsequent observer corrections.

#### HONEST JOHN AND LACROSSE REPLACEMENT TRAINING STARTED

Advanced individual training (AIT) of replacements for Honest John and Lacrosse battalions has begun at Fort Sill. The 2d Field Artillery Missile Training Battalion is conducting the training. The battalion is a table of distribution organization which is assigned to the 1st Field Artillery Missile Brigade.

The training consists of a 9-week course in which the men are instructed in the basic duties required of a field artillery missile crewman. Upon completing the training, the Honest John specialists are awarded an MOS of 147.1 (Honest John launcher crewman). Lacrosse specialists are given an MOS of 167.1 (Lacrosse fire control crewman).

Honest John classes consist of 150 men. At the completion of the training cycle, the missile students are assigned as replacements on a world-wide basis. Lacrosse classes consist of 40 men who are assigned as fillers for newly activated Lacrosse battalions.

Enlisted technicians for Lacrosse units will be trained at the US Army Artillery and Missile School.

## NEW LITTLE JOHN SYSTEM UNDER TEST

An improved Little John missile (318-mm) (fig 55) is being tested. A new launcher also is being tested. It has been designated the XM34. The prime mover for the new launcher and rocket is the 1/4-ton truck (fig 56).

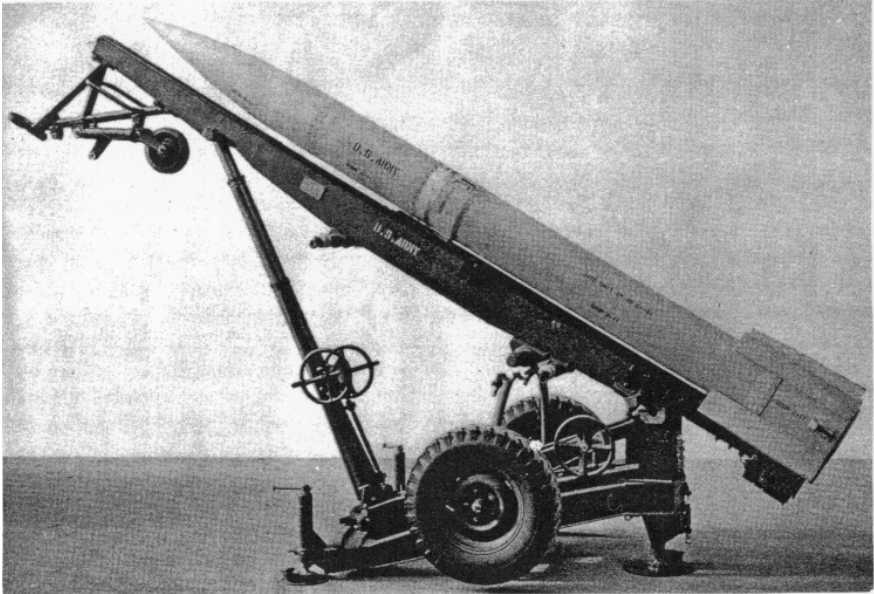

Figure 55. The new Little John and its launcher in firing position.

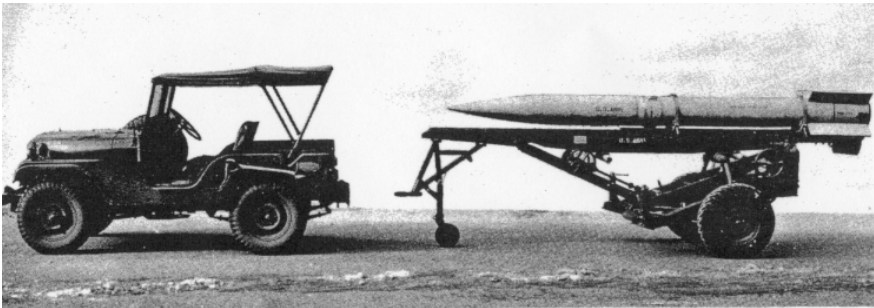

Figure 56. The XM34 launcher in traveling position with its proposed prime mover.

## RADIO SETS AN/GRC-87 AND AN/VRC-34

Two radio sets, the AN/GRC-87 and the AN/VRC-34, have been adopted to replace radio set AN/GRC-9 which has been declared limited standard. The AN/GRC-87 and AN/VRC-34 basically are adaptations of the AN/GRC-9.

Radio set AN/GRC-9 has been in the field for a number of years. It is an amplitude modulated (AM) radio which can be installed in the field or in a vehicle. In many instances units authorized radio set AN/GRC-9 did not need to install it in the field. The additional components required for field use were carried as dead weight, taking up needed space in already over-loaded vehicles.

Radio sets AN/GRC-87 and AN/VRC-34 are designed to alleviate this problem. Radio set AN/GRC-87 is an assembly of the AN/GRC-9 components required for field installation while radio set AN/VRC-34 is an assembly of the AN/GRC-9 components required for vehicular installation. If both field and vehicular installation is required, radio set AN/GRC-87 plus a vehicular installation kit must be used.

In present tables of organization and equipment, two field artillery units are authorized radio set AN/VRC-34. TOE 6-501 D authorizes 7 sets for corps artillery and TOE 6-401 D authorizes 3 sets for a field artillery group. Radio set AN/GRC-87 presently is not authorized for field artillery units. It has been discussed here because it is one of the radio sets which replaces the AN/GRC-9.

Training requirements for these sets are substantially the same as the requirements for radio set AN/GRC-9.

## NEW TRAINING AIDS AT THE SCHOOL BOOKSTORE

The US Army Artillery and Missile School bookstore has several new training items which field artillery units can use. Available are: target grids calibrated in meters (1/25,000 map scale), 20 cents each; observed fire (OF) fans calibrated in meters, 20 cents each; Notes for the Battery Executive, 3d Edition, 35 cents each; a new 8-inch howitzer graphical firing table (GFT) based on the new J-2 firing tables, containing charges 4, 5, 6, and 7, \$1.10 each; an unclassified nuclear weapons effect computation "wheel" which determines the probability of fractional (P(f)) damage, \$5.90.

Army regulations do not permit charge sales. To order any of the items listed above, make checks or money orders payable to the "Book Department." The purchase price includes postage.

## PERSHING MEETING HELD

Advance training plans for the Army's new Pershing missile were the subject of a top level US Continental Army Command programming conference held at Fort Sill from 28 through 30 April.

Some 75 representatives from 17 armed forces agencies discussed advanced training procedures and equipment for the Pershing, which currently is in its research and development stages.

## NEW CANADIAN SELF-PROPELLED 105-MM HOWITZER

The Canadian Army is testing prototypes of a new family of multipurpose vehicles. Most of the details are classified, but all versions can swim on inland waterways and will weigh under 22,000 pounds. The self-propelled 105-mm howitzer under test (fig 57) has an on-carriage ammunition capacity of 50 rounds.



Figure 57. Canadian self-propelled 105-mm howitzer.

Other versions are to be tested as weapons carriers for the infantry.

## NCO ACADEMY OPENED AT FORT SILL

The Fort Sill Noncommissioned Officers' Academy, located south of the Officer Candidate area, opened in June 1959.

The mission of the Academy is to broaden the professional knowledge of Fort Sill noncommissioned officers and increase their self-confidence and sense of responsibility.

The Academy offers two primary courses--the Advanced Noncommissioned Officer Course for grades E5 or higher and the Potential Noncommissioned Officer Course for enlisted men below the grade of E5. Each course is 4 weeks long. In addition there will be a 2-week course for noncommissioned officers from reserve units in the Fort Sill area.

The curriculum of the course is branch immaterial with emphasis on method of instruction rather than on the mere presentation of information. This emphasis is based on the premise that training at the Academy is not a substitute for unit training or for attendance at an Army service school.



The program of instruction for the Advanced Noncommissioned Officer Course includes principles of leadership, military instruction, tactics, and map reading. The Potential Noncommissioned Officer Course is essentially the same with more emphasis on leadership, drill, and physical training.

### WIRE SPLICING KIT

A new, time-saving tool has been developed for splicing wire. The tool is a manually operated, magazine-fed, crimping device (fig 58).

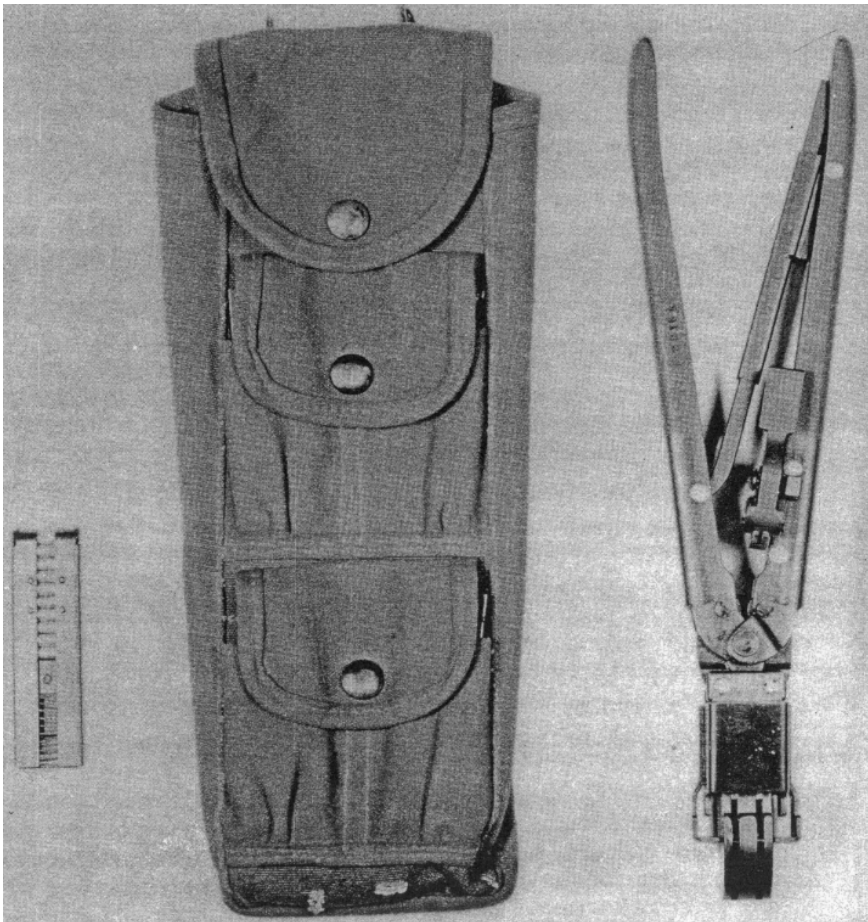

Figure 58. Wire splicing kit MK-356 ( )/G. The loaded magazine is shown at left, and the compressing tool, TL-582 ( )/U, is shown at right.

Called a compressing tool, splicing sleeve, TL-582( )/U, it is contained in wire splicing kit MK-356( )/G along with four unloaded magazines, a cotton duck cloth carrying case, and splicing sleeves (fig 58). The splicing sleeves contain a band of nylon insulation. The sleeves are stored in the magazines, and are fed forward when the handles of the tool are compressed.

A splice is made in one operation by inserting two ends of wire in the tool and compressing the handle. A splice made by the new tool is stronger and more waterproof than the average splice made by hand. Tape or other tools are not required because a cutter and wire stripper are mounted on one handle of the splicer.

The new tool is limited to splicing WD-1 field wire because of the size of the splicing sleeves.

The splicing tool should be issued in the summer of 1959.

#### FORT SILL TO HOST WORLDWIDE COMBAT ARMS CONFERENCE

The US Continental Army Command plans to sponsor a worldwide combat arms conference at Fort Sill in November or December 1959. The primary objective of this conference will be to determine and recommend measures which will perfect cooperation and teamwork among the combat arms and insure overall combat effectiveness.

The US Army Artillery and Missile School will host the conference and provide logistical and administrative support. In addition the School will prepare the final conference report.

#### REDSTONE GROUP TO EUROPE

The 46th Artillery Group (Redstone) left Fort Sill on 1 April 1959 to join the NATO forces in Europe. It is the second Redstone group of its type to be stationed outside the United States. The 40th Artillery Group (Redstone) which was trained at Redstone Arsenal, Alabama, went to Europe in July 1958.

The 46th Artillery Group was reorganized at Fort Sill in the summer of 1958 and conducted its training there. The Group is composed of a headquarters and headquarters battery, Batteries A and B of the 2d Missile Battalion, 333d Artillery; the 523d Engineer Company; and the 91st Ordnance Company.

A third Redstone group, the 209th Artillery Group, is currently training at Fort Sill.

#### SCHOOL DEPARTMENT REDESIGNATED

The former Department of Publications and Nonresident Training at the US Army Artillery and Missile School has been redesignated the Department of Training Literature and Nonresident Instruction. The new title better reflects the work performed by the department.

The department coordinates and prepares all "6" series Department of the Army field manuals, Army training tests, Army training programs, MOS proficiency tests, Army subject schedules, missile information letters, and ARTILLERY TRENDS.

Under the nonresident instruction responsibility, the department provides field artillery training material for ROTC instructors, the National Guard, US Army Reserve units, active Army units, and US Army Reserve Schools. All artillery subcourses (field and air defense) are administered by the department.

### STATUS OF TRAINING LITERATURE

1. The following training literature is under preparation or revision by the US Army Artillery and Missile School.

A. Field Manuals:

- 6-20 FA Tactics and Techniques
- 6-40 FA Gunnery
- 6-60 The FA Rocket, Honest John
- 6-61 FA Missile Battalion, Honest John Rocket
- 6-( ) Division Artillery (includes infantry, armored and airborne)
- 6-( ) US Army Missile Command (Air transportable)
- 6-( ) US Army Missile Command (Medium)
- 6-( ) US Army Missile Command (Heavy)
- 6-( ) FA Missile Lacrosse
- 6-( ) Warhead Section, W7, (Corporal)(U) 6X9 looseleaf
- 6-( ) Warhead Section, W7, (Honest John)(U) 6X9 looseleaf
- 6-( ) Warhead Section, W31, (Honest John)(U) 6X9 looseleaf
- 6-( ) Warhead Section, W39, (Redstone)(U) 6X9 looseleaf
- 6-( ) Warhead Section, W13, (Lacrosse)(U) 6X9 looseleaf
- 6-( ) Shell: Nuclear Explosive, T317E1; Training, T349E1, and Spotting, T347; 8-inch Howitzer (U) 6X9 looseleaf
- 6-( ) Shell: Nuclear Explosive, M366 (T315); and Training, T167; 280-mm Gun (U) 6X9 looseleaf
- 21-13 The Soldiers Guide

B. Training Circulars (TC):

- TC 6-8 (SRD) Change 1, Atomic Ammunition for Field Artillery Guns and Howitzers (U)
- TC 6-( ) Helicopter Transported Artillery

C. Army Training Tests (ATT):

- ATT 6-1 FA Howitzer or Gun Battery, Light and Medium
- ATT 6-5 FA Battalion, Light and Medium

ATT 6-10 FA Missile Battalion, Corporal  
ATT 6-30 Change 1, FA Missile Group, Redstone  
ATT 6-( ) FA Howitzer or Gun Battery, Heavy  
ATT 6-( ) FA Howitzer Battalion, 105-mm and 155-mm

2. Training literature submitted to USCONARC:

ATP 6-( ) Reserve Forces Act (Artillery)  
ATP 6-545 FA Missile Battalion, Corporal  
ATP 6-630 FA Missile Group, Redstone  
ATT 6-( ) FA Missile Battalions and Batteries, 762-mm  
FM 6-18 Mortar Battery, Airborne Division Battle Group

3. Training literature at the Government Printing Office:

ATP 6-585 FA Missile Battalion, Lacrosse  
ATT 6-585 FA Missile Battalion, Lacrosse  
FM 6-30 FA Missile Battalion, Corporal

4. Training literature recently printed:

FM 6-20 Field Artillery Tactics and Techniques, dated 10 Dec 58  
FM 6-31 Corporal Missile Firing Platoon, dated 13 Mar 59  
FM 6-32 Guidance System FA Missile, Corporal, dated 6 Mar 59  
FM 6-40 Change 1 to Field Artillery Gunnery, 16 Mar 59  
FM 6-45(C) FA Missile Battalion, Lacrosse, dated 5 Dec 58  
FM 6-155 (SRD) Warhead Assembly, HE 762-mm Rocket M6  
(2043E1) and T2043 (U)

5. The following artillery training films are currently under production. With the exception of the Lacrosse and Redstone films, they are scheduled to be completed and released during calendar year 1959. Training film numbers have not been assigned yet.

Artillery Orientation by Sun and Star  
Part I. Altitude Method (20 minutes)

The Lacrosse Battalion  
Part I. Operations and Functioning (30 minutes)  
Part II. Description of Equipment (30 minutes)

The Redstone Battalion  
Part I. Operations and Functioning (30 minutes)

Artillery Survey  
Part I. Methods (20 minutes)

Weapons of the Artillery (30 minutes)

Extension of Direction for Artillery by Simultaneous Observation (25 minutes)

6. The following training films and film strips have been released and are available at Signal Corps film and equipment exchanges:

FS 6-84 Observed Fire Procedure Trainer (4 sections)

FS 6-85 Observed Fire Procedure Trainer (4 sections)

FS 6-86 Observed Fire Procedure Trainer (4 sections)

TF 6-2404 The Corporal Missile--Defueling Procedure (25 minutes)

#### A GEM FOR CORPORAL UNITS

When a Corporal missile is being erected under blackout conditions, the erector operator needs to see the position of the erector's wheels. The use of two 24-volt lights is suggested. They should be mounted on the driver's side of the vehicle. One should be placed on the inside of the door pointed towards the front wheel and the other inside the left rear fender pointed toward the rear wheel. The light indicates the position of the wheels to the operator without an unnecessary amount of light.

--Submitted by Lt Kenneth B. Stinson  
2d Msl Bn, 40th Arty, APO 872, N.Y.

The 1959-1960 edition of "Extension Courses for Artillery" has been printed. Distribution is being made to all extension course students and to troop units of the active Army and reserve components.

This catalog has a list and brief description of the subcourses available for the field and air defense artillery. Additional copies are available by writing to: Commandant, US Army Artillery and Missile School, Fort Sill, Oklahoma, ATTN: Extension Courses Division.

The new price list of the US Army Artillery and Missile School Book Department has been published and is being distributed to all active Army and reserve component field artillery units. Included in this booklet are the prices of School prepared pamphlets, instructional notes and practical exercises which can be purchased by eligible individuals and units. All orders must be accompanied by a check or money order. Price lists are available by writing to the Book Department.

Additional copies of ARTILLERY TRENDS are available at 15 cents each, postpaid. All orders must be accompanied by a check or money order payable to the Book Department. Address correspondence to: Book Department, US Army Artillery and Missile School, Fort Sill, Oklahoma.