

# ARTILLERY TRENDS

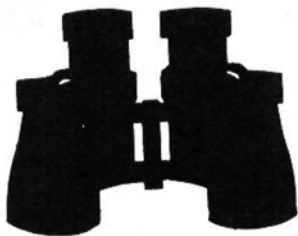
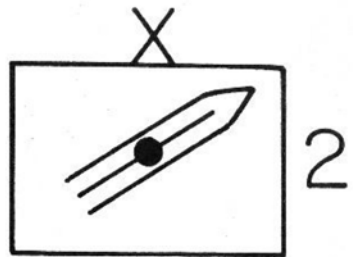

OCT  
1958

U S ARMY ARTILLERY  
AND MISSILE SCHOOL

UNITED STATES ARMY  
ARTILLERY AND MISSILE SCHOOL  
Fort Sill, Oklahoma

1 October 1958

ARTILLERY TRENDS attempts to keep field artillerymen informed of the technical and tactical changes in the state of the art. Desirable as it is to know what is new and forthcoming in organization, equipment, and techniques, artillerymen still must solve today's problems. To assist you and your battery, this issue of TRENDS offers several ideas on how to do a better job now. These immediately usable subjects range from map folding to antennas to the forward observer. Our aim is to assist your battery in getting that first round on the target sooner.

Several officers attending summer camp at Fort Sill asked this question of the Editor concerning TRENDS articles, "What is theory and what is fact?" Where applicable each article within this and subsequent issues will indicate if the subject is being taught at the School or if it's a proposal. "Gems" are offered as a possible solution. These ideas are not necessarily taught nor are they artillery doctrine. If a particular "gem" works for you, then use it.

Don't hide your "gems" in the section room! Captain Battery Commander, if one of your officers or men has a sound practical idea on how to better accomplish an artillery task and this idea is not found "in the book," urge him to send it to TRENDS. Several officers and NCO's did just that for this issue. If your idea appears to be reasonable, safe, and not against Army regulations, we will attempt to print it. --The Editor--

# ARTILLERY TRENDS

Contents Page

Editorial -----inside cover

A New Launcher for the Honest John----- 3

What's the Difference? ----- 4

Methods of Deploying Cannon and Missile Field  
Artillery----- 5

Increased Mobility With Reduced  
Maintenance----- 9

Juke Box Computer----- 10

Weapons of the Artillery -3----- 13

Remote Speaker Loudness Problems----- 14

SitePlus 12 ----- 15

A Do-It-Yourself Map Book ----- 17

4 Bits Is Not 50 Cents ----- 19

Missile Service Practice----- 21

The M2 Aiming Circle ----- 24

Field Research on the 762-mm Rocket  
System ----- 28

The First Round ----- 30

Weapons of the Artillery -4----- 33

Artillery Map Symbols Modernized----- 34

A New Method of Predicting Fallout ----- 40

Site to Communicate----- 43

Simplified Fire Planning for the Forward  
Observer----- 46

Good Gunnery Means Improved Honest John  
Accuracy----- 50

News Notes for Artillerymen----- 54





Figure 1. 15-foot launching rail in raised position.



Figure 2. Launching rail in traveling position (0° elevation).

## A NEW LAUNCHER FOR THE HONEST JOHN

First Lieutenant Robert H. Robinson  
Department of Materiel

In November 1954 the office of the Chief of Ordnance ordered a program started to develop an improved Honest John system. Out of that program has come the M386 Honest John launcher (fig 1).

Of course the new launcher has many advantages over the M289 launcher now in use. A shorter launching rail makes for better transportability and concealment. The new M386 is lighter than its older counterpart by some 5 tons, and greater maneuverability combined with improved operational characteristics has made the M386 better suited for tactical operations.

The new launcher can be air transported with an Honest John mounted and ready to fire. Minimum firing elevation on the M386 is  $6^\circ$  as compared to  $12^\circ$  on the old launcher. Both the M386 and the M289 will elevate to  $60^\circ$  and traverse  $15^\circ$  left or right of center.

Several changes have been made in the launching beam. For one thing, the new beam provides 15 feet of guidance for the rocket instead of the 30 feet provided by the old M289. The front 6.5 feet of the launching beam is split down the center and hinged just behind the launcher cab. The front sections fold back on each side of the beam and are pinned back for traveling (fig 2). The beam is at zero degrees elevation in the traveling position. This shorter, split rail provides the improvements in transportability and concealment. Moreover, no accuracy is lost. Experience has shown that the 30 feet of guidance is not necessary. In the traveling position, the launcher may be easily camouflaged with a tarpaulin to look like any other 5-ton truck.

The launcher jacks and the cross-leveling system have also been improved. On the M386 there are only 3 jacks instead of the 5 found on the M289. The two front jacks have been eliminated entirely. The remaining 3 jacks are used solely to remove the weight of the launcher from the truck springs. The launching beam is cross-leveled by manipulating the launcher bottom-carriage instead of the entire vehicle as before. The new jack and cross-leveling system have reduced emplacement and march order times considerably.

Following a successful user test by the US Army Artillery Board in the first quarter of fiscal year 1958, the United States Continental Army Command classified the Honest John launcher M386 as a standard item. Although the exact production schedules and dates of delivery to troops are not yet available, we can expect to see this greatly improved launcher in the near future.

---

Subcourse 5, "The Infantry Division, ROCID," is now available.

# WHAT'S THE DIFFERENCE?

Major William A. Naugher  
Captain James C. Elliott  
Department of Gunnery

During the course of instruction at Fort Sill, a student asked this question: "Why do the 155-mm howitzer tabular firing tables, charge 5, list different projectile weight factors (columns 16 and 17) for the green bag and white bag propellants, if the muzzle velocity produced by both propellants is the same?" The following answer is offered by the US Army Artillery and Missile School.

Green bag and white bag propellants, being of different composition and granulation, have different rates of burning and pressure travel curves. (The pressure travel curve traces the pressure on the base of the projectile at any position in the tube.) Peak pressure for the two propellants is not at exactly the same point. The amount of propellant loaded into the green and white bags is assessed to produce standard velocity with a standard weight projectile even though the two pressure travel curves are not symmetrically the same. Introducing a projectile of nonstandard weight upsets this balance.

A nonstandard projectile weight has two effects: one on the muzzle velocity, the other on the ballistic coefficient (measure of the relative efficiency of a projectile in overcoming air resistance). The nonstandard weight

effect can be shown by the equation  $\Delta MV = M \times \frac{\Delta W}{W} \times MV$

- Where:
- $\Delta MV$  is the change in muzzle velocity
  - M is a factor which compensates for the characteristics of the two propellants. For the 155-mm howitzer, the M factor is 0.46 for green bag and 0.37 for white bag.
  - $\Delta W$  is the change in weight. For the 155-mm howitzer, 1 square equals 1.1 pounds.
  - W is the standard projectile weight. For the 155-mm howitzer, 95 pounds is the standard projectile weight.
  - MV is the standard muzzle velocity. For the 155-mm howitzer, charge 5 equals 1,220 feet per second(ft/sec).

When the projectile weight is standard, both propellants have the same muzzle velocity. When the projectile weight is not standard, the above equation is applied to determine the effect figures to be placed in columns 16 and 17 of the firing tables. Here is an example using a variation of 1 square from standard.

Green bag       $\Delta MV = 0.46 \times \frac{1.1}{95} \times 1,220 = 6.5 \text{ ft/sec}$

White bag       $\Delta MV = 0.37 \times \frac{1.1}{95} \times 1,220 = 5.2 \text{ ft/sec}$

$$6.5 \text{ ft/sec} - 5.2 \text{ ft/sec} = \text{plus or minus } 1.3 \text{ ft/sec difference}$$

Hence, when projectile weight is plus 1 square, the green bag has 1.3 feet per second less velocity than the white bag; when projectile weight is minus 1 square, the green bag has 1.3 feet per second more velocity than the white bag. The differences between the two values in the firing tables reflect this 1.3 feet per second difference. Since the effect shown in the firing tables is for an increase in projectile weight, the green bag effect has a greater negative value. However, the difference for a given range will seldom equal exactly 1.3 times the unit effect for muzzle velocity because the computation has been rounded off.

## **METHODS OF DEPLOYING CANNON AND MISSILE FIELD ARTILLERY**

Lieutenant Colonel Kenneth B. Stark  
Department of Tactics and Combined Arms

As new missile systems have been added to the field artillery's inventory, methods of deployment have been devised for each weapon. Considerable confusion has resulted, especially in teaching the tactical employment of the Honest John, Corporal, and Redstone missiles.

Sufficient practical experience has now been gained so that the maze of variations has been boiled down into four standard methods of deployment (fig 3) which are applicable to all types and calibers of cannon and missile field artillery.

Our point of reference in this article is the battalion-sized unit. However, the four methods of deployment to be discussed are applicable to battery-sized units and to Redstone field artillery missile groups. The four methods have many variations, modifications, and combinations which the commander can use to meet a particular situation. Which method or variation he uses depends on the situation, the mission, and the enemy's capabilities.

### The First Is the Simplest

The first method simplifies command, administration, mess, survey, communication, and local security problems. All elements of the unit are within a common perimeter. Ammunition can be supplied to firing elements quickly. The reaction time, rate of fire, and reliability in meeting firing schedules are all favorable. However, there are disadvantages. Detection by the enemy is enhanced by the large concentration of men, vehicles, and weapons. If the position area is discovered, the entire battalion may have to displace or face the chance of destruction by a single nuclear weapon.

Method 1

Battalion Position Area: Headquarters and service elements and firing elements in a common perimeter. Alternate positions not shown.

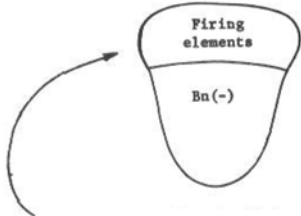

This area includes the firing battery of a missile battalion, or the firing batteries of a Redstone group, or the lettered batteries of a cannon battalion. The area includes firing positions.

Method 2

Battalion Position Area: Headquarters and service elements and firing elements in separate perimeters. Alternate positions not shown.

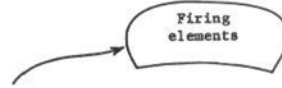

This area includes a firing battery of a missile battalion, or one firing battery of a Redstone group, or one lettered battery of a cannon battalion.

Therefore, the number of these areas will depend on the type of unit (most cannon battalions require three). The area includes firing positions.

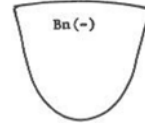

Method 3

Battalion Position Area: Headquarters and service elements and firing elements in a common perimeter. Fire missions are normally accomplished from firing positions outside the perimeter; such positions are occupied only long enough to complete the fire mission. Alternate positions not shown.

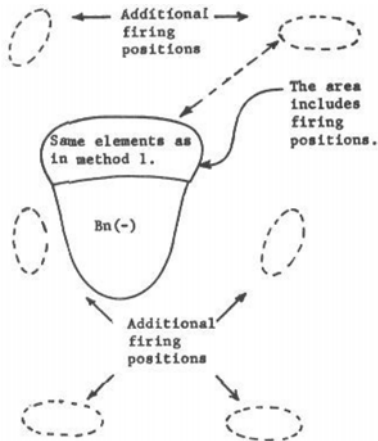

Method 4

Battalion Position Area: Headquarters and service elements and firing elements in separate perimeters. Firing elements occupy another firing position on completion of a fire mission. Alternate positions not shown.

Each of these areas includes one or more firing sections, and may include a battery. The number of these occupied areas can be varied to meet the needs of the unit.

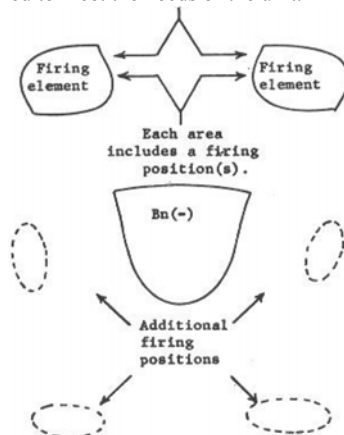

Figure 3. Methods of deployment of field artillery units.



### Separating the Firing Elements

The second method separates the battalion's firing elements from the headquarters and service elements. Each firing battery of a missile battalion or a Redstone group or each lettered cannon battery has its own position area. With this arrangement, the enemy can no longer annihilate the whole battalion with one nominal weapon. At the same time however, command, survey, local security, ammunition resupply, and communication are more complicated than in the first method. Working to the battalion's advantage in this method is the fact that discovery of one firing element does not mean discovery of the whole battalion. Along the same lines, even if enemy action is brought against one firing element, the remainder of the battalion can probably stay put.

### The Additional Firing Position

Method three introduces the additional firing position. An additional firing position is a predetermined area away from the battalion position area and normally is used by the battalion's firing elements to carry out their fire missions. Notice that the battalion position area is the same as in the first position area discussed, and can be used by the firing elements to shoot from if necessary. Ordinarily, however, the firing elements move to one of the additional firing areas, shoot, and return immediately to the battalion position area. This tactic leaves the enemy nothing to retaliate against even if he should spot the additional firing position. Neither will discovery of the additional firing position disclose the rest of the battalion. The battalion firing elements are separated from the battalion headquarters and service elements only for short periods of time, making supply, mess, and administration problems easier than in the second method. But survey and communication probably are more difficult than in either of the two previously discussed methods. Since the firing, headquarters, and service elements are bivouacked together much of the time, one nuclear weapon could finish them all--the same disadvantage found in the first method.

### Shoot and Then Move

In this final method, a firing element(s) is stationed in a firing position(s) away from the battalion headquarters and service area--essentially as in the second method. Instead of staying in one firing position, the unit completes a fire mission and immediately moves to an additional firing position. It does not return to the battalion area as the firing elements do in the third method. The shifting firing elements which never return to the battalion headquarters and service area make this method the most complicated considering command, ammunition supply, mess, and local security. Survey and communication problems are worse than those in methods 1 and 2 and just as difficult as those in method 3. In addition,

sustained and maximum rates of fire are hard to achieve. But there are advantages offsetting these disadvantages. For instance, the constant dispersion of the battalion gives it a very high degree of protection against nuclear attack. The battalion as a whole is extremely hard to find because the subordinate elements move frequently. And, as in method 2, if the enemy takes one of the elements under fire, it does not mean that the entire battalion has to move.

### Characteristics in Common

All four of the basic methods of deployment have certain characteristics in common. In each method, every action of every man and every element of the battalion must be pointed toward one goal: cutting the time needed to prepare for and fire a mission to an absolute minimum. In methods 1 and 2, the firing elements displace when the tactical situation dictates. In methods 3 and 4, firing elements displace on the completion of fire missions. Regardless of which method a unit uses, the headquarters elements and the service elements of the battalion may be separate or located together, depending on the decision of the battalion commander or on orders from higher headquarters.

### Additional and Alternate

The term “additional” firing positions used in methods 3 and 4 should not be confused with the term “alternate” position. Additional firing positions are primarily used in carrying out the assigned mission. An alternate position is a position to which the battalion or elements thereof moves when the primary position becomes untenable. This does not mean an additional firing position could not be used as an alternate position if the need arose. A commander should have an alternate position selected as well as his additional firing positions. Also, the use of the word “additional” does not mean that a new class of positions has been created. Positions continue to be classified as primary, alternate, and supplementary, as explained in FM 6-20 and FM 6-140.

Remember that the four methods of deployment discussed in this article are standard for all artillery units, regardless of the weapon they use. These position areas can be used with equal success by a 105-mm howitzer battalion or a Redstone field artillery missile group. The choice of method depends on the situation, the mission, and the enemy's capabilities. One of these four basic methods, or some variation thereof, will be the answer to most problems for artillery unit deployment.

### DO YOU HAVE A GEM?

If you have an idea that would assist other artillerymen in doing a better job in garrison, on maneuvers, or in combat send it to the US Army Artillery and Missile School, ATTN: Artillery Trends.

# INCREASED MOBILITY WITH REDUCED MAINTENANCE

Captain Eugene B. Humrighouse  
Department of Artillery Transport

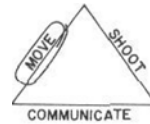

On the battlefield, victory is most often won by the force placing the first round on the target, which, for the artillery, is a simple way of saying “the timely and accurate delivery of artillery fire with all available weapons.” To make all weapons available, we must have maximum mobility. We are consequently interested in increasing our mobility in every possible way.

Increasing mobility is one of the tasks of the US Army Maintenance Board (USAMB). This board has recently revised the tactical vehicle maintenance procedures to remove the stumbling blocks and to redirect the maintenance effort towards maximum mobility. TM 9-2810, dated 4 August 1958, entitled “Tactical Motor Vehicle Preventive Maintenance, Supply, Inspection, and Training Procedures,” is a consolidated text containing all the pertinent information required for proper vehicular maintenance, supply, inspections, and training at battery and battalion level.

In the establishment of the revised maintenance intervals and services, USAMB accomplished these objectives:

1. The battery has been relieved of the necessity for maintaining excessive administrative maintenance records. Battery maintenance personnel can now devote more time to needed repairs and to providing technical guidance for the individual operator and crew.
2. A preventive maintenance system has been developed which is equally responsive to peacetime or wartime conditions. During combat it is impractical to have 10 percent of the wheeled vehicles and 20 percent of the tracked vehicles in the motor pool each day for the “B” service.
3. Certain functions have been deleted from the preventive maintenance services and incorporated in troubleshooting procedures or in direct support functions (e.g., compression test, fuel pump pressure, vacuum test, valve timing, etc.).
4. The weekly (tracked vehicles) and biweekly (wheeled vehicles) checks have been eliminated.
5. A system of periodic supervisors' inspections has been initiated, insuring chain-of-command participation in the detection and correction of deficiencies.
6. Lubrication of vehicles is now based on need and use rather than on a time schedule.
7. The “C” and “D” services have been combined into one comprehensive quarterly service. This quarterly service, or “Q” service, is the only scheduled service.

Although not listed as one of the major objectives, one of the greater

achievements of this revision is the boost in efficiency and morale of the battery motor sergeants and mechanics. Being relieved of the old "C" service, they will now have more time to perform the vital repairs and replacements, thus reducing or eliminating deadline losses thereby increasing the mobility of the unit.

The US Army Artillery and Missile School has revised programs of instruction to include the new maintenance procedures. However, instruction continues to emphasize the command responsibilities of the officers and noncommissioned officers who are in command of battalions, batteries, platoons, and sections.

Our most important reason for seeking increased mobility is to insure that we deliver that first round on the target fast.

## **JUKE BOX COMPUTER**

Captain Russel J. Miller  
Captain Enrico Meneguzzi  
Department of Gunnery

If you have a knack for solving gunnery problems, try your skill on this one: Type of mission--destruction, azimuth from firing position to target-- $256^{\circ} 42' 10.3''$ , range from firing position to target--240 kilometers (approximately 149 miles).

To complicate matters a little, assume that your weapon has certain characteristics which make any kind of registration impossible. You have only one round; it must be the fire-for-effect round. By the way, your weapon is the field artillery Redstone missile.

Using pencil and paper (assuming all the necessary information is at hand) you should come up with an answer in about 3 1/2 hours. Using the "juke box," a fire control digital computer designed for use with the Redstone, you could solve the same problem in about 5 minutes--a decided advantage over the pencil-and-paper method. What's more, the juke box answer will be accurate to 12 decimal places, or 1 part in 1 trillion. Another decided advantage.

Figure 4 shows the current model of the juke box. Preliminary design layouts indicate the complete computer plus maintenance support equipment, spares, and working area for three men, could fit into a standard 3/4-ton truck. However, based on a US Army Artillery and Missile School recommendation, a 2 1/2-ton van is used to increase its flexibility of employment.

The computer's control unit has been designed to minimize special operator training and to simplify operation. This simplification will minimize the chances of error during the data-input phase. A system of buttons and lamps is used to operate and test the juke box. The lamps show the computer's state of operation and also any malfunctions. The

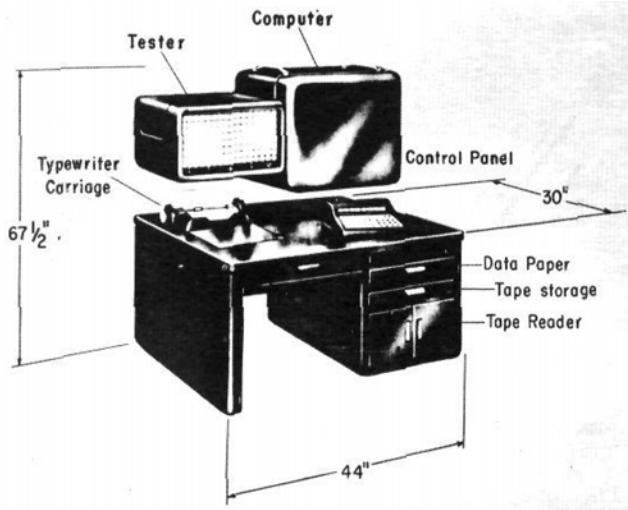

Figure 4. The "juke box" computer used to solve the Redstone guided missile gunnery problem.

keyboard is similar to those used on adding machines. When a number is fed into the juke box, it is translated into machine language and then read back and displayed. Thus the operator can be sure he fed in the right number. If the operator makes a mistake while entering his input information, he presses the "clear" button, and the number is cleared from the machine. If the information is correct, he presses the "parameter" button, and the information is placed in the proper location for use during the computation of the problem. All inputs and outputs will be identified by a two-digit code in the display section. After all the parameters have been entered, the operator presses the parameter button one more time and the machine starts computing, displaying the answers in the display section according to the output code.

Maximum use of transistors in the computer and test equipment has allowed a great saving of space. All circuits are designed as small, changeable, plug-in units, color and mechanically coded to prevent improper insertion into the computer. Figure 5 gives an idea of the size of the units.

The juke box has a completely self-contained maintenance system which includes the computer proper and special field test equipment. Present plans are to have the operator perform operator's maintenance and ordnance technicians perform higher echelons of maintenance. Operator's maintenance is simplified by the system tester unit which may be plugged into the computer during periods of operation. The operator, by referring to a special set of instructions in a manual, can check out certain areas

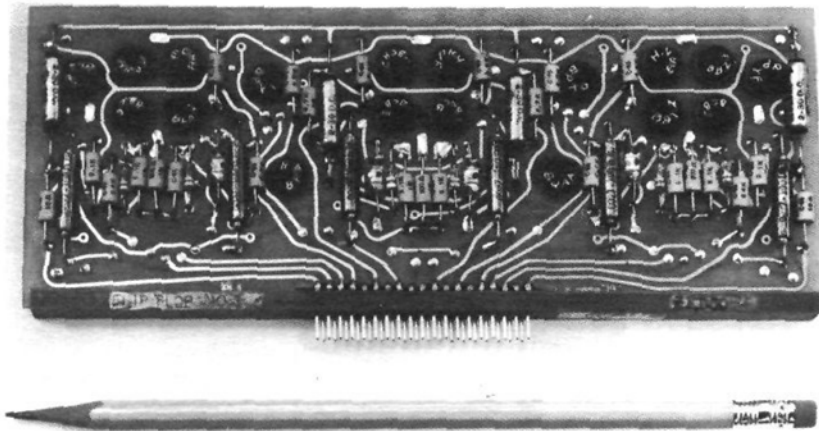

Figure 5. Tiny, plug-in units like this one are used throughout the juke box computer.

of the computer by watching the light patterns displayed on the front panel. Light patterns failing to follow certain test charts indicate a section of trouble. The patterns will also identify a group of 3 or 4 plug-in units which the operator can replace from his spares, allowing him to start computing again. He sends the defective units to an ordnance technician for repair.

The juke box is basically a general-purpose computer with a general-purpose computer's distinctive flexibility. This flexibility makes it suitable for computing any geographic or ballistic quantities associated with the longest range missiles. A reprogramming feature makes changing internal data (such as changes in fuel, warheads, or fuzes) easy. This feature also allows the same basic unit to be used with many different missiles without any mechanical or electrical changes whatever. The juke box can operate in any closed or open loop missile system. It can receive input data in standard, five-level teletype code and transmit the output data in electrical form to any control system.

A prototype model of the juke box computer will be available at the School and will be used for training in Redstone fire direction center procedures.

---

Are you up to date? Do you plan to attend a resident course soon? Prepare yourself by enrolling in the Special Extension "FA Officer Refresher Course."

---

## WEAPONS OF THE ARTILLERY-3

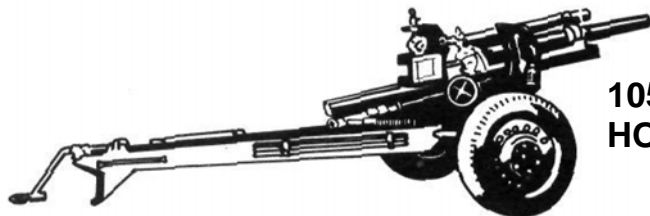

**105-MM  
HOWITZER**

### HOWITZER CHARACTERISTICS

Weight - - - - - 4,980 lbs  
Length - - - - - 101.3 inches  
Range - - 11,270 meters or  
12,330 yds  
Elevation - - 89 mils to 1,156 mils  
Traverse - - 409 mils right  
400 mils left  
Muzzle velocity - 1,550 ft/sec  
Rate - - first 1/2 min - 8 rds/min of avg  
first 4 min - 4 rds/min  
Fire sustained first 10 min - -  
3 rds/min  
Ammunition types - - HE, HEAT,  
chemical, smoke, gas, blank, drill  
Weight of projectile - - 33 lbs  
Firecontrol equipment - - panoramic  
telescope M12A7D direct fire  
telescope M16A1D  
Recoil mechanism, M2A1 - -  
hydropneumatic constant,  
dependent with floating piston  
Type gas in recoil mechanism - -  
nitrogen at 1,100 psi at 70°F w/o  
reserve oil  
Length of recoil - - 39-42 inches  
Breechblock - - horizontal sliding  
wedge weighing 74 lbs  
Tube life - - 20,000 rounds

### TRAINING REFERENCES

FM 6-75 105-mm How M2 (Aug 52)  
TM 9-325 105-mm How M2A1  
Carriages M2A1, M2A2 (May 48)  
TM 9-3008 105-mm Recoil  
Mechanisms (Oct 53)  
Training Films:  
6-1991 Service of the Piece 105-  
mm How (34 min-1955)  
9-1948 Recoil Mechanisms,  
Principles of Operations  
Hydropneumatic, Dependent  
System (12 min-1954)  
9-2050 How 105-mm Principles  
of Operation (21 min-1944)  
9-2532 FA Recoil Mechanisms  
Part II (29 min-1957)  
9-2543 FA Recoil Mechanisms  
Part I (24 min-1958)  
Tables of Organization:  
6-125T FA Btry 105 Towed 20  
Dec 56 (ROCID)  
6-127C FA Btry 105 Towed 13  
Feb 56  
6-317T Armored FA Btry 105  
SP, 1 Dec 56 (ROCAD)  
Army Training Tests:  
6- 9 Airborne Btry  
6-13 Btry (ROCID)  
6- 1 Btry (ROCAD)

# REMOTE SPEAKER LOUDNESS PROBLEMS

Mr. Billy Groves  
 Department of Communications and Electronics

Remote operation of tactical frequency modulated radio sets is often considered troublesome because performance is less reliable with remotod radios. This decrease in reliability is frequently the fault of the user rather than of the equipment. With proper installation and care of equipment, remote control can be a convenient and reliable method of radio operation.

Control group AN/GRA-6 is standard equipment for remoting frequency modulated sets. This group is comprised of the following components: local control C-434/GRC, remote control C-443/GRC, interconnection box J-654/G, handset H-33/PT, and loudspeaker LS-166/U. The interconnection box J-654/G permits simultaneous use of the loudspeaker and the handset on the C-433 remote control unit. Audio is

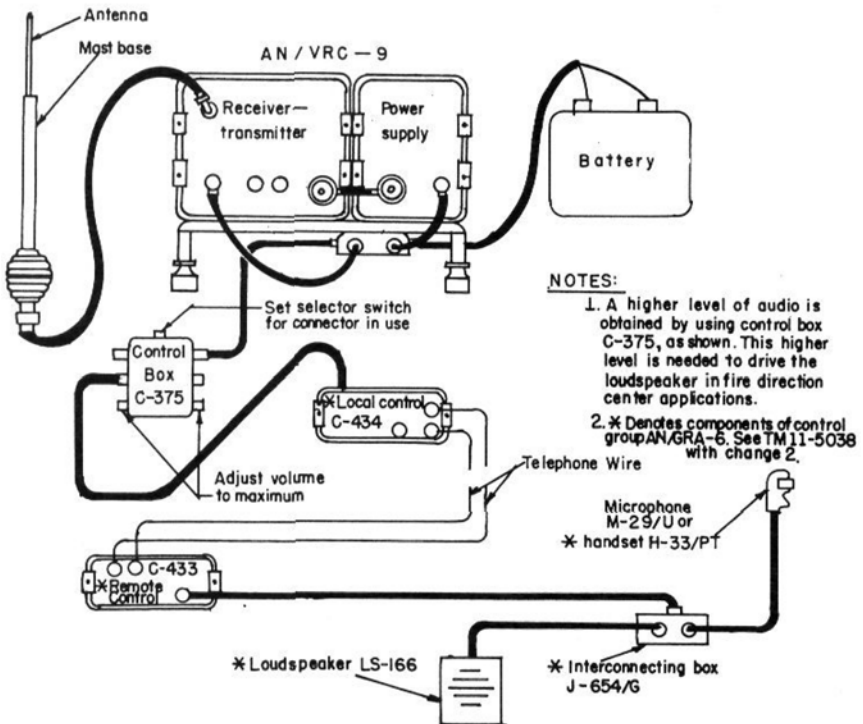

Figure 6. Remoting radio AN/VRC-9 into the fire direction center.



simply divided between the handset and the loudspeaker. The audio level may be maintained in the loudspeaker by using the M-29/U microphone in place of the H-33/PT handset.

The first audio (headset audio) is remoted from the front of the radio set, but this is inadequate when receiving weak signals or operating a loudspeaker in noisy locations. Increased volume can be obtained by using power audio (loudspeaker audio). Power audio is obtained without modifications by connecting the C-434 local control unit to the C-375 control box. The control box is a convenient connection point. The selector switch and volume control on this box must be set for proper operation. Figure 6 shows the required installation. Experience at the US Army Artillery and Missile School indicates this method of connection is preferred for fire direction center loudspeaker applications.

## **SITE . . . . PLUS 12**

Major Wayne H. Cofer  
Department of Gunnery

How fast can the members of your fire direction center determine and announce site? Chances are they are slowed down by the numerous steps involved. Those steps being--

1. Plot target.
2. Read the altitude and range.
3. Convert the altitude to yards (or meters).
4. Determine the vertical interval difference between the gun and the target.
5. Determine the site with the graphical site table--a three-step procedure in itself.

Obviously, anything that can be done to simplify, eliminate, or speed up these operational steps is desirable, be it a gimmick or a shift of functions among fire direction center personnel.

Sergeant Daniel D. Fetterley, 524th Field Artillery Battalion, Indiana National Guard, has suggested a simple and fast technique of converting feet to yards (meters) with the military slide rule.

Tape the window indicator to the slide so that the hairline is over the number 3 (or 3.05 for conversion to meters) on the C1-scale (fig 7), then:

1. Move the indicator and the slide so the C-scale index (left or right as required) is over the altitude on the D-scale.
2. Read the converted altitude on the D-scale under the hairline.

Another technique used for some time by many units is a simple table prepared in each position for converting the target altitude directly to the vertical interval (table 1).

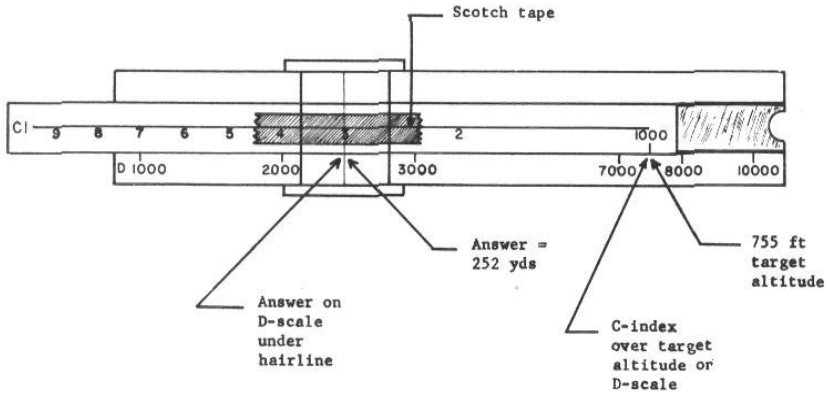

Figure 7. Converting feet to yards or meters using the military slide rule.

TARGET ALTITUDE*	VERTICAL INTERVAL**
100	-160
160	-100
200	-60
260	0
300	+40
360	+100
400	+140

Battery altitude: 260 yards.

\*Altitude in feet, yards, meters--whatever is used on the map.

\*\*Interval in yards or meters--as required.

Table 1. The vertical interval is read across from the appropriate target altitude.

Enroll Now

19,000 Extension Course students can't be wrong. Are you swinging with the breeze or are you in the know?

# A DO-IT-YOURSELF MAP BOOK

First Lieutenant Albert F. Hogle, Jr.  
Department of Target Acquisition

You are traveling over the back roads on a reconnaissance. You want to consult your map, but the wind and the bouncing and rolling of a fastmoving vehicle make map reading almost impossible. Before your trip is through, you will probably be willing to give a month's pay for some sort of a map made into a small and compact package. Here is an answer.

Any map book must protect the map, permit immediate reference to any portion of it, and be easy to handle in a vehicle or an aircraft. This article explains how to fold and cut a map into a book that will meet these requirements.

In the example below a 1:25,000 scale map sheet is reduced to a 5-by 6-inch booklet. This method of folding and cutting may be used for any number of sheets and made into a map booklet provided that the assembled sheets are square or rectangular. However, if more than one map sheet is used the finished book will be proportionately larger. The optimum number of sheets is four.

## Preparation of the Map Book

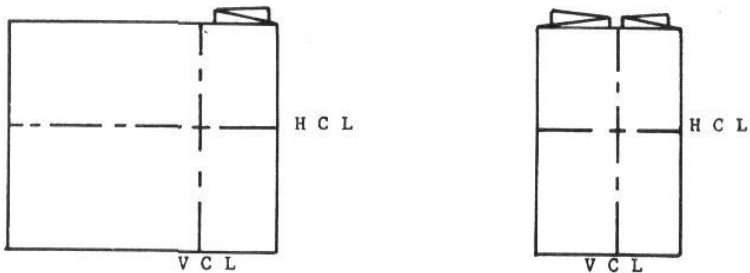

Figure 8.

Figure 8. Placing the map face down, fold and unfold first on the horizontal center line (HCL) and then on the vertical center line (VCL). With the creased but unfolded map face up, make the two folds (fig 8) which will result in three equal vertical divisions on each side of the vertical center line. The inside folds should meet at the vertical center line.

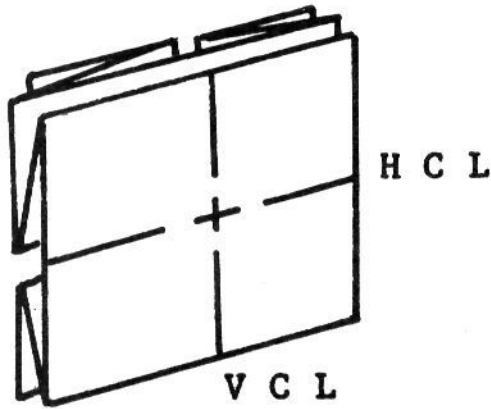

Figure 9.

Figure 9. With the map folded as in figure 9, fold the upper and then the lower half into three equal divisions on each side of the horizontal center line. Crease these folds firmly.

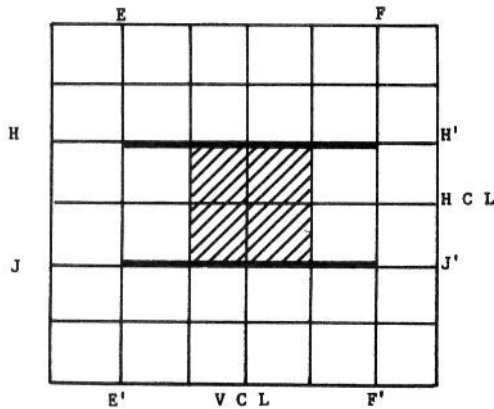

Figure 10.

Figure 10. Unfold and spread out the map--face up. Cut along lines HH' and JJ', being careful to cut no farther than lines EE' and FF'.

Refold the map on the original creases. The shaded portion (fig 10) of the folded map is now visible. Fold along the vertical center line--shaded portion of the map in. The backs of the four corners of the map sheet, now on the outside, are then pasted to the inside of a folder of protective material. If more than one map sheet is used per map book, the edges of the sheets should be trimmed and butted when joined to eliminate bulky folds.

### Visible Areas

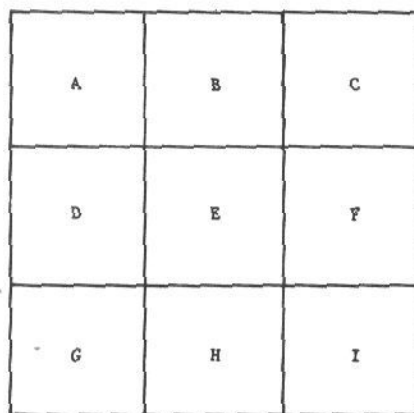

Figure 11.

Figure 11. On opening the map book, the center one-ninth of the map sheet (area E) is visible. Leafing from the left and the right will disclose areas D and F respectively; from the top and bottom, areas B and H respectively. With area B visible, leafing from the left and right will disclose areas A and C respectively; with area H visible, leafing from the left and right will disclose areas G and I respectively. To turn from area I to F, one must turn in sequence to areas H, E, and then F.

## **4 BITS IS NOT 50 CENTS**

Lieutenant Colonel Louis R. van de Velde  
Department of Gunnery

Nowadays "4 bits" is not 50 cents. Four bits at the US Army Artillery and Missile School means "four binary digits" and is often part of the conversation of those who work around Fort Sill's new high-speed, electronic, digital computer. Keeping up with the civilian world and with the United States Continental Army Command, the School has recognized the tremendous impact digital computing will soon have on our culture and on our Army. We of the School's faculty are studying computing by using a small computer, a Bendix G15D, for research and scientific problems.

The computer has already been used for a number of important research problems and many more problems will be presented to it when additional people are trained in its use. So far, computations solving in a matter of hours some 1,200 triangles have been completed in connection with a project designed to determine the error in met messages--Project

Metro Precision. Other relatively extensive data-reduction problems--a comparison of predicted and achieved metro effects in this same project--are being run at the present time.

One of the most promising missions planned for the computer is in connection with Honest John accuracy studies. A magnetic tape associated with the computer will be used to store the world-wide reports of firings submitted by Honest John units. Firing reports are arranged in a precise manner, each report being fitted in a prescribed sequence into a 100-word block on the magnetic tape. The tape becomes a well organized file that can be searched and read at will by the computer. With the file (magnetic tape) instantly available to it, the computer can be directed by a written program to select certain data and perform computations on them. By applying standard statistical methods, it will be possible to find correlations between certain errors and conditions existing at the time of firing.

Thus it is expected that improved gunnery procedures will result. Correlations derived from the digital computer will assist operational units in discovering errors and thus point the way to appropriate modifications and closer supervision of troop procedures. Of course the validity of the findings will essentially depend on the thoroughness and accuracy of the firing reports received from units. The computer can be taught to reject reports containing gross inconsistencies. The same type file will be established for 8-inch howitzer firing reports.

Another interesting computer problem centers around a helicopter march time table. By just looking up the time at the right spot in the table, an S3 can determine how many minutes are required to move a battery by helicopter considering, in turn, each of the following variables: number of craft available, number of craft that can be landed in the forward area at one time, distance outbound, distance inbound (over a different route), and head wind. The table also shows the time required to move less than a full battery and a table showing the time required to move the battery by truck is also provided. The machine computed and printed the entire table (one copy) in less than 2 hours. However, nearly 2 weeks were required to set up the problem for the machine. This time will be reduced greatly as personnel receive more training and become familiar with the equipment.

An automatic data processing system for the entire field Army is fast approaching reality. The small digital computer at the School will permit research and experimental applications of data processing and compute operational artillery problems such as fire control, survey, and fire planning.

In both immediate gains in accuracy studies and long range gains in procedures for field data processing, the School's computer is proving stimulating and productive.

# MISSILE

## SERVICE

### PRACTICE

Major Quentin C. La Prad  
Department of Materiel

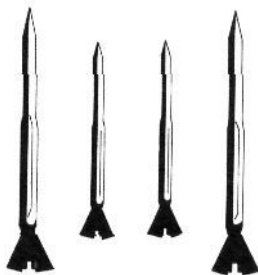

Missile service practice and firing exercises have created a new and special problem. Time tested planning, procedures, and experiences do not apply. Existing facilities on post ranges are no longer adequate. Instrumentation, recording, and observation equipment require long lead time procurement and require extensive maintenance. The Corporal missile provides an excellent example of present and future problems.

This is the third year in which all the field artillery's Corporal battalions have participated in annual service practice and Army training tests at Oro Grande Range Camp, White Sands Missile Range, New Mexico.

The Corporal missile's ability to engage targets 130 kilometers (80 miles) away coupled with range safety requirements presents a sizeable problem when considering ranges on which to fire an annual service practice. The only adequate range presently available to the US Army is at White Sands.

Although this article deals specifically with Corporal firings, the operations described are typical of the Redstone system as well as other long-range systems still being developed.

Prior to the annual firings, each Corporal battalion, whether overseas or in the Continental United States, receives notice of the time allocated to that unit for preparing and firing its missiles. The unit also is told the number of missiles it will fire. At present, the battalions fire four missiles each. Two of these are for annual service practice and the other 2 constitute the battalion's Army training test.

#### The Host Battalion

The 1st Missile Battalion, 40th Artillery, is permanently assigned to support the firings at Oro Grande Range Camp. This battalion furnishes the administrative overhead, billeting, mess, vehicles, missile test stations, ground guidance center, and ground handling equipment for the firing battalion. Only a portion of the host battalion is billeted at Oro Grande Range Camp. The remainder is quartered at Fort Bliss, Texas, 55 miles away.

The overseas battalion commander, key members of the battalion staff and headquarters battery, and practically the complete firing battery have to come to the United States for the service practice. They travel by

air. Battalion administrative, mess, supply, and other personnel whose functions are performed by the host battalion, remain overseas. All equipment is furnished by the host battalion.

Corporal battalions in the Continental United States traveling to Oro Grande for service practice normally take their own vehicles, missile test stations, and ground guidance and ground handling equipment. The host battalion itself is one of these Continental United States units, and therefore it also has annual service practice.

Before the annual service practice, a typical battalion will have spent approximately 1 week per month in the field occupying positions, checking out missiles, and simulating preparation for firing. Actual fueling does not take place during these exercises. A "mock shoot" will have been performed which simulates the conditions of an actual firing. Target data will have been computed and recorded and the appropriate settings placed on missile components and ground guidance equipment.

Since March 1958 improved checkout procedures have been used by all battalions. This year, for the first time, each battalion fired one type IIA missile. The type IIA Corporal incorporates the latest refinements in the Corporal missile system. At the request of the US Army Artillery and Missile School, the Department of the Army has arranged for 2 warrant officers and 2 enlisted electronic technicians from each battalion to come to Fort Sill to receive a 1-week transition course on the new procedures and the type IIA missile. These men finish the course in time to join their battalion when it arrives at Oro Grande.

#### Arrival at Oro Grande

An advance party of an officer and several enlisted men arrives at Oro Grande approximately 1 week before the rest of the battalion arrives. This group arranges billeting, mess, and other administrative matters; collects preliminary firing data; and arranges for the arrival of the missiles which the battalion will fire.

When the main party arrives at Oro Grande the battalion is briefed by the commanding officer of the host battalion and by members of the Field Artillery Missile Evaluation Group. This Group is a detachment from the 1st Field Artillery Missile Brigade stationed at Fort Sill. The Group assists the battalion in firing its two service practice rounds and normally holds a critique after each firing. Later the Group conducts the Army training test which includes checking the technical proficiency of the battalion while it prepares and fires its training test rounds. Each battalion examines the firing results of previous units thereby profiting from their experiences.

After the initial briefings, the battalion commander reconnoiters the firing area located some 7 miles from Oro Grande Range Camp proper. By choosing the launching sites for his 4 missiles from the 6 sites available, the battalion commander can obtain varying amounts of launcher offset from the radar-target line.



## Preparing the Missile

The missiles to be fired are drawn by the host battalion immediately after the briefing. They are checked out by Post Ordnance at Fort Bliss. The preparation of two missiles then begins by removing the missile body, fins, batteries, and warhead from their respective containers. The two missile bodies are rolled on tracks from their containers into a checkout shack. This is a semipermanent building provided by the host battalion in place of the tent normally used.

After the missile fins are fastened in place, the missile receives a complete electronic and propulsion system checkout. These operations are normally completed the day before the missile's scheduled firing. Precise firing times are established by the Integrated Range Mission at White Sands Missile Range because of the many projects using essentially the same range facilities.

When the checkout is completed, the missile to be fired first is taken to the firing area. Fueling, warhead mating, and compatibility checks (compatibility of the missile with the missile firing station) are then performed simultaneously. After these checks, the missile is erected; final checks are performed; and it is ready to fire. The same procedure is followed for each of the other missiles.

Because of possible delays due to range holds, missile firings are scheduled as soon after a battalion's arrival as practicable. Since the unit service practices are scheduled about 3 weeks apart, delays must be held to a minimum.

Missiles are prepared and fired under simulated tactical conditions. One nontactical aspect is introduced by range safety requirements. Range safety personnel install equipment on each missile that enables them to stop the propellant flow if the missile takes an erratic course and appears likely to land outside safe range limits.

Missile service practice has been eminently successful in achieving its objectives in the 3 years in which it has been held. Units engaging in endless field exercises have a goal to shoot for--live firing. Indeed, the annual service practice is the only opportunity most units have of seeing their weapon in actual operation.

### A GEM FOR THE MESS OFFICER

Stragglers can upset any unit's feeding plan--this can be eliminated by requiring all section chiefs to tell the Mess Sergeant at the time they pass through the mess line that all their men have eaten, or that \_\_\_\_\_ number will be late. This can be controlled even more by the rule that the chiefs of section eat after their men.

--Submitted by Capt Thomas J. Patton  
Dept of P&NRT, USAAMS

# THE M2 AIMING CIRCLE

Captain Alfred C. Ring  
Department of Target Acquisition

Since the most critical element in artillery survey is direction, it is imperative that the angular measuring instruments used to determine direction be simple, compact, and accurate. For many years this operation was accomplished using the M1 aiming circle which served its purpose fairly well before being modified and improved into the new M2 version (fig 12 and 13).

The basic mechanism of the M1 has not been changed. The upper (recording) fast and slow motions and the lower (nonrecording) fast and slow motions remain essentially the same in the M2 with the addition of oversized rectangular azimuth and elevation knobs for ease of handling in winter operations while wearing gloves or mittens. An additional feature has been added to the lower motion that is a definite aid to the operator. Once the instrument has been oriented by the lower motion, spring-loaded caps cover the knobs and prevent any unintentional use of the lower motion. The scales are still read in two parts, the hundred digits from the azimuth scale and the last two digits from the micrometer scale. The micrometer scale has been moved to the right side of the instrument head to present a logical reading order of left to right--from the azimuth to the micrometer scale.

## Many Improvements

Considerable improvement has been made in the leveling system of the M2 aiming circle. Unlike the ball and socket arrangement on the M1, the M2 has a leveling screw system similar to that used on the Wild T2 theodolite and other accurate measuring instruments. In addition to the spherical, or fish-eye bubble level which is not used in artillery survey, the M2 has the more accurate tubular level. Another tubular level is mounted on the telescope to increase the accuracy of vertical angle measurement.

The eye piece of the M2 has been inclined upward at an angle of  $45^\circ$  to the telescope axis. This permits the observer to assume a more comfortable position when sighting through the instrument than is possible with the straight line of sight type. A more important reason for the inclined angle is that the M2 has astronomic observation capabilities. With a straight line of sight telescope, astronomic observations become increasingly difficult when the vertical angles exceed 500 mils. This capability of azimuth determination by astronomic observation (including simultaneous observation) will enable the artillery batteries of a corps or division to be placed on common directional control in a much shorter time than has been possible in the past. A filter which enables the

observer to view the sun directly is included. A clip on the side of the aiming circle holds the filter when it is not being used.

Instead of having to interpolate for vertical angles as with the M1 aiming circle, the M2 measures vertical angles to the nearest 0.5 mil from a minus 440 mils to a plus 805 mils. The aiming circle head, when not in use, is protected by and carried in a dome-shaped metal case, which provides a watertight fit and can be placed over the instrument even when it is mounted on the tripod.

The M2 aiming circle is used with the universal tripod similar to the standard transit tripod except that the legs telescope. When the legs are extended, the tripod is 54 inches long; retracted, the length is 31 inches.

The tripod head contains a shifting center arrangement which permits more accurate plumbing or centering over a point. A plumb bob is used in conjunction with the shifting center to project the center of the instrument to a point on the ground. Accurate centering of an instrument is necessary if accurate pointings are to be made.

### The Accessory Kit

The M2 aiming circle accessory kit consists of a canvas pouch which is held to the inside of one of the tripod legs by an aluminum bracket. The kit contains a 2-cell battery case for the night-lighting device, 2 lamp holders containing a spare bulb, and a plumb bob and cord. The intensity of the night lighting device has been increased by using a 3-volt system instead of the 1½-volt system found on the M1. Furthermore, a rheostat control knob has been provided on the battery case so that illumination intensity may be controlled. This is important when observing stars as too much illumination in the telescope lens can make the star's image imperceptible.

Since 1 January 1958 the accuracies obtained by officer and enlisted students at the US Army Artillery and Missile School have been recorded by the Survey Division of the Department of Target Acquisition. Based on 130 surveys, the average accuracy obtained was 1 to 2,600. These accuracies indicate that, with proper care and handling, the M2 aiming circle has solved a majority of the mechanical problems of the artillery surveyor at battery level.

---

Moved Recently? Been Promoted? Unit Re-designated?

Advise the Extension Course Division, U. S. Army Artillery and Missile School of any changes in your status. Help us to better serve you.

---

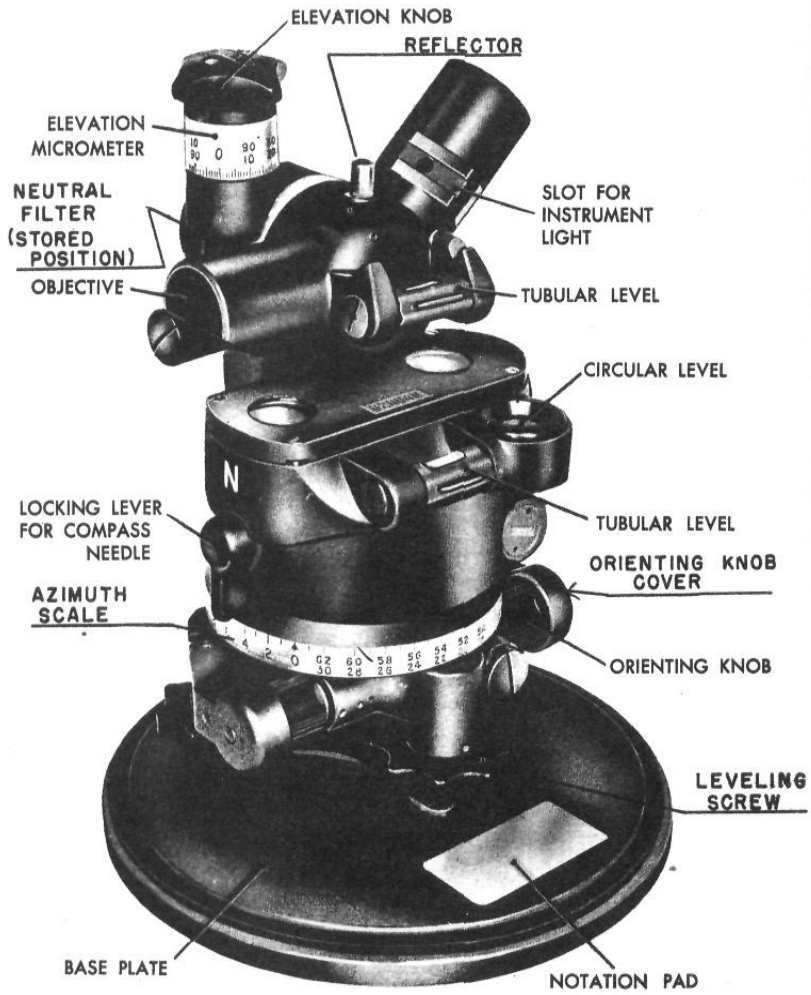

Figure 12. Left side view of M2 aiming circle head.

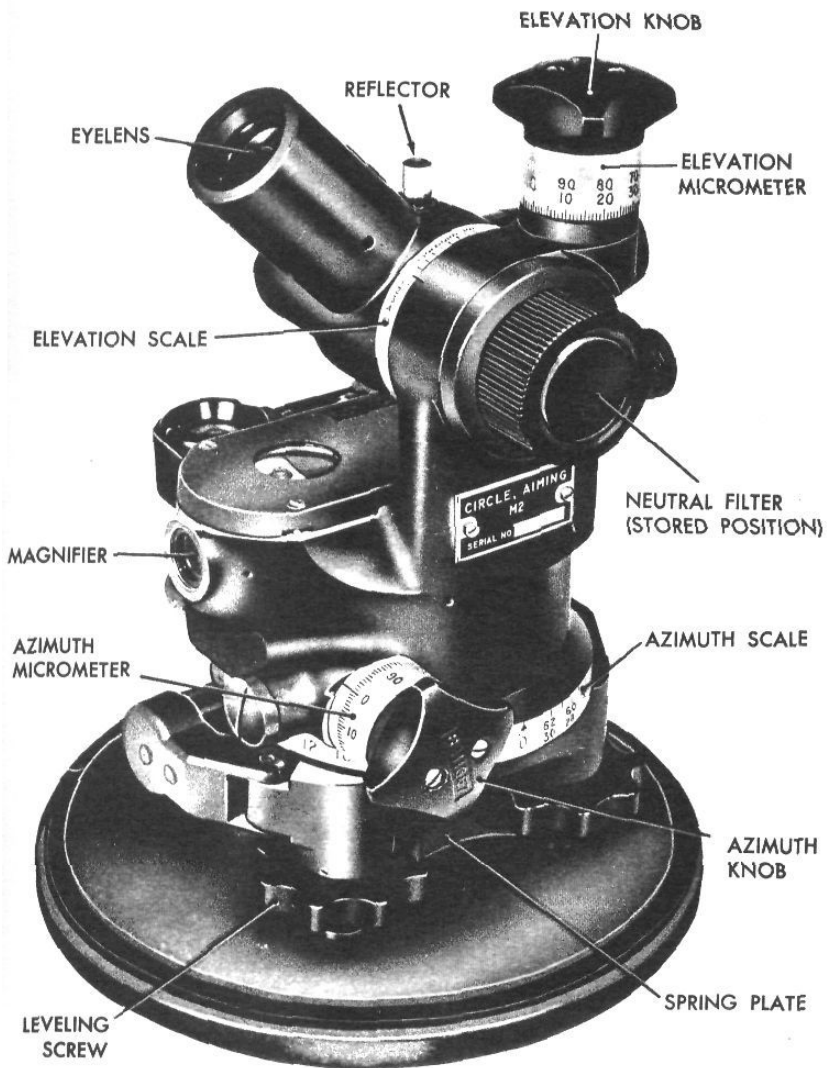

Figure 13. Right side view of M2 aiming circle head.

# **FIELD RESEARCH ON THE 762-MM ROCKET SYSTEM**

First Lieutenant Benjamin T. Meadows  
Department of Gunnery

Performance data on missile artillery is scarce compared with the vast storehouse of information accumulated on cannon artillery over the past decades. Since missiles were added to the family of artillery weapons only a few years ago, the actual number of rounds fired is still relatively small. Therefore, data about the performance of the system in the field is limited. The growing number of missile field units have a secondary job of providing the sound information needed on missile performance under actual field conditions.

When an Honest John rocket is fired, the firing unit prepares a report on the preparations made for and the results of the firings. These reports are exhaustively studied by the US Army Artillery and Missile School, the rocket manufacturer, and ordnance agencies to determine how the 762-mm rocket system is performing in the field.

Broad areas of missile science have yet to be explored, and these areas are where the firing reports prove invaluable. The Continental Army Command firing report is actually a research study on each round fired and is not intended as a means for checking up on the reporting unit. Data from the firing reports are grouped in various ways to demonstrate trends. When several firing reports indicate a similar deviation from the expected performance, basic research effort can be directed toward finding the cause and eventually a solution to the problem.

Under this system, troop units serve as eyes for the statisticians. The information gathered in the field must, therefore, be complete and accurate. Information covering any unusual conditions existing during the general firing period should be included. The condition of the round is also important, particularly if its performance is abnormal. Only through such accurate and detailed reports can the research agencies properly evaluate the performance of the tactical system.

Studies of previous firing reports and new information which the manufacturer and the Army Ordnance Corps has provided show that more information is needed than is now being gathered with the present Continental Army Command firing report. This information is only available in the field, but there is some reluctance to expanding the requirement for information. More information on the firing report means more work for the firing unit, and more work sometimes reduces the accuracy of the data submitted. Nevertheless, the additional field information must be collected for it is the primary source of data for the research agencies. Furthermore, the additional information required must not reduce the data's accuracy. This enlarges the research job already being done by

troop units, but in the long run the units, the 762-mm rocket system, and the Army will benefit. The results will surely be worth the effort.

The School has prepared a revised firing report form which will include additional information needed at this time. If it is approved and distributed by the Continental Army Command, it will facilitate the collection of vital information covering the system's operation. More data is needed in the seven areas listed below.

1. Detailed weather information, i.e., the metro message used for computing corrections, the metro message taken at the time of firing, the raw metro data used to compute these metro messages, and the location of the metro station with respect to the launcher. From this information, a relationship between metro data and accuracy can be established with the final result being the isolation of some of the so-called unknown effects on the missile's trajectory.

2. Modifications or damage to the rocket or its associated equipment. Any variations in the missile's configuration will affect the ballistic trajectory. The end result is poor accuracy. All such information must be reported so that every possible source of error can be considered in the overall analysis of the system's performance.

3. Changes to standard procedure that may have an effect on accuracy. Any experimental procedures used in an attempt to increase accuracy must be reported. Thus the validity of the procedure may be verified and the final results adjusted accordingly. The School is particularly interested in any procedures developed and used to improve accuracy.

4. Terrain and location of the equipment with respect to the azimuth of fire. Units in different parts of the world attain different degrees of accuracy. The exact cause of this trend has not been isolated; however, the terrain possibly effects the metro data. Data on surface winds and general comments on terrain, cover, etc., are needed to either prove or disprove this theory.

5. Determination and application of surface wind corrections. The effect of surface wind is one of the major factors affecting the system's accuracy. Even though it means extra effort by the troop units involved, more information in this area is needed. At the present time, surface wind effects are the subject of considerable research aimed at developing new and improved wind-measuring techniques. Additional information required by the revised Continental Army Command report will be invaluable in conducting this research.

6. Technical difficulties during service practice. Any technical difficulties, particularly with the rocket, may have a definite bearing on the results of the firing, and a detailed explanation should be included with the firing report.

7. Launcher condition and serial number. Variations in individual launcher rails have a considerable effect on accuracy. If this effect can be isolated, research can be directed towards a solution, i.e., measurement of the deviations in launcher rails and computation of an appropriate correction.

Firing reports received to date have been accurate and complete. The reporting units are to be commended for the time and effort expended in gathering the information and consolidating it into the final reports. The new form will represent a minimum increase in time and effort. However, the additional information required will be invaluable to the research agencies.

## THE FIRST ROUND

Major William W. Madison  
Department of Gunnery



Light and medium artillery batteries still have the mission of getting fire on the target immediately. We cannot slow down the speed of our supporting fires. This is particularly so in the meeting engagement type of shooting when rounds must be delivered now.

To maintain the field artillery's reputation for fast fire, few things will assist the battery commander more than a sound standing operating procedure (SOP) based on proven principles tailored to the battery's mission. Before you say "I've heard this story before," remember that as distances between units on the atomic battlefield increase, so do the responsibilities of the individual commanders. The battery commander of tomorrow will make decisions that yesterday were made by the battalion commander. The accent will be more on the battery than the battalion to deliver fire in a short time. The field artillery battery is coming back into prominence, and more than ever it needs a separate SOP to increase its speed. Are you and your unit ready?

A good SOP is not easy to develop. It has to be based on experience. Our training publications can provide general guidance. Specific details of how to accomplish a certain task must be developed at the unit level.

Standing operating procedures should be started and perfected during the training period. As the battery advances in training, the unit SOP becomes habitual guidance for the men and the unit. It is particularly valuable in a rapid occupation of position where decentralization of duties is essential. By using an SOP, key personnel can perform predetermined duties with little or no issuance of orders.

Not all SOP instructions need be in writing. Many operations and procedures can be developed and repeated during the training cycle until every man in the unit knows the way it will be done. Of course, certain procedural guides, checklists, and loading plans must be prepared on paper to assist both old and new personnel, but as to the scope and detail of the battery SOP, it is up to the commander.

As an aid in establishing an SOP, the following breakdown is given in the rapid occupation of position. Many readers will feel that the material presented is obvious and should have been learned long ago. Yet



in observing units going into position rapidly and delivering immediate fires, the US Army Artillery and Missile School has noticed repeatedly that these same simple procedures have been forgotten or ignored.

### Organization of the March Column

The battery commander must organize his march column to facilitate rapid occupation of position. The guns should be near the head of the battery column just behind the executive's vehicle. The fire direction center vehicle and personnel should be well forward in the column so the fire direction center can be operational by the time the pieces are ready to fire. In this manner, all elements required for delivering immediate fire are grouped at the front of the column. The battery commander or the reconnaissance officer precedes the battery, constantly looking for position areas should a call for fire be received during the march. Unit SOP's should provide the battery commander, battery executive, chiefs of sections, and forward observers with prearranged signals and codes that may be rapidly given orally or transmitted by radio. These signals or codes replace lengthy orders or instructions and, therefore, reduce the time required to emplace the weapons.

### Occupation of Position

The executive should perform a map reconnaissance before and during a march. The executive should be alert for position areas directly forward or a short distance to the rear of the column. The battery commander or the executive may select the first suitable position area for the firing battery when the fire mission is received. In the rapid occupation of position, only those tasks necessary to deliver fire should be accomplished initially, and duties should be decentralized as much as possible. The battery commander or executive normally designates the location for the first piece in the position area and permits the other chiefs of sections to select their own piece locations. Whether the first piece should be located to the flank or the center of the battery position should be a matter of unit SOP. The battery commander or the executive determines the direction of fire, passing it on to the battery usually by hand signals. Section tools not immediately essential for firing should remain on the prime mover. Ammunition, if carried by each section prime mover, can be taken from truck to weapon as needed. Boresighting will probably not be performed until after the first mission.

### Laying the Battery

Normally, the first gun into position should be the first piece laid and the fire mission started with this piece. A common mistake is to attempt to lay the entire battery at the same time (i.e., giving a deflection reading to all pieces before any one piece is laid). Unit SOP should indicate to what degree of accuracy the pieces are to be laid initially, e. g., to 0

mils or to within 3 mils and later relaid to 0 mils if time permits. The laying of the pieces by the aiming circle (grid-azimuth) method usually is delegated to the chief of firing battery. The executive cannot supervise emplacement of guns and simultaneously lay the pieces. However, if time is so critical that laying by aiming circle cannot be performed, a faster but less accurate method of laying can be used; for instance, the aiming point and deflection method using individual shifts (FM 6-40). Normally, aiming posts are emplaced as soon as the piece is laid; however, a distant aiming point may be used until time is available to emplace the aiming posts.

### Fire Direction Center Procedures

Determination of initial firing data is started as soon as the fire mission is received. The fire direction officer should follow the march on his map so that the battery location can be quickly inspected in on the firing chart. A firing chart and the fire direction center equipment should be ready for immediate use, and firing data should be sent to the executive as soon as it is available, whether or not the battery is ready to fire. Firing data and fire commands must not be delayed because of lack of wire communication. The fire direction center and executive post should be initially established within voice range of each other so that fire commands can be transmitted by voice. If standard fire direction center procedures cannot be used, then emergency forward observer-executive procedures (ARTILLERY TRENDS, June 1958) can be used. The unit SOP should cover such situations.

### Observer Procedures

Adjustment of fire by the observer must not be delayed because of improper radio procedures. Time will be wasted if the radio is keyed too soon or too late in sending a transmission or if the radio operator is overloaded with elements of a fire mission. The observer and the radio operator should be located so that the operator is looking directly at the observer. Thus the observer can verify what transmissions are being sent. The observer should not use his binoculars to observe the first volley impact. He should use bold range and deflection changes if rounds are lost or are a great distance from the target.

The old method of quickly going into position and delivering immediate fire is more applicable today than ever, and every battery must become expert in it. The success of a battery depends to a great extent on how well the battery SOP reflects the principles of fast occupation and delivery of fire. This matter cannot wait until tomorrow. Atomic battlefield concepts are with us now. Your battery must be prepared for them.

# WEAPONS OF THE ARTILLERY — 4

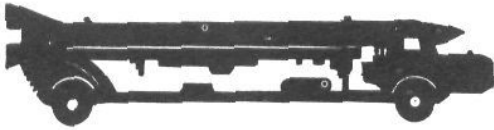

## CORPORAL MISSILE

### MISSILE CHARACTERISTICS

#### Weight:

warhead..... 1,500 lbs

body..... 3,200 lbs

#### propellants

oxidizer ..... 4,400 lbs

fuel..... 2,100 lbs

air..... 300 lbs

Total: 11,500 lbs

Length: 13.7 meters (45')

Diameter: 0.8 meters (30")

Range: 50-130 km  
(30-80 mi)

Guidance: preset & cmd

Speed: supersonic

Manufacturer: Firestone and Gilfillan  
Bros.

### ERECTOR CHARACTERISTICS

Purpose: pickup, transport, hold, and  
erect

Weight: 57,000 lbs

Length: 13.7 meters(45')

Height: 3.4 meters(11')

Width: 2.7 meters(9')

Wheelbase: 9.1 meters(30")

Max speed: 35 mph

Turn radius: 13.7 meters(45')

### LAUNCHER CHARACTERISTICS

Purpose: platform to hold missile in  
vertical pos

Allocation: 2 per bn

Weight: 6,000 lbs

Traverse: 6,400 mils

### TRAINING REFERENCES

(C)FM 6-30 FA Msl Bn Cpl (Oct 56)

(SRD)FM 6-30A FA Msl Bn (Oct 56)

FM 6-31 FA Msl Bn Cpl (Dec 56)

FM 6-32 Guidance System FA Msl  
Bn Cpl (Dec 56)

(C)TM 9-5036 Description Cpl Type  
II FA Msl System (Oct 57)

(C)TM 9-5038-1 Operation: FA Msl  
M2 (XM2E1) (Mar 57)

(C)TM 9-5038-2 Org Maint FA Msl  
M2 (Sept 57)

TM 9-5048 Operation and Org Maint  
FA MSL M2 (Dec 56)

TM 9-5060 GM Launcher XM  
27('56)

(C) TB-9-5036-3-1 Operational Pro  
for Mock Shoots (Jun 58)

#### Training Films:

(C) 6-2401 Intro to Cpl Sys Part I  
(25 min-1956)

6-2402 Intro to Cpl System, Eqp  
Part II (25 Min-1956)

6-2403 Cpl Msl Fueling  
Operations (35 min-1956)

6-xxxx Cpl Msl Defueling  
Operations (in production)

#### Tables of Organization:

TOE 6-545D (Feb 57) w/C1, C2

#### Army Training Test:

(C) ATT 6-10 (Dec 56) w/C1, C2

#### Firing Tables:

(C) FT Cpl B-2 (Apr 57)

# ARTILLERY MAP

## SYMBOLS

### MODERNIZED

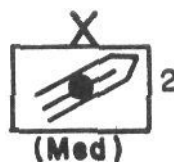

A revision of military symbols and abbreviations was necessitated by the Army's adoption of the combat arms regimental system, the program of modernizing Army terminology, and the activation of completely new units such as the US Army Missile Commands. The symbol shown above is that of the 2d US Army Missile Command.

The symbols below are currently in use at the US Army Artillery and Missile School for instructional purposes. As yet, these symbols have not been officially adopted by the Army. This information is published as a guide only, pending revision of FM 21-30 or a directive from Headquarters, United States Continental Army Command.

#### Field Artillery Symbols

Divisional field artillery units are designated by the infantry, armor, or airborne symbol superimposed on the field artillery symbol. Corps and army units are designated by the basic field artillery symbol, except for airborne corps field artillery which may be designated by the gull wing under the artillery dot. Aeropack field artillery units are designated by the same symbol as a comparable towed unit.

Self-propelled units are designated by the abbreviation SP in parenthesis after the regimental designation. The abbreviation SP should be used only when necessary. For example, it is unnecessary to use SP after the regimental designation in a symbol for a field artillery unit of an armored division. But it is appropriate to use SP for clarity with the symbol for a corps self-propelled field artillery unit unless all units of that type are self-propelled such as Honest John units.

A corps or army field artillery unit should not have the armored symbol superimposed over the field artillery symbol since this procedure is used in identifying the field artillery units of an armored division or separate armored unit.

When needed, the following weapon description information may be shown beneath the appropriate unit symbol: (105H), (155G), (8H), (HJ), (Red), (Sgt), (Cpl), (LX), (Obsr), (Slt), etc. This information can frequently be omitted when a suitable troop list is available.



The basic symbol for a field artillery unit of an infantry division (or separate infantry battle group).



The basic symbol for a field artillery unit of an airborne division (or separate airborne battle group).



The basic symbol for a field artillery unit of an armored division (or separate armored unit).



The basic symbol for a field artillery unit of corps of Army artillery.



Btry A, 1st How Bn (105-mm), 17th Arty. A field artillery unit of the division artillery, infantry division.



Btry A, 1st How Bn (105-mm) (SP), 14th Arty. A field artillery unit of the armored division.

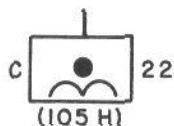

Btry C (105-mm) (Abn), 22d Arty. A field artillery unit of the division artillery, airborne division.



Mort Btry, 2d BG, 9th Inf. A field artillery mortar battery of an infantry division battle group or separate infantry battle group.

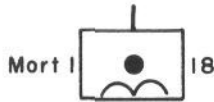

Mort Btry, 1st Abn BG, 18th Inf. A field artillery mortar battery of an airborne division battle group or separate airborne battle group.



Forward Observer, Mort Btry, 2d BG, 9th Inf.

Note. Used only when the forward observer occupies an observation post.



Observation post, 1st How Bn (105-mm), 17th Arty.

Note. Number of observation post may be shown below the base of the symbol if necessary.

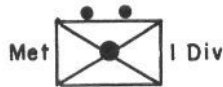

Meteorology section, Hq Btry, 1st Inf Div Arty.



Countermortar radar section, 1st How Bn (105-mm) (SP), 14th Arty.

### Corps and Army Artillery

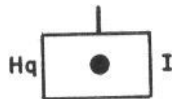

Hq Btry, I Corps Arty.

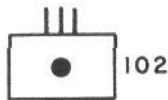

102d Artillery Group.

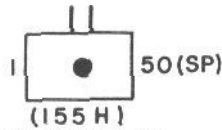

1st How Bn, (155-mm) (SP), 50th Arty.

Note. This is a complete symbol. It shows the battalion number, the regimental number, the caliber and type of the weapon, the method of organic transport and the fact the unit is corps or Army Artillery.

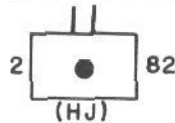

2d Msl Bn (Honest John) (SP), 82d Arty.

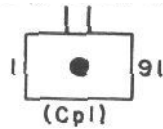

1st Msl Bn (Corporal), 91st Arty.

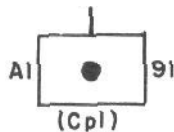

Btry A, 1st Msl Bn (Corporal), 91st Arty.

Note. This type of symbol is used when a complete firing battery of a field artillery missile battalion is located separately from the remainder of the battalion.

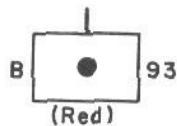

Btry B, 93d Artillery Gp (Redstone).

Note. The firing batteries of a field artillery missile group (Redstone) are designated as A and B.

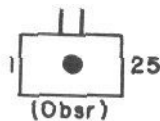

1st Obsr Bn, 25th Arty.

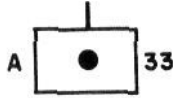

Btry A (Slt), 33d Arty.

Note. Battalion designation of parent battalion may be shown immediately to the left of the symbol if required or known.



Missile firing position (occupied). Use broken line if the position is unoccupied. Type of missile, if known, may be shown in parenthesis if desired. This symbol is useful in showing a missile launcher in firing position or in showing a firing position selected for a launcher. It is not suitable and should not be used to designate the location of a field artillery missile unit.

US Army Missile Commands

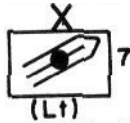

7th US Army Missile Command (Air Transportable).

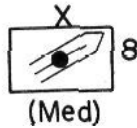

8th US Army Missile Command (Medium).

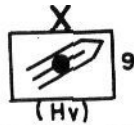

9th US Army Missile Command (Heavy).

Concentration Symbols



Concentration symbol (circle 200 yards in diameter) and concentration designation used in fire planning.

Note. AAC indicates that the concentration covers the first enemy artillery position located, and that the location has been confirmed.





Concentration symbol (see above) used in fire planning.

Note. MAHC indicates that the concentration covers the eighth enemy mortar position located, and that the location has been confirmed (FM 6-20).



Concentration symbol (see above) used in fire planning.

Note. Combinations of letters and numbers are used for targets other than enemy artillery and mortars. For procedure in designating groups of fires and series of fires, see FM 6-20.

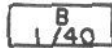

Symbol for a barrage (rectangle 200 yards wide by 100 yards deep) assigned to B Btry, 1st How Bn, 40th Arty.

Note. It is not necessary to number a barrage; a specific supported unit is allocated the barrage and a specific supporting unit fires it.

### Abbreviations Frequently Used in Field Artillery

ABst	-Air burst	LX	-LaCrosse field artillery missile
Atm	-Atomic	m	-meter(s)
Az Mk	-Azimuth mark	m	-mil(s)
BG	-Battle group (in combined form only)	Msl	-Missile
CCh	-Control chart	Mag	-Magnetic
Cpl	-Corporal field artillery missile	NFL	-No fire line
FDO	-Fire direction officer	RA	-Right ascension (in combined form only)
FEBA	-Forward edge of the battle area	Red	-Redstone field artillery missile
GZ	-Ground zero	Sgt	-Sergeant field artillery missile
HB	-Height of burst	TASCP	-Target area survey control point
HJ	-Honest John field artillery missile	TS	-Traverse station (in combined form only)
LJ	-Little John field artillery missile		

# A NEW METHOD OF PREDICTING FALLOUT

Lieutenant Colonel Robert B. Swatosh  
Department of Tactics and Combined Arms

If you hear ticking sounds on your helmet in any future war, you may not be hearing rain, but radioactive fallout. Yes, you can actually hear local fallout from a nuclear weapon whenever the radioactive particles are large enough to be of military significance (casualty-producing in a short time). To accomplish his mission, the commander must include in his planning the future locations of fallout areas.

The present method of fallout prediction (outlined in TM 23-200) developed by Armed Forces Special Weapons Project (AFSWP) is inadequate for tactical use and will soon be replaced by an Army method. The AFSWP method was devised during early nuclear weapons tests that were conducted only under the most stable weather conditions.

Three factors seriously complicate any method of predicting dose rate areas.

1. Metro data inaccuracies (wind direction measured only to the nearest 100 mils, and no measure of vertical wind motions).

2. Variability of the wind. In a typical problem, with a 15-knot scaling wind, 8 hours elapse before fallout reaches the ground about 100 kilometers from ground zero. The AFSWP method assumes that there is no change in wind direction during the 8 hours. Actually, at Desert Rock, Nevada, last summer the average variability of the wind was 50° in 6 hours.

3. The decay rate. The fallout particle decay rate may be considered as 90 percent in the first 6 hours with virtually no decay after 24 hours. When particles for the 100-roentgens/hour contour line actually reach the ground 8 hours from ground zero, they have decayed to a dose rate of about 8 roentgens/hour.

The present prediction method gives erroneous impressions and does not adequately consider these three complications. It will therefore be replaced by a new method outlined in Department of the Army Training Circular 101-( ), subject: "Prediction of Fallout and Monitoring and Survey of Radiation," which is scheduled for distribution this fall.

The new Army fallout prediction method will be used by both the radiological center and the fire support coordination center at division and higher headquarters. This method indicates a general area of probable contamination from fallout. It makes no attempt to predict the location of radiation dose rates within the area. Isodose lines or areas can be determined accurately only by monitoring and survey after the fallout is down.

The commander can use the fallout prediction to warn or alert personnel, as an aid in tactical planning, and as a basis for radiological survey. This alert should not be the sole reason for moving troops.

The artillery is responsible for furnishing meteorological data as

follows: to 102,000 feet or to the bursting altitude of the balloon 4 times daily (minimum acceptable altitude 78,000 feet) at 0600, 1200, 1800, and 2400 hours Central Greenwich Time; to 60,000 feet 8 times daily (minimum acceptable altitude 48,000 feet) at 0200, 0400, 0800, 1000, 1400, 1600, 2000, and 2200 hours Central Greenwich Time.

The first step in the new fallout prediction method is to prepare a basic wind plot on overlay paper (fig 14). The cross at the lower right

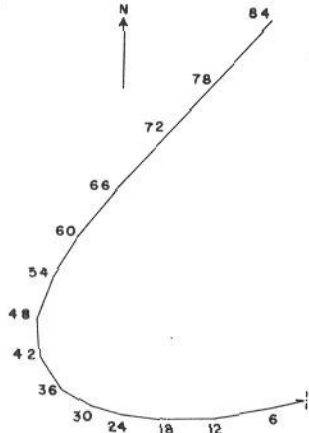

Figure 14. Basic wind plot.

represents the ground zero and the point of origin for the basic wind plot. The wind plot is for 6,000-foot zone winds with a vector for each zone.

The direction of each vector is the same as the wind direction for that layer. The length of the vector is the product of the wind speed in miles per hour and a weighting factor for the fall rate in that zone. This product is plotted in kilometers to the appropriate map scale. The altitude of the tropopause is marked with a tick mark and the letter "T." This is a weighted wind plot which represents the direction and distance of drift for the radioactive particles while falling through each 6,000-foot zone. The figures 6, 12, 18, 24, etc. indicate the point on the ground where particles originating at the top of that altitude zone will come to rest. This plot is prepared every 2 hours with the receipt of new meteorological data and is on hand in both the radiological center and the fire support coordination center in case a fallout prediction is required. A radiological fallout plotting device is on contract by the Continental Army Command and should be available in the field this year. With this device, trained personnel can prepare a basic wind plot in about 2 minutes.

The second step is to determine which portion of this basic wind plot to use. We must have the height of the atomic cloud at stabilization to determine this point. We can get the height of the cloud by one of two ways--measurements with optical instruments from units in the area,

or use of the weapon yield and charts published with the method.

In this case, we will assume that the cloud top is reported as 40,000 feet; therefore, our cutoff point is at the tropopause. We now draw lines called height lines (fig 15) from ground zero to the terminus of each wind

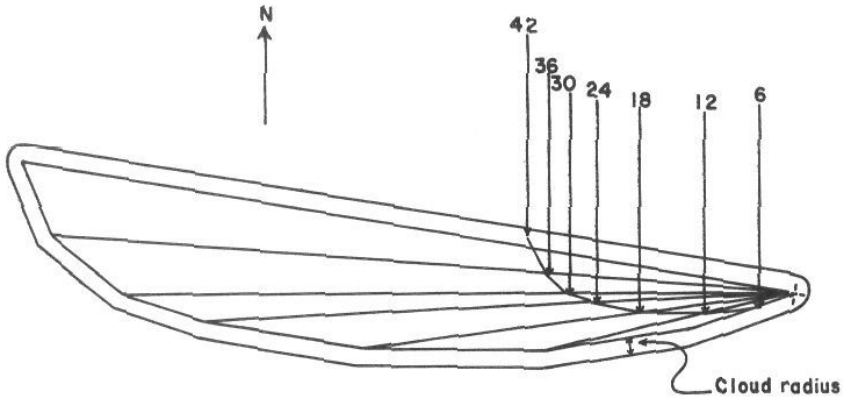

Figure 15. Primary fallout envelope.

zone level and one line to the point marking the top of the cloud. The length of the height lines is determined by a yield weighting factor from a table in the new Training Circular. The yield weighting factor for a 40,000-foot cloud is 3. In other words, the height line is drawn as three times the distance from ground zero to its intersection with the basic wind plot. Then this envelope is increased on all sides by a distance equal to the radius of the stabilized cloud. This diagram represents the primary fallout envelope. Fallout may be expected within the resultant envelope if the wind conditions remain the same as reported in the last metro message. Since the weather is expected to change, either the forecasted change or the average variability of the wind during the past 6 hours will be applied to the present envelope.

Assume that the average variability of the wind during the past 6 hours has been  $17^\circ$ . By pivoting the primary fallout envelope at ground zero by  $17^\circ$  right and  $17^\circ$  left, we outline the fallout alert area as shown in figure 16.

The new method also can be used to predict the earliest arrival times for fallout, to determine the "hot line," and/or outline the general area of contaminated air (not illustrated here). The new method is unclassified and is currently taught at the US Army Artillery and Missile School.

In the final analysis the total dose of radiation received by troops is directly related to the following tactical considerations: (1) average

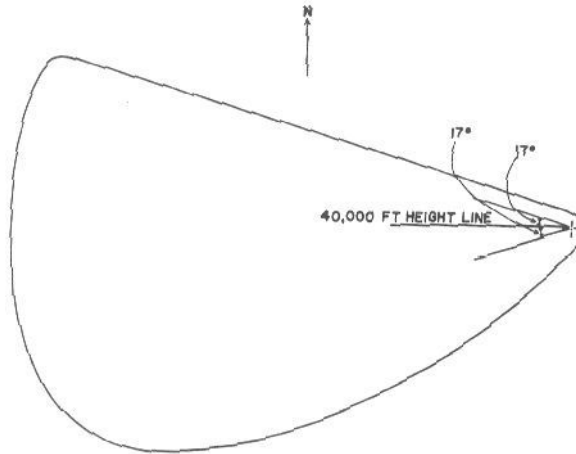
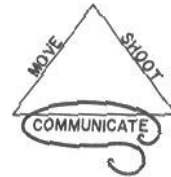

Figure 16. Fallout alert area.

dose rate, (2) attenuation--by foxholes, tanks, trucks, bunkers, etc., and (3) exposure time--speed is the keynote since exposure time has a direct correlation to total dose. In a fallout area move fast, dig fast, and stay underground as much as the situation permits.

## SITE TO COMMUNICATE

Major N. B. Pannell  
Department of Communication and Electronics



Reports from field exercises indicate that most failures in radio communication are the result of a failure to apply the principles of proper siting and antenna use. Radio operators must know these principles and incorporate them into every radio installation.

Let us state briefly the principles of proper siting:

1. Determine the general location of the other stations in the net, giving primary consideration to the control station.
2. Position the vehicle so that the mass of the vehicle is between the receiving and transmitting stations (fig 17). In our radio sets we generally use a half-wave antenna, but due to the size and length of such an antenna, we simply put a quarter-wave antenna on the vehicle and use the mass of the vehicle as the other quarter wave.

For example, radio communication between the front and rear of a long road column is often difficult. Pulling off the road and turning the vehicle toward the rear of the column will materially aid reception and transmission. In so doing, the principle of placing the mass of the vehicle

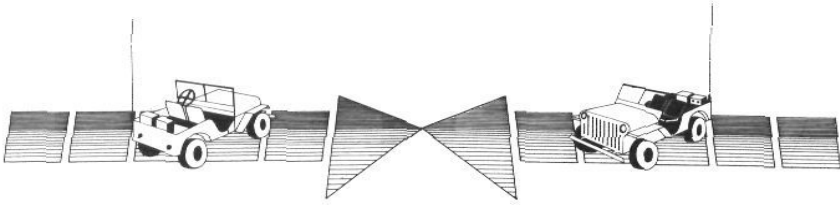

Figure 17. Properly sited vehicularly mounted radio sets.

between the receiving and transmitting station has been applied, affording maximum antenna use.

3. If necessary to improve reception, move the vehicle a few feet to determine the best operating position. In mountainous and heavily forested areas in Europe, moving a radio vehicle a few feet often has meant the difference between establishing communications or not. Often you find that you are in a "dead spot" and merely moving those few feet will open the way to clear operation.

Proper antenna use is just as important as proper siting of the set. The proper length and type of antenna is issued with each set, but the following principles of proper antenna use must be adhered to in order to gain the most range.

1. Make sure that the antenna is properly installed and connected.
2. Use the correct antenna for the set.
3. Install the RC-292 antenna (fig 18) when greater operating

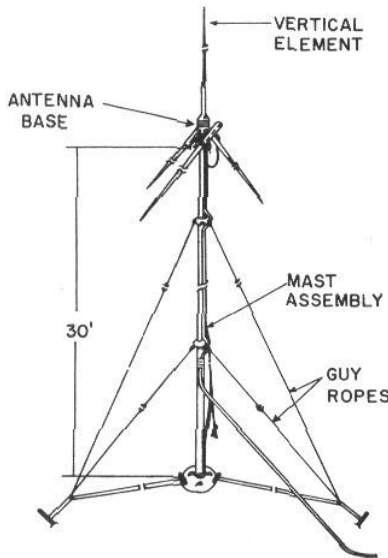

Figure 18. The RC-292 antenna is now issued to batteries.

ranges are needed than can be afforded by the standard issue antenna.

The RC-292 is an elevated, wide band, modified ground plane antenna elevated on a 30-foot sectional mast which is held erect by guy ropes and ground stakes. When disassembled it is packed in a canvas roll 35 inches long and 36 inches in circumference and can be carried by hand.

The RC-292 antenna is listed in the table of organization and equipment of all pentomic divisions. Even the airborne division with its emphasis on stripping to essentials includes one RC-292 per firing battery. Each ROCID mortar and 105-mm howitzer battery is allocated two antenna sets. The ROCAD 105-mm howitzer battery has one.

In dense forests where radio communication is difficult, the RC-292 gives line of sight by getting your antenna high in the air. Although the RC-292 requires some physical labor to install, the increased receiving range is well worth the sweat expended. Two men can erect the antenna in 12 to 15 minutes.

These principles may not answer all the problems of communication, but by following them, greater radio receiving ranges and more dependable radio communication will be achieved.

#### A GEM FOR THE COMMUNICATIONS OFFICER

In order to establish communication from the executive post to the pieces switching kit MX\_ 155/GT is normally employed. When the switching kit is not available a conference circuit may be established by placing male electric plugs (preferably rubber) on the wire lines employed by the firing sections. The executive phone is then connected in parallel with six female sockets (two three-way receptacles). The lines from the pieces may then be connected at the executive post.

--Submitted by Lt James J. McGinn  
Mortar Btry, 2d BG, 60th Inf  
Ft Devens, Massachusetts

#### A GEM FOR THE BATTERY EXECUTIVE

Have you ever had difficulty getting traction with a track-laying vehicle on icy roads? Place a 1/4- or 3/4-ton truck in front of your slipping SP, attach a towline, and slowly start pulling. Frequently this forward pull will be sufficient to get your track vehicle started again.

--Submitted by Maj Charles H. Moore  
Hq, 9th Inf Div Arty  
Ft Carson, Colo

# SIMPLIFIED FIRE PLANNING FOR THE FORWARD OBSERVER

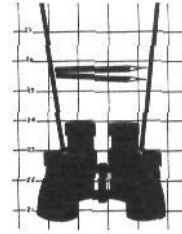

Captain Charles M. Hunter  
Department of Publications and  
Nonresident Training

To the newly commissioned artillery lieutenant, the subject of fire planning must frequently seem like the combined works of a juggler and a crystal ball gazer.

If the lieutenant will cast aside his preconceived ideas of large maps and numerous overlays and think of his level of fire planning in terms of a target list, rather than by the more imposing title of a fire plan, then much of the seemingly existing hocus-pocus will evaporate.

The method of fire planning for the forward observer outlined in this article is now being taught to resident and nonresident classes of the US Army Artillery and Missile School. A block diagram (fig 19) illustrates the basic steps in the preparation of the forward observer's target list. These procedures are illustrative of the infantry division's mortar battery forward observer but apply to all forward observers with minor variations. Observer gunnery procedures are not covered here since they are fully explained on pages 77-127 in FM 6-40, Field Artillery Gunnery (April 1957).

## Selecting Targets

First and foremost the forward observer must know the company's mission-- attack or defend. He must then understand the plan of maneuver or the scheme of defense to be used. Will it be 2 platoons up and 2 back or a 3 and 1 combination? Factors in the selection of targets are: the desires of the rifle or tank company commander, the forward observer's own observations, map inspection, and a knowledge of enemy tactics.

Whenever possible the forward observer accompanies the company commander on his reconnaissance and assists him in evaluating which targets should be attacked by the company's three organic 81-mm mortars and three 106-mm recoilless rifles and which would be more profitably engaged by the artillery. The commander decides which targets he wants the artillery to hit and the time he wants them hit; it may be on call or, if a preparation is to be fired, early or late in the preparation. As the company commander locates the targets, the forward observer should record their location and description.

## Fire Planning for the Offensive

For an offensive operation, the forward observer plans concentrations on known enemy targets, suspect enemy targets, and prominent terrain



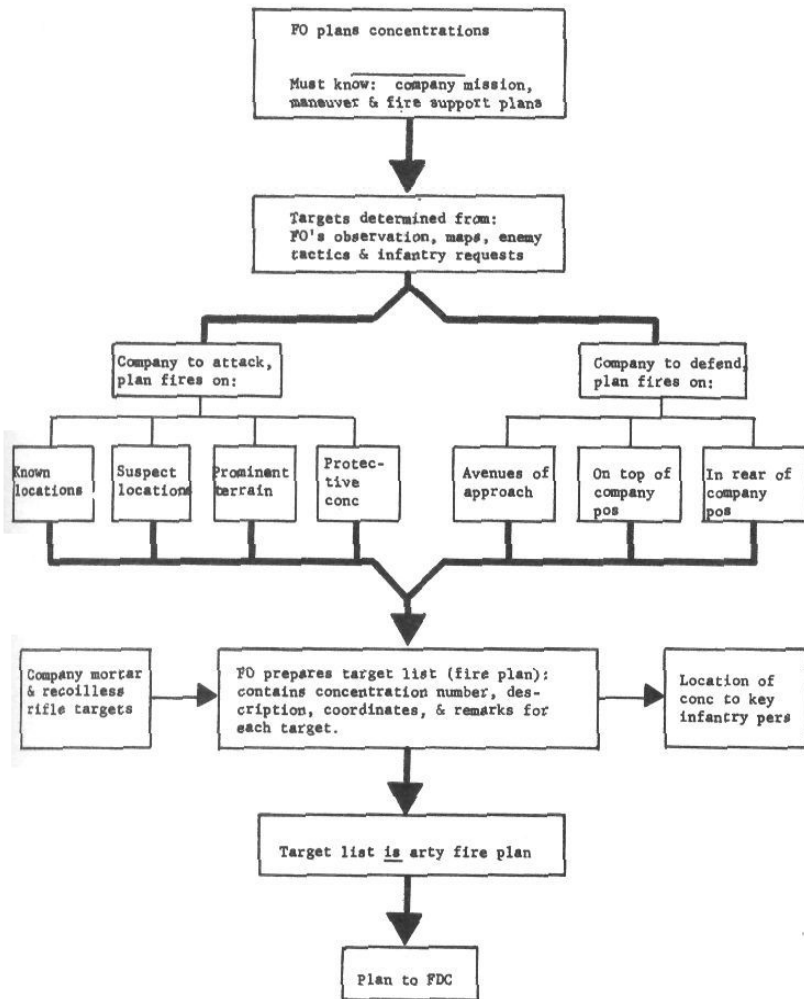

Figure 19. Steps in the preparation of the forward observer's target list.

features. Concentrations are planned on prominent terrain features so that the forward observer will have easily recognizable points upon which he can place fires or from which he can make accurate shifts and quickly enter fire for effect.

Protective concentrations are planned by the forward observer on prominent terrain features and avenues of approach near the objective (or reorganization area) to protect the infantry from counterattacks during the reorganization. These concentrations are located around the forward portion of the area approximately 450 meters (500 yards) away from the objective. Three or four concentrations are usually sufficient for a company-size objective. A few easily recognizable points are better than a dozen hard to identify points which might be difficult to distinguish in battle.

### Fire Planning for the Defensive

In a defensive operation, the infantry commander and the artillery forward observer locate artillery barrages to fill the gaps and dead spaces in the infantry's final protective fires. The forward observer plans defensive fire to protect the forward edge of the battle area in his company's zone. Defensive concentrations are located on likely avenues of approach in front of and behind the position and on avenues of withdrawal throughout the area. Easily recognizable terrain features such as roads and trail junctions, hills, buildings, or the edges of wooded areas are selected as reference points so the forward observer can rapidly shift fires and quickly enter fire for effect.

### The Forward Observer's Target List

The target list prepared by the forward observer is his fire plan. Each target should be identified by concentration number, target description, coordinates, and remarks. The list is informal and must be kept simple. Those concentrations which will be fired by the company's recoilless rifles or 81-mm mortars may be included.

All targets are given a concentration designation consisting of 2 letters and 2 or 3 digits such as "BC 309." The letters indicate division and battle group. The digits are taken from the block of numbers assigned to the infantry company with which he is working (table 2). All concentrations planned by the forward observer and the company commander are assigned a concentration designation. When appropriate the remarks column indicates which targets will be engaged by company recoilless rifles and mortars.

The locations and designations of the various concentrations are given to the company commander, the platoon leaders, and the three rifle company mortar observers so they may request artillery fire on targets which might not be visible to the forward observer.

<u>Unit</u>	<u>Numbers</u>
Battle group hq (liaison officer)	1-99
Company A (FO w/A)	100-199
Company B (FO w/B)	200-299
Company C (FO w/C)	300-399
Company D (FO w/D)	400-499
Mortar battery FDC	500-799
Attached units or as desired	800-999

Table 2. One method of assigning concentration numbers within a battle group.

The mortar battery forward observer's target list (fig 20) is sent to the fire direction center. It may be transmitted by wire, radio, or messenger.

The success or failure of the company or even the battle group may depend upon how well the forward observer knows his business. The fire plan, when considered as a target list, can be readily understood and effectively implemented with a minimum of training.

### Arty Target List

TO: Acorn Red  
Mortar Battery FDC

24 Oct 58

<u>Conc Nr</u>	<u>Description</u>	<u>Coordinates</u>	<u>Remarks</u>
BC 300	MG position	52314628	early in preparation
BC 301	recoilless rifle	53464501	late in preparation
BC 302	trail junction	51994610	on call
BC 303	stone marker	52374511	on call
BC 304	suspect OP	52314743	Smoke on call
BC 305	road junction	53114824	protective conc
BC 306	brick house	52194800	protective conc
BC 307	Steel bridge	54094788	protective conc
BC 308	trenches	52414648 to 53604599	81's fire at H-hour arty on call
BC 309	bunker opening	53814629	106's before H-hour

C.M. Hunter  
FO w/Co C

Figure 20. An example of a target list prepared by a forward observer.

# **GOOD GUNNERY MEANS IMPROVED HONEST JOHN ACCURACY**

First Lieutenant Benjamin T. Meadows  
Department of Gunnery

What can be done to improve the accuracy of the Honest John system? Because of the tremendous tactical importance of the Honest John, this question is continuously being asked by commanders at all echelons. The long range research and development program aims at advancements in the system through improved materiel and equipment such as the new rocket and launcher combination designated the XM50 and XM386 respectively. This long-range program promises improvements in the not too distant future, but it actually does not represent an answer to a second and more basic question-- What can be done now? The answer to this question must come as a result of improvements in troop procedures.

## What Is Good Gunnery?

Good, sound gunnery procedures are mandatory if the maximum capabilities of any weapon system are to be realized. This fact is well established and particularly true for the Honest John. But what is meant by good gunnery procedures? Too often the user loses sight of the fact that good gunnery procedures include, but are not limited to, the actual computation of firing data by the fire direction center. Such things as accurate survey, proper emplacement and laying of the launcher, and proper ammunition handling procedures are vital to attaining accuracy.

Considering first the solution of the gunnery problem, it is absolutely essential that all data be precise and accurate, and a few simple rules and precautions that will result in a greater assurance of accuracy are certainly in order.

A current metro message is needed; one that has been taken as near to the time of firing as possible with the metro station located as near to the center of the trajectory as is feasible. Above all else, however, the metro message must be accurate. Too often the metro message is accepted at face value by the fire direction officer, and the possibility of a mistake is seldom considered. A simple check can be made by just comparing the current metro message with the last metro taken. Serious discrepancies, such as a 9 percent density mistake (representing an impact error of approximately 700 meters at mid range), can be detected and corrected prior to firing.

Analysis of free rocket firing reports (CONARC Report 929-R) indicates that an error is being made in determining weights to be used in the fire direction center computations. Empty weight, propellant weight, and propellant temperature are the ammunition data necessary to solve the gunnery problem. Empty weight should be computed according to the

instructions appearing in change 3 to FTR 762-B-1 and change 4 to FTR 762-A-1 and verified by at least two persons. A simple recording or computation mistake can result in a serious dispersion error. Empty weight, defined as the gross weight of the complete missile excluding the propellant and spin charges, may be obtained in two ways.

In the case where only the gross weights of the rocket components are given, the following procedure must be used. Add the gross weight of the motor, the warhead, and a nominal weight of 166 pounds for the fins to obtain the gross weight of the rocket. Empty weight is then determined by subtracting the sum of the propellant (fuel) weight and 13.7 pounds for the spin rocket propellant. Example:

Gross weight, motor	4,100	Propellant weight	2,051.0
Gross weight, warhead	1.650	Spin rocket propellant	
Nominal weight, fins	166	weight	13.7
Gross weight, rocket	5,916.0		2,064.7
Propellant weight plus spin rocket propellant weight	2,064.7		
Empty weight	3,851.3 rounded off to 3,851		

Firing table data to be used in computations:

Empty weight	3,851
Propellant weight	2,051

In the case where the empty weight of the motor is given, the procedure is as follows. Add the gross weight of the warhead, the empty weight of the motor, and the nominal weight of the fins to obtain the empty weight. Propellant weight is stenciled on the motor body. Example:

Gross weight, warhead	1,650
Empty weight, motor	2,025
Nominal weight, fins	166
Empty weight	3,841

Firing table data to be used in computations:

Empty weight	3,841
Propellant weight	2,051

Keep in mind that the propellant (fuel) weight to be used in fire direction center computations is the weight of the propellant in the rocket motor and does not include the nominal weight, 13.7 pounds, allowed for the propellant in the spin rockets. As a quick check, propellant weight should not vary from standard (2,050 pounds) by more than plus or minus 1 pound, i.e., 2,049 to 2,051. There is one exception to this rule: gross weights and propellant weights of certain rocket motors (motor lots RAD 1-23 and RAD 1-24, RAD 1-28 through RAD 1-38) have been purposely stenciled on the motor body in error so that an elevation and time-of-flight

correction will be computed by the unit to compensate for a low impulse propellant. Stenciled weights appearing on these motors will be approximately 21 pounds less than normal, i.e., propellant weight 2,030. In all cases the stenciled weights should be used in solving the gunnery problem.

Propellant temperature is measured with the TOE M2 powder thermometer (Rochester type). To insure that accurate temperatures are reported, the temperature should be determined with a calibrated powder thermometer as close to the time of firing as possible. Troop units cannot, at the present time, calibrate the TOE powder thermometers; however, until such time as an adequate calibration device is provided, Ordnance will do the calibrating. The powder thermometers should be calibrated periodically.

### Accurate Survey Is Vital

Large dispersion errors sometimes accepted as being the result of an inherent error can often be traced to an inaccurate survey. Simple precautions can and must be taken if this type error is to be prevented. If time permits, as a check, the survey team should close the survey on a known point. The fire direction officer should give the launcher platoon leader the computed azimuth of fire and the azimuth of the orienting line. The platoon leader should always, as a check of the survey and fire direction center computations, measure the azimuth of fire and the azimuth of the orienting line with the aiming circle (the fire direction officer should insist on this check as a part of the platoon leader's report (executive's report) to the fire direction center).

Emplacing and laying the launcher is the second major consideration in achieving accuracy. To provide a firm, stable platform for launching the rocket, the weight of the launcher must be raised off the vehicle's tires and suspension system. Needless to say, the five launcher jacks are for this purpose. However, improper use of the jacks will result in an unstable firing platform. The question is often asked, "How do you know that the weight of the launcher is off the suspension system?" The answer is quite simple. If the launcher tires are clear of the ground, then it can be safely assumed that the weight has been removed from the springs of the vehicle. In cross leveling the launcher prior to initial laying, the launcher jacks should be employed simultaneously, i.e., the two jacks on the same side of the vehicle should be used together. The same holds true for longitudinal leveling. The two front jacks and rear jack should be used simultaneously.

Before the launcher is finally laid by the platoon leader in the direction of fire, the sighting and aiming devices on the launcher must be accurately boresighted. The boresighting bracket must be fastened securely to the launcher rail. The panoramic sight and sight mount extension must be seated tightly in the sight mount. Make sure the quadrant mount, M1 is checked against the permanently mounted quadrant seats

on the side of the launcher rail. If a discrepancy exists between the two sets of quadrant seats, then an elevation correction factor must be applied in firing until Ordnance can repair or adjust the quadrant mount. The actuating arm of the sight mount must be aligned in a plane which is offset 6.8 mils from the launching rail. To prevent errors from cant if a discrepancy is discovered in the sight mount, the launcher must be cross leveled as a last operation prior to firing. (Boresighting procedures are outlined in Technical Manual 9-3060 and Field Manual 6-60.)

### Proper Assembly and Handling

Proper assembly, conditioning, and handling of the rocket is the third major consideration in achieving accuracy. These operations should be checked thoroughly by the unit commander because this area has a vital effect on the system's accuracy.

In the assembly of the missile, the rocket assembly specialist's opinion as to the degree of tightness of warhead and fin bolts is not sufficient! The torque wrenches provided in the rocket assembly specialist tool kit must be used to tighten warhead and fin bolts. Also, the fins of the missile are not levers and should not be used to change the position of the rocket motor on the rocket trailer.

The aerodynamic characteristics of the missile are seriously affected by dents and abrasions to the rocket's surface. Therefore, the firing unit should not paint the missile, and extreme care should be taken in handling the rocket components to prevent dents and scratches in the surface of the rocket.

Proper use of the heating blankets will insure that the rocket motor is properly conditioned when it is fired. A few simple rules for using the blankets can be applied to great advantage. If the missile is to be fired within 24 hours after the time that the blankets are put on the missile, then no heat should be applied. Heating the rocket motor for less than 24 hours introduces serious temperature gradients which result in erratic burning of the fuel. Temperature gradients in the propellant grain can be minimized by a continuous heating period of 48 hours. In most cases (ambient temperature permitting), the blankets should be used primarily as an insulating device rather than to heat the motor. Another point to keep in mind is that the rocket motor is extremely sensitive to wind or direct rays of the sun; therefore, the blankets should be left on until at least 15 minutes before firing.

So to answer our original question, i.e., what can be done to improve the accuracy of the Honest John system, it can be said that research and development agencies will contribute to the improvement of the system by developing new materiel and equipment. But good, sound gunnery procedures are the best answer to the accuracy problem at the present time.

# **NEWS NOTES FOR ARTILLERY MEN**

---

## NEW MOS SYSTEM FOR ARTILLERYMEN

Department of the Army Headquarters is preparing a new MOS structure for cannon and missile artillerymen. The revision will establish a three-digit MOS system for classifying critical electronic maintenance jobs and men qualified to fill such jobs; classify many electronic equipment operating jobs in the combat rather than electronics occupational area; and establish a new MOS system which will permit more precise identification of jobs and men in terms of specific missile systems.

Appropriate changes to AR 611-201 and to pertinent tables of organization and equipment will be distributed in the near future. These changes will not be made effective until specific instructions are issued by Headquarters, Department of the Army. The change is planned for 1 November 1958.

A complete list of the new MOS structure is contained in DA Circular 611-19 dated 22 July 1958. A partial coverage of the new MOS system is listed below.

### Field Artillery Weapons

- 140 -- Field Artillery Basic
- 141 -- Light and Medium Field Artillery Crewman
- 142 -- Heavy and Very Heavy Field Artillery Crewman
- 143 -- Deleted
- 144 -- Deleted
- 145 -- Deleted
- 146 -- Field Artillery Rocket Crewman (Little John)
- 147 -- Field Artillery Rocket Crewman (Honest John)

### Field Artillery Missile Operations

- 164 -- Field Artillery Crewman (Corporal)
- 165 -- Field Artillery Missile Fire Control Crewman (Corporal)
- 166 -- Field Artillery Missile Crewman (Lacrosse)
- 167 -- Field Artillery Missile Fire Control Crewman (Lacrosse)
- 168 -- Field Artillery Missile Crewman (Redstone)
- 169 -- Field Artillery Missile Materiel Crewman (Redstone)

## 8-INCH HOWITZER NOW TOWED WITHOUT LIMBER

The 8-inch howitzer has a new prime mover--the M125, 10-ton truck--which can tow the weapon in two ways: trailed, that is with the limber, or semitrailed (fig 21), without the limber. For ordinary trailing, the standard towing pintle is used, but for semitrailing, the pintle is removed and a special drawbar put in its place.



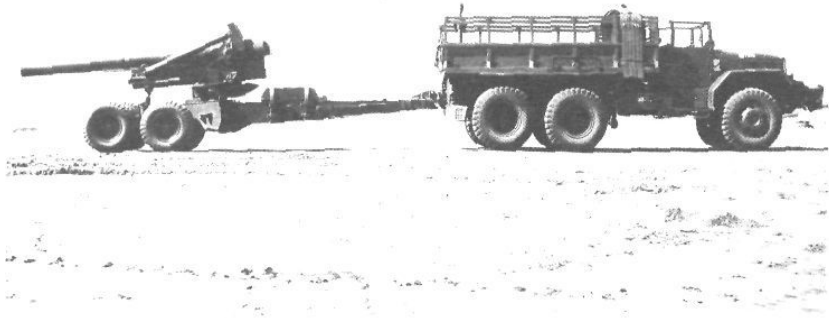

Figure 21. 8-inch howitzer semitrailed (without limber).

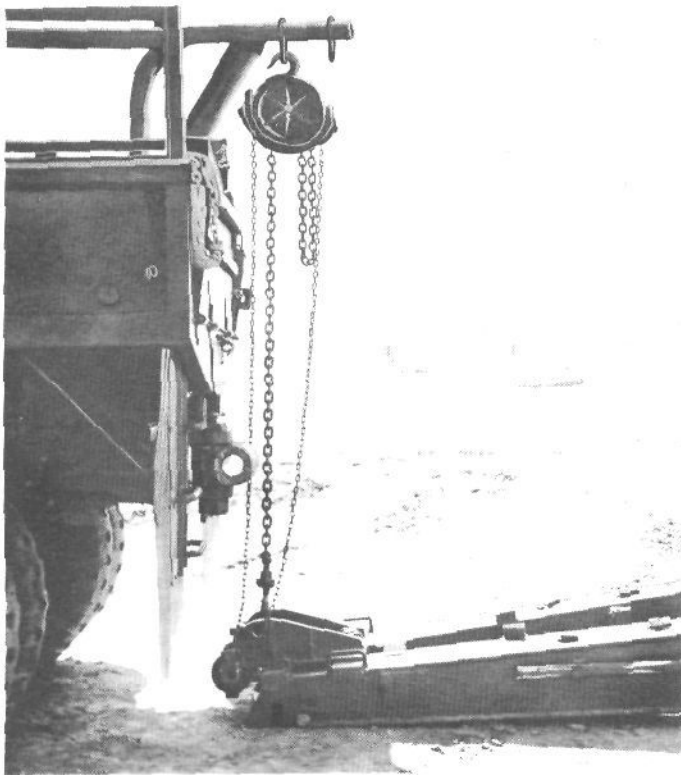

Figure 22. Davit and chain hoist. Preparing to lift trails.

An 8-inch howitzer semitrail is easier to back up and easier to maneuver in woods. Also, it has a shorter turning radius. But the new towing system has some limitations. A semitrail 8-inch howitzer will get stuck in a gully quicker than an 8-inch towed with a limber. The absence of the limber lowers the trails as soon as the truck crosses the gully.

When coupling, a chain hoist on the rear of the truck bed lifts the trails (fig 22) to the proper height, and the driver then backs into the trails to complete the coupling. One difficulty is that the truck drawbar and the trails must be almost perfectly aligned (fig 23) before the coupling can be

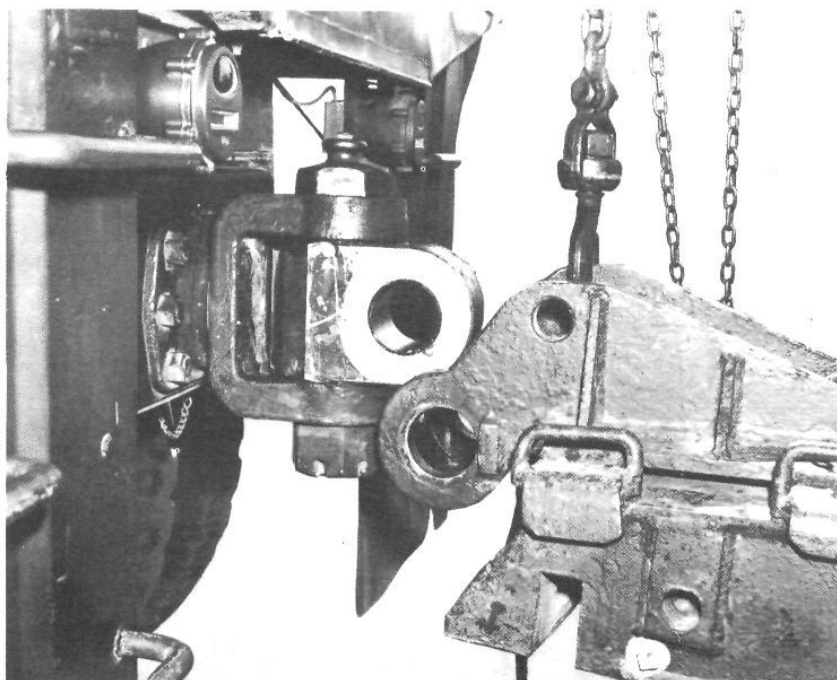

Figure 23. Careful handling is required to accomplish alinement.

made. Also, care must be exercised when lowering the chain hoist to prevent damage to the chain guide.

The M125 truck replaces the M8 tractor as the basic prime mover; however, some tractors will be kept in the batteries to tow the weapons in special situations.

CROSS-TRAINING COURSE FOR CAREER OFFICERS

In August of this year, newly commissioned Regular Army Artillery officers will start receiving both field and air defense artillery training for the first time since the fall of 1949.

The new artillery officer basic course (6-A-CIC/44-A-CIC) (table 3) will be unique in many aspects. First, it will cover the entire spectrum of artillery weapons, both tube (less the 75-mm, 90-mm, and 120-mm guns) and missile, in a 20-week period. Second, it will provide, in the last 2 weeks, appropriate familiarization training on the weapon of the unit to which the officer will be assigned upon graduation.

Phase I (Ft. Sill)		Phase II (Ft. Bliss)		Weapons Familiarization	
Dept	Periods	Subject	Hours	Phase--Example - Corporal -	
Comm & Elect	42	40-mm gun & misc	22	Dept	Periods
Gunnery	164	Nike systems	88	Comm & Elect	1
Materiel	74	Hawk system	20	Gunnery	11
Motors	33	Air def tactics	48	Materiel	28
Observation	53	Total	178	Motors	5
Tactics & CA	136			Observation	19
Total	502			Tactics & CA	24
				Total	88

Table 3. Breakdown of new basic course for career officers.

Phase I will be conducted at Fort Sill. This 13-week phase will give the students a sound knowledge of general artillery subjects including specialized training in field artillery techniques. Phase II will be conducted at the US Army Air Defense School, Fort Bliss, Texas, where the students will undergo an intensive 5-week course in surface-to-air artillery missiles and techniques.

SEVENTH ARMY ARTILLERY CONFERENCE

The annual Seventh Army artillery conference is scheduled for the 10th through the 12th of November in Frankfurt, Germany. The US Army Artillery and Missile School will participate for the third straight year together with representatives of the US Army Air Defense School and the Department of the Army.

Seventh Army conducts combat arms and services conferences to keep abreast of the progress in Army equipment techniques and organization concepts. The artillery conference is attended by senior artillery commanders and staffs.

Presentations by the School will cover the latest developments in target acquisition, communication, weapons and ammunition, nuclear weapons employment, Army aviation, gunnery, and organization.

## NEW ARTILLERY TERMINOLOGY

As weapons and tactics change so do artillery terms. Listed in table 4 are some of the recent changes which the US Army Artillery and Missile School is now incorporating into resident training and 6-series field manuals currently under preparation or revision.

<u>Changed from</u>	<u>To</u>	<u>Example of Usage</u>
launch	fire	They will fire the Corporal missile at 0900.
launching position	firing position	The Redstone battery will occupy a firing position at coordinates 12344421.
surface-to-surface missile (SSM)	field artillery missile	The family of field artillery missiles includes the Honest John, Corporal, Redstone, and Lacrosse.
surface to air missile (SAM)	air defense missile	The family of air defense missiles includes the Nike series and the Hawk.
atomic round	nuclear round	The first firing of a cannon-type nuclear round occurred at Frenchman Flats, Nevada, on 25 May 1953.

Table 4. New artillery terms.

## AIRPHIBIOUS EMPLOYMENT OF SOUND RANGING PLATOON

Studies at the US Army Artillery and Missile School Department of Target Acquisition have illustrated the feasibility of using the H34 helicopter for rapidly moving and employing the sound ranging platoons of the observation batteries. When terrain or weather makes overland transportation impractical, helicopters, such as the H34 can transport and install artillery sound ranging bases of any type.

Wire net installation is efficiently completed by using a new airborne wire-laying device mounted in an H34 helicopter. Accommodating eight dispensers of MX306-G wire at one time, the helicopter can lay 4 miles of wire without interruption, while a new version still being tested will increase this distance to 16 miles.

## 1958 ARTILLERY INSTRUCTORS' CONFERENCE

Periodically, each of the branch service schools conducts a conference for the instructors of their branch who are assigned to other service schools. These conferences are one of the principal means of standardizing the branch doctrine taught in the schools of the Army educational system. They also provide a look at equipment research-and-development programs.

The 1958 Artillery Instructors' Conference was conducted from the 23d through the 27th of June at Fort Sill. Eighty-one conferees from 38 service schools and other interested agencies attended. Guest presentations were made by the Office of Research and Development, Department of the Army; the Command and General Staff College; and the US Army Air Defense School.

Highlights of the week's program were presentations on:

1. A new concept of artillery organization and employment for atomic and nonatomic support which the US Army Artillery and Missile School is developing for the pentomic organizations.
2. The organization, tactical deployment, and nuclear logistic support of field artillery atomic fire units (a field demonstration).
3. Increasing the timeliness of cannon artillery fire by adherence to sound, simple procedures, and the age-old artillery spirit of getting that first round on the way. A proposed new fire direction center procedure under consideration by the School is also expected to speed up the delivery of fire.

At the closing seminar, Brigadier General Philip C. Wehle, Assistant Commandant of the School, stressed that in the new age of atomics, missiles, and electronics we must maintain a sound relationship between commander, technician, and machine. Technical complexities will require new categories of functions, but fundamentally the commander must always remain in control and be responsible for his unit. General Wehle also emphasized the need both in cannon and missile artillery for a thorough understanding of the unit's weapons system so that the commander may obviate the effects of an equipment failure in any part of the system by directing the use of simple field expedients.

## NEW DISTANCE-MEASURING EQUIPMENT FOR SURVEY

The Tellurometer, an electronic distance-measuring device capable of accurately determining line-of-sight distances of approximately 40 miles, is being put through its paces at Fort Sill. Methods of employment are being devised by actual field tests, and techniques are being studied which were formulated by the US Coast and Geodetic Survey, the US Geological Survey, the Army Map Service, and the Army Engineers. When completed, these operating techniques will be taught in the resident survey specialist courses and made available through instructional material issued by the US Army Artillery and Missile School.

CHANGES IN SCHOOL ORGANIZATION

The US Army Artillery and Missile School organization (fig 24) was recently revised. Two of the instructional departments have been renamed.

The Office of the Deputy Assistant Commandant for Research and Development was abolished. The functions of that office were assumed by the Department of Combat Development and other departments of the School. The Deputy Assistant Commandant for Instruction has been redesignated the Deputy Assistant Commandant.

The Department of Observation has been redesignated the Department of Target Acquisition and the Department of Artillery Transport is the new name for the Department of Motors. Both titles reflect the expanded areas of instruction each department now embraces.

Since "Target Acquisition" was selected as best describing the varied functions within the former Department of Observation, a further change became necessary redesignating the Target Acquisition Division--a recent consolidation of the Sound and Flash and Radar Divisions--the Sensory Equipment Division. The other divisions of Research, Survey, Meteorology, and Missile Guidance were not changed.

Similarly, the change to Department of Artillery Transport reflects the expanded role of the former Department of Motors in its mission of developing new, unusual, or unconventional means of artillery transport.

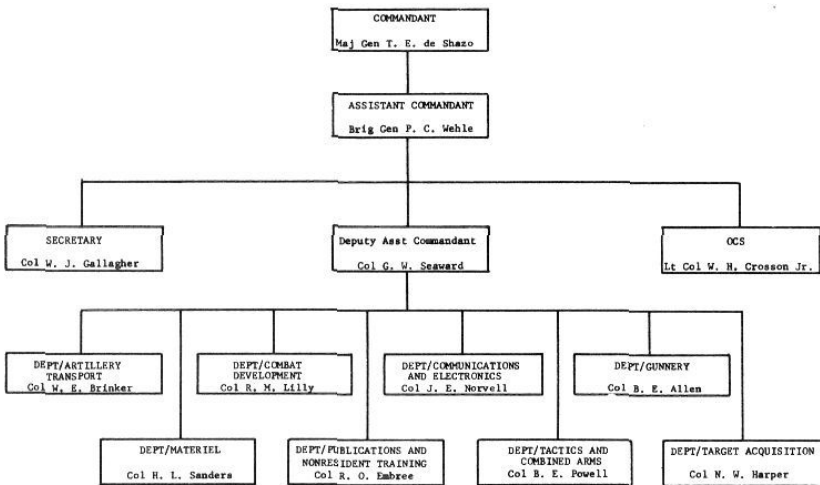

Figure 24. Organization of the US Army Artillery and Missile School.

NEW BUILDING FOR THE COMMUNICATIONS DEPARTMENT

On 17 June 1958 ground was broken for a new Department of Communication and Electronics building. The 80 by 315 foot structure will have three stories plus a small fourth story which will house Fort Sill's Military Affiliate Radio Station (MARS), AA5 USA.

The building, scheduled for completion in July 1960, will be named Burleson Hall in honor of the late Master Sergeant Clarence Burleson who performed outstanding service to the Army during his long military career.

Burleson Hall will contain 10 laboratories, 11 classrooms, administrative space, and a large, theater-type, tiered classroom which will have a stage for displaying radio vehicles and vans. An exhaust system will permit running the vehicle's engine during the class.

This permits demonstration of mounted radios indoors. Television outlets for all classrooms and laboratories are included and will be used should a television teaching facility become available on the post.

Artillerymen familiar with Fort Sill can easily visualize the building's location northwest of Snow Hall on the old golf course, just below the rise of ground which once marked the site of the old Redoubt.

REDSTONE MISSILE GROUP REORGANIZED

The 46th Field Artillery Group (Heavy) has been reorganized and redesignated the 46th Artillery Group (Redstone). The new organization will acquire its additional personnel from the inactivated Headquarters and Headquarters Battery, 2d Missile Battalion, 333d Artillery.

The group (fig 25) is composed of a Headquarters and Headquarters Battery; Batteries A and B of the 2d Missile Battalion, 333d Artillery; the 523d Engineer Company; and the 91st Ordnance Company. At present the 46th Group is undergoing training with the 1st Field Artillery Missile Brigade.

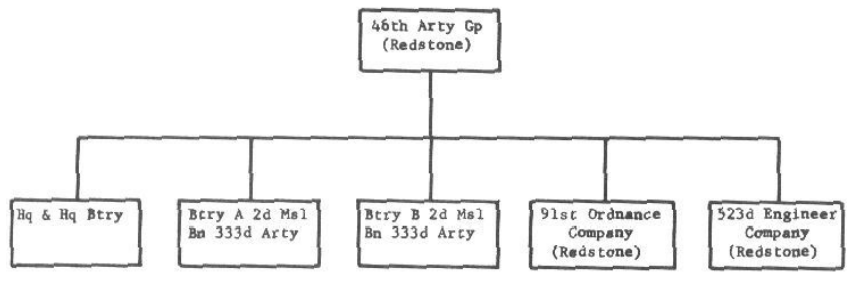

Figure 25. Organization of 46th Artillery Group (Redstone).

## AT THE SCHOOL BOOKSTORE

Numerous items of fire direction equipment identical to those issued can be purchased by mail order by individuals and organizations from the US Army Artillery and Missile School Bookstore. Research toward better fire direction equipment is conducted continuously, and approved developments are immediately made available at the Bookstore. Among the items currently available are components of the graphical firing table (Rizza) fan including the carrying case; charts and ballistic scales for preparing Rizza fans for weapons which have no commercially produced fan; the metro computer; the P(f) computer for atomic weapons effects (unclassified); and graphical firing tables, graphical site tables, and military slide rules. The Bookstore also stocks School training aids and mockups, including gunnery projection kits and mockup plotting equipment.

The Bookstore now has for sale plastic hobby kits for constructing models of current artillery weapons. These kits will make exact scale models of conventional weapons and the newest missiles.

The items mentioned above are fully described in the Book Department price list published 1 July 1958. Copies of this publication are available without charge. Request should be sent to the Book Department, USAAMS, Fort Sill, Oklahoma.

Current and past issues of ARTILLERY TRENDS are available at the Bookstore at 15-cents per copy, postpaid.

## SENIOR FIELD ARTILLERY OFFICER COURSE

The Senior Field Artillery Officer Course has been established incorporating the latest field artillery doctrine and developments. The purpose of the three week course is to acquaint senior artillery commanders and senior key staff officers with the tactics, techniques, and procedures for employing field artillery nuclear weapons.

Enrollment in the course is limited to lieutenant colonels or above, who require training in the employment of field artillery nuclear weapons. These individuals also must have an assignment or anticipate an assignment to a field artillery unit, artillery staff section, or artillery headquarters above battalion level. An interim security clearance of secret is another prerequisite. Applications for attendance must be made through appropriate command channels.

The course consists of--4 periods on communication trends, 19 periods on missile gunnery, 31 periods on missile materiel, 5 periods on ground handling equipment, 5 periods on target acquisition, 34 periods on tactical operations, and 20 periods on nuclear weapons employment.

Class dates for the only remaining class in fiscal year 1959 are as follows: report, 15 February; start, 16 February; finish, 7 March.



## NEW FACILITIES FOR REDSTONE TRAINING

Two separate projects were recently begun at Fort Sill to provide the School and various troop units with additional Redstone missile training facilities.

The east wing of hangar number 5 near Post Field is being revamped for use in Redstone instruction. This \$194,497 project will provide the School with 5 Redstone laboratories, 4 classrooms, a tool room, a missile bay, and some administrative space. Provisions will be made for high-pressure air outlets and high-voltage electricity, and underground, concrete air bottle storage facilities. Completion is scheduled for 22 November 1958. At that time, instructors from the US Army Artillery and Missile School, presently instructing at the Ordnance Guided Missile School, Huntsville, Alabama, will return and occupy the remodeled building.

Three new corrugated metal maintenance buildings are being erected about 3,000 feet west of the Department of Artillery Transport. This \$507,116 project will provide instruction and maintenance shops for Redstone units. The battalion maintenance and Ordnance support company buildings will each measure 70 by 140 feet with 20 feet clear height. The engineer support company building will be similar and all will have concrete floors. Completion is scheduled for 1 October 1958.

## 1st FIELD ARTILLERY MISSILE BRIGADE ACTIVATED

The US Army Field Artillery Missile Training Command (ARTILLERY TRENDS, June 1958) was redesignated the US Army 1st Field Artillery Missile Brigade on 20 August 1958. The organization and mission remain unchanged. Within the Brigade the former Missile Evaluation Team is now the Field Artillery Missile Systems Evaluation Group.

## NEW REDSTONE GROUP ACTIVATED

On 10 September 1958 a new Redstone Group was activated and organized at Fort Sill. Designated the 209th Artillery Group (Redstone) it has a similar organization to that of the 46th Group described above. The following units are assigned as organic elements: Headquarters and Headquarters Battery, Batteries A and B, 4th Missile Battalion (Redstone), 333rd Artillery; 76th Engineer Company (Redstone); and the 89th Ordnance Company (Redstone).

## STATUS OF TRAINING LITERATURE

1. The following training literature is under preparation or revision by the US Army Artillery and Missile School:

FM 6-18 Mortar Battery, Infantry and Airborne Division Battle Group. (revision) Submission to USCONARC contingent upon publication by DA of new ROTAD TOE.

FM 6-20 Field Artillery Tactics and Techniques. (revision) Submitted to USCONARC in June.

FM 6-30 Field Artillery Missile Battalion Corporal. (revision) Due USCONARC January 1959.

FM 6-31 Field Artillery Missile Corporal. (revision) Due USCONARC January 1959.

FM 6-32 Guidance System Field Artillery Missile Corporal. (revision) Due USCONARC January 1959.

FM 6-140 The Firing Battery. (revision) Forwarded from USCONARC to DA for printing.

FM 6-( ) Division Artillery. (new) Submission date to USCONARC contingent upon publication by DA of new ROTAD TOE.

(C) FM 6-( ) Field Artillery Missile Battalion, Lacrosse(U). (new) Submitted to USCONARC.

Change 1 to FM 6-40 Field Artillery Gunnery. Submitted to USCONARC in August 1958.

Army Training Programs (ATP) under preparation, revision or change:

6-300 Field Artillery Units (revision) at Government Printing Office.

6-545 Corporal (revision) Due USCONARC 1 Nov 58.

6-630 Redstone (new) to USCONARC 20 Sept 58.

6-( ) Lacrosse (new) to USCONARC 23 Nov 58.

Army Training Tests (ATT) under preparation, revision or change:

6-( ) FA Btrys (Lt & Med). (new) combines 6-1, 6-9, 6-13.

6-( ) FA Btrys (hvy). (new).

6-( ) Missile Bns & Btrys, 762-mm. (new) Combines 6-7 and 6-11.

6-15 FA Bn, ROCID. (change).

2. The following training literature has recently been printed and is available through the Adjutant General's Supply channels:

TM 6-200 Artillery Survey, June 1958:

An error in publication date was inadvertently made on the bound edge of this manual. It now reads "TM 6-200 Artillery Survey-1954". Units are urged to correct this date to read 1958. Otherwise this new edition will not be distinguishable from the 1954 edition which it supersedes.

### A GEM FOR THE FIRE DIRECTION OFFICER

To facilitate handling high-angle drift with a GFT fan, place a pin 40 mils to the right of the battery index. Label the 40 mark on the ballistic drift scale "0." Label the first 5-mil division down "plus 5" and the first 5-mil division up "minus 5." The next 5-mil divisions are marked "plus 10" and "minus 10" respectively.

Applying this system, the chart operator would read, for example, "deflection 2503 minus 6." The computer would announce in turn "deflection 2497."

This system uses numbers which usually do not exceed 15 and which can be computed mentally. It also gives accurate drift corrections and permits changing charges with little confusion and no loss of accuracy.

--Submitted by 1st Lt Herbert A. Harmison, Jr.  
Btry C, 3d How Bn, 28th Arty, APO 35, N.Y.

### A GEM FOR THE FIRE DIRECTION OFFICER

Is there a delay in your FDC when the observer is adjusting fuze time during an area mission? Do you notice that your computer is slow in adding 20/R to site when using VT fuze in effect after adjusting with fuze quick? Perhaps a portion of the slowness can be attributed to the conversion of height of burst corrections to site by your computer. Make a simple chart with the 100/R factors most commonly used or within the capabilities of your weapon and indicate the height of burst corrections in mils. For example:

100/R	6	17	18	19	20	21	22	23	24	25
40/R	6.4	6.8	7.2	7.6	8.0	8.4	8.8	9.2	9.6	1
20/R	3.2	3.4	3.6	3.8	8.0	4.2	4.4	4.6	4.8	5.
10/R	.6	1.7	1.8	1.9	2.0	2.1	2.2	2.3	2.4	2.5

Attach this scale to the computer's clipboard. Then, instead of figuring the change in mils each time the height of burst changes, refer to the 100/R factor announced and use the figure corresponding to the change in height of burst.

--Submitted by Master Sergeant Rodney A. Krull  
Btry "A", 260th FA Bn, Salem, South Dakota