

ARTILLERY TRENDS

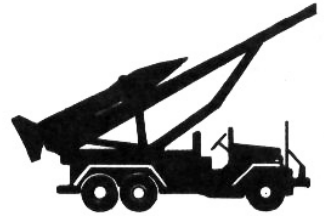
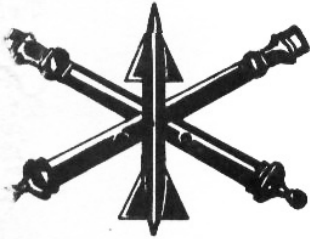

**JUNE
1958**

**U S ARMY ARTILLERY
AND MISSILE SCHOOL**

UNITED STATES ARMY
ARTILLERY AND MISSILE SCHOOL
Fort Sill, Oklahoma

2 June 1958

This issue represents a concerted effort to improve the appearance, quality, and readability of ARTILLERY TRENDS.

Our objective in TRENDS continues to be that of informing field artillerymen of new developments as far as is possible in an unclassified publication. To further this aim, several new sections are introduced. One section--"News Notes for Artillerymen"--consists mainly of one paragraph items of professional interest. Some of these items, such as the 175-mm self-propelled gun, will be explained in more detail in future articles. Within "News Notes" is a portion devoted to the status of field artillery training literature, telling what is being prepared or revised and what has recently been published. Please do not request Department of the Army publications from the School. We too must secure ours from the Adjutant General!

Another new section is called "Weapons of the Artillery." The 4.2-inch mortar and the 762-mm Honest John rocket are featured in this issue. Within space limitations, available training literature pertaining to these weapons is listed. The "Weapons" pages purposely are not printed back to back. It is suggested that these pages be cut out and posted on the battery bulletin board or placed under glass or acetate on your desk. The next issue of TRENDS will feature the 105-mm howitzer and the Corporal missile.

From Bunker Hill to the Yalu River artillerymen have met and successfully solved problems not covered "in the book." These field solutions or field expedients are better called "tricks of the trade." The problem has been and still is that of passing on these successful ideas to new generations of artillerymen. Within the active Army there is a continual transfer of officers and NCO's between units. Frequently these individuals pass on valuable practical solutions used in their previous units. This method of exchanging ideas is at best very slow and tedious.

Beginning with this issue, ARTILLERY TRENDS will pass on to its readers various "tricks of the artillery trade" normally employed at the battery level. They are called "Gems" for the Battery Commander, the Battery Executive, the Motor Officer, the Communication Officer, the Chief of Firing Battery, etc. These "Gems" represent a solution. Undoubtedly there are many other ways to solve the problems presented. Do you have a better solution? Do you have any ideas which would assist other artillerymen in doing a better job in garrison, on maneuvers, or

(continued inside back cover)

ARTILLERY TRENDS

	<u>Contents</u>	<u>Page</u>
Editorial -----	inside cover	
New Eyes for Countermortar Teams -----	3	
Emergency Fire Direction Techniques -----	6	
Nuclear Weapons -----	19	
Do You Want a Precision Fire "Sensing Stick"? -	21	
Weapons of the Artillery -1-----	24	
Boresighting the 4.2-Inch Mortar-----	25	
Error in the M30 Mortar Firing Tables? -----	30	
Send Your Mission, Wait -----	31	
Have You Chosen the Right Man for OCS? -----	34	
Weapons of the Artillery -2-----	38	
So You Need Direction? -----	39	
USA FA Missile Training Command -----	43	
Last Name-John, First Name - Honest, Occupation - Artillery Weapon -----	49	
Mobility with Versatility for Futurity -----	51	
News Notes for Artillerymen-----	55	
New Artillery Plotting Kit for Sound Ranging ---	62	
The Staff Training Program -----	back cover	



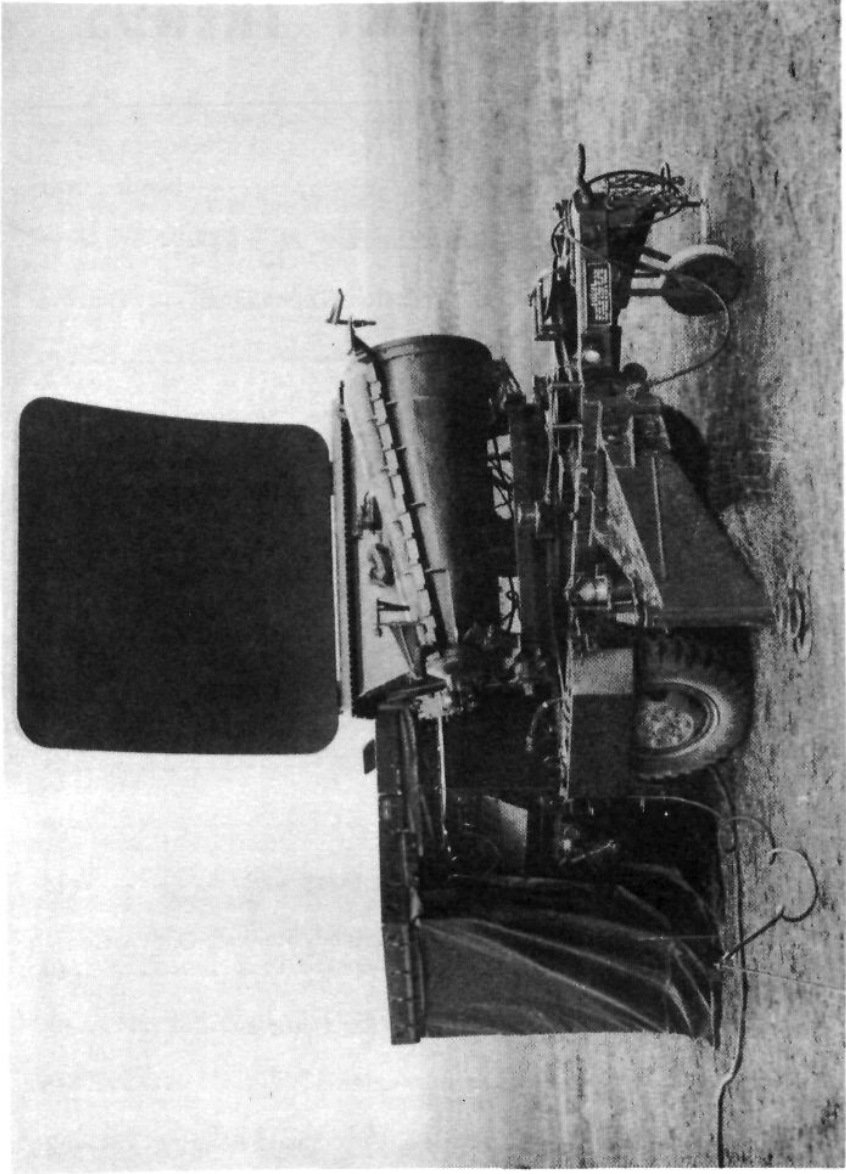

Figure 1. Counter-mortar radar AN/MPQ-4.

NEW EYES FOR THE COUNTERMORTAR TEAMS

Major John C. Marschhausen
Department of Observation

After 6 years of domination as the field artillery radar, the AN/MPQ-10 is going to have to share the spotlight with a brand new set. Countermortar radar set AN/MPQ-4 (fig 1) has passed its service test and has gone into production at General Electric.

Aside from greater electronic reliability, the AN/MPQ-4 will provide these additional operational advantages over the AN/MPQ-10.

1. Fifty percent greater effective range.
2. First round acquisition. This means an enemy mortar may be located as soon as it fires its first round. It will no longer be necessary, as is so frequently the case with the AN/MPQ-10, for the operator to spend many precious minutes concentrating on a specific point waiting for a second round which may or may not appear.
3. Location time reduced from 4 or 5 minutes to 20 seconds.
4. Maintenance of a continuous search of the area even when locations are being computed.

The method of operation of the AN/MPQ-4 is aptly stated in its technical description as a "dual beam, intercept" radar. The antenna system sweeps a 450-mil sector 17 times each second with 2 radar beams displaced 35 mils vertically. This displacement effectively places 2 radar "fans" over the area of suspected activity (fig 2). When a weapon under these fans fires, its projectile penetrates each fan and produces two echoes on the radar's "B" scope.

The operator, using azimuth and range handwheels, positions strobe lines on the lower-beam echo pip, thus automatically starting the computer and inserting the lower-beam data. As soon as he repeats this process on the upper-beam echo pip, the operator can read the coordinates on the face of the computer. If the computer has not received sufficient data, a red light comes on warning the operator of the doubtful accuracy of the coordinates. The normal elapsed time from the firing of the enemy mortar to the determination of coordinates, either grid or polar, is approximately 20 seconds.

For the technically minded, the AN/MPQ-4 is a "Ku" band, dualbeam intercept, nontracking radar with an analogue computer. It has a maximum presentation range of 10,000 meters, and tests prove that its

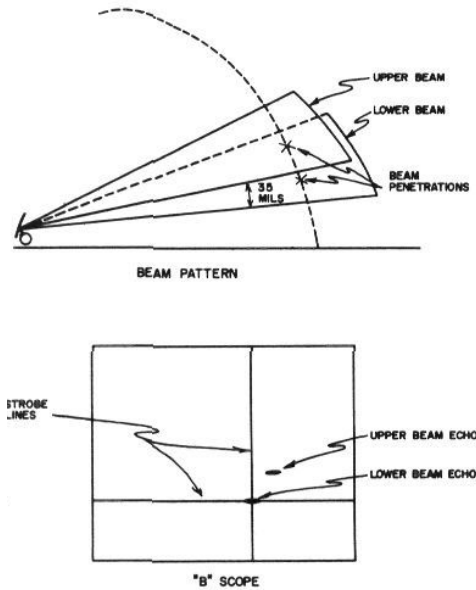

Figure 2. Method of operation.

effective range against mortars is close to its maximum range. Its accuracy has been well within the required 50-yard radial error. The radar including the 2-wheel, 1½-ton trailer on which it is mounted weighs approximately 6,100 pounds. It stands 13 feet high in operating position and 7.8 feet high in travel position. Power is furnished by the 400-cycle generator PU-304()/MPQ-4. The set may be controlled from the operator's shelter at the rear of the trailer or remotely to a distance of 150 feet. The controls for the radar and the computer (fig 3) are conveniently arranged so one operator can perform all the functions necessary to determine coordinates of an enemy mortar.

Countermortar radar sections of active army units can expect to receive the AN/MPQ-4 sometime after August 1958 to replace the AN/MPQ-10. The Department of Observation at Fort Sill has received three pilot sets and is now revising programs of instruction to include the AN/MPQ-4 in all applicable courses.

The Department of Observation will evaluate the AN/MPQ-4 in performance of the secondary missions of countermortar radar sections, i.e., gunnery and battlefield surveillance. As soon as results are obtained, the necessary changes to existing publications will be made.

The AN/MPQ-4 is replacing the AN/MPQ-10 in the countermortar

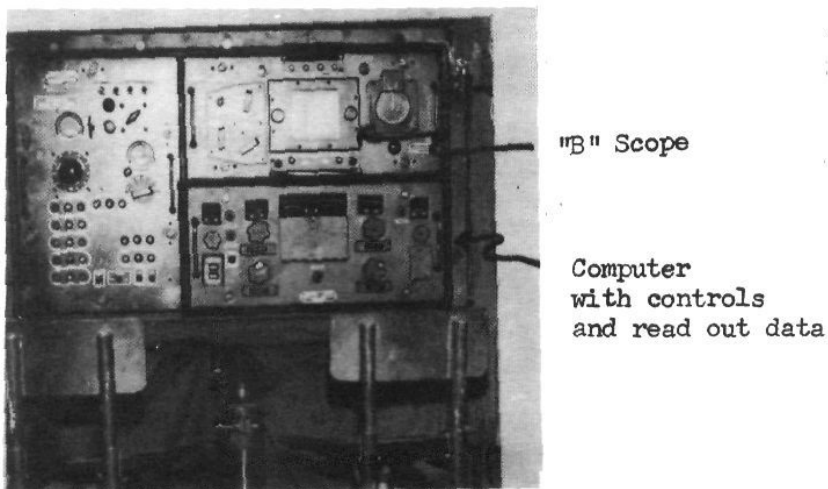

Figure 3. Control panels for the radar and computer.

role only. The AN/MPQ-10 will remain in the observation and 280-mm gun battalions.

A GEM FOR THE BATTERY EXECUTIVE

Your 105-mm howitzer battery is firing from a muddy rice paddy. The recoil is forcing the piece to the rear and is burrowing the weapon into the mud. Continued firing will soon be impossible. What might you do? One unit solved the problem by placing the section's 2½-ton truck about 150 feet to the front of the piece with the winch towards the howitzer. The winch cable was let out and fastened to the piece. Whenever the howitzer became too mired, firing was halted and the chief of section signalled the driver to winch the howitzer forward to more solid footing. A distant aiming point had been previously designated in the original position to facilitate quick resumption of firing.

--Submitted by Maj William J. Lanen
3d Msl Bn, 32d Arty, Ft Sill

Are you an active part of the 18,598 extension course student body?



EMERGENCY FIRE DIRECTION TECHNIQUES

Major Wilber N. Herndon, USMC
Department of Gunnery

BLAST 2, THIS IS BLAST 31, FIRE MISSION, OVER.

-----THIS IS BLAST 2, SEND YOUR MISSION, OVER.

CORD 2550 5010, AZ 1130, INF CO ON ROADBLOCK, VT, WA, OVER.

-----CORD 2550 5010, AZ 1130, INF CO ON ROADBLOCK, VT, WA, WAIT.

SITUATION: The forward observer (Blast 31) is advancing in a general northeast direction with Company A, 1st Battle Group, 5th Infantry, the advance guard for a larger force. Company A is halted by a roadblock defended by an entrenched infantry company with strong automatic weapons firepower.

The battery executive (Blast 2), who has a knowledge of the general situation, is on the road with the howitzers approximately 3 miles to the rear of the advance guard. He quickly orders the firing battery off the road into position, selects a general azimuth (600 mils) to point the tubes, and prepares to deliver the urgently needed artillery support. The fire direction center vehicle, which is following the last howitzer, strikes a mine as it leaves the road causing the fire direction personnel to become casualties.

This situation is an emergency. Combat experienced artillerymen have taken similar emergency situations in stride. They applied imagination and aggressive action to deliver timely and accurate supporting fires as long as tubes and ammunition were available. This capability must remain with all artillery organizations. The techniques that have been successfully

applied to convert the observer's requests into gun data have ranged from the simple educated guess to complicated calculations. All techniques have their unique advantages and disadvantages.

Recent ARTILLERY TRENDS articles have emphasized that the current tactical concepts (decentralized control of artillery units and decentralized determination of firing data) have in no way altered the artilleryman's time-honored mission. The artillery mission remains the delivery of timely and accurate supporting fires. That fire is to be expected, with or without a fire direction center.

A standard emergency technique is needed for conversion of observer requests to firing data. This technique must be simple, rapid, and completely chartless so the individual at the weapons location who is controlling the ammunition and firing can deliver supporting fires in all emergencies. It should retain current observer procedures for target designation and adjustment of fire and current firing battery techniques; it should permit a limited massing capability, chartless and without adjustment; and it should require minimum equipment. At most this equipment should be a graphical firing table (GFT) or tabular firing table, an M10 plotting board, and only enough communication equipment for the executive and observer to talk to each other.

The computed firing data conversion system fulfills these requirements. It is an accurate, chartless, flexible, and rapid technique applicable to all tube support weapons from light mortars to heavy artillery, to all fuzes, and to low or high angle fire. Stripped to bare essentials, pencil, paper, and a knowledge of the gunnery problem are all that is required. The system retains the current observer and firing battery procedures. The intervening fire direction center is eliminated, and the observer's requests go directly to the weapons location where the battery executive and/or recorder converts the requests to gun data.

The factors required for conversion of observer requests to gun data are the angle T, the 100/R factor, and the C factor based on the gun-target range. Angle T is the angle formed by the intersection of the gun-target (GT) and observer-target (OT) lines. For emergency fire direction purposes, the angle T is estimated to the nearest 100 mils. The 100/R factor is the number of mils in deflection (df) needed to move a burst 100 yards right or left at a given range (rn). The C factor is the number of mils in elevation (el) needed to move a burst 100 yards in range.

The 100/R factor may be obtained from GFT or ballistic scale or by computation. The C factor may be obtained from a firing table. If a firing table is not available, remember that the C factor and the fork (F factor) for most weapons are almost the same at middle ranges. The constant C factor for the 4.2-inch mortar is 4/8 of a charge (ring).

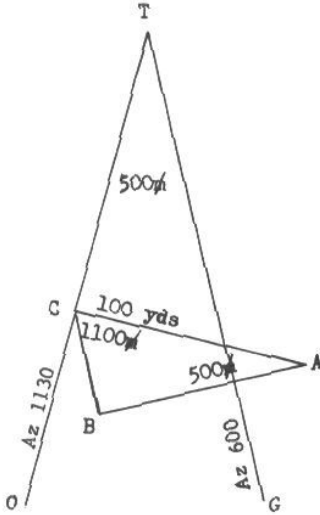

Figure 4.

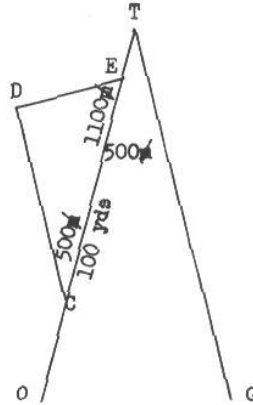

Figure 5.

BC = AC sin 500 mils = 100 sin 500 mils = 100 × .5 = 50 yds.
 $50/100 \times C = .5 \times 9 = +5$ mils (el change for guns).

Data for round at A: df 2800 el 365

FO request of LEFT 100, REPEAT RANGE converted to gun data:

left 15 +5

Data for round at C:

df 2815 el 370

Figure 5 illustrates the data conversion required to move a line burst along the OT line.

FO observes burst at point C and requests: ADD 100.

C (angle) = angle T = 500 mils.

D = 1,600 mils (right angle).

E = 1,100 mils (complement of angle C).

CE = FO request for add 100.

DE = Df shift for)

)

guns in yards.) To move burst from

CD = Range change for) point C to point E.

guns in yards.)

CDE is a right triangle for practical purposes.

$100/R = 100/6$ (or from GFT) = 17 mils.

C (factor = 9 mils; rough sin 1,100 mils = .9; rough sin 500 mils = .5).

DE = CE sin 500 mils = 100 sin 500 mils = 100 × .5 = 50 yds.

$50/100 \times 100/R = .5 \times 17 =$ right 9 mils = (df change for guns).

$$CD = CE \sin 1,100 \text{ mils} = 100 \sin 1,100 \text{ mils} = 100 \times .9 = 90 \text{ yds.}$$

$$90/100 \times C = .9 \times 9 = +8 \text{ mils (el change for guns).}$$

Data for round at C:	df 2815	el 370
FO request of ADD 100 converted to gun data:	<u>right 9</u>	<u>+8</u>
Data for round at E:	df 2806	el 378

The example above dealt first with a situation where the observer requested only a correction for deviation from the OT line and second with a situation where the observer requested only a correction in range along the OT line. If the observer's request includes corrections for both deviation and range at the same time, the deflection change for the guns is determined by combining the deflection change for the deviation correction with the deflection change for the range correction, due regard being given to their respective directions. The elevation change for the guns is determined by adding algebraically the elevation change for the deviation correction and the elevation change for the range correction. Note that for each element (deviation correction and range correction) of the observer's command, both a deflection change and an elevation change must be made.

In the example below, the same corrections as those contained in the two separate requests above are combined into one request. The situation is the same and the executive has fired the first round. Figure 6 illustrates the data conversion required to bring the off-line round (burst at point A) to the OT line and to move the point of burst along the OT line.

FO observes burst at point A and requests: LEFT 100, ADD 100.

To move round to OT line (i.e., to point C):

AB = 90 yds (calculations as demonstrated above).

Corresponding df change for guns: left 15 mils.

BC = 50 yds.

Corresponding el change for guns: +5 mils.

To move point of burst along OT line (i.e., to point E):

CD = 90 yds.

Corresponding el change for guns: +8 mils.

DE = 50 yds.

Corresponding df change for guns: right 9 mils.

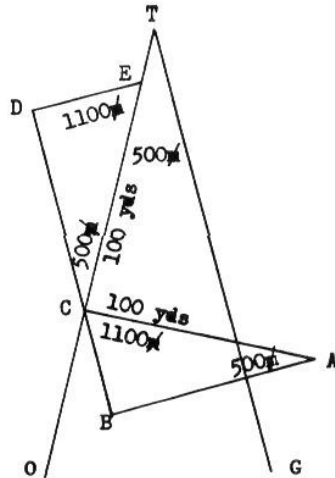

Figure 6.

Data for round at A:	df 2800	el 365
To move round to OT line:	left 15	+5
To move point of burst along OT line:	<u>right 9</u>	+8
Data for round at E:	df 2806	el 378

Initially, a sketch should be drawn in order to visualize the direction of the deflection shifts and range changes. Figures 7 and 8 reflect the direction of changes applied to the guns in compliance with forward observer corrections for angles T up to 1,600 mils:

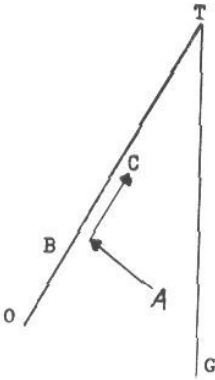

Figure 7.

Guns on right.

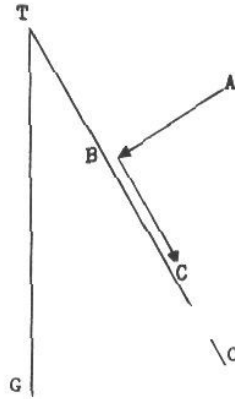

Figure 8.

Guns on left.

To comply with FO's request of
 LEFT _____ (A to B = to line),
 ADD _____ (B to C = on line).

To comply with FO's request of
 LEFT _____ (A to B = to line),
 DROP _____ (B to C = on line).

	<u>Df</u>	<u>Rn</u>
To line =	left	+
On line =	right	+

	<u>Df</u>	<u>Rn</u>
To line =	left	-
On line =	right	-

Similarly, forward observer corrections with combinations left (right) and add; left (right) and drop; left (right) and repeat range; etc., are applied.

Table 1 sets forth the sine factors of angles of 0 through 1,600 mils and indicates the factor (C or 100/R) to which the sine should be applied when calculating data to move a round to the OT line (left side of table) and when calculating data to move the point of burst along the OT line (right side of table). To determine values when the angle T is

greater than 1,600 mils, subtract angle T from 3,200 mils. The sine factors used in the preceding examples are circled in table 1.

Value to Line	Angle T 100 mils																	Value on Line
	0	1	2	3	4	5	6	7	8	9	10	11	12	13	14	15	16	
100/R C →	1.	1.	1.	1.	.9	.9	.8	.8	.7	.6	.6	.5	.4	.3	.2	.1	0	← C
	0	.1	.2	.3	.4	.5	.6	.7	.8	.8	.9	.9	1.	1.	1.	1.	1.	← 100/R

Table 1. The 100/R and C Factors Value Table
(the sine values--also see computer's record).

Using table 1, the deflection change to comply with a requested deviation correction is determined by multiplying together the number of hundreds of yards in the requested deviation correction, 100/R, and the appropriate sine read opposite "100/R" on the left side of the table (i.e., enter table from left). The elevation change to comply with a requested deviation correction is determined by multiplying together the number of hundreds of yards in the requested deviation correction, C, and the appropriate sine read opposite "C" on the left side of the table. The deflection and elevation changes to comply with a requested range correction are similarly determined except that the sines are read opposite "100/R" and "C" on the right side of the table (i.e., enter table from right).

The direction in which the changes are applied may be determined by reference to figure 7 or figure 8 (sketch is provided on the computer's record). In the example above (where the angle T is 500 mils, 100/R is 17 mils, C is 9 mils, the forward observer requests LEFT 100, ADD 100 after observing a round fired from guns on the right at df 2800 and el 365), the calculation using table 1 would be as follows.

$$\begin{aligned}
 \text{Df shift for deviation correction} &= 1 \times .9 \times 17 \text{ mils} = \text{left 15 mils} \\
 \text{El change for deviation correction} &= 1 \times .5 \times 9 \text{ mils} = + 5 \text{ mils} \\
 \text{Df shift for range correction} &= 1 \times .5 \times 17 \text{ mils} = \text{right 9 mils} \\
 \text{El change for range correction} &= 1 \times .9 \times 9 \text{ mils} = + 8 \text{ mils} \\
 \text{Total} &= \text{*left 6 mils} \quad \text{*+13 mils} \\
 &\text{*Direction and sign determined from figure 7.}
 \end{aligned}$$

The total deflection shift and elevation change are applied to the deflection (2800) and elevation (365) of the initial round to yield deflection 2806 and elevation 378.

If, during the adjustment, the range (GT) changes more than 1,000 yards, the executive should determine a new C and a new 100/R. If the angle T changes by more than 200 mils, he should change the sine factors.

Figure 9 is a computer's record designed for use with the computed firing data conversion system. Such a form is by no means necessary in order to use the system. It is, however, a valuable aid in training personnel.

Value to 100 mils	Angle T	0	1	2	3	4	5	6	7	8	9	10	11	12	13	14	15	16	Angle T	Value on Line
100/R	C	1.1	1.1	1.1	1.1	1.9	1.9	1.8	1.8	1.7	1.6	1.5	1.4	1.3	1.2	1.1	1.0	C	100/R	
F. Req.																			Order	
(Init data only)																				
From Conc Alt Ti Df Rn																				
To Line: x . x .																				
On Line: x . x .																			100/R Ti C Drift	
G Df Rn																			G	
Rn Corr GFT setting for large shifts																				
Value to Line (100 yds)																			Value on Line (100 yds)	
100/R Drift C																			100/R Drift C	
Df Rn																				
Change																				
2000 yds																				
200 # 2040																				
300 # 2090																				
400 # 2160																				
500 # 2270																				
600 # 2410																				
700 # 2590																				
800 # 2830																				
5000 yds																				
200 # 5100																				
300 # 5220																				
400 # 5410																				
500 # 5670																				
600 # 6010																				
700 # 6470																				
800 # 7070																				
7000 yds																				
200 # 7140																				
300 # 7310																				
400 # 7580																				
500 # 7940																				
600 # 8420																				
700 # 9060																				
800 # 9900																				
As corr from mil relation																				
100/R Corr #																				
Factor																				
0-300# = 0																				
400 # x .97																				
500 # x .95																				
600 # x .92																				
700 # x .89																				
800 # x .86																				
900 # x .83																				
1000 # x .80																				
AMMO TYPE																				
ON HAND																				
EXPENDED																				
REMAINING																				
(Exploit) AMMO FZ DF SI RN EL(Q)																				
Afire Corrected																				
Stry _____ Date and Time Fired _____ Conc Nr _____																				
GFT N/yd Corr = 2000 yds - 1830 M; 5000 yds - 4570 M;																				
7000 yds - 6400 M.																				

F 5 FORM 23-R (Gen) 1 Mar 58

Figure 9. Computer's record used with the computed firing data conversion system.

Let us return to the battery in the imaginary situation. The battery executive (BLAST 2), upon receipt of the fire mission from the forward

observer, takes the following actions. He designates generally the howitzer positions and direction of fire to the chiefs of sections, sets up and orients the aiming circle on azimuth 600, lays the first howitzer, and instructs the chief of firing battery to lay the remainder of the battery. The executive then selects the direction of fire (df 2800, az 600), fuze time for a high air burst (to facilitate location of round by the forward observer and to minimize danger to friendly troops), site 350, time 22.2, elevation 365 (rn 6,000). As time permits, he informs the forward observer that the target is designated concentration AB 401. He commences firing with a single howitzer (number 3 is ready). Only one round is fired until the forward observer locates the round and insures that there is no danger to friendly forces. Time lapse from the receipt of the mission until ON THE WAY is given is held to a minimum.

The first round is fired and the executive announces, BLAST 31, HIGH AIR BURST, ON THE WAY, OVER.

Now follow the mission on the computer's record (figure 11). Note that the forward observer's requested corrections after the initial round are not the same as those used in the above examples. For simplicity, requested corrections in the above examples were assumed to be 100 yards in deviation and range.

After the adjustment is completed, the forward observer may designate new targets in relation to concentration AB 401 since it becomes, in effect, a point of known location. Since 100/R and C factors change when large shifts are made, the data for the initial volley is computed in yards and then converted to firing data to maintain the desired accuracy. The following example demonstrates this method of determining initial data. The forward observer observes a new target and requests, THIS IS BLAST 31, FROM CONCENTRATION AB 401, AZIMUTH 1510, RIGHT 600, ADD 1000, MORTARS FIRING, WILL ADJUST.

Figure 10 illustrates the computation to comply with the forward observer's fire request.

Angles M, M', P and P' are equal.

Angles M = 1,000 mils (to the nearest 100 mils).

(Df 2907 for concentration AB 401 = az 493 mils, the FO reported

OT az 1,510 mils, angle at M=az 1,510 - az 493 or 1,017 mils.)

Angles at J and R are right angles (1,600 mils).

Angles at K and T(LTR)=600 mils (to the nearest 100 mils) or the right angles at J and R minus the respective angles at P and P'.

JK = LK'.

FO request RIGHT 600 = KL; ADD 1,000 = LT.

Sin 1,000 mils = .8; sin 600 mils = .6.

(AB401)

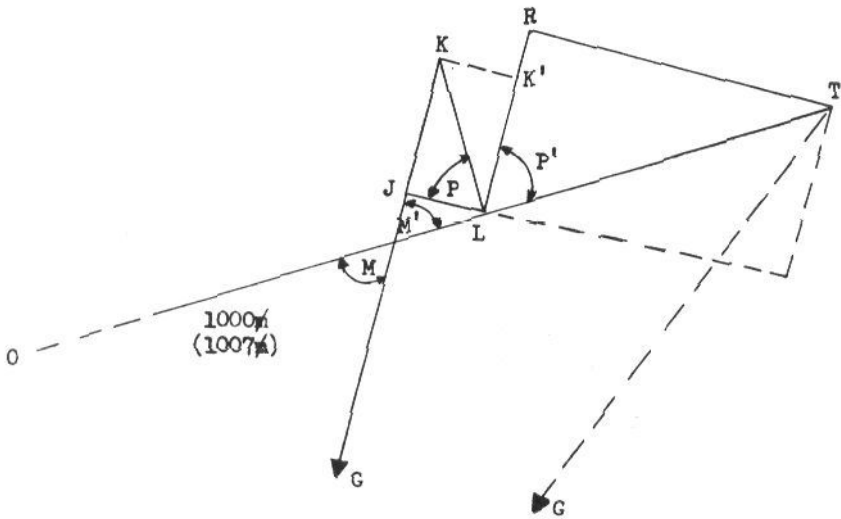

Figure 10. Diagram of observer's range and deflection changes.

JL = (KL, the FO's RIGHT 600 × .6) =	right	360 yds	
JK = (KL, the FO's RIGHT 600 × .8) =			-480 yds
RT = (LT, the FO's ADD 1,000 × .8) =	right	800 yds	
IR = (LT, the FO's ADD 1,000 × .6) =			<u>+600 yds</u>
From AB 401 the total change to			
guns =		right 1,160 yds and	+120 yds
Adjusted data AB 401 =		df 2907 rn 5,700 (el 340)	
Range change to T =			+120 yds
100/R at 5,820 yds = 18 mils.			
Df change from AB 401 = right 1,160 yds,			
right 11.6 × 18 mils =	<u>right</u>	<u>209</u>	
Gun data for T =	df	2698	rn 5,820 yds
			(apparent)

Ranges calculated in this manner are in slight error. A corrected range may be determined by means of a GFT. GFT settings for such purposes are shown on the left side of the computer's record (figure 9). In this case (with a deflection change of 209 mils and a range of 5,820 yds), a GFT setting of 5,100 yards under the manufacturer's hairline and a gauge line drawn at 5,000 yards is used. Then, with the gauge line at 5,820 yards, the corrected range of 5,920 yards will be read under the

hairline. See note (f) in figure 9.

The angle T for the new target is now determined as follows:
 Azimuth of GT = 493 + 209 = 702 mils.
 Azimuth of OT = 1,510 mils.
 Angle T = 1,510 - 702 = 808 mils (808 mils).

The reader may follow the mission by referring to figure 12.

Value to Line	Angle T 100 mils	0	1	2	3	4	5	6	7	8	9	10	11	12	13	14	15	16	Angle T 100 mils	Value on Line
100/R		1.	1.	1.	1.	1.9	1.9	1.8	1.7	1.6	1.6	1.5	1.4	1.3	1.2	1.1	1.0		C	
C		0	1	2	3	4	5	6	7	8	9	10	11	12	13	14	15	16		100/R
F. Reg. BLAST 31, FM COORD 2550-5010 Az 1130. Order VT, 5 VOLLEY, CONC AB 401.																				
INE CO ON REW AUTO WPNS. VT. WA																				
(Init data only)																				
From Conc	Alt	Ti	Df	Rn																
To Line:	x .			x .																
On Line:	x .			x .																
G			Df	Rn																
Rn Corr GFT setting for large shifts	Value to Line (100 yds)										Value on Line (100 yds)									
100/R	15%	Drift	C	5%	100/R	9%	Drift	C	8%											
Df	Rn	#3 Adj, Lot Sp Corr Sh HE Ch 5 Fz Ti MF *B(1)																		
Change	Df 2800 St 350 Ti 22.2 El (R) 365																			
2000 yds	CORRECTIONS																			
200 # 2040	R/L	U/D	A/D	Fz/MF	DE	SI	Ti	El (Q)												
300 # 2090	L 400		RR	Fz Q	L 60	300		+20												
400 # 2160					2860			38.5												
500 # 2270					L 72			-64												
600 # 2410					2932			321												
700 # 2590					R 6			-2												
800 # 2830					R 36			+32												
9000 yds	R 40		+400		2890			351												
200 # 5100					BTRY			-16												
300 # 5220					ADJ	L 18		335												
400 # 5410					C(1)	2908														
500 # 5670					L 3			+7												
600 # 6010					R 9			+8												
700 # 6470	L 20		+100		2902			344												
800 # 7070					Fz VT	L 5		-4												
7000 yds					BTRY (5)	2907	303	340												
200 # 7140					FFE															
200 # 7110	EM, AUTO WPNS SILENCED, AREA WELL COVERED.																			
400 # 7580	AMMO TYPE																			
500 # 7940	ON HAND																			
600 # 8420	EXPENDED																			
700 # 9060	REMAINING																			
800 # 9400	(Replot) AMMO FZ DP SI RN EL(O)																			
Az corr from mil relation	Refire Corrected																			
2-W/R Corr	Btry Date and Time Fired Conc Nr																			
Fz, tor	CPT M/yd Corr = 2000 yds - 1830 M; 5000 yds - 4570 M;																			
0-300A = 0	7000 yds - 6400 M.																			

F S FORM 23-K (Gun) 1 Mar 58

Figure 11. Computer's record for initial mission.

The computed data conversion system will fulfill the desired requirements of a true emergency system. The battery executive can easily memorize the range and C factor for each charge corresponding to a single elevation for his weapons (elevation 300 is suggested for the

ANGLE T₂ INITIAL DATA

Value to Line	Angle T 100 miles	0	1	2	3	4	5	6	7	8	9	10	11	12	13	14	15	16	Angle T 100 miles	Value on Line
	100/R	1.	1.	1.	1.	1.	1.	1.	1.	1.	1.	1.	1.	1.	1.	1.	1.	1.	1.	C
	C	0	1	2	3	4	5	6	7	8	9	10	11	12	13	14	15	16	100/R	

F. Reg. BLAST 31, FROM CONC AB 401, Az 1510,
R 600, ADD 1000, MORTARS FIRING, WA. Order Q 5 VOLLEY,
CONC AB 402

(Init date only)
From Conc AB 401 Altz(AB401) Tl Df 2907 Rn 5700

To Line: R 600 x .6 = R 360 x .8 = -480
ADD
On Line: 1000 x .8 = R 800 x .6 = +600

1000 Y (100/R) G R 1160 YDS x 18 X (100/R) Df R 209 (Corr) Rn 5920

100/R Tl C Drift
17 MILS G 9 MILS

100/R Tl C Drift
17 MILS G 9 MILS

Value to Line (100 yds)	Value on Line (100 yds)
100/R 12 MILS Drift	100/R 12 MILS Drift
C _G MILS	C _G MILS

Bl	Rn	BTRP	Adj, Lot	Sp Corr	Sh HE	Ch 5	Fz Q	MF C(I)
Change								
2000 yds					01 26 98	SI 300	Ts	EL(Q) 358

	CORRECTIONS			COMMANDS			EI (0)	
	R/L	U/D	A/D	Fz/MF	Df	SI		Tl
200 # 2040					L 7		+ 4	
300 # 2090					L 48		- 24	
400 # 2160					2 753		888	
500 # 2270	L 60		-400					
600 # 2410					R 24		+12	
700 # 2590					2 729		850	
800 # 2820					R 2		- 1	
5000 yds			+200		R 12		+ 6	
200 # 5100	R 20		+100		2 715		355	
300 # 5220					X 2			
400 # 5410					2 715			
500 # 5670					-50	BTRY		
600 # 6010					FIRE FOR	L 6	- 3	
700 # 6470					EFFECT (5)	2 721	352	
800 # 7070								
7000 yds	END OF MISSION MORTARS SILENCED.							

Az Corr from mil relation	AMMO TYPE	ON HAND	EXPENDED	REMAINING	(Replot) AMMO	FZ	DF	SI	RN	EI (0)
4-3/4 Corr										
0-3/4 Corr										
500 # x .7										
500 # x .95										
600 # x .92										
700 # x .85										
800 # x .86										
900 # x .81										
1000 # x .80										

Btry Date and Time Fired Conc Nr

GPT H/yd Corr = 2000 yds - 1830 M; 5000 yds - 4570 M;
7000 yds - 6400 M.

F S FORM 23-R. (Cont) L Mac 58

Figure 12. Computer's record for mission using shift from concentration.

105-mm howitzer). Complete lack of fire direction equipment then is no bar to the accurate and timely delivery of supporting fires. If personnel or equipment are lacking, the technique can be expanded to battalion sized units. A map (1:50,000) can be used to obtain initial data and to replot targets. A single computer for each two firing units is sufficient. Units can mass with sufficient accuracy from a 1:50,000 map or from an M10 plotting board. The computed data conversion system would provide an auxiliary system to the anticipated electronic or mechanical fire direction computer. Using computed data system as an auxiliary instead of the current fire direction procedures would mean a great reduction in

equipment. The advantages of a 1:50,000 map as a firing chart are obvious.

Teaching the system to those who understand fire commands has not been difficult or time consuming. The system has the disadvantage introduced by "grocery store arithmetic" errors since computations are involved. However, the computations are so basic and simple that this has not proven to be a serious handicap.

One "observed fire" period at Fort Sill is conducted without equipment in the hands of the students (i.e., field glasses, maps, etc.). This period is designed to prove to the student that it is possible to fire missions even when equipment is lost. There is a noticeable increase in aggressiveness as the student acquires the confidence that he can master the situation with or without equipment. With our present method of teaching fire direction procedures, many students do not acquire an adequate knowledge of the principles involved in the solution of the gunnery problem. Lacking this knowledge, they also lack confidence. Self-confidence is the necessary foundation for aggressive action. The computed firing data conversion system illustrates very simply the gunnery problem and its solution. The officer who understands this system will perform with confidence, knowing that he can accomplish his mission regardless of the situation.

The time-proved principles of artillery fire direction are well established. The current fire direction technique (using charts) meets the requirements of an accurate and rapid data conversion system when the required installations, communications, and FDC personnel are available. Since all situations, the unusual as well as the normal, must be provided for, an emergency technique must be within the capability of all artillery units. The computed firing data conversion system may not be THE emergency system; however, the many desirable characteristics of the system merit close evaluation.

A GEM FOR THE BATTERY COMMANDER

Achieving a uniform layout of field equipment, section equipment, or even drivers' tools is often very difficult. Draftsmen spend hours making detailed drawings so that each section will have a master plan to follow. Captain BC, you can save time and effort by photographing sample layouts. Frequently some man in your unit is inclined toward photography and can take the necessary pictures, or the signal corps will probably do the job for you.

--Submitted by Capt Richard O'Shea

Dept of T&CA, Arty and Msl School

NUCLEAR WEAPONS

(first of a series)

Captain Powell H. Skipper
Department of Tactics and Combined Arms



Nuclear weapons information, cloaked in a shroud of secrecy and awe for many years, need no longer remain a mystery to artillerymen. The why, how, and wherefore of atomic detonations and their effects are included in two unclassified pamphlets, DA Pamphlet 39-3 and DA Pamphlet 39-1. These are available to both active Army and reserve component units.

DA Pamphlet 39-3 (May 57), *The Effects of Nuclear Weapons*, furnishes the background information on all primary effects of an atomic detonation. Although written from a technical viewpoint, this pamphlet is readable and easily understood. For the reader who is unfamiliar with the technical terminology involved, a glossary of terms is included for ready reference. Admittedly, some detailed background formulas presented are complex and difficult to comprehend, but these can be passed over without loss of continuity or understanding of the basic principles.

An individual without any prior knowledge of nuclear weapons can uncover the mysteries of the fission process, the fusion process, blast effects, thermal radiation, and nuclear radiation by reading DA Pamphlet 39-3. Facts about all nuclear effects are compiled in tables, graphs, and charts with detailed explanation on the use of each. Example problems are solved to help the reader gain full comprehension of any necessary computations. The pamphlet covers the entire scope of nuclear weapons--from the basic 1 kiloton yield to yields in the megaton range.

DA Pamphlet 39-3 is well supplemented with pictures and illustrations. Results of the two atomic bombs used against Japan in the latter days of World War II are pictorially presented in great detail.

Turning from basic effects to Atomic Weapons Employment, we now refer to DA Pamphlet 39-1 (Jun 1956). Filling the need for an unclassified training publication, this pamphlet presents effects data for specific targets, damage estimation nomographs, troop safety data, and other information concerning atomic weapons employment.

Easy to read and written from the tactical rather than the technical viewpoint, 39-1 answers such questions as: What weapon should be used against a particular target? Which delivery means should be chosen? How much damage will result? How will the use of the chosen weapon affect friendly troops?

Two methods of target analysis are presented, the P(f) method (a step by step mathematical approach) and the atomic damage template method (a visual approach). Example problems are worked out in detail for easy reference using each of the methods mentioned above. All aids are furnished with the pamphlet and detailed explanations of their use are presented.

Under the present program of instruction for US Army reserve schools, classes are presented on effects of nuclear weapons, damage estimation, and troop safety. These classes, covering 10 hours of instruction, are currently cataloged in the T 5200 series.

Also available, through the Staff Training Catalog, is a series of classes based on DA Pamphlet 39-3 and DA Pamphlet 39-1. These cover the basic effects of nuclear weapons. Included with each are all the necessary materials and training aids to present the complete class. In the Staff Training Catalog, these are listed as the T 5600 series.

For worthwhile reading, DA Pamphlets 39-3 and 39-1 should be included on your list of best sellers, and coupled with these should be the T 5200 series or the T 5600 series of classes.

A GEM FOR THE BATTERY COMMANDER

You are in command of a recently activated battery. Many of your men have not had any field duty, and your unit is soon to move out on its first field exercise. You don't have enough time to brief the various section chiefs on their duties. Where might you turn for assistance? There is a little gem of a publication, DA Pamphlet 6-1 (Aug 55), entitled "Field Artillery Checklists." These lists remind the individual, from chief of section to battery commander, what to do and when to do it during field exercises. This pamphlet does not tell the individual how to perform his duties but gives references so that he can locate the detailed instructions. Captain Battery Commander, if you are not now using DA Pamphlet 6-1, you are overlooking a very valuable training aid.

--Submitted by Capt Charles M. Hunter
Dept of P&NRT, Arty and Msl School

DO YOU WANT A PRECISION FIRE "SENSING STICK"?

Major Wayne H. Cofer
Department of Gunnery

During a registration or any other precision fire mission, the fire direction center computer must convert the observer's sensings into FDC sensings. With the Record of Precision Fire (DA Form 6-12), the computer must:

1. Select the appropriate FDC sensing table (gun on left or right of observer) on the reverse side of the record of precision fire form.
2. Select the appropriate column on the selected table for the angle T value.
3. Read and record the FDC sensing.

There are at least three objections to this technique:

1. Either the form must be turned over after each observer sensing, or a separate form must be used to keep the reverse side continuously in the computer's view.
2. The unused table and columns must be heavily marked over to make sure the computer does not read an improper value in the wrong table or column.
3. The observer sensing column is on the left side of 10 FDC sensing columns; thus, for most angle T's, the 2 columns being used are so separated that the wrong value often may be read in the FDC sensing column.

Several artillerymen have suggested a graphical solution to these problems.

SFC Omero M. Garza, Headquarters Battery, 1st Howitzer Battalion, 7th Artillery, has suggested a circular device with two windows (fig 13). Capt Charles E. Click, 60th Field Artillery Battalion, has proposed mounting the FDC sensing tables on an old graphical firing table (fig 14). Recently, Sgt Richard D. Snow, Battery A, 21st Artillery, suggested perhaps the simplest device--one which units can construct easily (fig 15).

This homemade FDC sensing stick is built as follows:

1. Mount sensing the FDC tables for guns on right and guns on left on opposite sides of heavy cardboard.

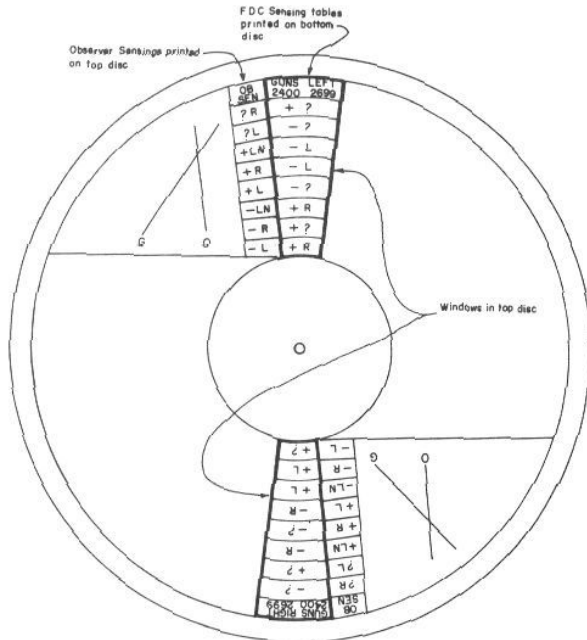

Figure 13. FDC sensing wheel made from two cardboard discs.

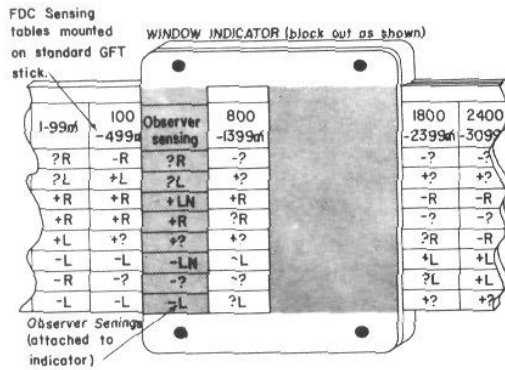

Figure 14. FDC sensing stick made from standard graphical firing table.

2. Cover one side with green and the other side with yellow transparent paper (optional).
3. Cover the entire stick with acetate for durability.

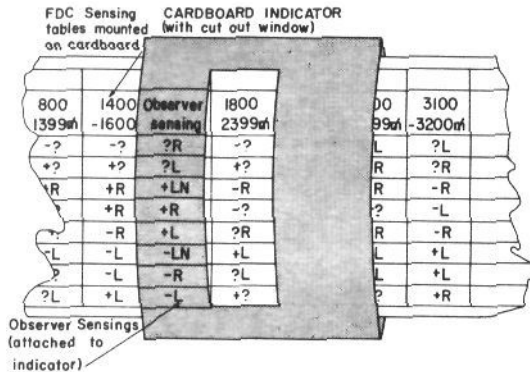

Figure 15. Simple FDC sensing stick made from cardboard.

4. Construct an observer sensing window indicator using the method described in steps 1 through 3.

All of these suggested devices have some merit, and the US Army Artillery and Missile School presents them as ideas for any fire direction center to use. Does the trained and skilled computer really need such a device? Would enough time be saved and enough errors be eliminated to justify the cost of ordnance production and issue? What do you think?

Address your comments to Major Wayne H. Cofer, Department of Gunnery, US Army Artillery and Missile School, Fort Sill, Oklahoma. If sufficient interest is expressed in these devices, it may be possible to have one of them manufactured and sold by the School's Bookstore.

A GEM FOR THE BATTERY COMMANDER

You as a battery commander have been getting caught short by the battalion commander. Seems he is always inspecting that portion of the battery that you had not visited within the last week. How might you keep one step ahead of the CO? One battalion suggested that the younger and less experienced battery commanders make an informal checklist of all battery installations from the oil shed to the arms room. This list is kept in the BC's desk drawer so he can record the date he last visited each portion of his battery. Any place he hasn't inspected recently will be readily apparent from his list.

--Submitted by Lt Col William S. Lancey
692d FA Bn, Ft Sill

WEAPONS OF THE ARTILLERY — 1

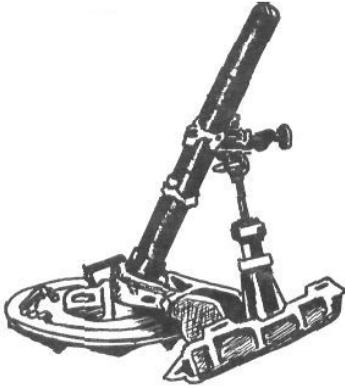

4.2 INCH MORTAR M-30

MORTAR CHARACTERISTICS

Range- 777 to 5486 meters or 830 to 6000 yards

Elevation - 800 to 1065m

Traverse -- 125 mils L & R

Muzzle velocity - 841 ft/sec

Weight

barrel - - - 155 lbs

bridge - - - 161

standard - - 59

base plate

and ring - - 217

rotator - - 58

sight - - 4

Total 654 lbs

Rate of fire - 15-20 rds/min

Propellants - sheet type

M6 - 82 sheets (41 charges)

M36 - 51 sheets (25 1/2")

Ammunition types - HE, WP, chemical, illuminating

Weight of projectile - - - approximately 25 lbs

Fire control - M34 sight

Time to emplace weapon - - 1 to 3 minutes

TRAINING LITERATURE (Short Titles)

FM 6-18 Mortar Battery ('57)

FM 6-50 4.2" Mortar (Jan 56)

TM 9-2008 Maint of 4.2 ('56)

Film Strip 9-310-Mortar ('55)

Graphic Training Aid 9-626

Firing Tables 4.2-F-1 ('54)

Army Training Test 6-14('57)

Tables of Organization - -

Inf Div Btry 6-18T (Dec 56)

Abn Div Btry 6-228T(Aug 56)

MORTAR BATTERY ORGANIZATION

Each battery contains 8 mortars organized into 2 platoons. Each section has a chief and 6 men. The prime mover is a 3/4-ton truck w/trailer. The airborne section has 2 light weapons carriers, one for the mortar, one for the ammunition. The airborne battery has a 4-man ammunition section. Infantry division batteries are dependent upon battle group headquarters to provide ammunition transport.

BORESIGHTING THE 4.2-INCH MORTAR

Major Duane W. Skow, USMC
Department of Gunnery

Since the artillery has adopted the 4.2-inch mortar M30 as a close support weapon for the infantry, two troublesome characteristics have been observed. First, errors as great as 20 mils may occur in boresighting the mortar using the prescribed aiming circle, distant aiming point method. Second, the mortar goes out of boresight during prolonged firing or successive missions.

Because of these difficulties and because a simpler means of boresighting the mortar was desired, the Infantry School, the US Army Artillery and Missile School, the US Army Artillery Board, and separate units have exerted all efforts to devise a simple and rapid method of boresighting the 4.2-inch mortar.

Prototype models of boresights, shown in figures 16, 17, and 18, were presented to the Artillery Board for test and evaluation as possible

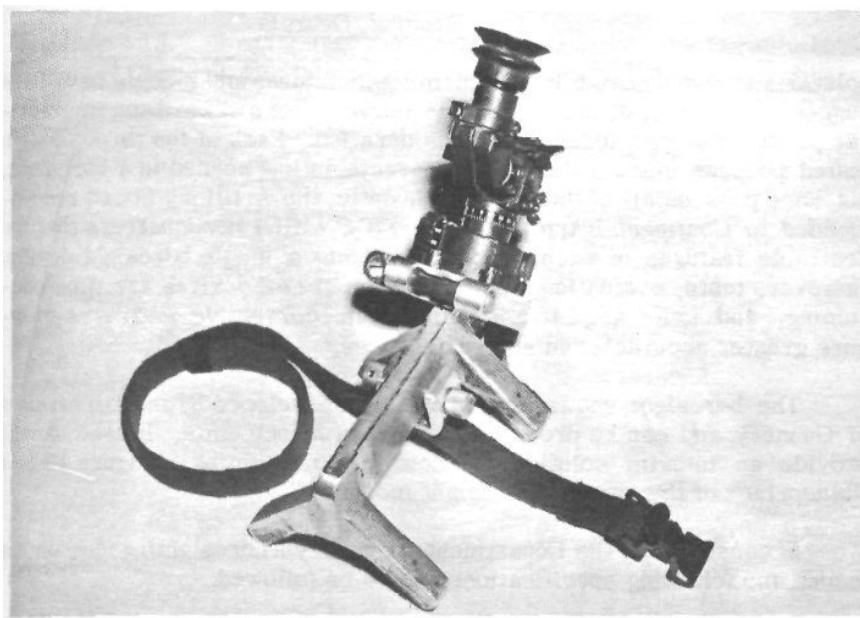

Figure 16. The 4.2-inch mortar boresighting instrument proposed by United States Army Artillery Board.



Figure 17. Boresighting instrument proposed by the Infantry School, Fort Benning, Georgia.

solutions to the boresighting problem. Other ideas and models have been suggested, but cost of production, inaccuracies, or awkward and impractical procedures precluded their consideration. Each of the three models tested possess certain desirable characteristics needed in a boresight, but none possess all of them. Consequently, the Artillery Board recommended to Continental Army Command (CONARC) Headquarters that the desirable features of each be combined into a single boresight device. However, tests, evaluation, and production of new devices are time consuming, and units need to take immediate corrective measures to insure greater accuracies in supporting fires.

The boresight shown in figure 18 was developed by the Department of Gunnery and can be produced by local ordnance units. If used, it will provide an interim solution to accurate boresighting. Figure 19 is a "blueprint" of the gunnery boresight mount.

In constructing the Department of Gunnery's boresighting instrument mount, the following specifications should be followed.

1. Surfaces AOJK and JKEN are critical surfaces and should be planed.
2. Width AO should not be less than 1 1/2 inches.
3. Length JK must be sufficient to permit seating of the gunner's quadrant.

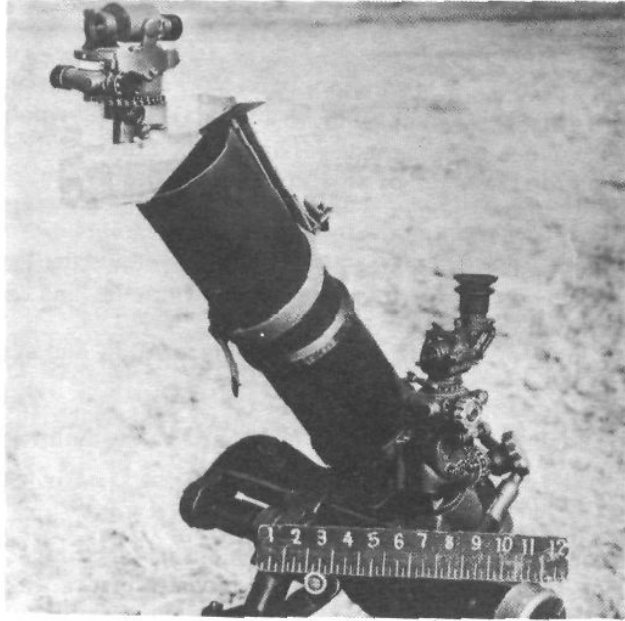

Figure 18. Boresighting instrument proposed by the Department of Gunnery, US Army Artillery and Missile School, Fort Sill.

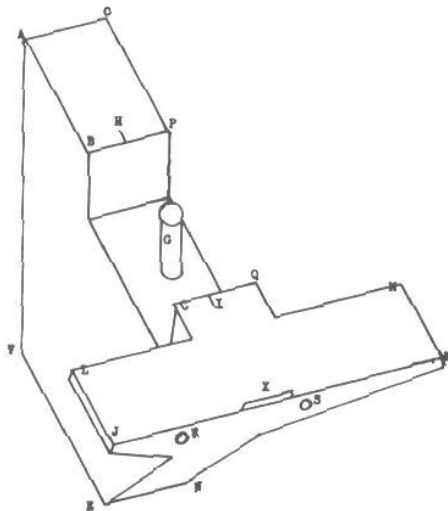

Figure 19. "Blueprint" of the Department of Gunnery boresighting instrument mount.

4. Width IJ must be at least three-fourths of an inch.
5. The center of post G is centered in the well between index H and index I and on width BP.
6. Index H is centered on width BP.
7. Index I is centered on width CQ.
8. The distance between index H and index I is one-sixteenth of an inch larger than the diameter of an aiming circle head.
9. Lug X is for attaching a strap which holds the boresight in position.
10. Pegs R and S are $\frac{3}{8}$ inch in diameter, extend $\frac{3}{4}$ inch perpendicular to surface JKEN, are equidistant on width JK, and are $\frac{3}{4}$ inch below surface LMJK.
11. The angle of incidence between surface AOJK and surface JKEN must be 700 mils.

The boresight shown in figure 18 is used in the following manner:

1. Emplace mortar in position.
2. Place mortar sight in sight mount.
3. Elevate tube to elevation 900 mils.
4. Attach strap to lug on top of boresight mount.
5. Place tube surface of boresight mount (surface JKEN) against end of mortar tube with pegs R and S resting on top and outside of tube.
6. Pull strap tight along tube and fasten securely around tube.
7. Set scales of gunner's quadrant to read zero.
8. Place gunner's quadrant on top of boresight mount (surface JKLM).
9. Level quadrant bubble by tilting boresight mount, keeping pegs against top of tube.
10. Place quadrant along axis of boresight mount so that quadrant shoes rest on either side of the well for the aiming circle head.
11. Elevate or depress tube until quadrant bubble is level.
12. Recheck cross level (step 9 above).
13. Recheck for elevation (step 11 above).
14. Level elevation bubble on mortar sight.
15. Set elevation scale on mortar sight to read 900 mils.
16. Set scales of aiming circle head to read zero.
17. Place aiming circle head on peg G.
18. Rotate aiming circle head until the zero index is coincident with boresight mount index I and the 3,200 index is coincident with boresight mount index H. Clamp aiming circle head in position and recheck for accuracy of index readings.
19. Pick distant aiming point at range of 1,500 yards or greater and, using upper motion, turn aiming circle head so that the vertical reticle is on aiming point. Record deflection read on aiming circle head.
20. Place vertical reticle of mortar sight on same aiming point and adjust sight scales to read the same deflection as read with aiming circle head. Mortar is now boresighted.

Note. Aiming point may be located in any direction from the mortar providing it can be seen through both the aiming circle head and the mortar sight. If the aiming point is directly to the left flank of the mortar, it should be at least 4,000 yards distant.

21. Remove boresight from tube.

Use of the standard angle method for paralleling axis of the sight and axis of the mortar tube has been difficult and inaccurate up to now due to parallax. A device has been proposed which makes possible a quick and accurate boresight check using the standard angle concept.

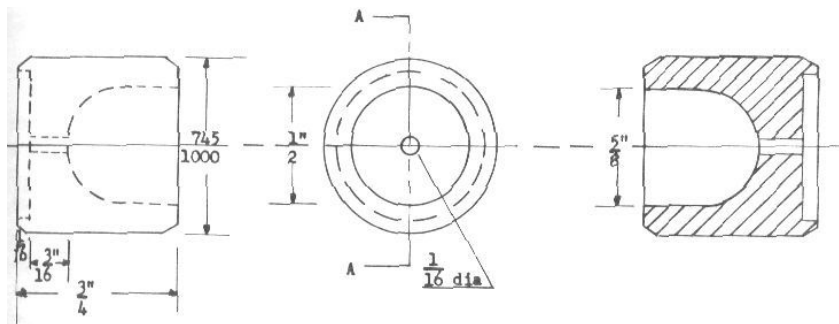

Figure 20. Diagram of the parallax shield designed by the Post Optical Shop, Fort Sill.

Figure 20 is a diagram of a parallax shield devised by the Post Optical Shop, Fort Sill. The device is placed in the object end of the M34 panoramic sight. It eliminates parallax so that a standard angle to the left edge of the muzzle may be determined accurately after the mortar has been boresighted. Using this device, the boresight of the mortar can be checked frequently, even during a mission. The shield is easy to produce locally.

The parallax shield is used in the following manner:

1. Boresight mortar.
2. Insert parallax shield in object end of M34 sight.
3. Tilt sight to rear and, using micrometer knob, rotate vertical reticle of sight to left edge of muzzle.
4. Check cross level bubble on sight.
5. Check position of vertical reticle to insure that it just touches the left edge of muzzle.
6. Read standard angle on sight scales and record for future reference.

As mentioned earlier, the boresight instrument described in this

article is a proposed interim solution to the 4.2-inch mortar boresighting problem. However, this should not stop units from using it since it has proved more effective than the present aiming circle, distant aiming point method. Use of the boresight instrument with its companion piece, the parallax shield, will improve the mortar's value to the artillery by improving its accuracy.

ERROR IN THE M30 MORTAR FIRING TABLES?

Major Duane W. Skow, USMC
 Department of Gunnery

Among the many inquiries received by the Department of Gunnery, US Army Artillery and Missile School, is a frequent request for an explanation of the apparent error in the drift column in Firing Table 4.2-F-1 and Change 1 to Firing Table 4.2-F-1. These publications show that when the constant elevation, variable charge principle is used, drift in mils decreases as range, time of flight, and muzzle velocity (charge) increases.

It is true that the mortar base plate and type of emplacement cause side jump and other launching conditions which are reflected in drift.

If drift is examined in linear units (lateral distance on the ground) rather than in the mil units of the firing table, you will see that the tables do not contradict statements made in FM 6-40 (Apr 57).

Drift, based on firing, is computed by stripping the lateral wind effect from the total effects observed and dividing the remaining effect by range. The result is the angle of drift. With the mortar, the angle of drift decreases as the range increases, but the lateral drift on the ground increases as range increases (fig 21).

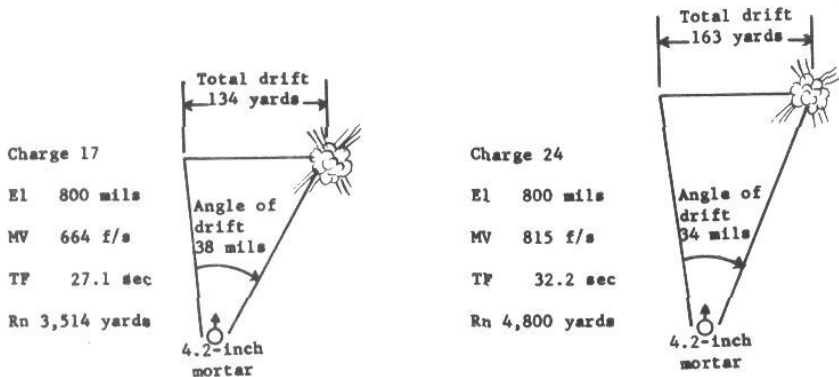
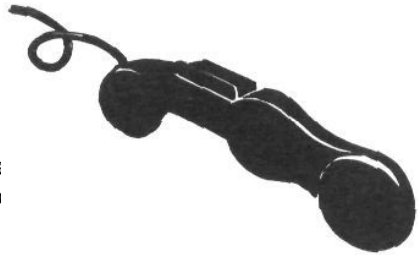

Figure 21. Angle of drift decreases but lateral drift increases with an increase of range.

The rate of drift increase due to increased time of flight and increased muzzle velocity (charge) is outweighed by the increase in range. Thus the angle of drift decreases but the lateral drift (yards on the ground) increases.

SEND YOUR MISSION, WAIT!

Lieutenant Colonel Austin J. Toth
Department of Communication and



For artillery to successfully furnish fire support to the ground gaining arms, accuracy and speed are of paramount importance.

Accuracy requires meticulous care in preparation and use of firing charts and preciseness in laying weapons. It also demands a completely reliable communication procedure.

To insure this reliability in communication, the short phrase repeat back method of radiotelephone conduct of fire procedure has long been used by artillerymen. Recognized as the best means available, this procedure is still being used and taught at the U S Army Artillery and Missile School. However, observation of students engaged in service practice and fire direction problems at the School and the performance of units in the field showed that modification of the procedure was necessary. More stringent procedural discipline was needed to attain the desired correctness. Necessary modifications have been made and radiotelephone procedure is currently receiving considerable emphasis throughout the School.

Before examining these modifications, consider the "short phrase," and "repeat back" principles.

The short phrase portion simply means that messages are transmitted in short phrases so the operator can retain the information long enough to check the repeat back against his memory. These messages include fire requests, information sent to the observer, subsequent corrections, and fire commands. There is no definite phrase length; this is a matter of judgment depending on the capability of the operator concerned. The main point is not to give the operator phrases so long that he cannot remember the message until it is repeated back.

The repeat back not only tells the sending operator his transmission has been received but also assures him it has been received precisely as he sent it. This repeat back must be made immediately upon receipt of a

short phrase. In this way, the correct receipt of the message may be verified by the sending operator, and he knows he is free to send another phrase.

Since most errors occur while sending the initial fire request, only the initial request is illustrated below. This example shows the proper length of short phrase to be used during training and when new operators are assigned to an observer or fire direction team. The illustration also points up some of the modifications which have been made and the reason for them. Note that the originator (the forward observer (FO) in this case) tells the operator precisely what words he is to send, including the call sign and suffix number. Thus the originator automatically sets the pace and the manner in which the mission is handled. Remember that the radiotelephone operator is not a translator but a second voice for the originator.

Example

FO ARMFUL 9, THIS IS ARMFUL 32, FIRE MISSION, OVER.
FO Operator ARMFUL 9, THIS IS ARMFUL 32, FIRE MISSION, OVER.
FDC Operator ARMFUL 32, THIS IS ARMFUL 9, SEND YOUR MISSION, OVER.
FO Operator SEND YOUR MISSION, WAIT.

This added transmission of SEND YOUR MISSION, WAIT notifies the observer that communication is established, that the mission will be accepted, and that he is to proceed with the mission. Communication between the two stations being established, the operators now drop their call signs and suffix numbers. However if more than one mission has to be fired simultaneously over a single channel, or should congested traffic conditions exist on a channel, call signs or suffix numbers or both must be used. As the mission is continued, terminating words are used after each short phrase. Proper terminating words normally are used after each transmission not only by radiotelephone operators but also by the originator. The originator's terminating words serve as a signal to the operator that the short phrase has been completed and should now be transmitted. There is one exception to this rule. When sending sensings to the fire direction center during fire for effect in a registration (time or percussion) or destruction mission, no terminating word is necessary.

FO FROM REGISTRATION POINT 1, AZIMUTH 2150, OVER.
FO Operator FROM REGISTRATION POINT 1, AZIMUTH 2150, OVER.
FDC Operator FROM REGISTRATION POINT 1, AZIMUTH 2150, OVER.
FO RIGHT 40, OVER.
FO Operator RIGHT 40, OVER.
FDC Operator RIGHT 40, OVER.
FO UP 20, ADD 400, OVER.
FO Operator UP 20, ADD 400, OVER.
FDC Operator UP 20, ADD 400, OVER.
FO 2 MORTARS ACTIVE, FUZE VT, WILL ADJUST, OVER.
FO Operator 2 MORTARS ACTIVE, FUZE VT, WILL ADJUST, OVER.

FDC Operator 2 MORTARS ACTIVE, FUZE VT, WILL ADJUST, WAIT.

Experience has proved that transposition of numerals or groups of numbers is the most common error in transmitting firing data, hence the length of phrase used in the above example. Note that only those elements of the fire request which contain numerals are sent in very short phrases. Other modifications or points worthy of emphasis are as follows:

An operator who discovers an error in the repeat-back must take immediate action by announcing CORRECTION and repeating the correct version of the short phrase. Otherwise, his silence verifies the correctness of the repeat-back.

Formerly, when the fire direction center transmitted ON THE WAY, OVER, the operator at the observation post indicated he had received the transmission by replying ROGER, WAIT. This has been changed to ON THE WAY, WAIT. Not only is this true repeat-back, but it also tells the forward observer (and all persons at the observation post during service practice) that the round is on the way and receipts for the message at the same time.

Also in keeping with the repeat back principle, students are now taught that the fire direction center operator repeats back the observer's surveillance rather than acknowledging it with ROGER, OUT.

Rapport must be developed between the originator and his teammate, the operator. To be effective as a team, each must have faith and confidence that the other will discharge his portion of the job with complete accuracy. For this procedure to operate smoothly, a sense of timing is necessary; phrases must be thought out and spoken distinctly; neither too fast nor too slow. The short phrase repeat back radiotelephone procedure currently taught for conduct of fire is not simple. It requires understanding, discipline, and alertness at all times by everyone involved. Actually, use of the shorter phrases rather than those formerly employed is the more difficult of the two procedures. However once the modified procedure is mastered, shifting to longer phrases is easy; the converse does not hold.

Strict compliance with established radiotelephone procedure and elimination of operating faults, such as transmitting too fast and failing to listen before transmitting, are basic communication principles known by experienced artillery officers and noncommissioned officers. Unfortunately these errors are too often accepted with such complacency that no corrective action is taken.

A single error which requires a radiotelephone operator to transmit: "SAY AGAIN, OVER," may be insignificant; however, an accumulation of such extra transmissions can well add up to failure to accomplish the mission on time.



Zero Week --and 50 men prepare for the coming 5½ months. Twenty-two weeks which, for most of the men, will be the toughest of their careers, both mentally and physically. Perhaps you as a commander have selected some of these men, for they are newly enrolled in the United States Army Artillery and Missile Officer Candidate School. Zero Week is Officer Candidate School terminology for orientation week.

The candidates train at Robinson Barracks, Fort Sill, Oklahoma. The barracks is named in honor of First Lieutenant James E. Robinson, Jr., who was awarded the Medal of Honor posthumously in 1945 for his heroic actions in the European Campaign. Lieutenant Robinson was graduated from the Officer Candidate School at Fort Sill in 1943.

Have you chosen the right man? The most important stage in selecting men for OCS is the unit commander's recommendation, because only he has had the opportunity to observe the soldier's performance over a prolonged period of time. If you as unit commander have not chosen the best and most qualified men in your unit, then those you have chosen have little chance for success at OCS.

The best and most qualified men -- these words have special meanings in terms of selecting soldiers for OCS. For instance, a study of the records of Officer Candidate Classes 1-56 through 7-57 showed that the ideal candidate was, among other things, 20 to 24 years of age. Older men often had difficulty adjusting their set behavior patterns to the strict and demanding OCS schedule.

Officer Candidates are required to make a minimum score of 250 (TM 21-200, Dec 1957) on their physical fitness test to qualify for graduation. Here is an example of what is required to achieve that score.

	<u>Raw Score</u>	<u>Points</u>
Pull ups	6	50
Squat jumps	52	50
Push ups	27	50
Sit ups	47	50
300-yard run	58.5 seconds	<u>50</u>
	Total	250 points

More and more artillerymen are being fed a brain-nourishing diet of electronic gadgets and rocket fuels, but none of the old body-building activities have been dropped from the OCS menu. Too many demerits during the week, and the officer candidate will spend Sunday afternoon marching up and down a mountainside at the rate of 150 steps per minute. Four afternoons a week, his class will spend 40 minutes doing calisthenics. Exercises are led by an upperclassman, who is graded on the performance he gets from the class, meaning 40 minutes of continuous physical exertion for everyone. One afternoon a week, those 40 minutes of exertion take the form of football, softball, or other team sports. The requirement for physical stamina is no less, for each team is playing to win. Winning means possible merits, and those merits could mean the difference between a Saturday afternoon pass or an afternoon of work details.

The importance of your potential officer candidates being in top physical condition cannot be overemphasized. Encourage your men to put themselves into the best possible physical condition before reporting to the school. Afterwards may be too late.

Now let's take a look at Corporal Arthur Smith over in your headquarters platoon. Corporal Smith is young, strong and has a good mind. You have your eye on him as a candidate for a commission. Is he qualified? Basically yes, but you can do a lot to make him more qualified. Being assigned to headquarters, Smith has seen nothing but typewriters and DA Forms for a long time. Cannons and fire direction centers may be as foreign to him as submarines.

The best thing for Smith is a tour in the firing battery as a computer or chart operator or as recorder or assistant gunner for the guns. Twenty-five percent of Smith's OCS academic training will be in gunnery. Another 25 percent will be in tactics and combined arms. Still another 25 percent will be divided between motors, materiel, survey, and com munications. The last 25 percent is devoted to OCS subjects. Any job you can give him to improve his working knowledge of these subjects will help greatly when he enters OCS. Smith should also be encouraged to enroll in certain extension courses before going to OCS.

The following courses are recommended: Basic Gunnery Subcourse 4, Leadership Subcourse 26, and Artillery Survey Subcourse 17. These

courses may be obtained by filling out DA Form 145 and mailing it to the United States Army Artillery and Missile School, Fort Sill, Oklahoma, Attention: Extension Course Division, Department of Publications and Non-Resident Instruction. These courses will help Smith attain the necessary academic background and qualify him as a candidate and potential officer.

Life in OCS demands much more of the person than just a good mind and body. An OCS student must have self-confidence. He will be making decisions commensurate with the jobs assigned him in the practical phase of his academic work. As a middle and upperclassman, he will hold jobs in the OCS class organization running from squad leader to battery commander and perhaps up to battalion commander. These jobs will all demand the self-confidence required to make an intelligent decision.

Each officer candidate must show his ability to command. He may be the battery commander on a field problem, or he may have to conduct periods of instruction for lowerclassmen. The cadre will watch him constantly for signs of strength or weakness in his ability to lead others.

Self-confidence and ability to supervise others are only two of many personal characteristics that OCS cadre watch for. Is the candidate dependable? Does he cooperate with others? Can he adapt himself to changing and trying situations? In short, the cadre is watching for leadership characteristics. The men you recommend for OCS may have the highest IQ's in your unit. They may be the outfit's star athletes. But they don't stand a chance for success at OCS unless they are potential leaders.

You should be able to answer, "Yes," to the above questions concerning the soldier you are considering for OCS. Should he fail in any respect, yet have the determination and desire to become an officer, he still has a chance.

Determination and desire are vital to an officer candidate. One OCS graduate, who is now a cadreman at the Fort Sill Officer Candidate School, put it this way, "Every candidate at one time or another during the course seriously doubts whether the goal of becoming an officer is worth the immense effort." This period of doubt is a critical point in an officer candidate's life. Whether the candidate tries to succeed or quits when he reaches this critical point depends on his determination or motivation to become an officer.

Here are two practical points which are sometimes overlooked by a commander when he recommends a soldier for OCS. First, anyone about to attend OCS should be free of heavy financial burdens. Students are required, of course, to keep their uniforms immaculate unless

practical field work makes it impossible. Consequently, his laundry and uniform maintenance bills probably will be considerably more than they were when he was in your unit. Second, the men should have a basic clothing allowance in their possession before they report for school. If this is impossible, he can buy clothes after his arrival, but this expenditure will add to his financial requirements. Neither of these considerations, by themselves, should keep a good prospect from attending OCS. However, they should be considered in planning exactly when to recommend a soldier for OCS.

Setting down a list of characteristics which would represent a truly ideal officer candidate is relatively easy. To find a soldier who represents the ultimate in each characteristic is quite another matter. Likewise, no "cut and dried" rating system or mathematical formula can determine whether or not a man will be successful at OCS. It can only indicate.

You, as a commander, will never find a man who is the ultimate in every desirable characteristic. He will be superior in some respects, average in others, and perhaps deficient in a few. The desirable characteristics denoted in this article together with your own knowledge and experience in dealing with men will guide you in choosing the right men for OCS.

A GEM FOR THE BATTERY EXECUTIVE

Occasionally gunners of howitzer or gun crews erroneously align their sights on the wrong aiming posts. This may happen frequently during practice to develop speed or when foliage, water, or other obstructions prevent placing the aiming posts at a desirable deflection. One way to whip this misidentification of aiming posts is to use different color schemes for alternate gun sections (red and white, yellow and black, or green and white). Another way is to use a varied pattern on the posts, i.e., short white sections and long red sections for howitzer section 1 and vice versa for section 2. These colors can not be identified at night, but alternating the green and red lights (for the close and far aiming posts) by sections might solve the problem. Keep in mind that the far aiming post light should be higher than the near.

--Submitted by Maj Ramey E. Wilson
Dept of P&NRT, Arty and Msl School

Review gunnery and tactics through enrollment in selected subcourses of the Artillery Extension Course Program.

WEAPONS OF THE ARTILLERY — 2

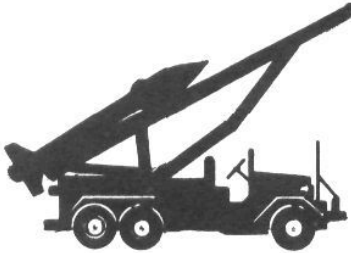

762-MM ROCKET "HONEST JOHN"

ROCKET CHARACTERISTICS

Weight:-total 5900 lbs
warhead -- 1500
propellant --2050
casing ---- 2350
Length----- 27 feet
Diameter
warhead -- 30 inches
motor - - - 23 inches
Range ----- 8500 to
25,300 meters
Thrust ----- 90,000 lbs
Guidance - none in flight
Speed ----- mach 2.5
or 2500 ft/sec
or 1800 mph
Warhead capabilities - - practice,
chemical atomic, fragmentation
Accuracy - 200 meter CPE
Manufacturer - Douglas
Aircraft Company

LAUNCHER CHARACTERISTICS

Type - self-propelled
Total length - 42' 4"
Weight - 42,000 lbs
Elevation limits:
12 to 60 degrees or
89 to 1066 mils
Traverse limits:
15 degrees L or R
or 266 mils L or R

TRAINING REFERENCES

FM 6-60 FA Rocket 762mm ('56)
(S)FM 6-60A FA Rocket 762mm
(Atomic) (U) (Jan 56)
FM 6-61 FA Bn 762mm ('56)
(S)FM 6-61A FA Bn 762mm (U)
TM 9-3060 Maint of Launcher
TM 9-3066 762mm Trailer ('54)

Training Films:

(C)6-2374 Introduction
Pt I (16 min-1957)
(O)6-2375 Mech Assembly
Pt II (14 min-1957)
(O)6-2376 Elect Testing
Pt III (16 min-1957)
(O)6-2377 Loading Pt IV
(14 min-1957)
(O)6-2378 Prep for Action
Pt V (19 min-1957)
(O)6-2379 Fire & March Order
Pt VI (20 min-1957)

Tables of Organization:

Battalion 6-525c (Dec 56)
Inf Div Btry 6-150T ('56)
Abn Div Btry 6-228T ('56)
Armd Div Btry 6-330T ('56)

Army Training Tests (ATT)

Battalion 6-11 (Dec 56)
Battery - 6-5 (Mar 56)
Firing Table - 762-A-1 ('54)
Trajectory Chart 762-A-1 ('56)

SO YOU NEED DIRECTION

Captain Fred N. Ozment, Jr.
Department of Observation

For many years, artillerymen have relied on the aiming circle's magnetic needle for initial orientation of weapons. The needle can determine direction, but its accuracy is not predictable. A magnetic needle is affected by metallic objects, electrical power lines, and most of all by variances in local magnetic fields of force. The Department of Observation, US Army Artillery and Missile School, recently measured magnetic declination at various points on the Fort Sill Reservation using a sensitive declinometer. The measurements show that the magnetic declinations for points on the Reservation vary by more than 100 mils. As this phenomenon occurs elsewhere, reliance on a magnetic needle can result in excessive errors in initial orientation of firing batteries.

Direction common to more than one unit is the most critical element in artillery orientation. Hence the US Army Artillery and Missile School is constantly searching for a way to obtain more accurate and timely common directional control. One method, though not new, seems to offer the best solution. The method is called simultaneous observation. Directional control from a master or control station is transmitted to any number of flank or receiving stations by observing a celestial body from each station simultaneously. The theory of simultaneous observation is that two or more instruments located on the earth's surface and sighted on a point an infinite distance from the earth will have parallel lines of sight. The nearest star is about 4.1 light years away, and the sun is about 93 million miles away. For survey purposes, this is an infinite distance. The difference in azimuth from any two points on the earth to a celestial body observed at the same time will be caused by the curvature of the earth. This difference can be determined and a correction applied. A star, the sun, or the moon may be used to transmit direction by simultaneous observation; however, the moon should be avoided because of its relative nearness and the difficulty of making accurate pointings to it.

Simultaneous observation requires communication from the master station to all flank stations. Radio, wire, or radio relay may be used. To transmit direction, the master station operator alerts all flank stations, identifies the celestial body to be observed, and announces the time observations will be made. In addition, coordinates of the master station must be given to each flank station. If correct grid coordinates are not known, they may be determined from a large-scale map. Flank station operators plot their own and the master station location. As with the master station, map inspected coordinates of the flank stations are satisfactory. Coordinates can be plotted on a map or grid sheet. The map or grid sheet will be used to determine a correction for the curvature of the earth.

The master station operator obtains a grid azimuth to an azimuth mark from known data, from a trig list, by reference to a previous survey, or by astronomic observation. Knowing this data, the master station operator can transmit a common grid azimuth to all flank stations.

The operator at the master station commands all flank station operators to "start tracking" the selected celestial body. He follows this with a countdown and the command, "tip." At this command, all station operators stop tracking. At this time all telescopes are parallel. The master station operator now adds the horizontal clockwise angle measured from the known azimuth mark to the body in order to obtain the azimuth to the body at the time of observation. In addition to measuring the horizontal clockwise angle, the master station operator also measures the vertical angle to the body.

The azimuth determined and the vertical angle measured are transmitted to all flank stations. Using this information, each flank station operator determines a correction to the announced azimuth to compensate for the curvature of the earth. The flank station computers must construct the announced azimuth from the master station to the body on the grid sheet or map. A line passing through the flank station is constructed perpendicular to the azimuth line. The distance from the flank station to the azimuth line is measured along the constructed perpendicular. The perpendicular distance measured and the vertical angle announced are used to determine the azimuth correction. Each receiving station operator determines the curvature correction for his station only. The correction will differ for each station because it is a function of the relative locations of the master and flank stations. The correction is read from a nomograph currently included in the Army Ephemeris (TM6-300-58) and in TM 6-200, Artillery Survey. After applying this correction, the flank station operators need only subtract the horizontal clockwise angle they measured from their azimuth marks to the celestial body from the announced azimuth at the master station. The result is the azimuth from the flank station to the azimuth mark.

For a more detailed explanation, refer to TM 6-200.

Simultaneous observation is not a new method of survey, but in the past it was only possible with the transit or theodolite. With the advent of the new M2 aiming circle, the possible applications of the method have greatly increased. The M2 aiming circle can be used for celestial observations on the sun or a star; however, it is limited to observing celestial bodies below 800 mils in altitude because of its maximum elevation of 800 mils. Simultaneous observations can be made throughout a division or corps sector down to battery level, establishing common directional control at each battery orienting station simultaneously. This capability makes the simultaneous observation method worthy of more consideration it has received previously.

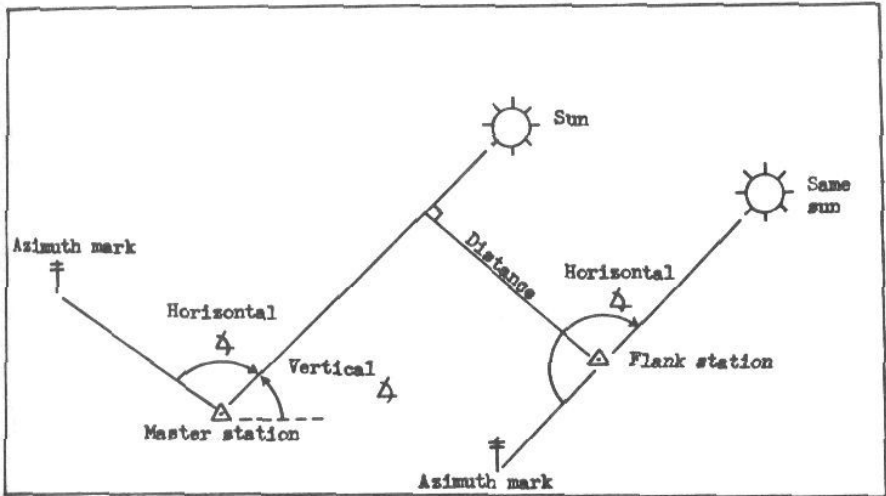

Figure 22. Angles and distance used when surveying by simultaneous observation.

In order to transmit azimuths simultaneously to all division artillery units, a transmitting time schedule should be prearranged. The schedule of observations would be announced by the master station operator. For example, three azimuths to an identified celestial body may be transmitted every 30 minutes. The schedule would resemble those arranged for transmitting ballistic meteorological messages. Units desiring directional control would tune their radios to the specified frequency and await the command to "start tracking" and "tip." Data for three azimuths would be transmitted so that receiving stations could compute a mean azimuth, thus insuring accuracy and providing a check on the final azimuth determined. Direction transmitted in this manner would provide artillery survey parties, battery executive officers, or forward observers with a way to determine common directional control before survey is completed. A unit which does not have communication with the master station can obtain direction from another unit which was able to receive the master station. Direction can be relayed if necessary. Units may decide between themselves which station is to act as the master station.

Sufficient frequency modulation radio receivers are available in artillery units to establish the required communications. If observations are conducted within a battalion, the battalion communications officer should select the frequency to be used. Observations conducted at division artillery or corps artillery level can use the corps artillery survey frequency. If for some reason this frequency cannot be used,

the communication officer at the level concerned should request a frequency from the communication officer at the next higher headquarters or the signal officer, whoever is appropriate.

Simultaneous observation offers one of the most rapid methods of establishing common directional control. Since the method requires direct observation of the sun or a star, lack of visibility will prohibit its use.

Does the method work? Brigadier General Philip C. Wehle, Assistant Commandant of the US Army Artillery and Missile School asked the same question. He requested that a thorough test be conducted to determine the expected accuracy, communication difficulties, and operator problems. The test was conducted on 22 March 1958 at Fort Sill. The situation consisted of a typical division sector with firing units tactically located. Only TO&E survey instruments and communication equipment were used. Simultaneous observation flank stations were established near the designated firing positions. A master station was established in the approximate center of the sector. The radios used were AN/VRC-9's.

The master station was equipped with a Wild T2 theodolite. Eleven flank stations were operational. These included 8 M2 aiming circles, 2 transits, and 1 theodolite. The theodolite representing the division artillery master station transmitted six azimuths in less than 30 minutes. One of the stations equipped with an M2 aiming circle acted as master station and transmitted six additional azimuths. All 12 azimuths were transmitted in less than 1 hour. All stations in the division sector, 18,000 meters from flank to flank, received the transmissions of the master station. The average accuracy obtained for all instruments was 0.41 mils. The greatest error was a 1.8 mil variation from the correct azimuth. Several instrument operators made determinations with zero mils error. These accuracies exceed the present required accuracy within a division sector.

The simultaneous observation method is simple and easily understood. It can be performed by an instrument operator with only a few days training in the technique of simultaneous observations.

We, as artillerymen, now have the means to transmit direction easily, rapidly, and accurately over great distances by using simultaneous observation. The need now is for units to familiarize their surveyors with the required techniques. Only then can we reap the benefits of this time-saving survey method.

Don't be a victim of the "summer slump". Keep active in Artillery Extension Courses.



First Lieutenant Rudolph S. Malooley
USAFAMTC

The Army's expanding missile program has enlarged the fields of endeavor of all branches of the service. The artillery has been given the mission of developing a training program and a tactical doctrine for Army missile units. To accomplish this, the artillery has divided its missile program into two fields--air defense (surface to air) and field artillery (surface to surface).

The air defense missile program conducted at Fort Bliss, Texas makes weapons operational for air defense of the field armies, overseas installations, and the Continental United States. The field artillery missile program conducted at Fort Sill makes weapons operational for the army commander to assure success in ground combat.

To fulfill its part of the program, Fort Sill has enlarged its school facilities, training program, and range areas. In addition, a new command has been created--The United States Army Field Artillery Missile Training Command (USAFAMTC). The purpose of this article is to introduce USAFAMTC to all artillerymen. It discusses USAFAMTC past, present, and future.

The origin of USAFAMTC dates back to the inception of the Army's guided missile program. On 11 October 1945, the 1st Guided Missile Battalion was organized from the 69th Antiaircraft Gun Battalion at Fort Bliss. This newly formed battalion rapidly grew in size to a regiment, then a group, and finally a brigade. The 1st Guided Missile Brigade included the 1st Guided Missile Group which was given the surface-to-air mission and the 2d Guided Missile Group which was given the surface-to-surface mission using the Corporal missile. Within the latter group, the 3d Guided Missile Battalion was formed. Its primary mission was to prepare troop-trained specialists to fill the vacancies existing in the 12 newly formed Corporal field artillery missile battalions.

The 3d Guided Missile Battalion moved from Fort Bliss to Fort Sill on 20 June 1957 and was attached to the 52d Field Artillery Group. On 20 September 1957 it was reorganized, made a major command, and redesignated the Field Artillery Missile Training Command (FAMTC). In addition to conducting the Corporal troop-trained specialist program, FAMTC was given broad additional missions which will be covered later in this article. On 1 April 1958, FAMTC was redesignated as the United States Army Field Artillery Missile Training Command.

Advanced individual training on the Corporal missile system has been in effect for some time (item 1a, fig 23). USAFAMTC is presently conducting a troop-trained specialist program on the Corporal missile. This is being accomplished by the 1st Field Artillery Missile Training Battalion. Similar training on the Redstone and Lacrosse missile systems

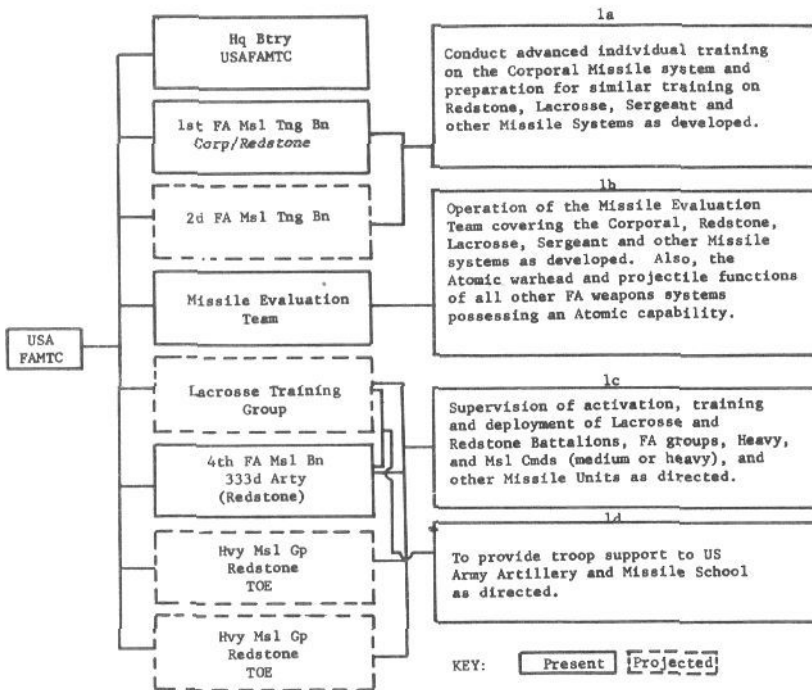

Figure 23. USAFAMTC missions are listed to correspond to the sub-organizations that specifically pertain to them.

will begin in the near future. Training on the Sergeant and other "second generation" missiles will be conducted in a similar manner.

The troop-trained specialist program on the Corporal missile is very similar to the second 8-week cycle of advanced individual training for conventional artillery, infantry, or armor. Classes begin approximately every 7 weeks, and students are assigned to the program on the basis of their aptitude area scores in electronics and general and motor maintenance. Students are received on Department of Army orders from the basic training centers throughout the country, e.g., Fort Dix, Fort Carson, Fort Chaffee, etc. Figure 24 explains exactly how the battalion conducts the program from the student orientation through the graduation to assignment to a Corporal battalion.

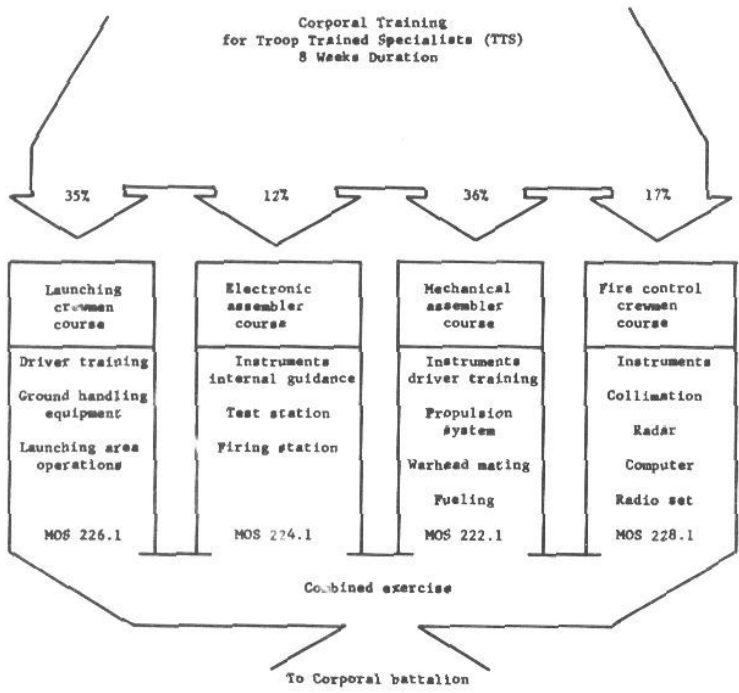

Figure 24. Men selected as replacements for Corporal battalions are trained in one of four divisions depending on their aptitudes.

The orientation familiarizes the students with the Corporal missile system. After this, the instruction is broken down into 4 specialized sections and continues for approximately 8 weeks.

Students possessing aptitude in motor maintenance are assigned to the launching crewman course. Here they become familiar with the ground handling equipment common to a Corporal battalion. They learn the emplacement and maintenance of a surface-to-surface missile launcher and prefiring and firing procedures for the Corporal missile.

Students possessing aptitude in electronics attend either the electronic assembler course or the fire control crewman course. In the former, they learn to use the test and assembly equipment of the Corporal missile. Also, they learn how to perform routine and basic electronic assembly tests without close supervision by advanced specialist personnel. In the fire control crewman course, the students study and use all the ground guidance equipment. They learn the mission of the guidance platoon of the Corporal firing battery, that is, keeping the missile on the proper path to the target after it has been fired.

Lastly, students possessing aptitude in general maintenance go to the mechanical assemblers course. Here they learn to use the test and assembly equipment used on the Corporal propulsion system and proper fueling and defueling procedures. They perform the checkouts necessary to make sure the propulsion system functions properly.

The instruction is culminated by a 2-day, nontactical, combined exercise (CEX). On this exercise the students, aided by their instructors, pool their knowledge and conduct a simulated firing of the Corporal missile. The students then graduate and, as directed by Department of Army, are sent to fill existing vacancies in Corporal battalions stationed in the United States and overseas.

Figures 25 and 26 outline the tentative troop-trained specialist programs for the Redstone and Lacrosse missiles. Note that while the Lacrosse program is similar to that of the Corporal and Redstone, the students will not be divided among the three subcourses. They will receive training in every subcourse. This is due to the simplification of the assembling, launching, firing, and forward observing equipment and the missile itself.

USAFAMTC has the mission of providing a missile evaluation team. This organization contains cellular sub teams highly trained in the technical procedures for emplacement, checkout, and firing of field artillery surface-to-surface missiles and their warheads. The missile evaluation team will also provide teams highly trained in the technical procedures used in preparation and checkout of atomic projectiles and rocket atomic warheads. The teams also will give on call assistance:

1. To field artillery units during Army training programs and training firings.
2. In evaluating the state of training of field artillery missile units during Army training tests and annual service practice.
3. To field artillery warhead support detachments supporting allied troops equipped with weapons which deliver United States Army atomic warheads and projectiles.

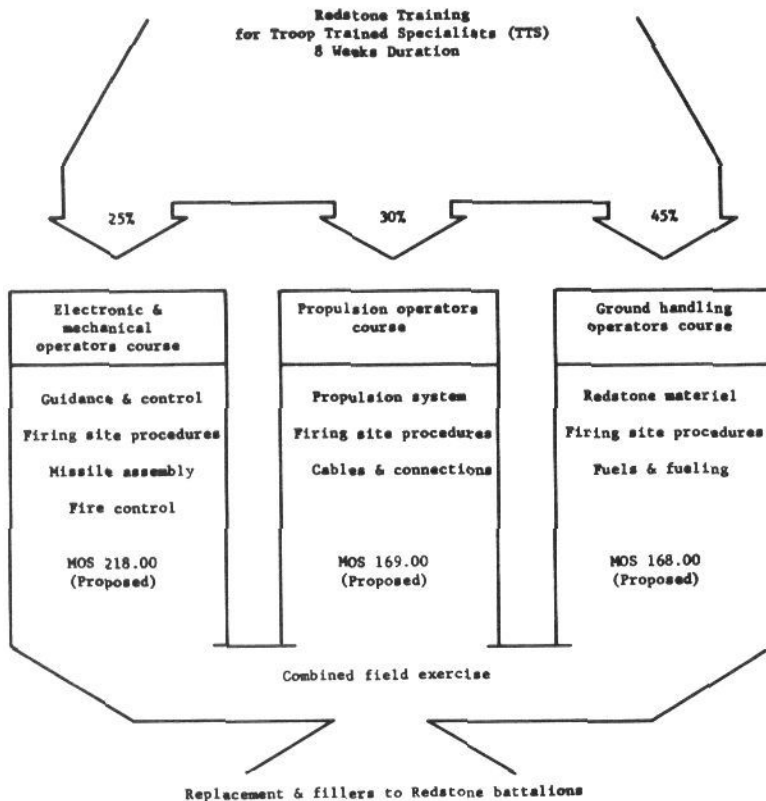

Figure 25. The orientation, breakdown and combined exercise of the Redstone program will closely parallel the Corporal training program.

One cardinal feature of the missile evaluation team is that they will collect, record, compare, and evaluate data secured during training exercises and firings. This data will be used in studies on weapon reliability, accuracy, and complexity to determine if procedure changes and improvement of the weapons system are needed. This will assist the missile program immeasurably in producing combat effective missile units--our ultimate objective. Two teams have been organized for the Corporal missile program. One team is stationed at Fort Bliss and the other at Fort Sill. The Fort Sill team has been in Europe assisting Corporal units stationed there. A cadre strength team was organized for the Redstone missile system and assisted the Third Army in administering the technical portion of the Army training test to the 40th Field Artillery Group (Redstone) stationed at Redstone Arsenal, Huntsville, Alabama. Similar teams will be formed for the Lacrosse, Sergeant, and succeeding second generation missiles.

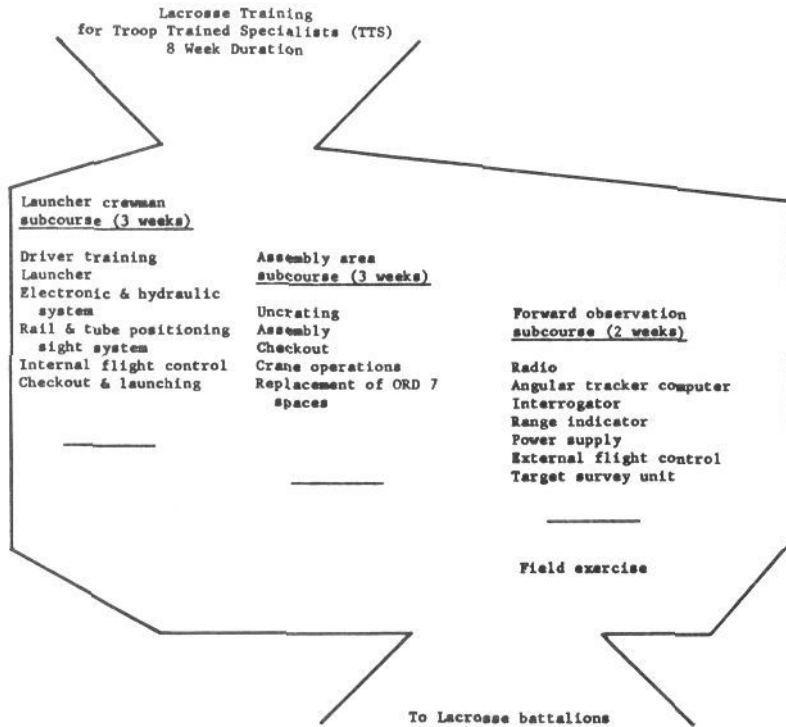
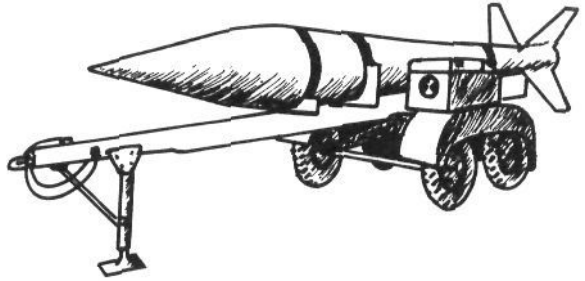

Figure 26. Men trained as replacements for Lacrosse battalions receive training in all three divisions.

In conjunction with the training program and the missile evaluation teams, USAFAMTC will supervise the activation, training, and deployment of Redstone and Lacrosse battalions and other missile units as well as heavy field artillery groups and heavy missile commands. These units will be trained and tested by USAFAMTC under both garrison and field conditions. Units recently activated include the 2d and 4th Field Artillery Missile Battalions (Redstone) of the 333d Artillery. USAFAMTC will also provide troop support to the US Army Artillery and Missile School when necessary.

The growth of USAFAMTC has been rapid. Since it was organized at Fort Sill on 20 September 1957, it has rapidly expanded from a battalion size unit to a major command. But even this rapid growth will be overshadowed by programmed expansion in the future.

Last Name--John
First Name--Honest
Occupation--Artillery Weapon



The weapon mentioned in the title of this article has been an employee of the artillery since 1954. However, since many facts about his personality have been declassified only recently, he is not well known to many artillerymen. Now that more of his vital statistics have become available, and his offspring are in worldwide use, you can become better acquainted with him.

From a materiel standpoint, the Honest John is a free flight, solid propellant rocket, 762- millimeters (approximately 30 inches in diameter.) Free flight means there is no way to alter the trajectory of the rocket once it has left the launcher. Solid propellant means the rocket fuel is in solid form as opposed to the liquids used in a missile like the Corporal. The Honest John can deliver a 1500-pound warhead against land targets at ranges from 5.3 miles to 15.7 miles. The rocket's launcher is the 21-ton, self-propelled M289.

The Honest John rocket breaks down into four major components; the warhead, pedestal, rocket motor, and fin assembly. Each component has a specific function in the overall operation of the rocket.

The Honest John is capable of delivering atomic, chemical, fragmentation, and practice warheads.

The pedestal section of the rocket houses eight spin rockets (fig 27). These small rockets are mounted in pairs in the four quadrants of the pedestal. They are positioned so their thrust is delivered perpendicular to the Honest John's longitudinal axis. The spin rockets are fired immediately after the Honest John clears its launching rail, giving the weapon a two revolution per second spin. Spinning the rocket in this manner distributes errors caused by uneven propellant burning.

The solid propellant filler of the rocket motor weighs over 1 ton. It burns for 4.5 seconds and delivers a 90,000 pound thrust. At burnout, the rocket has a velocity of 2,500 feet per second--about 1800 miles an hour. The propellant is a multiperforated double-base composition which can be stored and fired at temperatures from 0° F to 120° F. An electrical heating blanket covers the entire rocket prior to firing. Thermo-statically

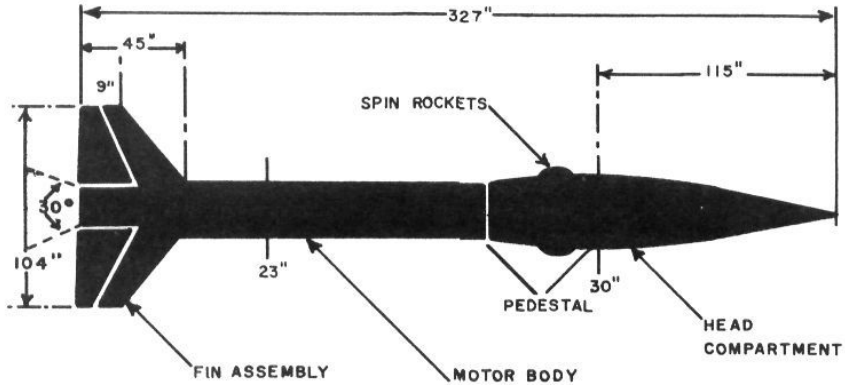

Figure 27. Main Characteristics of 762-mm Rocket.

controlled heating elements within the blanket attempt to keep the propellant at the optimum temperature of 77° F when the ambient temperature falls below this. At higher ambient temperature the blanket acts as an insulator. When the assembled rocket is being transported on its M329 trailer, power for the blanket is supplied by a 3,500-watt gasoline driven generator mounted over the left wheels. When mounted on the launching rail, power is supplied by another generator mounted on the launcher.

The last major component of an Honest John rocket is the fin assembly, which consists of four fins. These fins stabilize the rocket in flight. By being offset 0.5 degrees to the right, the fins also maintain the spin imparted by the spin rockets. This constant spin alleviates aerodynamic errors which may exist after motor burnout. The fin span is 104 inches.

Each 762-mm round is "fired for effect"; the firing data must be computed in detail for each round. The most critical factor affecting accuracy is surface wind in the immediate vicinity of the launcher. Each section, therefore, has an organic wind measuring set mounted on a 3/4-ton trailer.

Interception of an Honest John in flight would be extremely difficult. As it is a free rocket, no electronic countermeasures are effective. Theoretically, a heat homing device could be used against the Honest John since the motor body is hot all the way from burnout to target. However, high speed plus tactical surprise make interception improbable.

Honest John units are 100-percent mobile, comparing favorably with medium artillery on highways and cross-country. The launcher may be transported by a C124 aircraft which makes this unit employable in phase III of an airhead. The launcher can be readily transported in a utility landing craft (LCU).

Being a free rocket with no complicated guidance system, the Honest John is both simple and reliable, hence the derivation of its name. It is emplaced and laid for direction like cannon artillery and has no physical ramifications requiring highly technical maintenance.

As an atomic delivery means, the Honest John is inexpensive compared to guided missiles and should prove to be an effective method of delivery of atomic fires on the battlefield. The capability of the Honest John should never be overlooked in operational planning.

MOBILITY with VERSATILITY for FUTURITY

Captain Eugene B. Humrighouse
Department of Motors

In "ARMY" magazine appeared these words of General Maxwell D. Taylor, "Perhaps the most pressing problem which the Army faces today is to assess the impact of atomic missiles and projectiles on the nature of the land battle, and then to effect a proper adjustment of organization, techniques, equipment, and weapons."

The more you meditate, the greater grows the challenge from those few carefully chosen words. Accepting that challenge and doing something about the "equipment," we are immediately concerned with the vehicles for artillery transportation. What job will they have to do? Can that job be done by existing vehicles? If not, what characteristics must a vehicle have to help us perform our mission?

Artillery, the "King of Battle," has long been known for its superior ability to move, shoot, and communicate. However, now we must look to the future with its increased requirements for mobility which the Army must have to exploit its vast firepower in any area from the frigid polar ice caps to the steaming tropical jungles, under the conditions of atomic warfare (real or threatened) and in, through, or over undeveloped or devastated areas with a minimum of construction effort. To do this we must have vehicles that are air-transportable, have light overhead armor, are capable of crossing inland waterways, have low ground pressure, are more versatile, and require less logistical support. The reason for the latter is obvious. Supporting a fast moving force in an isolated area is somewhat like trying to feed a carrot to a rabbit running through a briar patch.

Perhaps we should all adopt the slogan, "THE DIFFICULT WE DO IMMEDIATELY--THE IMPOSSIBLE TAKES A LITTLE LONGER," which appears to have been adopted by the Army R&D people. When challenged by the problem of cross-country transportation of vast amounts of fuel, they have come up with a Rolling Fuel Transporter (see fig 28).



Figure 28. Rolling fuel transporter.

Developed for the Army by the Four Wheel Drive Auto Company of Clintonville, Wisconsin, utilizing containers developed by Goodyear Tire and Rubber Company, Akron, Ohio, the transporter has 10 fluid carriers (each 5 feet high, 3 1/2 feet wide, and 500-gallon capacity) mounted in pairs. The transporter is equipped with air-over hydraulic brakes, quick-disconnect type fittings, filtering system, static-electricity discharge devices, sealed bearings, combination hub and rims built for easy "tire" removal, standard design lunette and pintle, and a relay quick-release valve which applies transporter brakes in event of a breakaway from the towing vehicle. The "tires," or carriers, have a resistance to some chemicals and most fuels and can be stored outside in temperatures as low as minus 80 degrees or as high as 160 degrees Fahrenheit. Designed to go where conventional tank trucks cannot go, the transporter has very low ground pressure and low motion resistance which permit movement over most variables of terrain and allow large quantities of fuel to be moved at relatively high speeds from sea or air terminals to consumption points. (That's us--fuel consumption is one of our major problems, not because the engines of today are more or less efficient than those of yesterday, but because we require them to do more.)

Perhaps some of our requirements will be fulfilled by the new family of lightly armored, air-transportable, full-tracked, amphibious vehicles, some of which are now being tested for suitability as personnel and equipment carriers, mobile command posts, fire direction center, fire-support-coordination centers, prime movers and/or weapons platforms. One of these vehicles, the T117, is similar in appearance to the M59 armored personnel carrier but different in that it is lower and narrower, has one V-8 engine instead of two 6 cylinder engines, and weighs less than 1/2 the weight of the M59.

Another new versatile vehicle which is already in service is the "Mechanical Mule," named for its ruggedness, sure-footedness, and load carrying ability (fig 29).

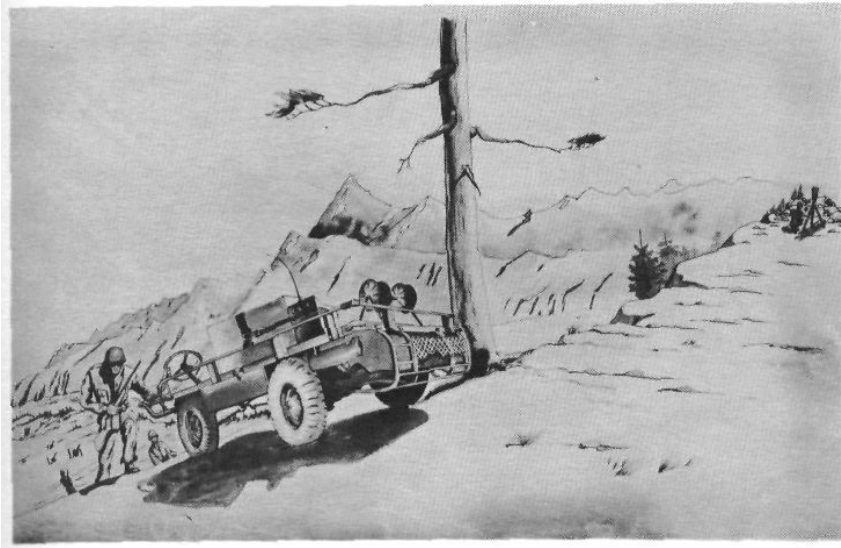

Figure 29. Mechanical Mule.

This lightweight, general purpose carrier has battlefield utilities limited only by its weight carrying ability and by the ingenuity of the user. Designed for minimum driver training and maintenance, servicing of the hard-to-work-underplatform locations can be accomplished easily by turning the vehicle on its side or upside down. The driver has the option of two or four-wheel steering from a mounted or dismounted position. A simple twist-of-the-wrist lowers the steering wheel in the forward position so that the driver can operate the vehicle in reverse and follow in a crouched position, thus retaining the low silhouette. Since the speed can be reduced to as low as .8 mph, the driver should have no difficulty keeping up. Exceptional mobility is attained by the combination of low speed, small turning radius, and four wheel drive and steering. The "MULE" is powered by a simple air-cooled, four-cylinder, horizontally-opposed, internal combustion engine which is started somewhat like an outboard motor.

If true freedom of mobility can only be obtained by a combination of surface and air mobility, some of our future vehicles must have this combination. The new "Aerial Jeep," (fig 30) shown by artists concept should weigh about 1,000 pounds and have a payload of about the same.

It could mount radio equipment, machine guns, and carry personnel. The use of the "Aerial Jeep" for command and reconnaissance staggers

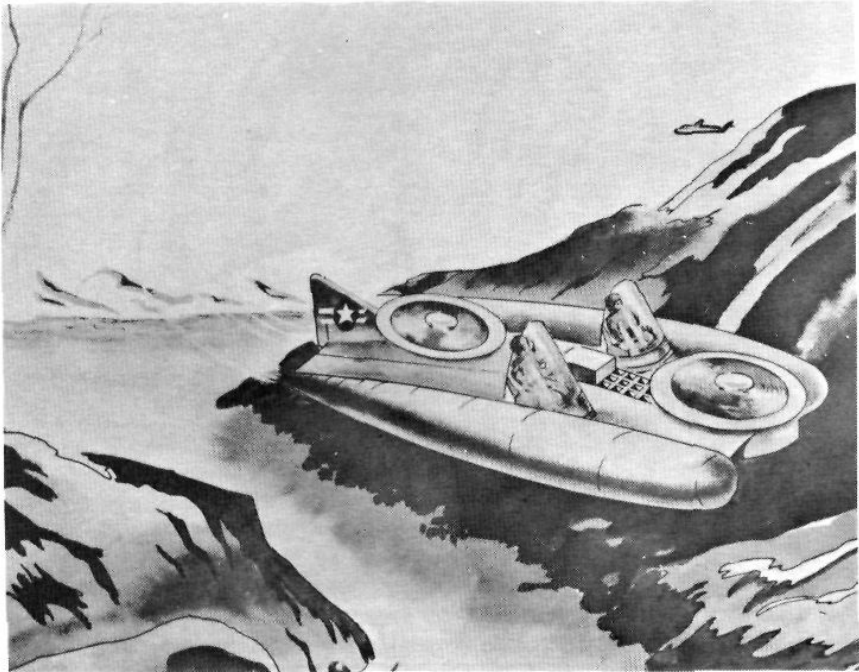

Figure 30. Aerial Jeep.

the imagination. Can't you visualize a commander being able to sneer at mine fields, swamps, road blocks, water and other obstacles? The low silhouette and protected rotor blades will give the "jeep a decided advantage over ordinary helicopters, allowing it to hug the ground between buildings and among trees. The small size and agility will permit quick movement and easy camouflage. Scheduled for troop testing in 1959, the projected new vehicle is under construction and testing by the Aerophysics Development Corporation, Chrysler Corporation, and Piasecki Helicopter Corporation, the three contracts totaling \$1,702,000.

These are but a few of the trends and "Irons in the Fire," but they are versatile vehicles, definite assets, a step towards our objective of "Mobility with Versatility for Futurity."

NEWS NOTES FOR ARTILLERY MEN

105-MM MORTAR ELIMINATED

Tests and evaluation of the 105-mm mortar have been terminated. The tests showed that this mortar did not possess the accuracy required of a close support weapon.

NEW WIRE REEL UNDER TEST

Presently undergoing evaluation tests at the Department of Communication and Electronics is an electrically powered wire reel for use in forward combat areas. This unit, the RL-172, uses a 24 -volt electric motor instead of the familiar gasoline engine. The unit may be mounted on a 1/4, 3/4, or 2 1/2-ton truck. Power for this 110-pound unit is furnished by the vehicle's battery. The standard RL-159 drum is used which has a capacity of approximately one mile of WD-1 wire. When used to pick up or play out field wire, the unit is normally hung vertically from the vehicle's tailgate.

175-MM SELF-PROPELLED GUN STATUS

The T235 self-propelled 175-mm gun will undergo firing tests using high explosive rounds at Yakima Firing Range, Washington, in June 1958. The T235's carriage (fig 31) is also designed to mount the new T236 8-inch howitzer. The carriage is being manufactured by the Pacific Car and Foundry Company, Seattle.

SIMPLIFIED DECLINATION DIAGRAM

The Chief of Engineers has approved a revised declination diagram to be applied to new maps printed by the Army Map Service.

An Engineer study revealed that many individuals had difficulty converting magnetic azimuth to grid azimuth and that the protractor scale shown at the top of military maps was seldom, if ever, used. The study revealed that very limited use was made of the true north arrow. A surprisingly large number of the individuals tested divided a degree into 100 minutes!

The new declination diagram (fig 32) simplifies conversion of azimuths and shows changes in grid declination in a simple, easy to read chart. A statement of the relationship between grid and true north allows quick calculation if the need arises.



Figure 31.
The T235 self-propelled 175-mm gun.

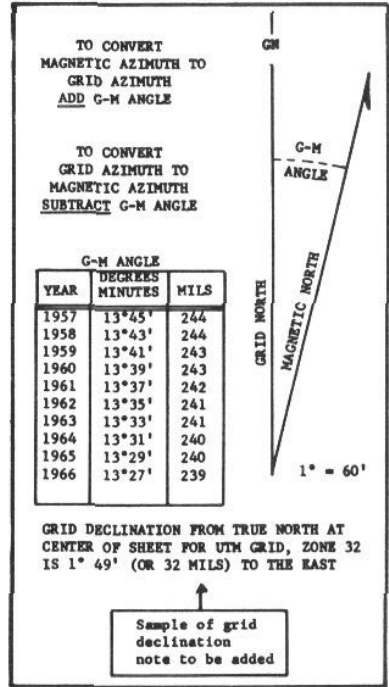

Figure 32.
New declination diagram to be used
on Army maps.

NEW 105-MM HOWITZER SHELL CASE ADOPTED

A new spiral-wrapped, multipiece, steel cartridge case for the 105-mm howitzer semifixed round has been recommended for standardization. This cartridge case, the M14E3, is lighter and cheaper than the old spiral wrap, drawn steel, or brass cases.

NEW 8-INCH SELF-PROPELLED UNDER TEST

A new, light weight, full tracked, self-propelled 8-inch howitzer will soon undergo service test. Known as the T236, it will have an unarmored flat deck from which the piece will be serviced. The howitzer will use the same carriage as the T235 175-mm gun. The carriage has a flat track suspension. Power is furnished by an AOI628-2 engine developing 340 horsepower. A suspension lockout gives a rigid base to the weapon. The howitzer has a traverse of 60 degrees and elevates from 0 to 65 degrees. Weight combat loaded is approximately 55,000 pounds.

EXPANDED FACILITIES FOR MISSILE TRAINING

Closed-circuit TV, a roof-top classroom, 111,000 square feet of floor space, and a built-in pneumatic system. Those are a few of the features that will grace the \$3,800,000 addition to Knox Hall now being constructed at Fort Sill.

The building will provide facilities for virtually all field artillery missile and nuclear weapon instruction conducted by the departments of the US Army Artillery and Missile School. Completion of the building is expected to take 2 years.

Knox Hall's present 39,000 square feet of space will be increased to 150,000 square feet. The addition will contain 16 classrooms, 4 nuclear warhead labs, 3 propulsion labs, and several bays for missile checkouts. The electric and pneumatic systems will accommodate the requirements of all present-day missiles and those still on the drawing board. The TV circuit will show the functioning and maintenance of missile parts to large classes.

When completed, Knox Hall will be another and stronger link in the training of field artillerymen.

NEW PRIME MOVER FOR THE 8-INCH AND 155

The 10-ton M125 cargo truck, a Mack Truck Company vehicle, is being issued to 8-inch howitzer and 155-mm gun battalions for use as a prime mover. The M125 was originally designed for use with the 90-mm antiaircraft gun. Power steering and power brakes are among the features of the M125. The V-8 Leroi engine develops 286 horsepower at 2,600 rpm, giving the truck a payload of 20,000 pounds cross-country and 30,000 pounds on the highway. An ammunition hoist is mounted in the aft section of the cargo body.

METRIC SYSTEM ADOPTED BY ARMY

The traditional linear scale used in measuring distances for artillery and rifle fire is being discarded by the Army in favor of the metric system.

Army Regulation 700-75 states that the existing survey and fire direction equipment and data for Army weapons will be converted from feet, yards, and miles to the metric system with the, "least possible delay."

Reasons for the changeover are (1) to establish a common unit of measure with NATO nations, (2) to permit greater use of allied or

captured enemy materiel, and (3) to simplify firing procedures for indirect fire weapons.

If existing equipment is to be replaced before 1 January 1966, it should not be modified. One January 1966 is the date that the changeover to the metric system is to be completed.

The field artillery is well along in the conversion to the metric system. The 30-meter tape is now standard equipment for battery survey work. All survey computations are now in meters. The Army Map Service may eventually print new maps of the United States with altitude shown in meters.

Tabular firing tables for certain weapons (Corporal, 762-mm Honest John, and the 8-inch howitzer) already have appeared using metric measure to express range. The remaining tables will eventually be converted. All Universal Transverse Mercator (UTM) maps utilize the 1,000-meter grid square. The issue firing chart grid sheets have been printed for several years with the 1,000-meter square. In three areas conversion must be made: a number of firing table factors, the ballistic scales on the graphical firing tables, and the target grid.

For the present, velocity will continue to be expressed in feet per second and temperature in degrees Fahrenheit. Wind speeds will continue to be expressed in miles per hour and barometric pressure in millibars or inches of mercury.

APPLICANTS WANTED FOR GUIDED MISSILE COURSE

The Guided Missile Staff Officer Course 44-A-1181 of 35 weeks' duration is conducted at the US Army Air Defense School, Fort Bliss, Texas. The course provides selected officers from all branches of the Army with a well-grounded knowledge of the physical sciences as they apply to guided missiles. The course also covers the theoretical and practical aspects which apply to all guided missile systems. By attending the course, officers prepare for duties involving research and development, testing analysis, and military applications of guided missile systems.

Graduates of this course are usually assigned to Department of Defense, Office of the Joint Chiefs of Staff, Department of the Army, appropriate joint and allied commands, United State Continental Army Command headquarters, United States Continental Army Command boards, and US ARADCOM headquarters and regions. Other typical assignments are as a military liaison officer with civilian research and development and production agencies or an instructor in an Army service school. A utilization tour of four years is the normal assignment on completion of

this schooling. Duty assignments after the utilization tour will depend on military requirements.

Officers with a rank of first lieutenant or higher who have completed the battery or company officer course and whose assignment as a missile officer is contemplated are eligible to attend this course if they have the required math background. The officer must have had courses in differential and integral calculus and one semester of college physics. For complete details, interested officers should read DA Pamphlet 20-21, dated 13 May 1957, as changed.

AAA NOW AIR DEFENSE ARTILLERY

The terminology antiaircraft artillery (AAA) has been changed to air defense artillery (ADA). One reason for this change is that the terminology air defense artillery includes the mission of antimissile defense. Brigade and group titles have been changed accordingly. An example of the new titles: the 47th Antiaircraft Artillery Brigade becomes the 47th Air Defense Artillery Brigade.

STATUS OF TRAINING LITERATURE

1. The following training literature is under preparation or revision by the US Army Artillery and Missile School:

FM 6-18-Mortar Battery, Infantry and Airborne Division Battle Group. A complete revision of previous edition, now includes airborne mortar battery. Due USCONARC August 1958. Tentative date pending change in ROTAD TOE.

FM 6-20-Field Artillery Tactics and Techniques. A complete revision of previous edition. It is designed to realine field artillery tactics with new organizations and weapons. This text deals only with field artillery tactics and techniques. Due USCONARC June 1958.

FM 6-30-Field Artillery Missile Battalion, Corporal. Due USCONARC December 1958.

FM 6-31-Field Artillery Missile Corporal. Due USCONARC December 1958.

FM 6-32-Guidance System Field Artillery Missile Corporal. Due USCONARC December 1958.

FM 6-101 The Field Artillery Battalion. This revised manual includes all type battalions other than observation and missile. Temporarily suspended.

FM 6-140-The Firing Battery. This manual eliminates much data formerly included which is now printed in FM 6-40. Due

USCONARC April 1958.

FM 6-()-Division Artillery. This manual covers the infantry, armored, and airborne divisions. Due USCONARC June 1959.

Change 1 to FM 6-40-Field Artillery Gunnery.

(C) FM 6-()-Field Artillery Missile Battalion, Lacrosse (U). Due USCONARC September 1958.

Notes for the Battery Executive and Fire Direction Officer. This US Army Artillery and Missile School printed text is divided into two portions as indicated by the title. The FDO portion pertains to the battery level. When available, this text will be sold by the School's Bookstore.

Army Training Tests (ATT) under preparation, revision, or change:

- 6-1-FA How or Gun Btry (change).
- 6-5-FA Bns, Lt and Med (revision).
- 6-7-FA Btry, 762-mm (revision).
- 6-8-FA Bn, 280-mm Gun (change).
- 6-10-FA Msl Bn, Cpl (change).
- 6-11-FA Bn, 762-mm (revision).
- 6-16-FA Bn, 8-in How (change).
- 6-()-FA Msl Gp, Redstone (new).

The following have been printed and are available through normal supply channels:

- (S) FM 6-25-FA Msl Gp (Hv) (U) (Feb 58).
- FM 6-35-FA Missile Redstone (20 Jan 58).

Army Training Tests (ATT):

- 6-12-FA Bns, 155-mm Gun (29 Jul 57).
- 6-13-FA Btry, 105-mm How(ROCID) (13 Sep 57).
- 6-14-Mort Btry, BG, Inf & Abn Div (13 Sep 57).
- 6-15-FA Bns, (ROCID) (13 Sep 57).
- 6-16-FA Bns, 8-in How (13 Sep 57).

2. Information concerning erroneous entry in Change 4 to FTR 762-A-1:

The Ballistic Research Laboratories have recently verified the presence of an erroneous entry in Change 4 to FTR 762-A-1. Reference page 4 of the change (replacement page 16 to the basic table), the elevation at a range of 8,500 meters and at 0 meters height of target above launcher should be changed to read 210 mils instead of 200 mils. The Laboratories will publish an errata sheet relative to this error.

3. Planned change to FM 6-40:

FM 6-40 (par 175 and table XII, p 313) states fuze delay can be used for the same purpose as fuze time or variable time, i.e., the attack

of troops in the open. FM 6-40 also states fuze delay may continue to be used though we achieve only 50 percent ricochet action.

This implies that ricochet action is at least twice as effective as impact bursts. Extensive studies show that this is not so. For standing troops, impact bursts are at least as effective as ricochet actions; for prone troops, ricochet fire is only moderately more effective than impact bursts; for shielded troops, ricochet action is markedly more effective than impact bursts. Therefore, the 50 percent effective air burst criterion is acceptable only when firing against shielded troops. The term "shielded" used here means the troops are protected by either natural or man-made shelters. Troops might be in natural depressions and hollows or in prepared holes of some kind.

The US Army Artillery and Missile School now teaches that ricochet fire should be used only against shielded troops. FM 6-40 will be changed accordingly.

A GEM FOR ALL ARTILLERYMEN

Are you prepared to "get the word"? There once was a time when all officers and NCO's equipped themselves with pencil and notebook. These items were as much a part of the uniform as the standup collar and campaign hat. This practice is nearly obsolete as evidenced by many of today's officers who either have to borrow a pen and paper or be satisfied with a frequently unreliable mental note when they have to take notes while away from their desk. Are you prepared?

-- Submitted by Capt David H. Northrip
Dept of P&NRT, Arty and Msl School

A GEM FOR THE COMMUNICATIONS OFFICER

Do your forward observers and liaison parties have difficulty establishing radio contact with headquarters? They should use a long wire antenna if possible. Wire of more than one wave length will become directional off the ends. Normally, 100 feet of WD-1 field wire is long enough for all artillery frequency modulation sets. The wire is oriented by pointing it toward the station with which you want to communicate and moving it left and right and up and down until the best signal is obtained.

--Submitted by Capt Isaac S. French
Dept of P&NRT, Arty and Msl School

NEW ARTILLERY PLOTTING KIT FOR SOUND RANGING

Lieutenant Colonel Eugene C. Rogers (Retired)
Department of Observation

The present sound plotting equipment and data correction devices issued to observation battery sound ranging platoons have proved to be inaccurate as well as inadequate in coverage. The equipment corrects time intervals for temperature, wind, and asymptote and makes rough and final plots of enemy weapons. The present major items of sound ranging correction and plotting equipment are two plastic fans, one for plotting time intervals from straight, regular 4-second sound bases and one for plotting time intervals from irregular bases. The necessary charts and devices are provided for correcting the time intervals for temperature, asymptote, and wind. As a result of research started in 1949 by the US Army Artillery and Missile School, a new family of plotting devices and correction charts were designed and recommended. Through the concentrated and coordinated efforts of the US Army Artillery and Missile School, the US Army Artillery Board, and the Frankford Arsenal, the new family of plotting devices has materialized as the T43 sound ranging plotting kit. The service testing of these devices is being conducted jointly by the US Army Artillery and Missile School and the US Army Artillery Board. At the present time, the devices are undergoing tests at the Department of Observation.

The sound ranging plotting kit T43 will provide all the items essential to a sound ranging plotting center for correcting, processing, and plotting time intervals. The kit will be suitable for use with the present GR-8 sound set and possibly with the future replacement sound ranging set now under development.

The plotting board for the T43 is the present flash ranging plotting board M5A2 modified by attaching a 4-second time scale to the board's framework (fig 33). The surface of the scale is level with the surface of the board, and the scale can be easily removed for transport or storage. Accurately machined surfaces and guide pins position the scale correctly with respect to the center and surface of the board prior to use.

To fully explore and test the capabilities of both string and pencil plotting, two devices were evolved. The first device is a metal fan calibrated with a 4-second time scale which can be used either for pencil plotting or string plotting as a floating fan. Specially designed pins or an adjustable template may be used as center points. To use the fans in either pencil or string plotting, the time intervals are corrected to a 4-second equivalent using the calculator method and then plotting time values.

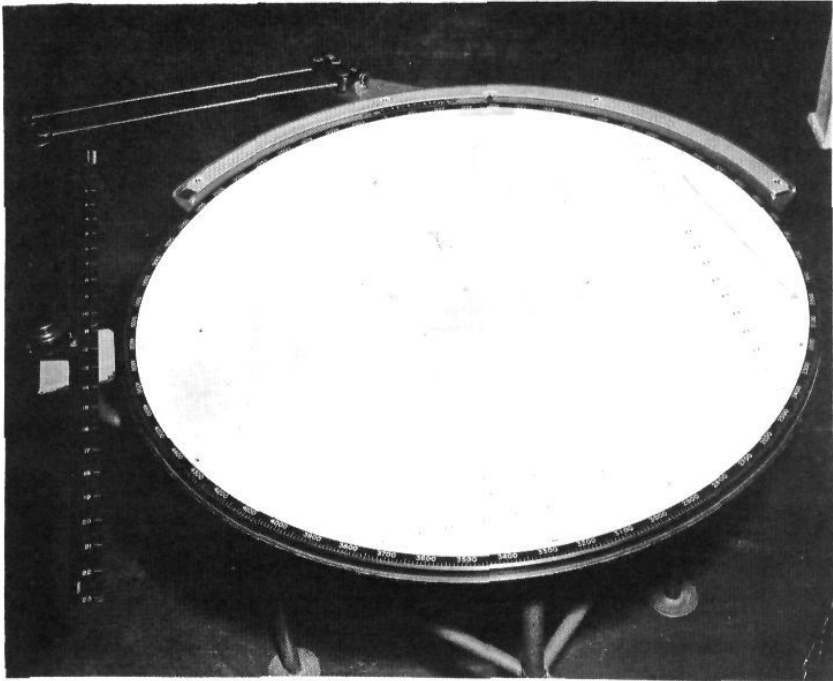

Figure 33. Flash plotting board modified for plotting sound ranging time intervals.

The second device consists of five metal arcs, strings, and weights and uses individual pins or a template for center points. These may be used to plot time intervals from regular or irregular bases (fig. 34).

As a result of present testing, a kit will be developed and issued to the sound ranging platoons in the near future that will allow fast and accurate processing and plotting of time intervals. This kit will, of course, include many other items such as straightedges, scales, erasers, pencils, grid sheets, forms, overlays, paper, ink, a drafting set, and a beam compass.

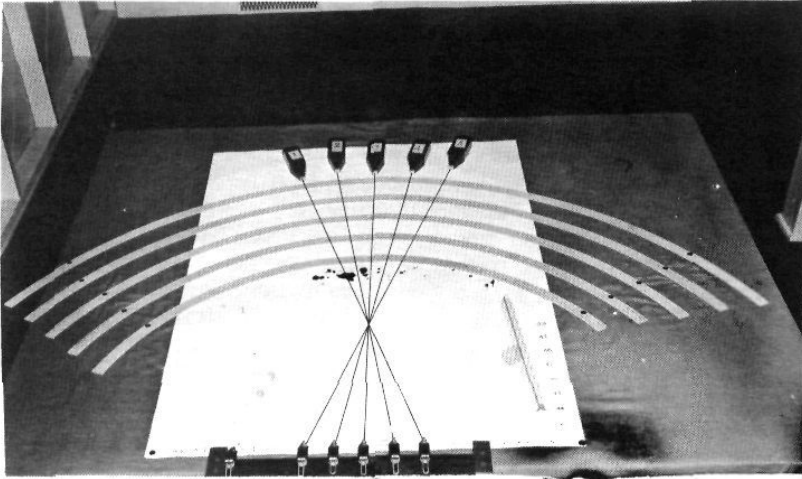

Figure 34. Metal arcs and string plotting.

DO YOU HAVE A GEM?

If you have an idea that would assist other artillerymen in doing a better job in garrison, on maneuvers, or in combat send it to:

"ARTILLERY TRENDS"
Dept of P&NRT, USAAMS
Fort Sill, Oklahoma

A GEM FOR THE MOTOR OFFICER

Your battalion commander is insistent that the vehicles be precisely alined in the motor park each night. This has proved to be a daily chore of some magnitude for the motor sergeant. The vehicles are alined, but the line bends backwards and forwards on various days. The communications officer advises against using telephone wire for marking purposes. How can you solve this problem? Take 4-inch squares of plywood, masonite, or even number 10 can lids and paint them a bright color. Using an aiming circle and some 16-penny spikes, nail the squares to the ground in the desired position, placing them about 4 feet apart. Your vehicles then can be quickly alined by having them stop with the bumper or other designated part directly over the squares. By placing the vehicle's battery number on the markers, each driver knows where to park when the line is empty.

--Submitted by Capt Charles M. Hunter
Dept of P&NRT, Arty and Msl School
1279 ARMY-FT, SILL, OKLA.

in combat? You will receive credit for your gem if it is printed.

Address your "Gems" and other correspondence to:

"ARTILLERY TRENDS"
Dept of P&NRT, USAAMS
Fort Sill, Oklahoma

Three unit-made precision fire mechanical expedients are illustrated in "Do You Want A Precision Fire Sensing Stick?" The individuals submitting these ideas to the School are commended.

-- The Editor --

A GEM FOR CHIEF OF A GUN SECTION

Your self-propelled unit is operating in cold weather on frozen terrain. During the night the tracks of your self-propelled weapon freeze to the ground. How might this have been prevented? Place straw, hay, or dried corn stalks under the tracks. This will greatly reduce the strain on the vehicle's engine and power train which otherwise would have been hard put to free the tracks from the frozen ground.

--Submitted by Maj William J. Lanen
3d Msl Bn, 32d Arty, Ft Sill

A HISTORIC ARTILLERY FIRST

The first troop unit firing of a field artillery missile occurred on 18 March 1954 at Fort Bliss, Texas, when the 246th Field Artillery Missile Battalion successfully launched a Corporal missile.

A GEM FOR FDC CHART OPERATORS

Have you ever used the wrong side of a coordinate square by mistake? This error can easily be prevented by covering the unwanted side with masking tape.

--Submitted by Capt John D. Kinnan
Dept of P&NRT, Arty and Msl School