

The FIELD ARTILLERY JOURNAL



SEPT.-OCT. 1949

LIBRARY
Artillery School
Fort Sill, Oklahoma



NOW A MODERN AMERICAN "BAEDEKER"

WHERE TO GO ★ WHAT TO SEE ★ HOW TO GET THERE



THE AMERICAN GUIDE

Edited by HENRY G. ALSBERG

GREATEST
SINGLE
AID
TO
TRAVELING
SINCE INVENTION OF THE AUTOMOBILE

A *HANDSOME VOLUME* packed with well arranged and indexed information on what you need to know for intelligent planning and enjoyable conduct of any trip. Equally valuable as a reference book in home or office.

*

*

1376 PAGES list and describe briefly all cities, historical points of interest, recreation areas, museums, local facilities of value to the traveler. The book divides the United States into eight regions; each is introduced by an excellent summary of its history, culture, industry and recreation high lights. Then the cities and all points of interest within each state are arranged by geographic position along the main routes of travel. Side tours are traced to take in places off the beaten tracks. 46 pages of maps and thorough index.

\$7.50

ORDER TWO COPIES:

(One for your own use—one as a perfect gift for another traveling service family)

U. S. FIELD ARTILLERY ASSOCIATION

1218 Conn. Ave., Washington 6, D. C.

TWO OUTSTANDING BOOKS *Just Published*

THE INTERNATIONAL SITUATION ———
OUR MILITARY STRATEGY TO MEET IT



THE STATE of EUROPE

By
HOWARD K. SMITH

An up-to-the-minute critique of the dynamic forces shaping the future of Europe.

A top newspaperman—former Rhodes scholar in economics and history—analyses European reaction to postwar economic stress, trade barriers, liquidation of colonial empires. He then presents a nation-by-nation survey on both sides of the Iron Curtain of the people and their hopes in light of the Marshall Plan and Russian propaganda.

\$3.75

OPERATION SURVIVAL

By
WILLIAM H. HESSLER



**A BOLD AND
OUTSPOKEN ATTACK**

on our present policy of depending so heavily on the atom bomb and long-range strategic bombers. A carefully analytical plea for strong foreign and military policy based on geographical realities. Also discusses in detail our need of allies, ERP, Marshall Plan, Arms Program and Atlantic Union.

\$3.00

FOR ADDED PLEASURE . . .

AND A WIDER CAREER:

▶ **LEARN ANOTHER LANGUAGE** ◀

**YOUR BEST INVESTMENT FOR OBTAINING THE MOST FROM
CURRENT OR FUTURE OVERSEAS SERVICE**

LINGUAPHONE Conversational Records

Proven over many successful years as the natural method for learning a new language or polishing a rusty tongue. Remarkable ease, simplicity and actual entertainment value in learning through these record courses. For use by the whole family—special instructions included for children. A complete Linguaphone course contains 16 double-face records, illustrated textbook, explanatory notes, grammar, vocabulary, student's instructions, and a free consultation service by mail. Each complete course is supplied in a handsome indexed carrying case. Federal tax paid by us. Deferred payment plan available on request.

(Normal Membership Discount)

U. S. FIELD ARTILLERY ASS'N—1218 Conn. Ave., Wash. 6, D. C.

Courses Available and Their Cost

SPANISH	\$50.00
FRENCH	\$50.00
GERMAN	\$50.00
ITALIAN	\$50.00
RUSSIAN	\$50.00
POLISH	\$50.00
NORWEGIAN	\$50.00
SWEDISH	\$50.00
FINNISH	\$50.00
DUTCH	\$50.00
PORTUGUESE	\$50.00
IRISH	\$50.00
ENGLISH	\$50.00
AFRIKAANS	\$50.00
HEBREW	\$50.00
CHINESE (Mandarin)	\$100.00
JAPANESE (Introductory)	\$35.00
PERSIAN	\$85.00
HINDUSTANI	\$85.00
ARABIC	\$85.00

Courses are also available in LATIN, GREEK, BENGALI, MALAY, CZECH, HAUSA, SYRIAC, EFIK and ESPERANTO.

*(We will gladly supply
additional information.)*

SOME NEW ASSIGNMENTS



GENERAL THOMAS T. HANDY
The former CG Fourth Army has been assigned as C-in-C European Command.



LIEUT. GENERAL RAYMOND S. McLAIN
The former Chief of Information, Dept of the Army (President of the USFA Assn), has been assigned as Army Comptroller.

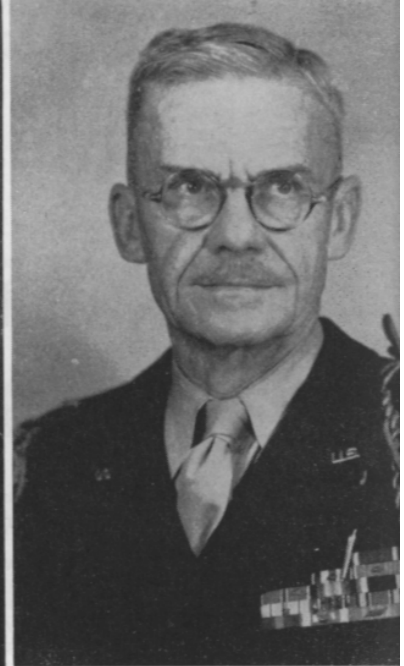

MAJOR GENERAL CLIFT ANDRUS
The former Commandant TAS (Vice-President of the USFA Assn) has been assigned as Director, Organization and Training Division GSUSA.



MAJOR GENERAL JOSEPH M. SWING
The former CG 11th Airborne Division has been assigned as Commandant TAS.



MAJOR GENERAL ALFRED M. GRUENTHER
The former Director of the Joint Staff has been assigned as Deputy Chief of Staff for Plans and Combat Operations.



MAJOR GENERAL ANTHONY C. McAULIFFE
The former CG 24th Infantry Division has been assigned as Chief of the Chemical Corps.



PUBLISHED BIMONTHLY BY THE UNITED STATES FIELD ARTILLERY ASSOCIATION WHICH WAS FOUNDED IN 1910 WITH THE FOLLOWING OBJECTS—AS WORTHY NOW AS THEN

The objects of the Association shall be the promotion of the efficiency of the Field Artillery by maintaining its best traditions; the publishing of a Journal for disseminating professional knowledge and furnishing information as to the field artillery's progress, development and best use in campaign; to cultivate, with the other arms, a common understanding of the powers and limitations of each; to foster a feeling of interdependence among the different arms and of hearty cooperation by all; and to promote understanding between the regular and militia forces by a closer bond; all of which objects are worthy and contribute to the good of our country.



The UNITED STATES FIELD ARTILLERY ASSOCIATION

Organized June 7, 1910

Honorary President

HARRY S. TRUMAN

President of the United States

LIEUTENANT GENERAL RAYMOND S. McLAIN, President

MAJOR GENERAL CLIFT ANDRUS, Vice-President

COLONEL BRECKINRIDGE A. DAY, Secretary-Editor and Treasurer



EXECUTIVE COUNCIL

- Lt. Gen. Raymond S. McLain
Maj. Gen. S. LeRoy Irwin
Brig. Gen. Edward J. McGaw
Brig. Gen. Henry C. Evans
Lt. Col. Lawrence M. Scarborough
Col. Jess Larson
Col. John Lamp
Lt. Col. Beverley E. Powell
Lt. Col. Robert F. Cocklin



The Field Artillery Journal is not a medium for the dissemination of Department of the Army doctrine or administrative directives. Contributors alone are responsible for opinions expressed and conclusions reached in published articles. Consistent with the objects of our Association, however, The Field Artillery Journal seeks to provide a meeting ground for the free expression of artillery ideas in the changing present.

COLONEL BRECKINRIDGE A. DAY Editor

MAJOR NELSON L. DRUMMOND, JR. Associate Editor

LENNA PEDIGO Business Manager



"Contributes to the Good of Our Country"

VOL. 39

SEPTEMBER-OCTOBER, 1949

No. 5

- Cover: Ft. Bundy, Puerto Rico's only FA station.

ARTICLES

Behind the Scene With the Target Grid (Continued), by Major Robert S. Stafford, FA .. 196
Organization of the New Infantry Division, by Lt. Col. George McCutchen, FA, and Major John F. Staples, Inf..... 199
More About Helicopters 204
Field Artillery, Model 1861, by Lt. Col. Philip R. Willmarth, FA-Res. 206
Short Titles for Radio Channels, by Major Edward C. Walter, FA 208
Economy in Killing, by Lt. Col. Theodore G. Bilbo, Jr., FA 210
The New Armored Division, by Lt. Col. Landon G. Cox, Cav., and Lt. Col. Harold G. Maynard, FA 218
Artillery and the Battle of Monmouth, by Major J. B. B. Trussell, Jr., CAC 221
Perimeters in Paragraphs, by Colonel Conrad H. Lanza, Ret. 224

ARTILLERY NOTES

Notice of Annual Meeting, U. S. Field Artillery Association 197
National Guard Subject Schedules, by Colonel William D. Williams, FA..... 198
Sensings by Fire-Direction Center in Precision Fire, by Lt. Col. J. S. Hughes, FA..... 201
Simultaneous Fire Missions, by Lt. Col. Paul D. Phillips 216
Students in the 1949-50 National War College Course..... 220

OTHER FEATURES

Station Data (Continued)..... 209
Extracts from the First Army Artillery Information Service WWII (Continued)..... 213
Circumstantial Evidence, by Francis L. Fugate 215
A Disastrous Victory, by Jerome Kearful 220
The Truth, by Captain James H. Reynolds, Jr., FA-Res. 234
Book Reviews 235
Books in Column, by Major N. L. Drummond, Jr., FA..... 239

Published bimonthly by The United States Field Artillery Association. Publication office: 3110 Elm Avenue, Baltimore, Md. Editorial and executive offices: 1218 Connecticut Avenue, Washington 6, D. C. Address all communications for publication to the Washington office. Entered as second class matter August 20, 1929, at the post office at Baltimore, Md. Accepted for mailing at the special rate of postage provided in Sec. 1103. Act of October 3, 1917. Copyright, 1949, by The United States Field Artillery Association. Subscription rates: \$3.00 a year; foreign, \$3.50; single copies, 60 cents; additional single copies to subscribers, 50 cents. The Field Artillery Journal does not accept paid advertising. It does pay for original articles accepted, but unsolicited manuscripts must be accompanied by return postage if they are to be returned.

BEHIND THE SCENE WITH THE TARGET GRID

(Continued)

*Prepared in the Department of Gunnery,
The Artillery School*

By Major Robert S. Stafford, FA



THIS article is the second in a series of three intended to explain in detail the operation of the observation post, the fire-direction center, and the battery, when the target grid system is employed. The first of the series gave an example of a precision registration including a time registration. Since the two standard types of missions remaining are area percussion and area time, the examples in this article are designed to explain and clarify all operations in these types of missions. Of course, the general procedure is the same as in the precision mission, but in order to delineate any minor differences, a short, but complete, example of each type follows:

Example. Target, infantry company in the open on fairly flat, rocky terrain; mission, neutralization. A base-point registration has been made in the target area, and the estimated observer-base point distance is 2000 yards.

OBSERVER: FIRE MISSION, AZIMUTH 790, FROM BASE POINT RIGHT 350, UP 10, DROP 600, INFANTRY COMPANY IN OPEN, FUZE DELAY, WILL ADJUST.

FDC: The S-3 decides this target is worth the battalion and gives his fire order, including *Battalion, Able, Fuze Delay, Two Volleys*. The HCO

orients the target grid on the OT azimuth with its center on the base point. The target is then plotted in the same manner as in a precision mission. The target pin is moved from the center of the target grid RIGHT 350 (perpendicular to the arrow on the grid) and DROP 600 (parallel to and in the opposite direction from the arrow). The HCO uses the range-deflection fan to determine the deflection and range to this plot, and announces, *Able, Deflection (so much), Range (so much)*. The Able computer announces the deflection to the battery, and upon determining the elevation corresponding to the new range, sends it to the battery. Since no special method of fire was requested, CENTER ONE ROUND is used. While the adjusting computer is giving the commands to fire the first volley in adjustment, the HCO gives data to the computers of the non-adjusting batteries. They use these data to determine fire commands for their batteries, which are then laid.

BATTERY: The gunners set off the deflection and the No. 1's set off the elevation. CENTER ONE ROUND is fired.

OBSERVER: The observer notes the location of the volley and sends the

correction, ADD 400.

FDC: The HCO plots this correction by moving the pin from the initial plot 400 yards parallel to and in the same direction as the arrow on the grid. He determines the data, announces it, and the computer sends fire commands to the battery

Note: This procedure is continued in the same manner until the observer sends FIRE FOR EFFECT. He sends this when he sees a bracketing volley or splits a 100-yard bracket on the OT line.

OBSERVER: The observer notes that a 100-yard bracket has been established and that the bursts are not on ricochet, and determines that his next correction will be to split this bracket and fire for effect. He sends FUZE QUICK, ADD 50. FIRE FOR EFFECT.

FDC: The HCO plots this correction by moving, from the plot of the last volley fired in adjustment, 50 yards parallel to and in the same direction as the arrow on the grid. The data is measured and announced. The computer sends the commands *FUZE QUICK, DEFLECTION (announced by the HCO), BATTERY 2 ROUND ELEVATION* (corresponding to range announced by the HCO). While the adjusting computer

(Able) is sending these commands, the HCO is reading and announcing the data for the other two batteries to the final plot of the target pin. (This procedure is, in effect, replotting every mission and is as fast as using corrections to deflection and elevation from the adjusting-battery computer.) The adjusting - battery computer now announces *Corrections, Fuze Quick*. ("Corrections" now contain only changes in fuze and site.) The non-adjusting computers incorporate this into their commands for two volleys.

BATTERY: The batteries set off the new data and fire two volleys with fuze quick.

OBSERVER: Seeing that the fire for effect is on the target and accomplishes the mission, the observer sends, CEASE FIRING, END OF MISSION, INFANTRY DISPERSED. (Note that the observer terminates area fire missions, while the FDC normally terminates precision missions.)

An area mission which requires the use of time fuze is conducted in the same manner as the preceding mission except that control of the height of burst is added. The total correction applied to the height of burst during the adjustment is transmitted to the non-adjusting computers by the adjusting computer. This is included in "Corrections" announced by the adjusting computer after he has given his battery the fire commands for initiating fire for effect. The following example covers this point.

Example. Target, machine guns dug in with light overhead cover; mission, neutralization. The observer is able to locate the target on a map by inspection.

OBSERVER: FIRE MISSION, AZIMUTH 1130, COORDINATES 68.240-73.190, MACHINEGUNS DUG IN

WITH LIGHT OVERHEAD COVER, FUZE TIME, WILL ADJUST.

FDC: The S-3 includes in his fire order *Battalion, Baker, Fuze Time, Three Volleys*. The HCO plots the target using a coordinate scale (the target grid is not used in any way for the initial plot). The target grid is then oriented on azimuth 1130. The center of the target grid is normally left over the base point, but it can be moved to any location. The essential points are that the grid must be oriented and that it cover the target. The HCO then measures and announces the data to the plot for all batteries, the adjusting battery first. The computers send the deflection, fuze setting, and proper elevation to the battery. Baker fires CENTER ONE ROUND.

OBSERVER: The observer notes the location of the round and sends RIGHT 100, UP 20, ADD 400.

FDC: The HCO moves the initial plot (made by coordinates) right 100 yards (perpendicular to the arrow) and 400 yards parallel to and in the same direction as the arrow. The target grid is again in the picture and is used for the first subsequent plot and all plots thereafter in this mission. Data is measured and announced, and the computer sends the appropriate commands. The UP 20 is determined by the computer as one-fifth of 100/R on the GFT.

Note: This procedure is continued until the observer sends FIRE FOR EFFECT.

OBSERVER: The observer notes that a 100-yard bracket has been established, that the sheaf is slightly to the right of the OT line, that the height of burst is 10 yards, and determines that his next correction will be to split the bracket, correct

the height of burst, and fire for effect. He sends LEFT 25, UP 10, DROP 50, FIRE FOR EFFECT.

FDC: The HCO plots this correction from the plot of the previous volley and announces the data. He then reads the data to the non-adjusting batteries. The adjusting computer sends the appropriate commands to his battery for three volleys. The UP 10 is determined as one-tenth of 100/R on the GFT. He then immediately announces *Corrections, Up (so much)*. This correction is the difference between the initial site and the final site fired by his battery. The non-adjusting computers apply this correction to their initial site, and, using the last deflection and range received, send commands to their batteries to fire three volleys.

All area missions are processed in essentially the same manner as the two preceding examples. There is no difference, due solely to the target grid, between percussion and time area missions. The changes necessary in procedures when various ammunitions are used to perform a mission are not affected by the use of the target grid.

It is believed that precision and area missions have been covered in sufficient detail to answer most questions about them. Some of the operations involved in the examples were, of course, the same as in the old range- and deflection-bracketing methods, but since the original intent of these articles was basic simplicity, the entire procedure was included for the sake of continuity.

The next of this series of articles will cover the use of the target grid in combined observation, the location of the observers being unknown. This system of adjustment offers some interesting variations from single observer shooting, and insures remarkably early fire for effect.

NOTICE OF ANNUAL MEETING, U. S. FIELD ARTILLERY ASSOCIATION

In compliance with Article VII, Section 1, of the Constitution notice is hereby given that the Executive Council has fixed 5:30 P.M. Monday, 19 December 1949, as the time of the annual meeting of the Association to be held at the Army and Navy Club, 1627 Eye St., N. W., Washington, D. C.

The business to be disposed of will be the election of six members of the Executive Council (three Regular Army, two National Guard, and one Organized Reserve), and the transaction of such other business as may properly come before the meeting. Nominations may be made by proxy, or from the floor of the meeting.

National Guard Subject Schedules

By Colonel William D. Williams, FA

DURING the past hundred years considerable progress has been made in training our citizen soldiers for the defense of our country. Most of this progress has been made during the past thirty years and has been energetically pushed since World War II. This is visibly exemplified by comparing the "training schedule" for one of the militia organizations of 1848, reproduced herewith, to those now being prepared, printed, and distributed through the various army schools which function under the Chief, Army Field Forces.

For the past six months or more a small group of selected and experienced National Guard officers has been on temporary duty at The Artillery School, preparing these schedules for field artillery units under the supervision of the Department of Training Literature and Visual Aids, and in accordance with directives issued by the Office, Chief, Army Field Forces. The Artillery School met its commitment by completing the preparation of 108 schedules and the training program for light-aviation officers within the time limits imposed

by OCAFF. The initial drafts are reviewed by the departments of instruction at The Artillery School before being forwarded to Fort Monroe, Virginia, for final review. They are then returned to Fort Sill, where they are processed for printing and distributing. Printing has been slower than anticipated because of the overall work load on the Printing Plant and personnel shortages. However, as each schedule comes off the press it is immediately distributed.

The National Guard Bureau has generously authorized the hiring of an additional linotype operator, to be paid out of its appropriation. The Artillery School feels that this will speed up printing, provided a qualified operator can be found who will take the job on a temporary basis and agree to Civil Service conditions.



2nd BATTALION. 54th REGIMENT.

District Company, No. 3,

COMMANDED BY CAPTAIN G. W. BLUFORD.

City of Norfolk, March 15th, 1848.

You are hereby commanded to attend, armed and equipped, as the law directs, on the field at the head of Granby Street, 10 o'clock, on the following days:

A Company Muster on the 19th of April.

A Regimental Muster on the 13th of May.

A Company Muster on the 19th of October.

Training of Officers on the 10th, 11th, and 12th of May, on Selden's Point, at 3 1-2 o'clock, P.M.

Take Notice, that a Battalion Court of Inquiry, for the 2nd Battalion, will be held at the Court House, on the 28th of October, at eleven o'clock, A. M.

The Regimental Court will convene on the 3rd day of November, at the same place and hour.

BY ORDER

C. W. CONSOLVO, O. S.

ORGANIZATION OF THE NEW INFANTRY DIVISION

By Lt. Col. George McCutchen, FA, and Maj. John F. Staples, Inf

INTRODUCTION

EXAMINATION of all components of the Armed Forces after World War II revealed deficiencies in the organization of the infantry division and the need for changes in that organization. Development of new weapons in new and different roles required changes to achieve the maximum effectiveness desired. The necessity for increased flexibility within all units of the division demanded a new

basis of organization to permit the units to meet changing battle conditions.

In general, flexibility has been incorporated in the various units by giving the commanders of the respective units the tools they need to accomplish any reasonable mission they may be given. For example, infantry divisions in World War II habitually had attached: a tank battalion, a tank-destroyer battalion, an AAA AW battalion, and 4.2-inch chemical mortar units. In the new

organization these units or their counterparts have been made organic to the division.

GENERAL

The principal changes incorporated in the new infantry division organization are as follows:

The DIVISION HEADQUARTERS COMPANY now has a light-aviation section with eight liaison-type aircraft for use on liaison, reconnaissance, and courier missions. The military police organization has been increased

INFANTRY DIVISION

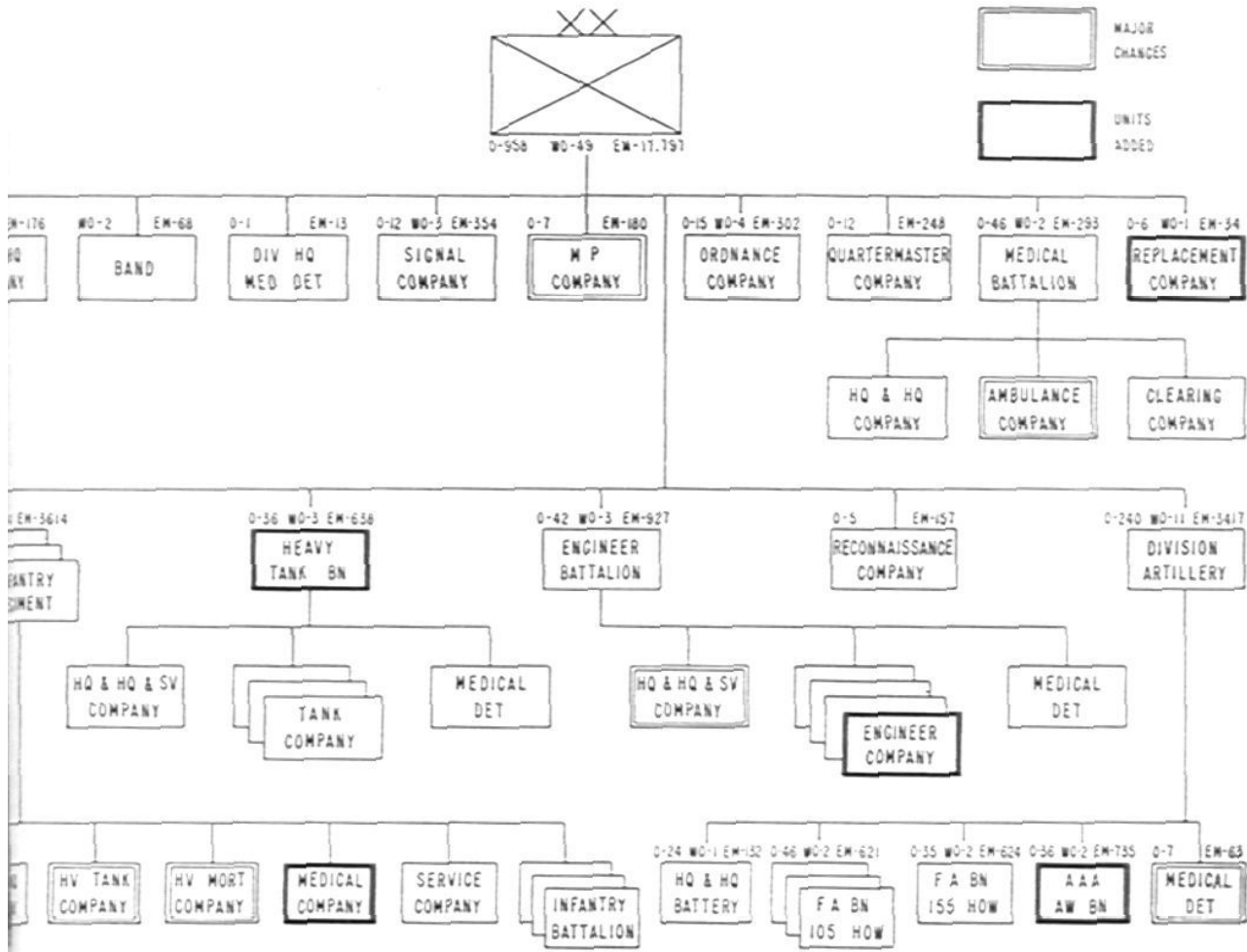

from a platoon, formerly part of division headquarters company, to a MILITARY POLICE COMPANY. The SIGNAL COMPANY and ORDNANCE COMPANY have been increased in size to provide more efficient signal and ordnance support for the larger organization. To the QUARTERMASTER COMPANY has been added a field service platoon which provides laundry and bath facilities and personnel for graves registration supervision. The REPLACEMENT COMPANY, consisting of six officers, one warrant officer, and 34 enlisted men, is entirely new to the organization. It has the mission of receiving, administering, and giving limited training and division indoctrination to replacements, pending assignment to units of the division. The M-8 armored cars of the RECONNAISSANCE COMPANY have been replaced by M-24 light tanks, giving the company greater mobility and fire power for the accomplishment of its mission of reconnaissance and security. The MEDICAL BATTALION has been reduced in size and consists of a headquarters and headquarters company, an ambulance company, and a clearing company, the latter two companies having three platoons each. The collecting companies, less the ambulance platoons which form the ambulance company in the medical battalion, are organic to the three infantry regiments, and are responsible for evacuation from the front lines to the regimental collecting station.

In World War II divisions often had all three regiments committed, each of which needed an ENGINEER company for support. This situation left no engineers for necessary work in the division rear areas; consequently, an additional letter company has been added to the battalion to assist in the alleviation of this deficiency. To the headquarters, headquarters and service company has been added: (1) a fixed and floating-bridge platoon to make short-gap bridging readily available to the units of the division; (2) an equipment and maintenance platoon with three motor-driven cranes, two bulldozers, and two road graders; and (3) an assault platoon with five engineer armored vehicles (at present the M4A3 medium tank with special attachments) to provide

protection for the equipment and crew when required to work under enemy fire. All of these units will increase the amount of engineer support available and consequently the tactical flexibility of the division.

A HEAVY TANK BATTALION, consisting of a headquarters, headquarters and service company, and three tank companies, has also been included in the new organization. The tank companies have a company headquarters with two M-45 tanks mounting 105mm howitzers and four tank platoons, each of five tanks mounting 90mm guns. This battalion provides the division commander with a highly mobile unit possessing great fire power which may be used as a unit to exploit any success of assaulting echelons or as a counterattacking force. It may also be used with the infantry regiments in whole or in part to increase their combat power.

The three INFANTRY REGIMENTS consist of a headquarters and headquarters company; three infantry battalions, each having a headquarters and headquarters company, three rifle companies, and a heavy-weapons company; a heavy tank company; a 4.2-inch mortar company, which has 12 mortars; a medical company; and a service company. The tank company and the mortar company replace the old antitank and cannon companies, and the medical company replaces the collecting company formerly in the division medical battalion. There have also been several important changes within the infantry battalions which increase their fire power and flexibility. Three 57mm recoilless rifles have replaced the light machine guns in the weapons platoons of the rifle companies. The light machine guns now appear in a new fourth squad (weapons squad) of each rifle platoon. The rifle squad has been reduced from twelve to nine men, which enables the squad leader better to control his squad as a single unit. In the heavy-weapons company one of the two machine-gun platoons has been replaced by a 75mm recoilless-rifle platoon with four rifles.

DIVISION ARTILLERY

The two major changes in DIVISION ARTILLERY are: first, there is a self-

propelled automatic weapon battalion now organic to division artillery; and second, there are six guns in each battery instead of four.

The new AAA AW (SP) battalion is capable of rapid fire from traveling position and has excellent cross-country mobility. It is armed with thirty-two M-16 multiple-gun motor carriages (quad 50's) and thirty-two M-19 twin-40mm motor carriages. The battalion contains a headquarters and headquarters battery and four lettered firing batteries.

The idea of having six guns in a battery instead of four is not new. During the First Battle of Bull Run, the turning point in the battle came when Battery I, First Field Artillery, and Battery D, Second Field Artillery, were silenced by infantry fire from the Confederate troops. Both of these were 6-gun batteries.

Some artillerymen feel that the addition of a 4-gun battery would give more flexibility than the addition of 2 guns per battery. Most artillerymen, however, feel that the 6-gun battery is the better solution because of the overhead that is saved by elimination of the battery that would be added. Sufficient flexibility is obtained by our method of using the fire-direction center.

The strength of the division artillery totals 240 officers, 11 warrant officers and 3,417 enlisted men. The breakdown is shown on the accompanying chart.

In addition to the newly organic AAA AW battalion and the medical detachment, the most notable strength changes are the addition of eleven officers to each light battalion, to include a battalion communications officer, an S-1, and an assistant executive and two forward observers per firing battery. The six officers that are added to the medium battalion include an S-1, one forward observer, a battalion communications officer, and one assistant executive officer for each firing battery.

The new medical detachment is organized into a headquarters detachment and five battalion detachments. A major commands the 7-officer detachment. The mission of the medical detachment is to provide unit medical service to include emergency treatment, operation of aid stations, evacuation of casualties if practicable, and supervision of sanitation.

Major changes in organization, technical development made since the war, and the practical application of

battle lessons have caused considerable change in the table of equipment for division artillery. The

following comparison of some of the major items of equipment gives the best idea of the changes made.

	T/O&E 6-10 1 June 45	T/O&E 6- 10 N 2 June 48		T/O&E 6-10 1 June 45	T/O&E 6- 10 N 2 June 48
Airplane, liaison	10	10	Trailer, ammunition, M-21	6	0
Trailer, fuel servicing	0	1	Trailer, ¼-ton	76*	165
Carbine, cal. .30	1,953	2,934	Trailer, 1-ton	40	110
Carriage, motor, multiple gun	0	32	Trailer, 1-ton, ammunition	0	32
Carriage, motor, twin 40mm gun	0	32	Trailer, 1-ton, water tank, 250 gal.	0	26
Gun, machine, cal. .50	92	106	Truck, ¼-ton	149*	210
Gun, submachine, cal. .45	12	151	Truck, ¾-ton, ambulance, KD	0	5
Howitzer, 105mm	36	54	Truck, ¾-ton, command, weapons carrier	0	45
Howitzer, 155mm	12	18	Truck, ¾-ton, weapons carrier	131*	83
Launcher, rocket, 2.36-inch	166	0	Truck, 2½-ton, cargo	61	141
Launcher, rocket, 3.5-inch	0	193	Truck, 2½-ton, cargo, SWB	82	121
Mortar, 60mm	0	3	Truck, 4-ton, cargo	0	9
Pistol, automatic, cal. .45	320	522	Truck, 4-ton, wrecker	4	3
Tractor, medium, M-5	18	0	Truck, wrecking, heavy	0	2
Tractor, high speed, 13-ton	0	22	Vehicle, tank recovery	0	1
Trailer, ammunition, M-10	57	87	Vehicle, utility, armored	0	17

*Includes attached medical and chaplain vehicles.

Sensings By Fire-Direction Center In Precision Fire

By Lt. Col. J. S. Hughes, FA

WITH the advent of the "Target Grid" method of conduct of fire, the problem of how to determine sensings with respect to the gun-target line during the fire-for-effect phase of precision fire was immediately presented. In past systems of conduct of fire, the observer was responsible for producing these sensings. However, using the target grid, in which the observer senses all fire on the O-T line, it is apparent that these observer sensings must be converted into G-T line sensings by some agency other than the observer. This responsibility fell to the fire-direction center.

Consequently, a project was undertaken with the object of determining the best fire-direction sensing that could be made from a given observer's sensing and for a given value of angle T. Since these conversions of sensings are to be made in the fire-direction center, and in furtherance of simplicity and accuracy, it is felt that the converted sensings resulting from this study should be prepared in tabular form and copies be placed in fire-direction centers for use in making these conversions. This will remove the necessity of the FDC personnel's analyzing the location of each round in order to convert to a G-T line sensing.

The sensings used by the observer in fire for effect relate to the quadrants formed by the O-T line and a perpendicular to that line at the target. These observer sensings are: Over, Left; Over, Line; Over, Right; Short, Right; Short, Line; Short, Left; Doubtful, Left; Doubtful, Right and Target. The fire-direction center has the problem of converting these observer sensings into sensings relating to the quadrants formed by the G-T line and a perpendicular to that line at the target. These become range and deflection sensings. The following sensings are possible: For range: Over, short, target, and doubtful; for deflection: Right, left, correct, and doubtful.

Observation and analysis of a large group of precision problems at The Artillery School in the past two years have indicated that there might be certain definite parts of the observer quadrants in which it is very unlikely that an observer will be able to sense a round for O-T range. Also, there might exist only certain areas in which the observer is likely to sense a round for O-T range. If such areas could be defined with any degree of certainty, then the determination of best G-T line sensings would be simplified and the accuracy of such sensings increased.

In order to determine those areas or parts of the observer quadrants in which the observer will be most unlikely to sense, firing tests were conducted. These test set-ups included variations in observer conditions and observing ranges, and variations of target terrain within practical limitations. It is realized that average or usual observing conditions cannot be set up; however, conditions of target terrain, observing range, and difference in altitude between observer and target selected for the tests were those considered to be most generally encountered by the ground observer. The observing ranges varied between 2000 and 3500 yards.

The doubtful areas which were sought by these tests lie within a circle having a 50-yard radius and centered about the target. This circle will contain the majority of rounds in fire for effect in a precision mission. The preponderance of test rounds fired were placed in this circle. However, in an effort to define this area at a distance greater than 50 yards from the target, rounds were placed in a circle having a 100-yard radius and with its center on the target.

On each test, a group of officers observed each round as it was fired and their sensings were recorded independently.

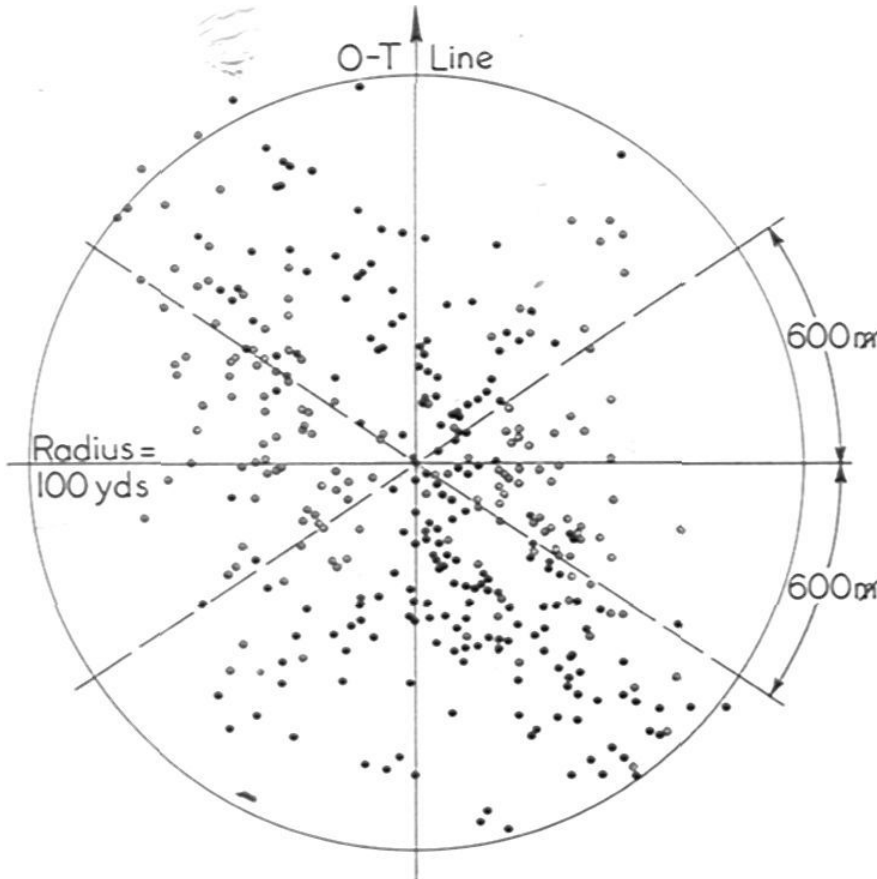

Combined results of test firings.

- Legend: ● — Sensed either "OVER" or "SHORT"
 ● — Sensed "DOUBTFUL"

Figure 1

As each round fell, its exact location was determined by survey. Thus, the exact location of each round and a large number of independent sensings were obtained for analysis and study. Approximately 9000 independent sensings were obtained from all tests.

The officers used for observers varied widely in experience and ability. Officers were drawn from the Department of Gunnery and from School Troops at The Artillery School, Fort Sill. The only prerequisite for their use in this test was that they be familiar with the method of sensing precision fire for effect, and understand terrain sensings. This varied group was used in an effort to eliminate any effect of "expertness" which might come from using Gunnery Department officers solely. It was also an effort to employ average observing ability and to obtain the sensings of a large number of officers on the same round.

The locations of rounds were plotted to a scale of 1/1000. The individual sensings made on each round were analyzed and a "test sensing" derived. For a round to be given a "test sensing" of over (or short) for O-T range, at least 51% of those officers sensing the round must have sensed it over (or short). Regardless of the tallies of over, short, and doubtful, if less than 51% sensed the round in the same positive sense, the round was recorded as doubtful. Figure 1 illustrates the combined results of the tests.

Examination of the plot showed that the rounds sensed as doubtful were concentrated and grouped rather symmetrically around the perpendicular to the O-T line through the target. After the study of the plot, two lines were arbitrarily drawn through the target and between areas containing doubtful rounds and rounds sensed positively (either over or short). The angle between

the perpendicular to the O-T line at the target and these lines was measured and found to be very nearly 600 ft (see Figure 2).

Obviously, it is impossible to define an area which will always contain *all* the doubtful rounds and *only* those sensed as doubtful and have this area be valid for different set-ups and conditions of terrain. However, the results of these tests clearly indicate that a "doubtful area" exists, that its limits are very close to 600 ft from the normal to the O-T line through the target, and that about 70% of the rounds sensed as doubtful will lie in this area.

Before beginning fire for effect, it is assumed that the target is within a 100-yard bracket on the O-T line and therefore the deflection must be within 1/2 S of the correct deflection. The "S" in the target-grid method is that angle at the gun subtended by 100 yards along the O-T line at the target. Note that this differs from the definition of "S" under previous systems of conduct of fire. Dispersion of the gun and probable error do not enter into this study, since the problem is based on the given location of a round and the determination of the best FDC sensing for that round.

The best FDC sensing for a given observer sensing and for a given angle T can be determined by a comparison of areas in which various sensings can, and/or probably will, be obtained. On a chart showing the O-T line and the doubtful area, we can superimpose the gun-target line and its perpendicular at the target (Figure 2). This type figure,

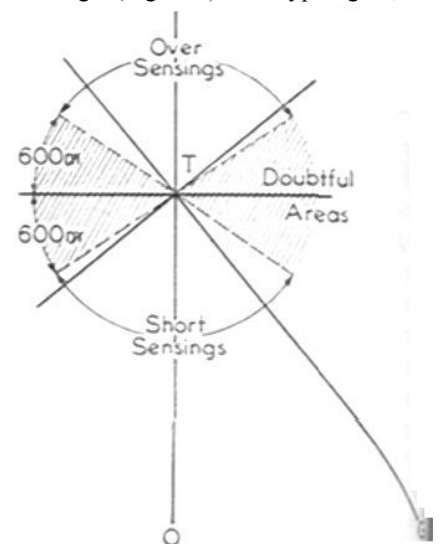
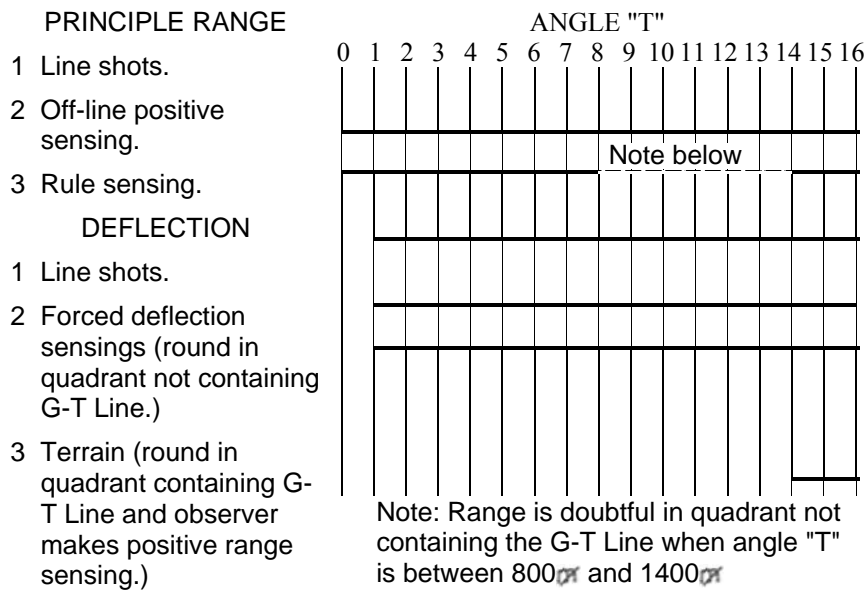

Figure 2



Principles employed in sensing

Figure 3

with the actual plots of rounds fired as a part of the study of sensings, was used to determine what percentage of various sensings would be correct. Of course, these percentages change with the angle T, and in all cases the best practical solution was sought. A percentage of false sensings must be accepted in some cases in order to expedite adjustment. The probability of a false sensing for various values of angle T was determined and limits established as shown in Figure 3.

Line shot: A line shot gives a positive sensing for deflection and range at all values of angle T.

Off-line range sensing: In the quadrants containing the G-T line (over left and short right in Figure 2), the sensing for the piece is the observer's range sensing at all angles. In the other quadrants (over right and short left), the observer's sensing is correct for the piece for angles T up to 600 mils on the assumption that all positive sensings will be outside the doubtful areas. By accepting a 15% error, we can extend this procedure to an angle T of 800 mils. When angle T is zero, the observer's sensing is correct for the piece in all quadrants.

Rule sensing: Sensing of shots on the side of the O-T line toward the piece as "short" and on the side away from the

piece as "over" are referred to as rule sensings. It is evident that a rule sensing is 100% correct when angle T is 1600 mils, valueless at 0 mils. The probability of error at 100 mils is 20%, at 300 mils, 15%. The rule sensing is applied when observer's range sensing is doubtful and angle T is between 100 and 1600 mils. The probability of missensing under this system when angle T is small is greater

than desirable. However, this possibility has been accepted for the past 30 years and is considered unavoidable. Fortunately, a determined effort to make terrain sensings will hold these cases to a minimum.

Forced deflection sensings: When the round is in a quadrant not including the G-T line, there is a positive indication of deflection. This is true for all angles T.

Deflection sensings for large angle T: As the angle T approaches 1600 mils, any observer's off-line range sensing will indicate a deflection sensing for the piece. A false deflection sensing would have more serious results than a false range sensing, since the range sensing is only one of six considered in computing the adjusted elevation. From 1400 to 1600 mils, deflection sensings in quadrants containing the G-T line will be nearly 100% correct.

The accompanying table gives the appropriate fire-direction center sensings for each possible observer sensing for groups of values of angle T. There still exists the condition of axial, small t, large T, and flank observation. Now, however, the burden has been moved from the observer to the fire-direction center, and the problem simplified for the fire-direction center by use of the table.

FDC SENSINGS IN PRECISION FIRE FOR EFFECT

	Observer Sensings	Fire-Direction Center Sensings		
		100-799 mils	800-1399 mils	1400-1600 mils
Guns on left Observer on right	? Right	+ ?	+ ?	+ ?
	? Left	— ?	— ?	— ?
	+ Line	+ Left	+ Left	+ Left
	+ Right	+ ?	+ ?	+ Left
	+ Left	+ Left	? Left	— Left
	— Line	— Right	— Right	— Right
	— Right	— Right	? Right	+ Right
	— Left	— ?	— ?	— Right
	Guns on right Observer on left	? Right	— ?	— ?
? Left		+ ?	+ ?	+ ?
+ Line		+ Right	+ Right	+ Right
+ Right		+ Right	? Right	— Right
+ Left		+ ?	+ ?	+ Right
— Line		— Left	— Left	— Left
— Right		— ?	— ?	— Left
— Left		— Left	? Left	+ Left

For angles T less than 100 mils, fire-direction center sensings coincide with observer sensings.

More About Helicopters

Prepared in the Air Training Department, TAS

THE day of the helicopter is not yet. Furthermore, the chances are that the day will not dawn with brilliant suddenness, but rather, as in the case of the automobile and the airplane, it will dawn slowly as a result of hard scientific and engineering work. Because the helicopter is not perfected, however, is no reason for adopting a blind and obstinate attitude about it. Right now it has flight characteristics which are sensational when compared to conventional aircraft. Almost, it will do, as a recent book was entitled, *Anything a Horse Can Do*. The imperfections which limit the helicopter, in the main, arise from the necessity which has forced the inventors to adapt airplane engines and airplane parts to their purpose. The only reason airplane engines are used to power the helicopter is that appropriate engines are in the development stage.

An air-minded artilleryman (and who isn't?), thinking about helicopters, will or should ask as his first question: "What about stalls?" Of course the helicopter will stall. If it did not, there would be no limit to its operation whatsoever. Like an airplane, when it stalls it quits flying. The helicopter is supported in the air by airfoils which are rotated through the air instead of pulled through the air. A stall can be induced in the rotating blades in very much the same conditions that it can be induced along a wing.

The first and most obvious style of stall would be that generated by insufficient rotational velocity. In this condition, the blades simply would not produce enough lift to maintain flight and the helicopter would settle. The pilot avoids this type of stall by maintaining rotor rpm's within the operating limits of the helicopter. These limits are marked on the tachometer by red lines, and you will notice when you are a passenger that the pilot is very careful not to

violate those limits. In flight, rotor revolutions are maintained by power, while in autorotation the revolutions are induced by the windmilling effect of the air passing up through the rotor blades as the helicopter descends. This is important to remember, as will be pointed out under the discussions of autorotations further along.

The next type of stall is more complex. It is called retreating blade stall, and it occurs like this:

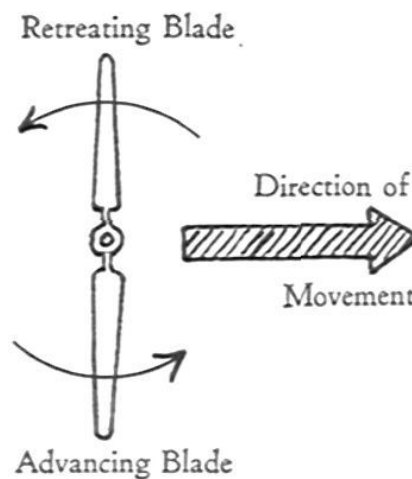

It is obvious that the speed of the advancing blade added to the directional speed will cause a higher relative speed on that blade. Likewise, the remainder arrived at by subtracting the directional speed from the speed of the retreating blade, will lower the relative speed of *that* blade. The higher the directional speed, the lower will be the relative speed of the retreating blade. This puts a practical limit upon the forward speed of helicopters at our present stage of knowledge. The advancing blade tip cannot approach the speed of sound. This limits rotational velocity. While the higher the directional velocity, the closer the

retreating blade will be to stall. If this sounds as complicated as it reads, it is perhaps easier to remember that the world speed record for helicopters is a little over 120 miles per hours, and at the present this looks as if it begins to approach the theoretical limit.

The next type of stall is also complicated. It is called "settling with power." This might come about in several ways, but the most easily explained could happen through the loss of translational lift. By moving through the air, the helicopter develops lift in addition to that from the rotation of the blades. This lift is called "translational lift," and its presence explains why it may take full power to hover, but only partial power to move through the air. Settling with power in the elementary case will happen if the pilot attempts to hover when he has insufficient power. The initial stall occurs near the root of the blade, naturally, since this part of the blade is traveling at slower speed. The downward movement of the helicopter increases the angle of attack and the stall progresses outward along the blade. Very shortly, the helicopter will be falling freely through the air. Recovery can only be made with the loss of considerable altitude.

These stalling characteristics of helicopters must be accepted with the same awareness with which we have come to accept the stalling of conventional airplanes. Moreover, there has been little progress toward reducing the effects of these stalls. This progress came slowly with airplanes because of a feeling among pilots that they knew all about stalls, and that they were therefore not important. With the same sort of occupational blindness, the helicopter industry will undoubtedly regard stalling characteristics lightly, and therefore it will take years for designs to be made which will protect the pilot in his foolishly assumed wisdom.

Autorotation is to the helicopter what the glide is to an airplane. It is the conversion of the force of gravity into lift. If the engine of a helicopter fails a free-wheeling clutch enables the pilot to reduce his pitch and convert altitude into rotational velocity through wind milling caused by the upward passage of air through the blades. This has some

limitations also. It is easy to imagine the wind velocity which would be necessary to turn over such a large windmill at, say, 270 rpm's. In practice this means that the helicopter comes down very rapidly in autorotation, and therefore cannot cover distance power-off the way a conventional airplane can. In other words, in autorotation, a helicopter pilot is limited in his choice of landing places to those which are almost immediately underneath when the engine quits.

There are some other considerations with regard to autorotation which are important for all to understand. The pilot is able to stop the rapid rate of descent by drawing upon the inertia which was stored up in the rotating blades. Skillful pilots have been known to stop the descent two or three times before the inertia is used up. However, in an emergency autorotation no pilot wants to experiment with this life-saving force. He plans on using it once—just above the surface of the ground.

Suppose the helicopter is placed in vertical autorotation. It will come straight down at a rate in the neighborhood of 25 feet per second. It will take about 25 feet to check this descent. This gives the pilot a mere fraction of a second leeway. If he applied pitch one second too soon, he might stall the blades twenty-five feet in the air, while if he were a half second late the descent would not be stopped before the helicopter arrived on the surface. *While vertical autorotations have been performed, they are risky to teach or practice.*

Autorotations should be made with about 45 mph indicated air speed. If the air speed is not there when the autorotation starts, only altitude can be concerted into speed. Therefore, between 10 feet and 300 feet a minimum air speed of 25 mph should be maintained. Below 10 feet, the inertia will check the descent, and above three hundred feet, there is enough altitude to build up the air speed.

Crosswind and downwind landings are very likely to result in loss of control and damage to the helicopter. Hence in crosswind or downwind flight, the pilot should have enough altitude to execute a turn into the wind during autorotation.

These disagreeable limitations upon the helicopter are mentioned to counteract the generally spread assumption that the helicopter is capable of doing anything safely. There are rules which should be followed, and commanders should consult with their pilots before requiring flights outside of these limitations. It might be embarrassing to have it appear upon an accident report that the pilot had been ordered to perform an unsafe maneuver.

In addition to this, it is necessary to point out the lack of a suitable helicopter engine. Those which are used now are converted aircraft engines, and in order to develop the required power, the operating rpm's have been raised almost out of sight. The result is that in present-day helicopters the engines sound as if they are straining mightily, and one is always conscious of this strain while in the air. Quietness makes for relaxation; noise for worry. This is a problem which must be licked before helicopters can go much further. In the meantime, the straining engine will keep the possibility of autorotation foremost in the mind of both the pilot and the passenger.

In the matter of weight, the helicopter is likewise a magnification of the characteristics of the conventional airplane. Weight is, of course, critical with any flying machine, but attention to the limitations, both in amount and in the movement of the center of gravity, are especially important in the helicopter. The instructions covering these problems are included in the pilot's operating instructions for each type helicopter, and it is vital that they be followed carefully. This sensitivity arises from the complex control systems of present-day machines, and we can expect that, in the future, methods of control will be invented which will reduce the need for extreme care.

The reader who has read thus far in this article will have very probably come to the conclusion that the helicopter is cantankerous and dangerous. In the first case he is nearly right, but in the second case he is not. If the helicopter is operated by a properly trained pilot, within the prescribed operating limits, it is as safe, even in its present stage of development, as the conventional airplane. As the development of

helicopters proceeds through the years, this safety will increase, and eventually the prospect is that the average man's helicopter will come—as it was dreamed for the post-war world.

In the meantime, while we are waiting for those halcyon days, the helicopter is with us to stay as a military vehicle. Its ability to land at zero ground speed takes all of the pain out of the preparation of landing strips, building of flight decks, as well as such problems as evacuation of wounded, emergency supply, and air rescue. Wherever operations in confined areas are required, the helicopter will prove its worth. In the jungle it licks the problem of the construction of landing fields. In the arctic, it can sit down at almost any spot. In amphibious operations, it can fly from existing landing craft. In the mountains, it outperforms the mountain goat. It is hard to picture any operation in which the helicopter would not be of great value. They are even talking about towing them behind airplanes for airborne operations.

On the other hand, it has not been decided where the helicopter will fit into the organizational scheme. In their present complicated and crude state, it does not seem practicable to include a helicopter in the Table of Organization and Equipment for the battalion. This may very well come about in the future. The same problems seem also to rule out organic helicopters anywhere in the division or corps. It would seem logical to balance the limitations of the vehicle against its proved worth. While it will be required in any operation, it is not yet suitable for highly mobile use. Right now, it appears that the most logical plan for helicopters would provide for organizations of sections at Army or higher levels. The appropriate commander would then dispatch helicopters to lower commanders as they were required for an operation.

In summary, it should be remembered that the helicopter is still a very young vehicle from the point of view of development and experience. Time will cure this weakness, and when it does the helicopter may take its place in the unit light-aviation section along with the light airplane. In the meantime, it should be treated as a special-purpose airplane.

Field Artillery, Model 1861

A Brief Glimpse of Union Artillery in the Early Days of the War Between the States

By Lt. Col. Philip R. Willmarth, FA-Res

ARTILLERYMEN of the present generation, struggling to keep abreast of T/O&E changes, juggling scores of SSN's, dealing with materiel varying from super-rockets to 60mm mortars, and searching for sound tactical doctrine amid the lessons of the last war and the implications of the atomic age, may look back with a certain amount of undisguised envy upon a less hectic though equally important era in the history and development of their branch — the early years of the Civil War.

It was a time when the jingle of harness, the shouts of drivers, and the crunch of iron-shod caisson wheels were heard in place of the clatter and roar of trucks, tractors, or SP carriages. Open sights and a good eye for terrain and distance served in lieu of aiming circles and panoramic telescopes. And a firm seat, a loud voice, and more than a touch of dash and daring were of much greater importance and value than a facility with logarithms or a quick hand with a slide-rule.

At least, that's the impression gained from *The Army Officer's Pocket Companion and Manual for Staff Officers in the Field*—a semi-official volume of doctrine and procedure published in 1862 by D. Van Nostrand, N.Y., and somewhat reminiscent of the ubiquitous *Officer's Guide* which appeared just before the last war.

Compiled in 1861 by William P. Craighill, then a first lieutenant in the Corps of Engineers and assistant professor of engineering at the USMA, the *Pocket Companion* is largely a translation of the writings of one Colonel de Rouvre, of the French General Staff Corps, modified to apply to the army of the United States. The author admits bluntly that "nothing in it is original . . . except its arrangement, and that is perhaps its worst feature".

Back in the days of crinoline, hoop skirts, and Bull Run, the *Pocket Companion* informs us, field artillery

was divided into two parts—horse artillery and mounted artillery. Horse artillery, we are told, rode horses and was generally attached to and maneuvered with cavalry — which is hardly surprising. The designation *mounted artillery*, however, is just a bit misleading. Generally employed with infantry, the majority of the personnel in these outfits slogged along on foot, "when necessary, mounting the ammunition chests"—a necessity which undoubtedly tended rapidly to become routine.

According to the *Pocket Companion*, pieces served at that time by blue-clad cannoners included six-pounder and twelve-pounder guns, and twelve-pounder, twenty-four-pounder, and thirty-two-pounder howitzers. Adding a note of modern nomenclature, there was also a "twelve-pounder *light* gun, or, as it is sometimes called, *gun-howitzer*." Proof that the *Pocket Companion* was kept abreast of current developments is found in a parenthetical comment to the effect that "rifled guns of different calibres are also now included into field batteries."

Comments on the personnel and equipment which constituted the various types of batteries employed reveal a flexibility with regard to T/O&E's calculated to induce shudders if not convulsions on the part of today's personnel officers, S-4's, S-3's, and anyone in any way connected with planning, supply, or procurement. Pieces were assembled, it appears, in batteries of six or eight—it doesn't seem to have made any particular difference which. Four or six of the pieces were guns, the other two howitzers. Six-pounder guns and twelve-pounder howitzers were usually employed together in the same batteries, which were known as *six-pounder batteries*. Twelve-pounder guns and either twenty-four-pounder or thirty-two-pounder howitzers formed *twelve-pounder batteries*. The twelve-pounder gun-howitzers were evidently

something strange and apart, for they were segregated into batteries by themselves. Present-day artillerymen will be interested to note that the battery rather than the battalion was the basic tactical artillery unit during this period, and nowhere does the *Pocket Companion* mention any larger permanent unit.

As to personnel, the *Pocket Companion* states that "the number of men required for the service of a battery, including non-commissioned officers and artificers, varies from twenty to thirty per piece, according to circumstances." Regarding SSN's, the *Pocket Companion* is also delightfully unspecific when compared to current practice. "They (artillery personnel) should be intelligent, active, muscular, well-developed, and not less than five feet seven inches high; a large portion should, if possible, be mechanics." Officer personnel is dismissed with the remark that "their number varies from four to six, depending on the number of pieces in the battery."

Campaign ammunition allowance for a six-pounder mounted battery is given as about 2200 rounds, consisting of shot, cannister, spherical case, and shells, in fixed proportion. Half of this allowance accompanied the battery and half remained in the reserve parks.

The service also boasted mountain artillery at this early date, according to Lt. Craighill. A twelve-pounder howitzer with an overall weight of 220 pounds was the standard weapon, and piece, carriage, and ammunition made loads for three mules.

Concerning tactics and technique in general, modern gunners— particularly those who have labored to absorb and digest the contents of FM's 6-20, 6-100 and 6-101—may find the *Pocket Companion's* comments in this regard some what disorganized and fragmentary but refreshingly brief. The duties of the artillery, for example, are simply stated as follows: "In the field, the artillery has charge of the service of their pieces." That's all. No mention here of close and continuous fire support or of giving depth to combat — the artilleryman's job, it would seem, was simply to shoot and he apparently was given credit for knowing what to shoot at and when to do it.

However, certain other observations on tactical employment strike a more familiar note. For example, the *Pocket Companion* advocates the employment of artillery in mass—although apparently for reasons somewhat different from those which underlie similar modern doctrine:

"Artillery, if scattered indiscriminately, two or three guns together, will produce little effect, being much in the way of the movements of the troops it is attached to, and will sometimes clumsily expose them to a fire it draws upon them. Employ it, therefore, in batteries tolerably strong, for from a distance it can do without supports near enough to suffer from the projectiles destined for it; and at close quarters, its grapeshot soon causes such mischief that it will be able to protect itself if it makes timely manoeuvres."

This same problem of artillery restricting the infantry's maneuver space seems to have been one of general occurrence and extreme concern, for it evokes the following enjoinder, which can hardly be regarded as complimentary:

"Let (artillery) above all avoid encumbering the ground on which other arms are moving, for it is only an accessory: it is, therefore, better to do without it than to let it cause pernicious delays and hindrances on a field of battle, where good order and time are everything."

While that is not a very flattering measure of the esteem in which artillery was held, it appears from further comments in the *Pocket Companion* that this attitude underwent radical change when it came to the assignment of tasks and positions in actual operations. Some of the jobs handed out to this "accessory" were exacting and important, to say the least. What's more, they were definitely not of a sort to be undertaken by anyone overly cautious or unduly concerned with preserving a whole skin. For instance, after mentioning unconcernedly that "a few pieces may be detached to increase the effect of skirmishers left in advance of the lines", greater distance to the front than 150 the *Pocket Companion* goes on to state:

"(Artillery) takes position on the wings in front of the line of battle, or opposite the intervals, especially while

the troops of the first line are not yet deployed, but it should not go to a greater distance to the front than 150 yards, nor approach the enemy within 300 yards."

Estimates as to the effective range of the Civil War musket vary, but a distance of 300 yards from an enemy battle line was sure to bring cannoneers under telling fire from sharpshooting skirmishers screening the line, and well within range of any troops in the line armed with rifles, as they were in increasing numbers during the period. Add to this an obvious vulnerability to cavalry attack, and you have a rather warm spot to occupy. Nevertheless, the *Pocket Companion* leaves no doubt that the place of the artillery was in the van.

"In offensive marches of infantry, as for example, in debouching upon the field of battle, the artillery moves at the heads of the columns of attack and upon their flanks, in order to overwhelm the enemy at the moment when he is attacked . . .

"In retreats in checkwise order, the artillery takes position in front of the wings of the first line . . .

"In squares, it should be placed at the angles, the pieces outside, and firing grape . . .

"In a front attack executed by a double column of squadrons which moves forward and deploys in order to charge, one or two light batteries placed between the leading regiments advance to the line of skirmishers, move into battery, cover thus the deployment, crush the part of the enemy's line which is to be attacked, cease firing at the moment of the charge, break rapidly into columns of sections to unmask it . . .

". . . Sometimes horse artillery, without being followed by its caissons, dashes itself in the very face of the enemy, who is deluged with grape in preparation for a charge . . ."

Add all the above roles and missions together, and you'll have a fair impression of the part played by artillery in operations of the period—and it's certainly not the sort of part that could be played by any mere "accessory."

Only a small part of the *Pocket Companion* is concerned with artillery. The majority of space is devoted to discussions of infantry and cavalry employment, military law and administrative procedures, helpful hints

on how to live in the field, and a long discussion of the French Corps d'Etat-Major, or General Staff Corps, which the author seems to indicate could well be emulated in his own service. In various places a distinctly Gallic flavor—attributable, no doubt, to an overly literal translation of the previously credited Col. de Rouvre—is unmistakably discernable—as in the following excerpt from the section titled "Useful Hints":

"*Mattresses, Blankets, and their Substitutes.*—A good substitute for a mattress is to strew the ground with dry grass and other things plucked from the ground . . . It gives great comfort to have scraped a little hollow in the ground just where the hip bone would otherwise press.

"Work hard at making the sleeping place dry and comfortable: it is wretched beyond expression for a man to lie shivering, and to think, with self-reproach, how different would be his situation if he had simply had energy and forethought enough to cut and draw twice the quantity of firewood, and to labor an extra half hour in making a snugger berth."

To this same Gallic influence, possibly, may be traced the inclusion, in the approved diagram of a cavalry camp, of a separate row of tents for what are delicately referred to as "camp-followers . . . &c."

The picture of early Civil War artillery gained from Lt. Craighill's *Pocket Companion* is undeniably somewhat dim, indistinct, and incomplete. Nevertheless, it is a recognizable portrait. Things were simpler then, no doubt. Technique was less elaborate, materiel less complicated and less powerful. There was more emphasis on the physical, less on the technical.

By and large, it is a picture of slapdash, hip-shooting action, calling for coolness and courage under fire and training of a high order. It portrays a light, short-ranged arm, dependent for protection largely on its own mobility, and for effective employment on the skill, daring, and judgment of the men who followed the red guidon—the same sort of skill, daring, and judgment that won the respect and admiration of all the fighting services from Bataan to Bastogne, from Leyte to the Rhine.

Short Titles for Radio Channels

By Maj. Edward C. Walter, FA

DURING the recent war many direct-support artillery battalions employed only two frequency-modulated radio channels; the battalion fire-direction channel and the battalion control channel. Since the SCR-610, and later its replacement the SCR-619, both had the letters "A" and "B" stamped on the set to designate the two available channels, it became common practice to refer to the battalion fire-direction and control channels by these letters.

The practice of alphabetically designating radio channels, developed in combat, was adopted by the Department of Communication as an instructional expedient and was further extended to include alphabetical designations for all nets of artillery with the corps. This system was found practicable as long as the nets concerned were limited in number. Recently, however, the increase in fire power of the artillery battalion has necessitated an increase in frequency-modulated channels to permit the more efficient processing of multiple fire missions. This increase, plus additional special-purpose channels such as the division artillery radar channel, has considerably expanded the number of nets concerned. Thus the alphabetical designation of each new net has resulted in a perplexing array of 19 short titles, ranging from "A" for one of the direct-support battalion fire-direction channels to "Z" for the corps artillery fire-direction channel.

The following extract from the current Fort Sill Signal Operations Instructions highlights the confused designation

system which has evolved:

<i>Short Title</i>	<i>Channel or Net</i>
A	Able Fire Direction (Lt Bn)
B	Baker Fire Direction (Lt Bn)
C	Charlie Fire Direction (Lt Bn)
D	Div Arty Control
E	Div Arty Fire Direction
F	Armd Arty Fire Direction
G	Group Arty Control
H	Heavy Arty Fire Direction
K	Arty Bn Control and Air OP
M	Medium Arty Fire Direction
O	Arty Obsn Bn Control
OA	Arty Obsn Bn, Able Btry Control
OB	Arty Obsn Bn, Baker Btry Control
OC	Arty Obsn Bn, Charlie Btry Control
R	Div Arty Radar
V	Corps Arty Control
W	Arty Command Net (a-m)
X	Arty Command Net (a-m) (Alt Channel)
Z	Corps Arty Fire Direction (a-m)

And these are for artillery channels only! It is apparent that continuation of the system would soon exhaust the alphabet, and short titles such as "AA," "A₂" would be resorted to, with a subsequent increase in confusion.

In order to alleviate this confusion, the Artillery School has recently adopted, for resident instruction only, a new system whereby all channels serving the same basic purpose are designated by the same alphabetical letter, regardless of the echelon at which the channel is employed. This system, already employed successfully with respect to the "W" or artillery command nets (a-m), materially reduces the number of short titles when applied to all artillery channels. For example, under the former system a total of 8 letters was necessary to designate the various fire-direction channels, whereas 5 letters suffice under the new system. Distinction between the same nets at various levels, where necessary, is accomplished by adding the name of the echelon concerned. For example, all frequency-modulated channels provided for control or command are designated by the letter "K." The control channel for division artillery, if a distinction is necessary,

W-A-N-T-E-D!!

— for a combat-experience volume on World War II—short articles on artillery battle experiences which illustrate the problems in combat of different phases of artillery in action. Narratives of actions that were unsuccessful, with the reasons for the failure, are just as acceptable as those of successes—the former often teach a sharper lesson than the latter.

This book is to be for the use of our sons and grandsons who may be handling the guns in a future conflict. The project was originated by Major General Orlando Ward, Chief of the Historical Division, Special Staff, U. S. Army, and has also the enthusiastic support of Major General Joseph M. Swing, the Commandant of the Artillery School. Both these officers, as well as numerous other senior officers with combat experience, feel that there is a definite place for such a book.

Send your narrative to the Secretary, The Artillery School, Fort Sill, Oklahoma, before 1 January 1950. You supply the story; if accepted. The Artillery School will edit it and prepare it for publication. Such narratives as are considered suitable for the purpose will be first published in the **FIELD ARTILLERY JOURNAL**, which will pay the authors for their articles.

may then be titled "K (Div Arty)." The following list shows the complete series of short titles as used in the new system:

A	— Fire-Direction or Flash-Ranging Channel (f-m)
B	— Fire-Direction or Flash-Ranging Channel (f-m)
C	— Fire-Direction or Flash-Ranging Channel (f-m)
D	— Fire-Direction Channel (f-m)
K	— Corps Arty, Div Arty, Group, FA Battalion and FA Battery Control or Command Channel (f-m)
R	— Division Artillery Radar Channel (f-m)
W	— Arty Command Net (a-m)
Z	— Corps Arty Fire Direction (a-m)

The following examples will serve to illustrate the system in its practical application:

<i>Unit</i>	<i>Channel</i>	<i>Short Title</i>
FA Bn	Able Fire Direction	A
FA Bn	Control	K
Btry B, Obsn Bn	Control	K
Btry C, Obsn Bn	Flash Ranging	C
Corps Arty	Control	K
Corps Arty	Fire Direction	Z
Div Arty	Fire Direction	A

It is apparent from the above discussion that the new system substantially reduces the number of letters used and more readily facilitates the addition of channels without excessive use of the alphabet. Army-wide adoption of the new system will increase the ease with which all artillerymen can grasp the communication systems employed in the Field Artillery.

ILLUSTRATION CREDITS

(If not listed, unsigned illustrations are from authors, by the Journal staff, or from special sources. Reference numbers are pages.)

U. S. Army: Cover, 194, 198

STATION DATA (continued)

SIXTH ARMY

Presidio of San Francisco, Calif. Includes Ft. Winfield Scott, and is located in the northwest corner of San Francisco. The site of Headquarters Sixth Army. The climate is temperate, with cool, damp, foggy days predominating; rainy during the winter months. There are about 250 sets of quarters, which are insufficient for the assigned personnel. The housing situation is critical, with an acute shortage in San Francisco, especially in the lower rent brackets. There are the usual commissary and post exchange facilities, and excellent city markets are readily available. The cost of living is considered high, considerably above the country's average. The Presidio has a golf course include bowling alleys, and abundant other recreational facilities are available nearby. There are no children's schools on the post. San Francisco schools, to which transportation is furnished for children, are available to military dependents, and several universities are within easy reach.

Ft. Ord, Calif. Located on Monterey Bay, about ten miles north of Monterey. Home of the 4th Infantry Division, which includes the 20th, 29th, 42nd, and 44th FA Battalions. The climate is temperate, with normally cool days and a minimum of rain, but considerable morning and evening fog. The available quarters are far from sufficient for assigned personnel, and a long waiting first exists. In Monterey, Carmel, Pacific Grove, and Salinas, each about ten miles from the post, there is a housing shortage. There are the usual commissary and post exchange facilities, with numerous good shopping centers nearby. Mainly because the Monterey Peninsula is a resort area, the cost of living is higher than the average for the state. recreational facilities on the post include tennis, bowling, and swimming. Available in the vicinity are five golf courses, cruising, surf fishing, and other sports. There are no children's

schools on the post. Nearby communities have grade and high schools, to which transportation is furnished post children.

Ft. Lewis, Washington. Located about 17 miles south of Tacoma and the same distance east of Olympia. The home of the 2nd Infantry Division (which includes the 15th, 37th, 387th, and 503rd FA Battalions) and the 4th Regimental Combat Team (which includes the 36th FA Battalion). The climate is temperate, though foggy, and unusually wet from October to May. Quarters on the post, while considerable in number, are insufficient for all assigned personnel. In Olympia and Tacoma, as well as in nearer smaller communities, there is an acute housing shortage. There are a large commissary and the usual post exchange facilities, and nearby communities have good shopping centers. The cost of living compares favorably with the national average. On-post recreational facilities are excellent, including golf, hunting and fishing, boating, and water sports. There is a grade school on the post, with transportation to it furnished. Tacoma and Olympia have excellent high schools, to which also transportation is furnished.

PANAMA AND THE ANTILLES

Usarcarib. Headquarters is at Quarry Heights, C. Z., on the Pacific Side; other posts in the zone are Ft. Amador, Corozal, and Ft. Clayton on the Pacific Side and Ft. Sherman, Ft. Davis, and Ft. Gulick on the Atlantic Side. The climate is essentially tropical; temperatures range from the high seventies to the middle nineties. During the rainy season, April to November, the humidity is excessive. Periodic relief from the climate is obtained by motor and air trips to the higher altitudes of the interior. Officers stationed on the Atlantic Side usually are assigned quarters shortly after arrival. On the Pacific Side the housing situation is particularly difficult, with a waiting period sometimes as long as twelve months, though present plans for improvement may ameliorate this

condition in the foreseeable future. Apartments and houses are available in the Republic of Panama, but at rather high rents. Commissaries and post exchanges carry practically all necessities, and in addition military personnel are privileged to use the excellent Panama Railroad Commissary. There are many fine shops in Panama City and Colon. The cost of living is on a par with that in the major cities of the U. S. For recreation there are ample facilities for most sports; a major sport is deep-sea fishing, for its enthusiasts. Excellent schools, comprising all grades through junior college, are operated by the U. S. Government on both sides of the Isthmus.

Puerto Rico. Headquarters U. S. Army Forces Antilles is located at Fort Brooke, near San Juan on the northeastern shore of the Island. The only FA unit on the Island is the 504th FA Bn at Ft Bundy, on the eastern tip. The climate is tropical but not unpleasantly so, having a year-round temperature range from 70° to 95°. Winter clothing is not worn, but it is advisable to have it available in case of temporary trips to the U. S., or completion of tour of duty, during winter months. At Ft. Bundy (considered by many an ideal one-battalion post) and at other posts on the Island, there are almost enough quarters for the assigned personnel. Civilian housing is scarce and expensive. Household servants are obtainable without much difficulty, but for the most part they lack experience and few speak English well enough to understand instructions properly. The wage scale is moderate. Each post has a complete commissary; in addition to standard staple items they handle fresh fruit and vegetable products purchased locally. Individual purchases of food items in local markets is inadvisable, owing to doubtful sanitary conditions. There are excellent recreational facilities on the Island, including the El Yunque Rest Camp for military personnel, nearly 4000 feet above sea level. Post schools run through sixth grade; above that children attend schools in nearby communities. Educational facilities in San Juan, Santurce, and Rio Pedras are excellent.

ECONOMY IN KILLING

By Lt. Col. Theodore G. Bilbo, Jr., FA

SOUND thinking requires that objectives be continuously reviewed in order to insure a continuous and steady progress toward these objectives. There must be no deviations from the path leading to a selected objective.

With this precept in mind, let us examine the development of light field artillery materiel. What is our objective? What piece of light field artillery is the ideal? It is doubtful if any two field artillerymen will agree on anything other than the desired destructive effect of field artillery—the ultimate object of field artillery fire is to kill and destroy the enemy with the least possible expenditure of effort and resources in order that "The destruction of the enemy's armed forces and of his will to fight" may be accomplished.

Our objective for a light field artillery piece thus becomes clear. To state it concisely—to develop a field artillery piece that will possess a maximum of fire power to kill and destroy the enemy with a minimum expenditure of effort and resources and still remain in the accepted classification of light field artillery. It is the intention of this article to show that of all weapons which are presently available, the mortar most completely satisfies our objective for a light field artillery piece.

It now becomes necessary to determine what we mean by the phrase, "the accepted classification for light field artillery." To make our definition concise and in agreement with the data contained in current technical and field manuals, light field artillery may be classed as guns, howitzers, rocket launchers, and mortars mounted on fixed or mobile mounts with a caliber greater than .68 inches and no greater than 105mm.

An examination of this technically correct classification of light field artillery leaves much to be desired. Why is the top limit of bore dimension placed at 105mm? Weight obviously has nothing to do with the classification, as the weight difference between the towed 105mm howitzer and the SP rules out

this possibility. Divisional artillery versus general reserve artillery has nothing to do with the classification, since we find the 105mm howitzer in both. The answer lies in the employment of the weapons rather than any arbitrary classification as to calibers.

The light field artillery piece is designed for the mission of giving close support to the supported arm. Returning to our announced objective, we can now interpret the phrase "accepted classification for light artillery" as an artillery piece of any size and caliber capable of performing the mission of close support of the supported arm.

In line with our announced principle of reviewing our stated objective, it is now time to restate that objective: "To develop a gun, howitzer, rocket launcher, or mortar of any caliber that will produce a maximum of fire power with a minimum expenditure of effort and resources and which will render adequate close support to the supported arm."

We must now determine what the phrase "adequate close support of the supported arm" really means. The questions that immediately occur are: How close is close support? How far beyond the front lines must this close-support fire extend? A moment's consideration will convince any experienced officer that close support cannot be defined in terms of distance. Close support can be described as that fire delivered on targets of immediate interest and danger to the supported arm. When analyzed, this statement is too general to mean very much. What targets are of immediate interest? Obviously, all targets which affect the mission of the supported unit are of immediate interest. At this point we come to the real divisions between light, medium, and heavy field artillery pieces. Each classification is designed for a special area of the battlefield and for a special type of target. Light artillery is designed to fire in that area immediately in front of the supported arm and against targets

which immediately threaten the accomplishment of the mission of the supported arm. Medium and heavy field artillery, while capable of performing the close-support mission within limitations, are designed for use in deeper areas of the battlefield and for heavier targets. As a result of this process of reasoning, we arrive at the definition of adequate close support as that fire delivered immediately in front of the supported arm against targets whose elimination (destruction) is within the capabilities of the weapon.

We may now return to our selected objective and restate this objective as follows: "To develop a gun, howitzer, rocket launcher, or mortar of any caliber that will produce a maximum of fire power with a minimum expenditure of effort and resources, and that is designed to deliver fire immediately in front of supported arms against targets whose destruction is within the capabilities of the weapon."

We now find that we can have a piece of field artillery of any caliber with any range, but this piece of artillery is limited in that it must have a maximum killing potential with a minimum expenditure of effort and resources.

What piece of field artillery requires a minimum expenditure of effort and resources? First, let us examine the field of production. Comparing the gun howitzer, rocket launcher, and mortar it is obvious that from all angles the rocket launcher and mortar require less effort to manufacture and require less materials. We must now compare the mortar and rocket launcher. Again considering the inaccuracy of the rocket in its present development, I think it is obvious that the mortar is the winner.

We have now established that the mortar fulfills one part of our objective, namely, that its production requires the least expenditure of national resources, both manpower and materiel.

Let us next examine these pieces from the training effort required. Again, little thought convinces one that it is much easier to train a mortar crew than a gun, howitzer, or rocket-launcher crew. There are fewer men to be trained for the mortar; the high degree of team work required for the crew which serve the gun, howitzer, or rocket launcher is not required. The maintenance problem is overwhelmingly in favor of the

mortar. The training required for tactical employment is certainly in favor of the mortar. Camouflage and concealment favor the mortar. Training in the use and care of auxiliary equipment leads to the selection of the mortar.

Transportation and mobility considerations result in selection of the mortar. Various types of terrain, such as swamps, jungles, forests, mountains, and normal terrain, favor the mortar. Desert and flat terrain would appear to favor the gun or howitzer, but on examination the mortar is still equally as good for the close-support mission of light artillery as we have defined it. We have our medium and heavy artillery that are designed for the longer range fires.

Traverse or field of fire with present known equipment favors the guns and howitzers, but only to a slight degree. It can be stated that a new mortar has been developed with a 360° traverse. However, the results of the tests of this new mortar have not yet been released to the public. It is obvious for wars of the future that all weapons must have a 360° traverse. This requirement should favor the mortar because the relative increase of weight for this characteristic will be less for the mortar than that required for the gun, howitzer, and rocket launcher, respectively.

Rate of fire of the gun and howitzer versus the mortar leads to the immediate selection of the mortar as the better weapon. At maximum rate, the mortar can fire 5 rounds to each round fired by the howitzer, but the rate of fire does not tell the entire story. The mortar (4.2-inch) delivers a projectile weighing 24 lbs while the howitzer (105mm) delivers a projectile weighing 33 lbs. The weight of each complete round delivered to the mortar is 24.5 lbs and to the 105mm howitzer 43 lbs; therefore, pound for pound of ammunition transported to the positions, the mortar is considerably more efficient than the howitzer.

Our next consideration is technique of fire control. Our doctrine of massed fire requires that all weapons within range of given targets be capable of rapid massing upon that target. With the presently developed technique employed with the gun and howitzer, we must select the howitzer; however, there

should be little argument to the statement that, given a fair trial and adequate communication equipment, the massing of mortar fire can be developed to at least the same degree as the gun or howitzer. There are many examples of the employment of massed mortar fires in the past war. The range limitation in massing of mortar fire can be offset to a large extent by the higher rate of fire of the mortar and, as will be shown, by the fact that the mortars in any given area will be capable of delivering more metal on the enemy than our present 105mm howitzer battalion.

Up to this point we have touched on a considerable number of points in favor of the selection of the mortar as our close support weapon. What are the disadvantages?

Figure 1 will give a comparison of the probable errors of the mortar HE shell and the 105mm howitzer HE shell.

quick, superquick, delay, and time fuses. The mortar shell is especially effective for blast destruction of hostile emplacements, burning of buildings, and establishing of smoke screens.

The projectile trajectories favor the mortar in that all defiladed areas can be fired into with ease, while with 105mm howitzer we must resort to high-angle fire, at best a tedious procedure.

One final point regarding the probable error of the mortar. The infantry conference of 1946 did not consider the probable error too great for close support. The latest T/O&E for the infantry regiment gives testimony of the confidence placed by the infantry in the mortar's capability to deliver accurate fire by the addition of the heavy mortar company to each infantry regiment as an organic close-support weapon.

Let us now consider the range. The

RANGE (YDS)

Weapon	600		1000		1500		2000		2500		3000		3500		4000		4400		
	E Pr	E Pd	E Pr	E Pd	E Pr	E Pd	E Pr	E Pd	E Pr	E Pd	E Pr	E Pd	E Pr	E Pd	E Pr	E Pd	E Pr	E Pd	
4.2-inch Mortar	19	1	18	2	19	3	21	3	24	4	27	5	33	7	39	8	46	10	
105mm How.	1	4	0	8	0	12	1	16	1	21	1	25	2	29	2
	2	6	0	8	0	12	1						27	2	31	2	33	3	
	3	7	0	9	0	12	1	15	1	18	1	21	1	25	1	28	2	30	2
	4	10	0	12	0	14	0	16	0	19	1	22	1	24	1	27	1	29	1
	5	15	0	15	0	17	1	19	1	21	1	23	2	25	2	27	2	29	3
	6	9	0	10	0	11	1	12	1	14	1	16	1	17	2	19	2	20	2
	7	8	0	9	0	10	0	11	1	12	1	13	1	14	1	15	1	16	1

Note. E Pr = range probable error. E Pd = deflection probable error.

Figure 1

At first glance it appears that the mortar is at a great disadvantage; but to get the true picture we must also examine the shell-fragmentation pattern and the trajectory of the projectiles. The mortar projectile-fragmentation pattern gives a full coverage of lethal fragments around the point of burst, while the 105mm howitzer projectile gives a butterfly-shaped fragmentation pattern with the wings approximately perpendicular to the line of fire.

The howitzer shell carries a TNT bursting charge of 4.8 lbs, while the mortar has 8.5 lbs. The ballistic characteristics of the artillery shell require more shell body and less TNT than does the mortar shell. Both the artillery and mortar are provided with

present mortar (4.2-inch) has a range of 4,400 yds, while the howitzer range is 12,205 yds. The range of a new mortar now under test is greater than the present standard mortar but information as to its exact range is classified. We determined earlier in the statement of our objective that we would confine ourselves to light artillery, and one requirement of our objective was to deliver fire immediately in front of the supported arm. The light artillery battle positions of the past war were seldom further than 4,000 yds behind the main line of resistance and more often varied from 1,500 to 3,000 yds behind the MLR. There should be little argument over a position area for our mortars 2,000 to 2,500 yds in rear of the MLR, leaving us a range of 1,900 to 2,400

yds in front of the MLR, and thus facilitating the massing of fires along the MLR. Targets beyond the range of the mortars must be taken under fire by our medium and heavy artillery. The next question that occurs is that of firing throughout the sector of the supported unit. Here we will have to use arbitrary figures. The front of an infantry regiment in defense is generally conceded to be from 2,500 to 5,000 yds, depending on terrain and the situation. In the offense the regimental front is generally less than 5,000 yds. The normal procedure under our present doctrine is to place a 105mm howitzer field artillery battalion of 18 howitzers in direct support of the infantry regiment, thus providing 18 howitzers for

platoons of 4 mortars each. If we can cover every point on the front with at least four mortars, we will be providing the same support that a direct-support 105mm howitzer battalion now provides when massed fires are employed. The answer to the question of adequate support according to present standards becomes obvious; but to illustrate: When we analyze Figure 3, we find that we can place our mortar platoons 3,330 yards in rear of the MLR and cover one-third of the regimental front with fire equivalent to the light artillery battalion. The further forward we move the mortar positions and the narrower the regimental front becomes, the greater the possibility of massing more than one

strength of 669 officers and EM. The chemical mortar battalion has a total of 656 officers and EM, a difference of 13 men. There are undoubtedly many solutions to the integration of the mortar battalions into the division artillery. One solution offered is for the division artillery to contain three battalions, each battalion to consist of a headquarters battery, three 155mm howitzer batteries, a 4.2-inch mortar battery, and a service battery. The battalion strength should be sufficient to allow the formation of nine forward-observer sections, as now provided in the 105mm direct-support battalion. Service battery should be increased by at least four 2½-ton trucks and trailers, with ammunition handlers.

A discussion of the tactical employment of a division artillery organization as outlined above involves many interesting and complex factors beyond the scope of this article. To mention only one, the assignment of tactical missions for such an organization would require a 155mm howitzer battalion to be in direct support of each infantry regiment, the mortar battery performing the close-support mission, reinforced by the parent 155mm battalion where required. Division artillery fire-direction center would have nine medium batteries to call upon to execute such fires as desired. The additional medium artillery available within the division would increase the effectiveness of

Battalion	No. of Pieces	Rds per Min	Wt of Metal Fired per Min	TNT Filler per Min	Wt of Projectile Delivered to Guns	Wt of Round Not Delivered on enemy per Min
Mortar	36	720	17,280	6,120	17,340	54
105mm howitzer	18	72	2,376	346	3,106	730

Figure 2

close-support fire at all times. Any change to the present artillery close-support doctrine must provide at least the same support as we now have available. Let us compare a light field artillery battalion with a mortar battalion, assuming both to be firing at maximum rate.

It is clear from Figure 2 that at maximum rate of fire the mortar is the more efficient of the two weapons and we arrive at the conclusion that, per minute of fire for metal delivered to the enemy, one mortar can replace 4.9 artillery 105mm howitzers. What is the significance of this figure? We can replace our direct-support battalion with only 4 mortars and in weight of metal on the target still have roughly the same amount of fire support that we now provide for the supported arm. With these figures as a basis, let us continue our discussion of the range limitation of the mortar.

For the moment let us limit our discussion to the delivery of close support fires at a distance not exceeding 1,000 yards in front of the MLR. How far behind the MLR can the mortar positions be located and still provide adequate close support? Let us take the widest sector that the infantry regiment will normally occupy—5,000 yards. For the close support of the regiment we will use one company of 12 mortars or three

mortar platoon.

From the foregoing discussion it would appear that by replacing one light battalion with a mortar battalion we can support a division with the same amount of metal delivered on the enemy as the present division artillery of three battalions of 105mm howitzers can deliver. Here we must consider the question of organization. The present 105 field artillery battalion has a T/O&E

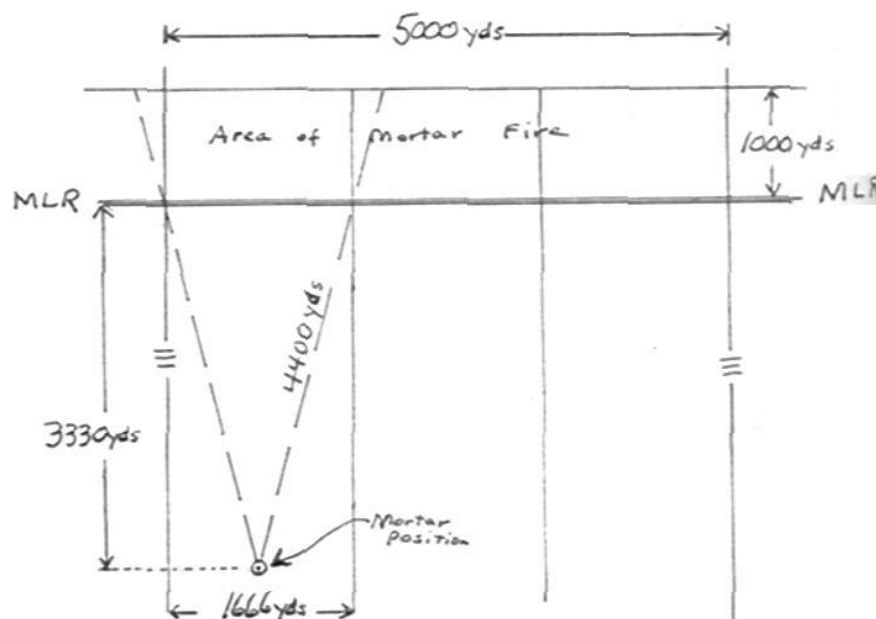

Figure 3

counterbattery fires when faced with a preponderance of hostile artillery. There can be no doubt but that the *addition* of two 155mm howitzer battalions would give the division artillery a greater striking power and an increased flexibility.

Returning to our original objective of "to develop a gun, howitzer, rocket launcher, or mortar of any caliber that will produce a maximum of fire power with a minimum expenditure of effort and resources, and that is designed to deliver fire immediately in front of supported arms against targets whose destruction is within the capabilities of the weapon," the case for the mortar is strong and is deserving of considerably more research, development, and experimentation than has been applied to date.

A discussion of the mortar would not be complete without some comment on the fact that the 4.2-inch mortar battalion is now a part of the Chemical Corps. Why should this potent weapon be under a branch of the service specializing in chemicals and not usually concerned with physical combat, except in the unlikely event that the enemy resorts to chemicals? There is no good reason other than the fact that the Chemical Corps had the initiative to develop the mortar as a dispenser of chemicals. The mortar is ideal for this purpose, and is still available for the distribution of chemicals when under artillery control. Each division has its own division chemical officer, and, in the event that chemical warfare is resorted

to, all that is required to employ the mortar as a chemical dispenser is for the chemical officer to go to the fire-direction center and state where, when, and what type chemical shell he desires fired.

In conclusion, a few thought-provokers are offered.

1. Has a self-propelled mortar been developed?
2. On what type terrain will our next war be fought?
3. Is the Chemical Corps better suited than the artillery to employ the mortar?
4. Has a searching and exhaustive test been made of the mortar battalion as a direct-support weapon?
5. How many chemical officers or artillerymen are thinking of the mortar as a direct-support weapon?
6. Why is so much emphasis placed on the location of hostile mortars?
7. What hostile weapon caused the most casualties to the infantry in World War II?
8. Will our next war be fought with an enemy possessing a superiority of artillery, thereby placing a premium on counterbattery fires?
9. Do the three light divisional field artillery battalions (2,007 men) offer a greater killing potential per man than can be gained from a similar number of mortar battalions (1,978 men)?
10. How effective would the mortar be, as compared to 105mm howitzer battalion, in support of airborne and amphibious operations?

Light artillery must site for anti-tank defense where an enemy penetration is possible.

Motor columns should not be halted under artillery interdiction fire.

Artillery must understand and use mine-clearing equipment.

White phosphorus shells must be stored vertically to prevent the contents from freezing off-center.

Bombing has a great morale effect upon inexperienced troops; however, it cannot replace artillery for neutralization or destruction.

Economy of fire, in artillery, is exercised by discovery of worth-while targets. Obtain photographs and make prompt interpretations. Use Air OP. Make extensive artillery reconnaissance. Secure information from all sources in regard to hostile artillery, particularly shelling reports.

Centralized control of artillery by highest capable echelon is essential. Reinforce break-through troops with plenty of artillery.

Employ counterbattery and survey personnel at earliest opportunity. Obtain photographs and use artillery air reconnaissance.

Time fire is very effective on a dug-in enemy.

Extracts Reproduced from a Training Directive Published by the CCRA, British X Corps

Common forms of radio insecurity:

Use of proper names, christian names, nicknames, etc., to refer to an officer or enlisted man defeats the object of daily changing code signs and helps to identify groups.

Use of unauthorized code names or code words may cause confusion. Units may not allot them without permission.

Long transmissions give the enemy plenty of time to tune in and increase his chances of gleaning information. Keep "off the air," if possible. Keep transmissions short.

An encoded map reference must not be accompanied by a description of the place referred to.

Administrative reports must not be sent in the clear. The enemy can obtain valuable information from them.

Close support of infantry at night is of doubtful value because the supported unit cannot follow artillery fire closely

EXTRACTS FROM THE FIRST ARMY ARTILLERY INFORMATION SERVICE (WWII)

By Brigadier General Chas. E. Hart, USA

EXTRACTS FROM AIS NO. 2, PUBLISHED IN FEBRUARY 1944

Lessons Learned During Sicilian Campaign (Arty Officer, Seventh Army)

Increasing carelessness is evident in camouflage and concealment.

Motor columns operating during daylight are too closed-up at bottlenecks. A rear guard is advisable to prevent vehicles passing at a halt. Attempted

passing results in filling the 75-yard intervals at the critical point where the column is blocked.

A mixture of HE, Time, and Smoke helps friendly infantry moral and is devastating to the enemy morale.

Long-range guns can assist amphibious night envelopments from positions behind the holding attack, using prearranged schedules.

enough to take advantage of its neutralizing effect, except possibly in bright moonlight. Flank support may be desirable. This view should be discussed with infantry commanders when planning night attacks.

It is the duty of junior artillery officers fully to represent their point of view to the other arms and not to accept a plan that they consider unsound from an artillery point of view.

In order to put into effect any artillery deception plan at short notice some details of equipment should be pre-arranged. Each unit should have plans prepared, including methods of erecting dummy guns, etc., and size and type of material required.

Ammunition discipline is generally very poor. Great waste of material and labor is being caused by leaving ammunition and empties in gun positions. Ample supply of ammunition does not excuse waste in any form.

Transportation is available in returning trucks for all empty used shell cases, and empty ammunition boxes will be returned to salvage dumps. Care will be taken not to damage ammunition boxes. Units complain of shortage of grommets, yet they are to be found in evacuated positions.

More attention must be paid to care of ammunition at gun positions. Dirty ammunition is dangerous. Particular attention must be paid to cleanliness of ammunition at night.

Rotation of adjusting pieces (Arty Officer, Fifth Army)

There are indications that some battalions equipped with high-muzzle-velocity guns are not rotating the adjusting pieces with a view of keeping the wear on the tubes uniform throughout. The ballistic effect of wear in high-velocity guns is considerable. Guns should be rotated from time to time within the firing batteries so that the different sections become the adjusting piece in turn. In this respect, when tubes are replaced in battalions, new tubes should be concentrated in one battery at a time. The different ballistic qualities of the old and new tubes then may be readily corrected.

Extracts from Army Training Memorandum No. 46 (British Notes)

The following is paraphrased from a recent British publication "Army

Training Memorandum No. 46" and reproduced because it is felt that a number of sound principles are brought out, all of which can well be acted on:

WASTE NOT, WANT NOT.

"For the want of a nail a shoe was lost; for the want of a shoe a horse was lost; for the want of a horse a battle was lost."

All ranks should be familiar with this saying. It is a reminder that "little things," often insignificant "little things" at first sight, are vital to the efficient performance of the whole. For example, a rifle will not fire without a striker; an engine will not run without spark plugs; or a soldier march without shoe laces.

Away from the theaters of battle, unit economy is of a high order. It is far from being the fact in the face of the enemy. Many units, formerly of the highest integrity, have become plunderers of army equipment and supplies. Hoarding, cannibalization, misappropriation, theft, and pilfering become a menace to the well-being and efficiency of expeditionary forces. The perpetrators of these crimes excuse themselves by the comfortable attitude, "We really are at war now and cannot be hampered by administrative restrictions." And "There is plenty more where that came from" . . . What fallacies! In war, production always lags behind demand. And even if replacements are available at the factories, shortage of transport will delay or may prohibit delivery.

Russian Artillery Counter-Preparation

The importance which the Russians attach to artillery is indicated in the following excerpts from a translated Russian article:

Experience has shown that repulsing the first large-scale enemy attack is repulsing the offensive in general. Counter-preparation is perhaps the decisive factor in disrupting the opponent's attack.

In preparing to repulse the German offensive on the Orel-Kursk sector, we were fully convinced that the artillery in the counter-preparation would first and foremost neutralize the enemy artillery and mortars. Certainly, troop concentrations, troop headquarters, and road-junctions should also be kept under

fire. However, these problems were considered as supplemental problems. It was necessary to take into consideration the fact that in the event our artillery thoroughly neutralized the German artillery and mortars, the enemy infantry and tanks would be greatly weakened. In accordance with this project, a plan of artillery counter-preparation was drawn up in the artillery units, long before the beginning of the engagement. This plan was distributed to the battery commanders, who prepared details pertaining to their sectors.

The positions of the enemy's artillery and mortars were placed on each battery commander's map. The commander knew that at a definite signal his battery was to fire at a specific target for given length of time with a definite number of rounds.

It stands to reason that this plan was flexible and that it was modified according to our knowledge of the disposition of the enemy installations. Particular care, for instance, was taken in the evaluation of the opponent's firing positions in order to distinguish between main, secondary, and dummy positions.

It is not enough to prepare a detailed plan for artillery counter-preparation; it is necessary to determine the exact time of commencement. The artillery counter-preparation that is too early or too late will not give the desired effect. The commander must have exact information as to the beginning of the enemy offensive. On the Orel-Kursk sector the time was determined on the basis of reconnaissance data, confirmed by examination of prisoners of war. Based on this information the signal was given for the artillery counter-preparation.

The order in which the firing was to be carried out was as follows: To begin with, all the guns fired a five-minute preparation on the enemy batteries. The target, rate of fire, and number of rounds was definitely agreed upon before hand. Immediately following this a twenty-minute concentration was placed on the same objective by a considerable part of the artillery. Finally, another five-minute concentration was fired. During this period fire was placed on assemblies of enemy infantry and tanks. Our bombers raided the enemy headquarters, communication centers, and tanks. The result was that

a large number of artillery batteries and observation posts were neutralized. This, of course, was reflected in the German artillery preparation; it was light and disorganized. The activity of those German batteries which had not been destroyed was disrupted.

Despite large forces of tanks and planes, the latter of which operated against our front line in groups of 10 to 15, the Germans were unable to pierce our front, because their artillery at the very beginning of the offensive had been neutralized and was unable to support the attacking troops.

As practice shows, it is chiefly artillery that disorganizes the defending system of fire. Because of our artillery counter-preparation, the Germans were unable in any way to disrupt our system of fire and the defenders confidently met the enemy tanks and infantry. Once more it was confirmed that a fortified zone can never be breached with success with weak artillery, despite the fact that large concentrations of tanks and planes take part. Therefore, the primary object of the defending force during the first period of the battle is the neutralizing of the enemy's artillery.

The effectiveness of the artillery counter-preparation depends primarily upon how well the reconnaissance of the opponent's artillery has been carried out. On the Orel-Kursk sector our reconnaissance succeeded in correctly determining the dispositions of the enemy artillery and relaying the information in time. This gave the opportunity of modifying the plan of artillery counter-preparation so that it was most effective when finally carried out.

This successful artillery counter-preparation compelled the enemy to modify his tactics to his disadvantage. Thus, since the German artillery and mortars had been neutralized early and thoroughly, they were forced to use their bomber planes as a substitute for artillery preparation. This reduced the activity of the German air force in our rear and allowed us to maneuver with more success.

In this example we have observed the artillery counter-preparation carried out on a large scale. Small-scale or individual counter-preparation is organized if the opponent is preparing to carry on active operations on a narrow sector of

the front or if the enemy counterattacks after our troops have captured certain positions. Naturally, reconnaissance is a determining factor in such a situation.

It is imperative to keep in mind the fact that it may be impossible to anticipate the enemy artillery preparation and we will have to commence our counter-preparations under enemy fire. There should be special signals and a specific plan for such an eventuality. It must be emphasized that the greatest number of artillery and mortar batteries should be used, in order to make the counter-preparation definitely successful.

Use of Roving Guns (War Department Intelligence Bulletin)

The following extract from a German Army document discusses the tactical use of roving guns.

The two principal reasons for using a roving gun are:

a. To avoid betraying the location of the actual battery positions if the target can be dealt with by a few guns.

b. To camouflage the fire of our own activity by offering considerable protection against flash spotting and sound ranging.

In the first case, each battery will site a gun 200 to 300 yards to the flank

of the battery position. From a gunnery point of view, it is technically desirable to site the roving gun well on the flank of the No. 1 gun. It is not an advantage to displace it further by putting it forward or to the rear of the actual gun position, because fire control thus becomes more difficult and enemy observers can more easily identify the explosions of individual guns. If the gun is merely put 200 to 300 yards forward or to the rear, it may deceive as to the location of the other guns of the battery, but it also will bring the battery position within the 100-percent zone of fire (that is, within the dispersion pattern) directed against the roving gun. All ranging and harassing fire can be carried out by these guns. The roving guns of a battalion or even larger unit may be concentrated against important targets.

In the second case, the best camouflage will be obtained if provision is made that all firing be done as far as possible by concentrated fire and by as many batteries as possible. Batteries will lay down the concentration only after fire from the roving guns has been seen or heard. The roving guns will fire until the batteries have concluded their concentrated fire.

CIRCUMSTANTIAL EVIDENCE

By Francis L. Fugate

A CURIOUSLY similar pair of cases faced the court-martial board. On the same day, on the same street, in the same block and almost simultaneously, two enlisted men had deliberately kicked commissioned officers. A sergeant had kicked a general, and just across the street a private had kicked a captain—all for no apparent reason.

The sergeant was brought before the court first. He took the stand in his own defense: "Sir, I'm the general's chauffeur. I opened the door for the general to get out of the car. I suffer with a very painful corn, and as the general dismounted he stepped on my foot. The pain was excruciating. I couldn't help it, sir — before I knew what I was doing, I had kicked the general."

The court decided that it was an unwilling act, resulting from an unavoidable accident. The sergeant was acquitted.

The case of the private was called, and various witnesses took the stand. According to their testimony, the private had walked up behind a captain who was standing on the street corner. Without provocation or warning, the private had deliberately kicked the officer. The private was sworn in.

"And you, private," said the president of the court, "what possible excuse could you have for kicking a commissioned officer?"

The private shrugged his shoulders: "I saw the sergeant over across the street kicking the general, and I thought the blooming war was over."

Simultaneous Fire Missions, Target - Grid System

By Lt. Col. Paul D. Phillips, FA

USE OF THE target-grid system of observed fires, during the past academic year at Fort Sill, revealed the desirability of evolving a solution to the problem of handling multiple missions at the fire-direction center. Although single missions were easily processed, practical fire-direction periods with students of the Advanced Class showed that the receipt of several simultaneous missions resulted in confusion and cross-talk. The establishment of a workable "standing operating procedure" was indicated.

To understand the problem thoroughly, it is necessary to understand the major change in fire-direction procedure incident to the implementation of the target-grid system of observed fires. This change requires that the target location and any subsequent observer corrections be plotted by a chart operator for each round or volley fired. The chart operator then announces chart data for the plot. A computer converts these data to firing commands and transmits them to the battery. Hence, a firing chart with operator and a computer are necessary for each mission being fired. Present teaching advocates six such two-man teams, one in each firing battery and three at the battalion fire-direction center composed of the three computers, HCO, VCO, and either the operations sergeant or the chief computer. As can be seen, when three missions are being handled, six men are busy and all may be talking simultaneously. Unless these men are well grounded in their respective duties and trained to function smoothly as two-man teams with no loud or excess talk, fire-direction fails.

It was apparent that the physical arrangement of the fire-direction center and fire-direction center communications were the two primary factors for which a suitable set-up should be developed if we were to have efficient fire-direction. Investigations of these two factors were undertaken. Only the men and equipment authorized by the tables of organization and equipment were considered as available. The number of possible

physical arrangements, using authorized tentage, is limited. The necessity for utilizing half the S-2 command post tent as added space for the fire-direction center was immediately evident, and is the only solution which will accommodate the necessary communications. The accompanying figure shows a usable arrangement of chairs, tables, and other equipment in one and one-half command post tents pitched end to end.

The objectives of a perfect communications system for the fire-direction center are these: The computer must not be so involved in communications that he cannot perform his primary function properly; all fire requests should terminate at one focal point, to the end that the S-3's attention need not be vied for by more than one man; chart operators should have a direct connection with the source of a mission; any possible source of fire requests should have a quick fire channel to the fire-direction center; the S-3 should be able to monitor any fire mission or routine message; administrative calls should not interfere with fire missions; simultaneous missions should be easily processed with a minimum of confusion; and the number of fire-direction center personnel should be kept to a minimum. Two schemes were tried. The first made use of a twelve drop (BD-72) switchboard in the FDC tent, at which all fire requests arriving by wire terminated and to which the three chart operators were connected. The twelve drops were used with the following lines: three for chart operators; one each to division artillery, counter-mortar liaison officer at regiment, and adjacent field artillery battalions, simplexed at the battalion switchboard; one for an S-3 telephone; two to the battalion switchboard; three left open. Inasmuch as the present radio equipment cannot be remotized through this switchboard using the equipment issued with the base radio sets, the plan afforded only slight advantages over the second system which employed four EE-8 telephones in

place of the switchboard. This second scheme, although not quite as flexible, was much simpler and eliminated a piece of bulky and complicated equipment and its operator.

The communication scheme finally decided on as a workable solution is depicted in the figure. The HCO, VCO, and third chart operator (chief computer or operations sergeant) wear head and chest sets which have cords and jacks long enough to be plugged into any one of the four fire-direction telephones. These four telephones are tended by the man who operates the third firing chart. Each computer has two telephones, one a direct line to his battery and the other a telephone simplexed at the battalion switchboard to the wire line connecting his battery and the battalion switchboard. The three base radio sets are remotized into the fire-direction center and are each tended by a radio operator. The four fire-direction telephones are connected as follows: Two to the battalion switchboard; one to the counter-mortar liaison officer at the supported regiment; and one to the division artillery. These last two are simplexed at the battalion switchboard to the wire lines running between the battalion and the supported regiment and between the battalion and division artillery. The S-2 has a telephone connected to the battalion switchboard.

The operation of the communication system will be explained by an example. Let us assume at the start that no missions are being processed, and that we receive in close succession a mission from a forward observer, from an air observer, and from the S-3 of division artillery. The forward-observer mission arrives over one of the telephones connected to the battalion switchboard. The chief computer plugs his head and chest set into the ringing telephone and answers. The forward observer's mission is repeated aloud by the chief computer so that the entire fire-direction center may hear it. Both HCO and VCO plot the mission. The S-3 examines the plot and issues his fire order to the fire-direction center, and decides to fire one battery, Baker. The initial data is announced by the HCO and VCO and thereafter observer's corrections are plotted by the HCO and converted to gun commands by Baker computer. No

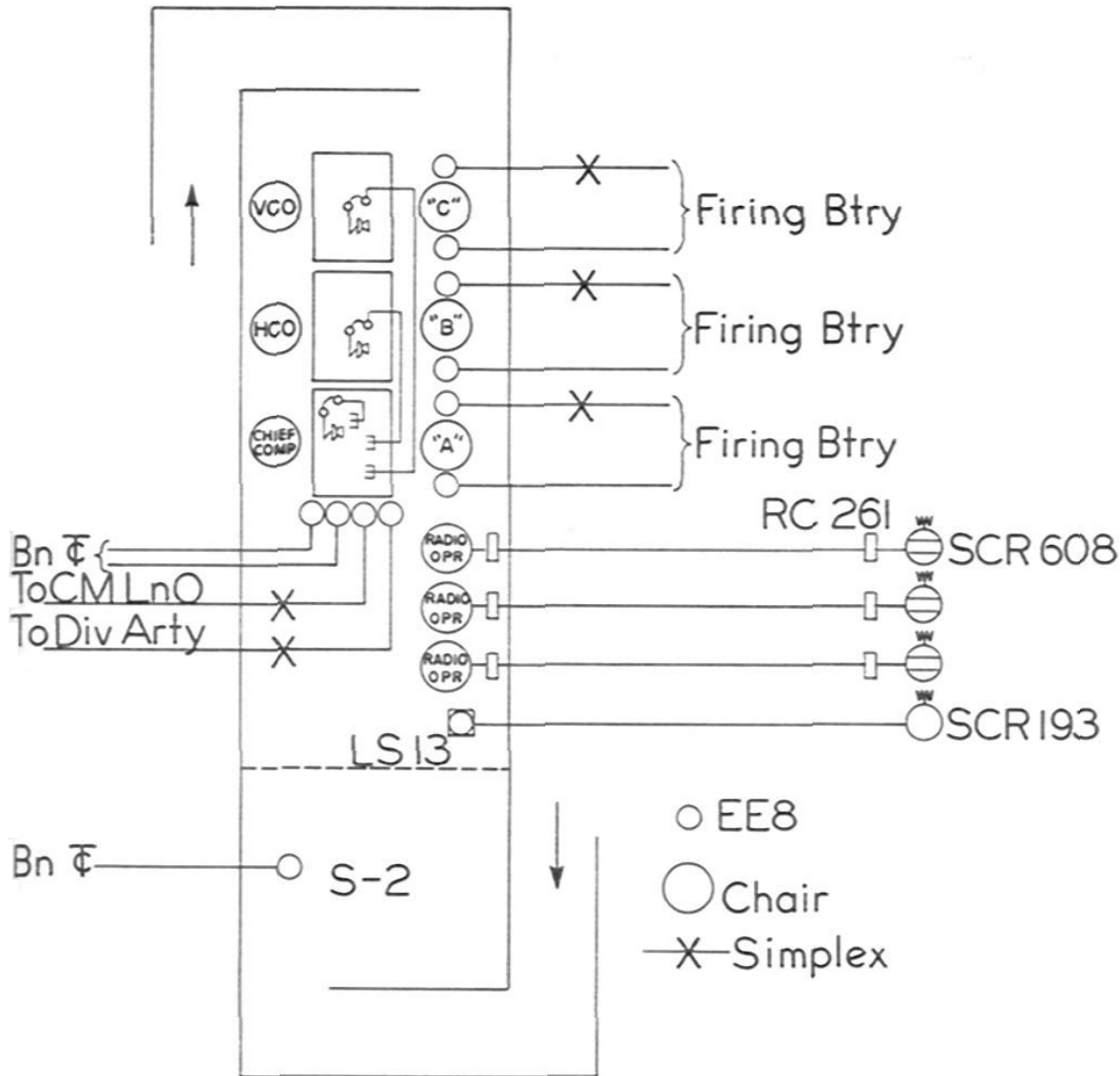

FDC – Physical arrangement and communications.

other FDC personnel are involved in the mission until it is replotted at its completion. While this mission is being fired, an air OP locates a target and sends a fire request which is received at fire-direction center by one of the radio operators. As soon as the operator hears "fire mission," he notifies the S-3, giving the identity of the source of the mission. He is then told to take the ear phones and hand microphone to the VCO. The VCO will accept the mission and process it exactly as was done on the mission which came by wire, except that the VCO must now act as HCO also. The S-3 decides to fire Charlie battery. The remainder of the mission will be handled by the VCO and

Charlie battery, acting as a two-man team. While these two missions are being fired, the division artillery S-3 calls; the chief computer answers the phone, and inasmuch as both HCO and VCO are busy, he himself plots the mission and determines the data for Able, the only battery not busy. In case the other two batteries finish their missions in time, they too may be used in fire for effect.

If chart operators are trained to function habitually with a particular computer, the noise level and amount of talking can be kept to an acceptable minimum.

A fire mission originating over the corps radio net is accepted by the S-3

over the loudspeaker connected to the AM radio set on the corps fire-direction channel.

The fire-direction center must acknowledge and record all missions. When more than three missions are received, the S-3 must make a tactical decision. He may decide to refuse to fire some missions; he may stop firing a mission in order to attack a more important target; he may take the mission and notify the observer there will be a delay; he may route missions to the battery fire-direction center for processing; he may call on attached, reinforcing, or adjacent battalions; or he may request fire from higher headquarters.

The New Armored Division

By Lt. Col. Landon G. Cox, Cav., and
Lt. Col. Harold G. Maynard, FA

ORGANIZATION

THE new armored division (T/O&E-17N, 8 Oct 1948) gives our Army the most powerful unit of its type in the world. With an increase of over twenty-five per cent in medium tank and armored infantry strength compared to that of the previous armored division, this new organization approaches the armored striking power of the former "heavy" type armored division (2d and 3d Armored Divisions), and contains a better ratio between tank and infantry companies than was available to the "light" armored division. The organization of the tank and armored infantry battalion is very similar; this facilitates the formation of reinforced units in the division tactical formations. The additional armored infantry increases the division's defensive and "staying" ability.

The reserve command remains as a unit in the division, commanded by a

colonel. It has been augmented in strength, equipment, and communications to equal that of Combat Commands A and B. The new armored division has three general officers in its T/O — a division commander and brigadier generals for CCA and CCB.

The separate-battalion organization which proved so successful is continued in the new division, endowing it with great flexibility and, at the same time, providing for the development of stronger and more capable battalion commanders.

A number of very desirable additions have been made to the division. They are: The heavy tank battalion, providing the division with a more heavily armed and armored unit; a quartermaster battalion for adequate minimum logistical support; an additional letter company and a bridge company in the

engineer battalion; a 155mm howitzer battalion (SP); an AAA AW Battalion (SP); a military police company in lieu of the former platoon; and now, as an organic unit, a replacement company to receive, process, and indoctrinate incoming replacements.

The mobility of the division has been greatly increased by replacing the half-track vehicle with a full-tracked, entirely enclosed armored utility vehicle—which may be used as a personnel carrier, command post, or cargo carrier. The armored car has been replaced by the light tank M-24.

The new armored division is roughly one-third larger with an aggregate strength of 15,973 officers and men, as compared with a strength of 10,865 in the old division.

Characteristically in the armored division, the tanks are the striking force. The new organization provides three medium tank battalions, each consisting of a headquarters, headquarters and service company, and four medium tank companies. The familiar five-tank platoon remains in all tank companies, both medium and heavy. The normal three-platoon organization is continued in the medium tank company. In the heavy tank battalion there

ARMORED DIVISION

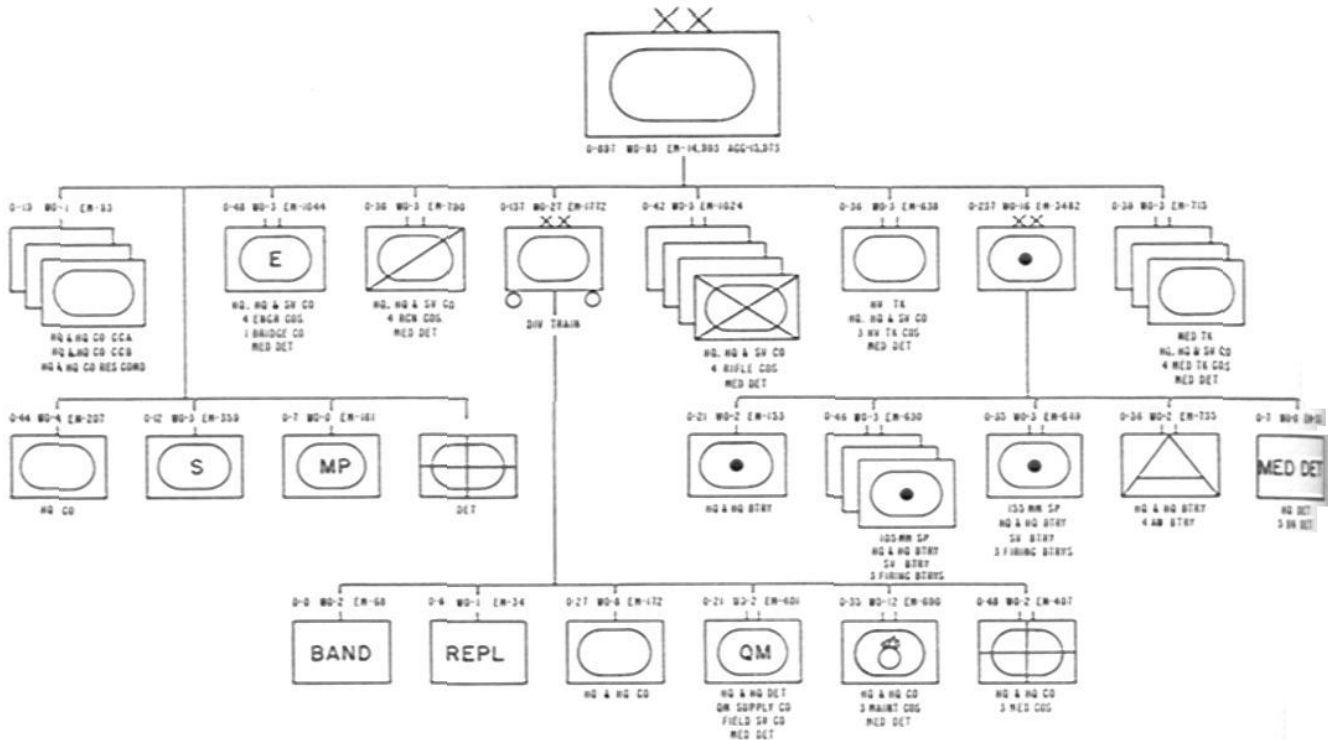

are a headquarters, headquarters and service company, but only three tank companies. Each tank company of this battalion, however, is organized with four platoons of five tanks each. Until a satisfactory heavy tank is developed, the M-26 medium tank (45-ton), mounting a 90mm cannon, will be utilized in the heavy battalion. The substitute-standard tank for the medium battalions is the battle-tested familiar M4A3E8 mounting a 76mm cannon.

The four infantry battalions, like the medium tank battalions, are "square." That is, each consists of four rifle companies, plus the headquarters, headquarters and service company. The organization of the infantry battalion is better suited to operation with tanks than was previously the case. The old rifle-company organization provided an aggregate of 257 officers and men; the new company has been trimmed to 202. The twelve-man squad has been replaced by one of ten men, making it identical to the nine-man squad found in the new infantry division, plus a driver for the personnel carrier. There are now sixteen rifle companies in the division as compared to the former nine. The old towed antitank platoon of the infantry company has been eliminated. This new organization provides sufficient organic infantry to the division to perform practically all missions assigned, without additional infantry support from other sources.

The reconnaissance platoons of the armored infantry and tank battalions are identical with those in the reconnaissance companies of the division reconnaissance battalion. The battalion headquarters of the tank, armored infantry, and reconnaissance battalions are similarly organized, thus facilitating the capability of these headquarters to operate task forces. By organizing two balanced groups, each of two tank companies and two armored infantry companies, functioning directly under each of the tank and armored infantry battalion headquarters, a combat commander has available two units of equal striking power with organic communications and control. The four battalions of armored infantry provide for support of the tank battalions and may be grouped as required for

operations demanding the primary characteristics of infantry.

The cavalry reconnaissance squadron, in name, has been eliminated and a reconnaissance battalion substituted therefor. This change in terminology is due to the proposed consolidation of the cavalry and armored forces into one arm, and to an effort to simplify nomenclature of the divisional units by referring to all of the combat units of the division as battalions.

The organization of the reconnaissance battalion consists of a headquarters, headquarters and service company, and four reconnaissance companies. The light tank company, the assault gun company, and the armored car have been eliminated and the light tank M-24 substituted for the latter throughout the battalion.

The engineer battalion is the largest unit in the division. It has a strength of 1,095 officers and men and consists of a headquarters, headquarters and service company, four lettered companies, and a bridge company. In addition to the seven diesel tractors, which type vehicle formerly comprised the only full-track special equipment of the engineer battalion, this unit now has twelve M-26 tanks with equipment for special operations.

Division train headquarters and headquarters company, the ordnance battalion, and the medical battalion undergo few, if any, changes in organization. Two valuable units have been added, however: (1) the quartermaster supply battalion, consisting of a headquarters company, a supply company (contains a company headquarters, a supply platoon to issue the Class I, II, III, and IV supplies, and three truck platoons of sixteen 2½-ton trucks each to haul supplies); and a field service company (contains a company headquarters, a field service platoon containing a bath section, a laundry section, and a graves registration section, and three truck platoons); and (2) a replacement company of seven officers and thirty-four enlisted men. Division special troops include the division headquarters company, the signal company, and the military police company.

TACTICAL FORMATIONS

The organization of the new armored division requires no changes in the fundamentals of employment or formations as outlined in FM 17-100. On the contrary, the doctrines and principles promulgated therein are perhaps even more apropos, for they were generally followed during the past war and recommendations for changes in doctrine and equipment were worked out concurrently. Thus the new division organization was kept in mind during the revision of FM 17-100, and vice versa.

Three senior tactical headquarters have been provided to insure maximum flexibility and control under operational conditions. The division is now in some respects a square organization in that it has four tank, four infantry, and four artillery battalions, with this same organization being repeated in four letter companies of the medium tank and armored infantry battalions.

During the last war the armored infantry battalion had three medium companies and a light tank company. Many commanders formed two task forces, utilizing (1) the tank battalion headquarters, its commander and staff to operate one, consisting of the tank battalion, less one company (either a medium or light company, depending upon the situation), reinforced by one armored infantry company; and (2) the armored infantry battalion headquarters, its commander and staff to operate the other, consisting of the armored infantry battalion, less one company, reinforced by one tank company.

Experience proved, however, that the most efficient, powerful, and hard-hitting basic grouping of combined arms was a team composed of a medium tank company and an armored infantry company. The normal taskforce organization, mentioned above, was a makeshift one, utilizing what many people considered the best possible grouping with the force available. Battle accounts indicate that the armored infantry battalion task force usually found itself short of tanks and the tank battalion task force found itself short in infantry. It would appear, therefore, as far as armored organization is concerned, that three is

not the ideal number. The new organization, which provides four rifle companies in the infantry battalion and four medium companies in the tank battalion, has provided future commanders with a possible combination of two medium tank and two armored infantry companies in each force, thus giving each commander a balanced force consisting of two of these powerful tank-infantry teams. It should be borne in mind that this is only *one* combination of several which may be racked up with these two types of battalions. The forces are "tailor-made" at each command level to fit the anticipated operational requirements. Another interesting feature in the organizational change of the armored infantry battalion provides the headquarters with communication facilities equal to those of the tank battalion, thus facilitating control of the tank units operating under control of the armored infantry commanders.

The light tank company and assault gun troop of the old cavalry reconnaissance squadron do not appear in the reconnaissance battalion of the new division. There are light tanks in each reconnaissance company in the new organization, and it is felt that the reconnaissance tanks will ordinarily prove sufficient for necessary tank action. If not, with the added tank strength in the division, medium tanks can be attached. By substituting the light tank for the armored car, the mobility of the reconnaissance battalion becomes equivalent to that of the other combat units of the division. Probably the most noteworthy observation regarding the division reconnaissance agency is that, in the future, it will fight for information rather than seek it by stealth.

If normal attachments to the World War II light armored division had been organic, then there would be very little difference between it and the new armored division, in strength and command organization.

SUMMARY

Major changes effected give the division better logistical support, a great increase in infantry and tank strength and fire power, a desirable increase in artillery, a further trend away from the

light tank as a major combat vehicle, and a marked additional mobility. In the future, further improvements and refinements in both organization and equipment will be accomplished. For the present, however, the organization and equipment of the new armored division incorporate practically all of the

essential changes deemed necessary by combat men during the last war, and it constitutes a highly mobile, flexible, balanced fighting unit.

(To be concluded. The balance of this article will discuss the new Armored Division Artillery.)

A Disastrous Victory

By Jerome Kearful

SELF-CONFIDENCE, in military operations as well as in any other activity, is a basic factor in success. Yet, in the Revolutionary War, a British general's self-confidence reached haughty disdain, and his consequent imprudence won a disastrous victory that did much towards uniting the wavering colonies and losing the war for England.

It happened at the memorable Battle of Bunker Hill. It was June, 1775, and the Thirteen Colonies were still unfixed in their determination to oppose British authority to the limit. Not only did many Americans doubt the wisdom and necessity of a break with the English crown, but there was a widespread respect for the power of the British arms and an apprehension that perhaps raw, unseasoned American volunteers would not prove their match in battle. "The shot heard 'round the world" had already been fired at Lexington, but no engagement of any military importance had taken place.

General Gates commanded the British forces occupying Boston. Overlooking the city were Bunker Hill and Breed's Hill in Charlestown. An untrained, poorly-armed American army had been

springing up to lay siege to Boston, and, on the night of June 16-17, 1775, some 3,000 Continental soldiers under Warren and Prescott took up positions on these two strategic hills.

The morning disclosed the activities of the Americans to the British. General Gates summoned his staff. Although the Americans could have easily been cut off from the rear and starved into an early submission, this course was beneath the dignity of the British commander! Self-confidence became haughty foolhardiness when Gates ordered Howe to lead 4,000 men in full dress, complete with knapsack and three days rations to a frontal assault!

What happened on the afternoon of June 17 has been told to every American schoolboy. The Americans fired first at forty yards, again at twenty, and discharged their final volleys as the British, decimated by the loss of 1,054 men, reached their positions. Then, having lost less than half the number of British casualties, they retreated. General Gates had won a disastrous victory!

Bunker Hill was disastrous to the British because it proved to doubting Americans that their own raw Continentals could stand up to the best that the British could offer. Gates was recalled by British authorities, and the effect of the battle upon Howe was so great that he thereafter acted with timidity and hesitation against the Americans. When George Washington took command of the Continentals a month later, he found that Bunker Hill had produced a core of reliable men that stood him in good stead through the war. A British general's pride brought it about!

Students in the 1949-50 National War College course include:
Col. Robert H. Booth, FA
Col. William C. Bullock, FA
Col. Thomas W. Dunn, FA
Lt. Col. Maddrey A. Solomon, FA
Col. Thomas M. Watlington, FA
Col. Paul W. Weyrauch, FA
Lt. Col. James R. Winn, FA
In the 1949-50 Industrial College of the Armed Forces:
Col. Ralph R. Mace, FA

Artillery and the Battle of Monmouth

By Major J. B. B. Trussell, Jr., CAC

PHILADELPHIA was gay during the winter of 1777-78: there were charming young Englishmen in glittering regimentals to squire the city's beauties to balls and routs, there was good gold coin in the merchants' tills—if it bore the image of George III, who counted it the less valuable for that?—and there was the universal conviction that the rebellion would not outlast the spring's campaigning. General Sir William Howe had resigned the command and his successor, Sir Henry Clinton, was a man of energy and vigor who would waste no time in putting an end to the high-flown aspirations of the American rabble.

Only a few miles away, the men of that rabble starved and froze at Valley Forge, but they would have given a different version of the future had they been asked. For to patriotism, courage and endurance was finally being added that essential ingredient of victory—discipline. Von Steuben, the Prussian soldier of fortune, had come to drill them and to teach the meaning of unquestioning obedience to orders when under fire as well as on the drill field, a quality which would ultimately spell success.

And so it was that, when Clinton determined to remove his army to the superior strategic location of New York and left Philadelphia on June 18, 1778, the American army which hit the road to follow him was a far different organization from the one which had gone into winter quarters a few months before. Clinton's aim was to march across New Jersey and reach New York City without interference. That required speed, which was difficult to attain with his cumbersome force. Washington followed by a more northern route, looking for an opportunity to attack where all the odds would be in his favor.

The two armies were approximately

equal in strength—numbering between 10,000 and 15,000 each — but Clinton was hampered by a large baggage train. When, after seven days, he had progressed only some forty miles on his journey, he issued orders that ". . . transportation would not be furnished for more than two 'ladies' per company officer." Even so, such improvement as was made was insignificant. Moreover, both forces suffered from a terrible heat wave and from the notorious New Jersey mosquitoes, but worse than the mosquitoes (for the British) were the American riflemen whom Washington had sent ahead to harry the English line of march.

Late on June 27, when the British had camped just to the north of Monmouth, Washington determined to force a major engagement. A part of the army was to move to the northeast to attack Clinton as the first elements of his column took the road on the next morning; Washington himself, with the main body of the army, would follow and provide reinforcement. Command of the advance party went to Charles Lee as the senior major general after Washington.

In most accounts of the battle of Monmouth so much attention has been devoted to the inexplicable behavior of Charles Lee that the significance and details of the battle have been subordinated. Lee was a peculiar man at best—a former regular officer of the British army, he had resigned his commission to become a soldier of fortune: although he joined the Revolutionary forces early in the war, he seems to have lacked faith from the very beginning in the fighting qualities of the American soldier and the possibility of success of the American cause; his behavior in combat was wildly inconsistent, to say the least—and it would not be unreasonable to conclude that he suffered from intermittent attacks of insanity. His association with the plot to displace Washington from command and his professional origin as a holder of the King's Commission made him an easy target for charges of disloyalty or even treason, especially by the younger

officers around Washington (such as Alexander Hamilton), whose devotion to their chief undoubtedly affected their impartiality toward his rivals. Lee was no coward; as to the quality of his judgment, that is another matter. Lacking confidence in his mission, Lee was to serve his commander at Monmouth as his own namesake (though no relation) was to be served by James Longstreet, not so far away in Pennsylvania, just eighty-five years later.

So much for Charles Lee. Our concern here is with the battle and with the part the American artillery played in it.

Long before sunrise on the morning of June 28 Lee sent out an advance party consisting of a reinforced regiment, with a battery of four guns under Lieutenant Colonel Oswald of the 2nd Connecticut Artillery, the whole task force commanded by Colonel William Grayson. Grayson was to march toward Monmouth and establish contact with the enemy. He had hardly left Lee's command post in Englishtown when a courier stopped there on his way to Washington's headquarters: General Philemon Dickinson, whose command was part of the force harassing the British, was reporting that Clinton's army was preparing to resume its march. Lee immediately issued orders for his main force to proceed after Grayson; but this was not accomplished without delay, for Lee had no plan for the order of march of his command, nor did he even know exactly where several of his units were encamped.

In the meantime, as Colonel Grayson approached the meeting house some three miles to the southwest of Monmouth, he heard from ahead and to his left the sound of firing. Doubling his speed, he hastened forward to the aid of General Dickinson, who was under attack by a detachment of the enemy. But as soon as Grayson's Continentals came into view, the British broke off the skirmish.

When Lee arrived on the scene he was in a temper: word had come from Von Steuben, who was also reconnoitering the British position at Monmouth, that the British were not moving after all. (Von Steuben had been watching what was to be the rear of the column, while Dickinson had seen

The town of MONMOUTH at which this battle took place is actually the present town of FREEHOLD, New Jersey, the name having been changed shortly after 1800 to avoid confusion with other Monmouths in the vicinity.—ED.

its vanguard move out.) This was in the days before Clausewitz and his famous dictum regarding the irritating affinity between war and uncertainty, and Lee was a product of the European school of combat, where soldiering was like chess on a grand scale and everything was largely cut-and-dried. Nevertheless, he yielded to the arguments of that ardent young man, the Marquis de Lafayette, and determined to push the attack.

As the Americans advanced they met a British attack head-on, and the American rifle fire promptly drove the redcoats back. The most conspicuous success was gained on the right, by the 9th Pennsylvania Infantry, which

was preparing to push off, he received incredible orders—to retreat! Lee and his staff were already headed toward the rear. With his flank in the air and his support vanishing, Lafayette had no choice but to follow. Colonel Oswald, who had been blazing away from a position far to the front, had to limber up and pull out at the double lest he lose his guns.

Washington arrived on the scene just as Lee reached the bridge over Wenrock Brook. While historians have disagreed as to just what was said, there is no question but what the commander was furiously angry. Analyzing the situation quickly, he ordered one division, under Lord Stirling, to take up its position on a

point not more than two hundred yards from the heads of the enemy columns, and there moving into line to the left, these troops held up the attack by a frenzied defense until the disposition of the two divisions on the main line of resistance was completed. Then, pressed hard by the superior enemy force, they moved back to the cover of the lines at the brook.

Not so, Oswald and his six guns. He had retired only some forty yards when Lee came up and ordered him to halt. Turning around toward the enemy again, the gunners poured a hot and heavy fire into the approaching British ranks. Through the smoke and flame of the guns' discharges, the men could see the

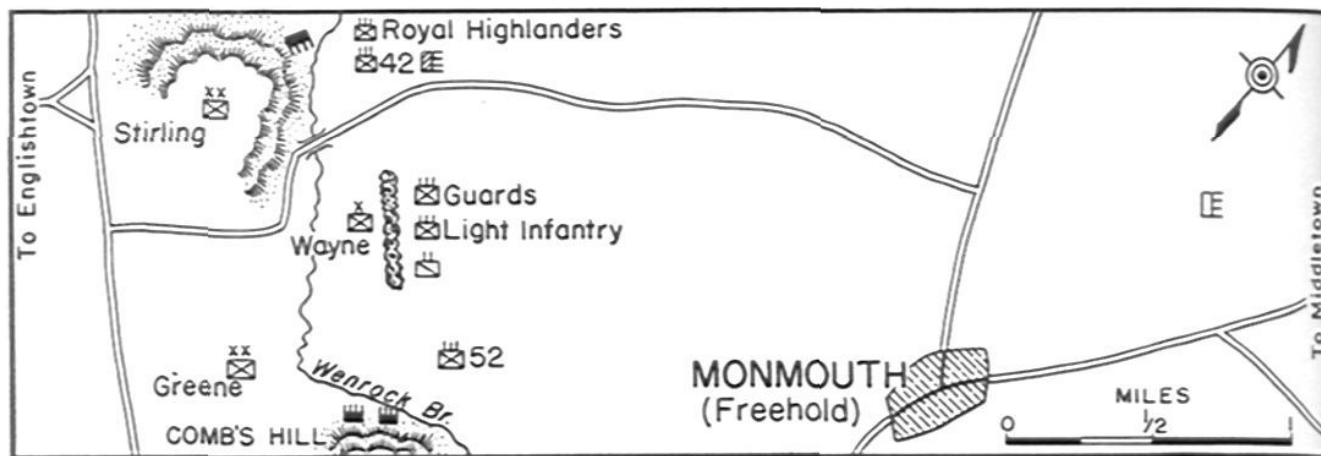

LEGEND

- ☐ - Oswald's most forward position (Initial attack)
- ☐ - Oswald covers withdrawal
- ☒ - American Artillery on MLR
- ⌘ - Hedge

completely routed a squadron of the Queen's Rangers and pushed them back into and through Monmouth.

The entire force was quick to follow up its advantage and moved rapidly to a series of positions on the other, or British, side of Monmouth. By that time Clinton had realized that this was a major attack rather than a continuation of the harassing raids, and sent Lord Cornwallis with a brigade of infantry and the 17th Dragoons to reinforce the troops being assailed. The Americans could see the approach of this new force; it was obvious that now was the time, if ever, for them to press home their assault, before Cornwallis could mount a counterattack. Lafayette sought and gained from Lee permission to do just that; but at the very moment when he

hill north of the road and west of the brook (the western bank was higher than the eastern), and another, under Nathanael Greene, to move south of the road to Comb's Hill. Anthony Wayne's brigade, the only remnant of Lee's force which was still in action by this time, was holding a position directly to the front, behind a hedge which marked the southwestern boundary of an orchard. But before the movements of the divisions could be completed, two enemy formations came into view. Time had to be gained to permit deployment of the main body. This desperate task Washington allotted to two regiments, supported by Oswald's battery, which had been strengthened by the attachment of two more guns that had come up. Racing forward to a

sweaty, grimly determined faces of the approaching enemy, could hear their outcries as solid shot ploughed through their ranks and the voices of their officers bellowed hoarse commands to re-form, fill up the gaps, and march on. Hands gripped rammer staffs more tightly. The glittering uniforms of the British must have seemed to shimmer through the heat haze and the film of perspiration that gun-pointers kept wiping out of their eyes as they peered through the open sights of their pieces. Still they stood by their guns and fired round after round. A force of British dragoons was sent round the flank to cut off this irritating battery, but even then Oswald fired on, despite the fact that at every gun cannons were dropping—although more of them were

victims of heat prostration than of enemy marksmanship. (British muskets were not accurate weapons and British infantry fired only at orders for a volley.) Rebel infantrymen shouted to the battery to retreat, but still it stood firm until at last word came from Lee that it might fall back.

As Oswald gained the shelter of the western bank of the brook the full British force began to deploy for a concerted attack. American artillery in the main line, firing over the heads of Wayne's brigade in the hedge, bombarded the scarlet ranks as they swung out of column. The English guns took up the fire and attempted to silence the rebel batteries. These, however, shifted to counterbattery and for an hour, or perhaps even longer, there went on a duel between the cannon which was the longest, most intensive, and largest scale of the war up to that time.

But despite the men falling right and left, British discipline moved the ranks like clockwork. Cornwallis completed the disposition of his force, placing the 52nd regiment of Foot on his left flank, the Guards, light infantry, and dragoons in the center, and the 42nd Foot and the Royal Highlanders on the right.

Clinton by now had taken personal charge of the action. It was obvious that before he could reach Washington he must first pass Wayne's brigade, so he threw his center forward in a frontal attack. Twice the Grenadiers moved up the rise, only to be blasted back by American artillery and the deadly American volleys fired at point-blank range. The two forces were so close together—a bare thirty yards apart—that the Americans could clearly hear Lieutenant Colonel Henry Monckton, brother of Lord Galway and a very gallant officer, when he turned to the battalion of Grenadier Guards which he commanded and made them a little speech to remind them of their heroic tradition and to urge them to carry the position. The Grenadiers answered his appeal with their bravery, but it was unavailing, for their third attempt fared no better than their first two, and their shattered remnants fell back, leaving their colonel dead and their colors in the hands of the Americans.

Against such heavy and persistent pressure, however, Wayne's force was

too small to hold its position, and under threat of being outflanked the brigade moved back, at command and in an orderly fashion, to Wenrock Brook.

Clinton next turned his attention on Stirling, on the American left, but his attack was met and repulsed by the 1st and 3rd New Hampshire and the 1st Virginia infantry regiments and by the enfilading fire of the intrepid and ubiquitous Colonel Oswald.

Perhaps the other flank would be easier to roll up, Clinton decided, and ordered the 52nd Foot to attack; but here again the line of redcoats melted away in the heat of rebel volleys. As on their left flank, the Americans held positions from which they could take the British advance under enfilading fire from their cannon. General Henry Knox, Washington's artillery chief, had himself selected the gun positions on Comb's Hill, and the batteries were commanded by Knox's brigade-major, a young French volunteer, the Chevalier du Mauduit du Plessis. One round of solid shot from these guns is said to have passed along a platoon of British infantry which was advancing exactly at right angles to the trajectory and snatched the muskets from the men's hands as neatly as an inspecting officer on a Saturday morning. This story has been cited both in proof of the skill shown by Knox in siting his guns and of the precision of British close order drill. Apparently, its interpretation varies with historians' national sympathies.

With the failure of this last attack, Clinton withdrew as rapidly as he might. Washington's position could not be broken—not when it was manned by soldiers who gave their opponents volley for volley and who came out to attack instead of breaking at the first sight of a line of scarlet coats.

As soon as he could recognize the intention of the enemy, Washington began organizing for pursuit; but before he could put a force on the road, night had fallen. The Americans could not afford to make a night assault on the British encampment. An attack by weary men, in the dark, against positions held by a veteran enemy in defenses which almost certainly would be fortified, would be pushing success too far. Pursuit would have to wait until the morning. However, as the dawn of

another blistering day broke over the field the American sentries saw that the enemy had marched away during the night. Thus the quarry—British, this time—escaped destruction, but only by abandoning the field and retreating by a forced march. Unqualified success this was not, but it marked the beginning of a new chapter of American military history. Britain may have lost the war when Burgoyne surrendered at Saratoga and France was emboldened to lend open support to the struggling colonists, but Monmouth was the first milestone on the road to final American victory.

Monmouth was the longest pitched battle of the war—that in itself is significant, for it was in this engagement that Americans for the first time, after being temporarily worsted, were able to rally to carry the fight back to the enemy. It testifies both to the value of the months of drill under Von Steuben and to Washington's growing generalship. ". . . Washington and his command had met the best the British Army had to offer . . . and driven it from the field. . . ."

In total casualties, compared with battles of no more than two decades later, Monmouth would hardly rank as a skirmish, for the Americans lost only 8 officers and 61 enlisted men dead (37 of whom died from sunstroke), 19 officers and 142 enlisted men wounded, and 132 enlisted men missing. British casualties totaled 358, and more than 60 of the fatalities were from sunstroke.

It was at Monmouth that Molly, wife of an artilleryman named Hayes, is said to have put down her water pitcher and picked up a rammer staff to take her husband's post at a gun when he was put out of the fight, either from wounds or the heat. Although the story of "Molly Pitcher" is known to every schoolchild, the artillery did far more than start a legend that day, for in the battle we find gallantry in the artillery pattern — Colonel Oswald's battery holding off the pursuing enemy at imminent risk to itself—excellent tactics, and sound technique. The outstanding employment and direction of the American artillery not only contributed much to the day's success in repeatedly breaking up enemy assaults, but gave brave promise of what was yet to come.



PERIMETERS in PARAGRAPHS



By Col. Conrad H. Lanza, Ret.

THE COLD WAR

Prepared by a widely-known military scholar and writer, PERIMETERS IN PARAGRAPHS is a recurring feature dealing with the military, political and economic realities in world affairs. Whereas an understanding of these realities is deemed essential to the American soldier, it is emphasized that PERIMETERS IN PARAGRAPHS reflects the opinions of the author, alone. This installment covers the period 1 July—31 August, 1949.

THE GENERAL SITUATION

The dominant factors are: 1. The Western Powers do not want war; 2. Russia is preparing for war, since its Rules for Communism state that communism and capitalism cannot work together—one or the other must be wiped out; 3. People under the Russian tyranny desire a war as the one way for them to become free. This includes from 70% to 95% of satellite peoples, and an undetermined number within Russia.

RUSSIAN PREPARATIONS FOR WAR

1st. Increasing industrial production, with emphasis on war materiel, by a succession of 5-year Plans. Nobody is interfering with this program, which is making progress.

2nd. 5th Column activities to disorient and weaken the Western Powers. This duty is assigned to the Cominform, whose communiqué No. 1, issued upon being reactivated in October, 1947, announced its first mission as organizing revolts to establish communist governments in Germany, France and Italy. Several attempts in this direction have failed, but the mission has not been withdrawn.

3rd. Keep wars going in Greece and China.

4th. Eliminate discontent among the satellites, where it is a major danger,

and within Russia, where at this time it is only a minor danger.

Missions among the satellites and in foreign lands are habitually assigned to the Cominform, whose CP was last reported in Bucharest, Romania, with a subsidiary CP in the Far East, believed, but not known, to be in China with the 6th Army Group Headquarters. The latter supervises China as part of its duties.

The Cominform is controlled by Russia, but it includes members from the satellite and most of West European states, who are usually the local communist leader and chief of the 5th Column. Such members, although Russian trained, are always citizens of the country from which they come. They can not be expelled as undesirable foreigners.

Each native communist leader knows his own country, people, and language. They can adjust propaganda originating in Russia to suit local circumstances. They can circulate within free countries, which find it difficult to prevent their disloyal acts while keeping within the law. Witness the trial of the communist leaders now in progress in New York. Native leaders give the Cominform a foothold in every country in the world.

Except in Greece and China, where war exists, and in Yugoslavia, where it is threatened, Cominform activities center on propaganda. This differs greatly in various countries. In the Catholic satellite states of Czechoslovakia, Poland, and Hungary it represents the Vatican as an agent of the United States seeking to raise revolts against the peace-loving communists. In West Europe it seeks to show that connection with the United

States through the Marshall Plan and/or the North Atlantic Alliance means war, while attachment to Russia would insure peace. In the United States it seeks to create disorders between workers and employers by inciting unreasonable demands. In Russia, the people are daily given details of the alleged horrible conditions under which workers in America are living, and their cry to Russia for liberation. All propaganda everywhere agrees in representing the United States as the villain warmonger, quite regardless of the facts.

THE BALKANS

The strategical situation centers around Yugoslavia.

Readers may recall that PERIMETERS previously reported that the Cominform on 20 March, 1948, preferred charges against Yugoslavia and its leaders for violation of the Marx-Lenin rules. On 20 June, 1948, a general court-martial convened at Bratislava to try this case. Yugoslavia declined to plead or proceed with a trial, on the ground that the Cominform had no authority in the matter. Thereupon, on 28 June, the Cominform formally expelled Yugoslavia from the community of communist states for as long as its then leaders remained in control.

Yugoslavia was not too unhappy about that event. Its chief, Marshall Tito, proceeded to strengthen his army and air Force, improve economic conditions, and establish liaison with the Western Powers. For some time the latter hesitated, believing that the dispute between Russia and Yugoslavia might be a ruse. As time passed the break between Russia and Yugoslavia

widened and the West cautiously bettered its relations with Yugoslavia. They furnished supplies, partly on credit, and later furnished certain political advice which has not yet been released. With the help received Yugoslavia managed, not without difficulty, in maintaining herself against a communist economic blockade. Main danger was the non-receipt of military supplies. Weapons and munitions had come from Russia or one of the satellites under her control, and without an assured supply it was doubtful whether a war could be undertaken.

As previously reported, about 1 May, 1949, Russia informally offered to conclude the war in Greece under certain conditions. That was considered a sign of Russian weakness and the proposal was rejected. Yugoslavia agreed that the Russian offer had been made because she foresaw the approaching defeat of the communists in Greece. She thereupon determined to further improve her relations with the West, and dosed her territory to Greek communist activities. This action became effective by the end of June. At the same time Yugoslavia arrested 31 Russians whom she charged with being Cominform agents acting under orders of the Russian embassy. A crisis with Yugoslavia had now arisen, which soon became worse.

During the first half of July, Greece started its summer offensive, which soon cleared the communists out of their corridor along the south border of Yugoslavia. This opened the Monastir (Bitoli on some maps) Pass, affording a line of supply into Yugoslavia. At the same time the line from Salonika northward was further cleared. Yugoslavia on her part concentrated a corps of two reinforced divisions in the Prilep area. This placed the Yugoslavia army in contact with the Greek army and prepared the way for establishing a connection with the Western Powers via Salonika. There already was a connection through Italy and the Adriatic.

On 21 July, the Yugoslav ambassador to the United States, Mr. Sava N. Kosanovich, upon arriving at New York from his own country, announced:

"We are not in the Soviet orbit. We

are not satellites. We are independent."

He declared his intention to seek economic support from the United States, which in fact he soon succeeded in doing.

Russia now became alarmed. The expulsion of Yugoslavia from the communist community had back-fired. The Cominform blockade against Yugoslavia had produced no decisive effect. Yugoslavia was going over to the West. Her geographical position was in the very center of the explosive Balkan region. Yugoslavia had grand opportunities to exploit her break with Russia among the dissatisfied peoples of Albania, Hungary, Romania, and Bulgaria, whose borders touch hers.

Yugoslavia cut the line of communications from Russia to Albania. This was a serious thing. Since 1946, an air and naval (submarine) base had been under construction at Valona and was approaching completion. It would be the only Russian naval base in the Mediterranean and in case of a World War III would be of major importance. To operate that base, land connection with Russia was a necessity. With the defection of Yugoslavia, and with Greece hostile, the land connection no longer existed. Moreover, the Albanians were dissatisfied and, if the opportunity presented itself, likely to revolt. In case of war the Valona base might be delivered to the Western Powers.

There was a possibility that Greece and Turkey, in case of a war with Yugoslavia, would aid her almost at once. Those three states might attack Bulgaria from converging directions. The Bulgars might join the invaders and there was no way to foresee what would happen. Romania and Hungary might also join in. Then there was the possibility that war in the Balkans might be the spark to start a World War III, which Russia does not want at this time.

The current strategical situation in the Balkans appears not to have been foreseen by the Russian High Command, who are acting as if they had been taken by surprise. They were not ready for war. Still something had to be done. It was decided to attempt to solve the problem without a general war, but

nevertheless to take precautions should war come.

On 24 and 25 July, Russia delivered notes to Yugoslavia. She charged that state with having negotiated with the Western Powers; and alleged that the 31 Russian prisoners who had been arrested were illegally detained, as no charges had been preferred against any of them. Yugoslav reports indicated that, at this time, the 3rd Russian Army Group, normally in the Balkan sector, moved up troops towards the Bulgar-Yugoslav border, but this has not been confirmed. The Cominform alerted the 5th Column within Yugoslavia and issued instructions as to sabotage and other activities which were to be prepared.

On 2 August, Marshal Tito replied in a speech at Skoplje. This was the day when Greece launched its offensive which opened a new route into Yugoslavia. Marshal Tito expressed his deep concern for the oppressed peoples of Bulgaria and Albania, who were suffering under the brutal Russian tyranny. He intimated that soon Yugoslavia might do something to free them.

Two days later, at a military luncheon, the Marshal extended his remarks. He knew about reported concentrations of new Russian units opposite Yugoslavia and particularly of the arrival of a reinforcing artillery division.* Of course he didn't believe the reports, but just in case, he had ordered a general alert. He warned that he and his army were quite ready for a fight. He had replied in writing, refusing to set free the 31 Russians, and on his part charged Russia with failure to support Yugoslav claims for cession of Slovene Carinthia from Austria at the Conference of Foreign Ministers at Paris between 23 May and 20 June.

Russia answered on the 11th. She considered Yugoslavia's defiance could only be explained on the ground that she had negotiated with the Western Powers, who were secretly supporting her. Consequently she would no longer regard Yugoslavia

"as a friend and ally but as an

*During World War II Russian artillery divisions were used to support offensives. Their arrival in line was almost a sure indication that an offensive war was under preparation.

enemy and adversary of the Soviet Union."

In former times this pronouncement might have been considered as a declaration of war, but in this case neither side chose to consider it as such.

On the 18th, Russia broadcast in the clear to her 5th Column in Yugoslavia, urging its members to

"Compel their present leaders of the Communist Party to admit their mistakes openly and honestly, and (then) correct them. . . . Or, if the present leaders of the Communist Party in Yugoslavia were incapable of doing that, remove them and replace them with a new international leadership for Yugoslavia. In all Marxist parties where there was internal democracy [discipline?], such a method of changing leaders is natural and entirely normal."

As the leader of the Communist Party in Yugoslavia was Marshal Tito, who was also Chief of State, this broadcast was understood as an appeal to revolt against the Yugoslav government.

On the same day Russia delivered a letter to Yugoslavia. It ignored the Yugoslav claim about Slovene Carinthia, and concentrated on protesting about the alleged illegal imprisonment of the 31 Russians with tortures claimed to have been inflicted upon them.* Even assuming that the 31 Russians had sought to cause a change in local communist leadership, was that worse or different from the elimination in the United States of communist leader Earl Browder, and his replacement by William Z. Foster? Marxist Communism has the right to replace leaders as necessary. Only Spain, Greece, and Yugoslavia deny such a right. Yugoslavia is now neither democratic nor socialist but a dictatorship supported by a Secret Police.** The note then continued.

"The Yugoslav Government apparently intends in the future to continue the practice of inhuman treatment of Soviet citizens, the practice of unlawful arrests and beatings, the practice of mockery

toward Soviet citizens. Apparently the Yugoslav Government does not intend to bring to account those who are to blame for these practices. If that is so, the Soviet Government deems it necessary to declare that it will not reconcile itself to such a situation and will be forced to resort to other more effective measures necessary to defend the rights and interests of Soviet citizens in Yugoslavia and to call the violators to order."

Yugoslavia replied on the 23rd, stating that she was an independent state and would under no conditions allow anyone to interfere in her internal affairs. She offered to deliver the 31 prisoners to Russia, and at the same time all other Russians within her territory wishing to leave. She offered to settle all disputes by negotiation and agreement.

On the 25th Russia convened two Councils, one at Moscow and the other at Sofia, Bulgaria. The Moscow Conference, which about 1500 delegates from all over the Soviet Union attended, was charged with considering how to carry on

"the struggle for peace against warmongers."

Speakers represented that the United States had become a military camp, that Wall Street capitalists were assaulting labor, that the President of the United States was hysterically demanding military appropriations, that the United States was issuing orders to Bevin (Britain), Blum (France) and Tito (Yugoslavia), and classified General Bradley as "the oversea cannibal." Results of this conference are unknown.

The Sofia Council was attended by the Bulgar Polit Bureau, the Foreign Minister of Romania (Anna Pauker), two Russian colonel-generals (probably Marshals Voroshilov and Zhukov), two Czech generals, other officers from Albania, Bulgaria, Hungary, and Poland. The military personnel attended in uniform and made no effort to conceal the importance of the meeting, although that itself was secret. Yugoslavia G-2 was of the opinion that this conference was that of the Chiefs of Staff of Russia and its satellites. This lacks confirmation. The conference ended on the 28th, and issued a communiqué stating that

"the council reviewed current events and made necessary decisions."

As the Sofia Council met through four days, it is presumed that its decisions were made only after mature consideration, and that they were important.

Russian troop concentrations against the Yugoslav border were reported on the 27th. An armored division moved from east of Vienna to the vicinity of Pécs-Mohács, which is in the angle between the Drava and Danube rivers, just north of the frontier. A second armored division, already in Hungary, was moved to the Szeged area, an important road and RR crossing over the Tisza (also spelt Theiss, Tiszo, and Tisa) river. Still a third armored division came into line between the preceding two, from an unascertained base. This line of armor was reported supplemented on the 29th by at least one more armored division, which had been in Romania concentrating near Timisoara. All movements were unconcealed.

Troop movements of Yugoslavia to meet the threat of Russian armor were secret. However, the Turkish Intelligence Service reported that the bulk of the Yugoslav army had as of the 27th already concentrated in south Yugoslavia, facing Bulgaria.

On 30 August, Russia delivered a new note to Yugoslavia, and at the same time broadcast it. It was not intended to appeal to the Yugoslav Government but to unmask it to help the Yugoslav people understand their own leaders. It denounced Yugoslavia's claims to Slovene Carinthia, and published a Yugoslav letter of 20 April, 1947, which had stated that it would not insist on a cession. It then went on to denounce Yugoslavia as a deserter from the camp of socialism and democracy to the camp of imperialism and fascism. It stated

"the Soviet people do not respect deserters. . . they despise deserters."

After discussing kinds of deserters, it classified Yugoslavia as a "boastful malicious deserter." The note ended with the statement that neither courtesy nor respect could hereafter be expected by Yugoslavia from the Soviet Government. The internal evidence of this note indicates it was written hastily—the latter part particularly repeats itself,

*The tortures are described in the note. They do not differ from those frequently reported as being usual in Russia.

**This is probably true, but seems to be a case of the pot calling the kettle black.

and the entire note shows an absence of editing.

COMMENTS

Communist Russia in the past has often spoken plainly. She has not hesitated to use the epithets of liar, double-faced, etc. Idle threats have not been her habit, and those launched in vitriolic language against Yugoslavia should not be ignored.

Failure by Russia to take decisive action against Yugoslavia would be sure to encourage the Underground movements in all the other satellites. Russia knows that. She is probably following a plan developed at least six months ago.

As previously mentioned, a line of blockhouses, MG posts, OPs, and other defensive works had been constructed this year along the north boundary of Hungary facing towards Austria. That line was later extended to along the south boundary of Czechoslovakia. Its main idea may have been to protect forces employed against Yugoslavia from raids, or other military action, based on Austria.

British reports have been noted that Russia commenced production of atom bombs in either June or July of this year. Unknown is the rate and place of production. Neither is it known whether the Russian atomic bomb is of the Hiroshima type, approximates modern types, or is an entirely new type. It is not impossible that Yugoslavia may furnish the excuse, and the occasion, to use atom bombs. Main reason for doing so would be, not so much the destruction of Yugoslav forces, but to demonstrate to the West that Russia is prepared to use the atom bomb against them.

The Yugoslav situation is serious. It deserves close military attention.

Yugoslavia appears ready to join the Western Powers. She obviously needs their aid if war with Russia comes. Yet Yugoslavia is not a democratic state—it has retained its communist and dictatorial government. There is a large dissident group in the country, centering around the Croats, who have never liked the ruling Serbs. The Croats maintain an Underground, and have a CP with radio station in touch with Yugoslavia-in-

exile, which in turn has a CP in the United States. It is far from true that all of Yugoslavia is united behind Marshal Tito. Besides the Croats, the Moslems (important only in Bosnia) and the Montenegrins do not favor the present government. A 5th Column against the Serb Government may be encouraged by Russia to undertake active operations at an early date.

Again, the Yugoslavia situation should be watched.

THE NORTH ATLANTIC TREATY

For the past century and a quarter the basic foreign policy of the United States has been the MONROE DOCTRINE, first promulgated on 2 December, 1823. That doctrine has, since the commencement of this century, been supplemented by an unwritten and unpromulgated inseparable addition: That in time of danger the United States and Great Britain will if necessary aid each other.

So at the beginning of World Wars I and II the United States went to the aid of the British, and the British, in August 1941, gave notice that they would aid the United States if the latter were attacked by Japan.

It is now generally agreed that the United States and the British Empire cannot survive in this world unless they support each other. They have consequently coordinated their political and military plans. Yet for the first time in their history they no longer feel able to preserve their own independence. They have sought allies, and have found them in West Europe. With them they have joined in the North Atlantic Alliance by treaty which prescribes that an attack upon any member state shall be considered as an attack upon all.

The United States ratified the Alliance on 25 July. It became operative on 24 August upon ratification by France and all other parties. This is a major change in American political and military policy.

The Army Chief of Staff announced on 29 July that the American policy will be:

1. The United States assumes control of strategic bombing and the atom bomb.

2. The American and British navies will keep sea lanes open. Navies of other allies will maintain own coast defense.
3. West Europe will conduct own ground defense. It has a combined population of about 150,000,000 and under the Marshall Plan is rebuilding its military forces and industries.
4. Great Britain, France, and adjacent small allies will conduct own air defense and tactical bombing.
5. Allies not in the theater of operations will aid those which are.

The Russian press correctly gave the vote of the U. S. Senate on 21 July for ratification of the Alliance as 82 for and 13 against. It then commented:

"In spite of wide popular opposition and serious doubts and reservations made by many senators, the Senate approved ratification of the North Atlantic Alliance. . . . The Government managed to collect more than 2/3 of the votes needed for ratification. At the same time, the reaction of public opinion of the United States showed clearly that the Pact does not have popular support and many millions of Americans speak determinedly against the Pact as an aggressive alliance that threatens the peace."

Nothing was said about similar Russian treaties with its satellites.

On 19 July Russia filed its official objection to Italy's participation in the Alliance. It charged that this was in violation of the Italian peace treaty. On 2 August, the United States and the other Allies rejected the objection. The peace treaty says nothing about alliances. Besides, there was nothing in the alliance that required Italy to depart from any peace-treaty obligation.

NOTES ON RUSSIAN SATELLITES

Czechoslovakia. A special effort is under way to dominate the Catholic Church. About 2/3 of the Czechs and 95% of the Slovaks are Catholics. Balance are principally Protestants (Hussites) but they are acting with the Catholics.

Church property is being confiscated, and the taking up of collections in churches has been prohibited. This is intended to deprive the clergy of support. In lieu thereof the state has agreed to pay the clergy salaries provided they follow the party line, which the clergy has refused to do. Clergy are to be disgraced by charging them with treason, acting as agents for the United States, or similar charges. Mail to and from other countries, especially the Vatican, is intercepted, but the Underground assures communication with the exterior. Religious communications, including sermons, are required to be submitted in advance to the censor for approval and modification, which has resulted in communications being secretly printed and distributed. The state seized the office of the senior archbishop and issued "orders" over his seal. This becoming known, the "orders" are disregarded.

Bishops have been invited to disown the Vatican and establish a state church on the ground that the Vatican is now primarily a political organization supported by the Western Powers, especially the United States. The communist state has much desired to secure the adherence of at least one bishop—Catholic or Protestant—with sufficient prestige to head a proposed new national church. None accepted and the Catholic bishops publicly announced their allegiance on religious matters to the Vatican. The Vatican supported the bishops by issuing an order excommunicating all who voluntarily accepted, or aided, communist rule.

This Vatican order was general and applied to other countries. It had an immediate and, for the communists, an unexpected effect within the Catholic satellites, in hardening the opposition to communism. To combat this, Czechoslovakia in its turn issued orders stating the Vatican order was annulled, and that anyone who sought to execute its provisions would be adjudged guilty of treason.

Comment. The excommunication order does not mention socialist schemes, such as nationalization of property. It applies only to communist principles such as denying God, or that human persons have no rights. Persons

having such ideas automatically lose their Church membership. No action by local authorities is called for.

Poland. The Army has been reduced to close to cadre form—probably considered as unreliable to communism. Divisions are still maintained, but now have neither armor, heavy artillery, nor AAA batteries, this equipment being stored. Units from regimental level upwards have each a commissar and a polit bureau to enforce communist training. Generals are mostly Russian, while most field officers are Russian-trained. Equipment and uniforms are Russian. Officers of the old army, suspected of favoring Polish independence, have been liquidated or purged. The C-in-C is Marshal Zymierski, a Polish Communist.

There is a large MP force, comprising:

Political Security Section	about 180,000	men	scattered all over.
Gendarmes	" 70,000	"	similar to our State Troopers.
Militia	" 80,000	"	volunteers watching for sabotage, spies, etc.
Communist Youth	" 180,000	"	similar to our NG.
Interior Security Section	" 60,000	"	equipped with armor and artillery, and trained for house and street fighting.
Total	about 570,000		

This is an unduly large state police force for a population of some 23,000,000. It is an indication of the insecure existing political conditions.

There is an Underground. This maintains two CPs, each with its radio station, respectively in east and west Poland, which maintain communication with friendly stations elsewhere.

Romania. The Underground has numerous partisan bands scattered over a wide area. They have occasional combats with the communist troops, but not above company level. Some bands have been eliminated, but new ones have arisen. Major mission of the partisans is to start a civil war on a sufficiently large scale to attract intervention by the Western Powers. In the meantime a minor mission is sabotage, especially of oil and food supplies which Russia requires to be shipped to her own territory.

The workers have lost their former faith in communism, as it hasn't provided the improvements promised.

Industries are deteriorating owing to lack of replacements for worn-out machinery. All Catholic Welfare agencies— asylums, hospitals, etc.—were suppressed as of 15 August, on the ground that such activities are the duty solely of the government. The Catholic population is only about 10% of the total.

Albania. Economic conditions are bad and becoming worse. There is unrest among the people. About 2 transports a week arrive from Baltic ports with munitions and supplies. Part of these cargoes goes to the Greek communists and part is utilized locally.

The original idea of the Valona base (see above) was to connect it with Russia by land lines of communication extending through Yugoslavia (a poor route) or through north Greece to south Yugoslavia and Bulgaria (better route).

The roads within Albania have been built, but the defection of Yugoslavia and the defeat of the Greek communists have prevented completing the land routes toward Russia. In view of this situation Albania, unlike other satellites, has no treaty with Russia and the other satellites guaranteeing mutual military support. The new base, which is well situated and has an independent oil supply from native wells, would with the impossibility of effective defense, be a temptation to an enemy. This unsatisfactory condition is another reason why Russia desires to liquidate the Yugoslavia problem at as early a date as practicable.

The Albanians do not like the Russians or their present government and can not be counted upon to remain faithful to Russia in case of war.

Note on "Confessions." Throughout the satellite states, trials continue charging the prisoners with treason and as being agents of a capitalistic imperialism country, sometimes designated as the

United States, again as "the enemy," and occasionally unspecified. The evidence consists principally of "confessions" in which the accused admit the charges. Witnesses or documents to prove the alleged criminal connection with the United States have so far as reported never been presented. The confessions" remain without corroboration.

The world has been surprised at the regularity of the "confessions." An explanation based upon the published decisions of the appellate court of Hungary seems to be the probable one. The court ruled that treason consisted

of opposition to the state. The law did not read *forceful* opposition; the court specifically announced that *peaceful* opposition was equally treason. Consequently, expressing opposition to the state, or to its agents and officers, was treason. On the same line of reasoning, expressing a wish that the United States, or some other Power, might eventually bring freedom to their land made that person an agent of the Power he mentioned. The law does not require witnesses to overt acts. Consequently, a mere acknowledgement by the accused that

he expressed discontent with the state, privately or publicly, or preferred some other form of government, was sufficient to convict.

The immense majority of the peoples of the satellites are opposed to communism, and very probably many of them have sometime and somewhere said so. They may well equally have expressed a hope that the day would come when a more enlightened, and a freer, government would be established. Many of the "confessions" may be true. They also correctly represent what the people think.

CHINA

POLITICAL

The Kuomintang Government, recognized by the Western Powers as the lawful one for China, has a temporary capital at Canton, under acting President Li Tsung-jen. He is not in complete control, being dominated by Generalissimo Chiang Kai-shek, the real President, supposed to be absent on leave. He is not on leave. He has set up a CP at Taipei in Formosa, on which island he has established his headquarters and bases for all air and naval forces. Besides these there are about 200,000 ground troops on that island. The Foreign Service is under the Generalissimo, and he has seized the gold reserve. He is the titular head of the Kuomintang Party and in that capacity issues directives throughout the part of China free from communists. As head of the Emergency War Council, appointed by himself, he issues orders to all military personnel. The acting President at Canton has the administrative section of the government under him, and in theory can issue orders to ground troops on the mainland.

General Li, acting President, made at least one effort to become independent. It is now known that on assuming the presidency on 21 January, 1949, he within a few days approached Russia for aid, in return for which he offered to eliminate American influence in China and thereafter co-operate with Russia. At the same time he approached the United States, asking it for aid in the shape of a loan, for which he offered Formosa as security. The

record does not show that the Generalissimo was aware of these attempted negotiations, which were repulsed by both Russia and the United States. On the contrary the Generalissimo has not ceased to be anti-communist and during July made trips to the Philippines and to Korea to line those countries up against communist expansion in the Far East.

The Communist Government, with temporary capital at Peiping, has strengthened its relations with Russia. On 16 August it celebrated the defeat of Japan, alleging that this had been brought about exclusively by Russian arms. It then announced an agreement with Russia granting the latter commercial privileges within Manchuria, which is being rehabilitated. On 24 August, a Communist Manchurian Government was established at Mukden.

MILITARY

The General Situation, as of 1 July, 1949. The Kuomintang realized that the war with the communists was going against them. They adopted the following plan:

Discontinue direct opposition to the ground advance of the communists southwards from the Yangtze River, except for delaying actions. Use the Navy and Air Forces, based on Formosa, to blockade the communist-held coast from Manchuria south to wherever the front happened to be, which at this date was north of Foochow. Hold and defend Szechwan, as

this province normally produced a large excess of food. That would insure subsistence for Kuomintang forces and, by withholding the export of the surplus, might cause a famine in communist-held areas. Hold and defend Yunnan, as that province had valuable tungsten and tin mines, the produce of which could be exported for needed funds, via the old Burma Road. Hold and defend the northwest provinces, which were partly Moslem and anti-communist.

The Communist plan was:

Advance southwards from the Yangtze in two main columns—west via the Hankow and Canton road and east via the Shanghai and Canton. Main difficulty expected was supply, not the enemy. Care to be taken not to go so fast as to out-run the maintenance of supplies. Establish air and naval forces to attack Formosa in order to lift the coast blockade, which seriously interrupted foreign and coast trade. Establish a 5th Column in Formosa, through purchase of arms by local communists from the corrupt Kuomintang officers and men, to aid invasion forces to seize that island. Advance into the Northwest Provinces and drive the enemy away from his connections with the Kuomintang forces in the south.

Operations south of the Yangtze. The communist C-in-C was General Lin Piao, who in 1948 had driven the Kuomintang out of Manchuria. He also assumed command of the west column. His east column was under General Liu

Po-cheng. Both columns jumped off on 18 July, and each had four armies (armies were really corps, normally of 3 divisions of some 10,000 men each) and advanced on two parallel roads. Liaison between west and east columns was maintained by intervening guerrilla bands. Other troops, initially in rear areas, were available if needed.

The Kuomintang C-in-C was General Pai Chung-hsi, an inseparable friend of acting President Li. He claimed to have about 300,000 troops on the west front, and 200,000 on the east. If true he was stronger than the enemy. He had no intention of taking the offensive, but detailed forces of about 40,000 men to keep in touch with the enemy.

On the west this advance Kuomintang force elected to defend Changsha. Its commander was General Cheng. At the beginning of August the communists arrived with their 42nd and 43rd armies north of that city, while their 12th and 16th armies came up from the east. General Pai suspected that General Cheng might desert to the enemy. He thereupon sent General Chen to relieve him. Cheng and Chen talked the matter over, with the result that on 5 August they both went over to the enemy, together with about 30,000 of their troops.

General Pai had a claimed 70,000 troops in support. He was afraid they too might desert. He thereupon withdrew 175 miles south to the Chenhsien area. The communists did not follow in strength. Finding nothing more than reconnaissance forces in front of him, General Pai at the end of August moved forward and as the month closed held the line Sinhwa - Hengshan - Yuhsien (all incl).

The east communist column arrived at Kanhsien on 15 August and at Foochow on the coast on the 17th, without meeting opposition. They rested until the 28th, then during that night made a 38-mile advance. The Kuomintang forces were in a defensive position at Tingnan. These were by-passed on both flanks. At the end of August the line was Tayu (Com)—Lungnan (Com)—Tingnan (Kuo)—Hoping (Com). The communists are in a position to interpose between the Kuomintang west and east columns, or

reach their common base at Canton ahead of the Kuomintang troops. The communist capture of Tayu and the earlier occupation of Suichwan, Kiangsi, gives them two old American air bases which are excellently situated for operations against Formosa. A detached Kuomintang force, claimed to be 40,000 strong, holds a beachhead around Amoy. It did nothing towards hindering the communist advance southwards.

Yangtze Operations. The British Gunboat *Amethyst* had since 20 April been in the Yangtze below Nanking. It had been disabled on that date by communist artillery, which had prevented its return to its own fleet at sea. By 31 July, the gunboat had been sufficiently repaired to be able to move. It was anchored in a defiladed spot and had been allowed to buy food upon payment of exorbitant prices. Its commander decided to run the batteries. It was a dark night. He slipped his anchors just as a commercial ship was passing going downstream. The communist batteries observed the escape and opened fire. They hit both ships. The *Amethyst* was slightly damaged but had no losses, while the commercial ship, which was loaded with passengers, was sunk, with loss of several hundred lives. The *Amethyst* reached the sea by morning and joined its fleet.

Naval and Air Operations. The Kuomintang Air Force has maintained an intermittent bombing of Shanghai, which has caused damage and loss of life, although nothing of military importance. The Kuomintang Naval Force has maintained blockade ships off Shanghai and off Tientsin. These measures have greatly curtailed trade to and from communist territory.

The communists are organizing air and naval forces. For a start they found 12 LSTs in Lake Tung Ting on their advance to Changsha, to add to 2 which they already had. Five more LSTs had deserted from the Kuomintang when Shanghai fell, together with 5 destroyer escorts. The Kuomintang, on abandoning Shanghai, scuttled 41 naval vessels near that port. Of these the communists have already raised 32. About 15 planes are known to have deserted to the communists.

On 14 August, the communists, sailing in junks, attacked and captured Miao Island at the entrance of Gulf of Chihli, supposed to be the Kuomintang naval base for their blockade of Tientsin. At the same time another expedition seized Chu Shan Island, southeast of Shanghai, supposed to be an air and naval base for operations against that port. In neither case was opposition met.

Northwest Operations. The communists entrusted General Peng Ten-Huk, with their 2nd, 3rd, 4th, and 6th Armies, with the mission of attacking Langchow, capital of Kansu, defended by the Moslem general Ma Hung-kwer. The communists advanced from Sian in July and arrived before Langchow in August. They commenced the attack on the 22nd. On the 28th the Moslems withdrew to Sining, 110 miles to the west, with the communists in pursuit.

COMMENTS

Generalissimo Chiang Kai-shek has waged war against the communists since 1927. In this long war he has never won a campaign, notwithstanding that for the greater part of this period his troops outnumbered those of the communists by not less than 10 to 1 and were better equipped.

It has lately been charged that lack of success was the fault of the United States. Specifically that the United States permitted the communists to arm themselves from captured Japanese stores in Manchuria in 1945. The United States did not *permit* this. How could it have been prevented? The U.S. Navy transported whole Kuomintang divisions to Manchuria to head off the communists while other divisions went overland. We did the best possible. On its part the Kuomintang received all the Japanese weapons and stores in China (less Manchuria). Yet they did not win.

Lack of success was primarily due to the Kuomintang's faulty strategy, not to lack of U. S. loans and grants of supplies. There were two major faults. First, instead of attacking the communists when Kuomintang was many times superior in strength, it just garrisoned cities, which the Generalissimo had

designated as "strategic centers." Secondly, the Kuomintang troops seldom fought, and not at all unless they were in overwhelming strength. The communists had three years—from 1945 to 1948—to organize and train armies. Then they fought and won.

The Kuomintang is discredited throughout China. Supposedly standing for democracy, it is a dictatorial state. It is very corrupt, with the profits of graft going to a relatively few individuals. For example: This year commanders drew the pay for the troops and then converted it into foreign currency, instead of paying it out. Some months later, the currency having declined, the commanders were able to buy back Chinese currency for the pay roll at a rate less than at the date of conversion. The difference went into the pockets of the commanders; soldiers received their pay (after a long delay) when the money

no longer was worth what it had been at the date of the pay rolls. Soldiers deserted, or sold their arms and equipment to anyone having the price.

The Kuomintang's current strategic plan of dividing their forces between Szechwan and Formosa, leaving the enemy unmolested in between holding the main part of China, is as inept as previous plans. It repeats the old error of occupying areas, instead of defeating the enemy.

It is doubtful if either Szechwan or Formosa can be defended. Kuomintang naval and air forces are slowly deserting to the enemy. The ground troops in Formosa are untrustworthy and likely to join the communists should the latter appear. A similar situation exists in Szechwan.

The fate of Formosa is of major importance. On paper it belongs to Japan, with China as the occupying

Power until a peace treaty is agreed upon. Three propositions for its future have been presented. These are: (1) annexation to the United States; (2) return to Japanese rule; and (3) independence. The natives are overwhelmingly against annexation to China, but what their preference is isn't known, as they have never been given an opportunity to speak for themselves. Reports indicate that if a vote were taken, the three propositions given above would be preferred in the order shown. Independence comes last, owing to cost and difficulty of maintaining independence for what would be a small state.

If something is not done about Formosa, the communists are likely to invade and conquer that island. From the American point of view that would be a very undesirable and dangerous change in the Far East strategic situation.

GREECE

THE GENERAL SITUATION

On 1 July the estimate of Greek G-2 as to the strength and location of the communist forces was: Main body on Mt. Vitsi, 8,000; support on Mt. Grammos, 5,000; detachment on Bulgar boundary, 1,000; scattered, 3,000; Total, 17,000, of which 1/3 were women. The communists appeared to be under the direction of the Cominform, with CP near Bucharest, Romania, where the "Free Greek" radio station was. The local commander was General Nicolas Zachariades. The action of Yugoslavia at the end of June, in closing its territory to Greek communists, had forced a change of the operational base to Albania, with a secondary base in Bulgaria. The two bases were separated from each other by a now neutral Yugoslavia. The Albania base included hospitals, replacement depots, truck trains, supplies, etc. The latter came by sea from Russian Baltic ports, with small amount by air. Albania supplied recruits from one of its tribes—the Tchams. Tchams have long been antiGreek. Also they are against the present government of Albania. By turning them over to the Greek communists, Albania removed a troublesome people from her care.

The High Command in Greece was under General Alexander Papagos. He had some 60,000 combat troops in addition to L/C troops and home guards. He planned to assume the offensive and destroy the enemy in three moves—first to clear the frontier between Greece and Yugoslavia. This would deny to the enemy the corridor along the frontier from Albania to Bulgaria and would isolate the communists into two bodies with no direct communication with each other. That operation would be followed by attacks against Mt. Vitsi and Grammos with a view to driving the enemy out of Greece unless he chose to fight and risk annihilation by greatly superior forces.

INITIAL OPERATION

A South Corps, with the 8th, 15th, and 1st Divisions from south to north, faced Mt. Grammos. A North Corps, with the 9th, 1st, and one other division, faced Mt. Vitsi and the area to the east. An attack was launched by part of these troops on 2 July. An enemy force of about 700 men was driven off of Mt. Profitis Ilias with a loss of 85 killed and 85 POWs. Another attack by 8 July captured Mt. Kaimakchalan, 7500 feet high and on the frontier, with an enemy loss of 124 killed and 124 POWs. Greek losses were not reported. These

operations were supposed to have opened up the Phlorina and Bitolj Road into Yugoslavia. However, a reconnaissance on 13 July showed small enemy forces back on the heights from which they had reportedly been cleared.

MAIN OPERATION

By the end of July General Papagos had concentrated his 6 divisions along the line Kónitsa-Kastoria-Phlorina. Accompanied by Lieut. General James A. Van Fleet, head of the U. S. Military Mission, a careful inspection of the front was made on 29 July. Enemy's main base was at Corizza within Albania, whence a motor road ran to Vatokhorion within Greece, which was the distribution point. South of Mt. Grammos the frontier was lightly held by Albanian troops, who remained on their side of the boundary. The plan was to first close in, taking Mt. Grammos if possible and closing the communist L/C to Corizza. If this was not possible, Mt. Vitsi would be attacked, and a pincer attack would follow from north and south against Mt. Grammos.

On 2 August, the South Corps, Lieut.

General Thrasivolos Tsakolotos commanding, started to close in on Mt. Grammos. During the first four days only patrol encounters occurred, but some troops got over the border into Albania and were captured. This gave the enemy identifications, and possibly other information. On the 6th a major attack was launched directly against Mt. Grammos from both the north and the south on a 30 mile front. A connecting attack westward from Nestorion covered the inner flanks of the main forces. Attacking troops had armor and artillery support while the Air Force furnished general support.

The communists seem to have judged the connecting attack to be the main one. They counterattacked it and stopped it. However the north attack made progress. The communists for the first time had an efficient artillery of 105 mm howitzers. The Greek attack continued to include the 9th, without making much gain. It was then temporarily discontinued.

On 10 August, the North Corps, General Constantine Vetiris commanding, jumped off against Mt. Vitsi. This communist force held a narrow corridor along the Albania frontier to Mt. Grammos. They were not dependent upon that, for a good road existed through Albania which enabled them to transfer troops from one position to the other. The Greek attack met heavy resistance. Twenty-five communist batteries were identified in line—a new development. However, the communists had neither armor nor an air force, and the Greeks had both. The battle continued until the 12th, when the communists started a general counterattack. This failed, with the Greeks capturing high ground from where they could place interdiction fire on the main road from Corizza. Next day the Greeks in a sudden attack took Vatokhorion and the guns of 2 batteries, but the communists advanced on the opposite flank and posted batteries overlooking Phlorina, which they placed under interdiction fire. That night the communist General Zachariades decided to abandon his position and withdraw

into Albania. he executed this maneuver in good order and marched south towards Mt. Grammos. The Greeks failed to discover this maneuver until too late. They then occupied the Mt. Vitsi area.

For the entire Mt. Vitsi operation the Greeks reported their own losses as 206 killed, and 826 wounded. They reported the enemy's losses as 1115 killed, 816 POWs, 31 field guns, 3 AA guns, and 26 AT guns.

Both sides moved troops south to the Mt. Grammos area for a final battle. The Greeks were ready first and attacked on 24 August. Main attack was against Mt. Grammos. The communist outer defenses on Mt. Tsarmon (9 miles northwest of Nestorion) were prepared for assault by an air strike by 16 planes (U. S. Helldivers) using 500 lb. bombs and an artillery preparation, both starting at 0400. For this battle many distinguished officers arrived at the OPs, including the King of Greece. It was hoped that this battle would end the war by the destruction of the communist army. The 9th Division, brought down from the north, attacked Mt. Tsarmon from the north; the 1st Division from the east. The 15th Division continued the attack toward the south, and the 8th division moved northwards along the Albania border. The terrain was heavily wooded; targets were hard to locate. There was much underbrush and going was difficult. Under these conditions the troops advanced slowly through the 26th, by which date Mt. Tsarmon had fallen, together with Mt. Psoriariks, 2 miles to the north, and Mt. Kouria, 4 miles to the west.

The communists now brought into line the troops from Mt. Vitsi. On the afternoon of the 26th part of these counterattacked the 15th Greek Division and drove it out of Zerma, which it had taken earlier that day. The 8th Division was also stopped.

Heavy fighting followed on the 27th. On the south the 8th Division sought to reach the Kamenik Gap between Greece and Albania, but failed to reach it. The 15th Division made some

advance, but this was arrested along the Sarandoporos River. Neither the 1st nor the 9th Divisions gained materially. The 3rd Division, in army reserve, was not used.

Next day, following an air strike by rocket and bombing planes and an artillery preparation, the 9th Division reached the summit of Mt. Grammos (about 7,000' high) by an attack from the north. Communist units were identified as the same which the 9th Division had fought at Mt. Vitsi ten days earlier. On the 29th the communists counterattacked the 9th Division. This made a considerable gain, the division CP being lost, together with the division commander and the entire headquarters. Reports are silent as to whether the communists regained the summit of Mt. Grammos. On the 30th the 8th Division seized high ground from where artillery fire could be brought to interdict Kamenik Gap. As the communist line of supply came through this gap, the communists during the ensuing night withdrew into Albania. The communist losses are given by the Greeks as 1,698 killed for the entire Grammos operation. Greek losses were not published.

COMMENTS

The Greek Army has thrown the communist force out of Greece into Albania. As the communists had that country directly in rear of their positions they were able to withdraw in apparent good order. Replacements and supplies are now available to them, and they can resume the offensive whenever they complete reorganization and wish to do so. In view of the present critical world situation, destruction of the communists by pursuing them into Albania wasn't attempted. Estimated communist strength escaped from the border battles, and before receiving replacements, is estimated by Greek G-2 as 8,000.

Greece's army has isolated Albania from its connections with Bulgaria, and stands just south of Yugoslavia. Inside Greece, communist bands have been greatly reduced.

SOUTHEAST ASIA

BURMA

The civil war between a multiplicity of parties, each at war with the others, continues. The Government, with capital at Rangoon, occupies the territory to east and west as far as the Sittang and Irrawaddy Rivers, and the greater part of the Irrawaddy valley.

A new element appeared in the war during August. The Kachins, who are located in the north, sent a detachment south to join with the Karens coming north. The two columns met and attacked Taunggyi, which they captured by a surprise attack on 15 August. The Government garrison, which seems to have escaped, counterattacked on the 17th, but failed to retake the city. The Kachins then withdrew, leaving only Karen troops to hold Taunggyi. On 27 August, the Kachins on the way back north captured Lashio, former base for the Burma Road. The Government intelligence service was so poor that they had failed to note the northward march of hostile forces. They did not even know, for several days, which of the various rebellious groups had taken Lashio.

MALAYA

The communist war against the Government continues. The British forces on the whole control the country, and the production of the basic products—rubber and tin—has been maintained. The communists have been broken up into small bands operating

from jungle hideouts. As there is very much jungle, it may take time to eliminate them.

INDO-CHINA

The new state of Viet Nam, under the former emperor Bao Dai, and comprising the former states of Tonkin, Annam, and Cochin-China, is functioning. It is having trouble securing competent natives for civil positions. A native army is being organized, while the French garrison of 110,000 troops maintains order at key positions. The French have about cleared Cochin-China of hostile elements. Commercially, that state is the smallest but most valuable in Indo-China. In Annam, part of the coast and the principal towns are controlled by French and native troops. In Tonkin, the lower Red River valley, the ports, and road blocks at the Chinese frontier are occupied.

The enemy is the Viet Minh, under Russian-trained Dr. Ho Chi-Minh and is communist-directed. Its activity has noticeably decreased and during the period of this report has been limited to attacks on convoys. It is believed, but not known, that this lack of action is due to the small remaining amount of ammunition on hand. Most of this was thought to come from China, which the road blocks at the frontier are charged with intercepting. To aid in this, the only military operation worthy of note was the French capture of Phucyen and Vinhyen, respectively 30 and 39 miles

up the Red River from Hanoi. Intervening Viet Minh troops were overpassed by using parachute troops, who dropped on their objective from 51 transport planes. The two towns are centers of food districts.

On 19 July, Laos, under a new treaty with France, became an independent state under its King Sisavang Vong. It is to remain within the French Empire with what amounts to dominion status. France has agreed to support requests from Laos and from Viet Nam for admission to the United Nations.

INDONESIA

The Dutch Government, on 6 July, released President Soekarno and other high officials who had been held as POWs. They returned to Jogjakarta and reassumed command of the Indonesian Republic, claimed as covering both Java and Sumatra. An armistice was then agreed upon between the troops of the two sides, and has been substantially respected. Both sides have also joined in a conference, convened at The Hague at the end of August, which is to decide a final settlement for Indonesia. The main hostile element left is a movement in Southeast Java for an all-Moslem state.

Comment. On the north coast of Java is an excellent naval base—Soerabaja. Good air bases are adjacent. It is of primary concern that these bases do not fall into the hands of elements hostile to the Western Powers.

5th COLUMN ACTIVITIES IN THE AMERICAS

A report on this was submitted in PERIMETERS in the May-June, 1949 issue. Since that date the main center of communist activity appears to center in Guatemala.

Operation Santo Domingo. On the night of 19/20 June, 1949, two planes loaded with communist agents landed in Santo Domingo. They had jumped off from Lake Izabal in Guatemala, despatched by Lieut. Colonel Francisco Cosenza, Chief of the Guatemala Air Force. The plan was that the communists were to be joined by the garrisons of 7 posts in Santo Domingo, who were then to overturn the existing government

under President Trujillo and install a communist government.

Probably due to advice from a friendly power, Santo Domingo had known in advance of this plan. It also knew that the initial landing point would be near Luperon on the north coast. When the communists landed they were promptly apprehended and rapidly executed. That ended that operation.

Operations in Guatemala. The Guatemala Army was not communist. Its commander, Colonel Francisco J. Arana, does not appear to have known in advance about sending two Government planes to Santo Domingo. As soon as he

found out about this, he relieved Cosenza, and sent him to an outlying station.

This action led to Government sympathizers assassinating Colonel Arana on 18 July. In turn this led to a spontaneous and unplanned revolt by army troops against the communist-controlled government. The Government brought into line the Caribbean Legion. This was about a 1,000 strong, composed of communists and a collection of hard characters. The Legion was last previously reported as intending to invade British Honduras (Belize) about 1 March, 1948, but was stopped by the

arrival of 2 battalions of British troops. It has since been in Guatemala. With the help of this unit the Government suppressed the Army's revolt, after considerable losses to both sides; total, 300 killed and 600 wounded.

The Government now became more communist. Newspapers and radio stations were placed under government control. A branch Cominform office opened in Guatemala on 11 August, with direct radio communication with Moscow. A G-3 section started to plan for communist revolts in Santo Domingo, Nicaragua, Costa Rica, Panama, and Chile—rather a full program. It is reported, but not confirmed, that a submarine

base functions on the Pacific side for receiving weapons and ammunition from Russian submarines. The quantity of weapons and munitions already on hand is reported as much more than what would be needed for the Guatemala military forces.

To expedite communist activities in the Caribbean area, a "Peace Congress" has been convened to meet at Mexico City on 5 September. Leading American communists are expected to attend.

The United States, alarmed by the increasing communist activity, on 3 and 18 August officially reported the situation to the Inter-American Peace Commission for report and recommendation.

THE TRUTH

By Capt. James H. Reynolds, Jr., FA-Res.

TO ATONE for a conscience besmirched by four years of lurid and apocryphal tall tales of personal war experiences, I now feel constrained to divulge the true cause of the most soul-smearing Walpurgisnacht it was my misfortune to undergo during the Recent Unpleasantness.

My battery's first formal action occurred at Metz. The momentum of the Third Army had just been diminished by a lack of gasoline and the arrival of German reinforcements in the Metz area.

In accordance with the principles of inertia, no respecters of the fitness of things, many rear echelon elements accorded to the front. Consequently, our green cannoneers greeted with considerable surprise the sight of an officers' PX truck, a QM laundry, and a bakery setting up in fields adjoining the howitzer position—a surprise tempered with relief that a benign higher command had seen fit to establish our initial combat position at a considerable distance from the enemy.

Our tacit gratification toward the Corps staff, however, suddenly underwent a regrettable reversal. After our registering rounds, patrols brought back news that the German OPLR was but three hundred yards in front of the battery position.

This upsetting information reached us simultaneously with a flurry of 150mm shells, fired by a German battery with commendable zeal, and with

that extra soupçon of energy which indicates that the gunners know they have a counterbattery mission.

Despite our detached professional admiration for the volume, but not the accuracy, of the hostile fire, a displacement was considered more commensurate with our mission than was burrowing between the trails. Unfortunately for our equanimity, the displacement was to be a lateral one, parallel to the front.

As Reconnaissance Officer for my battery I reconnoitered a route to the new position and as darkness fell posted the tense route-markers. With jeep and driver I decided to take position myself at a complex intersection in the midst of grotesque piles of noisome rubble which yesterday had been a town.

Awaiting the passage of the battery in the ambient, velvety darkness, my driver and I were visible to each other only when we attempted rare smiles of questionable charm, our apparently disembodied teeth gleaming tremendously. We were the only humans in this shell of a town, yet before our straining eyes rock mounds seemed to evolve into stealthy Bavarian grenadiers, truncated barns dissolved into hulking Panzer-kraftwagens.

These unnerving metamorphoses, however, were dispelled as the battery started to rumble through the town. Never was the clanking of the M-4's, the squealing of pintles on lunettes, the profane yells of lusty cannoneers so

joyously welcomed. The crescendo of motors rose as the fifth section tractors roared by, and then, like a poor relative, came the route markers' truck. The last vehicle, it scuttled after its more ostentatious battery mates.

The silence closed in after them; the dark became more impenetrable, the acrid stench of charred timbers was now all but palpable. The ghostly population of the rock piles again stirred.

With unusual haste, we prepared to follow the battery. Suddenly, from the direction of the front, 50 yards out of town, the sticky night was cleared by a tortured shriek—louder and sharper it keened, and then, as suddenly, choked into a bubbly gurgle. Two bowls of jello clad in olive drab looked at each other in wild surmise. "If only you weren't here," each of us thought. As it was, we both felt that we had to set an example for the other. Propelled by a stunted sense of duty we dismounted and moved up the road cautiously, bristling with weapons.

We were quaking like a grove of aspens. My .45 was describing frenetic ellipses, a pattern more suitable for zone fire than a precision registration. About to voice a challenge, I was again brought up short by another attenuated scream shattering the inky night. A long, thin shriek of unbelievable agony, and again the liquid, ominous ending.

By now thoroughly eviscerated emotionally, I managed to challenge from a ditch in an engaging falsetto. In stentorian, cocky Ozark tones the answer came back. "Jess a coupla Yanks kill-in' hawgs for breakfuss, bud."

Rallying a tattered dignity, I decanted myself from the ditch. My frustrated *beau geste* spawned a masterly philippic wherein I unleashed my six most lethal oaths. Working up to the fifth, which requires delicate timing and comments vividly on the unnatural biological proclivities of the victim's paternal grand-uncle, my poise was upset by a low chuckle from one of the dim forms confronting me. Suddenly, the *reductio ad absurdum* struck us simultaneously, and the tableau degenerated in a cacophony of raucous guffaws, my driver and I taking a spirited lead.

And that, grandchild, is the *real* story of how I got this tasteful gray around my temples.

Beware of a man of
one book.
—OLD PROVERB



From Egg to Eagle

GLOBAL MISSION. By H. H. Arnold, General of the Air Force. Harper & Brothers. 638 pages. \$5.
By Mark S. Watson

General H. H. Arnold's years in American aviation come close to representing the span of military flying, for it was in 1911 that the Army sent him, as second lieutenant, out to Dayton to learn flying under the guidance of the Wright brothers themselves. It was in late 1945 that he gave up command of the Army Air Forces; both Berlin and Tokyo were in ruins, largely by reason of the pounding bestowed on them by the establishment which this same "Hap" Arnold had helped materially to build into the greatest air force in the world.

Those 34 years were eventful in almost every field of human endeavor, but in aviation they were all but incredible. In General Arnold's telling there is an impressive record of the milestones in Army aviation, of the aids to air progress and the discouragements as well, and of the persons encountered by the narrator.

In 1911 there was no barrier to acquaintance with the principal figures of aviation. Wilbur and Orville Wright in person took young Arnold to their little factory to explain to him the construction and maintenance of an airplane. His first lesson in flying technique was given in a back room of the factory where a plane was balanced on sawhorses to permit the wing tips to move up and down. Bleriot, Curtiss and Wright controls were all different; the Wrights' was the hardest to learn, but there was no such complex control board as today. Arnold's recollection is of only one instrument, that being a piece of

string tied to the front crossbar; if it stood out straight to the rear, the flight was going fine, but if it drifted to one side, the plane was in a skid. The safety belt came into being because Admiral Jack Towers (then a lieutenant) was thrown out of his plane-seat in mid-air and saved himself by clinging to a strut. The first goggles come in because a bug flew into Arnold's eye and almost wrecked the plane. The first arming of a plane, in 1910, was by grace of Lieutenant Jake Fickel, who carried his rifle aloft with him one day (ignoring Glenn Curtiss' fears that the recoil might upset the plane's equilibrium) and proved that he could hit a ground target 100 feet below him. The first "bombing," also in 1910, was that of Paul Beck and Myron Crissy, who made a bomb from a section of pipe, and also put fins on a 3-inch artillery shell, and dropped both these bombs to a successful explosion.

Those were simple days, with startling aspects. The author notes that the Wrights' first design of a light engine included the principle of direct fuel injection, which suddenly reappeared during World War II and was then hailed as highly ingenious. For that matter, back in 1917 experiments with Sperry-Delco equipment produced a flying bomb which would travel 40 miles and come within 100 yards of its target, and then another, the "Bug" (which utilized the range principle of the German V-1 of 1944) but which came to development too late for use in 1918 and then was shelved in the post-war economy, to be dusted off years later.

General Arnold has written, not a World War II study, but a book of memoirs covering his life in aviation, the climax of which was the creation and employment of the Army Air Forces of

World War II. He pays warm tribute to General Marshall for his understanding of the aviation problem and his powerful aid in solving it, to Assistant Secretary Robert A. Lovett, to Harry Hopkins' skillful aid in winning the support of President Roosevelt (who placed Arnold firmly in the doghouse for a period, but fortunately gave him full release), certainly to Gen. William Mitchell, "Tooeey" Spaatz, Tom Milling, "Miff" Harman, the redoubtable Jimmy Doolittle, and a host of other distinguished Regulars. He gives generous praise to Charles Lindbergh, in whose life great good fortune and great sorrow have been mingled, and whose large aid to American aviation in World War II is far too little recognized. His observations on Air Force critics are more genial than tart, for "Hap" Arnold misses few occasions to make his points amusingly. Indeed there are those who feel his memoirs should contain a less tolerant study of what went wrong with the air performance, say, in the Philippines, and a more persistent examination of G-2 failings.

There are a few now-it-can-be-told items, such as the reasons for the tragic delay in delivering the long-range P-51 (those reasons were within the Air Force); the dismal failure of the Army aviators at Midway and the potency of the carrier-borne Navy planes ("it taught me a lesson"); the hair-raising occasion when a recklessly fired American torpedo narrowly missed the ship carrying Mr. Roosevelt; another when a French-piloted American fighter almost winged the plane carrying Arnold and Marshall.

There is much less than most readers would hope for in the way of discussion of World War II lessons, both as to

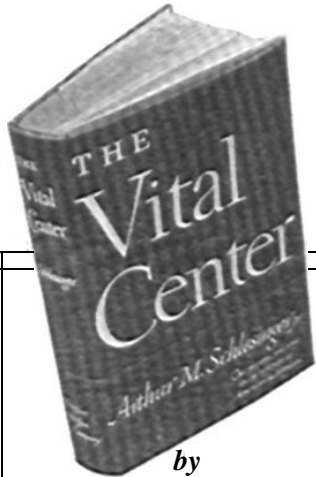

by
Arthur M. Schlesinger, Jr.
 Author of "The Age of Jackson"

"Precisely this kind of book has been needed to dissipate the confusion that has befogged and discouraged democratic thinking since the war. It is courageous, brilliant, clear, forcible, deeply learned and wise, and immensely heartening."

Bernard DeVoto
\$3.00

THE JUNGLE IS NEUTRAL

By **F. SPENCER CHAPMAN**

A story of high adventure which ranks with the very few top books to come out of the war.

For three years Col. Chapman lived and fought in the Malay jungle, completely cut off from the outside world behind Japanese battle lines. He underwent ordeals such as few men survive, trained Chinese guerrillas, and carried out really successful operations against the enemy.

\$3.75

U. S. Field Artillery Association
 1218 Conn. Ave., Washington 6, D. C.

the mistakes of Japan (such as going into defensive war too wholeheartedly) and of the German Air Force (such as failure to plan properly for replacements of men and materiel). There is no unexpected recommendation for American air in the future—although certainly no weakness of spirit in what is recommended. But there is an excellent portrayal of General Arnold and his historic times, most entertainingly done.

Danger to Right and Left

THE VITAL CENTER. By Arthur M. Schlesinger, Jr. Houghton Mifflin Co. 256 pages. Notes and index. \$3.00.

By Alan L. Otten

The age of Stalin and Truman is the new subject for this young (32 years old) historian, whose "Age of Jackson" won a 1946 Pulitzer Prize. Arthur Schlesinger, Jr., Harvard professor, columnist, magazine writer, one of the moving spirits in the Americans for Democratic Action, here steps forward as spokesman for a good part of the generation that grew to maturity under the New Deal. In a frequently brilliant and constantly thought-provoking book, he takes stock of the outlook for the continued survival and ultimate victory of free democratic society. His conclusion: it's going to be rough, but we can do it if we can recreate a fighting faith in freedom.

Both the businessman on the right and the intellectual, non-acting liberal on the left have failed to solve the economic and emotional problems created by the industrial revolution, the author argues. (He is guilty of creating grave semantic problems and also cheating a little by setting up a straw-man in his artificially narrow definition of the "left.") Neither right nor left (as here defined) is capable of saving free society from the challenge of totalitarianism. In crisis, the right turns to fascist totalitarianism, while the left turns to communist totalitarianism. While communism and fascism differ, their similarities far outweigh their differences. Schlesinger admits frankly that more of his book deals with combatting the challenge from communism than from fascism because that is the challenge we know least about and which we are most confused about meeting.

There is no hope for peace with Communist totalitarianism in the near

future, the author believes. Communism must continue to expand as long as there is a free society anywhere and the destruction of American capitalist democracy is a basic policy. Through the dual instruments of traditional power politics and the various Communist parties in the U. S. and other countries, Russia carries on unremitting war against the free society. (The analysis of the role of the CP in the U. S. and elsewhere is masterful.) So long as there is no democracy in Russia itself, there can be no peace, and totalitarianism in Russia, playing up natural and artificially created tensions, is now waxing rather than waning.

Where then lies the hope? It lies in the "non-Communist left" in the U. S. and throughout the world. It lies in the creation of a new American radicalism, which has faith in freedom and rejects totalitarianism. The new radical must be a practical politician, working with real facts, not in a dream world. Free society, to survive, must solve not only its economic problems but also must protect civil rights, and must rigorously safeguard civil liberties lest in the fight for a free society we lose what we are seeking to protect.

Abroad, we must follow several policies. In Europe, we must continue our present policy of containment plus reconstruction. In Asia, Africa and Latin America, where the U. S. is made unpopular by its record on racial discrimination at home and where the stirrings of economic-social revolution give Communism a superficial appeal, we must do more. We must immediately end old-fashioned imperialism, cease helping reactionary native regimes and instead aid local democratic factions. To this, we must add agricultural readjustment programs, industrialization, reclamation. "We must pit American technological dynamism against Russia political dynamism."

All this can be done, and there still is no guarantee of peace, for totalitarianism still exists in Russia, and tensions will have to be pyramided. However, Schlesinger maintains, this policy, plus continued economic progress throughout the non-Soviet world, will point up the cracks in the Soviet facade, accelerate what tendencies there are to disintegration.

This pattern may eventually reach the point where the Politburo decides the only way to retain power is by going to war. To prevent this, we must keep ourselves and Western Europe so strong from an economic and military point of view that the Russian general staff will advise against war.

The faults of this book are by no means minor. There is a tendency to the sweeping generalization. Too often, one feels, other sources are quoted not so much to make a point as to display the author's erudition. At many key points, the author gets vague and trails off into mystic phrases about "communion in action" or "genuine cultural pluralism." Some of the conclusions and solutions are most questionable. Nonetheless, "The Vital Center" does a fine job of clearing some very musty air and of charting some new paths. It is definitely must reading if you plan a serious discussion of politics any time during the next decade.

American "Baedekers"

THE AMERICAN GUIDE. Edited by Henry G. Alsberg. 1376 pages. Maps, index, bibliography. Hastings House. \$7.50.

GUIDE TO AMERICA. Edited by Elmer Jenkins. 705 pages. Maps, index, bibliography. Public Affairs Press. \$3.75.

The United States finally has a modern equivalent of the European traveler's "bible"—in fact two of them. Both books indicate that this country is too vast and varied for a detailed one-volume "Baedeker," but each will be of irreplaceable value to any traveler or student of Americana. When used in conjunction with the standard-issue gas station road maps (those in the books are no substitute), Duncan Hines' guides to bed and board, and local sources of detailed area information, either volume will take splendid care of your needs for intelligent planning or enjoyable, effective conduct of travel. For service people, who travel and change residence far more than any group of comparable size and income, it would be hard to conceive a more continuously usable and valuable book.

Both Guides use approximately the same amount of text to list information and points of interest to the traveler—cities, historical high lights, public

parks, resorts, natural wonders, etc.—resulting in a remarkably comprehensive and accurate set of helpful facts. Both introduce each separate region or state with a fine summary of its historical background, and outstanding features of its culture, commerce, industry and recreation.

The Alsberg volume divides the country into eight regions; within each the states, cities and tourist features are arranged by geographical position along the designated main routes of automobile travel. Side tours are traced to take in points of interest off the main beats. The Jenkins book uses a completely alphabetical system—first dividing the country by states, then listing under each state the cities and other points of travel interest.

The American Guide (Alsberg) is a somewhat handsomer volume with more historical content, larger-scale maps, better index and more detail, though this reviewer found its state-by-state text less enjoyable, owing to the arrangement by route and heavy use of abbreviations. *Guide to America* (Jenkins) is simpler for reference use and more selective since it marks the more important points of interest with a star. As so frequently, your judgment might well depend on where you are sitting—in your friend's fireside chair, planning a trip or looking up local information, the Jenkins book would be far easier to use; enroute in the front seat of your car, the Alsberg book's tour arrangement would come into its own. Difference in price makes the former a better value, but either volume will prove a fine investment. —N.L.D.

Graphic Guerilla Warfare

THE JUNGLE IS NEUTRAL. By F. Spencer Chapman. W. W. Norton, 384 pages, maps. \$3.75.

By Richard Gordon McCloskey

Deliberately staying behind the Japanese lines when Malaya fell, Colonel Chapman was for three years cut off entirely from the outside world. An experienced outdoorsman, he believed that the jungle was neutral, and at the command of whoever was intelligent enough to master it.

His story is one of very high adventure and belongs in the very small group of top notch war stories. In addition to being a story of spiritual survival,



KARAMOJO SAFARI

By W. D. M. BELL

The greatest of the early African hunters and explorers weaves a fascinating tale of his highly successful missions when Africa was truly dark. Tense action, immense hunting lore, and dramatic accounts of native life.

\$3.75

GUADALCANAL:

THE FIRST OFFENSIVE

By DR. JOHN MILLER, JR.

(Fourth volume in the series, U. S. Army in World War II, by Hist. Div., Dept. of the Army.)

The 6-month campaign on Guadalcanal—one of the longest of the war—turned the tide of Japanese victory, won an island, set the pattern for our combat throughout the Pacific—at cost of one American life to 15 Japanese.

Despite popular belief. Army troops shared the fighting almost equally with Marines—there in strength during half the campaign, in command the last two months, suffering over one-third of the casualties. This history covers both Marine and Army combat.

\$4.00

**U. S. FIELD ARTILLERY ASSN.
1218 Connecticut Ave.
Washington 6, D. C.**

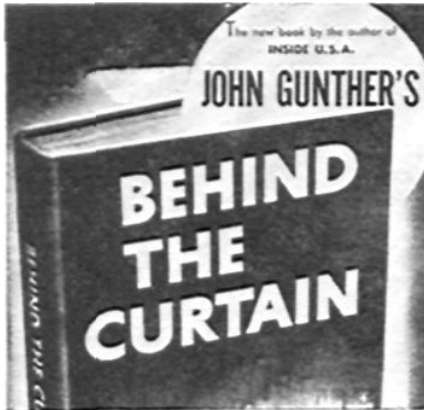

John Gunther's first report from Europe since the war. A timely, unbiased account of Russian satellite countries and other areas which feel the impact of Soviet power.

\$3.00

the book goes into fascinating detail on the organization and operation of intense guerilla actions against the Japanese. Chapman writes with simplicity and directness, and in so quiet a key that a casual reader is apt to miss the significance of some of the most exciting episodes. His volume has justifiably been hailed both here and in England as a "terrific and thrilling book."

Quick Look at Near East

HATE, HOPE AND HIGH EXPLOSIVES. By George Fielding Eliot. Bobbs-Merrill, 274 pp. Index. \$2.75.

By Col Conrad Lanza

Between March and May, 1948, the author toured the east Mediterranean, stopping at 13 places in 11 countries. Including time of travel, which was mostly by air, he spent on an average 4¼ days at each stop. His mission was to report on the military strength of the states which he covered, and on the probability of military operations. What he learned was based on interviews and on observation.

Major Eliot represented an important New York paper and easily obtained interviews with statesmen. What they told him forms the most valuable part of his account. His observations of troops

who happened to be garrisoned near his short stops are limited in value.

Readers moderately familiar with the Near and Middle East and their problems will find nothing particularly new in this book. Some predictions of things to come have been shown by subsequent events to be accurate: for example, that the Arab League would be unable to defeat Israel. Others have been disproved — as his statement that the Greek Communists were declining in numbers and would soon be extinguished.

The eastern Mediterranean areas are certainly of great importance in the present troubled world. Major Eliot gives a good bird's-eye view for the unprofessional man, notwithstanding the space devoted to a lengthy and detailed account of the number and type of cocktails, etc., consumed on each and every day.

Broth-Spoiling a la Capitol

CONGRESS ON TRIAL. By James M. Burns. 211 pages plus bibliography and index. Harper & Brothers. \$3.00.

By Alan L Otten

This small volume examines a very big problem—is Congress capable of carrying out the majority will? Mr. Burns, associate professor of government at Williams, declares that due to the dependence of each Congressman on his own locality and state, Congress represents not the majority will but rather the will of various minority pressure groups. We don't really have two-party government in Congress, he says—on each issue, different pressure groups line up on different sides. Rule by pressure group is aided by such archaic Congressional customs as seniority, the power of the House Rules Committee, and the filibuster, plus an outmoded representational pattern which heavily favors the rural areas against the more populous urban centers. The author points up his thesis with the history of three bills—the wage-hour law, the O.P.A. act, and the bill to create a Missouri Valley Authority.

Congress—and therefore the various pressure groups—are also having more and more to say about running the executive branch of the government, through provisions in legislation,

through influence on personal selection, through the threat of investigations and through the control of the purse-string. In fact, Mr. Burns finds, the President and Congress are constantly fighting for control of the various executive agencies.

Quite rightly, Mr. Burns believes that the 1946 Reorganization Act failed of accomplishing any major reform, and that no matter how much Congress streamlines its organization and administration, it can never get around the basic evil of undue dependence on local, provincially minded voters. In the coming crisis, he believes, Congress will inevitably refuse to carry out the will of the majority, and the only hope is that they will not block the President completely or that the President can find some constitutional method of circumventing Congressional inaction or sabotage. Mr. Burns applauds the presidency as the present source of action and progress in our government, but fears giving the President any more power. He also, for various reasons, rejects any sort of stronger Cabinet government. The answer, he believes, is to revitalize the two-party system and make it meaningful by having absolute party discipline, similar to the British system. Then the parties would be more responsive to the party representing the majority. He favors frequent use of the purge, along with strict use of patronage and financial aid, to enforce party regularity, and believes that the party leadership should have an absolute veto on candidates and planks. He outlines various powers that would still remain to Congress—chiefly that of carrying on investigations, serving as a national forum, incubating legislation, and deciding issues that the party doesn't want to pass on.

Mr. Burns is aware of the serious dangers and problems inherent in his proposal. He doesn't expect his reforms to take place very soon, but believes that it is the only possible method of preserving our democracy. His solution is open to many criticisms, which we don't have the space to go into here, but it's an extremely timely and thought-provoking book, well-written with apt examples at every point, and conclusively proves that very good things can come in small packages.

BOOKS IN COLUMN

By MAJOR N. L. DRUMMOND, JR. FA

One of the most unusual and interesting war books is Edward Ellsberg's *No Banners, No Bugles* (Dodd, Mead — \$4.00). The author, former naval officer and expert on underwater operations, has long been equally noted for his remarkably vivid sea and submarine fiction. During our recent North African campaign he was in charge of salvage operations for the Mediterranean theater, fighting to save torpedoed ships at sea and clearing axis-wrecked ports so that desperately needed troops and supplies could reach the allied front-lines. His competent authority in telling the story of these operations was to be expected; it is surprising to find the high degree of human interest, humor and tense action which the book has. With little equipment and less time, Ellsberg and his salvage crews tackled harbors so choked by wrecks from combat or sabotage that axis experts were sure they could never be of use until Rommel had been able to knock out our undersupplied ground forces. This situation perfectly suited the peculiar American genius for mechanical improvisation and production miracles; during intervals between dodging German bombs and saving battered, burning ships at sea. Ellsberg had the harbors functioning on a victory schedule. Although objectivity often gives way to the author's intense personal feelings and viewpoints, his story brings alive a little known and important aspect of the North African campaign; in a wider sense it forms a tribute to so many who performed prodigious feats in every theater of war in supporting roles so necessary to those who had the banners and bugles.

Life under the Kremlin dictatorship—current favorite literary target—catches three more effective rounds this month. *Thirteen Who Fled* is edited by Louis Fischer (Harper—\$3.00), who recently interviewed several hundred Soviet political exiles in Germany and presents that he considered the most interesting and valuable of their individual accounts. These fragmentary tales are disjointed and contain little new fare, though they furnish an average citizen's indictment of the Russian regime. One description of a Red Army officer's career from non-com to Colonel will be of particular interest to any military reader. *Guests of the Kremlin* (Macmillan—\$3.00) by Lt. Col. Robert G. Emmens, one of five Doolittle raiders who were interned for over a year in Russia, recounts a unique wartime experience in rather prosaic manner. Their group, carefully treated but

completely controlled, was shunted in stages from eastern Siberia to the Persian border where they voluntarily worked in a Russian factory and finally escaped (it seems likely with concealed Kremlin connivance). This unusual sojourn revealed many glimpses of wartime conditions and people in the Soviet—few of them attractive. Boris Ilyin's novel *Green Boundary* (Houghton-Mifflin — \$3.00) is a very readable and effective story of a young American Army officer of White Russian parentage who works with a Joint Soviet-American commission in Germany after the war, falls in love with its attractive young Communist interpreter and becomes deeply involved with Soviet refugees. The author's own life duplicates his protagonist's background and this is evident in the sharp strokes and deft touches which give an unforced substance to his book. Thought nicely balances action in a clash of ideologies and individuals; this thoroughly believable piece of fiction highlights more effectively than factual accounts the human values behind Soviet-American tension and the tragic dilemma of those who love a country but hate its system of government.

Another kind of cold war is covered by *Red Flannels and Green Ice* (Random House—\$2.75). Arthur Pocock's light-fingered and heavy-mittened account of naval service among the isolated sub-arctic outposts of Greenland and the North Atlantic. The author's experiences battling icebergs, weather and boredom while supplying scattered Army detachments, are recounted with a ruggedly disillusioned humor which will appeal to any who served in the far northern latitudes or face the grim possibility of doing so in the future. It's all there—the empty frigid spaces, seven-day storms and fifty-day fogs, huts huddled in the mud, back at headquarters the 2×4 officers' club with three bedraggled nurses as queens for 3000 men, above all, the informal individualism and grim humor that made it livable.

A thoroughly sound and highly paced novel of espionage behind the German lines in the winter of 1944-45. *Call It Treason* (Viking — \$3.00) is furnished by George Howe on the basis of his experience with the OSS detachment of G-2, Seventh Army. The fact that this manuscript captured the Christophers Award for a novel "in accord with Christian principles" is enough to illustrate the author's achievement beyond mere spy chasing. Daily functioning of the cloak-and-dagger business forms an

CURRENT and CHOICE

MILITARY

- Global Mission**
By H. H. Arnold \$5.00
- Lincoln Finds a General**
By Kenneth P. Williams \$12.50
- No Banners, No Bugles**
By Edward Ellsberg \$4.00
- Guadalcanal: The First Offensive (U. S. Army in World War II)**
By John Miller, Jr., Hist. Div., Dept. of the Army \$4.00
- Okinawa: The Last Battle (U. S. Army in World War II)**
By Hist. Div., Dept. of the Army \$6.00
- Soviet Arms and Soviet Power**
By Gen. Augustin Guillaume \$3.50
- Strategic Air Power**
By Stefan Possony \$5.00
- Trial of General Yamoshita**
By A. Frank Reel \$4.00

NON-FICTION

- Roosevelt and the Russians**
By Edward R. Staffinius \$4.00
- State of Europe**
By Howard K. Smith \$3.75
- Their Finest Hour**
By Winston S. Churchill \$6.00
- Operation Survival**
By William Hessler \$3.00
- The Vital Center**
By Arthur Schlesinger, Jr. \$3.00
- Behind the Curtain**
By John Gunther \$3.00
- Congress on Trial**
By J. M. Burns \$3.00
- Karamojo Safari**
By W. D. M. Bell \$3.75
- The Conquest of Space**
By C. Bonestell and W. Ley \$3.95

FICTION

- Nineteen Eighty-Four**
By George Orwell \$3.00
- Day Without End**
By Van Van Praag \$3.00
- Call it Treason**
By George Howe \$3.00
- Point of No Return**
By J. P. Marquand \$3.50
- The Egyptian**
By Mika Waltari \$3.75
- The Track of the Cat**
By Walter Van Tilbury Clark \$3.50
- A Rage to Live**
By John O'Hara \$3.75
- The Blue Ice**
By Hammond Inne. \$2.50

**U. S. FIELD ARTILLERY ASSN.
1218 Connecticut Avenue
Washington 6, D. C.**

interesting and authentic background to the main action in which three men parachute into Germany on a mission. Each is impelled by a different basic desire — avarice, adventure, ideals. One returns. Their five-day campaign of violence, stealth and bluff vibrates with tension, deftly relieved by induced overtones of the reader's speculation on human motives and means.

If you missed some of the outstanding summer humor books, here is an autumn reminder. *Love in a Cold Climate* by Nancy Mitford (Random House — \$2.75) gambols gaily among and over the still extant English nobility and its fringe fauna. Her humor is for those gourmets who like theirs just slightly gamey, with a very sharp sauce. Edward Streeter's best-selling *Father of the Bride* (Simon & Schuster \$2.50) is a warmly hilarious account of our most popular contemporary rite of social sacrifice, from the viewpoint of the man who backs the whole proceeding, but from the far, hazy background. Another solid best-seller. *White Collar Zoo* (Doubleday — \$1.00) is Clare Barnes Jr.'s invaluable contribution to your next party or any occasion on which dull relatives drop in to be entertained. Barnes has combined provocative animal pictures with clever tag lines to duplicate uproariously the familiar human animals indigenous to the modern office. Should be seen by any who appreciate—but perhaps you don't like to laugh?

John O'Hara's first book in many years. *A Rage to Live* (Random House—\$3.75) is a slick piece of writing and a withering indictment of America's wealthy small-town society—easily extended along just slightly curving lines to take in metropolitan areas. The book's large scope suggests a serious attempt to illumine the inner heart of middle-class America, but here the rays are refracted by the polished surface. The "rage" is surely a tempest in a Haviland teapot.

The Egyptian by Finnish author Mika Waltari (Putnam—\$3.75) comes via a fine translation from tremendous success in Europe. Its reputation seems well justified. The author has woven his historical novel across a vast tapestry—the whole known world of the Egyptian Pharaohs over 1000 years before Christ. The book has copious quantities of every well known ingredient for historical novels, but with an alloy of wisdom which makes its bright metal ring solidly. The age was one of flux in many ways, with clash of human thought and faith (somewhat parallel to our own) and Waltari has splendidly brought alive its rich colors and rhythms. His main character, Sinuhe,

physician to the Pharaoh, crosses the threshold from fearful superstition to scientific inquiry and his crowded career winds lustily but always carefully observant through years of power and exile, court intrigues and far wanderings, madly sensual orgies and high intellectual adventure. In the era's climax, he and the "gentle" Pharaoh labored to establish one merciful god in place of the dark symbols of superstition controlled by the powerful priest cult and both went down—not ingloriously—before the savage reaction.

Perhaps one of our many troubles today is the one which bothered Alexander—no obvious material worlds to conquer. A writer, Willy Ley, and a painter, Chesley Bonestell—both men recognized as artistic satellites in the scientific fields of astronomy and rocket travel—present a cure in *The Conquest of Space* (Viking—\$3.95). Their book is a preview of man's next really great adventure: rocket travel to the moon and eventually to most members of the solar system. This seems sooner than you think. Both text and pictures seem carefully based (as stated) on the latest scientific research, with sufficient technical information to be valuable yet not too much for the interest and understanding of a layman. The author first treats current rocket capabilities, which he feels already require no *major* inventions for sending an unmanned spaceship to the moon; next, future developments which might take men there and back within our lifetime. Then he projects the reader on a complete solar flight for a closeup of what science already knows is there and speculation on the mysteries which can only be solved by the first actual trip. Forty-eight pages of illustrations (sixteen in full color) accompany the text, furnishing views on or near the surface of each planet. These range from merely striking to nearly magnificent, and they create a remarkably handsome volume.

The Big Eye by Max Ehrlich (Doubleday—\$2.50) is lightly enjoyable "science" fiction with an interesting theme. The world in 1960 is about to plunge into atomic war when a dramatic world conclave of astronomers announces the approach of a maverick planet which will shatter the earth in exactly two years and one month. This makes it unnecessary for men to blow themselves up, so the mobilized armies embrace and human life does some strenuous readjusting to this apparently divine solution. Visible doom draws closer each night; after early excesses, many former visionary and impractical ideas seem to take hold quite simply — disarmament, world government, even a general application of the Golden

Rule. On the last day, extinction is finally avoided and it seems possible that mankind would remember its lesson. Appropriate hero, heroine, and supporting types carry the action adequately.

The Blue Ice by Hammond Innes (Harper — \$2.50) is adventure-mystery of a high order, in which three strange men and a girl are gathered by various powerful motives on a small boat, ostensibly to search the Norwegian fjords for a thorite deposit of fabulous wealth. Two men represent rival metal cartels the third is really seeking vindication and revenge; the girl sees the mine only in terms of her lover, reported dead while hunting for it. Each distrusts the other and tensions flare into violence as they uncover evidence of murder and the trail of a mysterious fugitive leads into the mountains. Each tries separately to win the race across the wildest stretch of Norwegian crags, where two dramatic deaths resolve the mystery alongside the blue ice of a towering glacier. The story's swift pace and mounting tension is always credible, while perfectly set against the background of brooding fjords and snowswept mountain peaks.

For actual adventure in the opposite setting of equatorial Africa, *Karamojo Safari* by W. D. Bell (Harcourt, Brace—\$3.75) is a splendid tale of highly independent hunting and exploration some fifty years ago. The author, now a living legend in Africa, trekked alone into the Karamojo sector of east Africa when it was unknown territory. For five years he hunted elephants for ivory, killing an average of 30 per month, plus untold quantities of game to feed his bearers and local tribes. During that time he saw no other white man; his was the first white skin any native of the country had seen. His book is the story of that first safari, under conditions which could never occur again. In addition to its immense hunting lore and tense action. Bell's story is fascinating in its keen, understanding portrayal of the natives, with whom he lived from first to last as friend and blood brother.

The stirring saga of mankind's beginnings is colorfully presented by Charles R. Knight, noted artist-naturalist, in *Prehistoric Man: The Great Adventurer* (Appleton-Century-Crofts — \$5.00). It readable terms the author describes the modern discovery of various prehistoric races of humanity, graphically recreating their struggles and contributions to the slow evolution which led up to today. An engrossing and heartening tale, ably supplemented by twenty-one fine halftones and many line drawings.

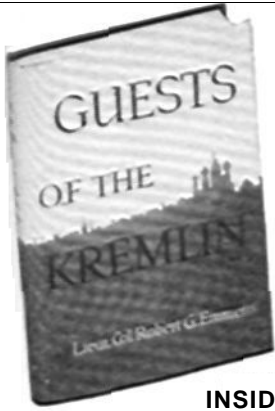

**INSIDE RUSSIA
WITH THE DOOLITTLE FLYERS!**

This is the first-hand story, by one of them, of the adventures of five Doolittle flyers who were forced down in Siberia after their famous raid on Tokyo. Interned by the Soviet government, they lived in various parts of Russia and escaped into Iran a year later. Here is communism in action, seen through the unjaundiced eyes of a typical young American.

\$3.00

GUESTS OF THE KREMLIN

By Licut. Col. Robert G. Emmens

**HELP
YOUR POCKETBOOK
YOUR LIBRARY
YOUR ASSOCIATION**

ORDER

**THESE TWO FINE BOOKS OR
ANY BOOK IN PRINT FROM
THE JOURNAL**

Best Book Service Obtainable

1. ALL BOOKS AT A DISCOUNT
You are not limited to a few selections as in most book clubs.
2. CONVENIENT AND QUICK

Buy all books through us — no shopping, no delays, no bills. All orders processed in one day.
3. SHIPMENT ANYWHERE
We ship directly from stock or publisher to any point on the globe.

**UNDERWATER OPERATIONS IN
SUPPORT OF OUR NORTH
AFRICAN CAMPAIGN**

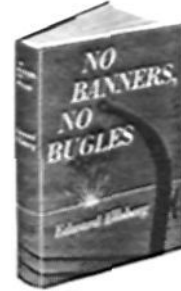

**NO BANNERS,
NO BUGLES**

By EDWARD ELLSBERG

Commander Ellsberg, noted as submarine expert and vivid writer, was in charge of all salvage operations for the Mediterranean Theater. This is his brilliant and dramatic account of that little known but essential part of amphibious warfare—where American technical genius put Axis-wrecked ports and ships back in action in record time.

\$4.00

ADDITIONAL ADVANTAGES: Books are always welcome gifts. We will ship your gift order directly to recipient, with your name on appropriate card. Advisory list of available books on any specified subject will gladly be prepared for you. Refer your book problems to us.

CLIP THIS COUPON FOR CONVENIENT ORDERING

**U. S. FIELD ARTILLERY ASSOCIATION
1218 Connecticut Avenue
Washington 6, D. C.**

**ORDERS OF \$2.50 OR MORE 10% DISCOUNT
ORDERS OF \$15.00 OR MORE 15% DISCOUNT**

ENCLOSED \$ _____ FOR THE FOLLOWING:

Name

Address

City

State