

The
FIELD ARTILLERY
Journal



IN THIS ISSUE:

Wedge and Kessel

NOVEMBER, 1941

A New Handbook for the FIELD ARTILLERY!

DRILL AND CEREMONIES FOR FIELD ARTILLERY

(COMPLETE)

Check the Table of Contents and see for yourself the completeness of this new and handy training manual for the Field Artilleryman. It is based upon and conforms to the latest training doctrines of the Army. We believe this to be the only single text in which the important subject of Dismounted Drill for the Field Artillery may be found in print today.

Nowhere else is all this information available under one cover. Every officer and soldier of Field Artillery should have a copy.



TABLE OF CONTENTS

DISMOUNTED DRILL

SERVICE OF THE PIECE

- Section 1. 75-mm Gun, M1897 (Horse-Drawn) and 77-mm Gun, 1897A4 (Truck-Drawn)
- Section 2. 155-mm Howitzer, M1918A1 (Truck-Drawn)

PISTOL

EQUITATION

THE MOTOR DRIVER

DRIVING AND DRAFT

MOUNTED FORMATIONS AND MANEUVERS

- Section 1. The Truck-Drawn Battery
- Section 2. The Horse-Drawn Battery
- Section 3. The Battalion, Regiment, and Brigade, Truck- and Horse-Drawn

STANDARDS AND GUIDONS

INTERIOR GUARD DUTY

CEREMONIES

INDIVIDUAL EQUIPMENT AND TENT PITCHING

MILITARY COURTESY, CUSTOMS OF THE SERVICE AND DISCIPLINE

Quantity orders: 10-24 copies, 10% discount, postpaid.
25 or more copies, 20% discount, F.O.B. Harrisburg, Pa.

PRICE \$1.00, POSTPAID

Order through

U. S. FIELD ARTILLERY ASSOCIATION

1624 H Street, N. W.

Washington, D. C.

MAJOR W. S. NYE, *Editor*
 LIEUT. HARVEY S. FORD,
Assistant Editor
 LENNA PEDIGO, *Business Manager*

The Field Artillery Journal

A Publication for the Field Artillery of the Army of the United States

FOR SEVERAL YEARS the motto of THE FIELD ARTILLERY JOURNAL has been, "THE FIELD ARTILLERY JOURNAL of today is the training regulations of tomorrow." This boast has just received striking support in that GHQ has "grabbed" the Handy and Burger opus currently running in the JOURNAL, and portions of it will be issued in a few weeks as part of a training manual. The JOURNAL, however, still expects to make reprints of this fine article available at a nominal price.

THE UNEXPECTED strength of Russian resistance to Hitler's war machine led many persons to ask, "Is the blitz on the fritz?" Furthermore, the paucity of clear and definite news as to what has been happening on the eastern front, the claim and counter-claim, the lack of an understandable pattern of campaign, has built up for many of us a picture of chaos. This confused concept of the Russo-German war actually coincided to a great extent with the situation itself. The spaces involved are vast, the numbers of men enormous. The battle zone is elastic and its limits are not sharply defined. Fighting has occurred not only at its forward edge but throughout its breadth and depth. Units acting semi-independently have conducted miniature blitzes of their own. In some cases the Germans have faced west and the Russians east. Within this moving zone dozens of battles of annihilation have taken place. But in spite of the apparent failure of assault units to dash madly ahead as they did in France, no stabilization set in. The blitz is definitely not on the fritz; but it has changed its outward aspect somewhat, and the Russians have used it as well as the Germans. The leading article in this issue tells briefly, yet clearly and authoritatively, how the war has changed in its tactical methods.

BEGINNING WITH the December issue, THE FIELD ARTILLERY JOURNAL will inclose a loose insert consisting of an attractive field artillery picture printed on a fine grade of paper and suitable for framing. Some of these will be reproductions of photos, others will be drawings or paintings. Each of these "bonuses" will be an attractive addition to your quarters, dayroom or office, and many of them will be sufficiently technical to serve for instructional purposes. These splendid pictures will be available only in the JOURNAL.

The United States Field Artillery Association

ORGANIZED JUNE 7, 1910

President

Major General Robert M. Danford

Vice-President

Brig. Gen. George R. Allin

Executive Council

Major General Robert M. Danford
 Brigadier General William H. Sands
 Brigadier General C. C. Haffner, Jr.
 Brigadier General John A. Crane
 Brigadier General Fred C. Wallace
 Lieutenant Colonel Ralph C. Bishop
 Lieutenant Colonel Edward S. Ott
 Major Thomas North
 Captain George L. Hart
 Secretary-Treasurer
 Major W. S. Nye

NOVEMBER, 1941—Vol. 31, No. 11

	PAGE
WEDGE AND KESSEL	810
ARTILLERY SUPPORT OF AN ARMORED DIVISION	818
<i>By Major Edward H. Metzger, FA.</i>	
IT MUST BE ARMORED!	821
<i>By Lieutenant Jean Dupont</i>	
ANTITANK ATTACK	830
<i>By Major D. S. Babcock, FA.</i>	
THE WAR IN NORTH AFRICA	834
HOW THE POLES FOUGHT IN FRANCE	841
<i>By Colonel Wlodzimierz Onacewicz</i>	
CRETE	848
<i>By Lieutenant Harvey S. Ford, FA.</i>	
HOW TO PRODUCE AN EFFICIENT FIRING BATTERY (Conclusion)	854
<i>By Majors H. F. Handy and V. F. Burger, FA.</i>	
ANTENNA MOUNTING	869
<i>By Major Stanley B. Bonner, FA.</i>	
WAR IN THE BALKANS	872
<i>By Colonel Conrad H. Lanza, FA.</i>	
NOT IN THE BOOK	885
CAMPAIGN OF FLANDERS, 1940, PART III	886
<i>By Captain Leo Framery</i>	
THE BATTERY COMMANDER (Conclusion)	895
ARTILLERY FIRE MARKING DURING SECOND-THIRD ARMY MANEUVERS	900
<i>By "Observer"</i>	
BOOK REVIEWS	902

Published monthly by the United States Field Artillery Association. Publication office 3110 Elm Avenue, Baltimore, Md. Business and editorial office. United States Field Artillery Association, 1624 H Street, N. W., Washington, D. C. Address all communications for publication to the Washington office. Entered as second class matter August 20, 1929, at the post office at Baltimore, Md. Copyright, 1941, by The United States Field Artillery Association. Subscription price \$3.00; Canada \$4.00; foreign \$3.50; single copies to subscribers, 25 cents; nonsubscribers, 35 cents. THE FIELD ARTILLERY JOURNAL pays for original articles accepted. It is published without expense to the government. Authors alone are responsible for statements made. *Addresses, and changes of rank, will be changed as frequently as desired, upon notification; not otherwise. Changes should reach the editor three weeks before date of next issue. Immediate notice should be given of any delay in the receipt of the magazine. Unsolicited manuscripts should be accompanied by return postage.*



Field Marshal Gerd von Runstedt, who is credited with the great "Kessel" of Kiev. Photo from European.

WEDGE

and

KESSEL



German tactics against the Russians

The outstanding characteristic of the German operations in the Campaign in the West during 1940 was the decisive role of the armored forces. At Sedan in May and again along the Aisne in June, Panzer divisions were hurled through the gaps that had been created by the combined action of the other arms. These armored forces, with the foot divisions following as rapidly as possible, pressed on relentlessly without regard to the safety of their own lines of communication until they either reached the English Channel or the Swiss border. The ruthless impetuosity of these daring tactics seemed to unnerve the French Army and caused its rapid collapse.

Successful as these tactics proved against the French, they do not appear so far to have been employed by the Germans in the Russian campaign. This is due in part to the vastness of the theater of operations but mainly to the number and quality of the Soviet troops in both training and equipment, which makes them stubborn and dangerous opponents. As a result, the Germans have found it impossible to take liberties with these adversaries whose unique morale causes each unit and each individual to fight to the death.

As a rule the German armored forces in Russia have advanced cautiously in a wedge-like formation, closely supported by the foot infantry divisions. In addition, the Air Force has rendered close support to the ground troops, seldom operating more than 200 miles behind the hostile front. This is shown diagrammatically below:

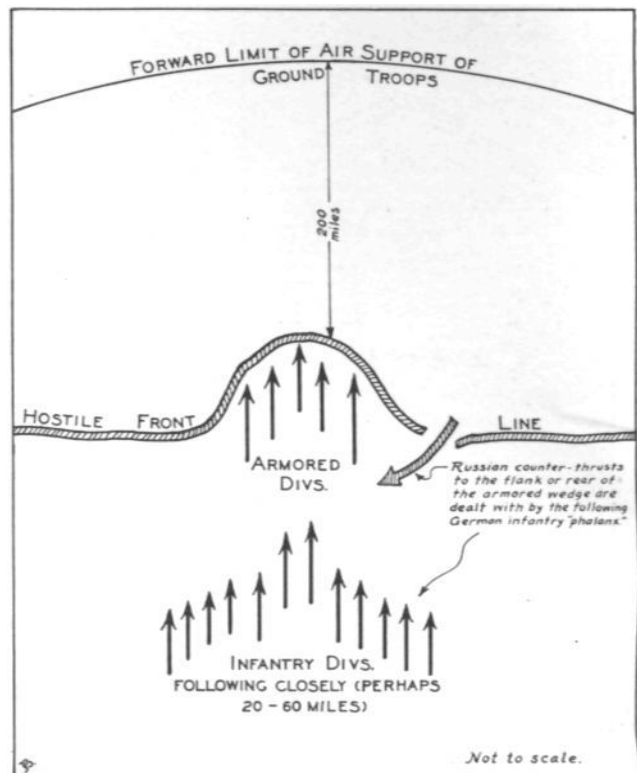

Figure 1

In this wedge formation, Russian forces that advance between or are by-passed by the armored divisions are dealt with by the advancing German infantry divisions.

The tactical result of the operations of these German armored wedges, closely supported by the infantry and aviation, has been the continuous breaking off and surrounding of portions of the Russian forces. This

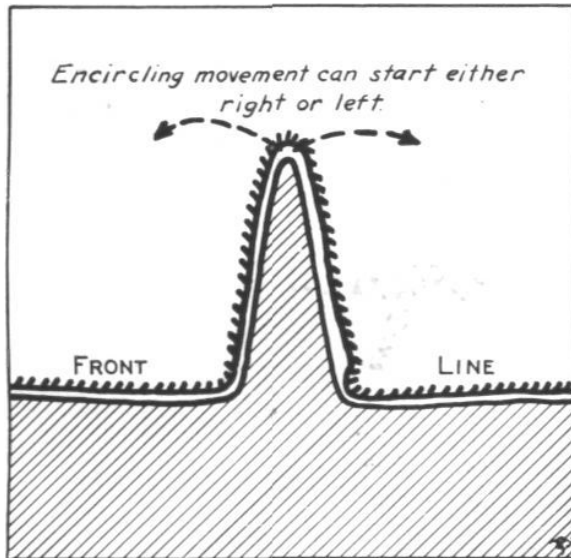

Figure 2(1)—The WEDGE is the start of the Kessel.

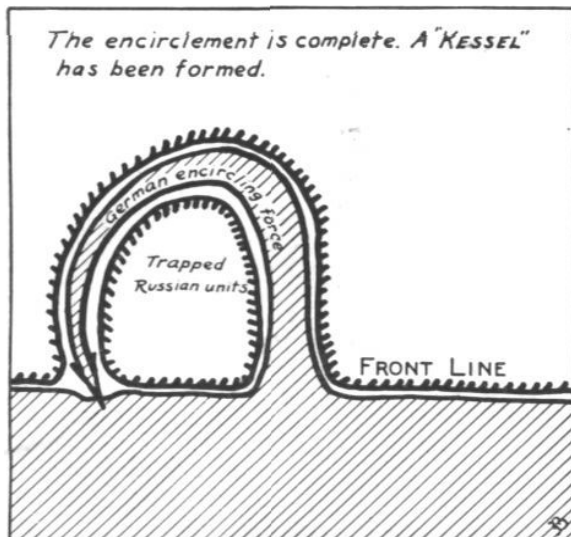

Figure 2 (2)—According to standard military doctrine, a breakthrough should be exploited by strong following forces who plunge headlong toward the hostile general reserves or toward areas of vital strategic importance. Also there may be a general fanning out in the open country in rear of the front. This could not be done in Russia. The so-called "open country" was full of Red units bent on counter-attack. Hence we see the Germans adopting a NEW STYLE OF WARFARE in which the breakthrough force doubles back on itself. In so doing it completes an encirclement of a local portion of the enemy; repeated time and again this process destroys the enemy more or less in place, without the necessity of strategically deep and risky advances.

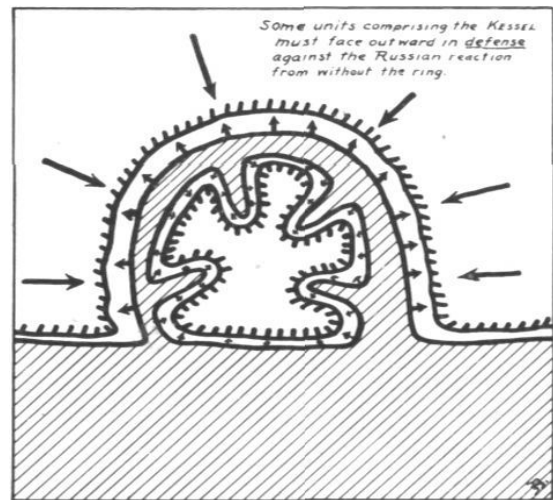

Figure 2 (3)—Sub-wedging the Kessel. The German forces facing inward act offensively while at their backs are others acting defensively.

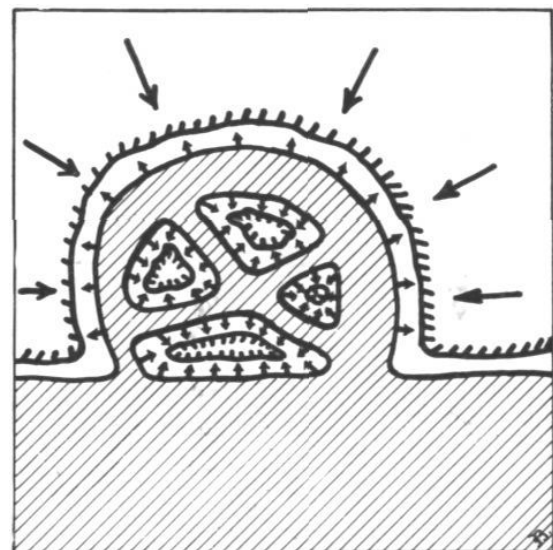

Figure 2(4)—The Kill. Sub-Kessels and final driving-in operations. The U. S. press seems to have failed to grasp the significance of "Kessel." It has been miscalled "Kettle."

encirclement of hostile forces is called by the Germans a *Kessel*. This is derived from a German hunting term *Kesseljagen*, in which the game, having been encircled, is driven in from all sides toward the center for the kill.

In case the *Kessel* is very large it is broken up into smaller areas by the armored forces.

Thus the two great concepts of the *wedge* and *Kessel* stand out as characteristic of the German operations in the East. The strategical plan of the two tremendous encirclement battles of Smolensk and Kiev were based on the successful carrying out of these two tactical operations.

An official report of the German High Command describes the battle of Smolensk as follows:



A tank trap constructed at a cost of immense labor by thousands of Russian peasants has been dug hastily across the vast steppes to stop the German Panzers. What happened? The German motorized infantry came up under cover of darkness, took refuge in the ditch, tore down ramps for the tanks to use, meanwhile reducing isolated redoubts by their usual storm-troop methods.



The beginning of the wedge. The vanguard of the armored spear head has passed the Russian tank traps and now moves swiftly and in open order through the flat Russian countryside. (Dever from Black Star.)



The encirclement begins. Motorized columns pour into the wedge. Resistance has been met, but the advance continues relentlessly. The formation of a Kessel, and its maintenance under hostile reaction from within and without the ring, is a hazardous operation. As a single example of the tactical and technical problems involved, consider the artillery. In which direction should each unit face? How is one to avoid shooting on across the Kessel into one's own troops? Photos by European.



The heavy infantry phalanx comes up to support the armored spearhead. Here we see a modern battlefield in which the German infantry is advancing in typical deployed formation through the Russian grain fields of the Ukraine. The tracks of two tanks may be seen crossing the field. The successful use of wedge and Kessel tactics implies the availability of masses of foot infantry who can make daily marches of 25-35 miles per day, for days on end.

Sketches 1-5 show graphically how the wedge and Kessel method was applied in the war in Russia. The successive pictures show how these encirclement operations were conducted in the great battles of Smolensk and Kiev. Illustrated also are the beginnings of the drives in the direction of Moscow and the Donets basin, both of which were developing rapidly as this issue went to press.

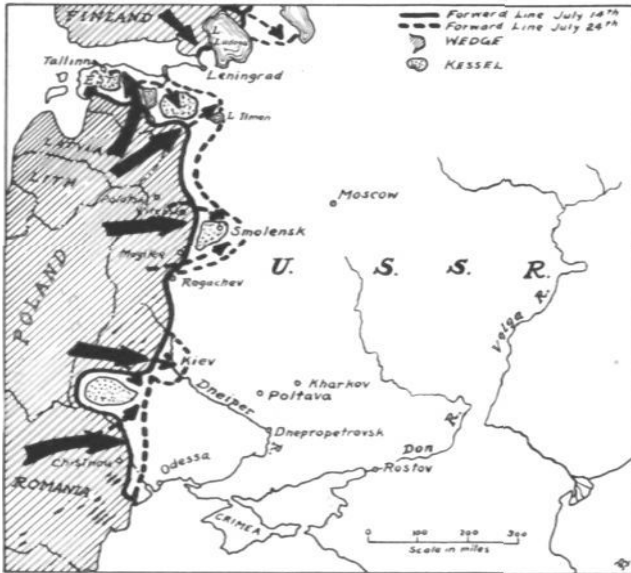

Sketch 1—Here, on a grand scale, are three major Kessels in process of being formed. In the north the Soviet forces in the Balkan States are being pinched off. In the center is the annihilation battle near Smolensk, and in the south, great groups of Reds are being surrounded in the western Ukraine. Within the scope of these major operations are many smaller wedge and Kessels, not shown hereon.

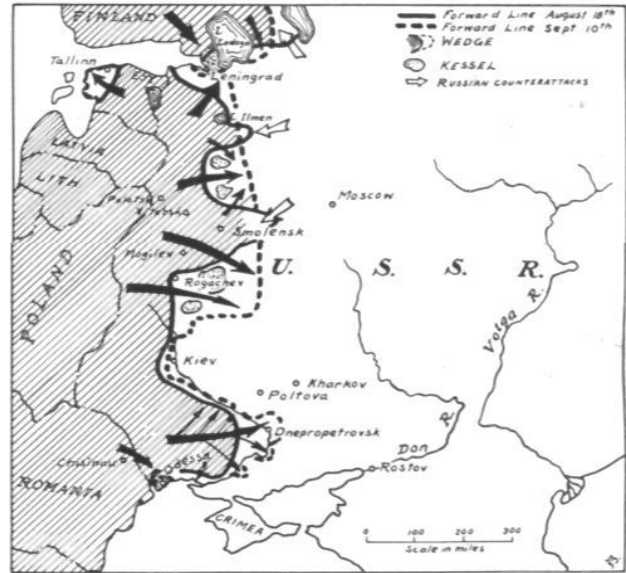

Sketch 3—A strategic operation which is to result in the fall of Kiev and the Crimea is developing here.

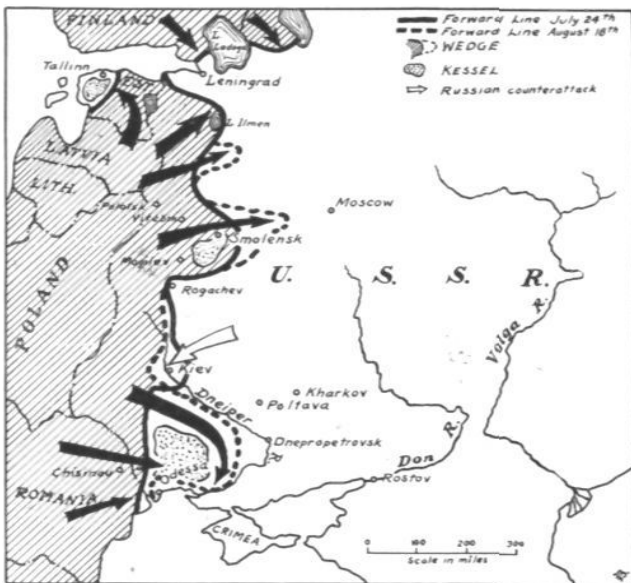

Sketch 2—The encirclement of Leningrad is beginning to show form in the north. In the center is another German wedge directed toward Moscow, which on this first attempt met effective resistance. In the south, Odessa is encircled, and Kiev passed temporarily (here the Germans were at one stage thrown back by a Russian counter-drive).



Sketch 4—The vast Kessel of Kiev and Crimea is completed, with its huge booty in prisoners and materiel.

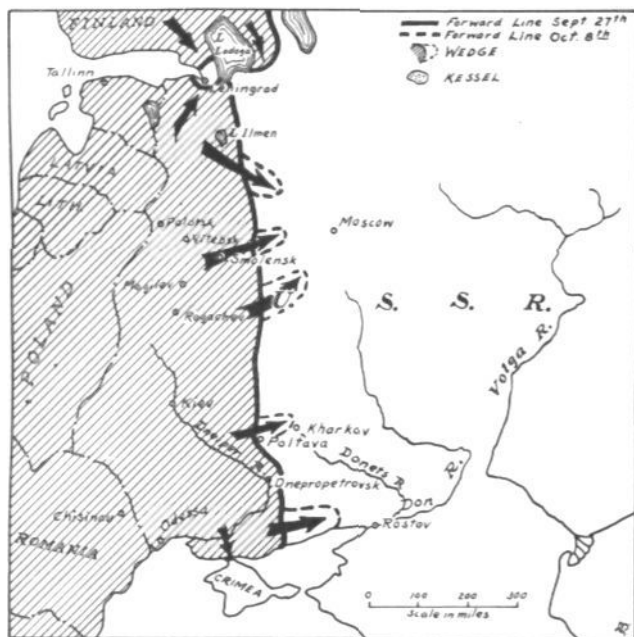

Sketch 5—With scarcely a pause, the Germans continue driving wedges towards the Donets basin and Moscow. Leningrad has not fallen, but is completely cut off, as is Crimea. The gigantic Russian military machine is being slowly ground to mincemeat in major and minor battles of annihilation, no two of which follow the same tactical pattern.

"During the breakthrough to the east and northeast of Smolensk by Panzer and motorized infantry divisions, the foot infantry divisions, in spite of the heaviest counterattacks, covered the flanks of the armored shock wedge, which was attacked time and again by the enemy, and carried out the encirclement of the enemy forces which had been broken through by the armored units. As a result, a mighty battle occurred in the general area: Polotsk, Vitebsk, Smolensk and Mogilev—an area 250 km. wide and 150 km. deep. In almost four weeks of fighting the Soviet forces sought to regain their freedom, fighting with the courage of desperation and suffering enormous losses, while new troops were thrown into the battle to relieve them. All these attempts failed due to the flexibility and tenacity of the German troops."

The form of the battle of Smolensk is typical of all the operations in the East and is indicative of the predominant part played by the two great concepts *wedge* and *Kessel*. From the first day of fighting and continuing throughout the operations Panzer wedges were a prominent feature, thrusting themselves deep into the enemy front and making a breach. These shock wedges executed their breakthrough operations with extraordinary boldness, often with flanks uncovered and the enemy on the right, on the left, in front and to the rear, where the Russians would again assemble after the passing of the wedge.

These wedges were a necessary preliminary for the *Kessel* operations in that they formed the wall separating the parts of the Soviet front and divided the Reds into groups.

These wedges of armored and motorized troops were widened and covered by the infantry divisions so that the German infantry had to make almost incredible marches in order to keep up with the Panzer formations and be able to cover the flanks of the shock wedge and carry out the encirclement and destruction of the Russian groups that were cut off.

So in this great battle of Smolensk there were many combat centers; the manifold nature of the separate operations was confusing even to the German troops who were not acquainted with the operation as a whole. The vast battlefield was broken up into numerous strong points of resistance and encircled areas of greater or less size in which the Russians were destroyed. These encirclement operations were carried out as a rule in the following manner: After splitting off an enemy group the shock wedge would then swing to the right or to the left and by quick turns cut out a sector from the enemy front, then with extraordinary rapidity, before the enemy realized it, the encirclement would be completed.

Often enough the Russians tried to save the situation by attacking the wedge on the flanks and trying to break through the German encircling movement. They also attacked the encircling forces from the rear and attempted to carry out encircling operations of their own. So at times there were situations when the location of the front was known only to the German High Command, while the individual soldier had the impression that the front was everywhere—in front, behind and to the right and to the left.

Due to the tenacity of the Russian defense and the way their troops preferred to fight and die rather than to surrender, every encircled area became a bloody battlefield. If it is remembered that the Russians are very skilled in the construction of field works, that they are masters of camouflage and know how to exploit to the full the possibilities of every terrain feature, then it can be understood that the desperate masses in the encircled areas utilized the areas for defense in a manner that was most effective. Every village, every house, every wall, every strong point was utilized, and natural obstacles were also used in the defense and their organization completed by barriers. So then every *Kessel* was a fortified area in which there were not only considerable masses of men for defense but also large quantities of arms and materiel.

The German troops, having completed an encirclement operation, often had to use considerable forces in cleaning up the fortified area. In these *Kessels*, the Russians were like game driven together trying to break out in all possible directions. At one encircled area, where the Soviets made a particularly desperate attempt to break out, the Germans claimed that only three hundred Russians were captured while two thousand were killed. This gives an idea of the fierce resistance offered by the trapped masses. If it is kept in mind that in the great encirclement battles of Smolensk or Kiev the fighting



The war in Russia involves a complexity and multiplicity of individual battles fought under conditions wherein individual commanders must operate on their own initiative. Unless complete chaos is to result, the high command must exercise some sort of control. The Germans accomplish this through the lavish use of radio combined with highly trained motorcycle messengers. Here, in the Ukraine wheat fields, we see a German short wave radio station receiving orders from the higher command echelon, with motorcyclists waiting to distribute them to the lower units. This is an important feature of the wedge and Kessel pattern.

was raging simultaneously in many of such encircled areas, then one can realize the effectiveness and the destructive power of such operations when both sides use enormous masses of men and materiel. The narrowing of the encircled area is the final stage in the strategy of encirclement and destruction, which was executed with such extraordinary success by the German command in the East, and which aims not only to defeat and drive back the giant masses of the Soviet armies, but to surround and destroy them.

It goes without saying that the employment of this system of wedge and Kessel operations demands troop leadership of the highest quality and one that can act with lightning like rapidity. In addition, the training and battle power of the troops involved must be developed to the highest degree. Subordinate commanders are often "on their own" for days at a time. Even when they are completely surrounded by superior forces (as happened frequently to units comprising the German wedges), the individual commanders must retain full faith that the eventual working out of the general plan will liberate them.

This wedge and Kessel is thus an interesting *variation*—not an abandonment—of the blitz, and shows that the Germans must be expected to employ a "change of pace" in conformity with each new theater of operations and new opponent.

For us the lesson is that we must look ahead, employ the utmost in vision based on solid realities, and devise our own tactical concepts to fit such theaters of operations and such opponents as we may expect to encounter.



Difficulties of supply. Here an obsolete light tank is being used to bring up gasoline. The deep mud in the country roads, and the heavy fall rains, have prevented the motorized columns from moving as fast as they did in France. Photo from European.



A fine view of the closing in on a Kessel. Artillery forward observers have brought down an intense artillery concentration on the Russian masses trapped within the encirclement. The widespread use of large quantities of field artillery by the Germans on the Russian front should completely settle the doubts and questions of those in this country who recently have felt that artillery has been superseded by dive bombers. (Dever from Black Star.)

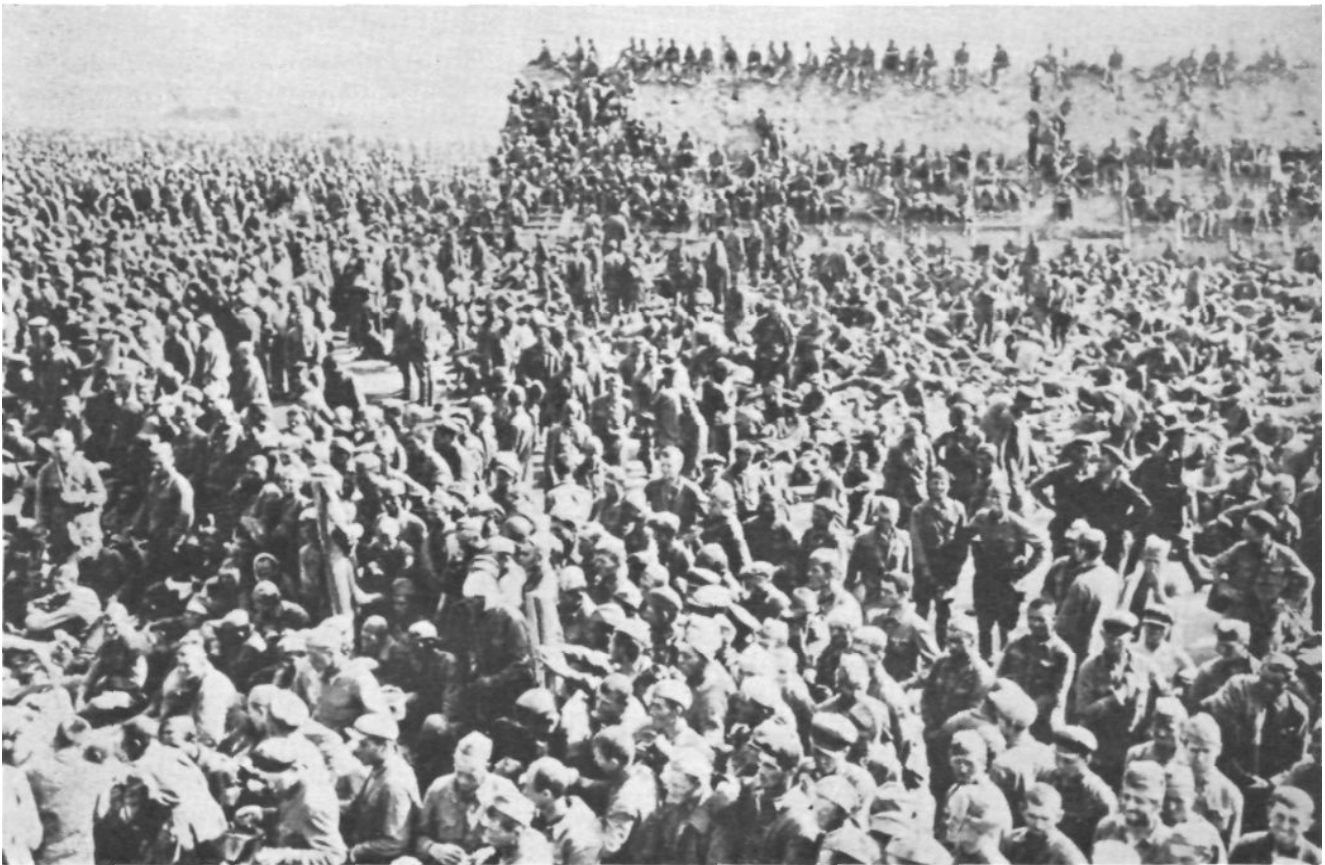

The final act in the Kessel. Here is part of the bag in Russian prisoners taken in one of the encircling operations near Uman (Acme Photo).



NOWADAYS much is being said by artillerymen and others as to the efficiency and desirability of field artillery in an armored division.

Particularly critical are large numbers of field artillery officers who through years have been associated with the problems of survey methods, computation of meteorological data and precision methods of conduct of fire. To them, field artillery support of a rapidly moving attack (except in the initial stages) appears impossible.

Intelligence reports, data on organization and articles on the campaigns in Europe to date all indicate that direct field artillery support was effectively rendered by units within the armored division in the German Army and that both the British and German Armies consider such support necessary is shown by their present organizations.

ORGANIZATION

The present organization of the field artillery in our armored divisions is a regiment of four six-gun batteries under one headquarters battery and a separate battalion consisting of three four-gun batteries and an eight-gun antitank battery.

The regiment is a part of the armored brigade consisting of the three tank regiments (two light and one medium) which is called the striking echelon. Almost from the beginning it was recognized that a battalion organization was desirable in this unit, and in both the 1st and 2nd Armored Divisions a provisional organization of two battalions was used for tactical exercises.

The battalion, except for the antitank battery, is organized similarly to the separate battalions of the triangular division and is a part of the support echelon. It normally operates with the infantry regiment (armored) as a combat team. The antitank battery is used primarily for protection of the support and service echelons.

A division artillery officer (with no command function) with a small artillery section is at division headquarters as artillery adviser and special staff officer.

It became apparent in the early training exercises of the division (as had already been demonstrated in the triangular divisions) that there was a need for some definite means of control and coordination of all the field artillery. In many instances there was also a need for using at least three battalions of artillery in support of the striking or tank echelons. Many operations of the infantry regiment, including the forcing of river crossings, establishment of a bridgehead, or holding ground already gained by the tanks from counterattacks, called for support of all the artillery. In operations with other divisions the need for coordination and centralized control was found necessary.

In view of the above, practically all the field artillery officers and most of the senior officers of the armored

Artillery Support of an Armored Division

By Major Edward H. Metzger, FA

divisions recognized the demand for a reorganization of the field artillery. However, War Department orders, in regard to freezing of changes in organization until October 1st, have delayed this reorganization. The consensus of opinion is that three or four battalions of artillery are the minimum, that one of these battalions, in addition to being capable of rendering artillery support, must be the antitank battalion. Many believe that this antitank battalion if properly equipped could very well be a dual-purpose antiaircraft and antitank battalion.

There are some differences of opinion in regard to the formation of three artillery battalions into a regiment, or as separate battalions with a Division Artillery Commander. The advantages of the separate battalions over a regimental organization far outweigh any disadvantages. It is particularly desirable that the organization follow along the lines of our present triangular and motorized divisions; a time may come when some of these divisions may become armored divisions. (Certainly such a plan would result in quicker combat efficiency than the continued process of dividing our present armored divisions.) In any event, the artillery headquarters, be it division or regiment, must be small.

The battalions should be organized similarly to the separate battalions of the triangular division, a headquarters battery, three four-gun (105-mm. howitzer) batteries and a service and ammunition battery. In making up detailed tables of organization it is surprising how nearly the totals of officers and men (even with the additions required for radio operators and machine gunners)

agreed with those of the triangular division artillery.

Recognizing that only through actual practice can the efficiency of any organization be tested, the division commander of the 2nd Armored Division authorized the organization of the field artillery of his division (for tactical purposes) into four separate battalions under the command of the Division Artillery Officer. This provisional organization was accomplished in April and used during the Second Army maneuvers of this summer. The artillery regiment operated as two separate battalions (the regimental headquarters functioned only in administrative matters not connected with combat). The artillery battalion with its three firing batteries was organized as one battalion and the antitank battery with some attachments from the remainder of the battalion, was organized to operate as a two four-gun-battery field artillery battalion, or for antitank purposes.

The artillery commander was able to control and coordinate all the artillery through a small detachment of three officers and twenty enlisted men. A command and operations section of one officer (Exec. and S-3) and six enlisted men was provided at the division command post.

A liaison officer and detail who remained at all times with the tank brigade commander (striking echelon) acted for the artillery commander and could call direct on artillery battalion commanders for fire support. When the infantry regiment was supported by two or more battalions, a liaison officer was detailed with that commander.

A reconnaissance officer operated with the division reconnaissance battalion; he kept the artillery commander and battalion commanders informed of the situation at the front, and performed any necessary reconnaissance missions. No attempt was made for this officer to select battery positions, as this can best be done by the battalions and battery commanders and staffs.

As previously stated, the division artillery headquarters organization should be as small and as mobile as possible. In comparing the needs of this organization with that of the Division Artillery Headquarters in the triangular division, there is no need for survey, meteorological or wire sections. With the small number of enlisted men involved and the wide separation of the various sections in combat, their attachment to the headquarters with which operating in the field would be desirable for administrative purposes, thereby eliminating the additional administrative overhead. In garrison, this detachment should be attached to one of the artillery units.

TACTICAL OPERATION

The armored division operates in two to four combat groupings, these groupings following no particular organization except that the tank or infantry regiment is normally the command headquarters of any grouping. The normal artillery support of such a grouping is the battalion. In march columns prior to contact, all batteries of the

battalion march at the head of the main body with one battery well forward in the advance guard. The general principle is that the artillery is always well to the front. When contact is imminent or when artillery support is expected or desired, the battalion commander places one or more batteries in position and, as the movement continues, displaces the batteries of his battalion by leap-frogging action, keeping the maximum amount of guns possible in position, but always well advanced. The artillery must move forward with the attack. This may violate the principle that guns on the road are of no use, but artillery that waits until the tank attack reaches the limits of its range will soon be lost, and difficulties of communication and control will be increased. It must be kept in mind that when the tanks are moving there is little need for the artillery. When the tanks are held up, it is essential and must be in position well forward.

At times the combat grouping which the battalion is supporting will be divided into smaller units and there will be a desire by some commanders to divide the artillery into separate batteries or even individual guns. Although such an employment of artillery may be necessary at times, it is generally faulty; artillery commanders in all echelons should recommend against such employment. The following paragraph of a report to a division commander in this connection will illustrate:

"It is not believed that all column commanders fully understand the use of the artillery supporting battalions. Instances were noted in which column commanders split batteries to make single antitank guns available. In another case, the column commander desired to split battalions into separate batteries. Although such an employment of artillery may be necessary at times, it is generally unsound and will result in a lack of sufficient artillery fire when it is critically needed. It should be made clear to column commanders that the artillery is assigned to their columns as supporting, not as attached, battalions. The details of the support should be left to the artillery battalion commander."

Though at times batteries of a particular battalion may be several miles apart, it is believed that any operation of a combat grouping, to which an artillery battalion is assigned to support, will not be so widely deployed as to prevent mutual support by all batteries. In advocating the control of artillery support by battalion, do not give the false impression that the batteries of the battalion will displace in echelon from one general battalion area to another, but rather that battery positions will be echeloned in considerable depth and in many instances will be dispersed laterally.

Displacement is normally controlled by the battalion commander, who keeps in touch with the situation through his liaison officer with the supported combat grouping; and also by actually roving the battlefield, keeping in personal touch with the situation. He normally does not remain at his command post, but communicates

with his batteries through the radio in his command vehicle. Battery commanders should be authorized to order displacement of their batteries when such becomes necessary.

FIRE SUPPORT

There is some belief that a large proportion of the artillery fires in support of an armored unit will consist of direct fire. This conception is erroneous, except when the position of the battery itself is attacked. Artillery fires are promptly delivered by keeping a large number of reconnaissance officers and observers well forward in tanks and armored scout cars (or in half-tracks with each echelon of the tank unit in the attack), and by radio through the battalion fire-direction center or direct to the firing batteries. The fire-direction center can operate while moving. In a rapidly moving attack it will assign the battery to fire a particular mission; thereafter, commands are direct to battery. The normal method of conduct of fire will be by forward observer using air-observation methods. The difficulty of obtaining an opening round in the observing area is at once apparent to any artilleryman, and this problem has been given a great deal of thought by many of the field artillery officers with the armored divisions. The following are some of the simple and rapid methods of obtaining initial data. There are others, but any method must be simple and rapid, as time and conditions do not permit the use of deliberate methods.

a. For use when any map is available. This method is sufficiently accurate with maps of scale 1/125000. Designate location of target on map from previously designated reference point, or from any point on map, direct to battery. Battery should always plot its approximate position on map from nearest crossroad or other convenient point on map. The initial data can be given to guns within two minutes.

b. When no maps are available. (1) By use of ground signals fired from projectors by forward observer, battery laying on rocket for direction and range. At present, no reliable means of obtaining a correct range has been devised. With experienced operators and under favorable conditions, very good results have been obtained with the range finder.

(2) By firing a high burst on a designated compass direction, and using an estimated range.

COMMUNICATIONS

The primary means of communication is radio, supplemented by motorcycle messenger or officer liaison. Direct wire lines are laid if the situation permits. The artillery commander's radio is in the division command net. The artillery command net includes the four battalions, liaison officer with the brigade, and the division artillery reconnaissance officer.

The battalion command nets include the firing batteries, ammunition train and the battalion liaison officer. Fire-direction and fire-control nets include the battalion fire-direction center, firing batteries, battalion and battery observers and reconnaissance officers. There are several plans of fire direction and fire control nets but each battalion has at least three of these nets. Each battalion has one air-ground net.

AIR OBSERVATION

The use of at least one air observer with each battalion is *essential*. It is hoped that in combat they will be available. The use of the civilian-type plane, capable of landing in small fields, may be the answer to a field artilleryman's prayer. It is hoped that experiments to be carried out during the maneuvers will convince those in authority of their value to us.

CONCLUSION

In conclusion, artillery support can and will be given to the armored divisions through aggressive leadership of the field artillery battalions, by keeping the guns well forward, maintaining at all times the eyes (observers) of the battalion and its batteries with the leading and flank tank elements on the battle front, and by reliable and constant radio communication.

In battle the casualties of armored artillery will be greater than the artillery with less mobile units. But the armored artillery travels in armored vehicles, is equipped with a powerful amount of armament and can put up a pretty good fight of its own. During the Tennessee maneuvers an armored artillery battery routed an infantry battalion in a hand-to-hand conflict.

ANNOUNCEMENTS

Don't forget to send in your proxy cards! These are urgently needed to establish a quorum at the annual meeting in December.

* * * * *

For some time it has been customary to publish a station list of officers in the December issue. We had planned to do so this year. However, we discovered that we should have begun this work several months ago. Last year the process of compilation, checking, and proofing required three months. This year we have five times as many names; so you can figure out when we should have started. Sorry, but the whole thing is quite out of question.



European

"One of the most hideous sights of this war was the spectacle of the French 75-mm. guns, in the open fields, surrounded by their dead and wounded crews." Above is an antitank gun (not a 75), which was attacked by a German tank. The narrow, thin shield was no protection to the gunners, who lie dead behind the piece.

IT MUST BE ARMORED!

EDITOR'S NOTE: *Lieut. Dupont described, in the August issue of THE FIELD ARTILLERY JOURNAL, his experiences fighting German tanks in France during 1940. He has arrived at some very definite conclusions as to means and ways to stop the armored attack. The following article points out, very aptly, that self-propelled tank chasers are fine, but do not provide the complete answer. There are always AREAS which must be made "tank proof" by use of emplaced guns, especially light field guns. Based on the experience of himself and others, Lt. Dupont offers a reasonable solution which should be given immediate consideration.*

NECESSITY OF A GUN

One read in the newspapers during the Finnish war that an effective way to stop a tank was to jump on it, open its trap door, and shoot its occupants with a pistol. Need I say that this is sheer fantasy?

Even close defense with grenades or bars slipped into the tracks or gasoline bottles thrown flaming is quite ineffective. Although we in the French Army had received instructions to use any of these methods, we were never able to employ them. True, it is easy for men, if they are at a certain distance from the tanks, to escape from their fire, but it is very difficult *to approach* closely.

By Lieutenant Jean Dupont, (formerly French Army)



International

The French used the unmodified French "75" in a desperate attempt to stop the German heavy tanks. The gun had sufficient power, but lacked flexibility of fire, and its small, thin shield afforded no protection to the personnel.

Only when the tanks are isolated or stalled in places where the ground is impassable or where an unobserved approach would be possible have attacks by grenades or similar weapons any chance of success. An example might be where an isolated tank is stuck in a ravine or in a narrow village street. But these cases were rare in 1940 because the German tanks moved in groups and carefully avoided localities where the field of view was limited.¹

More expensive devices like land mines and barriers do not appear very efficient, either; and by no means can one rely upon them in a war of movement.

For all these reasons most experienced military men agree that *to actually stop a tank, one must destroy it, and in order to destroy it one must use a gun.*

THE 75 AS AN ANTITANK GUN ON THE FRENCH BATTLEFIELDS

This was especially true in the Battle of France. The 75, particularly, proved to be efficient against tanks because of its flat trajectory, the high initial velocity of its projectile, and its favorable rate of fire. But, unfortunately, this gun is very vulnerable and cannot be turned around quickly enough to face a foe trying to circle it. So the fight between the 75-mm. and the tanks was tragically uneven; and, too often, after having fired a few shots its entire crew was wiped out. On the Somme the spectacle of the French 75-mm. guns in open fields surrounded by their dead and wounded crews was one of the most hideous of the war.

¹I must mention, however, that once at Pantin we saw German tanks in such places. They were effectively running in narrow streets, but at the same time they were accompanied by numerous men afoot. Under our fire these men fell back and the tanks also turned back quickly.

Early in the campaign of France, it became obvious (1) that the onslaught of the tanks was responsible for the cracking of the allied front (2) that the 75-mm., in its actual form, was inadequate. Therefore, the question arose as to how to improve the efficiency of the 75-mm. against tanks. A solution was all the more necessary because many 75-mm., obsolete as field guns, were replaced by long-range 105's and were therefore available for specific antitank action.

EXPOSITION OF THE PROBLEM

The problem was studied in particular by the artillery officers, engineers in civilian life, because it presented an industrial side as well as a military side. In order to arrive

at a correct solution, it is necessary to understand the main concepts:

1. To determine exactly the unsatisfactory features of the 75-mm. gun.
2. The modifications or additional devices must be easy and quick to manufacture by tools immediately available.
3. All their characteristics must be worked out closely according to the manner in which the panzer operates.

HOW THE TANKS OPERATE

It has often been described how the waves of tanks cracked the front line, surrounded the centers of resistance, destroyed the defending automatic weapons and opened the way to storm troops, while other tanks plunged deep into the defensive organization, destroying the batteries, blocking the roads and wrecking long lines of trucks. Wandering in the fields in groups of ten, twenty and more, tanks of different sizes (very likely in communication by radio) proceeded always in the same manner to storm the nests of resistance they happened to meet, the 75-mm. guns in particular. Locating the gun first, they would circle it, trying to find a *blind angle* or attacking from the rear and subjecting it, at a short distance, to a heavy fire of machine guns, semiautomatic 37's and even 88's.

LAND TORPEDO BOAT

In order to check the mobility of the tanks and their great swiftness of penetration, the U. S. Army, as is reported by the newspapers, plans to use numerous antitank weapons, *self-propelled*, slightly armored and consequently

very light, which would rush to the places where the panzers have cracked through, and would catch up with the tanks and harass them. Being in great numbers, these chasers could have numerical superiority. Being very fast, they could fire and flee, taking advantage of their speed to dodge the blows which the tanks wouldn't be long in returning.

This method seems to me extremely clever; against the "battleships of the land" (which the tanks are) the U. S. Army would use swarms of "destroyers" which would harass them, sink them, and then run off.

STATIC DEFENSE AS A COMPLEMENT TO AN ACTIVE DEFENSE

This hit-and-run defense is an active defense but a mobile defense like the above is not, by itself, sufficient. It must be completed by a static defense. In any war, indeed, even in the fastest war of movement, there are always definite locations which must be defended and the defense of which will be more or less static. For instance, cities, places of forced passage as bridgeheads, passes, important lanes of supply, centers of resistance, batteries, headquarters—all these have to be held against tanks at any cost. The guns which defend them cannot move as if in open field. The fight soon boils down to a kind of duel in which the gun struggles without moving and cannot fight otherwise.²

²Whereas a great tactical mobility is not so necessary because of the manner in which the gun is forced to fight, on the other hand a great strategic mobility is desirable in order that the gun be rushed to areas where needed.



German tanks in Norway were able to move readily through the defiles because no cannon were emplaced there to stop them.

One of the adversaries, the tank, tries to force its way to a definite spot. The gun tries to prevent it. At that point a great *tactical* mobility does not help the gun any, but its lack of protection handicaps it dreadfully.

In this struggle between a tank and a gun, often less than a hundred yards apart, the tank has a cupola which offers protection against a hit of a 47 or even a 75. The tank also is armed with a 47 or an 88, as well as with machine guns. Thus its opponent, the 75, must have an armor thick enough to withstand a direct hit of 47 or 88. *The thickness of the armor makes all the difference.* If it is less than a certain limit (7-cm. was considered as correct) it cannot "take it." The 75 will lose. If its protection is thicker, the 75 *can* take it, and has a good chance to win.

Let us not forget that the 75-mm., aside from its antitank action, has its other normal missions to perform: barrage and support of infantry. As a rule, this cannot be accomplished except by indirect fire, which requires that the gun be set in place.

PROTECTION OF THE ARTILLERYMEN

Let us examine more closely the question of protection. The infantryman has to protect himself mainly against bullets, shells and bombs; taking advantage of the fact that the course of the bullets is almost straight, he hides himself in holes or trenches. This protection is also effective against splinters from bombs or shells of which the course, at least in its early part, is also straight.



This tank, halted at a barrier in the woods, fell easy prey to an artillery piece which had been emplaced to protect the defile. The gun can always stop the tank, provided it and its crew are given adequate protection.

Even in the fastest war of movement there are places such as centers of resistance, bridgeheads, artillery areas, passes, forest roads, shores, cities, headquarters, supply depots., etc., which must be defended against tanks. There the gun in charge of the defense cannot move. The tank tries to force its way. The gun tries to burl it back. Heavy armor and fire power will decide the issue.



Deter, from Black Star

German antitank gun emplaced in street of Belgian town. In order to shoot at sight in a wide field of fire, the gunners of the "75" have to refrain from building much ground protection, and the gun too often has to stay in the open. This is true also of any antitank gun, but in a lesser degree because it is built to hug the ground, like the German 37-mm. gun shown above. During 1940 the Germans made much of their "37." In 1941, realizing that heavy tank armor was in the ascendancy, they produced a powerful 50-mm. antitank gun having a double-thickness shield. It still has very low silhouette, however. See illustration on page 884.

The artilleryman in World War I had only to fear the fire of the enemy artillery. To shield himself from splinters, he packed around his gun walls of sand bags, and in some cases he was able to build a casemate and to set his gun behind an embrasure. This was easy because he seldom had to traverse his piece through a great angle. So, what he had mostly to fear was the explosion of a shell very near by, or, as the French say, the "coup au but." Such hits were proportionately rare because of dispersion and lack of precision of the enemy fire. Dispersion, indeed, was large because the opposing batteries were far from each other. Inaccuracy was frequent because of the lack of direct view of the objective.

Finally, in the case of a too-heavy pounding, the artilleryman could often dive into a nearby shelter, interrupting for a while the service of his gun.

Tanks have upset all this. They fire at sight—at short distances—wreck the guns with their 37s and kill the gunners with their machine guns.

The relative safety which the artilleryman enjoyed is gone:

—He is subjected to the fire of *automatic weapons* as well as dive bombing.

—He has to watch for his adversary through a wide sector, to fire at sight. In order to do so, *he is prevented from*

building up efficient ground protection.

—The fire of the tanks at sight and at short distance is deadly accurate.

—Last, there is no chance for the gunner to sink into a shelter when his position becomes untenable. On the contrary, at this very moment he must stick to his gun and answer, blow for blow.

FORMER CONCEPTION OF ANTITANK FIGHT

We in France during 1940 often wondered why such grievous inadequacies of the gun had not been more obvious to us before the war. When we recalled the method of antitank fighting which had been set forth in training doctrines we found that, without being fully aware of it, we had based our method upon two main theories:

1. *Idea of surprise.*—The gun is hidden, easily camouflaged and sees the tank which does not see it. This is true—as long as the first shot is not yet fired. But, if the gun has missed its mark (which is generally the case), then the tank runs away, often succeeds in hiding itself more or less. Then the situation is reversed; the tank sees the gun, the gun does not see the tank. The effect of surprise has vanished.

Of course, one may say that, if the gun waits

to shoot only when the tank is very close, it will not miss it, and then can take full advantage of the effect of surprise. But it must not be forgotten that even if it is stopped by direct hit, a tank is not always rendered incapable of shooting. Anyway, by doing so, the area observed by the gun is too restricted. Finally, the tanks seldom attack individually. They move in groups; one or two of them can be caught but the others will overwhelm the gun.

2. *Idea of a head-on attack.*—It was more or less assumed (prior to the war) that the tanks would charge their opponents like a bull charges a toreador. In that case, provided the crew has enough stamina, the guns possess a full advantage:³

Indeed, its rapid fire is very accurate because the tank comes to it, whereas the fire of the tank in motion is erratic. *But, the tanks, at least in the sector where we were,*

³Much can be expected from troops fighting tanks provided they have efficient weapons. Instead of the kind of apathy which is common, during a heavy shelling coming from an enemy whom they don't see, the men are filled, when the tanks come, with a furor like the excitement of a big-game hunt. But this feeling disappears quickly, to be replaced by a sometimes unjustified fear once they have discovered that their weapon can do no harm to the tank, and once they have been chased into the fields and hunted like rabbits.

did not charge. They circled around, seeking a dead angle, tried to reach the rear, stopped, aimed, fired.

It may have been that we had focused too much on the great capacity of the tank to go through any sort of ground and crush and push down material obstacles; and overlooked, more or less, two other tank characteristics: its fire power and its armor.

In order to compensate for these advantages of the tank and to fight on even terms with it, the gun has to be armored and able to revolve easily in any direction.

Armored—because the men who serve it have no chance otherwise against the fire of a tank;

Able to revolve—in order quickly to face a foe attacking from an unexpected direction.

NOT TO MAKE A TANK

Let us see now the general line which should be followed in the choice of other features. An error which the French made was to seek the theoretical, technical perfection. In theory, the perfect armored 75 is a tank armed with a 75. The best defense against tanks is tanks, in great number, faster, with thicker armor and greater firing power. But tanks are complex machines, difficult to build, expensive and requiring special tools.



European

"The gun must be armored—because the men who serve it have no chance otherwise against the fire of a tank." Above is a Russian anti-tank gun mounted in an armored cupola (possibly a tank turret) set low in the ground and well camouflaged. These Soviet weapons have accounted for many German tanks. The principal defect of such a gun is, of course, its utter lack of mobility. A determined infantry attack will reduce it, as well as any other purely static defensive work.

Moreover, a tank is an *offensive* weapon. As an offensive weapon, it must fulfill severe requirements. For example, it must possess a powerful motor, a huge supply of gasoline and ammunition, all of them protected; it must be able to go through every kind of terrain, and must be equipped for close self-defense. These *requirements are often contradictory*. For instance, to be fast and also to be thickly armored; both are imperative. These requirements must be met. If they are not met, the tank can not fulfill its task. This is the very reason why a tank is a complicated machine. But an antitank weapon is primarily a defensive weapon. One must take advantage of the fact that for defense purposes, many of the requirements of a tank can be neglected; for instance, the men in charge of close protection (the men not actually serving the gun) need no shield. On rare occasions the lack of armor for these men may be badly felt. But most of the time it will not; whereas the complication imposed by providing a shield for such men will always be a hindrance to mobility.

Too often we did not realize that it was better not to try to meet *all possible* cases of emergency but only the ones which were the *most likely* to happen, and to take care of 98% of cases, for example, at the expense of the other 2%. Therefore, it should be figured exactly which cases happen most frequently. This is what we meant when we said that in choosing the characteristics of the armored 75 we *must first figure how the panzers operate so that advantage can be taken of their peculiarities and even of their weaknesses*.

PROPULSION

The following is an example of this: Should the armored 75 be self-propelled or pulled by a tractor which would bring it in position, leave it there, and then move off to hide nearby? We would prefer the second solution for the following reasons: The motor and all the mechanism of transmission which go with it, the supply of gasoline and so forth, if not removed from the gun would have to be protected as well as the gun itself. Indeed, if not protected, the power plant is much too vulnerable. Even on tanks, where under armor, the mechanism and supply of gasoline are the first to break down or to catch fire. If protected, the vehicle becomes heavy and complicated and closely resembles a tank. Besides, the dimensions of the vehicle would be larger⁴ and make more difficult the building up of some ground protection. On the contrary, the inconveniences of a tractor are small: one can always expect to find a hiding place for it. The gun, indeed, is on the defensive and fights on its own ground; therefore there are many places from which it can cover a designated area with its fire. There is generally concealment near at hand, in which the tractor could be hidden.

⁴Especially would its height be too great, making it difficult to conceal.—Ed.

But can a tractor be set close to a gun and not be endangered by the fight? Yes, because tanks have *one primary mission*, which is to crack the actual resistance they discover. *They do not mop up* and do not bother to seek out such things as hidden tractors. In fact, they avoid any places off at the side which can harbor unpleasant surprises. They will avoid them even more carefully if at the same time they run the risk of receiving a deadly blow from a gun in the vicinity. Let us not forget that the fight of a gun versus a tank, by its peculiar character, is *extremely localized: A small area around the gun is under a heavy fire but, a few yards away, one escapes it*.

The real inconvenience of the tractor is not the tractor itself but one of the operations which it imposes, i.e., limbering up under the adverse fire, in other words, breaking off the fight.

At this point let us return to the method of fighting guns versus tanks which we have already mentioned. Armored guns are not supposed to break off the fight; this is all right for the self-propelled, unarmored, fast antitank weapon. In fact, it is the proper way to fight; and by doing so the tank chasers take advantage of their speed to escape a superior foe and to outnumber him later. But the armored gun fights in a different manner because its mission is different; it must hold a very definite spot or defend a definite area and must keep the tank from penetrating it. To do so it must stay and fight where it is emplaced. It is up to the tank to break off the fight, not up to the gun.

Only in the case of a general retreat may it happen that the gun would have to be removed under an adverse fire. Then advantage would be taken of the sporadic nature of tank operation. Tanks, indeed, are not everywhere all the time. They come, go, come back. During an intermission, coupling up of the gun to its tractor can always be accomplished provided the gun is equipped with an adequate apparatus to do it quickly.

This is an example of how advantage can be taken of the localized character of the fight of tank versus gun: More generally this conception may be outlined as follows: *To reduce to the absolute minimum the number of men, the amount of materiel and supplies which are necessary for the service of the gun in combat* and must therefore be kept around it and are likely to be subjected to a very severe punishment. As a corollary, to remove from the gun to a place nearby where they will be relatively safe, as many of the men and as much of the mechanism, material, and supplies as possible. By doing so, the width and breadth of the gun armor can be reduced to a minimum, while its thickness is increased very substantially.

As a specific solution we propose: (1) To keep only three cannoneers around the gun. (2) To keep the main supply in the truck, and to set a reserve of ammunition in a nearby ditch. (3) To place the men who accompany the gun for close protection in trenches nearby.

These men will open fire only if the gun is attacked by men afoot. They are safe because as long as they do not open fire, the tanks do not see them. Besides, the 75 is likely to keep the tanks away and by shooting time shell with fuzes set at 0, it can make close approach very difficult to the enemy infantry. If, however, the latter succeed in reaching the gun, the crew in charge of close protection enter the fight. Then the whole detachment will be much more at its ease in the open than packed in a pillbox.

While the crew avails itself of the protection which the surrounding ground affords, the armored revolving gun is placed a few yards forward (but camouflaged) in the open if necessary, with the task of defending a wide sector as its main mission. In this way, several guns can take a tank under cross-fire. Only if armed and able to revolve can a gun be put in such a place. Ordinary guns cannot be so emplaced even when specially built for antitank action, not even the low-set 47 and 25. Their crews look for some natural protection and cover—a mound, as a rule, behind which they lie and are forced to keep their heads down by the machine-gun fire of the tanks.

In this position the field of vision is limited. The tank takes advantage of this to surprise, circle, isolate the guns and outnumber them one by one. Armored revolving guns, however, have a broad field of vision and escape such dangers.

WEIGHT

By the application of the general conception herein outlined, the amount of men, mechanism, and material which are around the gun and thus have to be protected, may be reduced to a minimum. By doing so, the armor may have a very small dimension in height and width and thus can have the necessary thickness without being too heavy. However, there is a limit—it cannot be reduced below a certain weight.

A calculation shows that the minimum weight of a 75 mm gun armored with 1¼" metal in rear and on top, and 2½" in front, is around 8,000 lbs.

This is a little heavier than the 155-mm howitzer with which we will be able to make a fair comparison: The 155 in the French army was used as a field piece and was an organic part of the regular infantry division. Even when horsedrawn (as was the case in my regiment) it was considered mobile enough to follow all the moves of the division. This proved to be true although the moves were numerous and often arduous. A tractor would have made



Ordinary guns cannot be set in conspicuous locations even when they are specially built for antitank action. Their crews will always look for some natural protection and cover, a mound, as a rule, behind which they will lie and be forced, by the fire of machine guns, to keep their heads down. While in this position, their field of vision is very limited. Tanks take advantage of this to surprise, circle, and isolate the guns, one by one.

them easier. It is mainly for getting out of position that the weight can be a handicap. In that case we found that its weight was not as much of a hindrance as the size of the gun and that a small overall dimension is very desirable.

Weight has to be considered too when the gun has to go over soft ground; very soft ground such as swamps can be disregarded because tanks themselves avoid such areas. Anyway, and this is one of the advantages of the defensive, guns choose their own ground; they can count, in order to reach a certain position, on finding more or less a convenient path, unlike tanks which must be able to go everywhere.

EXAMPLE OF THE USE OF ARMORED GUNS

We shall see by an example inspired from an actual case, how armored guns could be used. The sketch shows, as an example, the organization of the defense of a bridgehead by two armored revolving guns.

The guns are placed at two corners from which they dominate not only the road, but the flanks of the village as well. They are set in front of hedges, at a few yards, which will cover the ditches by which ammunition is brought to the guns. The tractors and trucks are hidden in the orchard. The main reserve of ammunition is set in a ditch behind a garden wall or similar protection. At some distance from the gun the men in charge of close protection are in the orchards, courtyards, etc., and they dig trenches.

The sketch shows only the artillery positions. The organization of the infantry defense is not shown. From what we saw in the Battle of France, an attack on this

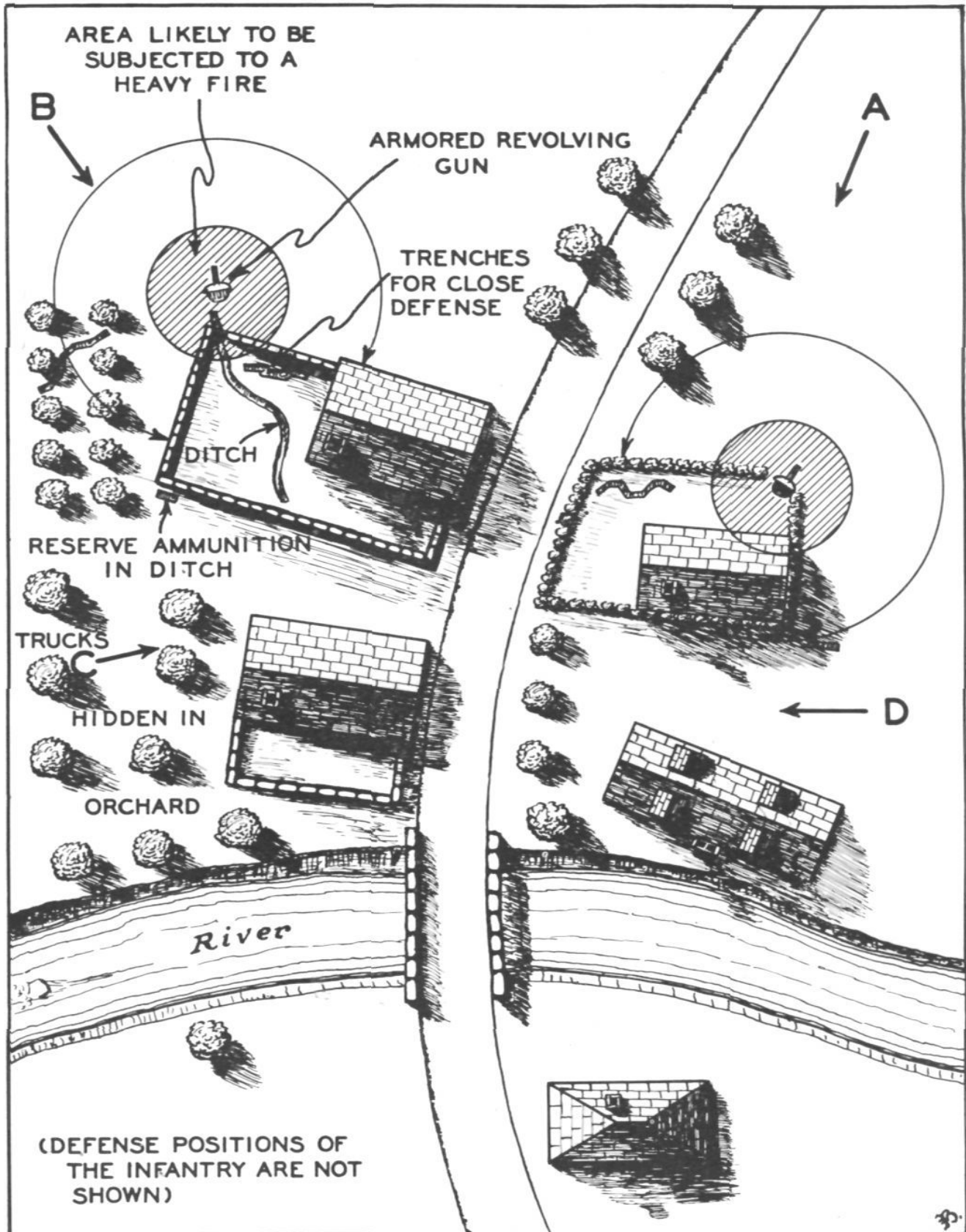

Figure 1

stronghold by tanks can be described as follows (two different actions must be considered):

- a. The enemy tanks try to silence the 75.
- b. The enemy tanks help their infantry to storm the village on the flanks.

a. *Attack on the 75 by tanks*

The enemy machine-guns the positions of the 75 from the right (Dir.A). During that time several tanks (a heavy one amongst them) reach the left, seeking a blind angle. During this move they try to dodge from view of the guns by using whatever natural screen the ground affords, even making a long detour, or using a smoke screen. When in area B they stop and shoot at the 75. Let us see now what would happen to an *unarmored* and *non-revolving, ordinary 75* set at the entrance of the village. Two cases must be considered:

1. The gunners have built a strong casemate and set their gun behind an embrasure. They can hope to escape the fire of the machine guns from direction A, but, because of their narrow field of fire, they will not be able to shoot back at the tanks from the left (Dir. B). The tanks win.
2. The gunners have not been able to build a casemate. This case is the most likely. At the very beginning of the fight, hostile fire will prevent the gunners from serving their gun. They will be killed or forced to take refuge in the trenches nearby. The 75 is neutralized. Tanks approach and finish the job. They win.

Let us see how an *armored revolving gun* would pull through these circumstances. The armored revolving gun has nothing to fear from the machine-gunning from A. It quickly faces the tanks at B. In the fight which will then develop, the weapons are equally armored but the tanks are more vulnerable than the 75 because they have treads, gasoline, etc. Therefore the 75 has a good chance to win.

b. *Attack by Tanks as Support of Infantry*

The enemy, even before he has silenced the 75, may storm the village on the flanks (Dir. C and D). Tanks will support their storm troops by shooting at the automatic weapons which defend the village as soon as they reveal themselves. Ordinary 75's placed at the entrance of the village can do nothing about it.

The armored revolving guns, because of their forward position, can command a broad field of fire, can answer the tanks and successfully defend their infantry.

Note 1. The armored revolving guns will be carefully camouflaged (with bushes, for instance). Because of their comparatively small dimensions this can be done successfully in spite of the location which is assigned. Even if the piece is sighted a little while before the battle, this is of little importance—during the artillery preparation which precedes the attack, as well as during the attack itself because:

- (a) During the artillery preparation the fire is aimed at the places which are likely to conceal AT weapons.

Even though these AT weapons are not seen, they will be pounded. This pounding can do little harm to an *armored gun*.

(b) During the fight the AT weapons will be revealed by their flashes. The fact that they hide behind a screen does not help them one bit.

Note 2. We have taken for granted that the ordinary AT weapons would be placed at the entrance of the village. But if they are numerous they can be placed all around. The field of vision of each one may be narrow, but being in great number they can succeed in covering all the area. This was the German manner of operating, when they defended Cote 111 in front of Amiens at the end of May. They were all the more successful because the French attack was supported by only a few tanks. This method of defense, however, requires a great many antitank guns. The same job can be done by armored revolving guns in far smaller numbers.

If an armored revolving gun can take the place of five ordinary cannon the result is:

- (a) To compensate for the small industrial output of cannon.
- (b) To diminish the number of trained men necessary.
- (c) To diminish traffic on the road.

CONCLUSION

Against the tanks, the 75 was too vulnerable and could not turn quickly enough in every direction. These were its fundamental weaknesses. Thus, it is imperative to armor it and make it revolve.

It was the purpose of this article to outline the other requirements which the gun must fulfill. This has been done by considering how the gun must fight and how the panzers operate and by always seeking the most simple characteristic. We saw how weight, for instance, the counterpart of a thick armor, can be reduced to a minimum; how the gun must have a great strategic mobility but it is not expected to fight in motion; how its action will thus complement the action of the planned, fast, self-propelled antitank guns; how, while the latter will chase the tanks in open field, the armored guns will defend the places which have to be held.

Only the *main features* of the apparatus for improving the gun have thus been outlined. Details can be figured out by competent designers. For each one there is a technical problem as well as a military one which can be solved by following the same principle: keeping in mind the lesson taught by actual experience, in the field of battle. By doing so only is it possible to produce a device efficient and at the same time rugged, simple, and easier to manufacture than the cannon itself, new or old, which it will equip. A successful achievement along these lines would make of the 75—now obsolete and inadequate—deadly to tanks. On any 37, 27 or 47 gun it would increase manifold its value for antitank fighting.

Antitank Attack

By Major D. S. Babcock,
5th Antitank Battalion (Prov.)

With the recent organization of antitank battalions, the divisional football team is now complete. To back up the sturdy line, there has now been added a powerful fullback, who from a central position waits to see where the play is coming and then rushes in to smear it.

This grouping of antitank weapons permits an active defense where once there was a static defense. It produces shock action as great as, if not greater than, tanks can themselves produce, for where a mass of guns can be concentrated on a single objective suddenly and with

EDITORIAL NOTE: Major Babcock's proposed methods have been demonstrated before higher commanders at Fort Custer, and more recently have been given a thorough test during the fall maneuvers. The current trend toward the use of self-propelled guns as equipment for antitank battalions adds emphasis to this article, as such weapons should facilitate the speedy action contemplated. Of course, the principles stated by the author are applicable also to units armed with older and more conventional types of guns. This study should be read in connection with that of Lieut. Dupont, wherein somewhat different ideas are presented. Actually, in defense against tanks, both methods and types of weapons will be useful. We can never have too many guns under such circumstances.

surprise, there is no longer antitank defense, but antitank offense. The potentialities of this mobile antitank striking force are great. Only the development of a suitable technique is needed.

This technique must be one based on speed—greater speed than is normally encountered on the battlefield—greater speed than tanks themselves develop. To resort



British antitank regiments, which are a part of the divisional artillery, frequently portee some of their weapons. In the Russo-German War both sides are carrying guns in trucks, and firing them therefrom, as tank chasers.

Tactics and technique of that new offensive-defense unit, the antitank battalion

to the football analogy again, the fullback plays a deep defense, from which point he can gauge accurately the movements of the man carrying the ball. Once determined, he charges in at all speed, striking him harder than the opponent himself, distracted by others, can strike him. So must the antitank battalion lurk in positions of readiness near the center of the division area awaiting reports from its intelligence system. It must not permit itself to be hurried forward by feints and alarms. But once the direction of the main threat has been definitely determined, it must rush in with the speed of a ten-second sprinter and throw itself in the path of the mechanized advance. All must be done by prearrangement; every shortcut to speedy action must be utilized.

In the position of readiness, the batteries of the antitank battalion are poised like a city fire department. Under available cover, all vehicles are pointed for a speedy exit, drivers are in their cabs, and cannoneers mounted. Radio sets are tuned-in awaiting the alarm. Platoon commanders are close at hand.

Over the air comes the command:

"MB 2068 FV NE." This brief message, requiring but a minute to send and receive, gives all the required information. MB means "Move battery"; 2068 is a map-coordinate indication of local significance only; FV means "formation V," indicating the basic pattern the guns of the battery will take up on arrival, and NE indicates the direction in which the battery will face to meet the hostile attack.

A siren alerts the command. The BC rapidly plots (on his map or photo) the new location, and sketches the route thereto. The platoon commanders mark their maps and rally their platoons, the motors of which are already turning over. The BC races ahead to reconnoiter the position. BC and battery are preceded by jeeps or motorcycles to clear the way; piercing horns or sirens secure them road priority.

On arrival at the indicated position the BC picks the best available positions, having due regard to cover and fields of fire. He cannot pick all gun positions, nor should he. As the platoons come up he indicates by arm signals the general line of their positions. Prime movers wheel toward the rear, guns are uncoupled and ammunition unloaded. In each section the truck withdraws 25 to 50 yards under cover and the driver takes up a position for local security, or anti-aircraft fire.

Within a matter of seconds after arrival at the position, all guns are ready to shoot. If the hostile tanks are not yet visible, progressive preparation of the position is undertaken. Scouts are sent to the front. If all is well, the

enemy is proceeding undeviatingly into the trap laid for him.

But if the enemy has swerved or his course has been poorly plotted, the battery must shift in order to place itself across the line of advance of the tanks, allowing enfilade fire on the lighter armored sides somewhat in the manner of the classic naval maneuver of crossing the T. Behind one battery is placed another. Artillery batteries are brought on his flanks so that no matter where he turns he finds the menace of massed guns. If he stops, the guns push forward and close in until the encirclement is complete.

The main brunt of the action is borne by the antitank battalion. The division commander brings up infantry antitank companies and field artillery batteries to complete the encirclement. The medium artillery throws in smoke where it will not mask our gunfire. Dive bombers go to work. Thus by shock action, by an aggressive, mobile antitank offense, by co-operation of all arms, the tanks are defeated at their own game. Figure 1 shows the action graphically.

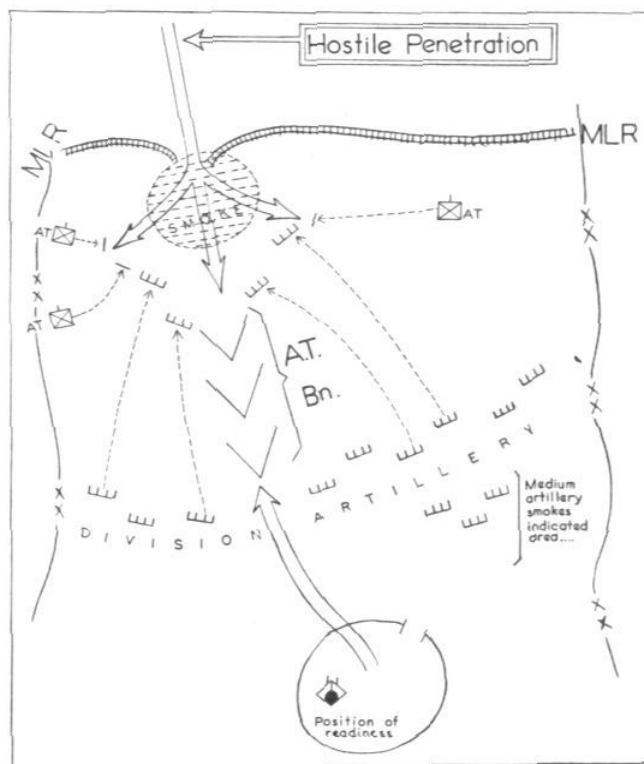

Figure 1

The keynote of the entire action is speed. Three principle elements combine to produce the speed of action required. These are:

(1) An adequate radio warning and command system. The observation squadron and the division reconnaissance troop, supplemented by radio patrols and observation posts aggressively used and constantly on the alert, are able to distinguish the main threat from the feint or local tank action.

(2) A prearranged code (already exemplified) by which orders are given quickly and with secrecy.

(3) Prearranged formations by which platoons and batteries place themselves most rapidly in the path of the hostile advance.

While the location of firing positions must be determined by the terrain, the basic pattern of these positions can be reduced to a few simple formations. These are named W, V, and Y for reasons clearly indicated in figures accompanying this article.

When speed is essential, the battery occupies the ground indicated, following the formation prescribed. Squad leaders, section leaders and platoon leaders improve the firing positions as time allows. If speed is not essential, cover positions are first occupied as prescribed in FM 23-70.

Actual application of these formations by 37-mm. and 75-mm. batteries is given in Figures 2-5.

Of these formations V and Y have the most general application. They comply with principles of depth, enfilade fire, mutual support and avoidance of bunching. All three formations permit of mobile, aggressive action necessary for the encirclement and crushing of hostile

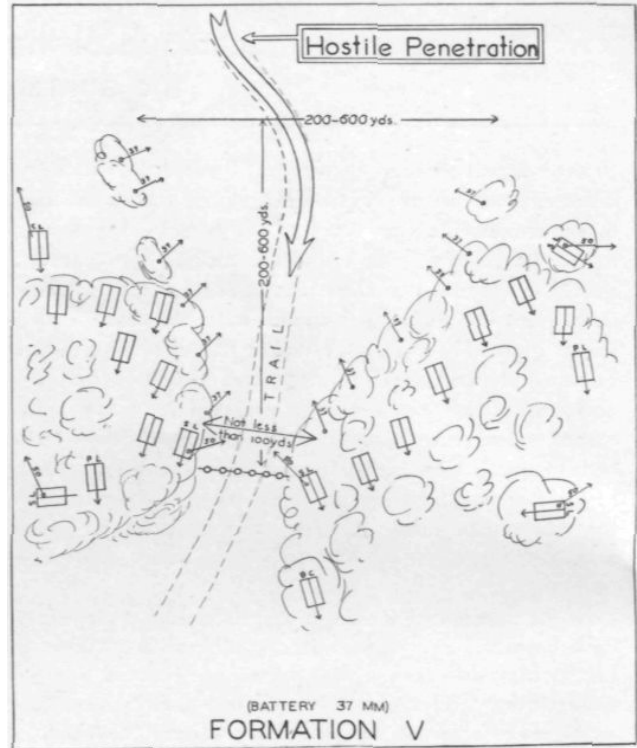

Figure 3
Formation "V"

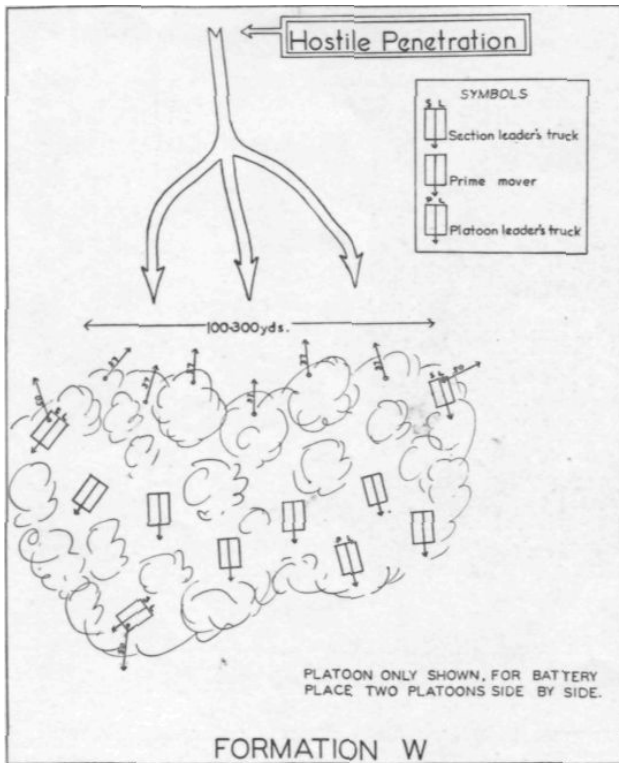

Figure 2

Formation "W." Battery: Two platoons—side by side each same as above.

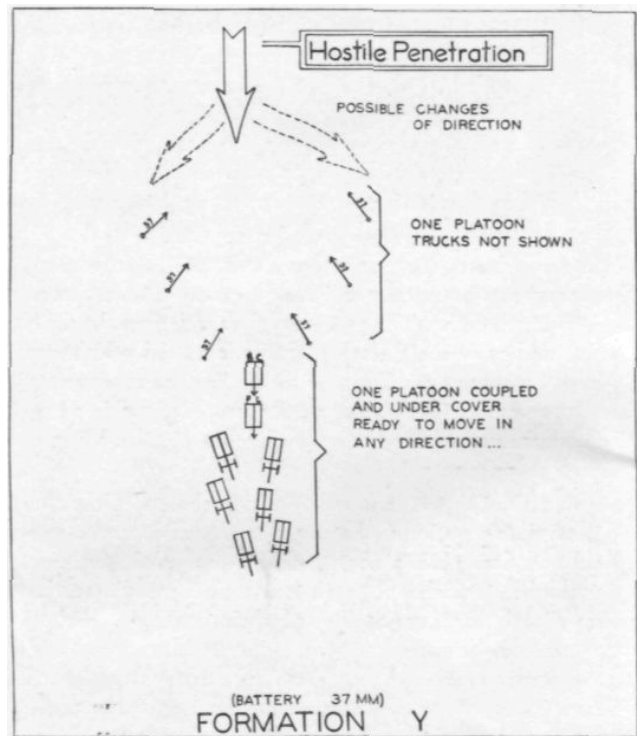

Figure 4

Formation "Y." Battery: Same as above with entire second platoon drawn up under cover behind center of formation prepared to shift into Formation "V." This formation is designed to await an expected attack whose direction has not yet been determined. When seen, reserve sections shift in indicated direction to form Formation "V."

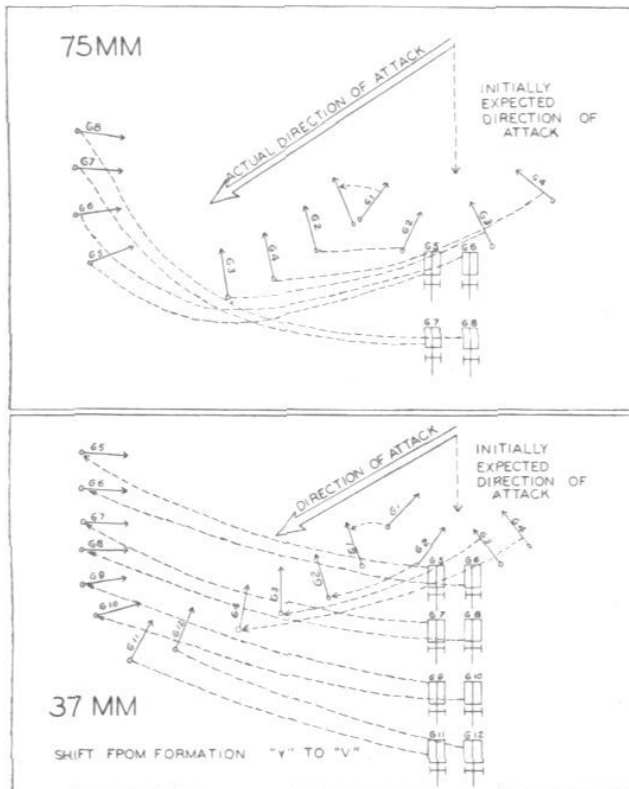

Figure 5
Shift from Formation "Y" to Formation "V."

tank invasions. In addition to the antitank battalion, the infantry antitank companies and all light field artillery batteries of the division are practiced in them. Thus a maximum of 60 guns of 37-mm. caliber and 44 guns of 75 or 105-mm. caliber can be brought to bear on a hostile tank

penetration. At the rate of only two tanks per gun this massed array will account for over 100 tanks. In addition, of course, corps, army and GHQ antitank battalions can be brought to the scene.

The single factor contributing to the success of this new technique is the SCR 245 radio set. It makes possible a massing of weapons at a threatened point similar to the assembling of police cars at the scene of a major crime. It enables the division artillery to continue its normal support missions until the moment required for antitank missions, and it permits the retention of the antitank battalion in a central position until the place where its services are most needed is definitely known. As a further advantage it permits all these units to remain concealed until the last minute and thus exposes them for the minimum possible time to dive-bomber attack. It will only prove successful if there has previously been a thorough reconnaissance of route and positions, adequate training in the fast-moving technique, and the antitank action is accompanied by proper local security, smoke screening and guerilla tactics. Antitank *defense* must become antitank *offense*. Only thus can the genuine menace of mechanized attack be overcome.

It has been said that "only a tank can defeat a tank."* With this view, issue is here taken. A speedy massing of an overwhelming number of antitank weapons at the point of penetration, accurate antitank gunnery, and an aggressive chasing and destroying of scattering tanks once the forward thrust has been stopped will soon break the grip these new monsters now have on the battlefield. The best defense is, now as always, a strong offense.

*Recently at Sollum the Germans proved the falsity of this would-be aphorism. Using a carefully prepared antitank defense of mines, obstacles, and guns, they decisively defeated a British tank attack with heavy losses to the latter. We would substitute: "Only a gun can defeat a tank."—Editor.



ADDITIONAL MEDAL WINNERS

1. Cadet Frank J. Niesen, Cincinnati, Ohio, Xavier University.
2. Cadet Captain Lloyd L. Leech, Jr., Parris Island, S. C., Virginia Military Institute; electrical engineering; baseball.
3. Cadet First Sergeant Robert Oliver Haas, Mobile, Ala., Alabama Polytechnic Institute; agricultural science; Scabbard and Blade, Phi Delta Theta; track, boxing.

The following are also medal winners, for whom the Journal regrets it has no photographs: Cadet Sergeant James E. Carlton, Oakland, Cal., University of Santa Clara; engineering; Saber Society. Cadet Hansford White Farris, Richmond, Ky., Eastern Kentucky State Teachers College; mathematics. Cadet Ewart John White, Jr., South Orange, N. J., Princeton University; physics. Cadet Master Sergeant Lewis Kercheville, Agricultural and Mechanical College of Texas. Cadet Captain Charles A. Ott, Jr., Santa Barbara, Cal., Stanford University. Cadet Robert A. Wright, University of Florida.

ALL ROTC CADETS ARE ELIGIBLE TO BECOME ASSOCIATE MEMBERS OF THE FIELD ARTILLERY ASSOCIATION

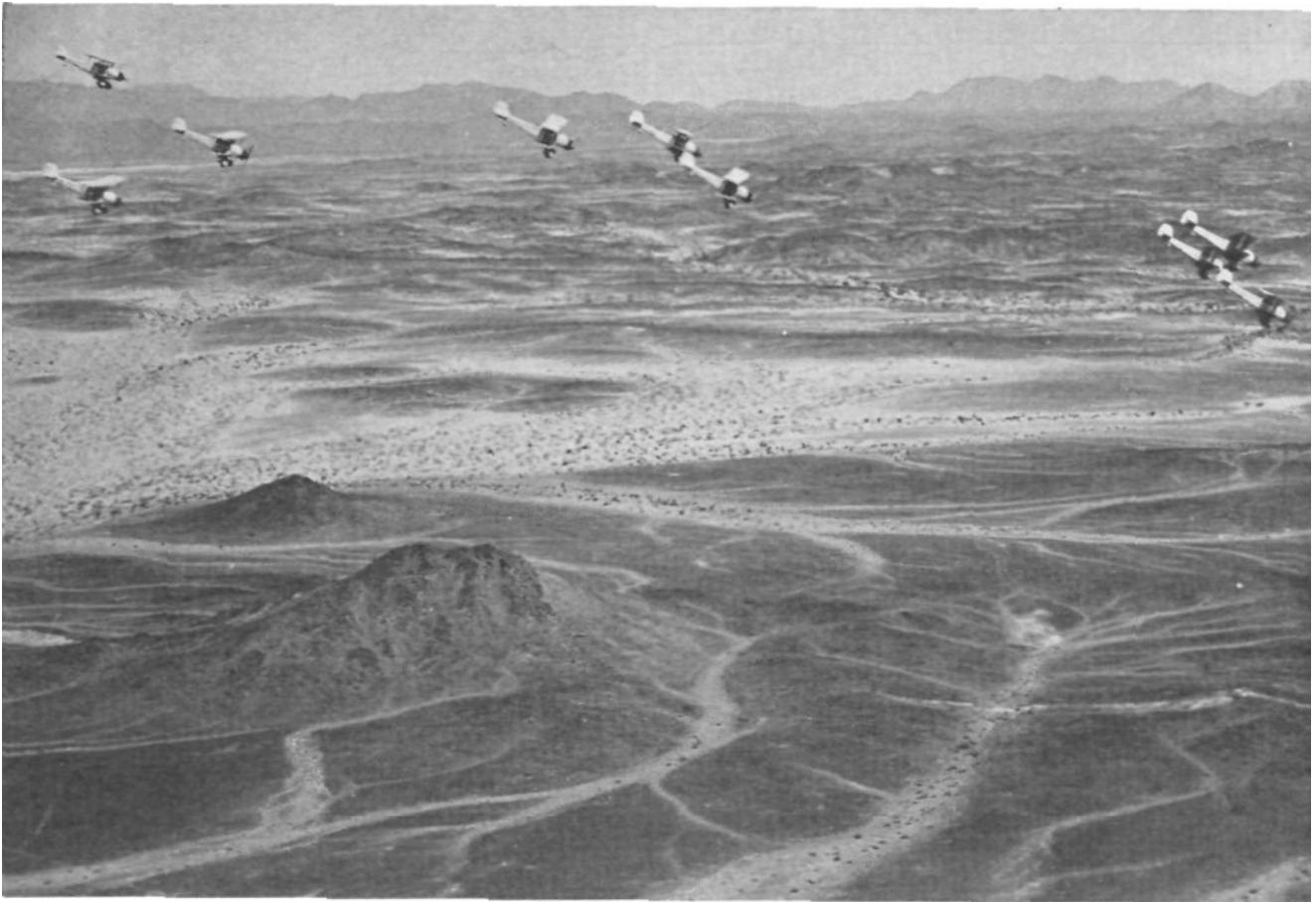

The terrain in North Africa

The War in North Africa

THE FIRST PHASE

Geography

Libya, situated in the central portion of North Africa, has, by virtue of its location, attained considerable importance in the present war and any consideration of Mediterranean questions must necessarily embrace a study of this large but relatively poor Italian colony.

The acquisition of Libya in 1912 by Italy was, primarily, a strategic move of great importance. This country, approximately 700,000 square miles in extent and lying in places less than two hundred air miles from the Italian island of Pantellaria and some three hundred miles from Sicily, afforded a means whereby the defenses of the

EDITOR'S NOTE: *This brief study should orient the reader as to the topography of this theater, supply him with a summary of the recent events, and thus provide a proper background for the opening of the next act of the play in Africa.*

extremely vulnerable coastline of the mother country could be materially strengthened and at the same time help to dispel the nightmare of her further confinement to the Mediterranean.

Libya comprises all of the regions known by their classical names of Tripolitania and Cyrenaica (which includes the coastal strip known as Marmarica), also the Fezzan, which borders on French West Africa, part of the Tibesti highlands, in which is located the highest summit to be found in the Saharan regions (about 11,200 feet), and several oases on the southern frontier bordering on French Equatorial Africa. On the west it is bounded by the French possessions of Tunisia and Algeria, on the south by French West and French Equatorial Africa and on the east by the Anglo-Egyptian Sudan and Egypt.

Geographically, Libya may most conveniently be divided into four regions: (1) *Tripolitana*, extending from the Tunisian frontier eastward to the great Syrtis (Sirte) desert consists of two distinct regions; a level coastal plain, dotted with fertile and well-populated oases, and

just beyond this plain a range of comparatively fertile hills known as the Jebel. (2) Cyrenaica, located on the northeast, and stretching from the Syrtis to Egypt, is a high limestone plateau serrated by deep wadis (beds of water courses that are dry except in the rainy season). Here the coastal region is a mere fringe to the plateau, which has an average height in the west of 1,000 feet and 2,000 feet in the center. Near Benghazi the coastal plain is widest (about 30 miles), while towards the east it becomes, in places, no more than one-half mile in width. From this coastal region rises an abrupt escarpment to the plateau, which consists of rolling downs intersected in places by deep water-worn gorges. To the south the plateau gradually slopes away until it merges into the sands of the Libyan Desert. (3) *The Fezzan*, located in the southwestern part of the colony, is an arid desert mostly of a rocky and mountainous character. It contains large tracts of sand and deep wadis in which some few oases occur. (4) *The Libyan Desert*, in the southeastern part of the country, is a flat, sandy desert of extreme aridity containing few oases.

The question of water supply is a serious problem in Libya. There are no perennial water courses that can properly be called rivers. The useful supply comes entirely from wells (*bir*) and springs (*ain*). There is, however, an abundance of subterranean water which is obtainable in most sections by digging or drilling wells to varying depths. Only water obtained from deep wells is potable and, in this connection, it should be noted that the Italians were quite successful in storing large quantities for a considerable time.

In addition to the problem of water supply, any consideration of this theater of war should not discount other factors having a marked effect on operations, such as: the intense heat during the day, extreme aridity, the lack of

good and adequate roads and means of communications and the difficulty of operations in sandy and rocky terrain. The road factor in particular more or less decided in advance the character of, and limitations imposed upon, operations in this territory. Other than one or two unimportant caravan-route passes, any invasion of Libya is better accomplished either from Tunisia on the west, Egypt on the east, or from the Mediterranean. The best road in Libya is the famed "Litorea Libica," or Libyan Shore Road, which parallels the coast the entire distance from the Tunisian to the Egyptian frontier. This is a recently completed asphalt-surfaced road which not only traverses the most fertile areas but commands the entire northern and most important part of the colony. This road connects up all the ports and most populous towns along the coast; therefore it is important from the point of view of logistics.

The aforementioned geographical conditions, especially difficult from the standpoint of defense, are therefore naturally very different from conditions prevailing in Europe and elsewhere in the temperate zones. The long distances by which this theater of war is separated from the home bases and sources of armament, the complete absence of auxiliary sources in the zone of operations, and lastly, the difficult climatic conditions, impose extremely severe demands on both the leadership and the combat troops. The commander is here (more than elsewhere) compelled to make very thorough advance preparations for all military operations, and to organize the service of supply in a very flexible and reliable manner. In this service the supply of water—which has assumed enormous proportions—plays a very important and frequently a decisive role. The great difficulties encountered in waging war in the desert are best illustrated by the fact that both sides have, on occasion, commenced

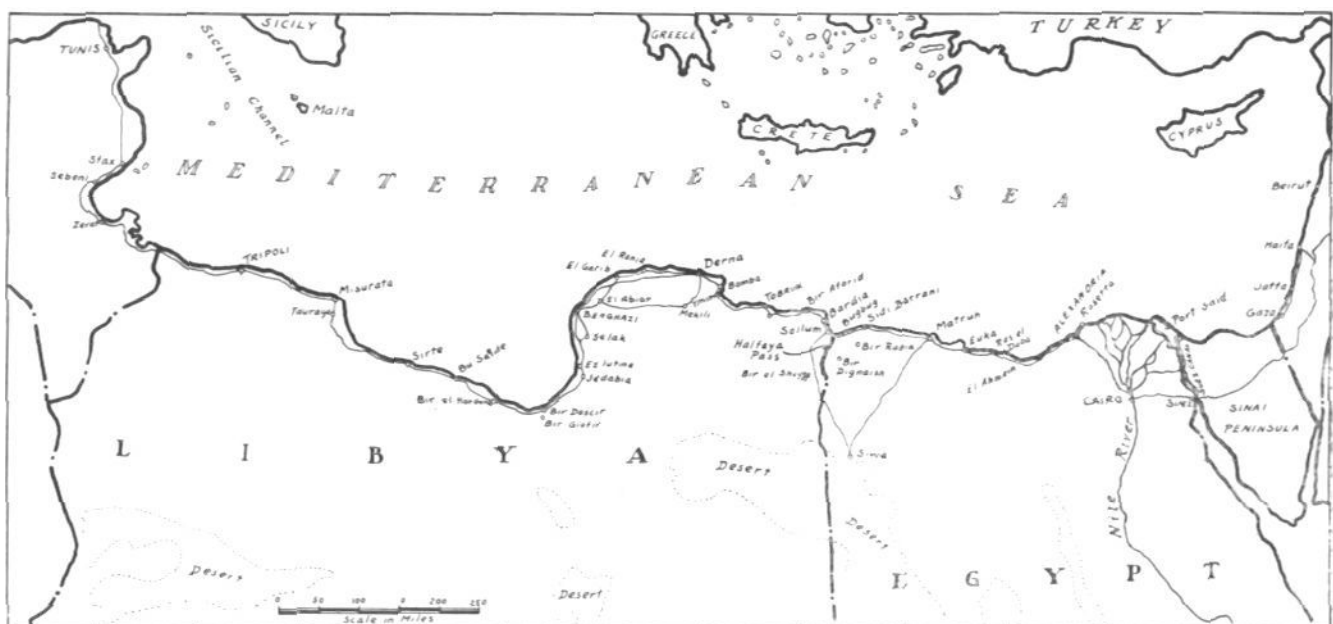

Map of the North African theater of war

operations from points ranging from 30 to 60 miles towards the rear in effecting merely incidental advances or enveloping movements. For a long time, the garrisons of the desert oases acted as a strategic flank guard.

BRITISH VICTORY OVER ITALIANS

Upon Italy's entry into the war in June, 1940, the African littoral suddenly took on new importance as a theater of operations. The collapse of France completely nullified Allied plans for the protection of the Eastern Mediterranean and removed the menace of a possible French invasion of Libya from Tunisia on the west. An Italian army, under Marshal Graziani, of close to 300,000 men was deployed at various towns along the Libyan coast and occupied the principal oases which covered the salient caravan routes from the south. It was therefore apparent to the British that an Italian invasion of Egypt could be expected at any time. General Graziani, they knew, was well equipped and had well trained troops for desert warfare at his disposal. Spurred on by the initial successes of the Duke of Aosta's mixed white and native army in British Somaliland, an Italian invasion might take place immediately. Marshal Graziani, however, had not perfected his plans. On September 12th his army moved forward from their bases at Bardia and Fort Capuzzo through Halfaya pass and occupied Sidi Barrani together with its perimeter defenses of Maktila, located just beyond Sidi Barrani on the coastal road, and the camps of Nibeiwa, Tummar East, Tummar West and Point 90, which were situated some 15 kilometers southeast of the town. Here his forces stopped, intrenched themselves, dug wells and generally assumed the appearance of an army that has finished its conquest. Why he did not advance to engulf Egypt was a mystery. Was it possible that he was waiting for the Duke of Aosta to complete the conquest of British Somaliland, after which he could expect that army to attack Egypt from the south? The question remains unsolved; however, Mussolini, in an address delivered before the Fascisti battle units in Rome on February 23, 1941, declared that the British attack on the Tenth Italian Army had preceded by some five to ten days the completion of Marshal Graziani's preparations which was to be immediately followed by a thrust at Mersa Matruh. Nevertheless, the Italians were not altogether surprised at the British attack. Since the first days of October their air pilots had been noticing a steady increase in the strength of the British forces; however, as those forces had remained east of Mersa Matruh it appeared as though they were being brought in solely to prevent a further advance by Marshal Graziani's army; it was not until the seventh of December that there was any intimation of a British attack. Italian sources state that on this day a British prisoner* had been taken while reconnoitering the dispositions of the 63rd Cirene

Division, which had been given the mission of securing the Italian right flank. For this purpose they had been deployed along the escarpment some 30 to 35 kilometers south of Sidi Barrani. The prisoner stated, according to the same source, that the British would attack within ten days. British air reconnaissance over the terrain behind the Italian front increased the next day, and strong motorized troops were reported in the desert southeast of the Italian positions. The Italians, however, beyond holding troops in readiness for an alarm, did nothing, relying, perhaps, on the knowledge that they were vastly superior to the British forces in armament and numbers. The marshal, it appears, failed to reckon the newly arrived British reinforcements in planes and tanks. General Wavell had received sufficient equipment to insure command of the air, and to put into action an armored division (the 7th) under General Michael O'Moore Creagh, the fighting vehicles of which were superior in quality to that of the Italian tanks. Nevertheless, numbers were still heavily on the Italian side. No less than 60,000 men were concentrated at Sidi Barrani and in outposts, while many more troops were held in support at Fort Capuzzo and Sollum. The British numbered less than 40,000, including the one tank division.

A fundamental tenet of modern desert warfare has held that surprise is impossible, that vast numbers of tanks and motorized equipment can be spotted from the air when still many miles away. But General Wavell laid his plans carefully. A dummy tank park and fake airdrome had been built east of Maktila. It was arranged that all signs point to a frontal attack in the conventional manner. Meanwhile, General Creagh had concentrated his armored forces in a real tank park southwest of Mersa Matruh. During the night of December 8-9 the tanks roared out of the desert northwestward toward the Italian positions, which were taken completely by surprise. The Italians did not even have an opportunity to man the more than thirty tanks which were caught in park. Despite this they defended themselves bravely; General Maletti fell from machine-gun fire while trying to put his tanks into action. Meanwhile, Sidi Barrani was being surrounded. Ships of the Royal Navy appeared offshore and shelled Italian dispositions unceasingly. The Royal Air Force destroyed most of the Italian Air Force while it was still on the ground.

By nightfall on the 9th the camps of Nibewa, Tummar East and Tummar West had fallen. Point 90 was passed by as the forces pressed on to the main show at Sidi Barrani. Thousands of prisoners were taken. The battlefield was in utter confusion, with much mopping-up yet to be done.

On the 10th the Support Group of General Creagh's forces continued the pressure on the 63d Cirene Division located on the escarpment. The 4th Armored Brigade sent a regiment of tanks north of the Sidi Barrani-Buq-Buq road to assist in the attack on Sidi Barrani, while a

*It is thought that this "prisoner" was purposely sacrificed to give the impression that a frontal attack would be made.

regiment of light and cruiser tanks dashed some forty kilometers around the entire Sidi Barrani position to assist in the Maktilla attack. A Hussar regiment was already patrolling ten miles west of Buq-Buq.

Sidi Barrani fell the same day before a heavy onslaught of the 9th Brigade, who suffered heavy casualties. Point 90 was reduced the next day, surrendering to a platoon of infantry tanks.

After the fall of Sidi Barrani a mixed column was formed under the command of Colonel Birks with the mission of moving astride the roads leading west to Bardia to strike at and if possible cut off the retreating Italian columns. Several isolated encounters took place in this movement but by the evening of the 11th the entire Italian Army was moving westward in complete disorder. The British Armored Division had captured 25,000 prisoners and a tremendous quantity of stores and materiel. Its mobility was somewhat hampered by this burden.

By the 13th one section of Colonel Birks' column had reached the vicinity of Sollum while another group had moved astride the Bardia-Tobruk road. On that day the Support Group moved north from the escarpment and effected the surrender of Sollum two days later.

As the elements of the 4th and 7th Armored Brigades, proceeding into Libya, boldly struck at Italian columns it became apparent that the Italians were intent on making a

stand at Bardia. Meanwhile, Italian air activity had materially increased; Birks' forces both south and west of Bardia were subjected to very heavy air attacks. He therefore felt that before proceeding further he had best clarify the situation in his rear with the result that he moved on Sidi Azeiz, and finding it abandoned, went to Sidi Omar. Here in a bold attack he captured nearly a thousand of the enemy without a single casualty in his own force. This action is noteworthy owing to the fact that the tank attack took place with full artillery support. Twenty-four guns were used to "soften" resistance with the result that the attack proved outstandingly satisfactory. The Armored Division now had the role of preventing reinforcements from reaching Bardia and to forestall any retreat of the Bardia forces towards Tobruk.

The Italian defense of Bardia was entrusted to General Bergonzoli (Electric Whiskers), who had the remnants of the divisions which had been used in the fighting at Sidi Barrani and Sollum—the 62d and 63d Infantry Divisions and the 1st and 2d Blackshirt Divisions. Around the little harbor had been erected, in a great semicircle, three rows of field fortifications, containing in all some forty major strong points and some sixty minor ones. The outer defense had a radius of thirteen kilometers, while the innermost ones, which were situated at an altitude of some five hundred feet above sea level, were just above the harbor. Beyond the Bardia fortifications, and complementing them, was a fortified flying field. This field was taken on the 18th by the British forces, who had also penetrated the outside Italian defenses from the south. Here they were met by stubborn resistance which necessitated further artillery preparation. In this, elements of the Royal Navy, which

British guns being brought into position on the side of Tobruk prior to taking part in a mass bombardment. Note the metal platform under the piece, which gives 360° traverse.



had put in an appearance offshore, took a prominent part.

After some few days' delay, during which time the city was rendered almost untenable, a British infantry attack was launched on January 3d. The Australian group, which was the first to go into action, led with heavy tanks which raised a huge cloud of dust. They penetrated the southwestern front, where some of the tanks were stopped in antitank trenches. These were later extricated upon arrival of the support echelons. The Australians had instructions to swing out to the right in the direction of the lagoon in order to prepare the way for the main attack which was to begin at eight o'clock from the west. The old fort on the eastern side of the town escaped attention at first but in the final coordinated attack it was taken along with the camp by the lagoon. The breakthrough between the two flanks of the inner circle of fortifications was complete. However, the Italians held the harbor district until evening, and detachments continued to fight throughout the night—both on the foothills east of the harbor and on the mountains on the northwest.

After the fall of Bardia the British proceeded at once against Tobruk, located some 78 miles to the west. Tobruk, possessing the best natural harbor in Libya, is an important seaport and the largest Italian naval base along the North African coast. It is of considerable strategic importance in its relation to the Mediterranean and North African theaters.

In the attack on Tobruk the British adopted the same plan of envelopment which had served them so well previously. Instead of attacking the stronghold directly they passed on around it, taking possession of the airfields at El Gubbi, Acroma, El Adem and two others; then cut communications with Derna. On January 7th they were west of Tobruk but the encirclement was not completed until the 12th. During that time they had transferred a considerable portion of their supplies to a point ahead so that they would not be held up when they were ready to advance on Mekili and Benghazi. On January 21st General Wilson commenced the attack, which again had the support of the Navy offshore. Beginning with an air thrust at 2:30 AM, followed up by destructive artillery preparation which lasted until dawn, a breakthrough was made over a wide front. By noon an advance of 8 kilometers had been made and numerous Italian batteries had been silenced. By evening there was little fight left in the troops garrisoning the town; during the early hours of the next morning the last defender had relinquished his arms.

After Tobruk, the British decided to move against Mekili-Benghazi across the desert rather than the more difficult Derna-Benghazi shore route. Accordingly, a detachment was made up for the purpose of containing the enemy about Derna until such time as the Australians could take over. The 4th Armored Brigade, which now constituted the bulk of the available striking force,

therefore moved up towards Mekili upon the news of the fall of Tobruk on the 22nd. Their principal mission was to cut off the retreat of the forces at Mekili while the Support Group, with the remnants of the 7th Armored Brigade in immediate support, was given the task of prosecuting a frontal attack against the Mekili defenders. Because of the supply situation, however, these moves were not made until early on the 27th. During the night of the 26th-27th the enemy withdrew from Mekili, moving by "pistes" or tracks not shown on the maps, towards Slonta. This move was not discovered until the 27th, and despite all efforts to bring the Italians to battle, they escaped.

A mixed column, including a regiment of artillery, was immediately despatched after the retreating Italians down the main Giovanni Berta-Slonta Road. The main force proceeded directly to Benghazi on the Mekili-Benghazi road with the object of cutting off the enemy in their retreat along the Benghazi-Jedabia (Agedabia) road. The march was via Msus and Antelat. Msus, being only lightly held, was taken without trouble. Antelat also was taken without much resistance; and the British made all haste towards the seacoast, moving via Bedafom. Advance outposts having reported the existence of considerable traffic along the shore road to Jedabia, the force sent to Bedafom planned to attack the enemy column on its flank. A short time later, reports came in to the effect that a long line of Italian motor transport vehicles had put in their appearance, advancing in a continuous stream. It appeared that the Italians had evacuated Benghazi earlier than was expected, probably due to the threat of the northern column.

By February 6 the now famous 7th Armored Division had reached the sea, cut the Benghazi-Tripoli road in the vicinity of Ghemines and trapped practically all the Italian troops remaining in the area. In two months, therefore, the 7th Armored Division had travelled and fought over some six hundred miles of difficult terrain, and had provided the mobile striking force necessary to play a leading role in the capture of some 100,000 prisoners, several thousand guns and much booty in the shape of needed stores and materiel. The demand on both men and equipment had been terrific, but Wavell's army had been well trained and toughened for such warfare. Nevertheless, the entire campaign was nothing short of miraculous.

—BY LIEUT. RICHARD J. RIDDELL.

THE SECOND PHASE

British retreat

The aftermath of Wavell's well-conducted campaign came as a shock to the English-speaking world. In the words of a British publication, "With disconcerting suddenness the situation in Libya was transformed when in a few days German mechanized formations recaptured



what the Army of the Nile had taken as many weeks to capture." On February 9, advanced British armored units occupied El Agheila. This was the high water mark of their advance.

For some time there had been rumors of German troops in Italy, and the newspapers in the U. S. at the time expressed the opinion that "the Germans were taking over Italy." On February 16 came the first notice that the Germans were taking an interest in Africa. That day, and for the four days following, the German air force heavily raided Benghazi. February 24, the first skirmish between German and British troops appears to have taken place, southeast of Agedabia.

At first, GHQ at Cairo did not take these reports of the presence of Germans in Africa with full seriousness. "Just a few light units," was the phrase used. After all, how could a force of any significant proportions have got past the British fleet? The answer to this question is still not definitely known, but it seems a fair guess that the transports must have slipped across from Sicily to Tunis at night, and then have proceeded south to Libya, carefully hugging the coast. At any rate, advance units of the Germans landed at Tripoli in the middle of February, and it soon became apparent that the German contingent was far more than a mere token force, sent to bolster Italian morale.

The aptitude which the Germans have shown for colonial warfare has always been somewhat astonishing, for Germany has never had an empire of any great significance. It will be remembered that Germany's pre-1914 empire was comparatively quite small, and moreover had been in their possession for only a few decades prior to the outbreak of the war. Yet the long and skillful defense

German AA gun going into position at Sollum. Note ammunition compartment in the prime mover. These guns destroyed many British tanks.

put up by the German commander in East Africa, General von Lettow-Vorbeck, attracted general admiration, not the least from the British themselves. In any case, no part of North Africa had ever belonged to Germany, and it is doubtful if any member of the expedition, from the commander-in-chief down, had ever set foot in the country before. We shall see that they were not slow in adapting themselves to the sun, dust and heat of the desert.*

The British gradually began to take a more lively interest in the reported presence of Germans in Africa. On the night of March 12, the RAF raided Tripoli, and repeated the operation at regular intervals thereafter. In the light of the facts as they now appear, this seems rather like locking the barn after the horse has gone. On March 24, the English outpost at El Agheila was taken, and it was no longer possible to conceal the presence of the Germans, even officially. In Berlin, it was announced that a German African Corps had been created, and that General Rommel was its commander. Rommel had risen from the ranks to become an officer in the Great War, and was now only forty-nine years old. He had served on Hitler's staff in the occupation of Czechoslovakia, and in the Polish campaign. In France he had commanded one of the armored divisions which had broken through and reached the English channel, closing the trap on the allied troops in Belgium. At the same time it was announced that Marshal Graziani had been replaced as commander-in-chief in Libya by General Italo Garibaldi.

*One report has it that the German troops designated for this campaign were conditioned on the sand dunes of East Prussia.



The approximate strength of the German African Corps was about two armored divisions and two motorized divisions. The armored divisions were somewhat smaller than those used in France because the inadequate Libyan road net would not permit of the movement of large bodies of troops. After March 24, the narrative becomes largely a chronicle of German successes. March 31 they took El Brega. Benghazi was captured without resistance on April 3, the British having withdrawn the previous night. Steadily the Germans pushed up the coast, the armored troops doing most of the fighting, aided by dive bombers. The British do not appear to have been so sadly lacking in air support here as in other campaigns, and the *Journal* of the Royal United Service Institution even declares that the Imperial troops enjoyed superiority in the air.

On April 8, the Germans carried out one of the outstanding individual achievements of the war. A few German motorcycle soldiers armed with sub-machine guns cut into a British column at night and carried off as prisoners three very prominent British generals—Lieutenant General Sir R. O'Connor, Lieutenant General P. Neame, and Major General M. D. Gambier-Parry. On April 11, the Germans passed to the south of the British garrison at Tobruk and pushed on to capture Bardia the next day. The Egyptian border was soon crossed, and on the 14th Sollum was taken. The campaign had moved back to about where it had been started months before.

Action at Sollum

One more event remains to be told. June 15, the British launched a tank attack on Sollum which was, to judge from

British tanks destroyed by German gunfire at Sollum. Some of these are a new air-cooled type of vehicle.

its strength, intended to be much more than a raid. The Germans had prepared for it a trap consisting of mines, AAA guns, and antitank guns, and by the 17th the attack had been disastrously repulsed with a heavy loss to the British in tanks. The Germans have aptly compared this with the British tank attack at Cambrai in 1917, which likewise, after initial advances, ended disastrously. Shortly after the Sollum affair Sir Archibald Wavell suffered the fate of Marshal Graziani and was replaced in command by General Sir Claude Auchinleck. At Tobruk the British continued to maintain their last foothold in Libya, where, at this writing, the siege is still in progress.

The events of other campaigns probably influenced the Libyan operation to some extent. The British state that the necessity of sending troops to Greece (the Balkan campaign had begun on April 6) had weakened their front in Africa. About the Germans it is said that they did not push on from Sollum to the conquest of Egypt because no reserves could be spared from the new campaign in Russia. Also, of course, by the time Sollum had been reached the campaigning season in North Africa was over. One thing is fairly certain: this winter should see the outbreak of renewed activity in Africa. Which side will take the offensive is anyone's guess. But it may very well be that history will view the British advance and retreat of 1940-41 as a mere curtain raiser for the decisive campaign that is to come.

—BY LIEUT. HARVEY S. FORD.



Polish National Day (in France), May 3, 1940, Gen. Sikorski (saluting), commander of the Polish Army in France, and President of the Polish Republic, M. Raczewicz, reviewing the 1st Polish Division in the Army Area near Nancy. Polish soldiers in the foreground.

How

The Poles Fought in France

By Col. Włodzimierz Onaciewicz, of
the Polish Army

An epic narrative of the actions of the 1st Polish Division in defense of and in the retreat from the Maginot Line in the Lorraine sector during June, 1940

In Two Parts—Part 1

A striking characteristic of the two major wars of the present century has been their long duration. This means that the adversaries must, even while locked in their death struggle, strive continuously to improve their methods and means so as to secure that margin of superiority vital to final victory. At the end of each campaign or phase of the war the defeated contestant must quickly search out the reasons for his non-success and take immediate and thorough corrective measures before the next blow falls. Similarly the victor must make every effort to maintain his advantage and to improve upon it, pressing relentlessly toward the annihilation of his foe.

Thus the Democracies, taken aback by the initial successes of the new German armaments and tactics, and already losers in the first phase of the war, are making



The fortified sector of the Saar was constructed on the pattern of 1914-18, and, "strictly speaking, was a GAP in the Maginot Line."

desperate preparations for the opening of the second act. They are mobilizing their material means, revising their strategy, tactics, and technique, as a result of the lessons which have been so painfully imposed upon them. In analyzing these lessons it is absolutely essential to determine without delay what actually happened in Europe; and to evaluate the reasons therefor. Only in this manner can proper remedies be devised.

However, it is not easy to get a true image of the battles fought in Europe. This is especially true in ferreting out the tactical details of actions of small units, since most of those who fought in the defeated European armies are either dead or prisoners in Germany. Therefore I think the story of the actual combat of the 1st Polish Division, in which I commanded the 1st Regiment of medium artillery, might be of some interest to my companions in arms of the United States Army. Although this was but an episode of the war, lasting only a few weeks and fought on a limited front, it might help to understand better the conditions under which the French campaign developed and came to its tragic conclusion.

I would like to tell first how this Polish Division came to be at the French front. When the whole of Poland was invaded by her enemies in September and October, 1939, the Poles did not cease their struggle. As early as autumn, 1939, General Sikorski, at the head of the Polish Government, began to organize in France a new Polish

Army composed of Poles who lived in France and of those who came from Poland across the enemy-guarded borders. In May, 1940, we had an army of 82,000 men. These fought both in France and in Norway. At the moment of the French collapse we had 40,000 men at the French front, organized into two divisions (the 1st and 2nd), and one small Armored Brigade. The 3rd and 4th Divisions were in Brittany awaiting their armament.

The 1st Polish Division, formed and trained in less than four months, was sent at the end of April, 1940, to the army area south of Nancy. At the end of May the divisional artillery was sent to reinforce the French artillery in the Maginot Line. About June 10th the whole 1st Polish Division was engaged, and it fought right up to the capitulation of the French armies.

The Polish Division, organized on the French plan, consisted of three infantry regiments, one motorized reconnaissance group, and two horse-drawn artillery regiments. The two artillery regiments were organized as follows: The light regiment consisted of three battalions of French 75's, each battalion having three batteries, while the medium regiment consisted of two battalions of 155-mm. howitzers, each battalion containing also three batteries. Moreover, the division had an antitank battery, a signal company, and various other minor units.

The artillery of the 1st Polish Division entered the Maginot Line at the Sarralbe-Puttelange Sector on the 28th of May as a reinforcement for the French artillery. The part of the Maginot Line which comprised our defensive sector was called "the fortified sector of Saar," and, strictly speaking, *was a gap in the Maginot Line about 25 miles wide.*¹

The main defensive position had no forts. It consisted of pillboxes, trenches, shelters covered with timber and antitank obstacles. The latter consisted of artificial inundations, ditches, rails set in concrete, minefields and dense zones of barbed wire. The belt of pill-boxes was 1 to 1½ miles wide. The pill-boxes in the front line were very numerous and then more scattered towards the rear. A few wooded spots on the main defensive position were also utilized and fortified. The artillery was in position behind the belt of pill-boxes; its emplacements were isolated and not linked with the infantry defenses.

The Puttelange-Sarralbe sector was protected by the small river Albe, whose water-level, raised by dams, constituted a serious antitank obstacle. Its weakness lay in the fact that the dams could be destroyed by artillery fire or by hostile engineer troops, when the enemy should make contact with the main defensive position. During the great drought of May and June the position was further weakened because the level of the water dropped

¹According to the account of some French officers, they left this gap because they hoped for a favorable issue of the Saar plebiscite and intended to include the Saar coal-basin in the Maginot Line. In 1935, however, the plebiscite resulted in giving the Saar to Germany. Unaccountably the French forgot to fill this gap in the Maginot Line.



dangerously, especially in the southern part of our sector.

The village of Holving, on the eastern bank of the Albe, formed a small bridgehead strongly fortified and bristling with antitank rails.

There was a strong and large outpost position some 1½ miles before the main position. It was, however, abandoned about the end of May, when all the French reserves were sent from Lorraine towards Paris. Only a few pill-boxes were held just in front of the main position. They did not form a continuous line. Behind the main position there was no other defensive position, and once the main position was pierced, the way to Nancy and to the heart of France stood open.

There were many prepared artillery emplacements along the main position. Some were not occupied because of a reduction in artillery assigned to this sector during the month of May. Furthermore, these emplacements were not completely finished, as they should have been, especially if one takes into account the nine months of respite which the French had had. The guns had no cover except for a camouflage network. The shelters for the men in general were but partially finished; the advanced emplacements had no shelters at all. Only one of the six battery positions had concrete shelter.

The most striking thing, however, was not these defects but rather the choice of locations for emplacements and the entire lack of camouflage. The French had chosen battery positions just behind the ridge of the cover, on the reverse slope; the guns had no field of direct fire either to the front

Inundations in front of the Maginot Line which failed to stop the Germans. (Dever from Black Star.)

or to the flanks. Thus the artillery had no possibility of engaging in the general fight against tanks should these break into the main position. Moreover, blind and isolated from the infantry, the artillery was absolutely defenseless if directly attacked and would be easy prey for enemy tanks. This was the more surprising as the gently undulant terrain offered everywhere excellent emplacements with a field of fire of from 500 to 800 yards in front and to both sides.

During the first days of June we received orders signed by Generals Weygand and Georges, to organize villages as centers of resistance and to put the artillery in them in emplacements enabling it to fire directly on the attacking tanks. These orders were suitable for antitank resistance in open country. They were not satisfactory for a fortified position, because the placement of a center of resistance in a village makes easy its destruction by artillery and aircraft. Much more should be demanded from a fortified position. It should provide well-camouflaged and properly-dispersed solid defenses using all the advantages of terrain. The idea of organizing infantry and artillery together in common strongholds in the second and third defensive lines, able to resist a tank attack, is sound, but these centers of resistance must be specially built and camouflaged. Such was the confusion of ideas at that time, however, that our French command insisted upon literally applying these tactics to the Maginot Line; and they issued appropriate orders therefor.

We had no time to carry these orders into execution. Nevertheless, I had to place two 75-mm. guns as antitank weapons in the villages of Ueberkinger and Ventzwiller. This useless sacrifice weakened two of my batteries to no purpose. Two isolated guns are easily put out of action, while whole batteries fighting tanks with direct fire can do a good job.

The French made no use whatever of camouflage. All gun emplacements and most of the infantry positions had been dug in yellow clay and consequently were surrounded by enormous yellow heaps which showed up from the air like bull's-eyes. The French command realized very well that all the details of the position had been photographed long before by German planes. The one solution for us in such a situation was not to change anything, in order not to reveal the recent occupation of the emplacements.

When I asked the French command about this lack of camouflage, they answered that the best camouflage was the great number of emplacements! Unfortunately, they were wrong. It was easy for the Germans to determine by their sound ranging stations which emplacements were occupied; and we were shelled with great precision by the German artillery, which knew exactly the location of every gun.

The observation posts also had been badly placed. As a general rule, they were located on the borders of woods, which were always regularly shelled by the German artillery. Their field of view was limited. Only very few of them were put into pill-boxes; the majority were lightly covered, while some of them were but open surface shelters, protected by sand bags.

The main position was covered by a dense cobweb of telephone lines, unfortunately strung above ground. At the

time of our arrival, towards the end of May, there was not one underground cable. Only later, partly at my request, the French built two underground cables, one parallel to the front and some three miles from the front line, and the other perpendicular to it. This latter was never finished. When the enemy shelling became heavy, all surface wires were continually cut, especially those running to the observation posts. However, the underground cable remained intact even after the German heavy artillery preparation of June 14th.

Our artillery never got its complete signal equipment as called for by the French tables of basic allowances. On the other hand, we thought it was not enough to have one OP per battalion, as the French specified. We wanted one per battery and one per battalion headquarters, making a total of four per battalion. We found a solution. As no one, not even the chief of the French divisional signal section, was familiar with the network of wires after the recent changes in troops, we cut every circuit which did not answer any calls for three days! In a short time we had *more* than 4 OP's per battalion.

We got wireless equipment (and not much) only at the Maginot Line. We were forbidden to use it without a special order, and then it was to be used only in case of damage to the telephone line.

Our sector, some four miles wide, was held by a special French infantry regiment of four battalions. Two of these were put in the first line and two behind them so as to bar two important directions: Remering-Hilsprich and Holving-Ueberkinger. (See Map No. 1.) One company was placed in the advanced stronghold at Grundviller in the outpost position. The commander of the

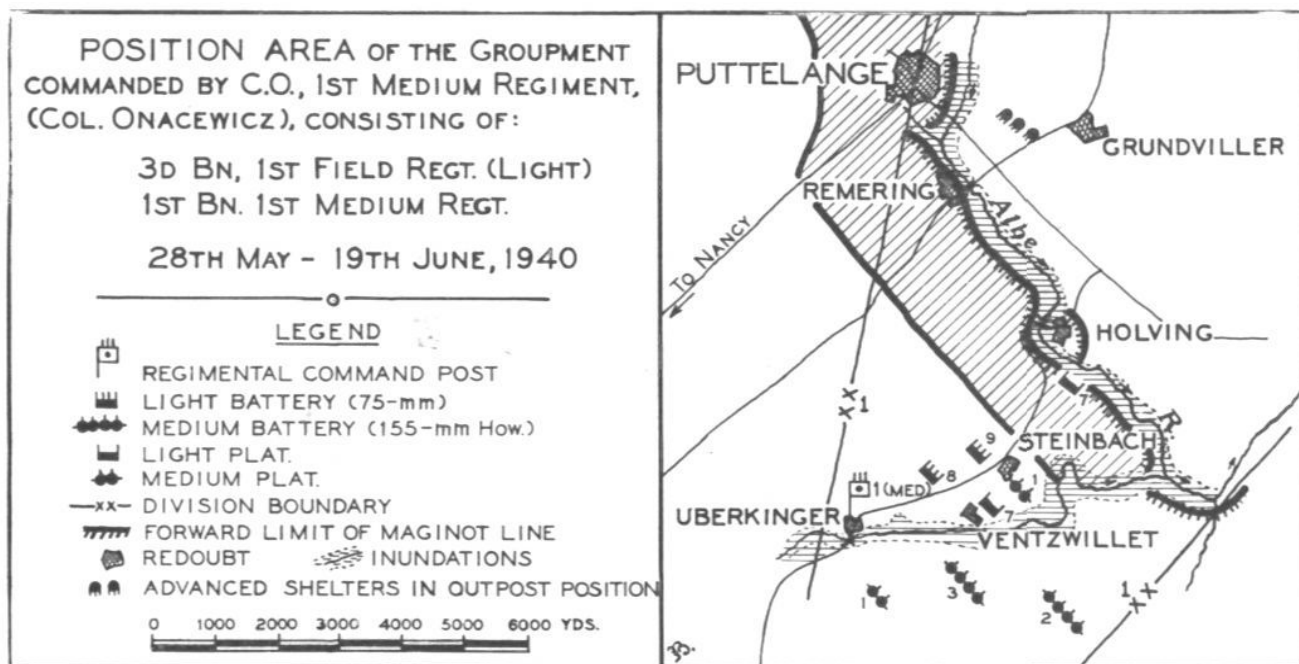

Map No. 1

regiment had a "corps franc" of 40-50 men, who were doing all the patrolling before the main position. He had no reserves.

This fortress infantry was armed with more machine-guns than average infantry and had many and various antitank guns, some of them immobile. The fire-power of these troops was great.

The artillery of the 1st Polish Division was divided into two mixed groupments (regiments), in support of the French infantry. One of these groupments, commanded by Colonel B., consisted of one battalion of 155-mm. howitzers, one battalion of 75's and two French battalions (CP in Fremestroff). The other, which I commanded, consisted of one battalion of 155-mm. howitzers and one of 75's (CP in Ueberkinger). Moreover, one Polish battalion of 75's was assigned to a French groupment.

Besides the Polish artillery, there was a great amount of French artillery of various calibers; 105-mm. guns with a range of from 12 to 18 thousand yards; 155-mm. guns (GPF), and 220-mm. long-range guns. Some of these batteries had their own means of transportation, horse-drawn or motorized, while others had none. In general, there was a lack of 75-mm. guns.

My groupment had a very large zone of action. It was in fact much wider than the sector of the supported infantry. This was because the French command tried to secure the greatest possible elasticity in the fire of their artillery in order to be able to concentrate the fire of a great number of guns at every point on the front.

Too-large zones of action are very dangerous for direct support artillery, because there is always a tendency to use this artillery in some neighbor's area. In case of unexpected attack on its own infantry the fulfillment of its primary mission may be unduly delayed. We had a good example of this during the action of June 10th. The French Command organized a counter-attack to eject some Germans from Puttelange in the adjacent areas on the main position. (See Map No. 1.) My groupment, which participated in the preparation and support of this counter-attack, fired continuously for four hours at the maximum permissible rate. Our guns became so hot that it would have been impossible to execute an immediate barrage in front of our own infantry, if the enemy had launched an attack in our sector. Fortunately nothing occurred.

My groupment occupied its normal emplacements as shown on Map No. 1 and advanced one light platoon (two 75's) to Hinsing and one medium platoon (155) to Steinbach. These advanced guns did all the shooting during the quiet period, so as to conceal as long as possible the location of our main emplacements.

The anti-aircraft defense consisted of a few French A.A. batteries of 75-mm. guns (about three in our sector), which fired continually. They shot down only one reconnaissance plane in about three weeks, despite the fact that the German planes often circled at 3,000 feet. During our entire stay in the vicinity of the Maginot Line,



French 220-mm. long-range gun

we did not see a single French fighter plane. At all times we experienced an unpleasant feeling of helplessness, under German aircraft which droned above us day and night.

The "Maginot Line" in our sector resembled only a field defensive position of 1915-1918 (which was usually built in a few months) with the addition of some antitank defenses. It was shallow, and it was contrary to common sense to trust it to resist a strong attack supported by artillery and tanks. The French Command must have believed in it, however, because they had provided no other defensive position behind this line.

Moreover, the position was planned poorly and very little had been done to provide antitank defense within the main position. Thus camouflage was entirely neglected, the communication network was superficial, the artillery had no field of fire for direct shooting within the main position, its emplacements were isolated from the infantry, and the great part of shelters were pitifully light.

As regards the garrison, the position was defended by numerous artillery, chiefly medium and heavy, whereas the infantry, special fortress units, had no reserves and obviously were not prepared to counterattack but only to resist passively on the position. Most of the antitank guns were not modern but adapted from old guns of various models.

Briefly, the "Maginot Line" in our sector did not at all represent that powerful and invincible wall which, as the world had been told so many times, barred the way to any invasion of France.



The French thought that the campaign of 1940 would be fought like that of 1916. Here we see a member of a "corps franc" training in trench warfare.

The end of May and the first days of June were quiet and enabled us to organize our emplacements. Our French associates took absolutely no precautions. Numerous civil workmen were engaged openly on the defenses during the daytime, digging antitank ditches and building shelters and roads. Officers drove openly in cars to OP's and battery emplacements. Meanwhile the German reconnaissance planes circled ominously above us every day and night. It was obvious that our position held no secrets for the Germans; all the new works were known to them before they were finished.

In the first days of June there was a certain animation on the German side. The number of their patrols increased, and they approached nearer the French outposts. Their artillery fire became more intense day by day. Evidently their artillery was ranging our gun emplacements, woods, and landmarks, and was harassing our rear area. This shooting was directed by aircraft. There was little fire on the infantry lines.

Our artillery energetically answered the Germans and fired more than the enemy. Our Polish artillery now took advantage of its numerous OP's which previously had been criticized by the French gunners. It watched diligently the space before the main position, and gave lightning punishment to every German detachment which appeared within range of its observation. Our young officers never tired of discovering and shelling the enemy, and were delighted to have an unlimited supply of ammunition. They acquired in those days an extraordinary dexterity in shooting shrapnel as well as high explosive. Soon the enemy disappeared entirely from in front of our position and moved only under the cover of woods or of darkness.

In an endeavor to induce their artillery to use observed fire, the French command of the sector issued every day a special bulletin of observed shoots. Among some twelve French battalions, the two Polish battalions were always credited with from $\frac{1}{2}$ to $\frac{3}{4}$ of all observed fire.

About the 6th of June the Germans began seriously to harass the French outposts. On calls from the infantry, our artillery had to execute many barrages, day and night, in front of the French outposts. Without a fight the French abandoned the concrete fort of Grundviller and blew it up. They preserved only three advanced shelters between Grundviller and the main defensive position (Remering).

Shortly after this the Germans wiped out the French outposts one after the other. Under the cover of the woods (which the French had left thick in front of the outposts!) they approached the selected shelters, suddenly poured upon them a great amount of high-explosive infantry mortar fire and then attacked from a short distance; the assault usually took place just before darkness. The French did not counterattack, but withdrew to the main defensive position.

This fate also met the last three strong points before Remering. The Germans under cover of the trees brought their mortars close to the left shelter and suddenly at 8:00 PM, concentrated fire on it and destroyed it in a few minutes. Both battalions in my groupment executed a fierce barrage on two sides of and very close to the two remaining shelters. This stopped the Germans, and enabled the French defenders of the work to withdraw to the main position. No one apparently thought about a counterattack; the French blew up the bridge at Remering.

By the 10th of June the Germans had liquidated all the outposts in ours and the neighboring sectors and had made contact with the main position. On our left flank they even broke into the village of Puttelange on the main position, from which they were driven out with great difficulty. The German artillery usually did not take part in the attack on the outposts; this mission was apparently left to the infantry mortars.

From this date on, a period of continual tension began, as it became obvious that the Germans were planning an attack on the main defensive position. A surprise attack was made easier for them because of the concealment afforded by the forests left by the French about one to one and a half miles in front of the main position. Under this cover, the Germans were digging into the ground and massing the means for an attack. I proposed to the French Command to set these forests ablaze by shell fire. This could have been easily done owing to the three weeks of extreme drought. The French declined this proposition, because they feared reprisals on the woods within their own main position, which were crowded with infantry and materiel.

As the enemy activity increased, so did that of our

artillery. It engaged in daily and nightly harassing activity. The long-range French artillery executed counterbattery energetically.

The 11th, 12th and 13th of June were days of uninterrupted artillery duelling, during which many artillery positions and rear areas were heavily bombed by German aircraft. The French Command estimated that there were at least eighty enemy batteries opposite our sector.

On the 13th of June, our second heavy battalion lost about 50 men, 300 horses and 10 trucks from one single unlucky air bombing. On the other hand, the Ninth field battery of my group fortunately escaped when its emplacement was attacked by fourteen dive-bombers. Thanks to good shelters and an absence of direct hits, only one man was wounded and one aiming circle destroyed; but the battery was so buried under the dirt thrown up by the bomb explosions that it took two hours to dig it out.

During the night of the 13th and 14th of June, as the enemy attack seemed imminent, the whole French artillery executed a general counter-preparation. At dawn on the 14th of June a heavy German artillery preparation was launched against the whole of our position. There were some periods when all my batteries were counterbattered at the same time. By 10:00 AM I had four guns damaged. Despite the enemy fire, all our batteries were shooting practically without interruption, in order to break up the German attack. The French infantry was continually asking for fire, and its demands were never refused.

After a preparation of several hours, the enemy launched his attack. It broke down under the fierce infantry and artillery fire—especially the latter.

Some time before noon the French commander of the

Colonel Onacewicz's regiment, 1st FA (medium) during the review on May 3, 1940.

sector asked for one of the prearranged concentrations within the main position, upon enemy tanks which he stated had broken into French lines. The news was terrifying and quite unexpected. The demand was urgent, but any mistake would direct the fire of my two battalions on a French battalion in Hinsing. I decided to verify the news personally, after having warned the battalions to prepare the fire. The rumor proved false and we avoided a mistake which could have been fatal to the defense.

In the afternoon, the Germans succeeded in entering the main position in two places. They were ejected by the brilliant counter-attack of a small detachment of Polish infantry, which happened accidentally to be near this breach, and by our motorized reconnaissance group. This counterattack strongly impressed the French infantry.

Up to nightfall the whole main defensive position was strongly held in our sector, but the French command ordered a retreat of the whole Army from the Maginot Line because of the general situation. The Polish artillery withdrew after dark, pursuant to this order. During the night we joined our 1st Polish Division and at dawn occupied new positions.

The statistics as to ammunition fired are characteristic of a defensive battle: in those last twenty-four hours my three field batteries fired a total of 10,000 rounds and my heavy battalion fired 2,700.

Our collaboration with the French infantry left us with the best of memories. Slowly our artillery gained the confidence of its French colleagues, who appreciated the eagerness, the skill and the spirit of sacrifice of the Polish gunners. The most popular with the French infantry were our advanced observers, who were often cheered by them after a good job.

During this period General Sikorski visited our artillery in the Maginot Line.

[TO BE CONCLUDED]





A crashed German glider with two of its crew lying dead beside the ship, after they had tried to land near Canea. (International News Photo.)

Crete

By Lieutenant Harvey S. Ford, FA

Without doubt, the German capture of Crete will be remembered in history along with the gas attack at Ypres, the tank breakthrough before Amiens, and other famous "firsts" wherein a new method of warfare was successfully employed. Not that Crete marked the original use of parachute and air-borne troops. The Germans introduced them in Norway, in Holland, and in Greece, but in these campaigns the air troops were used only as auxiliaries to strong ground units upon whom rested the principal burden of the attack. In Crete the air troops carried the attack alone, and carried it over a body of water controlled by a hostile fleet. The result was an outstanding success, and deserving of a far more protracted study than the amount of detail now available will permit.

Viewed in its proper perspective, the capture of Crete does not constitute a campaign in itself, but rather is the

logical continuation of the conquest of Yugoslavia and Greece. Strategically, this is quite clear. As the last piece of Greek territory remaining to the Greeks, it was important that resistance be continued on Crete. But it was far more important to the British that they maintain possession of the island. Crete is only 180 miles from the nearest point on the African mainland, and therefore stands in a commanding position in regard to the vital Mediterranean sea lanes. Secondly, it would offer the English an excellent jumping off position should they desire to attempt another invasion of the Balkans. Conversely, it was necessary for the Germans to finish the Balkan campaign by driving the allies out of their last foothold in Europe, and thus to forestall any future trouble from this quarter. Likewise, German air fleets based in Crete could harass shipping and assist their compatriots in Libya in the campaign against Egypt. Finally,



German parachutists rounding up civilians and Greek soldiers after the fight in streets of Herakleion. (Dever from Black Star.)

Balkans. Their number is estimated at 30,000 soldiers, 1,200 planes, and 500 gliders.

The British were sadly lacking in armament and equipment, most of which they had been compelled to abandon in Greece during the evacuation. The New Zealand Brigades in particular were short. It was reported that the average armament of a New Zealand battalion consisted of a couple of machine-gun carriers, a three-inch mortar, and a few light machine guns. Wire was very scarce, there were no hand grenades, and tools of all kinds were practically unobtainable. There were a few tanks in Crete. The transport of only one British unit was complete, and before the battle all the transport on the island was gathered together in a central pool, with about two trucks being left to each battalion. A few supplies were sent from Egypt, but constant German air attacks confined the time of unloading to a few hours at night, and, in consequence, no great amount was received.

Previous articles in the FIELD ARTILLERY JOURNAL have demonstrated the fact that adequate artillery support is the first prerequisite of defense against air troops, and it is therefore of importance to note what artillery the British had on hand. Their most effective unit was a 3.7-inch howitzer portee troop. This was supplemented by some 75-mm. and a few 90-mm. or 100-mm. cannon, most of which appears to have been captured from the Italians. Some of these guns were without sights and all of them lacked adequate supplies of ammunition. The Bulk of the British artillery had of course been lost in Greece.

But if the British were short of men and material, so likewise must have been the Germans, particularly in the early crucial stages. It must be remembered that all the German troops and all their weapons and equipment had

to be transported by air. Confining our comparison strictly to the ground forces we may say that the opponents were approximately equal, with the odds favoring the British during the first few days. But the Germans had one decisive, indeed overwhelming, advantage—superiority in the air. Shortly before the battle the RAF decided to evacuate Crete. The airfields in Crete were considered unsuitable and too close to German bombing bases on the mainland. We may well agree with a British source that this was "the deciding factor."

As soon as the Germans had occupied the Peloponnesus they began to prepare in secret for the attempt on Crete. Extensive aerial reconnaissances were undertaken, and all important points were photographed to the last detail. On 14 May, Italian bombers struck heavily at a British convoy in the eastern Mediterranean, and the air attack now rapidly increased in fury. Waves of planes attacked every defensive position which could be identified. Airports — particularly Maleme — were bombed again and again, and on the 19th six of the defenders' few antiaircraft guns were knocked out by direct hits. The antiaircraft guns had been distributed without proper regard for concealment. It was this preliminary attack, from May 15 to 19th, which brought about the decision of the RAF to abandon Crete. It also gave the British warning of the impending assault, and they immediately began to rush naval units from the various Mediterranean stations to Crete.

On May 20, the assault began, and was opened by an aerial bombardment of extreme vigor: high altitude bombing followed by dive bombing. The initial points of attack were all on the north shore of the island: Canea, the capital of Crete, and the adjoining Maleme airport, the naval base at Suda Bay, Rethymnon, and Candia (Herakleion). Maleme airport, about 15 kilometers west of Canea, was the principal objective, and the scene of the heaviest fighting. The air bombing here was without precedent in its violence, the bombs being of all sizes up to a thousand pounds.

Following the aerial bombardment the first wave of parachutists was dropped. Early in the battle the British suffered a serious loss. By accident or design, the second wave of parachutists fell behind the Maleme defenses, very near to the 3.7-inch howitzer troop. The latter was 800 yards from the nearest infantry support. Since the gunners had no rifles, they were quickly driven off, and the guns were lost. With them went the most effective body of British artillery. The captured Italian guns, some of which had to be fired over open sights, were all that was left.

The parachutists were dropped from heights of 300 to 600 feet. Observers reported that their parachutes appeared to have some attachment which caused them to open quickly. The parachutes supporting soldiers were colored white or gray, those carrying equipment

brown.¹ At one time as many as 600 parachutes were counted in the air, two-thirds of which were equipment carriers. At Maleme somewhat under two thousand parachutists were landed the first day. So long as an active ground defense was maintained, the parachutists were very vulnerable while in the air. One source maintains that as much as 80 per cent of one wave became casualties before reaching the ground, though this may well be an exaggeration.

Each parachutist carried a sketch map of his particular task, a large automatic pistol, four grenades, and a large knife. One in four carried a sub-machine gun. Immediately following their landing the parachutists set about to locate and open their equipment containers, which had been dropped at the same time. During this period they were in an extremely dangerous position, and in some cases their casualties were quite heavy. The Germans fought stoutly, as in fact they had to if the attack was to succeed. A British commentator writes: "It is only right to recognize the admirable fight put up by these first German arrivals who were not only outnumbered but enjoyed none of that

¹Apparently the Germans vary their coloring with the campaign, for a different color plan had been used in Greece.

superiority in armament on which they had hitherto been accustomed to rely for success in Poland, France, Greece and Yugoslavia. These German soldiery must not be despised as foes in a fair fight; picked troops, as undoubtedly were this spearhead of the attack on Crete, they were up against the best of our Imperial troops, hardened in recent war, and held their own long enough to allow of the arrival of their comrades to their aid and that in sufficient strength to complete the task set them."

Soon after landing the parachutists collected into small attack groups and began to assault assigned objectives. By radio they got in touch with their bases, reported the situation, and indicated what reinforcement was necessary. Verey lights were used to point out targets to the supporting dive bombers, red signals being used to indicate success.

Having gained a foothold at Maleme, the next day (May 21) the Germans commenced to bring in reinforcements by transport plane.² Air infantry, arms, ammunition, food, and medical supplies were landed. Since the Maleme airport was still under artillery fire, the Germans suffered considerable loss, especially after

²A German source declares that this phase of the action began on the late afternoon of the 20th.



Throughout this war the Germans have made intensive use of air transport for supplying ground forces with food, fuel, and munitions.

the planes were on the ground. Indeed, the fact that the airfield must have been well pitted with shell and bomb craters undoubtedly made the landing operation itself extremely hazardous. Air officers were landed to aid in the coordination of the air-ground attack. An interesting feature of this phase was the reappearance of gliders, which, it has been said, were first employed in the reduction of Fort Eben Emael the previous spring. Gliders were used because they were cheap to build, and their destruction, consequently, would involve no great loss. A glider carried twelve men and mounted a machine gun. Three gliders could be towed by a Junker "52" transport plane, and together they could carry a platoon of infantry and its equipment. As a rule the gliders were cast off about five miles from shore.³

Coincidental with this attack on Maleme the Germans dropped parachutists in the vicinity of Rethymnon and Candia. However, the allies succeeded in holding both of these towns, although Rethymnon was short of food and ammunition. On the night of May 21, the Germans attempted an attack by sea. According to a British naval officer, the flotilla consisted of about 50 small, wooden Greek fishing boats and a half dozen steamers guarded by a single Italian destroyer. The British fleet intercepted the convoy, and claim to have destroyed half of the convoy, driving the remnants back to Greece. The next day, May 22, the German air force turned its attention to the British fleet at Suda Bay, and once again demonstrated the superiority of an air force to a fleet operating in narrow waters. The British suffered heavily, and later admitted to the loss, during the whole Cretan operation, of four cruisers and six destroyers. The Germans claimed a total of 23 naval craft sunk. As a result of this air victory the Germans and Italians were able, in the closing days of the battle, to bring in men and supplies by sea.

On May 23 and 24 a large number of Germans were landed in the western part of the island, most of which were mountain troops. They were led by General Ringl, a mountain division commander. On the 25th the Germans commenced a systematic attack upon Canea, and at this time the British appear to have recognized the hopelessness of the situation. The fighting was severe, and the British slowly withdrew. Every ridge, olive grove and village was stubbornly defended, but the German mountain units pushed on, aided at every step by their air force. On May 27, Canea was taken, and the next day the Germans drove on and captured Suda Bay. German reinforcements were constantly arriving in ever increasing numbers, and some of them now began to come by sea. Italian naval vessels participated in the latter operation, and tanks were brought over. They were

carried on small boats of from twenty to one hundred tons. The superstructure and decks of the boats were removed, and platforms built at about the water level. The tanks were then loaded in by cranes. Upon reaching the island, the boats were beached, the bows blown off with small, carefully placed charges of dynamite, and the tanks were driven ashore.

On May 28, Italians from the Dodecanese Islands landed on the eastern end of Crete. May 29, the Germans from Canea and Suda Bay established contact with and reinforced those at Rethymnon. The same day Candia was taken. Both the Germans in the west and the Italians in the east now turned south, driving the British before them. On the 31st the Italians and Germans joined hands at Hierapetra (due south of Mirabella Bay), on the south shore of the island. June 1, Sphakia on the south shore—the last port of evacuation open to the British—was captured, and with it a great many prisoners. The campaign was over.

The Germans put their loss in the Cretan campaign at 5,893 officers and men killed, wounded and missing. They claim to have captured 15,700 British and Greek prisoners, and in addition to have killed about 5,000 more. A British source admits to a loss of about 15,000, but claims that the number evacuated exceeded the number lost. It is further maintained that the German losses equalled 20,000, together with 180 fighter planes and 250 troop carriers.

The lessons of the operations in Crete are clear and unmistakable. Primarily, the campaign was a lasting revelation of the effectiveness and utility of air-borne troops. However, we can easily be led to distort the true meaning of the operation. It is not likely that the particular circumstances of Crete will be soon repeated—an isolated island whose defenders were badly armed and equipped, attacked by a force having complete control of the air. Crete was indeed the ideal situation for such an attack, and full credit is due to the German High Command for recognizing this and taking immediate advantage of it. But it does not follow that an air-borne attack launched over the English Channel by either side would be likewise sure of victory. It may be assumed that the principal use of air-borne troops in the future will be to render valuable support to ground forces.

Certain lessons of previous campaigns were brought into focus once more in the Crete. The time to strike at air troops is while they are still in the air, and immediately after they have landed. Parachutists in the air are completely helpless, and may be easily destroyed by machine gun and rifle fire. When transport planes and gliders are landing they are very vulnerable to artillery fire. In the period directly following their landing, parachutists are fully occupied in locating their arms and equipment and in organizing themselves, and it is then that the defenders should undertake the most strenuous efforts to search out and eliminate them.

³For the record, it was at this early stage of the battle that Prime Minister Churchill made the startling statement that German parachutists had landed wearing New Zealand uniforms. This statement he later retracted, and it now appears that the confusion was caused by the unfamiliar German tropical uniforms worn by the parachutists.

Even the wholly insufficient artillery with which the British were equipped did excellent work in the first days of the battle, and the paramount importance of the arm in the defense of airfields against air-borne attack was again demonstrated. Likewise the need of the cannoneers to be armed with rifles was shown once more. Had the 3.7-inch howitzer troop possessed such arms they might very probably have staved off capture. One commentator added that in such confused and scattered fighting as occurred in Crete small units of infantry should be assigned to the artillery, in order to secure further the defense of the guns and to round up parachutists that fall near the gun positions. Finally, the value of concealment and of dummy gun positions was seen to be great in situations where searching and intensive air attack was to be encountered.

Perhaps the most important lesson of the Cretan campaign is the reemphasis of the fact that to insure the success of any operation adequate air strength must be assigned and placed at the disposal of the commander on the ground. The British have suffered very severely throughout the whole of the war from their failure to recognize this truth. Speaking of the British a short time

ago, General Marshall remarked that "the lack of unity of command between the air and ground forces has courted disaster in virtually every operation they have undertaken." The British failed in Norway largely because they lacked air support, and later in Belgium and France the decision of the RAF headquarters in London not to release its planes to the hard pressed allied armies made it certain that the assaults of the German air force would be practically unopposed. In December, 1940, the British set up an organization called the Army Cooperation Command in the RAF. This appears to have been an attempt to answer certain pointed criticisms with a superficial compromise, while at the same time yielding nothing in the way of real "cooperation" or support. At any rate, "cooperation" on the part of the RAF was notorious by its absence in Greece, and in Crete the lack of air support was, to be blunt, disgraceful. It can hardly be argued that had General Freyberg had sufficient planes under his control the outcome might well have been different. In any event, since we in this country have a tendency to follow the British with regard to the air force, it can not be repeated too often that no army commander can be expected to win unless he can *command* the support of an adequate air force.

*German parachutists attack British near Candia.
(Dever from Black Star.)*



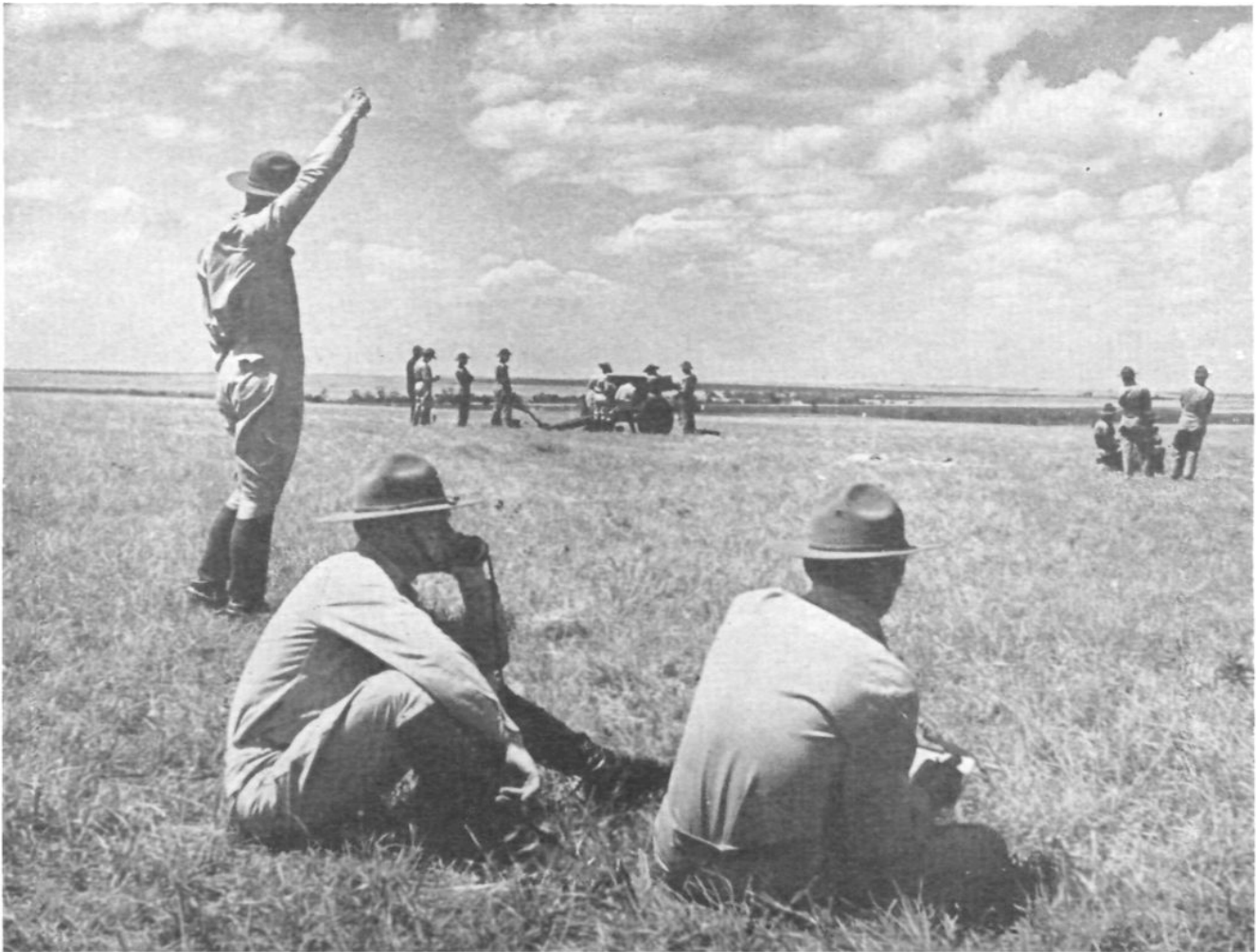

Life

HOW TO PRODUCE AN EFFICIENT FIRING BATTERY

By Majors H. F. Handy and V. F. Burger, FA

Part II—Conclusion

4. SERVICE PRACTICE.

a. General.—Service practice amounts to intensive training for battle. This applies not only to those few officers who fire the problems; it applies with equal force to all troops that participate.

b. Before leaving park.

EDITOR'S NOTE: In Part I of this splendid professional treatise the authors showed how the selection of a good battery executive is of prime importance; discussed the qualities which go to make up a real executive; and set forth many valuable hints for him. Part I also covered in detail the following subjects; Literature to be studied; key men and their training; fire discipline; prepared fire commands; precision; time fuzes; ramming; checks; recorders and telephone operators; and how to obtain *speed*. We consider this series to be outstanding in its field.

(1) Learn all you can about the assignment. In particular find out about the position, the OP(s), the type of firing, the amount and kind(s) of ammunition, and the safety limits.

(2) Set an hour for leaving park that will surely allow you time to be in position ready to fire at least ten minutes ahead of time. A half hour is better. Being late, even once, for a service-practice assignment takes a lot of "living down."

(3) Check the recoil mechanisms.

(4) Boresight the pieces; either do this yourself or delegate it to a single qualified individual. If subcaliber firing is the order of the day, boresight the subcaliber tubes both vertically and horizontally and then remove the tubes for travel. In every park there should be a convenient area where pieces can be boresighted with precision. A distant point serves the purpose rather better

than the test target; however, the test target should be properly mounted and readily available.

(5) Check the gunner's quadrants. These get out of adjustment more often than one would expect, owing in most cases to rough handling and to failure to keep them clean. The method of correcting an inaccurate quadrant is set forth in the FM's on Service of the Piece. Make additional tests to make sure that all quadrants read alike at each of several elevations. The quadrant is the basis of all adjustments of range scales and range quadrants; it must, therefore, be right.

(6) Check the range quadrants and range (elevation) scales in the manner prescribed in the pertinent FM on Service of the Piece.

(7) Check the fuze setters for excessive lost motion and to make sure that, with the same settings, all fuze setters will cut a given fuze with the same time of burning. No tolerance should be allowed.

(8) Test all firing mechanisms, breech mechanisms, gas-check pads, etc., for proper operation and functioning.

(9) Inventory the ammunition to see that it meets the requirements as to quantity and type; spot-check it for condition. Each section should be given approximately the same quantity of each ammunition lot. If it appears that too

many odd lots have been issued, report the fact and try to get the matter remedied.

(10) See that tires are inflated as prescribed.

(11) Have tools and accessories checked for completeness. In a seasoned battery with which you are completely familiar it is usually sufficient here to jog the memories of the NCO's and the mechanic by calling off the items and asking if they have them. Under other conditions you will have to do considerable checking in person. In any event, save as much time as you can be reducing this chore to a system.

(12) Make it a rule always to have field glasses and firing tables at the battery position. There will usually be a definite need for both. You cannot, for instance, compute the minimum elevation without a firing table (or an extract therefrom).

(13) The foregoing is not presumed to be complete. Experience will show you various other matters that have to be attended to. It is a wise idea to keep in the "permanent" section of your personal notebook a check list of all these matters so that none will be forgotten.

c. Occupation of position.

(1) Arrive at the position well ahead of the battery in order to determine how best to occupy it. Get the pioneer work started without delay; this consists chiefly

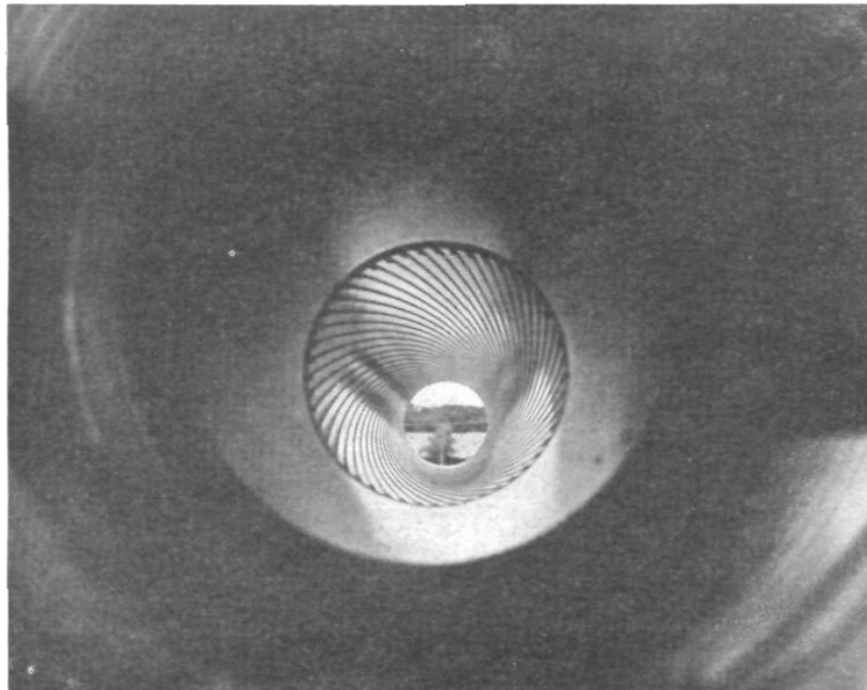

Bore-sighting the piece (Life Photo)

of digging trail pits and leveling wheels. If the pieces are to be fired from the wheels, the position of each piece wants to be carefully leveled laterally and sloped very slightly to the rear. Getting both wheels accurately at the same level speeds up the laying considerably, for it permits the cross-level bubble to remain centered while traversing, and it eliminates traversing uphill.

(2) With some types of materiel, trail pits are necessary and important. The trail pit is not just another hole in the ground; it has definite shape and dimensions and is dug neither smaller nor larger than necessary. Any trail pit must bring about three conditions, namely that the piece will not push back out of position during recoil, that the trail can be shifted easily, and that the piece can be given the highest quadrant elevation that the assignment may require.

(3) Recheck the recoil mechanisms. Recheck also the gunner's quadrants, the range quadrants and range (elevation) scales. Boresight again; do this in person, for it is highly important. Most of these latter operations can be carried on concurrently with the pioneer work.

(4) Determine the minimum elevation (s). This is always a consideration of compelling importance. It is vital when firing over friendly troops or when the mask is close. Strictly speaking, your battery is never ready to fire until you have computed the minimum elevation for every combination of charge, projectile and fuze that you have in the position. The minimum elevation equals the greatest of the minimum elevations reported by the chiefs of section, plus the elevation corresponding to piece-mask range, plus two forks at piece-mask range, plus the number of mils subtended by five yards at piece-mask range. To facilitate and speed up this computation it is a good idea to prepare a set (one for each combination of charge, projectile and fuze that can be fired by your weapon) of cards similar to the one illustrated in Figure 2.

155-mm. Howitzer. Shell Mk I. Charge 5. Fuzes
M46 and M47

Range to mask	Elev.	2 Forks	5 yds.	Total
100	-1.6	2.0	50	51
150	+0.6	3.0	33.3	37
200	2.8	4.0	25	32
250	5.0	4.0	20	29
300	7.2	4.0	16.7	28
400	11.4	4.0	12.5	28
500	15.8	4.0	10.0	30
600	20.2	4.0	8.3	33
700	24.8	4.0	7.1	36
800	29.2	4.0	6.3	40
900	33.6	4.0	5.6	44
1,000	38.0	4.0	5.0	47

(A separate card should be prepared for each combination of charge, projectile and fuze.)

Figure 2

To compute the minimum elevation determine (by the best means available) the range to the mask; select the card that pertains to the ammunition-combination under consideration; note the figure that appears in the "total" column and on the line with the piece-mask range (interpolating between adjacent lines when appropriate); and add to this figure the greatest of the minimum elevations reported by the chiefs of section. Keep the cards secured to your firing table.

Example. — 155-mm. howitzer; HE shell Mark I; charge 5; fuzes M46 and M47. The executive commands; MEASURE THE MINIMUM ELEVATION. The chiefs of section report, in the order 1, 2, 3, 4, minimum elevations (actually these are, of course, sites to the mask) of 113, 112, 116, and 111. The executive determines the piece-mask range to be 650 yards. Referring to the appropriate card (Figure 2), he finds, by interpolating between 600 and 700 (and taking the next higher whole mil in case of a fraction), that the "total" figure for 650 is 35; to this he adds 116 (the greatest of the minimum elevations reported) and thus finds that the minimum elevation is 151. He then repeats the process for all other combinations of the ammunition on hand.

(5) Initial laying for direction is accomplished by any of the methods set forth in training publication G-10. Whatever the method, the azimuth of the initial laying should be determined as soon as possible (preferably prior to firing). Do not wait to be told to do this. Always check the initial laying by an independent means if time permits; for example, if laying was accomplished with the aiming circle check it by referring to a distant aiming point and seeing if the referred deflections differ among themselves about as they should. Spot on the ground the direction of the initial laying. You will nearly always be able to do this with respect to a distant hill, a bush, a rock, or what not, on the terrain to the front. Knowing the initial direction, you are enabled to check visually the execution of such a command as; RIGHT 180; you simply measure 180 mils to the right, using your fingers, fist, matchbox, field glasses, or whatever your favorite angle-measuring expedient may be, and then glance over the tube (s) to see if they are pointed about as they should be. With practice you can, in this way, pick up an error as small as 20 mils. Require your assistant executive and all chiefs of section to make this visual check also. It is all-important because it serves to catch errors *before they are fired*.

Require that the initial laying be accomplished with each piece in the center of its traverse. This insures that the sector which can be covered without shifting trail will be the same for all pieces. Moreover, with split-trail materiel all tubes will have about the same horizontal inclination to the trails, thus affording an additional visual check on the laying for direction. To expedite shifting trail with box trail weapons, have the direction of initial laying materialized on the ground in prolongation of

the trail to the rear. If and when base deflection (new base deflection) is recorded have each piece brought to the center of its traverse and relaid; then have the base line (new base line) materialized in prolongation of the trail to the rear. Spot the direction of the base line (new base line) as indicated above, for visual checking.

The object of the initial process of carefully laying the pieces parallel in a known direction is to make it feasible to lay them parallel (or with a known deviation from parallelism), in *any* designated direction by the simple and rapid means of a deflection shift. This promotes accuracy because there is usually time both to do the work without haste and to check it by independent means; manifestly it makes for speed, for a deflection shift is by far the quickest way of giving direction to a piece. If you have had a reasonable amount of time for occupying your position, and if you then have to manipulate an aiming circle in order to execute fire commands, you will find yourself composing an answer to the question: "What's the delay?"

Once the initial laying is completed and the pieces have been referred you can proceed in a variety of ways. For example:

(a) You can command: RECORD BASE DEFLECTION. Then, when fire commands are received, you quickly determine the appropriate deflection shift and command: BASE DEFLECTION RIGHT (LEFT) (SO MUCH). If and when you are directed to record base deflection, your command to the battery is: RECORD NEW BASE DEFLECTION. This procedure is open to the objection that changing from one base deflection to another introduces chances for error (Par. 7 b).

(b) Many prefer to command: RECORD REFERRED DEFLECTION, and not record any base deflection (by that name) until so directed. This is virtually the same procedure as that outlined in (a) above. It is open to about the same minor objections. Some take exception to "referred deflection" as an additional bit of terminology for the enlisted personnel to cope with. Actually there is little choice between (a) and (b).

(c) You can omit requiring the gunners to record anything, merely commanding: RIGHT (LEFT) (SO MUCH) as soon as fire commands arrive and you have determined the correct shift. However, what if a sight setting is disturbed prior to receipt of fire commands? What if you find it expedient to have a few minutes of drill in service of the piece before the service practice begins? Nothing much, except that you will certainly have to have all deflections checked with the recorder before announcing any fire commands that involve direction.

(6) The initial laying being completed, have the safety stakes set out under the supervision of the chiefs of section. (See paragraph 8.) Check their work if time permits. The safety officer has to check it anyway. In

general, the more you help him, the more he will help you; and such cooperation will expedite the delivery of fire.

d. *Firing.*

(1) *The shift from initial deflection.*—This can be handled variously. One excellent technique, applicable when the *Y*-azimuth of the initial laying is known, is to compute rapidly the *Y*-azimuth of the laying that results from the initial fire command (computation being unnecessary, of course, if the fire command for direction is: COMPASS (SO MUCH)). The difference between these *Y*-azimuths is the numerical amount of the shift: the direction of the shift is determinable from the fact that an increase of azimuth is a shift to the right. The following example illustrates the method:

(a) No orienting line has been established. The battery is laid parallel on *Y*-azimuth 3100 and the (base) (referred) deflections have been recorded. The executive has measured and recorded the *Y*-azimuths from the base piece (No. 1) to all visible aiming points that are likely to be designated. In particular, he has determined that the *Y*-azimuth of the line from the base piece to a certain lone tree is 1062. The initial fire commands include: x x x AIMING POINT LONE TREE x x x DEFLECTION 1480. The executive computes the *Y*-azimuth of this laying by subtracting the announced deflection from the azimuth (increased by 3200 if necessary for purposes of subtraction) of the line; base piece—aiming point; $1062 (+3200) - 1480 = 2782$. The shift is *left* because 2782 is *less* than 3100 (azimuth of initial laying). In *amount* it is 318 mils ($3100 - 2782$). Thus a shift of (BASE DEFLECTION) (REFERRED DEFLECTION) LEFT 318 will put the shooter exactly where he says he wants to be *and with parallelism just as precise as that of the initial laying.*

(b) A good variant of the foregoing is to determine the shift by comparing *either* *Y*-azimuths or deflections, depending on which is announced in the fire commands. It is a little faster. It is also a little more susceptible of the error of shifting in the wrong direction, since deflection and azimuth increase in opposite directions. The following example will serve as an illustration:

(2) No orienting line has been established. The battery is laid parallel on *Y*-azimuth 4700. Pieces have been referred to the blockhouse on Signal Mountain and *base* deflection has been recorded, No. 1's base deflection being 3043. The executive has caused the base piece to measure the deflection to every visible aiming point that is likely to be designated. (Having No. 2 piece also measure these deflections will serve as a check against gross error. They have got to be right.) He has noted these deflections, together with the azimuth of his laying, on a small card (scrap of paper or what not) which appears as follows:

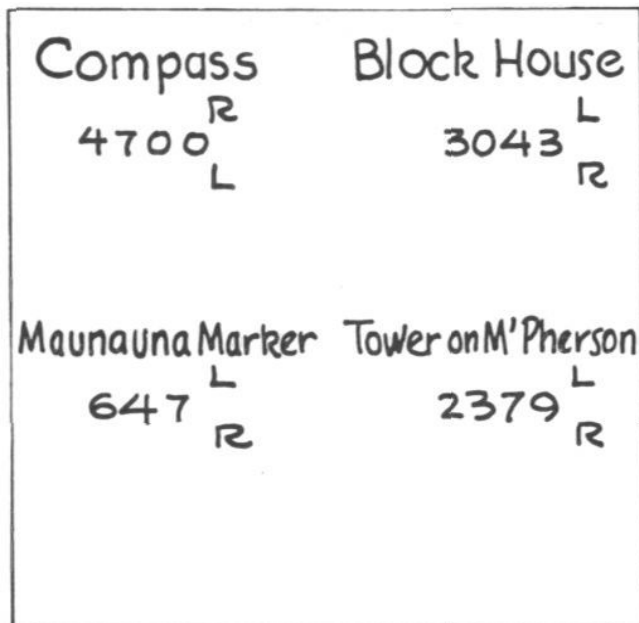

Figure 3(1)

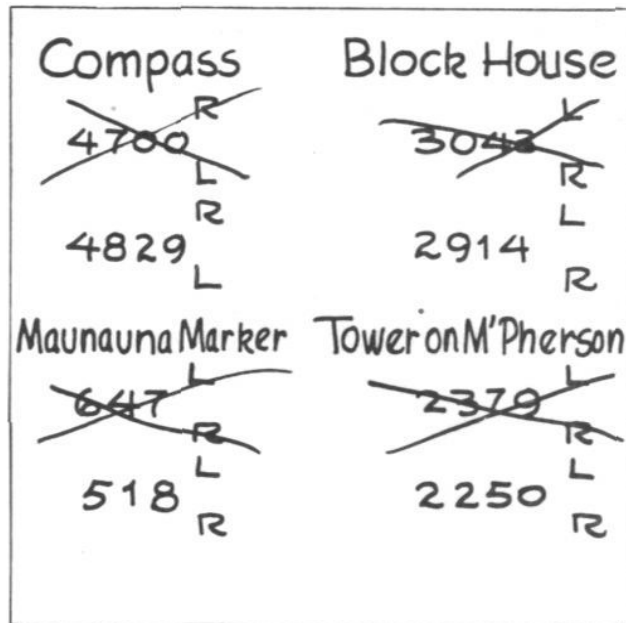

Figure 3(2)

The letters *R* and *L*, as set down on the card, afford a check against shifting the wrong way. This convention is described in some detail in paragraph 8.

The battery is now ready for business. (Refer to paragraph 6 *e* if the following abbreviations are not readily comprehensible.) The executive handles initial fire commands for direction as follows:

Fire Command	Executive's Command
Ca 4665	BDL 35
AP Blockhouse Sig Mt; Df 3125	BDL 82
AP Maunauna Marker; Df 525	BDR 122
AP Tower on MacPherson; Df 2170	BDR 209

Registration is accomplished, with only No. 1 following commands, and the executive is directed: ON NUMBER ONE FORM SHEAF PARALLEL, RECORD BASE DEFLECTION. He checks No. 1's current deflection and finds it to be 2914; that is, No. 1 is now laid 129 (3043 — 2914) mils to the right of its original base deflection. The executive commands: BASE DEFLECTION RIGHT 129, RECORD NEW BASE DEFLECTION, and spots on the ground the direction of the new base line. (Had Nos. 2, 3, and 4 been following commands, sheaf parallel, throughout the registration the executive would merely command: RECORD NEW BASE DEFLECTION.) He now "moves" everything on his card to the right by 129 mils and is again ready for any sort of data that may be announced. His card now appears as shown in Fig. 3(2).

(2) Note that either of the foregoing schemes permits the executive to use an aiming point of his own choosing (the aiming stakes included) throughout the firing, no matter what other aiming point may be designated from the OP. Aside from the considerations of visibility and convenience of location, retaining the same aiming point is

desirable because of *parallelism*. Throughout the delivery of fire the distribution (i.e., the proper covering of the target with fire) is based upon the hypothesis that the sheaf was parallel initially. It is for this reason that so much stress is laid upon parallelism of initial laying, and it is largely to achieve this parallelism that boresighting, laying, and kindred operations are done so meticulously. And it is obvious that, unless considerable referring is resorted to, changing aiming points will operate to throw away whatever parallelism may have been previously attained.

(3) In the first of the examples given in (1) above the executive could have accomplished the same result by laying parallel on a known azimuth, taking a nap until fire commands were received, and then measuring the azimuth to that aiming point which was designated. In the second example he could have waited until he found out, from fire commands received, which aiming point was to be used before having No. 1 measure the deflection to it. In either case such waiting would have thrown away about 300% of the time allowable for getting off the first round. To foresee the possible need and "can" some work ahead of time was simply an application of common sense.

(4) In determining a deflection shift divide the operation into two separate and distinct mental processes: First decide *which way* you are to shift, regardless of how much; then determine *the amount*. Shifting the wrong way is a common error.

(5) Oftentimes the orienting line is established before the base angle can be determined and announced. In such case the wise executive will, if the battery is firing, determine the base angle on which his battery is currently laid. To do this, with an instrument set up over a point on the orienting line he lays reciprocally with No. 1 and

thus establishes the 0-3200 line of his instrument parallel to the laying of No. 1; using the upper motion, he then lays the instrument on one end or the other of the orienting line and reads the base angle (always less than 3200). Now, whatever base angle may be announced, it remains only to make a deflection shift. Similarly, if the battery has just arrived at the position and is not expected to fire for a few minutes, the executive should select an arbitrary base angle and go ahead with laying the battery on it. The arbitrary base angle should be so selected as to place the laying close to the center of the sector and should be a multiple of 100 mils (to facilitate mental computation of any shift therefrom). Bear in mind that a shift to the left increases the base angle.

(6) If the mission opens with an individual piece, station yourself behind that piece, the recorder and T2 accompanying you, and check its direction (also, roughly, its elevation) by sighting over the tube. You should be able to pick up any deflection error in excess of about 20 mils. If the laying appears correct, the piece fires as soon as ready. (The loss of time consequent to checking with the recorder *before* firing is not justified unless you suspect that something is wrong. In fact, from where you stand you can probably see the sight plainly enough to read the deflection within a few mils.) Immediately the piece has fired, have its settings checked with the recorder so that should there be an error it can be reported *at once*. Then check quickly the laying of all other pieces that are following data, first by sighting over the tube and then with the recorder. Both at the start of a mission and after any large deflection shift *there is no substitute for the visual check*, for the gunner may be using the wrong aiming point. This latter happens far more often than one would believe possible. It is here that an assistant executive finds one of his best uses, namely to look after the visual checking of one platoon. Sometimes the first sergeant can be made available to do this. It is not a proper duty for the safety officer, who is concerned entirely with safety and not at all with errors made within the safety limits.

(7) Once in a great while, despite the wisest of precautions, an erroneous round may get away.* In such case there is only one course open to you; no matter how embarrassed you may be, you must make immediate report to the OP (FDC), stating the nature and amount of the error and (if so) that it has been corrected. The officer firing may have based the limit of a bracket on the one bad round, making the success or failure of his adjustment entirely dependent upon it. The men must be made to comprehend this, so that they will report errors immediately they detect them instead of acting with normal human frailty and "covering up."

*This calls to mind Charley Day's old grind about the time when an officer at the firing point phoned down to the battery, which was defiladed from the target area: "Was that last round a dud?" Quick as a flash the exec, replied, "It left here all right, sir!"—Editor.

(8) In firing by platoon or battery neither the chief of section nor the executive should hesitate to call a piece "out" if there is the slightest doubt as to its laying. The best of cannoneers will make an occasional mistake. The idea is to catch these errors *before* they are fired, not after.

5. NIGHT OCCUPATION.

a. Drill.—Never neglect an opportunity to practice occupying position at night, for it is under cover of darkness that batteries move and go into position in war. Executing these maneuvers at night involves no new principles; it is simply the strangeness of working in the dark that must be overcome. Practice is the answer. You will find that after a few sessions the men will become routinized so that they go about their work in a remarkably businesslike way. Develop discipline in the matter of lights and noise right from the start. The battery that shows more than the irreducible minimum in the way of light, or that seems unable to operate without a lot of shouting and bickering, stamps itself at once as an outfit of doubtful dependability.

b. Preparatory measures.—Generally a night occupation is preceded by daylight reconnaissance and survey, at least by the higher echelons, for otherwise the battery will not be able to fire very effectively until after daybreak. When circumstances are very favorable the firing battery may arrive at its position and find a guide for each section, the position for the site of each piece marked by a stake, aiming stakes and safety stakes set out and rigged for illumination, initial pioneer work completed, data as to base angle or base deflection, and various other improvements. When the reverse condition obtains, i.e., when neither reconnaissance nor survey of any sort has been possible, the battery has to get into position as best it can, lay by compass on a known Y-azimuth, and proceed in the dark with the organization of the position. The usual situation is somewhere between the two. Manifestly it is advantageous to get certain key personnel of the firing battery into the position before dark. Although you, as battery executive, have no voice in the matter of who may precede the battery to position, your suggestions may be listened to. You yourself should get a look at the position by daylight if possible.

c. Use of instruments.—In using fire control instruments at night it is often difficult to bring into the field of view the light to be sighted. Also, if more than one light is in the vicinity, the matter of sighting the right one needs consideration and care. It is obvious, then, that in using the aiming circle to lay the battery at night it is better to stay with one piece until its laying is complete than it is to follow the daytime procedure of reading on the pieces in turn and then turning back for check and recheck.

This difficulty of bringing into the field of view the light to be sighted has the effect of putting a good many panoramic sights (telescopes) in the repair shop. The

gunner, searching up and down (as well as right and left) in his anxiety to pick up the aiming circle (aiming stake) light, continues to apply force to the elevating knob after he has unwittingly reached the limit of elevation (depression) and thus jams or strips the elevating mechanism in the tilting head. With the 105-mm. and 155-mm. howitzers, and with various other weapons, this difficulty can be got around as follows: Train the gunner to keep his tilting head set always at zero (300 with some sights), day or night, until by rotation of the entire sight mount he has the aiming point (light) in his field of view and centered vertically therein, then to operate sight mount and tilting head in opposite directions, keeping the aiming point (light) centered in the field of view, until the sight mount has been rotated back to its proper position. The same procedure lends itself very well to accomplishing large changes of elevation with the 155-mm. howitzer and with other weapons of similar design.

d. Night lighting devices.—The newer weapons are equipped with excellent night lighting devices. (Even some of these neglect the gunner.) Some of the older ones have none at all. If your battery lacks any or all of these devices you should start improvising at once. A surprising amount can be done with a little wire, a few cigar boxes and tin cans, and some flashlight batteries and bulbs. The use of flashlights themselves in making settings and centering bubbles is inconvenient and slow. The matter of lighting the aiming stakes and safety stakes is a fertile field for ingenuity. In a really elaborate setup each piece might have lights of a distinctive color, the one on the far aiming stake being placed higher than that on the near so that misalignment will become readily discernible, and the whole system powered by a central battery or generator and thus permitting the position to be lighted or darkened by the flip of a switch. Such a setup is rather on the fancy side. Around a position there is plenty to trip over without introducing a maze of light wires. And wires have a way of shorting out when the weather is wet. In general the simpler things work best.

Another scheme is to tape ordinary flashlights, of the pattern having the beam at right angles to the barrel, to the various stakes. The excess brilliance can be dimmed by covering the lenses or by removing the reflectors. (The scheme of using a distinctive color, or system of colors, for each section is a good one and should be followed when possible.) Under this arrangement you have to send men out to the front to turn lights on and off. This takes a little time and introduces an additional safety precaution, for you must not fire until each chief of section has reported that all of his men are safely in rear of the guns.

The kerosene aiming lamp (issued) is entirely satisfactory. Various expedients that use lanterns or candles will work. It would seem advisable to have both electric and kerosene lights, one system being auxiliary to the other. For unless it runs out of aiming points the field

artillery can distribute explosives in the blackest of nights, when and where they belong. This the dive bomber cannot do.

6. RECORDING.

a. The recorder's mission.—Certain of the personnel at the OP (FDC) will often be inexperienced. Consequently there are bound to be occasional strange and unorthodox commands, notably "AS YOU WERE," which, unfortunately, will probably never die. If an error is made it must be studied in order to learn how to prevent its recurrence and also, if its consequences happen to be serious, to fix the responsibility and thus clear those who are not at fault. Because such study will oftentimes fail if complete data are not at hand, many artillerymen require the recorder to keep an exact record of every command and every message, whether it appears to make sense or not, that is repeated to him by T2. Others believe that so much detail is unnecessary.

Specifically, the recorder must be able to announce at any time the correct deflection (site, corrector, time, elevation, range, etc.) setting for any piece. It is *right now* that his check is wanted, not ten seconds hence. Bear this in mind in scrutinizing any recording system that requires him to compute a setting *after* a check on it is called for.

b. Deflections.—Unless the recorder is both reliable and fast he is a liability. In particular he must keep his deflection figures up to date. The one fundamental requirement for accomplishing this rapidly and dependably is a uniform deflection difference. Such a deflection difference never obtains in a staggered position. It is rarely found in a regularly-spaced position wherein anything has been done about adjusting the sheaf parallel. Fortunately it is possible to set up a common deflection difference artificially by the simple expedient of "recorder's constants."* If zero (usually the most convenient) be the deflection difference to be set up initially, the "recorder's constant" for a given piece is the result of subtracting No. 1's base deflection algebraically from that of the given piece. Thus, if the base deflection of No. 1 is 736 and that of No. 4 is 729, the "recorder's constant" for No. 4 is —7.

Deflection figures having a common deflection difference of zero are set up by arbitrarily making the deflection-column figures for all pieces equal to No. 1's base deflection, then compensating for these arbitrary changes by carrying the proper "recorder's constants," at the tops of columns 4, 3, and 2, to be applied according to sign when determining the actual deflection settings. In other words, the deflection figures of No's. 4, 3, and 2 are deliberately changed, with the intention of changing them back again later on. Once the figures are so set up, it is necessary to keep track of the net amount by

*The "recorder's constant" is so called simply because a better term fails to suggest itself. Any name will do.

which the sheaf has been opened or closed from parallel. This net opening (closing) is the common deflection difference. It is referred to hereinafter as the "Ex DD."

To handle a command that involves both a deflection shift and a deflection difference the recorder applies the announced shift to the directing piece* only, thus computing the new deflection-column figure for that piece. To this result he then applies mentally the current "Ex DD" and thus arrives at the deflection-column figures for the other three pieces. The following example illustrates this:

During the firing the "Ex DD" and the deflection-column figures have come to be as follows (note the common difference of 12 between adjacent deflection-column figures):

Ex DD	4	3	2	1
O 12	1442	1430	1418	1406

The command is received: LEFT 36; ON NUMBER 4 CLOSE 7. Manifestly the "Ex DD" now becomes *open 5* (*close 7* applied to *open 12*). The new deflection-column figure for the directing piece (No. 4) is found, by applying the announced shift of LEFT 36, to be 1478 (1442 + 36). To arrive at the deflection-column figures for No's. 3, 2, and 1 it remains only to apply mentally the current "Ex DD" of *open 5* (RIGHT 5, 10, and 15, respectively) to

*The directing piece is the piece on which the opening or closing is ordered. For the command: ON NUMBER THREE OPEN 12, it is No. 3.

1478. The results are:

Ex DD	4	3	2	1
O 12	1442	1430	1418	1406
	+36			
O 5	1478	1473	1468	1463

The following example (Figure 4) illustrates the entire recording process:

Note.—For the key to the abbreviations used in recording commands see subparagraph *e* below.

The sheaf has been formed (adjusted) parallel. (Since the practice of directing the executive to converge the sheaf at a given range has been discontinued it is immaterial whether the pieces are staggered.) Base deflections are recorded as follows:

4	3	2	1
2152	2157	2150	2153

By using recorder's constants (—1, +4, and —3, respectively, for No's. 4, 3, and 2), to be applied according to sign when determining the deflection setting that a given piece should actually have, the recorder now makes all base deflections agree with that of No. 1, that is, he sets up an "Ex DD" of zero. Note that he handles a shift for an individual piece by changing the "recorder's constant" instead of the deflection-column figure and thus leaves the uniformity of his "Ex DD" undisturbed. This change in "recorder's constant" remains in effect only for the duration of the current mission.



Chief of Section, by raising his arm, indicates that his piece is ready to fire. (Life Photo.)



Night firing involves no new principles; it is simply the strangeness of working in the dark that must be overcome. Illustrated above is a 240-mm. howitzer.

7. CERTAIN COMMON ERRORS, THEIR CAUSES AND PREVENTION.

a. The 100-mil deflection error.—This is the old standby. It seems that every green executive has to let one or two of these get by him before it can be brought home to him just how easy they are to make. These errors are always due either to a gunner's mistake in setting the sight or to a wrong aiming-circle setting by the executive, usually the former.

(1) *Example.*—The executive of a 155-mm. howitzer battery misread his instrument by 100 mils when giving No. 3 its initial laying. The first problem was registration of No. 1 on the base point with other pieces following data. The second problem was a bracket adjustment in which the BC elected to open with a single piece, No. 3. The first round burst about 100 mils left of the target. The BC promptly commanded: RIGHT 100 and continued bracketing with No. 3. When he brought in the battery the trouble broke out, for Nos. 1, 2, and 4 were, of course, 100 mils off the target to the right. This boner resulted in

throwing away some \$120 worth of ammunition. The consequences could have been far more serious.

(2) *Prevention.*—The best preventative here is the visual check of tube direction, *for which there is no substitute.* By this means it is readily possible to detect errors as small as 20 mils. (This is relatively more difficult with the 155-mm. howitzer because of the short tube, the high angle of elevation, and the height of the shield. It is often necessary to stand on the trail in order to see.) An independent method of checking the laying, always to be used when time permits, would also have caught this error. Assuming, for example, that the initial laying was done with the aiming circle, the executive should then have had all pieces measure the deflection to a common aiming point, granted that a suitable one was visible. No. 3's widely differing deflection would have pointed to the error at once. In laying by compass it is easily possible to apply the same large error to all pieces. The

Note.—This process is mentioned here purely for emphasis. A better and more detailed description of it appears in your FM 6-series manual on service of the piece.

independent check here is with the compass to spot approximately the announced direction on the ground, then verify the laying by looking over the tubes.

Require all gunners to use the following procedure when making an announced setting on the panoramic sight:

(a) Set the movable micrometer index in its zero position.

(b) Set the micrometer at zero.

(c) Set the hundreds with the rapid motion (throw-out).

(d) With the micrometer "go left the rest of it." Rigid adherence to this procedure will result in fewer 100-mil errors for you to catch and correct.

b. Other large deflection errors.—For these the gunner is nearly always primarily responsible. Generally he makes them either by getting on the wrong aiming point or by executing an announced shift from base deflection in the correct amount and direction but from an old, out-of-date base deflection. Neither of these contingencies is so rare as one would suppose. Note that a check with the recorder will catch the latter kind of error but not the former.

(1) *Prevention.* — The visual check over the gun tube will surely detect such errors if they are of appreciable size. Whenever a new base deflection is recorded see that you, your assistant, and all chiefs of section have the direction of the new base line adequately spotted on the ground, then assure yourself that every gunner has erased his old base deflection from both his shield and his memory and has recorded his new one correctly. This latter, plus due care in selecting aiming points, should keep such errors to a minimum. Nothing, however, will obviate the necessity for the visual check.

c. Errors in elevation.—The causes of these are more difficult to classify. Wrong settings of the range drum or the angle-of-site scale are possibilities. With the gunner's quadrant, 100-mil errors are possible, 10-mil errors fairly common.

(1) *Example.*—A 75-mm. gun battery fired a salvo with HE shell. The command was: QUADRANT 213. The chief of the third section erroneously set 113 and the piece was fired with that elevation. The projectile burst in the mask about fifty yards in front of the piece and a cannoneer was severely wounded.

(2) *Prevention.*—In this case the executive and his assistant, and above all the safety officer, should have noticed that No. 3 was laid at a much lower elevation than the other pieces. In general, large errors in elevation are detected by the visual check. With the gunner's quadrant 10-mil errors seem to be most prevalent at settings involving 30 or 80. This tendency can be offset somewhat by training men to verify a 30 setting as being 2 spaces below the 50, an 80 setting as 2 divisions below the hundred. Small errors can be caught by checking with the recorder, although this is seldom done before the piece is

fired unless there is some cogent reason for doubting the laying.

d. Errors in laying by base angle.—These are due to various causes, among the more common of which are setting the instrument incorrectly, setting up the instrument over the wrong point, and sighting the wrong point.

(1) *Example.*—A battalion occupied surveyed positions. A stake was placed on the orienting line near each battery. These stakes, together with suitable sighting-points on the orienting line, were pointed out to the battery executives by members of the survey party. Battery B registered. In a subsequent attempt at a battalion concentration Battery A was off the target by some 400 yards, Battery C by about 200 yards. Investigation revealed that the position area was liberally studded with old stakes and that the executives of Batteries A and C had become confused by this and set up their instruments over the wrong stakes.

(2) *Prevention.*—This occurrence is just one more testimonial for the practice of checking by independent means. Had each battery executive been given also the azimuth of his base line he could have first laid his battery with the base angle as given and then used his declinated instrument to measure the azimuth of his laying. If this measured azimuth disagreed materially with that furnished him by the survey party (as would certainly have been the case if he had set up over the wrong stake or had sighted on the steeple in the wrong village) he would know at once, without any erroneous shooting, that something needed correcting.

In setting instrument-position stakes on the orienting line it is good practice to tie securely to each a tag bearing the designation of the battery, the date to be used, and any other information that may be pertinent.

e. Firing with incorrect charge.—A short charge endangers friendly troops. One increment too many is likewise harmful in most noncombat firing. Both are harmful to careers. The best prevention here is to make all men keenly aware of the serious consequences of firing with the wrong charge. It is a good rule to require the chief of section to verify the charge as it is loaded.

f. Carelessness of personnel; examples. — (1) The executive of a 155-mm. howitzer battery very carefully laid his battery parallel with the aiming circle, then commanded: AIMING STAKES OUT TO LEFT REAR ON DEFLECTION 400; RECORD BASE DEFLECTION. The chief of the second section was observed to direct, by arm signals, the approximate placing of the far aiming stake and then to cause his gunner to traverse the piece by a small amount.

(2) The First Section, Battery X, is firing a precision adjustment. The command: 3 ROUNDS; 242, is received and is executed with remarkable speed. An experienced observer notes, however, that:

(a) For the second and third rounds the chief of

section did not so much as place his gunner's quadrant on the piece.

(b) For these two rounds the gunner did not so much as glance through his sight, to say nothing of getting back on his aiming point.

(3) The first piece of carelessness (and it was nothing else, for the chief of section was a thoroughly experienced old-timer) could have been checked up by calling for an additional reading on the aiming circle after the operation of setting out the aiming stakes was complete. This is always a good idea when time permits, for it surely detects any disturbance of the laying. As to firing two rounds without laying for either direction or elevation, there are grounds here for disciplinary action if it is certain that the omissions were due to carelessness and not to lack of instruction or training. In this particular case the executive had been pushing speed and neglecting accuracy. He got just about what he called for. Such omissions can be detected only through the powers of observation of the executive and his assistant. They are very flagrant, however, and certainly should not escape notice. Of course it can only be assumed, without interrupting the firing, that the gunner sees something—and acts properly upon what he sees—when he makes the gesture of looking through his sight. Likewise the fact that the motions of laying for elevation were gone through does not prove that the operation was correctly performed or performed at all.

g. Danger from recoiling tube and from ammunition with time setting.—(1) With the split-trail weapon the danger of men getting into the path of recoil and being killed or seriously injured is considerably enhanced. The only remedies are to make the men keenly recoil-conscious and to keep a sharp watch for indications of carelessness.

(2) Regulations prescribe that such time fuzes as may have been cut but not fired be set back at safety before being returned to caissons (ammunition trucks). The potential consequences of neglecting this matter are sufficiently grave to warrant requiring that the setting at safety be verified by a commissioned officer.

8. USEFUL EXPEDIENTS.

a. To guard against shifting the wrong way. — In computing a shift two distinct mental processes are involved: First determine the direction, then determine the amount. Compass increases to the right. Deflection and base angle increase to the left. The following example illustrates a convention that is designed to prevent the error of shifting the wrong way:

There is no survey. The executive has laid the battery parallel on compass 4400 and has caused the pieces to be referred. The referred deflection of No. 1 is 134. Through prearrangement the executive knows that the initial fire commands will include either a compass bearing or the aiming point to which the pieces are referred. He has made notes as follows:

Ca	AP	
R	L	L
4400	134	3334
L	R	R

If (in making his subtractions, he now adheres to the practice of *keeping the larger number above the smaller*, the R or L on line with which he writes the announced compass or deflection will automatically tell him whether the shift is *right* or *left*. Thus COMPASS 4730 calls for a shift of RIGHT 330; AIMING POINT x x x x DEFLECTION 390, requires a shift of LEFT 256; while an announced deflection of 3040 indicates a shift of RIGHT 294.

Ca	AP	
(4730) R	(390) L	L
4400	134	3334
L	R	(3040) R
—	—	—
330	256	294

Note the trick of writing down both 134 and 3334 (134 increased by 3200) to take care of shifts of more than 134 mils to the right. In like manner both the compass and the compass-plus-6400 would have been noted had the initial laying been close to Y-north.

b. Refinement in forming sheaf parallel with the aiming circle.—Cross-levelling the panoramic sight displaces the sight-head; so, with most weapons, does elevating or depressing the tube. It is therefore good practice, when using the aiming circle to form the sheaf parallel, to require that cross-level bubbles be centered and that the pieces be laid with a mid-elevation that is the same for all.

c. To lay an instrument on a high burst.—As executive you may have occasion to lay the 0-3200 plane of a BC telescope (aiming circle) (exactly on a high burst. This is a simple matter if the air is still. In a strong cross wind it is not so simple. The following trick solves the problem without calling for additional bursts: Sense the lateral deviation of the burst, using the mil scale in the reticule. Assuming, for instance, a deviation of 17 *left*, depress the instrument and note some terrestrial object (materialize one if necessary) that appears 17 mils to the left of the vertical hair. With the lower motion traverse left until the vertical hair rests on the object noted. The 0-3200 plane now contains the point of burst.

In performing this high-burst operation at night close your eyes when the piece is fired. Otherwise you will be so blinded by the flash that you will probably fail to see the burst. Also, have with you an assistant to spot the burst with his naked eye and thus assist you in picking up the second burst in case the first is outside your field of view.

d. Setting out aiming stakes.—The terrain often permits simplifying the recorder's work by placing the aiming stakes so that all pieces will start off with the same

deflection. *Example:* A 155-mm. howitzer battery has been laid parallel. No suitable natural aiming point is visible. The executive commands: AIMING STAKES OUT, LEFT REAR ON DEFLECTION 400. (The aiming point for the 155-mm. howitzer should be to the left rear, for in other directions the gunner's view is interrupted by the shield, the counterweight, or adjacent pieces and personnel.) After the aiming stakes are in place it is wise to make sure that the laying of some piece or other has not been disturbed, i.e., that only the *sights* have been moved.

When there is a possibility that the natural aiming point which you elect to use may become obscured by darkness, fog, or what not, have the aiming stakes for each piece set out on the line: Panoramic sight—aiming point. This will obviate the necessity for additional referring. Note, however, that if the aiming point lies much toward the flank you may have some difficulty, owing to displacement of the piece by recoil, in keeping the aiming stakes aligned.

e. Quadrant bubble.—With some types of materiel it is possible to save time in centering the bubble of the gunner's quadrant by setting the site at 0 (300), setting the announced quadrant elevation on the elevation scale, and then centering the range bubble approximately by elevating (depressing) the piece. The foregoing is accomplished while the chief of section is making the setting on the gunner's quadrant.

f. Precision and accuracy with the aiming circle.—In using the aiming circle take up the lost motion uniformly, just as you require the gunner to do in laying his piece. One way of doing this is to make the final motion of traversing always from left to right and then, before accepting a sight, to twist the head of the instrument lightly to the left and see if the vertical hair comes to rest on the point sighted (or if the needle comes to rest properly centered, if needle centering is the operation in hand). In centering the needle, tap the instrument gently with the finger tips to make sure that the needle remains free on its pivot.

Make it a habit to assure yourself, upon finishing such an operation as laying the battery, measuring the base angle, or the like, that a clamp left loose, an inadvertent movement of the lower motion, or other disturbance of the instrument, has not thrown your work into error. This can be done very easily by setting the instrument at its initial reading and seeing if the vertical hair falls on the point initially sighted. If the operation was based on a centered needle, and if you did not refer the instrument immediately after centering the needle, you can check by setting off the initial reading and then releasing the needle to see if it centers.

9. SAFETY OFFICER.

a. Regulations. — Army Regulations 750-10, dated May 22, 1939, require that for all artillery firing in time of peace a safety officer be stationed at the battery position.

b.—Duties of the safety officer.—These are:

- (1) To verify that all pieces are laid safely before permitting them to fire.
- (2) To verify that the proper (safe) charge is used.
- (3) To verify that the range is clear before firing. This is usually determined by a check on the red flag (red light at night) which is displayed at the control point.
- (4) To verify that no personnel are in the visible portions of the danger areas.
- (5) To verify the initial laying and the minimum elevations.
- (6) To notify the battery executive when it is safe to fire.
- (7) To enforce safety regulations at the battery position.

c. Safety data.—Prior to firing, the safety officer is provided with data pertaining to safety. Many organizations furnish him an overlay of the firing area. Others issue him a safety card (Figure 6). In either case all data shown on the card (Figure 6(1)) must be included. Figure 6(2), the back of the safety card, presents to the safety officer some suggestions concerning his duties. Prior to firing, the data on the safety card should be checked with the officer in charge of the practice.

SAFETY LIMITS FOR <u>105-mm. How.</u>		
Date	<u>9/12/41</u>	1941-1942
FIRING POINT	<u>82</u>	(Good for any position within 300 yards of this Firing Point.)
AREA	<u>JONES Ridge</u>	
REFERENCE POINT	<u>Y-Azimuth</u>	Y-Az
LEFT LIMIT	<u>Y-Azimuth 2800</u>	
RIGHT LIMIT	<u>Y-Azimuth 3400</u>	
MINIMUM RANGE	<u>2600</u>	yards.
MAXIMUM RANGE	<u>7000</u>	yards.
SPECIAL INSTRUCTIONS		
<u>Y-Azimuth 3300 to 3400 Maximum Range 5000</u>		
Card prepared by	<u>J.S.</u>	Checked by <u>V.F.B.</u>

Figure 6(1)

SUGGESTIONS FOR THE SAFETY OFFICER

The Safety Officer should locate the safety limits for direction by prominent points on the terrain, or by stakes properly placed, as soon as he arrives at the gun position.

He should make certain that the red flag is flying at the control point. If this flag is not visible he should report the fact to the instructor in charge.

He should assure himself that he has a compass or aiming circle which functions properly and that he knows its declination constant.

When all of the guns of the battery are visible from some point approximately fifty yards in their rear, the Safety Officer should, in most cases, be able to determine the general direction of each gun without taking the time to go to the trail and look over the line of metal, provided that the guns are all pointing well within the safety limits. *The responsibility for the determination of doubtful cases rests, however, with the safety officer and he must take such means and devote such time to this check as is necessary in each particular case.*

The Safety Officer will notify the executive of the battery when it is safe to fire by calling "safe to fire" as soon as he has assured himself

that such is the case. *The practice of assuring safety for direction by the deflection reading only is dangerous.*

In case a command is received at the battery requiring fire outside of the prescribed safety limits, suspend fire and notify the instructor. *Do not fire unless he assumes the responsibility.*

Ranges less than the minimum range determined by the executive will not be fired.

Figure 6(2)

d. *Safety stakes.*—Safety limits should be materialized on the ground; safety stakes afford a convenient means of accomplishing this. Each section should be equipped with sufficient stakes for any position. The stakes of each section must be so constructed that they can be easily identified. In some organizations the stakes of a given section are painted a distinctive color, and within the section the tops of the individual stakes are of different design. For instance, each section may have for its right limit a stake with a square top, for its left limit a disk, for its right intermediate limit a diamond, and so on. At night the stakes should be illuminated with a distinctive color for each limit within a particular section. Prior to arrival at the firing point, or as soon as the safety card (overlay) is delivered at the position, the safety officer should make a rough diagram of the firing area, including thereon all pertinent safety data which have been furnished him. Figure 7 shows such a diagram based on the data from the card in Figure 6, for 105-mm. howitzers firing HE shell.

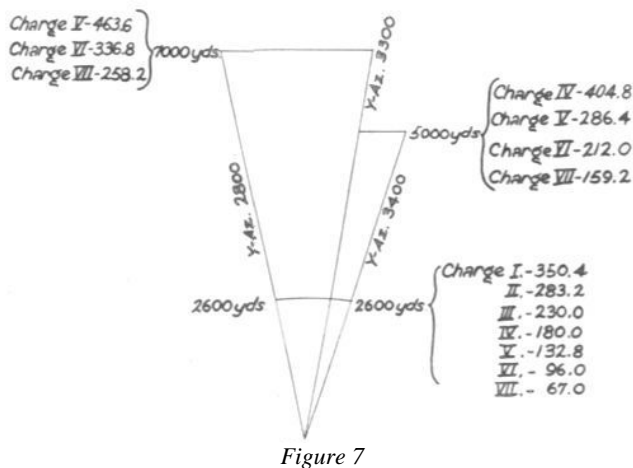

Figure 7

e. *To place the safety stakes.*—*Example:* Assume that the battery is laid on Y-azimuth 3100. The safety officer first verifies the initial laying of the battery. To determine the deflection on which to set the left safety limit the safety officer notes from his diagram that the Y-azimuth of the left limit is 2800; thus the battery can shift 300 mils left from its present laying. The azimuth circle (movable, with fixed index) of the panoramic sight is graduated counterclockwise, so that the deflection for the left limit is 2900 (3200 — 300). He proceeds in a similar manner for the intermediate limit and the right limit, and then announces to the chiefs of section: LEFT LIMIT, DEFLECTION 2900; INTERMEDIATE LIMIT,

DEFLECTION 200; RIGHT LIMIT, DEFLECTION 300. Each chief of section then has his stakes set out and reports: "Safety stakes ready for check." Finally the safety officer verifies the laying of the pieces and the positions of the safety stakes.

The foregoing method is fast and accurate, and it necessitates the minimum disturbance of the pieces after they are laid. The lateral displacement of the sight with respect to the axis of the tube is inconsequential if the safety stakes are placed as far as 100 yards from the sight. Having checked the placing of the stakes, the safety officer computes the maximum shifts that can safely be made from the initial laying. In this case shifts of *left 300* and *right 300* (3400 — 3100 = 300; 3100 — 2800 = 300) may be made within the lateral limits. Commands causing shifts greater than these will evoke an immediate report that (for the reason stated) it is unsafe to fire. *Example:* Upon hearing the fire command: COMPASS 2760, the safety officer immediately (i.e., prior to the laying of the pieces) reports to the officer conducting fire: "Unsafe to fire; 40 mils left of left safety limit." After adjustment on the base point and consequent recording of base deflection, the safety officer computes (measures) the adjusted compass. From the adjusted compass he computes the maximum safe shifts from base deflection. *Example:* The battery was laid as above (Y-azimuth 3100). During adjustment on the base point a total shift of *right 48* was made and base deflection was recorded. The shift (*right 48*) was determined by the difference between the gunner's initial deflection and his deflection at the end of the adjustment. The adjusted compass is, then, 3148. Shifts from base deflection as great as BDL 348 and BDR 252 may now be made within the lateral limits. Accordingly the safety officer completes his safety diagram by inserting BDL 348 on the left limit, BDR 152 on the intermediate limit, and BDR 252 on the right limit.

Elevation is handled as follows: The safety officer verifies the minimum elevation as determined by the battery executive. Assume it to be 165 mils for charge IV. Commands received include: x x x x CHARGE IV, BDR 200 x x x x; the safety officer, by reference to his diagram, notes that safe quadrant elevations for charge IV in the indicated part of the sector lie between 180 (comparing the minimum elevation as computed by the executive with the minimum elevation as determined from the safety card and *using the greater of the two*) and 404.8. Should a quadrant elevation of 160 (or a site and an elevation whose algebraic sum is 160) be announced the safety officer will report: "Unsafe to fire. Minimum elevation for charge IV in this part of the sector is 180."

Having determined by computation whether commands, if properly executed, are safe to fire, the safety officer then uses visual means to satisfy himself that the laying is safe.

10. RECAPITULATION.—The aim of this paper has been to point up in considerable detail certain important

matters on which official training literature is, of necessity, brief and to the point. It makes no pretense of covering the subject in its entirety.

By way of harping on a few highlights for the battery executive:

- a. Be able to do the following in your sleep:
 - Lay the battery on a given Y-azimuth with the aiming circle.
 - Measure the adjusted compass.
 - Lay the battery on a given base angle with the aiming circle.
 - Measure the adjusted base angle.
 - Determine the minimum elevations.

- b. Except for speed and manual dexterity, which can be acquired only through persistent practice, be able to do *any* job in the firing battery better than any of your subordinates.

- c. Be an expert trouble shooter for the materiel with which you are armed; know the cause and correction for

every likely malfunction, to the end that such may cause a minimum of delay.

- d. Know your NCO's and men, their strong points and their weaknesses, so that under given circumstances you may know about what to expect from each.

- e. Catch mistakes *before* you shoot them. This you will never be able to do consistently without the *visual check of sighting over the tube*.

- f. Be especially on your guard against errors of an even hundred mils.

- g. Take the greatest of pains with the initial parallelism of your sheaf, for on it depends the distribution for, and therefore in an appreciable degree the effectiveness of, the missions that are to be fired.

- h. Set a high standard of accuracy and speed for your battery, and never be satisfied with results that are short of superior. Toward this end take advantage of every opportunity to make finished, professional teams of your gun squads.

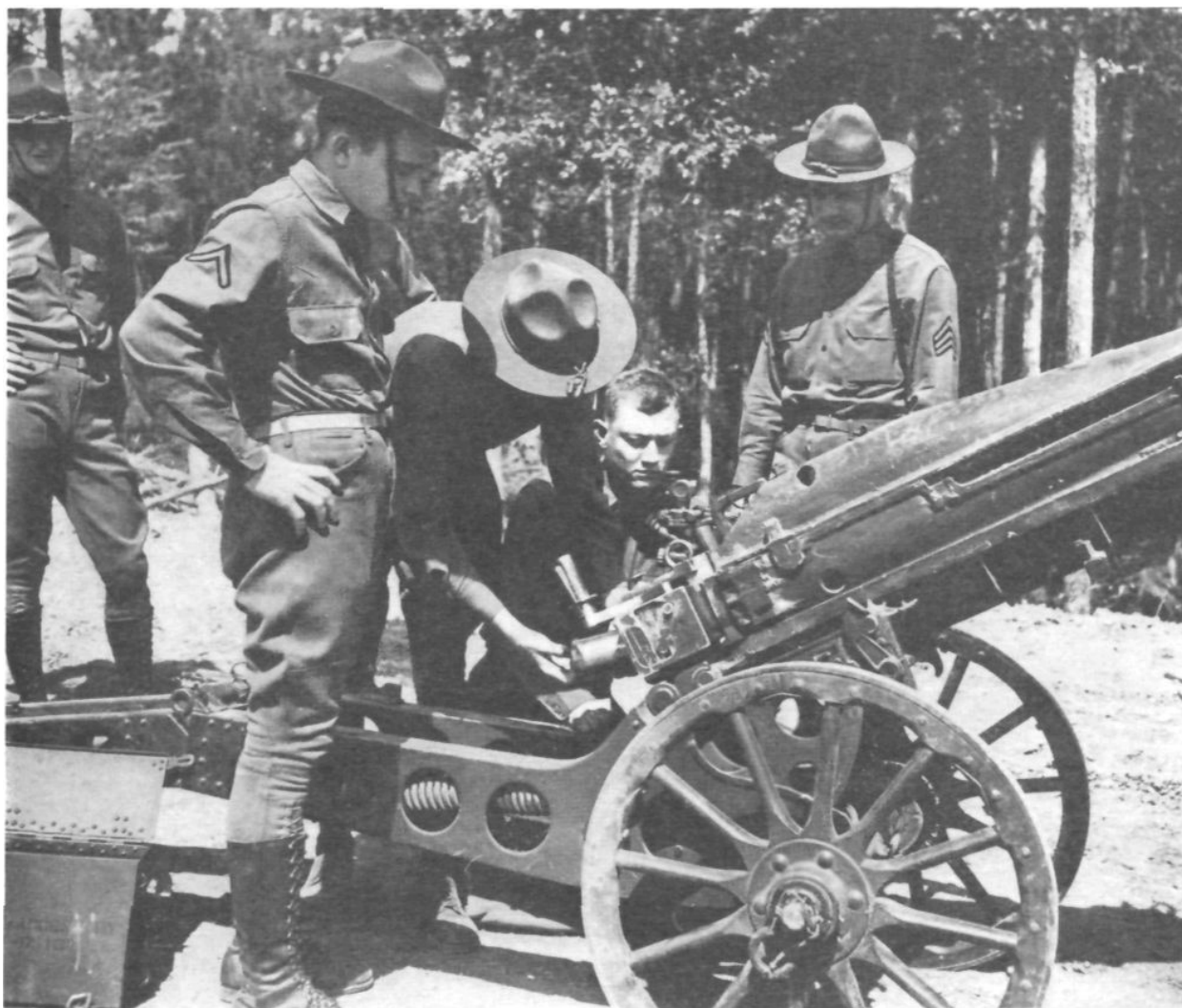

Be an expert trouble shooter for the materiel with which you are armed. Illustrated is the 75-mm. pack howitzer. Life Photo.

ANTENNA MOUNTING

By Major Stanley B. Bonner, FA

EDITOR'S NOTE: *This article describes another way in which the using arm has used its ingenuity in installing the SCR-245 radio set in the ½-ton, 4×4 radio car. The retractable antenna is a new "wrinkle" of considerable merit, according to field artillery officers who have had long years of experience in communication work.*

Initially, six vehicular radio sets, SCR-245-J, were issued to the 5th Division Artillery. Accompanying these sets were copies of the instruction books for Radio Installation in Truck (½-ton 4×4 Command Radio). Later one truck, ½-ton 4×4 Command Radio, Dodge 1941, was received by the 5th Division Quartermaster, and assigned to Headquarters Battery, 5th Division Artillery. Unfortunately, this vehicle differs materially from that shown in the instruction book, therefore it was necessary to modify this installation considerably. This truck, with modifications enumerated below, was used as a model to insure rapid and uniform installation when trucks for mounting the remaining five vehicular sets were received, about a week prior to departure for Second Army maneuvers.

Instead of bucket seats, as shown in the instruction book, the 1941 Dodge comes equipped with full-width, solid-back seats. Therefore it was decided that the chest in which the equipment is mounted should be bolted not only to the floor but also to the front-seat upper support. To insure room for the antenna insulator it was necessary to use three spacers, as shown in Figure 1. The antenna insulator was then mounted on top of the junction box bracket.

No means of attaching the antenna base bracket were provided. Therefore material was obtained for bracket supports mounted as I, J, and K in Figure 3.

To permit operation with vehicle in motion, the following means for lowering the upper sections of the antenna to a horizontal plane about three feet above the top of the car, and bracing it against excessive side-whip, were devised:

1. A small clothesline reel was purchased. The case of the reel was drilled with two openings to permit two lines (SCR-178 antenna guy rope) to be reeled in simultaneously. This reel was mounted inside the body, above the left end of the rear seat, as per Figure 3,N. The ratchet release lever on the reel permits the antenna spring to erect the antenna automatically. The two cords



Command car with antenna mounting

from the reel run over pulleys as shown at L, Figure 3, thence through two brass bushings, mounted on top of curve of body at rear corners of car, as shown at D, (Figure 2 and 3), at the top of which snap E is wired. This snap



View showing details of mounting at base of antenna

Installation of the SCR-245-J in the Truck ½-ton 4×4 Command (Radio), Dodge 1941

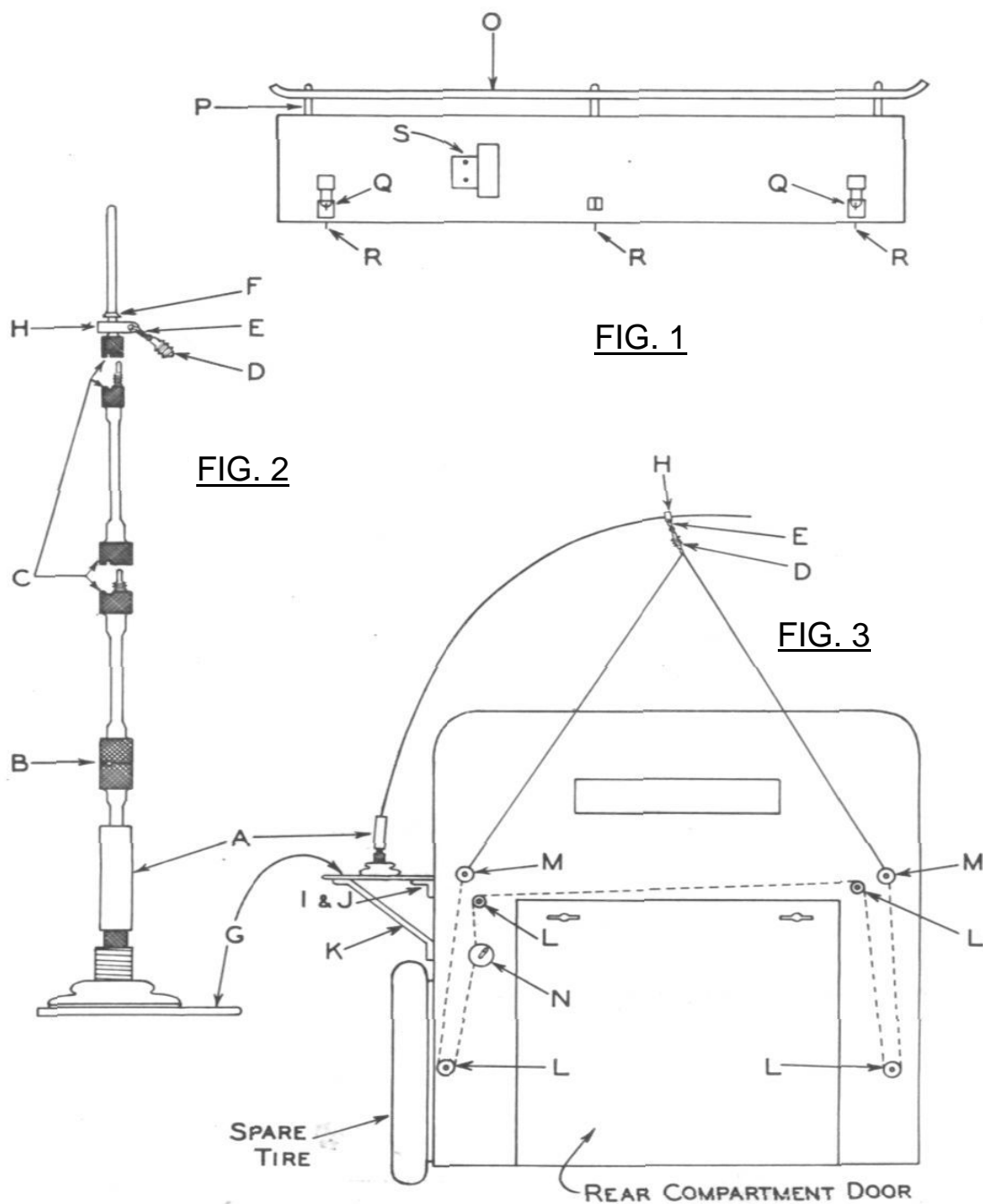

FIG. 1

FIG. 2

FIG. 3

- A—Eighteen-inch length of five-eighths inch garden hose installed over lower section of mast, to insulate mast from metal support in rear curtain when open.
- B—One-sixteenth-inch holes drilled off center of mast and not affecting the threads. Sections must be screwed tight and drilled to divide the hole in both mast sections. Wire is then inserted and wrapped one turn around mast, locking it securely.
- C—View of mast sections before screwing together.
- D—One-inch porcelain strain insulator.
- E—Snap.
- F—Band or washer soldered on fourth section of mast to hold clamp H in place.
- G—Mast base.
- H—Three-fourth-inch by one-sixteenth-inch metal strap made into a clamp fastened permanently on mast section. Mast must turn in clamp and a hole for Snap E in clamp.

- I & J—Two brackets: three-sixteenths-inch by two-inch, five inches long. Ninety-degree angle. Two three-eighths-inch holes in each.
- K—Bracket, three-sixteenths-inch by two inches, fourteen inches long. Two holes in lower end. One hole in top.
- L—Four swivel-type pulleys for one-fourth-inch rope mounted on body braces as shown.
- M—Two brass bushings, three-eighths by one inch with two nuts each, mounted on top of curve of body.
- N—One clothesline reel, double rope type, mounted on left side panel, six inches below railing and six inches in front of rear back rest.
- O—Front seat upper support.
- P—Three spacers, eleven-sixteenths-inch by one inch.
- Q—Hasps on removable door, CH-60.
- R—Studs installed on frame, CH-60.
- S—Dynamic speaker in plywood case.

hooks onto the eye of a movable clamp which swivels around the fourth mast section under washer F (Figure 2) soldered on fourth mast section, as indicated in Figure 2. Mast base G, swivel attachment D, E, and F on fourth mast section, and the two brass bushings M, form a tripod support for the antenna, both in the erect and traveling position.

2. When side curtains are in use, and the antenna is in the traveling position, the left rear curtain will touch the lowest mast section when the door is opened. When this occurs during operation of the transmitter, not only loss of radiation due to the metal reinforcement inside the curtain, but burning of the canvas, results. To prevent these conditions an eighteen-inch length of five-eighths-inch garden hose was fitted over lower section of mast, as per A, Figures 2 and 3.

3. To prevent mast sections from unscrewing while in the traveling position, and becoming lost, mast sections were drilled and keyed together, as per Figure 2, B and C. This obviates the clumsy appearance resulting from taping the junctions of the mast sections.

The alternate transmitter tuning unit case was mounted above the right end of the rear seat on the inside of the car

body, thereby providing an arm rest for the operator on the right.

A dynamic speaker S, Figure 1, was mounted in an OD painted plywood case on the top of the chest. This permits staff officers and others to hear reports of air observers, without the use of headsets, thereby eliminating relay time from the operators of the set.

The cover, or removable door, to the chest may be opened although the hasps Q, Figure 1, are locked, simply by lifting up the door until it becomes unseated. This has been prevented by placing horizontal studs, R, Figure 1, protruding to the rear, through corresponding holes bored through the door under each hasp. This prevents any vertical displacement of the door, permitting the cover to remain securely locked when set is not in use.

Hooks upon which to hang the headsets and microphones were attached to the under surfaces of the top and shelf of the chest. Also a small pigeon-hole for message books, log sheets and pencils. All equipment for operation is in front of the operator when door of set is unlocked and removed.

This set performed exceptionally well during the recent Second Army maneuvers in Tennessee.

POPULAR RM MISCONCEPTIONS

- FANCY :** The bulk of the German artillery is now carried on self-propelled mounts.
- FACT :** Horse-drawn artillery constitutes the bulk of German artillery.
- FANCY :** German tanks are employed in "steam-roller" fashion to mow down all obstacles and resistance.
- FACT :** Tanks take all measures possible to avoid obstacles and strong points of resistance. They circle the antitank guns and attack them from the rear, if possible. Nests of resistance are isolated and by-passed. The tanks are also charged with the mission of cutting lines of communications and disrupting the enemy's rear organization. Infantry, together with artillery in close support, overcomes obstacles and strong points of resistance.



War in The Balkans

Strategic Background



The Field Artillery Journal's military
commentator presents another profound
discussion of current history



By Colonel Conrad H. Lanza, FA



EDITOR'S NOTE: *This is the first of a series of studies by Colonel Lanza covering one phase of the European War. Each article will be complete in itself, but the series deals with the same general subject.*



IMPORTANCE OF THE BALKANS

In early 1939 the Balkan states constituted, as always, one of the "hot spots" of Europe. Their geographical position (which included the Straits at Istanbul), their raw material resources, and their own military forces made them valuable in war to any side they might espouse. They were well aware of this. Their aid was solicited by three mutually hostile groups:

- a. *The Axis*—who needed the Balkans for economic reasons, and wished to avoid a fighting front in that area, in order to concentrate forces elsewhere.
- b. *The Allies*—who wished to control the Balkans in order to deprive the Axis of its resources, and desired to have a fighting front ready if needed by them.
- c. *Russia*—who ardently desired control of the Straits, and to accomplish this, control of the Balkans; and whose traditional policy was to keep both Axis and Allies out of the Balkans.

The Balkan states, seeing that war was brewing, wanted to avoid becoming involved until the winner could be determined. They were accustomed to playing the three sets of Powers against each other, which meant that promises, threats, bribery and propaganda were commonplace in the Balkans. Thus everybody was kept guessing as to what the final outcome might be.

The exterior pressure on the Balkan region applied to each of its states. Their individual aspirations varied considerably, and each was motivated by self-interest.

Rumania was anti-Russian. She feared that Russia would attack her to recover Bessarabia. Unable to resist Russia alone, she needed an ally. King Carol was pro-French, and so, in general, were the influential classes. They preferred to join the Allies, but could not see any practicable way for the Allies to get help to them in case of war. Tentatively they did not desire to break with the Axis, which was within marching distance of their frontiers. A large section of the people was pro-Nazi, which had to be taken into consideration. There was a strong anti-Semitic movement in the country; this too might cause trouble. At the end of the World War, Rumania had seized territory formerly belonging to Hungary and Bulgaria. Neither of these states would now promise that in case of war between Rumania and Russia they would not take advantage of this fact to seize their old possessions. Hence Rumania might have to fight on three fronts—a hopeless situation, unless she were supported by a strong ally.

Hungary, having lost territory to Rumania and Yugoslavia, was hostile to both. She would not join either in a common war, unless they returned to her her former

lands. This they would not do. Hungary also was anti-Russian, owing to Russian efforts to establish communism in Hungary, which was overwhelmingly Catholic and bitterly opposed to communism. The Magyar Hungarians disliked the Teutonic Germans, but since the World War Germany had been their one friend. With German aid they had recovered from Czechoslovakia former Hungarian territory. As a business proposition, it looked like Hungary's best bet to side with Hitler.

Yugoslavia also disliked the Axis states. She did not, however, want war with them. She had a direct frontier with both Germany and Italy which was in the form of a salient protruding into enemy territory and which would be difficult to defend. This salient was Croatia, constituting roughly one-third of the entire state. The Croatians were in constant dispute with the other two-thirds of the joint state of Croats, Serbs and Slovenes, and had repeatedly threatened to secede. They were Catholics, and considered themselves as having superior culture to the Serbs and Slovenes who belonged to the Orthodox Church. Yugoslavia owned territory which had been taken from Hungary and from Bulgaria, and consequently feared that if she got into a war these two states would join with her enemies.

Bulgaria was hostile to Rumania, Yugoslavia and Greece, from all three of whom she claimed territory. She would join in nothing with any of them unless they first returned this territory. Her ruling class was pro-Axis, the royal family being of German origin and the King married to an Italian princess. No Bulgarians favored the Allies, since they associated the Allies with being responsible for the Bulgarian defeat in 1918, with the consequent loss of territories and other treaty clauses injurious to their autonomy and pride.

Turkey, as holding the Straits at Istanbul, was of major importance in any Balkan war. She was determined to take advantage of this situation. She did not fear the Axis, as their land forces were believed to be too far away, and their naval forces were manifestly inferior to those of the Allies. She recognized the value of sea power with its possibility of blockade, as well as to land expeditionary forces on her territory. Turkey was aware of Russian interest in the Straits—had had former wars with Russia over this matter. She also had a common frontier with Russia in Armenia. The Russian lines of communication to this area were superior to those of the Turks, which made it probable that Russia could maintain and supply a superior force in case of war on this front. Russian naval forces in the Black Sea were stronger than those of the Turks. Under no consideration did Turkey care to risk war with Russia, but as

between the Allies and the Axis, she definitely preferred the former as the stronger (sea power) of the two.

Greece was pro-Ally. She depended on sea-borne transportation for food. The Allies had the best fleet, and Greece remembered that in 1916 the Allies, by a blockade and subsequently by occupation of their capital, had forced her to join their cause. They wished to avoid a repetition of this. Greece knew that Bulgaria claimed a large part of Macedonia. She suspected Yugoslavia of waiting for a suitable opportunity to seize Salonika. On her part she wished for a substantial part of Albania, alleged to be really Greek in origin, but at the time independent.

Albania was the weakest country in the Balkans. She feared both Greece and Yugoslavia, whom she considered to be waiting for a convenient opportunity to pounce upon her to seize respectively the south and north sections of her small mountainous state. Her population was divided into Catholic, Orthodox and Mohammedan sects, who took pleasure in killing off each other. For some time Albania had been practically an Italian protectorate. The Albanians were divided in sympathy as to the Italians. Some were glad that Italy had established some respect for law, and was improving economic conditions. Others wanted the Italians out, but only provided the particular sect to which they belonged would succeed to authority.

Into this welter of antagonistic ideals and interests the Allies decided to plunge. Their goal was to establish order in the Balkans and unite them together for one cause—that of the Allies.

FIRST DIPLOMATIC MANEUVERS

The Allies realized that they would ultimately have to provide in the Balkans a considerable number of troops, a leader, and a very large quantity of supplies and munitions. Pending concrete results from diplomatic moves in the Balkans, it was decided to organize British and French expeditionary forces, respectively in Palestine and Syria. It was early agreed that General Maxime Weygand, a distinguished and competent French general, should lead his nation's troops, and that eventually he would be the C-in-C in the Balkans.

Russia made the first move in the Balkans. On 17 March she guaranteed to come to the aid of Rumania should that country be invaded by Germany. Rumania was by no means overjoyed by this apparent generosity. She suspected that if Russian troops ever occupied Rumania to "protect" her, they might stay there permanently. She made no move to "accept" the guarantee.

Russia's action was a hint to the Allies. If Russia could give a guarantee, the Allies could similarly promise *their* aid to the small Balkan nations. The latter needed help. Who could better give it to them than the great democracies, with their vast wealth, power and resources?

As Poland at the moment (mid-1939) seemed to be the next probable victim of the Germans, it was natural that the first Allied guarantee should go to that nation. But as soon as this was done, the Allies took up the question of saving Rumania and Greece. Greece could be easily reached by the Allied fleets, and nothing was wanted from her at the commencement, except her agreement to cooperate. No conditions were made as to the intended guarantee to Greece.

Something was wanted from Rumania. This country could not be easily reached by the Allies. Rumanian assistance to Poland in case of invasion by Germany was asked for, with permission for passage of Allied troops and supplies, should it be found practicable to forward these to Rumania.

Yugoslavia was approached without any request for an alliance.

The Balkans were far from enthusiastic. On the contrary, they were embarrassed and afraid to commit themselves. They considered the Russian and Allied offers of guarantees as an effort to secure their entering into a war with which they were not directly concerned, in order to benefit the guarantors.

The negotiations received a severe jolt when, on 7 April, the Italian Dictator suddenly invaded Albania, threw out King Zog and his government, and within 48 hours completed the occupation of that very small country. This unexpected event started a great activity among the democracies. The Axis was more ready to risk war than had been believed. Perhaps the major danger was not in Poland, but in the Balkans. The Allies felt that once again they had been caught napping. The British were particularly disgusted with themselves. April 7th had been Good Friday, two days before Easter. In preparation for this holiday, and in accordance with the usual custom, the powerful British Mediterranean fleet had been scattered in order to give the crews shore leave. Of five battleships, three were in Italian ports, and one each at Gibraltar and in the Near East. The destroyers were widely scattered between south Europe and north Africa. Several cruisers were at the Malta base, but the anti-aircraft protection was incomplete. The British fleet was not ready.

Notwithstanding all intentions to let pass no further aggression, it was necessary to let this one go. But relations between the Axis and the democracies were not improved.

Immediate orders were issued to concentrate both the British and French Mediterranean fleets. By 10 April, the British fleet was at Malta; the French fleet was close by at Bizerte. Greece was frightened by the possibility of the Italians continuing on into their country, but Italy assured Greece that she had no hostile intentions against her.

Yugoslavia now declined to accept the Allied guarantee. She had frontiers with both Germany and Italy and felt that she was in no position to antagonize these two aggressive nations.

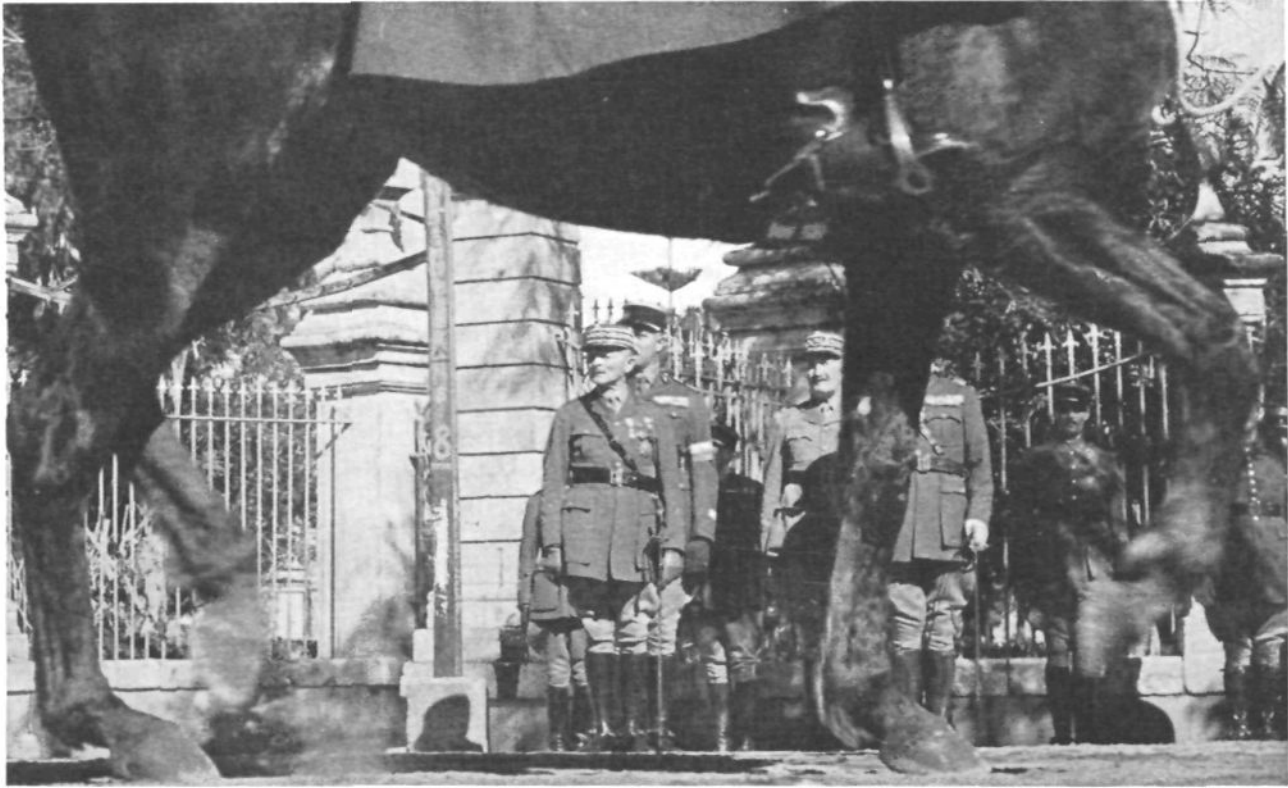

General Weygand reviewing a part of his army in Syria

On 13 April large German troop concentrations were reported from Silesia. The military experts were divided in opinion as to whether these would be used against Poland or be sent into the Balkans. In either case it was a sign that some new aggression was being planned. In view of this situation and of Yugoslavia's action, the Allies decided not to await a formal reply from Rumania and Greece as to the suggested guarantees. That same day they announced unilaterally a guarantee of both Rumania and Greece.

The reaction to this was not exactly what had been hoped for. Neither Rumania nor Greece was willing to associate openly with the Allies at this stage. They did not yet wish to commit themselves to either of the three sides whose political activities they could see were leading to a war which sooner or later would probably engulf the Balkans. For fear of displeasing the Axis they would not "accept" the proffered guarantees. For fear of displeasing the democracies, they would not "refuse" them. They just "disclaimed" the guarantees.

On 15 April, Russia replied to official requests which had been addressed to her, asking that she join in the various guarantees made by the Allies. She objected among other things to being placed in a role where she would be obliged to go to war if Poland or Rumania so decided. Russia suspected Rumania of indulging in the double-cross, and consequently did not desire to adopt a guarantee given to her. Russia doubted also whether the democracies could be counted on to follow *any* policy permanently.

The Allies particularly wanted Bulgaria on their side. Her army was good, her geographical position important. It was realized that Bulgaria was in general hostile to the Allies, and that her allegiance could only be secured by offering her substantial inducements. The Allies asked Rumania to agree to return Dobruja Province to Bulgaria, in order to preserve peace, reestablish friendship between these two states, and in an effort to form a coalition which would be so strong as to deter future aggressors.

At the same time Turkey was asked to join the Allies. As an inducement, the Allies suggested that they might arrange for the cession to Turkey of Alexandretta in Syria.

If Turkey, Bulgaria and Rumania all associated themselves with the Allies, a route would be opened along the west coast of the Black Sea straight to Poland, which had a frontier with Rumania.

On 20 April Bulgaria replied. She wanted territorial compensations from each of her three neighboring states—Greece, Yugoslavia and Rumania. She made it plain that she was prepared to talk business with whichever side would satisfy her demands.

Rumania was on the spot. She naturally wanted to retain all territory conquered from other countries, but she understood perfectly that her neighbors were only waiting for an appropriate occasion to recover it.

The Allies through their diplomatic representatives insisted that the first requirement for meeting a possible future Axis aggression was peace and understanding

among the Balkan states themselves. The good will and assistance of Bulgaria was of prime importance. To obtain this some concession was necessary. They asked Rumania to play the game.

Rumania inquired from Germany as to what she could expect from that quarter. It is not now known whether Rumania informed Germany as to the Allied offers. Germany told M. Gafenco, Rumanian Foreign Minister, that Hungary was considered as part of the Axis, and that territorial concessions to Hungary were required if Rumania sought aid from the Axis. No inquiry appears of record to Russia; Rumania knew Russia wanted Bessarabia.

Rumania decided that all European countries were out for what they could get, and that the safest policy was to stay clear of all and yield nothing. On 1 May, Prime Minister Galinesco announced in a public speech that Rumania was opposed to any cession of territory. Privately he notified the Allies that Rumania would never subscribe to any guarantee which involved Russian participation, for if Russia once entered Rumania it was very doubtful whether she would ever leave. As Poland made a similar reply about this date, it appears probable that these two states were acting together insofar as opposition to Russia was concerned.

In view of a growing belief that a forceful stand would cause Hitler to avoid war, the Allies on 2 May notified Russia that they would maintain their original proposition, which included a joint and unilateral guarantee by themselves and Russia, in favor of Rumania, Greece and Poland, but requiring no formal acceptance by these states.

On the same day, Sir Neville Henderson, British Ambassador at Berlin, conferred with von Ribbentrop, German Minister of Foreign Affairs. Herr von Ribbentrop stated that Germany would not quietly acquiesce in the policy which Great Britain and France had embarked on, of encircling Germany by arranging an alliance of surrounding states, under guise of "guarantees." Germany would fight this for from six months to twenty years if necessary. The conversation was renewed next day. It was very heated—in fact violent. Sir Neville tried unsuccessfully to calm von Ribbentrop. Nevertheless the British ambassador was not alarmed. His dispatches, as well as those of other British and French diplomats at Berlin at around this date, agreed that war was not imminent. The democracies were still of the opinion that whatever desires Hitler might have for the aggrandizement of Germany, he was not such a fool as to go to war with them. All that was necessary was to see that he understood that there was no bluff this time. Great Britain and France would go to war at the next aggression, regardless of where it might be, and regardless of the reasons for it.

On 6 May, Great Britain and France presented a new note to Russia. They again proposed that Russia join in the guarantees to Poland and Rumania. They suggested

that it was time to decide exactly what military measures were involved by the guarantees, and invited Russia to accept the guarantee and enter into military negotiations.

On 7 May, the French ambassador at Berlin in a confidential report advised his government that he had heard from a reliable private party that an agreement between Germany and Russia for a fourth partition of Poland was being discussed. The informant, whose identity was not divulged, stated that he had heard "dass etwas im Osten in Gange ist (something is going to happen in the East)."

Next day Mr. Tolischus, Berlin correspondent for the *New York Times*, wired that Hitler was seeking an accord with Russia, and would complete this before starting a war which would probably commence in a dispute with Poland. He did not know when this would occur.

The Allies paid no serious attention to either the news report or the confidential report as to German intentions. The British did move the base of their Mediterranean fleet to Alexandria, Egypt. This, however, appears to have been because it was believed advisable in view of the possible Allied expedition to be formed for service in the Balkans, and because Malta was thought to be an unsuitable base should Italy enter the war, owing to the possibility of extensive bombing from nearby Sicily.

On 12 May, the British Prime Minister announced that the Allied plan for joint action of states encircling the Axis had been strengthened by a long-term agreement with Turkey, which included provisions for mutual assistance in any Balkan campaign. This, the first Allied diplomatic victory, caused considerable satisfaction throughout the British and French Empires.

On 15 May, Russia disapproved the proposed pact with the Allies, as too one-sided. Russia might consider a straight alliance. The Allies immediately offered her a binding pact, providing that France and Great Britain would come to her aid if she would only agree to those guarantees to Poland and Rumania, to which she might add any other neighbor countries in which she was interested. It was suggested that the general staffs of the three Powers should lose no further time, but proceed to arrange necessary plans.

On 22 May, Germany and Italy signed a formal alliance to assist each other, if contrary to their hope (as they expressed it) war should occur. This treaty had a profound influence on the Balkan nations. It foreshadowed joint action of two great Powers who had land frontiers in the Balkans and powerful armies which they might use. It made the Balkans more hesitant than ever to commit themselves to the brewing war.

A treaty of alliance is only for war. It can have no other object. It may presage an intent to make war for conquest or to meet a war imposed by others. It might have been a precaution against possible British and French success in forming a ring of hostile states around the Axis, particularly in the Balkans. It may have been

a warning to the Balkans not to try to play Germany against Italy.

The terms of the treaty are too long to quote here. For assuring joint military and economic action by the contracting Powers, they were a model.

According to press reports, Greece received, about 24 May, a loan from Great Britain of £2,000,000 Sterling. She had doubts as to the Italian representations of friendship. She used the money in part to fortify her frontier with Albania. Greece's action aroused Axis suspicions that she was definitely joining the Allies. Italy lost no time reenforcing her troops in Albania, and proceeded to build new roads leading to her side of the Greek frontier.

About this time, the G-2 sections of the Allies had reliable information that the German Army would be mobilized, under pretext of maneuvers, by the end of July, with the main force opposite Poland. It was impossible to determine Germany's intention.

On 1 June, M. Molotov, Russian's Foreign Commissar, indicated a lack of sympathy for accepting the latest Allied proposals, or for any alliance with them. Thereupon, on 15 June, Great Britain with the consent of France made still another proposition to induce Russia to do something to hasten that understanding which was so much desired. This was that in case of complications in the Balkans, Russia should agree at least, and for the present, only to consultations.

On 16 June, the German ambassador at London in a conference with Lord Halifax, Minister for Foreign Affairs, expressed the resentment of Germany at the British encirclement policy. This failed to restrain the Allies. Both sides saw the danger of war, but neither side was willing to yield in the slightest. Each hoped that the other would give way in order to avoid a world catastrophe.

On 28 June, Mr. Winston Churchill stated:

"All preparations are apparently being made by the Nazis to force Poland to yield to the German demand; and if she does not yield, to attack her with very large forces, both from the west and from the south. . . . I think we must consider July, August and September as months in which the tension of Europe will become most severe."

This was an accurate estimate of the situation.

On 15 July, the British ambassador at Berlin, in his turn informed the head of the German Foreign Office that "if Hitler wanted war, he knew exactly how he could bring it about." The Allies would not again excuse a German aggression, no matter where it occurred.

The Balkan states were fully aware of the foregoing European diplomatic moves. They could not influence them, although they affected Balkan interests. Yugoslavia, immediately exposed to invasion by either Germany or Italy, made a determined effort to settle her burning interior troubles by securing the support of her Croatian subjects, totaling about 30% of the entire

population. The idea had been to grant Croatia local autonomy. Considerable progress had been made in this direction. At the last moment negotiations broke down. On 20 July it was announced that the proposed arrangement had been rejected. This event also caused the failure of another proposition, which was to secure an alliance with Bulgaria by ceding to her a small section of territory. Yugoslavia was left disrupted by interior hates and disputes and on bad terms with her neighbor state. On 1 August, 1939, the Croatian leader, Dr. Matchek, threatened that Croatia would secede from Yugoslavia and would accept a protectorate under Germany.

France now took a hand in the Balkans. War was approaching, and if a Balkan front was to be established before it was too late, concrete action was required at once. The French emissary to Yugoslavia was well received by the general staff, and arrived at an understanding with them. He was, however, unable to secure the Belgrade government's approval to anything.

The French emissary to Turkey (Gen. Huntziger) did better. He too was well received at Ankara. Realizing the danger of war at the end of the month, he induced the Turks to concentrate in Thrace a force of about 100,000 men which was to be in readiness by 21 August. As these troops were ill equipped, Huntziger appears to have promised a loan to secure arms and materiel. This success reacted on Yugoslavia. She now agreed to mobilize 500,000 men by 20 August, but without any promise as to what they were to do.

Greece, too, was sympathetic, but explained that she was a poor country. She was in no position to start a war, and could not manage one against the Axis without substantial aid. She would, if necessary, ultimately provide 800,000 men to support the Allies, provided that it was first shown that the Allies would aid materially, and do it before Axis troops could arrive. No Greek mobilization was to occur until the Allied troops had debarked.

The Allies realized that they would have to furnish troops to form a Balkan front. They were now busily engaged organizing the two British and French armies in Palestine and Syria. Considerable numbers of British Indian troops arrived during August for the Middle East army. French troops from Morocco and Senegal reinforced their army. The two combined did not as yet form a properly equipped and balanced army, and were not ready for field duty.

On 13 August, Hitler concluded what appeared to be most important secret conferences with Count Ciano from Italy. These involved repeated and long conversations by telephone with Mussolini at Rome. Notwithstanding most active attempts, the Allied secret services were unable to discover what all this activity was about. They feared that it meant war. The Axis press announced that the secret conferences had covered everything. The German and Italian Dictators had decided that the dispute over Danzig, as to whether it should be

Polish or German, was a minor matter. The important thing was to break the encirclement policy of Great Britain and France, and do this at once, before it could be made effective.

The G-2 sections in France and England appear to have been confused by this declaration. They failed to realize that it meant exactly what it said. The general staffs realized that the Axis had some sort of plan which they were about to spring. They looked for a single possible object of some new aggression. They now had information that German troops were concentrating in Slovakia. Although these might be intended for a war on Poland, it might be that they were for use against Rumania, as an easier mission, with a more valuable booty of oil and food should it succeed. French G-2 thought Hungary might be the next victim, as preliminary to an attack on Poland later. Neither the French nor British foresaw that the next Axis move would be a curtain raiser to a series of campaigns in which, by attacking in turn all Powers around the circle, the Axis would seek to break the Allied chain of encirclement.

On 21 August came the German-Russian non-aggression pact, followed ten days later by the invasion of Poland. The rapidity of the moves by the German armies, their overwhelming victory, and the frightfulness of the campaign greatly influenced opinions in the Balkans.

Rumania failed to support Poland as she was required to do by treaty. Her excuse was that assistance was to be rendered only after an *official* request had been received from the League of Nations and that no such request had been received. She was in fact afraid of Russia, and started work upon new defense positions along the Dniester River.

Yugoslavia was also impressed by the German success. She considered the Allies as poorly placed to give her military assistance and thought it might be better to look towards Russia. Russia, who appeared to be a new friend of Germany, might restrain that aggressive country from an advance into the Slav regions of the Balkans. Yugoslavia had had no diplomatic relations with Russia for many years. But in her present state of distress and anxiety, it seemed better to overlook her inherent dislike of the great communist state and seek her aid on the ground of being members of a common race. Russia accepted the advances, and in a friendly way encouraged Yugoslavia without obligating herself to any particular line of action.

Turkey felt it necessary to revise her estimate of the situation, *viz.*, that Germany was too far distant to constitute a military danger. She too decided that some kind of understanding with Russia would be a good precautionary measure.

M. Saracoglu, the Turkish Foreign Minister, was sent to Moscow to secure Russian support. He was agreeably surprised at receiving a warm and friendly reception. He soon found out why. The Russians were most frank, and

told him exactly what they wanted. Bessarabia was to be ceded back by Rumania; the latter state was also to cede Dobruja to Russia's friend Bulgaria. Turkey was to use her good offices to induce Rumania to accept this plan. Turkey was to receive Russian military aid, with which she was to close the Straits at Istanbul against any Power at war with Russia. As Bessarabia adjoined Dobruja, Russia would thus have a through route via Bulgaria to Istanbul and would be able to forward large forces overland.

Saracoglu was not now so much impressed with the character of his reception. He seems to have displayed considerable diplomatic ability in not committing either himself or his country. He stayed in Moscow until 17 October, and while continuing his discussions with the Russians, sounded out the representatives of both the Allies and the Axis. The Allies made the best offer. They also wanted control of the Straits, and Turkish troops for that eventual campaign in the Balkans. They recognized that Turkey was poor and needed funds to properly equip her army. They offered to "loan" her £25,000,000 Sterling. Saracoglu made no promise as to allowing any foreign Power to post troops at the Straits. This trump card he was able to reserve for some later occasion and in the meantime keep everybody guessing. He accepted the "loan" from the Allies, and left Moscow without signing any pact with Russia. On his return home he took two steps, namely, to:

- a. Collect the "loan";
- b. Mobilize on the Turkish side of the Russo-Turkish frontier in the Caucasus.

The consideration given by Turkey for the "loan" was embodied in a pact with Great Britain and France. This provided that should Italy join in the war on Germany's side, Turkey would then enter the war on the side of the Allies, with especial reference to making good on the guarantees to Rumania and Greece. One exception—in no case was Turkey to go to war with Russia.

Greece was of the opinion that the startling German success in Poland required more positive protective measures for her security. In the first part of October, the French minister at Athens secured a statement of the Greek policy. This was to the effect that Greece would not only do nothing to prevent a landing of the Allied armies at Salonika, but would even give them active support, provided that the success of the Allied landing, and the securing of a beach head, was assured. Greece requested that a French liaison officer be sent to Athens to arrange for proper coordination.

The first Balkan reactions to the German victory in Poland were:

- a. Turkey and Greece definitely moved closer to the Allies;
- b. Bulgaria and Yugoslavia turned towards Russia;
- c. Rumania remained independent and uncommitted.
- d. Albania was occupied by Italy; and Hungary under German direction was committed to the Axis.

Intrigue was continuous, and to all the Balkans a source of confusion, suspicion, and danger.

Rumania realized the danger of isolation. Recollecting the German warning that any help from that direction would be contingent on making a satisfactory territorial settlement with Hungary, this latter state was approached and invited to sign a non-aggression pact with Rumania. On 2 November, Hungary declined. Three days previously Russia had announced that she approved of the Bulgarian claim to Dobruja, which if secured would extend Bulgarian territory to Bessarabia.

The Allies made earnest representation to Bulgaria as to the desirability of aligning herself on their side. They promised that at the peace table they would be sympathetic to Bulgar claims to territorial



In the Balkans the mountain passes are always of strategic importance. Photo by H. S. Villard, courtesy American Foreign Service Journal.

compensation. The Axis made counter representations. They pointed out that the greater part of the Bulgarian trade was with the Axis, and that it was very much more logical for Bulgaria to join her best customer; besides, the Allies were responsible for all the indignities heaped upon Bulgaria since the Versailles Treaty. Russia called Bulgaria's attention to the fact that the Axis and the Allies were two bunches of capitalistic crooks working for nobody's interest except their own. Bulgaria's real interest lay in joining the great Slav communist state. Bulgaria refused to commit herself—she was unable, or unwilling, to choose between the three sets of suitors demanding her aid.

The confused situation in the Balkans led in November to a movement for a mutual association of the Balkan states for joint action against any aggressor. If this could be arranged the Balkans might escape war, as neither the Axis, the Allies nor Russia would be likely to attack if they knew in advance that the whole Balkans would fight as one. This movement received some encouragement from United States State Department reports of 20 November to the effect that Germany and Russia had no agreement over the Balkans and were acting independently. This Balkan movement never got beyond the stage of discussion; the Balkan states found it impossible to adjust their claims against each other and unite against outsiders.

The British at this time were engaged in attempting to win the war through economic pressure. They had great hopes as to the efficacy of this method of securing victory without major bloodshedding. It was obvious that the Balkans were furnishing supplies to Germany, and particularly that oil and food from Rumania were substantial props to Germany's continued fighting ability. On 5 December, Great Britain delivered a note to Rumania requesting her to stop delivery of raw materials to Germany. Rumania, in answer, stated that she was strictly neutral. She sold to all customers on equal terms and as nearly as practicable in about the same proportion as before the war.

On 6 December, the *Moscow International* in an editorial, apparently officially inspired, proposed that Rumania join Russia, as the Baltic states had already done, admitting Russian garrisons and granting naval and air bases to "protect" their country. Caustic remarks were made as to Turkey's having sold out to the Allies for a money consideration.

Rumania announced that she had received no Russian demands. If officially presented she was ready to negotiate on any matter, provided that her territorial integrity were respected. She was aware of, but could not understand, the hostile attitude of the Russian press. She did have a Russian minority, but it was not mistreated. She had recently granted them partial autonomy, and in an effort to remove grievances—real or imaginary—had done the same with regard to the Hungarian and Bulgar minorities.

On 8 December, Russia advised Rumania that the editorial

had been unauthorized. In fact, Russia "had no intention" of menacing Rumania. However, on the same day, Rumanian G-2 advised that a new Russian Army CP had been identified opposite Bessarabia, that new Russian troops in large numbers were assembling on the Rumanian border. G-2 thought *this* indicated hostile intentions.

During these diplomatic moves in the Balkans, the Allies had been proceeding with the organization of the nucleus of the force they expected to use in the Balkans. The French and British armies in Syria and Palestine were growing in size and in training and might be ready for the field early in 1940. The most likely place to land these troops appeared to be Salonika. The facilities for debarking and establishing depots were good. Mountains, with few passes which were narrow and easily defended, protected Salonika at a distance which left ample terrain for assembling large forces. Access in rear of the mountains could be had with Turkey, and of course Greek forces would be available from the beginning. Once at Salonika, Bulgaria and Yugoslavia might take heart and join the Allies. For the Axis to reach Salonika would, it seemed, require a long and costly campaign for which they probably could not furnish needed supplies.

On 4 January, 1940, General Gamelin reported that the Greek Chief of Staff had advised that the Greek army was now in position to cover the landing of an Allied army at Salonika, provided only that air support and antiaircraft artillery were furnished. However, General Weygand (commanding in the Near East) was not yet ready to start his expected campaign. A postponement was necessary.

Rumania had a trade war on her hands. The Allies were buying her products at above market prices and storing them to prevent possibility of Germany's securing them. They sought to prevent any exportation of oil to Axis lands, on the ground that the Rumanian oil companies were financed with British and French capital. Rumania pointed out that her laws provided that at least 50% of the capital of Rumanian companies must be nationally owned. In view of this she could not recognize the right of foreign nations to dictate what disposition she should make of her own products.

On 17 March Rumania mobilized. She would remain mobilized, she said, ready to fight. She would never accede to the demands of Hungary and Russia for return of peoples and territories formerly held by them. Hungary advised that although she was desirous of avoiding a war and had no intention to start one, she reserved her claim to Transylvania, and that if Rumania got into a war with Russia, she made no promise to abstain from seizing her claim. Russia made no answer to the Rumania mobilization. As far as can now be determined, Russia already had large forces opposite Bessarabia, and was only waiting for a favorable opportunity to make the grab.

On 2 April, in an effort to force suspension of trade from the Balkans to Germany, the British Prime Minister announced that formal notice had been given to Greece, Rumania and Turkey to limit their exports to Germany. If they did not do so, the Allies would blockade them with respect to particular commodities such as tin and rubber. Rumania, resenting this action, replied that she had not asked for any guarantee from the Allies and that, although she appreciated their kind interest, she felt under no obligations. She declined to alter her commercial policy to suit the Allies.

This concluded the first attempts to align the Balkans on the side of the Allies. Greece and Turkey had agreed to cooperate. The remaining Balkan states, less Albania held by Italy, were yet pursuing independent courses, with Yugoslavia inclined more towards the Allies than the Axis, but courting Russia.

INITIAL BALKAN MOBILIZATIONS

In April, 1940, the Allies felt that the blockade was too slow a method of making war. Some thought it would never work. Germany was conquering Norway, and the Allied prestige had there received a severe blow. Their own people called for an aggressive war. The Balkans appeared to be the only place where the Allies could open a new front. It was also a suitable place. It was decided to do so without other delay than necessary. Turkey and Greece were notified and asked to be ready in the first week of May. To the joy of the Allies, Yugoslavia, without definitely committing herself, agreed to mobilize at the same time. The Allied forces in the Near East naturally would be added. General Weygand was to be the C-in-C. It looked as if a campaign would be started with excellent prospects for success. The Germans were busy far in the north, could not uncover the French front, and were too far and too few to intervene in the south Balkans.

According to German reports, their secret service listened in on a telephone conversation held on 13 April between the Prime Ministers of France and Great Britain, M. Reynaud and Mr. Chamberlain. Mr. Chamberlain is alleged to have reproached the French with unnecessary delay in preparing their army in the Near East for the Balkans. He wished to know just when General Weygand and his men would be ready. M. Reynaud is alleged to have replied that there had been considerable difficulty in equipping this army, but that the end of the preparation period was in sight. He did not wish to commit himself to an exact date, but as he saw it at the moment, it looked reasonably sure that Weygand would be ready by 20 May. Reports of the same date from Italian sources were to the effect that Weygand's army, about 40,000 strong, was concentrating on the coast, having apparently completed its training program.

On 2 May, Yugoslavia, Turkey and Greece started to mobilize. The British fleet at Alexandria was ready, and

so (it is said) were the British and French armies in Palestine and Syria.

Information as to the foregoing moves having been made public, the British Broadcasting Corporation on 3 May declared in a broadcast:

"In Palestine, Syria and Egypt, great armies of England and France are massing. Hitler understands nothing but force, and the Allies have enough force in the Near East to smash utterly any Balkan adventure Hitler may undertake."

Germany worked fast. Also on 3 May, her legation at Bucharest held a gay party. Prominent statesmen and officials of Russia with their wives were invited and royally entertained. There were excellent refreshments, including plenty of the best champagne. For the pleasure of his distinguished guests, the German Minister presented a "peace" film which turned out to be movie scenes taken in the recent Norway campaign showing battle events, bombings, and destruction. This impressive spectacle was accompanied by appropriate remarks which wound up with the hope of the Germans that nothing like this would ever happen in the Balkans. They explained that Germany had neither territorial nor political ambitions in the Balkans. This movie may have left some effect in keeping Russia from joining the Allies.

Germany also let it be known that she had applied to Hungary for authority to move troops across her territory to the Balkans, should this become necessary. The German radio discussed the Balkan mobilizations, stated that Germany was well aware of the Allied moves, and was fully prepared to meet them.

On 6 May, Great Britain requested Italy to define by May 16 her "exact position" in the war. Great Britain considered that the Italian status of non-belligerency was unsatisfactory, in view of the importance attached by the Allies to their blockade of Germany. The British press published articles to the effect that they knew the make-up of the Italian forces in the Dodecanese Islands. The greatly superior British fleet based on Alexandria was in a position to cut off these units from their homeland, and crush them, thereby opening the Aegean Sea for the transportation of Allied troops and supplies to Salonika, or elsewhere in the Balkans.

The date fixed for the Balkan reply indicated to the Axis that the date alleged to have been given by M. Reynaud for the initial attack in the Balkans as 20 May, was still held to.

On 8 May, Sir Hugh Knatchbull-Hugessen, British Ambassador to Turkey, was at Sofia. He offered an Allied guarantee to Bulgaria, as well as to Hungary and Yugoslavia. He pointed out the strength of the Allied forces, their immense resources and wealth, the sympathy and assistance of the United States, the mobilization of Turkey, Greece and Yugoslavia, the British and French armies ready in the Near East to leap into the fray, the overwhelming Allied sea power.

In spite of able arguments and a most agreeable manner Sir Hugh failed to gain Bulgaria. That state did not wish to accept a guarantee. Neither did Hungary. Yugoslavia's sympathy was with the Allies; she rather thought it might be advisable to join that camp. She consulted Russia. According to documents subsequently released by Germany, Russia advised delay, stating that Germany was the mighty foe of tomorrow, but that at this date Russia was not in a position to risk war. Yugoslavia also turned down the British offer.

This first attempt at organizing a Balkan front came to an end a few days later. On 10 May, Germany launched her furious attack against the Allies in the Low Countries. Victory after victory was won. Within seven weeks France was crushed and the British driven from the Continent. With the falling away of France, joint Allied action in the Balkans vanished. The British army prepared for the Balkans was now switched to another mission. Italy in early June entered the war, her armies threatened Egypt. Great Britain temporarily abandoned the Balkan front to save the approaches to the Suez Canal.

On 11 June, Yugoslavia privately advised the French that her sympathies were with the Allies. For the present it was obviously impracticable to start a Balkan campaign. Should things later take a turn for the better, she was prepared to join in an attempt to be made at a more propitious moment. Turkey expressed similar sentiments, qualified with the provision that under no circumstances were her further actions to involve collision with Russia. Turkey did not yet fear German arms, believed that Germany was too far away.

Taking advantage of the situation caused by the mass of German troops being in France, and that considerable time would be required to transfer them to an east front, Russia on 24 June issued an ultimatum to both Germany and Rumania, demanding immediate cession of Bessarabia. According to Hitler's proclamation of 22 June, 1941, this was unexpected to him, found him entirely unprepared, and was in violation of his cooperation agreement of the preceding year. Russia appealed to Germany, but was advised that the German armies were too distant to save her. Hitler, accepting the ultimatum, bided his time. He advised Rumania not to fight, but to cede Bessarabia. He offered a guarantee to Rumania against further Russian encroachment. Rumania made a quick decision. Alone she could not fight Russia. Her former policy of playing off against each other the Allies, the Axis, and Russia had now left her without a friend. She ceded Bessarabia, which was occupied by Russia within the week. She accepted Germany's guarantee. To Rumania it looked as if the Axis were on the way to winning the war, and that consequently her best bet was to jump on to that band wagon. She sent emissaries to Berlin to advise Germany officially of her change of policy, and to make new necessary arrangements.

It is not yet known exactly what was agreed to in

this the first approach to Germany. The subsequent one of Rumania, and statements by her prominent statesmen, appear to make it fairly certain that Germany promised to obtain Bessarabia back for Rumania at a date to be decided upon later, by a joint war on Russia. There may have been a promise to secure additional Russian territory for Rumania. In return Rumania undertook to prepare for a war with Russia and, in view of the expected accretions of territory promised, agreed to return to Hungary and Bulgaria the territories claimed by them. This would secure Hungary as an ally against Russia, and would protect both Rumanian flanks against attacks.

An immediate effect of the new Balkan agreement was that Rumania now shipped all her oil, food and other available products to Germany and Italy. She made it so unpleasant for businessmen of British firms that these started to leave the country, and in a short time Germany had complete control of Rumanian economic resources. On 1 July, Rumania denounced the British unilateral guarantee.

At the same time that Rumania joined the Axis, Bulgaria did likewise. The terms have not yet been made public, but seem to have included the regaining of a part of Dobruja.

Germany lost no time in consolidating her new position in the Balkans. She decided to take no more chances on being unprepared to deal with Russian ultimatums. Troops were moved from France to the Russian frontier, and an intensive program of road and railroad construction of new airdromes, depots, etc., was initiated. Arrangements were made to give modern equipment to the Rumanian army units and to train them in its use. These preparations were first reported in the press as early as 19 July, and were of course known to Russia. Russia on her part took like measures on her side of the frontier. Neither Germany nor Russia being yet ready for their coming struggle, both continued to make friendly references to each other. There was no real mutual deception as to the ultimate event. But only Hitler knew the date when he would attack.

On 1 July, the Axis announced that for them peace in the Balkans was essential. Now that Hungary, Rumania and Bulgaria were lined in with the Axis, they were expected to settle their territorial claims by peaceful and direct settlement. Germany and Italy would allow them a reasonable time for doing this.

According to *New York Times* despatches from Moscow of 21 July, Stalin had made it known to both Germany and Great Britain that Russia's desire was to secure Constantinople (Istanbul) and the Straits. It was immaterial to him from which side he obtained it. He had not mentioned the subject to Turkey. He told the British that he was afraid of Germany, and would not go to war against her unless she was first decisively beaten. Although he considered the danger as rather remote, he had to watch for an attack by Japan, and consequently



Many "roads" in the Balkans are not suitable for motor traffic.

desired to obtain his objective—the Straits—without any major war.

On 29 July, Rumania not yet having agreed with her neighbors as to cessions of territory, Hitler intervened personally. In war, time was an important factor, and further unnecessary delays in settling inter-Balkan troubles could not be tolerated. The latest date for a settlement was fixed as 15 September. If direct negotiations failed to secure an agreement, the Axis offered its services as mediators. It was suggested that the basis of settlement should be that portions of what was now Rumania in which more than 50 per cent of the inhabitants were Hungarian, or Bulgarian, be ceded back to Hungary and Bulgaria. Rumanian minorities in these territories were to be given the option of moving to within the new Rumanian boundaries. Similarly Hungarian

and Bulgarian minorities remaining inside the new frontiers were to be permitted to move over to Hungary and Bulgaria. Anyone belonging to a minority who declined to exercise the option of moving to his country as newly defined, within a prescribed time, was to become a citizen of the country in which he had elected to remain, regardless of his origin or language. Rumania accepted this in principle.

On 17 August, Rumania settled her differences with Bulgaria by ceding to the latter South Dobruja, containing about 7,726 square kilometers and 378,364 inhabitants. No direct agreement being possible with Hungary, on 24 August the two states called in Germany and Italy as mediators. On 28 August, Count Ciano met with Hitler at Berchtesgaden. During the next two days Ciano met with von Ribbentrop at Vienna, and arrived at a basis for the new boundaries between Hungary and Rumania. It called for a cession of 55,656 square kilometers and 2,609,000 inhabitants.

The two cessions of territory by Rumania were a hard blow to her prestige. The people, knowing nothing about the secret arrangements for later compensation through a war with Russia, involving the return of Bessarabia, were inclined to blame their government for weakness, and for yielding to the Axis. Considerable anti-Axis feeling developed. An internal crisis developed, which resulted on 6 September in the resignation of King Carol in favor of his son, and the installation of a strong pro-Nazi government.

Within less than three months, the Axis without fighting had secured cooperation of three Balkan states—Hungary, Rumania and Bulgaria. This gave the Axis:

- a. Access to the gates of Istanbul;
 - b. Control of numerous economic resources;
 - c. Powerful support for an approaching war with Russia.
- a. A definite alliance with Turkey;
 - b. An understanding with Greece.

Yugoslavia still remained outside any commitment.

COMMENTS

The Allied intention of opening a front in the Balkans was strategically sound. The policy of the Axis was to fight on only one front at a time, smashing one nation after another. To counteract this it was necessary to attack Germany on several fronts simultaneously.

Had the Allies opened a Balkan front before May, 1940, with large forces, it is doubtful whether Germany with part of her forces thus occupied, would have been able to wage the campaign in France which she did. A Balkan front would have threatened Austria, with the possibility that what remained of Czechoslovakia might have joined the Allies.

To have had sufficient strength for such a campaign, it would have been necessary to have secured the *active* participation of the Balkan states and the use of their

military forces. In round numbers, such possible allies had in population: Turkey, 11 millions; Greece, 6 millions; Bulgaria, 6 millions; Yugoslavia, 14 millions; and Russia 18 millions. In all they formed a group having 55 million people. Their united armies, strengthened by French and British troops, could have had as decisive an influence in the war as they did in 1918.

For the reasons previously set forth, the Allies were unable to organize a Balkan front in time. The golden opportunity passed; control of the Balkans at the end of the first year of the war was divided, with the advantage in favor of the Axis.

The effort of the British to regain control during the second year of the war will be discussed in a later article. During the first year, as has been recounted, major efforts were limited to preparation and to diplomatic activities. At the end of this period it was clear that military action would be necessary to determine who would control the important Balkan area. War in the Balkans could not be won without fighting.

If the British lost the occasion to secure the Balkans for their cause, the Russians did also. The Russian desire to secure Istanbul and the Straits, together with the territory around the west end of the Black Sea, to furnish an overland route to Istanbul, was the result of an age-old dream. Russia could have counted on support from the people of Bulgaria, and would not have been opposed by Yugoslavia. If Russia, instead of limiting her offensive to seizure of Bessarabia had continued on to Istanbul, and had started the offensive about 10 May, there would have been a chance of success.

By waiting until late June, a minor success was obtained. But it was at the expense of putting Germany on guard. With his usual vigor and determination Hitler at once decided that Russia was playing a double game, and was really an enemy. Without losing a day, German troops began to move toward the Russian frontier, and preparations for war on a vast scale against Russia were commenced. Russia too lost a golden opportunity.

From the point of view of Germany, it was undesirable to have any front in the Balkans until the war in France was over. Even then it was not desirable, if the Balkans could be secured without fighting. The German problem was to induce the Balkan states to join the Axis peacefully. In the first year, Hungary and Rumania did voluntarily join the Axis through fear of Russia whom they detested more than they did the Germans. Bulgaria also joined, but for a different reason. She detested the Allies on account of alleged previous wrongs inflicted on her, and because union with the Axis promised return to her of territories claimed from her neighbors, which neither the Allies nor Russia would or could promise her.

When war started on 1 September, 1939, the democracies were of the general opinion that in view of their wealth, and their supposedly unrivalled industrial capacity,

they would become stronger and stronger as time passed. On the other hand they were equally certain that as they had overwhelming naval power, their blockade of the Axis would result in such deprivation of resources as to cause Germany and Italy to become weaker and weaker. It was almost a universal belief of the people, the democracies repeatedly emphasized in their press, that time was on the side of the Allies.

The Allies believed therefore that the longer the war lasted, the better would become their relative economic and strategical position. They put aside all temptations to attack the Axis, depending upon TIME to win the war for them.

TIME indeed *was* a factor—a most important one. In this case the popular idea was wrong. Time was on the side

of the Axis. The first year of the war eliminated one of the three democracies, and gained for the Axis the control with the attendant wealth and resources, of vast territories. This was obtained by FIGHTING AND LONG-RANGE PLANNING—the best methods to win a war. The Axis had understood this perfectly. Advantage was taken of the inertia and lack of vision of the Allies, to defeat them separately, and strengthen the Axis while weakening all the democracies.

The Balkans were an important factor in this, the second great war of this century.

EDITOR'S NOTE: In an early issue Col. Lanza will discuss the conflict in the Balkans, from the beginning of the Italian attack in Greece up to the moment of German intervention.

Rags to Riches

Top: German imitation antitank gun, 1925.



Bottom: The newest German antitank gun, 1941. A view of the powerful 50-mm. antitank cannon during the advance into Russia.



Not in the BOOK

MECHANICAL AID FOR FORWARD OBSERVER

It is frequently necessary to make a military sketch of the field of fire before the infantry positions have been sufficiently organized to furnish cover for this operation.

In June of 1918 our infantry held positions opposite Belleau Wood. The men were in individual fox holes and resented the presence of artillerymen and their conspicuous instruments. A sun flash on the lens of a B.C. scope was an invitation to the German trench mortar crews; an aiming circle exposed the head of the observer rather more than this observer cared to be exposed.

After having been run out of several positions from which the field of fire could be sketched, first by the Germans and then by the Marines, I retired several hundred yards into the woods behind the positions to consider the situation. In a refuse dump near the "hunting lodge" (a ruined tower said to have been the hunting lodge of an early French king) I noticed a piece of hardware cloth that had been used in an abandoned sieve.

In spite of much opposition from the Wire Sergeant I managed to keep his pliers long enough to cut a square about ten by eighteen inches. I measured the mesh of the wire and found it to be $\frac{1}{4}$ of an inch, which led me to believe that it was of English manufacture. I cut a section of 1" x 2" lumber to a length of 25 inches and nailed the wire to it so that it resembled a short-handled hoe. At the "eyepiece end" of the stick each square in the screen had a value of ten mils.

I returned to the front line, where I had no trouble in getting permission from a platoon sergeant to use this crude instrument from his personal fox hole. By pushing it over the edge of the hole, and placing my nose on the end of the stick, I not only had my field of vision divided into ten-mil squares, but the wire proved an effective screen for my operations.

I later did a bit of camouflage with some red and brown paint that decreased the visibility of my gadget and devised a method of connecting staff and screen with two small screw eyes and a ten-penny nail that made the staff demountable and thus more easily carried. It remained a very cherished part of the detail equipment to the end of the war.

—By Corporal H. H. Crane.

BELDEN WIRE USED IN RADIO CAR

Until recently, the radio cars of the Fourth Motorized Division were in nearly all cases afflicted with spasmodic troubles. It was found that if the radio was operated at a halt without the engine running, starting was difficult and the car often faltered. Our troubles have been completely eliminated through the ingenuity of Master Sergeant William R. Duke, by replacing the "second

EDITOR'S NOTE: *The short article of this title in the July issue proved so popular that we have decided to run it as a regular feature. This will be dependent, of course, on the number and quality of the contributions' received for inclusion in this column. Other artillerymen, old and new, are hereby invited to send in their suggestions for this column. Make them short and practical—no Rube Goldberg inventions, please.*

rate" wire (whose insulation is poor) with a few feet of BELDEN WIRE, Aviation specifications, in the high tension lead from the coil to the distributor. The wire in the vehicles as issued was unsatisfactory because of its proximity to the metal shielding. The insulation leaked and caused a loss of power which was grounded by the shielding. Belden wire has excellent insulation which permits little or no leakage. PACKARD IGNITION WIRE, TYPE 140, may also be used. Further, by setting the points at 20/1000, the job was completed and our cars are now able to keep up with the best of the "Rolling Fourth."

—By Lieut. John Ray, FA.

PROPORTIONAL DIVIDERS

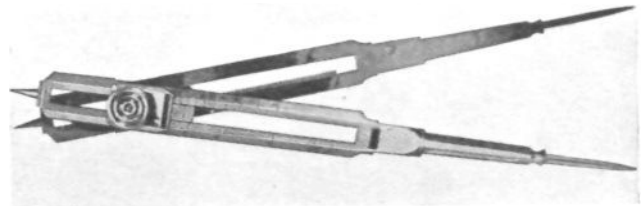

This, gentlemen, is the proportional divider. It came of a long line of architectural instruments but when map firing is in order it is a very desirable addition to the battery instruments.

As you can see from the cut, it has an adjustable radius point with stations that give varying ratios between the divider points on the two ends. When the radius point is set at "ten" the large end measures exactly ten times the small end.

In scaling contour distances on a small map, it is difficult to tell the difference of a yard or so, but when this distance is set off on the small end and then measured on the map scale with the large end, the yard becomes ten yards and is easily distinguished.

Used as an ordinary divider, it provides a ready means of checking map shrinkage or distortion.

Even good artillerymen are often careless in the use of maps, maintaining that at best the maps contain an error and that close measurement is unnecessary. A good bit of the firing in the last war was done from maps—and sufficiently well done to bring forth commendation from an enemy who was a critical one.

If properly used, a proportional divider will permit of an accuracy that will at least add nothing to the map inaccuracies and in many instances will be more accurate than a hastily-run traverse.

—By Corporal H. H. Crane.

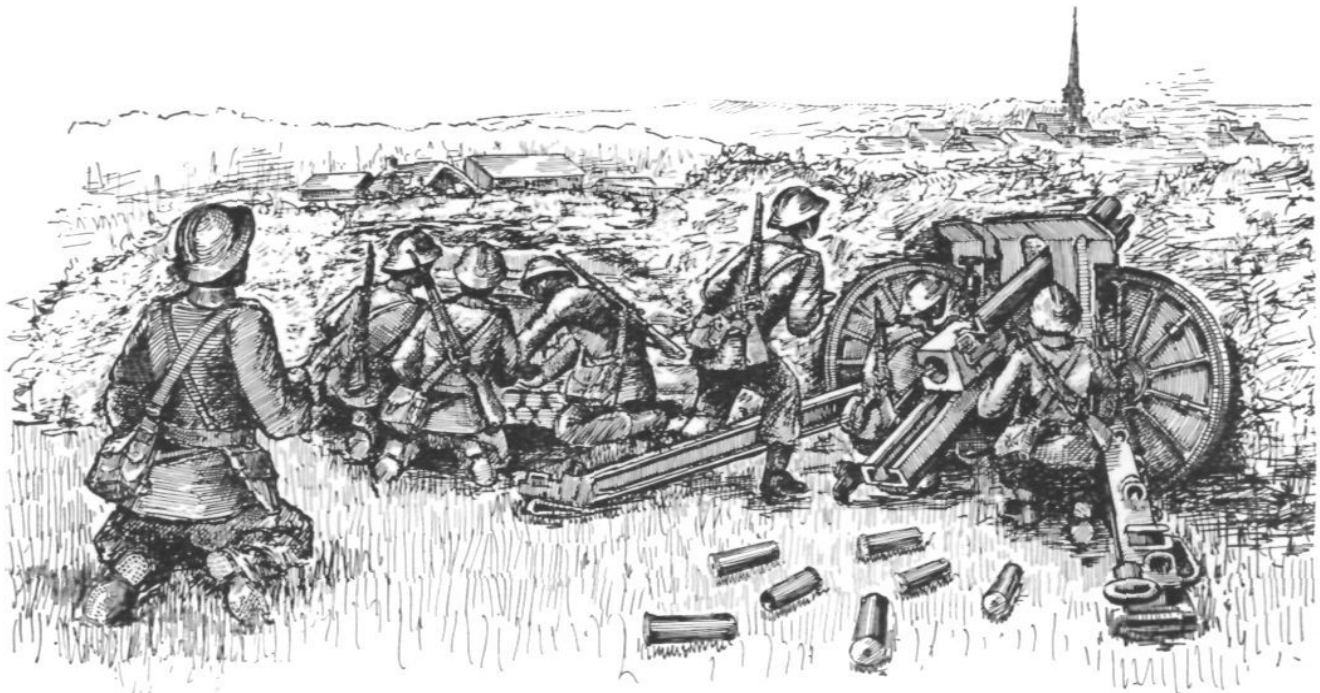

French 105-mm. howitzer in action. Note the unusual position of the wheels, moving outward with the trails on an articulated axle, and taking a position nearly perpendicular to the axis of the barrel. The spokes have small triangular shields bolted between them and the wheels act as shields for the gun crew.

Campaign of Flanders

By Captain Leo Framery

MAY 15TH—REST AT MORLANWEZ

The college at Morlanwez was a godsend. The dormitories provided good sleeping accommodation for all officers and enlisted personnel. However, before retiring, a careful check up was made of all men and vehicles. We thus found that several cars were missing, having probably followed a wrong direction. This was not surprising since the itinerary not having been pre-determined, we were in no position to provide each car leader with the description of the route. Motorcycles were dispatched to the most likely places, to round up the stray vehicles. It required two hours of diligent search in the blackout, in the midst of

EDITOR'S NOTE: *In the two previous installments, Capt. Framery (formerly battalion executive of the 2d Bn 71st FA, 2d Light Mechanized Division) described how his unit marched into Belgium and received the first thrust of the German armored divisions. The account continues with the retreat westward of the Allied divisions, outflanked on the south by the collapse of the Ninth French Army. JOURNAL readers should preserve all installments of this eyewitness account of one of the greatest cataclysms of all times.*

Illustrations by Andre Jandot

Part III—May 15th to May 20th

endless columns of refugees on foot and in cars, to locate our men and lead them to Morlanwez.

Early in the morning the Luftwaffe bombed the Morlanwez railroad station, unpleasantly close at hand. Notwithstanding these unavoidable annoyances everybody appreciated the comfort the college afforded. An early stroll around the buildings led to the discovery of shower baths which we soon put to good use.

The morning was spent in servicing guns, tractors and cars. The caissons and tractor chests had their normal contents of ammunition completed. As regards gasoline, a dealer of the city accepted our formal requisition order and we filled our tanks up to the regular 5 units

of fuel. For the mid-day meal, the college's kitchens provided the necessary equipment. As for the officers, we celebrated the occasion by patronizing a small restaurant which boasted a fair-sized dining room with a glass roof. Unfortunately a squadron of Dorniers having selected the hour of 1:00 PM to shower bombs on the nearby railroad station, the roof fell on the table and our plates were liberally sprinkled with broken glass.

At 2:30 PM we received the order to move. The idea was to occupy the defense line marked by the Charleroi canal; detailed instructions therefor were to be sent us later. For the present we were to take cover in the woods northwest of La Louvière. Itinerary: La Louvière, Aimeries, Houdeng. We started at once. I preceded the battalion in order to reconnoiter the ground and determine the best emplacement.

La Louvière, when we crossed it, was heavily bombed; the steel plants were certainly the objective of the Luftwaffe, but a large area was affected. After some research, I decided to place the battalion in the Bois du Sart, a fairly large wood with many imposing trees arching above shady lanes. It afforded the necessary cover for our guns and vehicles, with easy egress. The CP was to be located near a small rustic shrine with the game-warden house close by. While awaiting for the battalion to arrive, I chatted with the game-warden, veteran of the World War. It seems that the estate belonged to the Prince of C. Notwithstanding the obnoxious bombing of La Louvière, the place was amazingly peaceful. We spent there a quiet night in spite of the fact that the German planes set fire to La Louvière gas works, causing loud explosions and huge flames which reddened the sky.

MAY 16

Early next morning, May 16th, a dispatch rider from artillery headquarters brought us the order of operation

which we were expecting. We were to take position northeast of Charleroi.

The reconnaissances left at 9:30 AM; the batteries followed much later, at 2:30 PM. The itinerary was simple enough: La Louvière, La Hestrée, Pieton—there we were to take cover in the woods along Road No. 6 and await nightfall before proceeding ahead to the selected positions.

On the way, we noticed that many road signs had been displaced and pointed in the wrong direction. Most of the civilian population had fled, and we felt that many "fifth columnists" were replacing the bona-fide inhabitants. In two instances manifestly false information was supplied in answer to questions concerning our route, by civilians watching us pass by. We stopped several especially suspicious-looking individuals, to examine their identity papers. Obviously, many unfriendly observers were scattered among the watchers. In order to foil their inquisitiveness, instructions had been given to hide the regiment's number which appeared on the coat or blouse collar of French military uniforms. Small cloth shields to be sewn over the lapels or collar ends had been issued to the personnel for this purpose, before we left France.

We reached Pieton Woods at 5 PM. At 8 PM a liaison officer who had gone ahead with the reconnaissances, came to guide us to the new battery positions. Route: Road No. 6 to the south, then Road No. 22 eastward to Fontaine l'Évêque. The batteries were placed in pastures in the vicinity of Trieux, south of Forchies la Marche, due west of Charleroi. This was a coal mine district. Huge culm heaps, some of them 250 or 300 feet high, dominated the fields and villages. We arrived in the position area at 10 PM. The night was very dark and the blackout complete. However, disquieting blinkers were in operation on some of the culm heaps. In the village of Trieux shots were fired at us—a sergeant from battalion headquarters was wounded while chasing two

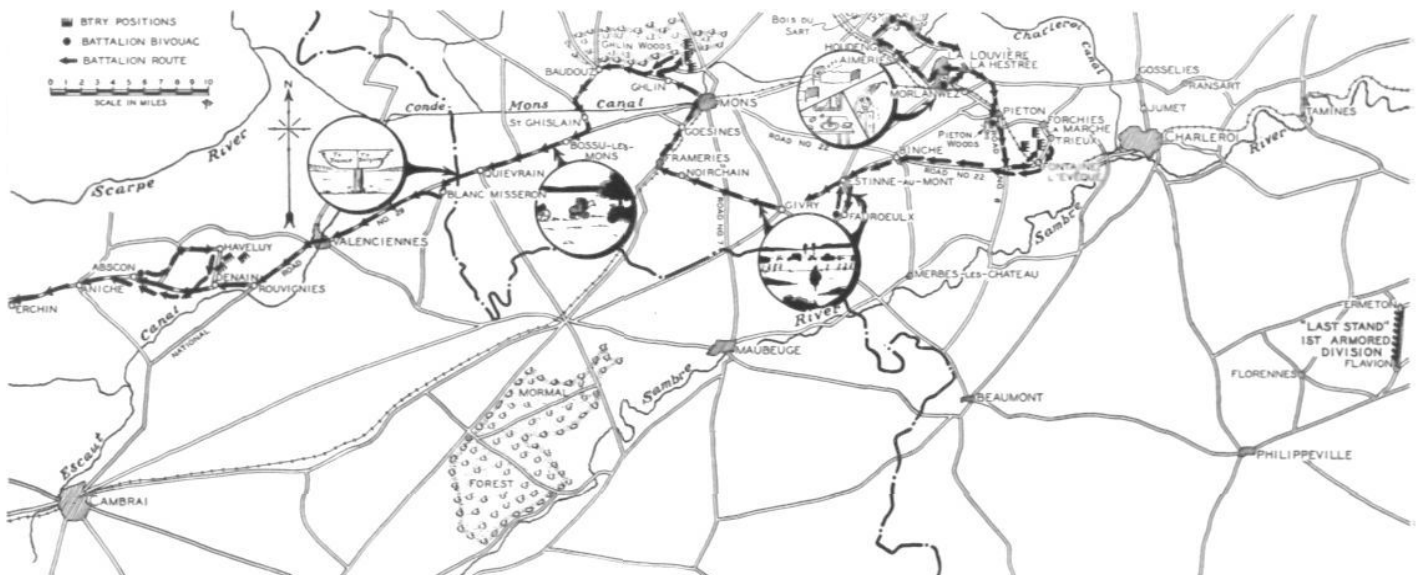

Map No. 1



Sergeant chasing fifth columnists

fleeing shadows in a dark alley from which an automatic pistol had been fired.

The guns were put in position, base deflection 1,600 mils. The battalion C.P. was installed in a cottage deserted by its usual occupants, but soon over-crowded with our men, telephonists, radios, fire direction detail, and so on.

The sentries were instructed to stop all civilians passing by and lead them to the guardhouse to have their identity papers scrutinized by the sergeant on duty. The dubious cases were brought to me. Several were kept in custody to be delivered the next day to the MP's; they were mostly young men unknown to the few villagers still remaining. Their identity cards were only two or three days old and their explanations far from convincing. What their ultimate fate was, I never learned.

The village was ominously quiet; too quiet to suit me. One could not help feeling that the enemy was either preparing some important action in the sector, or was already engaged in extensive operations at other points. Without reconnaissance planes, we could not expect to be warned in advance of any impending move and were consequently kept in a state of unpleasant expectancy.

We were to learn only long afterwards the cause of the enemy's quiescence during the night of the 16th-17th on the Charleroi front. South of us the 5th Infantry Division and the 4th Cavalry Division, decimated after five days of hard fighting, had had their centers of resistance ringed and finally submerged by the panzers. The artillery batteries as well as the horse-drawn antitank guns, in spite of the considerable damage they had inflicted, were overtaken by the mechanized forces and had to be destroyed and

abandoned, the draft teams having been dispersed and killed by bombs.

The 1st Armored Division, which we had encountered north of Tamines during the afternoon of the 14th, had been sent to counter-attack in front of these two divisions. It arrived ahead of the line of resistance between Flavion and Ermeton (Flavion is halfway between Philippeville and Dinant, Ermeton 4 miles due north of Flavion).

Although amount of fuel was low, the combat trains were expected with an adequate supply. But everything seemed to go wrong; the combat trains were bombed late in the afternoon and failed to appear. With a scant quantity of gas, all idea of maneuvering had to be abandoned, the "B" tanks were

such heavy consumers. Perforce, this was to be a last stand for the 1st Armored Division.

The tanks were disposed in two lines, holding a front of three to four miles. The German mechanized units attacked in the morning without any success; but later in the day, discovering the possibility of out-flanking the positions, they made a thrust toward Florennes and occupied Philippeville, surrounding several battalions, and finally submerged the thin line of infantry holding the ground in front of them. The same evening, May 15th, the vanguard of the enemy reached Beaumont, defended by the headquarters units of the 18th Infantry Division under the command of the General himself. The panzers had advanced 20 miles in 12 hours and had broken the French front.

Further to the south, the situation was as bad. The various corps which were holding the line from Fumay to Mézières were severely mauled and were overtaken by the enemy mechanized units while retreating to make a stand on the front Rocroi Couvin. The German tanks had filtered through. The 9th Army was practically annihilated. Thus a wide gap existed south of Charleroi and the Sambre. Division after division was poured by the enemy through this gap during the 16th and the 17th. No wonder the sector was calm in front of us during the night of the 16th-17th! Little did we know that the panzers were but a few miles south of us, driving at high speed westward toward the sea.

MAY 17

At daybreak on the 17th, our battery positions were organized, trenches dug, and machine-guns placed for

antitank action. The cannoneers at the gun emplacements were pestered by the numerous cows which had been driven to the fields and pastures by their owners, before fleeing. The animals had not been milked in possibly 48 hours and seemed to be in great pain. They approached anyone moving, visibly expecting to be relieved. They had to be led away from the guns before we could begin firing.

At 8:30 AM we received our first order to fire. The objective was Ransart, northeast of Charleroi, 6 miles away. We had passed through it on the afternoon of the 14th.

During the morning, the enemy endeavored to enter Charleroi; we were called upon for some stiff concentrations, the last one on Jumet on the road Charleroi-Gosselies. From the OP one saw considerable traffic of mechanized units going south. Around noon, elements of the 5th North African Infantry Division passed by. The 22nd F.A. reconnoitered battery emplacements in the vicinity, which they occupied at 4 PM.

At 5 PM we received the order to leave and proceed to Fauroelx, southwest of Binche, 2 miles from the French border. Route: Fontaine l'Evêque, Binche on Road No. 22, Estinne au Mont, Fauroelx. The infantry was retreating on Highway No. 22. We arrived at Fauroelx at 9 PM, and our combat trains were already halted in the village. Gun flashes illuminated the sky to the south of us. Four miles

away, the enemy was trying to cross the Sambre at Merbes-le-Château, where heavy fighting was in progress.

New orders: We were to stay only a few hours in Fauroelx, then proceed to the Ghlin woods northwest of Mons, to be ready to open fire at 9 AM.

MAY 18

We left Fauroelx at 1 AM, May 18th. The itinerary was Estinne au Mont, Givry, Noirchain, Frameries, Goesines, Ghlin. The reconnaissances had gone ahead by a shorter route.

The Luftwaffe appeared very early. Mons was heavily bombed, as well as Road No. 7, which our itinerary avoided. However, we were under cover in Ghlin woods by 7:30 AM. The magnificent trees sheltered excellent battery positions. We were soon ready to fire; base deflection 1,600 miles. The line held by our dragoons had the shape of a V with the point turned toward the east. The Germans were advancing north and south of Mons.

However, we were only in reserve; quiet prevailed and no firing orders were received. Sounds of gunfire in the north, east and south left us in expectancy as to what it meant. Only one exciting incident: Our dragoons arrested a parachutist, a young man who kept pacing up and down in front of Colonel de B.'s post of command. He had on a white cassock and a straw hat; in a suitcase

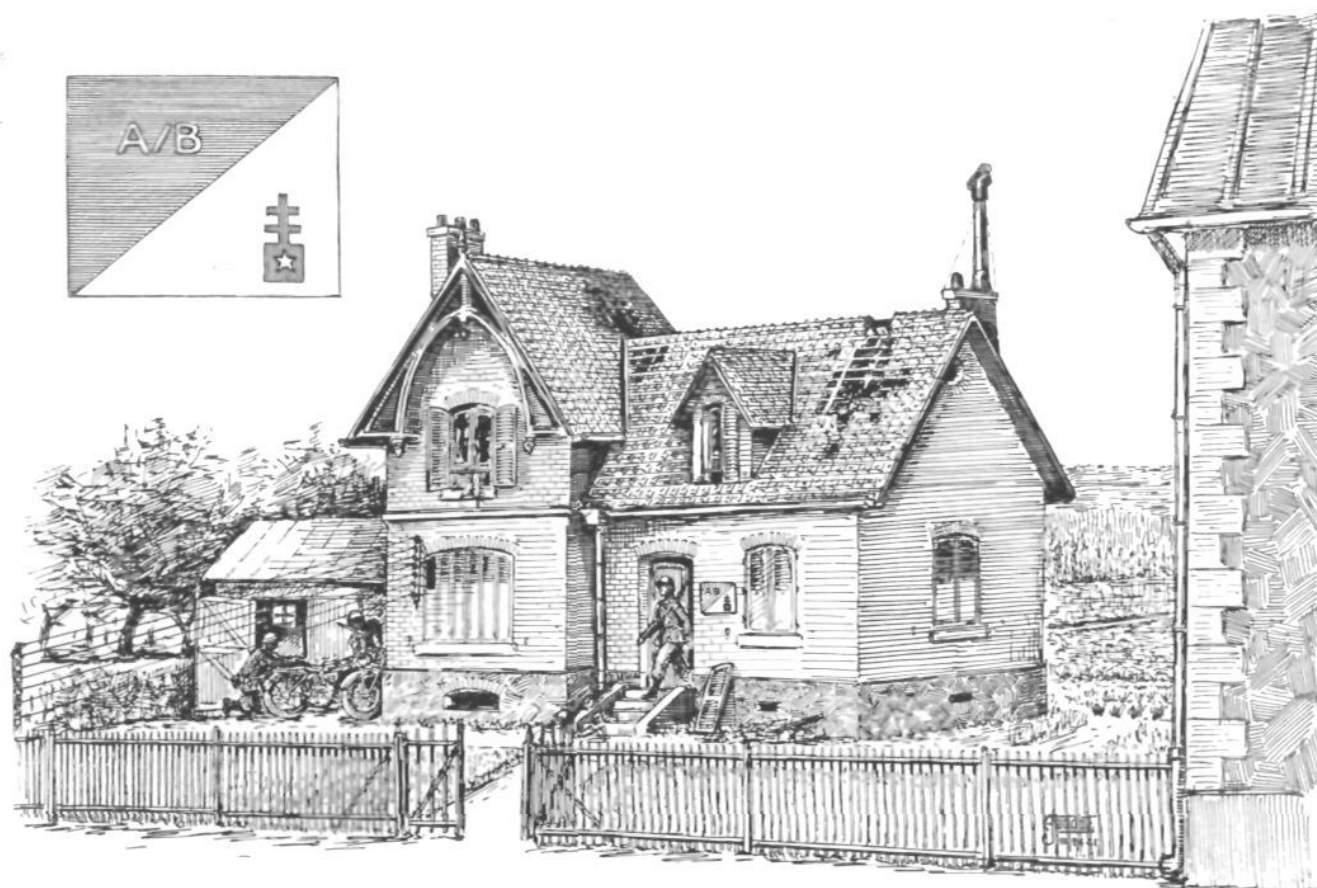

Battalion CP in cottage

he carried a woman's dress for disguise, if needed. After half an hour of questioning, he readily admitted he had landed early in the morning. On being asked if he knew the fate which awaited him, he simply answered: "Yes, it is the fortune of war."

At 6 PM we were ordered to move. We were going back to France, in the vicinity of Denain. The march commenced at 7 PM, and proceeded via Baudouz, St. Ghislain, Boussu les Mons, Quievrain, then Blanc Misseron in France and Valenciennes, Rouvignies, Denain, Abscon. This route had been bombed repeatedly as was shown by the ruins of houses on either side. However, there was not a single hole in the road, but instead they were 50 to 100 yards north or south of it. The fields bordering the highway were strewn with disabled cars, old carts, broken-down perambulators, miscellaneous flotsam and jetsam, dismal reminders of the Dutch and Belgian populations fleeing their invaded cities.

We crossed the Franco-Belgian border between Quievrain and Blanc Misseron. Field fortifications were to be seen scattered in the countryside along the border: pill boxes, bunkers, trenches, barbed-wire entanglements. None were occupied.

We followed the National Highway 29 through Valenciennes up to Rouvignies. Thence a smaller highway led us to Abscon, via Denain. Valenciennes and Denain showed signs of heavy bombing, but many inhabitants were still about. Abscon was reached at 11 PM, where we managed to shelter men and matériel in four large houses surrounded by extensive gardens with enough trees in it to provide adequate cover.

An elaborate system of sentries and guards was organized, using machine guns and Bren guns to avoid unpleasant surprise. After the usual servicing and maintenance work, the battalion rested, oblivious of any event which might occur outside of Abscon. Meanwhile, portentous happenings were indeed taking place not very far from our quiet bivouac.

I have stated that late in the afternoon of the 15th, the enemy mechanized units had reached Beaumont, west of Philippeville, and were thrusting westward as fast as they could. The defense opposed by the scattered French infantry battalions was of little avail against them. Most of these were mere skeletons of battalions, many men and a large fraction of the antitank equipment had been left behind, in the centers of resistance along the line, south of Charleroi. There, surrounded and hopelessly submerged, they were holding out obstinately.

In their advance towards the west, the German panzers soon found themselves on the right bank of the Sambre; crossing the river was a necessity. During the night of 17th-18th, while we were at Fouroeulx, they made a vigorous thrust to gain passage at Merbes-le-Chateau, without success.

During the 18th, other enemy attempts were made simultaneously on a wide front from Maubeuge down to the Mormal Forest. Their heavy tanks were brought into action, assisted by a considerable number of bombers.

Our division had charge of the defense. The squadrons of tanks and armored cars of the 2nd L.M.D. had been severely depleted during the fights of the preceding days. Two thirds of the H35's, one third of the S35's had been destroyed with no replacements available. The losses in men in many platoons exceeded 60 per cent. Covering the Sambre on a 15- or 16-mile front with these reduced means, against thousands of tanks and swarms of planes, was a desperate venture.

There followed nearly forty-eight hours of furious battling. Destructions were heavy; one of the brigades lost more than 80 tanks near the Mormal Forest. A colonel with four tanks, surrounded on every side, fought to the end, and, severely wounded, was removed from his wrecked vehicle by the Germans themselves. An armored car of the 8th Cuirassiers encountered in Maubeuge

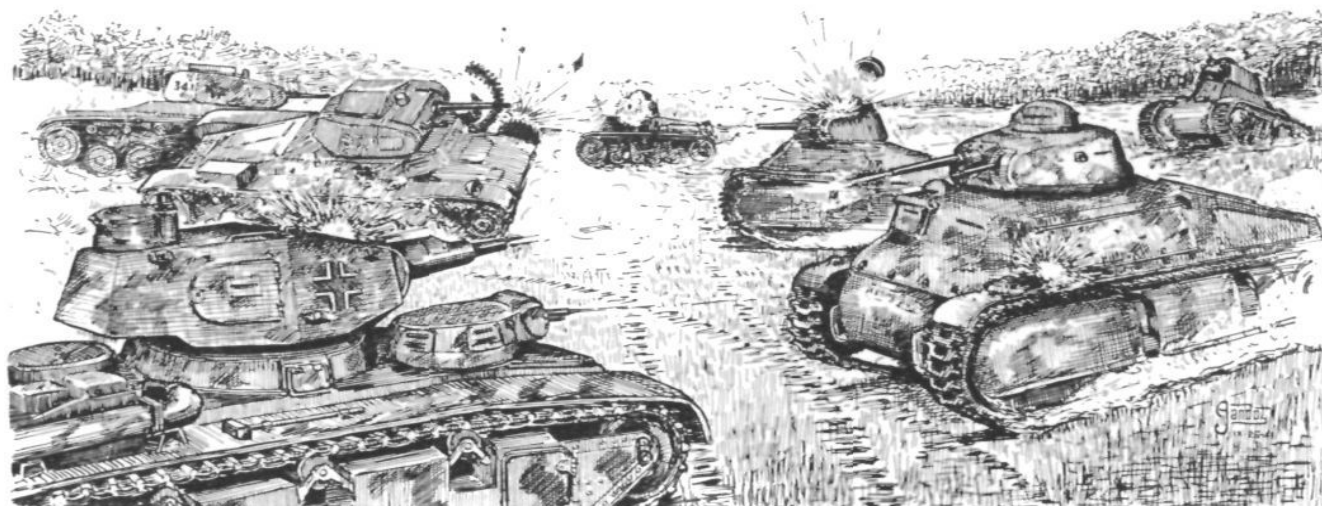

German heavy and medium tanks attacking French tanks S-35 and H-35 (Somua-35 and Hotchkiss-35).

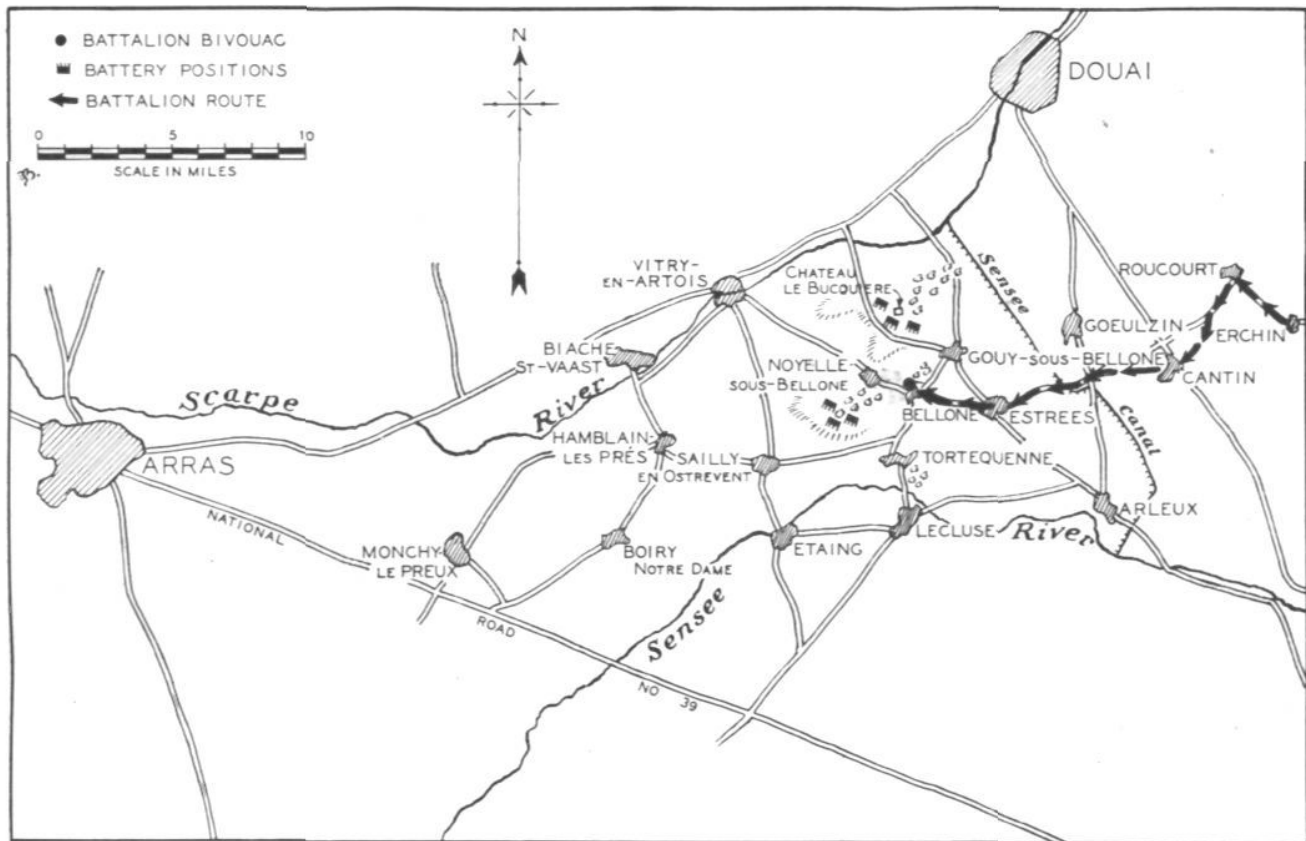

Map No. 2

one of the enemy heavy tanks. In a battle of David against Goliath (16 millimeter plates against 60, 25 millimeter projectiles against 77 millimeter shells), David won. The German monster was disabled by a hail of bullets before it could score a hit.

The division's log book recorded for these days many similar feats. However, outflanked on the south, the battered remnants of our dragoons and cuirassiers were compelled to break off the engagement and withdraw.

MAY 19

It was at this phase of the battle, in the early morning of May 19th, that we received the order to move from our bivouac in Abscon and occupy a position in the neighborhood of Haveluy, 1½ miles north of Denain. The reconnaissances left immediately. The battalion followed thirty minutes afterwards.

The chosen emplacement straddled two rows of miners' houses; a coal mine was near at hand. Base deflection, 2,400 mils. Instead of the anticipated order to fire, we received at 12:30 instructions to move westward to Bellone, 4 miles south of Douai, 12 miles east of Arras. Route: Haveluy, Denain, Aniche, Erchin, Roucourt, Cantin, Estrées, Bellone.

The roads were heavily congested. The Luftwaffe, particularly aggressive, bombed crossroads and main

highways. In such circumstances, regulations require 100-meter intervals between vehicles to decrease the vulnerability of the column. Actually, when a super-dense traffic clogs the roads and jams occur every few miles, as was the case in this afternoon of the 19th, it was nigh impossible to enforce this rule. Every time I tried it, the battalion was soon truncated in many fractions with strangers mingled in between. So I decided on 25-meter intervals.

At every halt the cannoneers were ordered to jump out of the cars and crouch in the ditches on both sides of the road, carbines held in readiness. Any German planes approaching within 300 or 400 yards were greeted by regular volleys fired by platoons to insure enough density. Our machine guns were constantly manned from the tractors or trucks on which they were mounted; and fired even while en route. We observed that the enemy planes kept safely away from us and went after more submissive objectives.

My log book shows as an event worth recording for this afternoon, a dog fight between several Dorniers and two Spitfires. We had not seen any Allied planes since the early morning of May 14th. Two of the German planes crashed in flames with their load of bombs exploding on impact; the tremendous blast shook the ground.

We reached Bellone at 4 PM. The 4th Battery was detached at Noyelles sous Bellone, 1 mile northwest

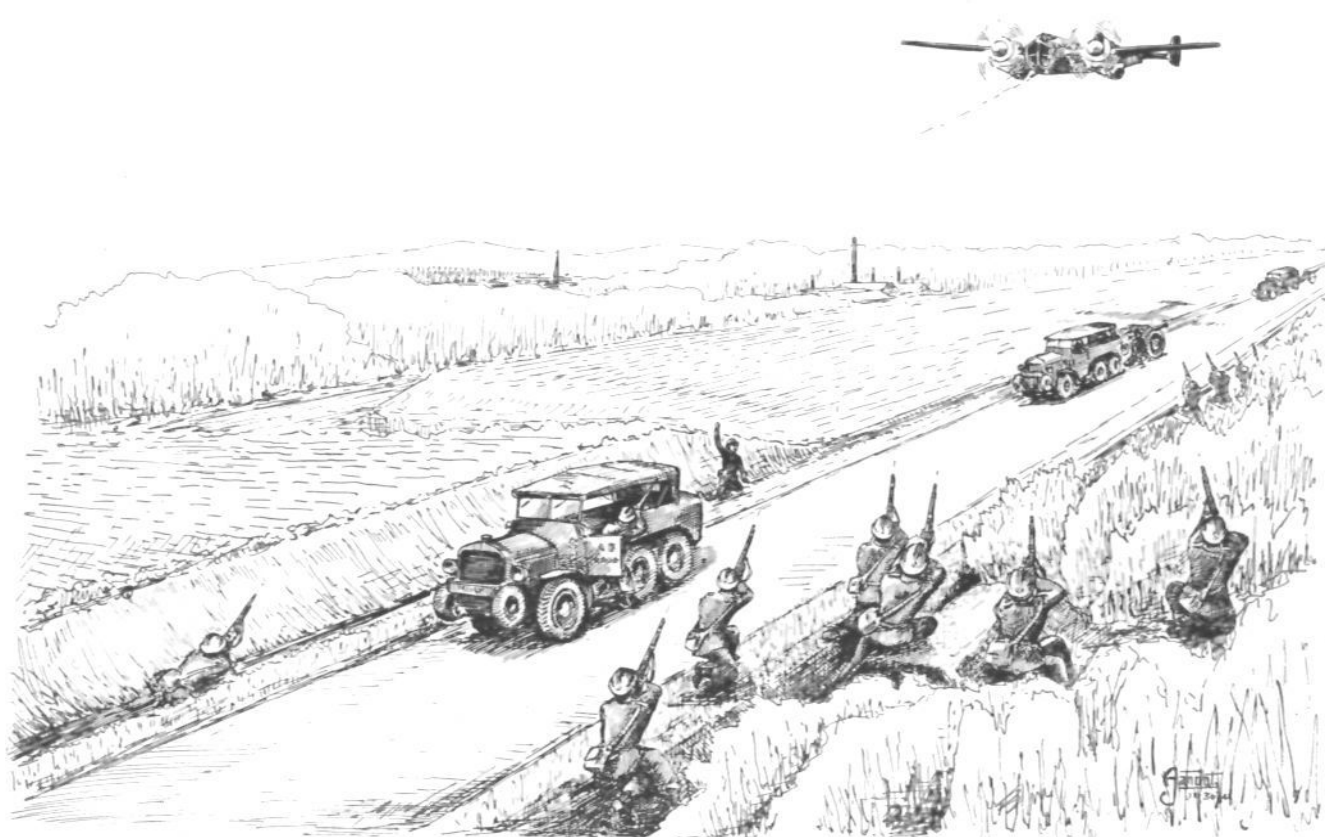

Artillery column halted on road is attacked by German planes. Cannoneers are firing their rifles in ordered salvos at the plane.

of Bellonne. It was to participate in the defense of the division's CP, bivouacked there. The other units of the battalion took position in Bellonne, which was organized as a ringed-center of resistance. The village was built on a knoll dominating the surrounding country. The guns were placed in readiness, oriented on different azimuths in order to cover all possible access to the village. Barricades were erected, trenches dug, look-outs were stationed at all vantage points. Half of the personnel stood watch.

However, nothing happened. The moonlit night was as quiet as anyone could wish a May night to be. Even towards the south or southwest, where the enemy doubtlessly was, there was no sign of activity; no gun flashes were to be seen or reports to be heard. Nevertheless, the advanced elements of the panzers were probably bivouacking not far from us.

Towards midnight, operation orders for the next day were received. We were to take a position along the valley of the Sensee River, east and west of Lecluse village, to prevent any northward progress of the enemy. The front of the division extended roughly from Biache St. Vaast to Arleux.

The reconnaissances left at 3 AM (May 20th), the batteries one hour later. They were guided separately to their respective emplacements. The selected position was on the southeast edge of small woods located one mile

south of Noyelles sous Bellonne. Base deflection, 3,500 mils.

The battalion CP, located at first in the woods, was moved at 10 AM to a small cottage just outside of Noyelles. The Colonel's CP was in the village. We placed the OP on the southern edge of Noyelles woods, on the military crest, thus affording an excellent view down the marshy meadows through which meanders the Sensee River. Across the valley, many landmarks could be observed: Lecluse, Etaing, Boiry Notre-Dame, Monchy le Preu, National Highway No. 39, Cambrai-Arras, etc.

While I studied the landscape, on this bright morning of May 1940, I couldn't help but remember that in December 1914, I had an OP located in a house on the east side of Arras, looking on the very same scene. It was then east of my station, whereas it was now west or southwest. Monchy le Preu and Etaing were regular objectives for our concentrations in 1914 as very likely they would be in 1940. But we now occupied positions that were the enemy's 26 years ago.

Soon the sector became lively.

The 2nd Battalion of the 1st Dragoons, which we were supporting, had their CP in Tortequenne, just north of Lecluse. Early in the morning they sent patrols to Lecluse, across the river. In the village, which they approached cautiously, they saw a section of German

motorcyclists stopped on one side of the main street. The Dragoons attacked. Result: The Germans scattered and fled, and our men brought back to Tortequenne the motorcycles and sidecars.

Shortly after this, the Germans (as a matter of course) retaliated. They fired at Tortequenne with everything they had, trench mortars, 37-mm guns, machine guns, and other weapons. They even undertook to ford the river. Finally, at 11:30, we were called upon to throw a barrage on the river bank. This activity was kept up during the whole of the afternoon. Many fires were required from us by the supported unit: barrages, O.C.P., concentrations, etc. All these fires were controlled from the OP.

I was informed that a counter-attack, in a southeast direction, in cooperation with a British armored division, was contemplated for tomorrow. British troops, I was told, were holding the lines east of us, north of Arras. The sector covered by our battalion, which extended from Lecluse (included) to Saailly-en-Ostrevent, might have to be stretched further to the west, to include Hamblain les Prés. This could not be done easily from the position we occupied. Hence a move was decided upon. We were ordered to put the batteries in the wooded park of the Chateau de la Bucquière, one mile northeast of Noyelles.

The movement was made in echelon. At 9:30 PM the three batteries were in their new positions and ready to fire.

The base deflection was 3,500, the same as for the morning, and the mission was the same.

After sunset the Dragoons and their antagonists across the river were much quieter; except for an occasional burst of machine-gun fire and a few Verey lights sent up now and then, the war seemed to be far off.

Our CP was conveniently located in the game warden's lodge where we found enough tables and chairs to equip a first-rate office and fire-direction center. The prevailing calm afforded us ample time to prepare the schedule of fires and examine the situation.

On the eve of a day which was to have a controlling influence on our fate, it may interest the reader to review with me the situation:

The 1st Dragoons, reduced now to 1,800 men, was deployed facing south, along the valley of the Sensée. Its left, anchored on Arleux was protected by the Sensée Canal. Its right was on the Scarpe River, at Biache St. Vaast.

The supporting artillery included:

1. The third battalion of the 329th FA (the 329th FA, I have mentioned in a preceding article, was the Corps Artillery Regiment of the Cavalry Corps) was placed in the vicinity of Goelzin. Zone of action: Arleux, inclusive, to Lecluse, exclusive.

2. Our battalion (2d Bn 71st FA). Positions: Chateau

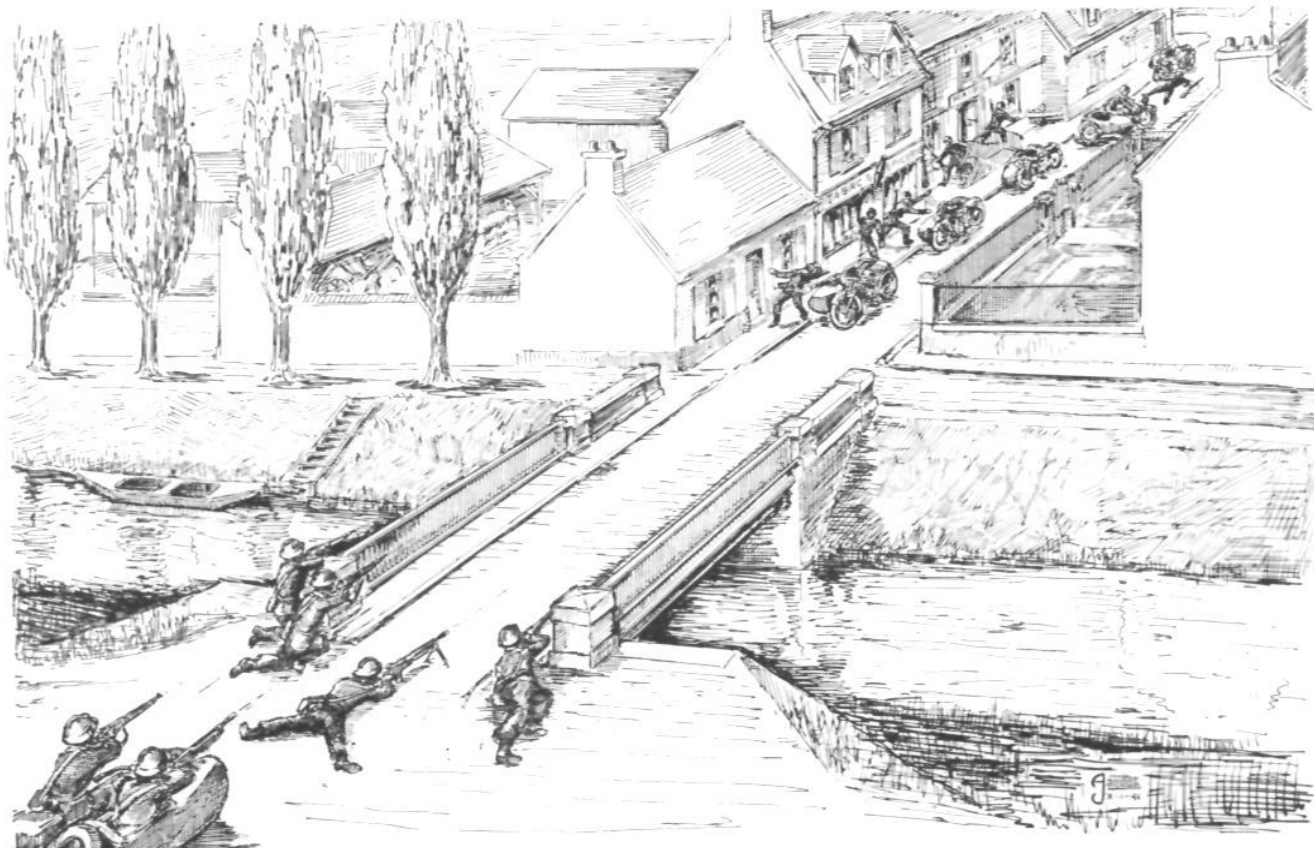

German motorcyclists attacked by French Dragoons

of LaBucquière. Zone of action: Lecluse, inclusive, to Saily en Ostrevent, inclusive, with possibility to fire as far west as Hamblain les Prés.

3. The 1st Battalion 71st FA. Positions: South of Vitry-en-Artois. Zone of action: Saily en Ostrevent to Biache St. Vaast, inclusive. These three battalions, armed with 75-millimeter guns, constituted a direct support groupment.

4. The 3d Battalion 71st FA, armed with 105-millimeter howitzers. Mission: general support. Positions: south of Gouy sous Bellonne. Zone of action: the whole front.

As for the enemy, we had rather scant information on him. It appeared that we had to deal now with a motorized infantry unit. Contact was established all along the front, but only the main centers of resistance were strongly held: at Palluel, Lecluse, Etaing and Hamblain. In between, the enemy had well-equipped outposts.

The Germans were very aggressive; on several points they undertook to ford the river or even to swim across it. Our Dragoons were also active and keen; both sides were bent on taking prisoners. A point worth mentioning, up to the night of May 20th-21st, no enemy artillery had been observed in the sector.

As regards happenings beyond the screen of infantry we had in front of us, information was also scarce. Reports were received stating that panzers had reached and even passed Arras in a swift thrust towards Abbeville and the sea. This was all we knew, but it gave us strong hopes of succeeding, in the counterattack contemplated for the next day, in cutting the thin east-west line of the panzers, and in joining hands with the French units which could not fail to be on the other side, further south.

(To be continued)

Proposed Amendments to the Constitution, U.S.F.A. Association:

TO THE SECRETARY, UNITED STATES FIELD ARTILLERY ASSOCIATION, WASHINGTON, D. C.

1. *Amendment to the Constitution.* The committee appointed by the President at the annual meeting December 16, 1940, proposes that the Constitution of the United States Field Artillery Association be amended as follows: (suggested changes are italicized)

ARTICLE V. Combine sections 3 and 4 to read: *Active and associate members shall be entitled to receive the JOURNAL without payment other than the annual dues.*

ARTICLE VI, Section 1—The Executive Council shall be composed of nine active members, five of whom shall be officers of the regular army, two officers of the *National Guard* and two officers of the Field Artillery Section of the Officers' Reserve Corps, to be elected biennially for a term of two years by a majority vote; *such majority vote to consist of a majority of active officers present or represented by written proxies at a meeting of the Association.* The Council shall hold its meetings at the headquarters of the Association, which shall be in the city of Washington.

ARTICLE VII, Section 1—The regular meetings of the Association shall be held annually at Washington, D. C., or at such other place as may be designated by the Executive Council, who shall also prescribe the time of meeting and *give at least thirty days' notice of same, by publication in THE FIELD ARTILLERY JOURNAL or by such other means as the Council may prescribe.*

ARTICLE VII, section 3—Special meetings may be called by the Executive Council, upon written request therefor signed by twenty members. At least thirty days' notice thereof shall be given in THE FIELD ARTILLERY JOURNAL, or by mail, to active members. The object of the meeting shall be stated in the request and in the notice.

ARTICLE VII, Section 4—*The number of active members present at a meeting or represented thereat by written proxies, shall constitute a quorum, except as provided in Article IX.*

2. *Reasons for the amendments.*

a. Sections 3 and 4 of Article V should be combined as indicated to permit the Association to augment its income by publishing books or pamphlets (if so desired) for profit.

b. The reasons for the other changes are as follows:

(1) It has now become practically impossible to obtain a quorum, which, according to the Constitution as now written, must consist of fifty per cent (by proxy) of all active members in the United States. This failure to secure a quorum arises because erroneous mailing addresses or frequent changes in address prevent proxy cards from reaching many members; and also because many members fail to return signed proxies.

(2) The proposed changes will obviate the necessity for sending out proxy cards. This will save the Association \$100 (or more) annually. No member who desires to vote will be deprived of his vote; he still will receive due and timely notice in the JOURNAL, and will still have the privilege of sending in his proxy if he so desires.

(3) In effect, and in brief, the changes will merely mean that all members and proxies on hand at a meeting will be counted, and a majority of this count will constitute a majority vote.

(4) There is no change in the authority of the Council, which will still continue to administer the affairs of the Association as in the past.

3. In accordance with Article IX of the Constitution, we (members whose signatures are appended below) accept the report of the committee, and propose that the foregoing amendments be made to the Constitution.

R. M. Danford; W. C. Potter; I. T. Wyche; Thomas North; J. V. Phelps; M. McClure; Rex Chandler; J. A. Stewart; J. F. Uncles; Rex W. Beasley; Stuart L. Cowles; John B. Anderson; David S. Rumbough; J. A. Lester; L. M. Riley; H. E. Maguire; Townsend Heard; B. M. Sawbridge; C. G. Helmick; I. Spalding; B. M. Bryan; A. W. Waldron; J. W. Mackelvie; A. F. Kibler; I. L. Foster; A. C. McAuliffe; F. A. Henning; John H. Hinds; L. Whitlock.

The Battery Commander

Practical advice on the relationship between the commander and his men.

Part II—Conclusion

THE DIFFICULT CASES

Knowing how to deal with human beings is an art, and skill in that art is the basis of leadership. This sort of skill presupposes that one has a capacity for studying faces and reading them. There is no such thing as training in a matter of that sort, where mastery presupposes true culture of the heart. Such culture will be found in an officer who combines the faculty of spontaneous insight with a deep sense of obligation toward his comrades. A certain spontaneous insight can to some extent be developed. Each battery has its quota of men who are difficult to deal with: those commonly referred to as the "difficult cases," such as the type given to pessimism or brooding, the type who are slow to adjust themselves, or the type who are troubled with an inferiority complex. Men like these are the kind most in need of help from their officers.

A fundamentally pessimistic outlook on life is a heavy burden not only for the individual himself but also for those about him. In a fighting force pessimism is harmful and even dangerous. The best antidote is contact with lively and cheerful companions. The men with a gloomy outlook on life will need speaking to more frequently than others; and usually it is best to address them in something of a humorous vein; the man's negative attitude will be less likely to exert its influence upon others. Often it is possible to get such men to overcome their temperamental handicap. There are instances, to be sure, where a pessimistic outlook on life has fastened itself upon the man's mind as a result of unfortunate experiences. In difficulties of that kind, discussion can often be very helpful. What such men need above all is the happy experience of living among a group of warm-hearted, friendly comrades. The battery commander usually can get results by privately asking a sympathetic comrade to look after his fellow soldier.

The brooding type can be dealt with in a similar manner. They should be assigned, if possible, to a section commander who is not overburdened and who is of the spirited kind that will carry the man away with him.

Among the men who are slow to adapt themselves may be some who are potentially very valuable, but who are in danger of being misunderstood or overlooked entirely. It

can easily happen, too, that their slowness is mistaken for indolence, with the result, usually, that the wrong method is chosen in dealing with them. The consequence often is that men of that type will be found to develop an inferiority complex. They ought now and

then be given a task they are really capable of handling well, so as to strengthen their self-confidence. Among the men that a company commander is called upon to deal with are those of the type, too, that have never been able to achieve their inner freedom. And nothing could be better suited than their term of service in the army to strengthen their backbone and make them free. In actual combat the quiet and slow men often show much better qualities than those who did all the talking.

It is an important problem all around to discover men who are more than they seem; and also to find means of severely testing the true quality of those who have a knack for creating a good impression, and to get informers and stool pigeons to show their true mettle.

CARE OF THE OLDER MEN

As a result of war we often find many of our men wearing the plain uniform of the enlisted man notwithstanding the fact that they are relatively advanced in years and may have substantial accomplishments to their credit in civil life. We must simply take it for granted that they will show willingness to adapt themselves and be content to take in army life the place to which their slight military experience entitles them. We have university professors, engineers, architects, and highly skilled workmen filling their place in the army as private soldiers or as NCO's; and they take pride in their opportunity to play a part in events where the very life of their nation may be decided by force of arms. The soldier's calling will always be of leading importance so long as men continue to walk on their hind legs and do not learn to creep past their enemies. To follow the profession of arms has always been regarded as a very high honor; and that holds true today more than ever. It would not be in keeping with our national character for a man to expect special acknowledgment for doing

Every officer in our Army should read this inspirational essay

his part for his country. His opportunity to give this service means fulfillment of the fundamental social law of his being—self-sacrifice for the good of others.

One must bear in mind, nonetheless, that military service ordinarily entails greater sacrifice for the older men than for young soldiers straight from school. A battery commander, therefore, should be glad to do what he can to have them regard the necessary duties as an obligation of the sort they will be only too happy to fulfill.

By finding the right spot for former service men in his battery the commander can greatly improve its life as a community: the wide experience of those older men, their greater maturity of mind, their seriousness of attitude, no less than their specific skills and knowledge, constitute values to be turned to account for the benefit of all. Cases will arise quite often where men of this type can be of help to the commanding officer in giving care to younger comrades. If capacities latent in the older, experienced soldiers are properly turned to advantage, such men can easily become the nucleus in creating "an indissoluble bond of battle comradeship to unite the troop and its leader."

CASES WHERE A REQUEST MUST BE TURNED DOWN

Soldierly obedience is silent obedience. Military orders must be carried out unconditionally, without reserving the right to remand justification or a statement of reasons. It is one of the fundamental tenets of military life that a military leader disposes of the unconditional obedience of his men. Two short words, Yes, sir, suffice to epitomize the whole situation.

Nor is there any necessity for a battery commander to give reasons in turning down a request for leave of absence, or any other. When it becomes necessary, as often happens, to turn down a perfectly reasonable request, it is none the less perfectly proper to add a few words of explanation not called for by routine procedure. War is cruel, and its hardships are often extreme. Suppose, for instance, that one of the men desires leave because of serious sickness at home. If such leave cannot be granted, it will probably be best to have the man come in, and to explain to him why it is impossible to let him go. If he can be made to see that his superior officer is tied down by the exigencies of the situation no less than he is, it might be easier for him to renounce his request willingly. He will master his disappointment and gain in self-reliance.

INSPECTION OF QUARTERS

As soon as his battery is newly billeted in bivouac, the commanding officer will inspect the quarters to which his men are assigned. This tour of inspection is one of his regular official duties. In the course of this inspection he will check up on the good order, cleanliness, and appropriateness of the quarters, and at the same time he will remedy objectionable conditions and suggest improvements.

Helpful hints will be yielded by a casual tour of inspection later on through the men's quarters and recreational facilities—an unofficial call to be made now and then, unannounced and unaccompanied. On these occasions the commander does not call in his capacity as the superior officer, but simply as an elder comrade; and his visit will be in the nature of a friendly call, because this time he will be much more at leisure. A commander should attend the various athletic games indulged in by his men. At these times he can see many of his company when they are completely at ease and gain new insight into their lives and problems.

REMARKS ON FOOD FOR THE BATTERY

Food at the mess will be plain, wholesome, and sufficient in quantity. And yet it will be found a matter of great consequence, too, if instead of merely insisting on the usual routine the battery commander devotes himself intelligently and competently to the very important problem of food for the men.

The cook of a field kitchen is an important personage; because if he knows his business, he can make valuable contributions toward the battery's good health and good spirits. A commanding officer must make it his business to consult frequently with his cooks and with the mess sergeant regarding ways and means of changing the fare, exploiting every opportunity to offer something special.

Furthermore, in campaign, the Captain himself should set an example in the way of being content with little in the way of food.

The cook and his helpers should keep themselves cleaner than any other men in the battery; and there is no such thing as being too tidy in a room where food is kept. The men will feel they are in good hands if they notice that from time to time their commander will stop to concern himself with the mess problem, contributing a good suggestion of his own now and then, and helping the cook as best he can. A chief who lives up to these principles will find he can ask almost anything of his men when the time has come for the fighting. They will be glad to follow a leader like him.

FURLOUGH IN WARTIME OR DURING OTHER NATIONAL EMERGENCIES

A soldier going to war draws a line under the rest of his life the day he leaves his home to go to the front. The tasks of war require the whole man, detach him from his family duties and other duties as a civilian, and compel him to give absolute, unquestioning obedience. His military oath requires him to be ready at any moment to risk his life if necessary. All this calls for thoroughgoing detachment from his previous mode of living. He no longer belongs to his family, nor even to himself: he belongs exclusively to his country and his nation.

Held down to the exacting tasks of his new duties and

new environment, he has, nevertheless, a new feeling of power and strength. He is led to discover for himself that the greatest of the forces of life consists in the strength of will as manifested in the making of bold decisions and in relentlessly carrying out these decisions.

In his better moments a soldier is bound to realize at least vaguely this greatness of his calling.

In the course of modern warfare, soldiers are granted furlough from time to time to go to their homes; and the men feel very strongly that such leave is a gift of incomparable value.

Great caution and careful reflection are required, therefore, in preparing a list of men to go on furlough; and the head of a battery will make every effort to see to it that full justice is done in every case.

When a man's turn has come to go on furlough, he will probably be in the happiest frame of mind conceivable; more than likely such perfect joy of anticipation has not been his since the days of early childhood. The first sergeant will give him the necessary instructions; whereupon, as soon as the purely official part of the business is settled, he might well be required to report to take his furlough from the captain. That will be an occasion for saying a few cheerful words, demonstrating that the commanding officer himself derives pleasure from the man's good fortune. And one could well add, also, a word of good wishes for the man's people at home.

Even more important it is to have a few hearty, soldierly words of greeting for the man himself when he reports back for duty; just a question from man to man, how everything is getting on at home. One might perhaps add a word or two of cheerful comment: "Well, I hope you'll feel better now, with all that off your mind. It's not a bad idea at all to go back once in a while—just to make sure everything is getting on all right."

A few remarks like that will make a soldier feel that his captain knows what goes on in a man's mind; and that he is, after all, just a human being "like the rest of us." In such manner a genuine bond of comradeship is easily formed between officer and man. There is no reason why a pair of shoulder bars should transform a man into a "stuffed shirt."

PROMOTIONS AND DECORATIONS

Promotions and decorations afford some of the rare moments where it is found desirable to raise the individual soldier above the great mass of his comrades, by way of specially recognizing his merits. One must not forget that when a soldier is given promotion, his whole battery will feel qualified, more than on any other occasion, to sit in judgment on the proceedings. For that reason it is highly important that a commander should never allow himself to be deceived by false pretenders of any sort. Persons of that type receive short shrift, as a rule, before the bar of public opinion in a company of soldiers. Granting a special reward is easy to decide upon

if one of the eligible men has made himself conspicuous by competence and bravery under fire. It is very much harder to make the right choice under circumstances where the only standard available is the man's conscientious performance of routine duties. Before decorating a man or effecting his promotion a battery commander must be very careful, therefore, to find out all he can about him, and to consult fully with the section chiefs. His decision in a matter of that sort will reveal his knowledge of human nature. If he has made a good decision, that is if the rest of the battery rejoice with the promoted or decorated man in his good fortune, the commander's authority will be all the more firmly and conspicuously established.

THE BATTERY COMMANDER AND HIS STAFF OF NONCOMMISSIONED OFFICERS

A soldier must "be aware within himself that he can do" is an old maxim and it applies to none more than to a noncommissioned officer. It has nothing in common, however, with a fondness for putting on airs of importance.

The real importance of noncommissioned officers for the battery's training and the development of its striking power could not easily be overestimated. It is one of the commander's outstanding duties, therefore, not only to provide ahead of time for a group of capable successors, but also to develop among his noncommissioned officers genuine respect for their own position and true pride in their chevrons. They must realize that they are the captain's right-hand men and that they hold a position of trust. They must be made to feel responsible for battery property and for the welfare of the men entrusted to their leadership. This responsibility must be accepted by them not as a burden but as an enviable distinction. Whenever the opportunity offers, each individual noncommissioned officer's duties should be discussed with him in detail; and in the course of such discussions the commanding officer should know how to impart the most favorable conception possible of the extent of their duties, showing interest even in the detail of their work, and proceeding simply by means of interrogation as well as by explicit control. The purpose to be kept in mind will be to train each man to judge for himself and make his own decisions; and the ultimate goal will be to have a force of noncommissioned officers who will always be glad to obey when obedience is called for, but also be able and glad to take the initiative if the situation demands it.

A period of quiet offers opportunity for the development and training of wholesome self-respect if the noncommissioned officer, aside from receiving the usual orders and commands, is called in now and then to give his opinion before the commander has made his decision. ("There is a thing or two I want to get your opinion on.")

Very much can be accomplished at times simply by a

brief word of encouragement. Just imagine a newly promoted young noncommissioned officer zealously at work in the line of duty, with the captain stopping to look on. "Well, what do you say, Smith?" remarks the captain. "How does it feel to be responsible for somebody else?" One can see an expression of pride come into the man's face: there is dawning in him a vague realization of the lofty ethos involved in taking responsibility. He is determined more than ever to do the very best he can.

Again and again every commanding officer should stop to remind himself that his noncommissioned officers more than anyone else in the battery will regard him as an example to imitate, and that his bad traits will be copied along with the good. If he is rigid and precise in his bearing, they will try to equal him in that. If he relaxes his self-control, an analogous trend will soon become evident in the non-commissioned ranks.

An unmitigated evil in any battery are the slave-driving type of noncommissioned officers. If it should happen that one of that kind is among his own men, the commanding officer must proceed immediately to put a stop once and for all to such doings. It is always a good idea, anyway, to check up unexpectedly on the inner workings of the battery. The result is at times surprising; and these surprises are not by any means pleasant every time.

A great deal depends on the first sergeant. He is the commanding officer's first helper and exerts leading influence among the noncommissioned officers; and he is in a position to do quite an amount of educational work. To be sure, his tasks properly speaking are only concerned with internal duty; and yet it is important to get him interested in all of the many-sided activities of a battery and to keep him from developing into a mere pen-pusher in the orderly room. A good first sergeant will try to run the battery as independently as possible; and it may happen, if he chances to be a particularly forceful personality, that his efforts largely eliminate the influence of the commanding officer. The great art for the commander is to keep the first sergeant enterprising and in good spirits without losing control of the situation. Final responsibility is the commander's. He is in command of the battery.

ORDERLIES AND MESSENGERS

Important problems arise also in connection with the duties of messengers and those of orderlies in the personal service of an officer. It is highly desirable above all that these personal orderlies, upon relatively close acquaintance with their officer, should spread the opinion that their chief "really is a fine fellow." It is simply a matter of good sense for an officer to make clear to himself that his orderly is not in any usual sense of the term his servant, but merely a soldier placed at his disposal to assist him. It is essential that the orderly should discover for himself that the captain is a man who needs all his time and strength for his battery, and who

must for that reason be relieved of responsibility for his own personal equipment and quarters. It is an honor for a soldier to be given a special position of trust as the personal orderly of his commander. It is a place that calls for extra duty, because the orderly has to perform all regular duties the same as the rest of the men. He is not allowed to absent himself from any of his training maneuvers. When the battery is in action, he should have a definite combat duty, say as messenger. There is no other way to prevent duty as a personal orderly from being regarded as an imposition on the enlisted man.

An officer should also be extremely careful, for instance, to plan carefully in advance for the use of the automobile assigned for his personal use, and to avoid having the driver waste his time waiting unnecessarily. There is no merit in the counter-argument that the man is on duty anyway, and that consequently it does not matter to him how he spends his time. Rendering service in his modest capacity constitutes for him the essence of his experience in the Army. That is reason enough for respecting him and his work, and making him feel that his time and effort will not be senselessly wasted. Careful appreciation of these "little things" is of decisive importance at times in determining the opinion entertained by the men of a battery regarding their commander.

Only an officer who is highly competent in the art of leadership will be able to attach due importance to every smallest act performed in the line of duty, making every man feel that his services really are needed. There are men in our Army who are badly needed at home by the family. A man like that must be enabled to perform his military duties cheerfully, in the awareness that he is contributing usefully to the great common cause. In no other way is it possible for him and his family to take the proper attitude toward the war. It is important in any situation for the battery commander to bear in mind that even the humblest of his soldiers have at home a family who have given to the Army their father, husband, son, or brother; and that these families think with pride and affection of their own soldier no less than the commander hopes his own family think of him. So long as he will bear this constantly in mind, he will succeed in finding the right way to deal with his men, and they will be grateful to him as long as they live.

MENTAL TRAINING

In giving attention to the intellectual life of the men of his battery, the commander must realize clearly to what extent the fighting spirit of his men will be influenced if they know what is at stake in the military effort of the Nation. The task involved is one that any officer is capable of meeting, so long as he can muster the iron will that is needed to make the effort.

The daily newspaper and military news publications at the front, radio and books, soldiers' theatricals and other performances are among the agencies suited to keeping the mind active.

But far more effective is the instruction given by the commanding officer in person. He will make use in that connection of whatever material happens to be available to him, translating this material into the language of the soldier and bringing it closer to the minds of his men. In doing so, one must be careful to reduce the facts to their simplest common denominator. The thing that a soldier most needs to know is that National Defense is a matter that closely concerns him, his people, and his children and children's children. Once he has thoroughly got hold of this idea, he will be able to appreciate also the value of his own personal effort and contribution. Mental training for the soldier is mobilization of head and heart. At the close of each lesson—and the lessons must not be too long—the soldier must feel that he can see it all very clearly now, and he must leave in high spirits when the meeting is disbanded.

If men can be found in the battery who have sufficient command of a subject of current interest, and are able to present their subject, the proper thing to do is to make use of them for such purposes.

CULTIVATING THE SPIRIT OF SERVICE

The men of a battery will enjoy the performance of their duties so long as those duties are suitably chosen and arranged and properly carried out, especially if the commanding officer himself is always cheerful and energetic in the performance of his own duties. It is essential to make the men feel that their duties are imposed on them for perfectly good reasons and that they are learning constantly. Greatest punctuality is important in all maneuvers; and even for the larger maneuvers the men should not be made to fall in a minute earlier than necessary, lest they get the idea that their commander is not good at planning. The very manner in which the commanding officer greets his battery in the morning is likely to provide a cheerful impulse to last the whole day. A word of praise after a great effort, as at a rest halt during a very strenuous march, will often accomplish wonders and stimulate further effort.

The ability to see the humorous side of things is indeed a gift of the gods. An officer endowed with that faculty will be able to dispose offhand of many difficulties that come his way. A mere gesture of the hand, one brief remark, will suffice at times to straighten out a situation that might create serious problems for a pedant without sense of humor. Humor is an expression of vigorous, healthy feeling and of a masterful attitude toward life. A spirit of good clean fun in the battery can only be regarded as a source of strength.

ATTITUDE TOWARD RELIGIOUS QUESTIONS

Each soldier is free to decide for himself his attitude in thinking of his God. At moments when a man's life is at

stake in battle, the religious problem will confront him with relentless insistence. To be a God-fearing man is honestly and without bias to seek an answer to the greatest and last of the questions we ask in life.

A battery commander's only concern in formulating an attitude toward the religious life of his men will be to protect every man's freedom to cherish his own convictions. Personal views should be revealed by the commander on rare occasions and with greatest reserve; no doubt should be left in anyone's mind, however, that problems of religion are to be touched upon only with the greatest of reverence.

ONCE MORE: OUR TASK

Once more, battery commanders and other officers of our nation, you are being intrusted with the leadership of the men of our country and in intrusting them to you we give into your hands the protection and care of one of the greatest values produced by this nation. We officers should never pass a day without making clear to ourselves what obligations are implied in that trust. Each morning when report is made to us that the battery is "all present or accounted for" our glance should take in every one of those hundred-odd men, reminding us that back of them are one hundred families who placed those men at the disposal of their nation, and that the safety of those men was entrusted to that one battery and its commander. What is going to be the judgment pronounced upon us by those families? "Our boy's battery commander? The less said the better. That man, unfortunately, is one of those egotists who do not take the slightest interest in their men and who know nothing better than calling them down." Or will they say, with gratitude in their hearts: "Our boy has a good chief over him, anyway; there is nothing he couldn't do, with a leader like that"?

Such opinions uttered by the people of our country are judgments pronounced not so much upon our military capacity as upon our personal worth as an individual.

We are thus brought face to face with the all-important problem of evaluating the services rendered by our officers to the nation, and of assigning to ourselves the position of leadership to which we are justly entitled. This is a question, too, which the commanding officer of a battery should frequently bring up for earnest discussion with the commissioned officers under his direction.

Let us take care that the officers of the Army remain always mindful of the great professional tradition they have the good fortune to be able to look back upon, in order that we may not fail to pass with honor the test of the present emergency; and let us work and live in such manner that our military leadership is joyfully acknowledged by our men because it furnishes for them a lofty example of cheerful responsibility, superior ability, and untiring care.

Artillery Fire Marking During Second-Third Army Maneuvers, September 15 to 30, 1941

The maneuvers of 1941 have witnessed the development of a method of artillery fire marking which has markedly contributed to realism and given visible evidence of the presence and influence of artillery fires. Too much credit cannot be given to the officers of the artillery section of GHQ for their imaginative conception, quick action, and perseverance in introducing the present methods; and to those officers and men of the four field armies who took over the work and perfected the technique. For the first time in the annals of the artillery the artilleryman feels himself a vital part of the maneuver game. No longer does the banging of breech blocks and click of the firing pins represent meaningless effort carried over from the drill field. Provided every step of the technique of fire has been gone through these men know that within a very few minutes an artillery fire-marking team will arrive at the spot in enemy territory where their fires would be falling, a flag will wave, a cow bell clang, and a bomb explode scattering powdered lime in all directions to give aural and visible evidence of shells falling. If the fire has been accurate and vehicles and personnel are caught in the area, penalties and casualties will be assessed by local umpires, all of which contribute the realism of the mock warfare and make the infantry-artillery combat team a team in fact.

During the Second-Third Army, GHQ-directed maneuvers in Louisiana artillery fire marking reached a peak of perfection, so far. It is interesting to note the following statistics compiled by the Artillery Fire Marking Section of the GHQ Director Group during the first phase of the maneuver September 15th to 19th inclusive:

Total Fires Marked	2,471
Percentage of Fires Marked.....	95.3%
Average time lag on fires marked (minutes)	5.1
Total time lag from receipt by Battalion Umpire until marked (minutes).....	8.8

Approximately the following officers, enlisted men, vehicles, and vehicular radio sets were assembled for these maneuvers:

- 64 Fire marking groups comprising:
 - 64 Fire marking umpires
 - 64 Radio sets
 - 128 Vehicles
 - 512 Enlisted assistants and chauffeurs



Picture of the explosion of one of the lime bombs, developed to simulate the bursting of an artillery shell. After the smoke has cleared, lime dust will be distributed over the ground to the extent of the smoke shown.

By "Observer"

- 114 Artillery battalion umpire groups comprising:
 - 114 Artillery battalion umpires
 - 114 Radio sets
 - 114 Vehicles
 - 342 Enlisted assistants and chauffeurs

Control of the firemarking was exercised by the Director Group by establishing monitor stations at GHQ, each Army and Corps Headquarters, and designating one artillery battalion umpire in each division to act as monitor. Actual radio control by these monitor stations was negligible; for the most part it consisted in logging transmissions, checking radio discipline, and dispatching reserve firemarking groups to sectors wherein the artillery action became too much for the local firemarking groups to handle. The whole organization appeared to be a well coordinated, smooth functioning, highly disciplined unit. It had to be because all fires were broadcast and received by radio sets all operating on the same frequency and in some cases in congested radio areas.

It is striking to note that all the transmissions were handled on a single radio channel. Frequency modulated, voice, police-type radio sets of commercial manufacture were used. These sets are known as the SCR-298. Their use required the highest type of radio discipline and training. Transmissions were limited to fire missions, monitor direction, emergency calls for ambulances, requests for replacement or repair of equipment incident to the marking of artillery fires, and other matters as directed by the Chief of Staff, GHQ.

The controlled photomap of an approximate scale of

1/20,000 was used. This map was divided into named quadrangles which in turn were subdivided into numbered sheets. The grid system overprinted on the photomaps was changed to use a lettered coordinate system for simplicity. Maps to cover the entire maneuver area comprised about 460 sheets.

The message to broadcast a fire, other than a prepared or scheduled fire, was limited to the following:

1. (a) The number of the set transmitting.
- (b) The name of the quadrangle in which the fire was to fall.
- (c) The number of the sheet in which the fire was to fall.
- (d) Red or Blue, designating the side transmitting.
- (e) The X and Y coordinates of the point of fall.
- (f) If an observed fire, the nature of the target.
- (g) The duration of the fire in minutes.
- (h) The number of batteries firing the mission.
2. The message was repeated once.
3. Thus a broadcast of an observed fire mission of five minutes' duration using three batteries was "85 Boyce 17 Red Hypo 5 Sail 8 Machine Guns 53 Repeat 85 Boyce 17 Red Hypo 5 Sail 8 Machine Guns 53."

("85" is the number of the transmitting set, "Boyce" is the name of the quadrangle, "17" is the number of the sheet, "Red" is the side transmitting, "Hypo 5 Sail 8" are the coordinates of the target, "Machine Guns" is the nature of the target, which is given only when fires are observed, "5" is the duration of fire in minutes, and "3" is the number of batteries firing.)

4. For an unobserved fire the same message was "85 Boyce 17 Red Hypo 5 Sail 8 Red 53 Repeat 85 Boyce 17 Red Hypo 5 Sail 8 Red 53." (Note the "Red" between the coordinates of the target and the duration of the fire, inserted merely to separate numbers.)

5. Scheduled fires were sent in advance, during quiet

periods at night, when it was reasonably certain that these fires would be properly executed at the times specified. The form for broadcasting these fires was the same as that specified in paragraph 4 above, except that the message was concluded with the word "Prep" and the time it was to be fired, for example "Prep 520A."

The broadcast of a fire mission was received by all fire marking umpires and by all artillery battalion umpires within hearing. It was acknowledged by the one closest to the target, by sending, "Roger 66." The "Roger" indicated received; the "66" indicated the number of the fire marking umpire.

When a fire mission was not acknowledged, the sender was privileged to repeat again the broadcast at any time after an elapsed period of ten seconds, provided the net was free of other transmissions.

Before a fire was broadcast the artillery battalion umpire had to assure himself that all of his technique of firing was complied with, that the ammunition (simulated) was available, and that the battalion could, under combat conditions, have actually fired the mission designated. Survey, if required, had to be completed. If registration was possible, the battery had to register, obtain, and apply a *K* in subsequent firing. All of this proved to be a definite, instructive, and valuable training aid. The umpires had a very thankless job; however, on the whole, it is believed that they carried out their job without fear or favor.

The principal criticism encountered from artillery officers was not of the fire marking itself but the failure of unit umpires to assess penalties and casualties, even on their own troops, which only goes to show that fire marking is here to stay in all future small and large scale maneuvers, and the field artilleryman is anxious and willing to play the game in the knowledge that the success of the infantry he supports is closely tied in to simulated fires which he can deliver.

Notice of Annual Meeting, U. S. Field Artillery Association

In compliance with Article VII, Section 1, of the Constitution, notice is hereby given that the Executive Council has fixed 5:30 PM, Monday, December 15, 1941, as the time of the annual meeting of the Association to be held at the Army and Navy Club, Washington, D. C.

The business to be disposed of will be the election of six members of the Executive Council; voting on proposed amendments to the Constitution (as printed in each issue of the JOURNAL beginning with June, 1941); and the transaction of such other business as may properly come before the meeting.

Proxy cards are being sent out to all active members of the Association within the continental limits of the United States, as required by the Constitution, and it is desired that they be returned promptly. Nominations may be made on the proxy cards or from the floor of the meeting.

BOOK By H. S. F. REVIEWS



"War is a science covered with shadows in whose obscurity one cannot move with an assured step. Routine and prejudice, the natural result of ignorance, are its foundation and support."

—MARSHAL DE SAXE

DOUHET AND AERIAL WARFARE. By Louis A. Sigaud.
With an introduction by Al Williams, G. P. Putnam's Sons, New York, 1941. \$1.75.

This book is an ingenious and cleverly organized piece of work which, nevertheless, fails in its purpose. For, despite all arguments, it is still abundantly clear that the Douhet theory is unsound. The author maintains that Douhet understood the significance of mechanization, but he is not convincing. The basis of the Douhet theory is that land fighting, in the long run, will stabilize after the manner of the Great War. Consequently, the decision must be won by air bombing. The events in western Europe, since May, 1940, are a plain refutation of this reasoning. The land fighting was sharply decisive. But the air offensive, which has been carried on first by Germany and then by England for over a year, has been both indecisive and costly. In fact, it has been in the air and not on land where the long war of attrition has taken place—that very war of attrition for which the Douhet theory was to be the cure.

Douhet likewise was an ardent advocate of the separate air force. Since France, Great Britain and Germany all had separate air forces, this pet project was surely not the decisive factor. Moreover a very good argument can be made out to the effect that the separate air force, with its resulting lack of unity of command, was an important cause of the successive British defeats. In modern war the most important service of the air arm has been to render close support to the land attack, and it seems no more logical for the air force to be removed from the control of the ground commander than it would be for the field artillery, which has a similar mission.

At the end of the book there is the now familiar sentimental tribute to General William Mitchell, coupled with the suggestion that the United States adopt the separate air force, and prepare to make its sole offensive effort in the air. The author says that "nowhere in this country are Douhet's views considered more significant than among officers in the Air Corps of the United States Army." We could suggest better reading matter.

THE NATURE OF MODERN WARFARE. By Cyril Falls.
With an introduction by Major George Fielding Eliot.
Oxford University Press, New York, 1941. \$1.25.

Captain Falls is now the military correspondent of the London *Times*. Falls, like Wavell in 1939, was a Lees Knowles lecturer at Cambridge, and four-fifths of the book is made up of lectures delivered there in January and

February of 1941. These four chapters are provocatively entitled "The Doctrine of Total War," "The Mechanized Attack," "Tactics of Defense," and "Immutable Realities." The fifth chapter, "Notes on Mountain Warfare," was added because, as the author rightly remarks, "the subject is of special interest at the present day."

Although recognizing that, in fact, there has never been a true "total" war, and that certain wars of the past have been more destructive, more "totalitarian" than the present one, Falls feels that a genuine total war is not an impossibility in the future. Consequently, he has some doubts as to the future of civilization. The author does not believe that the mechanized attack has done away with mass warfare, and, notwithstanding his progressive and enlightened viewpoint, we may in fairness say that his ideas are based on the war of 1914-1918. On defense and offense he gives no final answer—"whichever is most efficiently conducted, will win." Falls wrote the volume of the British official history of the last war which dealt with the Salonika campaign, and he is at his best when writing on mountain warfare. As he says, no theoretical work on this type of fighting has superseded the treatise by the eighteenth century French Staff Officer, Pierre de Bourcet. Yet in this chapter too Falls shows a certain conservativeness, as when he doubts the ultimate utility of mechanized and motorized equipment in the mountains, in spite of the fact, as he admits, that Germans put them to good use in Yugoslavia and Greece. There is much to recommend this book, which is one of the few theoretical works to come out of the present war.

CURRENT SPANISH. By Jose Martinez, New York, The Paulist Press, 1941. \$1.00

Current Spanish, as the title implies, is a practical and simplified textbook designed to meet the needs of the student who wishes to acquire a speaking knowledge of the language without delving into the intricacies of its grammar.

The author is one of our ablest teachers of modern languages and a recognized authority on his native tongue. His present position as instructor of Spanish at the United States Military Academy has given him a keen concept of the Army's requirements. This textbook is unique because, in addition to a complete compilation of modern conversational material, it contains military terminology which would be difficult to find in any other work.

Anyone familiar with the contents of this small volume should be able to converse naturally and correctly in modern Spanish, avoiding the stilted, artificial style so

common to the student of a foreign language. Languages change through common usage, so "written Spanish" differs considerably from the current spoken version. This attractive little pocket-style edition should thus be an invaluable reference book for the scholar who is making a comprehensive study of Spanish, as well as for the beginner with limited time to devote to the subject.—E. M. B.

"FIGHTIN' JOE" WHEELER. By John P. Dyer. Louisiana State University Press, University, La., 1941. \$3.00.

The Civil War career of Wheeler is generally familiar, but the test of his long life is relatively unknown, and this is the first biography of the Confederate general to give a complete picture of him. Wheeler was born in 1836 of New England parents who had emigrated to Georgia. He graduated from West Point in the Class of 1859, and left the army about a year and a half later to join the Confederacy. He rapidly rose in rank, and in quite a brief time received command of a cavalry corps. Perhaps the high point of his career was his rearguard defense of Johnston's army in the Atlanta campaign.

Most of the new material in the book is found in the latter half, which deals with Wheeler's post-war life. In 1865 Wheeler was still under thirty, a young man with a long life ahead of him, and this explains why he never joined the die-hard group of older Confederate generals who were, apparently, content to spend the rest of their lives in fruitless, sullen brooding over the glories of the lost cause. Since he was involved in the attempted escape of Jefferson Davis, Wheeler was for some time imprisoned by the Federal government. Released, he went into business in New Orleans. After a few years he moved to a plantation in northern Alabama and took up the study of law. He entered politics in 1880 and was elected to the House of Representatives. However, his election was contested, and he was eventually unseated. Re-elected in 1884, he served until the Spanish War. In politics he took the middle course between the ultra-conservative Democrats and the new, radical populists.

Wheeler was second to none in his eagerness to bring on war with Spain, and in 1898 was commissioned a major general. As is well known, in Cuba he commanded the cavalry division of the expedition, which included the famous Rough Riders. After the war there was an investigation of the obvious administrative negligence during the campaign, but Wheeler stoutly refused to admit that anything had been wrong. He served briefly in the Philippines in 1899, and returned to command the Department of Lakes at Chicago. He retired from the Army in the fall of 1900, and died in 1906. Throughout the author maintains an objective attitude, pleasantly free from the hero worship, prejudice and special pleading which so often encumber Civil War biographies, and the book is an ably written, authoritative piece of work.

Ninth Edition—

Published April, 1941

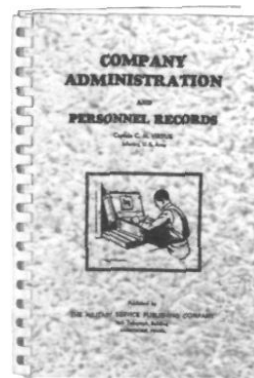

COMPANY ADMINISTRATION

Including SUPPLY AND MESS MANAGEMENT
and PERSONNEL RECORDS

Including Personnel Office Organization and
Procedure

By MAJOR C. M. VIRTUE

RECOGNIZED as the authority on Army paper work, this manual is a necessity for all battery commanders, first sergeants, and clerks. It will add to the efficient performance of administrative duties.

The readoption by the Army of a personnel system similar to that in use from 1926 to 1933, thus freeing the unit commander and first sergeant from responsibility for practically all individual records and concentrating these personnel records in the unit personnel section, has required a considerable rearrangement of the matter in this text.

In addition to the rearrangement, new chapters have been added on the following subjects: "Company Supply and Supply Procedure," "Mess Management and Records," and "The Company Fund." A chapter on the new personnel system, including a discussion of the organization and operation of the personnel office in the regiment, also has been added. The new addition contains pay tables for enlisted personnel, including air mechanics' pay and flying pay. 396 pages.

Prices: Waterproof paper binding, \$1.50; full cloth binding, \$2.00.

Quantity Orders:

10-24 copies, 10% discount, postpaid.

25 or more copies, 20% discount, F.O.B. Harrisburg, Pa.

THE FIELD ARTILLERY JOURNAL

1624 H STREET, NORTHWEST

WASHINGTON, D. C.

*Reprinted in the form of a handbook
the authoritative, timely article*

HOW TO BUILD AN EFFICIENT FIRING BATTERY

By Majors Handy and Burger

**Sound practical advice for the
battery executive and all
members of the firing battery.
STRICTLY UP TO DATE 64
pages. Field manual size.**

—————
*Single copies 20c each. In quantities of
10 or more, 15 cents.*

—————
**The Field Artillery Journal
1624 H Street, N. W., Washington, D. C.**

How to Say It in Spanish

**By Lieut. Col. Harry M. Gwynn, Capt. Enrique C.
Canova, and Lieut. Willard Webb**

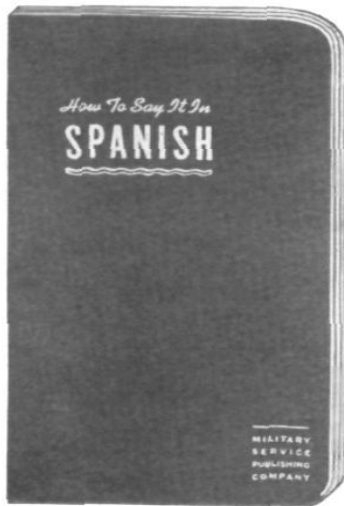

Today, when so many officers are taking Spanish lessons, and there is such increased interest in augmenting friendly relations with Latin America, a need has arisen for a concise book of common Spanish words and expressions. *How to Say It in Spanish* is not a dictionary nor a grammar. Neither is it a tourists' language guide. Yet it combines the best attributes of all three, with emphasis on those words, phrases, and sentences most useful to the military man. The scope of the book is shown best by an enumeration of the

principal topic headings; general conversation; instructions or requests; travel or direction; colors, sizes, and comparatives; time and seasons; cities and towns, inhabitants; transportation and communications; geography and topography; aviation nomenclature; nautical; food, drink, and tobacco; personal service and needs; supplies; parts of the body, illnesses, accidents, and wounds; numbers, weights, and measures; common names.

Sized to fit the pocket. Handy reference arrangement. Bound in durable red fabbkote. Price 75 cents per copy.

**Order from the FIELD ARTILLERY JOURNAL
1624 H Street, N. W., Washington, D. C.**

*WHAT THE CITIZEN SHOULD KNOW ABOUT OUR
ARMS AND WEAPONS. By Major James E. Hicks. W.
W. Norton & Company, New York, 1941. \$2.50.*

*BOMBS AND BOMBING. By Willey Ley. Modern Age
Books, New York, 1941. \$1.25.*

Although these books by no means parallel each other, they present enough similarities to justify a joint review. Both of the authors are men of reputation. Major Hicks' extensive and authoritative books on ordnance are widely known. Willy Ley was a native of Germany, where he was prominent in the development of rockets. He is now the science and weapons editor of the tabloid *PM*, and his writings on rockets have recently been seen in several service journals.

The notices of both of these books maintain that they are written for the layman, but the description is deceptive if it implies that any but specialists would be familiar with their contents. In his chapter on field artillery, for example, Major Hicks does not approach the subject from the tactical angle, but rather from the ordnance viewpoint, with special emphasis on historical development, and it is this reviewer's guess that much of the information contained therein will be new to many readers of the *JOURNAL*. Hicks' book is the more substantial of the two, and deals with all types and varieties of ordnance from automatic pistols to tanks, concluding with an excellent descriptive chapter on the Ordnance Department. The book is well and adequately illustrated with the precise drawings of Andre Jandot.

The varieties of air bombs and the precautions to be taken against air bombing may be said to provide the principal subject matter of Willy Ley's well written little book. There is also a chapter on gas, and the author maintains that it is not so much the fear of retaliation as the fact that gas is primarily a weapon of stabilized warfare, unsuited to the fast moving conditions of modern war, which explains why gas so far has not been used. Ley's knowledge of German methods adds much to this book which is not found in similar works by American authors. Both books are well above average in style, content, and method of presentation.

ENGRAVED VISITING CARDS

We have made arrangements to supply our readers with engraved copper plates and cards imprinted therefrom at prices substantially lower than commercial rates. Our prices vary from \$1.15 per line (for engraving only) to \$2.70 per line, depending on the style of engraving. We suggest that you send for a style card, showing the fifty-four styles of engraving available, and price list. Our price for imprinting cards from plates is \$1.65 per hundred for plain cards and \$2.20 per hundred for parchment. We suggest also that you leave your plates on file with us; when you need more cards, write or wire.

Christmas Gift Suggestions

THE UNITED STATES ARMY IN WAR AND PEACE	
By Brigadier General Oliver L. Spaulding, Jr.	
G. P. Putnam's Sons, 1937	\$6.00
The outstanding history of the army.	
GENERALS AND GENERALSHIP	
By General Archibald Wavell	
The Macmillan Company, 194150
The only theoretical treatment of warfare yet published by a leading participant of the present war.	
ROOTS OF STRATEGY	
By Lieutenant Colonel Thomas R. Phillips.	
Military Service Publishing Company, 1940	3.00
A collection of the five greatest military classics of all time, complete in one volume.	
INVASION IN THE SNOW	
By John Langdon-Davies	
Houghton-Mifflin Co., 1941	2.50
Still the best account of the late Russo-Finnish War.	
MAHAN ON NAVAL WARFARE	
Edited by Allen Westcott	
Little, Brown and Company, 1941	2.50
The essence of the world's foremost naval writer, summed up in one volume.	
CARBINE AND LANCE: THE STORY OF OLD FORT SILL	
By Capt. W. S. Nye	
University of Oklahoma Press, 1937	3.00
The historical and military background of the Field Artillery School. "This is a meaty and invaluable volume for collectors of Americana and for students of American history and it is a thrilling book for the general reader."—Burton Rascoe in <i>Esquire</i> , January, 1938.	
THE ARMED HORDE	
By Hoffman Nickerson	
G. P. Putnam's Sons, 1940	3.50
For all who are interested in the more profound aspects of military thought, this book by the most persistent advocate of the substitution of the professional for the mass army, is strongly recommended.	
THE ARMY OF THE FUTURE	
By General Charles de Gaulle	
J. B. Lippincott Co., 1941	2.00
The classic work on mechanization by the leader of the Free French Forces.	
UNITED WE STAND	
By Hanson W. Baldwin	
Whittlesey House, 1941	3.00
A leading civilian military analyst surveys the defense program.	
BRITISH STRATEGY	
By Admiral Sir Herbert Richmond	
The Macmillan Company, 1941	1.25
Here in a few pages we have the reason why British strategy now is substantially the same as it was in Elizabeth's time.	
WHERE THEY HAVE TROD	
By Lieutenant Colonel R. Ernest Dupuy.	
Frederick A. Stokes Co., 1940	3.00
A fine study of West Point, its history, and its graduates.	
ALLENBY, A STUDY IN GREATNESS	
By General Sir Archibald Wavell	
Oxford University Press, 1941	3.00
A first rate biography, by an outstanding soldier.	

U. S. FIELD ARTILLERY ASSOCIATION

1624 H Street, N. W.



WASHINGTON, D. C.