

# No. 4, July-August, 1932

<b>The 81mm Stokes-Brandt Mortar in Firing Position .....</b>	<i>Frontispiece</i>
<b>The Stokes-Brandt 81mm Mortar.....</b>	<b>357</b>
By Major Louis E. Hibbs, F.A.	
<b>Nelson E. Margetts .....</b>	<b>373</b>
By Lt. Col. Cortlandt Parker, F.A.	
<b>French Artillery Doctrine .....</b>	<b>374</b>
By Major John S. Wood, F.A.	
<b>Squads Write! .....</b>	<b>389</b>
<b>Trail Arc and Block for Firing at Fast Moving Targets .....</b>	<b>390</b>
<b>Planning a Great Battle: Artillery Preparations for St. Mihiel.....</b>	<b>393</b>
By Colonel Conrad H. Lanza, F.A.	
<b>Sketch of Origin of the Field Artillery Association .....</b>	<b>411</b>
By Major General Wm. J. Snow, Retired	
<b>Today's Conclusions—After Seven Years With the Army Horse Show Team .....</b>	<b>421</b>
By Captain W. B. Bradford, Cavalry	
<b>Reilly's Battery, China, August, 1900 (<i>Poem</i>) .....</b>	<b>428</b>
By Fairfax Downey	
<b>Tests of the Truck Drawn Battery .....</b>	<b>430</b>
<b>Type Problems .....</b>	<b>437</b>
<b>The New Halger-Ultra Bullet.....</b>	<b>445</b>
By Major J. K. Boles, F.A.	
<b>Field Artillery Notes .....</b>	<b>448</b>

The Retiring Secretary-Treasurer-Editor; Fort Sill Horse Show; To the Members of the U. S. Field Artillery Association; New State Highway Through Reservation; Fort Sill Aids in Flood Relief; Special Test at Aberdeen Proving Ground; Results of Field Artillery R. O. T. C. Pistol Competition for 1932; Artillery Hunt Racers; Graduates of the 1932 Class, U. S. M. A., Assigned to the Field Artillery; Graduation at Army War College.

AUTHORS ALONE ARE RESPONSIBLE FOR STATEMENTS CONTAINED IN THEIR ARTICLES

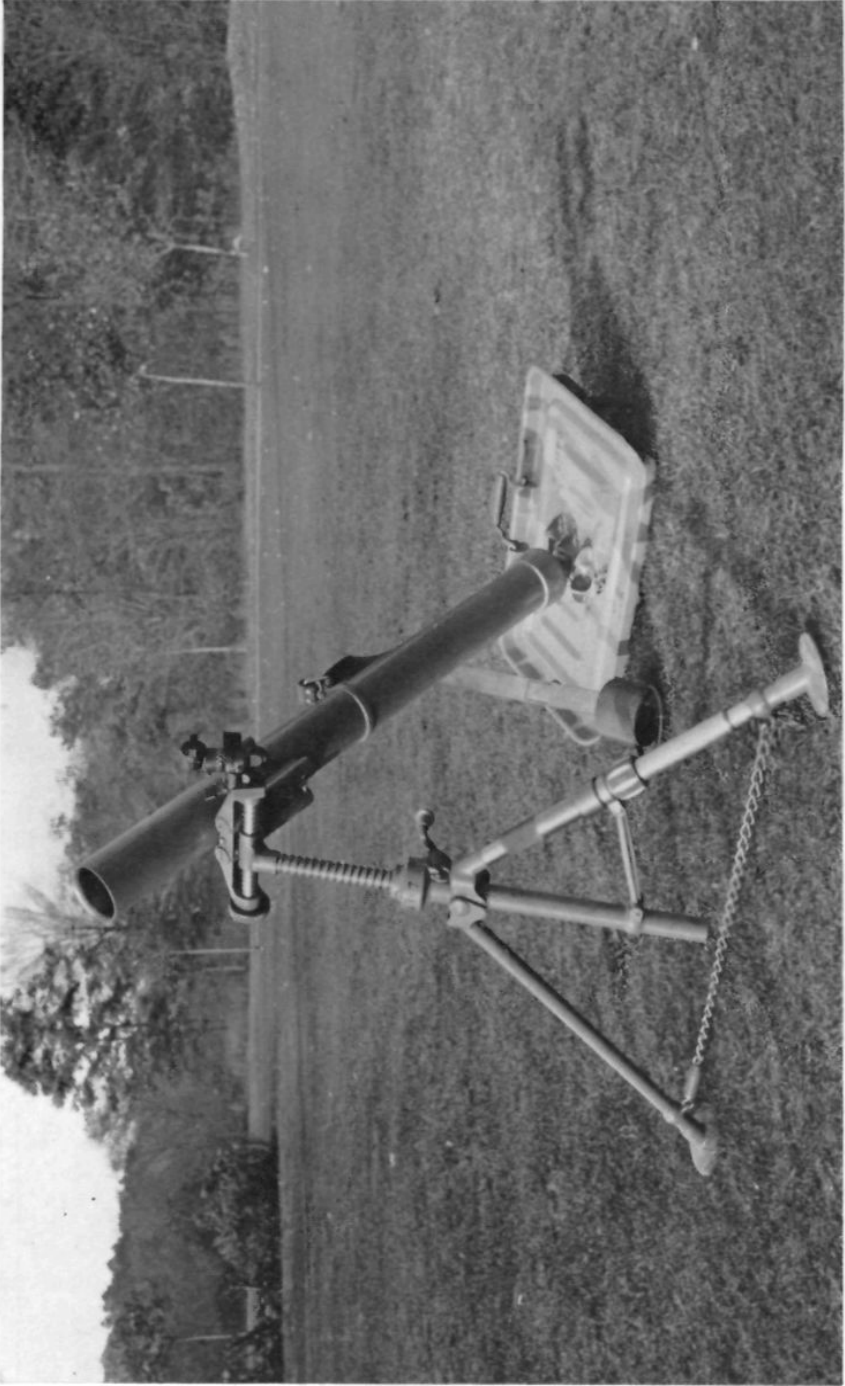

**THE 81MM STOKES-BRANDT MORTAR IN FIRING POSITION**

# THE FIELD ARTILLERY JOURNAL

VOL. XXII

JULY-AUGUST, 1932

No. 4

## THE STOKES-BRANDT 81MM MORTAR

BY MAJOR LOUIS E. HIBBS, Field Artillery

### PART I\*

THE Field Artillery Board has recently completed its test of the 81mm Stokes-Brandt Mortar, and has submitted its report to the Chief of Field Artillery. The object of this test was to determine the suitability of this weapon as an accompanying gun. To the Field Artilleryman it must necessarily be of vital interest to know that the report of the Board states that this weapon is admirably suited for such use, and that the Board recommended its adoption for that purpose and for such other special Field Artillery uses to which it is adapted.

The Board report discusses the subject of the accompanying gun:

"4. *Introductory Discussion:* a. The object of this test is to determine the suitability of the weapon for use as an accompanying gun. This necessitates a short review of the subject of accompanying artillery in order to point out the desirable characteristics of an accompanying gun. Upon this subject scant positive information derived from experience is available; this probably because in the past, endeavoring to utilize horse-drawn division artillery, not designed or fitted for this special purpose, it so far failed to accomplish its mission as to permit very few conclusions to be drawn as to the proper means of its tactical employment and fell so far short of efficiency as to generate serious doubts as to the advisability of attempting so to employ artillery.

"b. Since the advent of the machine gun, the basis of the infantry scheme of defense, and the development of elaborate

---

\*The data and facts in Part I of this paper have been taken from the Report of The Field Artillery Board.

## THE FIELD ARTILLERY JOURNAL

systems of wired-in strong points, many camouflaged and unsuspected by the attacker; infantry cannon of high power and mobility; the use of anti-tank guns by the defense; increased efficiency of the services of information and the development of rapid means of communication facilitating rapid transmission of orders to reserves for the purpose of meeting contingencies of the action; the development of smoke projectiles and smoke producers, obscuring the observation of the attacking artillery; the adoption of the elastic scheme of defense, forcing movement of the attacker's artillery to forward supporting positions before the critical portion of the battle is reached; all these engender in the attacking infantry a desire for a powerful weapon, close at hand and completely under their control, with which to meet contingencies arising in their immediate front. The infantry seeks a weapon with which to drive out and destroy machine guns, perhaps in bomb-proof emplacements, and trench mortars and machine guns firing from entrenched strong points; for cutting the wire in front of enemy entrenchments and assisting to obtain and maintain fire superiority for the attacker while his troops assault the position; to attack the defender's troops assembling or engaging in counter-attack, and his tanks which probably accompany them; to attack the defender's anti-tank guns, carefully concealed up to the time they open fire upon the attacker's tanks or upon his infantry; finally, upon the taking of a position, to be readily available to assist in its organization and defense against counter-attack.

"c. The desire on the part of the infantry to have this weapon present with their assault echelons and under their control arises from three general sources:

(1) In the present highly organized defensive systems, while elaborately planned artillery fires may destroy or neutralize many of the defender's installations, in many cases there will arise unforeseen situations calling for the use of artillery. In many instances the time factor is such that immediate action may save many casualties and may allow the attack to progress without appreciable delay, and, what is more important, with greater ease, since delays provide the opportunity, so urgently

## THE STOKES-BRANDT 81MM MORTAR

sought by the defender, to reorganize his forces, bring up reserves and improve his position. In many of these cases a delay, even such as might be occasioned by the transmission of a request to the supporting artillery with prompt response from it, is viewed as undesirable when compared with a possible more prompt action from a weapon immediately present with the infantry and under its control.

(2) Due to the fallibility of telephone lines and radio and the constant movement of command posts and switchboards, there is no assured continuous communication to the supporting artillery, observation of the target by the supporting artillery may be impaired by poor visibility or the target may be invisible from the supporting artillery's observation posts, target designation is extremely difficult, and effectiveness of fire suffers from inaccuracy due to long ranges. Moreover, the supporting artillery's information is received by word of mouth, second or third hand in most cases, and due to the inherent delay of transmission of such information there is an inherent lag in the information in possession of the supporting artillery. These factors contribute to reduced efficiency of the supporting artillery when compared with that which might be obtained by a weapon of the same power in the possession of the infantry and normally situated within the area occupied by the front line troops.

(3) At any stage in the action, unforeseen by the attacking infantry, the fire of the supporting artillery may be withdrawn, by order of the higher commander, to be concentrated elsewhere. While this occurs only in emergencies, and is well justified in order to carry the attack at a critical time, nevertheless the possibility is present in the infantry commander's mind that there may arise an occasion when he will be without the fire of his supporting artillery. In addition, during movement forward of the supporting artillery by echelon, there will be a period when the potential support of the artillery will be reduced. While this reduction may be foreseen, in general, both as to time and amount, it is not under control of the supported infantry commander nor subject in general to his direction

## THE FIELD ARTILLERY JOURNAL

since it must be coordinated throughout the division with other traffic on the roads.

"d. The need for a powerful weapon, under the control of the infantry and going into action with it, finds its greatest exemplification in the attack of a position prepared for zone defense; it exists to a lesser degree in all infantry offensive action.

"e. The following characteristics are considered desirable in a weapon to be used for the purposes outlined above, i. e., the accompanying gun:

(1) *Mobility*: The accompanying gun should have the same mobility as the troops it is supporting. This requirement is closely concerned with the weight of the weapon and its ammunition, and the type of transport.

(2) *Weight*: The weapon should be capable of being broken down into loads which may be carried by hand over rough terrain.

(3) *Range*: The targets for this weapon may be expected to lie within machine gun range from the attacking infantry; since it is believed that efficient use of the weapon depends in part, upon its actual presence with the attacking infantry, a range of 2,800 to 3,000 yards is deemed sufficient and will allow some latitude in selection of positions for the weapon.

(4) *Vulnerability*: Such a weapon, given power enough to justify its presence on the battlefield, will become the target of every effort on the part of the enemy to put it out of action immediately upon its opening fire. If it is to be of continued use to its own infantry it must be concealed from enemy view: not only must the weapon itself be hidden from view, but it must be so well concealed as to leave its position in doubt and so as to be protected from rifle and machine gun fire sweeping the front.

"In addition to the necessity of protection from enemy fire while in position, it is essential that the weapon while moving be capable of taking advantage of all available cover and folds in the ground; herein lies the desirability of transport by hand.

(5) *Projectile*: The projectile should have approximately

## THE STOKES-BRANDT 81MM MORTAR

equal power to that of the 75mm gun and should be shell (not shrapnel) furnished both with an instantaneous fuze for use against personnel and wire, and a short delay fuze for use against light cover.

(6) *Rate of Fire:* The rate of fire should be as high as may be consistent with accuracy, inasmuch as quick action on all targets engaged is desirable.

(7) *Accuracy:* The time element and, above all, the necessity for conservation of ammunition, dictate a requirement of extreme accuracy; the short range at which the weapon will fire will probably provide observation good enough to take excellent advantage of a high degree of accuracy.

(8) *Trajectory:* In order to obtain concealment at the ranges at which this weapon will find its targets, a flat trajectory gun must be taken out of consideration. The vital requirement of concealment necessitates curved fire, at least, and high angle fire would be preferable. The necessity for steep angles of fall to reach targets on reverse slopes, in trenches, in woods, and behind artificial cover, and to permit fire close in front of the infantry (at the ranges at which the accompanying gun will fire) without endangering them, also preclude the use of a high velocity, flat trajectory weapon.

"In general, weapons employing curved or high angle fire best meet the requirements of light weight, for both weapon and ammunition, and that of accuracy in range.

"Due to the low velocity, comparatively long time of flight and steep angle of fall, the curved fire and high angle fire weapons are not well suited for fire against tanks. This type of target requires a weapon of entirely different characteristics from that indicated by all other targets conceivably constituting the large majority upon which the accompanying gun will be called to fire. It should be withdrawn from consideration as one of the targets for fire against which the accompanying gun is designed, although the accompanying gun would undoubtedly attempt to take tanks under fire in the appropriate situation in the absence of weapons for that specific purpose.

"A weapon, embodying possibilities for both high velocity,

## THE FIELD ARTILLERY JOURNAL

low angle fire and low velocity, high angle fire, is believed to have been studied among foreign nations, but is not considered to promise a combination weapon as efficient for either purpose. The Board believes that design should be directed toward the development of a weapon for each purpose rather than for the combination, since their desirable characteristics are so widely variant."

It is of interest to note particularly the wide divergence of the desirable characteristics of the weapon suitable for accompanying gun purposes, and those of the anti-tank gun. This indicates a withdrawal from the accompanying gun of a mission hitherto considered to belong to it, probably more or less because the only weapon that we have had for accompanying gun purposes was also partially suitable for fire against tanks. The withdrawal of this mission from the accompanying gun will probably have a considerable effect upon the design of the anti-tank gun of the future, inasmuch as the separation of the two weapons will permit the design of the antitank gun in such a form as may be most efficient without attempting solution of the two missions by one weapon.

To the Field Artilleryman who has been forced in the past to visualize a horse-drawn 75 in the role of an accompanying gun or who has been fortunate enough to have so commanded one in action, there is a world of satisfaction in the contemplation of the possibilities of the 81mm mortar utilized in that capacity.

Here is a weapon capable of hand transport by three men over rough terrain for distances up to 1,000 yards at a time without undue fatigue to the crew; in fact, for short distances it may move at a dog trot. Here is the utmost in mobility for its combat purposes. For purposes of transport when not in combat its loads may easily be carried in any sort of vehicle or on the backs of pack animals. To anyone who has been faced with the problem of concealment of a horse-drawn 75 in the forward areas, with the problem of avoidance of casualties, and the problem of transportation when his animals have suffered casualties, can best appreciate what tremendous advantages this transport by hand offers. This gun in movement may utilize to the utmost all forms of available cover. It may move rapidly over rough



## THE STOKES-BRANDT 81MM MORTAR

ground and its crew may seek cover individually; a casualty of one member does not affect the transport ability of the others as does one animal of a team and the casualty may be replaced by another man without delay.

The lighter one of the two types of shell furnished for test weighs approximately one-third as much as the complete round of the 75mm gun and is considered to have equal effectiveness against personnel not protected by a good degree of light overhead cover. A heavier shell, which weighs approximately fourteen pounds, is of equal effectiveness per weight of metal as the light type; fired with the delay fuze, it is very effective against the best hasty cover and three times as effective in this respect as the light type. One of this heavier type of shell, with delay fuze, penetrated the roof of a dugout made of two layers of four to five inch logs separated by fourteen inches of earth, burst inside, and blew off a large portion of the roof, breaking several logs and throwing others fifteen feet or so into the air. Effectiveness of either shell against concrete or against tanks has not been tested, but their effectiveness in these respects is doubtful due to the low velocity.

The tremendous saving in the weight of ammunition to be sent forward to the accompanying gun, and, since it is suited to transportation by hand, the increased simplicity of the problem of its transport can be readily appreciated. When compared with the 75mm shell, and within the range capabilities of the weapon, it will be noted that the ratio of effectiveness against personnel, per weight of the complete round, is approximately three to one.

Being a mortar, the weapon offers the very desirable advantages of being capable of fire from positions behind steep banks, behind buildings, from shell holes and from positions in the thickest woods. Its curved trajectory permits the searching of deeply defiladed positions, is admirably suited to the attack of infantry in trenches, fire upon targets in woods and the attack of many targets otherwise denied to a gun of flat trajectory and high velocity. Due to its high angle fire the mortar is especially suited for fire at short ranges over friendly infantry in its front. Its fire may be safely placed 150 yards in front of friendly infantry without endangering them.

## THE FIELD ARTILLERY JOURNAL

The range of the mortar with the lighter type of shell is 3,300 yards and is considered to be amply sufficient for accompanying gun purposes; with the heavier type its range is 1,300 yards. It seems probable that the heavier shell will only be furnished for use when the nature of the enemy installations is such as to lead to the belief that he is protected by heavy hasty cover.

The accuracy of this weapon is remarkable, its probable errors being close to 1/200 of the range, in range; and 1/400 of the range, in deflection.

The Board commented favorably upon the practice shell, which is a projectile filled with black powder and pitch and so constructed that the nose of the projectile simply cracks off upon bursting, thereby making it unnecessary to observe many of our safety regulations now in force with respect to the firing of shell. In order to train crews in their combat duties, issue of this shell seems very desirable, though at present the burst of the projectile is reported upon as being difficult to observe at the longer ranges due to the small amount of smoke produced by the present type.

The maximum rate of fire of the mortar is very high and is about thirty rounds per minute; its stability after the firing of one to three rounds is such that accurate fire can be had at this rate.

The Board report discusses the combat transport of the weapon as an accompanying gun and also its other tactical uses:

"o. *Combat Transport.* (1) *Weapon:* The hand transport of the weapon itself offers the best means of combat transport; it offers the best solution of the problem of vulnerability while in movement and transport over rough terrain. The Board believes that with reasonable selection of the crew and proper training, the question as to resultant fatigue of the crew from such means of transport will become negligible. In this respect, while at first thought it would appear that the weights of the unit loads might be reduced by the use of light alloys, it is probable that such reduction in weight would affect adversely the stability of the weapon; this question is worthy of investigation.

(2) *Ammunition:* (a) Considering this weapon to be employed

## THE STOKES-BRANDT 81MM MORTAR

by Field Artillery as an accompanying gun, and thus superimposed upon the present division organization, some provision is necessary for its ammunition supply forward of the artillery ammunition distributing point. This means of supply should be entirely separate from that supplying the normal division artillery. In its early stages, up to a point in rear of the area swept by enemy small arms fire, this transport should be by truck, preferably by 1½-ton vehicles, pneumatic tired, four-wheel drive type, capable of cross-country movement. These vehicles thus may establish an ammunition distributing point or points, serving one or more mortars and operating between the artillery ammunition distributing point and the points mentioned above. It would seem desirable to have the forward distributing points in the same locality as that occupied by the infantry battalion munitions distributing points in order to facilitate the dissemination of information as to their location, movement, and routes to and from them, and to fit the traffic into the general traffic scheme. In the infantry ammunition supply plan the combat wagons of the infantry battalion are used to transport infantry ammunition from the rear to the battalion munitions distributing point; it seems reasonable to assume that these points will be accessible to the truck transport described above.

(b) The transport of ammunition between these forward distributing points and the position of the mortar presents difficulty by reason of the weight to be moved and the necessity for concealment to avoid the effect of enemy fire and the avoidance of the fire itself. In this, the final stage of movement of the ammunition, transport can be by animals (either on carts or packed), by some form of motor transport, or by hand (drawn on carts or carried on the person).

Animal-drawn transport in this forward area is efficient in the amount of ammunition which can be drawn by one animal over ordinary terrain, estimated at 40 to 60 rounds of T1 shell. It, however, has the disadvantage that it is not capable of the maximum utilization of cover, is not considered a rapid means of transport, if the animal becomes a casualty his load must be transferred to other means of transport which causes delay of

## THE FIELD ARTILLERY JOURNAL

the entire load, and, even when successfully moved forward, the load must generally be moved a short distance by hand. Packing of ammunition by animals offers better speed and better utilization of cover but lower efficiency in the amount of ammunition moved by a single animal. Animal transport has another disadvantageous aspect in that if 1½-ton trucks should be provided for ammunition supply, which would make them available also for the transport of the mortars and crews when not in combat, then the unit would find itself equipped with both truck and animal transport.

The Board feels that motor transport of the weapon, crew and an initial supply of ammunition, the trucks becoming available for ammunition service when the weapon goes into combat, offers advantages which are so important that animal-drawn carts as the last link in the ammunition supply chain should be taken out of consideration.

Contemplation of a motor vehicle for movement of ammunition forward in the fire swept zone is not considered profitable. A small motor vehicle having speed for crossing exposed ground, ability to take advantage of cover to the utmost, and high cross-country ability has not as yet been developed to the knowledge of the Board.

The Board believes that the individual man on foot offers the best means of rapid and sure movement through the final stage of ammunition supply. The ordinary man can carry nine rounds of T1 shell in carrying cases for upwards of 1,000 yards without undue fatigue. Estimating 1,500 yards as being the usual carry which would be necessary, a man could make this round trip in from forty minutes to an hour: given seven ammunition carriers per mortar this would deliver to the mortar 63 rounds of T1 shell (or about half that number of T3 shell) every hour. The same amount of ammunition could probably be moved in a hand cart drawn by three men; this, however, presents again the problems of utilization of cover and cross-country ability while possible failure of the cart, by fire or accident, results in delay or complete failure of supply while other expedients are being instituted. A test of the latter

## THE STOKES-BRANDT 81MM MORTAR

means of transport to develop its possibilities would be advisable.

\* \* \* \* \*

*"Other Tactical Uses:* (1) The Board sees a great field of usefulness for this weapon within its capabilities as to range. In all operations it offers a tremendous increase in fire power at small cost in transportation, men, and ammunition and with little resultant complication of positions, communications and ammunition supply of the division artillery: indeed, its steep angle of fall would make easier the work of the division artillery by relieving it of some of its difficult dead space problems.

(2) During the preparation fire preceding an attack all weapons, including certain weapons additional to those which are destined to operate as accompanying guns later, may participate. The crews serving the additional weapons may continue so to serve them to the limit of fire of the mortar. The mortars then become spares and the crews and their transport become available for use in the increasingly difficulty supply of ammunition to the accompanying guns and as replacements.

(3) The mobility of the weapon, its light weight and that of its ammunition, lend themselves admirably to the support of infantry in effecting landings on hostile shores, in river crossing operations, and in mountainous country.

(4) The steep angle of fall of the projectiles would make them useful in all defensive operations, especially so in the defense of steep or heavily wooded beaches and river banks, in case of street fighting in cities and towns, and in very broken and mountainous country.

"s. The Board believes that, other things being equal, the cost of the weapon and the probable speed of production, which without question must compare favorably with any rifled gun, are of material importance with respect to the question as to its final adoption as a weapon suitable for accompanying gun purposes."

## PART II

The first impression of the 81mm Stokes-Brandt mortar is

that of extreme simplicity. Here is a smooth-bore tube which rests upon a base plate to keep it from digging into the ground when firing, and is held up at the muzzle end by a bipod which carries the elevating and traversing mechanisms. The complete weapon separates in a matter of seconds into three parts each of which can be picked up and carried off by one man. Yet the shell of this mortar, up to 3,300 yards, is equal in effectiveness to that of the 75mm gun against personnel in the open, although its complete round weighs only one-third as much. In addition, it has accuracy within its range which compares favorably with that of the 75, can shoot out of almost any position in which it is placed and can attack many targets denied to the 75 within that range by reason of the 75's flat trajectory. It is supplied with a heavy shell which for ordinary destruction purposes against hasty cover and up to 1,300 yards is considerably more effective than that of the 75; this projectile weighs little more than half as much as the complete round for the 75. The only targets against which this weapon would seem to be inferior to the 75 are those for fire against which the higher velocity and flat trajectory of the 75 are necessary; i. e., targets such as tanks, concrete, etc.

This all sounds too good to be true until we realize that the weapon has been designed to perform the mission of transporting an explosive container a relatively short distance in the simplest and most efficient manner. The designer has not been hampered by the requirement of high velocity. The makers have streamlined their projectile and kept it from tumbling in flight by means of the ancient practice of placing feathers or wings on its tail; they have loaded the weapon in the simplest way, merely by dropping the projectile down the tube, and have fired it by the impact of its primer upon a firing pin fixed in the base of the tube—no breechblock, no rifling, no cartridge case, no costly recoil mechanisms, no inefficient excess weight, no complications in the service of the piece. This is a weapon designed for one purpose and to the exclusion of all others. In the design is a pleasing absence of gadgets—on the other hand, nothing necessary seems to have been omitted.

## THE STOKES-BRANDT 81MM MORTAR

For accompanying gun purposes the necessary crew for the weapon appears to be a non-commissioned officer, preferably a sergeant, and four men; this provides three carriers for the mortar loads and two for an initial supply of ammunition, or in case of casualties, possible substitutes for mortar load carriers. Given this crew, under command of an officer, the mortar can move anywhere that foot troops can go, and at the same overall rate of speed. A member of the crew has the same possibilities for utilization of individual cover as has the infantryman.

In the matter of conduct of fire the mortar presents the same problems in general as does any other Field Artillery piece. However, there are two peculiarities at once noticeable to the Field Artilleryman when conducting fire. The one which is most apparent is that the lateral dispersion is surprisingly large. This is because we have been used to firing weapons whose lateral dispersion is very small; with this weapon, if the first round is seven mils (for example) off in deflection one cannot make that flat deflection correction and then expect the next round to be reasonably close to a line shot, for when the next burst appears it may be a like amount off line in the other sense. Thus it becomes necessary to bracket in deflection even in axial observation; not hard to do but unusual in the general run of our experience. The other peculiarity is also concerned with the deflection—when firing at short ranges and under favorable conditions, even at ranges of 800 to 1,000 yards, the projectile can be observed throughout its entire flight, so that the deflection can be sensed even though the burst may be lost. This is of considerable advantage when firing into woods or on ground cut by ravines.

The effectiveness of the projectile is surprising, partially so because of the amusingly small noise made by the propelling charge compared with the large detonation of the shell, but mostly because of the excellence of the fragmentation of the shell and the fact that the low velocity and the very efficient quick acting fuze cause the projectile to burst before appreciable penetration has occurred. The pattern of the effect is almost circular and the fragments fly close to the ground. The magnitude of the

## THE FIELD ARTILLERY JOURNAL

detonation of the large shell, which carries more than three times as much high explosive as the 75 shell, is particularly impressive. It will surely take a determined enemy to stay in his position under a literal rain of fire from either of these projectiles, particularly since it is probable, though not yet determined by test, that the enemy may be able to see the projectile approaching in the later stages of its flight!

\* \* \* \* \*

The following speculation on the subject of organization of the unit in the division which is to be equipped with these mortars for use as accompanying guns, is intended only as an illustration of one way in which they could be provided.

With our present triangular organization of the infantry regiment there is need for a mortar unit of the same general character. In this unit, therefore, we may suppose three platoons for supplying accompanying guns to a regiment of infantry, each platoon manning two mortars, thus providing two mortars for the accompanying guns of each infantry battalion in the front line. This unit should be associated with the light artillery battalion, if not an integral part of it, for reasons which will appear later. For each mortar serving as an accompanying gun there must be provided a crew which actually mans the mortar and a crew whose duty it is to transport ammunition to the vicinity of the mortar from the point where the ammunition vehicles have dropped it. Thus the complement of men within the unit for each accompanying gun consists of a mortar crew and a group of ammunition handlers. Such a unit for work with an infantry regiment would number from one hundred and fifty to one hundred and seventy men, including the necessary overhead and maintenance personnel. This is not an unwieldy unit; in fact, it might be increased if desired.

It will be noted in the second quotation from the report of the Board that this weapon offers many advantageous possibilities as an additional weapon in the division artillery. These advantages appear in preparation for attack, more important still in their



## THE STOKES-BRANDT 81MM MORTAR

use in defensive fires, and would provide a weapon for artillery purposes in special operations. For use as an additional weapon for the division artillery purposes above mentioned, there is no need for providing the personnel designated as ammunition handlers, who are necessary only when the mortar is operating as an accompanying gun. In order to provide six additional mortars in each battalion of divisional artillery, it would be necessary merely to increase the size of our mortar unit by thirty men and the necessary trucks for transport. If this were done it would bring this unit to a total strength of some two hundred and twenty men, eight officers and twenty-eight trucks; the unit would man twelve mortars.

In attack situations, where accompanying guns are to be furnished, all mortars may participate in the preparation fire. Upon the withdrawal of those destined for use as accompanying guns (supposedly six) the remaining six mortars may continue to support the attack to the limit of their range. They then may be withdrawn from action, the mortars held as spares, and their crews and transport be available for replacements and to assist in the increasingly difficult job of ammunition supply to the accompanying guns.

The ammunition supply system for the accompanying guns should parallel closely that of the division light and medium field artillery. The truck transport of the unit is available for this purpose and should carry the ammunition forward to the points from which it must move through the zone swept by small arms fire. These points, it is believed, will approximate in general location the positions of the infantry battalion munitions distributing points. The officer commanding the unit should be available for the close supervision of the ammunition supply to the accompanying guns. The close association of the men of the truck transport with the personnel manning the accompanying guns may be expected to provide a beneficial impetus to the performance of their supply duties in the ultimate step of vehicular ammunition supply, which must necessarily, in the forward areas, be more or less decentralized.

Within the range of the mortar, such an addition to our division

## THE FIELD ARTILLERY JOURNAL

artillery as would be accomplished by the provision of such a unit in each light battalion, presents a possibility of increased fire power that almost seems something for nothing. It amounts to a doubling of the fire power of the light regiment up to 3,300 yards from the guns in all preparation fires for attack, and in all defensive operations; it provides accompanying guns for the infantry, still maintaining a material increase of fire power during the initial stages of the attack: it provides all these at a cost of an increase of about two hundred and twenty men, eight officers and twenty-eight trucks per light artillery battalion. The inclusion of this weapon in our light artillery will also provide an artillery weapon for special operations, as indicated in the quotation from the report of the Board.

It is interesting to note that this type of weapon is being adopted by many of the armies of the world: even the defenders of the Woosung Forts were photographed with a gun having much the same general appearance; a late photograph of some Swedish troops shows them equipped with a typical Stokes-Brandt mortar.

The Infantry Board has recommended that this mortar be adopted as standard in the Infantry Cannon Company. They have long asked for an accompanying gun and our artillery service has been searching for something with which to answer this demand. Here is the weapon almost ideally suited for this work: light, powerful, of high mobility and low vulnerability, accurate and of sufficient range, and promising an ease of ammunition supply far beyond anything so far developed. Here also, at low cost, is a powerful addition to our division artillery and one filling a need in artillery for special operations not hitherto satisfied.

Tests are at present in progress for the purpose of developing an anti-tank weapon. It is possible that the results of these tests may lead to a combination unit to handle both the accompanying gun and the anti-tank gun. Any such combination unit would, of course, effect a material change in the organization discussed above.

## NELSON E. MARGETTS

On April 17th of this year died at Letterman General Hospital, San Francisco, Lieutenant Colonel Nelson E. Margetts, Field Artillery. To his many and devoted friends news of this sad event came as a bitter shock and surprise.

Born in Utah in 1879, Colonel Margetts volunteered for the war with Spain and joined the "Astor Battery"—Battery "A" Utah Light Artillery—in May, 1898, seeing service in the Philippine Islands in the Spanish-American War and the Philippine Insurrection. Since those early days Colonel Margetts has rendered service in many positions of responsibility. An enumeration of his more important assignments was published in the May-June number of THE FIELD ARTILLERY JOURNAL. In the discharge of these duties "Nels" Margetts met many officers and men of our Army who will ever cherish memories of him as a devoted, forceful, energetic officer, a kindly gentleman and a loyal friend.

But we like to remember him best on the polo field. Built on Herculean dimensions, with the wrist and forearm of a giant, hitting probably as long a ball as any player in the game, he was at his best in a hotly contested match. We shall always remember him between periods, his face beaming with confidence and with enjoyment of the contest, his brown eyes glittering with determination and the will to win.

The passing of such a man deprives his friends of a comrade who endowed companionship with kindness, generosity and loyalty and who brought to the service of his country ability, energy and devotion.

CORTLANDT PARKER,  
Lieutenant Colonel, Field Artillery.

# FRENCH ARTILLERY DOCTRINE

## (Second Installment)

(The following is a digest by Major John S. Wood, F. A., of the course in artillery given at the Ecole de Guerre under the direction of Colonel de la Porte du Theil. Major Wood was a student there in 1929-1931—EDITOR.)

### SECTION III—MANEUVER OF MATERIEL

#### ORGANIC AND GENERAL RESERVE ARTILLERY

**I**N 1914, the artillery of a French corps of two divisions comprised two divisional artillery regiments (75) of 3 battalions and one corps artillery regiment (75) of 4 battalions. In addition to this organic artillery, there was a grand total of 67 heavy batteries as army artillery for five armies.

Today, an army corps of two divisions disposes of two division artilleries (one regiment of 75 of 3 battalions and one regiment of 155 howitzers of 2 battalions) and one regiment of corps artillery (2 battalions of 105 guns and 2 of 155 guns)—a numerical increase of 4 battalions and an incorporation of heavy artillery in the corps.

Even so, the artillery strength of the corps today is much less than that to which we became accustomed during the war.

In July, 1918, the 21st Corps in Champagne placed in line on a 20 kilometer defensive front 252 pieces of 75 and 244 of heavier calibers—1 gun per 20 meters of front.

In September, the same corps attacking on a 4 kilometer front engaged 292 light guns and 218 heavier pieces—1 gun per 8 meters of front.

In both cases, the fronts were fortified. The power of infantry, however, has become so great that strong artillery support must be provided even in a meeting engagement. Although a corps possesses sufficient infantry to attack on a front of five or six kilometers, it can cover only about half that front with effective artillery fire. So, in order not to engage in a series of partial efforts, it is necessary, at least, to double the artillery strength. Divisions and corps, however, cannot be loaded down with such amounts of organic artillery, nor can one count on the continuous use of artillery belonging to units which are temporarily in second line; hence the necessity for a *general artillery reserve*, independent

---

The first installment of this article appeared in the May-June, 1932, number of the FIELD ARTILLERY JOURNAL.

## FRENCH ARTILLERY DOCTRINE

of the organic corps and division artilleries, placed at the disposal of the higher command whenever necessary.

This is nothing more than an extension of Napoleon's tactical conceptions in the domain of strategy: "In sieges as well as in open warfare the cannon plays the principal role—it is with the cannon that one makes war. The art consists in converging a large mass of artillery on the same point; the melee once begun, victory belongs to the side which is able to surprise the enemy with a sudden concentration of artillery fire at a critical point."

Napoleon's artillery mass was his general reserve, the guns of the imperial guard. His campaigns are filled with examples of their mass action: Austerlitz, Jena, Wagram, Hanau.

The Russian-Japanese War also offers remarkable examples of mass artillery action and the World War, finally, has confirmed the idea of a general reserve.

The high command no longer organizes its maneuver with armies alone, but with its armies and its general reserves. The army is the basic unit of strategic maneuver, but the power and scope of its action are determined by the quantity of artillery allotted to it from the general reserve.

### ORGANIZATION OF THE GENERAL ARTILLERY RESERVE

The general artillery reserve does not include tactical organizations higher than the regiment which is considered the largest unit readily susceptible of incorporation in the artillery command of divisions, corps, and armies. Although its units are distributed among the larger tactical commands for combat, the general artillery reserve is not a purely administrative organization. Its general officers and colonels have well defined duties of training and inspection which continue even when their units are distributed under other commands for combat.

### MOBILITY

The greater the mobility of the general artillery reserve, the less the time lost in displacements—hence an increased possibility of reducing the time between successive offensives. For this reason, all such units are motorized; portée for the 75s, 105s and 155 howitzer, and tractor drawn for the heavier calibers. They gave convincing evidence of their mobility throughout the war.

## THE FIELD ARTILLERY JOURNAL

The truck drawn units were, however, entirely too dependent on hard surfaced roads. Since the war efforts have been made to remedy this; first, by carrying farm tractors along on the trucks; next, by the adoption of light crawler type truck\* hauling the guns and caissons mounted on special trailers for rapid displacement.

A certain number of light batteries have been furnished with these trucks and have performed very satisfactorily. The same scheme will undoubtedly be applied in time to the heavier calibers. The 306th Regiment (75) so equipped made the journey from le Mans to Coëtquidan, 200 kilometers, in a march of one day.

However, it is not to be assumed that this is the definite solution of the artillery motive power problem. No nation is wealthy enough to keep up in peace time the number of motor vehicles necessary for mobilizing all its artillery. Hence, recourse must be had in France to the requisition of horses which exist in abundance. Furthermore, a satisfactory motor fuel which can be produced in France has not yet been obtained. There is, also, the necessity of utilizing only commercial types of vehicles. Fortunately, the number of types under construction commercially is being limited by judicious subsidies.

So long as the crawler tread vehicles of the Citroen-Kégresse type are not in general use in France, the quantity supplied to the artillery will be limited to the small number provided for in the annual military budget. Generally speaking, it is reasonable to believe that the organic artillery of corps and divisions will remain for a long time horse-drawn. Only the general reserve will be motorized.

### RELATIVE PROPORTIONS OF ORGANIC AND RESERVE ARTILLERY

After Napoleon's time, the relative importance of the general artillery reserve decreased. In 1859, it comprised only 90 pieces and did not fire a shot. In 1870, it had 96 guns and was not much more effective. After 1870, the artillery reserve was discontinued and was not reconstituted until the World War again demonstrated its necessity.

---

\*Citroën-Kégresse type.

## FRENCH ARTILLERY DOCTRINE

On November 11, 1918, the French artillery comprised:

105 division artilleries	{	945 batteries (75)—3780 pieces
	}	315 batteries (155H)—1260 pieces
30 corps artilleries	{	90 batteries (105)—360 pieces
	}	90 batteries (155G)—360 pieces
General reserve	{	297 batteries (75)—1188 pieces
	}	mountain artillery—112 pieces
	}	heavier calibers—3148 pieces

Total—10208 pieces.

Proportion of general reserve—40 per cent, approximately.

The corresponding figures for the German artillery are as follows:

August, 1914

82 division artilleries .....	{	3936 pieces (77)
	}	1968 pieces (105H)

(For each division; 2 mixed regiments of 2 battalions, 77 and 105; 6 piece batteries)

41 corps artilleries .....	656 pieces
----------------------------	------------

(For each corps; 1 battalion of 4 batteries of 4 pieces)

General Reserve .....	1364 pieces
-----------------------	-------------

(21cm mortars; 15cm howitzers; 100mm guns; 130mm guns; 20 pieces of 305 or 420)

Total .....	7924 pieces
-------------	-------------

Proportion of general reserve—16 per cent.

July 15, 1918

243 division artilleries of:

1 mixed regiment of 9 batteries of 4 pieces (77 and 105H).....	8748 pieces
--	-------------

1 mixed battalion of 3 batteries (150H and 100).....	2916 pieces
--	-------------

3 corps artilleries (21cm mortars; 15cm guns).....	480 pieces
--	------------

General reserve:

Light artillery.....	3200 pieces
----------------------	-------------

Heavy artillery.....	4480 pieces
----------------------	-------------

Long range guns .....	200 pieces
-----------------------	------------

Total .....	20024 pieces
-------------	--------------

## THE FIELD ARTILLERY JOURNAL

Proportion of general reserve—40 per cent, approximately.

In regard to the future, the conclusions of a study made at the French General Headquarters in 1919 are of interest:

"In the future, the total force of artillery on a war footing must be increased considerably over the maximum attained in the World War.

"This conclusion is confirmed by the events of the 1918 offensive. From July 18th to November 11th, the artillery was used continuously without proper rest or relief and the high command was constantly obliged to modify its plans for successive attacks on account of the delays incident to the displacement of reinforcing artillery. The development of the strategic maneuver was unduly limited by the condition of our artillery and the necessity for its displacement."

In other words, the proportional strength of the general artillery reserve was considered insufficient. Since 1919, the French have not modified their artillery organization in division and corps except to bring it up to prescribed strength. The Germans, however, contemplate a considerable increase in the organic artillery of their ideal type of modern army. Just what their intentions are regarding the strength or use of a general reserve—a reserve denied them by the Versailles Treaty—remains unknown.

Other things being equal, in so far as the proportion of artillery to the other arms is concerned, it may be said that the French tendency will be to increase the general reserve strength with respect to that of the organic artillery. This tendency is characteristic of, and is derived from, their strategic and tactical conceptions.

### SECTION IV—AMMUNITION SUPPLY

#### THE GENERAL PROBLEM

The movement of artillery matériel to the field of battle must be accompanied by a movement of ammunition in sufficient quantity to keep the guns supplied throughout the action.

The supply of this ammunition, starting in the factories of the zone of the interior and affecting the entire industrial resources of the nation, attained unforeseen proportions during the war.

On August 2, 1914, the French had a total of 1,475 rounds per



## FRENCH ARTILLERY DOCTRINE

piece of 75mm (about 7 units of fire\*) of which 200 were unassembled. Moreover, the factories were capable of furnishing only 13,600 rounds a day (3.5 rounds per piece) which accounts for the critical ammunition shortage after the battle of the Marne.

In view of later events, the initial allotment of 7 units of fire per piece was entirely reasonable. It was sometimes exceeded during the war; but, more often, the requirements fell below this figure. The real lack of foresight was in the matter of manufacture and of mobilization of industry which, today, is of equal importance with the mobilization of troops.

In Germany, the light artillery situation was no better. There were only 1,300 rounds per piece of 77mm available in August, 1914, and the plan of replacement provided for only one round per gun per day (40 rounds per gun in the first six weeks). At the end of the year, the Germans had not reached a total of ten rounds per gun per day, although their production was much more rapidly reorganized than that of the French, who were severely hampered by the loss of the Briey basin.

The French, inferior to the Germans in heavy artillery, were equally so in heavy artillery ammunition; about 700 rounds per piece as compared with 1,300 for the Germans.

### SUPPLY TO THE ARMIES—ARTILLERY SERVICE

The artillery of the French army is responsible not only for the supply of ammunition, but also for the supply, repair, and maintenance of most of the matériel used by the artillery. It accomplishes this through its artillery service. All large units except the group of armies comprise an artillery service commanded by the chief of artillery of the unit.

After ammunition is received from the factories, it is stored in base and intermediate depots under the control of the Ministry of War. On mobilization, the stocks of these depots are placed at the disposal of the commander in chief who may order their transfer to advance depots and parks in the combat zone. Ammunition sent to the armies is kept in advance army depots or stocked in trains at the regulating stations.

---

\*The term *unit of fire* is now used instead of the old term *day of fire*. The unit of fire for the 75mm is 200 rounds.

## THE FIELD ARTILLERY JOURNAL

### AMMUNITION TRAINS

Ordinarily, ammunition trains carry three or four hundred tons of ammunition. A complete train comprises ammunition for one caliber only. Each car contains a certain number of complete rounds. The trains are loaded at the intermediate depots in accordance with the proportional allowances prescribed by regulations. At the advance depots and regulating stations, supply trains are made up in accordance with the demands of the armies and corps.

### AMMUNITION RAILHEADS

Special ammunition railheads are sometimes installed for the armies at 15 to 20 kilometers from the front. In such railheads, heavy artillery ammunition is assigned tracks separate from those used for other ammunition. Temporary stockages of ammunition are usually installed at these railheads.

### ARMY DEPOTS AND RELAY POINTS

In stabilized situations, army depots are maintained in the combat zone; but in open warfare situations, or if the railheads are too far from the front, relay points are established.

Corps depots are sometimes established; but, in general, there are no division depots, except for infantry ammunition. Separate depots are maintained for the various classes of ammunition, the whole being grouped in the same general locality. Normally, there is one of these groups per corps on each army front. The proportion of light artillery depots is often one per division in line.

Relay points are organized in a very simple fashion. The ammunition is distributed along a road parallel to the front and hidden under hedges or bushes. Ordinarily, the capacity per kilometer of road is:

10 to 15 lots of 75 (60,000 to 90,000 rounds)

10,000 to 15,000 rounds of heavier calibers.

The army artillery commander fixes the location of these establishments in concurrence with G-4 of the army. They are installed and managed by the army artillery service which provides personnel from the ammunition companies of the army parks.

## FRENCH ARTILLERY DOCTRINE

Ammunition handlers are provided on the following basis:

1 man per 6 tons of light artillery or infantry ammunition	} 10 hour day
1 man per 4 tons of heavier calibers	

In general, 6 men can unload an ammunition truck in 20 minutes or load it in 30 minutes.

The importance of the problem of ammunition supply may be better understood by considering some of the tonnages involved. For instance, during a single day of combat in 1918—August 8th—and for a single division, the total weight of ammunition supplied was 2,245 tons. Again, on September 24, 1917, in Champagne, the initial supply brought up for the 4th Army was more than 50,000 tons—a load for 166 trains of 300 tons each. The problem of handling such tonnages is attended with tremendous difficulties requiring for a successful solution trained specialists on the general staff as well as in the artillery.

### THE UNIT OF FIRE

The artilleryman makes his estimates in tons when figuring on truck or train loads of ammunition and in total number of rounds when a firing mission is concerned. But these calculations do not interest the higher command. From a command standpoint the important thing is to know how many rounds are available for each gun and, for convenience in calculation, an arbitrary unit of fire is assigned for each caliber:

200 rounds for the 75mm  
75 rounds for the 155mm howitzer  
100 rounds for the 105mm, etc.

The unit is based on the average expenditures during the war for the various calibers. It does not represent a fixed period of fire; however, for the calibers most frequently used, the unit of fire would be expended in about *two hours at the normal rate of fire*. But all the artillery engaged by a large unit in battle does not fire throughout at the normal rate. Hence, it may be stated that the unit of fire corresponds to four or five hours of ordinary combat.

The important thing to remember is that the *unit of fire is the unit of measurement of the time during which the artillery may remain in action*.

## THE FIELD ARTILLERY JOURNAL

The number of units of fire carried in the artillery limbers and trains is approximately:

2 U. for the 75mm

1 U. for the 105mm and 155mm howitzer

1 U. for the 155mm gun.

### ROLE OF THE HIGHER COMMAND IN AMMUNITION SUPPLY

Before the war, it was considered that the supply of ammunition was a more or less regular affair, like the supply of rations. The artilleryman fed the guns as the quartermaster fed the men, and this daily duty seemed to have little to do with the general plans for operations. The war, however, revealed the importance and amplitude of the problem and showed the necessity for planning the ammunition expenditure of large units according to their missions.

The higher command must decide on the amounts of ammunition to be allotted to the various large units involved. The operation plans of a commander depend closely on the quantity of ammunition at his disposal. The problem of ammunition supply becomes today an essential and vital element of the art of war in estimating the relative value of the forces opposed to one another. At what moment does the advantage incline in our favor? Is it better to attack today with two units of fire available than tomorrow with three? The commander must decide such questions and on his decision depend the ammunition to be supplied, its location on the terrain, and its allotment to the subordinate units.

### AMMUNITION TO BE SUPPLIED

The amounts and kinds of ammunition required for an operation depend on the results desired, which only the commander can define. The artilleryman gives the necessary technical directions to conform to the desires of the commander. In principle, this applies to all echelons of command; but it is of greatest importance in the army, for it is the army commander who initiates extensive operations of any sort.

### LOCATION ON THE TERRAIN

Ammunition establishments must be distributed in depth so as not to interfere with one another and so as to render them less vulnerable; but the main reason for the distribution is to secure

## FRENCH ARTILLERY DOCTRINE

elasticity of ammunition supply in the development of the tactical maneuver involved. The question is especially of interest to the army commander.

In a stabilized situation, the army depots are numerous and stocked to the limit. Combat and ammunition trains are considered only as means of transportation. In open warfare, on the contrary, depots are less numerous and well stocked, and the trains resume their role as rolling reserves.

### ALLOTMENT TO SUBORDINATE UNITS

In the division, the distribution of ammunition among the troops results too directly from the immediate maneuver for the division commander to exercise personal control. In corps and army, on the other hand, the ammunition allotment may have such a far reaching effect on the general operation that the commander must make a decision as to the amounts to be used in any subordinate action under his control.

## SECTION V—OBSERVATION

### CHARACTERISTICS

Only one paragraph of the French combat regulations for artillery is emphasized in italics. It consists of one sentence:

*"Observation is of supreme value to the artillery and every possible effort must be made to secure it."*

This indicates sufficiently the paramount importance assigned by French artillerymen to artillery observation.

### OBSERVATION OF FIRE

The remark often heard, "One no longer adjusts fire, one prepares it," has no place in the French artillery doctrine.

The precision of prepared fire depends on several factors: the correctness of topographical operations, and of target locations, the time available, the accuracy of ballistic tables and data. The resultant of the possible errors varies considerably according to circumstances. All one can say is that at present an accuracy closer than ½ per cent of the range and 5 mils in direction cannot be expected, and this only in the case of transfer of fire from a check point. Hence, a verification of fire is necessary; and it is for this reason, first of all, that observation is indispensable.

Given the time necessary, the artillery proceeds with the topographical organization of the terrain and then executes a series of

## THE FIELD ARTILLERY JOURNAL

registrations. These are carried through fire for effect only when necessary to check a new powder lot. Whether reduced or not, such registrations are essential, and it appears improbable that they can ever be dispensed with.

This done, the batteries are ready to act against any live targets in their zone of action. By live targets is meant those amenable to zone fire. On the contrary, the regulations strictly prohibit destruction fire, except against wire entanglements, unless observation is possible from start to finish on the objective itself or an auxiliary target very near by.

When time is lacking for the procedure outlined above, systematic observation of all fire is essential.

### SURVEILLANCE OF THE ZONE OF ACTION

Aside from the purely technical necessity, there is an even more important need for observation. Little is gained from firing against empty space. The real objective of the artillery is man and only vigilant surveillance of the battlefield will enable one to place fire where and when needed.

If, at times, there appears to be a certain lack of appreciation among artillerymen of the necessity for observation, it probably results from a strange confusion as to the two distinct purposes of observation. Within certain limits, observation may be dispensed with for adapting fire to the terrain, but we can never do without it for locating targets on the field of battle. It is more important and more difficult than ever before on account of the depth and relative invisibility of modern infantry combat formations.

### MEANS OF OBSERVATION—GROUND OBSERVATION

Within its limits, ground observation is the surest and most satisfactory form. It is carried out either by officers or special personnel of the firing organizations or by observation batteries. The former have the double task of adjustment of fire and surveillance, while the latter limit themselves generally to the location of targets.

For adjustment of fire, unilateral observation is of little use beyond 5 kilometers, whence the necessity either to push the observation posts well forward or to use combined observation. The latter process, however, requires considerable topographical preparation and is rarely undertaken by less than a groupment of

## FRENCH ARTILLERY DOCTRINE

artillery or with less than 24 hours available for its installation.

In open warfare situations, the single battalion observation post will often have to be relied on. This implies much closer contact between the batteries and the observation post than is generally realized. Light batteries, particularly, will be pushed forward in close proximity to their observation post.

For the precise location of targets and for general battlefield surveillance, the French employ observation batteries comprising a flash ranging section and a sound ranging section. Normally, one such battery operates on each corps front. The flash ranging sections install a central and from 3 to 6 posts, which requires about ten hours' time. In open warfare, general battlefield surveillance becomes perhaps their main role. The sound ranging sections set up a central and from 4 to 8 posts. Normally, about 24 hours are required for the installation.

### AIR OBSERVATION

Observation from the air, carried out by balloon and airplane, permits an extension of view as far as the extreme limit of range of the guns. The balloon observer, like the ground observer, is incapable of making a precise determination of the center of impact of a series of rounds. His role is chiefly one of surveillance. The airplane observer, on the contrary, can adjust fire by determining the error of centers of impact. From an artillery standpoint, his role is much more important.

The modern long range gun is of little use without airplane observation to seek out distant objectives and adjust fire on them. But the speed and limited duration of flight and the limited number of planes make the prolonged use of a plane for a single adjustment an exceptional affair and require that it be utilized normally by several batteries: in general, those of a single groupment. The assignment of airplanes for artillery use is affected by the following considerations:

Units which cannot act effectively without air observation must have priority in its use; hence, long range artillery of army and corps is given preference. Division artillery can function without it, corps artillery cannot.

The needs of the division artillery can usually be met by the infantry accompanying plane whose mission includes the

## THE FIELD ARTILLERY JOURNAL

location of targets which menace the infantry but remain unseen to the artillery observers.

The value of heavy artillery fire depends largely on effective air observation.

The problem of close cooperation between the artillery and the aviation is extremely important. The ideal solution is an organization comprising an air observation unit with each groupment of artillery. The Germans contemplate such an organization in their "modern army." The French assign an observation squadron to each long range gun regiment of the general reserve and provide for two air observers with each division and corps artillery headquarters and with the light artillery and howitzer regiments of the general reserve. They consider it desirable that all artillery officers be trained as air observers.

### SECTION VI—INFANTRY-ARTILLERY LIAISON

Every victory is completed by the occupation of terrain desired by the enemy. Since infantry alone is capable of occupying ground, it follows directly that no artillery action is possible except in relation to a corresponding action of infantry. Undoubtedly the distant fire of long range guns may seem to have little to do with the immediate support of infantry. However, even in this case, the relation is more marked than is generally realized: for, whatever the nature of the affair, the value of artillery fire lies in its effect on personnel; man alone being impossible of replacement during the course of a campaign.

In principle, artillery action is strictly dependent on that of the infantry. Conversely, the infantry is to a large extent dependent on artillery, for infantry weapons are often incapable of obtaining the necessary superiority of fire over an enemy organized in any degree for defense.

The possibilities of large units in an attack are limited by the possibilities of their artillery. Nevertheless, the fact that artillery alone cannot carry on combat and that infantry *is* capable of doing so has led certain minds to the conclusion that the general action is an affair of infantry to which the artillery lends its aid; also, since the artillery is capable of action beyond the immediate needs of the infantry, that a certain portion of it should be reserved to the higher commander for his use. Hence, the idea of dividing



## FRENCH ARTILLERY DOCTRINE

the artillery in two parts; one strictly subordinated to the infantry, the other under the commander to enable him to intervene in combat.

The conception is interesting, but has no place in the French doctrine. *There is only one artillery; and there is only one maneuver*, planned by the general commanding and executed in common by the two arms, each acting in accordance with its own possibilities, but in constant liaison with the other.

This accord is easily planned and organized in advance, but can it be maintained in action? The plans may or may not conform to the realities of combat. Sudden changes in the situation may require rapid and unforeseen artillery support of infantry units. How is it to be obtained?

In battle, the initial enemy resistance is broken down as a result of the combined efforts of the various arms at the same point. A breach is created in his defenses. To create this breach, the artillery action is necessarily centralized. Later, there comes a time when the pressure of small groups, here and there, resolutely led, may completely shatter the weakened defenses.

If artillery support is necessary at this time, it is the groups themselves who must furnish it. The artillery action should be decentralized. A special weapon is needed for this mission which is intrusted at present, as a matter of expediency, to accompanying units of light artillery.

If a sudden change is needed in prearranged plans for fire which have become more of a nuisance than a help, the infantry should be able to obtain it promptly.

Finally, even if it has been impossible to prepare *a priori* coordinated plans for fire, the infantry units should nevertheless be assured of certain and powerful artillery support when needed in their zone of action.

These are the problems that infantry-artillery liaison must solve. The solution does not lie in parcelling out the artillery among the various units engaged. In this way all possibility of concentration of effort would be destroyed. Before we can exploit an attack, we must assure its initial success. Against modern defenses, organized in depth, the moment for exploitation and a consequent splitting up of artillery is extremely difficult to determine.

## THE FIELD ARTILLERY JOURNAL

In any case, a commander must remain capable of quickly converging the fire of his artillery. He cannot parcel it out; besides, the difficulties of movement are such that a disorganized displacement of artillery, except for a few light units, would end in terrific traffic jams on the few roads available. The war furnishes many examples of this.

How then is the artillery to be assigned in order to keep it in hand and at the same time to be ready to decentralize the direction of fire? And to what degree should the decentralization be limited?

The regulations answer the second question by prescribing the regiment of infantry as the smallest unit, in principle, to whose support artillery will be definitely assigned. Regarding the method of assignment, the most suitable arrangement appears to be the organization of artillery groupments whose normal zones of action are those of the infantry regiments which they are to support.

The adaptation of such groupments for infantry support implies constant and sure contact between the units concerned. This involves a problem of communications that is always important but too often considered the essential feature of liaison. It also implies subordination of the artillery to the infantry, but only in a conditional and strictly limited degree. There is a limitation in time, since the artillery may at any time revert to the higher commander for general action. There is also a limitation as to fire, for the ammunition expenditures and the general displacements involving large amounts of artillery must be decided by the higher command.

Infantry-artillery liaison has only one purpose—the concerted thought and effort of the arms in action. The higher commander prepares it—a matter of training; organizes it—a question of orders; and is responsible that it works. The artillery executes it by means of groupments whose commanders, though under the orders of their own chiefs, are charged with the support of the infantry. They have the strict duty of carrying out this mission to the limit of their resources and possess, in consequence, an initiative which extends even to the engagement of their batteries at close range.

*(To be continued)*

## SQUADS WRITE!

A SELECTION of the best things in prose, verse and cartoons from "The Stars and Stripes."

No one who can wear in his lapel the button which marks him as one who saw service with the A.E.F. will ever forget that great overseas institution. Into an existence of endless drudgery in a country which seemed to be made up entirely of mud, this army newspaper burst with all the unexpected brilliance of a Verrey light.

"The Stars and Stripes" was immediately adopted by the American Army and attained a circulation of 550,000 copies, Only a paper shortage prevented its approaching the million mark; it was necessary to ration the available copies and each was read and re-read until the newsprint disintegrated. Here was a something which talked the soldier's own language and saw the war from his own point of view. "The Stars and Stripes" was ribald, scornful of authority, truthful within the limits of censorship, and above all funny. It was the one bright spot in a very dull and very dirty war; hundreds of thousands of Americans look back upon it with all of the affection which a man in a strange city feels toward his home town paper.

"The present compilation is presented" says Mr. Winterich, "not as a formal history, but as an olla podrida in informal quotation, bulwarked by notes of personal reminiscence."

Here are news stories, editorials, letters, verses—including Joyce Kilmer's immortal Rouge Bouquet—and cartoons from the newspaper which kept the A.E.F. in a good humor from February, 1918, until the time of its last issue, June 13, 1919, all made into a running chronicle which gives a true and savory history of America's part in the World War.

The book is published by Harper and Brothers and costs \$4.00. A reduction of 5 per cent will be made to members of the U. S. Field Artillery Association who purchase it through the Association.

## TRAIL ARC AND BLOCK FOR FIRING AT FAST MOVING TARGETS

THE Field Artillery Board has been conducting experiments with a traversing platform, trail arc and block to be used with the box trail 75mm guns in firing at moving targets. The drawing, showing dimensions, is self-explanatory, and is very accurately drawn to scale. The test was completed in May and the entire device worked very satisfactorily. The roller on the lunette shaft was found unnecessary and will not be used so that in this respect the drawing is incorrect. The lunette should be shown in place of the roller. As is indicated the brake beam of the gun rests in the two U-shape channels. This is the only fastening of the gun to the device. The Board is not satisfied with the device on account of its excessive weight and further experiments will be made to reduce this. The Board is of the opinion that a reduction in weight to less than one-half of the present device can be accomplished.

Tests were conducted with the gun firing with right traverse and an elevation of 350 mils and at the same traverse with an elevation of 50 mils. This was to test the stability of the pintle arrangement. Following this the gun detachment fired at a moving target traveling 25 miles an hour at a range of about 2,500 yards. Although the gun detachment was without previous experience, the firing was very well done, resulting in one direct hit in eight rounds fired. The rate of fire was about four rounds per minute, direct laying. This rate of fire can be greatly improved upon with practice. One defect noted was the obscuring of the target by the blast which in the sandy soil of Fort Bragg made a dense cloud. A paulin, placed in front, reduced this blast to some extent. The time for the emplacement of the device was about one hour. This time can be shortened to about one-half hour. The idea of the traversing platform was not merely to furnish a method of firing at moving targets, but also to permit large shifts in deflection to be made quickly, using aiming stakes and still retaining the proper deflections throughout. This was tested during the firing, and over a front of 700 mils, deflections were measured from the aiming stakes before and after the firing, the greatest variation being three mils.

## TRAIL ARC AND BLOCK FOR FIRING AT FAST MOVING TARGETS

The above test on the traversing platform, trail arc and block is one of the devices being tested by the Field Artillery Board in firing at fast moving targets. Such a device could best be used in a stabilized situation. The weight and bulk of the platform precludes its universal use as standard equipment.

The Chief of Field Artillery desires suggestions from the service on any device which will facilitate firing at fast moving targets.

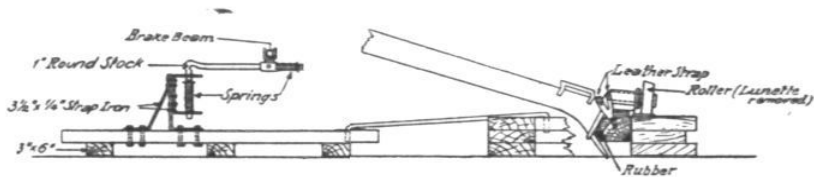
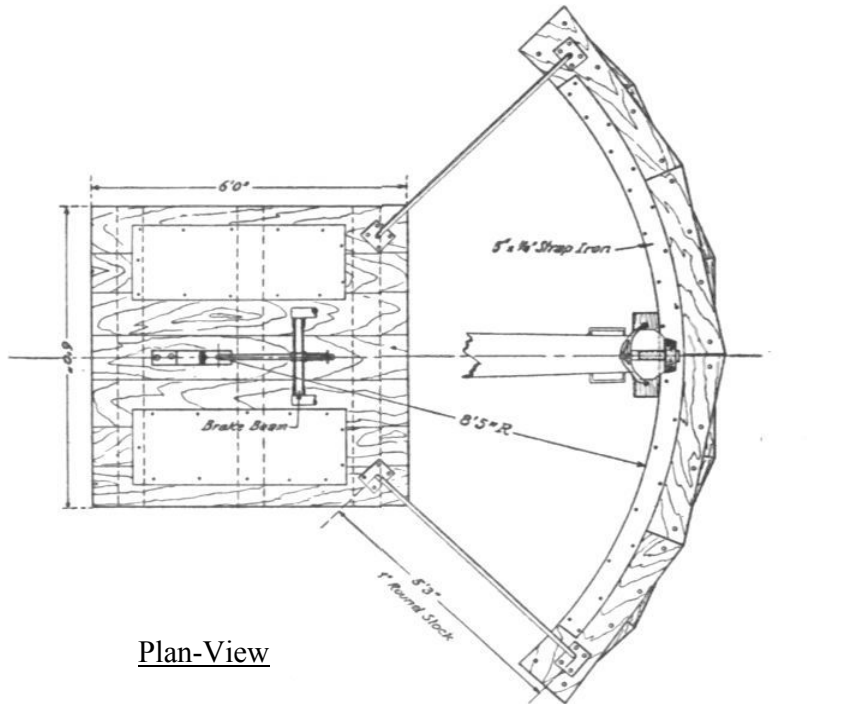

Traversing Platform for 75<sup>m</sup>/<sub>m</sub> Gun (French)

Scale: 1/2" = 1ft.

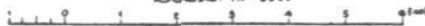

THE FIELD ARTILLERY JOURNAL

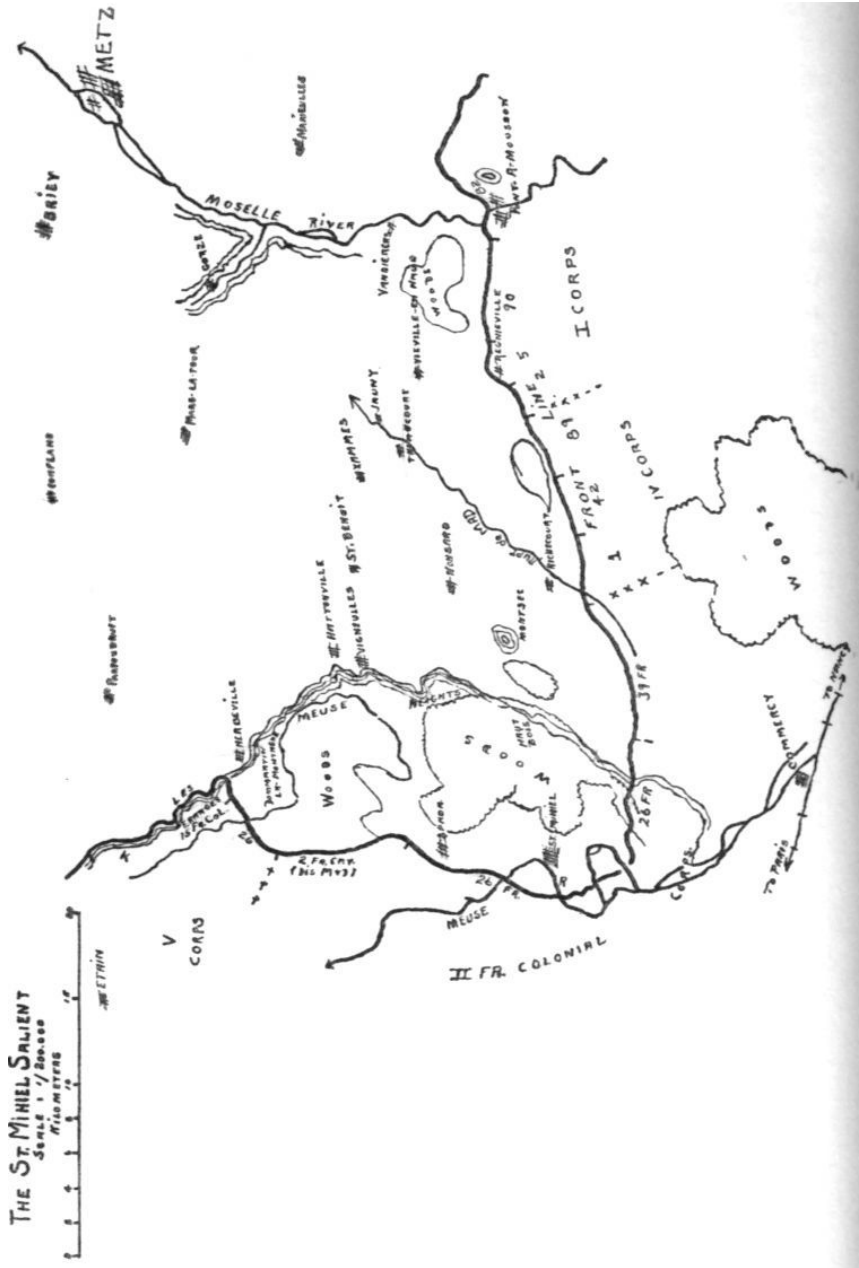

# PLANNING A GREAT BATTLE: ARTILLERY PREPARATIONS FOR ST. MIHIEL

BY COLONEL CONRAD M. LANZA, F.A.

THE reduction of the St. Mihiel salient in France, had been discussed at American GHQ, AEF, as early as November, 1917, and was later the subject of conferences between General Pershing and the French High Command. But it was not until July, 1918, that plans approached a practical stage. On July 10th, Marshal Foch, as Allied Commander-in-Chief, proposed the formation of an American army opposite the salient, to probably operate against it in September following.

On July 22nd, General Pershing suggested to both General Petain, commanding the French armies, and to Marshal Foch, that the south side of the St. Mihiel salient be assigned to the American army, about to be organized. Two days later, July 24th, at a conference at Chaumont, Marshal Foch approved this proposition, and suggested that the new American army attack the south side of the St. Mihiel salient, release the Paris-Nancy Railroad passing through Commercy, and advance the battle front nearer to the industrial and mining area of Briey. Upon inquiry from General Pershing as to whether the American army could obtain needed artillery, Marshall Foch promised to arrange for it. That same day, General Pershing ordered the formation at La Ferté-sous-Jouarre, of the First Army, to be ready for action August 10th.

On August 3rd (or 4th), Colonel Fox Conner, G-3, GHQ, AEF, submitted a memorandum, outlining a plan to attack the south side of the St. Mihiel salient with about fourteen American divisions, while a French army was to simultaneously attack the west side. This plan was presented by General Pershing to Marshal Foch, at Sarcus, on August 9th, who approved it as modified by letter stating:

"The American Army will carry out the whole of the operation contemplated. Forces considered necessary by the American Army, about 14 divisions, will be assembled . . ."

This required the Americans to attack both sides of the salient, with the force estimated for but one side. A second conference

## THE FIELD ARTILLERY JOURNAL

was held on the same day between Generals Pershing and Petain, at which details were discussed.

On August 10th, Pershing went to La Ferté-sous-Jouarre, and assumed command of the First Army. He at once started the staff to plan for attacking the two sides of the salient. The staff, under Colonel H. A. Drum, General Staff, was ready to function. With it were the headquarters of the First Army Artillery, under Major General E. F. McGlachlin, which commenced to draw the artillery plan, in cooperation with the army G-3 section. Between the 11th and 16th of August, First Army headquarters moved to Neufchateau, closer to the front where the initial operation of an American army was about to occur.

A letter of instructions was issued on August 16th, by GHQ, AEF, to the First Army, defining the intentions of General Pershing as commander-in-chief, which stated:

"1. The Commander-in-Chief directs that the First Army undertake the reduction of the St. Mihiel salient. The minimum result to be obtained by this operation is the reopening of the Paris-Nancy railroad, in the vicinity of Commercy.

"2. The main portion of the forces of the First Army will be used against the south face of the salient, the main attack extending from the vicinity of Fey-en-Haye to the vicinity of Richecourt. A smaller portion (approximately three to four divisions) will be used in the region immediately north of Les Eparges, this secondary attack being directed to the east and southeast. The general conception of the operation is thus the converging of enveloping forces in such a way as to cause the fall of the entire salient.

"3. The minimum objective of the operation may be roughly defined by the lines:

Vandieres; heights north of Jaulny; Thiaucourt; Vigneulles; eastern edge heights of the Meuse.

The ultimate objective may be defined by the line:

Marieulles (east of the Meuse); heights south of Gorze; Marsla-Tour; Etain.

"4. The decision as to the exploitation of the success . . . will be made by the Commander, First Army. It is desired that the attack be launched prior to September 11, 1918."

The St. Mihiel salient was known to be occupied by the Germans as a rest sector. Few first class divisions were in the area; which had been a tranquil one for a long time. The salient south of Les Eparges was ordinarily occupied by about ten divisions;



## PLANNING A GREAT BATTLE

the sector opposite the proposed main attack of the Americans, about 14.3 kilometers wide, by about four divisions. Divisions averaged below 10,000 men. Their artillery strength consisted of about six batteries of 77mm guns, three batteries of 100mm howitzers, and four batteries of 150mm howitzers, each. To these were added some batteries of 150mm guns (long range); a few large guns; and a considerable amount of sector, non-mobile artillery. In all, the salient south of Les Eparges probably contained around 100,000 hostile troops, with about 180 batteries of all calibers. Not over one hostile division was within one day's supporting distance.

On August 16th, the First Army issued informal instructions to its staff, based upon the verbal directions which General Pershing had given. These provided that the I and IV Corps on the south, and the V Corps on the west, were to attack the salient, each corps with three divisions in line, and one in reserve, with two additional divisions in army reserve, in rear of the south attack. The II French Colonial Corps, with three French\* divisions, was to connect the two attacks by a minor one around the tip of the salient.

An artillery preparation was to start on D minus 1 Day, with the mission of cutting the enemy wire on the east half of the south attack, about seven kilometers front, and all of the enemy wire in front of the west attack; the length of this latter front not having yet been determined. The wire in front of the west half of the south attack was to be cut by tanks. The question of how to dispose of the enemy wire worried the First Army up to the date of the attack. There was certainly a great deal of wire, much of it rusted and in poor condition, in numerous broad belts. Conferences were frequent as to whether this wire was to be cut by artillery, tanks, torpedoes, or wire-cutters, and how much by each method, or whether it was to be left uncut, and crossed possibly by use of mats. A definite decision was not arrived at until the last moment. At this date, the object of having an artillery preparation was to cut wire. The plan included a box barrage around large woods on the south side during the attack, or in lieu thereof neutralizing them with non-persistent gas. The

---

\*French divisions were roughly equivalent to one half of an American division.

THE FIELD ARTILLERY JOURNAL

woods covered an area of about eight square kilometers, a large area to gas. The length of the box barrage required, assuming no frontal attack on the woods, would be not over 2½ kilometers.

The forces in sight, on this date, were fourteen American divisions, two of them without artillery. There was one brigade of American heavy artillery. For the artillery this gave:

12	batteries trench mortars .....	72 guns
144	batteries 75mm guns.....	576 guns
72	batteries 155mm howitzers.....	288 guns
12	batteries 155mm GPF's .....	48 guns
<hr/>		
240	batteries in all .....	984 guns

This amount being considered inadequate, three estimates were prepared as to how much more artillery was necessary. These were:

<i>Batteries</i>	<i>Estimates</i>		
	<i>1st</i>	<i>2nd</i>	<i>3d</i>
75mm guns .....	100	100	66
155mm howitzers.....	50	50	28
Heavy guns or howitzers	100	86	88
	<hr/>	<hr/>	<hr/>
Total .....	250	236	182

The 2nd estimate was accepted, and the French High Command was asked to furnish the 236 batteries, 944 guns, together with the loan of two generals, with staffs, to act as corps chiefs of artillery. The heavy guns and howitzers were intended primarily for counter-battery; other batteries for assignment to divisions.

In addition to the foregoing demands on the French, they were asked to furnish all ammunition required, estimated as twelve to thirteen days' fire; large numbers of air units, including seven observation squadrons for the artillery; trucks to move the infantry into the area; railroad transportation for the entire army; several hundred tanks; and many miscellaneous services.

On August 17th, Marshal Foch, by letter, directed that the proposed attack strike the heaviest blow possible, and secure the line, Gorze; Mars-la-Tour; Parfondrupt; Bezonvaux.

This line was slightly in advance of the ultimate objective of

## PLANNING A GREAT BATTLE

General Pershing's letter of the preceding day. The First Army issued the same day a memorandum, announcing the new objective, which was to be reached in three stages, the south and west attacks to unite in the final stage. On August 18th, a decision was made that the II French Colonial Corps would confine its operations to demonstrations.

General Pershing visited the army headquarters on August 18th and 19th, examining the plans, especially as to the large installations required, which included signal communications; hospitals; water supply, known to be deficient in the area of the south attack prior to the arrival of the autumn rains; depots; roads and railroads; billets, and other important items.

Concentration of troops now commenced. About 500,000 men had to be provided for. Movements into the area were at night. Positions had to be found for nearly 500 batteries, and for all the facilities needed by such a large body of troops, and for concealing the entire movement from the enemy. The successful accomplishment of this task was secured by the First Army staff, and reflects great credit on them.

Serious attempts were made to keep preparations as secret as possible. In addition to marching by night, and hiding in towns and woods by day, the staffs, stationed in cities and villages where office space could be had, were concealed in unmarked buildings, where it was difficult for visiting officers on business to sometimes find them. This caused some delay, but it also aroused the suspicions of the inhabitants. The latter noticed the large staffs, with high ranking officers; and when the peasants went to work in the fields, the fact that the woods were full of troops of all arms, in some cases absolutely jammed, attracted attention. The continuous occupation of their roads by night, by long columns of trucks carrying infantry and supplies, of horse drawn artillery and trains, and of motorized artillery, were noted by those who resided nearby, and seen, although not always identified by hostile air planes, which flew over the area.\*

On August 21st, the I Corps, took command of the east half of the south sector of attack, and commenced supervision of placing in position the troops, guns, and matériel arriving. The

---

\*The first German warning of the impending attack was issued on August 20th.—C.H.L.

THE FIELD ARTILLERY JOURNAL

IV Corps was already at Toul, and the V Corps was established about this date at Ancemont.

On August 22nd, General Pershing requested the French for some additional troops, including ten more observation squadrons for the artillery. By verbal reports, and by informal memoranda, the French had by this date agreed to provide, by transfers from their armies, and from their Artillery Reserve, more artillery than had been expected. The Americans could now furnish some railroad artillery, and might be able to provide some tractor drawn heavy artillery. Two French generals, with staffs, General René Alexandre, and A. Vincent, and our American General William Lassiter, reported, and were assigned to duty respectively, to the V, I and IV Corps, as chiefs of artillery.

By August 22nd, it seemed possible that the following artillery might be available for the attack:

	<i>Batteries</i>			
	<i>U. S.</i>	<i>French</i>	<i>Total</i>	<i>Guns</i>
Trench mortars .....	15	19	34	228
75mm guns .....	144	135	279	1116
155mm howitzers .....	72	50	122	488
Heavy guns and howitzers...	59	103	162	597 (app.)
Foot (non-mobile) medium guns .....		55	55	360 (app.)
Total .....	290	362	652	2789

Of anti-aircraft artillery there was one battalion of machine guns, and two gun batteries, one battery without any guns, and the other with two guns only. The French promised to supply for the artillery five days' fire, and five balloons and five observation squadrons.

On this day, the preparation of a plan covering the best use of the artillery; and to recommend whether a preliminary preparation was, or was not, advisable; whether a rolling barrage should be had, and if so, what kind of a barrage; whether long distance artillery fire was profitable; and other similar questions, was started, under orders to have it ready for General Pershing by 9.00 A. M. the next morning.

The officer instructed to draw this plan had not then heard of

## PLANNING A GREAT BATTLE

the operation, and knew nothing either of the terrain, the enemy, or about our own forces, and intentions. He had to have it all explained to him, and was then told confidentially, that the scheme was impracticable with the forces available. The artillery staff was located in a fine old castle, beautifully furnished and magnificently situated, but not ideal for a military headquarters. The work room was the billiard hall; the billiard table the map table. The chairs were high seated, excellent for watching a billiard game; impossible for typists. The latter sat on boxes, with machines on anything they could find.

The hall was filled all day with American and French officers, many of them generals who had to be listened to. They came to get information, to give it, and just to visit. There being no other place to go to, there were conferences in every corner, and an incessant going and coming. Working on a brand new problem, of the importance of this one under these conditions was not easy. Not until about 8.00 P. M., when the crowd of visitors sufficiently cleared, was it possible to start the dictation of the first draft of the plan. In schools, officers have outline forms and reference books, and above all else, quiet, but here all these were lacking.

The initial draft, after being typewritten, was corrected, and a second draft was ready about 1.00 A. M. the next morning. This was in turn revised, and final retyping began about 2.30 A. M. Due more to exhaustion of the clerks, than to the length of the paper, the final draft was not ready until 7.30 A. M., when it was complete for submission to the army commander. This plan was taken to army headquarters by General McGlachlin at the prescribed hour. Although it was not for some time accepted, it was finally applied with only minor modifications.

This artillery plan was based upon the use of about 550 batteries, believed to be certainly available, or about 2400 guns. Two large groups were recommended:

1428 guns for the south attack, 14.3 kms., or 100 guns per kilometer;

466 guns for the west attack, about 9.0 kms., or 52 guns per kilometer.

The remaining guns were assigned to the II French Colonial Corps, or were unassigned. The plan provided for an artillery

## THE FIELD ARTILLERY JOURNAL

preparation of 4 hours, and 45 minutes, to be utilized as follows:

- a. Trench mortars during entire period to cut wire.
- b. All other guns, for first 15 minutes, to place an intense fire on command posts, telephone centrals, towns, billets, and important roads, to demoralize communications, and prevent the enemy from securing information, or transmitting orders. After the first 15 minutes, this fire to be maintained by a reduced number of guns.
- c. After the first 15 minutes:
  - (1) long distance fire on Metz, Conflans, Mars-la-Tour, for psychological effect, and to interrupt railroads.
  - (2) counter-battery.
  - (3) shelling and gassing trenches, and centers of resistance, to neutralize occupants, to include towns within the first day's objective, these fires to be continued until the end of the attack.
- d. Effective at H hour, a rolling barrage by 75mm guns, at the rate of 10 batteries per kilometer.
- e. Observation from the air, requiring 31 squadrons of planes, and 34 balloons.

It was a problem to locate positions for the guns, with command and observation posts. Including battalions, regiments, brigades and groupings, over a thousand command posts were needed. It was evident that if such a mass of artillery should be turned loose to reconnoitre and occupy positions, the whole area would be over run with reconnaissance parties and details, which would lead to endless confusion, and certain detection by the enemy. The situation on the west side was the simpler; as here the density of guns was only about one half that on the other flank, and extensive woods on high ground afforded concealment to the greater part of the batteries. On the south side the density of guns was equivalent to two continuous lines of batteries at normal intervals, and here large areas could not be used, because,

- a. on low ground, close to the front, overlooked by the enemy;
- b. extensive wooded areas on the west flank, south attack, were under water;
- c. ravines were narrow, and with slopes too steep, to afford positions.

Selection of positions was made, first, by accepting French

## PLANNING A GREAT BATTLE

records, as to suitable sites. As these did not furnish enough positions, the balance was selected by officers in automobiles. Luckily there was a gentleman's agreement in this part of France, by which a single passenger automobile, on either side, could circulate at reasonable intervals without being fired on. The reconnaissance consequently involved no delay. Sites were classified as for light, medium, or heavy artillery. The last were on roads, to insure rapid occupation, and satisfactory ammunition service. Other positions were if necessary off of roads, where it was possible to reach them without making trails sure to appear in enemy air photographs.

The army reserved, by letter to each corps, the positions it desired for the army artillery, including railroad guns. Remaining positions were allotted to corps, who similarly selected positions for the corps artillery, and sub-allotted the remainder to divisions. Extra positions were provided to compensate for possible errors in original selections, and for changes which might occur in the terrain, such as new overflows of streams.

Brigade and higher artillery commanders reported in person, with selected staff officers, at the army artillery command post, where the proposed operation was verbally explained to them. They were allowed to make notes, but cautioned as to secrecy as to the use of such notes. They were directed to occupy positions without other reconnaissance than identification of the places allotted, and routes thereto. No day reconnaissances, outside of woods, allowed. These commanders preceded their troops in time to enable them to arrange for an orderly occupation of positions.

Troops were routed into the First Army area by the army G-3 section, assisted in the case of the artillery by the same section of the Army Artillery. On account of the wide variety of matériel, it was necessary to have an experienced artillery officer determine the number of railroad trains, motor trucks, and road spaces required for his arm. Upon arrival, either by railroad, truck, or marching, the artillery was concealed in rear areas, to be later turned over to their respective commanders for occupation of positions. Hours for use of roads were arranged by the corps G-1s, who were also charged with finding sites for command posts and billets. Although there were some complaints that the artillery

## THE FIELD ARTILLERY JOURNAL

did not receive all that they asked for, on the whole, they received everything they needed, and no favoritism was shown to anyone.

The construction of lines of communication for the artillery was very difficult, due to the number of stations, and the fact that there were other large installations under way at the same time. Many lines put in were torn out by new troops marching over them in the endless night marches, and the artillery net was not perfect on the day of battle.

On August 24th, Pershing consulted Marshal Foch at Bombon, and requested that the arrival of French troops promised be hastened. He inquired particularly as to tanks. The reply as to the tanks was that the British could not spare any, but that the French would furnish three battalions complete with personnel, and tanks for two additional battalions to be manned by Americans. In discussing artillery preparations, and whether tanks could replace one, General Weygand, chief-of-staff, suggested that an insufficient number of tanks indicated correspondingly greater artillery preparation. He stated that the Germans in the preceding spring had done well in their attacks without any tanks, but with an intense artillery preparation. He pointed out that in the St. Mihiel salient only old fortifications and wire, defended by relatively weak forces were present.

Later on the same day, Pershing consulted General Petain at Chantilly. The latter was asked as to the possibility of French troops for the west attack. Petain answered that there were no available French troops, and explained that the plan of the Second French Army for the reduction of the St. Mihiel salient only called for eight French divisions. As the Americans were to have twelve of their divisions, equivalent to twenty-four French divisions, he could see no reason why the Americans could not furnish all troops necessary. It was, however, agreed that the French might extend the west attack to the north with six of their divisions.

The date for the attack was considered. General Petain stated that a part of the artillery promised was to come from the Tenth French Army, which was scheduled to make an attack on August 28th and 29th. It could not therefore release any artillery until September 1st. It was estimated that ten days would be needed



## PLANNING A GREAT BATTLE

to take this artillery out of line, move it, and establish it in position before St. Mihiel. This would make September 10th as the earliest date practicable if this artillery was essential. General Pershing thought it was, and consequently the attack could not occur before the 10th.\* Other details, including the boundary between the First Army, and the Second French Army on its left, were arranged.

Not satisfied as to dates the expected French artillery would arrive, on the following day, August 25th, General Pershing again visited Marshal Foch at Bombon, and requested that the artillery be expedited. He explained that reconnaissances had been made, and gun positions already selected. It was, however, decided that it was nevertheless necessary to wait until September 12th for the artillery from the Tenth French Army.

Pershing then proceeded to the First Army headquarters, where he had personal interviews with General McGlachlin, concerning the recommended artillery plan, which had not yet been issued, and with the chiefs of tanks and engineers.

The French sent the general commanding their Artillery Reserve to the army artillery command post. This general had authority, under general instructions issued by Marshal Foch, who kept him informed as to proposed operations, their missions, and relative importance, to give the necessary orders for attaching artillery temporarily to various armies. Similarly he could withdraw it, when the purpose for which it had been furnished had been accomplished. He arrived with a list of his artillery, and inquired as to the possibilities of employing various calibers and types (tractor, animal-drawn, railroad, etc.). After a full discussion a definite statement was made as to what would be furnished, and on what date and place, and for how long it could be kept. This general was a good calculator; he did what he said he would do.

On and after August 26th, drafts of corps attack orders were received at army headquarters for consideration. They were accompanied

---

\*The artillery from the Tenth French Army does not appear to have joined before the attack.—C.H.L.

## THE FIELD ARTILLERY JOURNAL

by corresponding artillery plans. These provided:

by the I Corps: a surprise attack, without an artillery preparation, except for a 10-minute burst of toxic gas. During the battle slow fire, gas and shell. Observation to be sought, but all that could be expected would be to note badly adjusted fire.

by the IV Corps: same as for the I Corps, except that the infantry would indicate the targets they desired fired upon. Stress laid upon observed fire, to be controlled by planes during the battle. One battery of 75mm guns for each infantry regiment as accompanying guns. Smoke screen on Montsec and adjacent high ground.

by the V Corps; a 4½ hour artillery preparation, rolling barrage, and other requirements of the army plan of August 23rd.

The only one of the three corps who expected to use observation of fire during the battle was the IV Corps, which had an American chief of artillery (Lassiter).\*

General Pershing again visited army headquarters during August 27th and 28th. Worried as to the situation concerning tanks, he sent an officer to French GHQ to inquire into the matter.

On August 29th, First Army headquarters moved from Neufchateau to Ligny-en-Barrois, closer to the front. The next day, August 30th, the First Army assumed command of the front around the St. Mihiel salient. There were under its orders, starting from the north:

V Corps, under Major General Geo. H. Cameron, for the west attack;

II French Colonial Corps, General Blandlot, around the tip of the salient.

IV Corps, under Major General Joseph T. Dickman, for the south attack.

I Corps, under Major General Hunter Liggett, for the south attack.

The same day, August 30th, Marshal Foch visited Ligny-en-Barrois. He had with him his chief-of-staff, General Weygand. They presented to General Pershing an entirely new plan for the

---

\*The orders of the I and IV Corps, which were drafts, are undated. General Dickman, in his "The Great Crusade," states the IV Corps submitted their draft early on August 26th. The I Corps draft is so similar as to indicate the two plans were drawn after consultation, and at about the same time. The V Corps draft order, is dated August 29th, by which date the army artillery plan had been issued.

## PLANNING A GREAT BATTLE

St. Mihiel attack in the form of a note, in which it was proposed that the American attack be limited to securing the line, Regnie-ville-Thiaucourt-Vigneulles, which could be done by a single attack, delivered from the south side. Foch stated:

"an attack from the west will employ many troops which we need. He thought that the Germans would fall back from St. Mihiel at the first sign; that we would only be playing into his hands if he could engage a large number of our troops for a certain length of time; that he did not look for much resistance."

He added that in view of his new plan, which was less extensive than the original,

"less artillery would be required,"

and that all this would permit of at once using a large number of American and other troops elsewhere. General Pershing did not like the new plan, but he promised to make a study of it, and to later submit a reply. While Marshal Foch was trying to reduce the magnitude of the St. Mihiel operation, General Liggett, I Corps, was attempting to have it extended to east of the Moselle, in order to seize the high ground just east of that river with one division, to prevent the enemy from overlooking an advance on the west bank, and enfilading it by artillery fire from across the river.

On the next day, August 31st, General Pershing met Petain, on the latter's special train at Nettancourt, and discussed the new limited plan. To the objections to having only the south attack, Petain stated

"he thought that two divisions, one French and one American, would, if they were launched on the Haut Bois demonstrating to the south, and in the clearing north of Spada, render very useful assistance to this battle."\*

To this Pershing agreed.

Pershing now wrote to Marshal Foch, stating that he considered an attack on the west front essential, and that he further desired to reserve his decision as to the exploitation of the attack; but recommended that if it was desired to employ sixteen American divisions elsewhere, that an attack on St. Mihiel be abandoned.

---

\*The places mentioned were in the II French Colonial Corps area.

## THE FIELD ARTILLERY JOURNAL

But he advised proceeding with the plan, and that the other proposed operations be the ones postponed.

On September 1st, a conference was had at the IV Corps headquarters at Toul with General Petain, at which the latter explained the reasons for artillery preparations to our corps commanders. Although they were opposed to having an artillery preparation, it was decided that there would be one.

On September 2nd, a final conference, ordered by Marshal Foch, to settle the whole question of St. Mihiel, was held at Bombon. General Pershing, accompanied by Major General McAndrew, his chief-of-staff, and Colonel Fox Conner, G-3, from GHQ attended. Generals Weygand, and Petain, with his chief-of-staff, were also present. A decision was made by Marshal Foch, at the conclusion of the discussion, which was reduced to writing. It was,

"The attack of St. Mihiel, limited as to objectives to securing the line Vigneulles; Thiaucourt; Regnieville; limited as a consequence as to the means to be employed, and also limited as to time, will be prepared to be launched on September 10th. This attack requires 8 to 10 divisions."

It was agreed that the attack would be completed on the second day of battle, after which troops could immediately be withdrawn for use in other theaters. This order enabled final arrangements to be made, and these from now on progressed rapidly, being limited only to the arrival of the troops.

During September 2nd and 3rd, the First Army issued battle instructions for the attack of the St. Mihiel salient, which provided,

- a. a *south attack*, to advance on the first day to the line, Nonsard; Thiaucourt; Veiville-en-Haye;
- b. a *west attack*, to advance on the first day to the line, Herbeville; Dommartin-la-Montagne;
- c. *both attacks*, to unite on the second day on the line, Herbeville; Hattonville; Benoit; Xammes; Vieville-en-Haye.

The last line was approximately two kilometers beyond that indicated by Marshal Foch. The mission of the artillery was defined, "as indicated in subsequent memorandum, based on the plan of the Chief of Army Artillery."

## PLANNING A GREAT BATTLE

But an artillery preparation was ordered to start at H minus 22 hours, which was not what the chief of artillery had recommended. The instructions continued,

"wire will be the greatest obstacle . . ."

and directed that artillery, tanks, torpedoes, wire-cutters, and trench mortars would be used to cut wire. The 22 hour preparation was thought necessary to solve the wire problem.

On September 7th the First Army issued a field order for the attack. There were slight changes in objectives. The rate of advance was everywhere 100 meters in four minutes. The artillery preparation was cancelled, and artillery fire ordered to start only with the rolling barrage, except where necessary to conceal the approach of tanks to the line of departure. Army artillery was prohibited from firing within the first day's objectives after H plus 3 hours, and within the second day's objectives, after an hour to be fixed by the IV Corps.

The abandonment of the 22 hour preparation was caused by a realization that it would be impossible for the artillery to cut all the wire desired within the day-light available, to lack of ammunition for 22 hours' fire for all guns, and to a desire not to give the enemy 22 hours' notice of the attack. The 4½ hour preparation recommended by the artillery plan had not yet been accepted. There was opposition by the corps commanders to any artillery preparation. The artillery annex to this order contained nothing more as to the general plan, but the length of this annex, which consisted of 21 large mimeographed pages, containing long lists of objectives with coordinates, illustrates the type of order of this date.

More guns having arrived than had previously been counted on, a new assignment of artillery was made, which resulted in the following distribution:

	<i>Front</i>	<i>Guns</i>	<i>%</i>	<i>Guns per km.</i>
<i>South attack</i> .....	14.3 kms	1882	62.5	131.6
<i>West attack</i> .....	11.0 kms	560	18.6	50.9
<i>Connecting attack</i> .....	36.8 kms	449	14.9	12.2
Anti-aircraft.....		35	1.2	
Reserve, not yet arrived.....		84	2.8	
	<hr/>	<hr/>	<hr/>	
Total.....	62.1 kms	3010	100.0	

## THE FIELD ARTILLERY JOURNAL

These guns were assigned as follows:

	<i>Guns</i>	
To the Army, including anti-aircraft.....	172	5.7%
I Corps .....	962	32.
IV Corps .....	813	27.
II French Colonial Corps.....	439	14.6
V Corps .....	540	17.9
Reserve, unassigned .....	84	2.8
Total .....	3010	100.0

Instructions as to an artillery preparation were once more modified on September 10th. No order was issued by the First Army, but the Army Artillery was authorized to issue one. This prescribed:

- a. for the V Corps..... 4 hour preparation
- b. for the west front, II Colonial Corps..... 5 hour preparation
- c. for the south front, II Colonial Corps..... 2 hour preparation

all to start at H hour, which was to be 5.00 A. M., the infantry to attack in each case mentioned on the completion of the artillery preparation.

On September 11th, the day before the battle, which occurred on September 12th, the orders as to an artillery preparation were changed, by another army artillery field order, which directed that a preparation would be fired over the entire front to start at H minus 4 hours, or at 1.00 A. M., September 12th. Arrangements were had with the Eighth and Second French Armies, respectively, on the right and left, to participate with their artillery in the preparation, in order that the enemy might not at once identify the portion of the front about to be attacked.

The infantry assault was to commence,

V Corps .....	H plus 3 hours
II French Colonial Corps, west attack .....	H plus 4 hours
II French Colonial Corps, south attack .....	H plus 1 hour
IV Corps .....	H hour
I Corps .....	H hour

The main attack had therefore a four hour preparation, and the secondary (west) attack a seven hour preparation, increased for each front by one hour for divisions of the II French Colonial

## PLANNING A GREAT BATTLE

Corps. The object of the preparation, fired at night, was primarily to neutralize the enemy positions and destroy his communications and command posts, in time for the infantry to advance and cross the nearest belts of wire, partially cut by trench mortars, before daylight on the south front, and shortly afterwards on the west.

The preparation recommended by the artillery in their plan of August 23rd was for 4½ hours. This was the result of a study of the history of the enemy divisions to be engaged, and ascertaining their reaction in past battles to artillery bombardments, the length and intensity of which were known. From this was calculated the amount of artillery and ammunition required to neutralize each hostile element. When on the last day, the army decided to accept the artillery recommendations, but reduced the preparation from 4½ to 4 hours, the artillery acquiesced, as in the meanwhile, the number of guns available had been increased, so that with the greater number of guns it was practicable to produce the same intended effect in the reduced time.

With this final change, almost at the last minute, the battle was started, and was successfully concluded exactly according to schedule.

### COMMENTS

#### I. STRATEGICAL

The original plan for reducing the salient of St. Mihiel, carried the intention of a strategical penetration towards Metz, and Briey, to deprive the enemy of important industries, mining areas and railroads.

After the defeat of the Germans on the Marne on July 15th, the victory of the Allies at Soissons on July 18th, the victories of the British on August 8th, and of the French later in that month, the strategical situation was changed, and Marshall Foch adopted a new plan to force the Germans out of France through a double envelopment, by

- a. an attack east, from the vicinity of the English Channel,
- b. an attack northwest, from the Meuse-Argonne area.

With this in view, St. Mihiel became a secondary operation, and according to the general rule to make no detachments not absolutely

## THE FIELD ARTILLERY JOURNAL

necessary, the Marshal suggested on August 30th a greatly curtailed plan for St. Mihiel, with the request that the American troops thereby released be made immediately available for the major operation.

Confronted with General Pershing's objections to any detachments from the American Army, and his insistence to go ahead with the St. Mihiel plan without changes, Foch compromised on September 2nd by agreeing to the St. Mihiel attack, with the understanding that it would not last more than two days, after which troops would be at once released to operate under an American control, for the Meuse-Argonne.

### II. ARTILLERY, TACTICAL

*Artillery Preparations.* Artillery fire for neutralization had not been taught in the United States before the World War. Artillery laid its fire by direct observation, and it was believed that infantry could not be displaced by artillery fire alone, but only when supplemented by an infantry attack.

When our artillery at St. Mihiel proposed to fire against entrenched infantry before there was an attack, and at night, when no observation was possible, the idea required considerable argument before it was accepted. The artillery did, in this battle, with minor exceptions neutralize the enemy, so that the wire which had been so greatly dreaded, was passed without difficulty, notwithstanding a general inability of the tanks to operate. Light artillery may not be able to drive infantry out of trenches, but medium or heavy artillery can either force the enemy to leave, or else bury them in the ruins of their trenches.

Night preparations enable the infantry to start their assault at daybreak, allowing all day for fighting and consolidating. It permits forming on the line of departure without the enemy being able to determine just where, and at just what time this occurs. This assures an orderly start, and saves lives, at the expense of a slightly increased expenditure of shells on account of lack of observation.



# SKETCH OF ORIGIN OF THE FIELD ARTILLERY ASSOCIATION

BY WM. J. SNOW

Major General, Retired, Chief of Field Artillery, 1918-1927

(The following was written by General Snow in order to outline the history of the origin of the Field Artillery Association. It was not written for publication. However, the value of this history to the Association was known to be so great that General Snow was prevailed upon to permit its publication.—EDITOR.)

## FOREWORD

Twenty-five years ago, and at just about the present time of the year, the idea first occurred to me of a Field Artillery Journal. It therefore seems appropriate that, a quarter of a century later, its genesis should be made of record.

WM. J. SNOW,  
*Major General.*

Washington, June, 1932.

WHEN, in the spring of 1907, the Coast and Field Artilleries, which up to this time had formed the Artillery Corps, were separated, I was on duty as Secretary of the School of Application for Cavalry and Field Artillery at Fort Riley, Kansas. The War Department orders, organizing the Field Artillery into regiments, prescribed that the 6th Regiment be organized at Fort Riley and assigned me to this regiment as one of the Captains. Colonel Montgomery M. Macomb, also stationed at Fort Riley, was designated as its Colonel. As a Lieutenant, I had served in his light battery in the Philippines and was very fond of him, and he had always shown a liking for me. Accordingly, when he asked me if I would give up my School Secretaryship (the tour of which was about a third over) and join the regiment, I said I would. I then asked him if I could have my old battery back again, as I had organized it originally and was much attached to it. He said he wanted to break up the old independent battery spirit, and create a regimental spirit, and so he could not give me what I had asked, but that I could have any other position in the regiment. I replied that, under these conditions, I left the choice entirely to him. He appointed me Regimental Adjutant. Our relations at once became close and personal,

THE FIELD ARTILLERY JOURNAL

and so remained to the day of his death, many years later, and of all the officers under whom I have ever served, he is the one for whom I have the greatest respect, admiration, and genuine affection. Even although not strictly pertinent to the present article, I cannot refrain here from paying this slight tribute to the man who had, I think, the greatest effect on moulding my future career. In our morning horse-back rides, after the regiment was organized, we discussed about everything under heaven; and upon one of these occasions, I brought up the subject of a Field Artillery Journal as one of the means to forward this arm of the service. He entered into the idea quite enthusiastically and said that he would give a smoker for the field artillery officers who were temporarily at Riley. Unfortunately, the number of visiting officers at the smoker was small—but they favored the idea. Colonel Macomb then told me to ascertain the sentiments of the entire field artillery, and, accordingly, I drafted and mailed the following circular letter to each regular officer of the arm early in October:

HEADQUARTERS SIXTH FIELD ARTILLERY

FORT RILEY, KANSAS

*September 18, 1907.*

.....  
..... Regiment, Field Artillery.

DEAR SIR:

In order to witness the firing on the redoubt on this reservation, there were recently present at the post, officers from all the field artillery regiments, except the Fourth. Accordingly, it seemed to Colonel *Macomb*, that the occasion was an auspicious one to ascertain the sentiments of the Field Artillery on the subject of establishing a Field Artillery Association, and the publication of a Field Artillery Journal. He therefore invited all field artillery officers to attend a smoker and discuss the subject. Unfortunately, before the date set for the meeting, the firing on the redoubt was completed, and a number of visiting officers left for their stations. It is thought, however, that all, before leaving, were interviewed and expressed opinions in harmony with those obtained later at the meeting, where the unanimous sentiment was in favor of establishing a Field Artillery Association and publishing a Field Artillery Journal.

The desire to establish our own journal was arrived at after fully discussing the advantages of uniting with either the Cavalry or Infantry Journal. In considering a union with either of the above publications, it must be borne in mind that while there are many tactical points of common interest to all arms, there are also many technical questions purely of interest to each particular arm, and this is especially true of the Field Artillery. Such technical questions would be of no interest to any arm except

## SKETCH OF ORIGIN OF THE FIELD ARTILLERY ASSOCIATION

the one they pertain to, and would take up much space in any magazine devoted to any combination of two arms, with the result that such a magazine would be unsatisfactory to both arms. But by publishing an independent Field Artillery Journal, the three arms of the mobile forces would each have its own organ, and by freely republishing in any journal articles of special interest to its readers appearing in either of the others, close relations could be maintained, and a correct understanding of each other obtained, thus producing that mutual confidence so necessary in time of war.

The principal difficulties in the way of establishing the journal are two; first in getting an editor and second in defraying the cost of publication. There are many officers in the Field Artillery who would make excellent editors, and it is thought that if the field artillery wants to establish a journal, the War Department, by a proper representation of the facts, would probably detail an officer for this duty, as is done now in the case of the Artillery Journal. The second difficulty is more serious; but here again, if the Field Artillery desires such a journal, an effort will be made to secure help from the War Department. It is needless to say, however, that too much help, if any at all, must not be counted on in this latter respect.

There are now in the Field Artillery, about 180 officers, and the number will increase. A good journal will be subscribed to by many officers, other than Field Artillery, just as many of us now take the Cavalry Journal and Infantry Journal. Some revenue will be derived from advertisements. It is thought that the journal could be gotten out for about 40 cents per copy. If we assume 200 paid subscriptions at \$2.50 it will give an income of \$500, which will enable a quarterly to be published, provided we had the printing plant. Such a plant, with a press large enough to print four pages at a time, and barely enough type, furniture, etc., etc., would cost about \$2,500.00.

Colonel *Macomb*, as an eye witness during the Russo-Japanese War, has had greater opportunities than any of the rest of us, to observe warfare on a large scale, to familiarize himself with actual conditions of war, and separate practice from theory. And he gives it as his opinion that absolutely nothing beyond a careful study and practice of the Drill Regulations, is of such importance today to the Field Artillery of our army, as the establishment of a journal, disseminating field artillery information, and affording a medium through which the field artillery officers can fully discuss the important developments of this arm, and keep abreast of modern ideas and practice.

There is no branch of the military service, in which more rapid development is taking place today; there is no branch in which such a wealth of literature is being published in European languages, there is no branch in which there are so many unsolved problems. All of which, in the Colonel's opinion, goes to show the great importance of our taking immediate action looking toward the establishment of the Field Artillery Association. Under our present organization, we are given the chance to develop we never had before; whether we take advantage of this opportunity or not, rests with us.

It is therefore earnestly requested that you give your careful consideration to the subject of this letter and reply, with as little delay as practicable, answering the following questions:

1. Are you in favor of at once establishing a Field Artillery Association and publishing a Field Artillery Journal?
2. If established, are you willing to help it along, by sending in such matter as you think will be of interest to the service?
3. If necessary, are you willing to contribute financially to the Association, for the purpose of getting it started, to the amount of five dollars or more?
4. Please express your ideas fully on the subject of the desirability and feasibility of carrying out the ideas expressed in this letter. A mere formal reply is not so much desired as a full expression of your views on any feature connected with this subject.

It must be distinctly understood by all, that this is not a "Sixth Artillery Scheme,"

## THE FIELD ARTILLERY JOURNAL

and that this circular letter originates here only for the reason, that under our old organizations of batteries and battalions, Fort Riley happened to have a larger field artillery garrison than any other post, and the Field Artillery Board being located here, this place became and still is more or less of a center of Field Artillery information. Moreover if the Journal could be published under the supervision of this Board, as the Artillery Journal at Fort Monroe, is under the Artillery Board, a standing would be at once obtained for it.

Very respectfully,

WM. J. SNOW,

*Captain and Adjutant, 6th Field Artillery.*

Before replies could be received to this letter, Colonel Macomb received the following War Department telegram:

"Desire suitable and representative officer of experience to represent field artillery at War College Course beginning November 1st. Chief of Artillery suggests Captain Snow, if no objection on your part. Do you approve? Wire me reply.

J. F. BELL

*Chief of Staff."*

Colonel Macomb left the decision to me, and I left for the War College at Washington, D. C. Before leaving, Colonel Macomb exacted from me a promise that I would return to the Regiment upon completion of the course—a year's duration. Shortly after I left Fort Riley, Colonel Macomb was detailed as a member of the General Staff Corps and also left Riley for Washington. Upon completion of my War College detail, I was offered the position of Instructor there, but was compelled to decline, on account of my promise and return to the regiment, which I rejoined in November, 1908. In the meantime, replies to my circular letter were forwarded to me from Fort Riley. But I have always thought that not all the replies were forwarded, as, of the total of about 180 officers of Field Artillery, I received replies from less than half. No one replying disapproved, though some had doubt as to the possibility of financing the magazine. During my year's absence from the regiment, Lieut. Colonel Eli D. Hoyle had succeeded to its command, and accordingly upon my return, I asked him to take up the subject of the Journal with the War Department. This he did in the following letter, which I drafted:

# SKETCH OF ORIGIN OF THE FIELD ARTILLERY ASSOCIATION

## HEADQUARTERS SIXTH FIELD ARTILLERY

FORT RILEY, KANSAS

*December 5, 1908.*

THE ADJUTANT GENERAL, U. S. A.,  
War Department, Washington, D. C.,  
(Through Military Channels).

SIR:

I have the honor to invite attention to the great desirability of establishing a Journal of the Field Artillery, similar to the Journal of the U. S. Artillery (Coast), the Cavalry Journal and the Infantry Journal.

The influence of the journals named is unquestionably for the good of the service, and the Field Artillery is the only arm not represented by a publication. Moreover, it is the arm at present needing such a Journal more than any other branch of the service, for the following reasons:

1. The introduction of the present rapid fire gun caused a revolution in Field Artillery so great that all the powers of the world were compelled to adopt it. This change was not merely an improvement in the arm, as for instance was the case with the magazine small arm, but involved a radical change in the use of the arm itself. In other words, the underlying principles of use of the new gun are radically different from the old; this fact is not yet fully realized in our service (due, it is believed, to a lack of accessible literature on the subject).

2. We have had independent batteries for many years, provisional battalions for a very few, and our regiments were only organized last year. We therefore have few traditions or precedents and little experience to guide us in the handling of any thing larger than a battery, yet artillery now works in war almost exclusively in large units.

3. With few exceptions our field artillery officers may be divided into two classes, one composed of those who had practically no knowledge of field artillery, prior to their assignment to this arm last year, and the other class, those who have had more or less service with the field artillery, but who have not yet acquired a good knowledge of the tactics required by the present R. F. gun.

4. As the strength of the field artillery in proportion to the other arms is very small in the regular army, and smaller yet in the militia, and as it is the arm that requires most time and work to make proficient, and as an army is now more than ever before dependent upon its artillery, it is of vital importance that every facility be afforded by the government to secure efficiency in its field artillery. It is believed that the above remarks show the urgent necessity for this Journal. There is a great mass of current publications on field artillery (mostly in foreign languages), accessible to but few of our field artillery officers. A journal would promulgate translations of the best of these articles. It would thus serve as an educational means for this arm. In addition, it would induce professional thought, study, composition and invention, and would promote the efficiency of the arm and its future development. Almost every profession and calling in civil life has a publication, affording a medium for the exchange of ideas.

In short, there seems to be every reason for and no objection to the establishment of this publication.

Both the Infantry Journal and the Cavalry Journal kindly held out overtures for the field artillery to join them: but while the kindly spirit of these journals was fully appreciated, it is believed that the kind of information the field artillery needs and desires, can be obtained only through a separate journal with a field artillery officer as editor.

## THE FIELD ARTILLERY JOURNAL

From my standpoint it would pay the Government to detail a suitable officer as Editor of the proposed journal and to publish it and distribute it at public expense. But as there is, according to my information, a quite universal desire among field artillery officers for such a publication it is believed that nearly all of them would subscribe for it and with the profits from advertisements it is thought it could be made self-supporting.

It is believed that a Field Artillery Journal should have its home in Washington, because there could be obtained (from the War College, the Military Information Division, etc.) more matter for publication than elsewhere.

In view of the above, it is respectfully recommended that steps be taken to establish a journal for the field artillery.

Very respectfully,  
ELI D. HOYLE,  
*Lt. Colonel, 6th Field Artillery, Commanding.*

It will be noted that my letter of September 18, 1907, spoke of the cost of a printing plant with which to publish the Journal, while the letter of December 5, 1908, states the headquarters of the Association should be in Washington, D. C., and makes no mention of money. This is due to the fact that, originally, I had contemplated headquarters of the Association at Fort Riley, but my year at the War College had opened to me a vista of the immense amount of field artillery literature in foreign languages, particularly in French and German, the very existence of which we at Fort Riley had not known of. This made it evident that the headquarters should be in Washington; and here, of course, we were surrounded by civilian publishing houses, and would not need our own printing plant.

The action taken on Colonel Hoyle's letter is shown in the following indorsements and memoranda:

### *1st Indorsement*

December 8, 1908.

HEADQUARTERS, FORT RILEY, KANSAS.

Respectfully forwarded to the Adjutant General, Department of the Missouri, Omaha, Nebraska. The establishment of a Field Artillery Journal would doubtless be of great benefit to the officers of that arm. It would afford the best possible means of disseminating technical information and knowledge among the field artillery personnel.—J. B. KERR, Brigadier General, Commanding.

### *2d Indorsement*

December 11, 1908.

HEADQUARTERS D. MO., OMAHA, NEBR.

Respectfully forwarded to the A. G., U. S. A., Washington, D. C., for consideration.—CHAS. MORTON, Brigadier General, Commanding.

## SKETCH OF ORIGIN OF THE FIELD ARTILLERY ASSOCIATION

### *3d Indorsement*

January 5, 1909.

W. D., A. G. O., WASHINGTON, D. C.

Respectfully returned through the Commanding General, D. Mo., to the Commanding Officer, 6th Field Artillery, inviting attention to the inclosed approved memorandum of the Chief of Staff. The return of these papers is desired. By order of the Secretary of War.—HENRY P. McCAIN, Adjutant General.

### *4th Indorsement*

January 7, 1909.

HEADQUARTERS D. MO., OMAHA, NEBR.

Respectfully returned through the Commanding General, Fort Riley, Kansas, to the Commanding Officer, 6th F. A. By command of Brigadier General CARTER—C. W. KENNEDY, Adjutant General.

### *5th Indorsement*

January 11, 1909.

HEADQUARTERS. FORT RILEY, KANSAS.

Respectfully returned to the Commanding Officer, 6th Field Artillery, inviting attention to the 3d indorsement. By command of Brigadier General Kerr.—ERNEST HINDS, Adjutant General.

### *6th Indorsement*

January 20, 1909.

HEADQUARTERS, 6TH FIELD ARTILLERY, FORT RILEY, KANSAS.

Respectfully returned to the Adjutant General, Fort Riley, Kansas, contents noted. Steps are now being taken to organize a Field Artillery Association as suggested within.—ELI D. HOYLE, Lieutenant-Colonel, 6th Field Artillery, Commanding.

## WAR DEPARTMENT OFFICE OF THE CHIEF OF STAFF WASHINGTON.

*December 16th, 1908.*

MEMORANDUM FOR THE ASSISTANT SECRETARY OF WAR:

SUBJECT: *Establishment of a Journal of Field Artillery.*

Lieutenant Colonel Eli D. Hoyle, commanding 6th Field Artillery, writes from Fort Riley, Kansas, on December 5th, 1908, requesting that steps be taken to establish a journal for the Field Artillery similar to the journals for the other arms of the service. He states that changes in the Field Artillery arm have changed the principles governing the use of the arm; that the field artillery has been newly organized and there are few traditions or precedents in the handling of bodies larger than the battery; that the present Field Artillery officers are either those who have had no knowledge of Field Artillery or those who, on account of little service in the Field Artillery have not acquired a good knowledge of the tactics required by the present gun. He also states that this arm of the service requires more time and work to make it efficient

## THE FIELD ARTILLERY JOURNAL

than other arms and that there is a great mass of current publications which are accessible to but few Field Artillery officers.

He therefore recommends that a suitable officer be detailed as the editor of the proposed journal, with headquarters in Washington, where information can be obtained more easily.

The U. S. Infantry Journal and the U. S. Cavalry Journal are edited by retired officers and the Journal of the U. S. Artillery has for its editor an active officer. The Infantry Journal is published in Washington, the Cavalry Journal at Fort Leavenworth and the Artillery Journal at Fort Monroe.

While the advisability of establishing such a journal for the Field Artillery is concurred in, and while it is believed that such a journal would tend to the better education and training of field artillery officers, it is thought that the methods followed by the officers of the other arms should be followed by the officers of the Field Artillery if they wish to obtain such a publication. The natural home for such a journal would be at the Mounted Service School at Fort Riley, where the esprit de corps of this service is most highly developed and where the most recent practical ideas are discussed and experimented with.

The 2d Section of the General Staff is ready to assist in every possible way by the supply of information, as it does to the other service journals and to individual officers when requested.

It is recommended that the Commanding Officer, 6th Field Artillery, be informed substantially as above.

J. F. BELL,  
*Major General, General Staff.*  
W. W. W.,\*  
*Assistant to the Chief of Staff.*

This memorandum is signed as prepared by the second section, but with the conditions attached which are set forth as memorandum by Colonel Macomb hereto appended.

J. F. BELL,  
*Chief of Staff.*

January 1, 1909.

APPROVED: January 4th, 1909.

ROBERT SHAW OLIVER,  
*Assistant Secretary of War.*

Office Chief of Staff  
Received, January 4th, 1909.  
*The Adjutant General.*

### WAR DEPARTMENT OFFICE OF THE CHIEF OF STAFF WASHINGTON

*December 23d, 1908.*

MEMORANDUM FOR THE ASSISTANT TO THE CHIEF OF STAFF:

SUBJECT: *Establishment of a Journal of Field Artillery.*

Lieutenant Colonel Eli D. Hoyle, Commanding 6th Field Artillery, requests that steps be taken to establish a journal for the Field Artillery similar to the journal of

---

\*W. W. W.—Major General W. W. Wotherspoon.



## SKETCH OF ORIGIN OF THE FIELD ARTILLERY ASSOCIATION

the other arms of the service. He recommends that a suitable officer be detailed as the editor for the proposed journal, with headquarters in Washington, where information can be obtained more easily. It is evident that before any steps can be taken by the War Department relative to the establishment of a Field Artillery journal it is first requisite that the officers of that arm form themselves into an association with the object of disseminating the latest information concerning the Field Artillery among the officers of that arm. A suitable journal could then be agreed upon as the mouthpiece of the Association, but the plans for conducting this journal must be formulated by the officers of the Field Artillery themselves and the funds for printing must be provided by them. When a definite plan has been formulated by the Field Artillery and submitted to the War Department with suggestions as to the detail of some competent officer to act as editor there is no doubt that the same aid which has already been given to the other service journals will be extended to this one. Owing to the fact that all the latest information concerning foreign Field Artillery and that collected by our military attaches is sent to the second section of the General Staff, it is believed that the best location for the headquarters of the journal would be in Washington, where there is no difficulty in securing the necessary facilities for publication. Articles intended for publication in the journal relating to our own arm could be furnished by the Field Artillery Board with permission of the War Department, and that would form one source to furnish information, but owing to the fact that there are no facilities for publication at Fort Riley, where this board is permanently stationed, it would not be practicable to publish the journal at that point. Facilities for publication exist at Fort Monroe, where the Coast Artillery Journal is published, and at Leavenworth, where the Cavalry Journal is published, but it is believed to be in the best interest of the Field Artillery that their journal be placed as nearly as possible upon the same basis as that of the Infantry, which has found Washington a very convenient headquarters.

It is recommended that the Commanding Officer of the 6th Field Artillery be informed of these views and be advised that, if the Field Artillery can unite upon a definite plan, the War Department will be willing to extend the same aid as has been already extended to encourage the publication of the other service journals.

Very respectfully,

M. M. MACOMB,

*Colonel, General Staff; Chief, First Section.*

The views above expressed are concurred in, but by this concurrence, I do not mean to commit myself to the detail of an active officer nor to the connection of General Staff Officers with the active management, either as officers or members of councils, and executive or other committees for the management of associations or journals organized or conducted by any branch of the service.

J. F. BELL,

*Major General, Chief of Staff.*

January 1, 1909.

1462621, A. G. O.  
WAR DEPARTMENT  
OFFICE OF THE CHIEF OF STAFF  
WASHINGTON

*December 28, 1908.*

MEMORANDUM FOR THE CHIEF OF STAFF:

Upon receipt of the accompanying memorandum from the 2d section (on the "establishment of a journal of Field Artillery") I referred it to Colonel Macomb for his

## THE FIELD ARTILLERY JOURNAL

views; these appear in the appended memorandum addressed to the assistant to the Chief of Staff.

It will be noted that the two memoranda are in accord except as to the place of publication; the second section recommends Fort Riley, while Colonel Macomb gives reasons, which seem to me conclusive, for preferring Washington, as recommended by Lieutenant Colonel Hoyle, who, of course, knew of the disadvantages of Fort Riley which were stated by Colonel Macomb.

Approval of these memoranda is recommended, with the modification (just explained) of that of the 2d section.

Very respectfully,  
W. P. DUVALL,  
*Major General, General Staff,  
Assistant to the Chief of Staff.*

When this letter and accompanying papers were received back at Fort Riley early in 1909, Colonel Hoyle appointed a Committee, consisting of Major John E. McMahon, Captain W. S. McNair, and myself, to draw up a constitution for a Field Artillery Association. Work of various kinds interfered and the committee never held a meeting; but I read over the constitutions of all Service Associations in the United States, and, by taking the best of them all and inserting ideas of my own, I had a constitution completed by the fall.

*(To be continued)*



## TODAY'S CONCLUSIONS

### After Seven Years with the Army Horse Show Team

BY CAPTAIN W. B. BRADFORD, Cavalry

ARMY horsemen owe a deep debt of gratitude to civilian horse shows for the assistance they have given in the development of our equestrian teams. They have furnished both the incentive and the material aid which have enabled us to ride from a condition of inferiority to one of very definite superiority, among our countrymen and in our own country.

However, in recent years, all international competition, except in America and the British Empire, has undergone a great change. The International Equestrian Federation has grown in power and now regulates such competitions absolutely. It controls even the Olympic Games. Due to its influence, the great majority of international shows have adopted conditions, courses and obstacles of a type utterly different from those found in any American show. Consequently, we find that our horses, wonderfully successful under New York and Boston conditions, are often of little value in other international contests.

In this connection the experience of the Italian Team in New York in 1929 is very interesting. Previously in Europe, this team had been almost unbeatable. Arriving in New York, they found their horses entirely unaccustomed to the very special and artificial conditions of the National Horse Show and failed to win even a single international class.

Briefly, our shows differ from International Federation shows as follows: our ring is a small affair about 30 or 40 yards wide by 80 to 100 long. This is generally so, whether indoors or out of doors. The typical jumping course consists of two jumps on each side of the ring. The contestant enters and passes around twice on the right hand. Occasionally there is a figure of eight course copied from London. But London itself is far behind the times. A horse takes this same course many times during a show, and, if he then goes to a different community, he finds exactly the same thing and the same jumps. He rapidly develops habits that are undesirable and bad.

The European arena is a tremendous affair, 200 to 300 meters

## THE FIELD ARTILLERY JOURNAL

wide and 300 to 500 meters long. It contains many natural features and always several different bank, ditch and water jumps. It is usually out of doors and turfed over. *There are no typical jumping courses. The obstacles, courses and conditions all vary for every class.* Obstacles are usually numbered consecutively, and the rider follows his course as he would across country. He never sees the course, or knows it, until the time for competing arrives. The number of obstacles in a class vary from 10 to 25 or 30 and the distance from  $\frac{1}{4}$  mile to  $1\frac{3}{4}$  miles. There is generally a time element requiring a gallop of 16 to 18 miles per hour. The courses are planned so as to encourage the development of courageous galloping horses and bold, fearless riders. There is a thrill for both contestant and spectator during every moment, and interest is always intense.

How different from our own shows, where horses and riders become routined! One soon tires of seeing them go round and round, over the same old jumps, in class after class, whether the show is in New York or California. Perhaps this can be called sport, but it is certainly not a very interesting one.

With such a vast basic difference existing between our methods and others, one can easily see that we must seek a more satisfactory medium for developing international equestrian material. Furthermore, I believe that it will be increasingly difficult for the very shows themselves to exist, unless there is a radical change in their character. The many of our best amateur civilian show riders who have deserted the ring for the more alluring point to point and steeplechase give proof of this.

As for Army riding, if we are to make further improvement, we must forget our riding halls and the poor old Olympia (not Olympic) figure of eight course, which has been jumped and hounded to death. We must seek something more thrilling and varied than the old familiar brush, gate, post and rail courses, "twice around the outside." We must have many times the space that is generally available in an indoor ring, or the usual outdoor affair, so that we may develop our galloping horses and also ourselves. Then will come the thrills and excitement that will change this riding into a real sport.

Europe is leading the way, under the auspices of the International

## TODAY'S CONCLUSIONS

Equestrian Federation. Olympia in London, and the great Dublin show as well, have now become members of this International Federation, whose rules are most strict and whose tendency is ever towards the sporting type of event I have just been eulogizing. Now New York, Boston and Toronto are entering the fold of the Federation. Beginning this fall, complete new regulations and conditions will govern their international classes.

But, unfortunately, these shows are indoors and necessarily limited as to the changes they will be able to make.

Because of these prevailing out-of-date conditions, those responsible for the selection of horses and riders for the Olympic Games—where unknown courses and unfamiliar conditions will be encountered—are now faced with a serious problem. Certainly they can determine the horses and riders who are consistently best over our own training courses, or our own training ground. But will these same combinations also be the best in the Games? We have no way of telling. One might say, what of the horses that did so well in New York last year? But, as I have tried to explain before, we cannot go by results at New York, because conditions there are totally dissimilar from what we must expect elsewhere. Our best indoor horses are not the best outside.

Your Frenchman or Italian is not faced with this problem. For the past few years, he has been trying out his Olympic prospects for the three equestrian contests at all the greatest shows of Europe, shows where conditions approximate those prescribed for the Games. He *knows* what his jumper will do when faced with a course such as he is bound to meet in Los Angeles. The three-day man and the high schooler also *know*, from many actual tests, just what to expect from their mounts.

Our American Team can only *guess*. For example, one of our best horses in practice at San Diego is *Ansonia*. Last year in our Association Horse Shows, he was the poorest. *Suzanne*, an outstanding horse at New York, Boston, and Toronto, cannot even be considered for the Olympics. One must surely see that the situation for us is always very difficult. Can there be any solution? I have studied the matter a great deal, these past few years, and believe that there is an answer.

We know that our present shows are inadequate. We know

## THE FIELD ARTILLERY JOURNAL

that there is little hope of getting them to initiate a change.\* Why then depend on them any longer for guidance? Why not form our own association and lead where formerly we have been led? From the ground up, we must build and carefully encourage the riding and the horses that we need, thus contributing not only to keen enjoyment of the sport, but even more to our success as international horsemen.

More specifically, I propose the creation of two military associations; one in the middle west, to include Fort Bliss, Fort Sill, Fort Leavenworth and Fort Riley; a second in the east to include West Point, Fort Hamilton, Fort Meyer, Fort Oglethorpe, and Fort Benning. Each association should stage three or four consecutive shows a year, preferably in the spring. Using the Middle Western Circuit as an example, a show would be held at Fort Leavenworth from April 29th to May 2nd inclusive; at Fort Riley from May 6th to 10th; Fort Sill May 14th to 17th; Fort Bliss May 24th to 29th.

There should always be an admission charge and entry fees. Prizes should be simple and inexpensive—perhaps a copper plaque. Expenses must be curtailed. Net receipts from the four shows should be placed in a general fund and guarantee the freight or express shipment charge of horses and automobile travelling expenses of officers and grooms. After these expenses are paid, any sum remaining should revert to each of the four shows in proportion to the amount subscribed.

There should be teams of 4 to 5 officers and 7 jumpers, 3 three-day horses and 1 *dressage* horse from each post in the association. Restricting teams to 11 horses would permit combined express shipments if desired. Traveling expenses for these teams would be guaranteed by the general fund insofar as possible. Teams would assemble at each of the four shows in turn, where they would compete with each other, and also with all the local military and civilian horses that could be encouraged to enter.

The arena selected for each show should be not less than 200 meters wide by 300 meters long out of doors with some natural

---

\*NOTE: A single exception to this is the class known as the "Melbrook Bowl" at Bryn Mawr, generously sponsored by Mr. J. Brooks B. Parker of Philadelphia as his part in assisting to solve the problem of Army riders.

## TODAY'S CONCLUSIONS

terrain obstacles. Each arena should differ from the other three as far as possible and should be patterned after those of Europe, such as that of Rome, Arachen, Warsaw, Nice, or Lucerne! (The shows of England and Ireland are not the type contemplated by the International Federation). The grounds should contain several types of water, ditch and bank obstacles, as well as built-up jumps, and combinations of all. *The course and obstacles should vary for each class so that rider and horse would never know exactly what might confront them.* Courses should be from 500 meters up to 1200 or more and obstacles number from 10 to 24. Time should always be an element. The metric system of measurement should be used, to conform to international custom. Tips should not be counted. Contestants should never be allowed to practice in the arena.

Each program should contain both *Local Classes*, and *Open Classes*. The *Local Classes* should be framed to meet local needs and might be for children, for green horses, polo ponies, local horses, civilians, or whatever seems needed. Military teams, transported at Association expense, should be excluded from *Local Classes*. The *Open Classes* should be for official military teams, and also for any other competitor, military or civilian, who might pay the entry fee.

The *Local Jumping Classes* should be patterned exactly after the International plan, though the obstacles would naturally be quite small.

The *Open Jumping Classes* should be for various height, spread, rate, and distance conditions. There should be jumping and schooling classes limited to three-day horses and also a *dressage* class. The three-day horses should have the complete three-day test at the last show on the circuit and perhaps a preliminary short test at the first.

The programmes should show the plan for trace of the course for each open jumping class, and the number and maximum heights of obstacles, maximum spread, rate of gallop, and total distance.

A system of handicapping should be inaugurated to encourage the presentation of young and new horses and to prevent the older ones from winning year after year. Horses of the Army Team

## THE FIELD ARTILLERY JOURNAL

should be handicapped at once. Winners recorded each year should be added to this list, so as to constantly make way for new blood. Handicapping is accomplished either by raising certain specified jumps 10 centimeters for each handicap classification or by adding from 4 to 8 jumps to the given course. Handicapping should not be employed in courses exceeding 1 meter 40, or in *Prix des Nations* (team) classes.

A program for the *Open Classes* of a show might be planned as follows:

### Class I—Open Jumping.

18 obstacles. Maximum height 1 m., 30. Maximum spread 4 m.  
Rate 400 m. Distance 900 m.

### Class II—Open High Jumping.

12 obstacles, 1 m., 40 to 1 m. 60. Maximum spread 5 m. Rate 300 m. Distance 600 m. Jump-off will be decided by raising jumps. Time will not count unless the rate falls below that prescribed. No handicaps.

### Class III—Open *Dressage* Contest.

Olympic conditions to govern.

### Class IV—Open Three-Day Jumping.

Horses that do not compete in the final complete three-day test will be disqualified.

12 obstacles. Maximum height 1 m. 15. Maximum spread 3 m.  
50. Rate 375 m. Distance 1000 m.

### Class V—Open Double Class.

Each rider to mount two horses. Scores to be added.

15 obstacles about 1 m. 30. Maximum spread 4 m. Rate 375 m.  
Distance 700 m.

### Class VI—Open Three-Day Schooling.

Olympic standards to govern. Horses disqualified unless shown in final complete three-day test.

### Class VII—Open Team Class.

For teams of three riders.

Olympic standards to govern. No handicap.

### Class VIII—Open Jumping.

17 obstacles. Maximum height 1 m. 40. Maximum spread 4 m.  
50. Rate 375 m. Distance 800 m.



## TODAY'S CONCLUSIONS

### Class IX—Open Consolation Jumping.

Ribbon winners of previous classes barred.

15 obstacles. Maximum height 1 m. 30. Maximum spread 3 m. 50. Rate 400 m.

Distance 750 m. Post entries.

A circuit of shows thus conducted would be interesting, popular and instructive for all concerned. It would be our best American school for international competition and would tend to develop horses and riders better by far than any we now possess. Were such a system now in operation, the problem of our Olympic Team would be vastly simplified. Spring training completed, we would tour this Mid-Western Circuit. With the results from these shows to go by, horses and riders could be definitely selected. Their training and conditioning would be completed and we could send them confidently into the ring at Los Angeles fully aware not only of what they *can do*, but knowing also what they *probably will do* when faced by the supreme test of Olympic competition.



## REILLY'S BATTERY

CHINA, AUGUST, 1900

The Peiho's floating corpses down,  
As we hike up its banks.  
A scorching, parching Chinee sun  
Beats down on thirsty Yanks,  
On Limeys, Rooshians, Frogs, and Japs,  
With Germans in reserve—  
Allies for once—all pressing on  
To where the Dragon's curve  
Is coiled 'round our Legations,  
With the Boxers closing in,  
Those days when Reilly's Battery  
Was rolling to Pekin.

Unlimber! Action front! Cease fire  
And limber up again.  
In Captain Reilly's Battery  
"There's nothing to explain."  
Our bursting shrapnel clears the way;  
There's little time to spare.  
No foreigner is going to beat  
The U. S. getting there,  
Where women, children, facing death  
Hear war gongs' clanging din.  
And Reilly's Battery must hump  
A-rolling to Pekin.

Pekin! Its ancient walls can't stem  
Our doughboys khaki tide.  
Before the smashing of our shells  
A massive gate swings wide.  
We gallop narrow, twisting streets.  
Our thundering cannonade  
Brings sniper-filled pagodas down  
And blasts each barricade.

REILLY'S BATTERY

Through to Legations none too soon  
The allied columns win,  
And Reilly's outfits' done its bit  
In rolling to Peking

The fight's still on. The Boxers man  
Forbidden City walls.  
It's "Mount!" and "Forward, Ho!" once more  
The blaring bugle calls.  
While rifle fire sweeps parapets,  
Summerall leaves his gun,  
And calmly chalks each gate to show  
Where teakwood cross bars run.  
"Right thar, sir," answers Gunner Smith  
And gives his wheel a spin.  
A crash! And Reilly's Battery  
Goes rolling through Peking.

But Taps must blow for us before  
The victory is won.  
A Boxer bullet finds its mark  
And Captain Reilly's done.

\* \* \* \*

Our gallant Old Man's name will live,  
While caissons rumble on  
And golden cannon crossed adorn  
The waving red guidon.  
The letters of the alphabet  
On outfits now they pin,  
But it was REILLY'S Battery  
That rolled on to Peking.

**FAIRFAX DOWNEY.**

## TESTS OF THE TRUCK DRAWN BATTERY

A DIRECTIVE for the tests of the truck-drawn battery has been forwarded to the Field Artillery Board. This battery was described in the May-June number of THE FIELD ARTILLERY JOURNAL. In view of the importance of these tests and the future possibility of truck-drawn batteries being used as divisional field artillery, the Chief of Field Artillery felt that the publication of this directive in the JOURNAL would be of great value. It should be remembered that this is the first homogeneous unit of the latest and best motor vehicles, fully manned and equipped, for comparative tests along side of equivalent horse-drawn units in an attempt to definitely determine, in the present state of motorization, whether or not the truck-drawn battery can supersede or replace horse-drawn units.

"1. The following factors affect economy and rapidity of mobilization:

- a. Rapid diminution of the horse population of the United States.
- b. Probable industrial and mechanical development of the country.
- c. Probable experience and aptitude of the M-day American soldier.
- d. Probable procurement facilities for motor vehicles during the next decade.

"The foregoing, coupled with the probable nature and development of the routes of communication in probable theatres of operation and the probable tactics, organization, and transportation developments of the other branches of the Army, have brought us almost to the point where motorization of division field artillery will be forced upon us. This office accepts as a fact the superiority of a tractor over a truck in ability to negotiate bad ground, but, for many practical reasons, present type tractors should be excluded as prime movers for division artillery. This test must, therefore, be wholly constructive. If any item falls short of a fair accomplishment, it is the duty of the Board to attempt to produce a successful substitute.

"In other words, it is the mission of the Board to bring to a

## TESTS OF THE TRUCK DRAWN BATTERY

successful conclusion the preliminary work started in this office for the production of a Division Truck-Drawn Light Battery.

"Partial reports are desired from time to time showing wherein this battery equals, excels, or fails in the accomplishment of specific missions when compared to a horse-drawn battery, and, in the event of failure, recommendations for alterations or substitutions.

"Until the materiel furnished, or a satisfactory substitute is definitely accepted, details of personnel and their duties, of equipment and accessories and of organization need be studied only so far as to facilitate the test.

"2. The reason in being for this experimental battery is to facilitate mobilization for a major effort by the utilization of the existing stock of 75mm guns, supplemented by purely commercial productions existing in major quantity and capable of prompt quantity production, and a reduction in training time and effort with personnel received from the draft. The final objective is to accelerate the appearance on the firing line of batteries able to go where they would normally be ordered, and to deliver accurate fire upon designated objectives.

"3. The objectives of the test by the Board is mainly technical and is specifically concerned with:

- a. Suitability of the make-shift device for conversion of the running-gear for the present 75mm carriage from low to high speed, and the suitability of the firing base, if it is found that this conversion requires such an auxiliary.

This involves a comparison of the performance of the modified carriage with the standard carriage in both strategic and tactical mobility, including man-handling and in accuracy, speed and mobility of fire in all the various classes.

- b. Suitability of the prime mover and auxiliary vehicles for division artillery.

This involves comparison of the prime mover with a team of 3 pairs of average U. S. farm horses, handled by drivers of mediocre training, and a comparison of the auxiliary vehicles with army wagons and individual

## THE FIELD ARTILLERY JOURNAL

mounts, handled or used by personnel of mediocre training.

By mediocre training is meant the training which an average product of the Draft Board, originally ignorant of horses, would acquire after three months' effort by instructors of doubtful ability.

"4. Tests, having as their primary purpose that of ascertaining the mechanical limitations of the motor vehicles, are not to be permitted. Such tests should be limited to the pilot model now in the hands of the Field Artillery Board. It must be borne in mind that lack of funds must dictate the most careful supervision of the maintenance and upkeep of these vehicles, under all conditions.

"5. The Board should give due consideration to the following:

- a. Motorized organizations must accept the fact that they will frequently be unable to reach their destination, particularly on reconnaissance and communication duty, wholly by riding a vehicle and thus it will be a normal procedure for them to accomplish their mission only by the sweat of their brows. On the other hand, the great conservation of physical and mental energy in a motor unit, compared to a horsed unit under normal march and maintenance conditions, enables a greater physical effort in emergencies, and no vehicle is out of the march until, with due regard to tactical considerations, all of the physical and mechanical power of the organization has failed.
- b. The superior speed of a motor unit does not restrict it to the shortest route as in horsed organizations, but, within the tactical limitations existent at any time, it may take an easier if more circuitous route—avoiding obstacles, and may even be sent to a position different from one that would normally be selected for a horsed organization. For this reason, the vehicles should not be subjected to conditions which are abnormal to their mechanical limitations, when the choice of another, more suitable condition is not prohibited by the tactical situation. It is to be expected that the approach to and departure from positions, as well as the routes of wire lines, will be over longer routes than those normally traversed by horse-drawn

## TESTS OF THE TRUCK DRAWN BATTERY

or tractor-drawn artillery. If a swamp lies between the battery and its position area, it is deemed illogical to attempt the traverse of the swamp when a detour, within the tactical limitations of the problem, would accomplish the object.

"6. It must be borne in mind that the specific point of all tests of this unit is to ascertain if the unit, with or without necessary logical deviations from the normal doctrines, established for horse-drawn and tractor-drawn light artillery, can accomplish the missions of division light artillery. If, in fulfilling its mission, the sphere of operations of the truck-drawn battery are limited and restricted to its particular mechanical capabilities, then the rules and doctrines established for horse-drawn and tractor-drawn units should be examined for permissible changes to comply with these limitations.

"7. From the time the vehicles and equipment are delivered to Field Artillery personnel at Holabird until the test is completed, it is desired that a concise record be kept of all incidents pertaining to the operation of the battery. In addition, this record should be compared with the records of a horse-drawn and a tractor-drawn battery under like conditions, wherever possible. While the form of such a record is left to the discretion of the Board, the following items are deemed necessary:

- a. Initial cost of the vehicles, equipment, and accessories of the three types of units considered.
- b. A comparison of the organization of the personnel including cost of personnel equipment, ratings, pay and allowances, etc.
- \*c. An operation record of the vehicles including the following:
  - (1) Gas, oil, and grease used.
  - (2) Daily mileage.
  - (3) Repair and alterations:
    - (a) Type of materials and parts used, where and how obtained.
    - (b) Cost of materials.
    - (c) Man hours of labor.

---

\*Comparison with like records of both horse-drawn and tractor-drawn units desirable, wherever possible, substituting headings analagous to horse-drawn units.

## THE FIELD ARTILLERY JOURNAL

- (4) Maintenance (Man hours).
- (5) Time and distance of travel.
  - (a) *Strategical moves.*
    1. Climatic conditions.
    2. Roads and terrain.
    3. Length and reasons for halts.
  - (b) *Tactical moves.*
    1. Climatic conditions.
    2. Roads and terrain.
    3. Length and reasons for halts.
    4. Time between receipt of battalion orders and firing of first shot in position.
    5. Length of time going into action and executing march order at position.
    6. Communications:
      - a. Length and number of lines.
      - b. Length of time to install.
    7. Use of traction devices:
      - a. Type.
      - b. Length of time used.
    8. Mechanical defects noted.
    9. Practicability of equipment.
    10. Miscellaneous.

"8. If the Board's tests are interrupted by necessary withdrawals of the battery personnel for other duty, the vehicles will be used for tactical purposes only, and, as the motor vehicles are experimental, they are not subject to post pooling.

"9. The Board should endeavor to complete its tests by March 1, 1933, when the battery will be sent to The Field Artillery School for extended service test."

The Chief of Ordnance desired the following additional information:

- a. Can the segments be dispensed with and firing conducted entirely from the pneumatic tires?
- b. Is a spring support in addition to the pneumatic tires desirable or necessary?
- c. Is the effort on the traversing handwheel satisfactory when firing from the tires? From the segments?



## TESTS OF THE TRUCK DRAWN BATTERY

- d. Is the handspike satisfactory as to type and location?
- e. How much can the handspike be shortened without affecting its serviceability?
- f. Is the panoramic sight attachment (Sight Mount M2) satisfactory as to type?
- g. Is the method of mounting the panoramic sight case on the shield satisfactory? Should additional springs be added to reduce longitudinal motion of this case?
- h. Does the oiler holder furnished satisfactorily retain the the Oiler, M1, when traveling at high speeds?
- i. Does the lunette shake too much in the pintle?
- j. What arrangements are made for carrying battery accessories and Ordnance stores and are any additional chests required? If so, give type and size.
- k. A list of Ordnance equipment for the motorized battery made up to show deletions from and additions to the similar equipment for horse-drawn batteries is desirable.
- l. What detrimental effects, if any, does high speed have on the materiel?

The Quartermaster General desired the following information:

- a. With reference to the attached directive to the Field Artillery Board for test of the truck-drawn battery, it is suggested that under paragraph 1, there be added a subparagraph *e*, to read, "maintainability of a fleet of motor vehicles." In sub-paragraph *d* of the same paragraph, it is believed the word "procurement" should be changed to "manufacturing."
- b. This office will be interested in having a definite or as near a definite statement as is possible to obtain in regard to the suitability of these commercial 4-wheel 2-wheel-drive vehicles, as compared to the 1¼-ton 4-wheel 4-wheel-drive of similar weight and capacity. In testing these vehicles for substitutes the degree to which they meet the requirements as compared to the military types for multi-wheel drive types should be as clearly stated as is practicable to do so. If it is found by actual test that such vehicles can be relied upon to go places and to transport the equipment to a degree that approaches the multi-wheel

## THE FIELD ARTILLERY JOURNAL

drive, it would not seem advisable to buy more expensive equipment. On the other hand, if the 2-wheel-drive equipment is so inferior in performance and capabilities as to make their utilization as compared to the multi-wheel-drive type of doubtful value, it would seem to be more economical to buy military types at all times, even though they cost more per unit.

- c. The test of this battery should afford some valuable information on this subject, inasmuch as there have been vehicles of both types tested by your Board at Fort Bragg. This office would also be interested in having a copy of the comparative cost of two (2) similar organizations as required by paragraph 7 *b* of the directive.



# TYPE PROBLEMS

## Lateral Precision

Target: A Machine Gun emplacement seen in the center of the first picture.

Mission: To destroy the emplacement.

Materiel: French 75mm, Model 1897.

Initial Data: Estimated.

The Battery is to the left rear.

$T=200$        $R=4000$        $d=7$        $s=5$

$r=3000$        $OG=1000$        $c=5$

$s/c=1$        $r/R=3/4$

Initial Data: Aiming Point, Water Tower on sky line to right front.

Plateau 4, Drum 120

Shell Mark I

Fuze Short

No. 1: Adjust

No. 1: One Round

Quadrant 130

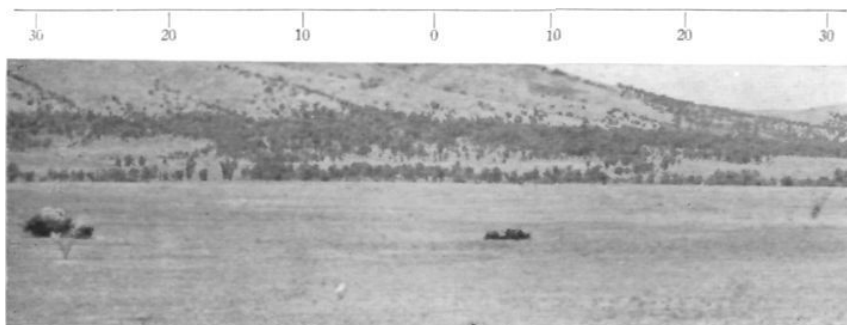

**SENSING: 35 L. DOUBTFUL.**  
**COMMAND: RIGHT 27, 130.**



**SENSING: 12 R. DOUBTFUL.**  $\frac{r}{R} = \frac{27}{47} = 6$   
**COMMAND: LEFT 7, 130.**



**SENSING: 3 R. SHORT.**  
**COMMAND: LEFT 22, 150.**



**SENSING: LINE, OVER.**  
**COMMAND: RIGHT 10, 140.**

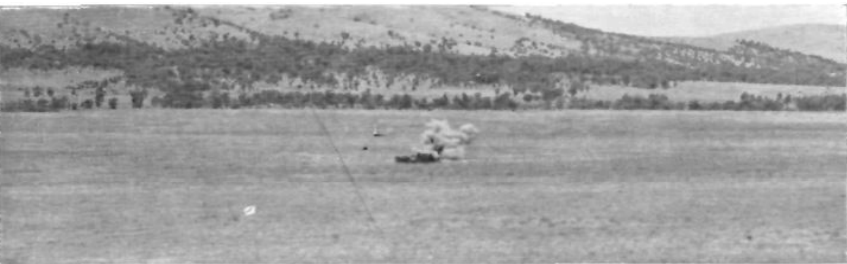

**SENSING: LINE, OVER.**  
**COMMAND: RIGHT 5, 135.**



**SENSING: 5 L. SHORT.  
COMMAND: LEFT 1, THREE ROUNDS, 138 (137).**



**OVER.**



**LINE, OVER.**



**SHORT.  
COMMAND: RIGHT 2, 138.**



**SHORT.**



**OVER.**



**LINE, OVER.**  
**COMMAND: RIGHT 2, 137.2.**

## TYPE PROBLEMS

### Lateral, Time Bracket, Large T

*Target Description:* Hostile machine guns in vicinity. *Mission:* To neutralize. *Type:* Time bracket lateral—large T. *Materiel:* French 75mm gun, Model 1897. *Ammunition:* Shrapnel. *Visibility:* Excellent. *Wind Direction:* Left to right. *Initial data obtained:* Deflection, estimated; range, estimated. *Corrector for the day:* 35, Battery Commander on the right.

$$T=410, R=3.7, r=2.6.$$

$$s=41/3.7=11, d=41/2.6=16,$$

$$1/s=.09, 1/d=.06.$$

*Initial data:*

Base Deflection Left 180

Site zero

Corrector 35

No. 2, 1 round

Commands	Range	Deviations as viewed from OP but not announced	Range	Sensings	Defl.	Remarks
	3600	20 right	G doubtful		doubtful	20×.06=120.
U 5	3500	2 left	A over		over	100×.09=900. As this was more than 800 yards BC shifted 50 mils in deflection reducing his range to correspond.
R 50, D3	3100	5 right	A short		short	
L 25, BR	3300		G over A over G doubtful G doubtful	}	over	
R 15, on No. 2 open 4 U 5, B 1 rd. Zone 3100	3300					Cease firing, end of problem.

Summary: Errors in initial data: Deflection 40 mils; range 400 yards or 12.5%. Time from identification of target to announcement of first range, 1 minute, 25 seconds. Average sensing and command, 10.5; total time of problem, 3 minutes, 45 seconds. Ammunition expended, 7 rounds. Classification: Satisfactory. General comments: An excellent problem.

In this type of fire it is believed a better practice to fire one volley at the middle of the final bracket rather than to pass to zone fire immediately. This enables the battery commander to make early correction of any element of his data found to be incorrect.

## THE FIELD ARTILLERY JOURNAL

### Lateral, Time Bracket, Large T

*Target Description:* Machine gun in position firing. *Mission:* To neutralize. *Materiel:* French 75mm, Model 1897. *Initial data obtained:* Relocater sheets, estimated ranges, OP on the left of the gun target line.

T=500 mils, R=4000, r=2600.

S=50/4=12, d=50/2.6=20.

Initial Commands: Compass 1760, Si 0, Kr 40, No. 2 one round, 4000.

Commands	Range	Deviations from OP	Sensings Range	Defl.	Remarks
	4000	0-50L- Δ	A?	? 50/20=2.	
D 5	3700	○ Δ	A+	?	
D 5	3700	-20L- ×	G+	?	Should have been fired at 3600. Going down on corrector moves burst to left.
U 3	3600	○ Δ	A+	+	Deflection appears close.
L 50	3200	×	G-	-	50/12=4.
R 25 BR	3400	○ ×○ Δ ×	A? A? G+ G-	Correct	Target lies between No. 3 and No. 4 in deflection.
On No. 4 C1 4 U 3 B 2 rds	3400	Cease firing end of problem			Closes sheaf to 20 yards.

Summary: Changing height of burst 5 mils should move burst one "d" as seen from the OP. Officer closed sheaf to get immediate effect on the machine gun. Later he could open sheaf and fire through a zone, 3400-3600, searching for personnel.



## TYPE PROBLEMS

### Bilateral Precision (Diagram Method)

(Paragraph 94a, page 146, TR 430-85)

*Target Description:* Disabled Tank. *Mission:* To destroy. *Materiel:* French 75mm gun, Model 1897. *Observers:* One on each side of Gun-Target line, OT and T about the same for both. *Wind Direction:* Left to right. *Initial data:* Deflection shift, estimated. Range, estimated. *Visibility:* Excellent. Firing Tables 75 B 1.

Initial Commands: No. 1 Adjust, Base Deflection Right 150, Shell Mk I, Fuze short, No. 1, one round, Quadrant.

Commands	Elev.	Rd.		Sensing		Defl.	Remarks
		No.	OR	OL	Range		
	160	1	38L	45L	?	Left	Deflection is obviously in error.
R 40	160	2	14L	11L	-		Range is indicated as short, but not far from target.
	166	3	8L	14L	+	15m Left	Diagram indicates deflection 15m left.
Rt 15	166	4	2R	L+	+	Right 2m	Round No. 3 established range bracket, and the approximate deflection error. Round No. 4 completes the adjustment.
3 rds	163	5	2L		-	?	Should have ordered "Left 2" before firing, based on diagram. Commenced sensing on rule with round No. 5.
		6	2L		-	?	
		7	5L		-	?	
L 4, 2rds	166	8	L+		+	Left	Officer realized he had failed to improve deflection before firing last 3 rds.
		9	3L		-	?	
R2, 6 rds	165.5			CF	By	Instructor	Should continue firing in groups of 3 until deflection is correct. $164.5 + (1/6 \times 6) = 165.5$ .

Summary: Error in initial data: Deflection 53 mils; range 100 yards or 2.1%. Ammunition expended 9 rounds. Classification: Satisfactory. General Comments: When the difference between observations of lateral observers is as small as occurred on round No. 2, the range sensing is not positive. With some situations, this round could have been range over, and usually should be verified. The observations on round No. 4, however, indicated that it fell very close to the target, and removed the necessity of verifying the short limit of the range bracket.

## THE FIELD ARTILLERY JOURNAL

NOTES: (1) In general, with observers at about the same distance from the target, a line sloping down from left to right indicates that the range is short; one sloping down from right to left indicates that the range is over.

(2) For the second and third shots the range and deflection are changed successively. The deflection should be changed first if it appears greatly in error.

(3) To compute the deflection error after the 3rd shot:

$$\frac{AB}{BC} = \frac{40}{x}, \text{ using any convenient scale to measure AB and BC we get, } x=15.$$

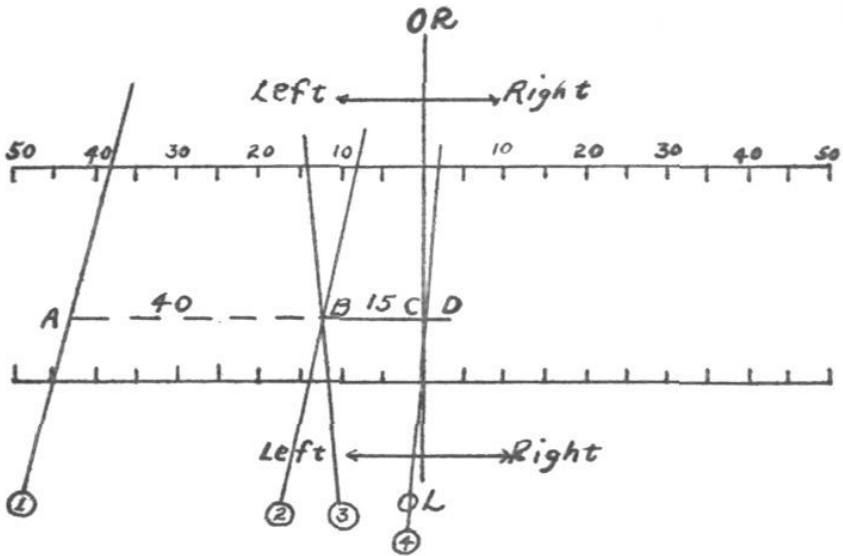

# THE NEW HALGER-ULTRA BULLET

BY MAJOR J. K. BOLES, Field Artillery

THE modern craze for high speeds in the air and water and on the ground seems to have affected bullets as well, and some amazing results have recently been obtained according to reports concerning the new Halger-ultra bullets developed by Dr. H. Gerlich, of Kiel, Germany.

Dr. Gerlich was born in America of German parentage, and was for many years in the gun shops of Vickers, Sons and Maxim, in England. He is an engineer by profession, specializing in thermodynamics, and for many years has had the hobby of trying to improve the modern rifle and cartridge to a far higher standard of efficiency than it now possesses.

The latest information is that Dr. Gerlich has been able to step a bullet up to a velocity of about 6,000 feet per second, and that this bullet at short distances can penetrate armor plate more than one-half inch in thickness. In working up this ammunition at a somewhat less velocity, extremely small groups have been made—one of five shots at a hundred meters which it is said could be covered by a dime. This, in itself, is not exceptional, as the writer has seen at least one group at three hundred meters very slightly larger than a quarter, but it is mentioned here solely to indicate that accuracy has not been neglected in developing this high speed cartridge.

If a cartridge can be developed with such characteristics, it will have a far-reaching effect both in military and hunting fields. From a military point of view, it will simplify greatly the problem of protecting our troops from attacks by tanks, armored cars and airplanes, which are thought by some to be the greatest threats in modern warfare.

In recent years the trend in the development in tanks and armored cars has been to armor them with speed instead of metal, carrying only enough of the latter to protect them from machine gun and rifle fire, and relying upon their speed to prevent direct hits by artillery. The development of such a cartridge as the Halger would therefore eliminate from the battlefield any lightly armored vehicle, so that the only tank we might expect to see

## THE FIELD ARTILLERY JOURNAL

would be the heavily armored battleship type, which is so slow that it can be easily stopped by the field artillery. Even though the lighter type should be clad in armor of sufficient thickness to stop this bullet, it would be forced also to strengthen its running gear in order not to be put out of action by a few shots.

As for the airplane, many of those familiar with the shoulder rifle are convinced that the only place for the "strafing" of ground troops by hedge-hopping attack planes is in the movies. A few duck hunters scattered in each company of infantry would soon stop the low flying planes. It is only a question of teaching riflemen how to "lead" the target. That has been done in our infantry. A cartridge possessing the characteristics claimed for the new one would enable the rifleman to take far less "lead" and therefore increase the probability of hitting the rapidly moving target. It would also greatly increase the effectiveness of fire upon the battlefield because with such velocities the trajectory is so flat that at ranges of less than 500 yards only one sight setting would be necessary. This same feature makes it especially valuable to sportsmen, most of whom have lost desirable trophies because of a slight error in estimating the range.

This question of super-velocities is nothing new. Many governments have made tests years ago, none of which proved entirely satisfactory. However, not many people are familiar with the fact that even our 3,500 foot-second 110 grain bullet sporting cartridge for the Springfield rifle has the tremendous armor-piercing ability it possesses, even though such cartridges have been on the market for about ten years.

Dr. Gerlich, it is said, obtains these tremendous velocities mainly by the shape of his bullet, which weighs only about a hundred grains for the 7mm or .276 caliber; and by the use of about 100 grains of dense powder. The bullet, it is understood, is made of a soft iron jacket with soft lead core coated with cupronickel. Instead of having a long bearing surface, as does the ordinary bullet, only two bands touch the bore (somewhat similar to an artillery projectile with two rotating bands). These are understood to expand on discharge and thereby form very efficient gas-checks. The cartridge case is made somewhat larger than that

## THE NEW HALGER-ULTRA BULLET

for the Springfield in order to hold the hundred grains of powder, more than twice the service charge of the latter.

It is difficult to understand why such a small comparatively fragile bullet should not disintegrate upon striking a hard steel surface. The only explanation advanced is simply that it "hasn't time to fly to pieces," but instead it drives through this armor plate with such speed as to make a hole practically twice the original diameter of the bullet, and when fired against heavy armor plate too thick to penetrate, it will dig a crater about five-eighths of an inch deep and an inch and a half across, and blast splinters, like shell fragments, from the far side, provided the armor is not more than 1½ inches in thickness.

One of the most difficult claims to understand is that of the absence of excessive recoil when this cartridge is used in the rifle of the normal weight. An excessive recoil would bar this cartridge from use in shoulder weapons but not for use in machine guns or other mounted weapons for anti-tank and anti-aircraft purposes.

The claims made by Dr. Gerlich for his new cartridge have aroused considerable controversy in the ranks of the ballasticians, who claim that such velocities are unobtainable in barrels of a length practicable for a military or a hunting weapon and that we could hardly expect to attain these velocities with any known powder with a barrel less than 42 inches in length. In respect to recoil, one eminent ballastician claims that, according to formulae, the recoil necessary to obtain such velocities with a rifle of normal weight would be many times that which is physically endurable.

It remains to be seen whether further tests will prove that Dr. Gerlich has attained such velocities that the usual theories no longer apply, and, if so, what will be the effects on the future armament of land, sea and air forces.

## **FIELD ARTILLERY NOTES**

### **The Retiring Secretary-Treasurer-Editor**

On June 1, 1932, Major John M. Eager, Field Artillery, was relieved from his duties as Secretary-Treasurer of the Field Artillery Association and Editor of THE FIELD ARTILLERY JOURNAL, and has been assigned to duty with the First Field Artillery Brigade at Fort Hoyle, Maryland.

For four years Major Eager has carefully and successfully guided the affairs of the Association through a period of general depression and unfavorable legislation. His efforts have been directed towards the maintenance of a high standard for the JOURNAL and towards the publication of material of professional value.

To Major Eager are extended the thanks of the Association and best wishes for his continued success.

### **Fort Sill Horse Show**

The 10th annual horse show of the Field Artillery School, staged by a committee headed by Brig. Gen. William M. Cruikshank, Commandant, closed its four-day session Thursday afternoon, June 9, with a record of being the best show of its kind ever held here. The field of nearly 700 entries produced stellar competition in all of the 39 listed events. 1st Lt. James T. Dawson won the Major General Harry G. Bishop cup as the advanced class in horsemanship champion.

The Commandant's cup went to 1st Lt. John Meade, while 1st Lt. Albert J. Hastings captured both the Bowman Memorial and the Lorillard cups. The three cups offered by the American Remount Association were won by 1st Lt. T. B. Whitted, Jr., 1st Lt. Alfred B. Devereaux and 1st Lt. John Meade, being awarded to the best schooled horse, to the winner of the cross country and to the best jumping horse, respectively. Mrs. Alfred Kitson was the winner of the Fanny Maloney Memorial cup.

Francis LaGarde was first in the Children's Horsemanship class, with Major Carl Baehr and daughter, Katherine, the blue ribbon pair of the Parent and Child event. In the Handy Hunters

## FIELD ARTILLERY NOTES

class Mrs. David Rumbough, on Antelope, took first in the ladies' section, while Lt. Col. George M. Peek, M. F. H., of the Artillery Hunt, was the winner, on Sumpter, in the gentleman's class, and Mrs. Rumbough repeated in the Master's Plate event by taking first on Southern Gold.

The Officers' Charger event, open to all branches of the service, was won by Capt. Horace Harding, on Drummer Boy, and the same combination took the Hunters, middle and heavyweight. Lucius II, the outstanding horse of the service Hunt race meets this spring, was the winner in the Artillery Hunt Plate class. Mrs. A. C. Gale took the Ladies' Jumping, on John Gamble, over a course of eight jumps, with Mrs. Giles Carpenter, on Kayson, winner in the Ladies' Hacks.

Sergeant Arno, 18th F. A., on Whirligig, won the Touch and Out and then, riding Nigger, captured both the Enlisted Men's Jumpers and the Bareback Jumping classes. Lt. James L. McKinnon took first in the Open Jumping, on Carlyle. Capt. A. C. Gayle, on John Gamble, won both the Officers' Private Mount Jumpers and the Handicap Jumping. Lt. J. E. Theimer, riding Selma, won the School Troop Officers' Jumpers, while Lt. John Meade, on The Skyrocket, took first in the Novelty Jumping, and Lt. G. C. Stewart, on Hulagirl, won the School Troop Officers' Novelty Jumping.

Capt. G. D. Wahl rode My Mistake to first in the Poly Pony stake race and Capt. Hugh J. Gaffey won the lightweight polo pony event on Ruth B. Capt. C. E. Sargent rode Pulchra to a win in the In and Out event and Corp. Gillmore, Btry. F., 1st F. A., on Sam, won the Troopers Mounts class. Major and Mrs. Baehr, on Lunette and Luncette, took first in the Pair of Hacks, with Capt. A. P. Kitson, on Silver Tip, the blue ribbon winner in the Road Hacks event.

The pair, Missouri and Nebraska, from the F. A. S. Det. (c) won the Artillery Pair class. Other winners were: Polo Mounts, Lt. J. T. Dawson, on Bonny Rachel; Polo Mounts, middle and heavyweight, Lt. J. M. Callicutt, on Kiluna; Novice Hunters, Lt. S. H. Fisher, on Unknown; Hunters, lightweight, Capt. David Rumbough, on Antelope; Colts, suitable to become hunters or officers' mounts, Capt. H. E. Watkins, on Vin Rouge.

## THE FIELD ARTILLERY JOURNAL

One of the features of the closing day was an exhibition by the Artillery Hunt and the winning of the Hunt Teams event by the entry of Lt. Giles Carpenter. Music was furnished each day of the show by the 1st Field Artillery Band.

### **To the Members of the United States Field Artillery Association**

The Army Appropriation Bill for the fiscal year ending June 30, 1932, made it necessary either to eliminate paid advertising in THE FIELD ARTILLERY JOURNAL or Regular Army officers from its management and editorship.

THE FIELD ARTILLERY JOURNAL has carried on without paid advertising since the January-February, 1931, issue. The publication of the JOURNAL, therefore, depends entirely on paid subscriptions. Full payment of back subscriptions and regular payment of future dues are necessary adjuncts to the successful management of this publication.

### **New State Highway Through Reservation**

On Saturday of this week Brig. Gen. William M. Cruikshank, Commandant of the Field Artillery School, and Capt. Leonard S. Doten, construction quartermaster, inspected the newly completed paved highway No. 277, running through the military reservation. Capt. Doten accepted it from the contractors. This is one of the main north and south highways in Oklahoma and the four and seven-tenths miles running through the post have been paved at the joint expense of the state and the United States, at a total cost of about \$120,000. In addition, the state has paved the nearly two miles between the reservation and the city of Lawton, thus providing two well paved highways between the post and the city.

### **Fort Sill Aids in Flood Relief**

Once again the Army has responded to civilian distress, this time Fort Sill sending 150 tents, 1,200 cots and 2,400 blankets to Oklahoma City, on the request of the Governor of the state to take care of the thousands rendered homeless over the week-end by the worst flood in the history of the Oklahoma capitol. The request of the state to the War Department was relayed to the commanding general, 8th Corps Area, and by him transmitted to



## FIELD ARTILLERY NOTES

Brig. Gen. William M. Cruikshank, Commandant, The Field Artillery School.

Col. E. E. Haskell, Chief of Staff of the 95th Division, and stationed in Oklahoma City, was called on for particulars of equipment required and within 10 minutes loading was commenced of the 13 trucks required to haul the tents and bedding. The following day the relief equipment was delivered in Oklahoma City by Major O. W. Humphries and Lt. P. M. Shockley, who accompanied the convoy.

### Special Test at Aberdeen Proving Ground

The following is an extract from the Second Partial Report on Caterpillar "20" Tractor (High Speed Gears Installed). Each vehicle hauled its tactical load. The test shows a comparison of the speed of the tractor with the Ford truck.

"The Caterpillar '20' with high speed gears from Aberdeen Proving Ground, one from Fort Hoyle with the same type of high speed gears, one from Fort Hoyle with standard gears, and a Ford 1½-ton Truck with Hipkins Traction Device, were entered in a test of 7.1 miles, starting at machine shop, going then to Aviation Field course, then twice around Hopkins area course, crossing sunken road at each trip at a point where it was necessary to ascend a 23-degree slope. Each of the three Caterpillar '20' tractors towed a 75mm gun carriage M1897, and a 75mm caisson loaded with the equivalent of 70 shells making a total load, the weight of which was 5,400 pounds.

"The Ford truck towed a 75mm gun carriage and a cargo load in the body of 2,000 pounds.

"The weather during test was rainy, ground slippery with from 1 to 2 inches of mud. The following table gives results of the test:

<i>Vehicle</i>	<i>Time</i>	<i>Speed, M.P.H.</i>
Caterpillar '20' Standard .....	1 hr. 18 min.	5.46
Caterpillar '20' Fort Hoyle with high speed gears .....	1 hr. 2.75 min.	6.79
Caterpillar '20' A. P. G., with high speed gears .....	1 hr. ½ min.	7.04
Ford truck .....	49 min.	8.70

THE FIELD ARTILLERY JOURNAL

"The Caterpillar '20' with standard gears negotiated the whole course in high gear except the 23-degree slope where it was necessary to use low. The two with high speed gears had to change into second or low on slight grades and had some difficulty even in low in making the 23-degree slope."

**Results of Field Artillery R. O. T. C. Pistol Competition for 1932**

The two leading teams of the Field Artillery R. O. T. C. .45 Caliber Pistol Competition for 1932 are announced as follows:

<i>Team Standing</i>	<i>Score</i>
1. University of Oklahoma .....	1200
2. Virginia Military Institute.....	1129

Since the inauguration of the annual Field Artillery R. O. T. C. Pistol Competition, the .45 Caliber Challenge Cup has been won as follows:

- 1923—Alabama Polytechnic Institute
- 1924—Alabama Polytechnic Institute
- 1925—Princeton University
- 1926—Alabama Polytechnic Institute
- 1927—Purdue University
- 1928—University of Missouri
- 1929—University of Missouri
- 1930—University of Oklahoma
- 1931—University of Oklahoma

The individual scores of the two leading teams were as follows:

*University of Oklahoma*  
*.45 Caliber Challenge Cup—Silver Medals*

<i>Name</i>	<i>Slow</i>	<i>Timed</i>	<i>Rapid</i>	<i>Total</i>
	<i>50 yds.</i>	<i>25 yds.</i>	<i>25 yds.</i>	
Vogt, William L. ....	75	77	66	218
Mayrath, Thomas .....	84	87	83	254
Mayrath, Robert .....	72	92	81	245
Bucy, Paul .....	64	72	84	220
Miller, Ivan .....	86	83	94	263
Total .....				1200

FIELD ARTILLERY NOTES

*Virginia Military Institute  
Bronze Medals*

<i>Name</i>	<i>Slow 50 yds.</i>	<i>Timed 25 yds.</i>	<i>Rapid 25 yds.</i>	<i>Total</i>
McGee, C. L.....	76	86	74	236
DeSaussure, W. P.....	63	88	83	234
Marklis, A. W.....	73	84	76	233
Gilliam, G. R.....	72	81	72	225
Hill, A. G., III.....	65	78	58	201
Total .....				1129

The highest individual scores for the .45 caliber pistol were made by the following men as indicated:

Ivan Miller, University of Oklahoma .....	263
Thomas Mayrath, University of Oklahoma.....	254

The five leading teams of the Field Artillery R. O. T. C. .22 Caliber Pistol Competition for 1932 are announced as follows:

<i>Team Standing</i>	<i>Score</i>
1. University of Missouri .....	1392
2. Purdue University .....	1383
3. Cornell University.....	1374
4. Princeton University .....	1346
5. Iowa State College of A. & M. ....	1345

Since the inauguration of the Field Artillery R. O. T. C. .22 Caliber Pistol Competition it has been won as follows:

1930—Purdue University
1931—Princeton University

The individual scores of the three leading teams were as follows:

*Princeton University  
Silver Medals*

<i>Name.</i>	<i>Slow</i>	<i>Timed</i>	<i>Rapid</i>	<i>Total</i>
Gee, Owen F.....	90	96	96	282
Snead, George O. ....	87	98	95	280

THE FIELD ARTILLERY JOURNAL

<i>Name</i>	<i>Slow</i>	<i>Timed</i>	<i>Rapid</i>	<i>Total</i>
Smith, Richard B. ....	89	96	93	278
Smarr, Lawrence K. ....	86	98	93	277
Cook, Duward F. ....	88	94	93	275
Total .....				1392

*Purdue University  
Bronze Medals*

<i>Name</i>	<i>Slow</i>	<i>Timed</i>	<i>Rapid</i>	<i>Total</i>
Medow, J. ....	96	98	87	281
Cors, J. G. ....	90	97	93	280
Dapprich, C. ....	91	92	95	278
Ratcliff, R. A. ....	92	95	89	276
Degler, R. H. ....	87	93	88	268
Total .....				1383

*Cornell University  
Bronze Medals*

<i>Name.</i>	<i>Slow</i>	<i>Timed</i>	<i>Rapid</i>	<i>Total</i>
Gray, G. T. ....	90	97	98	285
Schultz, W. A. ....	89	96	92	277
West, C. O. ....	85	96	91	272
Jett, R. M. ....	83	98	91	272
Blau, H. H. ....	85	93	90	268
Total .....				1374

The highest individual scores for the .22 caliber pistol were made by the following men as indicated:

J. D. Rivet, University of Illinois.....	289
Albert Jordan, Iowa State College of A. & M. ....	287
G. T. Gray, Cornell University .....	285

The P. M. S. & T. of the University of Oklahoma will retain the Challenge Cup for another year. He will have it suitably engraved and furnish the Secretary of the N. R. A. with a voucher covering the cost.

## FIELD ARTILLERY NOTES

The P. M. S. & T. of Princeton University will forward the .22 Caliber Challenge Cup to the P. M. S. & T., University of Missouri. The latter will have it suitably engraved and furnish the Secretary of the National Rifle Association with a voucher covering the cost.

Silver and bronze individual medals for members of the various teams winning places in the matches will be forwarded as soon as received from the National Rifle Association.

### **Artillery Hunt Racers**

Horses and riders of the Artillery Hunt continued their winning ways in the spring race meets by winning both first and second in the Elliott Memorial Race, on June 1, at the Cavalry Hunt meet, Fort Riley, Kans. Lucius II, with Lt. R. I. Taylor up, took the event, closely pressed by his team mate, Gaunt, ridden by Lt. E. W. Searby. This was the feature event of the Riley races and winning it assures that it will be held at Fort Sill in 1933, since it is provided that the race shall be held on the home course of the winner. The race was established last year by the Mission Valley Hunt Club as a memorial to its former president, Colonel Elliott, who, at the time of his sudden death, was formulating plans for a special race to be held at his club and open only to riders from military hunts.

Lucius II has proven one of the outstanding horses of the hunts in this section of the country in the spring races, where he has been run. On May 7, with Lt. Bryan Evans up, he won the Fort Leavenworth Hunt Cup race and on May 14, ridden by Lt. R. L. Taylor, he placed second in the Mission Valley Hunt Club race at Kansas City, Mo.

### **Graduates of the 1932 Class, United States Military Academy, Assigned to the Field Artillery:**

Andrew Hero, III  
John Henry Weber  
Roger Derby Black, Jr.  
John Campbell Street  
Alexander Graham  
William Menoher  
George Wilson Power  
James Aloysius Cain, Jr.  
Stanley Sawicki

Dale Eugene Means  
Hugh Willard Riley  
Ray James Stecker  
Curtis Alan Schrader  
Floyd Allan Hansen  
James Edward Godwin  
John Brinton Heyburn  
Harold Simpson Sundt  
Horace Freeman Bigelow

## THE FIELD ARTILLERY JOURNAL

Frank Lester Howard	Charles Albert Clark, Jr.
Samuel Watson Horner, II	James Bates Rankin
Robert Augur Hewitt	David Emory Jones
Edwin Simpson Hartshorn, Jr.	Harvey Porter Huglin
James Forsyth Thompson, Jr.	Bernard Thielen
Roland Francis Bower	George Dowery Campbell, Jr.
Joseph Edward Gill	Todd Humbert Slade
Frederick William Ellery	Charles Ratcliffe Murray
Loren Boyd Hillsinger	Francis Garrison Hall
Horace King Whalen	Charles Louis Willams, Jr.
John Paul McConnel	William Russell Huber
Walter Parks Goodwin	Gordon Whitney Seaward
John Abner Meeks	Walter Marquis Tisdale
John Clifford McCawley	Charles Albert Piddock
Edward Gibbons Shinkle	Nelson Landon Head
Harry Cecil Porter	Walker Raitt Goodrich
Dwight Edward Beach	David Hamilton Kennedy
Arthur Walter Blair	Edwin Guldilin Simenson
Theodore George Burton	

### **Graduation at Army War College**

The Army War College, Washington, D. C., graduated its 26th class on June 24th.

The graduation class, consisted of 76 Army officers, 5 Naval officers, and 3 Marine Corps officers. The following list shows the officers of the Field Artillery who completed the course this year:

<i>Name</i>	<i>New Stations</i>	<i>Home Address</i>
-------------	---------------------	---------------------

#### LIEUTENANT COLONELS

Barrows, Frederick M., F.A....	Historical Section, Army War College .....	Washington, D. C.
Kennedy, John T., F.A. ....	War Dept. General Staff .....	Washington, D. C.

#### MAJORS

Connor, Daniel A., F.A. ....	University of Florida.....	Washington, D. C.
Hatch, John E., F.A. ....	War Dept. General Staff .....	Liberty, Me.
Lucas, John P., F.A.....	War Dept. General Staff .....	Charles Town, W. Va.
Magruder, Marshall, F.A. ....	Naval War College.....	Washington, D. C.
Ross, Frank K., F.A. ....	Office Chief of F.A. ....	Washington, D. C.
Sloan, John E., F.A.....	C. & G. S. School .....	Greenville, S. C.
Waterman, John J., F.A. ....	Fort Bragg, N. C. ....	A. G. O.