

**VOLUME VIII**

**NUMBER 1**

**JANUARY-MARCH**

**THE  
FIELD ARTILLERY  
JOURNAL**

**EDITED BY**

**ARTHUR F. CASSELS**

**MAJOR (FIELD ARTILLERY), UNITED STATES ARMY**

**THE UNITED STATES FIELD ARTILLERY ASSOCIATION  
WASHINGTON, D. C.**

**COPYRIGHT, 1918, BY  
THE UNITED STATES FIELD ARTILLERY ASSOCIATION**

# Contents

## No. 1

	PAGE
<b>A Message to the Field Artillery</b> .....	1
Wm. J. Snow, Brig. Gen. Nat. Army, Chief of Field Artillery.	
<b>Remarks on Trench Artillery</b> .....	5
<b>Coöperation Between Infantry and Artillery in the British Army</b> .....	14
Major D. M. McRae, Infantry, British Army.	
<b>Lecture on Use of Artillery in Defensive</b> .....	24
Major Legrand, French Mission.	
<b>Firing Charts and the Reconnaissance Officer</b> .....	44
Major Walter S. Sturgill, Field Artillery.	
<b>A Protractor for Field Artillery</b> .....	102
Major George Payne Nickerson, N.A.	
<b>A Field Method of Calculation for Adjustment with Lateral Observation</b>	111
Lieut. S. C. Spear, 315th Field Artillery.	
<b>Field Artillery Fire for Beginners</b> .....	116
Col. A. U. Faulkner, 344th F. A., N. A.	
<b>Disc for Spotter Practice</b> .....	128
Capt. C. A. Chapman. 81st Field Artillery.	
<b>Current Field Artillery Notes</b> .....	130
<b>The United States Field Artillery Association Constitution</b> .....	132
<b>The American University Union in Europe</b> .....	138
<b>Roll of Honor</b> .....	141
<b>Editorial</b> .....	142
A Chief of Field Artillery. Editorial Difficulties Under Our Constitution. Field Artillery Training at Yale. College R. O. T. C.'s. Service Books.	
<b>Book Review</b> .....	154
<b>Index to Current Field Artillery Literature</b> .....	160



**BRIGADIER GENERAL WILLIAM J. SNOW, NATIONAL  
ARMY, CHIEF OF FIELD ARTILLERY**

WAR DEPARTMENT.

General Orders

No. 15

WASHINGTON, February 10, 1918.

1. By direction of the President. Brig. Gen. William J. Snow, National Army, having reported to the Chief of Staff, in accordance with orders heretofore issued, is detailed as Chief of Field Artillery. (201, A. G. O.)

By order of the Secretary of War:

JOHN BIDDLE,  
Major General, Acting Chief of Staff.

Official:

H. P. MCCAIN,  
The Adjutant General.



# THE FIELD ARTILLERY JOURNAL

---

---

VOL. VIII

JANUARY - MARCH, 1918

NO. 1

---

---

## A Message to the Field Artillery

*I have been asked by the management of the Field Artillery Association to send a message to the Field Artillery generally. This I gladly do, not from any desire to rush into print, but from a wish to speak to field artillerymen of the army in an informal way, such as would be possible, for instance, could we all meet together face to face. My object is to get acquainted, to the end that we may know each other and all put our best efforts in the work now concerning us; that is, securing efficiency in our arm.*

*But first I want to thank those numerous officers who have been kind enough to write and telegraph their congratulations to me upon my appointment as Chief of Field Artillery, and I want to further state that I am not egotistical enough to assume that these good wishes are sent to me personally, but rather that they represent the satisfaction of the sender over the fact that we have at last obtained what we have so long regarded as necessary, viz., a Chief of Field Artillery. In this sense, and omitting all questions of personality, I think we may well congratulate one another. It may, therefore, be assumed that the office would not have been created had there not existed a crying need for it, and such is actually the case.*

*I think I betray no confidence when I state that our arm is far from being in the satisfactory condition we all desire to see it reach, and which it must reach if we are to win this war, and, of course, we are going to win the war. But we are not going to do so by merely saying so. In the language of the advertisement, "We must not only think it over, but put it over."*

## THE FIELD ARTILLERY JOURNAL

*Now it seems to me that the two essentials to success in the Field Artillery are equipment and training. The former comes under my province more than under anyone else's, and I shall do all within my power to hasten it. In this connection, I want to add that I am meeting with hearty coöperation on the part of the Staff Departments. Training, on the other hand, can be influenced either positively or negatively more by field artillery officers generally than by me individually. Those officers who have read Hohenlohe's "Letters on Artillery" (as all of the older officers have) will doubtless recall the fact that in the Austrian War of 1866 the German Field Artillery was a disappointment. On the other hand, four years later, in the Franco-Prussian War, the reverse was the case. The rejuvenation of the artillery in this period was due to General Von Hindersin more than to any other one individual. His favorite saying during this time (and this is the point of the whole story) was that "the day has twenty-four hours of duty; and it is possible to make use of the night also." It seems to me that these men had the true spirit, and that we could not do better at the present time than to adopt their saying as the motto for ourselves. All reports that I have seen indicate that we have trifled with that one asset which we never can recover. I mean time. So, while we never can get back lost time, we can at least by strenuous efforts see that we lose no more. We must bear in mind the magnitude of the responsibility resting upon us as field artillerymen.*

*Nothing happens in this war until the artillery is ready. No matter how highly trained the infantry and other branches may be, there is no action until the artillery is ready. Every day that we delay, therefore, is a day wasted for the whole army. I ask you to take that seriously to heart, to think over the gravity of that. There was never a time in the history of the world when one single arm had within it so much responsibility for the fate of a nation. Our responsibility is then truly gigantic. But, like all problems, the harder we go at the solution the simpler and easier it becomes. The key to the present solution is work. I do not mean a mere time-killing service, but an intelligent application*

## A MESSAGE TO THE FIELD ARTILLERY

*of our energies. The former leads nowhere. I think that work can be speeded up very materially if we stop for a moment and quietly think over the problem and analyze it, asking ourselves just what we must accomplish in the way of training. Manifestly all training can be divided into two parts, one comprising all essentials, and the other taking in desirables. The next step is to list under each head the different classes of drills and exercises that go to make up a soldier of artillery. Having done this, scratch out under the essentials those things in which proficiency has been secured and then proceed with the remainder as fast as thoroughness will permit. Leave the desirables until last. We can skip them if we find our time too limited.*

*No man has greater respect for the regular army than I have, but at the same time I am prone to think that at times our methods in the past could have been very materially improved had we followed the procedure I have just outlined. We have been too prone to blindly follow precedent. However, whether or no that statement is actually true, let us now use the best method that we can devise to meet the conditions actually confronting us, irrespective of peace-time conceived methods, and always bear in mind that time, time, time is pressing on our heels.*

*Bear in mind that we are starting with a tremendous asset; that is, the interest and enthusiasm of the recently appointed officers. Such an asset covers a multitude of sins and goes a long way toward overcoming the numerous difficulties confronting us. So far as we older officers are concerned, our principal function is to coördinate these efforts of the young and enthusiastic officers, direct them along wise channels, and generally act as a guide. That is the task of the older officers. To the younger ones I would say: Don't get discouraged. None of us in the army can have his individual will or desires carried out entirely. The army is a big machine in which the individual is merely a cog. If your individual ideas are rejected, why, forget the matter and turn to the next subject at hand. The rejection is not a personal matter, but is merely an application of the fact that these individual ideas or cogs do not mesh into the larger scheme. The*

THE FIELD ARTILLERY JOURNAL

*great thing is team work. Remember that there is no standard by which the quality of the individual's work can be judged with absolute accuracy, and there is no standard day's work. Results are obtained only by a combination of many individual efforts. Let us all then realize this, help each other, put in our work the best that is in us, have faith in one another, and look upon the present as the one golden moment to get ready for the coming struggle.*

*If we do this and do it whole-heartedly, we may look to the future with confidence and then back upon the past with satisfaction.*

WM. J. SNOW,  
*Brig. Gen. Nat. Army, Chief of Field Artillery.*

## Remarks on Trench Artillery

AS INDICATED by its name, trench artillery is an auxiliary and special artillery employed in the most advanced position, and particularly as an offensive weapon. It is the economical heavy artillery, which is easily moved in the trenches and whose projectiles are, above all, explosive carriers.

In its employment it does not take the place of the field artillery or of the ordinary heavy artillery. Many targets cannot be reached effectively by the field artillery, because they are greatly defiladed or strongly entrenched. On the other hand, because of the men, horses, and ammunition necessary, heavy artillery is very expensive.

The most characteristic feature of trench artillery is its ability to fire from any position and under circumstances where it would be impossible for other artillery "to live"; trench artillery can live and be effective because of its ability to establish itself in any trench or similar excavation. Its powerful effectiveness has rendered its employment indispensable, and, owing to its vertical fire, any target within its range can be reached; both in the calm sectors as well as the fiercest combat trench artillery takes an important part in modern warfare.

With the exception of a few German *minenwerfer* designed several years before the outbreak of the hostilities, trench mortars have never been made or employed before the present war, and hence it will not take long to tell their story.

As a matter of fact, these *minenwerfer* were intended for use only in siege warfare. The extensive entrenchment after the battle of the Marne gave them their initial opportunity. The Allies had, therefore, perforce to adjust themselves rapidly to the new conditions of war, to build a similar material, simple, solid, compact, as light as possible, easily moved over an upturned terrain, and of effective action against the *minenwerfer*. To be sure, makeshift devices were employed at first, but now

## THE FIELD ARTILLERY JOURNAL

such mortars and bombs can be regarded only as "curios" or "antiques."

At the same time appeared bristling along the front a most formidable means of defence—the wire entanglements. Their destruction was the fundamental preliminary to the success of any attack by the infantry. At first the brave engineers were forced to creep up to the entanglements and destroy them with charges of explosives.

Then some engineer officers hit upon the idea of the explosive charge to the end of a rocket-rod which was thrown by hand and reached only a distance of thirty or forty yards. Subsequently they succeeded in propelling the explosive from a 75-cartridge case employed as a gun. As such a device was useless after each shot, they decided to employ it as a projectile; for this purpose they placed a 75-cartridge case containing two charges of explosive and the propelling black powder on a wooden mandrel which served to give the angle of fire. This rudimentary projectile was improved by welding three vanes to it, which gave it a more regular trajectory. All these experiments took place in the front-line trenches. There were evolved the first lineaments of the modern bomb, which opened the way whereby the trench artillerymen met with entire success and won considerable honor and glory.

Since that time, on both sides of No Man's Land, many models of trench mortars have been built and used, each new type bringing with it a new improvement, but retaining the facility of manipulation as the most important quality; at the same time, both the accuracy in firing and the range were increased. During this process many types were rejected; by the selection of only the best the first batteries of trench artillery were formed. The initial scheme was to use these mortars as "accompanying artillery." This employment has since been abandoned. Subsequently, the trench artillery was divided into three types—light, medium, and heavy. The light type is employed only by infantry; the medium and heavy types are served by the artillery.

## REMARKS ON TRENCH ARTILLERY

But, since the present war requires a constant adaptation to new conditions of battle, the models to be employed seem at present to tend once more toward a multiplication of devices in order that each new type may fit more thoroughly the special conditions required. It would be foreign to the purpose of this article to review the different models now in use at the front; it would be sufficient here to indicate the most important characteristics of trench mortars.

Let us glance rapidly at the light material employed by the infantry. The mortars must be light—that is, susceptible of being carried by only one man; owing to the necessity of firing from any part of the trenches, they must not require special installation, thus avoiding discovery by the enemy due to the possibility of frequent removal. The most important qualities are a great accuracy and a great rapidity in firing.

From the front-line trenches the presence of the enemy is disclosed by very slight tokens which very often are not noticeable from the artillery observation posts. Furthermore, there are but few men in the front lines, and thus it is not always advisable to waste the projectiles of field artillery in firing at worthless objectives.

The objectives which are most frequently attacked by this type of mortars are: Fatigue parties bearing water, food, and ammunition passing through the communication trenches or in the vicinity of commanding posts; the telephone operators verifying or repairing the wires; soldiers working for the maintenance of the trenches, etc., visible only for a short time, and hence it will readily appear that the fire must be rapid and accurate in order to secure effective shots before the enemy is sheltered.

Since the employment of this material does not require a long range, due to the small extent of the enemy's trenches visible from our own front lines, it is possible to make use of very simple mortars which are very accurate in fire. The projectile desirable for this purpose is one nearly as powerful as the high-explosive shell of 75 mm. Valuable use of such mortars is in firing repeatedly around and at the place of a work already

## THE FIELD ARTILLERY JOURNAL

destroyed by the heavy artillery in order to prevent the enemy from rebuilding it.

In the same class of material can be placed the grenade throwers, which employ grenades for analogous purposes.

Enough, however, regarding these small-hit useful mortars. Let us now consider the more powerful materials of medium and heavy type.

The most important characteristics of these mortars is that they may be taken down rapidly in order to facilitate their transportation. This condition is fulfilled when their heaviest part can be transported by two men in the case of medium and by a *one-horse voiturette* in the case of heavy mortars. It has been shown by experience that the heaviest part of each mortar should not exceed 160 pounds for the medium type and 850 pounds for the heavy type.

Trench mortars are generally built for vertical firing, and hence it has been found advisable to mount them by means of trunnions placed near the breech. A few of the latest types are furnished with a buffer, but more generally the carriage is placed on a platform. This question of the platform must be considered with great care, and, indeed, the *reactions* from the ground must interfere neither with the projectile nor with the mortar. Therefore the weight and the bearing surface of the platform must be sufficient, even though these conditions are contrary to the first quality desired in a mortar; namely, its faculty of being easily transported. Moreover, especially in the case of heavy mortars when an important operation is in preparation requiring a considerable number of shots, the platform is placed on a solid foundation made of quick-setting cement.

As stated at the beginning of these remarks, the trench mortars are the economical heavy artillery; this is obvious if we consider that generally trench mortars have no rifling, the projectiles being stabilized by means of vanes. Consequently the power of the powder is employed only in propelling the projectile, whereas in the ordinary heavy artillery a considerable part of this power is employed in forcing the projectile to take the



## REMARKS ON TRENCH ARTILLERY

grooves and in imparting to it the rotating motion, so that if we compare a projectile of heavy artillery with a projectile of trench artillery of the same weight and thrown to the same distance the necessary amount of propelling powder is smaller for trench artillery. In consequence of a lower internal pressure the mortar may be made lighter and so it appears clearly that, as regards the cost of the material and the expense for the propelling charge, the trench artillery is the economical heavy artillery.

The vaned bomb which contributes so much to this economical character is, above all, an explosive carrier. In this respect, for instance, the best type employed in the French Army is the 240-mm. bomb, which weighs about 190 pounds and contains about 100 pounds of explosive (this is over 50 per cent. of the total weight); whereas in heavy artillery the 155-mm. shell weighs 94.6 pounds and contains 22.44 pounds of explosive (this is about 24 per cent. of the total weight).

Since the internal pressure in the mortar is low, the bomb is not submitted to great stresses, and consequently its manufacture does not demand so high a quality as the shells of heavy artillery. The bombs are made in order to have the greatest possible internal capacity for containing the greatest amount of explosive.

The explosives employed are particularly the chlorated or perchlorated explosives, because of their great effectiveness in upturning the ground. Thus we may say that if the amount of ground upturned by a given volume of picric acid is 10, then the amount of ground upturned by an equal volume of chlorated explosive would reach 16. Moreover, due to the fact that the muzzle velocity in the case of the trench mortar is not considerable, the chlorated explosive can resist the shock on firing. However, the explosive must be strongly compressed in order to avoid premature explosions, because of the friction of the explosive sliding by its inertia along the walls of the bomb—just as the friction of a rifle bullet produces an explosion of a bomb after piercing its walls.

The bombs are primed with different types of fuzes, according

## THE FIELD ARTILLERY JOURNAL

to the effect to be produced: with instantaneous fuzes when firing against personnel or wire entanglements, and with fuzes with delayed action for destroying shelters, dugouts, etc. But these fuzes must be especially built to arm themselves, even with the small initial velocity of the bombs.

The effectiveness of the bomb is easily shown by the craters formed in the ground, which have a diameter of 12 feet and a depth of about 4 or 5 feet for the medium mortars. The craters formed by the bombs of 240 mm. have a diameter reaching 30 feet and a depth reaching 10 or 12 feet.

When employed for destroying the wire entanglements, the medium bombs can clean an area from 200 to 400 square feet. In fire against personnel the fragments of the medium bomb are dangerous at a distance of 500 yards from the point of impact.

When employed for filling up the trenches, we may consider that a medium bomb falling within one-half yard from the parapet can fill the trench for a length of 4 yards, and a bomb of 240 mm. falling within 2 yards from the parapet can fill up the trench for a length of about 10 yards.

It may seem somewhat difficult to obtain good results with trench mortars which have a considerable "probable error," but in a practical way we should not calculate this "probable error" as a percentage of the range. We must consider only the extent of this error in comparison with the extent of the error in the fire of heavy artillery. For instance, for the 240-mm. the "zone of dispersion" is about 160 yards long and 80 yards wide, whereas for the 155-mm. gun the zone of dispersion is about 270 yards long and 25 yards wide. The advantage of the heavy artillery is not considerable, and, moreover, it seems possible to increase largely the accuracy of trench artillery.

The adjustment of the fire of a trench battery is not always an easy matter, the targets being generally very difficult to distinguish, so that it is often advisable to have an observation post behind the battery with a command of the terrain for adjusting the direction and an advanced post for adjusting the range. But in an advanced post the observation is somewhat dangerous from the very explosion which is to be observed. Two kinds of fragments

## REMARKS ON TRENCH ARTILLERY

may be of danger for an advanced observer: the ones projected in the air, which fall nearly vertical to the ground; these are not especially to be feared because it is easy to be protected by a slight shelter. But the fragments projected by the explosion parallel to the ground are especially dangerous, because they may attain a velocity of over 3000 feet per second. Thus one cannot think of observing an explosion and of sheltering one's self afterward, because of the great risk of being hit by a fragment before it is possible to take shelter.

The method of attacking the different targets may be resumed in a few words. When the destruction of trenches is desired it is obvious that the best results are obtained by *enfilade* fire rather than by firing in a direction perpendicular to the trench. On the contrary, for the destruction of "wire entanglements," due to the necessity of obtaining a way cleared through the entanglement, it is better to fire in a direction perpendicular to this entanglement.

It is to be remembered here that trench artillery is an auxiliary artillery, and that each time an important bombardment by trench artillery is in preparation the simultaneous employment of field and heavy artillery is to be provided, especially at the time when the fire for effect is to be carried out. They should have the coöperation of field and heavy artillery to distract the attention of the enemy, so that the opposite observers may not have the opportunity of noting carefully the places whence the bombs are fired. This collaboration may be outlined thus: The field artillery opens fire against the enemy's trenches, directing the shells especially at the points where the observation posts are supposed to be; the occupants of the shelter then are no longer able to observe carefully, and may be even prevented absolutely from observing at all. Then the trench artillery opens fire as quickly as possible, and meanwhile the heavy artillery keeps itself in readiness to attack the enemy's heavy artillery which would attempt to destroy our own trench mortars.

As soon as a definite task has been intrusted to a trench battery the commanding officer of the battery has at first to determine the number of mortars to be employed and their

## THE FIELD ARTILLERY JOURNAL

position. In view of this, he begins by studying the map, the sizes of the objectives, their distance from the zone to be occupied, and fixes the space in which the positions can be selected. Thereupon he can determine the number of mortars which are to be fired at each target; this number is determined according to the time within which the task can be accomplished.

Then the commanding officer proceeds to a rapid reconnaissance of the ground, whereupon he goes over the same ground again with his lieutenants and gives them general instructions regarding the position of the battery, but lets them choose the exact position of each mortar in a narrow zone previously appointed by him for each one; finally he gives his approval to the position chosen by his lieutenants.

A few principles are to be kept in mind in fixing the positions:

- (a) For destroying trenches, enfiladed fire is better.
- (b) For destroying wire entanglements a trajectory perpendicular to the entanglement is to be employed.
- (c) For firing at a small target with a great number of mortars it is more convenient to have a concentration of fire from scattered mortars than to gather numerous mortars in a small sector; the installation is easier, less vulnerable, and the enemy's observation made more difficult.
- (d) Positions are to be avoided in the vicinity of commanding posts, central stations of telephone strongholds, shelters for reserve troops, etc.
- (e) So far as possible, the battery should be protected from the enemy's sight; however, it is not advisable to place the mortars behind an isolated wall, a bush, a tree, a hedge, an embankment, or, in general, behind anything noticeable silhouetted on the landscape, the protection offered by these points being of quite an illusory character, because they make easier for the enemy the adjusting of fire.

Moreover, it is advisable to prepare a few more positions of mortars than are strictly necessary, and, on the other hand, no position is to be definitely chosen before being approved by the commanding officer of the infantry of the sector.



155-MM. H. P. SCHNEIDER GUN  
Position No. 1. Gun in travelling position

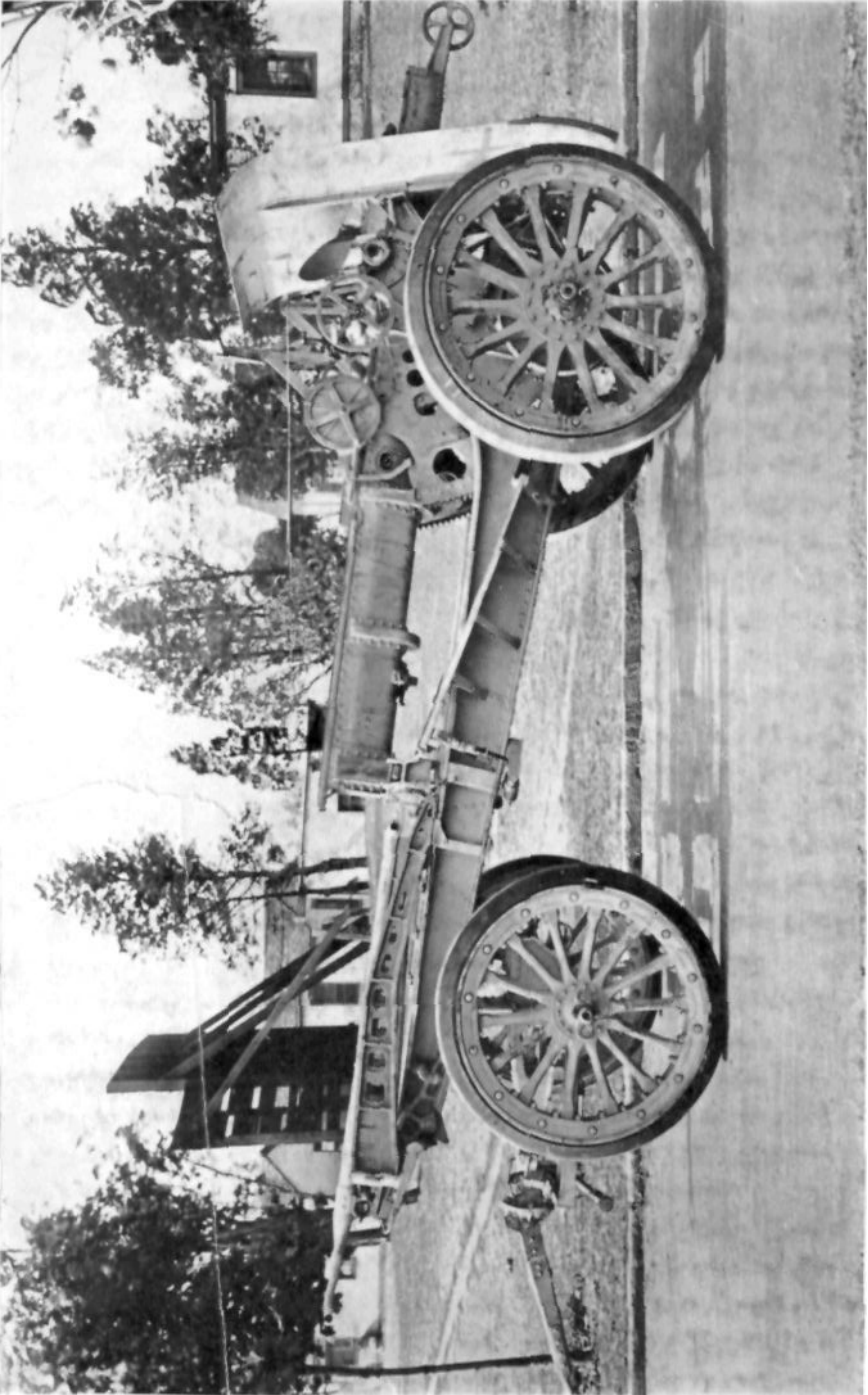

CARRIAGE IN TRAVELLING POSITION

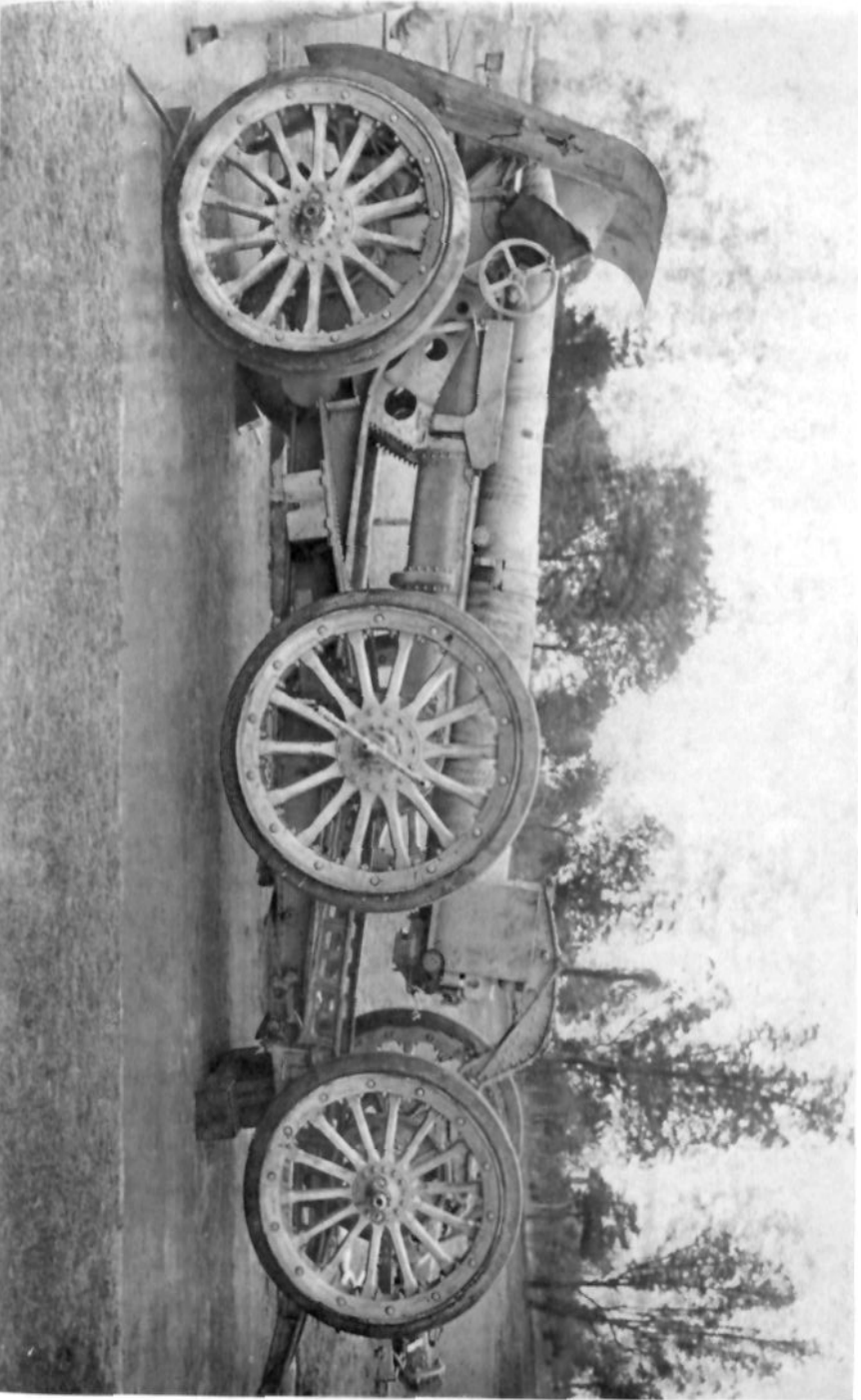

POSITION NO. 2. PLACING GUN ON CARRIAGE

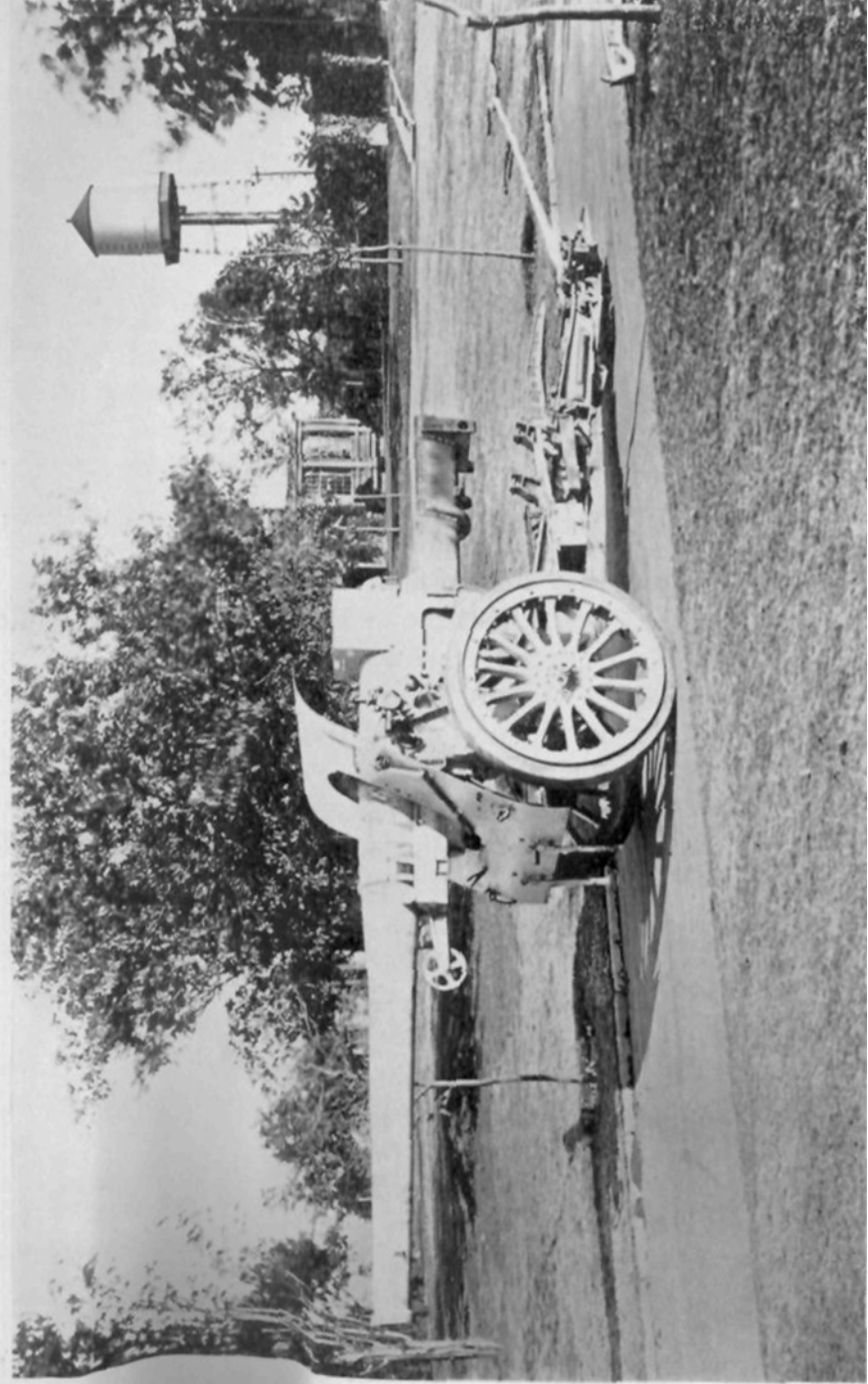

POSITION NO. 3. GUN IN FIRING POSITION



## REMARKS ON TRENCH ARTILLERY

The organization of the position then takes place. Sometimes trench mortars are designed for vertical firing; the positions are to be organized accordingly. The mortars can be placed in deep craters or special trenches so that they are properly protected from view even if the terrain itself presents no satisfactory shelter. The depth of the platform is limited only by the dimensions of the pit from which the bombs are fired; the length and width of this pit are generally equal to the depth.

Owing to the possibility of premature explosions, special care is to be taken in the disposition of the mortar. Each mortar position must be prepared with two escape-trenches provided with *traverses* which allow a rapid evacuation from the mortar position by the gunners, and minimize the results of an accident. However summary the first installation of the battery may be, a definite plan should at least be determined on regarding the cover and with a view to further improvements.

For each mortar we have to prepare, on the position itself, an entrenchment for the mortar, a dugout for the artillerymen, and a few shelters for ammunition; at some distance behind the battery, intermediary depots for bombs, and, if possible, good shelters for gunners, in which they can rest between the rounds of fire and take shelter against bombardments.

When preparing the positions it is of great importance to avoid regular outline or geometrical lines which are noticed from airplanes. The most careful camouflage should be employed.

At present the most satisfactory medium material for trench artillery must be able to throw from 300 to 2300 yards a projectile containing at least 8 pounds of explosive; it must be readily movable and easily installed.

The most considerable difficulty is to supply the battery with a sufficient amount of bombs, especially in the front lines. That is the reason why we require a range of about 2300 yards, thus enabling the trench batteries "to live" at a short distance behind the front line. That is why we require greater accuracy in firing; namely, because it enables the trench mortars to attain the maximum results with the minimum expense of ammunition.

# Coöperation Between Infantry and Artillery in the British Army

BY MAJOR D. M. McRAE, INFANTRY, BRITISH ARMY

[Reprinted from *Infantry Journal*]

## LACK OF COÖPERATION IN THE EARLY STAGES OF THE WAR

FOR quite a time after the war began there was little or no coöperation between the infantry and the artillery, and, what was worse, there was a bad form of antagonism. This was due to a number of causes. In the first place, neither branch knew practically anything of the other and had no conception of the troubles and limitations that controlled the actions of the other. Both branches were prone to too much secrecy, and disastrous operations were carried out without the necessary consultations taking place. It used to be nearly a physical impossibility for an infantry officer to learn anything about the batteries covering him or to visit the artillery O.P.'s on his front. Another item in this awful misunderstanding was the shortage of shells. The infantry blamed the artillery, and the artillery were too touchy to take the trouble to explain.

## GRADUAL IMPROVEMENT

When matters were at their worst some genius must have taken charge, for an improvement started, due to no one that could be traced. This improvement was very gradual at first and sort of half-hearted, but was soon going along full swing by leaps and bounds. "Personal acquaintances between the two arms" became the watchword. There were plentiful invitations from the infantry messes to the artillery messes covering them, and *vice versa*. As a result of these dinners, bridge parties, etc., and of the information gained here of each other's difficulties, each branch began to realize that the other was not entirely composed of a collection of grouchy rotters, and that a large part of the blame could be laid on each side.

## COÖPERATION BETWEEN INFANTRY AND ARTILLERY

One of the first things noticeable was that where an artilleryman and infantryman met there were friendly words of greeting and mutual congratulations over a good piece of work done, instead of the curses and black looks. But, above all, each branch began to ask the other questions and would get pleasant answers. This good work was greatly helped along by a series of good addresses given by artillery officers to the infantry, and *vice versa*. From this time on, it was a common sight to see infantry officers at the batteries and O.P.'s, and they were always certain of a warm welcome by personal friends. The author has the privilege of counting many of his best personal friends among the artillery that has covered the fronts he has been on, and recalls with great pleasure the times he has been allowed to fire different calibre guns into Fritz's back country. He is also certain that numerous artillery officers have enjoyed their trips to snipers' posts for the chance of a little hunting.

A big factor in the maintenance of the now almost perfect coöperation is the presence of artillery liaison officers in the front line. There is one such with each British battalion, and he doesn't just sit around the headquarters dugout. He is supposed to be the shadow of the battalion intelligence officer and follows him all over the frontage. These two work hand in glove for the discomfort of the enemy and the increased safety of our troops. They compare maps and at once correct any disagreement. The names and locations are checked of all sections of front-line trench, bays, posts, craters, gaps, etc., and any changes at once given to the artillery. Serious mistakes will be made unless these maps are identical, and it will be the infantry's fault. When the battalion observers locate an enemy battery, trench mortar, or machine gun, the information is given to the artillery at once, and they pass back the information as to the result of their fire. Each branch has a pride in its share of the good work. The following incident that came under the author's notice will illustrate this close harmony in which the two branches work and which would have been impossible a year and a half ago.

Opposite the city of Lens there is a huge pile of slag from

## THE FIELD ARTILLERY JOURNAL

one of the coal mines, called the Double Crassier. It is a long mound, about two hundred feet high and twelve hundred yards long, with a very narrow top of about eight yards and extremely steep sides. One end of this crassier is at our front line, and from there it runs across No Man's Land to quite a distance behind the enemy's front line. We have dug a sap running up the end in front of us and a narrow trench along the top so that the post at the end is about on a line with the German front line, way down below in No Man's Land. The Germans have a sap on top that runs up to within ten yards of ours, but they were so close that a sort of *status quo* was established. From this wonderful watch tower all the surrounding country could be seen, on the right clear down to Vimy Ridge and on the left to Loos.

There had just been a number of successful raids against the Germans and they were very jumpy and kept numerous machine guns swinging over the whole countryside every night. These guns, while they did little damage, were an awful nuisance and to some extent interfered with the nightly working parties who were in the open. Besides this, there were a number of large trench mortars (*minenwerfer*) located very near the foot of the crassier which had a habit of lobbing their huge bombs over the top of the crassier into the trenches of the battalion on the north. Then, while up on the crassier one night, an officer observed the relief of a German listening post crawling out in the snow directly below him, and took its position and the times of relief.

Then a little surprise party was organized. Some artillery friends and one from the brigade machine guns were taken up on the crassier and they immediately entered into the spirit of the game. (Right here it ought to be stated that when they have plenty of ammunition, as they always have now, the artillery are almost childish in the joy they take in letting off their guns at almost any old target the infantry finds for them.)

When the visiting officers had grasped the idea, a systematic effort was made to locate all the enemy emplacements and have these accurately registered in daylight from the crassier. This registration was done in such a way as to lead the enemy to

## COÖPERATION BETWEEN INFANTRY AND ARTILLERY

believe it was just desultory shelling. The brigade machine guns were then accurately registered on the path taken by the relief of the listening post. This was done by watching the bullets kick up the snow. When this work was done, a "tug wire" was rigged up from a good observation post on the crassier along the top and down the back to a place where a man with a signal lamp was invisible to the enemy but could be seen from an artillery observation tower in a town, well to the rear. In this tower was an artillery officer with a set of push buttons that connected with the different batteries. When all was set and it was dark an infantry officer crawled out to the observation post, tugged a few times on the wire in his hand to see if his signalman was on the job, and then waited for developments.

The first thing to happen was for one of the trench mortars to go off. The flash had hardly died away before one tug was sent back, one flash given on the lamp, one button pushed in the tower, and four 4½-inch shells landed on the T.M. emplacements. This must have surprised the enemy, but didn't quite put him out of action, for he fired again and the same process was repeated. He was never heard of again.

Practically the same thing happened to the other T.M.'s, and then the Germans' machine guns started their nightly song. They received the same treatment as the T.M.'s. A machine gun can't very well compete with a salvo of well-placed three-inch shells. There was no more machine-gun fire for days, and then they would just fire short tentative bursts to sort of see what would happen.

The serious part of the work now over, there was a lot of amusement caused by playing with the relief for the listening posts. Every time they would try to crawl out a well-directed burst of machine-gun fire would land on them and they would slide into a shell hole. If one man lifted his head the gun would open. It must have caused a lot of surprise and wonder as to how a machine gun about twelve hundred yards away could see to fire at the slightest movement of one to two men on a dark night. It probably never entered their heads that a Canadian

## THE FIELD ARTILLERY JOURNAL

infantry officer was lying straight above and could see every move against the snow. This very interesting game continued for some time until a man with a rifle couldn't resist the temptation any longer and shot one of the Huns. This must have put them on to the game at once and broke up the *status quo*. Shells began to remove the top of the crassier, so the game was called off for that evening.

This is given just to show how all the branches can work together and cause a great deal of local damage. When this kind of thing is extended over the entire front it amounts to something. This was done under very special conditions, but other conditions and other opportunities exist at other places and must be utilized whenever possible.

The guns on any corps front are composed of the corps heavy artillery and the lighter guns, of which on a corps frontage there are three divisions of field artillery in the line and one in the reserve. A division of field artillery covers an infantry division and is composed of three brigades. A group of the corps heavy artillery is also assigned to an infantry division. A brigade of field artillery covers an infantry brigade. It has fewer guns than a brigade in the United States Army.

A battalion is covered by its group of guns. In case an offensive is being planned or the enemy is planning one, the artillery is greatly concentrated and absolutely no estimate of the guns covering a unit can be made. Any infantry officer in the front line can call for the fire of the field artillery brigade covering him, but he cannot call for fire from the corps heavies direct. This last call goes through battalion headquarters and brigade headquarters, and sometimes even has to go through divisional headquarters, according to local arrangements. This takes a very short time, as special arrangements have been made to facilitate these messages. This indirect method applies only to retaliation or *strafing* fire, for if an S. O. S. signal is given everything opens up at once.

Information that the infantry should give the artillery:

(a) As mentioned before, they check up maps and at once let the artillery know of any changes in posts, etc.

## COÖPERATION BETWEEN INFANTRY AND ARTILLERY

(b) Distinctive sign-boards should be put up against the parados of different sections of the front line, as it is very difficult to tell our trench from the enemy's when looking from an O. P.

(c) Immediately send in any bearings of T.M.'s, M.G.'s, or batteries obtained, giving map locations of point the bearing was taken from and time taken. You may get only one bearing, but others with other bearings may send theirs in and give enough data to locate the target.

(d) In calling for retaliation, the enemy rate of fire and calibre of his shells should be sent back so our artillery can know what size and rate to use.

*The principle of retaliation calls for a faster rate of fire with larger shells than the enemy is using.* Often a big artillery fight will start from a mere trifle; maybe some one will heave over a trench mortar bomb; the other side sends back two, which compliment is returned by four. Next some artillery is called in; beginning with three-inch, they work gradually up the scale until the fifteen-inch may even get in the show. Then everything goes full swing, the infantry of both sides being the target, until one side calls quits and gets its artillery fire to die away.

It is usually the German who gives away, both because his morale is not as good and he is weaker in artillery power than the Allies. After the German guns let up we usually pound for a little while longer and then quit ourselves. After a few experiences of this kind the Hun infantry will be loath to call for his artillery fire and will take a certain amount of punishment without coming back strong. We find out this limit to his patience and work right up to it.

(f) Any movement of the enemy that any infantry officer may detect or suspect, especially working parties, ration parties, or, above all, reliefs, should be gotten to the artillery, through the liaison officer, just as quickly as possible. This is just the chance the artillery is looking for, and at night the infantry are the ones who discover these things.

(g) The following is the kind of thing that an infantry lieutenant may have to do any night, and was worked very successfully, to the author's knowledge.

## THE FIELD ARTILLERY JOURNAL

A German working party was seen and the men in the front line not allowed to fire. If they had opened up, the chances are that no Germans would have been hit, as it was night, and the fire would have driven them into their trenches with no damage done. The infantry officer decided on a zero hour and put three Lewis guns in position, with orders not to fire until the time specified. He then ran down to the trench mortar headquarters dugout and arranged for them to fire at the same time. Next he got hold of the artillery liaison officer and arranged for the artillery to open at the same time.

At zero everything let loose, in a short burst, all together, the idea being to get over all the explosives possible in the short time it would take the party to get from their work into their trench. From the cries the fire was highly successful.

The following are some of the things that an infantry officer must take the trouble to find out for himself:

- (a) What batteries are covering his front.
- (b) Where the liaison and F.O.O.'s dugouts are.
- (c) S.O.S. signal.
- (d) Where the T.M. dugouts are.
- (e) Barrage lines (S.O.S.).
- (f) Forward O.P.'s.
- (g) Quickest way of getting in touch with his artillery.

The artillery covering him is just as much a part of his defense as his men and Lewis guns, and he should know how and when to use it just as well as he does the other weapons at his disposal.

The following are some of the things the artillery must be certain to tell the infantry:

- (a) When their range will be dangerous to the front line or outposts.
- (b) When a shot will be likely to bring heavy retaliation and what steps have been taken for a counter-retaliation.
- (c) Any changes in disposition.
- (d) Any changes in barrage lines.



## COÖPERATION BETWEEN INFANTRY AND ARTILLERY

### *S.O.S., or Retaliation Program*

#### *Short Rounds:*

(A) These were the cause of most of the grievance of the infantry against the artillery, and this grievance was mainly due to the fact that the infantry didn't know the reasons for these shorts. They felt certain it was due to the gunners' carelessness. They now realize that this is so rare as to be negligible. The main causes for short rounds are:

1. Defective ammunition (charges or fuzes).
2. Error of gun (50 per cent. and 100 per cent. zone error).
3. Heated or worn gun.
4. Prematures.
5. It may not be the guns covering your front.

#### (B) Immediate steps to be taken.

1. Do not lose your head.
2. Withdraw men if fault continues.
3. Advise artillery. Do not start the conversation by a flow of profanity. It will take just that much longer time to reach an understanding, during which time you and your men are apt to be hurt.
4. Give artillery as accurately as possible:
  - Map location of bursts.
  - Type of shell.
  - Height of bursts.
  - Angle of fire.
  - Number of rounds and time.

If the above is followed the matter will be quickly corrected and you will invariably find out it wasn't the gunner's fault.

### *Coöperation During Advances*

It is during the advance that the infantry reap the benefit of their efforts at establishing cordial relations with their artillery. Without the most perfect coöperation the best-trained infantry is lost.

## THE FIELD ARTILLERY JOURNAL

Before the attack the infantry can be of immense assistance to the artillery in locating enemy batteries, T.M.'s, machine guns, O.P.'s, etc., and in reporting on the results of wire cutting. Since the infantryman's life depends on the excellence of the artillery, it is up to him to use every means, day and night, of getting all the information possible to the artillery. The trained scouts and observers do a good portion of this work, and just before an offensive the battalion intelligence officer is one of the busiest and most important men on the front. He is a sort of general information bureau for his frontage, and must be fully prepared to answer the most minute questions as to his own and the enemy lines.

He will be called upon to give lectures to the battalion on the nature of the ground behind the enemy front line, as determined from observation, maps, and air photographs. He will have to take all kinds of staff officers to his O.P.'s and explain everything in detail. He will have to run the patrols all night and the O.P.'s all day. There is practically no sleep or rest for this officer at this time. It is on his shoulders that most of the responsibility rests for the close touch kept with the artillery.

When the attack has once gotten to its objective it is of vital importance that the artillery be notified at once as to just where our and the German lines are. It is no use calling for S.O.S. fire, when the counter-attack comes, unless the artillery know just where you are. They cannot put down a barrage without knowing where to put it. The best way to give them this information is by means of a sketch showing your position and that of the enemy as far as possible. These little sketches can be all drawn except the actual line before the attack starts, and they take only a minute to complete. Information of when and where your battle patrols are being sent out must be given to the artillery at the same time; otherwise they may be cut up badly by our own fire.

A method of locating our lines that is in common use now is by the use of air maps. A contact machine is assigned to a certain sized unit, usually about one per battalion or brigade, and it

## COÖPERATION BETWEEN INFANTRY AND ARTILLERY

flies over low at prescribed times, say once an hour. At these times it sounds a succession of "G's" on its Klaxon horn, and the infantry light then flares all along their front. The airman puts in the line on his map from these flares and, after taking any visual messages sent, flies back and drops his information at a report centre. From here it very quickly gets to the artillery.

The subject of the best means of communication in assault has been covered so fully by so many experts that it will not be touched on here except to say that it is one of the most important features of the assault and, if not properly arranged for beforehand, will be very likely the cause of losing a lot, if not all, of the ground taken, when the counter-attack is launched. Only too often the success of the entire operation depends on the quality of the information sent back. If an infantry officer hasn't a clear conception of this work, for his own sake and the sake of his men, he should at once make every effort to get some of the War Department publications on the subject. The information he will get from an hour's reading may very well mean the difference between success and failure in a few months' time.

In conclusion of this subject of coöperation, it is again stated that it is the infantry who receive the greatest benefits and whose very lives hang on it, and therefore they must not sit around and wait for the artillery to open negotiations, but must get up and start things. They should drop this banter at messes that is so noticeable at present. While done only in fun, it tends to draw a line between the artillery officers and the infantry officers.

In a mixed mess you will notice that one branch sits on one side of the table and the other branch on the other, a kind of mobilization for the battle of witty remarks that takes place at every meal. This is wrong and, while apparently harmless in peace conditions, may have very serious results in battle. Get together. Both branches are members of one big service, each, by his own work, aiming and helping toward one big result, the destruction of Germany.

# Lecture on Use of Artillery in Defensive

DELIVERED BY MAJOR LEGRAND, FRENCH MISSION, SEPTEMBER 27, 1917

THE prolongation of the war, the form it actually assumes, the constant and growing increase of matériel with all belligerents, and its increasing power, make the rôle of artillery more important every day.

All the operations during the last two years have shown this, and have shown, also, that, to be efficient, the defence must be very active.

In their offensives the Germans have employed their guns in the following manner (in accordance with our own principles, also):

They have started a bombardment on a large front and a great depth of ground before each one of their attacks, making the point specially aimed at very doubtful and uncertain. After several hours the bombardment has increased on the point of attack without stopping on the other points. After the assault was delivered the bombardment was continued with the same intensity in the rear and on the flanks of the region specially attacked.

At the same moment, or more usually one or several hours afterward, the intensity of fire grew on another point of the bombarded front; a preparation was completed and then followed by an attack on this new point.

Several hours before the attack, during it, and a long time after it was delivered, a heavy bombardment with 105's, 130's, and 150's, and especially with gas shells, was performed on all the communications (approach trenches, paths, tracks) at the rear of the front to prevent the movements and supplies of the attacked troops.

The tactics to be used by the defence, which has obtained full success when it has been applied in due time, consists in answering every preparation by an identical counter-preparation; every

## LECTURE ON USE OF ARTILLERY IN DEFENSIVE

increase of fire on one point by a similar increase of fire on an enemy's point in the vicinity from which the assault could start, thus crushing the storming troops before the outlet.

At the same time one must endeavor to destroy, or at least neutralize, the hostile batteries.

However, the task in this duel is far more difficult for the defence than for the attack.

The attack has chosen the day and the place, and has been able to obtain an intense increase of bombardment, to concentrate the fire of numerous batteries, many being specially established for this purpose, successively directing their fire from one end of the battlefield to the other.

The defence must answer with the greatest power and rapidity possible; but its action, at least in the details, is improvised. Its retaliation comes in time only if the artillery is extremely supple, able to receive rapidly all information, use it without delay, and concentrate on successive targets all the means at its disposal.

That suppleness, absolutely indispensable in giving the artillery the utmost activity in the defensive, must be searched for in the organizations of the command, of the artillery information service, and of the liaisons; in the technical improvement in the use of the guns, and in a methodical preparation of the work which will reduce to a minimum the improvisation in a critical moment.

The instruction of the French Great Headquarters, dated May 27, 1916, indicates the different means of using the artillery in the defensive.

### CHAPTER I—ARTILLERY'S MISSION IN DEFENSIVE

The artillery is the principal weapon in active defence, for alone it is able—

- (1) To reach, at any time, the enemy's vital points;
- (2) To hinder and often to stifle all his offensive preparations before they develop;

## THE FIELD ARTILLERY JOURNAL

- (3) To regain rapidly in case of attack, the balance of power.

Therefore, the duties of artillery will be—

- Systematic destruction of enemy's forces;
- Offensive actions on sensitive points of the front;
- Counter preparations and barrages.

### CHAPTER II—ORGANIZATION OF COMMANDS

The organization of commands is based on the following principles:

- (1) All the artillery placed at the disposal of any unit (division, army corps, army) is grouped under the orders of one commanding officer only.
- (2) The calibres are divided between the different *échelons*, leaving to each command the batteries which work normally for it and grouping with the next higher command the batteries which have a normal action over several sectors.
- (3) Each command has the duty to prepare thoroughly the plan for the rapid interference of the greatest possible number of batteries to second the troops in need of it.

According to these rules, artillery's assignment is as follows:

- (a) To generals commanding sectors (usually divisions):

The normal artillery of the division, reinforced by the groups of army corps' artillery which the artillery corps commander thinks he can place at their disposal;

The trench artillery;

The batteries of curved fire artillery (155 howitzers and mortars of 220 mm.).

- (b) To generals commanding the Army Corps will be assigned:

## LECTURE ON USE OF ARTILLERY IN DEFENSIVE

The corps artillery which the commander wishes to keep exceptionally under his direct orders.

The heavy artillery of medium calibre (95 and 120 guns and eventually 105 and 155 guns, as well as a few batteries of howitzers of large calibre).

(c) To the general commanding an army will be assigned:

The heavy artillery of long range or large calibre (100 mm., 105 mm., 140 mm., 155 mm., 16 cm., 240 mm., 270 mm., 280 mm., 370 mm., etc.) and the railway heavy artillery.

The foregoing assignment is, of course, not absolute, and can be modified according to circumstances; it must not create sharply defined limits, bulkheads between sectors or army corps or armies.

It is of greatest importance that, in case of emergency, all the batteries capable of coming into action may intervene on the threatened point, no matter to what groupement they belong, or from what officers they receive orders.

It is therefore necessary to take the measures to facilitate this intervention, and to include them in a special chapter on the "Plan of Defence of the Artillery."

### CHAPTER III—EXECUTION OF MISSIONS ENTRUSTED TO ARTILLERY

#### 1. *Fire for Destruction*

These daily fires aim at the progressive destruction of the different elements of the enemy's forces, proportioning the expense of ammunition to the importance of the target.

The fire is always an accurate fire, well adjusted and constantly observed. It is continued, the allowance of ammunition permitting, so long as is necessary to accomplish the destruction.

## THE FIELD ARTILLERY JOURNAL

DESTRUCTION OF BATTERIES.—The destruction of the enemy's artillery is the most important factor of success, from both a moral and material aspect. Every hostile battery destroyed is one step gained; the destruction of the enemy's artillery must not be left until the eve of a battle, nor neglected until the enemy attacks.

The struggle against hostile artillery must therefore be the constant consideration of commanders. The counter-battery work is not a matter of spasmodic effort, but it is a continuous operation, depending for success on accuracy of fire, continuity of plan, unremitting study, and firm control.

The generals in command of the army corps must pay very particular attention to this destruction of batteries, and therefore establish a plan of methodical destruction.

Guns and howitzers of all calibres may be employed for this task. The requirements of the tactical situation alone indicate the nature and volume of artillery fire to be devoted to each phase of artillery action.

All means of observation must be fully considered and carefully organized. Artillery must not look upon the aeroplane as essential to successful fire; observation from the air and the possibility of delivering an accurate, though unobserved, fire by means of calculation; must not belittle the value of direct observation from the ground, which remains, whenever it is possible, given well-selected observing posts, good liaisons, and observers who know how to observe, the best means of observation.

DEFENSIVE WORKS.—Their destruction is accomplished in each sector by the artillery of the sector, according to orders of the general in command of the sector. He chooses the best opportunity and asks, if necessary, the desired calibres and an extra allowance of ammunition.

The destruction of the enemy's observing stations must not be overlooked among these objectives.

UNITS OF ENEMY'S TROOPS.—These targets are generally fleeting; the fire must be opened and executed very rapidly. The officers commanding battalions or batteries in whose zones



## LECTURE ON USE OF ARTILLERY IN DEFENSIVE

these targets appear have consequently full initiative. Furthermore, in each battery, all important points of the ground are exactly registered; firing charts and data books are carefully kept up to date; firing data established in advance and the range of the moment determined, as well for heavy as for field artillery.

### *2. General Bombardments*

These bombardments are executed by concentration of the fire of several batteries at the same moment, on the same target or the same zone, and constitute real fire attack.

The target can be either a portion of the enemy's front where aggressive intentions have been noticed; offensive works; preparation for gas emission; drum fire on our opposing lines, etc., or nests of batteries.

Concentrations are ordered by the generals in command of divisions, army corps, and armies, but they may, for certain objectives and in order to avoid delay, delegate this authority to their artillery commanders.

It is very important to be able to execute fire for concentration with utmost rapidity on any part of the front.

Delay in receiving the necessary information and in controlling the fire may be avoided by a good organization of the observation and liaisons.

A plan of observation is established, therefore, in every artillery high command.

Delay in carrying out orders may be avoided by creating concentration tables showing, for each square of the firing chart, the batteries which can fire at it.

Delay in opening fire may be avoided by each battery by preparing beforehand the data for each target and carrying out with great discretion the necessary adjustments.

### RULES OF EXECUTION

(a) Concentration does not prevent in the least the battery commanders from firing with accuracy at a defined target, and, even if fire for concentration is given on a zone, each battery must always receive in that zone a well-defined target.

## THE FIELD ARTILLERY JOURNAL

(b) The result of the concentration fire is the best when the target zone is smallest, the batteries most numerous and most judiciously chosen.

(c) Accuracy of adjustment depends on the target: large brackets against cantonments and important columns; close adjustments against batteries; fire absolutely against trenches and communication trenches.

(d) The batteries used for a concentration generally execute simultaneously fire for effect so as to realize fully the surprise and give the enemy the sensation of being crushed.

(e) During the fire for concentration the infantry must play its part, especially when one is firing on the first lines, for, if threatened, the enemy will man his trenches.

(f) Our infantry is always warned of these fires for concentration, so as to allow it to take all necessary measures of safety.

### 3. *Defensive Fires*

Defensive fires are intended to check the attack of the enemy's infantry before they gain our first-line trenches.

All the artillery available coöperates in this defensive fire.

The manner in which to use artillery in such a case, and the results one can expect, depend:

(a) On the nature of the means of which one can make use, and

(b) Their quality.

It is therefore necessary to consider separately:

1. The defensive battle in which the artillery of the defence has been reinforced and has become about as powerful as the hostile artillery.

2. The defence of the quiescent fronts, in which the artillery of defence is to resist with its normal means a concentration of the enemy's powers and, as a rule, is therefore in a position of inferiority.

1. *Defensive Battle.*—The artillery coöperates in the defence

## LECTURE ON USE OF ARTILLERY IN DEFENSIVE

in two distinct forms—Counter-offensive, Preparation and Barrage.

The counter-offensive preparation is the most powerful means of defence, if executed as indicated by the instruction of May 27, 1916. Answer every preparation by an identical counter-preparation; every increase of fire on a point by a similar increase on the point opposite, thus crushing the storming troops before they start the attack. At the same time, endeavor to destroy, or at least to neutralize, the enemy's batteries.

Counter-offensive preparation is for the purpose of checking the enemy's attack before he leaves his trenches, by the violent bombardment of the trenches where the storming troops are likely to assemble.

It is ordered, according to circumstances, by army corps or division commanders, each time one notices signs of attack, and it is carried out on the sector directly threatened.

For field artillery, it consists of a violent fire for effect during a few minutes on the works of the enemy's first lines (trenches, supports, and communications). The commander fixes, according to circumstances, the intensity and duration of this bombardment.

For the howitzers, it consists of an intense bombardment on certain works.

For the long-range artillery, independently of its counter-battery work, it consists of prohibition fires on the rear communications.

When executed with such powerful means, the counteroffensive preparation should check the attack, as the enemy's infantry, when it comes out of its shelters, becomes very vulnerable.

Nevertheless, however carefully prepared, the counteroffensive preparation may be a failure, because it is difficult to discern accurately where to give it and when to start it.

Should the counter-offensive preparation prove a failure and the storming troops jump out of their trenches, then is the time to start the barrage.

## THE FIELD ARTILLERY JOURNAL

BARRAGE.—The barrage is intended:

- (1) To check the enemy's attack at the very moment of the assault.
- (2) To prevent any arrival of reserves brought to feed and sustain the attack.

The barrage is the form taken by the counter-offensive preparation when the enemy gets out of his trenches. At that very moment only field artillery guns have time to modify their methods of fire. While the howitzers and guns which fired on communication trenches and important crossings keep on firing as they did in the counter-preparation, the 75-mm. guns, which fired on the first-line trenches, shorten the ranges as much as possible, so as to get ahead of the assaulting wave, which is progressing in the open, and then sweep methodically all this open ground; afterward they lengthen progressively their ranges and settle again on the enemy first lines.

Barrage is executed by the field artillery guns and the howitzers. It is completed by the action of long-range artillery on the rear of the enemy's position.

Everything must be arranged in the regiments, battalions, and batteries so that the counter-offensive preparation is automatically followed, in case of emergency, by the barrage.

BARRAGE OF FIELD ARTILLERY.—All the field artillery, without any exception, must coöperate in the barrage. When the fronts to defend are large, each battery has a distinct sector. When the fronts are narrow enough, the fires of several batteries can be superimposed, but the assignment is made so as to reinforce a barrage already dense enough by itself, in the event of the original battery being neutralized.

It is advantageous, each time it is possible, to assign the same bounds to the front covered by the barrage of an artillery unit to the sector defended by an infantry unit.

The barrage must form a continuous curtain as near our lines as the safety of our infantry will permit. This distance varies with the lay of the ground, the emplacement of the batteries, and the shells or shrapnel to be used.

## LECTURE ON USE OF ARTILLERY IN DEFENSIVE

To be of real efficiency, it must be placed in front of the enemy's first lines, or at least on them. Regimental commanders must try, by every possible means, to have this kind of barrage. If necessary, the guns are brought nearer; some are placed to give enfilade fire; the batteries use percussion shrapnel, etc.

If, on the contrary, the barrage is placed in the rear of the first hostile lines, the enemy will be able to mass the troops in these and start the assault without suffering from our fire. The barrage has in such case scarcely any value.

OPENING OF THE BARRAGE.—The barrage must be started automatically and instantaneously, according to a plan previously arranged. All arrangements must be taken in batteries to avoid any delay. When not firing, the guns are laid on their barrage lines; the successive ranges and kinds of fire, well known by all, are marked on data charts near each gun, and the range of the moment is carefully determined. There is always at least one gun squad on guard; a rocket watchman, with a well-defined sector, is permanently on guard in each battery; communications with the infantry are constantly tested.

The signal for starting barrage can be given on demand of the infantry (by telephone, optical signals, rockets), on indications from observing stations, airplanes, balloons, or when the situation seems to need it (gas attacks, sharp musketry and machine-gun fire).

EXECUTION OF FIRE.—The execution of fire includes at the start the greatest speed allowed, and then is modified according to the desires of the infantry or on the orders of the battalion commanders.

VARYING OF BARRAGE.—When the intense barrage is started, it is advisable to modify it so as to obtain greater efficiency. When barrage is made in front of enemy's first trenches, the ranges are progressively lengthened and the screen fixed on these first lines. When the barrage is executed on the enemy's first lines, it remains there. When it is given in the rear of the enemy's first lines, it is fixed, if possible, on the support and approach trenches.

## THE FIELD ARTILLERY JOURNAL

If the enemy has penetrated in our lines, the batteries must be able to bring back whole or part of the barrage on the portion of the trenches occupied by the enemy.

**BARRAGE OF HOWITZERS.**—The action of howitzers is not the same as that of field artillery. While the 75-mm. guns form a screen on the whole front, the howitzers fire on precise points at the rear of the first lines (intersection of trenches and approaches, C.P., groups of shelters), to prevent the arrival of reserves. The barrage of howitzers is not started automatically in that case, but following the orders of the colonel commanding the artillery of the sector.

To sum up, the barrage in the defensive is characterized by its short duration and the uncertainty in starting it at the right time. It will be very useful to prevent the arrival of reinforcements and reserves, but it will not always give good results on the first assaulting waves.

The counter-preparation, which may have a long action on all these objects, remains, therefore, in the defensive battle the safest and most powerful action of the artillery.

2. *Defence on Quiescent Fronts.*—One must admit that a high-powered attack will not be started on a quiescent front without any preliminary signs, which will cause a reinforcement of the artillery, and in which case the counter-offensive preparation and barrage will be able to give, at least partially, the same results as in the defensive battle. Most generally on quiescent fronts one has only to resist local attacks and simple raids.

On quiescent fronts the artillery consists only of the batteries of the infantry division holding the sector. It is possible to concentrate on any point of the enemy's lines the batteries a distance of five or six kilometres. The number of guns able to coöperate in such a concentration depends, therefore, on the front of the division and the emplacements of the batteries. As a rule, with four battalions of 75 mm. in the division, if the front is of 12 km., one can concentrate seven to nine batteries.

The principles governing the usage of these guns are always the same as in defensive battle. Before the attack, try to destroy

## LECTURE ON USE OF ARTILLERY IN DEFENSIVE

the storming troops in their trenches; when they attack, try to check them in the open.

As there are rather few howitzers, it is not possible to destroy the shelters before the attack, so fire should be given on trenches and approaches. It should be very heavy, but intermittent; frequently started over again in order to take the enemy by surprise while gathering his storming troops. This cannot be considered as a real counter-offensive preparation, as there will be very little destructive effect.

If the moment when the attack is started can be discerned, the largest part of the fire will be brought back and placed as near our lines as possible. The barrage will be, at least in its mechanism, exactly the same as in the defensive battle.

*These fires must be dense enough*, the rule being not to have less than one battery for each 200 metres of enemy's front. It will generally be possible to give a dense enough barrage at more than 1000 to 1200 metres to resist a local attack. Of course, against a larger attack, one must not stay inactive; the means to be used will be the same, and if they don't succeed in checking the attack they will at least inflict heavy casualties on the assailant.

One must never be forced by lack of batteries to assign the barrage to a wide front; they would become everywhere entirely inefficient on account of their lack of density. They must, on the contrary, be concentrated on a few well-selected places where the enemy is the most vulnerable. This compels one, when the front of a division is larger than 2500 metres—that is, on all quiescent fronts—to settle the normal barrage only in front of the sensitive points, thus giving to it, in such places, a high density. These sensitive points are the points on which probably an attack will be started, and this attack can thus be checked instantly. If the attack starts on other points, the batteries should be concentrated in the same way, but only in case of need. Such concentration should, of course, be carefully prepared beforehand. If the attack is started on a broad front, the artillery will not

## THE FIELD ARTILLERY JOURNAL

only work on limited points, but will have a high power on such points.

To resume, the intervention of artillery in defensive will take place as follows:

In the defensive battle: Counter-offensive preparation, with barrage started when the enemy's waves arrive in the open. This preparation will give the most powerful and safest effects along quiescent fronts by concentration on the zone of outlet of the attack by all batteries able to fire at it; and eventually local barrage, as has been seen above.

**ACTION OF TRENCH MORTARS.**—Their action is the same as those of howitzers; they fire on particular works of the enemy's lines and enter into action on the order of the artillery groupement commander in whose sector they are, according to the demand of the infantry.

**ACTION OF HEAVY GUNS OF LONG RANGE.**—They coöperate in the barrage by:

- (a) Counter-shelling the enemy's batteries;
- (b) Bombarding cantonments and bivouacs in the sector of attack;
- (c) Firing on the enemy's communications at the rear;
- (d) Firing, instead of field artillery, in case of need on the enemy's first lines.

The fire for counter-battery is given without orders, as soon as the hostile batteries are seen in action, while the fire on cantonments and bivouacs is ordered by the general in command of the army corps artillery.

**SUPPORT OF THE ARTILLERY OF NEIGHBORING SECTORS.**—In case of local attack, the artillery of non-threatened sectors support the artillery of the attacked sector with a certain number of the batteries, following the plan of barrage and the special orders of the army corps commander.

**PLAN OF BARRAGE.**—A plan of barrage is always established, indicating:

- Point to be fired at;
- Methods of fire;
- Rate of fire;



## LECTURE ON USE OF ARTILLERY IN DEFENSIVE

Arrangements made in the batteries for immediately starting barrage during day or night;  
Use of trench mortars;  
Use of heavy artillery;  
Support of neighboring artillery;  
Observing stations and liaison.

### EMERGENCY FIRE

(a) Harassing Fire: Is generally executed by a single gun firing at irregular intervals. It is intended to hinder the movements of supplies for enemy's troops, and is directed on the most frequently used paths, roads, and tracks, according to information given by S. R. A. When the circumstances permit, it will be executed by gas shells.

(b) Retaliation Fire: Retaliation fire is executed to support the infantry's morale by showing them that the artillery is on guard and to prove to the enemy our firm will to return every blow with interest.

This fire is executed by the field artillery whenever possible, and directed on trenches and cantonments, according to the enemy's bombardment of our own trenches and cantonments. It is executed with a higher intensity and accompanied, every time it is possible, by a counter-battery fire on the batteries in action.

## CHAPTER IV—PREPARATION OF THE ARTILLERY'S WORK IN THE SECTORS

In all the army, army corps, and divisional staffs will be executed:

- (a) A plan for the use of the artillery, including the following chapters:
- (1) Organization of commands.
  - (2) Allotments of duties between the *groupements*.
  - (3) Rôle of heavy artillery and organization of counter-batteries.

THE FIELD ARTILLERY JOURNAL

- (4) Counter-offensive preparation, with indication of measures to shift rapidly to the barrage in case of need.
- (5) Plan of barrage:
  - (a) Allotment of duties.
  - (b) Objectives to be fired on (with sketches).
  - (c) Preconcerted dispositions to start instantly the barrage (liaisons, signals, day and night organization in the batteries).
  - (d) Methods of fire; speed; quality; intensity; cessation, etc.
  - (e) Concentration to foresee in case the enemy's attack is limited to the portion of the front of the unit only.
  - (f) Support received from or given to the neighboring divisions.
- (6) Plan of retaliation fire.
- (7) Index book of concentrations.
- (8) Plan of observation and liaison:
  - (a) Map of observation and information stations; ground observing posts; balloons, wireless posts, etc.
  - (b) Map showing the parts visible and hidden for each terrestrial observation station.
  - (c) Same map for the balloon.
  - (d) Assignment of the observing personnel.
  - (e) Normal and eventual assignment of observing posts between the artillery units.
  - (f) Map of liaison of all kinds between observing stations, balloons, squadrillas, wireless rods, C. P., battalions, and batteries.

## LECTURE ON USE OF ARTILLERY IN DEFENSIVE

- (g) Duties of the observing personnel.
  - (h) Equipment for observing posts.
  - (i) Plan for an eventual retirement.
  - (j) Plan of distribution of ammunition.
- (b) A plan of possible reinforcement of the sector by batteries of all calibres coming from outside. This plan deals with the case of an important attack of the enemy. It includes:
- (1) List of prearranged reinforcements.
  - (2) Organization of commands.
  - (3) Assignment of missions and emplacements.
  - (4) Organization of C. P., O. P., and liaisons.
  - (5) Map of itineraries.

### CHAPTER V—MATÉRIEL ORGANIZATION OF THE ARTILLERY

(a) *Battery Positions*.—The battery positions are determined by their tactical missions. In the field artillery they are determined by their rôle in the barrage. To obtain a barrage in front of the enemy's lines, one must not hesitate to move the batteries, and even to place them in a neighboring sector, so as to obtain enfilade fire. The batteries must be *écheloned* in depth to insure the continuity of barrage, whatever may happen; they must be placed so as all of them, or at least a certain number, can beat our first and second lines.

The batteries must have a wide field of fire (at least 1200 mils), to be able to coöperate in the concentrations of fire. The positions of curved fire batteries are determined by the necessity of firing with great intensity on the enemy's first line and at the rear of it. They must have as large a zone of action as possible.

The positions of long-range batteries are determined by the necessity, while having ranges *écheloned* in depth, of reaching even the most remote of the enemy's batteries. This may result in placing the batteries in front of the field artillery.

Battery positions are to be prepared beforehand for the batteries of reinforcement.

## THE FIELD ARTILLERY JOURNAL

(a) How to Choose the Positions: The battery positions are to be selected so as to conceal the batteries from terrestrial and aerial observation. The positions can be ranged in following order, according to the increasing difficulties they give to the enemy's observations and adjustments:

- (1) Normal casemated battery in the open, with a reference point (tree, lone house) in the vicinity.
- (2) Normal casemated battery in the open, without any reference point in the vicinity.
- (3) Irregularly placed casemated battery.
- (4) Casemated battery in a steep slope, on the side of a road, or at the edge of a wood.
- (5) Casemated battery hidden in an infantry work; in a network of trenches.
- (6) Guns with lattice under a line of trees.
- (7) Guns sheltered under the roofs in a village.
- (8) Isolated guns in a big wood.

(b) How to Organize the Positions: The whole position is to be sheltered by camouflage, and not only isolated portions of it.

The parts of a position most easy to see are the tracks leading to it. One must use as much as possible the tracks already existing and prevent the men from creating new ones, especially tracks ending in a "blind alley." To hide the battery itself, make use of the infantry works; place the guns in an irregular way in connection with the lay of the ground. To hide the guns, avoid the well-marked contours of the casements, take large intervals, place the guns behind a road on a path already existing so that the blast cannot mark on the ground. Do not lengthen the telephone trenches to the battery itself.

(c) Assignment of Targets: The zone of action of artillery is divided between the different artillery commands (Army, Heavy Artillery, Army Corps Heavy Artillery, Divisional Artillery) into well-determined sectors, according to the difference of calibres. A similar assignment is made inside the *groupements* between battalions and batteries so that every one (battery,

## LECTURE ON USE OF ARTILLERY IN DEFENSIVE

balloon, airplane, observing station, agent of liaison) knows what unit must intervene as soon as an objective appears. Every battalion must have, besides its normal zone of action, an eventual zone of action in case of need.

(d) Registrations: All necessary adjustments are to be made beforehand and registered in the data books to permit an immediate intervention of the batteries in their normal or eventual zones.

(e) Collection, Transmission, and Use of Information: In the defensive, any kind of fire must be started without delay by the artillery; it is therefore very important to organize very carefully the collection, transmission, and use of information.

1. *Collection of Information.* It is made in two ways:

(a) By means of permanent agents of liaison. Each artillery battalion commander sends an officer of his staff near the infantry colonel of the regiment which he must support (subsector commander). This officer has under his orders a liaison and observation detachment, consisting of noncommissioned officer-observers and noncommissioned officers of liaison (one or two for each battalion of the first line), and telephone operators and signalmen with the necessary matériel. The officer, chief of this liaison detachment, remains near the colonel and goes in the sector anywhere it is necessary to insure proper liaison and observation. He detaches noncommissioned officers of liaison near each battalion commander of the first line and establishes his connection with them (telephone, signals, courier). All this personnel remains permanently with the infantry. It completes a close connection between infantry and its supporting artillery, informing the infantry of all the possibilities

## THE FIELD ARTILLERY JOURNAL

of action of the artillery, and the artillery all the needs of the infantry.

The officer reports daily to his battalion commander all the information he can gather and all events of the day. This personnel can start the barrage if asked to do so by the infantry, and can also conduct the fire for adjustment for the batteries of their battalion.

- (b) By means of terrestrial and aerial observations. The principles for organization are as follows: All observing stations of any kind, ground posts, balloons, airplanes, are—
- (1) Independent and are to work for any unit when required.
  - (2) To participate in both operations—collection of information and adjustments.
  - (3) Connected by telephone with both commands and battalions and batteries, so that information or rangings reach their destination in the minimum of time.
  - (4) Connected by telephone between one another to complete and check their observation.

2. *Transmission of Information.*—It is effected by means of:

THE TELEPHONE. The telephone network includes—

The network artillery-infantry, established in accordance with the note of May 4, 1915, (No. 2073) of General Headquarters. It is a double liaison established on one side by the infantry and on the other by artillery.

The artillery network is used to establish direct communications between the army artillery commander, the army corps artillery, and divisional artillery commanders, the *groupements*, battalions and batteries, and the observing stations.

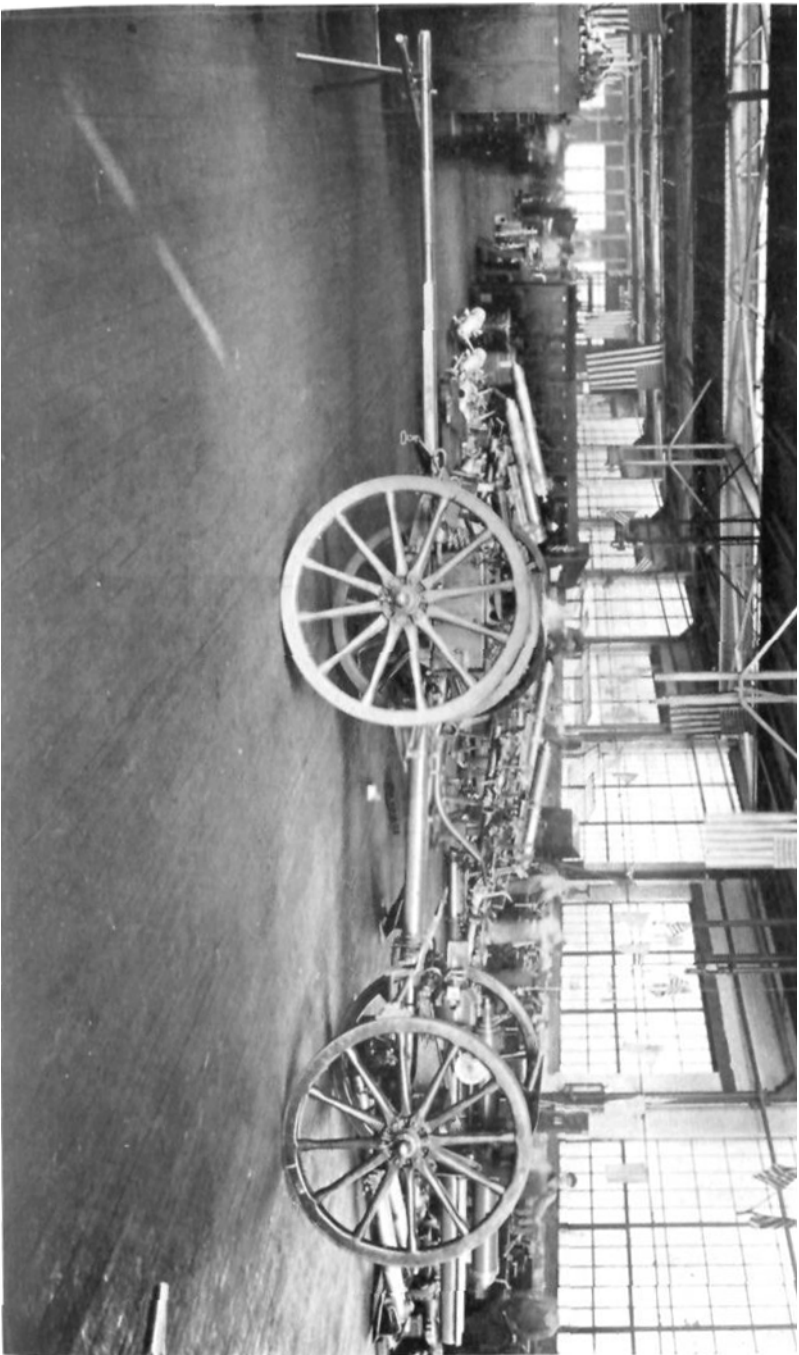

75-MM. FIELD GUN, MODEL 1917 (BRITISH), GUN LIMBERED

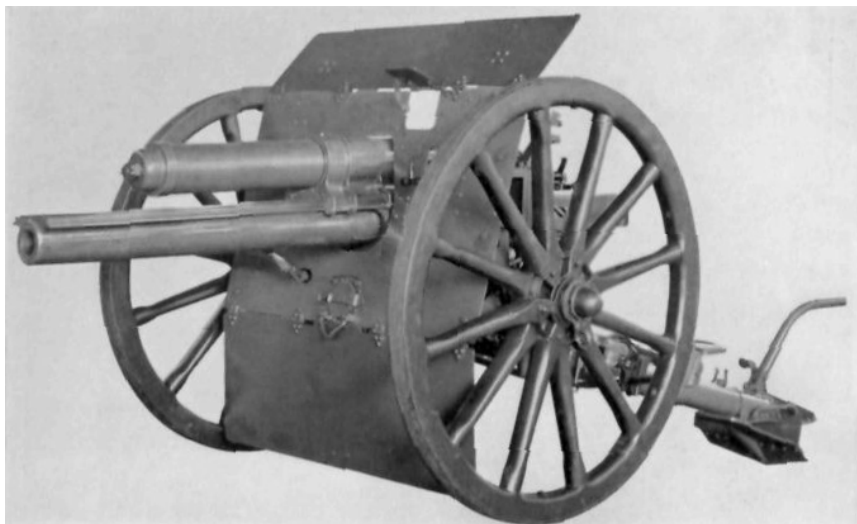

75-MM. FIELD GUN, MODEL 1917 (BRITISH), GUN IN FIRING POSITION

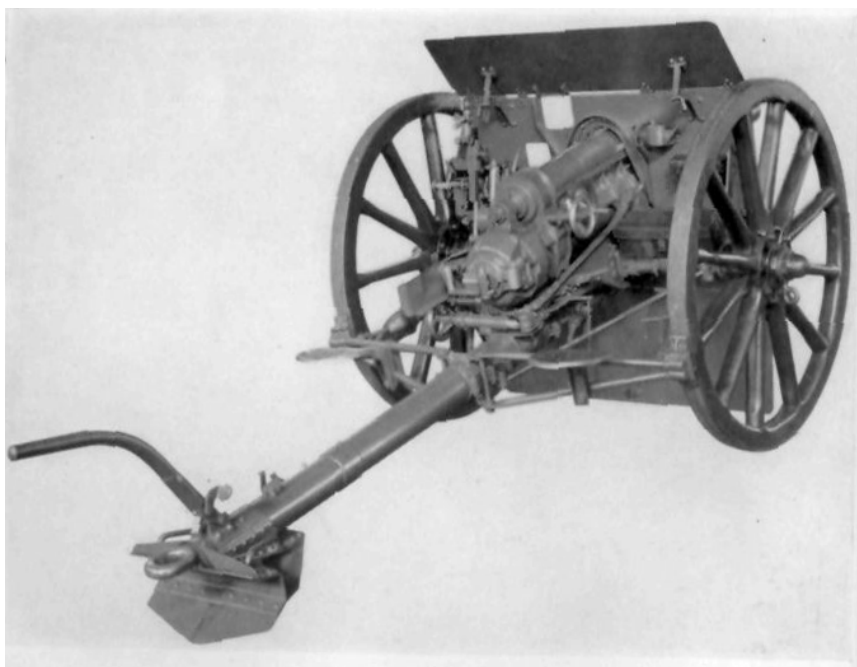

75-MM. FIELD GUN, MODEL 1917 (BRITISH), GUN IN FIRING POSITION



## LECTURE ON USE OF ARTILLERY IN DEFENSIVE

In the army artillery, between the army artillery commander, the officers in command of *groupements*, battalions, batteries, and observing stations.

The artillery network is also used to establish lateral communications between all the commanders of artillery, of *groupements*, of *sub-groupements*, of battalions, of batteries, whatever may be their calibres, and between all observing stations.

Transmission of information can also be made:

- (a) By visual signalling, which usually doubles the telephone liaisons between artillery and infantry, and can also be organized between observing stations and batteries.
- (b) By rockets, or any other means which can replace the telephone or visual signalling for barrage.
- (c) By wireless between airplanes and batteries and between infantry and artillery commands.
- (d) By ground transmission, sounds transmission, pigeons, etc.

3. *Utilization of Information.*—It varies according to the objective. If the target is fugitive, the observer warns immediately the *groupement* commander or battalion commander whose guns can fire at it, and the fire is started without delay. If the objective is important or remaining a long time in the field of view, the observer reports to the artillery commander of the sector, who can give orders for a concentration fire, and avoids, therefore, the lack of coördination between his battalions.

# Firing Charts and the Reconnaissance Officer

A SERIES OF LECTURES DELIVERED AT THE SCHOOL OF INSTRUCTION FOR FIELD ARTILLERY  
AT —, FRANCE

BY MAJOR WALTER S. STURGILL, FIELD ARTILLERY, SENIOR INSTRUCTOR,  
INSTRUCTOR IN FIRING CHARTS AND MAP WORK  
(Based on "Manuel de L'Officier Orienteur D'Artillerie")

## FIRST LECTURE

- I. *Generalities.*
- II. *Equipment:*
  - Maps.
  - Lambert's Projection.
  - Map Squares.
  - Examples.
- III. *Units of Measure:*
  - Angular.
  - Linear.
- IV. *Magnetic Declination:*
  - General.
  - To Orient the Plotting Board.
  - To Obtain the Declination of the Plotting Board.
  - To Orient the Plotting Board with the Compass.
  - To Orient a Map.

### I. GENERALITIES

THE conditions of warfare that have existed on the Western Front for the last three years have revolutionized the science and use of firearms. The power of the defensive has increased to such an extent, through trench warfare and its various accessories, that science and ingenuity have been taxed to the utmost to break down this power. Deeper and ever deeper trenches and shelters, the use of concrete and metal covering, powerful barbed-wire entanglements, etc., the destruction of all of which is necessary to enable the infantry to advance, have given to

## FIRING CHARTS AND THE RECONNAISSANCE OFFICER

artillery a rôle never before imagined; a position of responsibility of primary importance; a mission the success or failure of which spells victory or defeat.

The necessity of firing from masked positions, of hitting, often at great ranges, as many times as possible, small, skilfully concealed, powerfully protected targets, under vastly varying conditions of observation or with no means of observation, has given the subject of "*The Determination of Initial Firing Data*" a place of first importance among the duties of field artillery officers. It is no longer admissible for the battery commander to calculate his deflection approximately to within 30 or 40 mils, say, or to measure or estimate his range to within 200 or 400 yards, upon the assumption that he will be able to sense his first salvo and make corrections accordingly. The existence of any one of numerous conditions constantly encountered on the front may make impossible the observation of any portion of the terrain except that in the very immediate vicinity of his target—the necessity of adjusting by balloon or aero observer, or of adjusting when many other batteries are firing in the vicinity; of firing at a target when no observation is possible, or at a fugitive target; the saving of ammunition or, of what is often more important, *time*—all these facts emphasize the importance of accuracy—not that adjustment may be rendered unnecessary, but that the time consumed may be reduced to the irreducible minimum. The coördination of many groups of artillery, the concentration of a great number of guns on a small front, the precise assignment to sectors and targets, in order to insure efficient results—these duties of the higher commanders, no matter how well performed, will be barren of fruit unless those under them do their work accurately, thoroughly and quickly.

## II. EQUIPMENT

Firing from the map has become the rule and the necessity. Accurate maps are essential, and such are, fortunately, ready for our use. In addition to maps, we must have distance-, angle-, and slope-measuring instruments, in order to utilize the information

## THE FIELD ARTILLERY JOURNAL

contained on the maps and to determine certain data from the ground itself. The instruments are: the plotting board and tripod, the firing board, the box compass, the alidade-slope rule, the stadia, the surveyor's alidade, the Peigné (prismatic-mirror) compass, the aiming-circle, steel chain, protractor, square, rulers, scales, etc.

*Maps.*—The maps in which we are particularly interested and which are used throughout the front in France are what are called "Plans Directeurs"—we call them "Firing Maps" or "Firing Charts." They are made to large scales (1/20,000, 1/10,000,

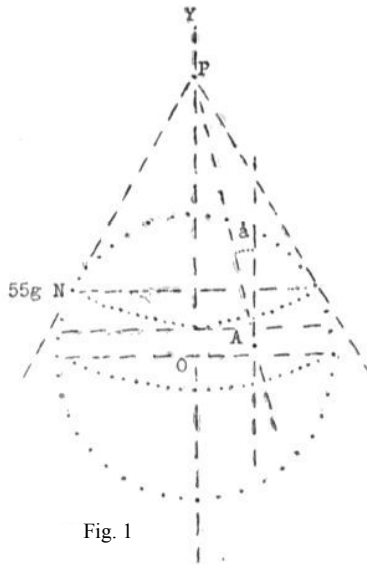

Fig. 1

1/5,000), the 1/20,000 being the one mostly used. They have been made according to the Lambert system of projection.

*Lambert's Projection.*—Without entering into detail concerning the construction of maps according to this system, the method may be briefly explained as follows (see Fig. 1):

The projection is obtained by considering the cone which is tangent to the terrestrial sphere along the parallel 55 grades north of the equator, the cone being developed around the generatrix represented by the meridian passing through a point

## FIRING CHARTS AND THE RECONNAISSANCE OFFICER

6 grades east of Paris. The meridians are right lines converging at the vertex of the cone. These lines make with each other an angle proportional to their difference of longitude, or which is given by the formula  $(M-M') \sin 55$  grades, or  $(M-M') \times 0.76$ . The parallels are concentric circles (the vertex of the cone being the common centre), so spaced as to make the projection uniform; that is, to preserve angles. Lengths are preserved in the neighborhood of the parallel of origin, but are increased when far away. By means of a certain numerical factor used in the construction, lengths are preserved on the two parallels of 53 and 57, 2 grades on each side of the meridian of origin. But these parallels and meridians are not traced on the maps. Instead, a system of kilometric squares is used, the  $Y$ -axis of which is the meridian of origin and the  $X$ -axis of which is the right line tangent to the parallel 55 grades at the point of origin. So that at any point  $A$  considered, the  $Y$ -axis makes with the local true meridian an angle equal to the convergence of the meridians, that is,  $a$  equals  $(M-M_0) \times 0.76$ . But  $M_0$  is equal to  $-6$ , the origin being 6 grades *east* of Paris, therefore the convergence,  $a$ , equals  $(M + 6) \times 0.76$ ,  $M$  being the longitude of the point considered.

To avoid having to deal with negative coördinates, the coördinates of the origin are numbered.

$$X = 500,000 \text{ m,}$$

$$Y = 300,000 \text{ m,}$$

$X$  increasing from west to east and  $Y$  from south to north. Each sheet is divided into squares, as above stated, the sides of which are one kilometre long, the axes being numbered along the sides and ends of the sheet.

Any point on the map is then definitely located if its coördinates are given in terms of six figures each, thus:

$$X = 391,675,$$

$$Y = 142,786.$$

The first digit of each coördinate taken together indicates the sheet on which the point is to be found; the next two of each serve to locate the southwest corner of the particular kilometric

THE FIELD ARTILLERY JOURNAL

square in which the point is; the last three of each locate its exact position in this particular square, measured to the nearest metre, fractions of metres not being considered.

In numbering targets or other points on the map, to avoid obscuring details the coördinates are usually given in four figures. For instance, a point having  $X = 395,655$  and  $Y = 248,755$  would be numbered 56.87, the first two and last two

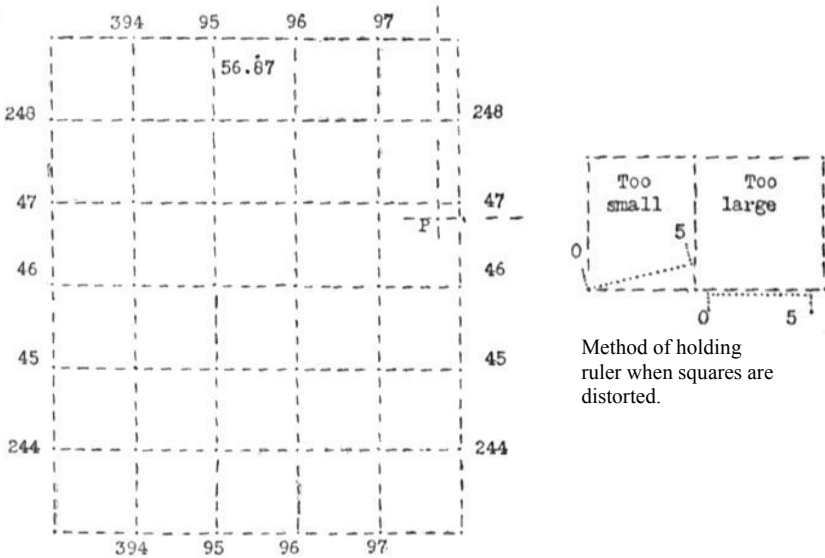

Find the coordinates of P, having given: x equals -102,250  
 y equals -053,200  
 x equals 500,000 - 102,250 equals 397,750  
 y equals 300,000 - 053,200 equals 246,800

Fig. 2

figures of the abscissa and ordinate being omitted, thus: ~~395, 655, 248, 755~~. This number of four figures serves to identify the point on the map or plotting board, from which, having given its exact coördinates in our "Canevas" or note-book, we may determine its exact location.

As an aid and supplement to the *Plans Directeurs*, we are furnished with a document ("Canevas D'Ensemble") giving the coördinates and description of necessary geodetic points,

## FIRING CHARTS AND THE RECONNAISSANCE OFFICER

traverses, and declination points. The maps and other documents are constantly being corrected and brought to date by topographic sections of the Army Corps and by the *Groupes de Canevas*.

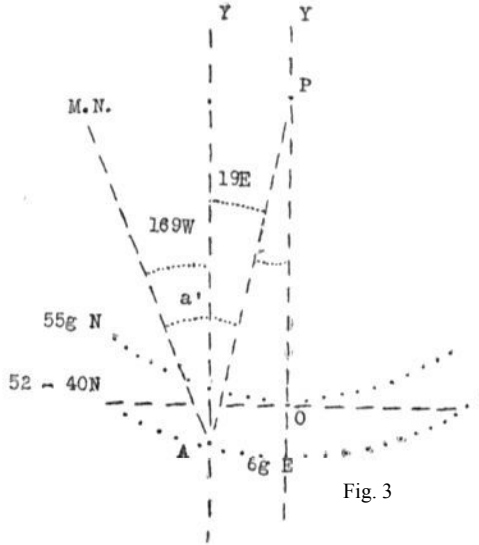

Fig. 3

### III. DIFFERENT UNITS OF MEASURE

(a) Units of angular measure:

1. Degrees:

60" .....	1'
60' .....	1°
360° .....	1 circumference

2. Grades:

100" .....	1'
100' .....	1 grade
400g .....	1 circumference

3. Mils (6400 system):

6400 mils make one circumference.

4. Relations between units:

1° = 1g 11' 11" = 17.78 mils = 20 vingtiemes (20ths of a degree)

1g = 54' (sexagesimal) = 16 mils = 18 vingtiemes

1 mil = 3' 22" .5 (sexagesimal) = 6' 25" (centesimal) = 0.9 vingtiemes

(b) Units of linear measure:

1. English system:

12 inches .....	1 foot
3 feet .....	1 yard
5½ yards .....	1 furlong rod
40 rods .....	1 furlong
8 furlongs .....	1 mile

2. Metric (French) system:

10 millimetres .....	1 centimetre
10 centimetres .....	1 decimetre
10 decimetres .....	1 metre
100 metres .....	1 hectometre
1000 metres .....	1 kilometre

THE FIELD ARTILLERY JOURNAL

3. Relations between units:

1 inch .....	0.0254 m.	0.03937 inch .....	1 mm.
1 foot .....	0.3048 m.	0.3937 inch .....	1 cm.
1 yard .....	0.91432 m.	3.937 inch .....	1 dcm.
1 mile .....	1609.315 m.	39.37 inch .....	1 m.
		0.6214 (% approx.) mile.....	1 kilometre

IV. MAGNETIC DECLINATION

The magnetic declination is the angle which the magnetic needle at the point considered makes with the local true meridian. The magnetic needle points toward the magnetic pole, which is to the west of the true north.

Declination is effected by yearly and daily as well as local and accidental variations. Magnetic maps show the curves of equal declination, calculated for the first of the year and for mean values. At present the declination is decreasing at the rate of about 12 feet a year. During the course of a day the needle oscillates back and forth from the mean position, which it passes about 10:30 A.M. and 6:00 P.M. The daily variation is not equal throughout the year, being much greater in June and much smaller in January than the mean value. Locally, in moving from east to west the mean declination increases at the rate of about 0.72 foot per kilometre. From south to north the rate of increase is about 0.18 foot per kilometre.

Declination may also be subjected to accidental variations, due to masses of metallic substances in the vicinity of the station. This fact should be remembered when orienting the plotting board with the magnetic needle.

*To Orient the Plotting Board.*—Before undertaking this operation, locate carefully, by means of their coördinates (taken from the list of coördinates), a number of known points, at least five or six, of which at least three should be visible from a fourth.

METHOD.—Set up over a known point *A*; lay the edge of the ruler of the alidade, or slope ruler (*regle Éclimet*), along the line *ab* on the board, which represents the line *AB* on the ground; turn the board and sight on *B*, being careful not to disturb the position of the ruler. When the line of sight is exactly on *B*, clamp the board and it will be oriented. Check



## FIRING CHARTS AND THE RECONNAISSANCE OFFICER

the operation by sighting on two other known points, *C* and *D*, and note whether the lines of sight along *ac* and *ad* pass exactly over *C* and *D* respectively. If not, repeat the operation and search for errors.

NOTE.—Other methods of orienting the board will be given in a subsequent lecture.

*To Obtain the Declination of the Plotting Board.*—Having oriented the board by the method above described, fasten the box compass to the board by the thumb-screw provided for that purpose. Then turn the compass so as to bring the needle exactly between the indices representing the north and south points. Now tighten the screw so as to hold the box in place. Then with a sharp-pointed pencil draw lines on the board along the edges of the box, in effect a plan of the base of the box. This is simply to permit one to replace the compass in its oriented position on the board in case it should be necessary to remove it for a time. Place some mark of identification on the compass and board so that the same two instruments may be habitually used together.

*To Orient the Plotting Board with the Compass.*—Set up at a station, being careful to level the board so that the needle will work freely. The compass being in its oriented position on the board, unclamp and turn the board until the needle rests exactly between its markers. Then clamp, and the board will be oriented. Check by sighting on one or two known points if any such are visible.

CAUTION.—If you are at a known station, it is always more dependable to orient by sights on known points, if any such are to be seen. This is on account of local attraction, which may affect the needle. However, in the great majority of cases, the needle alone must be depended upon.

*To Orient a Map Which Shows Neither Magnetic Nor True Meridian.*—(1) Calculate the angle of convergence between the local true meridian and the meridian of origin.

(2) Calculate the magnetic declination at the point considered.

## THE FIELD ARTILLERY JOURNAL

(3) If this point is west of the origin, take the difference of the amounts obtained in (1) and (2); if east, the sum.

(4) Lay off from the *Y*-axis on the map the angle found in (3). Then turn the map so that the magnetic needle points along this line, and the map will be oriented.

PROBLEM.—The longitude of a certain point is 4g 42' E and its latitude 52g 40' N. On January 1, 1917, the magnetic declination at the point, taken from the magnetic map, was 197 mils *west*. The magnetic declination decreases at the rate of about 12 feet a year.

(a) What is the angle of inclination of the local true meridian to the *Y*-line? (b) On October 1, what was the angle of inclination of the local magnetic meridian to the *Y*-line?

(a) Angle *a* equals  $(M + 6) \times 0.76$ ; or  $(-4.42 + 6) \times 0.76$ ; or 1.2 g, which equals 19 mils. Since the point considered is west of the origin, the inclination of the local true meridian is to the east.

(b) Angle *a'* (see Fig.3) equals  $197 - (9/12) \times 12$ ; or  $197 - 9$ , or 188. Therefore, on October 1 the local magnetic meridian made with the *Y*-axis an angle of  $(188 - 19) W.$ , or 169 W.

## SECOND LECTURE

### V. *Means of Locating Points:*

#### Topographic Operations—

1. Intersecting.
2. Oriented Resection.
3. Resection by Means of Known Line and Backsight.
4. Resection Combined with Orientation:
  - (a) Intersection of Arcs.
  - (b) Inverse Triangles.
  - (c) Three Point Problem.
  - (d) Tracing Paper.
5. Radiation.
6. Traversing.

Note on the "Triangle of Error."

## FIRING CHARTS AND THE RECONNAISSANCE OFFICER

### V. METHOD OF LOCATING POINTS

Having given the instruments and the map of the sector in which we are to work, the question arises, "How are we to use them?" The positions of the target, of the directing piece, and of the observatory must be known, or determined if unknown, and located on the plotting board. Also, there must be located on the plotting board a sufficient number of geodetic, declination, or other reference points to serve as starting points or stations for the various topographic operations to be performed in locating targets, gun or observatory. In addition, the plotting board should be provided with means for orienting it—that is, with a compass of known declination.

#### *Topographic Operations*

1. *Intersection.*—This consists in determining the position on the map of an unknown point,  $X$ , on the ground by sighting on  $X$

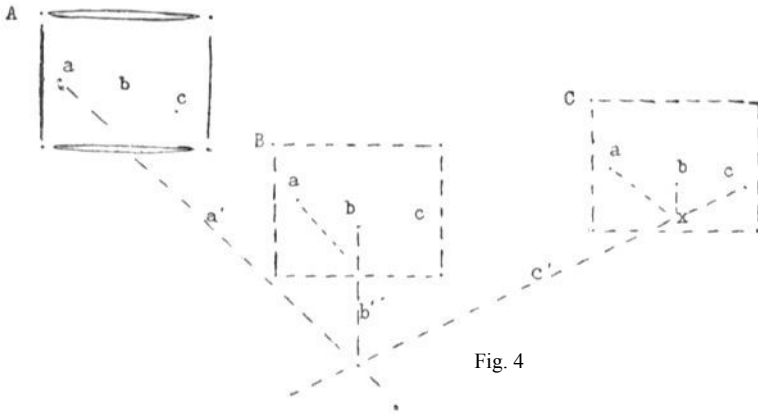
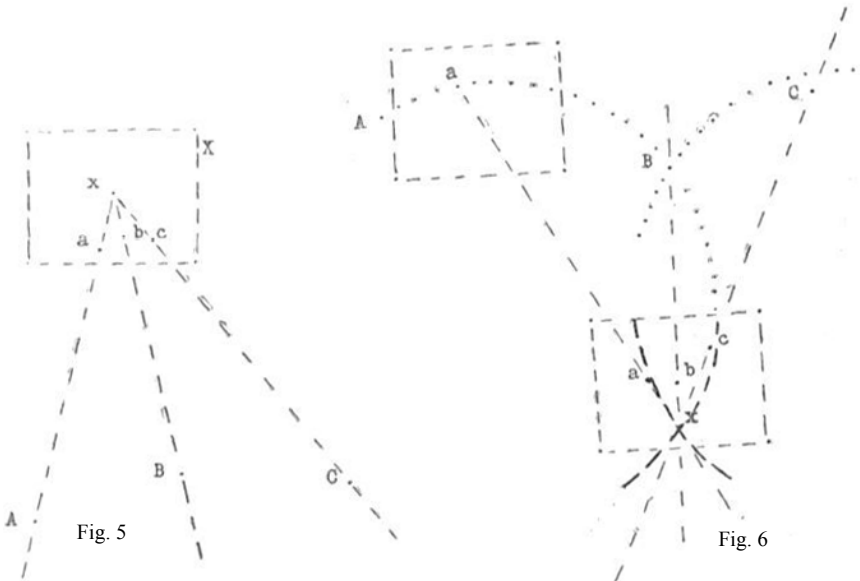

Fig. 4

from at least three known points,  $A$ ,  $B$ ,  $C$ . Set up and orient the board at  $A$  with the compass. Sight on  $X$  and draw the line  $aa'$ , thus determining the direction of  $X$  from  $A$ . Move to  $B$  and  $C$  in turn, performing a similar operation at each. The common point of intersection of the three lines  $aa'$ ,  $bb'$ ,  $cc'$ , will be the point  $x$  on the board corresponding to  $X$  on the ground (see Fig. 4).

2. *Oriented Resection (Relèvement orienté).*—Set up and very carefully orient the board at  $X$ . Sight on  $A, B, C$ , and draw the corresponding lines on the board. The point of intersection of the three lines is the point  $x$  (see Fig. 5).

3. *Resection by Means of a Known Line and Backsight from  $X$  (Récoupement).*—Suppose the direction  $ax$  is known and plotted. Move station to  $X$ , orient by a backsight on line  $xa$ . Then sight on known points  $B, C$ , determining  $x$  by the intersection of the lines  $ax, bx, cx$  (see Fig. 6).



4. *Resection Combined with Orientation (Relèvement non orienté).*—When the declination of the plotting board is not known, or when it has been badly determined, so that orientation can be only approximate, or when no known point is available to use as a station, it is necessary to combine the problem of orientation with that of resection so as to orient the board and at the same time determine the point  $x$ .

This may be accomplished in four ways:

- (a) By intersection of arcs (segments capables), Fig. 7.

FIRING CHARTS AND THE RECONNAISSANCE OFFICER

- (b) By inverse triangles, Fig. 8.
- (c) By the "Three Point Problem," Figs. 9 and 10.
- (d) By the use of tracing paper.
- (a) *Intersection of Arcs.*—Take station at *X*. Orient the

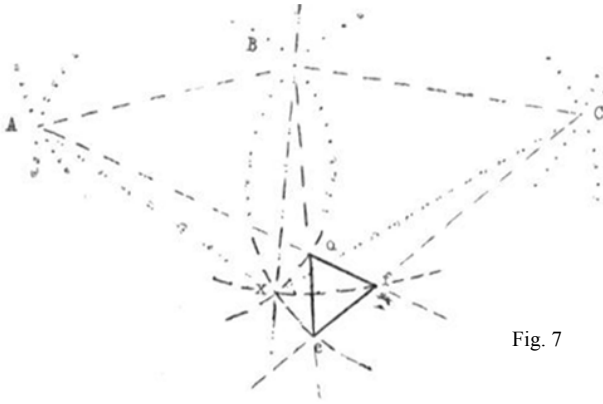

Fig. 7

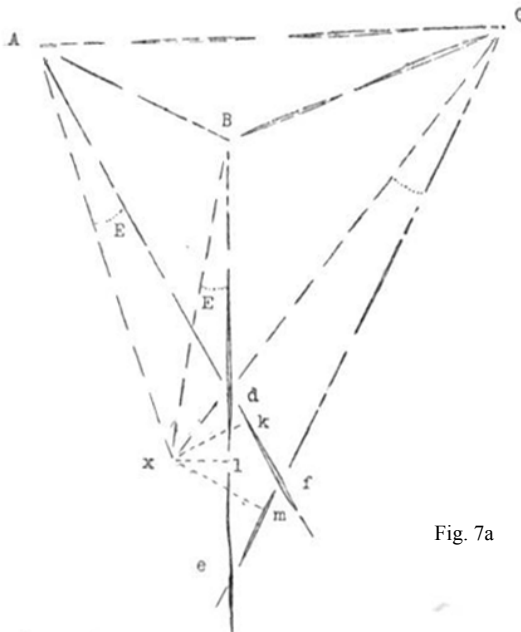

Fig. 7a

board approximately by the compass. Sight on *A*, *B*, *C*, from *a*, *b*, *c*, respectively. These lines form the triangle *def*. Sketch in with the pencil segments of the circumferences passing through *ABd*, *BCE*, *CAf*. The point of intersection of these

three arcs represents a trial position of  $x$ . Orient the board by sighting on the most distant of the points, laying the ruler along the line  $xc$ ; then sight on the other two points. If the lines  $xa$  and  $xb$  do not pass exactly through  $A$  and  $B$ , respectively, then repeat the operation.

NOTE.—This method is not recommended.

(b) *Inverse Triangles*.—The board having been oriented as accurately as possible, displace it by turning it slightly to the right. Clamp it in this position, then sight on  $A$ ,  $B$ , and  $C$ , in turn, from  $a$ ,

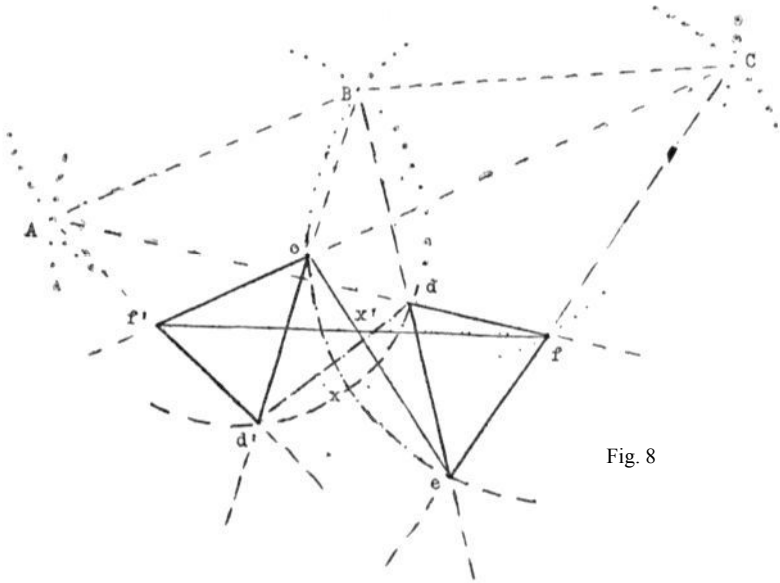

Fig. 8

$b$ ,  $c$ , respectively, obtaining the triangle  $def$ . Then displace the board similarly to the left and make a new series of sights, forming the triangle  $d'e'f'$ . Join the corresponding vertices,  $dd'$ ,  $ee'$ ,  $ff'$ , by right lines intersecting at  $x'$ . This trial position must be verified and corrected if necessary, as described in (a) above. The two triangles must be quite small in order to give good results.

NOTE.—The points  $d$  and  $d'$  are in reality two points on the circumference passing through  $A$ ,  $B$ , and  $x$ . In the construction, the chord  $dd'$  is substituted for the arc, a permissible approximation if  $d$  and  $d'$  are very near each other. Similar

FIRING CHARTS AND THE RECONNAISSANCE OFFICER

remarks apply to  $e$  and  $e'$  and  $f$  and  $f'$ . The true  $x$  is the point of intersection of the three arcs.

(c) *The "Three Point Problem" (Relèvement Italien).*—The principle involved (Fig. 9).—Let  $A, B, C$  be three known points on the ground, located on the plotting board as  $a, b, c$ , respectively;  $X$  the unknown point on the ground at which the station is located;  $Y$  the intersection of the circle  $ABX$  and the right line  $XC$ . The problem is first to find the location of  $Y$ . The angles  $d$  and  $d'$  are equal, likewise the angles  $e$  and  $e'$ . (*Proof.*—The angles  $d$  and  $d'$  are on the circumference, and each is subtended by the same arc, therefore they are equal. The angle  $AXY$  plus angle  $ABY$  equals  $180^\circ$ . The angle  $e'$  plus angle  $ABY$

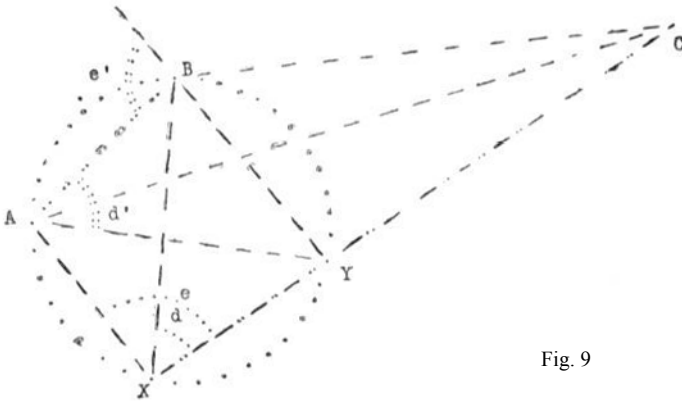

Fig. 9

equals  $180^\circ$ ; therefore angles  $e$  and  $e'$  are equal.)

But the angles  $d$  and  $e$  are known on the ground— $d$  is the angle between  $XB$  and  $XC$ , and  $e$  is the angle between  $XA$  and  $XC$ , both measured from the station. Knowing the angles  $d$  and  $e$ , the triangle  $aby$  may easily be constructed on the plotting board as follows (Fig. 10):

2. *Practical Procedure.*—Set up and orient the board, approximately, at  $X$ . Choose the line  $AB$ , say, as your base. Lay the ruler along  $ab$ , sight on  $B$ , and clamp the board. Then from a sight on  $C$  draw the line  $az$ . Reverse the ruler, laying it along the line  $ba$ , unclamp the board, sight on  $A$ , and clamp. Then from  $b$  sight on  $C$  and draw the line  $bz'$ ; the intersection of  $az$  and  $bz'$  will be  $y$ , which represents on the board the point of

intersection of the circle passing through  $ABX$  and the right line  $XC$ .

To orient the board, lay the ruler along the line  $yc$ , turn the board so as to sight on  $C$ , then clamp it. The board is now oriented. To locate the station on the board it is only necessary to sight first from  $a$  on  $A$ , drawing the line  $al$ ; then from  $b$  on  $A$ , drawing the line  $bm$ . The lines  $yc$ ,  $al$ , and  $bm$  should all intersect at a point, which is  $x$ , the required location on the map of the station  $X$ .

(d) *By Means of Tracing Paper.*—Fasten a piece of tracing paper over the board and assume any convenient point,  $C$ , to

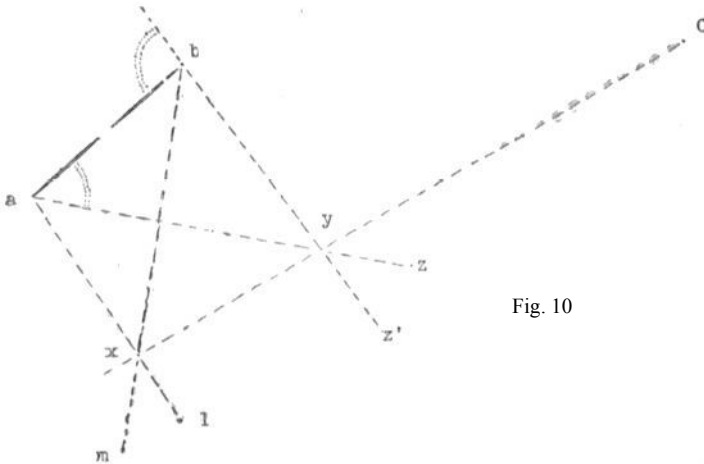

Fig. 10

represent the station occupied. From this point sight on known points,  $A, B, C$ , in succession and draw the corresponding lines. Unfasten the paper and place it on the board so that the lines  $oa, ob, oc$  pass through the plotted positions  $a, b, c$ . Then prick through to the board the point  $o$ , and this will be the required point  $x$ .

5. *Radiation (Rayonnement).*—This consists in sighting on  $X$  from  $A$ , the board being oriented, thus locating the direction of  $X$ ; then measuring the distance  $AX$  on the ground and plotting in  $x$  on the board according to the scale used. The inverse problem is solved by sighting over  $x$ , orienting by compass; sighting on  $A$ , and measuring  $XA$ .



## FIRING CHARTS AND THE RECONNAISSANCE OFFICER

6. *Traversing (Cheminement)*.—This consists in locating  $X$ , from which no known points may be visible, by what may be called repeated radiation, starting from a point  $A$ , which is known or can be located, passing over  $X$  and ending at another known point, or closing on  $A$  itself, thus enabling you to make a check on the operation, the distances between the various stations being measured with stadia or chain and orientation at various stations being by compass, unless known points are visible which serve as a check on orientation.

Note on the "Triangle of Error" (see Fig. 7a):

1. If we assume that the points  $A, B, C$  are correctly located on the plotting board, that our sights through  $a, b, c$  are true, and that only our orientation of the board is in error, we have: (a) The true point  $x$  will be outside the triangle  $def$  if our station is outside the triangle  $ABC$ , and inside the triangle  $def$  if our station is inside the triangle  $ABC$ . (b) The perpendicular distances of this true point  $x$  from the sides of the triangle  $def$  will be proportional to the distances of  $x$  from the points  $A, B, C$ . (c) The true  $x$  will be either to the right or to the left of all the lines of sight from  $A, B, C$ .

(From the figure,  $\sin E$  equals  $xk/xA$  equals  $xl/xB$  equals  $xm/xC$ ;  $xk$  equals  $xA \sin E$ ;  $xl$  equals  $xB \sin E$ ;  $xm$  equals  $xC \sin E$ ; or, since  $E$  is very small,  $xk$  equals  $ExA$ ;  $xl$  equals  $ExB$ ;  $xm$  equals  $ExC$ , approx.)

2. If, combined with the error of orientation, we also have errors of sighting (which are, in effect, errors of plotting), the same conditions hold good, provided the latter errors are all made in the same direction (that is, to the same side of  $a, b, c$ ). But if the errors of sighting on  $A$  and  $C$  are to the *left*, for instance, and on  $B$  (the middle point of our three) to the *right*, then we will have a triangle of error on the *inside* of which will be found the true  $x$ . Under the same assumptions, the true  $x$  will be *outside* the triangle of error if our station is *inside* the triangle  $ABC$ .

However, the rules given in 1 are sufficient for the general case, but our work should be so accurate that we may not be

## THE FIELD ARTILLERY JOURNAL

forced to make any considerable approximations. When an unusual triangle of error is obtained, first satisfy yourself that the known points are correctly plotted, then repeat the operation, paying particular attention to sighting, so as to make the triangle very small or disappear altogether.

Of course, in the "Inverse Triangles" method of orientation and location, triangles of error are deliberately made as part of the operation, but they should be very small.

### THIRD LECTURE

#### PREPARATION OF FIRE—TOPOGRAPHIC OPERATIONS

##### I. *Location of position of directing piece by means of the canevas.*

Examples.

##### II. *Location of position of directing piece from the maps.*

##### III. *Expedients.*

##### IV. *Altitude of the directing piece.*

##### V. *To determine the altitude of a point.*

##### VI. *Determination of the aiming direction of a battery:*

(A) Direct Determination of the Aiming Direction: with Plotting Board; examples. With an Angle-measuring Instrument.

(B) Determination of the Aiming Direction from the Coördinates of an Aiming Point.

(C) Direct Orientation by Topographic Methods without Using an Aiming Direction:

(a) By Using the Plotting Board;

(b) By Using the Aiming Circle.

##### VII. *Note on sight graduations.*

##### VIII. *Expedients.*

#### PREPARATION OF FIRE—TOPOGRAPHIC OPERATIONS

The *preparation of fire* consists of two problems: the *ballistic* and the *topographic*. We shall confine ourselves to the topographic problems to be solved.

## FIRING CHARTS AND THE RECONNAISSANCE OFFICER

### I. *Location of Position of Directing Piece by Means of Points of the Canevas d'Ensemble*

This is simply the application of the topographic principles explained in the Second Lecture. The choice of the method or combination of methods to be used depends upon the position of the directing piece with respect to known points on the *canevas*, and upon the character of the terrain surrounding it. If the piece occupies a depression, for instance from which a view of the surrounding country is impossible, it will usually be necessary to resort to a traverse in order to locate it. Other things being equal, however, we should employ that method in which there are the fewest chances of accumulating errors, and which offers the greatest number of opportunities for checking our operations.

Before deciding upon the method, a preliminary reconnaissance, aided by the map if necessary, should be made in order to determine what method can be used to the best advantage. The operations should be as few in number as practicable, and too long traverses are especially to be avoided.

Examples of problems likely to be encountered:

1. The position selected for the battery lies on a slope of a large valley, and from the position marked for the directing piece numerous points are visible. This indicates the "Three Point Problem," "Inverse Triangles," or tracing-paper method.

2. Directing piece situated generally as above, with, say, three known points in rear of it. But the circle passing through the three points passes over or near the piece position. Therefore above method will not apply, and we have recourse to radiation.

3. Directing piece is in a depression, but from covering mass known points are seen. Locate two points by "Three Point Problem," say, and then run a traverse from one through the position of the directing piece, ending at the other to check the operation.

4. From the top of the covering mass locate two points from which the directing piece can be seen. It may then be located

by intersection from these two stations, and the operation verified from the piece itself by measuring the included angle.

5. At night or in a wooded country traversing is almost always the only applicable operation. Start from a known point, traverse through the position of the piece, and check the operation by continuing to a second known point.

## II. *Location of Position of Directing Piece from the Map*

Instead of the blank squared sheet of the plotting board we may use a map fastened to the board with thumb tacks or paste. But, before attempting to use it, great care must be taken to verify the details given on the map, to see that no features, such as corners of woods, walls, woods, roads, crossings, etc., have disappeared or changed in appearance; also, that the map contains any new features that may be of assistance. Then any points that are to be used on the map may be utilized without fear of grave error.

In conjunction with either the map or the plain squared sheet we must use our instruments, in order that the greatest possible accuracy may be secured through combination. It is preferable, if a map itself is to be used, to have one of larger scale—1/10,000, 1/5000, or 1/2000 rather than 1/20,000. We do not thereby increase the precision of location of known features to be utilized, but we do reduce the graphic errors of the operation itself. The *operations* to be performed are the usual single or combined methods heretofore indicated.

## III. *Expedients*

Instead of the plotting board or map, we may, in case of necessity, use simply the steel chain and Peigne compass, or the stadia and aiming circle, or even the binocular telescope. The operations made are carefully entered in a note-book, accompanied by sketches showing the operations performed. Then the necessary constructions are made on the map, with the aid of tracing paper if necessary.

Such methods are, however, always subject to error and

FIRING CHARTS AND THE RECONNAISSANCE OFFICER

are to be resorted to only when conditions are such that more accurate means cannot be used.

IV. *Altitude of the Directing Piece*

This is usually obtained directly from the map itself, interpolating between contours if necessary. But it may happen that, due to accidents of the ground or to failure of contours, this method will be insufficient. In such a case direct measurements will be necessary.

V. *To Determine the Altitude of a Point* (See Fig. 11)

Let *A* be a station of known altitude, *H*; *B*, the station, the altitude *H'* of which is required; *D*, the distance *AB* reduced to the

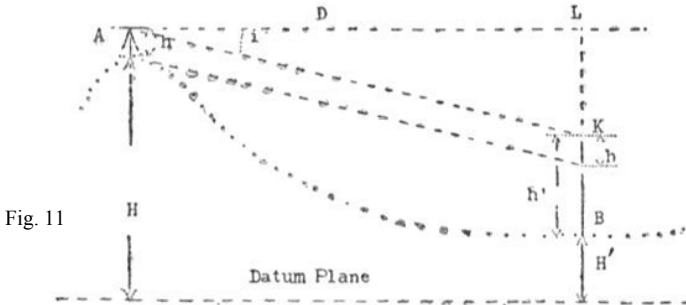

Fig. 11

horizontal; *h*, the height of the instrument at *A*; *h'*, the height of the point sighted on at *B*; *i*, the measured slope.

If we consider that the slope angle, *i*, is positive for an ascending slope and negative for a descending slope, we have:

$$H' = H + D \times \tan i + (h - h')$$

If the point sighted on at *B* is at the same height as the instrument, for instance the middle mark on the stadia rod, then *h'* equals *h*, and the formula becomes:

$$H' = H + D \times \tan i.$$

The reverse problem—that is, sighting from a station of unknown elevation to one of known elevation—may be solved by the same formula.

Tables are available showing the corrections in metres to be applied to the measured distance of *AB* of slope *i* in order to reduce *AB* to the horizontal.

VI. *Determination of the Aiming Direction of a Battery*

The right piece is generally used as the directing piece in orienting the fire, the other pieces being placed in their proper places by the formation of the sheaf. In order to lay that piece for direction, there may be used what is called the *aiming direction*. This is a line on the terrain, well defined, known, and exactly determined. It is defined by two points, one of which is the sight of the directing piece, the other being some object, such as a tree, church steeple, chimney, flag, or stake, which presents a real appearance to the gunner at the piece.

The determination of this line is the topographic procedure which enables us to trace it exactly on the plotting board, firing board, or map. The operation of determining this line is almost always quite independent of that of locating the position of the directing gun. We may always utilize the coördinates of the piece, together with those of a topographic point, in order to define the aiming direction, *provided* that this point is very far away and that its position is exactly known.

But it will happen, in many cases and for certain battery positions, that we cannot avail ourselves of an aiming point in order to establish this direction, and it will then be necessary to orient the piece directly by topographic operations.

Three cases, therefore, are to be considered:

- (a) Direct determination of the aiming direction.
- (b) Determination of the aiming direction by the coördinates of an aiming point.
- (c) Direct orientation of the directing piece without the use of an aiming direction.

(a) *Direct Determination of the Aiming Direction—With Plotting Board*

Examples:

1. From some point which may be determined accurately by topographic methods and from which known points are visible, the directing gun is seen. This point is chosen as an

## FIRING CHARTS AND THE RECONNAISSANCE OFFICER

aiming point, in order to define the aiming direction. Place a stake at  $P$  and set up over it; determine  $p$  on the board and orient by sighting on the most distant of the known visible points,  $C$  say. Then from  $p$  on the board sight on the sight shank of the directing gun and draw the corresponding line, prolonging it all the way across the board with the wooden straight-edge. This line is the

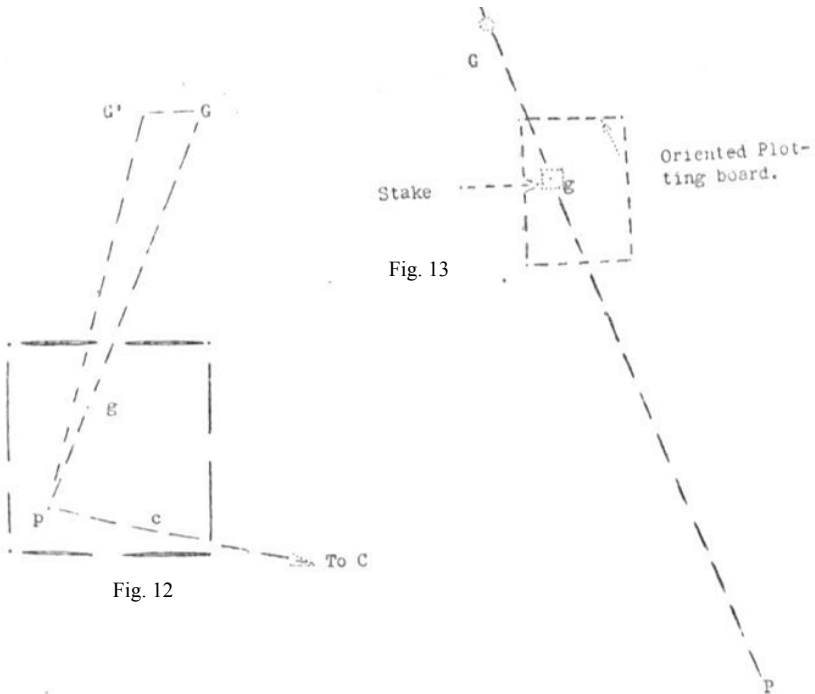

*aiming direction*, and it should pass through the plotted position of the gun. The line may now, by means of the coördinates of the squares or a protractor, be transferred to the firing board if so desired.

If the line of sight from  $p$  does not pass over the plotted gun position, have the piece shifted slightly so that the sight shank will be exactly in line with  $p$  and  $g$ . Then draw the line representing the aiming direction (see Fig. 12).

2. If the point  $P$  selected cannot be used as a station, or if its coördinates are not exactly known, though it is suitable for

an aiming point, proceed as follows: Place a stake in the ground 20 metres from the point marking the sight of the directing piece (or at least 50 metres away if the piece is already in position) and exactly on the line joining sight and aiming point. Set up over this stake and orient very carefully, so that the plotted position of the gun will be exactly over the stake. From  $g$  sight on  $P$  and draw the line representing the aiming direction (see Fig. 13).

3. From a point  $O$ , which is known or easy to determine, we can see the battery position, also a church steeple far in rear, the

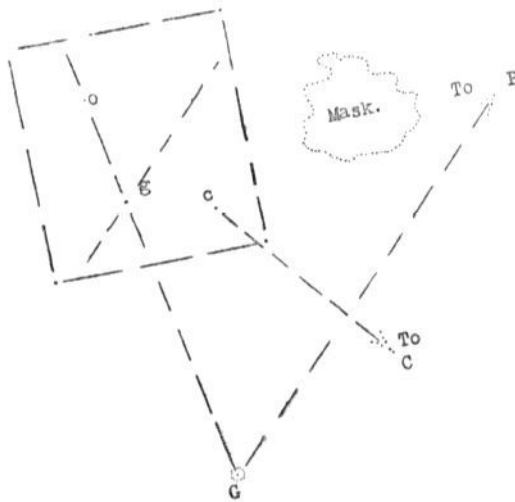

Fig. 14

exact coördinates of which are known, but we cannot see the aiming point chosen.

Set up at  $O$ , determine  $o$  by an appropriate method, and orient the board by sighting through  $c$  on  $C$ . From  $o$  lay on the sight of the directing piece and draw the corresponding line. Then cause the gunner to measure with his sight very carefully the angle  $OGP$ . With the protractor and ruler construct at  $g$  a line making an equal angle with the line  $og$ . The line so constructed is the desired aiming direction (see Fig. 14).

If the gun is not already in position, measure this included



FIRING CHARTS AND THE RECONNAISSANCE OFFICER

angle from the position itself, with an aiming circle or other angle-measuring instrument.

4. The position selected for the directing gun is on a counterslope, from which objects on the slope in front are seen, but no known points. On the crest in rear of the position there is a bench mark, *B*; also a church steeple is visible about five miles away. But from *B* the gun position cannot be seen.

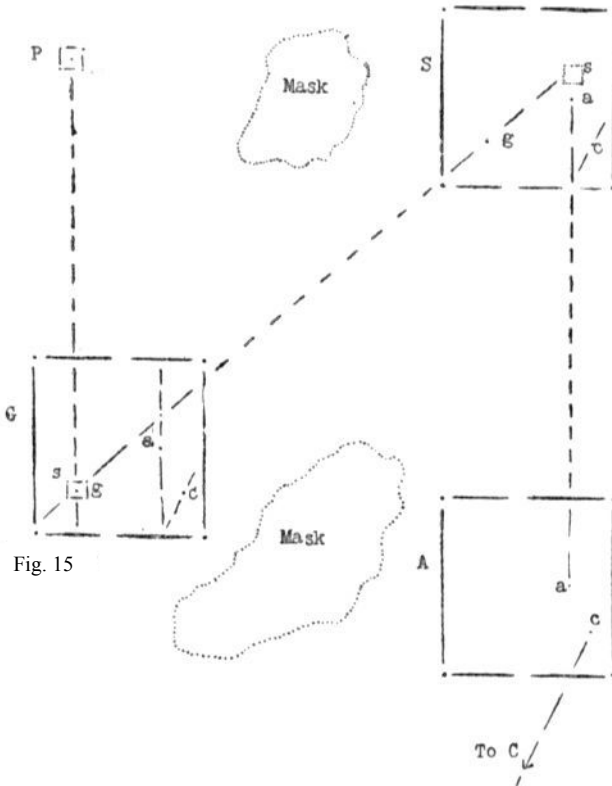

Fig. 15

This problem may be solved by traverse of angles. On the slope in front of the position, where it can be seen from the gun position and from *B*, plant a stake in the ground. Locate *B* and *C* very carefully by means of their coördinates. Then set up over *b* as accurately as possible, so that *b* will fall directly over *B*, orienting the board by sighting on *C*. Then sight on the centre of the stake at *S* and draw the corresponding line throughout

the length of the scale. Now move to *S* and set up very carefully, orienting by a backsight on *B*. Sight on *P* and draw the corresponding line as before. Then move to *G*, orienting by backsight on *S*. Then sight on *P* and draw the corresponding line, which will be the direction sought (see Fig. 15).

The objection to this method is that errors are very likely to accumulate, so that it must be very carefully done, and checked independently if possible.

#### WITH AN ANGLE MEASURING INSTRUMENT:

The same principles apply. Great care must be taken to check readings of angles, and sketches should be made showing the operations performed. Practical problems identical with those just given may be solved for instructional purposes if so desired.

*Using a "Declinated" Aiming Circle.*—If the *declination constant* of the instrument has been determined, and there is no local attraction to cause deviation, the aiming circle may be used to great advantage and with a corresponding saving of time; also with quite accurate results.

One example will suffice to show the method. The selected position is in a depression from which a view of the surrounding country is cut off. The aiming point selected may be a natural object or a stake set in the ground. Suppose the constant to be 6150 mils. If that reading be set on the instrument, and the needle then centred by using the *general* motion, the line of sight will be on the *Y*-line *when the instrument reads zero*.

If the position has not been occupied, set up the instrument over the stake marking the position of the *sight* of the directing piece, and put the line of sight on the *Y*-line as just indicated. Then, using the *upper* motion, lay on *P* and read the resulting azimuth. The aiming direction may now be constructed with a protractor, using the known coördinates of the selected position.

If the guns are already in position, set the instrument very accurately on the line joining aiming point and gun sight and

FIRING CHARTS AND THE RECONNAISSANCE OFFICER

at least 50 metres away. Then proceed as before (see Fig. 16).

NOTE.—In the figure,  $Y_m$  is the  $Y$ -azimuth of the Magnetic North, and  $Y_p$  that of the line  $GP$ .

(b) *Determination of the Aiming Direction from the Coördinates of an Aiming Point.*

If from the position selected for the directing gun we see a clearly defined point, such as an isolated tree, a church steeple, a clock tower, the coördinates of which are given in the *canevas*,

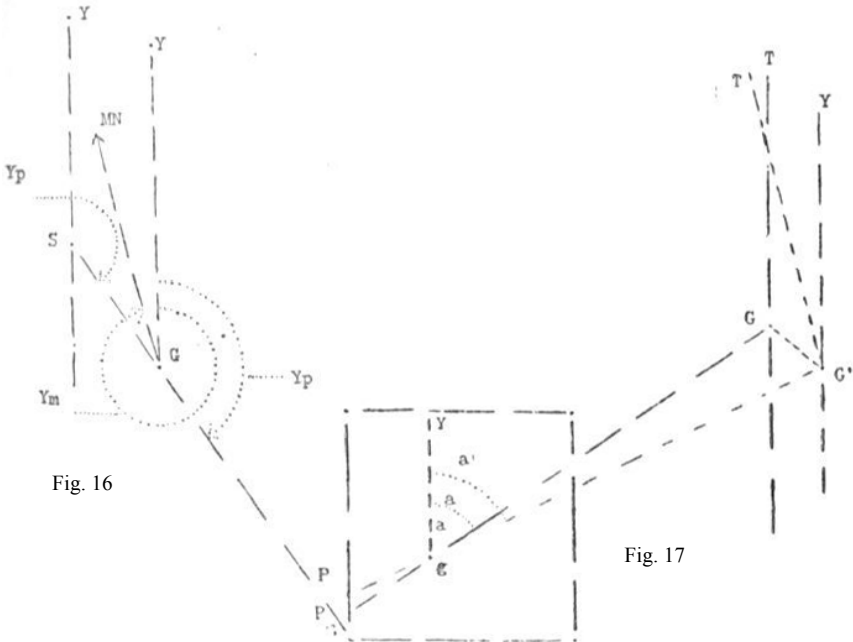

we may use this as the aiming point and determine the aiming direction directly from the plotting board by drawing a straight line between the plotted positions of gun and aiming point.

But this method must not be used unless the point selected is at least 1000 metres away, and even then we have to fear an error of 20 mils. The error to be feared for a point 2000 metres distant is 10 mils, 3000 metres 7 mils, etc., so that the more distant the point is the better. (This results from the fact that, in locating a position by plotting, the error may reach 10 metres,

so that the combined error of gun and aiming-point location may be as much as 20 metres.)

(c) *Direct Orientation of the Directing Piece by Topographic Methods without the Use of an Aiming Direction:*

(a) By using the plotting board, the declination having previously been determined. Trace on the plotting board the line Gun-Target (by means of their coördinates), or, better, consider the *Y*-axis of the sheet which passes through the plotted gun position. Place the plotting board at least 20 metres from the gun (better 50 metres), at a point from which the gun sight can be seen, and orient it by means of the needle with the greatest care. First lay the gun as nearly as possible in the desired direction of fire by shifting the trail. Then lay on the sight, using the alidade or slope-rule, and draw a corresponding line through *g*, along the whole length of the ruler. Measure with a protractor the angle which this line makes with the line *GT*, or with the *Y*-line, as the case may be. Have the gunner set this reading on the sight and lay the piece for direction, using as an aiming point a pencil held vertically on the point *p* of the plotting board. Repeat this operation once or twice, on account of the displacement of the sight during laying. With the gun finally in the desired direction the gunner lays on an auxiliary aiming point and notes the corresponding deflection (see Fig. 17).

(b) By using the aiming circle, the declination constant having been already determined (see Fig. 18).

This is the normal method, especially with 75-mm. batteries, when the aiming circle is available.

Suppose that we measure—clockwise, of course—on the plotting board the angle which the line Gun-Target makes with the *Y*-line; that is, the *Y*-azimuth of the target. Assume this to be 4625 mils. Assume that for our particular locality and instrument the *Y*-azimuth of the Magnetic North is 6150 mils. From the figure we readily see the relations between these azimuths. So, if on the aiming circle we set off a reading of (6150—4625, or) 1525 mils, release the needle, and with the *general* motion turn the instrument until the south end of the needle is exactly

## FIRING CHARTS AND THE RECONNAISSANCE OFFICER

opposite its index, then stop the needle; the instrument will be so oriented that the line of sight will be parallel to the line  $GT$  when the reading on the lower (red) scale is zero. Then we have only to turn the line of sight, using the *upper* motion, on the sight of the directing piece note the reading, and announce it to the gunner in terms of "plateau" and "tambour." The gunner sets off the announced deflection on his sight and lays on the spindle of the aiming circle as an aiming point. The operation should be

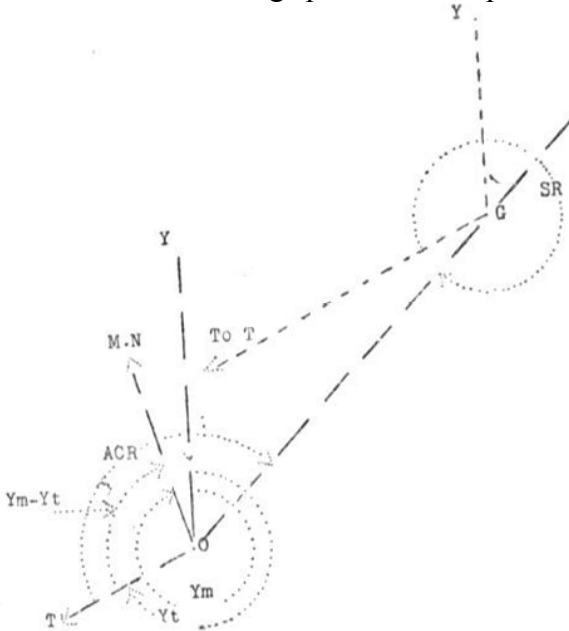

Fig. 18

repeated once or twice until the reading of the aiming circle when laid on the sight does not change.

(NOTE.—The instrument should be set at least 50 metres away from the nearest gun.)

Being in station at his observatory and having measured the  $Y$ -azimuth of the target as described, the battery commander simply telephones to his executive:

Reading on Magnetic North, 1525.  
Lay the pieces for parallel fire.

## THE FIELD ARTILLERY JOURNAL

The executive then proceeds as described above to obtain the deflection of the directing gun and of the other pieces by laying successively on the gun sights from right to left and announcing the corresponding deflections. Each gunner lays on the aiming circle as an aiming point, with the deflection announced for his piece. After all the guns are laid the executive reads through again and announces new deflections, if necessary, as described above. The laying having been completed, each gunner turns his sight on his auxiliary aiming point and records the deflection.

NOTE.—Sight Graduations. The 75-mm. sight plate is divided into four quadrants, each graduated clockwise into 8 parts, numbered 0, 2, 4, 6, 8, 10, 12, 14, each division being with 200 mils. The drum (tambour) is divided into 200 parts, each division being 1 mil, so that one complete turn of the drum corresponds to a change of one division or 200 mils on the plate. The zero reading (when line of sight is parallel to the axis of the bore) is "Plateau 0 Tambour 100," which corresponds to the zero reading of the lower scale of the aiming circle. In the 75-mm. sight the scale is fixed, while the index, together with the line of sight, is movable.

The 155-mm. sight (Schneider, Model 1917) is graduated counterclockwise for the first half of the circle from 0 to 3200, and in the same direction for the second half, likewise from 0 to 3200. The index is at 1000. For the problem assumed above, the reading on Magnetic North would be 2525. The same procedure would be followed as in the case of the 75-mm. sight, except that the terms "plateau" and "tambour" are not used, the direct reading being announced, except that when the reading on the gun sight is greater than 3200, that amount must be subtracted from the reading before it is announced to the gunner.

The aiming circle has two graduations: one on the lower dial, from 0 to 6400 in a clockwise direction, used in conjunction with the black index of the upper dial; and one on the upper dial, in terms of "plateau" and "tambour," designed especially for use with the 75-mm. gun. The lower dial is used with the 155-mm. howitzers, and for measuring angles in topographic operations.

## FIRING CHARTS AND THE RECONNAISSANCE OFFICER

The lower scale is fixed, while the line of sight, together with the index, is movable. The upper scale and line of sight are movable, while the index is fixed. Hence the graduations of the upper scale are counterclockwise.

NOTE.—With reference to problem given above: If the battery commander does not know the constant of his instrument, he simply telephones to the battery:

Azimuth of Target, 4625

Lay the pieces for parallel fire.

The executive himself makes the necessary calculations and lays the pieces as described.

The methods just described—(a) and (b) of (C)—will be the normal procedure when the battery is in a wood; in a ravine where view is impossible; in a region where there are no aiming points; and at night.

With respect to the method just described, (b) of (C), there is this remark to make:

The accuracy of the laying depends, of course, upon the exactness with which the declination constant has been determined. Theoretically, this constant changes every day (see "*Magnetic Declination*"), and, while the change during the course of a month, say, would be practically negligible as a whole, still the cumulation during the course of a year, added to the daily variation for certain months, would amount to as much as 5 mils, an error which should be considered, especially for heavy long-range batteries, for which the greatest accuracy of laying is desirable. Laying by this method would certainly be inaccurate if the constant of the instrument were determined from the map, and especially so if the variation due to elapsed time were not taken into account.

In cases in which the same positions are likely to be occupied for a period of several months at least, as in the present state of siege warfare, the following procedure is preferable, especially for heavy artillery:

The pieces having been established in position, the executive,

using an aiming circle the constant of which has been recently accurately determined, establishes the *Y*-line on the ground itself by means of a line of stakes or other expedients, this line usually being directly in front or rear of the pieces, the stake or mark used as a station for the instrument being at least 50 metres from the nearest piece.

This line, once established, becomes a permanent line of reference from which the executive lays off the *Y*-azimuth of any line Gun-Target without further reference to the needle.

Suppose the *Y*-azimuth of the target to be 650 mils. To lay his

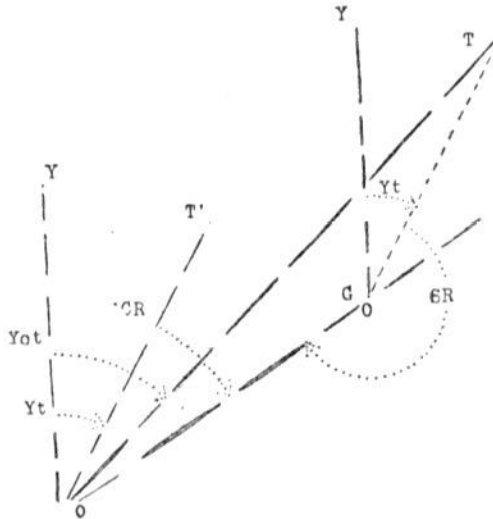

Fig. 19

pieces, the executive sets up the aiming circle at its station, sets off the reading (6400-650), or 5750, and lays on the established *Y*-line. This puts his zero on a line parallel to Gun-Target, from which he reads around to his gun sights.

For the 155-mm. sight he would set his instrument to read 350 before laying on the *Y*-line, since the zero of the instrument corresponds to the graduation "1000" on the sight.

EXPEDIENTS.—Suppose that the declination of the aiming circle is unknown or that the needle is broken. The instrument may still be used to solve the problem *if the observatory is visible from the gun position*.



## FIRING CHARTS AND THE RECONNAISSANCE OFFICER

1. Measure on the plotting board the *Y*-azimuth of the line Observatory-Target and of the line Gun-Target.

2. Set off on the aiming circle the azimuth of *OT*, lay on *T* with the *general* motion, and clamp the instrument. This so orients it that the line of sight, when the reading is zero, will be on the *Y*-line.

3. With the *upper* motion set off the azimuth of *GT*. The line of sight is now parallel to *GT*. Establish this line by setting a stake in the ground on the line of sight.

4. With the instrument set at zero (1000 for the 155-mm.), lay on the stake with the *general* motion and clamp. Then lay with the upper motion on the sight of the directing piece and announce the deflection (see Fig. 19).

NOTE.—Suppose the target is difficult to identify on the terrain, but that there is some visible known point which may be accurately plotted on the board. This point may be used as a reference point on which to orient the instrument. The problem will then be solved in the general manner indicated above. Also, the angular displacement between the reference point and the target, measured on the plotting board, may be of assistance in identifying the target through the binoculars or monoculars, for instance.

### FOURTH LECTURE

#### *Calculation of the Initial Elements*

Direct Determination.

Transport of Fire.

"Witness" Target.

Fire without Observation.

Ballistic and Atmospheric Corrections:

Deflection—

Drift.

Lateral wind.

Range—

Variation of initial velocity.

Variation of weight of projectile.

Variation of density of air.

Longitudinal wind.

## THE FIELD ARTILLERY JOURNAL

### CALCULATION OF THE INITIAL ELEMENTS

We have now seen the different procedures to be employed in locating the gun position, in orienting the piece, both with and without the use of an aiming direction, and in determining the altitude of the directing piece. Having given the target or targets and their coördinates, they may be easily located on the plotting or firing board.

The determination of the *deflection* then becomes a simple matter of measuring on the board the angle between the line Gun-Aiming Point and the line Gun-Target (or between the *Y*-line and the line Gun-Target, which is the usual procedure).

The *site* is determined by dividing the difference of elevation in metres between gun and target by the range in kilometres. It is positive if the target is above the gun, and negative if below.

The *range* is obtained directly from the board or map by measuring with a double-decimetre scale or with the zine ruler to the nearest 10 metres the distance in metres between gun and target.

This is what is called "direct determination of the initial elements."

A *second* method of obtaining the initial elements for a target is what is called "Transport of Fire" (*Un Transport de Tir*).

Transport of fire consists in determining, by means of results obtained from perfectly adjusted fire on an auxiliary (or registration) target, *B*, and for which conditions permit the best of observation, the elements necessary for opening effective fire on another target, *O*, without the necessity of a second adjustment. The fire on *B* should be immediately followed by the fire on *O* and with the same powder and projectile lot, in order that both series may be affected by the same perturbing influences. The positions of both targets should be accurately known. The distance to the target *O* should not be greater than  $\frac{4}{3}$  nor less than  $\frac{3}{4}$  of that to *B*, and the angular displacement between the two should not exceed 300 mils.

The *ranging coefficient*, *K*, is the ratio of *Rb*, the adjusted

## FIRING CHARTS AND THE RECONNAISSANCE OFFICER

range to  $B$ , reduced to the horizontal, to  $gB$ , the map distance to  $B$ . That is,  $K = Rb/gB$ . The range at which fire is to be opened on the target  $O$  is equal to the ranging coefficient multiplied by the map distance to  $O$ ; that is,  $Ro = KMo$ .

The battery commander prepares his fire for the auxiliary target by the direct method, and adjusts on it; from the results of this fire he deduces the value of  $K$ . He then measures on the board the angular distance between the two targets and the map range  $Mo$ . Next, by means of the expression  $Ro = KMo$ , he readily obtains the range with which to open fire on  $O$ . Lastly, he calculates the angle of site of  $O$ .

### EXAMPLE

Map range to  $B$ ,  $Mb$ , equals 3000 metres

Adjusted range to  $B$ ,  $Rb$ , equals 3200 metres

Map range to  $O$ ,  $Mo$ , equals 4000 metres

Range for opening on  $O$ ,  $Ro$ , equals?

$$K = Rb/gB = 3200/3000 = 16/15$$

$$Ro = K Mo = 16/15 \times 4000 = 4270, \text{ approx.}$$

Transport of fire is particularly advantageous from a topographic point of view, since it corrects, to a great extent, errors due to erroneous determination of the location of the directing piece. Also, the auxiliary target becomes a real registration point about which the battery commander may shift his fire.

A *third* method is by means of a "witness" target (*Un but témoin*). This procedure is necessary in case the battery commander is called upon to fire at an invisible target, adjustment being by aero observer, for instance. In such a case he selects some object which he can see and which is as near to the real target as possible, although its position on the map may not be exactly known. He first adjusts his fire on the "witness" target, his adjustment including *fire for improvement*. Then, his aero observer being available, he immediately shifts his fire to the real target and adjusts on it. The time required for this adjustment should be very short, by reason of the results obtained from the adjustment on the "witness" target, and his first salvo on

the real target should be very near it. Then, his adjustment ended, he begins fire for effect if deemed advisable.

From the results of those two adjustments he is able to determine the angular distance between the two targets, and the *ratio* of the two adjusted ranges. If, then, on a subsequent day he is called upon to open fire on this real target, he first fires on the "witness" target, using a simple fire for improvement of six rounds, then, by means of this range and the ratio previously determined, he immediately deduces the range to be used in opening fire on the real target—that is to say, for any subsequent firing on the real target he will execute a "transport of fire," as described above. The "witness" target becomes the auxiliary (or registration) target, and the two previously adjusted ranges become, for the purpose of the transport, topographic ranges.

*Fire Without Observation.*—When fire for effect cannot be observed, preparation is made, as already explained, by passing through the medium of an auxiliary or "witness target." If a large number of rounds are fired, it is well, if firing on the same object is to take place often, to ask that the necessary number of photographs be taken, in order to verify the results obtained. This is indispensable for night firing on roads, road crossings, etc. Photographs often show that, due to unsuspected or unknown causes, the mean point of impact of the shots is not at all on the spot desired. By taking into account these revelations, better results will be obtained.

It is necessary that the battery commander exercise considerable caution in utilizing the results of previous firing prepared as explained, by means of auxiliary or "witness" targets. On account of meteorological conditions of the moment, elements obtained in previous firing may be employed only in zone fire, fire on very large targets, or in *barrage*. Information obtained as a result of previous transport of fire (or fire by means of a "witness" target) could not be depended upon for more than this without adjusting anew with accurate fire. The battery commander is able, during the very short while that conditions

## FIRING CHARTS AND THE RECONNAISSANCE OFFICER

remain unchanged, to eliminate, by the use of the ranging coefficient, the influence of atmospheric conditions. But he cannot hope to secure as good results on succeeding days, nor at another hour of the same day. The value of  $K$  varies too much as momentary conditions change.

In order to preserve the useful portions of results obtained by previous ranging, he must employ another procedure. This is to take into account certain ballistic and *at mospheric corrections* in the manner indicated in the range tables.

The measured deflection and topographic range are modified by these corrections in order that the initial deflection and range

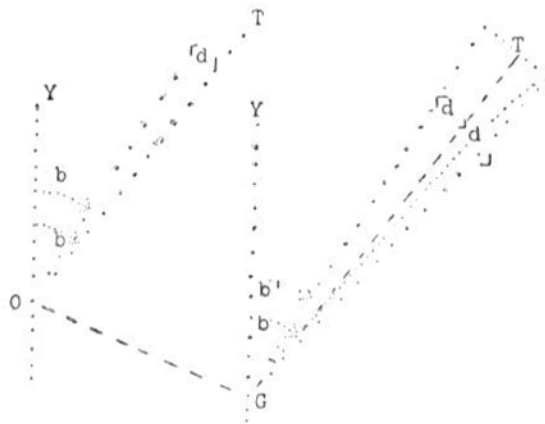

Fig. 20

may be as nearly correct as possible under the conditions existing at the time of firing. The range tables were calculated for normal conditions, that is, *Wind*, nil; *Temperature*,  $15^{\circ}$  C.; *Barometric Pressure*, 750 mm.; *weight of a litre of air*, 1g 208; *standard weight of projectile*; and *predetermined initial velocity*. If these ideal conditions existed for our firing, we should have only to correct the deflection by the amount of drift, and the elevation (range) by the total value of the angle of site.

The *ballistic* corrections to be considered are those due to:

- (a) Drift.
- (b) Variation of initial velocity.
- (c) Variation of weight of projectile.

THE FIELD ARTILLERY JOURNAL

The *atmospheric* corrections are those due to:

- (a) Wind.
- (b) Variation of the density of the air.

The *deflection* is affected by *drift (derivation)* and *lateral wind* ( $dW_y$ ). Drift causes the projectile to deviate to the right of the line of fire, and the correction to be used is therefore *positive*. The correction to be applied is given in the range tables.

It should be noted that the correction for drift, if applied to the initial setting of the aiming circle, is negative, as will be readily seen from the figure (see Fig. 20).

Lateral wind may be either additive or subtractive. The

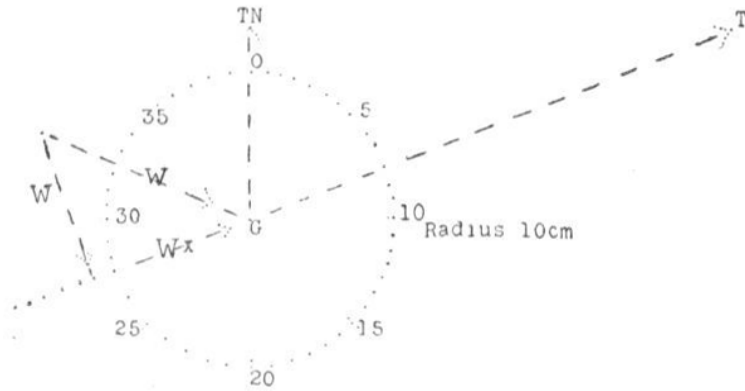

Fig. 21

correction ( $dW_y$ ) due to a 10-metre lateral wind is given in the range tables. The wind is resolved into its two components (lateral and longitudinal) by a simple graphical construction, as shown in Fig. 21. The total correction to be applied is  $(dW_y) \times W_y/10$ . The direction and velocity of the wind at a height equal to  $4/5$  of the maximum ordinate of the trajectory under consideration is usually that considered in making the correction. Wind is usually announced by a group of six figures—thus: 15–10–16 means that at a height of 1500 metres the wind is blowing from the east (direction 10) at a rate of 16 metres per second. Soundings for wind are made for the different atmospheric strata or at altitudes varying by 500 or 600 metres.

## FIRING CHARTS AND THE RECONNAISSANCE OFFICER

The range is affected by:

- (a) Variation of initial velocity due to temperature of powder.
- (b) Variation of weight of the projectile.
- (c) Variation of the density of the air.
- (d) Longitudinal wind.

The procedure to be followed in general in making these corrections is given in the range tables, and is beyond the scope of this subject.

### FIFTH LECTURE

#### *Reconnaissance and Study of Positions and Objectives:*

- (A) Reconnaissance and Study of Positions:
  - Generalities on reconnaissance.
  - Defilade, how determined.
- (B) Reconnaissance and Study of Objectives:
  - Visible and hidden areas.
  - Possibilities of fire:
    - Counterslopes.
    - Dead angles and zones.
    - Minimum range.
    - Examples.

#### RECONNAISSANCE AND STUDY OF POSITIONS AND OBJECTIVES

##### (A) *Reconnaissance and Study of Positions*

The topographic operations necessary for the determination of the initial firing data should be performed at the earliest possible moment, during the reconnaissance and occupation of battery positions, and before any adjustment is begun, since even a few simple operations may greatly assist in the first laying and ranging. These operations may be made by the battery commanders or battery reconnaissance officers, but in all cases the battalion reconnaissance officer should be present from the preliminary reconnaissance to aid in the operations incident to occupation of position and determination of data.

*Defilade.*—The question immediately arises as to the defilade not only of the battery positions but of the routes leading thereto.

## THE FIELD ARTILLERY JOURNAL

Study of the map previous to reconnaissance of the terrain itself may give useful indications if one is careful to study the contours. A hasty glance of the eye over possible routes of approach, for instance, is not sufficient, and it is necessary to supplement the study of the map by construction of profiles in any case of doubt. This study is followed by a reconnaissance on the terrain itself. It should be really a study and not a simple examination.

For battery emplacements we must not be content to determine simply that the guns are hidden from terrestrial view by the enemy, or that they are or are not defiladed from balloons—we must give a definite value in metres to the defilade. In order to do this, if possible, take a station on the covering mass, approximately on the line battery-enemy position, and measure with the most accurate instrument at hand the slope  $s'$  of the line station-battery and the slope  $s$  of the line station-enemy position. Also measure or calculate, as precisely as possible, the distance  $d$  in metres from station to battery. The defilade in metres is then given by the expression  $H-d(s'-s)/1000$ .

When a traverse along a route of approach is not totally defiladed, it is necessary to determine the parts not hidden and to designate the points in the enemy position from which they are visible. These points will often be difficult of identification from above the mask, and they must be reconnoitred with care, using, if necessary, the Peigne compass or plotting board. By this means we have definite concrete information which will permit the battalion or battery commander to organize his movements intelligently. All useful information concerning defilade, visibility of routes of approach, practicability of the ground, etc., is given on the *plan directeur* or on a squared sheet of tracing paper oriented to the map. A rough sketch is often worth more than a long discussion.

### (B) *Reconnaissance and Study of Objectives*

This is not only a topographic but a tactical operation, in that it embraces not only the location in position of enemy organizations



## FIRING CHARTS AND THE RECONNAISSANCE OFFICER

but a search for all information which may aid in determining the true character not only of artillery objectives but of known points and zones in the enemy lines.

For the orienting officer the reconnaissance and study of objectives comprises the following subjects:

1. Determination of areas, visible and hidden, as viewed from the observation post.

2. A study on the terrain of these visible and hidden areas, to serve as a supplement to a check of the areas shown on the map.

3. A graphical study, in the form of panoramic sketches, of the country, resulting from reconnaissance on the terrain.

4. A more or less continuous observation and examination of the terrain, with particular attention to the determination and location of new objectives and constant surveillance of the old.

5. Determination from the map of the possibilities of fire for the batteries, involving a study of counterslopes and dead spaces.

6. Study of aerial photographs.

In this lecture nothing more will be attempted than to indicate the methods of determining hidden and visible areas, dead angles, and possibility of fire on counterslopes.

VISIBLE AND HIDDEN AREAS.—These are first determined from the map, the 1/20,000 *plan directeur* being used. The contours on these maps being accurately drawn, such a determination, if carefully made, will be sufficiently precise. But the graphical construction from the map will, in any case, be considered as only a first approximation, which must be verified and corrected, if necessary, from a direct study of the terrain itself. The graphical method is to construct profiles by imagining vertical planes passed through the observation post in sufficient number to determine and limit the sought-for areas. For this purpose cross-section paper is used; horizontal distances are preserved to the scale of the map, but vertical distances are multiplied, usually 10 times. After the profile is constructed, tangents are drawn to the crests of the profile from the origin;

the points of tangency and "impact" of these lines determining for that particular plane the limits of visible and hidden areas. It is usually unnecessary to construct the whole profile, as it will be obvious from the study of the contours, after the profile of the critical points is drawn, that certain portions are surely visible or hidden. By this means we construct point by point the curves which separate the hidden and visible areas. The hidden areas are usually indicated by tints or *hachures*.

Such a construction takes into account, of course, only the topographic surface—woods, hedges, villages, etc.—and may modify these areas considerably.

After having completed the theoretical lines of separation, we must consider:

*First.*—Whether masks in the visible areas will create additional hidden spaces.

*Second.*—Whether such objects as steeples, houses, woods, etc., in the hidden parts may show above the covering crests; also, whether defiladed roads might be revealed through the rim of trees bordering them.

All these points should be carefully studied during the reconnaissance made at the observatory itself.

Then, the work on the map itself having been completed, take station at the observatory and try to trace with the naked eye the lines of separation, measuring angles, or directions, if need be. Note any points which may by their position in direction change the trace of the separating lines—the masking of one crest behind another nearer one, for instance; also points at which a line of separation intersects a road, edge of wood, or enemy trench.

Then study with field glasses or with the observation telescope each section of visible terrain, included between two successive lines of separation; try to determine whether a certain ridge, for instance, forms a continuous glacis or has secondary ravines leading off from it, constituting small hidden areas which escaped notice during the first map study; also limit the parts of this visible terrain which are hidden by natural or artificial masks.

## FIRING CHARTS AND THE RECONNAISSANCE OFFICER

Finally, in the areas in which the surface of the ground is hidden look for objects which stand out in relief from behind the covering crests—borders of woods, tops of trees, chimneys, clock towers, etc. These are carefully identified and marked on the map.

It is only by a careful and exhaustive study in this manner that we are able really to complete our map of the hidden and visible areas.

### STUDY FROM THE MAP OF POSSIBILITIES OF FIRE

The slope of the terrain in the vicinity of the objectives is a means by which we may determine the conditions under which

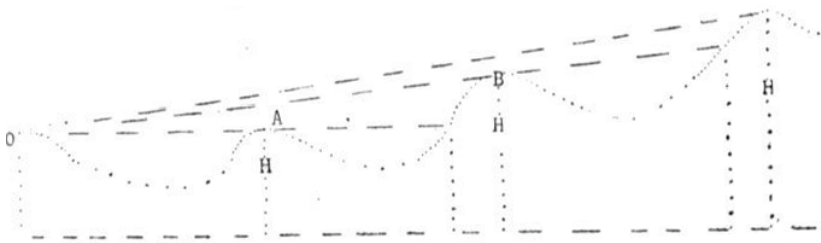

Fig. 22

defiladed objects situated on ground sloping toward the enemy (counter-slopes) may be reached efficiently. As an incident to this study of the terrain in front of the batteries, we determine the dead angles and areas with respect to the fire of the different batteries.

#### (a) *Possibility and Efficiency of Fire on Counter-slopes*

This is purely a map study, its value depending upon the accuracy of the map used. But in no case must it be neglected, since we must consider any topographic condition which might influence the efficiency of our fire. A simple graphical construction enables us to consider possibilities of counter-slopes (see Fig. 22).

Trace the line of fire on the map. Let  $d$  be the horizontal distance between two consecutive contours, measured along the

line of fire, in the vicinity of the target;  $e$  the contour interval (usually 5 metres). The slope of the terrain in mils is then  $(e \times 1000)/d$ .

In the figure, let  $s$  be the angle of site. The slope of the ground with respect to the line of site is:  $p = i + s$ . If for the given range the angle of fall,  $c$ , given by the range tables, is less than  $p$ , the counter-slope is in a dead angle. If  $c$  is greater than  $p$ , the counter-slope can be reached, but the real angle of fall with respect to the terrain is reduced to  $(c-p)$ .

The probable error in range on the counter-slope, compared with the range table probable error, increases directly in the ratio

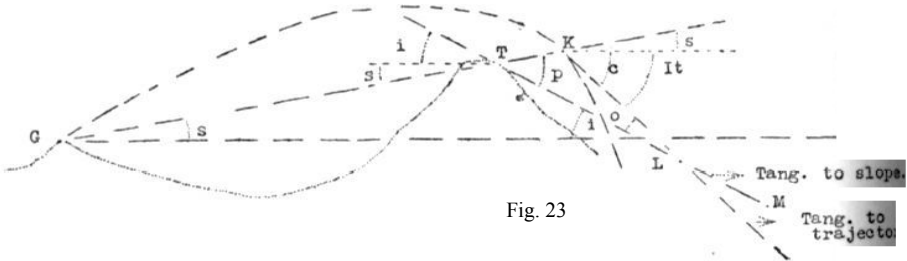

Fig. 23

$$\frac{TK}{\sin o} = \frac{TL}{\sin LKT}; \quad o = c - p; \quad LKT = (180^\circ - c);$$

$$\sin LKT = \sin (180^\circ - c) = \sin c$$

Therefore:  $\frac{TK}{\sin (c - p)} = \frac{TL}{\sin c}$ ; But  $TK = E_o$ ; range table probable error along line  $GTK$ ;

2nd  $TL = E_p$ , probable error along slope  $TM$ :

Therefore:  $\frac{E_o}{\sin (c - p)} = \frac{E_p}{\sin c}$ ; or  $E_p = E_o \frac{\sin (c - p)}{\sin c}$ ; or since  $c$  and  $c - p$  are small,  $E_p =$

$$E_o \frac{c - p}{c}.$$

$c/(c-p)$ —to be exact, in the ratio  $\sin c/\sin (c-p)$ . The numerical value of this ratio gives an idea of the diminution in efficiency which may result.

(b) *Determination of Dead Angles and Zones*

Dead angles result:

1. From the mask or the covering mass behind which the battery is defiladed, from which there results a minimum range at less than which the guns cannot fire.

2. From the defilade of the targets themselves behind covering masses.

## FIRING CHARTS AND THE RECONNAISSANCE OFFICER

The use of contoured maps enables us to determine these zones with a degree of accuracy depending upon the accuracy of the contours.

### DETERMINATION OF THE MINIMUM RANGE

Measure from the emplacement of the piece itself and in several probable directions of fire the angle of site of the covering mass.

Determine for each of these the minimum range. If the mask is near the gun, the measured angle of site gives the minimum elevation for the piece. If the mask is some distance away, we must consider the drop in the trajectory. The minimum elevation to give the piece is obtained by adding to the measured angle the angle of departure for the range to the mask. The minimum elevation, transformed into range by the tables, gives a first approximation, which may, due to the conformation of the terrain, be much too great. In order to determine the exact minimum range we must consider the altitude of the point of fall—and it is here that the map is necessary. Take from the map the altitude of the piece and of the point of the terrain corresponding to the first approximated range. From this deduce the angle of site of that point (the point of fall). By correcting the first minimum elevation by the variation due to this site we arrive at a second approximated minimum. Calculate, then, the angle of site of the second point of fall obtained and, if necessary, make even a third approximation. (*See Example.*)

### DEAD ANGLES DUE TO THE FORM OF THE TERRAIN IN THE VICINITY OF THE TARGET

Any point on a counter-slope at which the slope of the terrain measured in the direction of fire is greater than the angle of fall is defiladed against fire. A brief examination of the map, measuring a few slopes, if necessary, will indicate the areas in which this may happen. In these suspected areas we may locate the limits of these zones by determining the points of

contact of *grazing* trajectories and their points of fall. This is done by drawing profiles and then constructing tangents to the trajectories at the points of graze. (*See Example.*)

If  $c$  is the tabular angle of fall,  $s$  the angle of site of the point considered, the inclination of the trajectory is:

$$It = c \pm s$$

The tangent is constructed graphically, taking into consideration the amount by which the scale of heights is multiplied in the profiles. For angles greater than 350 mils the substitution of the trigonometric tangent for the angle itself is not accurate, and in such cases the profile is constructed without increasing the scale of vertical heights, and the angle of fall is constructed with the protractor.

PROBLEM IN MINIMUM RANGES AND DEAD ANGLES (SEE FIG. 24)

155-mm. F.A. shell; long fuze; Charge 1.

I. Consider the Mask *A*.— $R$  to mask is 1000 m.; site of mask is  $(295-250)/1$ , or plus 45 mils; angle of departure for 1000 is 2 degrees 25', or 43 mils; therefore, the minimum angle of elevation to give the piece is 43 plus 45, or 88 mils; 88 mils, or 4 degrees 53', corresponds to a range of 1800 m.; point of fall for this trajectory is at the point  $a$ , the elevation of which is 260; the site of  $a$  is  $(260-250)/1.8$ , or plus 5 mils; therefore to reach  $a$  the total elevation would be 88 plus 5, or 93 mils; 93 is greater than 88, therefore the projectile will clear.

The minimum range is then 1800 metres, and  $a$  is a point on the curve of minimum ranges for the Crest *A*.

II. Consider the Mask *B*.— $R$  to  $B$  is 4320; site of  $B$  is  $(325-250)/4.32$ , or plus 17 mils; angle of departure for range of 4320 is 14 degrees 15', or 256 mils; therefore the minimum elevation to give the piece is 256 plus 17, or 273 mils; the range corresponding to this elevation is 4520 m.; the point of fall is  $b$ , the elevation of which is 302, site of  $b$  is  $(302-250)/4.52$ , or plus 11 mils; therefore the elevation to reach  $b$  would be 273 plus 11, or 284 mils; 284 is greater than 273, therefore the projectile will clear.

# FIRING CHARTS AND THE RECONNAISSANCE OFFICER

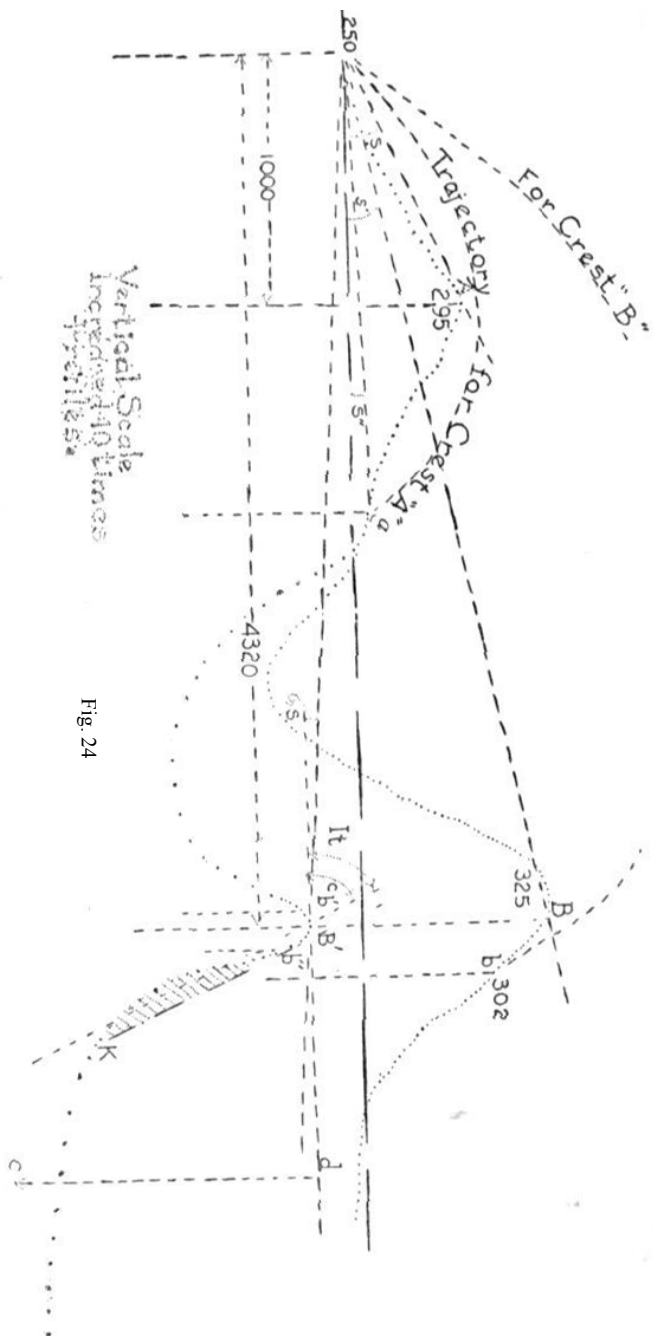

Fig. 24

## THE FIELD ARTILLERY JOURNAL

III. Consider the profile  $AaB'$  and the Crest  $B'$ ; elevation of  $B'$  is 230 m.; site is  $(250-230)/4.32$ , or  $-5$  mils; the range is 4320 and corresponding angle of departure is 256 mils; therefore the minimum angle of elevation is  $256-5$ , or 251 mils; an angle of departure of 251 mils corresponds to a range of 4260; the point of fall is  $b'$ , the elevation of which is 230; site of  $b'$  is  $(250-230)/4.26$ , or  $-5$  mils; therefore, to reach  $b'$  the elevation would be 251 minus 5, or 246 mils; 246 is less than 251, therefore the projectile would not clear. Increase the angle of site by 10 mils; 251 plus 10 is 261, and the corresponding range is 4400 m., the point of fall of which is  $b''$ ; the elevation of  $b''$  is 220; site of  $b''$  is  $(250-220)/4.4$ , or  $-7$  mils. To reach  $b''$  the elevation would be  $261-7$ , or 254 mils; 254 is greater than 251, therefore the projectile would clear.

The minimum range is 4400, and  $b''$  is a point on the curve of minimum ranges for the Crest  $B'$ .

The angle of fall,  $c$ , for R of 4400 is 17 degrees 31', or 315 mils. Inclination of the trajectory: It is  $c-s$ , or 315 plus 7, or 322 mils.

To construct the tangent:

Take  $B'd$  equal to 1000 m., or 50 mils (at 1/20,000).

$de$  equal to  $315/2$ , or 157 mils (1/2000), since vertical scale has been multiplied 10 times.

The space contained between the tangent  $b''K$  and the profile is in a dead angle.

## SIXTH LECTURE

### RECONNAISSANCE AND STUDY OF OBJECTIVES (*Continued from Fifth Lecture*)

#### *Orientation*

For orientation and to make what we call the *tour of the horizon*, when we find ourselves at a point from which an extended view is possible, is to go through certain operations so as to be able to answer accurately two questions, "Where are we?" and "What do we see?"



## FIRING CHARTS AND THE RECONNAISSANCE OFFICER

### *Use of the Plotting Board*

The best method for orientation consists in the use of the *declinated* plotting board to which the map has been fastened, and the alidade (or slope-ruler). Set up at a station. If the declination of the plotting board has been previously determined, orient it and locate the point either by *relèvement* on points of the *canevas* or by traverse from known points in the vicinity. If the declination of the plotting board has not been determined, locate an approximate point by means of the approximate declination, sight on a distant point in order to check it, then take another trial point, and so on. In any case, do not begin the tour of the horizon unless the station has been accurately determined, nor, above all, unless the orientation of the plotting board is absolutely correct. Then sights in direction with the alidade or slope-ruler will permit us to identify positively all visible points; the evaluation of distances, and the study of the forms of the terrain on the map will suffice, as a general rule, to allay any doubts which may arise. Pay particular attention to the hidden and visible areas, and try to connect the apparent contours of the terrain with the crests indicated by the map contours; thus we may avoid gross errors (such as, for example, seeing a trench which is really situated on a counterslope).

### *Special Difficulties*

It may happen that, in a particular direction, several crests stand out near each other in such a manner as to make it difficult to see details of the terrain. In this case, by moving your position to the right or left 100 or 200 metres, the angular displacement between the doubtful points will be changed, thus furnishing indications as to their respective distances. If need be, make a small calculation of parallax.

For example, we see almost in the same direction a clock tower *A* clearly identified, and two intersections of trenches, *B* and *C*, in such a position as to make them difficult of identification, for the map shows in the direction of *A* several organized crests. From the station where the plotting board is set up, measure the angular distance *AB*; that is found to be 10 mils,

$B$  being to the right. Move your position to the left a distance of 150 metres. From this point we find that the angular distance between the two points has increased and is now 35 mils,  $B$  being still to the right. The clock tower  $A$  is clearly identified; it is 6000 metres away. What is the distance to  $B$ ? The difference of the parallaxes,  $a$  and  $b$  of  $A$  and  $B$  is equal to the difference of the angular distances:

$$b-a=35-10=25 \text{ mils}$$

But, since the clock tower  $A$  is 6000 metres away, its parallax

$$a=\frac{150}{6,000}=25 \text{ mils}$$

Therefore,

$$b=25+25=50 \text{ mils}$$

The parallax being 50 mils for 150 metres, the point  $B$  is about 3000 metres away. If a similar calculation gives for the distance  $C$  2500 metres only, there is no longer any doubt, and the two points  $B$  and  $C$  are identified on the map.

*Remark on the Subject of Detailed Observation in a Restricted Zone*

Reconnaissances are generally made with the plotting board and the 1/20,000 map. However, for detailed reconnaissance of a restricted zone, for example the part of a position assigned for destruction to a group of artillery, it is better to use a map of larger scale (1/10,000 or 1/5000); the entire map need not be fastened on the plotting board.

We take simply the part of the map to be used and fix on it a protractor made of tracing paper, oriented in direction and distance by means of some prominent point in the zone to be studied, previously identified on the 1/20,000. The other observations will be referred to this prominent point by measurements of angular displacements with the field glasses or with the monocular or binocular lunette.

*Tour of the Horizon with Angle-measuring Instruments*

If we cannot use a plotting board (for example, in a trench), we may make our reconnaissance by measuring angles with an instrument, such as aiming circle, goniometre-periscope, binocular lunette, monocular lunette, or Peigne compass.

## FIRING CHARTS AND THE RECONNAISSANCE OFFICER

The observed angles or directions are transferred with the protractor to the map, which should be placed on a table, a box, or some other suitable support. The impossibility of putting the whole map on an improvised table will generally make it necessary to perform the operation in two parts. We would first study a certain number of reference points easy to identify, using the celluloid protractor and a small scale map (80,000 to 50,000). Then we would study the details with the aid of the tracing-paper protractor and the firing chart (20,000, 10,000, or 5000), of which we would need to use only a small part at a time.

### *Perspective Sketches and Panoramic Views*

Panoramic views present various forms, from the very complete and detailed panorama, executed at leisure, to the rough sketch made by the orienting officer in the course of a rapid reconnaissance, in order to show his battalion commander the principal points around the horizon.

A panoramic view will not be really useful unless it fulfils the following conditions:

It should be *simple*; leaving out all artistic considerations, it should indicate only that which is essential: the crests which separate the different planes, prominent objects which may serve as reference points for the designation of the details, the principal points of enemy crests identified on the terrain. It should be *accurate*, and to this end should be made to a certain scale; it should, therefore, be based on a *canevas* established by measurements of angular distances and angles of site: the angular graduation in direction and site should be shown on it.

It should be *distinct*, more distinct than reality itself, and should show at the first glance all necessary military details which may have been discovered only after a patient examination of the terrain; that is to say, it should not be necessary to refer to conventional signs and written inscriptions in order to read the sketch. It is quite evident that these conditions can not be fulfilled by photography. The latter may always be usefully employed in order to facilitate the execution of a panoramic sketch, by furnishing quickly a detailed *canevas* completing

the *canevas* established by measuring angles and sites. The use of photography in the execution of a panorama should always be preceded by a minute and careful study of the terrain, made at the observatory, with the aid of the map and observation instruments if necessary. It is only under this condition that we may be able to select judiciously from the photograph useful details and eliminate those which are of no value.

PERSPECTIVE SKETCHES.—(a) Having analyzed the terrain which we find before us, make from this analysis a written impression, easy to establish quickly, and capable of being utilized by anyone who comes to that same station.

(b) Analysis of the terrain: We must commence by studying the terrain closely, not only with respect to what we see but with respect to what is hidden. With this object in view, use the map. Having made a tour of the horizon by this means, and recognized the objects which are clearly seen, try to discover from these other objects, from their direction and their position on the map. Mark exactly the direction of these hidden objects with reference to those which are visible. For example: The map indicates that between the villages *A* and *B* there is a main road which runs through a wood—try to see with the field-glasses the points at which this road enters the villages *A* and *B*; try to find it again between the two villages. Perhaps you may thus be able to discover at least certain parts of it. Perhaps you will be able to see nothing except the border of trees along which the road runs, etc. Between this crest and that crest the map indicates a valley. Try to distinguish the crests from each other, etc.

The analysis having been made, in order to record it rapidly and in such a manner that it will be immediately comprehensible, it is better to use the *language of drawing*, completed by a simple legend. The document made according to these principles is called a *perspective sketch*. It is not a copy of the terrain that we must make; but it is more: it is a *caricature* of the terrain.

(a) *Drawing*.—The principles of drawing to be applied are as follows: Simplify and emphasize the important or salient points, and thus facilitate its use in firing by whoever may be

## FIRING CHARTS AND THE RECONNAISSANCE OFFICER

called upon to make use of it, no matter whether battery or battalion commander. We must therefore indicate on the sketch angular distances in mils measured with respect to a reference point situated near the centre of the zone; also it should show the angles of site and distances for the principal points of the zone. It being necessary to graduate the sketch in width as well as in height, use if possible squared or cross-section paper. Also use a well-sharpened medium pencil. Having chosen a reference point, first construct the framework of the sketch by putting in place certain objects (we should use as a scale at least 5 cm. for 100 mils). The reference point being about the middle of the sheet, put in the salient objects: clock towers, prominent trees, isolated houses. In height begin with the plane of the horizon. We may, in order to differentiate clearly between successive crests, adopt a larger scale of heights (double that of the horizontal scale, for instance). Having thus placed in position the principal points, complete the sketch by eye. Successive crests are indicated by lines which are heaviest for those nearest and lightest for those farthest away. Woods are indicated by outlines and by *hachures* which are heavier for those woods in the foreground and lighter for those farther away. Trees are represented by conventional signs resembling, as nearly as possible, the particular kind of tree shown. We may indicate slightly the form of the terrain by *hachures* following the lines of greatest slope or by very light contour lines. Only a little drawing is necessary in order to make a very clear perspective sketch. Leave out every useless line from the sketch.

(b) *Lettering*.—Lettering should not obscure the drawing. Keep it separate from the drawing itself. It is better to have the lettering on the upper part of the sketch. The lettering is placed horizontally, and for objects closest in it should be lowest down; and for objects farthest away it should be highest. We may, if necessary, use abbreviations and carefully drawn lines with arrows pointing out the object to be designated. Underneath the lettering for the visible objects put the lettering for the principal defiladed objects given on the map, such as villages, railways, streams, etc. Do not forget to note in the lower left-hand

corner of the sketch the point of view from which the sketch is made.

REMARK 1.—The execution of the sketch should be done progressively. The one who begins it does not, as a general thing, know how much time he has before him. He should therefore indicate, first, all the principal points to be shown on the sketch; then it may be completed afterward if necessary. The battalion commander, for example, coming into the position should be able to understand the terrain before him as soon as he takes the sketch in his hands, even though it be uncompleted.

REMARK 2.—It is a good idea to name immediately, by characteristic expressions, the objects on the terrain which may be used as aiming or registration points. In fact, we must anticipate the use of such objects in designating objectives, and that these objects will be used by those who will be called upon to refer to them, though placed at a different station; for instance, the liaison officer with the infantry.

(c) *Panoramic Sketches or Views.*—In open warfare the only artillery sketch to use is the perspective sketch, as defined in the preceding section, completed, if necessary, by small planimetric sketches. On the contrary, when warfare is of the present form it is possible to do more. In observation posts which are to be used by certain organizations they should have at their disposal a panoramic sketch. The panoramic sketch is a detailed perspective sketch on a large scale (10 cm. for 100 mils, or even more). On this panorama will be shown all the interesting details of the terrain, utilizing, if need be, a powerful field glass, graduations being placed every 5 mils in direction and in site. It is better to reserve the top of the paper for the legends and the bottom for interesting information which would be used in firing. A panoramic sketch aids the firing chart very effectively. It is of special value when intelligent noncommissioned officers or privates are to be utilized in observing the battlefield. A flash indicating a hostile shot might appear somewhere, and the observer would mark it with respect to the neighboring objects: for example, at the border of the wood *B*, between the third and fourth poplar. He would then be able to mark its

## FIRING CHARTS AND THE RECONNAISSANCE OFFICER

place on the panoramic sketch. The piece thus revealed would therefore be located in direction and, if the line of poplars and the wood *B* were quite close together (see map), we would have also a close approximation of the range of the piece. This method of writing on the sketch itself, with the date and hour, is the best and most simple method of noting the results of daily observations. It will likewise permit us to take notice of new works executed by the enemy, etc. The sketch will be kept constantly up to date. Finally, what is an enormous advantage: in case of relief the new artillery will inherit thus all the experience of its predecessor, and the mission will be carried out without any period of transition or confusion.

It would be well for the battery commander to possess in his observatory perspective sketches drawn from the auxiliary observing posts. He should make a point of reconnoitring on the terrain objects shown on these sketches, which will evidently serve as reference points to the auxiliary observers for adjustment or for the designation of objectives. For example, from an auxiliary observatory three trees are seen at the crossing of two roads. From the observatory the captain can just see the three trees, but only their tops. If, after an accurate adjustment on the crossing, made from the auxiliary observatory, the captain should have to fire again on this same object without being able to use the auxiliary observatory, he would have, at least, approximate control of his fire. It is evident that the study of the terrain may be made without recourse to neighboring observatories.

### TERRESTRIAL OBSERVATION IN THE BATTERIES AND GROUPS

#### *Survey of the Zone of Action and Determination of New Objectives*

*Precautions to Take—Documents to Establish.*—In order to survey their zone of action, to study their principal targets, to discover those which may reveal themselves, the batteries and groups place on the terrain a system of terrestrial observation posts comprising principal observatories, presenting a certain character of stability by their installation and construction for

the service for which they are intended, and, in addition, other posts of observation, which may be quickly organized, and which are intended to supplement the main observatories. Each unit has a principal observatory and a number of secondary observatories. Leaving out the question of the material installation of the observatory, we will concern ourselves solely with the organization of the service of observation, and the conditions which should be fulfilled by the observatories in order that they may give all the precision and accuracy obtained through the use of measuring instruments.

1. The observatory should be located precisely. This determination is made by the regular topographic methods, sometimes by geodetic methods, by the orienting officer of the group, or the chief of the observation service of the unit occupying the observatory, or, finally, if necessary, by the *Groupe des Canevas de Tir*.

2. Each permanent observatory possesses one or more sighting instruments capable of being used for measuring angular distances: *triangle de visée*, *circle de visée*, monocular or binocular lunette. The principal instrument in the observatory should always be kept oriented on the same line or reference point. This orientation should be known by all those who may have to use readings made from the observatory. It may be done in two ways:

The observatory may possess a principal reference point, a directrix, which corresponds to an even reading of the instrument (500 or 1000). This reference point is a point of the *canevas*, or, if no such point is visible, then we will use a well-established point on the map. It is defined not only by its coördinates, but, in addition, by the orientation of the line *Observatory-Reference Point*.

The orientation may be defined by reference to one of the axes of the Lambert squares, the zero reading of the instrument corresponding to the sight along one of these axes. If this zero reading corresponds to the positive direction of the *Y*-axis of the squares, and if the graduation of the instrument is in the direction of the hands of a watch, the readings of the instrument give the azimuths directly. If the graduation is in the opposite



direction, or if the zero does not correspond to the positive *Y*-axis, the readings have a simple relation to the azimuths. Laying the instrument in direction is assured by means of sights on one or more reference points. The determination of the azimuths of these reference-directions is the result of topographic determination made at the same time that the coördinates of the observatory are determined. The readings corresponding to these reference-directions are posted in the observatory and serve to check the readings and the accuracy of adjustment of the instrument. It is not necessary that these should be known by those receiving observations from the observatory, as it will be sufficient for them to know the geographic orientation, and also the direction of graduation of the instrument and the nature of the graduation—whether in mils or decigrades.

3. The observations thus being accurate in direction, we must, in order to locate them in distance, take special precautions. The character of these observations in general is known as single, or, as we say, *unilateral*; the reading of the instrument gives only a direction. The objective, seen in a determined direction, can be placed on the map accurately only if the observer knows perfectly his sector of observation, if he knows precisely what parts of the terrain are seen and hidden, if he has identified all the planimetric details and all the visible objectives. This work of reconnaissance will require the use of the following documents:

*Plan directeur (planchette de tir).*

Map of visible and hidden parts.

Panoramic views.

*Planchette for the Observatory.*—The observatory is equipped with a firing chart pasted on a planchette (*planchette de tir*). This *plan directeur* or firing chart should carry a graduation in direction corresponding to that of the instrument and to that of the perspective or panoramic sketch; it carries, in addition, all the special indications written on these latter documents (letters, numbers, etc.). This simple precaution facilitates considerably the reconnaissance of the sector of observation in case of change of personnel.

## THE FIELD ARTILLERY JOURNAL

*Map of Visible and Hidden Areas.*—The visible and hidden zones from the point of view at the observatory should be indicated accurately, either on a special map posted in the observatory or on the observatory planchette itself. The establishment of this very important document should always precede the execution of the panoramic sketch.

*Panoramic Sketch.*—It is essential to have at the observatory a precise, detailed panoramic sketch, carrying numerous indications (under the form of names, letters, numbers) which will allow one to see immediately the relation of the elements shown on the sketch to those shown on the map.

Besides the above-mentioned documents, it is convenient to have at the observatory a *plan directeur* of the latest edition, constantly kept up to date by means of the additions or corrections published by the *Canevas de Tir*, or the Topographic Section. Finally, there should be posted a table of readings corresponding to the *reference-directions* of the principal instrument, and the various information relative to the organization of the information service: tours of service of the personnel, missions of observers, nature and form of reports to be rendered.

*Practice of Observations. Data Book (Carnet) of Observations.*—Following out the rôle for which the observatory is intended, observations are transmitted either immediately by telephone, or periodically at a fixed hour by telephone or by written message. But, in all cases, the observation should be recorded immediately on the *carnet* according to a regular form. The model and disposition of the *carnet of observation* will be established by the orienting officer or the chief of the observation service to which the observatory pertains, conforming to the following general indications: any observation should comprise an indication of the hour, an indication of direction, an indication of presumed position, and, finally, all the information of a military order concerning the objective reported which may interest those to whom the observation is to be transmitted.

### EXAMPLE

At (such an) hour, (such a) minute (at such a second if necessary); (such a) reading; (such an) objective, revealed in

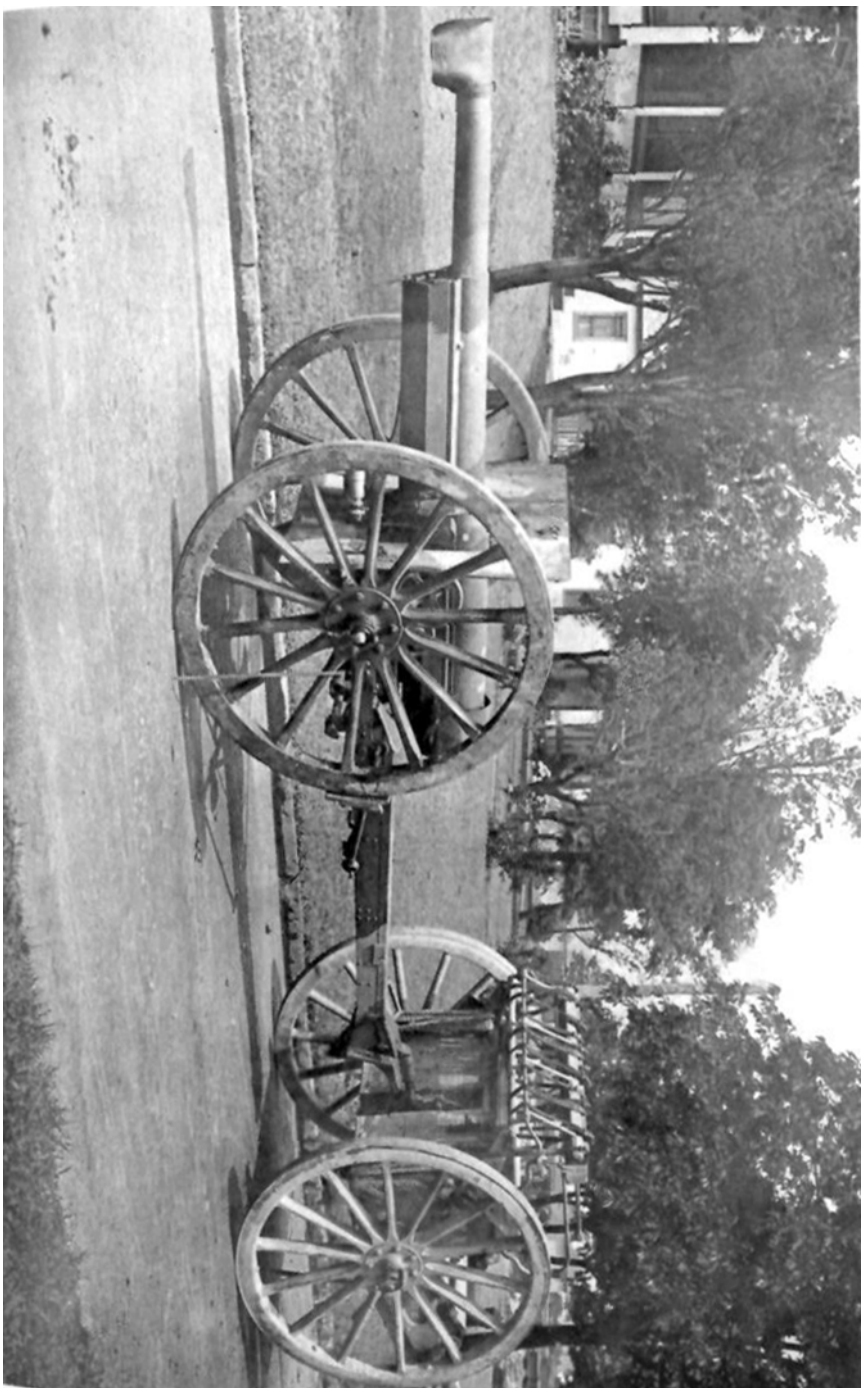

FRENCH 75-MM. GUN  
No. 1. Gun limbered

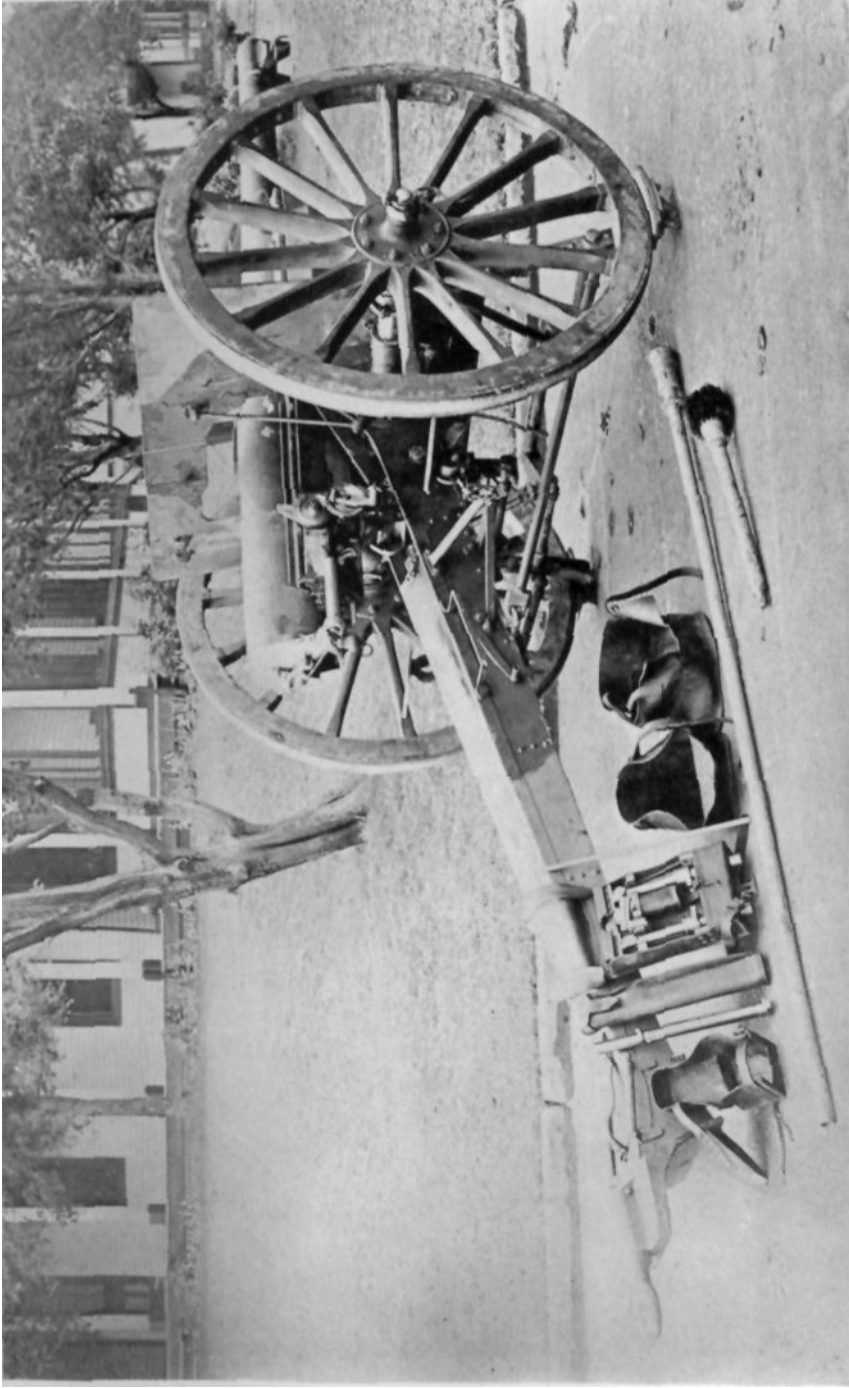

FRENCH 75-MM. GUN  
No. 2. Gun unlimbered and in firing position

## FIRING CHARTS AND THE RECONNAISSANCE OFFICER

(such a) way, is found towards (such a) point, is going in (such a) direction, at (such a) speed.

It will therefore be necessary that the watch at the observatory should be regulated; that is to say, it should be known whether it is *fast* or *slow* and by how much with respect to the *official* time. So far as *direction* is concerned, the indication would be given in the form: to the right (or to the left) of such a reference point, so many decigrades (or mils), but it is preferable to ask the observer the simple reading given by the instrument, the zero of which always corresponds to a reference point well known to the battery commander or battalion commander.

*Note on Official Time.*—There is only one *official time*—that which is transmitted every day at 10:45 A.M. from Eiffel Tower, and which may be caught by all radio receiving stations. The comparison of watches from hand to hand by telephone should be made, not by eye, but by sending a precise signal. The radio or other officer charged with giving the official time to several observatories, for instance, holds with each in turn a conversation somewhat as follows:

*Radio Officer:* "Hello! I'm ready to give you the official time. Have you your watch ready?"

*Orienting Officer:* "All ready, sir."

*R. O.:* "I will send the signal at exactly 11 o'clock by my watch. *Ready* (given 5 seconds before the signal)—*Check.*" (Given at the exact moment the second hand crosses the zero mark.)

*O. O.* (announcing successively the seconds, minutes and hours shown by his watch at the exact moment the command *Check* was given): "35<sup>s</sup> 2<sup>m</sup> 11<sup>h</sup>."

*R. O.:* "I will give it to you again at eleven one." "*Ready*—*Check.*"

*O. O. Announces:* "36<sup>s</sup> 3<sup>m</sup> 11<sup>h</sup>."

The *R. O.* then makes this calculation: "His watch is 2<sup>m</sup> 35<sup>s</sup>, nearly, ahead of mine. Mine is 3<sup>m</sup> 20<sup>n</sup> fast of Eiffel Tower, therefore his is 5<sup>m</sup> 55<sup>s</sup> *fast.*" Then he telephones: "Your watch is 5<sup>m</sup> 55<sup>s</sup> *fast.* Note it on your *Carnet.*"

# A Protractor for Field Artillery

BY MAJOR GEORGE PAYNE NICKERSON, N.A.

WITH the present war accuracy and speed have become determining factors to a greater extent than ever before in the effective delivery of artillery fire. This not only refers to the guns themselves, the projectiles, with their many types of fuzes and the delicate instruments employed, but also to the prompt and accurate determination of firing data.

Having heard that a protractor had been proposed that quickly

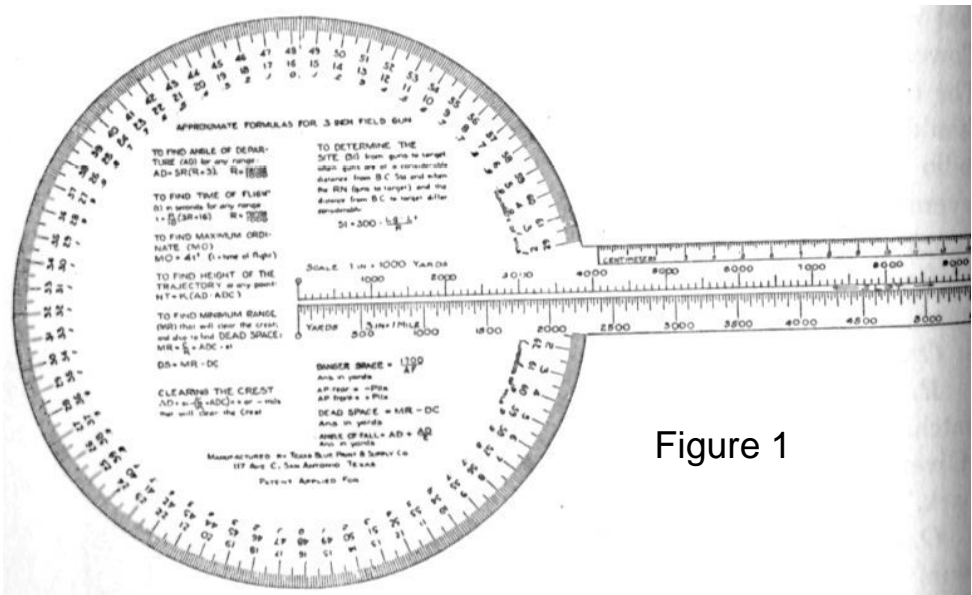

Figure 1

determined the deflection and true range, a metal protractor similar to the one shown in Fig. 1 was designed and developed, and it is hoped that it will fill a long-felt want in the Field Artillery.

Through its use the deflection and true gun-target range can be determined and the deflection difference figured easily without reference to a map or the type of field-piece used. It is accurate, and an ordinary problem can be solved in about

## A PROTRACTOR FOR FIELD ARTILLERY

one and one-half minutes, doing away with "Rules of Thumb," exceptions, or mathematical calculations almost entirely.

The illustration (Fig. 1) shows the shape and graduations of the protractor. The projecting portion, known as the range arm, is divided on one side into an arbitrary scale for use without a map, one inch equalling one thousand units of linear measure, be they yards or metres. Subdivisions are provided, and every hundred units shown and every thousand numbered. The other side shows a scale for use with maps of one, three, six, or twelve inches to the mile, the unit of measure being doubled or trebled in length to correspond with the scale of the map used. This side of the arm may be left blank or additional scales placed thereon to interpolate any scale to correspond with the one of the particular map used.

The protractor is divided into six hundred and forty equal parts around its outer circumference, each division equalling ten mils, and each hundred mils being shown in figures. The zero or 6400 division lies in the line with the edge of the arbitrary range scale, and the mils divisions read clockwise.

If one wishes to use the protractor with a compass subdivided into degrees, another scale may be laid off in three hundred and sixty equal divisions, reading clockwise inside the original mils scale.

As our present aiming circle compass is divided into mils and bearings may be so read, the outer scale will more generally be used.

The following is a brief description of some of the more common uses of this protractor, showing its speed and simplicity.

### TO DETERMINE THE DEFLECTION AND TRUE RANGE GUN TARGET

#### *Without the Use of Map or Figures*

Place a sheet of plain paper on a sketch-board or other flat surface and draw a line *AB* (see Fig. 2) approximately bisecting the sheet through its long dimension. Centre the protractor somewhere on this line, preferably near the centre, and call this

THE FIELD ARTILLERY JOURNAL

point the battery commander's station, and lay the three-inch range scale along *AB* ready to measure.

Measure the actual range from the battery commander's station to the aiming point and lay off on line *AB* a point representing the aiming point at a reading on the three-inch range scale equal to the actual range measured, calling the point "P."

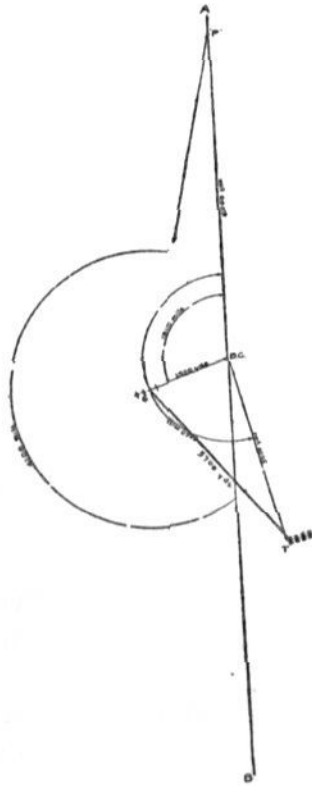

Figure 2.

Next measure the actual angle between the aiming point and the second piece at the battery. Lay off this angle with the protractor by turning the range arm in a counter-clockwise direction and reading the mils scale where the line *AB* cuts the circumference of the protractor.

Draw a line along the edge of the three-inch scale, using a sharp pencil. This line indicates the direction of the second



## A PROTRACTOR FOR FIELD ARTILLERY

piece of the battery. Measure range battery commander's station to second piece.

Lay off on the line drawn in the direction of the battery a point "G," representing the second piece, at a reading on the arbitrary scale equal to the actual range measured.

Measure the angle between the aiming point and the target. Lay off this angle with the protractor, reading it as before and drawing the line along the range arm to indicate the direction of the target.

Measure the actual range from the battery commander's station to the target. Lay off on the line drawn in the direction of the target a point, "T," representing the target, at a reading equal to that of the actual range measured.

Recenter the protractor on the point "G" and draw line from "P" to "G." Turn the protractor counter-clockwise until the three-inch range arm scale cuts the point "T."

Read the mils scale on the protractor where it is cut by the line "PG." This reading is the deflection in mils.

Read the arbitrary range scale at the point where it cuts the point "T." This is the true range from second piece to the target in the unit of measure you have used in measuring the actual ranges.

### EXAMPLE (*see Fig. 2*)

Given (as measured with instruments):

1. Range to Aiming Point, "P" ..... 6000 yards.
2. Angle  $P-BC-G$  ..... 1910 mils.
3. Range to Second Piece, "G" ..... 1500 yards.
4. Angle  $P-BC-T$  ..... 3460 mils.
5. Range to Target, "T" ..... 3500 yards.

Required:

1. Deflection or Angle  $PGT$ .
2. True Range  $G$  to  $T$ .

Point off 6000 yards on line  $AB$  with range scale and label it  $P$ . Turn protractor counter-clockwise until the reading where  $AB$  cuts mils scale is 1910 mils. Draw line close along edge of

## THE FIELD ARTILLERY JOURNAL

range scale. Point off on this line at 1500 yards and label the point *G*. Continue to turn the protractor until mils scale reads 3460 mils as before. Draw line along range arm as before. Point off on this line at 3500 yards, labelling it *T*.

Recenter protractor on *G*. Draw line from *P* toward *G*, so that it will cut through the mils scale. Turn the protractor counter-clockwise until the edge of the range scale cuts the target *T*. Read where line *PG* cuts mils scale for deflection, viz., 4100 mils.

Read the range scale where it passes through *T* for the true range, viz., 3700 yards.

The above process can be adapted to the present battery detail somewhat in the following manner:

The instrument sergeant uses the board and protractor and drafts his problem as the data are furnished him. The range finder corporal first finds the range to the aiming point, then the range to the target. The signal sergeant measures the range to the second piece at the battery by means of his telephone line, communicating the range to the instrument sergeant. The aiming circle corporal measures the angles with his instrument.

Provided the data come to the instrument sergeant progressively as it should, and the angle (either to the guns or target) is measured first—the smaller angle in a counter-clockwise direction should always be measured first—the sergeant will have his problem completed almost immediately after he has received the last data. By close coöperation between the members of the detail such rapidity can be developed that the time necessary to complete this part of a problem is dependent upon the speed in the use of the instruments employed.

As there are no mathematical calculations involved in the above solution and the result is obtained mechanically, the chance of error is practically eliminated even in actual warfare.

## THE DEFLECTION DIFFERENCE

The deflection difference in such a problem as the above is readily computed by the use of simple figures and the use of

## A PROTRACTOR FOR FIELD ARTILLERY

ranges measured by the protractor, guns to aiming point and guns to target, rather than the ranges from the battery commander's station as measured by the range finder. The differences in ranges vary as the guns are nearer or farther from the battery commander's station and as they are in front, to the rear, or to the right or left of the battery commander's station. In France, when the stations are likely to be far in advance of the guns, the differences would be very marked.

Notice, also, that the protractor bears an obliquity scale immediately inside of the inverted mils scale. By zeroing the protractor on the target it is readily seen what quadrant the aiming point lies in and also the value of the correction for obliquity by reading the scale for that purpose at a point corresponding to the deflection reading already determined, this reading coinciding with the line Guns- $P$ , the protractor having been centred at the guns.

In the problem (Fig. 2) the deflection difference can readily be solved by the instrument sergeant as follows:

Range Guns to A.P. is 6650 yards. B.C. to  $P$ , 6000 yards. Difference, 650 yards.

Range Guns to  $T$  is 3700 yards. B. C. to  $P$ , 3500 yards. Difference, 200 yards.

Deflection difference for parallel fire ( $P-T$ ):  $P$  is  $20 \div \frac{6650}{1000}$  is approximately 3. Knowing the deflection to be 4100 as solved in example, read the obliquity scale which coincides thereto, which is 0.7 (seven-tenths). Three times 0.7 is approximately 2.  $P$  being a minus quantity, it therefore equals  $-2$ .  $T$  is  $20 \div \frac{3700}{1000}$  is approximately 5. ( $-P-T$ ) is  $(-2-5)$  is  $-7$ , or close on second piece by 7, all data having been figured for that piece.

The reader's attention is called to the difference between the ranges as measured from the battery commander's station and those measured by the protractor from the gun position.

### SITE

In making an accurate determination of the site, the true range as read on the range arm, guns to target, should be used.

## THE FIELD ARTILLERY JOURNAL

Otherwise if the range battery commander's station to target is used the site determined will be incorrect.

### OTHER USES OF THE PROTRACTOR

#### *Map Firing*

The protractor can successfully be used in map firing, and because of the auxiliary scales which are or may be laid off on the range arm to correspond with the map scale, the data desired, once the positions of aiming point, guns, and target are located on the map, can be determined.

#### *Protractor and Compass*

This protractor can be used to determine the magnetic variation of the aiming circle compass as described in subject No. 37, "School of Fire for Field Artillery," dated January, 1916.

It is useful in determining a magnetic bearing on the map in mils, the range arm being particularly adaptable here in intersecting the points desired, the results being in mils.

It must be borne in mind, however, that the angle must be measured by swinging the range arm in a counter-clockwise direction and reading at the intersection of the North-South line and the mils scale.

A position can be located on the map by the use of this protractor and the compass. The range arm is helpful here because it supplies a ready means of intersecting the points from a common centre without removing the protractor to use a ruler.

In obtaining a deflection by using the compass the protractor can graphically measure the deflection from the bearings given, from an arbitrary North-South line laid off as described in the lesson pamphlet mentioned above.

### THE PROTRACTOR AT THE BATTALION STATION

It is believed that the protractor would prove valuable in determining and locating targets by battery commanders when

## A PROTRACTOR FOR FIELD ARTILLERY

the targets are likely to be partially obscured by smoke or fire and where they are difficult to pick up in a trench system, the direction and range from the battalion station being determined by

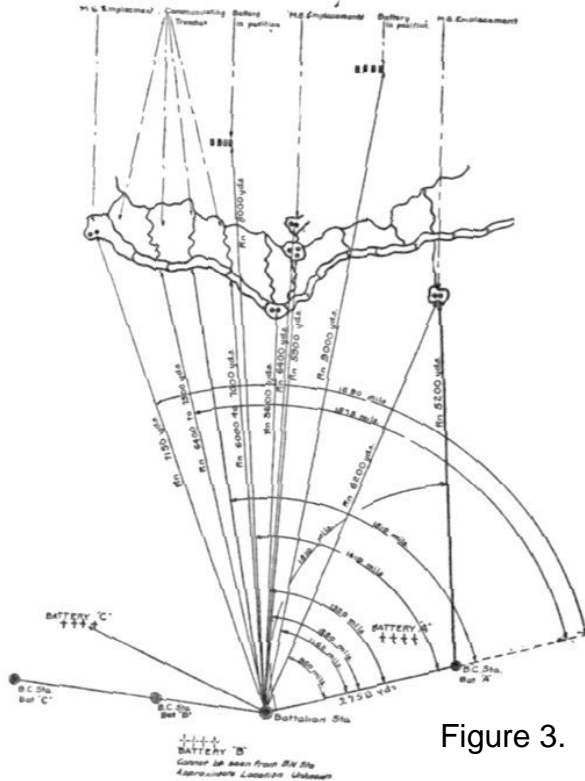

Figure 3.

Illustrating how sketch may be made to forward to organization commanders from the battalion station using the protractor. Targets and troops are located by means of instruments and plotted with protractor. Battery commanders may then use the battalion station as reference point and by protractor measurements determine the location from the sketch and pick up troops and targets with their own instruments, using their results as obtained from the sketch. The battery commander, Battery "A," draws line B.C. to target and measures angle on sketch battalion station to target equalling 1810 mils. With his protractor he then sets the zero of his B. C. telescope on the battalion station and turns it 1810 mils, and if he has the proper angle of site, is looking at the machine-gun emplacement indicated on the sketch, and by the use of the range scale on sketch can find the range to the target.

means of instruments there, the protractor being used to plot the targets and our troops and batteries and observation stations as indicated in Fig. 3. The battery commander can, upon receipt of the sketch, use the battalion station or other visible

## THE FIELD ARTILLERY JOURNAL

point indicated on the sketch for a reference point and by intersection on the sketch and measuring the angles with his protractor pick up the target and know, by using the range scale, its exact range. By sighting his battery commander telescope on the visible point above mentioned and turning off the angle which he has measured from that point to the target by means of the protractor on the sketch, the battery commander will be looking directly at the target, provided the elevation is the same. By depressing or raising the instrument an amount equal to the site of the target he looks through his glass directly at it. If the major has plenty of time in which to complete his sketch, he can compute the angle of site for each target from each of his batteries, thus simplifying the use of the sketch and instruments.

From the above it can be seen that it is possible to indicate (as the major has done in Fig. 3) definite parts of the enemy's lines, his trenches, machine-gun emplacements, batteries, ammunition dumps, and our own trenches, troops, or batteries, with their observation points. By furnishing each battery commander with a copy the major gives them a means of knowing the surrounding territory in a very short time and before it is possible to furnish maps. By super-imposing this sketch on a map of like scale it is possible to locate thereon this needed information as it is secured.

The protractor should be a great aid in place, position, and area sketching, in map reading, and should be adaptable to many uses hitherto unthought of.

It is believed that a similar instrument has been in use for some time in France, but that they are not to be procured there. The Texas Blue Print and Supply Company, of 117 Avenue C, San Antonio, Texas, kindly made up the original here under my direction. It has improved it from time to time and is now prepared to furnish them at a nominal cost. The protractor as sold is similar to the one in Fig. 1 and is made up in thick celluloid or metal, die stamped.

It is hoped that the Field Artillery can make some use of it.

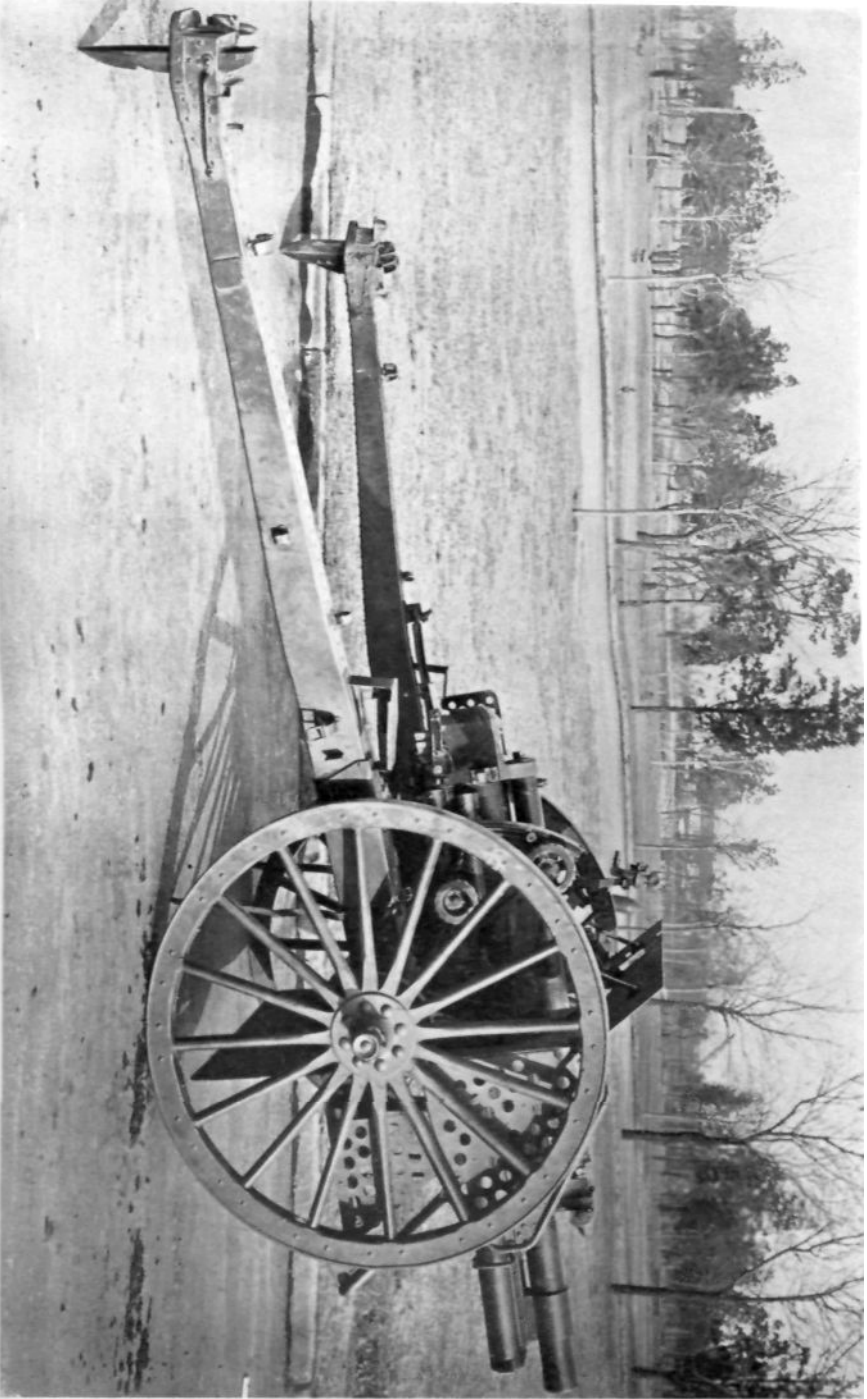

75-MM GUN, U. S. ORDNANCE DEPARTMENT, MODEL 1916  
No. 1, Gun in firing position

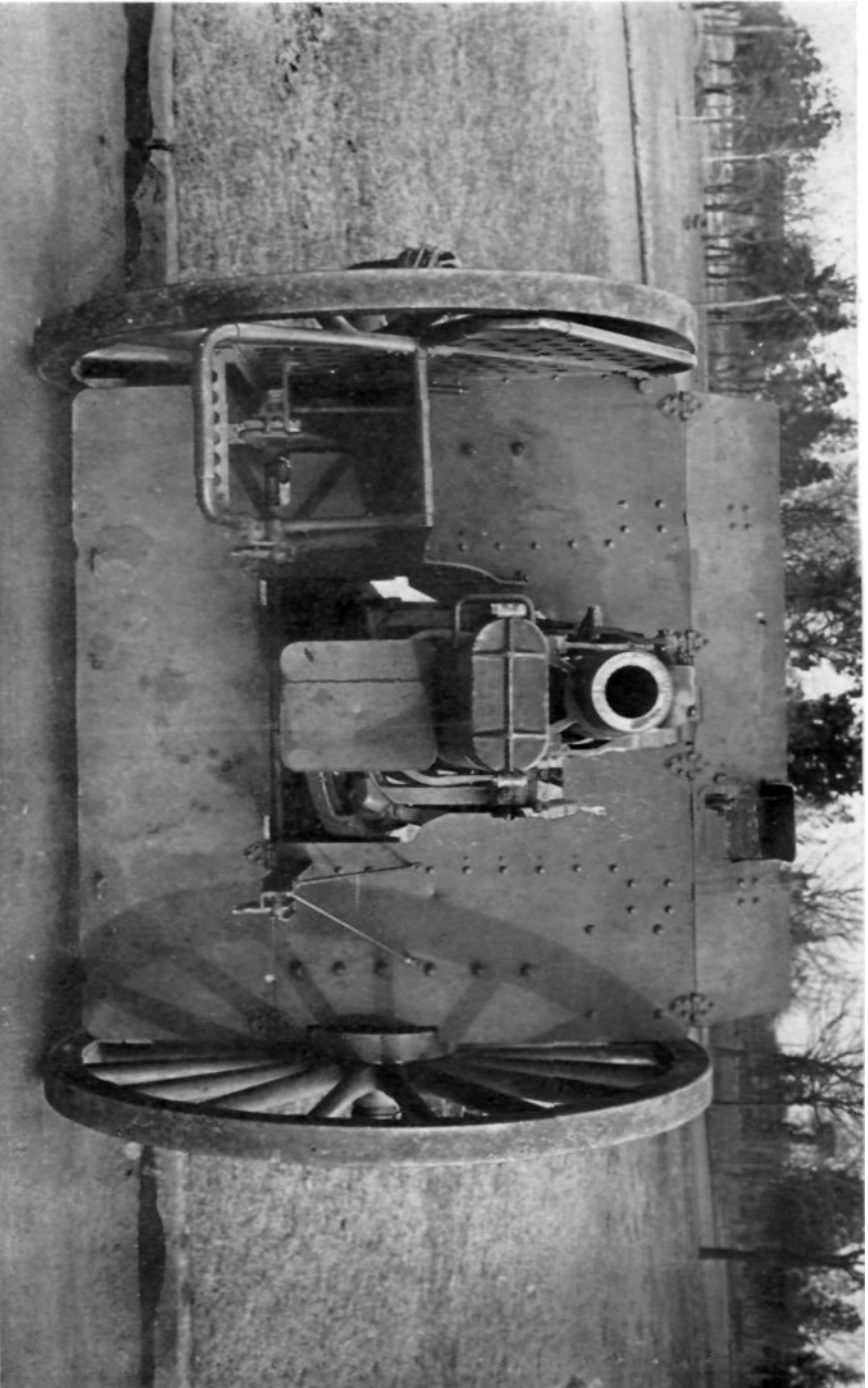

75-MM GUN, U. S. ORDNANCE DEPARTMENT, MODEL 1916  
No. 2, Gun in firing position, showing protection afforded cannoners



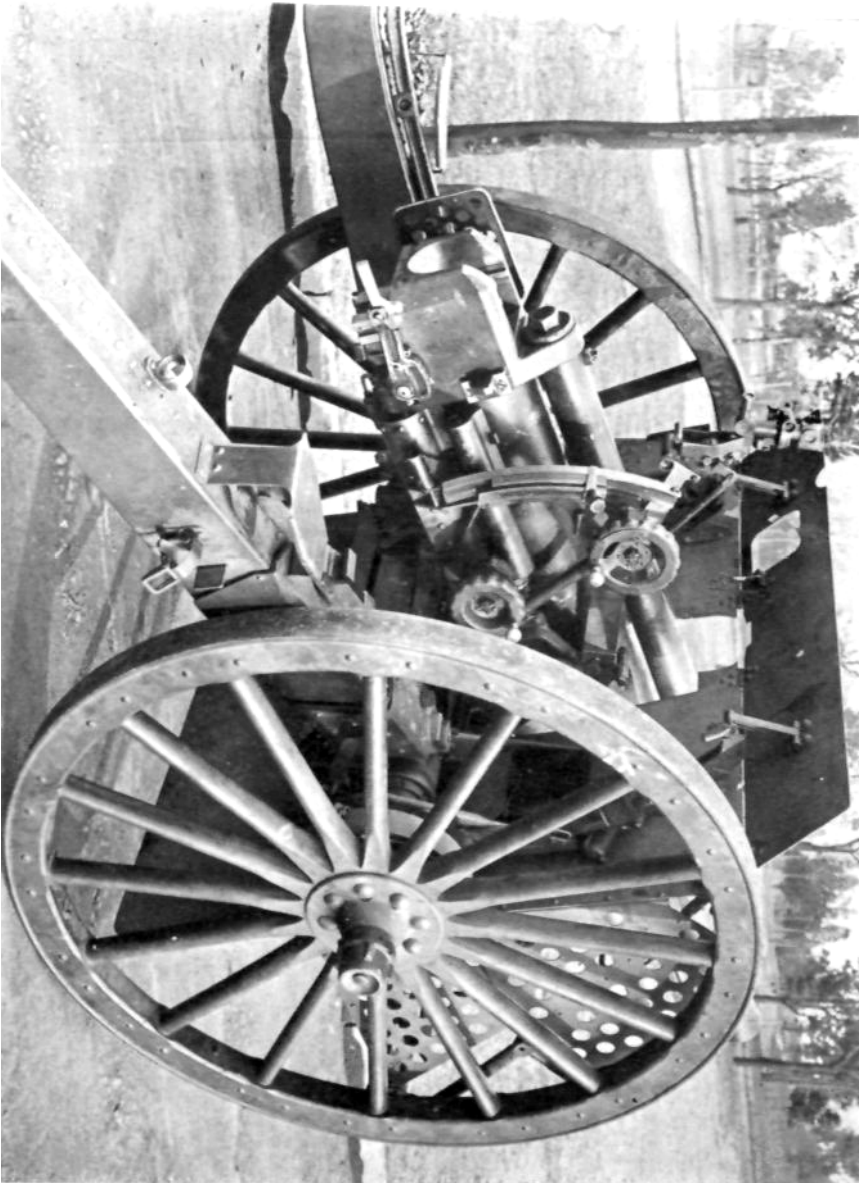

75-MM GUN, U. S. ORDNANCE DEPARTMENT, MODEL 1916  
No. 3, Right rear view of carriage

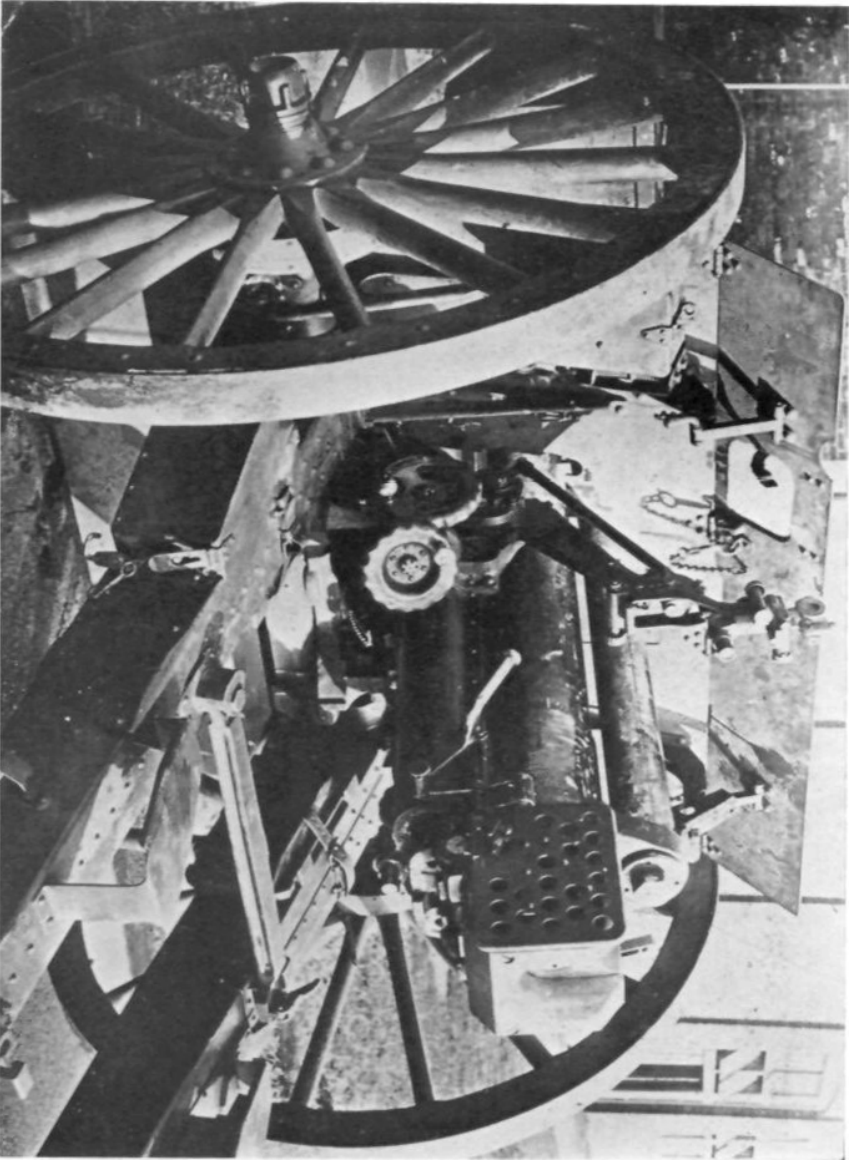

75-MM. GUN, U. S. ORDNANCE, MODEL 1916  
No. 4, Left rear view of carriage

# A Field Method of Calculation for Adjustment with Lateral Observation

BY LIEUT. S. C. SPEAR, 315TH FIELD ARTILLERY

As various authorities have shown, there are at least two principal correctives to be made when observing from a flank position: (*a*) The shots must first be brought to the line Observer–Target; (*b*) the shots must be moved along this line until they include the target within the limit of the probable error.

## (*a*) BRINGING THE SHOT TO THE LINE OBSERVER–TARGET

1. To bring the observed shots to the line Observer–Target, either the range may be changed or the deflection, depending chiefly upon the observer's position. If the line Observer–Target makes an angle with the line Guns–Target, which is greater than 30 degrees (600 mils, approximately), then it is apparently customary to change the deflection; if this angle is greater than 600 mils it is customary to alter the range.

2. If the *deflection* is changed, it is easy to show that, in all cases, the amount of the change will be equal to the amount of the displacement of the shot divided by the obliquity of the complement of the angle between the line Guns–Target and the line Observer–Target. Or, to express this concisely:

Deflection change = Displacement ÷ Obliquity of Complement:

$$H^1 = D \div O \text{ of Complement.}$$

3. If the *range* is altered, it is easy to show that, in all cases, the amount of this change will be equal to the amount of the displacement of the shot divided by the obliquity of the angle

---

<sup>1</sup> In yards. To convert to mils at the guns, divide by 1/1000 Rn., or use a suitable diagram.

## THE FIELD ARTILLERY JOURNAL

between the line Guns–Target and the line Observer–Target. Or, to express this fact:

Range Change = Displacement  $\div$  Obliquity of Angle:

$$V = D \div O.$$

### (b) MOVING THE SHOT ALONG THE LINE OBSERVER–TARGET

1. When once the shot has been brought to the line Observer–Target, and it has been accurately sensed, the problem becomes one of moving it backward or forward along this line until a suitable bracket is obtained. It is clear that both the gun range and the deflection at the guns must be changed whenever the shot is shifted in this manner.

2. It is easy to show that for any assumed change of gun range,<sup>2</sup> due to shifting the shot along the line Observer–Target, there will be a proportional change of deflection. This proportional relation is given by the following:

Deflection Change = Range Change  $\times$  Tangent of Angle:

$$DF = Rn. \times T.$$

### OUTLINE OF METHOD

1. The application of the foregoing to field problems with lateral observation is as follows:

(a) Prepare, in advance, a list of values of "H" and "V" for all practical values of the displacement and of the angle between the line Guns–Target and the line Observer–Target; also a list of deflections corresponding to given range changes.

(b) Having these tables,<sup>3</sup> enter the first one with the proper displacement figure, to get the necessary horizontal (*H*) or vertical (*V*) correction. (In the case of the horizontal correction, the value in yards must be converted to mils at the guns by dividing by 1/1000 range.)

(c) When, after successive application of the *H* or *V* correction, the shot can be accurately sensed, then, using the second

---

<sup>2</sup> In theory, the distance along the line Observer–Target should be the basis of the changes made. This, however, results in obtaining uneven figures for gun-range changes, which are avoided by assuming the amount of *Rn.* change to begin with.

<sup>3</sup> Or diagrams.

## A FIELD METHOD OF CALCULATION

table, assume a range change sufficient to move the shot a desired distance on the line Observer–Target, and read off the corresponding deflection necessary. (This must also be converted to mils at the guns.)

(*d*) In case, after applying the second correction, the shot again falls where it cannot be sensed for range, then bring it back by means of the *first* correction; *i.e.*, start the adjustment anew.

2. Tables of values of  $H$ ,  $V$ , and  $DF$ , for probable values of the displacement of the shot from the line Observer–Target, are attached to these notes.

To use the table,<sup>3</sup> first take the displacement (in yards) and find the proper  $H$  or  $V$  correction which applies to the angle Gun–Target–Observer. If the  $H$  correction is chosen, divide it by 1/1000 of the gun range to get mils at the guns. The  $V$  correction reads direct, in yards of range; take the nearest even value, within the limit of the probable error.

After sensing the shot on the line Observer–Target, assume a range change *in the proper direction*, which should give a sufficient shift along this line. Find the corresponding  $DF$  necessary and reduce this, as in the case of the  $H$  correction, to mils at the guns. Apply both the corrected deflection and the corrected range to the next shot.

If the shot again goes off the line Observer–Target, bring it back by means of the  $H$  or  $V$  correction and start the process over again. (With each successive adjustment the limits of error decrease very greatly, so that after the third or fourth shot the fire should be fairly close to the target.)

3. To approximate the longitudinal displacement of the shot along the direction Observer–Target, once the lateral displacement has been noted and a correction made, it is to be remembered that the relation between the correct and the attempted adjustment is the same as the relation between the correct and the assumed distance between the observer and the shot. If the actual distance is less than the assumed distance, then the correction will be too much; if the actual distance is

THE FIELD ARTILLERY JOURNAL

greater than that assumed, then the correction will be too small. Also, *the measure of the difference between the proper and the attempted change is the measure of the difference between the correct and the assumed distance Observer-Shot.*

Take a concrete example: A shot is sensed 20 mils R. of the line Observer-Target and the assumed distance to the shot is 2500 yards; then the displacement, laterally, will be estimated at 50 yards and the *H* or *V* correction at the guns applied accordingly. If the next shot is sensed 5 mils L. of the line, it will show that the correction was too much; in other words, the actual distance to the shot is less than 2500 yards. The distance is, in fact, 20/25 of 2500 yards, or 2000 yards, as analysis will show. Use of this simple relation will save much confusion in adjustment from a lateral observing station.

TABLE NO. 1—CORRECTIONS FOR DISPLACEMENT  
(To change "H" corrections to mils at Guns, divide table figures by 1/1000 range)

(PROVISIONAL ONLY)

Angles under 600 mils: $H = \frac{\text{Displ.}}{\text{Ob. (1600-"A")}}$							Angles over 600 mils: $V = \frac{\text{Displ.}}{\text{Obliquity}}$									
(Horizontal Corrections Only)							(Vertical Corrections Only)									
Displacement	100 mils	200 mils	300 mils	400 mils	500 mils	600 mils	700 mils	800 mils	900 mils	1000 mils	1100 mils	1200 mils	1300 mils	1400 mils	1500 mils	
5 yards	5	5	5	5	6	6	8	7	7	6	6	5	5	5	5	
10 yards	10	10	10	11	11	12	16	14	13	12	11	11	10	10	10	
15 yards	15	15	15	16	17	18	24	21	20	18	17	16	16	15	15	
20 yards	20	20	20	22	22	24	32	28	26	24	22	22	22	20	20	
25 yards	25	25	26	27	28	30	39	35	32	30	28	27	26	25	25	
30 yards	30	30	31	32	34	36	47	42	39	36	34	32	31	30	30	
35 yards	35	35	36	37	40	42	55	49	46	42	40	37	36	35	35	
40 yards	40	40	41	42	46	48	63	56	53	48	46	42	41	40	40	
45 yards	45	45	46	47	52	54	71	63	60	54	52	47	46	45	45	
50 yards	50	51	52	54	57	60	78	71	65	60	57	54	52	51	50	
60 yards	60	60	62	64	68	72	94	84	78	72	68	64	62	60	60	
70 yards	70	70	72	74	80	84	110	98	92	84	80	74	72	70	70	
80 yards	80	80	82	84	92	96	126	112	106	96	92	84	82	80	80	
90 yards	90	90	92	94	104	108	142	126	120	108	104	94	92	91	90	
100 yards	101	102	104	108	113	120	156	148	129	120	114	108	105	102	101	
110 yards	111	112	114	119	124	132	172	156	142	132	125	119	116	112	111	
120 yards	121	122	124	130	135	144	188	174	155	144	136	130	127	124	121	
130 yards	131	132	134	141	146	156	204	188	168	156	147	141	138	136	131	
140 yards	141	143	144	152	157	168	220	202	181	168	158	152	149	144	141	
150 yards	151	153	156	162	170	180	234	213	194	186	171	162	157	153	151	

## A FIELD METHOD OF CALCULATION

TABLE NO. 2—CORRESPONDING DEFLECTION—YARDS  
 (For mils at Guns, divide table figures by 1/1000 Range)  
 (PROVISIONAL ONLY)

Assumed range change	100	200	300	400	500	600	700	800	900	1000	1100	1200	1300	1400	1500
25 yards	2.5	5	7.5	10.5	13	17	21	25	31	38	47	60	83	136	254
50 yards	5	10	15→	21	27	34	41	50	61	75	94	121	165	251	509
75 yards	7.5	23	23	32	40	51	62	75	92	113	141	181	248	377	763
100 yards	10	20	30	41	54	67	82	100	122	150	187	241	330	502	1018
150 yards	15	30	45	62	81	101	123	150	183	225	281	362	495	753	1527
200 yards	20	40	60	82	108	134	164	200	244	300	374	482	660	1004	2036
250 yards	25	50	75	103	135	168	205	250	305	375	468	603	825	1255	2544
300 yards	30	60	90	123	162	201	246	300	366	450	561	723	990	1506	3054
350 yards	35	70	105	144	189	235	285	350	401	525	655	844	1155	1757	3563
400 yards	40	80	120	164	216	274	328	400	488	600	748	964	1320	2008	4072

# Field Artillery Fire for Beginners

(LIGHT FIELD GUN)

BY COLONEL A. U. FAULKNER, 344TH F. A., N. A.

## LIGHT FIELD ARTILLERY FIRE

IN order to secure the best results in firing, there has been kept, at the School of Fire, during the past few years, an accurate record of over 500 problems with the 3-inch gun, with an accurate plotting of over 5000 shots in these problems. This work was supplemental to the work at the proving-ground, which gave probable error or 50 per cent, zone for the gun. The result of this work was published, from time to time, and certain conclusions drawn in a final pamphlet, called "Principles of Fire."

But in the study of these principles we must bear in mind that there are so many elements in Field Artillery firing—the tactical situation, what the enemy is doing to us, ammunition supply, condition of personnel, of matériel, of weather, of terrain, facility for observation, etc.—that no two firings are the same, and the simplest problem requires decision for which there is no rule. But the decision should be based on certain principles.

These "Principles of Fire" referred to were written for use of men who have had considerable experience in observation of Field Artillery fire, and I will try to give an idea of them to men who have had little experience.

In addition, there are embodied herein other details in the preparation for fire. The projectile considered is, as a rule, shrapnel. Bear in mind that the object of fire is to get most effect on target. Theoretically, this is attained when  $Kr$  is normal and centre of impact at  $T$ —trajectory exact in deflection and range.

Probable errors should be increased by factor 1.5 for field firing.



## FIELD ARTILLERY FIRE FOR BEGINNERS

First, consider the preparation for fire. For this, the following:

Sector in which expect to fire is taken under observation. Reference point, or points, for designation of target are chosen. At once, note terrain (ravines, or bushes to hide grazes), choose secondary reference point that can be picked up at once with field-glasses for use in quick identification of target by officer firing. When have target, note: width in mils, height of burst reference point; and whether  $T$  is horizontal or relative height of parts of  $T$ ; direction and force of wind, relative height and intervals of guns. Have idea of time of flight, 8 seconds = 3000, 5 seconds = 2000 yards. This not to keep eye at glass longer than necessary.

### METHODS OF GETTING DEFLECTION

Initial deflection is for right or left gun. Don't use  $P-T$  method, especially by platoon fronts, but may use method  $O$  on left, correction Lt. or plus;  $O$  on right, correction Rt. or minus.  $AP$  in front  $T$  has same correction, but  $P$  changes.

Best method is to make offsets away from gun, beginning always with  $P$ .

B. C. telescope,  $AP$  3200 on  $G$  and read to  $T$  gives deflection to lay gun parallel to line  $O-T$ , then correct for distance  $O$  to  $G$ .

If distance  $O$  to  $G$  is great—1000 yards or over—use protractor or map.

If  $O$  far in advance of  $G$  and can see  $G$  nearly in line  $O$  to  $T$ , use special method, B. C. telescope as  $AP$ , by noting where deflection zero will place fire, and correct.

Corrections in offsets more accurate by obliquity method than by length of normal line.

A table easy to remember is (mils from  $O-G$  correction):

100 = 0.1	600 = 0.6
200 = .2	800 = .7
300 = .3	1000 = .8
400 = .4	11-12 = .9
500 = .5	

About 12 or within 400 mils of normal—to line  $O-G$  full value.

## THE FIELD ARTILLERY JOURNAL

"Change  $T$ " correct for difference in range, old  $T$  as  $AP$ , or mechanically by aiming circle, with offset previously taken for old  $T$  as  $AP$  or for original  $AP$ —read new  $T$  with its offset. Old  $T$  as  $AP$  best as original  $AP$  error eliminated.

OBSERVATION.—Shrapnel, time fire when within 100 mils of line  $G-T$ .

DEFLECTION.—Probable error  $2\frac{1}{2}$  mils.

First deflection—multiple of 10 mils. For battery salvo get deflection for right piece to right of  $T$ . Fire first salvo to put centre of sheaf in centre of  $T$ . If  $T$  wider than 20 mils and deflection not surely accurate, open on first piece by 10 from parallel fire, with right 10 mils if  $T$  less than 40 mils wide.

Open sheaf (10 mils from parallel fire) is about 50 mils. For narrow  $T$ —less than 15 mils from burst in line with  $T$  necessary for observation, open with parallel fire or fire one gun. If deflection surely accurate, use parallel fire.

For first deflection use D. D. to nearest 5 mils.

For platoon, open on first piece by 10 from parallel fire for  $T$  wider than 15 mils, and for very wide  $T$  move centre of sheaf to centre of  $T$ . If small  $T$  and burst in line with  $T$  necessary, fire one gun or use parallel fire.

After first salvo: Keep guns inside  $T$ ; divide difference between sheaf and  $T$  by three, or make correction by interval between two adjacent shots. Make changes in deflection on piece nearest its place in  $T$ , as a rule.

Shifts of sheaf to right or left on one observation should be made in multiple of 5 mils, on several shots smaller corrections. All of 3 or 4, 2 or 3 mils off, make correction indicated. Don't try to make small corrections in deflection difference if all in  $T$ . No changes less than 2 mils in deflection difference.

## METHODS OF GETTING SITE

P. E. with instrument  $2\frac{1}{2}$  mils.

One mil in site = about 25 yards mid-range. Twenty-seven yards at 2000 to 16 yards at 5000.

## FIELD ARTILLERY FIRE FOR BEGINNERS

1. When near guns: Always divide height of  $O$  above  $G$  in yards by  $R/1000$  and add result. This height is constant. "Change  $T$ ," this constant divided,  $R/1000$  added to measure new angle, gives new site. When  $O-T$  and range differ by more than 500 or 600 yards, use other method; *i.e.*, height of  $T$  above  $G$ .

Site given first in multiple of 5 ordinarily, but may use less. If difference more than 5 yards between height of right and left guns, make individual corrections.

Site up burst up.

Kr. up burst up.

### CORRECTOR

1. Point of Kr. = about 20 yards range at short and mid-ranges. From 20 yards at 2000 to 16 at 5000. P. E. in height of burst 2 mils.

For adjustment try to get zero height of burst. This  $\frac{1}{2}$  graze or below, but burst centre better, I think. Don't make changes in Kr. of less than 5 points on two observations or less. On three or more bursts in air, small changes can be made on burst centre, unless erratic bursts—10 mils apart.

Three graze below or air below to one air line or above (all near plane of site) "up 3," but consider burst centre. When first salvo is graze below within 2 mils (near plane of site) Kr. U. 5.

If graze below within 5 mils of  $T$  but not within 2 mils of horizontal plane (plane of site),  $G-T = K$ . U. 10.

If all are graze above but not near plant of site, don't change Kr.

If all observed rounds graze more than 5 mils below, change site in nearest multiple of 5 and K. U. 5, also change R. 200 yards.

If observer 30 mils above  $T$ , a 3-mil burst looks a 2-mil, 100 yards short. In such cases must take proportion of airs and grazes.

If first salvo "lost," Kr. U. 10. If "very high," make site corrections.

## THE FIELD ARTILLERY JOURNAL

Remember—graze or A. below = "short"; graze above—"over." Changes in Kr. of I mil not made.

### FIRE FOR ADJUSTMENT (*To Fire Shrapnel*)

In range (probable error 40 to 25 yards increased by factor 1.5 for field firing).

To get centre of impact of each gun at  $T$  takes a long time and can be done at all only when  $T$  stationary and all its parts very distinct in outline. Shrapnel targets are living and are not likely to be long exposed either to view or to bullets. They may be divided into stationary, slowly moving, transient, rapidly moving, and fugitive. The stationary, slowly moving, and transient are attacked in one way—rapidly moving in another, and fugitive in another.

Stationary include artillery in position, trench occupied by troops firing on ours, machine guns emplaced.

Slowly moving include infantry unable to take immediate cover, heavy artillery.

Transient include machine-gun firing, skirmish line only occasionally visible.

Rapidly moving include cavalry, light artillery moving.

Fugitive include observation party not in permanent station, that can quickly take cover behind crest or in woods, group of horsemen or group of dismounted men just emerging from cover.

Unless a target is of great depth, there is one range which will produce greatest effect on it, but we do not try to first find this range and then keep to it. We try to get the target between two ranges in a space we can cover quickly with fire that will certainly give considerable effect on the target, wherever it is in the space or bracket.

Note shrapnel sheaf. Angle of opening 15 degrees and bullets effective about 300 yards from point of burst.

Most effect is produced by shrapnel when target at point that would be hit by graze projectile on trajectory. At mid-ranges effectual sweep of shrapnel 3-mil burst  $-40$  to  $+85$  =

## FIELD ARTILLERY FIRE FOR BEGINNERS

125 yards. At short ranges both heel and toe become longer.

At long ranges effective sweep 3-mil burst from  $-15$  to  $+30 = 45$  yards. Five mils high increases these. A hostile forward slope cuts this down at toe of sheaf, and reverse slope lengthens it. Width 50–15 yards graze bursts are ineffective, especially at high angle fall, except for demolition.

### FIRE FOR ADJUSTMENT OR RANGING

#### *Stationary, Slowly Moving and Transient Targets*

Battery salvos are normally used if fire for effect is to be by battery. This is the most rapid method of ranging. By piece, the most economical of ammunition.

R. F. P. E. = 94 yards, all ranges.

Bounds: If range finder range 200 yards, also map range. Range estimated 400 yards—long ranges 800 yards—and use platoon probably.

Bracket sought: Slowly moving and transient targets, 200 yards; 400 yards infantry in open, considerable depth. Stationary, 100 yards—to keep down fire (neutralize)—for demolition, 50 yards or less.

Target practice targets usually have no depth; most real targets will have. For known narrow targets 50-yard bracket O. K. if time permits, and have at least three sure observations in each sense. There is a difference between 50-yard bracket and eliminating. Always eliminate *clearly* ineffective ranges when observed.

In observations for adjustment, the probability of shot observed over, being over, increases with height of burst; of shot observed short, being  $\oplus$  short, decreases as height of burst increases. Graze or zero burst indicates exact range of that particular shot.

Grazes are measured from bottom. Bursts are measured from top of burst to bottom of target, and zero bursts, except at range under 2000, should be below top of target. If horizontal hair at base of target, top of burst near (within mil of) hair. Diameter of burst about 4 yards.

## THE FIELD ARTILLERY JOURNAL

One observation surely over is sufficient for range change. A sure over is graze or burst any height and effect, also shadow.

One observation surely short is sufficient for range change. A graze or zero height may be taken, also effect all or nearly all short. If question zero or 1 mil, take it. Effect short should not be taken if only heel of sheaf is seen short.

"Target" only sensed, if see target go down or in middle of effect sheaf or graze on slope at height of target and near in deflection. Rule at target practice is graze or burst within 10 yards of target in range.

### *Before Accepting Bracket and Going to Effect*

For 400- or 200-yard bracket, one sure short and one over, The movement of *T* must be considered. If changing position very slowly.

For 100-yard bracket, two sure shorts and one over.

If take low bursts (time important), one for 400 and 200, or two low or one zero, or graze for 100 and drop back 100 yards.

See that deflection and height of burst adjusted. If necessary to fire salvo for this, use the least sure limit, or if both surely ascertained fire at middle of bracket.

### FUGITIVE TARGETS

For fugitive target, immediate effect, estimated range, take 400-yard bracket and go through. With range finder take R. F. range as middle of 400-yard bracket and Kr. for 3-mil burst. But if our troops near target, first get an over and creep.

For target in rain, smoke, or fog, try to get a sure over and sure short and go through with 100-yard bounds, or if can get only shorts or overs, cover and estimated bracket.

### RAPIDLY MOVING TARGETS

For rapidly moving targets, estimated range: 600-yard bracket or 800-yard if long range, and go through, beginning at end of bracket ahead of target and taking at least 200 yards more in direction of movement.

R. F. range: Fire volley at R. F. range and observe. If burst is ahead of target, target moving toward or from gun,

## FIELD ARTILLERY FIRE FOR BEGINNERS

take 200 to 500 yards in direction of movement and go through with one-round volleys. If bursts behind target, assume at least a 600-yard bracket and begin at assumed range, going through until target is passed. To stop a charge at short range put down barrage ahead of target until time for fire at will.

If target moving across range, observe first shot and assume bracket toward target and go through.

### FOR EFFECT

One-hundred-yard increments cover space in bracket, but 50-yard better, especially at long ranges. Fire two rounds each range. Better to be short than over. For effect bursts 3 mils high best, but profile of sheaf indicates lower best at short and higher at long ranges.

It is desirable to reduce number of ranges during fire for *E* and observations on effect are made as carefully as on adjustment, but sensings are more difficult to get. When begin, search bracket as rapidly as possible and eliminate ineffective ranges. Some grazes desirable: 1 in 4 to 1 in 8 (3 A. to 1 G.), don't raise Kr. General rule, go up 3 mils from zero height of burst. Reports from Europe low bursts necessary to stop infantry.

Never use range longer than long limit of bracket.

But better always use long limit for 100-yard bracket and eliminate later, and also for 200, unless two shots effect over or two bursts normal or higher or grazes on slope. For 400 may eliminate on three zero or graze observations or one normal over or one graze above or one sure effect over. If use 50-yard increments, less important to fire at long limit. For 50-yard bracket, three or four sure observations, each sense.

Bracketing and mixed salvos: They indicate an effective range, if graze or zero height, and probably most effective. Go at once to effect if deflection and Kr. adjusted. If not, fire again at same range to adjust them.

Bracketing S. 4 shots zero height: Take that range and 50 less (two rounds).

Two shots, take that range and 100 less.

Four mixed, take that range and 100 yards away from the S.

## THE FIELD ARTILLERY JOURNAL

Three mixed, 100 away from the 2.

If bursts 2 mils high or more, may drop back another 100. In all cases, as on page 122, but if time lower Kr. and fire again.

Take 50-yard increments for best effect and eliminate on about two salvos surely over or short.

Begin fire for effect at long range, unless have dropped back.

Salvo sensed bracketing, mixed or target, begin at that range; or if think one range give most effect on target and time important, use that range first.

After rafale resume fire for adjustment, unless sure of most effective range.

In shell fire for effect at living targets bounds for effect depend on nature of shell.

For incendiary effect, low burst shrapnel or shell.

### SHELL FIRE OR FIRE FOR DEMOLITION AND BARRAGE

#### *Trench, Emplacements, Battery, Stone Wall*

If time, after getting 100-yard bracket by four shots each limit, or after bracketing salvo, adjust each gun separately, firing at mid-range of 100-yard bracket, or at range of bracketing salvo. If get both overs and shorts for one gun at this range, continue until decided preponderance in one sense and change 25 yards by site; or may calculate centre of impact from proportion of overs to shorts. If all in one sense, verify other limit of 50-yard bracket and split bracket by change of site.

If time does not permit foregoing method, get 100-yard bracket by four shots each limit; fire several salvos at midrange of bracket and correct for preponderance, 25 yards by individual site corrections, if practicable. Similar method if get bracketing or mixed salvo before 100-yard bracket.

With large targets for demolition, as buildings, observed effect will give best range.

For observations of fire when more than 100 mils from line of fire, these principles generally apply, but deflection corrections are difficult and follow certain rules.

Table: 100 mils off line of fire, correct for 10 yards in deflection



# FIELD ARTILLERY FIRE FOR BEGINNERS

Scale, 50 yards = 1 inch.

Angle of Fall,  $\frac{1}{3}$ .  
 Angle opening constant all ranges,  $15^\circ$ .  
 $R = 2500$  yards 3-mil and 5-mil bursts.  
 Bullets effective from point of burst 300 yards. Effective  $V = 365$  f.s.

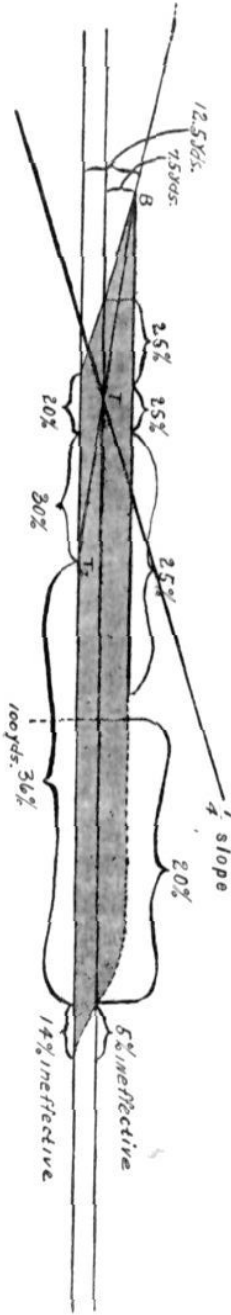

Danger space each bullet on T 3 feet high = 17 yards and less heel of sheaf.  
 Most of shorts 3 mils height of burst effective at T.  
 Width of pattern from 50 to 30 yards. Take 30 to 15.  
 Effective sweep 3 mils — 40 to +100 = 140.  
 5 mils — 60 to + 60.

Angle of Fall =  $\frac{1}{3}$ . All effective—Effective sweep, 3 mils from — 15 to + 30.  
 Width of pattern, 15 to 25 yards.

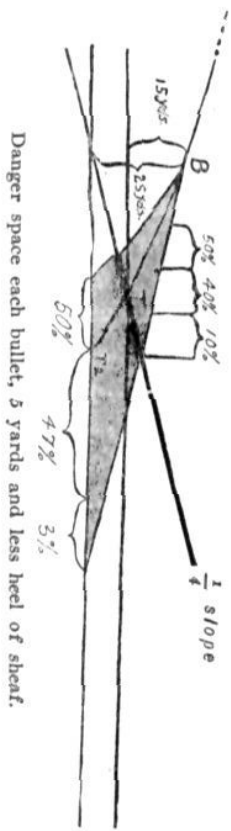

Danger space each bullet, 5 yards and less heel of sheaf.

THE FIELD ARTILLERY JOURNAL

for 100-yard bound; twice this, or 20, for 200-yard bound, and four times, or 40, for 400. Corrections: 100-yard bounds, up to 800 mils off line fire, use

200 mils = 20 yards	600 mils = 70 yards
300 mils = 30 yards	700 mils = 90 yards
400 mils = 40 yards	800 mils = 100 yards
500 mils = 50 yards	

To repeat range and put shot in line with *T*, use multiples as follows:

400 mils off line of fire.....	1.1
800 mils off line of fire.....	1.4
1200 mils off line of fire.....	2.5

but when more than 800 mils from line of fire, better to change range than deflection. This for one observer.

For night firing, the deflection should be exact and a flank observer, at least 300 mils from line of fire, used. Second method: Firing with guns converged on *T*, "over" or "short" may be sensed by noting if order of bursts appear same above as fired, or opposite. This method will give only 400- or 600-yard bracket. Third method: Two flank observers who signal "short" if shot appears toward gun from line *O-T*, and "over" when away from line.

Firing over our troops near guns: Get trajectory about 10 yards above the men. This puts them about 200 yards in front, Rn. 2000, site 300. If our troops near *T*, get first salvo surely over *T*. In this situation trajectory should be 10 yards above our troops, which at 3000 is about 70 yards beyond on level ( $\angle$  Fall =  $\frac{1}{7}$ )—but four times probable error = 120 yards, and  $1\frac{1}{2}$  times this for field errors = 180 yards.

LEAST RANGE

Gun 500 yards from mask, allow 5 mils for drop; gun 1000 yards from mask, allow 20 mils. For greater distance *G* to mask than 1000 yards, add vertical height of mask in mils to elevation for distance *G* to mask, and range of this angle of

## FIELD ARTILLERY FIRE FOR BEGINNERS

departure will give least range. Site 300. Deduct value of site above horizontal and add it below.

### DEFILADE

At gun: By looking through bore of gun (or sight) zero range, gun laid at site of hostile observation station—note where line through axis of bore strikes crest. If 8 yards below, have flash defilade. Executive officer by this method report highest site for defilade, etc. (8 yards taken instead of 4 as proper defilade).

At crest: An angle equal to angle of hostile observation station above crest taken below horizontal toward gun gives where line from *T* tangent to crest meets ground at gun; 10 yards (or 8) below this gives point of flash defilade. If observer at gun position can just see hostile positions over covering crest, flash defilade is 10 yards below. This is sufficiently accurate.

Can be readily estimated if note height at which line *T*–Observer strikes a tree near Observer, or if Observer on counterslope, note 10 yards below line *T*–Observer tangent to crest.

### *∠ Departure, 3-inch Gun*

1000 yds	2000 yds	3000 yds	4000 yds	5000 yds	6000 yds
20 mils	50 mils	90 mils	140 mils	200 mils	270 mils

### *∠ Fall*

Multiply *∠ Dep.* by—

1.2	1.4	1.5	1.5	1.5	1.6
-----	-----	-----	-----	-----	-----

# Disc for Spotter Practice

BY CAPTAIN C. A. CHAPMAN, 81ST FIELD ARTILLERY

THE accompanying drawing illustrates the disc used in connection with spotter practice batteries in the 81st Field Artillery, giving more satisfactory results than the disc with a simple straight handle.

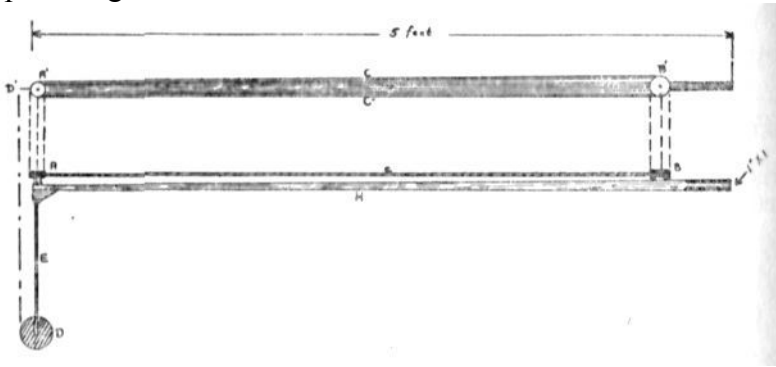

- A—WOODEN PULLEY, 1½ INCHES IN DIAMETER, MADE OF WHITE PINE.  
 B—WOODEN PULLEY, 1½ INCHES IN DIAMETER, MADE OF WHITE PINE.  
 C—BELT: COTTON COD LINE.  
 D—TIN DISC, 3½ INCHES IN DIAMETER; RIVETED TO.  
 E—QUARTER-INCH IRON ROD, 18 INCHES LONG; UPPER END THREADED ABOUT 3 INCHES.

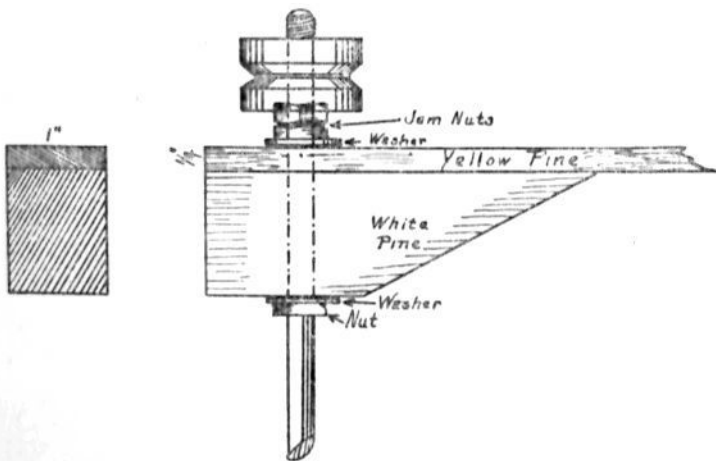

It is used in connection with the Ordnance issue of sub-calibre figures, which are properly spaced for use at about 300 yards.

### DISC FOR SPOTTER PRACTICE

It consists of a wooden handle, *H*, about 5 feet long; two pulleys, *A* and *B*, connected by a cotton cod line belt which has an extra turn about pulley *B*; the vertical rod *E*, with pulley *A* fixed to upper end and disc *D* to lower end. Operating pulley *B* places black side, white side, or edge of disc toward the observer, the edge being presented during any movement of the disc.

The operator may thus stand three or four feet in rear of the line of targets and illustrate the desired salvo without allowing the observer to see the disc except during the time it is in its desired position.

# Current Field Artillery Notes

IN your October–December number I read an article entitled "Recording Firing Data," and feel that the system we have been using is a much simpler system of keeping data than this method. This is based on the use of the new sight as prescribed; that is, the deflection difference is set off on the small scale, and the deflection changes are set off on the main scale.

The advantages of this system are:

1. Speed in recording and simplicity and ease in reading.
2. Speed and ease in checking both scales on the sight.
3. The fact that it can be recorded on any ordinary note-book sheet.

The main disadvantage lies in the fact that an extra column is needed, but at the same time this extra column does away with a lot of figuring and lessens the chances of mistakes.

For this method, one more column is added to those usually used, and is put in between the DF and the DD columns. In this column are recorded the actual readings of the small scale for the directing piece, say No. 1, and takes care of our transferring the openings and closings on the different pieces to No. 1. This may be called the  $\pm$  column.

For example:

As sent down		As recorded							
		DF		$\pm$	DD	SI	Kt	MF	Ra
(1)	Def 3960, on No. 1 open by 10, etc.	3960			10				
(2)	Rt 50, on No. 4 open 15 .....	3910		–45	25				
(3)	Left 15, on No. 2 close 10 .....	3925		–35	15				
(4)	Left 30, on No. 3 close 20 .....	3955		5	–5				
(5)	No. 4, Rt 30, on No. 1 open 5.....	4–30			0				

Referring to the above table, the site, etc., are recorded as usual, so they are not considered here.

(1) The deflection is recorded as usual in the first column. When opening or closing on No. 1, the small scale of No. 1 is not moved, so no entry appears in the second column, but 10 is entered in the third column, showing a DD of plus 10.

(2) "Rt 50" is entered by subtracting 50 from 3960 and entering 3910. "On No. 4 open 15" throws the small scale of No. 1 45 mils Rt or –45. The DD is now 10 plus 15, or 25.

(3) "Lt 15" gives us 3925 and closing on No. 2 by 10 throws the small scale of No. 1 Lt 10, giving a reading of –35. As we opened 25, closing 10 makes our DD now 15.

CURRENT FIELD ARTILLERY NOTES

(4) "Lt 30" gives us 3955, and on "No. 3 close 20" brings the small scale on No. 1 Lt 40, so that it now reads Lt 5 or plus 5. Our open 15 is now changed to close 5 (-5).

(5) "No. 4 Rt 30" can be indicated by "four -30" and can be included whenever a check is made. "On No. 1, open 5" does not affect the small scale of No. 1, so no entry is made in the second column, but our DD is reduced to 0.

Now let us check deflection at (4) for example:

No. 1 reads 3955 on the main scale and Lt 5 on the small scale.

No. 2 reads 3955 on the main scale and 5 plus (-5) or 0 on the small scale.

No. 3 reads 3955 on the main scale and 5 plus twice (-5) on the small scale.

No. 4 reads 3955 on the main scale and 5 plus three times (-5) on the small scale.

That is: No. 1 ..... 3955 Lt 5  
No. 2 ..... 3955 Lt 0  
No. 3 ..... 3955 Rt 5  
No. 4 ..... 3955 Rt 10

In other words, we can at a glance check up the settings at the guns on both scales, and at the same time, with a very little practice, a man can tell by a glance what the last command was, or what any command was at any time during the firing. We have been using this system with our detail for the last four or five months and find that it is the most satisfactory that we have tried so far.

A. D. FISKEN,  
*Lieut. 19th F. A.*

# The United States Field Artillery Association

## CONSTITUTION

### ARTICLE I

#### *Title*

This Association shall be known as the "United States Field Artillery Association."

### ARTICLE II

#### *Objects*

The objects of the Association shall be the promotion of the efficiency of the Field Artillery by maintaining its best traditions; the publishing of a journal for disseminating professional knowledge and furnishing information as to the field artillery's progress, development, and best use in campaign; to cultivate, with the other arms, a common understanding of the powers and limitations of each; to foster a feeling of interdependence among the different arms and of hearty coöperation by all; and to promote understanding between the regular and militia forces by a closer bond; all of which objects are worthy and contribute to the good of our country.

### ARTICLE III

#### *Membership and Eligibility*

SECTION 1.—The Association shall consist of (1) active members and (2) associate members.

SEC. 2.—The following shall be eligible to active membership:

Commissioned officers on the active lists of the field artillery of the regular army and of the organized militia of the several states, territories, and District of Columbia; *Provided*, That officers of the regular army when separated from the field artillery, by promotion or detail in staff departments, shall not thereby lose their status as active members.

SEC. 3.—The following shall be eligible to associate membership:

(a) Commissioned officers on the retired lists of the regular army and of the organized militia of the several states, territories, and District of Columbia.



## U. S. FIELD ARTILLERY ASSOCIATION CONSTITUTION

(b) Those who, as commissioned officers, either regular, militia, or volunteer, have served with batteries or larger units of field artillery in time of war.

(c) Commissioned officers of the regular army and of the organized militia of the several states, territories, and District of Columbia, not now belonging to the field artillery, who have served at least one year as commissioned officers in field artillery.

(d) General officers of the regular army, except as provided in Section 2 of this article, and of the organized militia of the several states, territories, and District of Columbia.

(e) All commissioned officers and former officers of the United States Army, Navy, and Marine Corps, and of the organized militia in good standing, not included in the classification hereinabove set forth.

(f) Those in civil life whose applications are approved by the Executive Council hereinafter provided for.

### ARTICLE IV

#### *Applications for Membership; Withdrawals*

SECTION 1.—Any person, eligible, under the foregoing article, to membership, may become a member by making written application to the Secretary and paying the first year's dues. The decision of the Executive Council as to eligibility of an applicant shall be final.

SEC. 2.—Any member may withdraw from the Association at any time by tendering his resignation in writing, but such resignation shall not take effect until such member has paid all indebtedness due the Association at the time of such resignation.

SEC. 3.—Any member may be dropped for cause by a majority vote of the Executive Council; but no member shall be so dropped without first previously notifying him, in writing, at his last known post-office address, of the proposal to so drop him, and waiting a reasonable time for his reply.

SEC. 4.—A member dropped under the foregoing section may be reinstated by a majority vote of the Executive Council, and by paying all sums, if any, due the Association.

### ARTICLE V

#### *Rights and Obligations of Members*

SECTION 1.—Active members only shall be entitled to vote.

SEC. 2.—The annual dues of the Association shall be fixed by the Executive Council, but shall not exceed \$4.00 per annum.<sup>1</sup>

---

<sup>1</sup> The present dues are \$3.00 per annum.

## THE FIELD ARTILLERY JOURNAL

SEC. 3.—Active members shall be entitled to receive all publications issued by the Association without payment other than the annual dues.

SEC. 4.—Associate members shall be entitled to receive the JOURNAL without payment other than the annual dues.

### ARTICLE VI

#### *Executive Council; Officers*

SECTION 1.—The Executive Council shall be composed of five active members, three of whom shall be officers of the regular army and two officers of the organized militia, to be elected biennially for a term of two years by a majority vote, in person or by written proxy of the active members. The Council shall hold its meetings at the headquarters of the Association, which shall be in the city of Washington.

SEC. 2.—The Executive Council shall appoint the following officers of the Association:

1. A President, to be selected from its own members, and who shall be an officer of the regular army.

2. A Vice-President, to be selected from among the active members of the Association.

3. A Secretary-Editor, to be selected from its own members, or other active members of the Association, and who shall be an officer of the regular army.

4. A Treasurer, to be selected from among the active members, and who shall be an officer stationed or residing in Washington, D. C.

These officers shall hold office at the pleasure of the Executive Council and shall perform the duties usually and customarily performed by like officers in civil associations.

SEC. 3.—The Executive Council shall meet from time to time, at the call of its senior member present in Washington. Three members shall constitute a quorum for the transaction of business.

SEC. 4.—The Executive Council shall have power to fill any vacancy in its own membership by temporary appointment from among the active members and subject to the requirements of Sections 1 and 2 of this article; *Provided*, That such temporary appointment shall not extend beyond the next annual meeting of the Association.

SEC. 5.—It shall require a majority vote of the members of the Council present at any meeting to carry any proposition.

SEC. 6.—The Executive Council shall be responsible for the administration of the affairs of the Association. To this end, they are empowered to carry out any measures whatsoever which, in their judgment, seem expedient to further the interests of the Association and to

## U. S. FIELD ARTILLERY ASSOCIATION CONSTITUTION

attain its ends and aims; *Provided*, Such measures are not in conflict with the rules, decisions, or practice of the War Department.

SEC. 7.—No contract involving expenditure of funds of the Association shall be made except pursuant to a general or special resolution of the Executive Council, duly recorded. The Executive Council shall have no power to place any personal liability on any member of the Association, and shall incur no obligations which cannot be met by the funds on hand in the treasury of the Association.

### ARTICLE VII

#### *Meetings and Elections*

SECTION 1.—The regular meetings of the Association shall be held annually at Washington, D. C., or at such other place as may be designated by the Executive Council, who shall also prescribe the time of meeting, and at least thirty days' notice, by mail, must be given to each active member.

SEC. 2.—At regular meetings, any existing vacancies in the Executive Council shall be filled; the Treasurer's financial statements shall be submitted and his accounts audited; the Secretary-Editor shall submit a report on general affairs and progress of the Association and the conduct of the JOURNAL since the last regular meeting; and such other business shall be transacted as may come before the meeting.

SEC. 3.—Special meetings may be called by the Executive Council upon written request therefor signed by twenty members. At least thirty days' notice thereof shall be given, by mail, to active members. The object of the meeting shall be stated in the request and in the notice.

SEC. 4.—Fifty per cent. of the members in the United States, either present in person or represented by written proxy, shall constitute a quorum, except as provided in Article IX.

### ARTICLE VIII

#### *Adoption*

SECTION 1.—This Constitution shall be considered as adopted and shall be of full effect when it shall have been accepted by eighty officers having the qualifications herein prescribed for active members, and when it shall have been subscribed to by the same officers, who shall then, and thereafter, be known as charter members of this Association.

SEC. 2.—Immediately after the adoption of this constitution, the charter members shall proceed to the election of the Executive Council. For this first election, those eligible to join the Association as active

## THE FIELD ARTILLERY JOURNAL

members, under Article III, Section 2, shall be eligible for election as members of the Executive Council, the same as if they had already signed the constitution as charter members; *Provided*, Officers so elected shall have the other qualifications provided for in Article VI, Section 1; but any officer so elected shall qualify as a member of this Association upon notice to him of his election, and before undertaking the duties of the office to which he is elected.

### ARTICLE IX

#### *Amendment*

This Constitution may be amended or altered by a three-fifths vote of the active members, either in person or by proxies in writing. To secure consideration of a proposed change, application must be made to the Secretary, in writing, signed by not less than twenty-five active members, setting forth clearly the alterations desired and the principal reasons therefor. This application must be submitted at least six months prior to the time of the meeting. The Executive Council will direct the Secretary to give notice, by mail, to the members entitled to vote, so they may receive it at least ninety days prior to the meeting. The notice will contain the proposed amendment with the names of the proposers. The notice will also be published in all copies of the JOURNAL issued between the receipt of the application and the date of the meeting.

Proposed amendments to the Constitution will be voted on at annual meetings only.

Made effective June 7, 1910, at Fort Riley, Kansas, under the provisions of Article VII.

The first Executive Council of The U. S. Field Artillery Association was composed of:

Brig. Gen. Montgomery M. Macomb, U. S. Army.

Capt. Oliver L. Spaulding, Jr., 5th Field Artillery, U. S. Army.

Capt. Fox Conner, General Staff, U. S. Army.

Capt. John F. O'Ryan, 1st Battery, National Guard, State of New York.

Capt. Robert H. Tyndall, Battery A, National Guard, State of Indiana.

The first officers of the Association were:

President—Brig. Gen. Montgomery M. Macomb, U. S. Army.

Vice-President—Lieut. Col. E. St. J. Greble, General Staff, U. S. Army.

Secretary-Editor—Capt. Wm. J. Snow, 6th Field Artillery, U. S. Army.

Treasurer—Capt. Wm. J. Snow, 6th Field Artillery, U. S. Army.

## U. S. FIELD ARTILLERY ASSOCIATION CONSTITUTION

### LIST OF CHARTER MEMBERS

Eli D. Hoyle,  
Jno. E. McMahon,  
P. C. March,  
F. E. Stevenson,  
C. F. Sargent,  
T. M. Wortham,  
J. B. Goodman, Jr.,  
Wm. J. Snow,  
W. S. McNair,  
Chas. Rees Lloyd,  
A. F. Cassels,  
W. B. Carr,  
J. W. Kilbreth, Jr.,  
J. Edmond Hill,  
Raymond W. Briggs,  
C. M. Bunker,  
D. F. Craig,  
Chas. A. Salisbury,  
Louis S. Cox,  
Jos. A. Smith,  
Quido A. Kulish,  
J. S. White,  
F. E. Hopkins,  
John F. O'Ryan,  
Robt. H. Tyndall,  
Branch Johnson,  
Edwin H. Tracy,  
Wm. C. Webb,  
Philip C. Westfahl,  
Luther E. Gilmore,  
D. S. Hanley,  
Grant S. Taylor,  
J. Ed. Eubanks,  
Tilman Campbell,  
S. G. Barnard,  
D. H. Currie,  
Chas. J. Ferris,  
Courtlandt Parker,  
John W. Downer,  
Wm. O. Richardson,  
Jno. L. Thomas,  
A. J. McBride, Jr.,  
Frank H. Hines,  
Wm. W. Mullen,  
Frank H. Frisbie,  
E. O. Sanguinet,  
Beverly F. Browne,  
Robt. M. Danford,  
Chas. S. Mortimer,  
Dawson Olmstead,  
D. C. Cubbison,  
Walter J. Cookson,  
A. L. P. Sands,  
Thos. D. Sloan,  
J. W. Rumbough,  
John J. Coates,  
Thorndike D. Howe,  
Marshall Magruder,  
Saml. E. McRickard,  
Harvey D. Highley,  
H. M. Boyer,  
T. W. Peck,  
E. P. King, Jr.,  
E. S. Steinel,  
Paul C. Hunt,  
A. C. Allen,  
Roger D. Swaim,  
O. W. Scharch,  
John S. Williams,  
Harvey W. Vint,  
Ralph McT. Pennell,  
Wm. G. Hinderer,  
Alonzo J. Comstock,  
Harry T. Speakman,  
John S. Purucker,  
Joseph A. Le Fever,  
Henry C. Moriarity,  
Robert H. Lewis,  
Clinton T. Bundy,  
Chester B. McCormick,  
Chas. F. Nowell.

## **The American University Union in Europe**

FOR the benefit of our readers who may "go across" we publish the following notice:

"The general object of the Union shall be to meet the needs of American university and college men who are in Europe for military or other service in the cause of the Allies."

The more specific purposes of the Union are thus stated in the Constitution:

"1. To provide at moderate cost a home with the privileges of a simple club for American college men and their friends passing through Paris or on furlough: the privileges to include information bureau, writing and newspaper room, library, dining-room, bed-rooms, baths, social features, opportunities for physical recreation, entertainments, medical advice, etc.

"2. To provide a headquarters for the various bureaus already established or to be established in France by representative American universities, colleges, and technical schools.

"3. To coöperate with these bureaus when established, and in their absence to aid institutions, parents, or friends in securing information about college men in all forms of war service, reporting on casualties, visiting the sick and wounded, giving advice, serving as a means of communication with them, etc."

The Union maintains two establishments, as follows:

Paris Headquarters, Royal Palace Hotel, Place du Théâtre Français. This hotel is at the head of the Avenue de l'Opéra. It is within one block of the Palais Royale station of the "Métropolitain"—the Paris subway.

It is a general meeting place for American university men in Paris—in fact, a University Club.

The London Branch of the American University in Europe is located in the Farmers' Loan and Trust Company of New

THE AMERICAN UNIVERSITY UNION IN EUROPE

York Building, 16 Pall Mall East, S. W. 1. The building is near Cockspur Street and Haymarket.

The following institutions have joined the Union up to December 1, 1917, or have formally notified the secretary of their intention to do so:

Allegheny College	Indiana, University of
Amherst College	Iowa State University
Beloit College	Johns Hopkins University
Boston University	Kentucky, University of
Bowdoin College	Knox College
Brooklyn Polytechnic Institute	Lafayette College
Brown University	Lehigh University
California, University of	Leland Stanford University
Carleton College	Louisiana, University of
Carnegie Institute of Technology	Maine, University of
Catholic University of America	Massachusetts Institute of Technology
Chicago, University of	
Cincinnati, University of	Michigan, University of
Clark University	Michigan Agricultural College
Colby College	Michigan College of Mines
Colgate University	Minnesota, University of
Colorado College	Missouri, University of
Colorado State Teachers College	New Mexico, University of
Columbia University	New York, College of the City of
Cornell University	New York, University of the
Dartmouth College	State of
Delaware College	North Carolina, University of
Denison University	Northwestern University
George Peabody College for Teachers	Oberlin College
Georgetown University	Ohio State University
George Washington University	Ohio Wesleyan University
Georgia, University of	Oklahoma, University of
Grinnell College	Oregon, University of
Harvard University	Pennsylvania, University of
Haverford College	Pennsylvania State College
Hobart College	Pittsburgh, University of
Holy Cross, College of the	Princeton University
Idaho, University of	Purdue University
Illinois, University of	Reed College
	Rensselaer Polytechnic Institute

## THE FIELD ARTILLERY JOURNAL

Roanoke College	Washington University (St. Louis)
South Carolina, University of	Washington, University of
Stevens Institute	Washington and Jefferson
Syracuse University	College
Tennessee, University of	Wesleyan University
Texas, University of	Western Reserve University
Tufts College	West Virginia, University of
Union College, Schenectady	Williams College
University of the South	Wofford College
Utah, University of	Worcester Polytechnic Institute
Vanderbilt University	Wyoming, University of
Vermont, University of	Yale University
Virginia, University of	

### CLUB MEMBERS

Beta Theta Pi	Phi Gamma Delta
Delta Kappa Epsilon	Psi Upsilon
Phi Beta Kappa	

### HONORARY MEMBERS

United States Military Academy	United States Naval Academy
--------------------------------	-----------------------------

### SUSTAINING MEMBERS

The following list includes the names of all individual gifts of one hundred dollars or over, such gifts constituting, according to the constitution, sustaining memberships for the year:

Otto T. Bannard, New York City  
William M. Barnum, New York City  
Robert S. Brewster, New York City  
S. D. Brewster, New York City



# Roll of Honor

## PRO PATRIÂ

### DEAD

VON HOLTZENDORFF.—Died in France, March 5, 1918, of wounds received in action, Captain John D. Von Holtzendorff, Field Artillery, United States Army.

### WOUNDED

Major JOHN W. DOWNER, Field Artillery, United States Army.

NOTE.—It is intended to publish in each issue of the JOURNAL the names of those officers of Field Artillery who are killed in action, wounded, or died of wounds. Members of the Field Artillery Association will confer a favor on the JOURNAL if they will communicate any information they may have of casualties to officers of the Field Artillery, whether they are members of the Association or not. (EDITOR.)

## EDITORIAL

### A Chief of Field Artillery

AT last the Field Artillery has a Chief. At last the War Department has been able to carry out the recommendations of distinguished soldiers whose opinions were formed in the hard school of actual combat, and appoint a chief for that arm upon the efficiency of which the issue of modern war so largely depends. To be sure, the office was created to meet the present emergency, under the general authority vested by Congress in the President, but there can be no doubt that it will give such proofs of its necessity that the requisite legislation to make it permanent will be demanded later. There is nothing new in the idea to American soldiers. Our Civil War proved that a Chief of Field Artillery was a necessity. The testimony of experienced officers, veterans of that war, given in hearings before the Committee of Military Affairs of the House of Representatives over forty years ago, caused it to spread upon its records the following statement:

"A suggestion, not without weight, is made that there should be three additional staff officers at Army Headquarters or with the Secretary of War. These are a Chief of Artillery, a Chief of Cavalry, and a Chief of Infantry, *whose specialties shall be to look after the interests of each particular arm*, whose knowledge and skill would inspire confidence and whose character would give authority to his declarations upon the subject intrusted to his care."<sup>1</sup>

We italicize certain words because they state clearly and concisely the duties of the chief of any arm and announce the principle that *each particular arm should have a chief*.

It is interesting to note that we were awakened to the necessity for these chiefs by our own experience in war, and not by

---

<sup>1</sup> H. Rept., No. 74, 42nd Cong., 3rd Sess.

## EDITORIAL

the fact that they, or their equivalent, existed in European armies. Our awakening, however, was brief, the chiefs were not appointed, and, so far as any real advance in military organization was concerned, the country fell into a lethargy from which it was only partially aroused a quarter of a century later by the war with Spain. The events of this war so palpably exposed our military deficiencies as to result in legislation of the greatest interest to the Army, particularly the artillery. We refer to the reorganization act of 1901. Under its provisions the regimental organization of the artillery was discontinued and that arm was designated the Artillery Corps. The radical difference between Coast Artillery and Field Artillery was recognized, but, notwithstanding this, the new corps was made to comprise both branches. The special sphere of each was determined and its duties definitely defined. To crown all, the President was directed to select and detail a Chief of Artillery "from the colonels of artillery, to serve on the staff of the general officer commanding the Army." It was further prescribed that the colonel so detailed should be the ranking officer of the Artillery Corps. The new corps was not large, as the law provided for only one hundred and twenty-six companies of coast artillery and thirty batteries of field artillery—a modest force, to be sure—but with a chief to look out for their special needs the progress of both branches toward efficiency began.

Another step forward was taken under the provisions of the act approved February 14, 1903, which not only created our General Staff, but made the Chief of Artillery an additional member thereof and gave him the rank, pay, and allowances of a brigadier general. The prestige and influence thus conferred upon its Chief gave a decided impetus to progress in the new corps, which was especially noticeable in the coast artillery branch, which had back of it the interest of our great coast cities in their own safety, and whose Chambers of Commerce were a unit for strong coast defences handled by a well-trained personnel. It was also found that, while the battery organization made it easy for the Coast Artillery to form the provisional

## THE FIELD ARTILLERY JOURNAL

higher units needed to meet the varying tactical requirements of the different forts, harbors, and districts of our coasts, it did not lend itself to the wants of the Field Artillery, which is best handled and administered by organizing it in permanent units like battalions, regiments, and brigades, as in the other mobile arms. Thus it came about that six years' experience with a corps composed of batteries of Coast and Field Artillery led to the conclusion that it would be best to organically separate the two branches. This was accomplished by the military legislation of 1907, the most important feature of which was "an act to reorganize and to increase the efficiency of the artillery of the United States Army," approved January 25. This provided for the complete separation of the Coast and Field Artillery. It stipulated that the Coast Artillery should be a corps with a chief and a personnel of one hundred and seventy companies, and that the Field Artillery should consist of six regiments of six batteries each. During the process of separation the two branches were to remain under the supervision of the Chief of Artillery, but it was especially provided "that on and after July 1, 1908, the Chief of Artillery shall cease to exercise supervision over the Field Artillery and shall hereafter be designated the Chief of Coast Artillery."

There was a general feeling of satisfaction over this separation, because it seemed at last possible to place the Field Artillery in its proper relation to the Infantry and Cavalry, and, together with them, to form a well-balanced mobile force comparable in efficiency to the Coast Artillery, capable of uniting with it to form a powerful defence of our coast or of acting independently upon the offensive, which is the real province of mobile troops, and is the basic principle of their training. But unfortunately the Field Artillery, at the outset of its career as a separate arm, was left without a chief and rowed aimlessly about in the same boat with the Infantry and Cavalry, with no one at the helm to steer a definite course toward efficiency. This was in such marked contrast with the progress made by the Coast Artillery under its influential chief that the service at

## EDITORIAL

large became convinced that every arm, if it hoped for efficiency, must be represented at the War Department by a capable head—the identical conclusion of our Civil War generals fifty years before. Of recent years this question has been often discussed by the General Staff, and that body is on record in asserting that each of the mobile arms should have a Chief with the rank of Major General. So far as our army is concerned, there is not the slightest doubt of the soundness of this principle. Why, then, was it not adopted? Largely because it was an innovation, and innovations are ruthlessly fought by the vicious spirit of conservatism which seems to pervade our War Department in time of peace and which in this instance it has taken the violent shaking up of a great war to overcome. Without any chief to fix our ideas during a long period of peace we wasted time trying to solve the insoluble problem of the perfect field gun. We already had a fine 3-inch, an excellent 4.7, splendid sighting appliances, and an unsurpassed system of fire. We needed only an up-to-date 6-inch howitzer to give us a system of field pieces capable of attacking, with every hope of success, the kind of targets field artillery is expected to overcome in modern war. But we did not go ahead with the manufacture of the good things in hand. Instead, we embarked, after the outbreak of war, upon a course of experimentation and alteration. And here is the field of our new chief. It is his duty to make the decisions that will give us a satisfactory system of field artillery; to answer the numerous questions deluging the War Department from our allies and others as to what matériel we are going to adopt for our field artillery: whether it is to include trench mortars or not, and what other pieces to supplement the 3-inch or, better, the "75," which is now the basic gun for our new system. Then, again, will the question of mobility confine the field artillery to guns and howitzers not exceeding 155 mm. (or 6 inches) calibre? Who is to man the heavier types handled in European armies by what is known as foot artillery? Is the personnel to come from our Coast Artillery (better termed Fortress Artillery), or must we organize a separate corps with its

## THE FIELD ARTILLERY JOURNAL

own chief and a personnel especially trained to handle the heavy artillery of the army, leaving to the Coast Artillery the task of handling its own guns on movable mounts (improvised if need be) to attack land targets resisting any but the heaviest calibres? These are questions that can be decided only in consultation with other chiefs—but decided they must be before the end of the war.

Field Artillery is essentially an arm of mobile troops. It must therefore be permanently organized in suitable tactical units and be sufficiently mobile to meet its particular task. To clarify our ideas as to what properly constitutes this arm, the following definition has been suggested by one of our most competent field artillery officers: "Field Artillery includes all that artillery which is armed with pieces firing from their travelling carriages and which is *permanently* organized into tactical units, which include within themselves, as an integral part of their organization, all necessary means of transportation." All other artillery *provisionally* organized for field service should be served by Coast Artillery (Fortress Artillery) or other provisional units specially trained to handle it. Another question to be settled is that of inspection. A radical change from our present methods is required if we hope to make and keep our field artillery effective. The following governing principle should be kept in mind: "The service of inspection of Field Artillery should be intrusted to the agency responsible for its present efficiency and its future development." Under our present system of inspection thorough and expert inspections are being made, but the results have been practically *nil* as regards progress, because the Field Artillery has had no responsible head in the War Department to prescribe the conduct of this service or to make the necessary decisions. Now that we have such a head, the inspections can be so conducted as to get results by coöperation with the Inspector General, with whom the Chief of Field Artillery should be in *direct and close touch*. That is, a special inspection, as well as a special chief, for Field Artillery should be a permanent feature of the War Department.

## EDITORIAL

Responsibility for the technical training of the personnel also lies with this Chief, and therefore the conduct of the School of Fire for Field Artillery should be as prescribed by him. After this war we have a right to expect that the division and the corps will become permanent tactical units in our army. The responsibility for the tactical efficiency of these great fighting machines will rest with the division and corps commanders, who will, of course, be so familiar with the functions of all the parts as to enable them to prescribe the instruction and conduct the inspections necessary to insure the attainment of the end in view. Therefore, the inspections conducted under the Chief of Field Artillery should be largely confined to the technical training of that arm, its matériel and personnel. The two inspections should supplement, not interfere with, each other.

The third important function of the Chief of Field Artillery is the control of the assignment of the commissioned personnel of the arm. He, better than any one else, knows the individual characteristics of his officers, their special abilities and how best to utilize them. This prerogative has already been recognized as belonging to the Chief of Coast Artillery, and has long been exercised by him for that corps with excellent results.

The characteristic duties of the Chief of Field Artillery may therefore be summarized as follows:

1. Control of design and assignment of matériel.
2. Control of training and inspection.
3. Control of the assignment of the commissioned personnel.

So much for the office of the new Chief.

Now a few words as to the man. How can we define his qualifications better than to repeat the brief but lucid words of the Committee on Military Affairs of the 42d Congress, namely: He should be an officer "whose knowledge and skill would inspire confidence and whose character would give authority to his declarations upon the subject intrusted to his care."

That the War Department has followed this idea literally in the present selection is patent to all who know the quiet forcefulness, excellent judgment, and patient tact of the father

of the reorganized and greatly enlarged School of Fire for Field Artillery.

In conclusion, it may be said that the same principles apply to the functions of the chief of any other mobile arm, and, should each arm eventually have a chief, they would together constitute in the War Department what the Army has never had, a fully qualified training committee having the respect and confidence of the entire service—a body that could be relied upon to work for the harmonious development of our mobile forces as a whole, with the authority to get results, and that, too, without interfering with the proper functions of any of the established agencies of the War Department.

OBSERVER.

### **Editorial Difficulties Under Our Constitution**

IN the last number of the JOURNAL we called attention to the frequent change of editors brought about by the provisions of the constitution of our association. For example, last year there were no less than three editors. All of these had to work under extreme pressure, due to the fact that their service duties as officers on the active list were in themselves more than sufficient to fully occupy them. Then again, under the constitution, the separate office of editor is not provided. We have a Secretary-Editor who is required to be an officer of the Regular Army, selected by the Executive Council "from its own members or other active members of the association" (Art. VI, Sec. 2). Now an active member must be a commissioned officer on the active list of the Field Artillery (Art. III, Sec. 2), so that under the constitution our Secretary-Editor must be an officer of the Regular Field Artillery on the active list. It has also been customary (with few exceptions) for the Executive Council to select the same officer for Treasurer. The constitution requires that the Treasurer shall also be an active member and "shall be an officer stationed or residing in Washington, D. C." (Art. VI, Sec. 2). In other words, these cast-iron provisions require that our Secretary-Editor-Treasurer shall be an



## EDITORIAL

active officer of the Regular Field Artillery stationed in Washington. The constitution especially provides that the headquarters of the association shall be in the city of Washington, and naturally the editorial and business offices of the JOURNAL should be at headquarters.

Thus far these constitutional requirements have been rigidly fulfilled, but, since the outbreak of war, under great difficulties, because the rapid shifts of station under war conditions have made it uncertain whether our Secretary-Editor would remain in Washington long enough to see a single number of the JOURNAL through the press. Of course, in time of peace, conditions were better, because there was more certainty of his remaining in Washington, but under no circumstances did the Editor have sufficient time to devote to the JOURNAL. He had to work under stress and burn the midnight oil. Fortunately, the editorial office has always had an efficient clerk in charge whose interest in the JOURNAL enabled the work to proceed without serious hitch. But these efforts were entirely outside of his regular duties as a War Department clerk; he, too, had to work overtime.

Evidently some special action was required to keep the JOURNAL going during the present strenuous days. At the last meeting of the Council it was definitely decided to continue to issue it during the war. This much seemed to be due our subscribers and our advertisers. The Council therefore selected an artillery officer of the Regular Army (on the retired list, to be sure), but one of the charter members of the association, who was placed upon a status of *active duty*. He fills the dual office of Secretary-Editor and Treasurer, is stationed in Washington on active duty, and therefore practically complies with all the constitutional requirements. This ruling of the Council should meet with general approval. The great advantage of this arrangement is that the JOURNAL has now an Editor who, for the first time in its history, can devote his entire time to its affairs. The continuance of the JOURNAL without interruption is now assured, and, while the editorial uncertainty is for the

## THE FIELD ARTILLERY JOURNAL

time being overcome, it is believed that we ought now to amend the constitution so as to prevent a recurrence in the future of the troubles just mentioned.

We print elsewhere the constitution, with the list of charter members, who made it of full effect. In the next number of the JOURNAL we will publish certain proposed amendments desired to give the constitution the flexibility it now lacks, and to remove certain features shown by experience to be not entirely satisfactory. All members are requested to take advantage of this opportunity to study the constitution and consider the proposed amendments when submitted so that the vote thereupon may be cast understandingly at the proper time.

### **Field Artillery Training at Yale**

DURING the period of the war the energies of Yale University are to be directed especially on the task of qualifying its students as subalterns of Field Artillery. The Faculty has adopted for its Field Artillery Unit of the R. O. T. C. a special three years' course that, from the prospectus just issued, appears to be excellent to a degree. The course not only includes everything prescribed for the R.O.T.C. in G.O. 49 W.D. 1916, but goes far beyond it. The academic and military work is definitely prescribed and closely resembles the course at West Point, except that the military work is to be confined exclusively to specialization on technical field artillery training. Over forty members of the Faculty are to be the instructors in this special course—among them being Ex-President Taft in the Department of Military Law.

The Field Artillery owes much to Yale. According to figures just compiled by the Secretary of the University, 703 Yale men are now commissioned officers of Field Artillery. This is a most remarkable showing, and Yale may rest assured that the Field Artillery is deeply interested in her new work and will render every possible assistance in making it so successful that this already large number of officers may still further be greatly increased. In this unprecedented war

## EDITORIAL

specialization is more essential than ever before. It is therefore fortunate for the Field Artillery and for the country that Yale and her alumni in 1915 became interested in, provided unusual facilities for, and took up the specialization of field artillery. On account of the great and serious need for field artillery we earnestly hope that many other American colleges and universities may speedily start the work upon which Yale is now engaged.

### **College R. O. T. C.'s**

As might be expected, the war is making it practically impossible for colleges to hold in their student body any young men except those who are under military age. The question at once arises, "What part does education play in the prosecution of war?" It was none other than one of the greatest soldiers of our methodical and efficient enemy that declared "The commissioned personnel of the army must belong to the nobility—the nobility of mind."

Officers who were instructors at our officers' training camps were struck by the keenness, the intelligence, and the adaptability of the college man—the educated man, the man who is accustomed to working his mind. If education is any asset, any capital for the man in civil life, it becomes a positive requirement for the man who is commissioned by our country to the responsible task of leading its soldiers in battle. A keen, alert, trained mind on the part of its officers is the best insurance a government can give its soldiers that their lives will not be needlessly or uselessly sacrificed. Granting the general principle that an officer's education is of the very greatest value to his country, the question arises, "Is our country at the present time utilizing as well as it might our many thoroughly equipped educational institutions?" It is not.

The undergraduate feeling in college to-day is that he is looked upon as something of a "slacker"; that he is expected to let his education go at this critical time and get out and enlist. No one thinks of the cadet at West Point or Annapolis

as a "slacker," and no one expects him to get out and enlist. All the colleges and universities that are supporting units of the R. O. T. C. should to-day be turned into training schools for officers as are West Point and Annapolis. The R. O. T. C.'s as at present organized will not accomplish this result. They would accomplish it if their students were enlisted for the period of the war and were then kept on duty as members of the college R. O. T. C. until they graduate or fail in the course, in which event they should be sent to join their regiments. A young man who joins his regiment or a replacement camp as a graduate should be carried as a "Candidate Officer" or "Aspirant," and should be commissioned after a few months' try-out in service to determine whether or not he has sufficient soldierly qualities to justify a commission.

As a reward for the soldier at the front who distinguishes himself for heroism or gallantry the government should, if he lacks sufficient education to become an officer, return him to the United States and place him on duty with some college R. O. T. C. He should profitably be put through the college at government expense and then commissioned immediately upon graduation.

Our educational institutions should at this time be working under the same kind of pressure to turn out educated men to become officers as are our manufacturing plants to turn out munitions of war.

### **Service Books**

THE recent order prohibiting the printing by any person now in the service of any book on a service subject was indeed timely. The market was being overrun with books of a technical nature, treating of army subjects. As a rule, these books have seemed to be either a combination of some of the service standard manuals rewritten, usually very badly, or books written by some one on a subject of which he knew very little, hoping to put it across because he expects to sell it to people who know even less than the author, and whom they in turn regard as an expert.

## EDITORIAL

As a result of the publication of books by these so-called experts, there has been circulated a vast quantity of misinformation regarding things military.

SO MANY complaints have been received from members of the Association of the non-receipt of their copies of the JOURNAL that we take this occasion to again impress upon them the necessity of promptly informing us of any and all changes of address. Changes of address are carefully observed by us, and the JOURNAL is forwarded to the latest address given us in all cases.

If your copy of the magazine does not reach you within a reasonable time after the date of publication, congestion of the mails considered, write to the postmaster at your former address or station and ask that all second-class mail matter be forwarded to you. Officers changing station under orders are entitled to have second-class mail as well as first-class mail forwarded to them free of extra postage. If the new address is given to the postmaster before leaving, the JOURNAL will be forwarded.

THE FIELD ARTILLERY JOURNAL is a very expensive magazine to print, and it is necessary to limit editions to a few copies more than enough to supply the regular mailing list. If the magazine is not received because of failure of members to notify us or the postmasters of change of address, we cannot undertake to furnish extra copies.

DURING the past, articles regarding service matters have appeared in the JOURNAL from time to time. To the writer these articles have probably seemed to be all that could be desired; however, others might not always agree. It is therefore thought to be desirable to inaugurate a section in the JOURNAL for the purpose of discussing such matters. It is not desired to open up a place for "knockers" to spread themselves, but to enable the man with an idea, backed by what seems to him sound reasons, to put his idea before the Field Artillery for consideration. It is understood, of course, that all articles under this section will be signed.

## BOOK REVIEWS

FIELD ARTILLERYMAN'S GUIDE. Prepared by the officers of the 108th (2d Pennsylvania) Field Artillery. P. Blakiston's Son & Co., 1012 Walnut Street, Philadelphia, Pa., publishers.

This book contains information regarding almost all points that will come up to a new officer or a recruit during his early service and at the time when he is readjusting himself from living his own life to living with his comrades. This information is both personal as regards his personal hygiene, and technical as regards his professional work. It covers, in the technical work, the elementary drills of the 3-inch, 4.7 howitzer, and 6-inch howitzer batteries, matériel, horsemanship, harnessing, guard duty, and several kindred subjects, in the form of questions and answers. After all, though, it simply covers all of the regulations on the subjects touched, and amounts to a reprint of parts of these manuals, in many cases in language not as clear-cut or well defined as in the regulations.

FIELD ARTILLERY DATA BOOK AND FIELD MESSAGE PAD. By Major W. F. Sharp, Field Artillery. Price, \$1. Book Department, Army Service Schools, Fort Leavenworth, Kan., publisher.

This is one of many small handbooks that have been gotten out for service use and whose principal function is to gather together from several published sources into one small book data that might be of value to the field artilleryman. The particular information contained in this book consists of a few definitions regarding firing data, signalling, and the signal codes. The major portion of the book is taken up by sheets ruled for battery commander's data and field messages. The cover of the book has on its edge a battery commander's ruler.

LEADERSHIP AND MILITARY TRAINING. By Lieut.-Col. Lincoln C. Andrews, U. S. A. J. B. Lippincott Company, Philadelphia, Pa., publishers.

The author, in his preface, states: "There is nothing here of the drill manuals, nor of the technic of the art of war. It is rather an analysis of the psychology of soldiering, getting at the spirit of it, trying to point out how to make good in leadership, how to avoid making a failure." He is here putting down on paper the results of many years spent in the army, where the question of psychology has

## BOOK REVIEWS

long been recognized, not by the name itself but in the fact that there have been many things that were never put into the manuals and drill-books: the many intangible things necessary to transform the recruit into the seasoned soldier or the "shave-tail" into the efficient officer. These questions were "absorbed" one by one from their various sources in the more or less leisurely process of transformation in the peace time of the past. Now we are in the midst of a struggle calling for finished soldiers in shortest time. The author has collected together these many intangible things and put them down in such shape that the person so minded can obtain the maximum amount of value from the many years' experience gained by him in the "Old Army."

FRENCH FOR SOLDIERS. By Arthur F. Whittam and Percy W. Long, with collaboration of officers of the French Military Mission. Price, 75 cents. Harvard University Press.

A series of twenty lessons containing the essentials of French pronunciation and grammar, and vocabularies of a practical and military nature. There are also included French money, weights and measures, trench slang, and German phrases for use with prisoners. The book is published in a handy pocket size, and, while the lessons are primarily intended for beginners and for use in classes, it is a good book to have with one, especially if he is "going across."

COMPANY ADMINISTRATION. By Lieut.-Col. Wm. H. Waldron. Price, \$1.25. Geo. U. Harvey, Inc., publisher, 109 Lafayette Street, New York City.

The author, an officer of experience, has gathered together and placed in concise form all of the necessary information relative to the daily company administration. In this form, with the bulk of former publications of a like nature reduced to a minimum, it should prove of great value to the troop, company, or battery commander, and to his subalterns, who any day or hour may be called upon to take up the work of company administration. It will also be of great value to the first sergeant and company clerk. It should be of especial value to the large number of officers who have just entered the service or who are about to enter. Every company officer should own a copy, and, with a remembrance of the past, "we know whereof we speak."

THE MODERN GASOLINE AUTOMOBILE: Its Construction, Operation, Maintenance, and Design. By Victor W. Page. Published by The Norman W. Henley Publishing Company, New York. 1032 pages. Price, \$3.

The more or less universal use of the gasoline-driven vehicle has

## THE FIELD ARTILLERY JOURNAL

brought forth many books on the gasoline engine—its construction, design, and repair; also, all points with reference to its installation in the camping vehicle.

The present book is, however, as complete as could be desired—it covers all of the above points and several others; in addition, it has the value of being absolutely up to date.

This book is essentially written for the novice or the one beginning to learn gas-engine construction and operation. It gives in minute detail the reasons why the various parts work as they do, including the different types of the same apparatus used in different makes of machines.

In addition to the minute mechanical description, a considerable space is devoted to a description of the proper way to run, handle, and care for an automobile under all circumstances, including the location of trouble and its repair. This book is well worth the price for which it sells.

ARMY AND NAVY UNIFORMS AND INSIGNIA. By Colonel Dion Williams, United States Marine Corps. Frederick A. Stokes Company, New York. \$1.50 net.

This book is one of decided value to every officer and enlisted man in the service, regardless of the branch in which he may be serving. It contains accurate information as to all of the various uniforms of the United States Army, Navy, Marine Corps, Coast Guard, Lighthouse Service, and Public Health Service, and of the naval and military services of the principal foreign powers as well. All of the insignia of rank, corps and service, specialty marks, rating badges, and distinctive devices authorized for these different services are accurately described and fully illustrated with official accuracy and precision.

The first chapter treats of the origin and history of uniforms from their first use down to the present day, and shows how sentiment, tradition, expediency, and military necessity have all played a part in producing the uniforms of our fighting forces.

The second chapter describes the divisions of the services into corps and branches and gives all of the grades of rank and the duties of these grades, and also contains a table showing relative rank of officers in every service.

There is a chapter on ensigns, flags, and pennants, with illustrations in color of the flags of the principal nations engaged in the present world war.

A chapter is devoted to the uniforms and insignia of each of the services which make up the fighting forces of the United States—the Army, Navy, Marine Corps, Coast Guard, Lighthouse Service, and Public Health Service—each chapter being profusely illustrated.



## BOOK REVIEWS

The medals, badges, and ribbons authorized by the United States Government for service in peace and war are described and handsomely illustrated, the illustrations of the distinctive ribbons for the various medals and campaign badges being in color.

A chapter is devoted to the uniforms and insignia of the principal foreign services, with illustrations of the rank marks by which the officers of these services may be recognized at a glance.

The closing chapter is on the honors and distinctions shown to the colors, to the national anthem, and to the officers of high rank.

The book contains 450 pages, including 118 full-page illustrations in black and white and eight in color. It is published under the authority of the Navy Department, and is highly commended by the leading officials of the services, as shown by the following extracts:

*The Secretary of the Navy:* "It contains much instructive material which is of special interest at this time and will, I am sure, be found very useful by those who wish to learn the various distinctions of services, corps, and grades."

*The Adjutant General, U. S. Army:* "Examination of the book shows that it was most carefully prepared, and there can be no doubt that it will be of great assistance to all branches of the military and naval services, as well as to others who may be interested in the subject."

*The Quartermaster General, U. S. Army:* "I have looked through the subject-matter of the book and find it most useful and timely, well and clearly presented. It is a most complete and thorough type of presenting the subject."

*The Major General Commandant, U. S. Marine Corps:* "Officers and enlisted men in any branch of the service should be able to recognize at a glance the uniforms, insignia of rank, rating badges, and specialty marks of other branches of the United States service and of foreign armies and navies. The book gives the desired information with clearness and official accuracy."

*The Surgeon General, U. S. Public Health Service:* "I have examined it carefully and am satisfied that it will become the standard authority on the subject."

AVIATION ENGINES, DESIGN, CONSTRUCTION, OPERATION AND REPAIR.

By Lieut. Victor W. Page, Sig. R. C. Aviation Section. 576 octavo pages, 253 engravings. Norman W. Henley Publishing Company, 2 West Twenty-fourth Street, New York City. Price, \$3 net.

The rapidly increasing interest in the study of aviation and the prominence this has attained in the present war have created a demand for a text-book suitable for schools and for enlisted men in the various

## THE FIELD ARTILLERY JOURNAL

services to study that will clearly and concisely explain the workings of aircraft parts. This treatise deals only with the airplane engine in its numerous forms, and appears to be a thorough exposition on this subject, considering in some detail and in simple language representative types of leading domestic and foreign engines. It considers the rotary forms as well as the fixed cylinder types, and the auxiliary groups, such as carburetion, cooling, ignition, and lubrication, are also completely described. The book contains twelve chapters, and the construction and repair of the various engine parts are taken up in a logical manner so any practical man can easily follow the subject. Very complete lists of tools used for adjusting and erecting engines are given and leading repair processes are explained. In fact, the chapters on repairing and "trouble shooting" appear to be of great value and not usually found in books on such subjects. It is our opinion that this is a very complete aviation engine book, because it considers both elementary theory and actual construction and repair practice.

THE WAR OF POSITIONS. By Lieut. Col. Paul Azan, Chief of the French Military Mission, Harvard University. Preface by Maj. Gen. J. E. Kuhn, U. S. A. Published at Cambridge, Mass., Harvard University Press.

This is quite the best book of its kind we have read, and may be considered as one of the books of the year. The author, Colonel Azan, because of his ability, was detached by his Government to organize officers' schools in France. Later he was sent to Harvard University for similar work. He discusses his subject under the following headings: The Present War. Positions. Attack on a Position and Defence of a Position. The book should prove of great interest to the soldier, as it puts in his hands information that could only be gained by actual service in the field under present-day conditions of warfare. Every officer should own a copy, as it is the clearest and most instructive exposition of operations as conducted on the Western Front.

AVIATION CHART. Location of Airplane. Power Plant Troubles Made Easy. By Lieut. Victor W. Page, A.S., S.C., U.S.R., author of "Modern Gasoline Automobile," "Aviation Engines," etc.

A large wall chart outlining all parts of a typical airplane power plant, showing the points where trouble is apt to occur, and suggesting remedies for the common defects. Intended especially for aviators and aviation mechanics on school and field duty. Price, 50 cents. Published by the Norman W. Henley Publishing Company, 2 West Forty-fifth Street, New York.

## BOOK REVIEWS

This chart gives a complete exposition of the subject, and should prove of great help to the aviator and his mechanic. It shows in detail sectional views of the engine, carburettor, magneto, and pressure-feed fuel system. The chart shows, for ready reference in parallel columns: Part affected, nature of trouble, symptoms and effects, and remedy. These are given under the headings: Lost Power and Overheating; Noisy Operation of Power Plant; Valve Timing; Anti-freezing Compounds; Defects in Cooling Systems; Oiling System Faults; Defects in Ignition System Components; Skipping or Irregular Operation; Common Power Plant Troubles and Likely Causes.

CARE OF TROOPS (For Line Officers). By Frederick S. Macey, Major, M. C., U. S. Army. Published by George U. Harvey Publishing Company, Inc., 109 Lafayette Street, New York. Price, \$1.

This volume, in pocket size, places in the hands of the line officer such facts in connection with military hygiene as will enable him to properly insure the effectiveness of his troops. The author has been guided in the preparation of his work by those questions asked by line officers on the subject of the care of troops. The work discusses, but without technicalities or tedious details, the following: Recruits; Care of the Person; Marches; Transmissible Diseases; Mosquitoes, Flies, and Vermin; Disposal of Waste and Excreta; Supply and Purification of Water; Food; and Camps and Trenches. The book will be of interest and help to line officers inexperienced in field service, and to physicians from civil life suddenly called into the military service.

MILITARY OBSERVATION BALLOONS. By Emil J. Widmer, Published by D. Van Nostrand Company, 251 Park Place, New York. Price, \$3.

This book is based on the German balloon manual which was in use before the war. It is out of date and useless for purposes of instruction. The only captive balloon described is a type which has been obsolete for eighteen months. The technical terms used are not those in use in the United States Army, and would not be understood. As regards instruction of the observer in artillery observation, not one word is said on the subject; in fact, on page 90 we read: "The balloon is used in field war for tactical observation, and only rarely for artillery purposes." At the present time, ninety-five per cent. of the work of the balloon observer is in artillery observation and in the location of enemy batteries. The reading of this book by young officers of our balloon service would be a waste of time.

## Index to Current Field Artillery Literature

Compiled from monthly list of military information carded from books, periodicals and other sources furnished by the War College Division, General Staff.

- Abbreviations—France.*—Official list of military abbreviations authorized for use in the French army. (Bulletin Officiel, edition chronologique, November 12, 1917, p. 3126.)
- Abbreviations—France.*—Prescribed military abbreviations used in the French army. (Manual for Commanders of Infantry Platoons, p. 269.)
- Aeronautical Terms.*—Aeroplane parts in French and English. (Aerial Age Weekly, November 12, 1917, p. 384.)
- Ammunition—Expended in battle—France—European war.*—Expenditure of artillery ammunition in the French army. Statement of the French High Commission to Washington, July 30, 1917. (Official Bulletin, August 4, 1917, p. 2.)
- Ammunition supply—France.*—Replenishment of munitions and matériel. Armament, tables of and supply, French army. (Manual for Commanders of Infantry Platoons, p. 301. Filed U15 A35 No. 36. UD155 F8 A-2-a (1917).)
- Anti-aircraft fire.*—Firing at captive balloons and proposed aids in the direction of fire against aircraft. Table showing probability of hitting; use of computing sticks for determining the distance to the target, etc. (Journal of the U. S. Artillery, July-August, 1917, p. 109.)
- Anti-aircraft guns—Italy.*—Illustrations of the anti-aircraft guns used by Italy in the European war. (The War in Italy, vol. 9, p. 576.)
- Anti-balloon gun fire.*—Firing at captive balloons and proposed aids in the direction of fire against aircraft. Table showing probability of hitting; use of computing sticks for determining the distance to the target, etc. (Journal of the U. S. Artillery, July-August, 1917, p. 109.)
- Armor—European war.*—Construction and efficiency of breastplates, helmets, and shields designed during European war. (Le Gehie Civil, September 15, 1917, p. 174.)
- Armored cars.*—Mobile armament for defense. Armored cars, motor and railway; guns on railway cars, etc., European war. Illustrated. (Journal of the U. S. Artillery, July-August, 1917, p. 17.)
- Artillery—Chile.*—Artillery organization in the Chilean army. (Revista del Circulo Militar, August, 1917, p. 569.)
- Artillery drill and tactics—Germany.*—Notes on use of German artillery in Belgium, European war. (La Guerra y su Preparacion, September, 1917, p. 234.)
- Artillery drill and tactics—Germany.*—Shell fire, European war. Photographs showing artillery shell fire destruction by successive stages. Destruction of a French farm home. (Collier's, December 1, 1917, p. 12.)
- Artillery equipment—France—European war.*—Artillery equipment of the French army. Statement of the French High Commission to Washington, July 30, 1917, (Official Bulletin, August 4, 1917, p. 2.)
- Artillery—Italy.*—Illustrations of the different types of guns used by the Italians in the European war. (The War in Italy, vol. 9, pp. 544, 573-576.)
- Artillery—Italy.*—Illustrations of the 305-mm. mortars of the Italian army. (The War in Italy, vol. 8, p. 491.)
- Artillery matériel—European war.*—Care of matériel. European war experience. (The Field Artillery Journal, July-September, 1917, p. 345.)
- Artillery terms—Great Britain.*—Artillery terms in trench warfare, definition of British terms. (The Field Artillery Journal, July-September, 1917, p. 345.)
- Automobiles.*—New standard army truck will be made in two models. Short description; deliveries in January, 1918. (Engineering News-Record, October 4, 1917, p. 672.)
- Balloons.*—Military observation balloons. Advantages of the captive balloon; aeroplanes not able to replace captive balloon, etc. (Journal of the U. S. Artillery, July-August, 1917, p. 116.)

## INDEX TO CURRENT FIELD ARTILLERY LITERATURE

- Balloons—European war.*—Coöperation between balloons and artillery. (Aerial Age, November 5, 1917, p. 339.)
- Balloons—Great Britain.*—Coöperation between balloons and artillery. (The Field Artillery Journal, July–September, 1917, p. 233.)
- Battle tactics—European war.*—How battles are fought to-day; new conditions of offensive warfare, by Gen. Malleterre, (Harper's Magazine, October, 1917, p. 593.)
- Battle tactics—France.*—Matériel, preparation and results obtained in French offensive of July 3, 1917. (L'illustration, October 20, 1917, p. 387.)
- Belgium.*—Ministère de la guerre. Organisation des établissements d'artilleries, 15 Fevrier, 1917. (Nancy, Berger-Levrault, 1917, 79 pp., tables. UF 335 B41 (1914) A3.)
- Belgium.*—Ministère de la guerre. Instruction sur l'organisation et le service des batteries de mortiers "Van Deuren." (Paris, Nancy, Berger-Levrault, 1916, 43 (2) pp. UF 475 B4 A3.)
- Bombs.*—Battlefield illumination. An example of practice in battlefield illumination in America. Battlefield illumination with searchlights; illumination with rockets, star shells, illuminating grenades and bombs; problems in battlefield illumination. Diagrams. (Professional Memoirs, November–December, 1917, p. 682.)
- Bombs, dropping.*—Armor-piercers, incendiaries and tracers in air fighting. Reasons for Germany abandoning her Zeppelin raids. Four ways to bring down enemy aircraft. Camouflaging machines. (Arms and the Man, September 29, 1917, p. 7.)
- Camouflage.*—Company A: American camouflers. Descriptive work of the company. (The Literary Digest, October 13, 1917, p. 32.)
- Camouflage.*—Camouflage methods in European war. (The Saturday Evening Post, September 29, 1917, p. 14.)
- Camouflage.*—Illustration showing camouflage of a big gun. (The Illustrated War News, December 19, 1917, p. 1.)
- Camouflage.*—Right and wrong methods of camouflage. (The Literary Digest, September 22, 1917, p. 55.)
- Camouflage—European war.*—Artillery camouflage on the western front. By Joseph Whitney-Ganson, an American officer in the French Artillery. Illustrated. (Aerial Age Weekly, December 17, 1917, p. 604.)
- Camouflage—Germany.*—Strange colors on the German air machines. Germany's system of camouflaging her aircraft. (Clip. from The Japan Advertiser, August 7, 1917. Filed Env. Case—Camouflage—Germany.)
- Cannon.*—Cannon making in past centuries. (American Machinist, October 11, 1917, p. 617.)
- Conventional signs—France.*—Conventional signs employed obligatorily on maps of scale of 1/5000 and larger. (Manual for Commanders of Infantry Platoons, p. 130. Filed: U15 A35 No. 36.)
- Equipment—United States.*—List giving equipment, with prices, recommended for abroad. (Army and Navy Journal, October 13, 1917, p. 233.)
- Equipment—United States.*—Officers. Army uniforms. List of arms and articles of equipment to be in possession of army officers, according to newly issued uniform regulations. (Army and Navy Register, November 3, 1917, p. 549.)
- Fair, John S.*—The supply of animals for the army. Lecture delivered before the Quartermaster Reserve Corps, Washington, July 3, 1917. (Washington, Government Printing Office, 1917. 32 pp.)
- Field artillery training—European war.*—Methods of employment and training in European war. (The Field Artillery Journal, July–September, 1917, p. 294.)
- Field artillery training—United States.*—Scheme for field artillery training. Spotting practice for artillery. Improved instruments for instruction. (The Field Artillery Journal. July–September, 1917, pp. 252, 302, 316, and 352.)
- Field fortifications—European war.*—The trench system of defense vs. the pill box system. Illustration showing a concrete blockhouse or large pill box typical of the many used by Germans in their 1917 system of flexible defense on the western front. (Scientific American, September 22, 1917, p. 469.)
- Field fortifications—France.*—Pictures of German concrete field works. (L'illustration, October 20, 1917, p. 390.)

## THE FIELD ARTILLERY JOURNAL

- Field fortifications—Germany.*—German concrete construction on the French front. Illustrations of. (The Illustrated War News, November 28, 1917, pp. 76–77.)
- Field fortifications—Germany.*—The passing of the "pill box." This and other German defensive schemes which have succumbed to Allied artillery. (Scientific American, October 20, 1917, p. 284.)
- Field guns—Germany.*—Wastage of German artillery. Statement by Germany. (The Canadian Military Gazette, December 26, 1917, p. 7.)
- Flame projectors.*—Illustration of German "Flammenwerfer"; type of. (The Illustrated London News, September 15, 1917, p. 292.)
- Fortification.*—History of the development of fortification as a means of defence against artillery fire. (Boletín del Ejército, November, 1917, p. 271.)
- Fortifications, field—France.*—Construction of field fortifications in the French army, 1917. Tactical employment of. Illustrated. (Manual for Commanders of Infantry Platoons, pp. 31, 192. Filed U15 A35 No. 36. UD155 F8 A-2-a (1917).)
- Fortresses.*—The rise and fall of the formal fortress. Illustrated. (The New York Times Current History, November, 1917, p. 300.)
- Grenades—Canada.*—Training in the use of grenades and bombs at the Canadian Grenade School, Canadian training division, Shorncliffe. (Canada, February 5, 1916, p. 155. EA.)
- Grenades—France.*—Types and use of grenades in the French army. Illustrated. (Manual for Commanders of Infantry Platoons, pp. 76 and 171. Filed U15 A35 No. 36. UD155 F8 A-2-a (1917).)
- Gruber, Edmund L.*—Notes on the 3-inch gun matériel, comp. for the field artillery unit of the Reserve officers' training corps of the Yale University. New Haven, New Haven Printing Company, 1917. 91 pp., illustrated.)
- Heavy artillery—Germany.*—German use of heavy artillery. Probable sources. (Scientific American, October 20, 1917, p. 282.)
- Kitchens—United States.*—Motor transportation, United States. Motor equipment of field kitchens, etc. Illustrations. (Collier's, December 29, 1917, pp. 15 and 22.)
- Krupp—Switzerland.*—New Krupp plant in Switzerland. Brief information concerning munition plant. (Scientific American, December 29, 1917, p. 491.)
- Lecture* on the probability and dispersion of fire. Translated at the Army War College from a French document. (Washington, Government Printing Office, 1917, 23 pp. UF330 C74-a.)
- Les Batailles de la Marne* par un officier d'Etatmajor allemand, avec un croquis du champ de bataille. Translated by Thomas C. Buyse. (Bruxelles et Paris, Librairie nationale d'art et d'histoire, G. van Oest et cie., 1917, 149 pp., folder, plan. D534.1 M3 S33-f.)
- Liaison—European war.*—Liaison methods in European war. (The Military Historian and Economist, October, 1917, p. 441.)
- Lines of communication—France.*—Maintenance of communication (liaison) between units and signalling. (Manual for Commanders of Infantry Platoons, p. 269. Filed U15 A35 No. 36. UD155 F8 A-2-a (1917).)
- Manual* for the artillery orientation officer, consisting of extracts from "Manuel de Pofficier orienteur d'artillerie," a French official manual. Translated by the Army War College in collaboration with the United States Geological Survey and the United States Coast and Geodetic Survey. (Washington, Government Printing Office, 1917, 238 pp., plates, fold., tables, diagrams. UF353 M29-e.)
- Map making—European war.*—Map making from photographs in war zone, European war. (Current Opinion, October, 1917, p. 255.)
- Marne, Battle of.*—Faults committed by the Germans during and before the battle of the Marne, European war. (Revista Militar, Argentina, October, 1917, p. 899.)
- Mechanical transportation—United States.*—Final tests of U. S. aviation engine. (The Journal of the Society of Automotive Engineers, September, 1917, p. 194.)
- Military art and science.*—The situation and organization. Political; strategic; tactical and logistical estimates of the situation and organization to meet it. Overseas expeditions. (U. S. Naval Institute Proceedings, October, 1917, p. 2247.)
- Military aviation—United States.*—America's air service. Growth, types of aeroplanes, and methods. (Journal of The Franklin Institute, January, 1918.)
- Military service.*—Historical study of universal military service. (Boletín del Ejército, October, 1917, p. 174.)

## INDEX TO CURRENT FIELD ARTILLERY LITERATURE

- Moretti, Onorio*.—Notes on training, field artillery details, prepared under the direction of Capt. Robert M. Danford. (New Haven, Conn., Yale University Press, 1917. 275 pp., illustrations, maps, forms.)
- Mortars—Italy*.—Illustrations of various trench mortars of the Italian army. (The War in Italy, vol. 9, pp. 543–544.)
- Mortars—Italy*.—Illustrations of the 305-mm. mortars of the Italian army. (The War in Italy, vol. 8, p. 491.)
- Motorcycles—United States*.—The motorcycle in army use. Recommendations to Committee on Organization, A. W. C., by the Committee on Organization, Motorcycle Division, of the Automotive Engineers. (Journal of the Society of Automobile Engineers, October, 1917, p. 241.)
- Motor trucks—United States*.—America's achievement in truckdom. Details of construction of U. S. A. type B war chassis. Illustrated. (Motor Age, November 1, 1917, p. 5.)
- Motor trucks—United States*.—Motor transportation as a military asset. Mobilization of motor transportation in United States. Output in European war. (Collier's, December 29, 1917, p. 7.)
- Mules—United States*.—Mules superior to horses in the light of European war experiences. (The Literary Digest, September 29, 1917, p. 59.)
- Munitions of war—France*.—Replenishment of munitions and matériel. Armament, tables of and supply, French army. (Manual for Commanders of Infantry Platoons, p. 301. Filed U15 A35 No. 36. UD155 F8 A-2-a (1917).)
- Munitions of war, manufacture of—Great Britain*.—Number of men engaged in England as compared with those in the arsenals of the United States. (American Machinist, October 4, 1917, p. 606.)
- Notes on the French 75-mm. gun*. Edited at the Army War College, Washington. (Government Printing Office, 1917, 12 pp., diagrams. UF575 F82 75-mm. E57-a.)
- Observation—France*.—Means of observation and reconnaissance. Field glasses—periscope—compass—maps, sketches, and plans. Illustrated. (Manual for Commanders of Infantry Platoons, p. 116. Filed U15 A35 No. 36. UD155 F8 A-2-a (1917).)
- Obstacles—Trench "Trappery"*. German man traps left in the trenches on retreating. (The Literary Digest, October 13, 1917, p. 73.)
- Ordnance—United States*.—Comparison of the army and navy efficiency. What the navy has done and the army has not done. (Scientific American, December 22, 1917, p. 470.)
- Ordnance—United States*.—Crozier tells of great progress made. Despite delays and many obstacles, preparedness has advanced further than investigators expected; detailed report of testimony taken by Senate Committee. Great lesson of the war; summary of things done; coöperation of allies; appropriations insufficient, etc. (The Iron Age, December 20, 1917, p. 1472.)
- Ordnance base—France*.—Acres of shops to form ordnance base in France. Functions and construction of plant. (Engineering News-Record, January 3, 1918, p. 23.)
- Ordnance factories—Switzerland*.—New Krupp plant in Switzerland. Brief information concerning munition plant. (Scientific American, December 29, 1917, p. 491.)
- Parachutes—The parachute up-to-date*. Brief history of the parachute. Use of same with an aeroplane. (Scientific American Supp., No. 2180, October 13, 1917, p. 238.)
- Pistols, automatic—Looking over the hand guns*.—Various types of automatic pistols. Advantages and disadvantages of same. (Arms and the Man, October 27, 1917, p. 83.)
- Projectiles—Germany*.—Effects of projectiles. Penetrating effect of German bullets; effects of artillery fire, etc. Illustrated. (Manual for Commanders of Infantry Platoons, p. 148. Filed U15 A35 No. 36 UD155 F8 A-2-a (1917).)
- Prussia*.—Kriegsministerium. Utilization and rôle of artillery aviators in trench warfare. (Washington, Government Printing Office, 1917, 94 pp. U226 P97.)
- Reed, Edward Bliss, 1872*.—Seven hundred French terms for American field artillerymen. (New Haven, University Press; London, H. Milford, 1917, 64 pp. U26 F8 R32.)
- Roads—France*.—Means employed in France, 1917, for preparing roads for intense motor traffic. (La Science et la Vie, November, 1917, p. 407.)

## THE FIELD ARTILLERY JOURNAL

- Shells*.—Shells of the fighting nations; variations in design. (Scientific American Supplement, No. 2178, p. 204.)
- Signalling—France*.—Illuminating artifices and appliances employed in signalling. Illustrated. (Manual for Commanders of Infantry Platoons, p. 103.)
- Signalling—France*.—Maintenance of communication (liaison) between units and signalling. (Manual for Commanders of Infantry Platoons, p. 269.)
- Trench mortars*.—Trench mortars against U-boats. Opportunity to use trench mortars against U-boats at short ranges. (Scientific American, November 17, 1917, p. 363.)
- Trench troops—United States*.—Organization and duties for trench fighting. Organization of our new company; specialists; use of specialists; formation for maneuvering this resultant company of specialists; principles of the organization; elements of the organization; sector and trench duties; artillery support in a sector, etc. Illustrations and diagrams. (Professional Memoirs, November-December, 1917, p. 708.)
- Trench warfare—European war*.—In the training trenches. British methods of training U. S. troops in France. (The Literary Digest, October 20, 1917, p. 57.)
- Trench warfare—European war*.—Allies' methods of attack on German fortified lines. (Scientific American, December 22, 1917, p. 470.)
- Veterinary service—European war*.—Horse surgery at the front. Field hospitals for the treatment of sick and wounded animals. Illustrated. (Scientific American, October 13, 1917, p. 272.)
- Viall, Ethan*.—United States artillery ammunition. (New York, McGraw-Hill Book Company, Inc., 1917, 98 pp. UF533 V61.)
- Waldron, William Henry*.—Elements of trench warfare. (New York, E. A. Appleton, 1917, 225 pp., illustrations, folder, diagram. U169.3 W16.)
- Water supply*.—Horsewater troughs and horsewater points. With diagram. (The Royal Engineers' Journal, December, 1917, p. 264.)
- Zeppelins*.—To-day's warplanes *versus* Zeppelins. Zeppelin defense against warcraft. How it can be developed. (Scientific American, September 1, 1917, p. 152.)