



# Navy Reserve Direct Commission Officer Handbook





You were selected because you have the ability to make the Navy Reserve a better, more prepared and capable Force.



Congratulations on your selection for the Navy Reserve's Direct Commission Officer Program! Every year, this highly competitive program chooses a select group of Americans from across our Nation for a commission in the United States Navy Reserve. You were selected among some of the most educated, dedicated, and experienced citizens our nation has to offer. The Navy will utilize your unique expertise to help accomplish our global mission. You were selected because you have the ability to make the Navy Reserve a better, more prepared and capable Force.

For over a century, Navy Reserve Sailors have helped the Navy respond to some extraordinary challenges. Our mission is to deliver strategic depth - surge support - and operational capabilities to the Navy, Marine Corps, and Joint Force. To accomplish this

mission, we draw upon the extensive skills and abilities embodied in each Reserve Sailor. Our "Citizen Sailors" come from communities across America and all walks of life. They provide valuable support to Fleet and Combatant Commanders and serve at home, abroad, on shore, in the air and at sea.

As the Chief of Navy Reserve, I want to extend my personal congratulations on your selection as an Officer in the United States Navy Reserve. Thank you for your willingness to serve. Your adventure begins on your first drill weekend. Welcome aboard!



VICE ADMIRAL R. R. BRAUN  
UNITED STATES NAVY  
CHIEF OF NAVY RESERVE

# Table of Contents

<b>I. GENERAL INFORMATION</b>	<b>7</b>
Preparing for your first drill weekend - Checklist	6
Direct Commission Officer Indoctrination Course	7
ID Cards	7
Uniforms	8
Information Technology	11
General Military Training (GMT)	12
ProcessQuik	13
<b>II. YOUR RESPONSIBILITIES</b>	<b>14</b>
Navy Standard Integrated Personnel System (NSIPS)	14
Electronic Service Record (ESR)	14
Civilian Employment Information (CEI)	15
Family Care Plan (FCP)	15
Page 2/ Servicemembers Group Life Insurance (SGLI)	16
Navy Family Accountability and Assessment System (NFAAS)/MyPay	17-18
<b>III. RESERVE ADMINISTRATION</b>	<b>21</b>
Drilling Status/Requirements/Enhancement for Drill Management (EDM)	21
Navy Reserve Order Writing System (NROWS)/Defense Travel System (DTS)	24-25

Government Travel Charge Card (GTCC) . . . . .	27
Security Clearance . . . . .	27
Berthing . . . . .	28
Urinalysis Program . . . . .	29
Physical Fitness Assessment . . . . .	29
Medical and Dental Policies and Procedures . . . . .	30
Ready Reserve Screening Questionnaire (RRSQ) . . . . .	33
Manpower Availability Status (MAS) Codes . . . . .	33
Mobilization . . . . .	35
Calculating Retirement . . . . .	38
Interactive Customer Evaluation (ICE) Survey . . . . .	39
<b>IV. CAREER MANAGEMENT . . . . .</b>	<b>40</b>
Managing Your Personnel Record . . . . .	40
Officer Billet/JOAPPLY . . . . .	47
FITREPS/EVALS . . . . .	48
<b>V. APPENDICES . . . . .</b>	<b>53</b>
DCO Drill Weekend Milestones . . . . .	53
References . . . . .	54
Important Websites . . . . .	55
Acronyms . . . . .	57



## Where Do I Start?

A NOSC is a Navy Operational Support Center. You will likely attend your first drill weekend at your NOSC and may conduct subsequent drill weekends there as well. Depending on your officer community and unit assignment, you may also drill at an aviation squadron/ wing or other locations referred to as Navy Reserve Activities (NRA). For the purpose of this handbook, the terms NOSC and NRA will be used interchangeably as a reminder that all information contained in this handbook applies to all Direct Commission Officers (DCOs), whether you are attached to a NOSC or a NRA. As a new Sailor, one of the first things you should do is contact your NOSC Direct Commission Officer Sponsor to discuss the logistics of your first NOSC visit. You can find your sponsor's contact information in your "welcome aboard" email from Commander, Navy Reserve Forces Command (CNRFC). The enclosed, "Preparing for your first drill weekend – checklist," will help guide you through this process (see next page).







## Direct Commissioned Officers Indoctrination Course (DCOIC)

In accordance with (IAW) Chief of Naval Operations Instruction (OPNAVINST) 1120.3B, officers appointed under the Direct Commission Program are required to attend the DCOIC in Newport, Rhode Island, within one-year of appointment. DCOs shall use their first Annual Training (AT) to attend DCOIC. The Training Department at your NOSC will help you schedule this course, which is 12 days in length and includes academic instruction, military training and physical conditioning. For more information, go to: [www.ocs.navy.mil/dcoic.asp](http://www.ocs.navy.mil/dcoic.asp).

## ID Cards

All Selected Reserve (SELRES) Sailors are issued a military identification card (ID card) that identifies you as a member of the U.S. Uniformed Services. This ID is also referred to as a Common Access Card (CAC). Many of the Reserve pay and order writing systems (Navy Reserve Order Writing System (NROWS) and Navy Standard Integrated Personnel System (NSIPS)) require CAC access. CACs are issued at Real-Time Automated Personnel Identification System (RAPIDS) sites. To locate your nearest RAPIDS location, go to: <http://www.dmdc.osd.mil/>

Many RAPIDS locations require an appointment to get your CAC. You can schedule an appointment through the website above. Before you go, make sure to bring two forms of ID, and check to see that your NOSC has completed your NSIPS check-in.

You can acquire a CAC reader for your home computer from your NOSC Information Technology (IT) Department. CAC readers will be discussed in the IT section of this handbook.

# Uniforms

Donning the Navy uniform is one of the most exciting and humbling parts of being a part of the U.S. Navy. DCO's can order their uniforms when they either: **(1)** receive a copy of your commissioning certificate/ oath of office and bring that to the NEX uniform shop; **(2)** obtain a military ID; or **(3)** once your gaining Navy Operational Support Center (NOSC) inputs you into DEERS you can then call the uniform call center (800-368-4088) and order your uniforms by providing them your social security number. The Navy has many types of uniforms which vary by season and occasion. Commonly worn as the prescribed uniform of the day are the Navy Working Uniform (NWU) Type I, Service Khakis (SK), Summer White (SW), Service Dress Blue (SDB), and Service Dress White (SDW). Your NOSC will determine what uniform to wear to drill weekend (known as the uniform of the day), but you will usually wear NWUs or Khakis. Additionally, you will be required to wear Navy Physical Training (PT) gear during physical training and when performing your Physical Readiness Test (PRT).

While attending DCOIC, you will be required to have a PT uniform, Khakis, NWUs and SDBs. Please contact Officer Training Command Newport (OTCN) at [http://www.ocs.navy.mil/DCOIC\\_program\\_overview.asp](http://www.ocs.navy.mil/DCOIC_program_overview.asp) to confirm uniform requirements. For more



information regarding uniforms, please visit: <http://www.public.navy.mil/bupers-npc/support/uniforms/uniformregulations/Pages/default.aspx>.

Proper wear and care of your uniform is an important part of being an officer. Correct display of rank insignia and other devices is critical to good order and discipline. Read the Navy uniform website carefully, watch the Navy's uniform videos, available on YouTube, and ask a shipmate if you have questions. The staff at the Navy Exchange (NEX) are experts, and a great source of information. They are familiar with uniform regulations, as well as optional and required components. Every time you wear your uniform, you will want to look sharp!

### Uniform Guidance

Communicate with your NOSC regarding the uniform for first drill weekend. You will probably wear khakis, NWUs or will be authorized civilian business attire. The Navy uniform shop will take care of the proper placement of your name and rank insignia on your NWUs. In the event that you wear SK, cover and collar insignia placement are shown below.

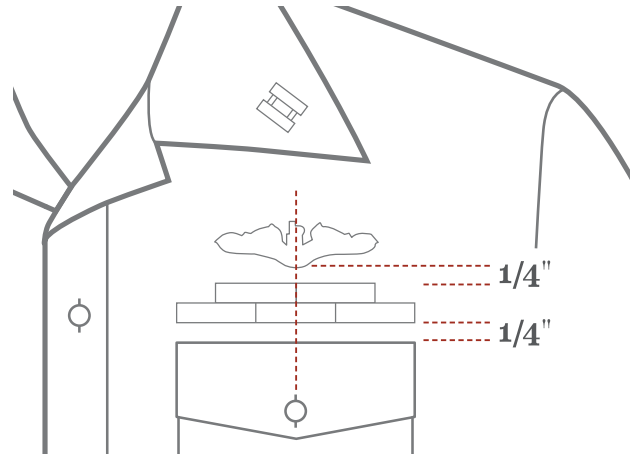

On your short-sleeved khaki shirt, center the insignia one inch from the front and lower edges of the collar and position the vertical axis of the insignia along an imaginary line bisecting the angle of the collar point.

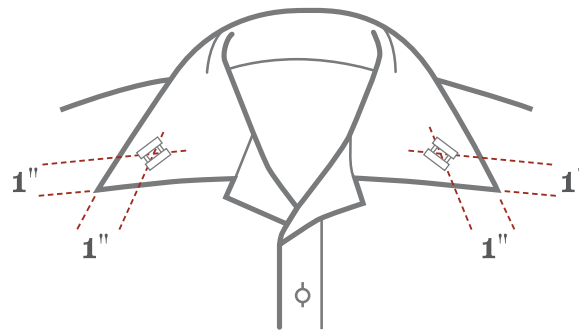

If you are a Line Officer, you will wear your rank insignia on both collars. If you are a Staff Corps Officer, you will wear one rank insignia collar device and one insignia indicating staff corps or line. Staff corps officers and warrant officers wear their rank on their right collar point and their insignia on their left collar point as shown below. The vertical axis of the insignia is aligned with the bisecting line of the collar point on open collar shirts.

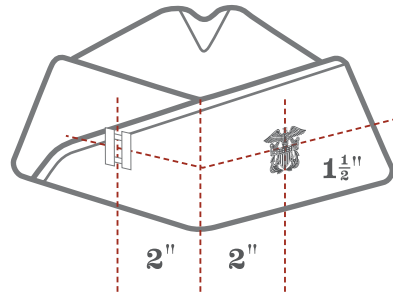

Cap devices and rank devices, for “khaki cover” or garrison caps, are worn on the left and right side, respectively. Grooming standards for both males and females can be found on the NPC website: <http://www.public.navy.mil/bupers-npc/support/uniforms/uniformregulations/chapter2/Pages/default.aspx>.

# Information Technology (IT)

During your career in the Navy Reserve, you will rely heavily upon Information Technology (IT) to carry out your duties. In order to gain access to the Navy's IT assets, such as Navy electronic mail (navy.mil) accounts, you will need to do the following:

1. Obtain a Common Access Card (CAC).
2. Obtain a CAC Reader from the NOSC.
3. Complete DOD Information Assurance (IA) training during indoctrination (INDOC). This training is also available on Navy Knowledge Online (NKO) <https://www.nko.navy.mil/>. This training could be completed from your home computer (requires CAC Reader) prior to attending your first DWE, but this is not required.
4. Complete and sign the System Authorization Access Request Navy (SAAR-N) form and turn in to the NOSC IT department. Copies of the SAAR-N are available through the NOSC IT representative, also known as the Contract Technical Representative (CTR) or Assistant Contract Technical Representative (ACTR). You will need to know the date you completed your IA training to complete your SAAR-N form.

5. The CTR will establish your Navy/Marine Corps Intranet (NMCI) account and will notify you when it is created. From here, the CTR will work with you to get your account activated and set up.
6. After NMCI account activation, engage your NRA IT department on how to access Microsoft Outlook Web Access (OWA) from your home computer using a CAC reader.



The OWA web application, when accessed with your CAC reader, will enable you to securely access your “navy.mil” email for conducting official business with your NOSC and unit leadership. Once you have a valid “navy.mil” email account, you can self-register for a Navy Reserve Homeport (NRH) account which has many helpful tools and resources for SELRES. If you need help, please contact the NMCI Helpdesk at: 1-866-THE-NMCI.

## Navy Reserve Homeport Website

The Navy Reserve Homeport Website is a one stop venue for Navy Reserve Sailors. Located at: <https://www.navyreserve.navy.mil/Pages/default.aspx>, it is an excellent resource. It has a public and private side (need CAC to access the private side) that can answer many of the questions you may have as you progress in your Navy Reserve career. From this website you can also access such links as Bupers Online, Navy Personnel Command and the Defense Travel System.

## Free Antivirus Software

Once your computer is CAC enabled, you can go to <https://infosec.navy.mil/>, and click on the tab to download McAfee or Norton Symantec antivirus software at no cost to you.

## General Military Training (GMT)

General Military Training (GMT) is non-occupational general training required periodically for all Navy personnel. GMT is divided into two categories: **(1)** Standardized Core Training (SCT); which is comprised of topics mandated by higher authority and a portion are conducted as face-to-face, instructor-led sessions provided at the command level with the

remaining completed by each individual; or **(2)** Navy Command-Assigned Readiness Enhancement (CARE) training; topics comprise the remaining annual GMT requirements where the training is done by a locally-run training program, operating within a minimal framework, which ensures coverage of key topics to enhance individual and command readiness. Required Navy-wide GMT topics are provided each fiscal year and can be found on the Navy Personnel Command's website (<http://www.public.navy.mil/bupers-npc/Pages/default.aspx>) in the NAVADMIN section that



lists the GMT schedule for the Fiscal Year. The Federal Government's Fiscal Year is from October 1st to September 30th.

Fleet and Type Commanders may issue their own organizational training requirements beyond that of

Navy GMT based on the needs of their platforms and personnel. The Navy Reserve adheres to the same training requirement as our Active Duty counterparts.

## ProcessQuik

ProcessQuik is the Navy Reserve's interactive process library, a one-stop shop for core business processes and supporting documentation. It is designed to streamline and standardize processes in an electronic interactive map format, eliminating the need to update paper-based processes or procedure binders.

forms, and manuals that support consistent mission delivery. You can access the ProcessQuik site at the following link: <https://private.navyreserve.navy.mil/sites/ProcessQuik/Pages/default.aspx>.

### ProcessQuik Process Areas

Over 300 processes and supporting materials are available in the areas of:

- Assignments
- Medical/Dental
- Pay
- Training
- Mobilization
- Orders Generation
- Travel



The ProcessQuik site, located on the Navy Reserve CAC-enabled private website, is designed to provide Reserve Sailors with convenient access to your roles and responsibilities, and associated instructions,





## Navy Standard Integrated Personnel System (NSIPS)

NSIPS is the Navy's single, field-entry, electronic pay and personnel system for all Active and Reserve Component Sailors. This web-enabled, Enterprise Resource Planning (ERP) system offers you 24-hour access to your Electronic Service Record (ESR), training data, and career counseling records. NSIPS is available world-wide, both ashore and afloat.

To gain access to NSIPS or your Electronic Service Record, a hard-copy SAAR-N request is required in addition to an NSIPS specific online request available on the NSIPS web site.

For more information please contact 1- 877-589-5991, Comm: 504-697-5442, or email: [Nsipshelpdesk@navy.mil](mailto:Nsipshelpdesk@navy.mil).

## Electronic Service Record (ESR) and Civilian Employment Information (CEI)

The ESR provides individual Sailors, Personnel Support Detachments (PSDs), Personnel Offices that are service record holders, NOSCs and customer commands of PSDs with secure worldwide internet access to personnel, training and awards data. Self-service accounts can be created at: <https://nsipsprod.nmci.navy.mil>.

**Navy - Official Military Personnel File** Return to BOL

All record and document links are webRed.

WebView		CMRF Documents		Submissions Documents		
Multi View	Form Name	Form Number	Subject Title	Document ID	Field Code	Document Date
<input type="checkbox"/>	<input type="checkbox"/>	<input type="checkbox"/>	<input type="checkbox"/>	<input type="checkbox"/>	<input type="checkbox"/>	<input type="checkbox"/>
<input type="checkbox"/>	NAVPERS	1016/29	EVAL REP ANIC COUNSELING RECORD (EI-BD)	12020729	35	19971115
<input type="checkbox"/>	DD	1466	MIL PROC RCD	29602122	34	19640719
<input type="checkbox"/>	DD	4	EVAL REEVAL OCC	29602133	30	19640719
<input type="checkbox"/>	DD	93	EMERG DATA RCD	29602135	28	19641127
<input type="checkbox"/>	NAVPERS	1070/601	EMERGED REEVAL CONTR	29602143	30	19800913
<input type="checkbox"/>	NAVPERS	1070/601	EMERGED REEVAL CONTR	29602142	30	19800913
<input type="checkbox"/>	NAVPERS	1070/602	EMERG DATA RCD DEP APP	29602151	30	19800918
<input type="checkbox"/>	NAVPERS	1070/602	EMERG DATA RCD DEP APP	29602159	30	19800913
<input type="checkbox"/>	NAVPERS	1070/602	EMERG DATA RCD DEP APP	29602165	30	19801003
<input type="checkbox"/>	NAVPERS	1070/602	EMERG DATA RCD DEP APP	29602172	30	19800917
<input type="checkbox"/>	NAVPERS	1070/602	EMERG DATA RCD DEP APP	29602168	30	19801008
<input type="checkbox"/>	NAVPERS	1070/602	EMERG DATA RCD DEP APP	29602180	30	19841204
<input type="checkbox"/>	NAVPERS	1070/602	EMERG DATA RCD DEP APP	29602197	30	19830603
<input type="checkbox"/>	NAVPERS	1070/602	EMERG DATA RCD DEP APP	29602203	30	19830316
<input type="checkbox"/>	NAVPERS	1070/602	EMERG DATA RCD DEP APP	29602205	30	19800304
<input type="checkbox"/>	NAVPERS	1070/602	EMERG DATA RCD DEP APP	29602201	30	19840104

The dependency data information in your ESR must be reviewed/updated annually or when there is: **(1)** a change in dependent status; **(2)** a change in the



number of your dependents; **(3)** or you are on active duty, active duty for training or temporary active duty for more than 30 days. You are ultimately responsible for your ESR. Sailors requiring assistance with the accuracy of their ESR should contact their NOSC Manpower/Reserve Pay (RESPAY) Department.

Civilian Employment Information (CEI) is required to be collected in accordance with Title 10 United States Code (U.S.C.) 10204 and 10205. After initial submission of your employment information to your NOSC at NOSC indoctrination, you can then update it if your job or employer status changes or annually re-verify it in the ESR section of NSIPS.

## Family Care Plan (FCP)

The purpose of the Family Care Plan (FCP) is to assist you in ensuring that you are prepared for any military contingency, by identifying who is responsible for caring for your dependents while deployed. This policy is relevant for Reserve Sailors who are single sponsors or dual military couples who have custodial responsibility for family members or other dependents. You have the responsibility to ensure that your family members are cared for during deployments, mobilizations and temporary Reserve duty. The Family Care Plan requires that



you designate one or more caregivers for your dependent family members. The Family Care Plan Certificate (NAVPERS 1740/6) and Family Care Plan Arrangements (NAVPERS 1740/7) are used to identify caregivers. By their signature, caregivers acknowledge and accept responsibility for the care of your family members. Ensure that, as a change occurs in your dependent situation, you notify your administration office immediately. You are required to update your FCP annually. Refer to OPNAVINST 1740.4D for further information (<http://doni.daps.dla.mil/Directives/01000%20Military%20Personnel%20Support/01-700%20Morale,%20Community%20and%20Religious%20Services/1740.4D.pdf>).

## Page 2

NAVPERS 1070/602 Dependency Application/Record of Emergency Data is used for both officer and enlisted Sailors. It is referred to as a “Page 2” and serves as an application for dependency allowances as well as an up-to-date record of emergency data. Remember to update your “Page 2” annually and maintain a copy. Immediately notify your unit chain of command and the NOSC/NRA Admin Department whenever you have a change in phone number, home address, e-mail address or dependency status. The importance of this document cannot be overstated. The information included on this form will determine who will be notified in the event of a member’s serious injury or death, and lists beneficiaries for unpaid leave, allowances and pay.

## Servicemembers’ Group Life Insurance (SGLI)

### **SGLI for Selected Reservists**

Service members are automatically enrolled in SGLI at a cost of \$29.00 per month for \$400,000.00 coverage. Members may decline or lower the coverage by filling out and submitting a SGLI election form. By law, if this form is not submitted, the

coverage will automatically be applied and the cost deducted from your pay. SGLI must be requested on the Servicemen’s Group Life Insurance Election and Certificate (SGLV-8286). This form designates the principal and contingent beneficiaries of your SGLI. Whenever there is a change to your named



The screenshot shows the U.S. Department of Veterans Affairs website. The header includes the VA logo and the text "U.S. Department of Veterans Affairs". Below the header is a navigation menu with tabs for Health, Benefits, Burials & Memorials, About VA, Resources, News Room, Locations, and Contact Us. The main content area is titled "Life Insurance" and features a sidebar with a search box and a list of menu items: Pre-Discharge, Compensation, Education & Training, Vocational Rehabilitation & Employment, Home Loans, and Life Insurance. The main content area contains the heading "Servicemembers Group Life Insurance (SGLI)" and a brief description of the program. To the right, there is a section titled "I WANT TO..." with links for "Download SGLV 8286", "Apply for VGLI/Convert SGLI to VGLI", "Download Insurance Forms", and "Update My Beneficiary".

beneficiaries, you must submit a new SGLV-8286. A named beneficiary will not be changed automatically by divorce, annulment, death, etc. This is another document you must validate regularly to ensure it is correct! A Last Will and Testament or other legal document will not change any beneficiary listed.

### **Family Service Members’ Group Life Insurance (FSGLI)**

Family coverage is automatic for all family members who are listed as dependents on the Record of Emergency Data (NAVPERS 1070/602), also known as “Page 2.” FSGLI provides up to a maximum of

\$100,000 of insurance coverage for spouses, not to exceed the Service members' SGLI coverage amount, and \$10,000 for dependent children. Declining coverage for family members is an option and will be effected when the change is received by Defense Finance and Accounting Services (DFAS).

### Eligibility

Members of the Ready Reserve/Guard of a uniformed service who are assigned to a unit or position in which they may be required to perform Active Duty or Active Duty for Training and each year will be scheduled to perform at least 12 periods of inactive duty training that is creditable for retirement purposes under U.S. Code Title 10, are eligible for SGLI. While a member of the Navy Reserve, SGLI coverage is in effect 365 days of the year and you are automatically covered for \$400,000, the maximum amount of coverage. You are also covered for 120 days following separation or release from Active Duty. To lower the amount of coverage, form SGLV-8286 can be obtained from your administrative department to initiate this change.

### Traumatic Injury Protection

Traumatic Injury Protection is provided to all Service members carrying any amount of SGLI at a cost of \$1 per month. This is not life insurance. It is disability compensation for serious injury and loss of limbs. Compensation amounts are up to \$100,000.

Specific information regarding SGLI coverage can be found on the VA website (<http://www.benefits.va.gov/insurance/sgli.asp>).

## Navy Family Accountability And Assessment System (NFAAS)

The Navy Family Accountability and Assessment System (NFAAS) is a web-based method for the Navy to account, assess, manage, and monitor the recovery process for personnel and their families affected and/or scattered by a wide-spread catastrophic event (i.e. hurricanes, fires, floods, etc.). NFAAS provides valuable information to all levels of the Navy chain of command, allowing commanders the ability to track and support Sailors in need.

### NFAAS allows you to do the following:

- Report their accounting status after a catastrophic event.
- Update contact/location information.
- Complete a needs assessment.
- View reference information.

A CAC card or your SSN is required to access this site. See your NOSC NFAAS coordinator to gain access and verify your personal and family information, which is required semi-annually. You can access the NFAAS website at: <https://navyfamily.navy.mil>.

## MyPay

MyPay is the Department of Defense's online payroll and accounting system that allows you to view your pay account, view travel vouchers, make changes to withholding and allotments, and change Thrift Savings Plan (TSP)—similar to a private sector 401(k) plan—contributions. MyPay is accessible with or without a CAC.

The screenshot shows the MyPay website interface. At the top, there's a blue header with the 'myPay' logo and a navigation bar. Below the header, the page is organized into three main sections: 'Log In', 'Important Information', and 'Quick Links'. The 'Log In' section includes fields for 'Login ID:' and 'Password:', along with a 'Go' button and a link for 'Forgot or Need a Password?'. The 'Important Information' section contains several news items: 'SmartDocs Spoof' warning about fake emails, 'Combined Federal Campaign (CFC) AVAILABLE' for the 2015 season, 'Stopping TSP Contributions' for active duty members, and 'AFFORDABLE CARE ACT' information. The 'Quick Links' section lists various resources such as 'DFAS Resources', 'External Resources', and 'SmartVoucher'.

**The system, created and maintained by DFAS, allows you the capability of viewing and printing the following:**

- Leave and Earnings Statements (LES)
- End-of-year W-2 Wage and Tax Statement Forms

**In addition to viewing and printing documents, users can also:**

- Start and change Direct Deposit
- Change their tax withholding deductions
- Enroll in the Thrift Saving Plan (TSP)

**How to create a MyPay account (prior to receiving a CAC):**

1. If you have not done so already, access the MyPay Web site by going to: <https://mypay.dfas.mil>.
2. Locate the “Account Access” section on the left-hand side of the homepage.
3. Within this section, locate the light blue-colored box containing the words “If you are a new customer OR haven’t established a Login ID, enter your SSN below”.
4. Enter your Social Security Number in the field provided and click the “Go” button.

5. A new window will open containing the MyPay virtual keyboard. Using your mouse on the virtual keyboard (or a combination of the tab key and space bar on your actual computer keyboard), select the numeric characters of the 8-digit temporary password that you previously received from MyPay. The characters of your selection will automatically appear masked in the edit field. If you make a mistake, click the blue “Backspace” button to erase the previous character entered or the blue “Clear” button to erase all of the characters entered. Once you have entered your password, click the “Accept/Submit” button.
6. Read the system message explaining the MyPay conditions of use and User Agreement, then click the check box to agree to the terms and conditions and click the “OK” button.
7. A new window will open containing two steps: “Step One: Create Login ID” and “Step Two: Create Password.”
8. Locate “Step 1: Create Login ID.” Read the criteria for creating a new Login ID. Using your actual computer keyboard, enter your new Login ID in the edit field beside the words “Establish Your Login ID.”
9. Scroll down and locate “Step 2: Create Password.” Read the criteria for creating a new password. Using the MyPay virtual keyboard, select the alpha, numeric, and special characters of your new password. The characters of your selection will automatically appear masked in the edit field beside the words “Your New Password.”
10. Click the button to the left of the words “Re-enter Your Password” and, using the MyPay Virtual Keyboard, again select the alpha, numeric, and special characters of your new Password. The characters of your selection will automatically appear masked in the appropriate edit field. Click the “Accept/Submit” button.
11. You will see a message confirming that your new Login ID and Password have been established. Click the “To continue, click here” button. NOTE: If you receive a message telling you that your Login ID and Password customization failed, it may be because the Login ID that you selected is already being used by another member. No two members can have the same Login ID. Try again using a different Login ID.
12. If MyPay has your e-mail address on file, the next screen will ask you to validate your e-mail address (continue to Step 13). If MyPay does not have your e-mail address on file, you will be asked to provide one. Enter your e-mail address in both edit fields and click the “Accept/Submit” button. You will be asked to confirm that the e-mail address you

provided is correct. If it is correct, click the “Yes” button. If not, click the “No” button and enter your e-mail address again.

13. You will be asked to certify the e-mail address on file. If the information is correct, click the “Accept/Submit” button. Next, you will be asked to confirm that the e-mail address you provided is correct. If correct, click the “Yes” button. If not, click the “No” button and correct the information accordingly.
14. After you have confirmed your e-mail address, you will see a screen acknowledging that your certification has been successfully completed. Click the “To continue, click here” button and you will be presented with the MyPay main menu of options.

If you require further assistance after referring to these instructions, contact the DFAS Customer Care Center by calling toll free 1-888-332-7411 or DSN 580-5096 and selecting Option #5 for MyPay.



## Drilling Status/Requirements and Types Of Training/ Enhanced Drill Management (EDM)

**Enhanced Drill Management is housed on the NSIPS webpage.**

In July 2014, the Navy launched Enhancement for Drill Management (EDM) giving the Navy Reserve automated 24/7 self-service drill management capability for rescheduling normal monthly Inactive Duty Training (IDT) periods and the requesting/scheduling of additional Inactive Duty Training (IDT) periods.

A link to the Enhanced Drill Management system is available on the Navy Reserve Homeport N11 tab at the following link [https://private.navyreserve.navy.mil/cnrfc/N-Codes/N1/CNRFc\\_N11/SitePages/Home.aspx](https://private.navyreserve.navy.mil/cnrfc/N-Codes/N1/CNRFc_N11/SitePages/Home.aspx) Please visit this website, scroll down and select “What’s new for you EDM” to access the helpful PDF guide.

This guide contains a link to the NSIPS site where EDM is housed. There is an interactive “how to” video located on <https://nsipsprod.nmci.navy.mil/nsipsclo/jsp/index.jsp> which takes the user through every mouse-click of EDM and instructs the user on how to use this system.

### **Inactive Duty Training (IDT)**

IDT, often referred to as a “drill” period, is authorized training performed by Selected Reserve Sailors and consists of regularly scheduled unit training periods and additional IDT periods. The primary purpose of IDT is to provide individual and/or unit readiness training. Reference the Reserve Personnel Manual (RESPERSMAN) 1570-010 for more information.

### **Inactive Duty Training with Travel (IDTT)**

Similar to IDT, but with funded travel. IDTT must be started and completed at the member’s residence and is not to be performed within a 100-mile radius from the supporting NRA. IDT requiring travel greater than





100 miles from the member's NRA requires issuing IDTT orders. IDT, greater than 50 miles and less than 100 miles, may be authorized travel reimbursement in certain situations. Contact your NRA to inquire about what IDT may be authorized travel. Orders and a muster form are also required to perform IDTT.

### **Annual Training (AT)**

A DCO must use their first AT to complete DCOIC in accordance with OPNAVINST 1120.3B before executing any other AT orders. Selected

Reserve personnel must perform a minimum of 12 to 14 days AT each Fiscal Year as scheduled by the Unit Commanding Officer (CO) and per COMNAVRESFORCOMNOTE 1001 (Fiscal Year (FY) Force Execution Guidance). Failure to perform AT or obtain a waiver will result in unsatisfactory participation for the FY. AT that overlaps two FYs may be considered as satisfying the requirement for either FY; however, retirement point credit will be applied only to the anniversary year (see page 22 for details on anniversary year) in which it was earned.

### **Active Duty Training (ADT)**

ADT is an additional period of Active Duty, which may be authorized for training, schools, or gaining command support. Travel may or may not be authorized for ADT; however, orders are required. ADT can fulfill AT requirements.

### **Active Duty for Special Work (ADSW)**

ADSW is an additional period of Active Duty sponsored by a gaining command for periods up to 365 days. Travel may or may not be authorized for ADSW; however, orders are required.

### **Presidential Selected Reserve Call-Up (PSRC)**

Often called Presidential Recall, this is a recall to active duty for up to 270 days, by order of the President of the United States. Orders are required.

### **TYPES OF DRILLS:**

#### **Regular Scheduled Drill**

All IDT periods, regardless of type, must be scheduled in advance.

#### **Flex Drill (FLEX)**

The FLEX IDT Drill option offers added flexibility for members to best meet the requirements of their supported command. FLEX Drills can be performed consecutively using regular IDT or additional IDT.

You will need to sign a Flex IDT Drill Option (NAVPERS 1070/613) in order to participate in this program. A Unit's Flex drill option is determined by the Commanding Officer.

### **Incremental Drill**

Incremental IDT (regular and additional IDT) periods provide an opportunity for unit personnel to receive Reserve IDT pay, training credit and/or retirements points. See RESPERSMAN 1570-020 for additional information.

### **Additional Training Periods (ATP)**

Additional paid drill periods authorized for specific units/personnel to complete additional required training.

### **Additional Flight Training Period (AFTP)**

Additional paid drills are used for Aircrew training to attain and maintain flying proficiency. A maximum of 48 AFTPs may be authorized each FY.

### **Readiness Management Periods (RMP)**

Additional paid drills used to support day-to-day unit operation and accomplish unit administration, training preparation, support activities, and maintenance functions.

## IDT Duration

Paid IDT periods will be at least four hours in length. Non-paid IDT periods will be at least three hours in length. If two IDT periods are performed in a single day they each must be at least four hours in length. No more than two IDTs may be performed in a 24-hour period.

## Drill Requirements

Members must satisfactorily complete a minimum of 40 drills in an anniversary year to attain a qualifying year for retirement.

A “satisfactory year” is not the same as a “qualifying year.” You can technically get a qualifying year without getting a satisfactory year. “Satisfactory” refers to drill and AT participation whereas “qualifying” pertains to earning 50 retirement points per anniversary year. See RESPERSMAN 1001-010 for more information.

Individuals who miss drill without prior approval or authorized absence (“AA”) may receive an unexcused absence (“U”) for those drill periods missed. Exceeding nine “U” drills over any rolling 12-month period will be considered a failure to maintain satisfactory participation and may result in administrative separation and recoupment of bonus if applicable.

## Satisfactory participation is defined in RESPERSMAN 1001-010:

- Must attend 40 of 48 regular IDT periods
- Perform a minimum of 12 days AT each FY, unless waived by the NOSC CO
- Report for physical exams and provide medical information as required
- Provide current address, as well as home and work phone numbers
- Notify command of changes in physical, dependency, and employment status
- Acknowledge receipt of and respond to all official correspondence
- Comply with involuntary recall to active duty as required

## Navy Reserve Order Writing System (NROWS)/Defense Travel System (DTS)

**NROWS** is the single, enterprise-wide web-based application for putting a Reserve Sailor on AT, ADT and IDTT orders. It incorporates the orders application process with an automated approval

workflow and the delivery of official orders. Contact your NOSC/NRA to establish an NROWS account. The NROWS website can be accessed through the NRH website.

**DTS** is a fully integrated, automated, end-to-end travel management system that enables DoD travelers to create authorizations, prepare reservations, receive approvals, generate travel vouchers, and receive a split reimbursement between their bank account and the Government Travel Charge Card (GTCC). Contact your NOSC to establish a DTS account.

## 1. Create an application in NROWS

- Requirement owner assigns Sailor to requirement and resource owner approves assignment
- Traveler completes order application in NROWS
- The traveler saves and routes the application for approval
- NROWS automatically emails the traveler when their application is approved or disapproved
- Once approved, the document serves as the traveler's approved orders

## 2. Approved Transportation Authorization

- DTS automatically notifies the traveler via email, to complete their transportation authorization request in DTS
- The traveler signs the travel authorization, which is then automatically routed for approval
- Once approved, the Commercial Travel Office will purchase airline tickets and reserve a rental car 72 hours prior to travel, if applicable. Approval serves as authorization for the traveler to incur the pre-approved expenses

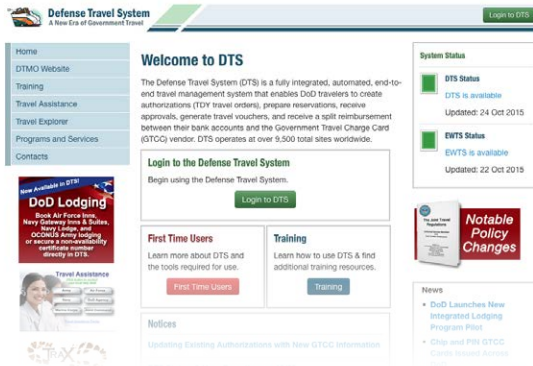

**Don't be intimidated by this process as your NOSC Training Officer will be available to assist you with NROWS and DTS! All travel is comprised of two distinct actions, both of which must be completed for travel to occur:**

Once the mission has been completed, the traveler is required to submit a travel voucher within five working days.

*Note: DTS does not support transportation for Permanent Change of Station (PCS) and Back-to-Back (B2B) orders.*

### **What is the role of the NOSC/NRA in the travel process?**

Your Reserve Unit is the first source of information, guidance, and support regarding military travel. Your NOSC/NRA supports your Reserve Unit, and will directly support a member if challenges occur during military travel. If your Reserve Unit cannot answer one of your questions, your NOSC/NRA staff can assist you with NROWS and DTS issues.

### **Common misconceptions and mistakes:**

#### **NROWS mistakes:**

- Forgetting to save and submit the NROWS application
- Travel dates do not correspond with the order dates
- Manually entering an airport instead of selecting available airport from drop down menu

- Incorrectly selecting “POV not advantageous to government/POV advantageous to government” when choosing POV as the travel mode

### **DTS Authorization mistakes:**

- Forgetting to “sign” the authorization
- Forgetting to select a mode of travel, or selecting the wrong mode of travel
- Forgetting to enter all estimated anticipated expenses
- Forgetting to adjust lodging and per diem daily rate to account for government lodging, provided meals, and flat rate per diem
- Calling airlines and rental car agencies directly to make reservations. All air and rental car transportation must be procured by the CTO
- Missing detailed justification for flagged items

### **DTS Voucher mistakes:**

- Forgetting to “sign” the voucher
- Not selecting the correct split disbursement amount to cover all GTCC charges
- Forgetting to adjust estimated expenses to actual expenses

- Forgetting to upload substantiating documents (endorsed NROWS Orders; E-invoice; rental car and hotel receipts for expenses over \$75.00; currency conversion table, if applicable)
- Missing detailed justification for flagged items

## Government Travel Charge Card (GTCC)

Every military member is required to have a GTCC. Currently these cards are issued through Citibank. The GTCC is a credit card to be used only for the purposes



of government travel while on official orders; it is not for any private or personal use. You will want to apply for a GTCC when you first affiliate with the Navy Reserve. Do not wait until you have official travel orders to apply. The card is only active, or “turned on”,

while you are on official orders. This is managed by your NRA staff. Once you return from orders, the card will be turned off. The GTCC is to be used for expenses such as lodging, rental car, and gas for the rental car.

Upon applying for a GTCC, you as the member have the option to decide whether you would like your credit checked or not. If you choose to have your credit checked by Citibank, they will issue a credit line based on your credit history.

You are responsible for paying your GTCC bill and required to have split disbursement selected in DTS when submitting your travel claim. This feature pays your GTCC bill directly for GTCC expenses incurred during official government travel. The account is considered delinquent immediately after the cycle due date. If payment is not made, the card is suspended upon reaching 61 days delinquent and canceled after 121 days delinquent.

## Security Clearance

Maintaining security clearance eligibility is critical to serving in the Navy Reserve. It is the responsibility of every Sailor to ensure their clearance remains active, and to take steps to ensure that events in their professional and personal lives do not negatively

impact their ability to maintain a security clearance. Negative issues such as poor performance, Uniform Code of Military Justice (UCMJ) violations, financial trouble, and violations of federal, state and local laws could result in you losing your security clearance. Loss of one's clearance could result in administrative separation from the Navy.

Personnel needing to initiate or update a security clearance must provide the NOSC Security Officer a valid email address and contact information to initiate the process. Members will then log-in to the Electronic Questionnaires for Investigations Processing (e-QIP) website to complete their Personnel Security Questionnaire (PSQ). If the PSQ is not completed within 30 days of initiation, the system automatically terminates the investigation.

The NOSC/NRA Security Manager is required by instruction to ensure all assigned personnel comply with eligibility and clearance requirements, and report or initiate administrative procedures for those Service members who fail to comply with all requirements.

## Berthing

Your NOSC will provide berthing for Navy Reserve personnel traveling more than 50 miles to their permanent or administrative drill site. The member

must be in an IDT drill status and reside 50 miles or more driving distance from their NOSC, perform 8 hours of scheduled drills on the day before or day following the use of commercial berthing, or four 4-hour drills within a 48 hour period. Contract berthing privileges do not apply to IDTT, AT, ADT, or ADSW orders. Lodging while on active duty orders is provided through a separate process.

Each Sailor must fill out a "Statement of Eligibility for Contract Berthing" at their home NOSC prior to using contract berthing. Each member must re-certify their "Statement of Eligibility for Contract Berthing" annually.

Berthing must be requested 14 days prior to DWE each month. Rooms will be double occupancy of same gender with officers separated from enlisted E1-E6, E7, and O1-O4. Senior officers (O5-O6) and senior enlisted (E8-E9) will have single occupancy rooms. Unit CO's will not be roomed with a member of their unit. Reserve personnel are not authorized to use government-funded commercial berthing with their spouse/guest. Failure to provide cancellation notification and/ or non-conformance to berthing policy may result in revocation of government berthing privileges and/or probation or both. Members who do not satisfactorily perform required drills will reimburse the government for any and all expenses.

Any member requesting additional nights other than their scheduled drill weekend must contact their berthing coordinator at their NOSC to make scheduling arrangements with properly approved paperwork from the NOSC Manpower Department.

## Urinalysis Program

The Navy has a zero tolerance policy regarding drug abuse. The Navy's urinalysis program is designed to provide comprehensive drug abuse prevention and control policy and procedures for all Navy military personnel, while establishing regulations to enforce that policy.

Urinalysis testing is mandatory. Each NOSC samples 30%-40% of all Reserve personnel on a monthly basis via a computer-generated random selection. If a Sailor's name is on the participant list, they must report to the urinalysis testing location when directed. Failure to report for a urinalysis test is treated like a failed test, and could result in administrative action or separation if not resolved.

## Physical Fitness Assessment (PFA)

The PFA is comprised of three parts: medical screening, Body Composition Analysis (BCA) and a Physical Readiness Test (PRT). BCA requirements were changed in August 2015 and can be found by referencing NAVADMIN 178/15 on the NPC website. The PRT has three sub-parts: curls-ups, push-ups, and a cardio-respiratory event. All SELRES will



participate in a semi-annual PFA, and if required, the Fitness Enhancement Program (FEP) as scheduled by their NOSC. All commands will report results of two PFAs per person per FY via the Physical Readiness Information Management System (PRIMS) website



<https://prims.bol.navy.mil>. See the PFA instruction, OPNAVINST 6110.1J, for more information and details regarding the execution of the PFA. Unit CO's shall ensure that command data for PFAs is entered into PRIMs within 30 days and the FEP is managed appropriately.

**Medical Screening.** Once the command has given the 10 week PFA notification, all personnel shall complete a medical screening using the Physical Activity Risk Factor Questionnaire (PARFQ) as soon as possible and present it to their Command Fitness Leader (CFL) for review. "Yes" responses to risk factor questions require a Navy Medical clearance for participation in PRT, FEP and/or physical conditioning. Medical waivers can be recommended for any aspect of the Physical Readiness Program. Waivers may only be signed by a Navy physician on a NAVMED 6110/4 (01/2011). Medical waivers are subject to the CO's final approval. Waivers shall not exceed 6 months in duration. Members requiring a waiver exceeding 6 months shall be referred to their NOSC medical department for further evaluation, including consideration for medical board processing. BCA waivers must be obtained prior to the official weigh-in date, and must be signed off by two medical personnel, one being a Command Authorized Medical Department Representative (AMDR).

**Pregnancy.** After confirmation of pregnancy by a health care provider, pregnant servicewomen shall not be required to meet PRT and BCA standards from the time the pregnancy is confirmed until and up to six months following delivery.

All medical and pregnancy waivers must be submitted to the NOSC CFL prior to the end of the PRT cycle. Further clarification and guidance can be found in OPNAVINST 6110.1J ([http://www.public.navy.mil/bupers-npc/support/21st\\_Century\\_Sailor/physical/Pages/default2.aspx](http://www.public.navy.mil/bupers-npc/support/21st_Century_Sailor/physical/Pages/default2.aspx)).

## Medical and Dental, Policies and Procedures

Maintaining mobilization readiness is the top priority of every Navy Reserve Sailor. As mobilization readiness is dependent upon medical and dental readiness, it is incumbent upon Reserve Unit COs and individual Sailors to track medical/dental readiness and ensure full deployment capability at all times.

In an attempt to better serve the Reserve community, NROWS and the Medical Readiness Reporting System (MRRS) communicate with each other to streamline the approval process of active duty order requests. If you have an outstanding medical issue that has

been identified by MRRS, your orders will be flagged and placed on hold until the deficiency is corrected by you and annotated in MRRS. NOSC Medical Departments remain proactive in ensuring Sailors are identified 60 days in advance of any upcoming deficiencies. Sailors with current or upcoming medical requirements are identified on their unit medical tracker each DWE. This action requires the member to contact the Medical Department during the DWE to complete his/her medical requirements. Failure to comply with this requirement could result in administrative actions if not corrected.

### **Service Treatment Records (Medical Records)**

Service Treatment Records are commonly known as medical records. These records are property of the U.S. Government and shall be maintained on file at your NOSC. Original medical and dental records, both military and civilian, shall be maintained in each Reserve Sailor's military medical records. It is imperative that all medical issues are correctly recorded to ensure proper care of each Sailor.

### **Medical Requirements**

Readiness requirements: Periodic Health Assessments (PHAs) and dental exams are due annually. Immunizations, including flu shots, are mandatory and must be completed per prescribed periodicity.

Individual Medical Readiness (IMR) reports are used to identify upcoming or expired requirements. If you are under the care of a physician, you are responsible for providing documentation concerning treatments and medications to your NOSC medical department. Some conditions may require you to be placed in a "Medical Hold" status. Some examples include: Temporarily Not Physically Qualified (TNPQ), Temporarily Not Dentally Qualified (TNDQ), Medical Retention Review (MRR) or Line of Duty (LOD) determination if injured while performing military duties.

Any injury incurred during a drill weekend must be reported to NOSC medical staff prior to the conclusion of the drill weekend. A written monthly update is required from the member prior to the last day of each month when assigned to a Medical Hold status. Based on the nature of your injury or condition, you may remain in a drilling status or be placed in a non-drilling status. Members are not authorized to perform active duty orders (AT, ADT, or IDTT) while in a Medical Hold status, as the medical issue may also affect mobilization readiness. A determination of whether a member can continue drilling or not while on Medical Hold will be determined on a case by case basis. Recommendations are based on medical documentation and a military physician's referral. Final approval is at the discretion of the NOSC.

## **Line of Duty (LOD) Determination**

While on Active Duty or IDT, Reserve members are covered for injury, illness or disease incurred or aggravated in the line of duty. This includes injuries sustained when traveling directly to or from the place of duty.

To receive health care for these injuries or illness after your Active Duty period is complete; the Navy must issue a LOD determination. This LOD documentation is used to establish, manage, and authorize health care for the specific injury, illness or disease. LOD coverage is separate from any other TRICARE coverage received including transitional health benefits provided under the Transitional Assistance Management Program and coverage provided under TRICARE Reserve Select.

## **Documenting Eligibility and Obtaining Line of Duty Care**

Once the Navy has issued your LOD determination, it is your responsibility to ensure all LOD documentation is on file at either a Military Treatment Facility (MTF) or the Military Medical Support Office (MMSO) at your NOSC.

If you reside within the MTF enrollment area, that MTF will manage your LOD care. Ensure your service-issued LOD determination is on file at that MTF.

If your residence is NOT within the MTF enrollment area, the MMSO will coordinate your care via your unit medical representative.

## **Dental Requirements**

To execute Active Duty orders (AT/ADT/ADSW), a member must be Dental Class I or II. Dental exams for SELRES are required every year.

All dental deficiencies must be completed within six months, unless an extension is granted by the NOSC Commanding Officer.

## **Dental Classes:**

Class I – Patients not requiring dental treatment or re-evaluation for 12 months.

Class II – Patients who have oral conditions that, if not treated or followed up, have the potential but are not expected to result in dental emergencies within 12 months.

Class III - Patients who have oral conditions that if not treated are expected to result in dental emergencies within 12 months. Patients should be placed in class III when there are questions in determining classification between class II and class III.

Class IV - Patients who require dental examinations. This includes patients who require annual or other required dental examinations and patients whose dental classifications are unknown.

### Tricare Reserve Select (TRS)

TRS health insurance may be available to you as a SELRES. Please visit: <http://www.tricare.mil/trs> for more information.

## Ready Reserve Screening Questionnaire (RRSQ)

All members of the Ready Reserve who are not on active duty will be screened at least annually. The purpose of the screening is to ensure that Ready Reserve Sailors:

- Meet Navy wartime standards of mental, moral, professional, and physical fitness
- Possess military qualifications required of their various ranks, rating, and specialties
- Are immediately available for recall or mobilization

### Ready Reserve Screening Questionnaires (NAVPERS 1001/3)

All Reserve Sailors and members of the VTU will complete NAVPERS 1001/3 upon initial affiliation and each FY.

Unit COs are responsible for ensuring NAVPERS 1001/3 is reviewed and members are interviewed

after they complete the questionnaire. The supporting NOSC CO is responsible for reviewing and signing the unit CO's section of the NAVPERS 1001/3. If a unit CO determines that a member has a situation which cannot be resolved locally and would preclude the member from being immediately available for mobilization, that unit CO will submit a letter to the supporting NOSC CO for review. If the NOSC CO determines that the situation cannot be resolved utilizing the references listed on NAVPERS 1001/3, the NOSC will forward a letter to NAVPERSCOM (PERS-91) via the Echelon IV command requesting appropriate action and will make an annotation on the retained questionnaire.

Unit COs will submit completed NAVPERS 1001/3 to the supporting NOSC CO for review. NOSC COs will ensure the completed NAVPERS 1001/3 is retained in a manner accessible during mobilization.

## Manpower Availability Status (MAS) Codes

MAS codes help the Navy Reserve track who is available for mobilization. NSIPS is the Navy's single, field-entry, electronic pay and personnel system for all Sailors. It allows the tracking of three

categories of MAS codes: Medical, Administrative, and Training. When assigning MAS codes, Echelon IV and V commands, typically your assigned NOSC or NRA, are directed to follow the order of precedence provided below.

1. Medical/Dental MAS Codes: Medical/Dental MAS codes are used to report and track potential medical/dental issues that may preclude a Sailor from mobilizing or executing active duty orders.

*Note: RC Sailors assigned medical/dental MAS codes are expected to aggressively correct the issue resulting in assignment of the MAS code. If unable to correct the issue, NRAs are to submit required Medical Retention Review (MRR) packages in accordance with current guidance.*

2. Administrative MAS Codes: Administrative MAS codes are used to report and track administrative issues that may preclude a Reserve Sailor from mobilizing or executing active duty orders.
3. Training MAS Codes: Training MAS codes are used to report and track RC Sailors who are in special training programs or who have not completed all training required by law, DOD directive or other directives/instructions. Some examples are provided as several of these may apply to a DCO.

## TRAINING MAS CODE DEFINITIONS:

<b>MAS Code</b>	<b>Meaning</b>
<b>TBH</b> .....	Member has not completed prescribed basic training (e.g., DCOIC, BQC-NR, A and C schools). (1825 days)
<b>TRL</b> .....	Attending validated religious leader training. (730 days)
<b>TMS</b> .....	Attending authorized medical/dental/nursing school. Requires letter designating member has been accepted into the program and U.S. Navy Bureau of Medicine and Surgery (BUMED) Reserve Affairs Officer (RAO) approval. (1460 days)
<b>TRP</b> .....	Prior Service Reenlistment Eligibility - Reserve (PRISE-R)/designator or rate conversion training. (545 days)
<b>OWS</b> .....	Member is on ADSW. NRA will assign code upon member departing on orders and will remove the code when member returns to the NRA.
<b>THS</b> .....	Mobilization Capacity Hold (Commander, Navy Reserve Force (CNRF) use only).
<b>VOL</b> .....	Member is a volunteer and fully available/ready for mobilization. (Should be verified annually)

# Mobilization

The Reserve Force is the principal source of trained units and personnel to augment the active forces in time of war or national emergency. It is comprised of personnel recalled to active duty in structured units or in specific mobilization billets. CNRFC, at the direction of the CNO, is responsible for directing and overseeing activation processing at NOSCs and identifying qualified SELRES personnel to fill mobilization requirements.



Direct Commission Officers are not normally mobilization eligible for OCONUS mobilization until completion of the Direct Commission Officer Indoctrination Course (DCOIC) plus a sufficient number of calendar days of training to total a minimum of 84 days (BUPERSINST 1001.39F).

Community specific training requirements must also be met prior to mobilization and this may take as long as 3-5 years to complete depending upon community specific requirements. Once these requirements have been completed your MAS code will be changed to show that you are now available to be mobilized.

Navy Reserve Sailors have mobilized to fill a wide range of missions to include, detainee operations, provincial reconstruction teams, embedded training teams, cargo handling, maritime security, engineering, field medical hospitals, and Marine Corps support. Information regarding mobilization guidance and procedures, as well as how to volunteer for a mobilization and frequently asked questions, can be found on the NRH at the link: <https://private.navyreserve.navy.mil/cnrfc/N-Codes/N3/Shared%20Documents/N35.aspx>. Please also reference BUPERSINST 1001.39F Administrative Procedures for Navy Reservists (Chapter 22) for mobilization policy and procedure: <http://www.public.navy.mil/bupers-npc/reference/instructions/BUPERSInstructions/Pages/default.aspx>

## Pre-Mobilization Process

A NOSC/NRA receives notification of a Service member's mobilization from CNRFC via a daily notification report. The NOSC/NRA is then required to notify the member within two business days and

update the member's Mobilization and Availability Status (MAS) code from R## (member identified for mobilization) to RC1 (member notified of pending mobilization).

After notification, the NOSC mobilization officer will immediately complete an administrative and medical record review of the member to identify any mobilization issues. They will also provide and explain

pre-mobilization requirements, to include screening checklists and guidance to the member.

It can take up to 30 days for a member to receive orders after being notified of their mobilization. Once mobilization orders are received, you will have 30 days to complete all screening requirements. The NOSC CO is required to verify completeness within 30 days of the date time group (DTG) on the member's



mobilization orders. It is recommended that service members start their medical screening early. Medical disqualification is the leading reason mobilization orders are cancelled.

All mobilizing service members will report to their NOSC on their ready load date (RLD), usually a Friday. Members shall report with all parts of the pre-mobilization checklist completed, to include copies of their completed NKO course certificates done within the last 60 days.

The NOSC will establish travel arrangements for all members directed to report to a Navy Mobilization Processing Site (NMPS). NMPS in-processing starts on Monday, therefore the member will travel over the weekend to NMPS. If a member needs to travel earlier due to traveling by privately owned vehicle (POV), then arrangements need to be made with the NOSC and Navy Personnel Command (PERS) if an orders modification is required.

### **Command Individual Augmentee Coordinator (CIAC)**

Individual Sailors mobilized in support of Navy and other service requirements are referred to as Individual Augmentee (IA) Sailors. During and after an IA assignment, the CIAC is a key component of IA Sailor support and acts as a mentor, advocate, and a source of help and information for the IA Sailor and their family.

CIACs contact IA Sailors monthly during the pre-mobilization process, while mobilized, and for 9 months after being demobilized.

### **Demobilization Process**

The demobilization process at NMPS can take between 3 and 14 days depending on if Transition Goals, Plans, Success (GPS) is required. The Veterans Opportunity to Work Act of 2011 mandates Transition GPS attendance for all personnel released from Title 10 Active-Duty periods of 180 days or more. It is intended to help you during your transition back to civilian life by offering job-search assistance, career planning, retirement planning, higher education information, and related services. After completing all NMPS requirements members are then ordered back to their NOSC where the final stages of the demobilization process are completed.

### **Returning Warrior Workshop (RWW)**

These 2 day workshops are held at various geographical locations to assist demobilizing service members and families in their transition from Active Duty service while on mobilization back to inactive Reserve Component service. These weekend workshops are booked at premier locations, and are dedicated to recognizing Sailors and families and improving the mobilization and demobilization process. The orders are fully funded for



the Reserve member and their guest. Information about the RWW program to include workshop schedules and POC's for the respective Reserve Component Commands (RCCs) can be found at: [http://www.public.navy.mil/ia/Pages/R3\\_FM\\_RWW.aspx](http://www.public.navy.mil/ia/Pages/R3_FM_RWW.aspx). The following link can be used to directly register for a Returning Warrior Workshop: <https://www.yellowribbonevents.org/Default.aspx>.



## Calculating Retirement-Anniversary v. Fiscal Year

### Anniversary Year

The Anniversary year serves one ultimate purpose—retirement! The non-regular (Reserve) retirement calculation uses the anniversary year to determine

one qualifying year of Reserve service towards a non-regular retirement. Eligibility for retirement is contingent upon reaching 20 qualifying years. A qualifying year is a year where a minimum of 50 points are accrued. For more information about retirement go to: <http://www.public.navy.mil/bupers-npc/career/reservepersonnelmgmt/Pages/default.aspx>.

### During a qualifying year, each Sailor should complete the following to earn 50 points:

- Complete AT for a period of 12 to 14 days (plus a travel day). For each day of Active Duty a point is received, AT should yield 12 to 14 points
- Participate in at least 40 of 48 scheduled IDT periods. Each IDT period (4 periods per drill weekend) a point is received, IDT periods should yield 40 to 48 points per year
- Receive 15 gratuitous points (these points are automatically awarded)
- Pursue additional points via non-resident courses, online courses, funeral details and classroom educational venues

A member's anniversary year starts on the date of their oath of office, and that date stays the same for as long as the member remains in the Navy, whether in an Active or Reserve status.

## Fiscal Year

The federal government fiscal year is designed for the purpose of controlling and distributing funds, and reporting budgets. The FY starts October 1st and ends September 30th the following calendar year.

The individual member is responsible for keeping track of their date of enlistment or oath of office and accruing points in order to successfully complete a qualifying year. Points do not cross over from one year to the next. For example, a member could achieve the required points during a FY for a satisfactory year, but fall short for their anniversary year. It is imperative for each individual Reserve Sailor to track their points within the context of both anniversary and fiscal years.

A member's retirement point total can be verified by going to BUPERS Online at: <https://www.bol.navy.mil> and clicking the "ARPR/ASOSH Online" access application link one logged in.

## Interactive Customer Evaluation (ICE) Survey

The Interactive Customer Evaluation (ICE) system is a web-based tool that collects voluntary feedback on services provided by various organizations

throughout the DoD. The ICE system allows Sailors to submit online comment cards to provide feedback to service providers they have encountered at military installations and related facilities around the world. ICE smartphone scan codes can be seen all around your NOSC/NRA, ICE stand-alone computers in Navy medical and dental facilities Force wide, and ICE can be accessed by visiting: <https://ice.disa.mil/>. It is designed to improve customer service by allowing leaders to monitor the satisfaction levels of services provided through reports and customer comments and gives feedback directly to the organization. ICE provides the following benefits:

- Allows Sailors to quickly and easily provide feedback to service providers
- Gives leadership timely data on service quality
- Allows managers to benchmark the performance of their service providers against other DoD organizations
- Encourages communication across organizations by comparing best practices to increase performance results
- Saves money by providing leaders a free tool to collect and organization feedback data used for process improvement

Serial No.	Form Name	Form Number	Form Title	Form No.	Form No.	Form No.
01	NAVPERS	1500/00	EMERGENCY DATA RCD	1500000	1500000	1500000
02	DO	1300	EMERGENCY DATA RCD	1300000	1300000	1300000
03	DO	4	EMERGENCY DATA RCD	0400000	0400000	0400000
04	DO	81	EMERGENCY DATA RCD	0810000	0810000	0810000
05	NAVPERS	1070/001	EMERGENCY DATA RCD	1070001	1070001	1070001
06	NAVPERS	1070/001	EMERGENCY DATA RCD	1070001	1070001	1070001
07	NAVPERS	1070/002	EMERGENCY DATA RCD	1070002	1070002	1070002
08	NAVPERS	1070/002	EMERGENCY DATA RCD	1070002	1070002	1070002
09	NAVPERS	1070/002	EMERGENCY DATA RCD	1070002	1070002	1070002
10	NAVPERS	1070/002	EMERGENCY DATA RCD	1070002	1070002	1070002
11	NAVPERS	1070/002	EMERGENCY DATA RCD	1070002	1070002	1070002
12	NAVPERS	1070/002	EMERGENCY DATA RCD	1070002	1070002	1070002
13	NAVPERS	1070/002	EMERGENCY DATA RCD	1070002	1070002	1070002
14	NAVPERS	1070/002	EMERGENCY DATA RCD	1070002	1070002	1070002
15	NAVPERS	1070/002	EMERGENCY DATA RCD	1070002	1070002	1070002
16	NAVPERS	1070/002	EMERGENCY DATA RCD	1070002	1070002	1070002
17	NAVPERS	1070/002	EMERGENCY DATA RCD	1070002	1070002	1070002
18	NAVPERS	1070/002	EMERGENCY DATA RCD	1070002	1070002	1070002
19	NAVPERS	1070/002	EMERGENCY DATA RCD	1070002	1070002	1070002
20	NAVPERS	1070/002	EMERGENCY DATA RCD	1070002	1070002	1070002

## Managing Your Personnel Record

### Web-based Personnel Systems

There are several web-based personnel systems where your information is stored. It is a common misconception that when one record is updated, the others are updated automatically. This is not true. You will need to be familiar with each system or record type below, reviewing each on a regular basis for accuracy:

1. Official Military Personnel File (OMPF), also known as Web Enabled Record Review (WERR), provides the ability to view, download and print copies of documents in your permanent OMPF file.

2. Electronic Service Record (ESR) is maintained by your command or servicing Personnel Support Detachment (PSD) and includes the information contained within NSIPS. The ESR “Tasks” function allows you to update ESR self-service items.
3. Performance Summary Record (PSR) and Officer Summary Record (OSR) are online professional record systems that allow you to view, download, and print a summary of your professional information, performance history, and personal decorations.
4. Navy Department Awards Web Service (NDAWS) is the Navy’s authoritative electronic awards system. It is a searchable database that provides access to Navy awards information and application processing.
5. Annual Retirement Report Record (ARPR)/Annual Statement of Service History (ASOSH) Online - Reservists with a CAC can login BUPERS Online to view their ARPR/ASOSH. Those non-drilling IRR members, Retired Reservists (Gray Area) and personnel on the Retired List (receiving pay) who do not possess a CAC and wish to view their online point record may contact the nearest Navy Operational Support Center for assistance.

Your OMPF is maintained in the Electronic Military Personnel Records System (EMPRS) at Navy Personnel

Command (NPC) in Millington, TN. You can view your OMPF online via the WERR option on BUPERS Online (BOL) at: <https://www.bol.navy.mil/DefaultPub.aspx?Cookies=Yes>. Access to BOL requires the use of a Common Access Card (CAC) and CAC reader, along with a Public Key Infrastructure (PKI) root certificate that can be downloaded from a link on the left side of the website.

You are responsible for the contents of your official record. Your record should be complete and clearly present your qualifications for promotion, or billet selection. Maintaining a complete record, which properly reflects all of your accomplishments, requires on-going attention. Although you are required to view and verify your OMPF documents at least once a year, checking your record more frequently is highly recommended as it may be difficult to find a missing document (when needed most) after an extended period of time.

### **Know your Record!**

The completeness of your record is integral to your success as an officer. You do not want to allow an incomplete record to become a negative factor in a Board's consideration of your fitness for promotion or billet selection. Do not assume your record is being properly maintained by others. Common service record discrepancies can put you at a serious

disadvantage with your contemporaries when competing for selection. These include:

- a. Missing Fitness Reports
- b. Official photo not in current rank (see MILPERSMAN 1070-180 for guidance)
- c. Unexplained broken service
- d. Missing data on special qualifications, decorations, awards, education, etc
- e. Missing Navy Reserve Appointment
- f. Missing or illegible Navy Reserve Qualification Questionnaires (NRQQs)

Reserve officers can update their data by downloading the NRQQ form emailing it to PERS-9 or mailing it to:

**Navy Personnel Command**  
PERS-9  
5720 Integrity Drive  
Millington, TN 38055-3110

It is recommended that you always maintain a personal file of all important documents for verification purposes in order to enable you to submit missing documentation should it become necessary. Since your official record is the principle instrument used during selection board deliberations and billet assignments, you should make sure your record is

current, complete, and accurate. Remember, you are responsible for making sure all fitness reports and other important documents are in your record. If you are missing a fitness report, send a legible copy that has all required signatures, most importantly yours and the reporting senior's, to:

**Navy Personnel Command**

PERS-32

5720 Integrity Drive

Millington, TN 38055-3110

For administrative errors in your record please visit the website for NPC listed below.

**Submitting Missing Documents to Your OMPF**

The procedures for submitting OMPF documents are contained on the NPC OMPF website which can be accessed at: <http://www.public.navy.mil/bupers-npc/career/recordsmanagement/Pages/MyOMPF.aspx>.

The NPC Records Support Division (PERS-31) controls the official personnel records of current and former members of the U.S. Navy and Navy Reserve, maintaining these records in electronic format via EMPRS. You and your NOSC are the primary sources for submitting documents to Navy Personnel Command and updating your OMPF. Some of the most common documents that need to be forwarded to an office other than PERS-31 are:

- Transcripts and degrees (PERS-45E)
- Fitness Reports and any documents that pertain to them such as extension letters and statements (PERS-32)
- Personal awards (Please see the NPC website listed above for awards submissions)

**Before submitting a missing document, ensure that:**

- The document is the “Original Signed” document, if required by the regulation directing the documents be filed in the OMPF
- The document is of actual size – no reduction or enlargement
- If the document is a copy, such as an award citation or course completion certificate, it is of good quality with black lettering and white background
- The document does not contain Privacy Act information on another service member
- The full SSN is recorded on the document – if not, **handwrite it in the upper right corner**

**Electronic Service Record (ESR)**

You may access your ESR via NSIPS, which is a web-based repository for both personnel and pay data for all Active Duty and Reserve Sailors in the Navy. Similar to BOL, you must use a CAC/CAC

reader to access NSIPS. Once at the NSIPS website select the “ESR Self-Service (New Users)” link and follow the individual steps presented. Once an individual account is created, you can access your ESR by clicking the “Login” button from the main web page, again using a CAC/CAC reader.

Navy - Official Military Personnel File						
all record and document links are enabled						
Welcome		OMPF Documents		e-Submission Documents		
Multi View	Firm Name	Firm Number	Subject Title	Document ID	Field Code	Document Date
<input type="checkbox"/>	NAVPER5	1051/02	BVAL REP AND COUNSELING RECORD (ID-85)	23287723	35	19871115
<input type="checkbox"/>	DD	1368	MIL PROC RCD	25052121	34	19840719
<input type="checkbox"/>	DD	4	ENL REGIL DOC	25052333	35	19840719
<input type="checkbox"/>	DD	93	EMERG DATA RCD	25052335	38	19841117
<input type="checkbox"/>	NAVPER5	1070/001	BUMED REGIL CONTR	25052143	33	19880313
<input type="checkbox"/>	NAVPER5	1070/001	BUMED REGIL CONTR	25052142	33	19880313
<input type="checkbox"/>	NAVPER5	1070/002	EMERG DATA RCD DEP APP	25052151	38	19891008
<input type="checkbox"/>	NAVPER5	1070/002	EMERG DATA RCD DEP APP	25052153	38	19890313
<input type="checkbox"/>	NAVPER5	1070/002	EMERG DATA RCD DEP APP	25052156	38	19890903
<input type="checkbox"/>	NAVPER5	1070/002	EMERG DATA RCD DEP APP	25052173	35	19890903
<input type="checkbox"/>	NAVPER5	1070/002	EMERG DATA RCD DEP APP	25052181	38	19891008
<input type="checkbox"/>	NAVPER5	1070/002	EMERG DATA RCD DEP APP	25052183	38	19891014
<input type="checkbox"/>	NAVPER5	1070/002	EMERG DATA RCD DEP APP	25052187	35	19890912

It is your responsibility to view and verify your ESR data at least once a year. When required by regulation, ESR data is printed on documents that personnel offices electronically submit for direct filing into your OMPF by using the “eSubmission” application on BUPERS ONLINE. It benefits you to ensure your record is up to date. The e-submission process expedites the processing of priority documents into the OMPF. A list of documents that can be electronically submitted is available by selecting the “eSubmission Forms List” link under “Tools” available on the NPC Electronic Submission website.

Documents not on the “eSubmission Forms List”, and documents submitted by activities not authorized to submit documents electronically, shall be mailed to the following address:

**Navy Personnel Command**  
 PERS-313  
 5720 Integrity Drive  
 Millington, TN 38055-3130

*Note: Faxed documents or email attachments will not be accepted for filing into the OMPF record. It is critical to ensure your SSN is on each document; if a document does not have an SSN or the SSN is incorrect, the document will be placed on hold until it can be researched, causing further delay in getting it into your record. An incorrect name (e.g., initials, nickname) or multiple names on documents will also complicate research.*

For further information regarding maintenance related to your service record, visit the NPC Records Management website.

### **Officer Summary Record (OSR) and Performance Summary Record (PSR)**

In addition to your OMPF, selection boards will review your OSR and PSR. These documents are the only sources of information available to selection boards other than your OMPF and any correspondence from you to the Board President.

The fitness report section (PSR) is generated from a database within NPC that is separate from your OMPF record. As the two databases are created from different copies of the FITREP, there is a very real possibility that they are not synchronized. The OSR/PSR is simply a computer-generated summary record that assists selection boards in reviewing an officer's record. This is an important part of your official record and should be reviewed by you prior to any selection board. You can view your OSR/PSR by logging onto BUPERS Online. Begin by visiting: <http://www.public.navy.mil/bupers-npc/career/recordsmanagement/Pages/MyOMPF.aspx>.

### Military Awards

There are five separate areas where your awards data is maintained: **(1)** the Navy Department Awards Web Service (NDAWS) website, **(2)** your OSR/PSR on BOL,

**(3)** your ESR in NSIPS, **(4)** your Electronic Training Jacket in the Navy Training Management and Planning System (NTMPS), which can be accessed via Navy Knowledge Online, and **(5)** your OMPF via WERR. It is important that all of these systems, several of which are independent from one another, accurately present the same information. Dependent upon which system is incorrect, different procedures would be taken to correct the error:

1. If an award is missing from a search conducted via NDAWS and it may/may not reflect on your PSR:
  - a. Make a copy of your missing award certificate (the one with the embossed, color picture of the award).
  - b. Write your SSN at the top right-hand corner of the copy.
  - c. If your award is a Meritorious Service Medal or higher (excluding the Purple Heart), then you must also submit the citation that came with the certificate. The citation usually has 18-22 lines of text. Write your SSN at the top right-hand corner of a copy of the citation.
  - d. Send the copies of your certificates/citations to the NDAWS Authority/ Administrator in your chain of command. A list of these commands, including mailing information is posted at

**QUERY PERSONAL AWARDS HISTORY** [ Search ]

To find the Personal and Unit Awards for a particular person, enter the appropriate search criteria below and then click search above.

To search for awards using a Social Security Number (SSN), enter data below and click on [Search] in the upper right corner. If the individual has changed their last name a separate query by last name will be required.

First Name:  Middle Initial:

Last Name:  Last 6 Digits of SSN:

If you are a veteran who used a service number or serial number while in the Navy, type your serial or service number here and click on [Search] in the upper right corner. Only enter the numeric value of your service number and add leading zeros if your number is less than 7 digits long.

Service or Serial Number:

**PRIVACY ACT STATEMENT**

**AUTHORITY:** Title 18 U.S.C. 5013, Secretary of the Navy; 10 U.S.C. 5541, Headquarters, Marine Corps; Secretary of the Navy Instruction 1855.1H, Navy and Marine Corps Awards Manual; and E.O. 11652 (DHS, UNCLASSIFIED).

**PURPOSE:** To maintain records of military personal awards and unit awards and to electronically process award recommendations.

**ROUTINE USES:** In addition to those disclosures generally permitted under 5 U.S.C. 552(a) of the Privacy Act, these records or information contained therein may specifically be disclosed outside the DOD as a routine use pursuant to 5 U.S.C. 552(a)(3) as follows: The DOD National Defense User that appears at the beginning of this Navy's compilation of systems of records notices apply to this system. To public and private organizations, including news media, for the purpose of granting access and/or authorizing awards or honors.

**DISCLOSURE:** Voluntary. However, if you fail to provide information, NDAWS will be unable to verify an individual's record and will be unable to furnish you with the record you are seeking.

**SECURITY STATEMENT**

You are accessing a U.S. Government (USG) Information System (IS) that is provided for USG-authorized use only. By using this IS (which includes any device attached to this IS), you consent to the following conditions:

- The IS contains information and operations communications on this IS for purposes including, but not limited to, penetration testing, COMSEC monitoring, network operations and defense, personnel recruitment (PR), for enforcement (LE), and operational/force (O) investigations.
- At any time, the USG may request and access data stored on this IS.
- Communications sent to, or data stored on, this IS or its contents, are subject to routine monitoring, interception, and search, and may be disclosed or used for any USG-authorized purpose.
- This IS includes security measures (e.g., authentication and access controls) to protect USG information not for your personal benefit or privacy.
- Unauthorized disclosure of the above using this IS does not constitute a crime, and/or an unauthorized recording or monitoring of the content of privileged communications or work product, related to personal communication or service to personnel, participants, or users, and their activities. Staff with qualifications and work product are private and confidential.

the NDAWS web site under the “NDAWS Authorities” button at the left.

*Note: Once NDAWS has been updated, awards should reflect in the other electronic systems (PSR/ESR/ETJ) in approximately 1-2 weeks.*

2. If the award shows on your PSR but a copy of the certificate/citation is missing from your OMPF:

a. Mail a legible, clean copy of the signed citation, with your SSN printed in the upper right hand corner, to:

**Navy Personnel Command**

PERS-312A

5720 Integrity Drive

Millington, TN 38055-3130

(No cover letter required)

b. For questions go to the NPC Records Management website: <http://www.public.navy.mil/bupers-npc/career/recordsmanagement/militarypersonnelrecords/Pages/default2.aspx>

3. If you run an NDAWS search for a personal award and find it in NDAWS, but the award does not show on your OSR:

a. Mail a legible, clean copy of the signed citation, with your SSN printed in the upper right hand corner and “IN NDAWS NOT IN OSR” written

at the top. Also include a phone number where you can be reached and mail to the PERS-312A address above.

4. When submitting awards to NDAWS or PERS-312 for updating your online record only (the award is already in your OMPF record) annotate in the upper left corner “For Data Entry Only (NDAWS/PSR) - Do Not Scan to Record.” This will prevent having duplicate entries in your OMPF.

*Note: If you cannot find an NDAWS Authority/Administrator in your Chain of Command, call the contact number below for current fax/email directions, or mail the award to:*

**Commander Naval Reserve Forces Command**

N01A - Attention: Awards

1915 Forrestal Drive

Norfolk, VA 23551

(757) 322-5630

Email: [CNRFC\\_CommandServices@navy.mil](mailto:CNRFC_CommandServices@navy.mil)

**After Your Record Review**

If you have fully analyzed your record, you should now be aware of your strengths and weaknesses. An officer senior to you in rank can provide some valuable insight into your record and give you career advice. Consider looking for a mentor within your community (designator), if you don't have one already.



Use the record review process as a catalyst for further improvement, growth and professional development.

If you are in a situation where you are unable to review your record, do not assume that every FITREP you receive is a good indicator of your record in its entirety. Each FITREP is important, but patterns or trends of performance that exist in the record are just as important. FITREPs are reviewed alone as well as compared to how you were marked previously, perhaps more importantly, what will come after.

If you were marked highly on your last report, it is extremely important that you maintain or improve your performance to show growth and an “upward” trend or “moving to the right”, especially with the same reporting senior.

If your last report was marginal, do not be disheartened. You can reduce the significance of a single report if you improve – particularly with regard to direct and indirect competition. A Naval Officer is always expected to perform his/her best. Ensure you learn from your experience by discussing the report with your Reporting Senior. Additionally, marginal/adverse FITREPs should not be a surprise if you are proactive in seeking periodic performance feedback earlier than FITREP reporting time. Mid-term counseling, as well as FITREP debriefs, are

opportunities to develop courses of action for continued performance improvement.

If you need to submit documents that are missing from your OMPF and have less than three months before your record will be reviewed by a selection board (either statutory or administrative), there is no guarantee that your OMPF will be updated in time for the board. In this case, it is highly recommended that you submit the missing documents directly to the Board President in addition to sending the documents using the procedures outlined above. Per NAVADMIN 016/13, award citations received as part of a Selection Board package will be entered into the officer’s OMPF if the award is accurately reflected in NDAWS.

Officers must check NDAWS prior to submission, and if necessary, contact their NDAWS coordinator for entry into NDAWS. A list of NDAWS coordinators is available on the Navy Awards website: [https://awards.navy.mil/awards/webbas01.nsf/\(vwWebPage\)/home.htm?OpenDocument](https://awards.navy.mil/awards/webbas01.nsf/(vwWebPage)/home.htm?OpenDocument). Sending documents (other than awards) to the Board only will NOT update your OMPF because all correspondence is destroyed when a board adjourns.

# Officer Billets/JO Apply

All officer assignments are conducted through the Reserve Forces Manpower Tool (RFMT) which has replaced the APPLY website. The RFMT link can be found by logging in to the private side of the Navy Reserve website. Select the “Applications” menu and then select “RFMT.”

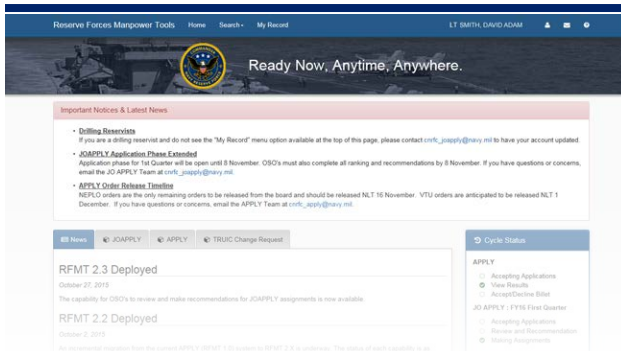

All functionality that existed within the APPLY website for Senior Officers, Junior Officers, OSOs and Reserve Unit COs is available in RFMT. Each officer will be required to create an RFMT account the first time they access the application. A RFMT Quick Guide and a power point presentation, outlining the initial registration and dreamsheet submission process, have been created to assist officers. These documents can be found on the RFMT website at: <https://private.navyreserve.navy.mil/apps/rfmtweb/>.

## Officers obtain billets in one of two ways:

Senior Officers (O5-O6) and any officer seeking a command billet: Must submit their billet preferences to the annual Command/Non-Command Screening Board, commonly known as the APPLY Board. Essentially, the APPLY board places all O5 and O6 officers in competition for a limited number of pay billet assignments. Unlike a statutory promotion board, there is no automatic process for being considered on the APPLY board.

Junior Officers (O1-O4): The JO application process is accessible through the RFMT website. Once registered, officers can search and apply for billet opportunities per the JO APPLY calendar. Officers in an “In Assignment Processing” (IAP) status or with expired Projected Rotations Dates (PRD), who are not actively participating in JO APPLY may be assigned a billet by CNRFC N1 (Manpower & Personnel Department) if a billet is available, or may be transferred to a non-pay status.

Regardless of tenure remaining, Junior Officers may request a change to their current assignment due to relocation, unit to unit transfer, or unit/billet disestablishment. In order to request a change, you must submit the “Reassignment Request Form” located in the member’s profile within the JO APPLY website.

# Fitness Reports (FITREPS)/ Evaluations (EVALS)

Your CO will provide you with annual evaluations that report strengths and developmental needs. Refer to BUPERSINST 1610.10 (series) for enlisted evaluation and officer fitness report details and deadline dates.

The following is a chart outlining when FITREP/EVALS are due. FITREPs are due the last day of the month, EVALS on the 15th.

	PERIODIC FITREP/CHIEFEVAL/EVAL	
	Officers (ALL)	Enlisted (ALL)
<b>Jan</b>	O3	
<b>Feb</b>	O2	
<b>Mar</b>	W5, W4, W3	E5
<b>Apr</b>	O5	E9
<b>May</b>	O1	
<b>Jun</b>		E4
<b>Jul</b>	O6	E3, E2, E1
<b>Aug</b>		
<b>Sept</b>	W2	E8, E7
<b>Oct</b>	O4	
<b>Nov</b>		E6
<b>Dec</b>		

## More FITREP Guidance

This is a subject that cannot be over-emphasized. The ability to write strong FITREPs and EVALS is a valuable skill that all officers should master early in their careers. As noted in the previous section, all officers should read and become intimately familiar with the BUPERSINST 1610.10 series. When you become a Unit CO, you will impact many careers, so it is imperative that you learn FITREP/EVAL basics.

## How to write a FITREP

Remember that FITREPs are not only written to the recipient, but also to the board that considers the officer for promotion and APPLY billets. It should provide the board with meaningful and clear metrics that demonstrate performance, and comment on specific traits. All officers have some degree of input into the content of their FITREPs. The recommended approach is that an officer submits their input to their Reporting Senior in NAVFIT98A paying particular attention to the “Comments on Performance” (Block 41) portion of the FITREP. Please visit the following link on the Navy Personnel Command website, for a NAVFIT98 user guide. <http://www.public.navy.mil/bupers-npc/career/performanceevaluation/Pages/default.aspx>

The CO assigns trait scores and edits the comments, as needed. To catch the attention of a board, consider the following recommendations:

- Make a strong opening statement that ranks the officer within a group or across groups and characterizes performance (e.g., “My #2 of 12 Commanders of any designator” or “A highly capable, hard charging Naval Officer with outstanding analytical skills and proven leadership abilities.”)
- Rank top EP (Early Promote) (e.g., “My top-performing officer”)
- Rank MPs (Must Promote) who just missed the cut for EP (e.g., “Indistinguishable from my EP, he received an MP only because of system limitations.”). It is not necessary or appropriate to rank “pack” performers and boards always appreciate honest comments for poor performers
- Make sure that trait scores match Block 41 comments. Bulletize points that quantify specific accomplishments and show impact. At least one bullet should highlight leadership accomplishments, if possible
- Prioritize bullets based on their importance to the evaluation of the officer. Bullets that describe demonstrated leadership and contributions to

mission accomplishment should come first. Do not waste lines on superfluous achievements (e.g., “15th consecutive Excellent PRT”)

- Note personal awards in a bullet (e.g., “Awarded NAM from previous tour with ONI.”) This will call a Board’s attention to the award in another part of the OMPF

The image shows two overlapping forms used for officer evaluation. The top form is the 'FITNESS REPORT & COUNSELING RECORD (E7 - O6)'. It includes sections for 'PERFORMANCE TRAITS' with a grid for scores (1-5) and 'LEADERSHIP' with a grid for scores (1-5). Below these are sections for 'COUNSELING' and 'COMMENTS'. The bottom form is the 'EVALUATION RECORD (E7 - O6) (cont'd)'. It also includes a grid for trait scores and a section for 'COMMENTS'. Both forms have signature lines for the evaluator and the officer.

- Write gaining command support actions in terms that the board will understand. Avoid non-standard abbreviations and terminology

- Include a strong closing statement that summarizes potential for promotion or follow-on assignment recommendation (e.g., “This officer is ready for command NOW!” or “He has all the skills necessary to be a successful XO and CO of any size unit in the near future; ready now for promotion to Commander!”)
- Explain any situation that may confuse a board or cast doubt on a top performer (e.g., “Formerly the CO of the unit, I personally selected him to be XO when the unit reorganized and the CO’s job was elevated to a CDR billet.”)
- Reporting seniors need to remain familiar with the most up-to-date version of BUPERSINST 1610.10 series and know their promotion recommendation limits. Frequently, it is normal for officers who are new to the unit to be ranked P or MP behind more senior officers (although, keep in mind that officers at the rank of Ensign and Lieutenant Junior Grade CANNOT be ranked higher than Promotable, “P”, for their promotion recommendation in Block 42). If warranted, clarify when this occurs only because they are competing with more experienced officers
- The instruction does not require Reporting Seniors to use all EPs or MPs allotted. For example, three EPs may be authorized, but a CO may choose to use only two and increase the number of MPs

allowed by one. Be aware, however, that a CO’s failure to use the quota of EP’s and MP’s allowed may send an unintended (or intended) message to a board

- Do not leave any unexplained promotion recommendation “air gaps”. The instruction authorizes EP recommendations for any 1 of 1 ranking. A board views negatively an officer ranked 1 of 1 and MP. If warranted, this situation should be explained in the comments so as not to leave the board members guessing as to why the officer was ranked in this manner
- Make appropriate career assignment recommendations in block 40 based on where an officer is in his or her career. For CAPT, “CO” and “Joint Staff” are common recommendations. For CDRs and below, “CO”, “OIC”, “XO”, and “Major Staff” are common. An XO not receiving an endorsement for “CO” sends a clear “do not select for command” message to the board

Competitive categories are the groupings within which officers compete for statutory promotion. Competitive categories may be restricted to a single community or designator, or they may comprise multiple communities or designators, like Unrestricted Line, Limited Duty Officer, and Chief Warrant Officer. Further explanation of Officer

Summary Group (OSG) and Competitive Categories can be found in BUPERSINST 1610.10 series.

Amplifying verbiage and soft breakouts by individual community are strongly encouraged when utilizing a single competitive category.

Reporting Seniors are required to use a single Competitive Reporting Category by combining OSGs. OSGs are the groupings within which reporting seniors rank officers to determine FITREP promotion recommendations, such as Early Promote, Must Promote, and Promotable. Other factors that go into determining OSGs include pay-grade, designator, duty status, promotion status, end-date, type of report, billet subcategory, and reporting senior.

Please visit: [http://www.public.navy.mil/bupers-npc/reference/instructions/BUPERSInstructions/Documents/BUPERSINST\\_1610.10D.pdf](http://www.public.navy.mil/bupers-npc/reference/instructions/BUPERSInstructions/Documents/BUPERSINST_1610.10D.pdf)

BUPERSINST1610.10D, the governing instruction for the Navy Performance Evaluation System.

“Today’s Navy Reserve is an essential element of America’s Navy. Each day our Sailors provide global operational support to fleet and combatant commanders using skill sets they hone through both military and civilian training. It is this breadth and depth of experience, unique to the “Citizen Sailor” that enhances operational readiness, provides strategic depth, and strengthens the fabric of our force.”

- VICE ADMIRAL ROBIN R. BRAUN, CHIEF OF NAVY RESERVE



## APPENDICES

### DCO Drill Weekend Milestones

Below are some of the items to become familiar with should discuss with your NOSC within your first three Drill weekends.

- SCHEDULING OF DCOIC CLASS
- ID CARD ISSUANCE
- UNIFORMS
- IT: NMCI ACCOUNT/CAC READER
- GENERAL MILITARY TRAINING (GMT)
- MYPAY - DIRECT DEPOSIT

- DRILL STATUS/REQUIREMENTS
- RESERVIST CALENDARS
- PAGE 2 VERIFICATION
- FAMILY CARE PLAN
- SGLI/FSGLI INSURANCE ELECTION
- ESR/CEI
- MAS CODES
- MOBILIZATION
- RRSQ
- NFAAS
- MEDICAL/DENTAL RECORDS
- NROWS TRAINING
- GTCC APPLICATION
- DTS TRAINING
- SECURITY CLEARANCE VERIFICATION
- BERTHING ARRANGEMENTS
- URINAYLSIS PROGRAM
- PHYSICAL READINESS PROGRAM
- ICE SURVEY



# References

---

**OPNAVINST 1120.3B:** Navy Reserve Direct Appointment Program

**RESPERSMAN M-1001.5:** Navy Reserve Personnel Manual (RESPERSMAN)

**OPNAVINST 5350.4D:** Navy Alcohol and Drug Abuse Prevention and Control

**OPNAVINST 6110.1J:** Physical Readiness Program

**BUPERINST 1610.10D Series:** Navy Performance Evaluation System

**NAVPERS 15665I:** U. S. Navy Uniform Regulations

**BUPERSINST 1001.39F:** Administrative Procedures for Navy Reservists

**COMNAVRESFORINST 3060.7A:** Manpower Availability Status (MAS) Codes

**OPNAVINST 1001.20C:** Standardized Policy and Procedures for the Active Duty for Special Work (ADSW) Program

**OPNAVINST 3060.7B:** Navy Manpower Mobilization/ Demobilization Guide

# Important Websites

Below is a list of common websites. Please note: most of these will require a CAC card/reader.

---

**APACS (Aircraft and Personnel Automated Clearance System):** <https://apacs.dtic.mil>

**APPLY (JOAPPLY):** <https://private.navyreserve.navy.mil/apps/rfmtweb/>

**BOL (BUPERS Online):** <https://www.bol.navy.mil>

**CAC Issues:** <http://militarycac.com>

**CEI (Civilian Employer Information):** <https://nsipsprod.nmci.navy.mil>

**CETARS/CANTRAC:** <https://www.netc.navy.mil/Development.aspx>

**Citigroup (Government Travel Charge Card):** <https://home.cards.citidirect.com>

**CMS-ID (Career Management System Interactive Detailing):** <https://www.cmsid.navy.mil>

**DEERS (Defense Enrollment Eligibility Reporting System):** <https://www.dmdc.osd.mil/>

**DFAS (Defense Finance and Accounting Service):** <http://www.dfas.mil>

**DTMO (Defense Travel Management Office):** <https://www.defensetravel.dod.mil/Passport>

**DTS (Defense Travel System):** <http://www.defensetravel.osd.mil>

**E-QUIP (Electronic Questionnaires for Investigations Processing):** <http://www.opm.gov/investigations/e-qip-application/>

**GovDelivery:** <https://public.govdelivery.com/accounts/USNRFC/subscribers/new>

**MyPay:** <https://myPay.dfas.mil>

**Navy Advancement Center (on NKO):** <https://wwwa.nko.navy.mil/portal/careermanagement/navyadvancementcenter>

**Navy Exchange (NEX):** <https://www.mynavyexchange.com/>

---

**Navy Education and Training Command:** <https://www.netc.navy.mil/>

**NFAAS (Navy Family Accountability and Assessment System):** <https://navyfamily.navy.mil>

**NKO (Navy Knowledge Online):** <https://wwwa.nko.navy.mil>

**Navy Personnel Command:** <http://www.public.navy.mil/bupers-npc/Pages/default.aspx>

**NMCI East WEBMAIL (Navy Marine Corps Intranet):** <http://militarycac.com/owa.htm>

**Navy Safety Center:** <http://www.safetycenter.navy.mil>

**NROWS (Navy Reserve Order Writing System):** <https://nrows.sscno.nmci.navy.mil/nrows/>

**NRRM (Navy Reserve Readiness Model):** <https://nrrm.navyreserve.navy.mil/nrrm.Web/Modules/Login/Login.aspx?>

**NSIPS (Navy Standard Integrated Personnel System):** <https://nsipsprod.nmci.navy.mil>

**Officer Training Command Newport:** [http://www.ocs.navy.mil/DCOIC\\_program\\_overview.asp](http://www.ocs.navy.mil/DCOIC_program_overview.asp)

**Recruiting and Referral information:** <http://www.navy.com/yvr>

**U.S. Navy official website:** <http://www.navy.mil/>

**U.S. Navy Reserve official website:** <http://www.navyreserve.navy.mil>

**U.S. Navy Reserve Facebook:** <https://www.facebook.com/U.S.NavyReserve>

# Acronyms

ACRONYM	DESCRIPTION
AC	ACTIVE COMPONENT
AD	ACTIVE DUTY
AJPME	ADVANCED JOINT PROFESSIONAL MILITARY EDUCATION
ADOT	ACTIVE DUTY OTHER THAN FOR TRAINING
ADSW	ACTIVE DUTY FOR SPECIAL WORK
ADT	ACTIVE DUTY TRAINING
APPLY	NATIONAL COMMAND AND SENIOR OFFICER (O5/O6) NON-COMMAND BILLET SCREENING AND ASSIGNMENT
AQD	ADDITIONAL QUALIFICATION DESIGNATION
ARPR/ASOSH	ANNUAL RETIREMENT POINT RECORD/ANNUAL STATEMENT OF SERVICE HISTORY
AT	ANNUAL TRAINING
BOL	BUPERS ONLINE
BUPERS	BUREAU OF NAVAL PERSONNEL
CNRFCC	COMMANDER, NAVY RESERVE FORCES COMMAND
CO	COMMANDING OFFICER
CTO	CAREER TRANSITION OFFICE
DCO	DIRECT COMMISSION OFFICER
DFAS	DEFENSE FINANCING AND ACCOUNTING SERVICES
DoD	DEPARTMENT OF DEFENSE

<b>EDM</b>	ENHANCEMENT FOR DRILL MANAGEMENT
<b>ESR</b>	ELECTRONIC SERVICE RECORD
<b>FITREP</b>	FITNESS REPORT (EVALUATION REPORT ON E-7 - O-6) (NAVPERS 1610/2)
<b>IDC</b>	INFORMATION DOMINANCE CORPS
<b>IDT</b>	INACTIVE DUTY TRAINING
<b>IDTT</b>	INACTIVE DUTY TRAINING TRAVEL
<b>IMAPMIS</b>	INACTIVE MANPOWER AND PERSONNEL MANAGEMENT INFORMATION SYSTEM
<b>IRR</b>	INDIVIDUAL READY RESERVE
<b>JOAPPLY</b>	JUNIOR OFFICER APPLY
<b>JOPD</b>	JUNIOR OFFICER PROFESSIONAL DEVELOPMENT
<b>JPME</b>	JOINT PROFESSIONAL MILITARY EDUCATION
<b>JQO</b>	JOINT QUALIFIED OFFICER
<b>JQS</b>	JOINT QUALIFICATION SYSTEM
<b>MAS</b>	MOBILIZATION AVAILABILITY STATUS
<b>MILPERSMAN</b>	NAVAL MILITARY PERSONNEL MANUAL
<b>NDAWS</b>	NAVY DEPARTMENT AWARDS WEB SERVICE
<b>NIOC</b>	NAVY INFORMATION OPERATIONS COMMAND
<b>NOBC</b>	NAVY OFFICER BILLET CLASSIFICATION
<b>NOOCS</b>	NAVY OFFICER OCCUPATIONAL CLASSIFICATION SYSTEM

## Acronyms *continued*

<b>NPC</b>	NAVY PERSONNEL COMMAND
<b>NRA</b>	NAVY RESERVE ACTIVITY
<b>NRQQ</b>	NAVY RESERVE QUALIFICATION QUESTIONNAIRE FOR INACTIVE DUTY PERSONNEL (NAVPERS 1200/2)
<b>NSIPS</b>	NAVY STANDARD INTEGRATED PERSONNEL SYSTEM
<b>OIC</b>	OFFICER IN CHARGE
<b>OMPF</b>	OFFICIAL MILITARY PERSONNEL FILE
<b>OSO</b>	OPERATIONAL SUPPORT OFFICER
<b>OSR</b>	OFFICER SUMMARY RECORD
<b>PHA</b>	PERIODIC HEALTH ASSESSMENT
<b>PME</b>	PROFESSIONAL MILITARY EDUCATION
<b>PSR</b>	PERFORMANCE SUMMARY RECORD
<b>RC</b>	RESERVE COMPONENT
<b>SECDEF</b>	SECRETARY OF DEFENSE
<b>SECNAV</b>	SECRETARY OF THE NAVY
<b>SELRES</b>	SELECTED RESERVE
<b>TA</b>	TRANSITION ASSISTANT
<b>XO</b>	EXECUTIVE OFFICER
<b>VTU</b>	VOLUNTARY TRAINING UNIT

## OFFICER RANKS

O1	O2	O3	O4	O5	O6	O7	O8	O9	O10	Special
<b>Ensign (ENS) / 2nd Lieutenant</b>	<b>Lieutenant Junior Grade (LTJG) / 1st Lieutenant</b>	<b>Lieutenant (LT) / Captain</b>	<b>Lieutenant Commander (LCDR) / Major</b>	<b>Commander (CDR) / Lieutenant Colonel</b>	<b>Captain (CAPT) / Colonel</b>	<b>Rear Admiral Lower Half (RDML) / Brigadier General</b>	<b>Rear Admiral Upper Half (RADM) / Major General</b>	<b>Vice Admiral (VADM) / Lieutenant General</b>	<b>Admiral (ADM) / General</b>	<b>Fleet Admiral (FADM) / General of the Air Force /Army</b>

\* Navy rank (abbreviation) / equivalent service rank; i.e. Army, Air Force, Marine Corps

## OFFICER COMMUNITY INSIGNIAS

<p>Naval officers serve either as a line officer or as a staff corps officer. Unrestricted Line (URL) and Restricted Line (RL) officers wear a gold star above their rank on the service dress uniform while staff corps officers wear devices unique to their community.</p>						
	Medical Corps	Nurse Corps	Dental Corps	Medica Service Corps	Supply Corps	Civil Engineer Corps
	Law Community	JAG Corps	Christian Chaplain	Jewish Chaplain	Buddhist Chaplain	Muslim Chaplain

## ENLISTED RANKS

	E1	E2	E3	E4	E5	E6	E7	E8	E9
<b>NAVY</b>	None								
	Seaman Recruit (SR)	Seaman Apprentice (SA)	Seaman (SN)	Petty Officer Third Class (PO3)	Petty Officer Second Class (PO2)	Petty Officer First Class (PO1)	Chief Petty Officer (CPO)	Senior Chief Petty Officer (SCPO)	Master Chief Petty Officer (MCPO)
<b>MARINE CORPS</b>	None								
	Private	Private First Class	Lance Corporal	Corporal	Sergeant	Staff Sergeant	Gunnery Sergeant	Master Sergeant	Sergeant Major
<b>ARMY</b>	None								
	Private	Private	Private First Class	Corporal / Specialist	Sergeant	Staff Sergeant	Sergeant First Class	Master Sergeant	Sergeant Major
<b>AIR FORCE</b>	None								
	Airman Basic	Airman	Airman First Class	Senior Airman	Staff Sergeant	Technical Sergeant	Master Sergeant	Senior Master Sergeant	Chief Master Sergeant



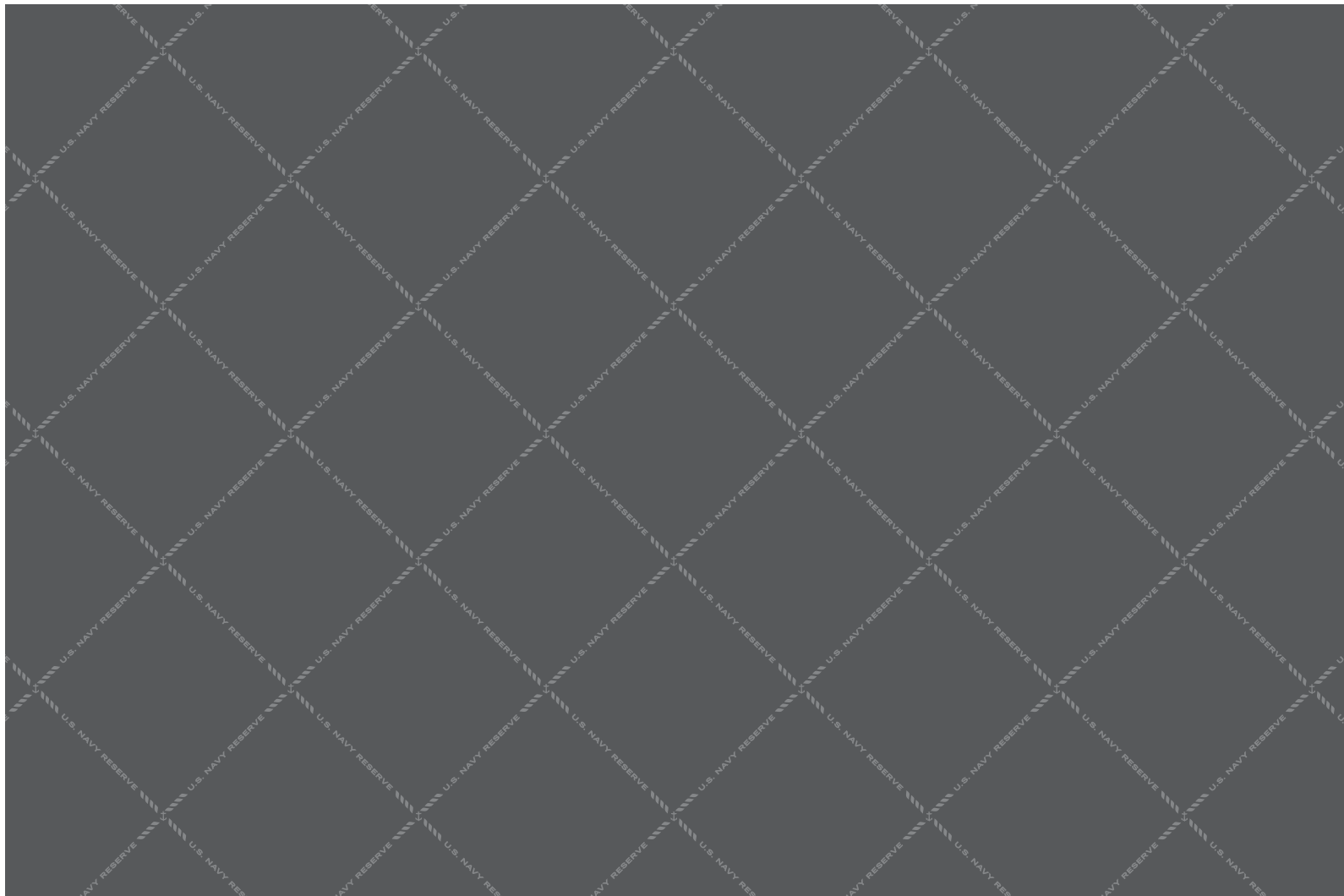

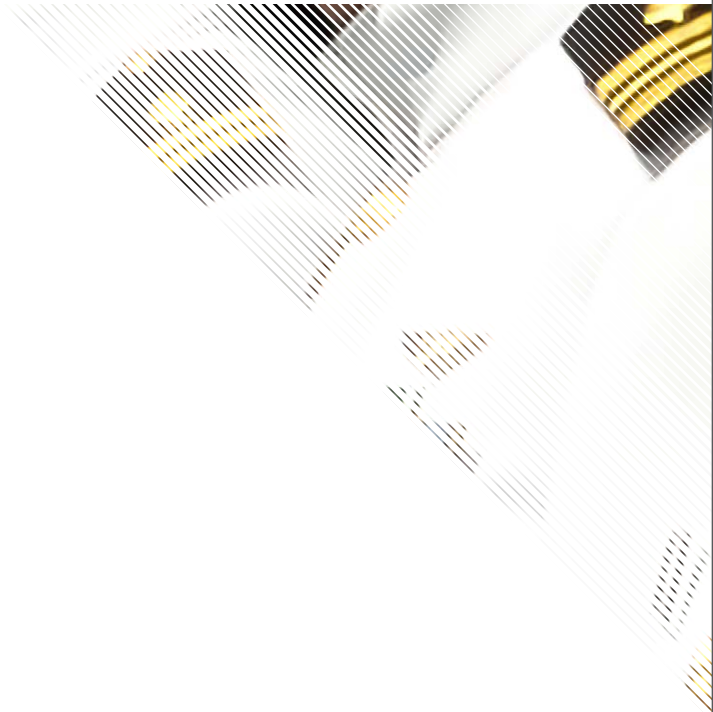

For a digital copy, go to:  
[www.navyreserve.navy.mil](http://www.navyreserve.navy.mil)