



United States Army Corps of Engineers
New York District

Regulatory Program Applicant Information Guide

FY 2014



Table of Contents

- SECTION I: Regulatory Program Background: 1
 - Regulatory Program Goals 1
 - Regulatory Program Jurisdiction Laws 1
- FREQUENTLY ASKED QUESTIONS 4
- NEW YORK DISTRICT OFFICE 6
- UPSTATE NEW YORK FIELD OFFICE 6
- Explanation of Some Commonly Used Terms 7
- SECTION II Wetlands 10
 - 1. Vegetation indicators 11
 - 2. Soil indicators 12
 - 3. Hydrology indicators 12
 - Wetland determination 13
- SECTION III: THE PERMIT APPLICATION SUBMITTALS 14
 - Instructions for Permit Applications in New York State 14
 - Instructions for Permit Applications in New Jersey 14
 - ADDITIONAL GUIDANCE FOR SECTION 404 PERMIT APPLICANTS 15
 - JURISDICTIONAL DETERMINATIONS 15
 - Section 404 (b) (1) Guidelines of the Clean Water Act 16
 - REFERENCES 16
- SECTION IV: GENERAL INFORMATION 17
 - FORMS OF AUTHORIZATION 17
 - Individual permits. 17
 - General permits. 17
 - FEES 17
 - PROCESSING PROCEDURE FOR AN INDIVIDUAL PERMIT 18
 - Section 404 (b) (1) Guidelines of the Clean Water Act 19
- Section V: Permit Applications Drawings 20
 - PERMIT APPLICATION DRAWINGS SET - GENERAL 20
 - VICINITY MAP (MUST BE FIRST DRAWING) 20
 - PLAN VIEW 21
 - ELEVATION AND/OR CROSS-SECTION VIEW 22

DREDGING PROJECTS	23
SECTION VI: ADDITIONAL RESOURCE INFORMATION	47
U.S. Army Corps of Engineers Districts	47
New York State Projects.....	47
New York State Department of Environmental Conservation (NYSDEC)	47
New York State Historic Preservation Office	48
New York State Department of State Division of Coastal Resources	48
U.S. Fish and Wildlife Service.....	48
Environmental Protection Agency	49
NOAA Fisheries Service	49
New York City Watershed	49
New Jersey State Projects.....	49
New Jersey Department of Environmental Protection	49
NOAA Fisheries Service	49
U.S. Fish and Wildlife Service.....	49
New Jersey State Historic Preservation Office	49
New Jersey Meadowlands Commission.....	50
Bridges and Waterway Management – United States Coast Guard	50

SECTION I: Regulatory Program Background:

Regulatory Program Goals

1. To provide strong protection of the Nation's aquatic environment, including wetlands.
2. To enhance the efficiency of the Corps administration of its regulatory program.
3. To ensure that the Corps provides the regulated public with fair and reasonable decisions.

The U.S. Army Corps of Engineers (Corps) has been involved in regulating certain activities in the nation's waters since 1890. Until 1968, the primary thrust of the Corps' regulatory program was the protection of navigation. As a result of several subsequent laws and judicial decisions, the program has evolved to one involving the consideration of the full public interest by balancing the favorable impacts against the detrimental impacts. This is known as the "public interest review." The program is one which reflects the national concerns for both the protection and utilization of important resources. The regulatory authorities and responsibilities of the Corps are based on the following laws:

Regulatory Program Jurisdiction Laws

Section 10 of the Rivers and Harbors Act approved March 3, 1899, (33 U.S.C. 403) (referred to as Section 10), prohibits the unauthorized obstruction or alteration of any navigable water of the United States. The construction of any structure in or over any navigable water of the United States, the excavating from or depositing of material in such waters, or the accomplishment of any other work affecting the course, location, condition, or capacity of such waters is unlawful unless the work has been recommended by the Chief of Engineers and authorized by the Secretary of the Army.¹

Section 404 of the Clean Water Act (33 U.S.C. 1344) (referred to as Section 404), authorizes the Secretary of the Army, acting through the Chief of Engineers, to issue permits, after notice and opportunity for public hearing, for the discharge of dredged or fill material into the waters of the United States at specified disposal sites.

Section 103 of the Marine Protection, Research and Sanctuaries Act of 1972, as amended (33 U.S.C. 1413) (referred to as Section 103), authorizes the Secretary of the Army, acting through the Chief of Engineers, to issue permits, after notice and opportunity for public hearing, for the transportation of dredged material for the purpose of disposal in the ocean where it is determined that the disposal will not unreasonably degrade or endanger human health, welfare, or amenities, or the marine environment, ecological systems, or economic potentialities.

Other laws may also affect the processing of applications for Corps permits such as:

- National Environmental Policy Act
- Coastal Zone Management Act
- Magnuson-Stevens Fishery Conservation and Management Act
- Fish and Wildlife Coordination Act
- Endangered Species Act
- National Historic Preservation Act

¹ Regulation of bridges over commercial navigable channels was transferred to the USDOT/U.S. Coast Guard Bridge Administration office under the Bridge Act of 1946.

Figure 1. Corps of Engineers Regulatory Jurisdiction in Tidal Waters

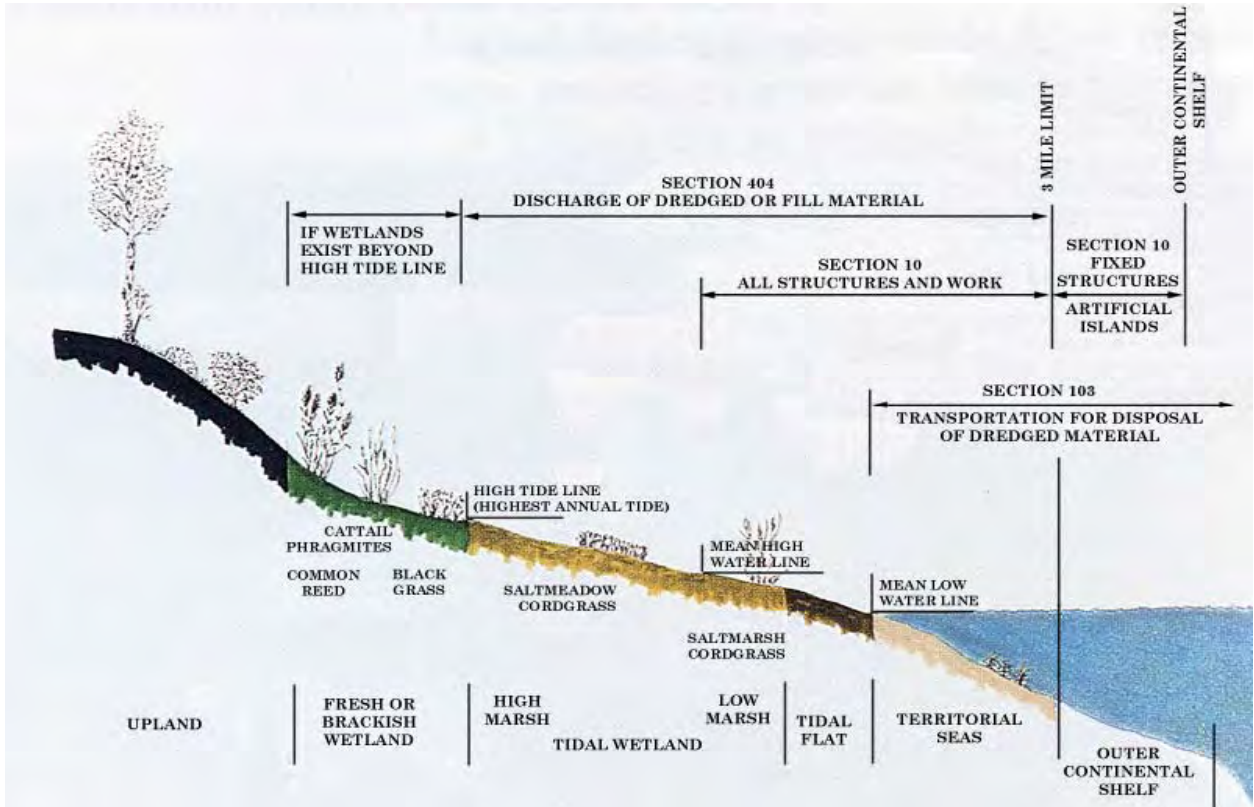
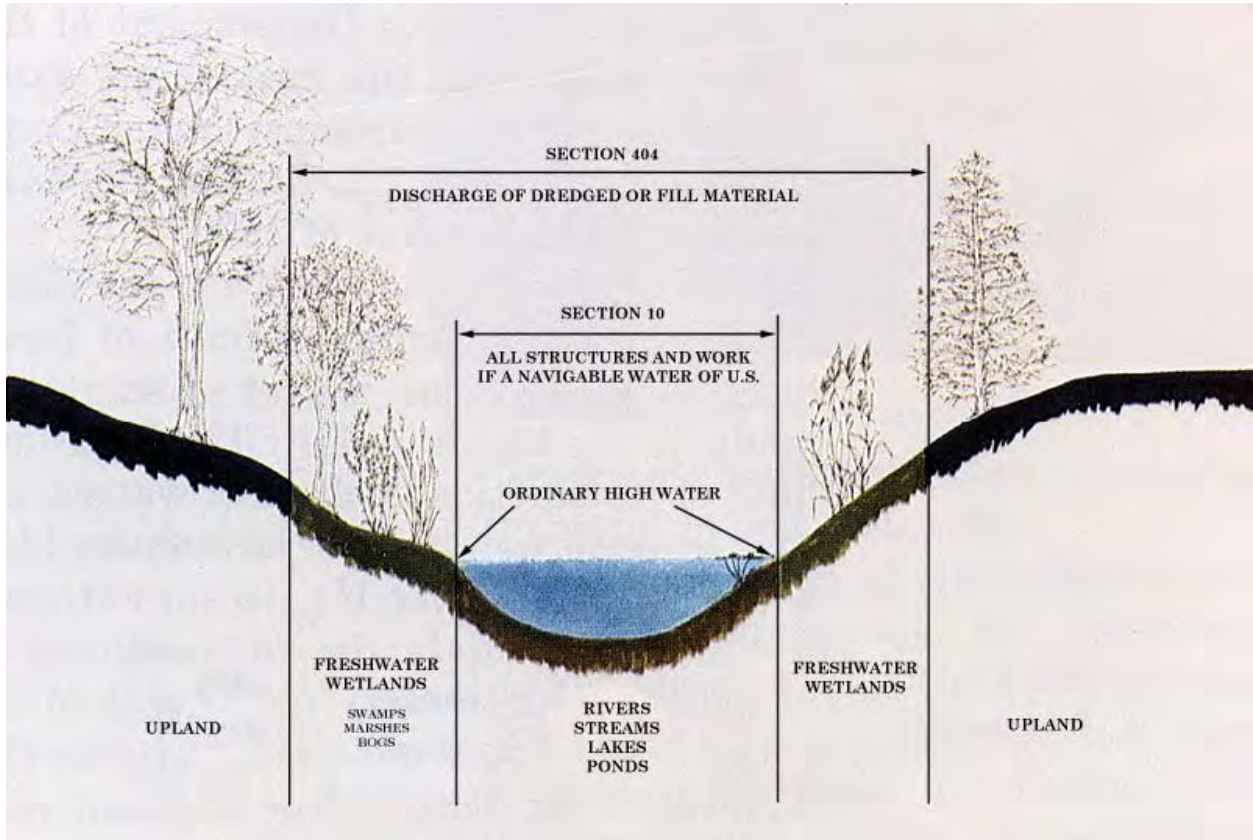

Figure 2. Corps of Engineers Regulatory Jurisdiction in Non-Tidal Waters



FREQUENTLY ASKED QUESTIONS

1. When should I apply for a permit?

As early as possible in the project planning stages. A minimum of three months is normally required to process a routine application involving a public notice. The Corps' application review process usually requires site visits, federal, state and local government inter-agency coordination and data analysis, before a proper determination can be made. Therefore, we urge contacting the Corps of Engineers as a first step in planning any project.

For a large or complex activity that may take longer, it is often helpful to have a “pre-application consultation” or informal meeting with the Corps during the early planning phase of your project. You may receive helpful information at this point, which could prevent delays later. When in doubt as to whether a permit may be required or what you need to do, call the local Corps office (See contact information on page 8).

2. What activities require Corps permits?

Examples of regulated activities within waters of the United States include but are not limited to: building structures such as bulkheads, piers, catwalks, boathouses and pilings; excavation, dredging, filling and depositing dredged or fill material in waters and wetlands such as marshes, swamps, bogs, forested wetlands, some isolated wetlands, and in lakes and waterways; construction of overhead and underwater transmission lines, cables and pipes; and, construction of breakwaters, jetties, groins and stone revetments.

3. Who is required to obtain a permit from the U.S. Army Corps of Engineers?

Any individual, company, corporation or government body planning construction or fill activities in waters of the United States, including wetlands, must obtain a permit from the Corps of Engineers. In general, the Corps of Engineers has jurisdiction over all construction activities in tidal and/or navigable waters, including adjacent wetlands, shoreward to the mean high water line. In other areas such as non-tidal waterways, adjacent wetlands, some isolated wetlands, forested wetlands, and lakes, the Corps has regulatory authority over the discharge of dredged or fill material.

Delineation or identification of Federally regulated wetlands is not always obvious to the untrained, inexperienced individual. Thus it is important that, prior to initiating any construction in coastal areas and/or in proximity to any stream or suspected wetland area, the Corps be contacted in order to determine the nature and extent of Federal jurisdiction over the proposed activity.

In addition, state and local governments should be contacted to obtain any required authorizations. The Corps' jurisdiction often exceeds that of state and local governments. Persons planning any work in waters of the United States, including wetlands, must obtain Corps of Engineers approval prior to commencing work.

Apply for all required permits as early as possible and obtain the necessary approvals before you commence work.

4. If local or state permits have been issued, is a Corps of Engineers permit still necessary?

Yes. The Corps' jurisdiction is separate from that of local and state governments. Again, by contacting us early, the applicant can determine whether or not a Corps permit is required for the proposed work. We also recommend early contacts with appropriate local and state agencies to determine their permit requirements.

5. What will happen if I do work without getting a permit from the Corps?

Performing unauthorized work in waters of the United States or failure to comply with the terms of a valid permit can have serious consequences. You would be in violation of Federal law and could face stiff penalties, including fines and/or requirements to remove the structures and restore the area. Enforcement is an important part of the Corps regulatory program. Corps surveillance and monitoring activities are often aided by various agencies, groups, and individuals, who report suspected violations. When in doubt as to whether a planned activity needs a permit, contact the nearest Corps regulatory office.

6. Why should I waste my time and yours by applying for a permit, when you probably will not let me do the work anyway?

Those applicants denied permits usually have refused to change the design, timing or location of the proposed activity.

To avoid unnecessary delays, pre-application consultations, particularly for applications on major activities, are recommended. The Corps endeavors to give you helpful information, including factors which will be considered during the public interest review, and alternatives for your consideration that may prove useful in designing your project.

7. How can I design my project to eliminate the need for a Corps Permit?

If your activity is located in an area of tidal waters, the best way to avoid the need for a permit is to select a site that is above the high tide line and avoids wetlands or other water-bodies. In the vicinity of fresh water, stay above ordinary high water and avoid wetlands adjacent to a stream or lake. Also, it is possible that your activity is exempt and does not need a Corps Permit.

Another possibility for minor activities is that a Nationwide or a Regional General Permit may have authorized them. So, before you build, dredge or fill, contact the Corps regulatory office in your area for specific information about location, exemptions, and regional and nationwide general permits.

8. Where can I obtain forms and file my application?

For any work planned within the New York District, you may download forms from the following website: <http://www.nan.usace.army.mil/Missions/Regulatory.aspx>, or request forms by writing or calling us at the appropriate office for your area:

NEW YORK DISTRICT OFFICE

U.S. Army Corps of Engineers, New York District
Attn. Regulatory Branch
26 Federal Plaza, Room 1937
New York, NY 10278-0090

Telephone:

(917) 790-8511 for **EASTERN PERMITS SECTION** areas: New York City (the 5 Boroughs), NY State counties (Nassau, Suffolk, Westchester and Rockland), and NJ State counties (Essex, Middlesex, Passaic, Somerset, Union, and portions of Hunterdon, Mercer, Monmouth and Sussex)

(917) 790-8411 for **WESTERN PERMIT SECTION** areas: NY State counties (Dutchess, Orange, Putnam, Sullivan and Ulster), and NJ State counties (Bergen and Hudson)
Fax: (212) 264-4260

UPSTATE NEW YORK FIELD OFFICE

U.S. Army Corps of Engineers, New York District
ATTN: CENAN-OP-RU,
Bldg. 10, 3rd Floor North,
1 Buffington Street, Watervliet Arsenal
Watervliet, NY 12189-4000

Telephone:

(518)-266-6350/6360 for NY State counties (Albany, Clinton, Columbia, Delaware, Essex, Franklin, Fulton, Greene, Hamilton, Montgomery, Otsego, Rensselaer, Saratoga, Schenectady, Schoharie, Warren and Washington)

Fax: (518) 266-6366

Note: The remaining New Jersey counties are within the regulatory boundaries of the Philadelphia District. The remaining New York counties are within the regulatory boundaries of the Buffalo District.

Refer to Section VI of this guide for additional resource information.

Explanation of Some Commonly Used Terms

Certain terms which are closely associated with the regulatory program are explained in this section. If you need more detailed definitions, refer to the Code of Federal Regulations (33 CFR Parts 320 through 330) or contact a Corps district regulatory office.

Activity(ies) As used in this pamphlet, it includes building of structures (for example a pier, wharf, bulkhead, or jetty) and work (which included dredging, disposal of dredged material, filling, excavation or other modification) of a navigable water of the United States.

Best Management Practices (BMPs) Policies, practices, procedures, or structures implemented to mitigate the adverse environmental effects on surface water quality resulting from development. BMPs are categorized as structural or non-structural. A BMP policy may affect the limits on a development.

Dredged Material Material that is dredged or excavated from waters of the United States. The discharge of dredged material means any addition of dredged material into, including any redeposit of dredged material within, the waters of the United States.

Fill Material Any material used for the primary purpose of replacing an aquatic area with dry land or changing the bottom elevation of a water body. The term does not include any pollutant discharged into the water primarily to dispose of waste, as that is regulated under Section 402 of the Clean Water Act.

Headwaters Non-tidal rivers, streams, and their lakes and impoundments, including adjacent wetlands, that are part of a surface tributary system to an interstate or navigable water of the United States upstream of the point on the river or stream at which the average annual flow is less than five cubic feet per second.

High Tide Line (HTL) The line of intersection of the land with the water's surface at the maximum height reached by a rising tide. The high tide line may be determined, in the absence of other data, by a line of oil or scum along shore objects, a more or less continuous deposit of fine shell or debris on the foreshore or berm, other physical markings or characteristics, vegetation lines, tidal gages, or other suitable means that delineate the general height reached by a rising tide. The line encompasses spring high tides and other tides that occur with periodic frequency but does not include storm surges in which there is a departure from the normal or predicted reach of the tide due to the piling up of water against a coast by strong winds such as those accompanying a hurricane or other intense storm.

Isolated Waters Those non-tidal waters of the United States that are not part of a surface tributary system to interstate or navigable waters of the United States and not adjacent to such tributary water bodies.

Mean High Water Line/Mark (MHWL) The line on the shore in tidal areas established by the fluctuations of water and indicated by physical characteristics such as a clear, natural line impressed on the bank, shelving, changes in the character of soil, destruction of terrestrial vegetation, the presence of litter and debris, or other appropriate means that consider the characteristics of the surrounding area.

Navigable Waters of the United States Those waters of the United States that are subject to the ebb and flow of the tide shoreward to the mean high water mark and/or are presently used, or have been used in the past, or may be susceptible to use in the future to transport interstate or foreign commerce. These are waters that are navigable in the traditional sense where permits are required for certain activities pursuant to Section 10. This term should not be confused with the term “waters of the United States”.

Non-tidal Wetland A non-tidal wetland is a wetland (i.e., a water of the U.S.) that is not subject to the ebb and flow of tidal waters. The definition of a wetland can be found at 33 CFR 328.3(b). Non-tidal wetlands contiguous to tidal waters are located landward of the spring high tide line.

Ordinary High Water Mark (OHWM) The line on the shore in non-tidal areas established by the fluctuations of water and indicated by physical characteristics such as a clear, natural line impressed on the bank, shelving, changes in the character of soil, destruction of terrestrial vegetation, the presence of litter and debris, or other appropriate means that consider the characteristics of the surrounding area.

Pre-application Meeting/Consultation A pre-application meeting/consultation is one or more meetings between members of the District Engineer's staff and an applicant and his agent or his consultant. A pre-application consultation is usually related to applications for major activities and may involve discussion of alternatives, environmental documents, National Environmental Policy Act procedures, and development of the scope of the data required when an environmental impact statement is required.

Public Hearing A public hearing may be held to acquire information and give the public the opportunity to present views and opinions. The Corps may hold a hearing or participate in joint public hearings with other Federal or state agencies. The district engineer may specify in the public notice that a hearing will be held. In addition, any person may request in writing during the comment period that a hearing be held. Specific reasons must be given as to the need for a hearing. The district engineer may attempt to resolve the issue informally or he may set the date for a public hearing. Hearings are held at times and places that are convenient for the interested public. Very few applications involve a public hearing.

Public Interest Review This term refers to the evaluation of a proposed activity to determine probable impacts. Expected benefits are balanced against reasonably foreseeable detriments. All relevant factors are weighed. Corps policy is to provide applicants with a timely and carefully weighed decision that reflects the public interest.

Public Notice The primary method of advising interested public agencies and private parties of the proposed activity and soliciting comments and information necessary to evaluate the probable impact on the public interest. Upon request, anyone's name will be added to the distribution list to receive public notices.

Single and Complete Project The term “single and complete project” is defined at 33 CFR 330.2(i) as the total project proposed or accomplished by one owner/developer or partnership or other association of owners/developers. For linear projects, the “single and complete project” (i.e., a single and complete

crossing) will apply to each crossing of a separate water of the U.S. (i.e., a single water body) at that location. An exception is for linear projects crossing a single water body several times at separate and distant locations: each crossing is considered a single and complete project. However, individual channels in a braided stream or river, or individual arms of a large, irregularly shaped wetland or lake, are not separate water bodies.

Tidal Wetland A tidal wetland is a wetland (i.e., water of the U.S.) that is inundated by tidal waters. The definitions of a wetland and tidal waters can be found at 33 CFR 328.3(b) and 33 CFR 328.3(f), respectively. Tidal waters rise and fall in a predictable and measurable rhythm or cycle due to the gravitational pulls of the moon and sun. Tidal waters end where the rise and fall of the water surface can no longer be practically measured in a predictable rhythm due to masking by other waters, wind, or other effects. Tidal wetlands are located channelward of the high tide line (i.e., spring high tide line) and are inundated by tidal waters two times per lunar month, during spring high tides.

Waters of the United States All waters which are currently used, or were used in the past, or may be susceptible to use in interstate or foreign commerce, including all waters which are subject to the ebb and flow of the tide, as well as other waters such as intrastate lakes, rivers, streams, (including intermittent streams), mudflats, sandflats, wetlands, sloughs, prairie potholes, wet meadows, playa lakes, or natural ponds. These are waters where permits are required for the discharge of dredged or fill material pursuant to Section 404.

404 (b) (1) Guidelines (40 CFR Part 230) These Guidelines, prepared by the U.S. Environmental Protection Agency in consultation with the Corps of Engineers, are the federal environmental regulations for evaluating the filling of waters and wetlands. The Guidelines restrict discharges of dredged or fill material where less environmentally damaging, practicable alternative exist.

SECTION II Wetlands

What is a Wetland?

The U.S. Army Corps of Engineers (Corps) and the U.S. Environmental Protection Agency define wetlands as follows:

Those areas that are inundated or saturated by surface or ground water at a frequency and duration sufficient to support, and that under normal circumstances do support, a prevalence of vegetation typically adapted for life in saturated soil conditions. Wetlands generally include swamps, marshes, bogs, and similar areas.

Wetlands are areas that are covered by water or have waterlogged soils for long periods during the growing season. Plants growing in wetlands are capable of living in saturated soil conditions for at least part of the growing season. Wetlands such as swamps and marshes are often obvious, but some wetlands are not easily recognized, often because they are dry during part of the year or "they just don't look very wet" from the roadside.

Some of these wetland types include, but are not limited to, many bottomland forests, pocosins, pine savannahs, bogs, wet meadows, potholes, and wet tundra. The information presented here usually will help you to determine whether you might have a wetland. If you intend to place dredged or fill material in a wetland or in an area that might be a wetland, contact the local Corps District Office for assistance in determining if a permit is required.

Why is it necessary to consider whether an area is a wetland?

Section 404 of the Clean Water Act requires that anyone interested in depositing dredged or fill material into waters of the United States, including wetlands, must receive authorization for such activities. The Corps has been assigned responsibility for administering the Section 404 permitting process. Activities in wetlands for which permits may be required include, but are not limited to:

- Placement of fill material.
- Ditching activities when the excavated material is sidecast.
- Levee and dike construction.
- Mechanized land clearing.
- Land leveling.
- Most road construction.
- Dam construction.
- Residential and Commercial Development

The final determination of whether an area is a wetland and whether the activity requires a permit must be made by the appropriate Corps District Office.

How can wetlands be recognized?

The 1987 Corps of Engineers Wetlands Delineation Manual (1987 Manual) is the current Federal delineation manual used in the Clean Water Act Section 404 regulatory program for the identification and delineation of wetlands. The Corps uses the 1987 Manual's three characteristics of wetlands when making wetland determinations: **vegetation, soil, and hydrology**. Unless an area has been altered or is a rare natural situation, wetland indicators of all three characteristics must be present during some portion of the growing season for an area to be a wetland. Each characteristic is discussed below.

However, there are some general situations in which an area has a strong probability of being a wetland. If any of the following situations occur, you should ask the local Corps office to determine whether the area is a wetland:

- Area occurs in a floodplain or otherwise has low spots in which water stands at or above the soil surface during the growing season. **Caution: Most wetlands lack both standing water and waterlogged soils during at least part of the growing season.**
- Area has plant communities that commonly occur in areas having standing water for part of the growing season (e.g., red maple swamps, cordgrass marshes, cattail marshes, and sphagnum bogs).
- Area has soils that are called peats or mucks.
- Area is periodically flooded by tides, even if only by strong, wind-driven, or spring tides.
- Many wetlands can be readily identified by the general situation stated above. At the boundary of these areas and in numerous other wetlands, however, it is unclear whether these situations occur.

In such cases, it is necessary to carefully examine the area for wetland indicators of the three wetland parameters as identified in the 1987 Manual: vegetation, soil, and hydrology. Wetland indicators of these characteristics, which may indicate that the area is a wetland, are described on the following pages.

1. Vegetation indicators

Nearly 5,000 plant types may occur in wetlands in the United States. These plants, known as **hydrophytic vegetation**, are listed in regional publications of the U.S. Fish and Wildlife Service (USFWS). However, you can usually determine if wetland vegetation is present by knowing a relatively few plant types that commonly occur in your area. For example, red maple, tupelo, sweet gum, common reed, cattails, bulrushes, cordgrass, sphagnum moss, willows, dogwoods, sedges, rushes, sweet pepper bush, arrowwood, and arrowheads usually occur in wetlands.

Other indicators of plants growing in wetlands include trees having shallow root systems, swollen trunks (e.g., tupelo and sweet gum), or roots found growing from the plant stem or trunk above the soil surface.

If you cannot determine whether the plant types in your area are those that commonly occur in wetlands, ask the local Corps District Office or a local botanist for assistance.

2. Soil indicators

There are approximately 2,000 named soils that may occur in wetlands in the United States. Such soils, called *hydric soils*, have characteristics that indicate they were developed in conditions where soil oxygen is limited by the presence of saturated soil for long periods during the growing season. If the soil in your area is listed as hydric by the U.S. Natural Resource Conservation Service (NRCS), the area might be a wetland.

If the name of the soil in your area is not known, an examination of the soil can determine the presence of any hydric soil indicators, including:

- Soil consists predominantly of decomposed plant material (peats or mucks).
- Soil has a thick layer of decomposing plant material on the surface.
- Soil has a bluish gray or gray color below the surface, or the major color of the soil at this depth is dark (brownish black or black) and dull.
- Soil has the odor of rotten eggs.
- Soil is sandy and has a layer of decomposing plant material at the soil surface.
- Soil is sandy and has dark stains or dark streaks of organic material in the upper layer below the soil surface. These streaks are decomposed plant material attached to the soil particles. When soil from these streaks is rubbed between the fingers, a dark stain is left on the fingers.

3. Hydrology indicators

Wetland hydrology refers to the presence of water at or above the soil surface for a sufficient period of the year to significantly influence the plant types and soils that occur in the area. Although the most reliable evidence of wetland hydrology may be provided by gaging station or groundwater well data, such information is limited for most areas and, when available, requires analysis by trained individuals. Most hydrologic indicators are those that can be observed during field inspection, although inspections might not reveal the frequency, timing, or duration of flooding or the soil saturation.

However, the following indicators provide some evidence of the periodic presence of flooding or soil saturation:

- Standing or flowing water is observed on the area during the growing season.
- Soil is waterlogged during the growing season.
- Water marks are present on trees or other erect object. Such marks indicate that water periodically covers the area to the depth shown on the objects.
- Drift lines, which are small piles of debris oriented in the direction of water movement through an area, are present. These often occur along contours and represent the approximate extent of flooding in an area.
- Debris is lodged in trees or piled against other objects by water.
- Thin layers of sediments are deposited on leaves or other objects. Sometimes these become consolidated with small plant parts to form discernible crust on the soil surface.

Wetland determination

One or more indicators of wetland vegetation, hydric soil, and wetland hydrology must be present for an area to be a wetland. If you observe definite indicators of any of the three characteristics, you should seek assistance from either the local Corps District Office or someone who is an expert at making wetland determinations. Note: Use of the 1987 Manual to identify and delineate wetlands potentially subject to regulation under Section 404 is mandatory.

What to do if your area has wetlands that you propose to alter?

Contact the Corps District Office that has responsibility for the Section 404 permitting process in your area. This office will assist you in defining the boundary of any wetlands on your property, and will provide instructions for applying for a Section 404 permit, if necessary.

REFERENCES

1987 Corps of Engineers Wetlands Delineation Manual

<http://el.erdc.usace.army.mil/wetlands/>

Corps of Engineers Regulatory Program Regulations (33 CFR 320-331)

<http://www.usace.army.mil/Missions/CivilWorks/RegulatoryProgramandPermits/FederalRegulation.aspx>

Corps of Engineers Mitigation Guidelines

<http://www.nan.usace.army.mil/business/buslinks/regulat/index.php?compensatory>

National Wetland Plant List

<http://rsgisias.crrel.usace.army.mil/apex/f?p=703:1:>

NRCS Hydric Soils

<http://soils.usda.gov/use/hydric/>

SECTION III: THE PERMIT APPLICATION SUBMITTALS

Instructions for Permit Applications in New York State

[NOTE: NYSDEC and USACE share a common permit application form]

Material that should be contained in your permit application submittal:

- Joint NYSDEC & USACE Application Form :
<http://www.nan.usace.army.mil/Portals/37/docs/regulatory/geninfo/Permitapplications/Joint%20Application%20Form.pdf>
- USACE Environmental Questionnaire (EQ):
<http://www.nan.usace.army.mil/Portals/37/docs/regulatory/geninfo/Permitapplications/Environmental%20Questionnaire.pdf>
- NYSDOS Federal Consistency Assessment Form (FCAF), to be used for projects that will occur within and/or directly affect the New York State Coastal Area
<http://www.nan.usace.army.mil/Portals/37/docs/regulatory/geninfo/Permitapplications/Federal%20Cost-share%20form.pdf>
- Permit application 8 ½ by 11" Drawings set, including Vicinity Map drawing
- Color photographs of the aquatic worksite, including photo key map
- For regulated work in marine, tidal waters, which are Essential Fish Habitat (EFH), a completed EFH Worksheet or Assessment is required. This information can be downloaded from the NOAA Fisheries Service website, <http://www.nero.noaa.gov/hcd/appguide1.html>

For US Army Corps of Engineers:

Mail a original of the completed Joint Application form , one set of original, reproducible permit application drawings, one set of original color photographs and key map, one completed Environmental Questionnaire and original attachments and one copy of the signed FCAF directly to the New York District Regulatory Branch.

For New York State Department of State:

An original, signed, completed FCAF is to be mailed to the New York State Department of State at the address shown on that form, along with a photocopy of the completed Joint Application Form and completed EQ with attachments, and an additional set of project vicinity photographs and application drawings

For New York State Department of Environmental Conservation:

Mail the completed Joint Application form, along with 3 copies, to the appropriate office of the New York State Department of Environmental Conservation (NYSDEC). Include 4 sets of photographs of the project vicinity and drawings with the Joint Application Form.

Instructions for Permit Applications in New Jersey

Material that should be contained in your application submittal:

- Standard USACE Permit Application Form (ENG Form 4345):
http://www.nan.usace.army.mil/Portals/37/docs/regulatory/geninfo/Permitapplications/Eng_Form_4345_2012OCT.pdf
- USACE Environmental Questionnaire (EQ):
<http://www.nan.usace.army.mil/Portals/37/docs/regulatory/geninfo/Permitapplications/Environmental%20Questionnaire.pdf>
- New Jersey Coastal Zone Management Act Consistency Statement Form, to be used for regulated activities within the New Jersey State Coastal Zone:
<http://www.nan.usace.army.mil/Portals/37/docs/regulatory/geninfo/Permitapplications/nj-czmfo.pdf>
- Permit application 8 ½ by 11" Drawings set, including Vicinity Map drawing
- Color photographs of the aquatic worksite, including photo key map
- For regulated work in marine, tidal waters, which are Essential Fish Habitat (EFH), a completed EFH Worksheet or Assessment is required. This information can be downloaded from the NOAA Fisheries Service website, <http://www.nero.noaa.gov/hcd/appguide1.html>

For US Army Corps of Engineers:

Mail the completed ENG Form 4345 with a copy of the completed and signed NJ Coastal Zone Form, a set of vicinity photographs and project application drawings (8 ½" x 11"), a completed EQ, and a completed EFH worksheet or assessment, to the New York District office.

For New Jersey Department of Environmental Protection:

The original of the completed NJ Coastal Zone Form is to be mailed to the NJDEP LURP at the address shown on that form, along with a photocopy of the completed ENG Form and completed EQ, and an additional set of project vicinity photographs and drawings. You may download LURP form and obtain more information at the following website:

<http://www.nj.gov/dep/landuse/index.html>

ADDITIONAL GUIDANCE FOR SECTION 404 PERMIT APPLICANTS

JURISDICTIONAL DETERMINATIONS

The identification and location of jurisdictional Waters of the United States (which includes wetlands) regulated by the U.S. Army Corps of Engineers under Section 404 of the Clean Water Act of 1977, is physically determined through a process known as a jurisdictional determination (JD). The method of performing a wetland JD employs a multi-parameter approach defined in Technical Report Y-87-1, Corps of Engineers Wetlands Delineation Manual, dated January 1987, and supplemental guidance. It generally requires positive evidence of hydrophytic vegetation, hydric soils, and wetlands hydrology for a determination that an area is a wetland.

The JD process establishes a line that separates and identifies the Corps-regulated wetland areas and waters from non-wetland (upland) areas that are not regulated by the Corps. The JD provides important information to a landowner or investor for planning purposes or carrying out certain activities on a given parcel of land. It is essential in making an application for a permit from the Corps to determine if work would occur in wetlands or navigable waters of the United States.

Typically, the Corps will confirm a JD, prepared by a consultant is hired by an applicant to delineate waters of the United States on a site. Upon receipt of a request to perform a jurisdictional determination, the following procedures would be followed:

- A review to determine if the request has sufficient information to perform a jurisdictional determination. If not, a letter requesting additional information will be sent.
- Once sufficient information is received, a site visit (if needed) will be scheduled.
- During the site visit, Corps personnel will review the delineation for accuracy. If any changes are necessary they will be pointed out to the applicant/consultant so that the determination can be amended, surveyed and added onto a revised delineation drawing for Corps review/approval.
- Once the final delineation is received and reviewed, a final letter of jurisdiction will be sent.

Section 404 (b) (1) Guidelines of the Clean Water Act

If your project involves the discharge of dredged or fill material into waters and/or vegetated wetlands of the US, it will be necessary for the Corps of Engineers to evaluate your proposed activity under the Section 404 (b) (1) Guidelines. In order for the Corps to evaluate, it is required that you provide an alternatives analysis that details how your project meets the Section 404 (b) (1) Guidelines (Refer to page 21 for Alternative Analysis information). Please visit <http://www.epa.gov/owow/wetlands/pdf/40cfrPart230.pdf> for information on the 404 (b) (1) Guidelines.

The Corps must determine the “basic project purpose” after which the applicant must analyze practicable alternatives to avoid filling waters and wetlands. For individual permits, subject to public notice, the Corps uses a sequential approach of first analyzing off-site alternatives. Second, we look at on-site project modification to avoid and minimize wetland impacts. Third, we consider compensatory mitigation to replace the functions and values of wetlands unavoidably impacted. In this way the Corps follows the following sequencing to minimize impacts to wetlands: avoid, minimize, compensate.

Note that for **NON-WATER DEPENDENT [the construction project does not have to be in waters or wetlands to fulfill its basic purpose, e.g. a warehouse does not have to be in waters or wetlands to function as a warehouse]** projects, there is a required, specific presumption in the 404 (b) (1) Guidelines that practicable alternatives are available that do not involve filling wetlands and other special aquatic sites. Unless the applicant can rebut this presumption, a permit for non-water dependent fills cannot be issued. Project modification to avoid unnecessary wetland filling may result in reduced wetland impacts. These modifications may qualify the project for a general permit, in which case permit review is expedited.

If an individual permit is required including a public notice, permit application drawings should show the limits of waters, wetlands, fill and the footprint of all project elements in a clear schematic fashion (See Section IV for details on drawings requirements).

REFERENCES

1987 Corps of Engineers Wetlands Delineation Manual
<http://el.erdc.usace.army.mil/wetlands/pdfs/wlman87.pdf>

Section 404 (b) (1) Guidelines

http://water.epa.gov/lawsregs/rulesregs/cwa/upload/CWA_Section404b1_Guidelines_40CFR230_July2010.pdf

Corps of Engineers Mitigation Guidelines

<http://www.nan.usace.army.mil/business/buslinks/regulat/index.php?compensatory>

SECTION IV: GENERAL INFORMATION

FORMS OF AUTHORIZATION

Individual permits.

An *individual permit* may be issued as a standard permit, or as a Letter of Permission.

A standard permit is one processed through the typical review procedures, which includes public notice, opportunity for a public hearing, and receipt of comments. It is issued following a case-by-case evaluation of a specific activity.

A *Letter of Permission (LOP)* may be used if work is minor or routine with minimum impacts and objections are unlikely. A decision on an LOP can be issued more quickly than a standard permit since the public notice requirements are less. The district will notify you if your proposed activity qualifies for an LOP.

General permits.

Regional permits. Regional permits are a type of general permit. They may be issued by a division or district engineer after compliance with the other procedures of the regulations. If the public interest so requires, the issuing authority may condition the regional permit to require a case-by-case reporting and acknowledgement system. However, no separate applications or other authorization documents will be required.

Nationwide permits. Nationwide permits are a type of general permit and represent Department of the Army authorizations that have been issued by the regulation (33 CFR Part 330) for certain specified activities nationwide. If certain conditions are met, the specified activities can take place without the need for an individual or regional permit.

Programmatic permits. Programmatic permits are a type of general permit founded on an existing state, local or other Federal agency program and designed to avoid duplication with that program.

FEES

Fees are required for most individual permits. A \$10.00 fee will be charged for a permit for a non-commercial activity; a \$100.00 fee will be charged for a permit for a commercial or industrial activity.

The District Engineer will make the final decision as to the amount of the fee. **Do not send a fee when you submit an application.** If the Corps issues a permit, you will be notified and asked to submit the required fee payable to the Treasurer of the United States.

No fees are charged for general permits, transferring a permit from one property owner to another, for Letters of Permission, or for permits to government agencies or non-profit agencies.

PROCESSING PROCEDURE FOR AN INDIVIDUAL PERMIT

1. Pre-application consultation (optional)
2. Applicant submits application to District regulatory office (either ENG Form 4345 or Joint Federal-State Application Form in New York State)
3. Corps receives application and assigns a application file identification number
4. Corps notifies applicant that application was received, who the point of contact is, and what the application file number is.
5. Corps notifies applicant if additional information is required
6. Public Notice issued within 15 days of receiving the complete application and all necessary materials.
7. A 20 to 30 day comment period is provided, depending upon the nature of activity
8. Proposal is reviewed² by the Corps and:
 - i. Public
 - ii. Special Interest Groups
 - iii. Local agencies
 - iv. State agencies
 - v. Federal agencies
9. 404 (b) (1) Clean Water Act Guidelines determination, if applicable
10. Corps conducts Public Interest Review
11. Corps considers all comments and applicant's response to comments.
12. Other Federal agencies consulted, if appropriate
13. Corps may ask applicant to provide additional information
14. Public hearing or public meeting held, if needed
15. Decision made
16. Permit issued or permit denied and applicant is advised of decision

EVALUATION FACTORS

² Review period may be extended if applicant fails to submit information or due to requirements of other certain laws (i.e. lack of a state water quality certificate or coastal zone management general consistency concurrence).

The decision whether to grant or deny a permit is based on a public interest review of the probable impact of the proposed activity and its intended use. Benefits and detriments are balanced by considering effects on items such as:

- Conservation
- Economics
- Aesthetics
- General Environmental Concerns
- Wetlands
- Historic Properties
- Fish and Wildlife Values
- Flood Hazards
- Floodplain Values
- Land Use
- Navigation
- Shore Erosion and Accretion
- Recreation
- Water Supply and Conservation
- Water Quality
- Energy Needs
- Safety
- Mineral Needs
- Food and Fiber Production
- Considerations of Private Ownership
- Needs and Welfare of the People

The following general criteria will be considered in the evaluation of every application:

1. The relative extent of the public and private need of the proposed activity;
2. The practicability of using reasonable alternative locations and methods to accomplish the objective of the proposed activity; and,
3. The extent and permanence of the beneficial and/or detrimental effects which the proposed activity is likely to have on the public and private uses to which the area is suited.

Section 404 (b) (1) Guidelines of the Clean Water Act

If your project involves the discharge of dredged or fill material into waters and/or vegetated wetlands of the US, it will be necessary for the Corps of Engineers to evaluate your proposed activity under the Section 404 (b) (1) Guidelines. In order for the Corps to evaluate, it is required that you provide an alternatives analysis that details how your project meets the Section 404 (b) (1) Guidelines (Refer to page 21 for Alternative Analysis information). Please visit <http://www.epa.gov/owow/wetlands/pdf/40cfrPart230.pdf> for information on the 404 (b) (1) Guidelines.

Section V: Permit Applications Drawings

PERMIT APPLICATION DRAWINGS SET - GENERAL

Three types of drawings – Vicinity Map, Plan View, and Elevation View – are required to accurately depict activities (See sample drawings following this section).

Submit one **original** or **very good quality copy**, of all black and white drawings on 8.5 inches by 11 inches white paper.

Submit the fewest number of sheets necessary to adequately show the proposed activity. Drawings should be clear, legible, and prepared in accordance with the general format of the samples, using block style lettering. Each map and drawing should have a title block. See check list below. Drawings do not have to be prepared by an engineer, but professional assistance may become necessary if the project is large or complex.

Leave a 1-inch margin at the top of each sheet for purposes of Corps of Engineers labeling, reproduction and binding.

In the title block of each sheet of drawings, identify the proposed activity and include the name of the waterbody, river mile (if applicable); name of county and state; name of applicant; number of the sheet and total number of sheets in set; and, date the drawing was prepared.

Since all drawings must be reproduced, use heavy dark lines. Color shading cannot be used because it does not reproduce well; however, dot shading, hatching, or similar graphic symbols maybe used to clarify line drawings.

VICINITY MAP (MUST BE FIRST DRAWING)

The vicinity map you must provide is the first and most important drawing and will be used by the Corps of Engineers and other reviewing agencies to locate the site of the proposed activity. It also is the first drawing in any required public notice for your project. You may use an existing road map such as Hagstrom or U.S. Geological Survey topographic map as the Vicinity Map, with a proper title block. Please include sufficient details to simplify locating the site from both the waterbody and from land. Identify the source of the map or chart from which the Vicinity Map drawing was taken and, if not already shown, add the following:

- Title Block
- Location of activity site (draw an arrow showing the exact location of the site on the map);
- Latitude and longitude;
- Name of waterbody and the name of the larger creek, river, bay, etc., that the waterbody/wetland is immediately tributary to;
- Names, descriptions and location of landmarks;

- Name of all applicable political (county, parish, borough, town, city, etc.) jurisdictions;
- Name of and distance to nearest town, community, or other identifying locations;
- Names or numbers of all roads in the vicinity of the site;
- North arrow; and,
- Scale, both graphic and numerical.

PLAN VIEW

The plan view shows the proposed activity as if you were looking straight down on it from above. Your plan view should clearly show the following:

- Title Block
- Name of waterbody (river, creek, lake, wetland, etc.) and river mile (if known) at location of activity;
- Existing shorelines;
- Tidal areas: mean high, mean low and spring high tide lines, and direction of ebb and flood of tide;
- Non-tidal areas: ordinary high water line and ordinary low water line; direction of flow;
- Wetland boundary as delineated and surveyed using the three-parameter approach found in the 1987 Corps of Engineers Wetland Delineation Manual;
- Current average water depths around the activity;
- Existing and proposed ground contours or spot elevations;
- Vertical datum (reference elevation);
- All project elements, including access roadways, parking areas, buildings, utility lines, detention ponds, and all property lines at site;
- Dimensions of the activity and distance it extends from the high water/spring high tide lines into tidal waters or from ordinary high water line into freshwater and wetlands;
- Distances to nearby Federal projects³, if applicable;

³ For projects that are located within 200-feet of a Federally maintained navigation channel or flood risk management project (new structures as well as extensions to existing structures), the applicant must provide state plane coordinates of the seaward ends of the proposed structures, which must be included on plans.

- Distance between proposed activity and navigation channel, where applicable;
- Location of structures, if any, in navigable waters immediately adjacent to the proposed activity, in narrow waterbodies show width of waterway and include structures located across from proposed work; if no structures present, identify on drawings;
- Location of the 100-year, 500-year, and regulatory floodway boundaries as shown on the current effective National Flood Insurance Program maps, if applicable;
- North arrow;
- Graphic scale;
- Dimensions of all filling in waters and wetlands, including backfill and temporary fill for structures such as cofferdams and access roads; structure should be identified by length and width; and, fills should be identified in square-feet.
- If dredged material is involved, you must describe the type of material, number of cubic yards, method of handling, and the location of fill and disposal area. The drawing should show proposed retention levees, weirs, and/or other means for retaining hydraulically placed materials;
- If upland disposal is proposed, show on a plan the proposed detention levees, weirs, dewatering structures, and/or other means of retaining the material. Include the capacity and the points of return flow into the aquatic system; and,
- Mark the drawing to indicate previously completed portions of the activity.

ELEVATION AND/OR CROSS-SECTION VIEW

The elevation and/or cross section view is a scale drawing that shows the side, front, or rear of the proposed activity. If a section view is shown, it represents the proposed structure as it would appear if cut internally for display. Your elevation should clearly show the following:

- Title Block
- Water elevations as shown in the plan view;
- Water depth at waterward face of proposed activity or, if dredging is proposed, the depth of dredging, estimated disposal grades, and volume of dredged (in cubic yards) or fill material (in square-feet). In non-tidal bodies, indicate volumes in cubic yards and square-feet below ordinary high water or in wetlands;
- Dimensions from mean high water line (in tidal waters) for proposed floating or pile-supported structures or dimensions from high tide line or the upland edge of

- wetland or fill. Describe dimensions and square-footage of any facility where you proposed to build the structures or fill;
- Approximate side slopes;
- Existing and proposed ground contours or spot elevations;
- Vertical datum (reference elevation);
- Graphic scale; and,
- Principal dimensions of activity.

Notes on Drawings

- Names and mailing address of adjacent property owners who may be affected.
- Legal property description: Number, name of subdivision, block and lot number. Section, Township and Range (if applicable) from plot, deed or tax assessment.
- Drawings should be clear and simple as possible (i.e. not too “busy”).

DREDGING PROJECTS

Applications for dredging projects must submit the following information to the appropriate office of the Corps of Engineers.

- Plan view with existing bottom depths;
- Section view;
- Amount of material to be dredged;
- Proposed dredging depth;
- Method of dredging (hydraulic or mechanical);
- Stipulate maintenance or new dredging;
- Disposal site for dredged material;
- Show the location of any discharges on the plan and any potential non-point sources of pollution;
- Point source discharges/spills must be investigated. This information may be obtained from the local harbormaster, U.S. Coast Guard, NJDEP, or NYSDEC;
- Submit any previous dredged material or sediment test data (either at your site or a nearby site), with sampling station locations shown on a plan;

- If the disposal site is upland, specify the site on a map; provide the site's existing characteristics (normal use, landscape; prior to use as a disposal site, any aquifers in the area?);
- Method of containment; dike or depression;
- Specify the materials to be used for berm construction and the construction method;
- Specify the method of transporting the dredged material from the site to the disposal area (pipeline, sealed trucks);
- Submit grading plans;
- Specify containment site capacity calculations; and,
- If open water disposal is chosen as the disposal site for the material to be dredged, please submit a detailed upland disposal alternatives analysis. This analysis should include the names and addresses of nearby landfills or other available upland disposal sites that were looked into as well as the immediate upland availability.

SAMPLE Permit Application Drawings

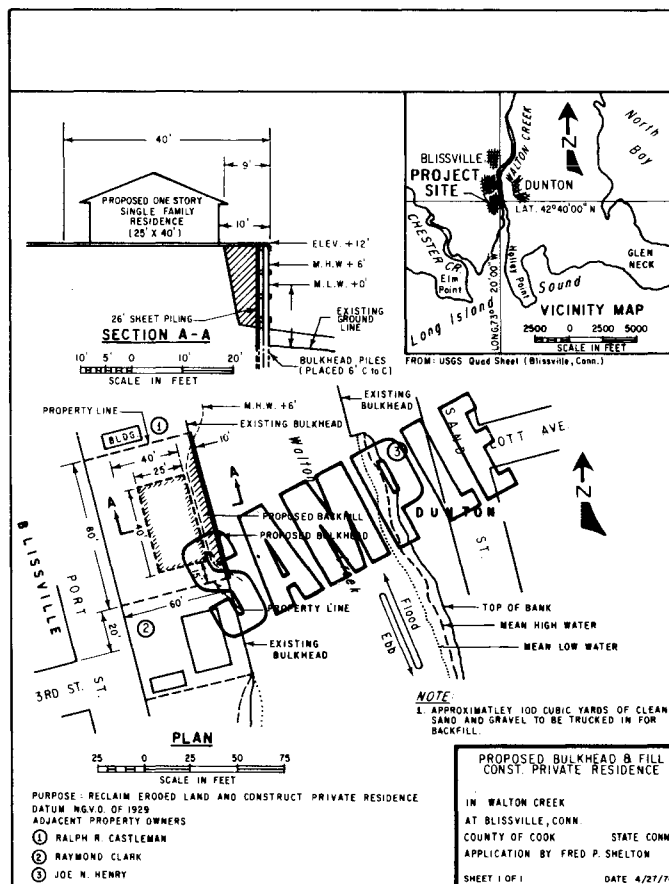

The sample application drawings shown here and on the following page are examples of the type of drawings that should be submitted with ENG Form 4345 for simple projects. For complicated structures and activities, more detailed drawings are required.

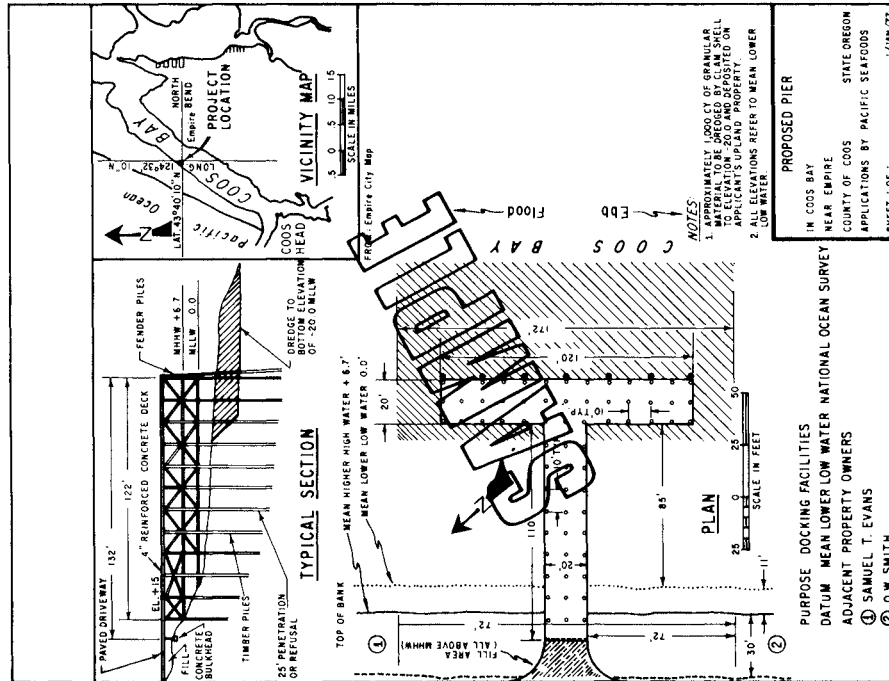
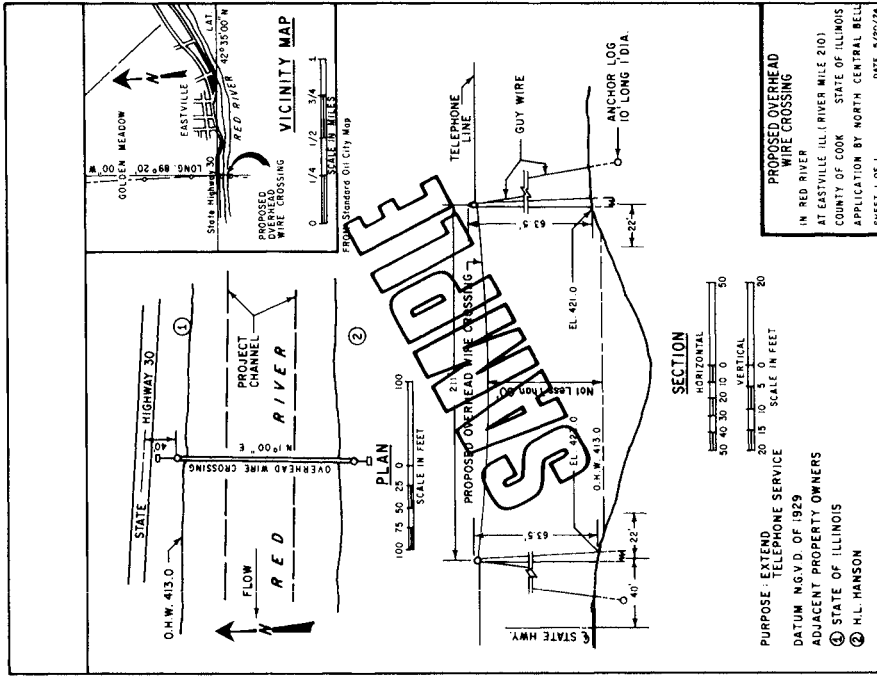

SAMPLE DRAWINGS FOR A PERMIT APPLICATION

NOTE: THE DRAWINGS SUBMITTED NEED NOT BE PREPARED BY A PROFESSIONAL DRAFTSMAN AS IN THESE SAMPLES.

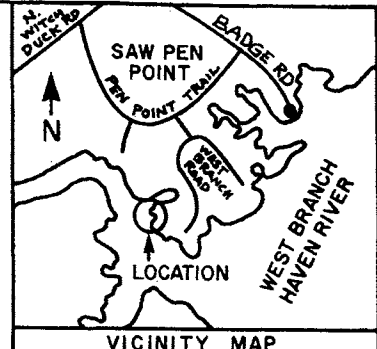
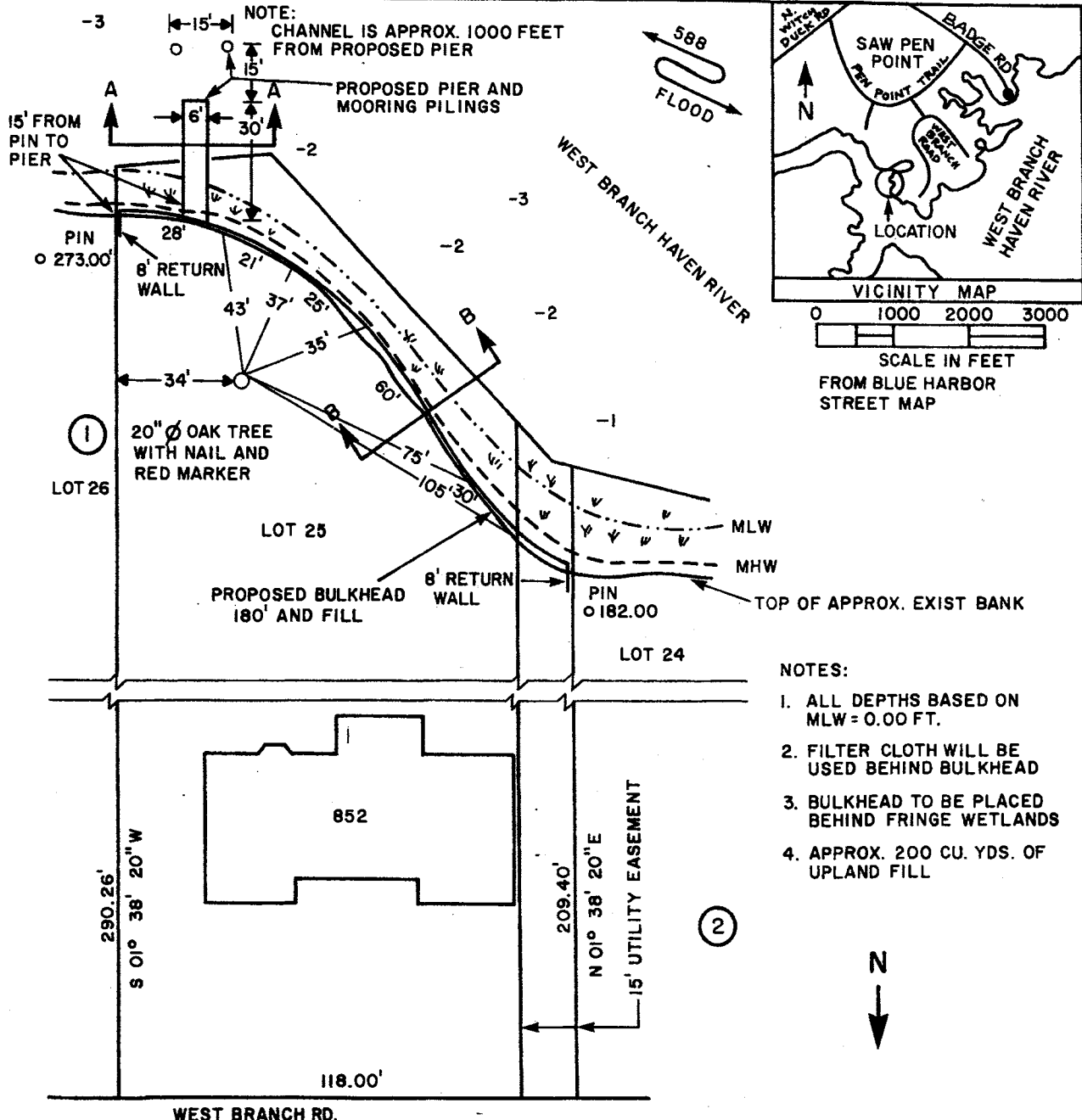

- NOTES:
1. ALL DEPTHS BASED ON MLW = 0.00 FT.
 2. FILTER CLOTH WILL BE USED BEHIND BULKHEAD
 3. BULKHEAD TO BE PLACED BEHIND FRINGE WETLANDS
 4. APPROX. 200 CU. YDS. OF UPLAND FILL



PURPOSE: PREVENT EROSION AND PROVIDE BOATING ACCESS

DATUM: MLW

ADJACENT PROPERTY OWNERS:

1. MARY L. CLARK
2. HARRY N. HAMPTON
- 3.

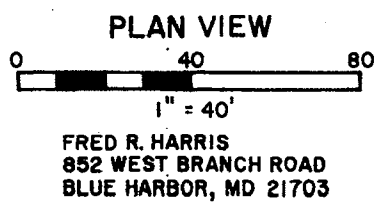

PROPOSED BULKHEAD PIER AND FILL

IN: WEST BRANCH HAVEN RIVER

AT: BLUE HARBOR

COUNTY OF: KING EDWARD **STATE:** MD

APPLICATION BY: FRED R. HARRIS

SHEET 1 OF 2 DATE 10-16-82

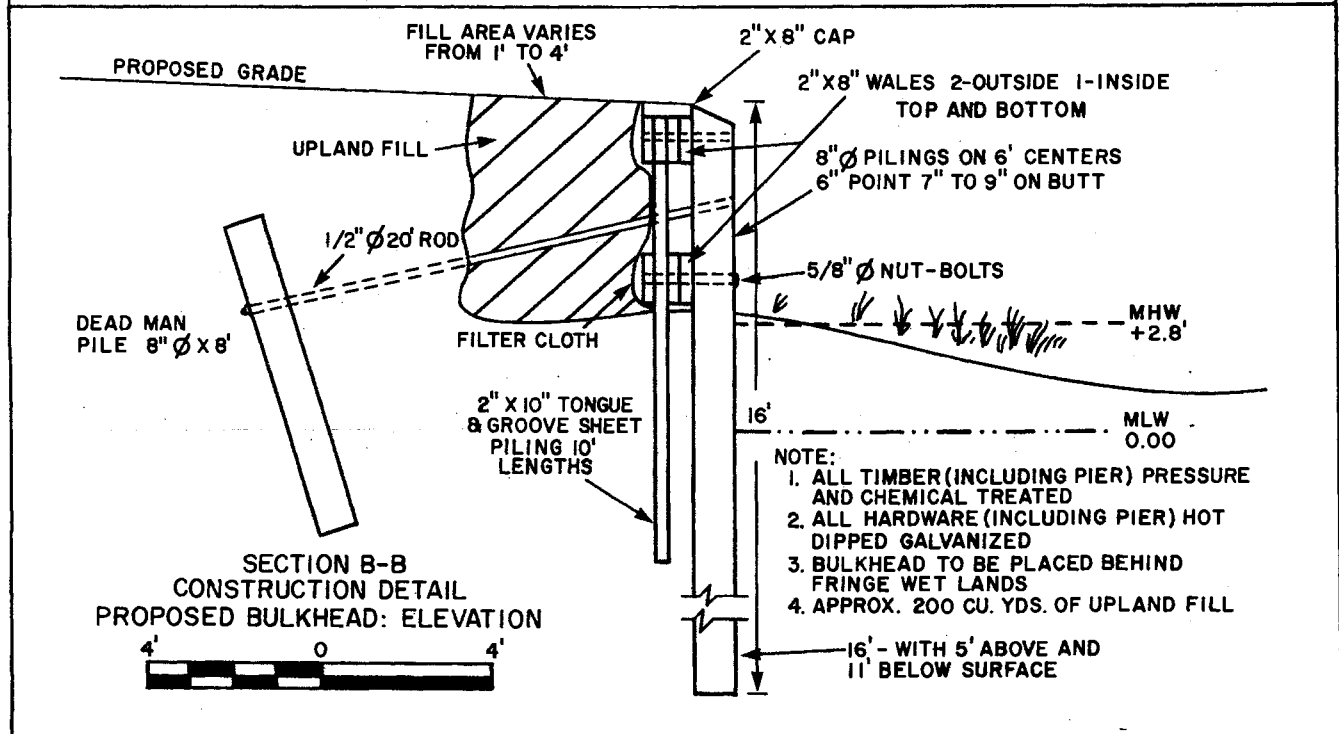
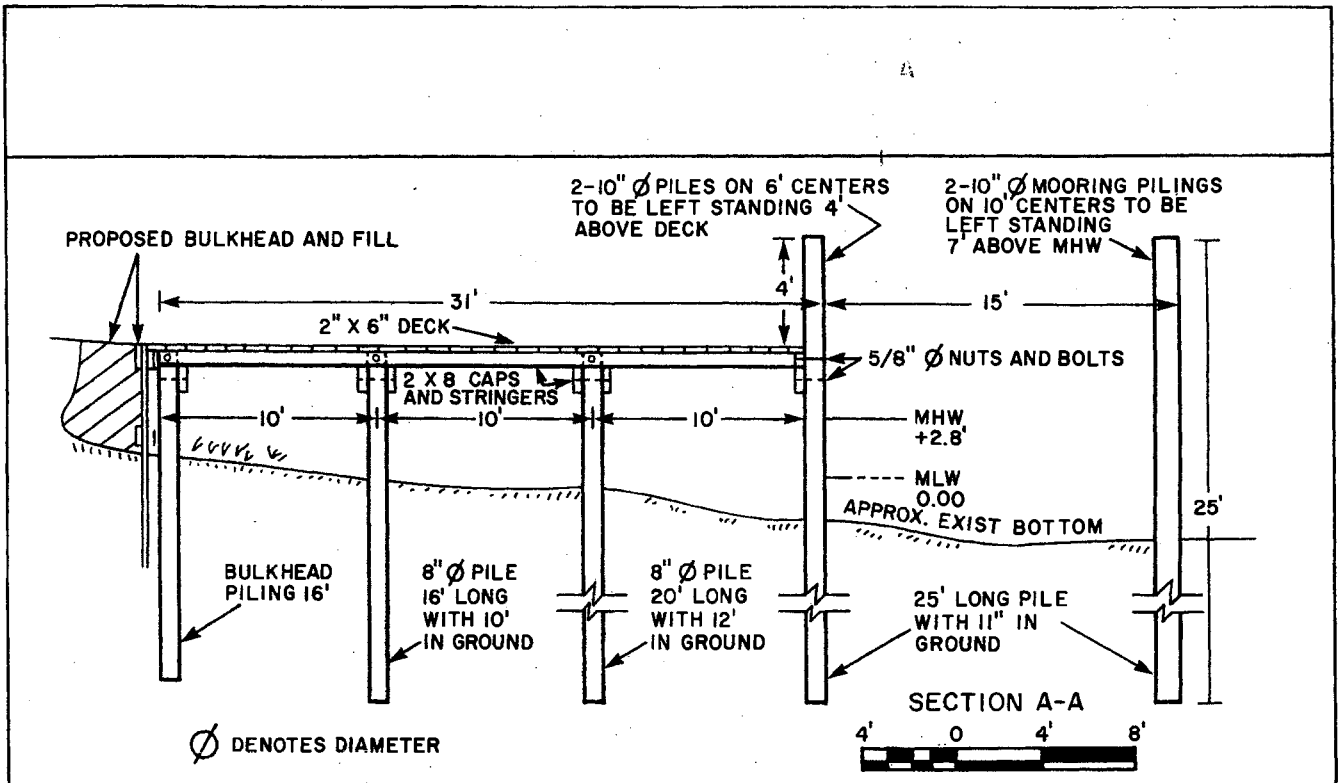

PURPOSE: PREVENT EROSION AND PROVIDE BOATING ACCESS

DATUM: MLW

ADJACENT PROPERTY OWNERS:

1. MARY L. CLARK
2. HARRY N. HAMPTON
- 3.

SECTION VIEWS

FRED R. HARRIS
852 WEST BRANCH ROAD
BLUE HARBOR, MD 21703

PROPOSED BULKHEAD PIER AND FILL

IN: WEST BRANCH HAVEN RIVER
AT: BLUE HARBOR
COUNTY OF: KING EDWARD STATE: MD
APPLICATION BY: FRED R. HARRIS

SHEET 2 OF 2 DATE 10-16-82

SUBMARINE AND AERIAL CABLE ACTIVITIES

Sample Drawing - the type of drawing which is required by the reporting procedure

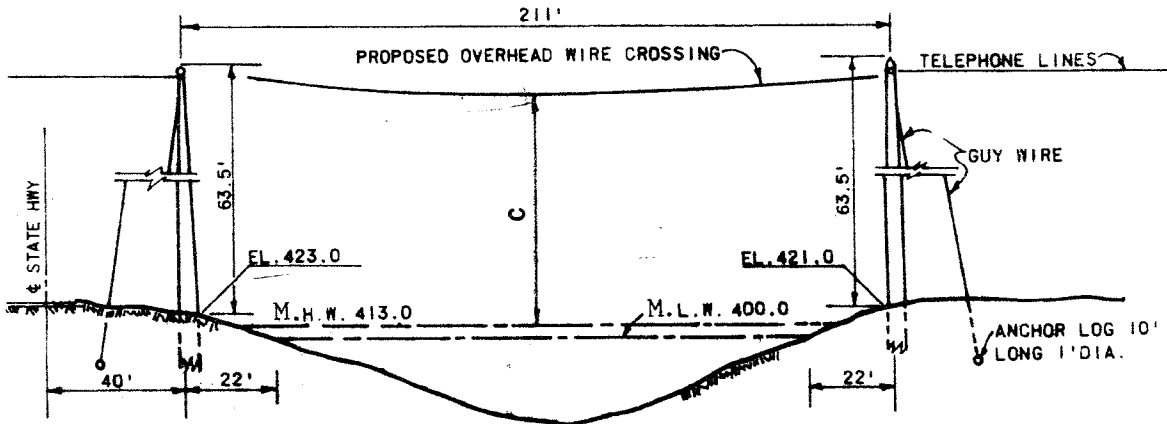
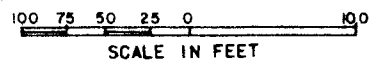
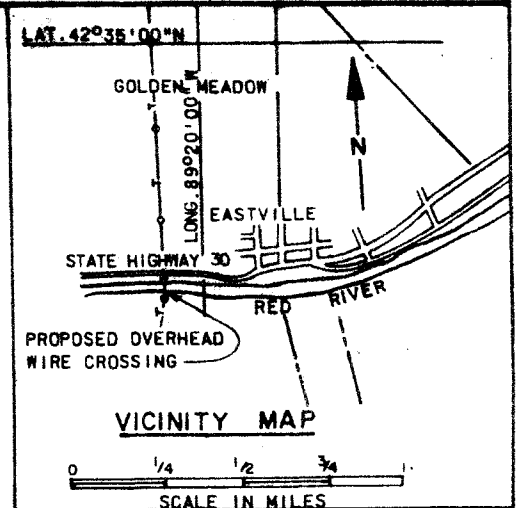
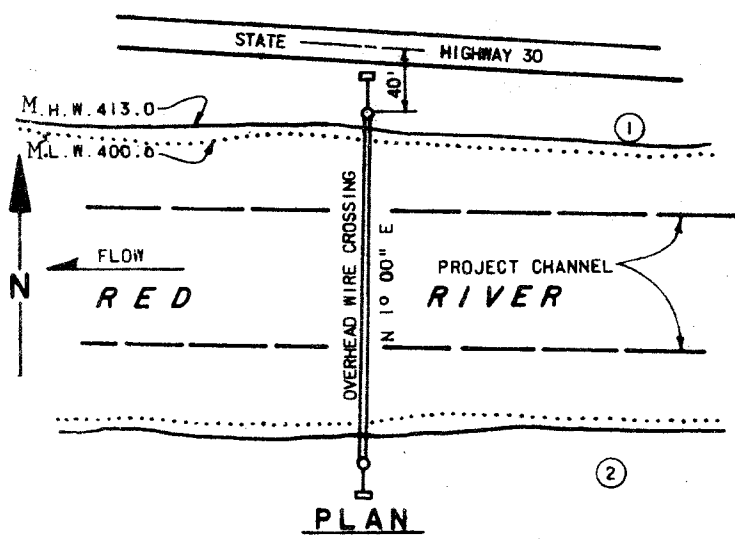

C =
Clearance (ft.)
as established in
condition (b) of the
general permit.

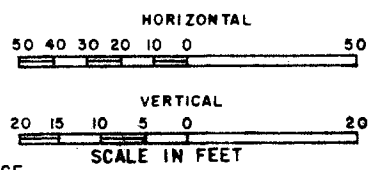

PURPOSE: EXTEND TELEPHONE SERVICE
 DATUM MEAN SEA LEVEL
 ADJACENT PROPERTY OWNERS:
 ① STATE OF ILLINOIS
 ② H. L. HANSON

PROPOSED OVERHEAD WIRE CROSSING
 IN RED RIVER
 AT EASTVILLE ILL. (RIVER MILE 210)
 COUNTY OF COOK STATE ILLINOIS
 APPLICATION BY NORTH CENTRAL BELL

SHEET 1 OF 1 DATE 5/20/74

SUBMARINE AND AERIAL CABLE ACTIVITIES

Sample Drawing - the type of drawing which is required by the reporting procedure

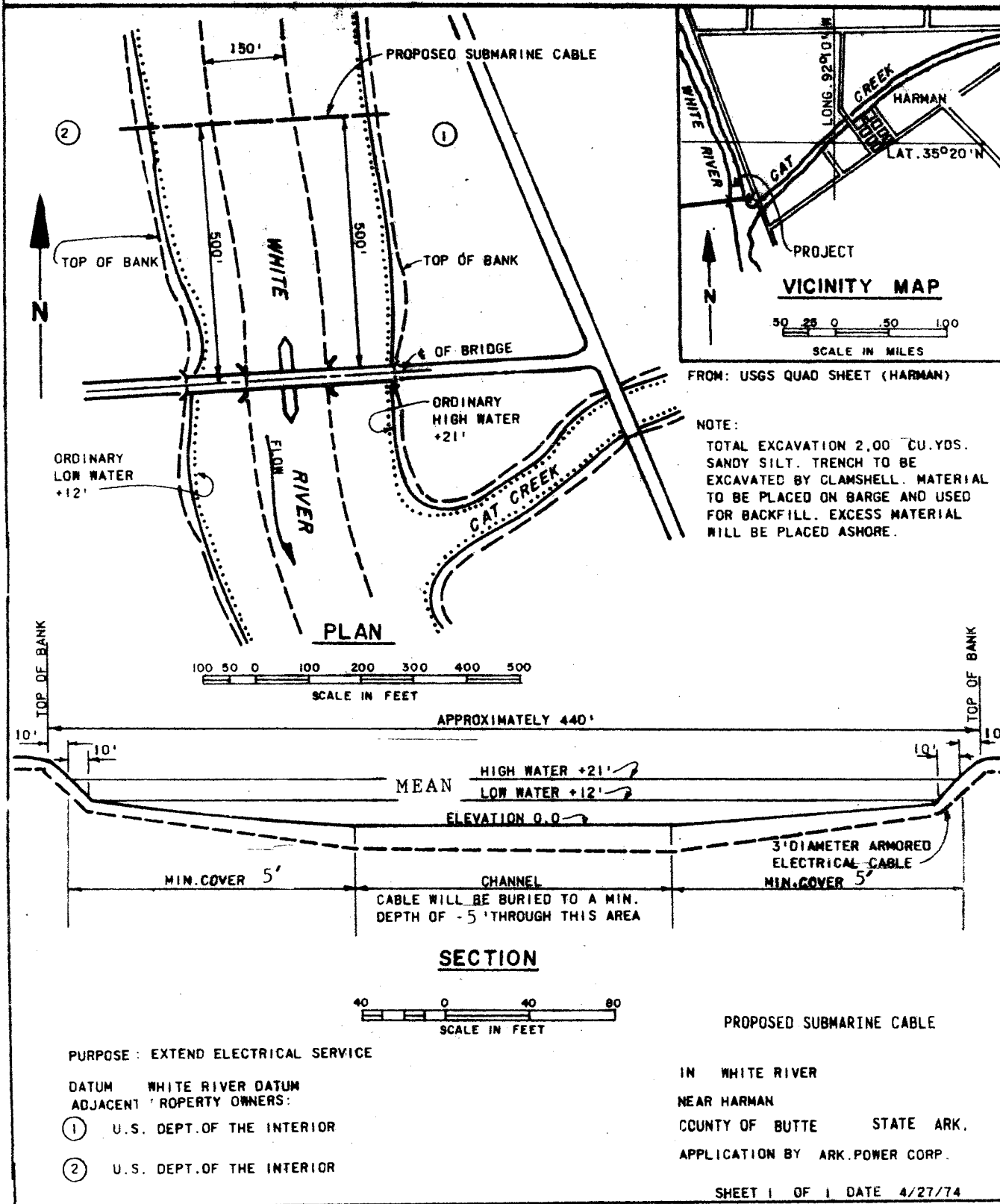

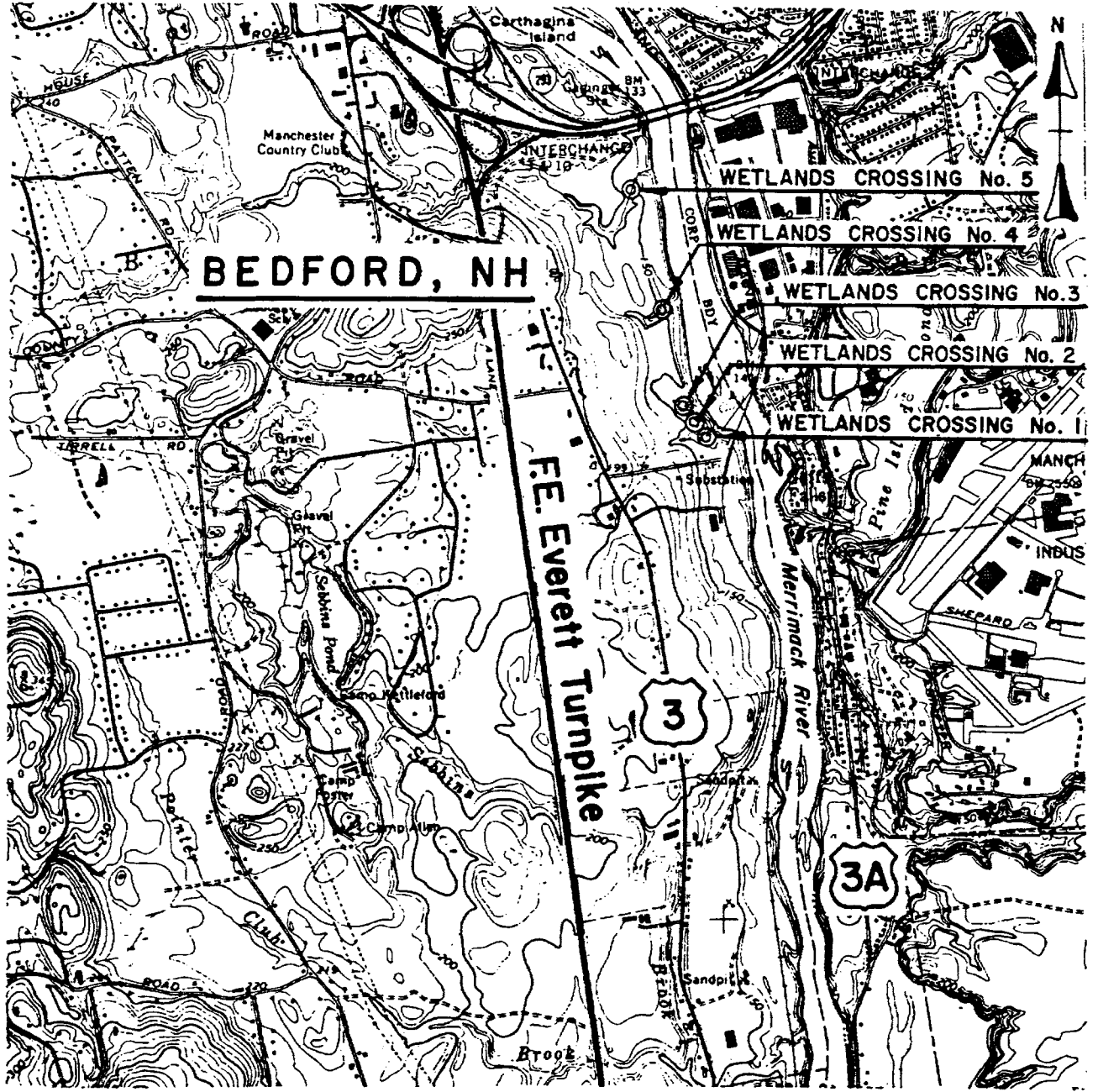

Map Source : U.S.G.S. 7.5' Quadrangle , Manchester South, NH , 1985

PURPOSE : WASTEWATER COLLECTION SYSTEM
 DATUM : NGVD 1929
 ADJACENT PROPERTY OWNERS :
 SEE ATTACHED SHEETS

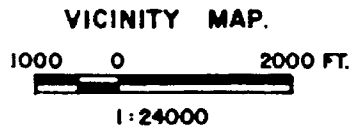

TOWN OF BEDFORD, NH
 PUBLIC WORKS DEPARTMENT
 24 NORTH AMHERST ROAD
 BEDFORD, NH 03102

SEWER INTERCEPTOR
 WETLANDS CROSSINGS
 ADJACENT TO : MERRIMACK RIVER
 AT : TOWN OF BEDFORD
 COUNTY : HILLSBOROUGH, STATE : NH
 APPLICATION BY : TOWN OF BEDFORD
 SHEET 1 OF 12 DATE : AUGUST 15, 1990

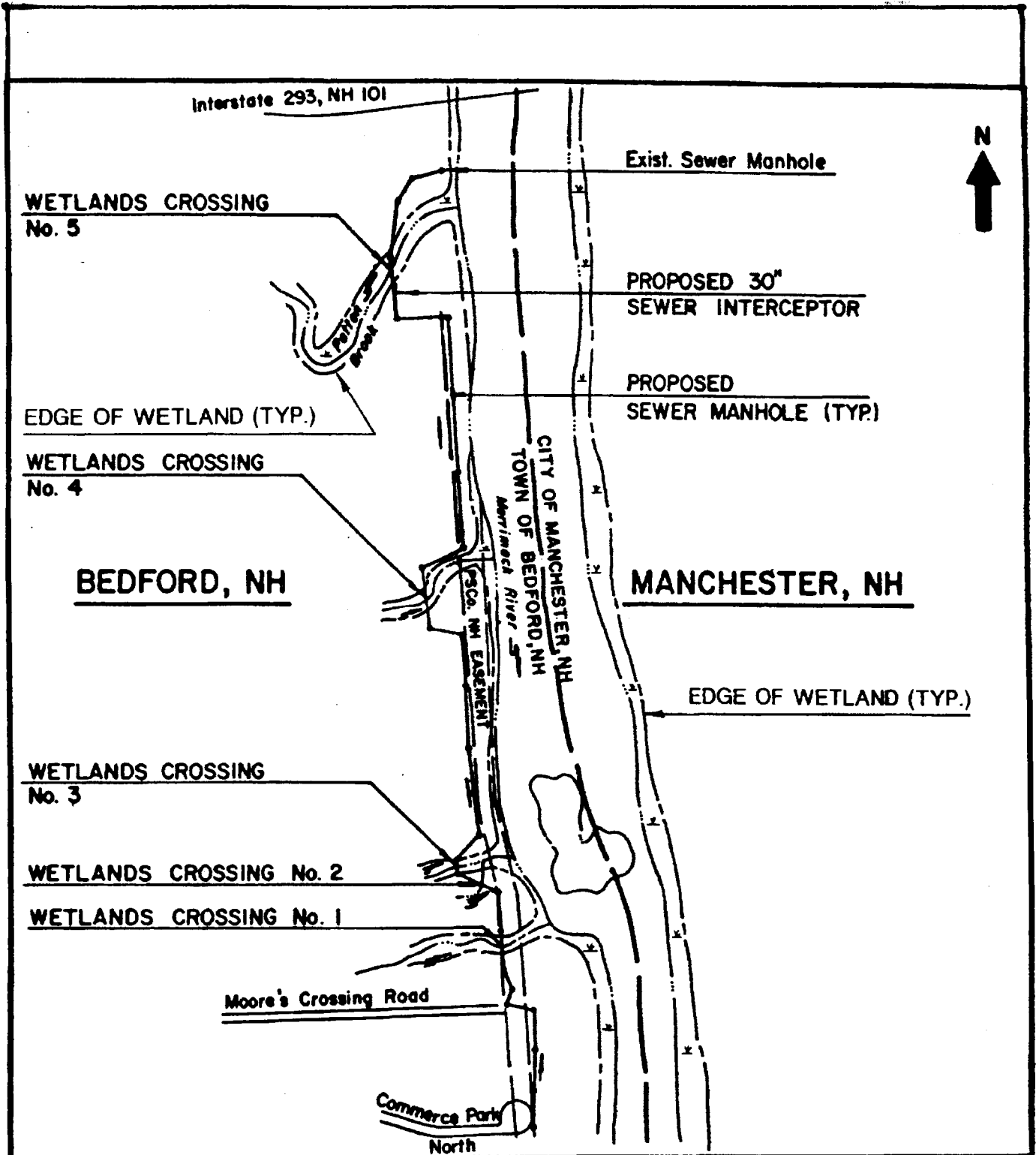

PURPOSE: WASTEWATER COLLECTION SYSTEM
DATUM: NGVD 1929
ADJACENT PROPERTY OWNERS:
SEE ATTACHED SHEETS

OVERALL PLAN
NOT TO SCALE
TOWN OF BEDFORD, NH
PUBLIC WORKS DEPARTMENT
24 NORTH AMHERST ROAD
BEDFORD, NH 03102

SEWER INTERCEPTOR WETLANDS CROSSINGS
ADJACENT TO: MERRIMACK RIVER
AT: TOWN OF BEDFORD
COUNTY: HILLSBOROUGH, STATE: NH
APPLICATION BY: TOWN OF BEDFORD
SHEET 2 OF 12 DATE: AUGUST 18, 1990

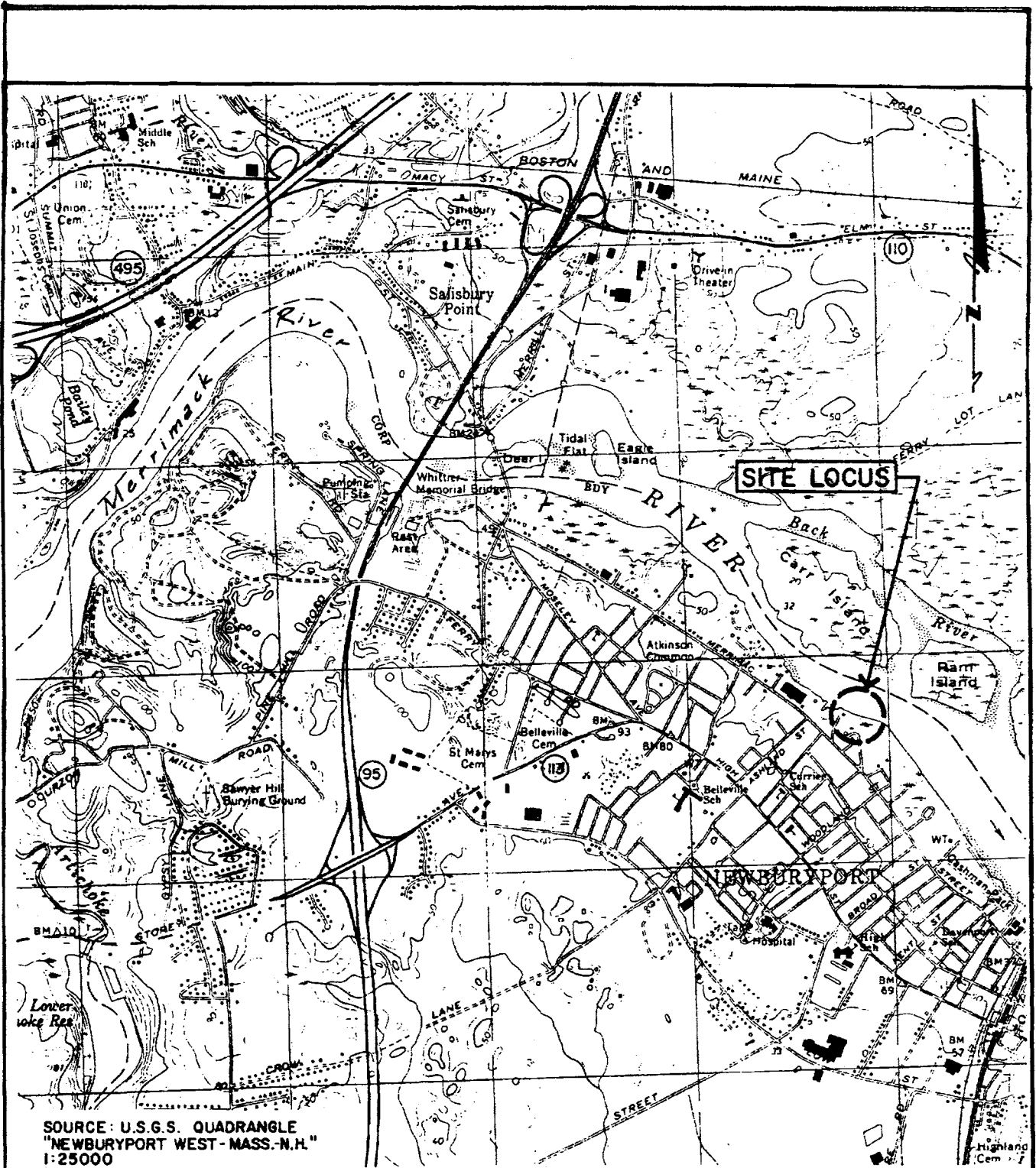

SOURCE: U.S.G.S. QUADRANGLE
 "NEWBURYPORT WEST-MASS.-N.H."
 1:25000

PURPOSE: ENLARGE MARINA
 CREATING ADDITIONAL SLIPS

DATUM: MLW = 0.0
 MHW = 7.5
 HTL = 7.8

CARMICHAEL ASSOCIATES, INC.
 1898 MERCER STREET SUITE 42
 PORTLAND, MAINE

VICINITY MAP

PROPOSED MARINA PLAN IN:
 MERRIMACK RIVER
 AT: 3-R MARINA
 COUNTY OF: ESSEX, MA.

APPLICATION BY:
 SIMON REALTY TRUST

DATE: MAY 1989 SHEET 1 of 5

LEGEND

- : EDGE OF WETLANDS
- : LIMIT OF AREA TO BE DISTURBED
- ▨ : AREA TO BE DISTURBED = 170 S.F.

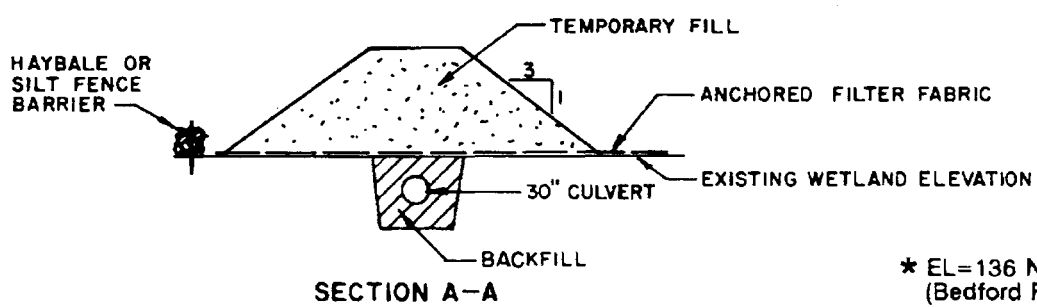
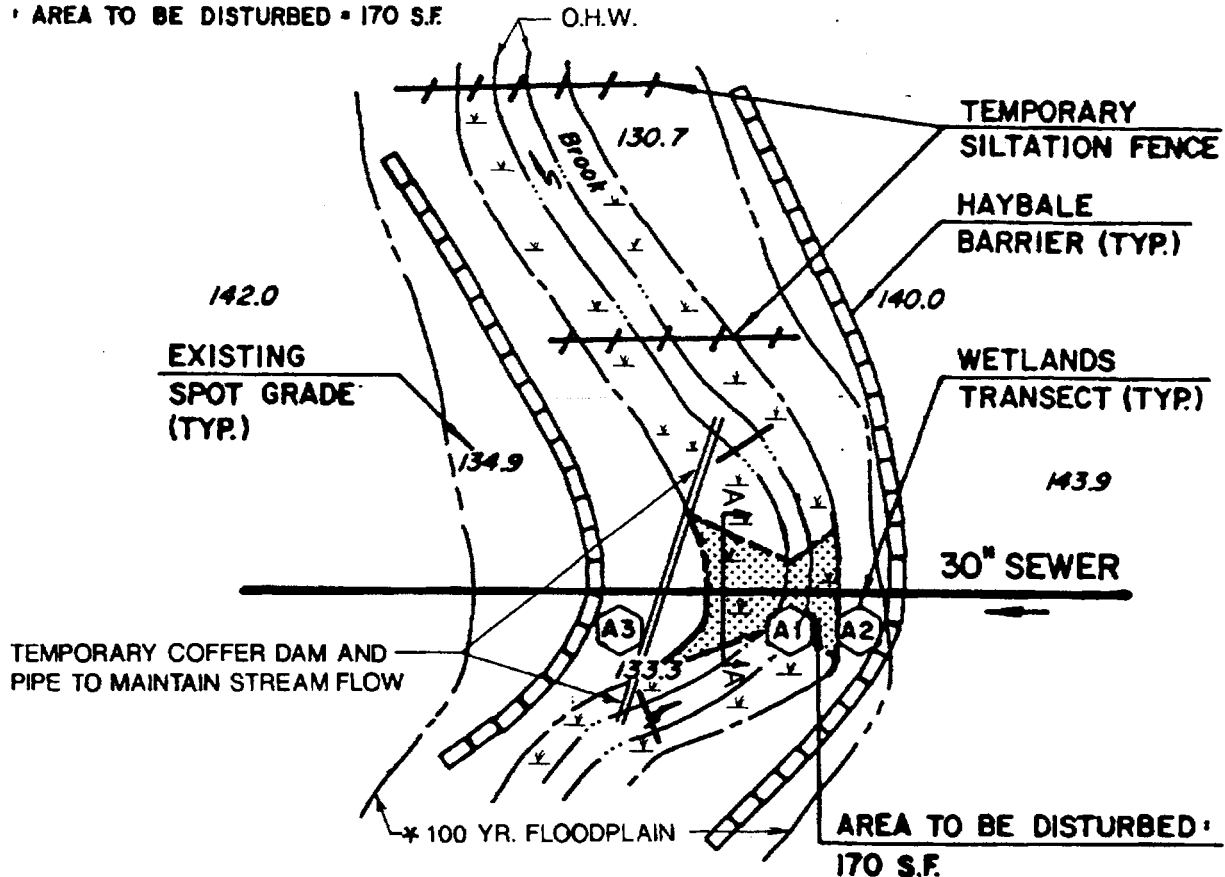

* EL=136 NGVD
(Bedford FIRM 4/16/79)
No Floodway Published
CROSSING No. 1

PURPOSE: WASTEWATER COLLECTION SYSTEM
DATUM: NGVD 1929
ADJACENT PROPERTY OWNERS:
 SEE ATTACHED SHEETS

PLAN VIEW: CROSSING No. 1
 10 0 20 FT.

 TOWN OF BEDFORD, NH
 PUBLIC WORKS DEPARTMENT
 24 NORTH AMHERST ROAD
 BEDFORD, NH 03108

SEWER INTERCEPTOR WETLANDS CROSSINGS
 ADJACENT TO: MERRIMACK RIVER
 AT: TOWN OF BEDFORD
 COUNTY: HILLSBOROUGH, STATE: NH
 APPLICATION BY: TOWN OF BEDFORD
 SHEET 3 OF 12 DATE: AUGUST 15, 1990

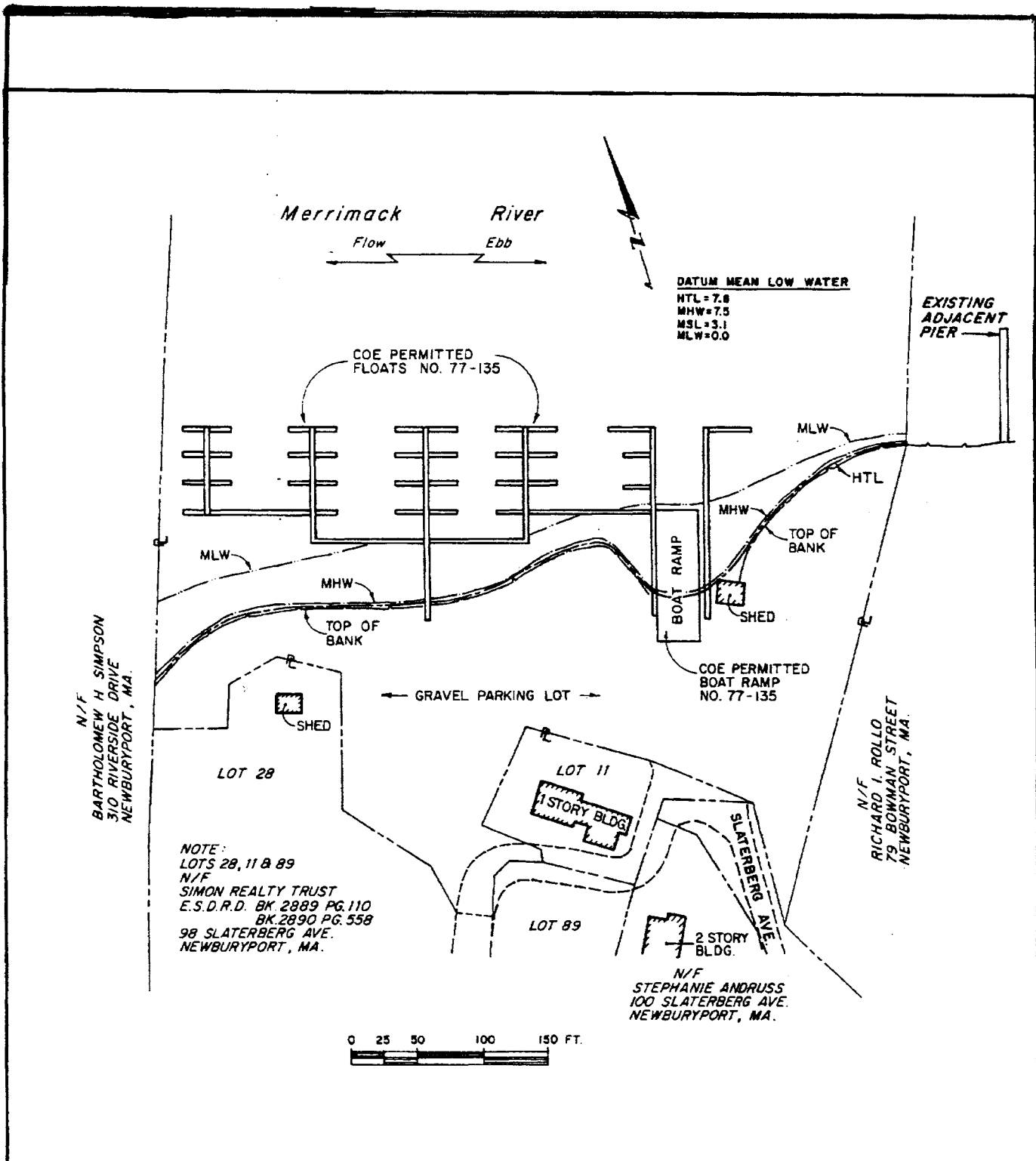

PURPOSE : ENLARGE MARINA
CREATING ADDITIONAL SLIPS

DATUM : MLW = 0.0
MHW = 7.5
HTL = 7.8

CARMICHAEL ASSOCIATES, INC.
1898 MERCER STREET SUITE 42
PORTLAND, MAINE

EXISTING MARINA

PROPOSED MARINA PLAN IN:
MERRIMACK RIVER

AT: 3-R MARINA
COUNTY OF: ESSEX, MA.

APPLICATION BY:
SIMON REALTY TRUST

DATE: MAY 1989 SHEET 2 of 5

STATE PLANE COORDINATES

	N	E
1	665349	764733
2	665329	764822
3	665247	764907
4	665205	764996
5	665139	765072
6	665092	765150
7	664937	765085

Merrimack River

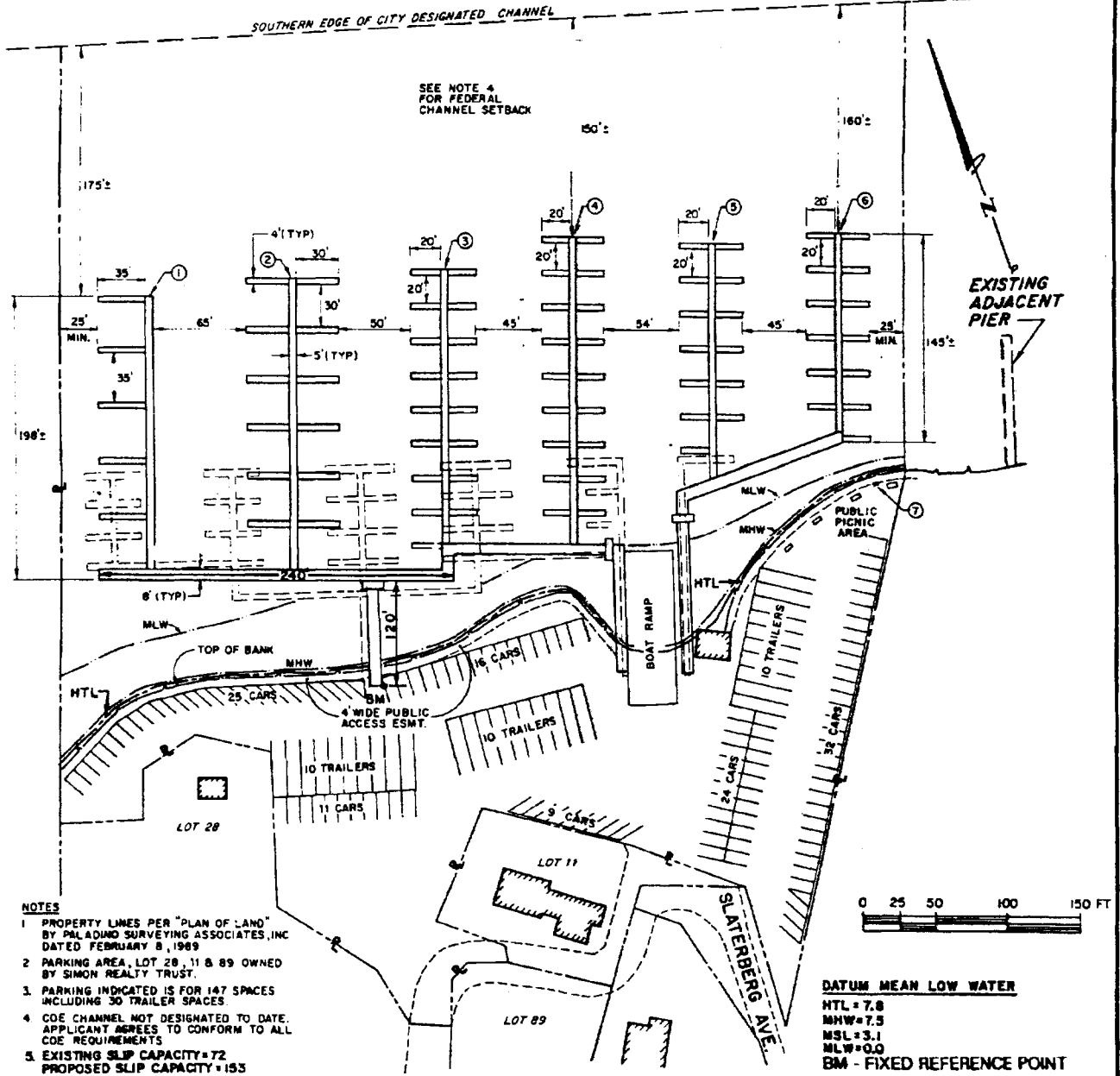
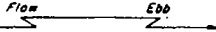

NOTES

1. PROPERTY LINES PER "PLAN OF LAND" BY PALADINO SURVEYING ASSOCIATES, INC DATED FEBRUARY 8, 1989
2. PARKING AREA, LOT 28, 11 & 89 OWNED BY SIMON REALTY TRUST.
3. PARKING INDICATED IS FOR 147 SPACES INCLUDING 30 TRAILER SPACES.
4. COE CHANNEL NOT DESIGNATED TO DATE. APPLICANT AGREES TO CONFORM TO ALL COE REQUIREMENTS
5. EXISTING SLIP CAPACITY = 72
PROPOSED SLIP CAPACITY = 153

PURPOSE : ENLARGE MARINA
CREATING ADDITIONAL SLIPS

DATUM: MLW = 0.0
MHW = 7.5
HTL = 7.8

CARMICHAEL ASSOCIATES, INC.
1898 MERCER STREET SUITE 42
PORTLAND, MAINE

**PROPOSED
MARINA
PLAN VIEW**

PROPOSED MARINA PLAN IN:
MERRIMACK RIVER

AT: 3-R MARINA

COUNTY OF: ESSEX, MA.

APPLICATION BY:
SIMON REALTY TRUST

DATE: MAY 1989 SHEET 3 of 5

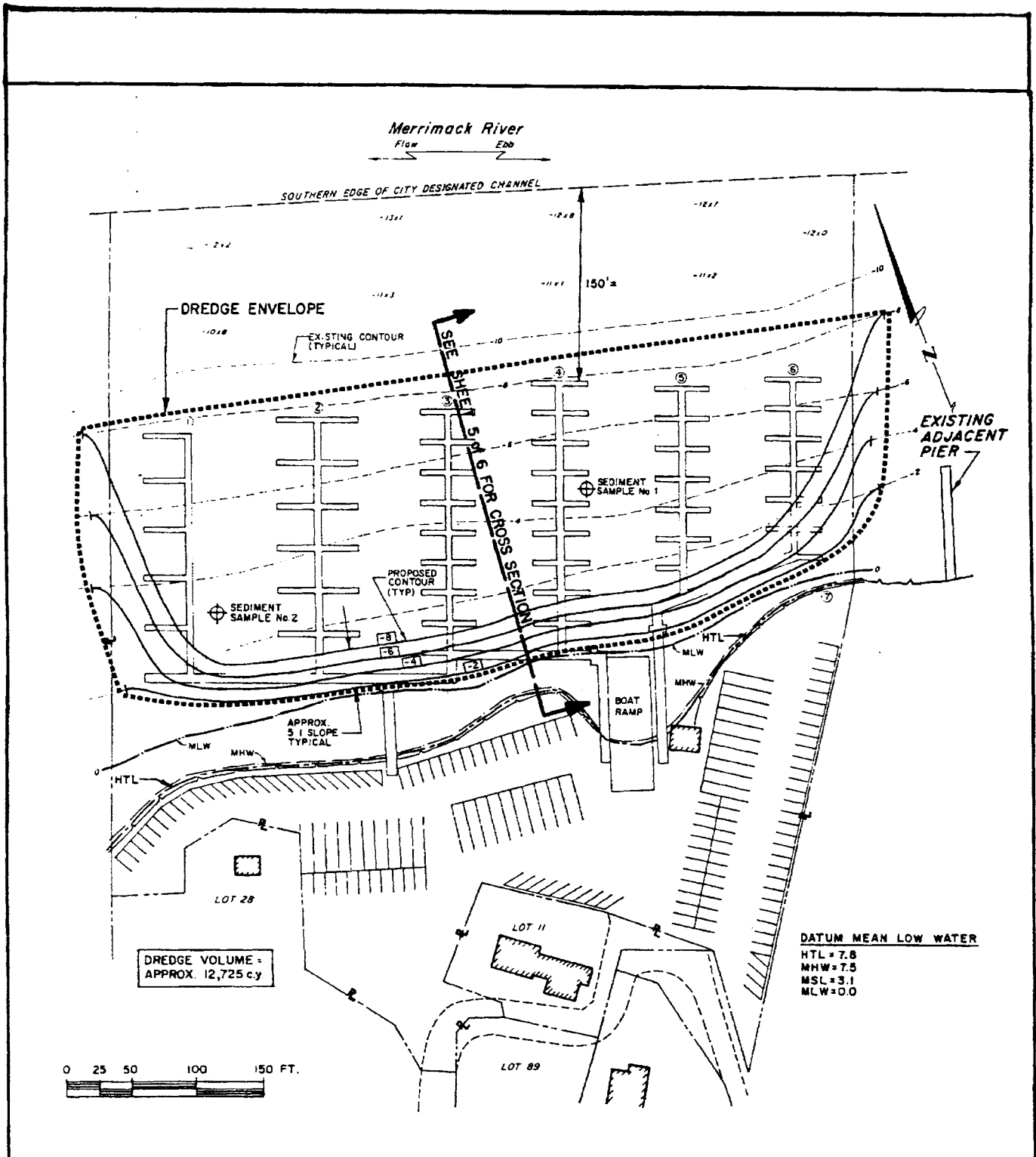

PURPOSE: ENLARGE MARINA
CREATING ADDITIONAL SLIPS

DATUM: MLW = 0.0
MHW = 7.5
HTL = 7.8

CARMICHAEL ASSOCIATES, INC.
1898 MERCER STREET SUITE 42
PORTLAND, MAINE

DREDGING PLAN

PROPOSED MARINA PLAN IN:
MERRIMACK RIVER
AT: 3-R MARINA

COUNTY OF: ESSEX, MA.

APPLICATION BY:
SIMON REALTY TRUST

DATE: MAY 1989 SHEET 4 of 5

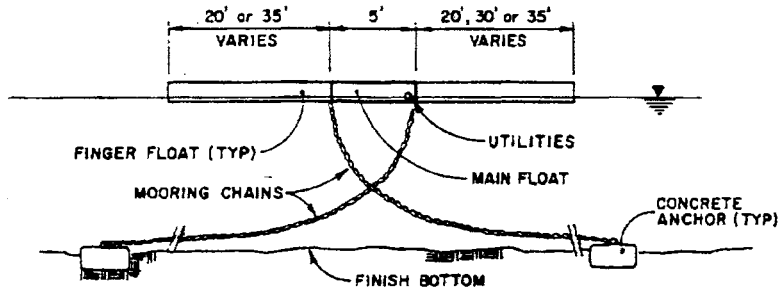

TYPICAL CROSS SECTION THROUGH FINGERS
NOT TO SCALE

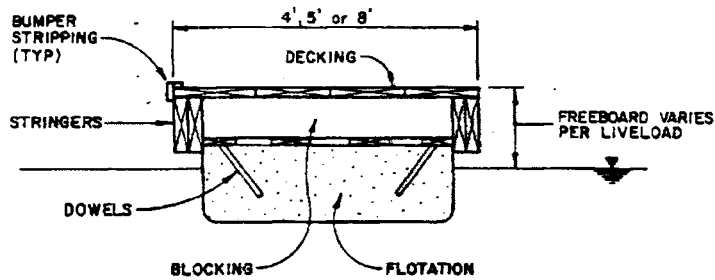

TYPICAL MARINA FLOAT
NOT TO SCALE

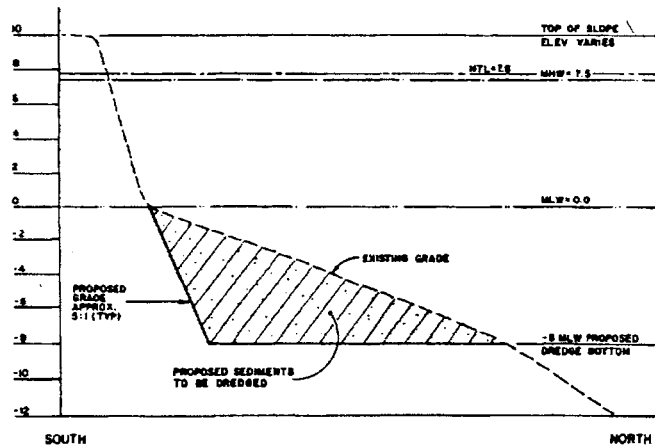

CROSS SECTION OF DREDGED AREA
SCALE: H 1" = 100' V 1" = 10'

PURPOSE: ENLARGE MARINA
CREATING ADDITIONAL SLIPS

DATUM: MLW = 0.0
MHW = 7.5
HTL = 7.8

CARMICHAEL ASSOCIATES, INC.
1898 MERCER STREET SUITE 42
PORTLAND, MAINE

**FLOAT DETAILS
AND
CROSS SECTION
OF
DREDGED AREA**

PROPOSED MARINA PLAN IN:
MERRIMACK RIVER

AT: 3-R MARINA

COUNTY OF: ESSEX, MA.

APPLICATION BY:
SIMON REALTY TRUST

DATE: MAY 1989 SHEET 5 of 5

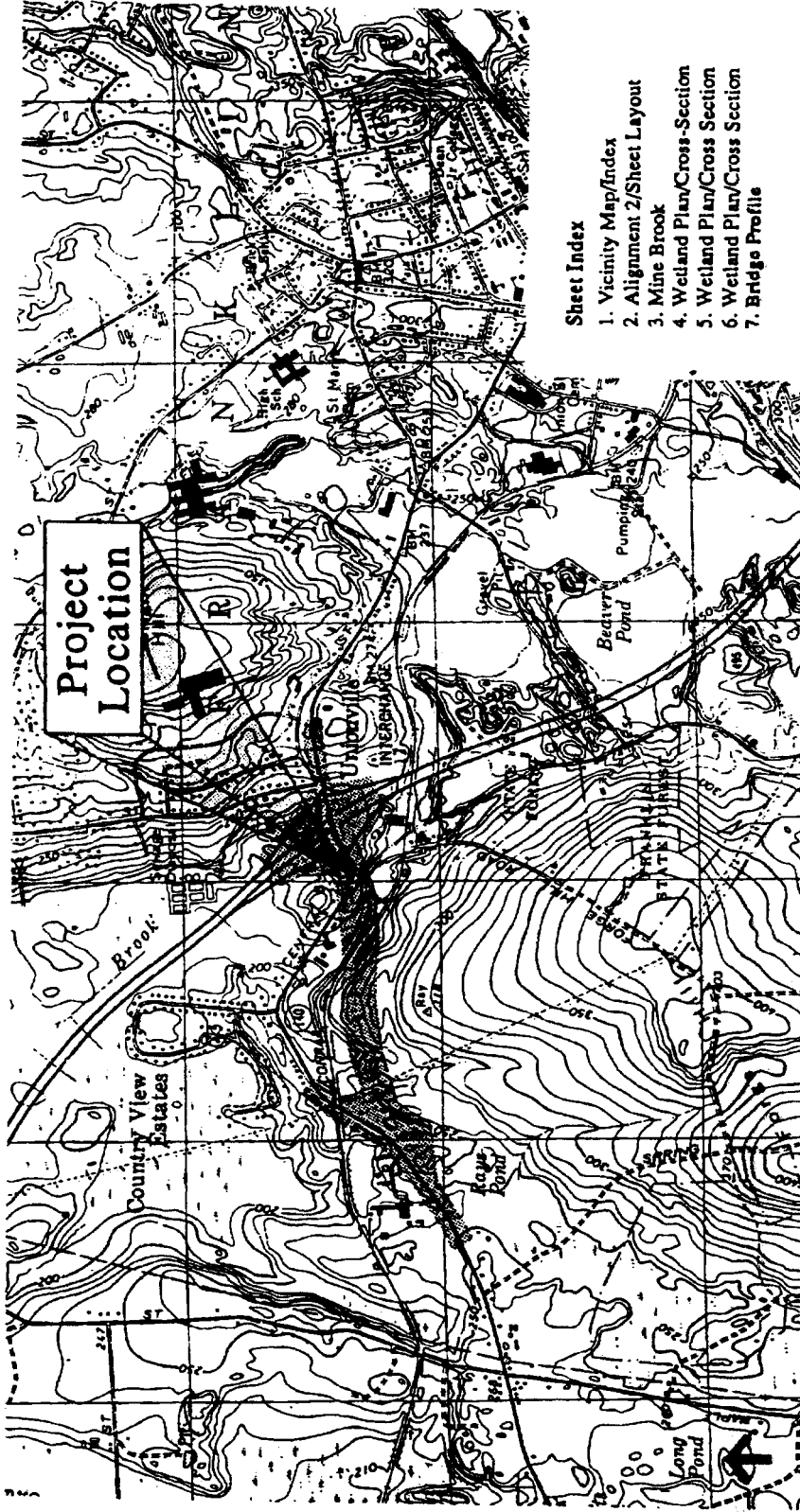

Sheet Index

1. Vicinity Map/Index
2. Alignment 2/Sheet Layout
3. Mine Brook
4. Wetland Plan/Cross-Section
5. Wetland Plan/Cross Section
6. Wetland Plan/Cross Section
7. Bridge Profile

VICINITY MAP

U.S.G.S. FRANKLIN QUADRANGLE



Massachusetts Department of Public Works
 10 Park Plaza, Boston, MA 02116-3973

**RELOCATED ROUTE 140
 VICINITY MAP / INDEX**

DATE
 NOVEMBER, 1990

ATL. FRANKLIN
 IN. MINE BROOK
 NORFOLK COUNTY
 COMMONWEALTH OF MASSACHUSETTS

APPLICATION BY:
 COMMONWEALTH OF MASSACHUSETTS
 DEPARTMENT OF PUBLIC WORKS

SHEET OF
 1 7

* HIGHWAY PLANS COURTESY OF
 VANASSE HANGEN BRUSTLIN, INC.

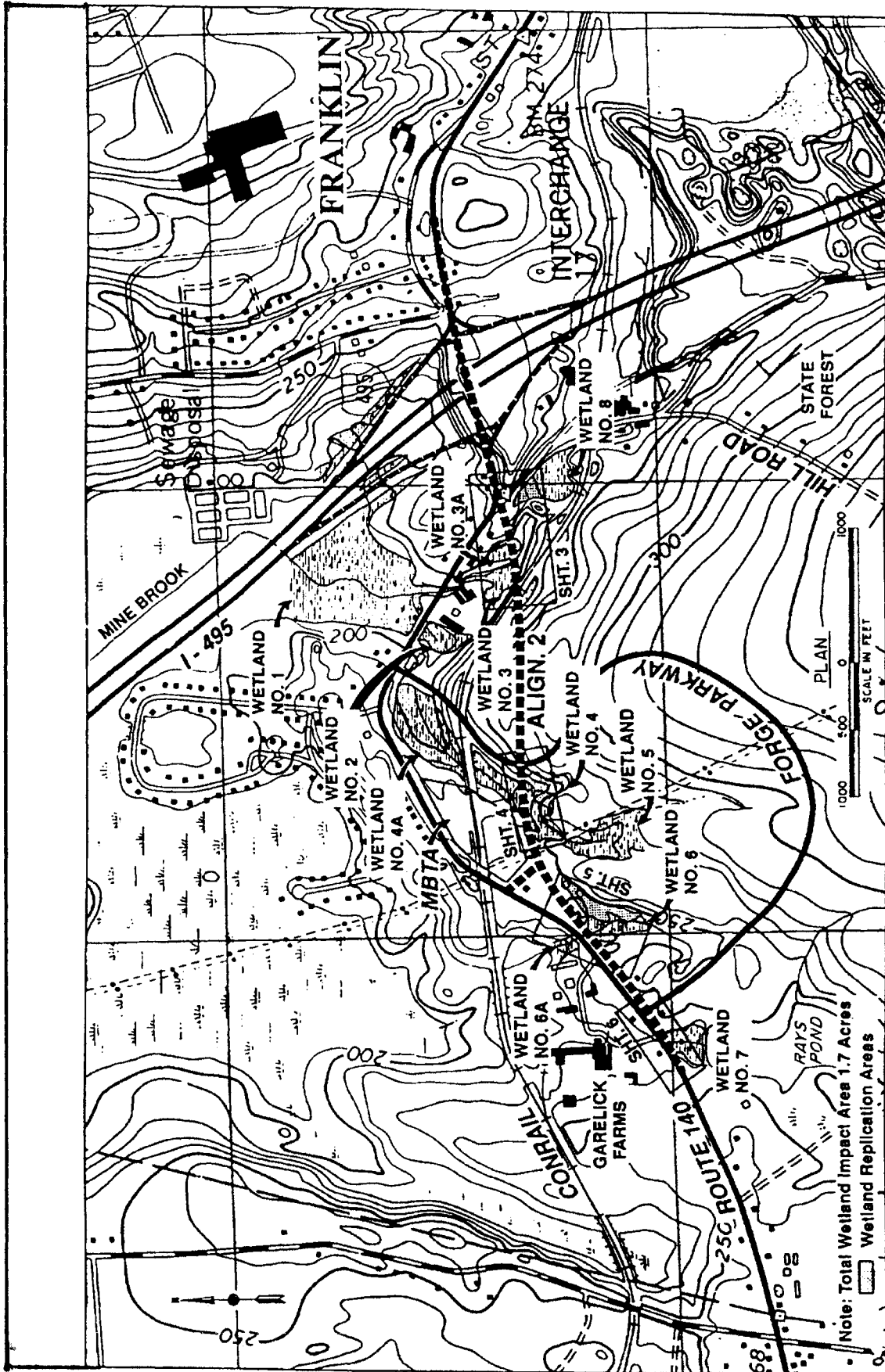

Massachusetts Department of Public Works 10 Park Plaza, Boston, MA 02116-3973		RELOCATED ROUTE 140 ALIGNMENT 2 / SHEET LAYOUT		DATE NOVEMBER, 1990
AT: FRANKLIN IN: MINE BROOK NORFOLK COUNTY COMMONWEALTH OF MASSACHUSETTS		APPLICATION BY: COMMONWEALTH OF MASSACHUSETTS DEPARTMENT OF PUBLIC WORKS		SHEET 2 OF 7

Note: Total Wetland Impact Area 1.7 Acres
 Wetland Replication Areas

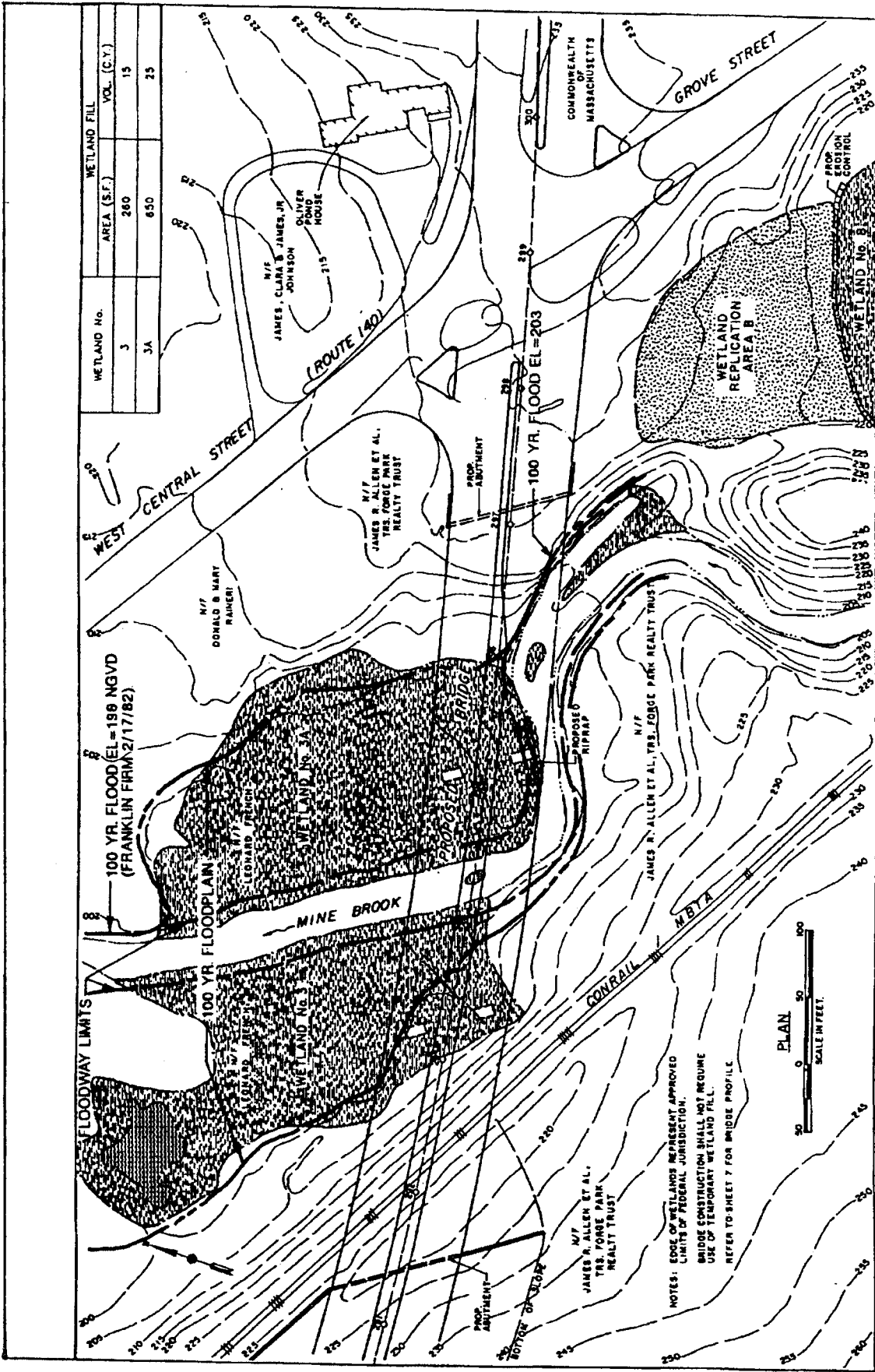

WETLAND FILL	
WETLAND No.	AREA (S.F.)
3	280
3A	650
	VOL. (C.Y.)
	15
	25

Massachusetts Department of Public Works 10 Park Plaza, Boston, MA 02116-3973	RELOCATED ROUTE 140 MINE BROOK		DATE NOVEMBER, 1990
	APPLICATION BY: COMMONWEALTH OF MASSACHUSETTS DEPARTMENT OF PUBLIC WORKS	SHEET 3	OF 7

WETLAND No.	4
AREA (S.F.)	57,025
WETLAND FILL VOL. (C.Y.)	20,890

N/F
MASS. BAY
TRANSIT
AUTHORITY

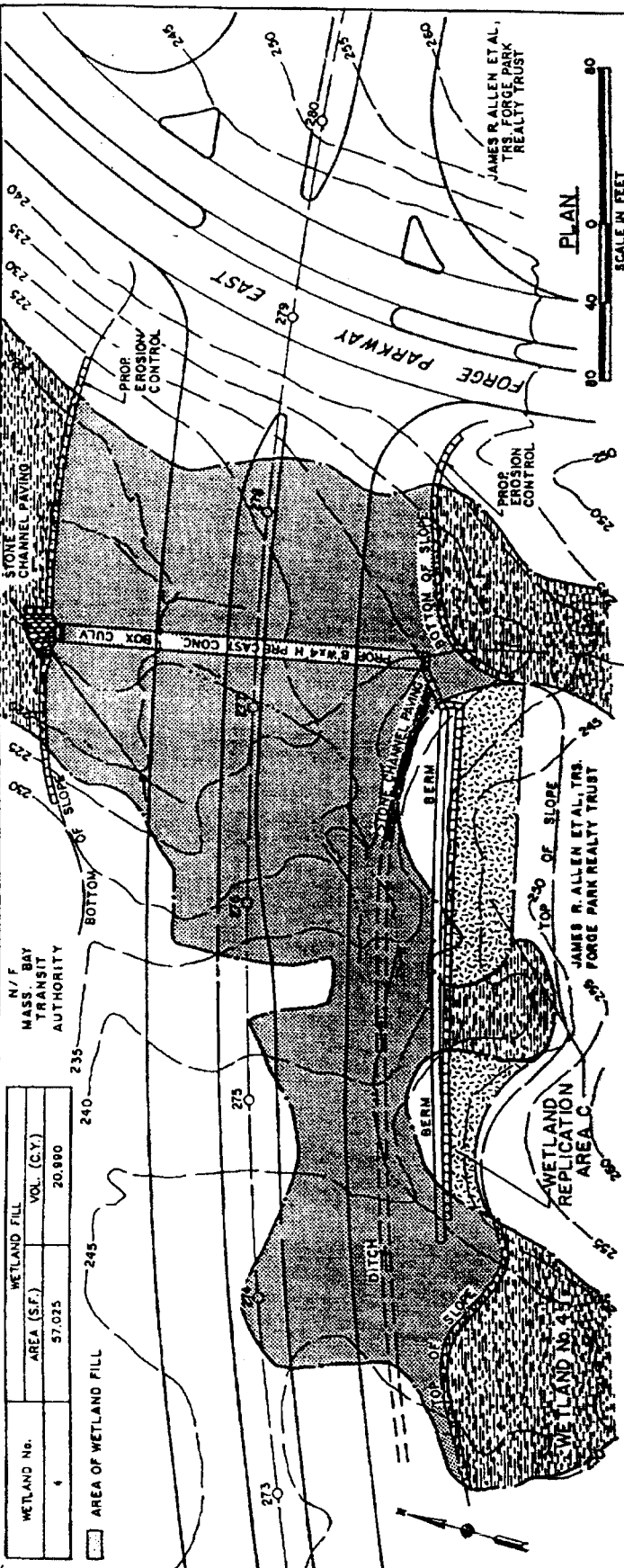

PLAN

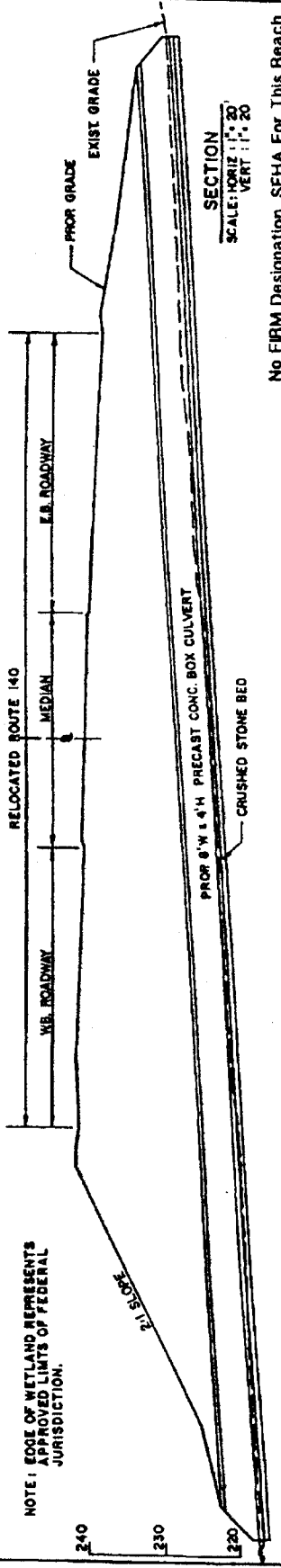

SECTION
SCALE: HORIZ. 1" = 20'
VERT. 1" = 20'

NOTE: EDGE OF WETLAND REPRESENTS APPROVED LIMITS OF FEDERAL JURISDICTION.

No FIRM Designation, SFHA For This Reach

Massachusetts Department of Public Works 10 Park Plaza, Boston, MA 02116-3973	AT, FRANKLIN IN, MINE BROOK NORFOLK COUNTY COMMONWEALTH OF MASSACHUSETTS	RELOCATED ROUTE 140 WETLAND PLAN / CROSS SECTION	DATE NOVEMBER, 1990
	APPLICATION BY: COMMONWEALTH OF MASSACHUSETTS DEPARTMENT OF PUBLIC WORKS	SHEET 4	OF 7

Blank permit application drawing sheet

Blank permit application drawing sheet



US Army Corps
of Engineers

Drawing Checklist



The ultimate objective of a set of drawings is to allow someone who is unfamiliar with the project to quickly obtain a clear understanding of what is proposed and how the impacted waterbody and/or wetlands will be affected. Drawings should be originals and not reduced copies of large-scale plans. Engineering drawings are not required. Existing and proposed site conditions (manmade and landscape features) should be drawn to scale.

Page 1 should be a vicinity map, Page 2 should provide a top-down plan view, Page 3 should show a cross-sectional view; additional pages should be used if needed. Every drawing should have a Title Block.

1. GENERAL GUIDELINES AND USEFUL INFORMATION TO INCLUDE ON DRAWINGS

- Use clear black lettering and the fewest number of pages necessary; use 8 1/2- by 11-inch paper
- Even if drawings are created by hand please use a graphic scale
- Vertical and horizontal scales should use the same units of measure
- Vicinity maps and plan drawings must include an accurate North Arrow
- Descriptions/types of substrate can be included on drawings along with photographs
- Critical habitat and/or known essential fish habitat can be indicated on drawings along with surveys
- A drawing with the existing water features overlaid with the proposed project would be helpful

2. TITLE BLOCK EXAMPLES

- A completed title block (first example) should be on the first page; for subsequent sheets you can use the smaller abbreviated form (second example)

FILE # <u>NAN- (USACE will provide)</u>	LOCATION: _____ <i>(address/intersection/ parcel number)</i>	PROPOSED PROJECT: <i>(three – five words description)</i>
APPLICANT: _____	LAT/LONG: _____	IN: <i>(waterbody)</i>
ADJACENT PROPERTY OWNERS: 1. <i>(include name/parcel on plan view)</i> 2. <i>(include name/parcel on plan view)</i>	PAGE # OF # DATE: <i>(last revised)</i>	NEAR/AT: <i>(closest city or town)</i> COUNTY: <i>(county)</i> STATE: _____

FILE # <u>NAN- (USACE will provide)</u>	
Applicant Name:	
Proposed Project:	
Location:	
Sheet # of #	Date:

3. VICINITY MAP

- Show and label location of each **project area** (e.g. circle the perimeter, use an arrow, etc.)
- Show and label location of each **mitigation site**, if applicable
- List latitude, longitude, section, township, and range and parcel numbers – a parcel map can be helpful
- Show and label all waterways (e.g. ditches, wetlands, ponds, streams, rivers, lakes, inlets, oceans, etc.)
- Show roads, streets, and/or mileage to nearest town or city limits
- The map should be zoomed out enough to show the area but detailed enough to see landmarks for context

4. PLAN VIEWS

- () **Marine/tidal waters:** U.S. Harbor Lines; Mean High Water (MHW) /Mean Higher High Water (MHHW) / Spring High Water (SHW)
- () **Freshwater wetlands, bogs, fens, lakes, streams, etc:** Ordinary high water (OHW) / Wetland boundaries
- () Waters, including wetlands and other features extending across property boundaries
- () Show dimensions of proposed and existing structures
- () Indicate location, quantity, and type of fill and excavation (area and volume)
- () Direction of currents, if known (e.g. tidal ebb, drift cells, creek flow, etc.)

5. ELEVATION AND/OR SECTION VIEWS

- () Label shorelines with the SHW line, MHW line, MHHW line, OHW line, and/or wetland boundary, as appropriate in tidal or non-tidal waters.
- () Show original and proposed elevations, water depths, dimensions of proposed structures or fills, and pertinent vertical dimensions to top and base of structure/fill; use the same vertical and horizontal scale

6. DRAWINGS INVOLVING DREDGING AND/OR THE DISPOSAL OF DREDGED MATERIAL

If proposing to discharge dredged material in one of the Dredged Material Management Program Disposal (DMMP) sites, another in-water disposal site, or as beach nourishment the information below should be submitted:

- () Include pages with all applicable items in Sections 1-5 of this document
- () In-water disposal site name (if applicable) with coordinates and boundaries (*see Note*)
- () Upland/beach “beneficial use” disposal site coordinates and boundaries
- () If using an in-water disposal site specify the type (non-dispersive or dispersive)
- () Identify the barge positioning method (either the U.S. Coast Guard Vessel Traffic Service and/or a differential GPS used in conjunction with the National Dredging Quality Management Program automated monitoring system)

7. MITIGATION AND/OR PLANTING PLAN DRAWINGS

- () Include pages with all applicable items in Sections 1-5 of this document
- () Reference the title and date of the approved mitigation/planting plan (*See Note*)
- () Planting areas with key identifying specific species and plant spacing
- () Buffer areas and staging or construction access areas
- () Amounts and locations of temporary fill or excavation work (area and volume)
- () Structures, piers, piling, over-water floats, etc. to be removed for the purpose of mitigation

Note: See also 33 CFR Part 332.4(c) regarding the contents of a mitigation plan

8. DRAWINGS FOR AQUACULTURE PROJECTS

- () Include pages with all applicable items in Sections 1-5 of this document
- () Include the town parcel numbers; a parcel map is helpful
- () Show and label the current project area including fallow areas (*see Note*)
- () Show and label areas proposed for expansion or new aquaculture activities
- () Specify species and methodologies
- () Identify areas with canopy predator nets
- () Identify the latitude and longitude for each corner of the project area
- () Show and label areas with eelgrass, kelp, or mudflats

Note: For the purposes of Nationwide Permit 48, *Commercial Shellfish Aquaculture Activities*, the project area is the area in which the operator is currently authorized to conduct commercial shellfish aquaculture activities, as identified through a lease or permit issued by an appropriate state or local government agency, a treaty, or any other easement, lease, deed, or contract which establishes an enforceable property interest for the operator.

SECTION VI: ADDITIONAL RESOURCE INFORMATION

U.S. Army Corps of Engineers Districts

U.S. Army Corps of Engineers, Buffalo District Attn. Regulatory
1776 Niagara Street,
Buffalo, New York 14207
(716) 879-4330
<http://www.lrb.usace.army.mil/>

U.S. Army Corps of Engineers, Philadelphia District Attn. Regulatory
Wanamaker Building, Room 600
100 Penn Square East
Philadelphia, PA 19107-3390
(215) 656-6728
<http://www.nap.usace.army.mil/>

New York State Projects

New York State Department of Environmental Conservation (NYSDEC)

All of Region 1

Regional Permit Administrator
NYSDEC – Region 1
SUNY – Building 40
Stony Brook, NY 11790-2356
(631) 444-0365

All of Region 2

Regional Permit Administrator NYSDEC – Region 2
1 Hunter's Point Plaza
47 – 40 21st Street
Long Island City, NY 11101-5407 (718) 482-4997

All of Region 3

Regional Permit Administrator NYSDEC – Region 3
21 South Putt Corners Road New Paltz, NY 12561-1696 (845) 256-3059

Region 4 – Montgomery, Schenectady, Albany, Greene, Columbia and Rensselaer Counties

Regional Permit Administrator, NYSDEC – Region 4
1150 North Westcott Road
Schenectady (Rotterdam), NY 12306
(518) 357-2234

Region 4 Suboffice – Delaware, Otsego and Schoharie Counties

Deputy Regional Permit Administrator
NYSDEC – Region 4
65561 State Highway 10, Suite 1
Stamford, NY 12167

Region 5 – Clinton, Franklin, Hamilton and Essex Counties

Regional Permit Administrator
NYSDEC – Region 5
Ray Brook Headquarters
1115 NYS Route 86, P.O. Box 296
Ray Brook, NY 12977-0296
(518)897-1200

Region 5 – Fulton, Saratoga, Warren and Washington Counties

Deputy Regional Permit Administrator
Warrensburg Sub-office
232 Hudson Street, P.O. Box 220
Warrensburg, NY 12885
(518)623-1200

New York State Historic Preservation Office

For Federal Express:

Director
New York State Office of Parks, Recreation and Historic Preservation (NYSOPRHP)
State Historic Preservation Office (SHPO)
Pebbles Island Resource Center, Delaware Avenue
Cohoes, NY 12047

For Mail Delivery:

Director
NYSOPRHP, SHPO
Pebbles Island Resource Center P.O. Box 189
Waterford, NY 12188-0189
(518) 237-0643

New York State Department of State Division of Coastal Resources

41 State Street – 8th Floor
Albany, NY 12231
(518) 474-6000

U.S. Fish and Wildlife Service

Field Supervisor U.S. Fish and Wildlife Service New York Field Office
3817 Luker Road
Cortland, NY 13045
(607) 753-9334

U.S. Fish and Wildlife Service

Long Island Field Office
Box 1, 500 St. Mark's Lane
Islip, NY 11751
(631) 581-2941

Environmental Protection Agency

Chief, Wetlands Protection Section U.S. Environmental Protection Agency
290 Broadway, 24th Floor
New York, NY 10007
(212) 637-3801

NOAA Fisheries Service

NOAA Fisheries Service
James J. Howard Marine Sciences Conservation
74 Magruder Road
Highlands, NJ 07732
(732) 872-3023

New York City Watershed

Supervisor, Project Management Section
New York City Department of Environmental Protection
465 Columbus Avenue
Valhalla, NY 10595

New Jersey State Projects

New Jersey Department of Environmental Protection

New Jersey Department of Environmental Protection
Land Use Regulation Program
501 East State Street, 2nd Floor
P.O. Box 439
Trenton, NJ 08625
(609) 292-1235 or (609) 292-0060

NOAA Fisheries Service

NOAA Fisheries Service
James J. Howard Marine Sciences Conservation
74 Magruder Road
Highlands, NJ 07732
(732) 872-3023

U.S. Fish and Wildlife Service

Field Supervisor U.S. Fish and Wildlife Service
927 N. Main Street, Heritage Square, Building D
Pleasantville, New Jersey 08232
(609) 646 9310

New Jersey State Historic Preservation Office

New Jersey Department of Environmental Protection Natural and Historic Resources
Historic Preservation Office P.O. Box 404
Trenton, NJ 08625-0404
(609) 292-2023, 292-2028, 984-0140

New Jersey Meadowlands Commission

New Jersey Meadowland Commission
Land Use Planning
One DeKorte Park Plaza
Lyndhurst, NJ 07071
(201) 460-1700

Bridges and Waterway Management – United States Coast Guard

Commander (dpb)
First Coast Guard District Bridge Administration
Battery Park Building
One South Street
New York, NY 10004-5073
(212) 668-7021

Coast Guard Sector New York (spw)
212 Coast Guard Drive
Staten Island, NY 10305
(718) 354-4195