

**ORGANIZATIONAL
DEVELOPMENT
OF THE
JOINT CHIEFS
OF STAFF**



1942-2013

**Joint History Office
Office of the Chairman of the Joint Chiefs of Staff
April 2013**

Foreword

This book examines the organizational origins and evolution of the Joint Chiefs of Staff and the Joint Staff over the past seventy-one years. Established in January 1942 to expedite strategic coordination during World War II, the Joint Chiefs of Staff have been at the center of US military planning ever since. Composed of the nation's senior military officers, the Joint Chiefs of Staff initially operated under the direct authority and supervision of the President, performing whatever duties he assigned in his capacity as Commander in Chief.

After World War II, as part of the 1947 reorganization of the armed services under the National Security Act, the Joint Chiefs of Staff acquired statutory standing, with a list of assigned duties, and became a corporate advisory body to the President, the Secretary of Defense, and the National Security Council. Subsequent amendments to the National Security Act refined the composition and statutory organization of the Joint Chiefs and further clarified their authority and responsibilities. The corporate nature of the Joint Chiefs' advisory role ended upon passage of the 1986 Goldwater-Nichols Act, which transferred the tasks and duties previously performed collectively by the JCS to the Chairman.

The Joint Staff has continued to evolve since the terrorist attacks on September 11, 2001. This volume incorporates the changes to the organization of the Joint Staff which resulted from the August 2011 disestablishment of Joint Forces Command.

John F. Shortal
Brigadier General, USA (Ret)
Director for Joint History

CONTENTS

1. Origin of the Joint Chiefs of Staff	1
Establishing the Joint Chiefs of Staff	1
The Wartime Reforms.....	5
2. The National Security Act of 1947	11
Postwar Plans for Defense Organization	11
Passage of the National Security Act	16
Organizing the Joint Staff	18
The Key West Agreement of 1948	19
3. The National Security Act Amendments of 1949	22
4. Reorganization Plan No. 6 of 1953	29
5. The Defense Reorganization Act of 1958	35
The President’s Plan.....	37
Implementing the President’s Plan	41
6. Developments in the 1960s and 1970s	47
Changes through 1967	47
Organizational Consolidation, 1968-1976	48
Changes in the Carter Period	51
7. The Reorganization of 1986	58
The Jones and Meyer Proposals	58
Changes, 1982-1984.....	59
The Goldwater-Nichols Defense Reorganization Act	62
8. Joint Staff Reorganization, 1989 – 2001	68
After Goldwater-Nichols	68
Peacekeeping & Humanitarian Assistance	69
Proposals for Major Headquarters Reductions	71
9. Joint Staff Reorganization, 2001– 2013	74
The Joint Staff After the 9–11 Attacks	74
Chief of the Guard Bureau Elevated to the JCS.....	79
The Disestablishment of Joint Forces Command	80
Appendix 1 – Membership of the Joint Chiefs of Staff	89

**Appendix 2 – Authorized and Assigned Strength of the
Organization of the Joint Chiefs of Staff
and The Joint Staff (1947 – 2012).....97**

Index.....99

CHARTS

1. The JCS Organization on 1 November 1942	8
2. The Committee Structure Immediately Following the JCS Reorganization of 10 May 1943	9
3. The JCS Organization on 1 April 1945	10
4. The JCS Organization on 26 October 1947	21
5. The JCS Organization on 28 August 1949	28
6. The JCS Organization on 30 June 1953	34
7. Organization of the Joint Chiefs of Staff, 30 June 1958	45
8. Organization of the Joint Chiefs of Staff, 30 June 1959	46
9. Organization of the Joint Chiefs of Staff, 1 September 1969	54
10. Organization of the Joint Chiefs of Staff, 31 December 1970	55
11. Organization of the Joint Chiefs of Staff, 31 December 1976	56
12. Organization of the Joint Chiefs of Staff, 31 December 1979	57

13. Organization of the Joint Chiefs of Staff, 30 June 1982.....	65
14. Organization of the Joint Chiefs of Staff, 30 June 1984.....	66
15. Organization of the Joint Chiefs of Staff, 30 June 1987.....	67
16. Organization of the Joint Chiefs of Staff, 30 March 1992	73
17. Organization of the Joint Chiefs of Staff, 30 June 2010.....	86
18. Organization of the Joint Chiefs of Staff, 30 June 2012.....	87
19. Organization of the Joint Chiefs of Staff, 7 August 2012.....	88

1. ORIGIN OF THE JOINT CHIEFS OF STAFF

The Joint Chiefs of Staff (JCS) came into being during the early days of World War II to meet an immediate need. They functioned throughout the war as the corporate leadership of the US military structure under the immediate direction of the President as Commander in Chief. They were his principal military advisers and the primary agency for coordinating and giving strategic direction to the Army and the Navy. As the President's military advisers, they made recommendations directly to him on war plans and strategy, on logistical needs of the armed forces, and on matters of joint Army and Navy policy. As coordinators of the Army and Navy, they prepared joint war plans and issued directives to implement them, allocated critical resources, such as munitions, petroleum products, and shipping, and supervised the collection of strategic intelligence and the conduct of clandestine operations.

Establishing the Joint Chiefs of Staff

With the entry of the United States into the war following the attack on Pearl Harbor, 7 December 1941, some form of US-British military cooperation and coordination became necessary. The problem was addressed at the ARCADIA conference, held in Washington during the period 22 December 1941 through 14 January 1942, between President Franklin D. Roosevelt and Prime Minister Winston Churchill and their advisers. At the conference, the Combined Chiefs of Staff (CCS) were established as the supreme military body for the strategic direction of the Anglo-American military effort in World War II.

As his military assistants at the ARCADIA Conference, Prime Minister Churchill had presented the British Chiefs of Staff Committee, a body consisting of the First Sea Lord, the Chief of the Imperial General Staff, and the Chief of Air Staff. In existence since 1923, this committee held a corporate responsibility for the command and strategic direction of the forces of the United Kingdom and for providing military advice to the Prime Minister and the War Cabinet.

The United States had no comparable organization. A Joint Board of the Army and Navy had prepared joint war plans and dealt with questions of interservice coordination during the prewar years. Its membership of eight officers, however, did not fully encompass the chiefs of staff level of the US Services as constituted in December 1941, but did include several officers of lesser rank. Primarily an advisory and deliberative body, the Joint Board was not suited to direct wartime operations.

The US delegation for the military discussions at ARCADIA consisted of the officers whose responsibilities most closely matched those of the members of the British Chiefs of Staff Committee. The US representatives were never specifically designated by the President or other authority. Their assumption of the duty was simply recognized as appropriate under the "opposite number" formula. General George C. Marshall, the Chief of Staff, US Army, held a position directly comparable to that of the Chief of the Imperial General Staff. The responsibilities of high command in the US Navy had recently been divided between two officers, Admiral Harold R. Stark as Chief of Naval Operations and Admiral Ernest J. King, the Commander in Chief, US Fleet (COMINCH). Both appeared as US representatives in the military discussions as a dual counterpart to the British First Sea Lord. In arranging for US air representation, direct comparability was not possible. In the United Kingdom the Royal Air Force was an autonomous service, co-equal in all respects with the British Army and the Royal Navy; in the United States, air forces functioned as integral or subordinate elements of the Army and the Navy. The foremost spokesman available, however, was Lieutenant General Henry H. Arnold, Chief of the Army Air Forces and Deputy Chief of Staff for Air. It was recognized that, when sitting as a US representative, General Arnold could speak authoritatively only for the air forces of the Army and that he functioned always as a subordinate of General Marshall.

During the ARCADIA meetings the US and British officers mapped broad strategy and settled upon an organizational arrangement for the strategic direction of the war. They recommended establishment of the Combined Chiefs of Staff, consisting of the British Chiefs of Staff and their "United States opposite numbers." With the approval of the President and the Prime Minister, the Combined Chiefs of Staff came into operation almost immediately, holding their first meeting on 23 January 1942.

The establishment of the Combined Chiefs of Staff had a profound influence on the evolution of the military high command of the United States. The four officers who represented the United States at ARCADIA continued to sit as the US members of the Combined Chiefs of Staff. In preparation for the Combined Chiefs of Staff meetings, they had to consult closely and oversee the preparation of US position papers by subordinate staff agencies. Thus, establishment of a new organization, the "Joint US Chiefs of Staff," was implicit in the arrangement. The title followed the definition of terms agreed to at ARCADIA, under which "combined" signified collaboration between two or more nations while "joint" was used to designate the interservice collaboration of one nation.

The Joint Chiefs of Staff held their first meeting on 9 February 1942 to deal with agenda items associated with their Combined Chiefs of Staff

duties. Brought together in an organized way to represent the United States on the Combined Chiefs of Staff, these officers, as the Joint Chiefs of Staff, began to function as a corporate leadership for the US military establishment. By March 1942 this development was largely completed and the Joint Chiefs of Staff absorbed the functions of the prewar Joint Board.

The functions and duties of the Joint Chiefs of Staff were not formally defined during the war period. They were left free to extend their activities as needed to meet the requirements of the war. The desirability of preserving this useful flexibility was the chief reason offered by the President himself for declining to issue a formal directive.

During March 1942 Admiral Stark left Washington for a new command in the United Kingdom. The two posts of Chief of Naval Operations and Commander in Chief, US Fleet, were combined in one individual, Admiral King, and the JCS membership was reduced to three. Shortly thereafter, General Marshall became convinced that it would be desirable to have a fourth member, designated to preside at JCS meetings and maintain liaison with the White House. For this purpose the President on 20 July 1942 appointed Admiral William D. Leahy to the new position of Chief of Staff to the Commander in Chief of the Army and Navy.

The Joint Chiefs of Staff were directly responsible to President Roosevelt, who had assumed to the full his constitutional role as Commander in Chief. When dealing with strategy and military operations, President Roosevelt preferred to work directly with the uniformed chiefs of the Services, rather than through the civilian leadership of the War and Navy Departments. The responsibilities of the Secretaries of War and the Navy were limited largely to matters of administration, mobilization, and procurement. In these circumstances the appointment of Admiral Leahy proved particularly valuable in facilitating the direction of the war. As Chief of Staff to the President he served as the normal channel for passing White House decisions and requirements to the Joint Chiefs of Staff and for presenting JCS views and recommendations to the President. This arrangement did not preclude direct consultation by President Roosevelt with Generals Marshall and Arnold and Admiral King, but it removed the need for such consultations for the routine exchange of opinions, information, and direction.

A supporting organization for the Joint Chiefs of Staff evolved piece by piece during 1942, more in spontaneous response to need than in fulfillment of any conscious design. A number of joint committees were created to provide US representatives to sit with the British in combined committees subordinate to the Combined Chiefs of Staff, but they also supported the Joint Chiefs of Staff in discharging responsibilities at the national level.

The most important component of the JCS organization was the Joint Staff Planners, a committee that provided the US representation on the Combined Staff Planners. By March its membership had been stabilized at five officers: the Assistant Chief of Staff (Plans) of the Commander in Chief US Fleet Headquarters and two of his assistants; the Chief of the Strategy and Policy Group of the War Department's Operations Division; and the Assistant Chief of Staff (Plans) of the US Army Air Staff. Thus, all the members had major primary responsibilities in the Service staffs, and their assignment to the Joint Staff Planners was an additional, part-time duty.

Besides drawing assistance from their own Service staffs, the members of the Joint Staff Planners were supported by a full-time working group, the Joint US Strategic Committee. A former Joint Board agency, it had been absorbed into the JCS organization and made subordinate to the Joint Staff Planners on 9 March. The Joint US Strategic Committee consisted of six officers on assignment from the war plans divisions of the Army and Navy staffs.

Another element of the initial JCS organization was the Joint Intelligence Committee, consisting of the US membership of the Combined Intelligence Committee. Like the Joint Staff Planners, it had a working level supporting agency composed of officers on full-time assignment from the Service staffs. This body was the Joint Intelligence Subcommittee, later called the Joint Intelligence Staff.

Other joint agencies established during the first months of 1942 included the Joint Military Transportation Committee, the Joint Meteorological Committee, the Joint Communications Board, the Joint Psychological Warfare Committee, and the Joint New Weapons Committee. Of these, the first three provided US membership on CCS committees with parallel titles, while the last two were strictly joint US organizations. The need for a committee at the JCS level to coordinate the efforts of the various agencies operating in the psychological warfare field had first been suggested by the Army G-2; the Joint New Weapons Committee grew out of a proposal by Dr. Vannevar Bush, Director of the Office of Scientific Research and Development, a White House organization. The Joint Chiefs of Staff were also served by a Secretary, who headed the Joint Secretariat.

Another component of the early JCS organization was the Office of Strategic Services, the World War II forerunner of the present Central Intelligence Agency. It had been formed in 1941 as the Office of the Coordinator of Information (COI), a civilian agency directly responsible to the President. Investigation convinced the Joint Chiefs of Staff that the Coordinator of Information was capable of making an important contribution to the war effort, but that its activities must be placed under military control to assure proper coordination with military operations. In

March 1942 the Joint Chiefs of Staff supplied the President with a proposed executive order, drafted in collaboration with the COI director, that would make the agency responsible to the Joint Chiefs of Staff. In June, as part of a broader reordering of government operations that also included establishment of the Office of War Information, President Roosevelt placed the Coordinator of Information under JCS jurisdiction and redesignated it the Office of Strategic Services.

The Wartime Reforms

During 1942 the vast majority of JCS business funneled through the Joint Staff Planners, an under-manned, part-time committee. The shortcomings of this committee became evident to the Joint Chiefs of Staff in early 1943 at the Casablanca Conference. At this gathering of the President, the Prime Minister and their principal assistants, the US Joint Chiefs of Staff found themselves at a disadvantage when confronted by the large and smoothly functioning British staff, which had not only prepared thorough positions on every anticipated point but could quickly produce additional papers during the conference itself. The handful of officers making up the Joint Staff Planners was unable to match the skill and speed of this efficient planning organization.

Inadequate performance of the Joint Staff Planners stemmed from both their composition and the scope of their responsibilities. Already heavily burdened by their regular duties in the Service staffs, the members constituted the sole agency for accomplishing most of the planning tasks required for the support of the Joint Chiefs of Staff in both their national and international roles. As a result, the agenda of the Joint Staff Planners was heavy and exceedingly varied.

The members of the Joint Staff Planners, still committed during this first year of the war to the traditional Army and Navy staff practices, were further handicapped by their methods of operation. The leading members of the Joint Staff Planners were reluctant to relinquish immediate and detailed control over the planning process in favor of a broader general supervision. The Planners assigned some subjects to their only permanent and full-time agency, the six-man Joint US Strategic Committee. Most of the subjects on the agenda, however, were assigned to ad hoc subcommittees composed of planning personnel and staff experts drawn from both Services. All work returned to the Joint Staff Planners for review, and final decision on all matters required the personal approval of the two senior members.

The inadequacies of the JCS supporting organization revealed at Casablanca led to sweeping reappraisal and fundamental reform during the first half of 1943. Even before that time officers within the JCS organization and the Service staffs had recognized the need for improvement and had

successfully initiated two significant changes. These were the establishment of the Joint Strategic Survey Committee, on 7 November 1942, and the Joint Deputy Chiefs of Staff on 11 December 1942. The former, consisting of three general and flag officers on full-time assignment but with no involvement in short-term operational problems, performed long-range planning and advised the Joint Chiefs of Staff on current strategic decisions in light of the war situation and national policy objectives. The Joint Deputy Chiefs of Staff relieved the Joint Chiefs in the consideration of routine matters. They acted in the name of their superiors and interpreted and implemented policies already approved by the Joint Chiefs of Staff.

These limited improvements were followed in early 1943 by a comprehensive reorganization of the supporting structure of the Joint Chiefs of Staff. On 20 January the Joint Deputy Chiefs of Staff appointed a special committee, the Committee on War Planning Agencies, to conduct a thorough investigation of the problem, based on inputs from all the components of the JCS organization. The committee also completed studies on the British staff organization and on the workload of the Joint Staff Planners.

On 12 March 1943 the Committee on War Planning Agencies submitted its findings to the Joint Deputy Chiefs of Staff. Recognizing the overloading of the Joint Staff Planners, the committee recommended the shifting of a vast amount of administrative and routine planning detail to a new Joint Administrative Committee. It would consist of the Chief of the Logistics Branch of the Army Operations Division and the Director of the Logistics Plans Division of the Office of the Chief of Naval Operations and would be supported by ad hoc groups from the Service staffs. The Joint Staff Planners, with duties restricted to broad strategic and operational planning, would be limited to three members: the Assistant Chief of Staff (Plans), Commander in Chief, US Fleet; a representative of the Army Operations Division; and the Assistant Chief of Air Staff, Plans, of the US Army Air Forces. The Joint Staff Planners would continue to receive support from the Joint US Strategic Committee, redesignated the Joint War Plans Committee and augmented by officers transferred from the Service planning staffs in order to reduce the need for ad hoc committees. The Committee on War Planning Agencies also proposed broadening the Joint Intelligence Committee by adding to it the Assistant Chief of Air Staff, Intelligence.

After making minor changes, the Joint Chiefs of Staff approved the recommendations of the Committee on War Planning Agencies at meetings during the period 4 through 10 May 1943. Specifically, they approved a set of revised charters for all JCS committees and agencies.

Later in 1943, the Joint Chiefs of Staff redesignated the Joint Administrative Committee as the Joint Logistics Committee and strengthened its capabilities by adding a supporting Joint Logistics Plans Committee. This change resulted from an increasing awareness of the complexity of logistics in military planning and from recognition of the degree to which this field had already become the primary concern of the committee. The new supporting Joint Logistics Plans Committee, like the Joint War Plans Committee and the Joint Intelligence Staff, was manned by officers on full-time assignment. From mid-1943 to the war's end several other joint committees were created to deal with matters that had assumed increased importance, such as the full-time Joint Production Survey Committee and Joint Post-War Committee and the part-time Joint Civil Affairs Committee.

Charts 1, 2, and 3, depict the evolution of the JCS supporting organization during World War II.

CHART I

JCS ORGANIZATION

1 NOVEMBER 1942

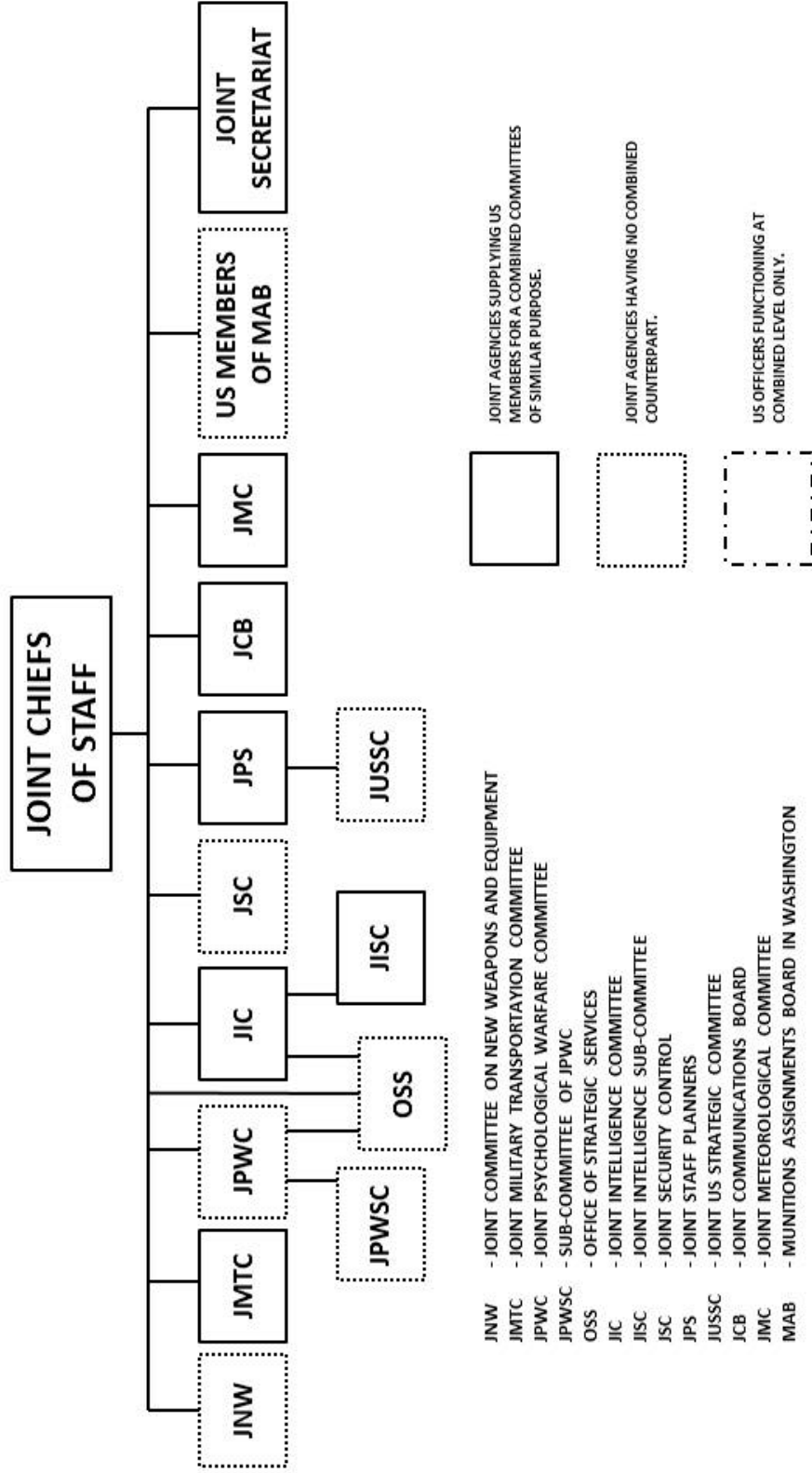

NOTE: ONLY MAJOR ORGANIZATIONAL ENTITIES SHOWN.

CHART II JCS ORGANIZATION 10 MAY 1943

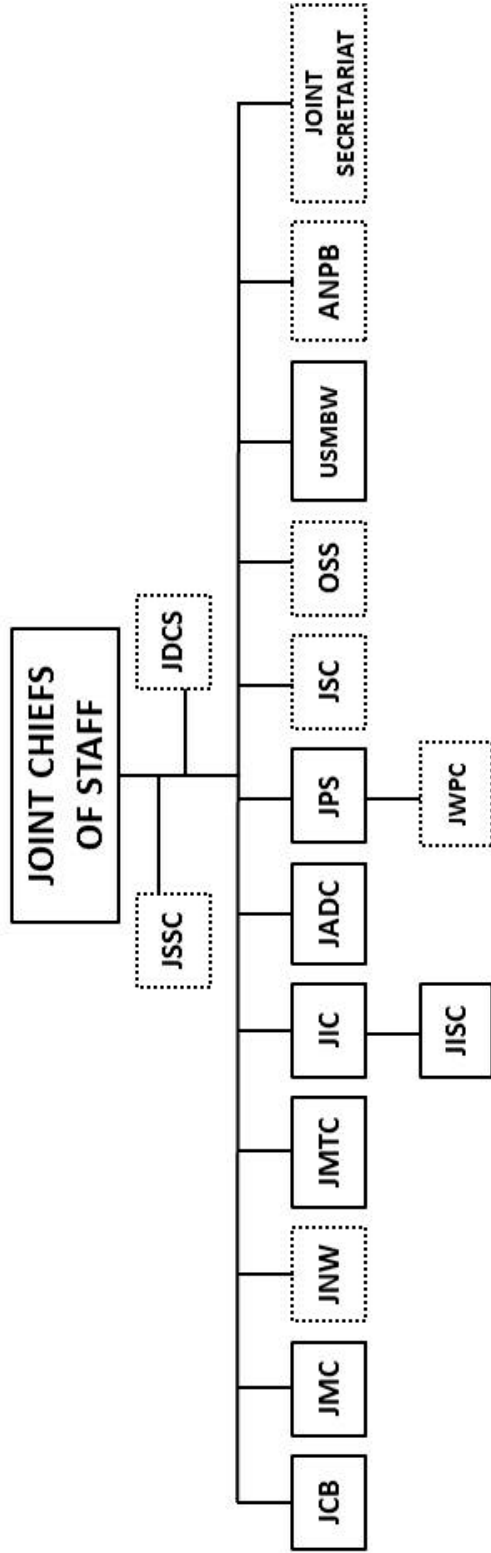

- JDCS - JOINT DEPUTY CHIEFS OF STAFF
- JSSC - JOINT STRATEGIC SURVEY COMMITTEE
- JCB - JOINT COMMUNICATIONS BOARD
- JMC - JOINT METEOROLOGICAL COMMITTEE
- JNW - JOINT COMMITTEE ON NEW WEAPONS AND EQUIPMENT
- JMTC - JOINT MILITARY TRANSPORTATION COMMITTEE
- JIC - JOINT INTELLIGENCE COMMITTEE
- JISC - JOINT INTELLIGENCE SUB-COMMITTEE
- JADC - JOINT ADMINISTRATIVE COMMITTEE
- JPS - JOINT STAFF PLANNERS
- JSC - JOINT SECURITY CONTROL
- OSS - OFFICE OF STRATEGIC SERVICES
- USMBW - U.S. REPRESENTATIVES, MUNITIONS ASSIGNMENTS BOARD, WASHINGTON



NOTE: ONLY MAJOR ORGANIZATIONAL ENTITIES SHOWN.

CHART III JCS ORGANIZATION 1 APRIL 1945

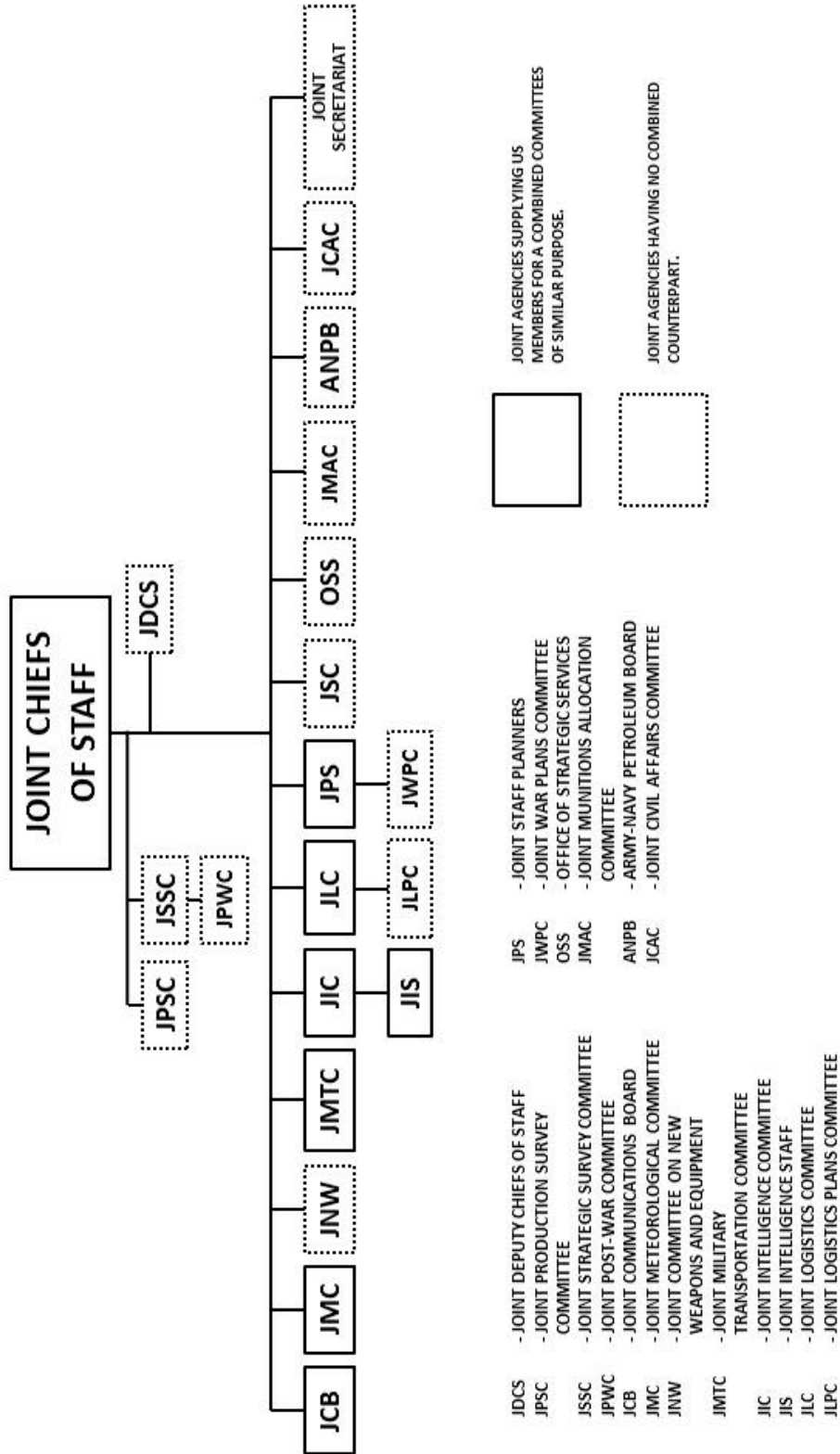

2. THE NATIONAL SECURITY ACT OF 1947

By the end of World War II, there was widespread agreement among military and civilian leaders that the military establishment would have to be reorganized to meet the needs of the United States in the postwar era. During World War II the Joint Chiefs of Staff had emerged as a corporate command and planning agency serving directly under the constitutional Commander in Chief, the President. The Army Air Forces had become virtually autonomous. There had been some centralization of intelligence collection and analysis; war production, prices, manpower, shipping, propaganda and scientific research had been subjected to control by civilian agencies. These wartime arrangements had worked well on the whole, but there was no certainty that they would be adequate in time of peace.

The Joint Chiefs of Staff, as a central element of the military establishment, would be affected by any reorganization. Although few questioned the desirability of continuing some such agency in the national defense structure, there was authoritative opinion that improvements were needed, possibly involving a somewhat different conception of the JCS role. General Marshall observed that "the lack of real unity has handicapped the successful conduct of the war." In his view a system of coordinating committees, such as that embodied in the JCS organization, was not a satisfactory solution. It resulted in delays and compromises and was "a cumbersome and inefficient method of directing the efforts of the Armed Forces." Secretary of War Henry L. Stimson declared that the institution of the Joint Chiefs of Staff was an "imperfect instrument of top-level decision" because "it remained incapable of enforcing a decision against the will of any one of its members." Others, recalling the record of difficulties encountered in Army-Navy cooperation in earlier times of peace, doubted that the Joint Chiefs of Staff could "continue to work together effectively for very long after the termination of hostilities."

Postwar Plans for Defense Organization

Deliberation on the nature of the postwar military establishment began even before the termination of hostilities. A House committee under the chairmanship of Representative Clifton A. Woodrum conducted hearings on postwar military organization in the spring of 1944 and heard varying testimony from Army and Navy witnesses. The Army proposal, presented by General Joseph T. McNarney, called for a single military department under a secretary of the armed forces, who would supervise such matters as procurement and recruiting but have no authority over the military budget. The Joint Chiefs of Staff, redesignated the United States Chiefs of Staff, would remain in existence and continue to be directly responsible to the

President. Their central duty would still be that of making recommendations to the President on military strategy, but they would gain the significant new power to recommend the military budget. The proposal called for adding to the membership of the Joint Chiefs of Staff a director of common supply services. Further, the Chief of Staff to the President was to "head" the United States Chiefs of Staff. Navy witnesses made no specific proposals but cautioned against reaching any conclusion on the question of military organization without thorough study. At the conclusion of the hearings, the committee recommended that the Congress take no further action until the end of the war.

While the Woodrum hearings were in progress, the Joint Chiefs of Staff initiated their own study. They created a Special JCS Committee on Reorganization of National Defense to submit recommendations on postwar defense organization, including a recommendation on the advisability of continuing the Joint Chiefs of Staff. As part of its survey, the committee spent the fall of 1944 touring the combat theaters and ascertaining the views of the major commanders. Fifty-six high-ranking officers were interviewed. The large majority of the Army officers and about half of the Navy officers favored a single military department.

On 11 April 1945 the committee submitted a report to the Joint Chiefs of Staff. With the senior Navy member, Admiral J. O. Richardson, dissenting, the committee recommended the creation of a single military department presided over by a secretary of the armed forces. It would include a commander of the armed forces supported by an armed forces general staff, and a purely advisory United States Chiefs of Staff consisting of the secretary, the commander of the armed forces, and the Service heads.

The Joint Chiefs of Staff began serious consideration of the special committee's report shortly after the Japanese surrender. General Marshall, while he did not fully concur in the report, recommended that it be sent to the President along with a statement that the Joint Chiefs of Staff agreed in principle on a single-department system of organization. General Arnold supported this view, but Admirals King and Leahy opposed it on the grounds that a single military department would be inefficient, would weaken civilian control over the military, and was contrary to wartime experience that showed the superiority of a joint over a unitary system. The Joint Chiefs of Staff forwarded the report and their individual comments on it to the President on 16 October 1945. They set forth four possible options for his consideration:

1. Submit all the pertinent papers to Congress.
2. Appoint a special civilian board to study national defense organization.

3. Achieve a degree of unification by appointing a single individual as Secretary of War and Secretary of the Navy.
4. Retain the existing organization, "with appropriate augmentation of the joint agencies."

With the end of World War II, congressional attention focused anew on defense organization. In October, the Senate Military Affairs Committee began hearings on the various defense organization plans produced up to that time. Several months earlier, Secretary of Navy James V. Forrestal, at the suggestion of Senator David I. Walsh, Chairman of the Senate Committee on Naval Affairs, had asked Mr. Ferdinand Eberstadt, a New York banker and personal friend, to study postwar military organization. Assisted by a committee of civilians and Navy officers, Mr. Eberstadt undertook the study and submitted his committee's report to the Secretary of the Navy in September 1945.

The Eberstadt committee concluded that "under present conditions unification of the Army and Navy under a single head" would not improve the nation's security. It favored a coordinated system, in which there would be three military departments—war, navy, and air—each with a civilian secretary of cabinet rank. The committee recognized serious weaknesses in the existing organization, particularly in the coordination of foreign and military policy and in the relationship between strategic planning and its logistic implementation. To counter these weaknesses, it recommended the creation of two important bodies directly under the President: a national security council and a national security resources board. The secretaries of war, navy, and air would be members of both organizations.

The Eberstadt committee believed that, irrespective of whether or not the separate military departments were ultimately unified under one department of defense, legislation should be sought to insure the continuation of the Joint Chiefs of Staff. In the committee's opinion, the Joint Chiefs of Staff had performed very satisfactorily during the war. The committee conceded that the Joint Chiefs of Staff had sometimes experienced delays in reaching decisions, but it found such delays preferable to the alternative of placing full military control in the hands of one officer at the head of a single armed forces general staff. Although it would be a more efficient instrument for reaching decisions, such an arrangement had the inherent danger that expert minority opinions might be overridden without sufficient consideration. The committee feared that, owing to inevitable limitations in the background, knowledge, and experience of the single superior officer, decisions might be reached that would prevent development of weapons, concepts, or command arrangements vital to fulfillment of the mission of one of the Services.

Under the proposed organization for national security, the Joint Chiefs of Staff were to be part of and meet with the national security council. They would be charged with: a) preparing strategic plans and providing strategic direction for all US forces; b) furnishing strategic advice to the President, the national security council and other government agencies; c) preparing joint logistics plans and assigning logistic responsibilities to the Services in accordance with such plans; and d) approving major Service materiel and personnel programs in accordance with strategic and logistic plans.

The Eberstadt committee proposed that the Joint Chiefs of Staff consist of the three Service chiefs, plus the Chief of Staff to the Commander in Chief if the President desired to continue that position. The committee had assessed the wartime experience as showing that full-time supporting groups such as the Joint War Plans Committee were more effective in producing a unified joint position than were the negotiations conducted in the part-time interservice committees. Accordingly, it recommended establishing a full-time joint staff to serve the Joint Chiefs of Staff. It would be headed by a chief of the joint staff, who would function as an executive to the Joint Chiefs of Staff and perhaps sit as a JCS member.

As for the relationship between the Joint Chiefs of Staff and the military departments, the committee merely noted:

In time of war the military strategists may be required to operate directly under the President. There does not seem to be any compelling reason for this during peace time. Approval of the Secretaries might well be required to render effective the plans of the Joint Chiefs of Staff in periods of peace.

The Joint Chiefs of Staff were to maintain close liaison with other agencies within the proposed organization for national security, including a proposed central intelligence agency.

The Eberstadt proposal was presented to the Senate Military Affairs Committee by Mr. Forrestal on 22 October 1945. A week later Lieutenant General J. Lawton Collins set forth the Army position. This so-called "Collins Plan" had been prepared by a board of senior Army officers convened only a month earlier. It proposed the establishment of a single department of the armed forces headed by a civilian secretary of cabinet rank. The Joint Chiefs of Staff, renamed the US Chiefs of Staff, would continue in existence. Their functions, to be fixed by law, would be advisory on matters of military policy, strategy, and budget requirements. They would have specific authority to prepare and recommend to the President the military budget. The secretary of armed services could comment on but not amend these budget recommendations. The membership of the Joint

Chiefs of Staff was to be increased to five by the addition of a chief of staff of the armed forces, whose duties were not precisely indicated.

The Senate Military Affairs Committee adjourned its hearings on 17 December 1945. Two days later, President Harry S. Truman transmitted a message to Congress on reorganization of the armed forces in which he endorsed the main proposals of the Collins Plan: a single department with one cabinet-level secretary, a separate air force, a chief of staff of the armed forces, and a purely advisory Joint Chiefs of Staff. This message, along with the testimony gathered at the hearings, was referred to a subcommittee of the Senate Military Affairs Committee headed by Senator Elbert Thomas. Major General Lauris Norstad and Vice Admiral Arthur W. Radford were assigned to assist the subcommittee in its deliberations.

On 9 April 1946 the committee reported out a bill combining elements of both the Navy and Army plans. Like the Eberstadt proposal, this bill (referred to as the Thomas bill after the committee chairman) called for a general reorganization of the entire national security structure and the inclusion of a national security council, a central intelligence agency, and a national security resources board. Like the Collins Plan, it called for a single department of common defense, a chief of staff of common defense, and a Joint Chiefs of Staff consisting of the Service chiefs and the chief of staff of common defense. However, the powers of the Joint Chiefs of Staff in the Thomas bill were less than those proposed in the Collins plan. The responsibility for preparing the military budget, which General Collins would assign to the Joint Chiefs of Staff, became the responsibility of the secretary of common defense. The Thomas bill was referred to the Senate Committee on Naval Affairs, which conducted hearings on the bill early in May.

During the hearings Navy witnesses attacked the provisions of the bill calling for a secretary of common defense and a chief of staff for common defense and expressed their fears that the Thomas bill, if enacted, would permit removal from the Navy Department of its naval air arm and Marine Corps.

It soon became clear that the Thomas bill did not provide the compromise its drafters had intended. Therefore, President Truman on 13 May requested the Secretaries of War and Navy to submit for his review a list of points upon which they agreed and disagreed. He made it clear that, while not committed to either Department's position in the controversy, he no longer favored the establishment of a single chief of staff.

The Secretaries submitted their views to the President on 31 May. They listed eight points upon which they agreed and four on which they did not. The War Department had receded from its previous position on two points.

First, it agreed to the establishment of a higher national security structure as proposed in the Eberstadt proposal. Second, in line with the President's wishes, it agreed not to press for a chief of staff of common defense. Instead, both Departments agreed that the Joint Chiefs of Staff would be retained and given responsibility beyond the purely advisory role depicted in the early bills that had proposed a chief of staff or commander of the armed forces. The Joint Chiefs of Staff were to:

formulate strategic plans, to assign logistic responsibilities to the services in support thereof, to integrate the military programs, to make recommendations for integration of the military budget, and to provide for the strategic direction of the United States military forces.

On 15 June, President Truman announced his resolution of the outstanding issues, none of which affected the Joint Chiefs of Staff. The Thomas bill was appropriately amended, and hearings resumed. Navy witnesses, however, opposed this revised version, leading to a postponement of further consideration until the 80th Congress convened early in 1947.

Secretary of War Robert P. Patterson and Secretary of Navy Forrestal chose not to wait. In view of points of agreement already reached, they appointed General Norstad and Admiral Forrest Sherman to develop a blueprint for unification upon which legislation could be based. On 16 January 1947, the conclusions reached by the two officers were forwarded to the President by the Secretaries of War and Navy as the plan under which the two departments could agree to unify under a single secretary of national defense.

President Truman accepted the proposal, and Admiral Sherman and General Norstad then drafted a bill based on their plan. On 26 February the President forwarded it to both houses of Congress.

Passage of the National Security Act

Following several months of hearings and debate, the Congress passed the legislation in amended form as the National Security Act of 1947 (Public Law 80-253). It provided for a National Military Establishment, headed by the Secretary of Defense, that included the Joint Chiefs of Staff and the Departments of the Army, Navy, and Air Force. The congressional amendments to the Norstad-Sherman bill placed further limitation on the powers of the Secretary of Defense and provided additional safeguards for the Navy air arm and the Marine Corps. Provisions relating to the Joint Chiefs of Staff, however, remained unchanged. They provided:

1. There is hereby established within the National Military Establishment the Joint Chiefs of Staff, which shall consist of the Chief of Staff, United States Army; the Chief of Naval Operations, the Chief of Staff, United States Air Force, and the Chief of Staff to the Commander in Chief, if there be one.
2. Subject to the authority and direction of the President and the Secretary of Defense it shall be the duty of the Joint Chiefs of Staff —
 - a. to prepare strategic plans and to provide for the strategic direction of the military forces;
 - b. to prepare joint logistic plans and to assign to the military services logistic responsibilities in accordance with such plans;
 - c. to establish unified commands in strategic areas when such unified commands are in the interest of national security;
 - d. to formulate policies for joint training of the military forces;
 - e. to formulate policies for coordinating the education of members of the military forces;
 - f. to review major materiel and personnel requirements of the military forces, in accordance with strategic and logistic plans; and
 - g. to provide United States representation on the Military Staff Committee of the United Nations in accordance with the provisions of the Charter of the United Nations.
3. The Joint Chiefs of Staff shall act as the principal military advisers to the President and the Secretary of Defense and shall perform such other duties as the President and the Secretary of Defense may direct or as may be prescribed by law.

The functions assigned to the Joint Chiefs of Staff were, in large part, those that had been agreed to by Secretaries Patterson and Forrestal in May 1946. There was, however, one significant deletion. In the Secretaries' version, the Joint Chiefs of Staff were to "make recommendations for integration of the military budget." The National Security Act made no specific provision for a budgetary function of the Joint Chiefs of Staff.

The National Security Act did provide for a Joint Staff, a provision originally included in the Eberstadt proposal and revived by General Norstad and Admiral Sherman for inclusion in the draft act. The appropriate provision of the National Security Act, unchanged from the bill as originally introduced, was as follows:

There shall be, under the Joint Chiefs of Staff, a Joint Staff to consist of not to exceed one hundred officers and to be composed of approximately equal numbers of officers from each of the three armed services. The Joint Staff, operating under a Director thereof appointed by the Joint Chiefs of Staff, shall perform such duties as may be directed by the Joint Chiefs of Staff. The Director shall be an officer junior in grade to all members of the Joint Chiefs of Staff.

Organizing the Joint Staff

With President Truman's signature of the National Security Act on 26 July 1947, the Joint Chiefs of Staff began consideration of the implementation of the provisions affecting their organization. On 4 August, Fleet Admiral Chester W. Nimitz, Chief of Naval Operations, proposed that the Joint Chiefs of Staff continue the existing structure of part-time interservice committees, with their full-time supporting groups incorporated in the new Joint Staff. Admiral Nimitz also recommended that the Joint Chiefs of Staff approve a directive to the Director, Joint Staff, spelling out his supervisory duties over the Joint Staff and imposing a specific limitation on his authority. The Director would be required, according to Admiral Nimitz's proposal, to forward all reports of JCS committees to the Joint Chiefs of Staff. In cases involving disagreements, however, the Director would be authorized to submit his own views along with those of the majority and minority members of the committee.

The Acting Chief of Staff of the Army, while he agreed with Admiral Nimitz on the need to proceed immediately with the reorganization of JCS agencies, proposed that the details be worked out by the officer selected to be Director of the Joint Staff. He accordingly recommended, and the Joint Chiefs of Staff approved, that the Director be selected at once and be directed to recommend a statement of functions for the Director and an internal organization for the Joint Staff. In preparing his recommendations the Director would take into consideration the views of Admiral Nimitz.

Major General Alfred M. Gruenther, USA, was named by the Joint Chiefs of Staff on 25 August to be the first Director, Joint Staff. After considering the opinions and recommendations of individuals both within and without the JCS organization, General Gruenther submitted his plan to the Joint Chiefs of Staff on 26 September 1947. The plan encompassed a statement of functions for the Director, Joint Staff, an organization for the Joint Staff, and a basic staff procedure. Underlying General Gruenther's proposals was the premise, based on the provisions of the National Security Act, that the Joint Chiefs of Staff would function as a planning, coordinating, and advisory body, not as an operating or implementing

group. The Joint Staff was therefore designed to support the Joint Chiefs of Staff in this role. The Joint Chiefs of Staff approved the plan on 26 October 1947.

The new Joint Staff modified and added to the existing committee structure. It consisted of the office of the Director and three staff groups—the Joint Intelligence Group, the Joint Strategic Plans Group, and the Joint Logistics Plans Group. These groups (redesignations for the existing Joint Intelligence Staff, Joint War Plans Committee, and Joint Logistics Plans Committee) continued to support the appropriate senior part-time interservice committees. The membership of these committees, however, had been broadened to include on each the director of the appropriate supporting joint staff group. In addition, while the Joint Intelligence Committee continued under the same title, the names of the other two were changed as follows: the Joint Staff Planners became the Joint Strategic Plans Committee; the Joint Logistics Committee became the Joint Logistics Plans Committee. The work of the other JCS committees, which were not part of the Joint Staff, also came under the general supervision and coordination of the Director. These were the Joint Communications Board, the Joint Civil Affairs Committee, the Joint Military Transportation Committee, the Joint Meteorological Committee, the Army-Navy Petroleum Board, and the Joint Munitions Allocation Committee.

The Joint Strategic Survey Committee, the Joint Secretariat, the Historical Section, and the US Delegation to the UN Military Staff Committee were placed outside the Joint Staff and directly under the Joint Chiefs of Staff.

The functions of the Director, Joint Staff, included supervising and coordinating the work of the Joint Staff, assigning problems and studies to appropriate components of the Joint Staff, and insuring that the necessary reports were completed and submitted to the Joint Chiefs of Staff. His supervisory functions did not include the authority to approve or disapprove the reports before submission. This power remained with the joint committees, but the Director was authorized to submit his own recommendations along with the committee reports.

The Joint Chiefs of Staff organization resulting from the enactment of the National Security Act of 1947 is shown in Chart IV.

The Key West Agreement of 1948

In amplification of the National Security Act of 1947, the new Secretary of Defense, James V. Forrestal, worked out with the Joint Chiefs of Staff an expanded functions statement for the Joint Chiefs of Staff and the armed forces. The final details were resolved during a meeting of the Secretary

with the Chiefs in Key West, Florida, during the period 11 through 14 March 1948.

The resulting "Functions of the Armed Forces and the Joint Chiefs of Staff," or the Key West Agreement as it was more popularly known, was issued on 21 April 1948. It set out in detail the functions of the Joint Chiefs of Staff, the functions common to all the armed forces, and those of each individual Service. The Key West Agreement made clear that the JCS responsibility for providing strategic direction of the armed forces included "the general direction of all combat operations." It also sanctioned the practice, begun during World War II, by which the Joint Chiefs of Staff designated one of their members as executive agent for each of the unified and specified commands for certain operations; for the development of special tactics, techniques, and equipment; and for the conduct of joint training.

CHART IV JCS ORGANIZATION 26 OCTOBER 1947

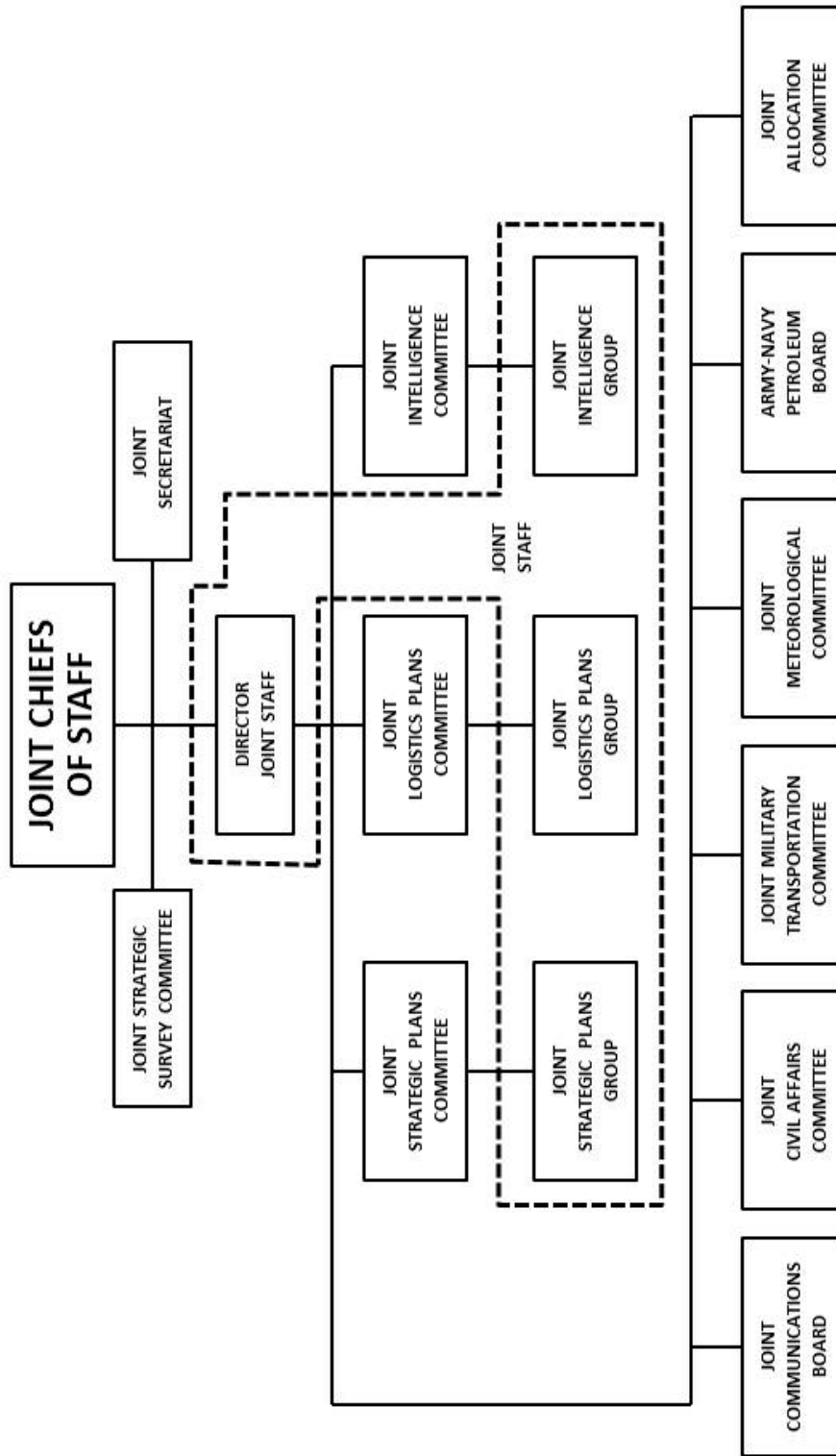

NOTE: ONLY MAJOR ORGANIZATIONAL ENTITIES SHOWN.

3. THE NATIONAL SECURITY ACT AMENDMENTS OF 1949

A Defense reorganization in 1949 was accomplished by legislation entitled the "National Security Act Amendments of 1949," which President Truman signed on 10 August 1949. This law strengthened the direction, authority, and control of the Secretary of Defense over the elements of the National Military Establishment, which was now redesignated the Department of Defense. The law also created the position of Chairman, Joint Chiefs of Staff, who was to preside over the meetings of the Joint Chiefs of Staff and expedite their business (although he was prohibited from voting in their decisions). This new position replaced that of the Chief of Staff to the Commander in Chief, which had been allowed to lapse with the illness and subsequent retirement of Admiral Leahy early in 1949. The Joint Chiefs of Staff were designated as principal military advisers to the National Security Council as well as to the President and the Secretary of Defense. The maximum personnel strength allowed the Joint Staff was increased from 100 to 210 officers.

These amendments had their origin in the experience of the first Secretary of Defense, James V. Forrestal, in administering the 1947 Act. Secretary Forrestal had soon found the need for a single officer to advise him on military problems and to provide liaison with the Joint Chiefs of Staff. For this purpose, he turned to Major General Gruenther, Director of the Joint Staff. In the spring of 1948, Mr. Forrestal sought to have General Omar N. Bradley, Chief of Staff, US Army, assigned as his principal military adviser, but both General Bradley and Secretary of the Army Kenneth C. Royall objected that the General was needed in his current position. Later in 1948, the Secretary arranged to have General of the Army Dwight D. Eisenhower recalled to active duty to serve as presiding officer of the Joint Chiefs of Staff for a period of several months beginning in January 1949.

In his first annual report, Secretary Forrestal made clear his conviction that there should be a "responsible head" for the Joint Chiefs of Staff. One of the JCS members might be selected for this purpose, or a fourth officer might be appointed to the position. In either event, the Chairman "should be the person to whom the President and the Secretary of Defense look to see to it that matters with which the Joint Chiefs should deal are handled in a way that will provide the best military staff assistance to the President and the Secretary of Defense." Mr. Forrestal believed that the Joint Staff should be enlarged and that the provision for JCS membership for the Chief of Staff to the Commander in Chief should be deleted from the law. He also set forth his conviction that the Secretary's authority over the National Military Establishment should be clarified and strengthened.

Secretary Forrestal had another opportunity to present his views as a result of the creation of a commission to survey the operations of the Federal Government. Mr. Forrestal had, in fact, been instrumental in instituting the legislation (the Lodge-Brown Act) under which this commission was established; he served as a member of it, but did not participate in the preparation of the commission's final report. Former President Herbert C. Hoover was named Chairman and Under Secretary of State Dean Acheson, Vice Chairman. To carry out an intensive survey of the National Military Establishment, the commission set up a special committee, or "task force," headed by Mr. Ferdinand Eberstadt. The committee took testimony from Secretary Forrestal, from the members of the Joint Chiefs of Staff, and from a long list of other military and civilian officials.

The Eberstadt committee's report unmistakably reflected the views of Secretary Forrestal. The members recommended that the Secretary be given clear authority over the defense establishment and that he be provided additional assistance, military and civilian. He should be authorized to designate one of the JCS members as Chairman, with the responsibility for "expediting the business of the Joint Chiefs of Staff and for keeping their docket current," but with no command authority over his JCS colleagues. The report also recommended that the Secretary take advantage of a provision in the existing law to appoint a "principal military assistant or chief staff officer." This appointee should sit with the Joint Chiefs of Staff, but should not be a member thereof. He should be responsible, in the Secretary's absence, for presenting and interpreting the Secretary's viewpoint and also for bringing "split" JCS decisions to the attention of the Secretary. He would thus play somewhat the same role as that in which the Director of the Joint Staff had been cast by Secretary Forrestal. The committee further agreed with the Secretary that the Joint Staff should be "moderately increased."

One of the members, former Secretary of War Robert P. Patterson, wished to go farther and combine the three military departments into one department of defense. The rest of the committee, however, did not endorse his views. Another member, John J. McCloy, urged the creation of a single, overall Chief of Staff, who would serve as the Chairman of the Joint Chiefs of Staff and have "at least the power of terminating discussion in that body after he had given full opportunity for discussion."

The Hoover Commission not only published and disseminated the report of the Eberstadt committee but also prepared one of its own on national security organization in which even greater status and authority was recommended for the Secretary of Defense. The commission desired to reduce the Service secretaries to the status of under secretaries of defense,

without cabinet rank, recommendations that even Mr. Patterson had not made. The commission's report also endorsed the proposal for a JCS Chairman, apparently envisioning him as a fourth appointee and not as one of the three incumbents elevated above his colleagues. The Vice Chairman of the commission, Dean Acheson, supported by three other members, joined Mr. McCloy in urging a "single chief of staff," who would have control over the Joint Staff and serve as principal adviser to the Secretary and the President. These conclusions went beyond the views of the majority of the commission.

President Truman incorporated the major conclusions of these two reports in a message to Congress on 5 March 1949. He recommended that the National Military Establishment be converted into an executive department, to be known as the department of defense, within which the existing Departments of the Army, Navy, and Air Force would be redesignated as military departments. The Secretary should be given clear responsibility for exercising "direction, authority, and control" over the department of defense. He would be empowered to make "flexible use" of the Joint Chiefs of Staff and the other agencies set up by the National Security Act of 1947, such as the Munitions Board and the Research and Development Board. Finally, there should be a Chairman of the Joint Chiefs of Staff, nominated by the President and confirmed by the Senate, who would take precedence over all military personnel and be the "principal military adviser to the President and the Secretary of Defense."

Shortly thereafter, Senator Millard Tydings of Maryland, Chairman of the Senate Armed Services Committee, drafted a bill intended to carry out the President's proposals. In some ways it went beyond the President in the degree of authority proposed for the Secretary of Defense. For example, it would confer upon the Secretary the right to appoint the Director of the Joint Staff. The duties of the Joint Chiefs of Staff were enumerated as in the 1947 Act, but it was specified that the Joint Chiefs of Staff would perform these duties, or others, at the "discretion" of the Secretary of Defense. All statutory limits on the size of the Joint Staff were to be removed.

Secretary Forrestal sent a draft of this bill to the Joint Chiefs of Staff for comment on 15 March 1949. Two months earlier, he had asked the Joint Chiefs of Staff whether, in their view, the functions assigned them by the 1947 Act should be revised.

The Joint Chiefs of Staff replied to both requests on 25 March 1949. They voiced no major objections to the Tydings bill but suggested changes that would delimit more clearly the status and duties of the Secretary and the proposed JCS Chairman. The Joint Chiefs of Staff believed that it should be specified that the Chairman would not, by virtue of his office,

exercise military command over the other JCS members or the Services. Moreover, it should be made clear that the Chairman, in giving advice to the President and the Secretary of Defense, would be acting in his capacity as JCS Chairman, not as an individual. The purpose of this JCS recommendation was to indicate that a Chairman would be expected to present the views of his colleagues, as well as his own, on any issue. The Joint Chiefs of Staff believed that they, and not the Secretary of Defense, should appoint the Director of the Joint Staff. They found no fault with the duties assigned by the 1947 law, but recommended that these continue to be prescribed by statute and not left to the Secretary's discretion.

This last recommendation was unacceptable to Secretary Forrestal, who reminded the Joint Chiefs of Staff that President Truman had expressed a firm desire to give the Secretary flexible authority. The other JCS proposals were acceptable, and he promised to submit them to Congress. Subsequently, his successor, Louis Johnson, sent Senator Tydings copies of the exchange of views between the Secretary and the Joint Chiefs of Staff.

The Senate Armed Services Committee opened hearings on the Tydings bill on 24 March 1949. The first witness was Secretary Forrestal, who was scheduled to leave office in a few days. He gave general approval to the measure, while admitting that minor amendments might later be found desirable. He explained why he had in some degree altered the views he had expressed prior to becoming Secretary of Defense. Concerning the proposal for a JCS Chairman, the Secretary explained that General Eisenhower's performance in this role had shown "how much more in the way of results can be attained by a man who is sitting over them directing and driving the completion of unfinished business." In his view, the Chairman's job would be to provide the agenda for JCS meetings, to see that the business of the Joint Chiefs of Staff was "vigorously prosecuted," to seek to induce agreements, to identify those issues on which no agreement was possible, and to advise the Secretary of Defense. The Chairman would not, however, exercise command, nor would he himself make any decisions when the other JCS members could not agree.

Subsequent witnesses included Messrs. Hoover and Eberstadt, former Secretary of War Patterson, Secretary of the Army Kenneth C. Royall, and Dan A. Kimball, Assistant Secretary of the Navy for Air (speaking in the absence of the Secretary, who was ill). None of these opposed the bill, although Mr. Patterson alone fully supported it as written. The strongest reservation came from Mr. Eberstadt, who believed that it would confer upon the Secretary of Defense and the JCS Chairman a degree of power that would be dangerous. He believed that the law should stipulate that the Chairman would not outrank the other JCS members and would not exercise command or military authority over them and that he would serve a

fixed term of office. He also urged that the Joint Chiefs of Staff as a body, and not merely the Chairman, be named as advisers to the President and the Secretary. His viewpoint on the status of the Chairman was upheld by ex-President Hoover, who added the suggestion that the Chairman should be given no vote in JCS decisions. Secretaries Kimball and Royall, while not seriously objecting to the provisions relating to the Chairman, agreed that a limited term of office would be desirable (Mr. Kimball recommended two years).

All three members of the Joint Chiefs of Staff were called upon to testify. Admiral Louis E. Denfeld, the senior member, acted as spokesman and presented the recommendations that he and his colleagues had made earlier to the Secretary of Defense. The senators were generally sympathetic to the JCS viewpoint. The question of a limitation on the size of the Joint Staff was introduced. Mr. Eberstadt, in his testimony, had suggested a ceiling of 200 officers. Admiral Denfeld told Senator Tydings that the Joint Chiefs of Staff had discussed this question with Major General Gruenther, who had suggested 250 as a reasonable number.

In the end, the Senate and the House of Representatives modified the Tydings bill considerably in the direction recommended by the Joint Chiefs of Staff, as well as by Messrs. Eberstadt and Hoover. The Chairman was to serve for two years and was to be eligible for one reappointment only, except in time of war when there would be no limit on his reappointment. He would take precedence over all other officers of the armed forces, but would not exercise military command over the Joint Chiefs of Staff or the Services. His duties were carefully prescribed as follows:

1. Serve as the presiding officer of the Joint Chiefs of Staff;
2. Provide agenda for meetings of the Joint Chiefs of Staff and to assist the Joint Chiefs of Staff to prosecute their business as promptly as practicable;
3. Inform the Secretary of Defense and, when appropriate as determined by the President or the Secretary of Defense, the President, of those issues upon which agreement among the Joint Chiefs of Staff has not been reached.

The advisory function was assigned to the entire JCS membership, not merely to the Chairman. The JCS duties were listed, essentially as in the 1947 Act, in language that did not leave the assignment of these tasks to the Secretary's discretion. The Joint Chiefs of Staff were to continue to appoint the Director of the Joint Staff, and a limit of 210 officers was set for that body.

The Senate approved the modified bill on 28 July and the House on 2 August. President Truman signed the bill into law on 10 August and General Bradley was sworn in as the first Chairman on 16 August.

In summary, clearly the initiative for the 1949 reorganization came from Secretary Forrestal. The continuing debate over unification and the general demand for economy in defense expenditures created a favorable opportunity for seeking changes that the Secretary considered necessary to create an efficient, well-integrated defense organization. In Ferdinand Eberstadt and Herbert Hoover, he found influential (though only partial) allies whose reports helped to focus public and congressional attention upon the issues involved. President Truman, and subsequently Senator Tydings, sought to carry the reorganization somewhat beyond the objectives originally envisioned by Secretary Forrestal. But Congress was not receptive to the degree of centralization that would have resulted under the original Tydings bill. The desire of the Joint Chiefs of Staff for a definite recognition of their corporate responsibility and a correspondingly circumscribed role for a Chairman found a ready response in Congress and was reflected in the provisions of the National Security Act Amendments as finally passed in August 1949.

Chart V depicts the JCS organization on 28 August 1949.

CHART V

JCS ORGANIZATION

28 AUGUST 1949

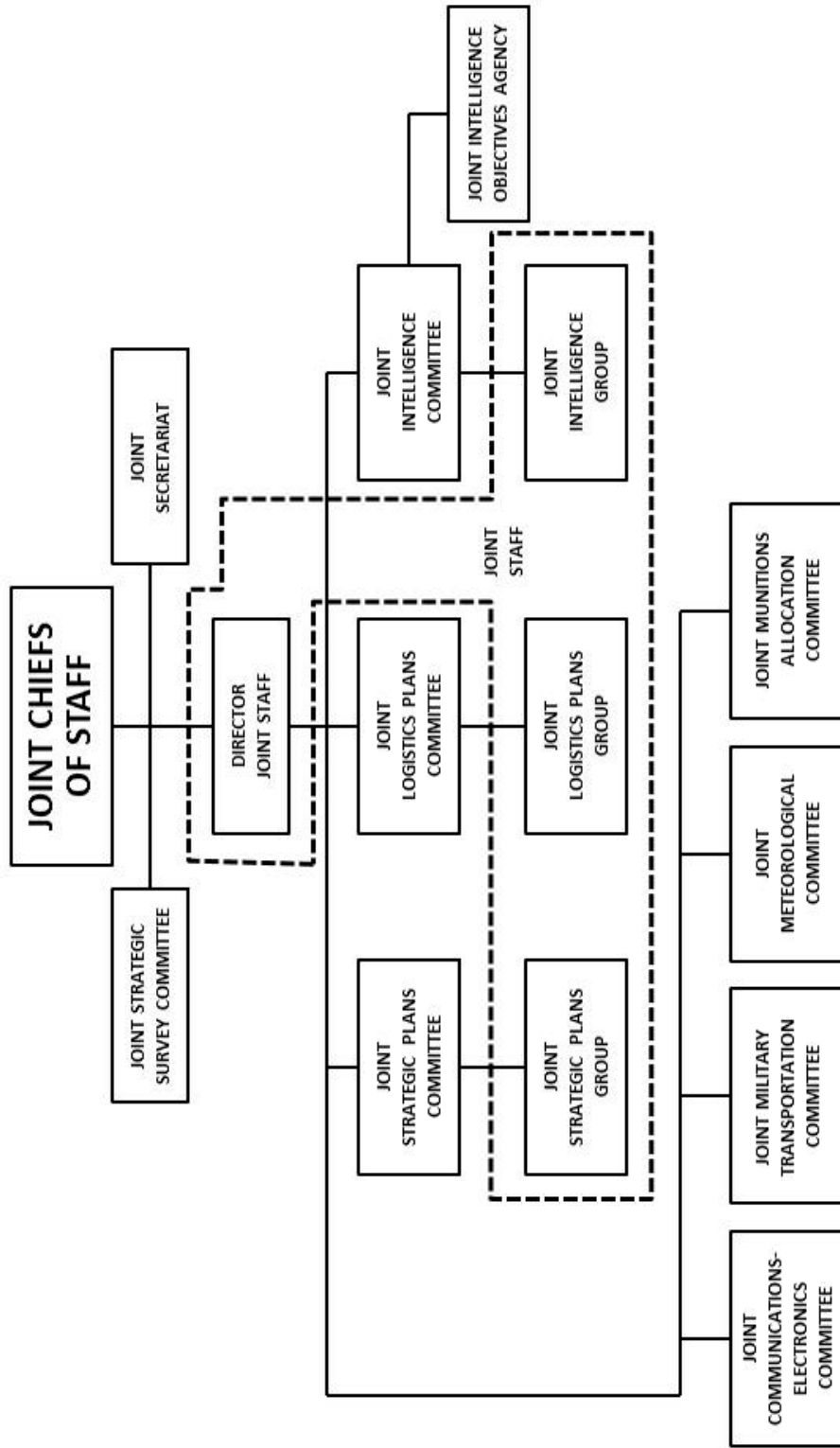

NOTE: ONLY MAJOR ORGANIZATIONAL ENTITIES SHOWN.

4. REORGANIZATION PLAN NO. 6 OF 1953

In April 1953 President Eisenhower proposed to Congress a reorganization of the machinery set up by the legislation of 1947 and 1949. The origin of President Eisenhower's 1953 reorganization plan could be traced to a statement that he had made during his successful campaign for the Presidency. On 25 September 1952, in a speech devoted entirely to the problems of national defense, he had called for the creation, "at the earliest possible date next year," of a commission composed of "the most capable civilians in our land" to study the operations, functions, and acts of the Department of Defense. He did not indicate the nature of the improvements that he considered necessary. The principal theme of his speech was criticism of waste and inefficiency as a result of "stop-and-start planning."

The President redeemed his promise soon after he took office. Secretary of Defense Charles E. Wilson appointed a committee headed by Mr. Nelson A. Rockefeller to study the Department of Defense. Other members named to the committee were the former Secretary of Defense, Robert A. Lovett; the President's brother, Dr. Milton S. Eisenhower; Dr. Vannevar Bush; Dr. Arthur S. Flemming; Mr. David Sarnoff; and one military member, the Chairman of the Joint Chiefs of Staff, General of the Army Omar N. Bradley. General of the Army George C. Marshall, Fleet Admiral Chester W. Nimitz, and General Carl Spaatz, USAF, served as military consultants.

Before the committee began operations, several of its members had placed on record their views regarding the changes needed in the existing defense organization. Particularly prominent in this regard was Dr. Bush, who, in two speeches made in September and October 1952, publicly advocated what was to become the cardinal feature of the President's reorganization plan: establishment of a purely civilian chain of command from the President through the Secretary of Defense to the secretaries of the military departments. Indeed, he wished to go even farther than the President did later in circumscribing the role of the Joint Chiefs of Staff. In his view, the Joint Chiefs of Staff should, as a body, issue no orders whatsoever, even in wartime. He favored empowering the Chairman to resolve disagreements among the Joint Chiefs of Staff, though he expressed opposition to a "supreme military commander." Dr. Bush also criticized the JCS planning process for failing to make use of civilian specialists in various fields of knowledge.

Mr. Lovett's views were embodied in a long letter to President Truman on 18 November 1952, the result of a suggestion by Mr. Truman that he place on record his recommendations for the benefit of the incoming

President. Mr. Lovett believed that the authority of the Secretary was still ambiguous in some ways and needed strengthening. He characterized the provisions regarding the Joint Chiefs of Staff as "one of the principal weaknesses of the present legislation." The statutory prescription of their functions was "excessively rigid." They were grievously overworked as a result of the numerous papers referred to them and, as a result, were "too deeply immersed in day-to-day operations" to do justice to their principal function, which was strategic planning. It was extremely difficult for the members of the Joint Chiefs of Staff and the Joint Staff "to maintain a broad non-service point of view," owing to their connections with individual Services.

Mr. Lovett's solution was to redefine the functions of the Joint Chiefs of Staff to confine them exclusively to the preparation and review of strategic and logistic plans. The Joint Chiefs of Staff should create a strong planning division under their control; their other functions, and most of the Joint Staff, should be transferred to the Office of the Secretary of Defense. Each JCS member should be encouraged to delegate to his deputy his individual Service responsibilities, and legislative authority should be sought for this purpose if necessary. Mr. Lovett's views regarding the chain of command from the President to the unified commands were identical with those of Dr. Bush. He believed also that the unrealistic prohibition of a vote for the Chairman should be dropped.

A more radical suggestion offered by Mr. Lovett was to assign to the Joint Chiefs of Staff only senior officers who had completed terms as military chiefs of their respective Services. The corporate Joint Chiefs of Staff would be served by an advisory staff of officers under a separate promotion system. Mr. Lovett admitted that this suggestion would require careful evaluation before being put into effect and that it might involve the creation of an armed forces general staff, which had been specifically forbidden by the National Security Act of 1947.

General Bradley, the Chairman, Joint Chiefs of Staff, did not go as far as Dr. Bush or Secretary Lovett, but he agreed that the Joint Chiefs of Staff advisory function should be given more emphasis. His solution was to establish, at a higher level, a national military council. It would serve as a staff for the Secretary of Defense and be responsible for reviewing JCS decisions on strategic matters, for settling issues on which the Joint Chiefs of Staff could not agree, and for establishing and exercising operational direction of joint commands.

The report of the Rockefeller committee, submitted in April 1953, was based on extensive consultation with military and civilian officials in the Department of Defense and the military departments. Its recommendations, though unanimous, were clearly dominated by the Bush-Lovett viewpoint.

The Joint Chiefs of Staff were afforded no opportunity to review the report. The Chairman, General Bradley, however, was a member of the committee and the other JCS members had appeared before the committee. In any event, the President accepted the committee recommendations and used them in preparing his proposals for the Congress.¹

On 30 April 1953, President Eisenhower submitted to the Congress a message on defense organization, designating it Reorganization Plan No. 6.² It could be implemented by executive order within 60 days unless formally rejected by Congress. As an old soldier, the President explained, he found the defense establishment in need of immediate improvement. He hoped to achieve an organization that was modern yet economical, while also strengthening civilian control and improving strategic planning.

To enhance civilian control, the Joint Chiefs of Staff would be removed from the chain of command and confined to an advisory role. They would no longer designate one of their members to serve as executive agent for each unified command. Instead, the Secretary of Defense, after consulting the Joint Chiefs of Staff, would designate one of the military departments for this purpose. The channel of responsibility would thus run from the President to the Secretary of Defense and then to the civilian secretaries of the military departments. However, "for strategic direction and for the conduct of the combat operations in emergency and wartime situations," the secretary of each designated department would authorize the corresponding military chief "to receive and transmit reports and orders and to act for such department in its executive agency capacity." In such cases, the order issued by the military chief would be "in the name and under the direction of the Secretary of Defense," and would clearly so state.

This scheme, President Eisenhower explained, would clarify the lines of authority in the Department of Defense and strengthen civilian control of the military establishment. The 1948 directive on the functions of the armed forces, according to the President, had partially obscured the intent of the National Security Act of 1947 by inserting the Joint Chiefs of Staff in the chain of command. The new arrangement, in the President's words, would "fix responsibility along a definite channel of accountable civilian officials as intended by the National Security Act."

¹ This was one of a number of reorganization plans dealing with various executive departments that President Eisenhower submitted to the Congress during the spring of 1953.

² This was one of a number of reorganization plans dealing with various executive departments that President Eisenhower submitted to the Congress during the spring of 1953.

Additionally, under the reorganization plan, the Chairman, Joint Chiefs of Staff, would receive additional authority. He would become responsible for managing the work of the Joint Staff and its Director, and the appointment and tenure of officers to the Joint Staff would be subject to his approval. At the same time, the Secretary of Defense would be empowered to approve the appointment of the Director, Joint Staff.

The enlargement of the Chairman's duties, according to the President, would relieve the Joint Chiefs of Staff of administrative detail, leaving them free to concentrate on their planning and advisory role. The overall objective was to improve the military planning process. With this end in view, the President declared that he would instruct the Joint Chiefs of Staff to arrange for the participation of experts from the Office of the Secretary of Defense in the deliberations of the Joint Staff in order to make certain that technological, scientific, economic, and other matters were properly integrated into military plans.

Later the President gave an additional explanation for empowering the Chairman to veto the appointment of officers for the Joint Staff. He hoped by this step to insure the choice of officers who could rise above narrow Service partisanship. "My objective," he wrote in his memoirs, "was to take at least one step in divorcing the thinking and the outlook of the members of the Joint Staff from those of their parent services and to center their entire effort on national planning for the overall common defense of the nation and the West."

The President's explanatory remarks did not touch upon the role given the Secretary of Defense in the selection of the Director of the Joint Staff. The Deputy Secretary of Defense, Roger M. Kyes, in explaining Reorganization Plan No. 6 to Congress, pointed out that the new requirement would regularize a practice informally followed in the past, when the Joint Chiefs of Staff submitted to the Secretary of Defense their nomination for the position of Director. Mr. Kyes also observed that the laws of 1947 and 1949 had been largely silent concerning the duties and responsibilities of the Joint Staff and the Director and that the new reorganization plan would remedy this deficiency. He remarked that "the one area which most concerns those who express fears about the emergence of a super-staff system is the one area which is the least carefully prescribed in the law."

Criticism of the reorganization plan quickly focused on the proposed new authority for the Chairman, Joint Chiefs of Staff, to approve the appointment and tenure of Joint Staff appointees and to manage the work of the Joint Staff. These provisions reawakened fears of the establishment of a "Prussian general staff" or of the rise of a "man on horseback."

Representative Clare E. Hoffman of Michigan, Chairman of the Committee on Government Operations of the House of Representatives, introduced a resolution providing that the plan would take effect except for the portions conferring additional authority on the Chairman, Joint Chiefs of Staff. Hearings on the Hoffman resolution by the Committee on Government Operations were held during June 1953. Mr. Rockefeller, Deputy Secretary of Defense Roger M. Kyes, and Budget Director Joseph M. Dodge testified at length in favor of the plan. Two letters from President Eisenhower, pointing out that the authorities of the Chairman, Joint Chiefs of Staff, would remain clearly circumscribed and subject to acceptable controls under the proposed plan, were also placed in evidence. Those witnesses favoring the Hoffman resolution included Ferdinand Eberstadt; Charles E. Bennett, a Congressman from Florida who was not a member of the committee; Thomas K. Finletter, former Secretary of the Air Force; and others, including several retired Navy and Marine Corps officers. Most confined themselves to the matter immediately at issue—the authorities proposed for the Chairman. Several ranged farther afield, notably Mr. Finletter, who criticized the trend of events since 1947 and urged a return to the original concept underlying the National Security Act, with the Secretary of Defense as a coordinator rather than an executive. Former President Herbert C. Hoover, though he did not appear as a witness, submitted a letter in which he supported the Hoffman resolution.

The arguments of witnesses hostile to the enlargement of the Chairman's authority proved convincing to the members of the Committee on Government Operations, which approved the Hoffman resolution on 22 June. Five days later, however, the House of Representatives rejected it by the substantial margin of 234 to 108. Accordingly, Reorganization Plan No. 6 took effect on 30 June 1953 in the form in which the President had submitted it. Subsequently, on 1 October 1953, the President and the Secretary of Defense promulgated a new directive governing the functions of the Armed Forces which revised the chain of command to accord with the President's announced intentions.

In July 1954, Secretary of Defense Wilson issued a directive to the Joint Chiefs of Staff that was intended to give further expression to the principles enunciated by the President on 30 April 1953. It provided that "the Joint Staff work of each of the Chiefs of Staff shall take priority over all other duties," and that the Secretary of Defense and the secretaries of the military departments would be kept fully informed of JCS deliberations. It also required the Chairman, Joint Chiefs of Staff, to forward to the Secretary of Defense his own "views, advice and recommendations" whenever he found himself in disagreement with his colleagues.

Chart VI shows the JCS organization on 30 June 1953, the date on which President Eisenhower's Reorganization Plan No. 6 became effective.

CHART VI

JCS ORGANIZATION

30 JUNE 1953

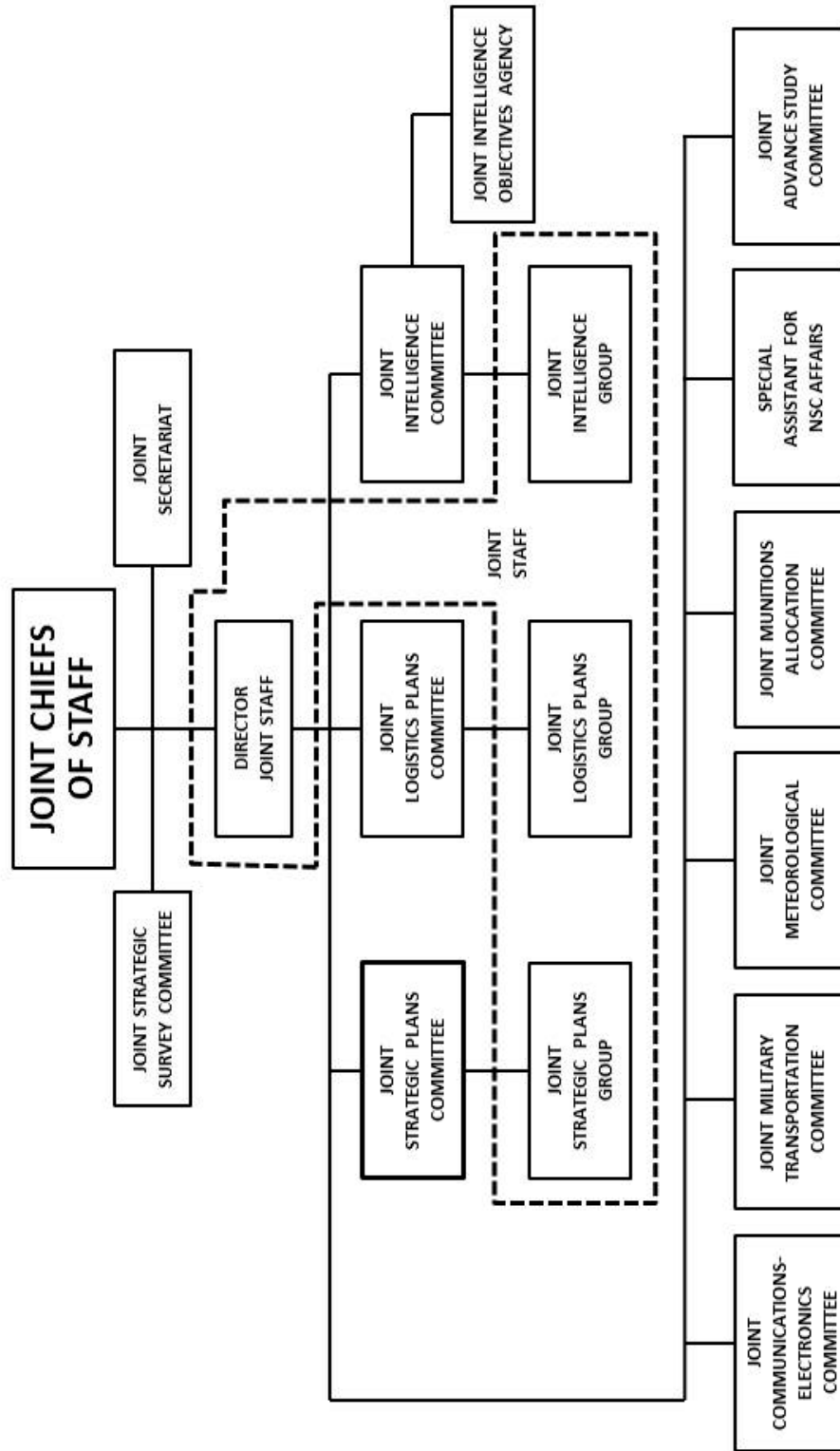

NOTE: ONLY MAJOR ORGANIZATIONAL ENTITIES SHOWN.

5. THE DEFENSE REORGANIZATION ACT OF 1958

In the several years following the reorganization of 1953, revolutionary advances occurred in military science and technology, particularly in missile delivery systems. The capabilities for ever-swifter delivery of long-range missiles being acquired by the Soviet Union as well as the United States underscored an increasingly urgent requirement for a more direct and responsive chain of military command with positive civilian control. Beyond this, the immense and rising costs of the national defense effort and the problems of allocating weapons systems and resources among the Services brought into public question the adequacy of the existing defense organization. During 1956 and 1957 considerable discussion took place in the Congress and the press regarding the need for reorganization of the Department of Defense. President Eisenhower at a press conference in mid-1957 expressed some dissatisfaction with current arrangements. General Maxwell D. Taylor, Chief of Staff, US Army, voiced the sentiment of many defense officials when he pointed out that dynamic changes in "weapons, transportation and techniques" indicated that studies of defense organization should be undertaken to "make it continually more responsive to requirements of national policy."

In December 1957 the Joint Chiefs of Staff established an ad hoc committee, headed by Major General Earle G. Wheeler, USA, to study Department of Defense organization, particularly with respect to the system for directing military forces in peace and wartime situations. This committee submitted interim findings to the Joint Chiefs of Staff in early January 1958, but at that point the JCS effort was superseded by a broader consideration of defense reorganization instituted by the President and the Secretary of Defense.

President Eisenhower in his State of the Union message to the Congress on 9 January 1958, revealed a deep concern over the potential effects on US deterrent power of the Soviet Union's growing missile delivery capability. He assured the Congress that he meant to make certain that military organization facilitated, rather than hindered, the functioning of the military establishment in maintaining the nation's security. "Recently," he continued, "I have had under special study the never-ending problem of efficient organization, complicated as it is by new weapons. Soon my conclusions will be finalized. I shall promptly take such executive action as is necessary, and in a separate message, I shall present appropriate recommendations to the Congress."

The President aimed to achieve "real unity in strategic planning and control" and what he described as "clear subordination of the military

services to duly constituted civilian authority." Although the President remarked that the problem of defense organization was under special study, it was not apparent that any special study group had formed for this purpose at the time of his address. More likely, he was referring to close consultations on the matter with his new Secretary of Defense, Neil H. McElroy.

Following the President's message, Secretary of Defense McElroy, who had replaced Secretary Wilson in October 1957, formed a panel of consultants to assist him in studying the organization of the Defense Department and in preparing "any recommended changes." He named Charles A. Coolidge, former Assistant Secretary of Defense, as a full-time special assistant on defense organization. Members of the panel were: William C. Foster, former Deputy Secretary of Defense; Nelson A. Rockefeller, Chairman, President's Advisory Committee on Government Organization; the current Chairman, Joint Chiefs of Staff, General Nathan F. Twining, USAF; and two former Chairmen, General of the Army Omar N. Bradley and Admiral Arthur W. Radford. The Secretary of Defense planned to continue discussing defense organization with the President and to make formal recommendations to him as soon as practicable.

The panel met regularly with the Secretary of Defense in the next several weeks, reviewing various proposals by individuals and study groups. They examined, for example, a Rockefeller report published in early January. Other major proposals reviewed by the panel included those made by the Hoover Commission and by such knowledgeable men as Congressman Carl Vinson, former Deputy Secretary of Defense Reuben Robertson, Under Secretary of the Army Charles Finucane, Secretary of the Navy Thomas Gates, and former Secretary of the Air Force Thomas Finletter. The panel heard the testimony and opinions of many top officials in the Department of Defense, including the Service chiefs and the secretaries of the military departments.

The panel made no written report. By the time it had completed its hearings the Secretary of Defense had developed his recommendations for the President. As General Twining expressed it in testifying before the House Armed Services Committee, "We did not know what the Secretary of Defense was going to recommend. He listened and made up his own mind."

Secretary McElroy had, however, discussed his proposed recommendations with the Armed Forces Policy Council at two separate meetings. This afforded all Service secretaries and the members of the Joint Chiefs of Staff, in their Service capacities, an opportunity to comment and recommend changes. Some minor changes occurred as a result.

The President's Plan

On 3 April 1958, President Eisenhower addressed a special message to the Congress, spelling out his decisions and recommendations on defense reorganization. "Separate ground, sea, and air warfare is gone forever," the President stated. "Peacetime preparation and organization activity must conform to that fact. Strategic and tactical planning must be completely unified, combat forces organized into unified commands, each equipped with the most efficient weapons systems that science can develop, singly led and prepared to fight as one, regardless of service." Accomplishment of this, the President pointed out, was the basic function of the Secretary of Defense, advised and assisted by the Joint Chiefs of Staff and operating under the supervision of the Commander in Chief. The President stated that he deemed certain revisions to be essential.

"We must organize our fighting forces into operational commands that are truly unified, each assigned a mission in full accord with our overall military objectives." The President informed Congress that all operational forces would be organized into truly unified commands unless personally exempted by the Commander in Chief. These commands would be in the Department of Defense but separate from the military departments. "I expect these truly unified commands to go far toward realigning our operational plans, weapons systems, and force levels in such fashion as to provide maximum security at minimum cost," he explained. To allay the concern of those who might fear he was moving toward abolition or merger of the Services, President Eisenhower emphasized that he had no such intention and that his proposals would have no such effect.

"We must clear command channels so that orders proceed directly to unified commands from the Commander in Chief and Secretary of Defense." The existing chain of command included the secretaries of the military departments—an arrangement the President had championed in 1953. Because of the changed situation, he now directed the Secretary of Defense to discontinue the use of military departments as executive agencies for the unified commands. He asked the Congress to repeal any statutory authority that vested responsibility for military operations in any official other than the Secretary of Defense. Specifically, he asked repeal of the provisions that the Chief of Staff, US Air Force, should command major units of the Air Force and that the Chief of Naval Operations should command naval operating forces.

With reference to the Joint Chiefs of Staff, the President stated, "We must strengthen the military staff in the Office of the Secretary of Defense in order to provide the Commander in Chief and the Secretary of Defense with the professional assistance they need for strategic planning and for operational direction of the unified commands." In furtherance of this,

several improvements were needed in the duties and organization of the Joint Chiefs of Staff. President Eisenhower believed the Joint Chiefs of Staff concept to be essentially sound and that the Joint Chiefs of Staff should continue as presently constituted. "However," he said, "in keeping with the shift I have directed in operational channels, the Joint Chiefs of Staff will in the future serve as the staff assisting the Secretary of Defense in his exercise of direction over unified commands. Orders issued to the commands by the Joint Chiefs of Staff will be under the authority and in the name of the Secretary of Defense. I think it important to have it clearly understood that the Joint Chiefs of Staff act only under the authority and in the name of the Secretary of Defense. I am, therefore, issuing instructions that their function is to advise and assist the Secretary of Defense in respect to their duties and not to perform any of their duties independently of the Secretary's direction."

The President went on to describe the current limitations on the strength of the Joint Staff and called attention as well to the committee system. He termed the operations of the existing system "laborious."

"With the operational channel now running from the Commander in Chief and Secretary of Defense directly to unified commanders rather than through the military departments," President Eisenhower informed the Congress, "the Joint Staff must be further unified and strengthened in order to provide the operational and planning assistance heretofore largely furnished by the staffs of the military departments." In order to accomplish this he had directed Secretary McElroy to discontinue the JCS committee system and to add "an integrated operations division." The President asked that Congress remove or raise the statutory limit of 210 officers on the size of the Joint Staff and empower the Chairman, Joint Chiefs of Staff, to assign duties to the Joint Staff. Further, he proposed authority for the Chairman, Joint Chiefs of Staff, with approval of the Secretary of Defense, to appoint the Director, Joint Staff, and deletion of the provision denying the Chairman a vote in JCS decisions.

Because of the heavy duties imposed on the individual members of the Joint Chiefs of Staff by the fact of their being chiefs of their Services, the President asked the Congress to change the law to make it clear that each military chief might delegate major portions of his Service responsibilities to his vice chief. "Once this change is made, the Secretary of Defense will require the chiefs to use their power of delegation to enable them to make the Joint Chiefs of Staff duties their principal duties," the President observed.

Two weeks after his 3 April message, President Eisenhower transmitted to the Congress draft legislation to implement the defense reorganization he had proposed. The House Armed Services Committee

decided to hold general hearings on the President's proposals. Already pending before the committee were several bills sponsored by individual Congressmen proposing changes in defense organization and arrangements. These hearings, according to Representative Carl Vinson, chairman of the House committee, would not be aimed at a particular bill but at "organization of the Department of Defense to enable us to prepare whatever legislation we find to be necessary to strengthen the security of the nation We are convinced that certain changes must be made in the Department of Defense. The basic structure is, in my opinion, sound—but it can certainly be improved."

The House hearings began on 22 April 1958. Testimony was taken from all key defense officials, including members of the Joint Chiefs of Staff. For nearly four months the President's legislative proposals underwent detailed and critical examination by the Congress. The unusual prestige of President Eisenhower, particularly in military matters, did not prevent extensive questioning of the need for and motivation behind the proposed changes in defense organization. Some legislators, public officials, and private citizens questioned the need to broaden and strengthen the powers of the Secretary of Defense. They were concerned as well by the apparent intent to diminish the roles of the individual Services, to centralize authority in the person of the Chairman, Joint Chiefs of Staff, and to enlarge the Joint Staff and widen the scope of its responsibilities. Some read into the proposals an effort to induce Congress to relinquish its authority and control of some aspects of national defense. There were others who feared that passage of the legislation would lead to a merger of the Services or the abolition of the Marine Corps.

In the lengthy congressional hearings, proponents of the President's plan attempted to make it clear that there was no danger of the feared developments and that the reorganization was necessary in the interest of national security. The testimony before the congressional committees by key officials of the Department of Defense was, with one exception, in full support of the legislation proposed by the President. Typical of the testimony offered by these officials was that of General Twining on 28 April.

General Twining spelled out for the House committee the specific military objectives being sought in the proposed reorganization. The first was to streamline the chain of command. A second was to strengthen and widen the authority of the field commanders. "We cannot afford to delay until after war starts the processes of assigning and reorganizing our major combat forces," he stated. The third major objective was greater flexibility in adjusting the functions, roles, and missions of the Services. "I think it important," the Chairman told the committee, "that the Secretary of Defense have the authority which he needs in this area." The fourth objective was to make the Joint Chiefs of Staff the "directing agency for the field commands."

A fifth objective involved making certain minor changes in the role of the Chairman that would lead to more efficient management. "No sweeping realignment of the services is contemplated," General Twining said, "but we do want a better mechanism for providing for decision in areas which invite duplication, waste, or inefficiency. A man on a white horse cannot emerge from this legislation. Civilian control is clearly delineated; the Joint Chiefs of Staff, as a corporate body, retains their present important powers; and numerous checks and balances will continue to exist."

To refute charges that a Prussian general staff would result if the Joint Staff were reorganized as proposed, General Twining presented information on the form and history of the Prussian staff system, pointing out its differences from the proposed Joint Staff. He also described the coordination procedures by which it was intended to insure that individual Service viewpoints continued to receive full consideration during the Joint Staff's development of reports for submission to the Joint Chiefs of Staff.

Other Defense officials testifying generally in the same supportive vein for the President's plan included Secretary McElroy and JCS members General Taylor, Admiral Arleigh Burke, and General Thomas D. White, USAF. With respect to an enlarged Joint Staff, none of these witnesses prescribed a definite number of officers, although Secretary McElroy did state that no more than 400 would be needed.

The Commandant of the Marine Corps, General Randolph McCall Pate, did not support the proposed legislation completely and so informed the Congress. General Pate supported the general objectives and principles of the President's proposals, but had certain reservations. For example, he did not believe that the proposals relating to the unified commands were well-founded, since in his view "these commands are operating satisfactorily today." Principally, however, his objections lay in those features of the bill that would relax restrictions on the transfer, reassignment, abolition, or consolidation of "combatant functions" by the Secretary of Defense. He feared that such relaxation might be used as a mandate from Congress to "rationalize the Marine Corps out of a job." While he did not object to letting the Chairman vote, General Pate did oppose permitting him to select the Director and to assign work to the Joint Staff. He wanted both these things done by the corporate Joint Chiefs of Staff.

The House hearings continued during the first three weeks of May. The overwhelming weight of the testimony in favor of the President's proposals gradually swung the balance away from the opposing views. The House committee reported the bill out on 22 May, strongly urging its enactment.

Following passage by the House, the legislation was referred to the Senate Committee on Armed Services, which held hearings from 17 June through 9 July. All of the Defense officials who had appeared before the House committee testified before the Senate committee, presenting the same views. The Senate committee reported favorably on the bill on 17 July.

In its final form the Department of Defense Reorganization Act of 1958 was passed by the Senate and House of Representatives on 24 July 1958 and signed by President Eisenhower on 6 August 1958. With respect to the Joint Chiefs of Staff, all of the changes proposed by the President were given legislative approval. The statutory limit on the size of the Joint Staff was raised to 400 officers. The legislation further prescribed that: "The Joint Staff shall not operate or be organized as an overall Armed Forces General Staff and shall have no executive authority. The Joint Staff may be organized and may operate along conventional staff lines to support the Joint Chiefs of Staff in discharging their assigned responsibilities."

Implementing the President's Plan

Once the President had submitted his message to Congress on 3 April, planning for the reorganization began in the Department of Defense. Secretary McElroy had informed the Chairman, Joint Chiefs of Staff, that he did not intend to give the Joint Chiefs of Staff a formal directive to carry out the applicable portions of the President's 3 April message to the Congress. He desired, instead, that the Joint Chiefs of Staff, based on their study and analysis of the spirit and intent of the President's message, recommend to him the necessary implementing measures. Accordingly, the Joint Staff was requested to develop suitable recommendations.

One feature of the President's proposed reorganization, the abolition of the JCS committee system, required no enabling legislation. The President had already directed the Secretary of Defense to accomplish it. On 27 May, the Chairman announced the disestablishment of the committee system of the Joint Chiefs of Staff, effective 7 June 1958.

Committees of the Joint Chiefs of Staff disestablished on that date were:

Committee for Joint Policies and Procedures, Permanent Logistics Reviewing Committee, Joint Munitions Allocation Committee, Joint Strategic Plans Committee, Joint Logistics Plans Committee, Joint Military Transportation Committee, Joint Intelligence Committee and certain subcommittees thereof, Joint Communications–Electronics Committee, Joint Military Assistance Affairs Committee, Joint Subsidiary Activities Committee, and Ad Hoc Committee on Service

Distribution of US Military Personnel Requirements of NATO Headquarters and Agencies.

The four committees that it was deemed necessary to retain in the JCS organization were redesignated. The Joint Strategic Survey Committee became the Joint Strategic Survey Council. The Joint Advanced Study Committee, the Joint Meteorological Committee, and the Joint Middle East Planning Committee were redesignated groups.

Meanwhile the Joint Staff had submitted a draft plan to implement most of the expected reorganization provisions. The chief question remaining concerned the internal organization of the Joint Staff itself, which continued under JCS discussion until early August. The matter could not be settled in detail, in any event, until it was known what limitations the Congress would enact regarding the size and operating procedures of the Joint Staff, but the concept the reorganization would follow also required careful consideration. It was possible to view the President's brief reference to adding "an integrated operations divisions" as setting a limit on the scope of the Joint Staff reorganization. In light of Secretary McElroy's instructions to consider the spirit and intent as well as the detailed provisions of the President's message, and with growing awareness of the dimensions of the new responsibilities to be assumed by the Joint Staff, the Joint Chiefs of Staff became convinced that a broader approach was necessary.

The reorganization plan that the Joint Chiefs of Staff approved provided for a Joint Staff arranged in the numbered J-directorates of a conventional military staff. In this form it would be organized to work effectively with the similar staff structures of the unified and specified commands. Transition to the new arrangement would be accomplished by realigning and redesignating the existing Joint Staff groups, accompanied by a phased absorption of additional personnel. From this process would emerge a Joint Staff composed of the following elements:

- J-1 Personnel Directorate
- J-2 Intelligence Directorate
- J-3 Operations Directorate
- J-4 Logistics Directorate
- J-5 Plans and Policy Directorate
- J-6 Communications-Electronics Directorate
- Joint Military Assistance Affairs Directorate
- Joint Advanced Study Group
- Joint Programs Office

With the approval of the Secretary of Defense, implementation of the first stage of the JCS plan began on 15 August 1958. The existing Joint Strategic Plans Group was divided to form the nucleus of the new J-3 and J-

5 Directorates. Similarly, the Joint Logistics Plans Group supplied the initial personnel for the J-1 and J-4 Directorates. The Joint Intelligence Group became J-2, and the Joint Communications-Electronics Group became J-6.

During this same period of organizational realignment, the Joint Chiefs of Staff progressively assumed operational responsibility for the unified and specified commands, which passed from the control of the military departments that had theretofore served as executive agencies. Both this transfer of responsibility and the reordering and expansion of the Joint Staff were completed by 1 January 1959.

On 18 August 1958, General Twining had requested the Secretary of Defense to authorize a Joint Staff of 356 officers and 79 other personnel and an overall strength of 902 for the Organization of the Joint Chiefs of Staff. Secretary McElroy did so on 23 August.

The 1958 reorganization required revision of the two DOD directives, 5100.1 and 5158.1, which prescribed the functions of the Joint Chiefs of Staff and their relationship with the Office of the Secretary of Defense. After extensive consultations, the JCS and OSD differences in draft revisions of the directives were reconciled in meetings of the Armed Forces Policy Council. On 31 December 1958, Secretary McElroy issued the final version of both directives.

The formal statement of the functions of the Joint Chiefs of Staff contained in DOD Directive 5100.1 reiterated their legislative designation as the principal military advisers to the President, the National Security Council, and the Secretary of Defense. The Joint Chiefs of Staff were designated the immediate military staff of the Secretary of Defense, serving in the chain of operational command extending from the President to the Secretary of Defense, through the Joint Chiefs of Staff, to the commanders of unified and specified commands. The Joint Chiefs of Staff were to recommend to the Secretary of Defense the establishment and force structure of unified and specified commands and the assignment to the military departments of responsibility for providing support to such commands; also they were to review the plans and programs of commanders of unified and specified commands. The basic planning function of the Joint Chiefs of Staff was directly related to the operational command responsibility by the following provision of the DOD directive:

To prepare strategic plans and provide for the strategic direction of the armed forces, including the direction of operations conducted by commanders of unified and specified commands and the discharge of any other function of command for such commands directed by the Secretary of Defense.

The remaining functions assigned to the Joint Chiefs of Staff were to:

(1) prepare integrated logistic plans and plans for military mobilization;

(2) review major personnel, materiel, and logistic requirements of the armed forces in relation to strategic and logistic plans;

(3) recommend the assignment of primary responsibility for any function of the armed forces requiring such determination and transfer, reassignment, abolition, or consolidation of such functions;

(4) provide joint intelligence for use within the Department of Defense;

(5) establish doctrines for unified operations and training and for coordination of the military education of members of the armed forces;

(6) provide the Secretary of Defense with statements of military requirements and strategic guidance for use in the development of budgets, foreign military aid programs, industrial mobilization plans, and programs of scientific research and development;

(7) participate, as directed, in the preparation of combined plans for military action in conjunction with the armed forces of other nations;

(8) provide the United States representation on the Military Staff Committee of the United Nations and, when authorized, on other military staffs, boards, councils, and missions.

The changes in the structure of the Organization of the Joint Chiefs of Staff that resulted from the 1958 reorganization are reflected in Charts VII-VIII.

CHART VII

JCS ORGANIZATION

30 JUNE 1958

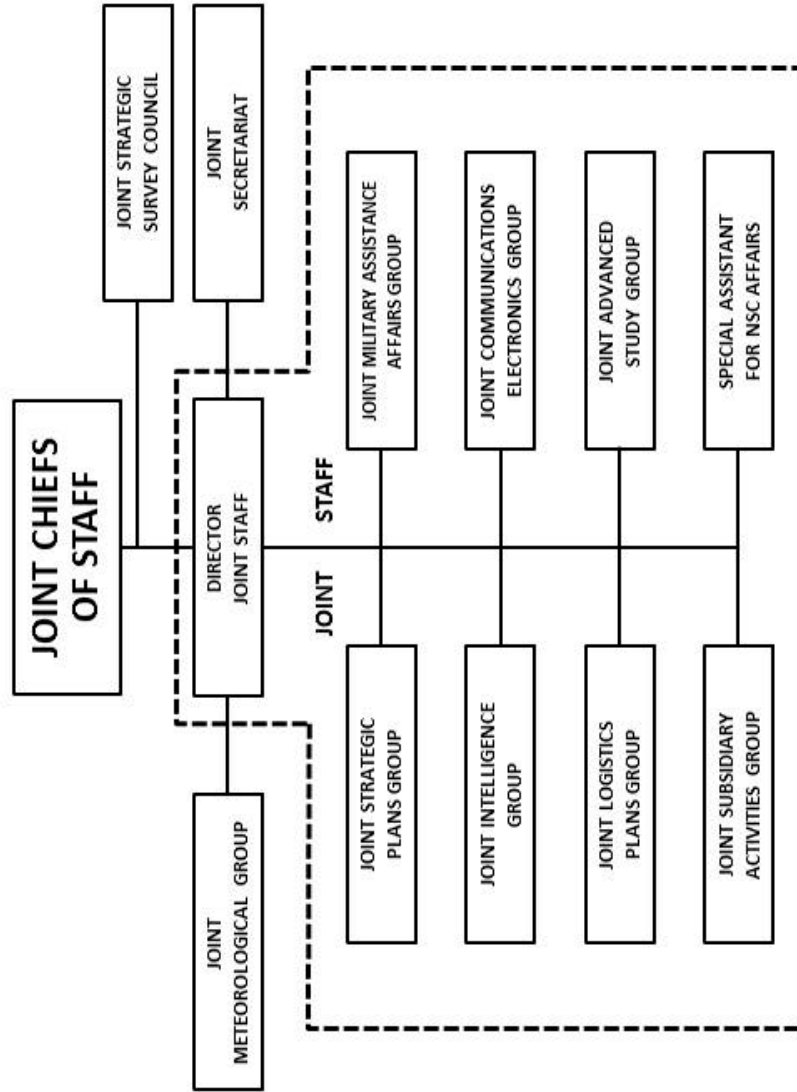

NOTE: ONLY MAJOR ORGANIZATIONAL ENTITIES SHOWN. BY 1958, THE DESIGNATION "ORGANIZATION OF THE JOINT CHIEFS OF STAFF" HAD COME INTO USE TO INCLUDE THE JOINT STAFF AS WELL AS THE OTHER OFFICES, AGENCIES, AND GROUPS SUPPORTING THE JOINT CHIEFS OF STAFF.

CHART VIII

JCS ORGANIZATION

30 JUNE 1959

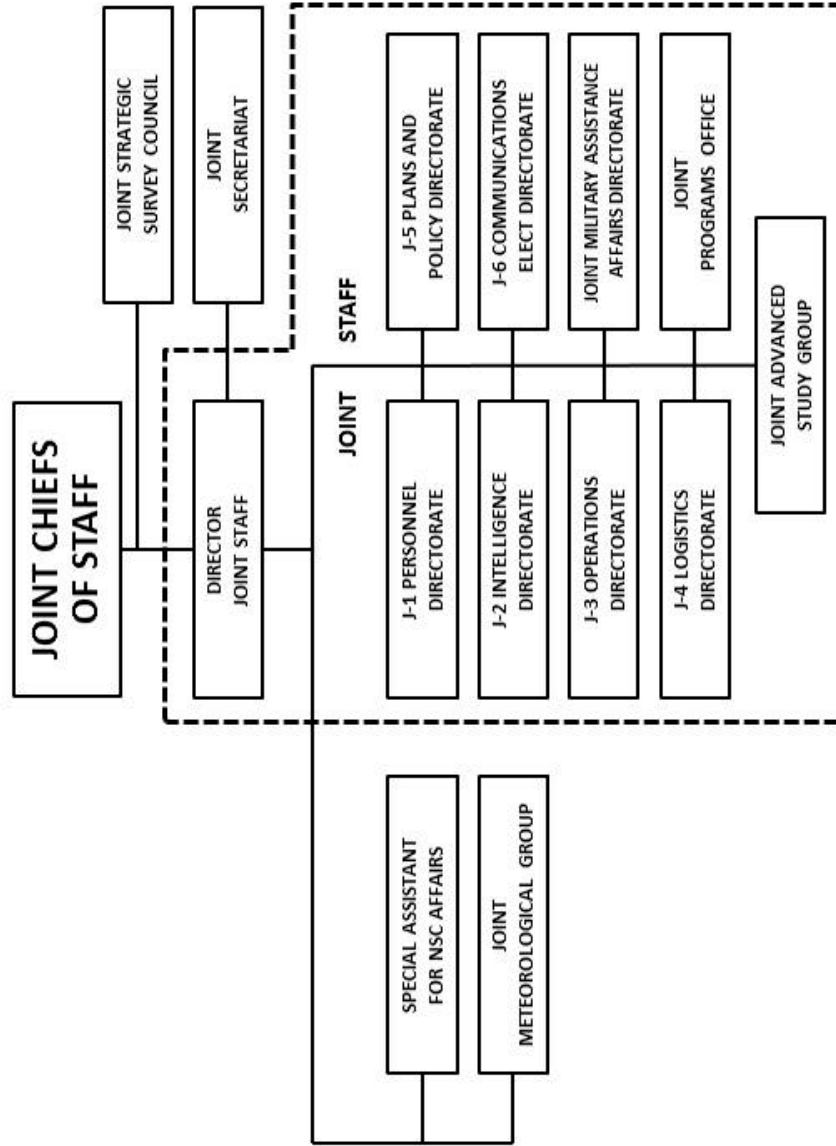

NOTE: ONLY MAJOR ORGANIZATIONAL ENTITIES SHOWN. BY 1958, THE DESIGNATION "ORGANIZATION OF THE JOINT CHIEFS OF STAFF" HAD COME INTO USE TO INCLUDE THE JOINT STAFF AS WELL AS THE OTHER OFFICES, AGENCIES, AND GROUPS SUPPORTING THE JOINT CHIEFS OF STAFF.

6. DEVELOPMENTS IN THE 1960s AND 1970s

For over two decades following the 1958 defense reorganization, JCS responsibilities and organization remained basically unchanged. The new J-staff structure proved sufficiently flexible to meet the expansion of the Vietnam War years and the subsequent contraction in the period of reduced defense budgets of the middle and late 1970s. There were nevertheless continuing adjustments in the internal JCS organization during the 1960s and 1970s in response to changing needs and situations.

Changes through 1967

The period of the Kennedy and Johnson administrations brought a proliferation of new agencies and groups, both within and outside the Joint Staff. The Office of the Special Assistant for Disarmament Affairs (later redesignated Special Assistant for Arms Control), the Joint Command and Control Requirements Group, and the Joint War Games Agency were all established in 1960 outside the Joint Staff. In February 1962 the Joint Chiefs of Staff established a Special Assistant for Counterinsurgency and Special Activities as part of the Joint Staff and, in October of that same year, the National Military Command Center began operating outside the Joint Staff but under the supervision of the Director for Operations (J-3). In the meantime, the Office of the Special Assistant for National Security Council Affairs had been abolished in May 1961 and the Joint Advanced Study Group in October 1962, their functions absorbed into the Plans and Policy Directorate (J-5). On the latter date, the Joint Program Office was also transferred into J-5.

During this same period, the Secretary of Defense had established several organizations charged with responsibility for certain functions for the entire Department of Defense. These included the Defense Nuclear Agency (originally the Defense Atomic Support Agency) in 1959 and the Defense Communications Agency and Defense Intelligence Agency, both in 1961. The chief or director of each of these was responsible to the Secretary of Defense through the Joint Chiefs of Staff. Subsequently, on 1 July 1963, the Joint Chiefs of Staff abolished the Intelligence Directorate (J-2) of the Joint Staff, and the Defense Intelligence Agency became responsible for providing intelligence staff support required by the Joint Chiefs of Staff.

On 31 July 1964, the Joint Chiefs of Staff disestablished the Joint Strategic Survey Council, the last organizational remnant of the World War II structure. Its functions had, in practice, already been assumed by other JCS agencies. Later that year, during October 1964, a new Directorate of Administrative Services was established, incorporating certain divisions that

had formerly been part of the Joint Secretariat. The Directorate of Administrative Services operated outside the Joint Staff but was responsible to the Director thereof.

Expansion to meet increasing JCS needs after the start of the Vietnam War took place outside the Joint Staff, which, by the 1958 legislation, was limited to 400 officers. New agencies were added to the Organization of the Joint Chiefs of Staff (OJCS), a usage that had evolved to encompass the entire organization supporting the Joint Chiefs of Staff—the Joint Staff, the enlisted military and civilian personnel working for the Joint Staff, and the offices and agencies outside the Joint Staff. In December 1964 the Chairman's Special Studies Group (originally a part of the J-5 Directorate) was removed from the Joint Staff; in October 1965 the Office of the Special Assistant for Military Assistance Affairs was similarly removed; in March 1966 the Office of the Special Assistant to the Joint Chiefs of Staff for Strategic Mobility was created outside the Joint Staff but subject to supervision and guidance from the Director of the Joint Staff; and in June 1967 the Office of the Special Assistant for Environmental Services was established in a similar status.

Title 10 of the US Code was amended in 1967 to extend the term of the JCS members, other than the Chairman, to four years. Only in time of war or national emergency could JCS members be reappointed for a second term of not more than four years. The Chairman's two-year term, with right of reappointment for one term, remained unchanged.

Organizational Consolidation, 1968–1976

By the late 1960s, there was a move to streamline the JCS organization, consolidating groups and agencies under existing staff directorates. This trend continued during the 1970s in response to continuing budget and congressional pressures for reduced defense expenditures. Effective 1 June 1968, the Director, J-3, assumed responsibility for monitoring and coordinating the work of the Special Assistant for Counterinsurgency and Special Activities, the Special Assistant for Environmental Services, and the Joint Command and Control Requirements Group. At the same time, responsibility for the Special Assistant for Arms Control, the Special Assistant for Military Assistance Affairs, and the Joint War Games Agency was assigned to the Director, J-5.

On 11 July 1968, as a result of President Lyndon Johnson's intention to begin negotiations for strategic arms limitations with the Soviet Union, the position of Special Assistant to the Chairman, Joint Chiefs of Staff, for Strategic Arms Negotiations was created. This Assistant was supported by officers on temporary duty until May 1970, when the Secretary of Defense approved personnel authorizations for a support staff within the

Organization of the Joint Chiefs of Staff. The Chairman, General Earle G. Wheeler, USA, established this staff to provide a focal point for military preparations for the Strategic Arms Limitation Talks (SALT) and to supply the nucleus for the military representation at the negotiations.

In July 1969, President Richard Nixon and Secretary of Defense Melvin R. Laird appointed a group of experts from outside government to review the organization and management of the Department of Defense. This Blue Ribbon Defense Panel, headed by Gilbert W. Fitzhugh, submitted its findings on 1 July 1970. It reported staffs within the Department that were too large and too layered. With specific regard to the Joint Chiefs of Staff, the panel found their workload "excessive." Each member, other than the Chairman, had to perform three roles: supervise his military Service; participate in the advisory and planning functions assigned to the Joint Chiefs of Staff by statute; and participate, by delegation, as a member of the Secretary of Defense's staff for military operations in the chain of command to the unified and specified commands. Also noted was the additional responsibility given to the Joint Chiefs of Staff since 1958 to supervise various Defense agencies, including the Defense Atomic Support, Defense Communications, and Defense Intelligence Agencies. The panel believed the Joint Chiefs of Staff would be more effective in performing their important statutory duty as principal military advisers to the President and Secretary of Defense if relieved of the necessity of performing delegated duties in the field of military operations as well as supervision of the Defense agencies.

To that end, the Blue Ribbon Defense Panel recommended rescinding the responsibilities delegated by the Secretary of Defense to the Joint Chiefs of Staff relating to military operations and the unified commands and eliminating all personnel in the Organization of the Joint Chiefs of Staff who supported these functions. A deputy secretary of defense for operations would assume these functions. He would have under him a senior military officer to supervise a separate staff to support military operations and to serve as the channel of communications from the President and the Secretary of Defense to the unified commands. All intelligence and communications functions of the Department of Defense would report to the Secretary of Defense through the deputy for operations as well. Further, the panel recommended that the Organization of the Joint Chiefs of Staff be limited to the Joint Chiefs of Staff and a reconstituted Joint Staff of not more than 250 officers augmented by professional civilian analysts as required.

The recommendations of the Blue Ribbon Panel for the Joint Chiefs of Staff were not implemented, but General Wheeler directed several organizational changes, effective in April 1970. These continued the consolidation of organizational entities and reduced substantially the number of separate OJCS agencies as well as the number of assigned

personnel. The Office of the Special Assistant for Counterinsurgency and Special Activities was transferred to J-3; the Special Assistant for Environmental Services was reconstituted as one of the deputy directors of J-3; the Joint Command and Control Requirements Group was abolished with its functions absorbed by J-3; the Office of the Special Assistant for Military Assistance Affairs was disestablished and its functions transferred to J-5, except for those aspects of follow-on support of approved programs for which J-4 had responsibility; the Joint War Games Agency and the Chairman's Special Studies Group were combined to form the Studies, Analysis, and Gaming Agency, which remained outside the Joint Staff, with the Director, J-5, charged with monitoring and coordinating its activities.

In August 1971 the Special Assistant for Arms Control was reconstituted as a deputy director in J-5, heading a new International Negotiations Division. A year and a half later, in March 1973, the Special Assistant to the Chairman, Joint Chiefs of Staff, for Strategic Arms Negotiations and his support staff were inactivated. Thereafter the Joint Chiefs of Staff participated in international negotiations through separate representatives designated for each matter under discussion (SALT, Mutual and Balanced Force Reductions, Law of the Sea). The JCS representatives were supervised by the Director of the Joint Staff with staff support provided by J-5.

In the meantime, in January 1972, Secretary of Defense Laird had established the Defense Mapping Agency. As was the case for the Defense Nuclear, Defense Communications, and Defense Intelligence Agencies, this new agency reported to the Secretary of Defense through the Joint Chiefs of Staff.

To accommodate a 15 percent manpower reduction imposed by the Secretary of Defense, the Joint Chiefs of Staff tightened their organizational structure in 1974. No existing agencies were disestablished, with a few minor exceptions, such as the Deputy Director for Operations (Counterinsurgency and Special Activities) in J-3; his functions were transferred to the Special Operations Division at a lower echelon within J-3.

Personnel reductions in the Department of Defense continued and, at the beginning of 1976, Secretary of Defense Donald H. Rumsfeld ordered another 15 percent reduction in military and civilian personnel. The Joint Chiefs of Staff could accomplish this action only through reorganization. Accordingly, two directorates of the Joint Staff, Personnel (J-1) and Communications-Electronics (J-6), were abolished. Functions and residual personnel of J-6 were transferred to J-3, those of J-1 to J-5 (except for prisoner of war matters, inspections, and data services, which went to J-3). Regional functions of J-3 and J-5 were consolidated within J-5. A Current Operations (now Joint Operations) Division was established in J-3. Internal

reorganization also occurred within J-5; the Studies, Analysis and Gaming Agency; the Joint Secretariat; and the Directorate of Administrative Services. The position of Deputy Director, Joint Staff, was abolished.

Changes in the Carter Period

Shortly after he entered office, President Jimmy Carter initiated reviews of several aspects of DOD organization, including resource allocation, the management structure, and the national military command structure. In regard to the last-named area, the President was particularly interested in the role and responsibilities of the Joint Chiefs of Staff.

A group headed by Richard C. Steadman, a former Deputy Assistant Secretary of Defense, conducted the study of the national military command structure and presented its report in July 1978. The group recommended no change in the JCS role in the national command structure or in JCS organization. It did, however, criticize the JCS staffing procedures and paper system. It was, the group said, "difficult for the Joint Staff to produce persuasively argued joint papers which transcend Service positions and difficult for the JCS to arrive at joint decisions in many important areas." To remedy the situation, the Steadman group recommended revised procedures: to make the Joint Staff alone responsible for authorship of JCS papers; to present "comprehensive analysis of alternatives whenever appropriate, encouraging expression of differing views"; and to supply the Joint Staff high-level guidance at the onset of the review of a given issue. In addition, the group urged that the military Services should make their most outstanding and highly qualified officers available for assignment to the Joint Staff.

The Steadman group also saw a certain inability by the Joint Chiefs of Staff to address effectively resource allocation and force structure issues because of conflict in their dual roles as both JCS members and heads of military Services. Since the Chairman, Joint Chiefs of Staff, was the only military officer with no present or future Service responsibility, the group believed that he was in a unique position to provide national military advice. Accordingly, it recommended that the Chairman be charged with supplying the Secretary of Defense advice on program, budget, and force structure issues, allowing him augmented staff support in the studies, analysis, and gaming area, as appropriate. Further, in order to enhance command management, the group recommended that the Secretary of Defense designate the Chairman as his agent to supervise the commanders of unified and specified commands.

The Steadman group anticipated that improvement in Joint Staff procedures and the added responsibility for the Chairman would improve the quality of military advice available to the Secretary of Defense and the

President. If, however, implementation of these changes did not bring the required improvement, then the group suggested consideration of separating "the joint advice and command functions from those of Service administration." This could be accomplished by creating a body of national military advisers. Such a body would include a senior officer from each Service, one of whom would be Chairman and would serve the Secretary of Defense, the National Security Council, the President, and the Congress much as the present Joint Chiefs of Staff. The national military advisers would be responsible for joint planning, operations, and advice but would have no Service assignments. Consequently, they could provide independent and objective military advice, uninhibited by conflicting Service responsibilities.

No change in the JCS organization resulted from the Steadman recommendations, nor was any action taken to create a body of national military advisers. The Joint Chiefs of Staff did, on their own initiative, carry out various internal reforms to improve Joint Staff procedures and enhance both their own and the Chairman's role in resource and allocation planning and decisions.

Meanwhile, over a two-year period from 1976 to 1978, the Secretary of Defense had removed the Joint Chiefs of Staff from the chain of command for the Defense Communications Agency, the Defense Intelligence Agency, the Defense Mapping Agency, and the Defense Nuclear Agency. Previously these agencies had reported to the Secretary of Defense through the Joint Chiefs of Staff, but now the Secretary placed them under the direction, authority, and control of various assistant or under secretaries of defense. In each case, however, the agency was required to support the needs of the Joint Chiefs of Staff as appropriate. In addition, the Chairman, Joint Chiefs of Staff, (acting for the Joint Chiefs of Staff) supervised the military aspects of the activities of the Defense Nuclear Agency, and the Defense Intelligence Agency continued to provide the Joint Chiefs of Staff intelligence support serving, in effect, as the J-2 of the Joint Staff. In August 1979, the Joint Chiefs of Staff approved a clarification and enumeration of the responsibilities of the Defense Intelligence Agency in its role as the J-2 of the Joint Staff. Theretofore, that role had not been defined in any detail.

In October 1978, the Congress enacted and the President signed legislation formally making the Commandant of the Marine Corps a member of the Joint Chiefs of Staff. Since 1952, the Commandant had co-equal status with the members of the Joint Chiefs of Staff when any matter directly concerning the Marine Corps was under consideration.³ Since that time, the Commandant had attended virtually all JCS meetings, in effect

³ See above, p. 31.

participating as a member, and this legislation merely recognized what had long been the actual practice.

During 1978, the Defense Science Board reported that US command and control systems had not kept pace with changes in warfare or developments in weapons and in command and control technology. The board saw a need for a central organization to oversee the design and testing of systems, to allow commands initiative in evolving systems, and to insure interoperability among allied systems. Various solutions were considered including the creation of a Defense command and control systems agency or expansion of the Defense Communications Agency. The Joint Chiefs of Staff, however, favored the formation of an appropriate element within the Joint Staff, and Secretary of Defense Harold Brown accepted their approach. Accordingly, on 30 May 1979, the Joint Chiefs of Staff established the Command, Control, and Communications (C3) Systems Directorate as part of the Joint Staff. They charged the new directorate with developing policies, plans, and programs to insure adequate C3 support for the commanders of unified and specified commands and the National Command Authorities for joint and combined military operations. The new directorate was also responsible for "conceptualizing" future C3 systems design and providing direction to improve command and control. At the same time, the Operations Directorate (J-3) was realigned to transfer responsibility for command, control, and communications systems to the C3 Systems Directorate.

The changes in the structure of the Organization of the Joint Chiefs of Staff that took place between 1959 and 1979 are reflected in Charts IX–XII.

CHART IX

JCS ORGANIZATION

1 SEPTEMBER 1969

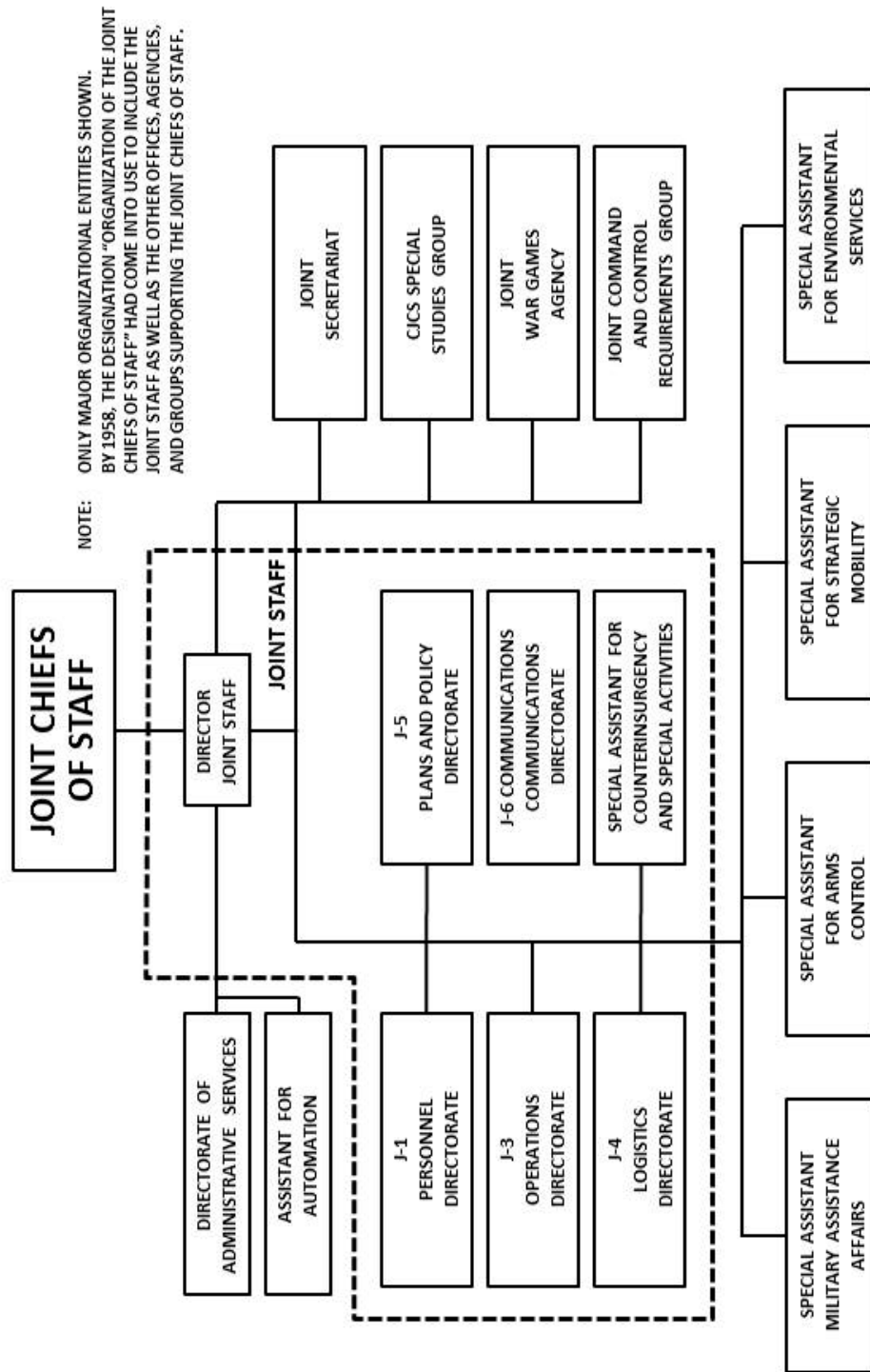
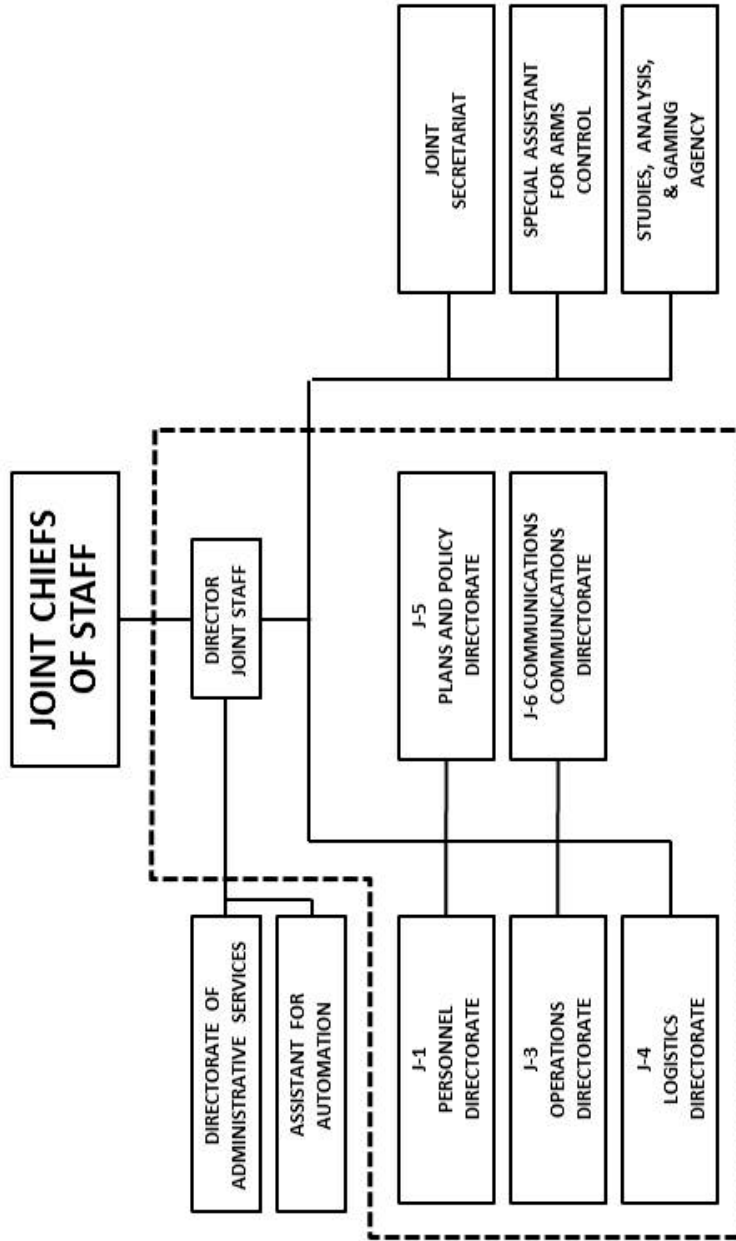

CHART X

JCS ORGANIZATION

31 DECEMBER 1970



NOTE: ONLY MAJOR ORGANIZATIONAL ENTITIES SHOWN. BY 1958, THE DESIGNATION "ORGANIZATION OF THE JOINT CHIEFS OF STAFF" HAD COME INTO USE TO INCLUDE THE JOINT STAFF AS WELL AS THE OTHER OFFICES, AGENCIES, AND GROUPS SUPPORTING THE JOINT CHIEFS OF STAFF.

CHART XI

JCS ORGANIZATION

31 DECEMBER 1976

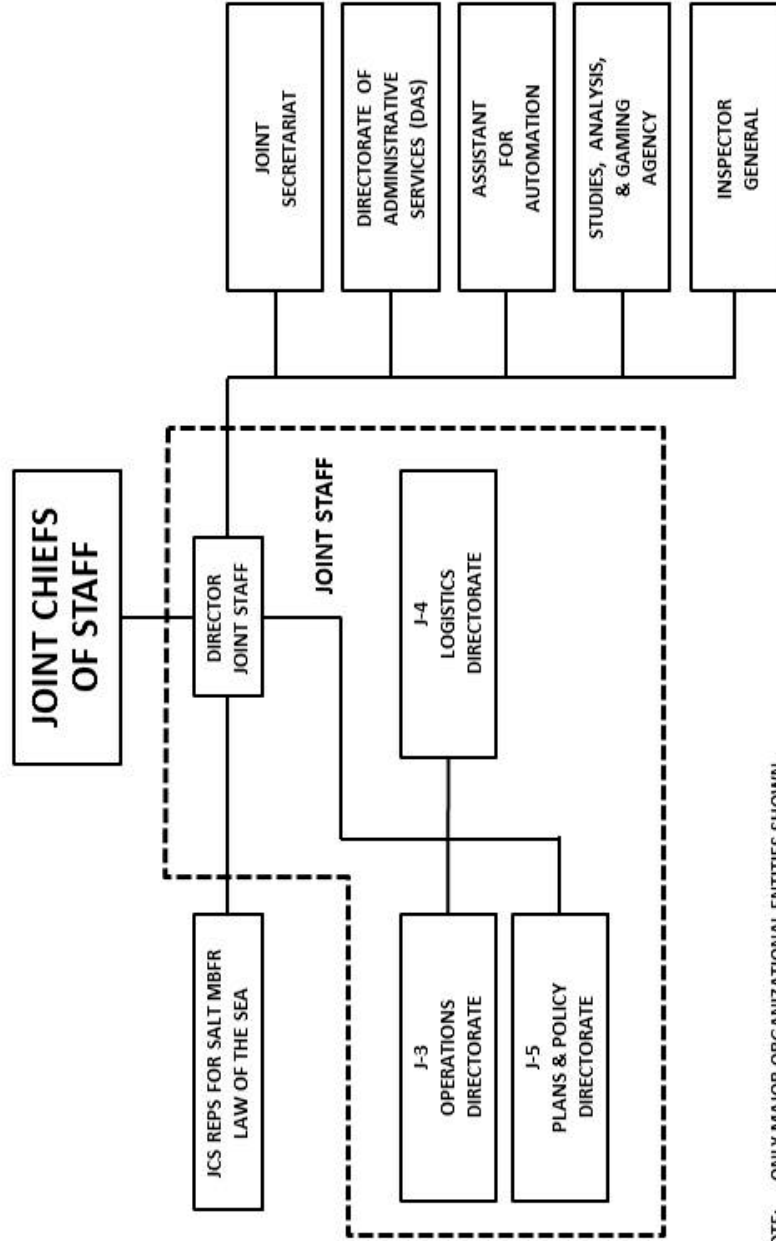

NOTE: ONLY MAJOR ORGANIZATIONAL ENTITIES SHOWN. BY 1958, THE DESIGNATION "ORGANIZATION OF THE JOINT CHIEFS OF STAFF" HAD COME INTO USE TO INCLUDE THE JOINT STAFF AS WELL AS THE OTHER OFFICES, AGENCIES, AND GROUPS SUPPORTING THE JOINT CHIEFS OF STAFF.

CHART XII

JCS ORGANIZATION

31 DECEMBER 1979

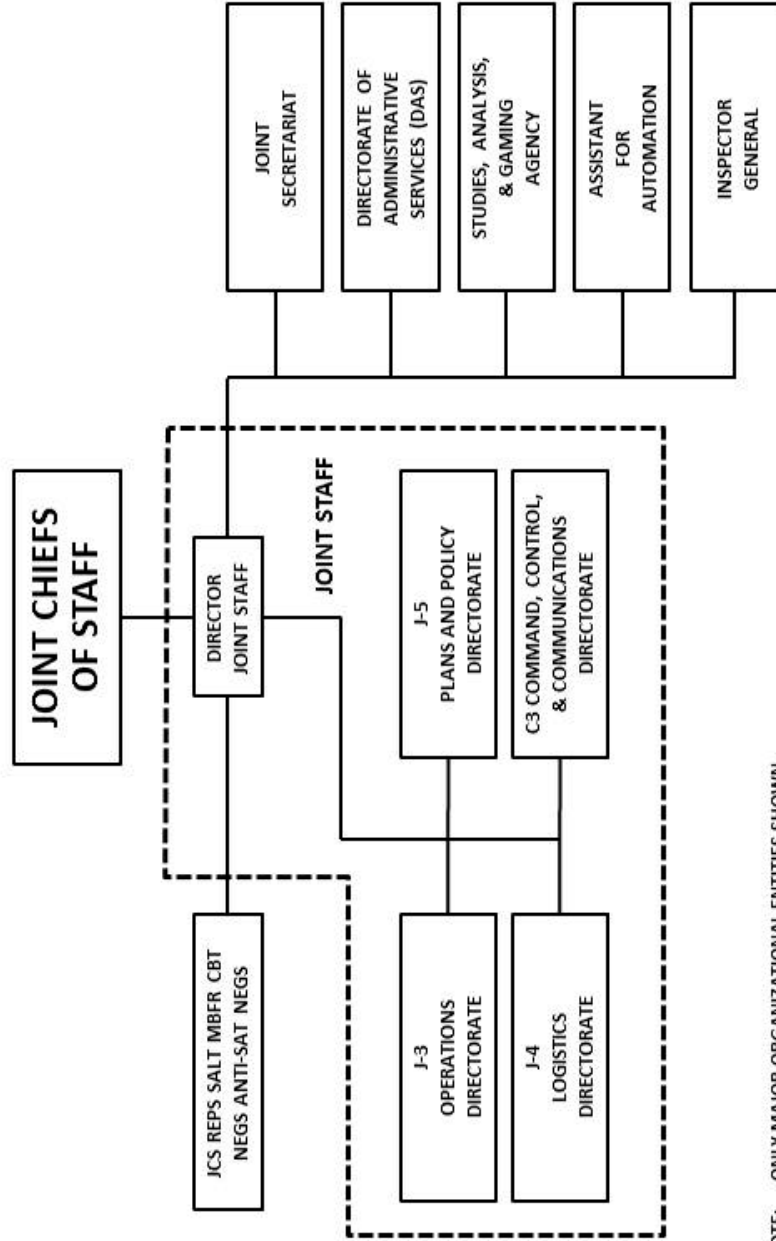

NOTE: ONLY MAJOR ORGANIZATIONAL ENTITIES SHOWN. BY 1958, THE DESIGNATION "ORGANIZATION OF THE JOINT CHIEFS OF STAFF" HAD COME INTO USE TO INCLUDE THE JOINT STAFF AS WELL AS THE OTHER OFFICES, AGENCIES, AND GROUPS SUPPORTING THE JOINT CHIEFS OF STAFF.

7. THE REORGANIZATION OF 1986

By the late 1970s, there were increasing demands for reform of the Joint Chiefs of Staff. The studies of defense reorganization in the last years of the decade had found the JCS military advice to the President and the Secretary of Defense inadequate and the JCS organization and procedures in need of change. The abortive Iranian hostage rescue attempt in 1980 fueled these criticisms. Then, in the spring of 1982, two sitting JCS members—the Chairman, General David C. Jones, USAF, and the Army Chief of Staff, General Edward C. Meyer—called for reform of the Joint Chiefs of Staff. Critics in the Congress and the academic community quickly joined the call, and this debate launched an examination of JCS and defense organization that culminated over four years later in the defense reorganization of 1986.

The Jones and Meyer Proposals

General Jones identified a number of persistent shortcomings in the JCS organization in an article published in February 1982. Based on almost eight years of experience as a JCS member (four as Air Force Chief of Staff and more than three as Chairman), he found inadequate cross-Service and joint experience in the US military "from the top down" and a built-in conflict in the situation where the Service chiefs also served as JCS members. He proposed changes in three areas. First, he recommended strengthening the role of the Chairman. He would make the Chairman, rather than the corporate Joint Chiefs of Staff, the principal military adviser to the President, the Secretary of Defense, and the National Security Council and would authorize a deputy to assist the Chairman. Further, he would make the Joint Staff responsible to the Chairman in lieu of the corporate Joint Chiefs of Staff and would have the Chairman, in consultation with the commanders of the unified and specified commands, serve as the interservice spokesman on issues involving distribution of resources. The latter proposal would, in turn, require strengthening the role of those commanders with respect to their component commands. Second, General Jones proposed limiting Service staff involvement in the joint process. He would accomplish this objective by requiring the Joint Staff to support the JCS members on joint matters and limiting the role of the Service staffs in the joint process. Finally, General Jones hoped to broaden the education, experience, and rewards for joint duty.

General Meyer did not believe the Jones proposals went far enough. Several problems would remain, he said, including the divided loyalty built into the dual-hatting of the Service chiefs as both Service leaders and JCS members, the inadequate provision for a structure and procedures that

could make a rapid transition to war, and insufficient involvement of the commanders of the unified and specified commands in the decision-making process. Accordingly, General Meyer made additional proposals for reform of the joint system. He recommended in March 1982 the creation of a council of national military advisers, a body of full-time military officers with no Service responsibilities to advise the Secretary of Defense and the President. The Chairman's position would continue and be greatly enhanced in the new council. He would direct planning and operations, be able to speak his own mind as well as disagree with the opinion of the council, and be supported by a strengthened joint staff to include an effective programming and budgeting capability. The Service chiefs would be restricted solely to leading their individual Services. General Meyer believed that such a division of responsibility between a council and separate Service chiefs would bring major improvement in the timeliness and value of military advice in peacetime and would allow enhanced decision-making by both bodies in time of crisis.

The other members of the Joint Chiefs of Staff did not believe such radical changes were necessary and, with the retirement of Generals Jones and Meyer in June 1982, the arena for discussion of reform moved to the Congress and the academic community. The Joint Chiefs of Staff, meanwhile, proceeded with various changes to enhance the functioning of their internal organization.

Changes, 1982–1984

In April 1982, at the recommendation of General Jones, the Joint Chiefs of Staff had approved a realignment of the Joint Staff. The realignment included transferring the operations plan review function from J-5 to J-3 with the creation of an Operations Plans Division in J-3, reestablishing a Manpower and Personnel Directorate (J-1) in the Joint Staff, and establishing of a Program Budget Analysis Division within J-5. These changes were designed to improve the management of joint manpower and personnel matters, increase the effectiveness and responsiveness of the joint operational planning and execution system, and improve the staff support for the Chairman throughout all phases of the planning, programming, and budgeting system.

During 1983 and 1984 the Joint Chiefs of Staff made further refinements and adjustments to their organization in response to changing needs and circumstances. In January 1983, the Director, Joint Staff, redesignated the Directorate of Administrative Services as the Directorate of Support Services only to change the name again two and a half years later (August 1985) to the Directorate for Information and Resource Management (DIRM). In October 1983 the Joint Chiefs of Staff directed establishment of the Joint Special Operations Agency (JSOA) to advise them on all aspects of

special operations and related military activities including strategy, planning, programming, budgeting, resource allocation, joint doctrine, readiness evaluation, and employment of forces. The new agency became operational on 1 January 1984 with the Special Operations Division, J-3, providing the nucleus for the staff. It was subordinate to the Joint Chiefs of Staff with staff monitorship and coordination through the Director, Joint Staff.

Earlier, in November 1983, the FY 1984 DOD Appropriations Bill Conference Report had expressed concern over the ability of the Chairman, Joint Chiefs of Staff, to fulfill statutory responsibilities for review of materiel and personnel requirements of the US armed forces in accordance with logistics and strategic plans. To provide additional support in this area, the conference report agreed that the Secretary of Defense should provide the Joint Chiefs of Staff an additional 20 military and 20 civilian billets. Accordingly, on 5 January 1984, the Chairman, General John W. Vessey, Jr., USA, directed the formation of a separate staff element, the Strategic Plans and Resource Analysis Agency (SPRAA), to assist the Joint Chiefs of Staff by providing independent analyses and recommendations on resource allocation matters and national military strategy. The Strategic Plans and Resource Analysis Agency became a part of the Organization of the Joint Chiefs of Staff, outside the Joint Staff, administered and supervised by the Director, Joint Staff.

During this same period, the Joint Chiefs of Staff were considering command arrangements for space and decided that a unified command for space should be established in the future. In the interim, they created, effective 1 February 1984, the Joint Planning Staff for Space (JPSS) to facilitate joint planning for space systems supporting the unified and specified commands and to develop a transition plan for a new unified space command. The Joint Planning Staff for Space was located in the Organization of the Joint Chiefs of Staff and reported to the Joint Chiefs of Staff through the Director, Joint Staff. (With the establishment of the unified US Space Command in September 1985, the Joint Chiefs of Staff phased out the Joint Planning Staff for Space and disestablished it on 31 January 1986.)

In response to significant new demands for analytic support, the Director, Joint Staff, approved on 3 March 1984, the reorganization of the Studies, Analysis, and Gaming Agency (SAGA) as the Joint Analysis Directorate (JAD). The redesignated directorate remained outside the Joint Staff. It was responsible for conducting studies, analyses, net assessments, and evaluations of military forces, plans, programs, and strategies and for conducting joint war games. It performed these duties under the authority and direction of the Chairman, Joint Chiefs of Staff, but subject to the supervision of the Director, Joint Staff.

On 20 March 1984, the Joint Chiefs of Staff established the Joint Requirements and Management Board (JRMB) to monitor the development and acquisition of joint programs. The board would evaluate potential joint military requirements; identify, evaluate, and select candidates for joint development and acquisition; oversee cross-Service requirements and management issues; and resolve Service differences arising after initiation of joint programs. The membership of the board comprised the vice chiefs of the Services and the Director, Joint Staff. The chairmanship would rotate among the four vice chiefs with the Vice Chief of Staff, US Army, designated as the first chairman for a term of one year. (Subsequently, in June 1986, the Joint Requirements and Management Board was renamed the Joint Requirements Oversight Council (JROC))

Later in 1984, proponents of JCS reform in the Congress succeeded in passing legislation making minor changes in the organization of the Joint Chiefs of Staff. The changes, which the President signed into law on 19 October 1984:

1. Made the Chairman, Joint Chiefs of Staff, subject to the authority, direction, and control of the Secretary of Defense, the spokesman for the commanders of the unified and specified commands on "operational requirements";
2. Allowed the Chairman to determine when issues under JCS consideration would be decided;
3. Authorized the Chairman (vice the corporate Joint Chiefs) to select and remove officers assigned to the Joint Staff;
4. Removed the three-year restriction on the tour of the Director, Joint Staff, and eliminated the prohibition against former Directors being reassigned to the Joint Staff;
5. Raised the limit of Joint Staff officer tours from three to four years;
6. Required the Secretary of Defense, in consultation with the Chairman, to insure that military promotion, retention, and assignment policies gave appropriate consideration to Joint Staff assignment performance.

Even though the legislation of 1984 went beyond what the Joint Chiefs of Staff thought was needed, the changes did not satisfy the advocates of reform either in the Congress or the academic community. In December 1984, for example, the Heritage Foundation published Mandate for Leadership II, Continuing the Conservative Revolution that included a chapter criticizing the JCS system and calling for defense reform. Two months later, the Center for Strategic and International Studies of Georgetown University issued a report, Toward a More Effective Defense, prepared by a panel of defense experts. The report was highly critical of defense organization in general and the Joint Chiefs of Staff in particular

and contained specific recommendations to remedy the identified deficiencies of the JCS system. Then, after several years of hearings and preparation, the Senate Committee on Armed Services published a lengthy staff report, Defense Organization: The Need for Change, in October 1985. The Senate report pointed out 16 problem areas and made 91 recommendations for change. Among the more significant were a call to abolish the Joint Chiefs of Staff to allow the Service chiefs to devote all their time to Service duties, a proposal to create in the place of the Joint Chiefs of Staff a joint military advisory council free from Service responsibilities, and a recommendation that the Chairman of such a council be the principal military adviser to the Secretary of Defense on operational matters and that the chairman develop and administer a personnel management system for all military officers assigned to joint duty.

In the hope of diffusing the growing criticism, President Ronald Reagan had ordered a Blue Ribbon Commission on Defense Management to review defense organization in June 1985. The commission, headed by former Deputy Secretary of Defense David Packard, heard testimony from a wide range of defense experts from both within and outside government, including the Joint Chiefs of Staff. In an initial report of 28 February 1986, the commission concluded that both the defense decision-making process and the organization of the US military leadership could be improved, that US combatant forces could be better organized and commanded to attain national objectives, and that the entire acquisition system—including research, development, and procurement—could be streamlined. With specific regard to the Joint Chiefs of Staff, the Packard Commission recommended: designation of the Chairman, Joint Chiefs of Staff, as the principal military adviser to the President, the National Security Council, and the Secretary of Defense, representing his own views as well as those of the corporate Chiefs; placement of the Joint Staff and the Organization of the Joint Chiefs of Staff under the exclusive direction of the Chairman and removal of the statutory limitation on the size of the Joint Staff; and retention of the Service chiefs as members of the Joint Chiefs of Staff and creation of a four-star deputy chairman as the sixth member of the Joint Chiefs of Staff to assist the Chairman. Thereafter, on 1 April 1986, President Reagan implemented those recommendations of the Packard Commission that did not require legislative action. Those affecting the Joint Chiefs of Staff, however, awaited congressional attention.

The Goldwater–Nichols Defense Reorganization Act

By the late summer of 1986, the Congress, too, was ready to act. Led by Senator Barry Goldwater and Representative Bill Nichols, the Congress passed in September an act named for the two leaders. President Reagan signed the Goldwater–Nichols Department of Defense Reorganization Act on 1 October 1986. Now, four and a half years after General Jones had

proposed reform of the Joint Chiefs of Staff, the issue was finally resolved. The result was the first major reorganization of the Joint Chiefs of Staff in almost 30 years and the most significant one since the National Security Act of 1947. The 1986 act greatly enhanced the authority of the Chairman at the expense of the corporate Joint Chiefs of Staff, established the position of Vice Chairman, bestowed wide new powers upon the commanders of the unified and specified commands, and provided for actions and procedures to increase the prestige and rewards for joint duty in an effort to improve the functioning of the joint system and the quality of joint military advice.

The new law designated the Chairman, in place of the Joint Chiefs of Staff, the principal military adviser to the President, the National Security Council, and the Secretary of Defense, but included provision for the other JCS members to continue as military advisers, submitting their advice when they disagreed with the Chairman or when requested by the President, the National Security Council, or the Secretary of Defense. The act assigned all the functions previously the responsibility of the corporate Chiefs to the Chairman and also gave him additional ones. The Chairman's responsibilities under the 1986 law included: assisting the President and the Secretary of Defense in the strategic direction of the armed forces; preparing strategic and logistics plans and net assessments; providing for the preparation and review of contingency plans; advising the Secretary of Defense on requirements, programs, and budgets; developing doctrine for joint employment of the armed forces; formulating and coordinating policies for the training and education of the armed forces; providing US representation on the United Nations Military Staff Committee; and performing such other duties prescribed by law or by the President and the Secretary of Defense.

Further, the act provided for a Vice Chairman to assist the Chairman and to act for the Chairman in his absence or disability. The Vice Chairman would outrank all officers of the armed forces except the Chairman, but would not exercise military command over the Joint Chiefs of Staff or any of the armed forces. He could participate in all JCS meetings, but would vote only when acting for the Chairman.

The 1986 act removed the 400-officer limitation on the Joint Staff and stipulated that, effective 1 October 1988, the total number of military (officer and enlisted) and civilian personnel assigned to the Joint Staff would not exceed 1,627. (This figure represented the actual size of the Organization of the Joint Chiefs of Staff when the Goldwater-Nichols Act passed, and this provision, in effect, enlarged the Joint Staff to include the entire Organization of the Joint Chiefs of Staff, a usage the Director of the Joint Staff discontinued in September 1988.) The 1986 act placed the Joint Staff and its Director under the Chairman and gave the Chairman the authority to select or suspend any member of the Joint Staff. Finally, separate titles

of the act spelled out the added authorities for the commanders of the unified and specified commands and a new joint officer personnel policy.

The 1986 act necessitated a restructuring of the JCS internal organization. Subsequently, on 6 November 1986, the Chairman, Admiral William J. Crowe, Jr., USN, approved the following actions:

1. Redesignation of the Command, Control, and Communications Systems Directorate as the J-6, Command, Control, and Communications Systems Directorate;
2. Establishment of the J-7, Operational Plans and Interoperability Directorate, to consolidate responsibility for the functions of joint doctrine, tactics and techniques, exercises, and operational planning;
3. Establishment of the J-8, Force Structure, Resource, and Assessment Directorate, to combine responsibility for resource and force analysis;
4. Authorization of other adjustments in the internal organization, within the congressionally mandated size limitation, as necessary to facilitate responsiveness, efficiency, and ability to execute revised missions.

The restructuring proceeded and was accomplished within existing manpower resources. The J-7 Directorate was created by transferring the Operation Plans, Joint Exercise, Readiness Programs, and Joint Operational Planning and Execution System (JOPES) Divisions from J-3 together with some spaces from J-5 and the C3S Directorate and the Strategic Plans and Resource Analysis Agency. The Joint Analysis Directorate, the Strategic Plans and Resource Analysis Agency, and the Force Planning and Programming Division and part of the Policy Division of J-5 combined to form the J-8 Directorate. The C3S Directorate transferred five officers to J-1 for accomplishment of additional responsibilities required by the joint officer personnel policy portion of the 1986 reorganization act. The J-8 Directorate became operational on 15 December 1986; the C3S Directorate was redesignated as J-6 on 1 January 1987; and the J-7 Directorate became operational on 17 February 1987. In the meantime, General Robert T. Herres, USAF, had assumed the duties of Vice Chairman on 6 February 1987. Subsequently, with the establishment of the unified US Special Operations Command as directed by the Congress, the Joint Special Operations Agency was disestablished on 1 August 1987. Its functions were assumed by the new unified command or realigned within the Joint Staff, primarily in a Special Operations Division, J-3. With these actions, the internal restructuring of the JCS organization to comply with the Goldwater-Nichols Reorganization Act was essentially complete. The changes in organizational structure of the Joint Chiefs of Staff that occurred between 1982 and 1987 are shown in Charts XIII-XV.

CHART XIII

JCS ORGANIZATION

30 JUNE 1982

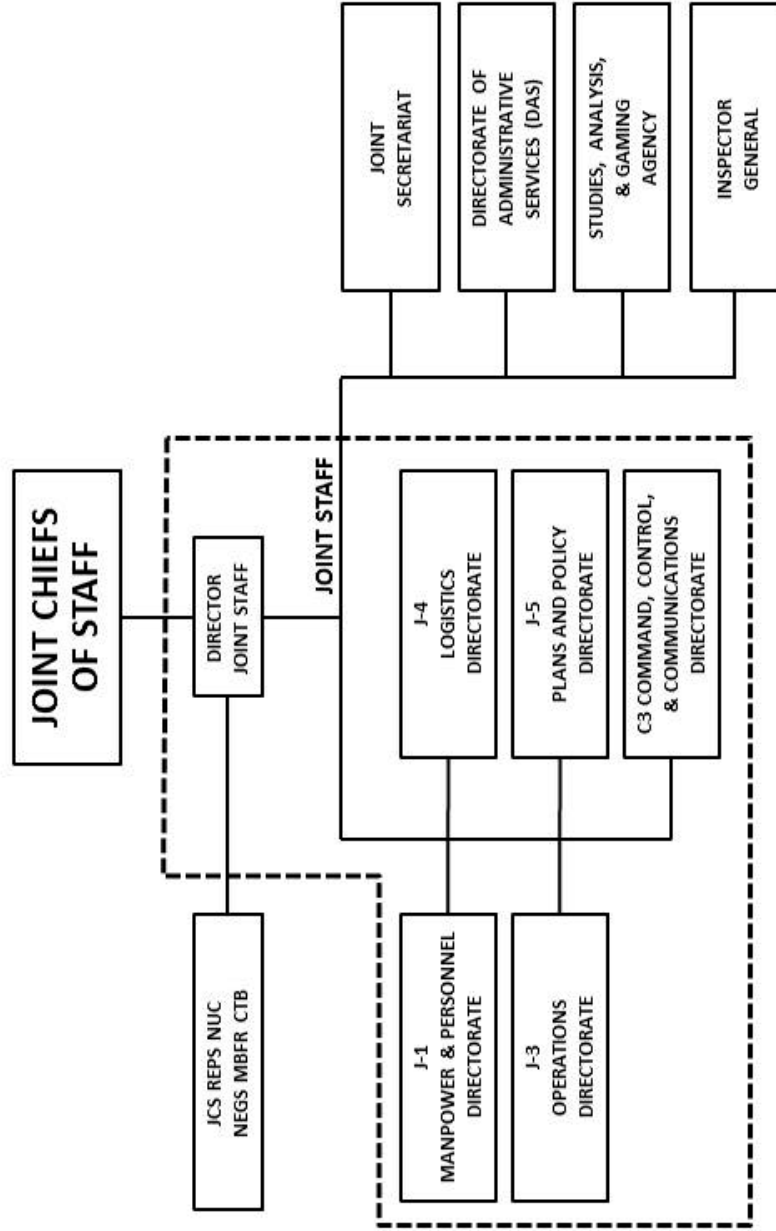

NOTE: ONLY MAJOR ORGANIZATIONAL ENTITIES SHOWN. BY 1958, THE DESIGNATION "ORGANIZATION OF THE JOINT CHIEFS OF STAFF" HAD COME INTO USE TO INCLUDE THE JOINT STAFF AS WELL AS THE OTHER OFFICES, AGENCIES, AND GROUPS SUPPORTING THE JOINT CHIEFS OF STAFF.

CHART XIV

JCS ORGANIZATION

30 JUNE 1984

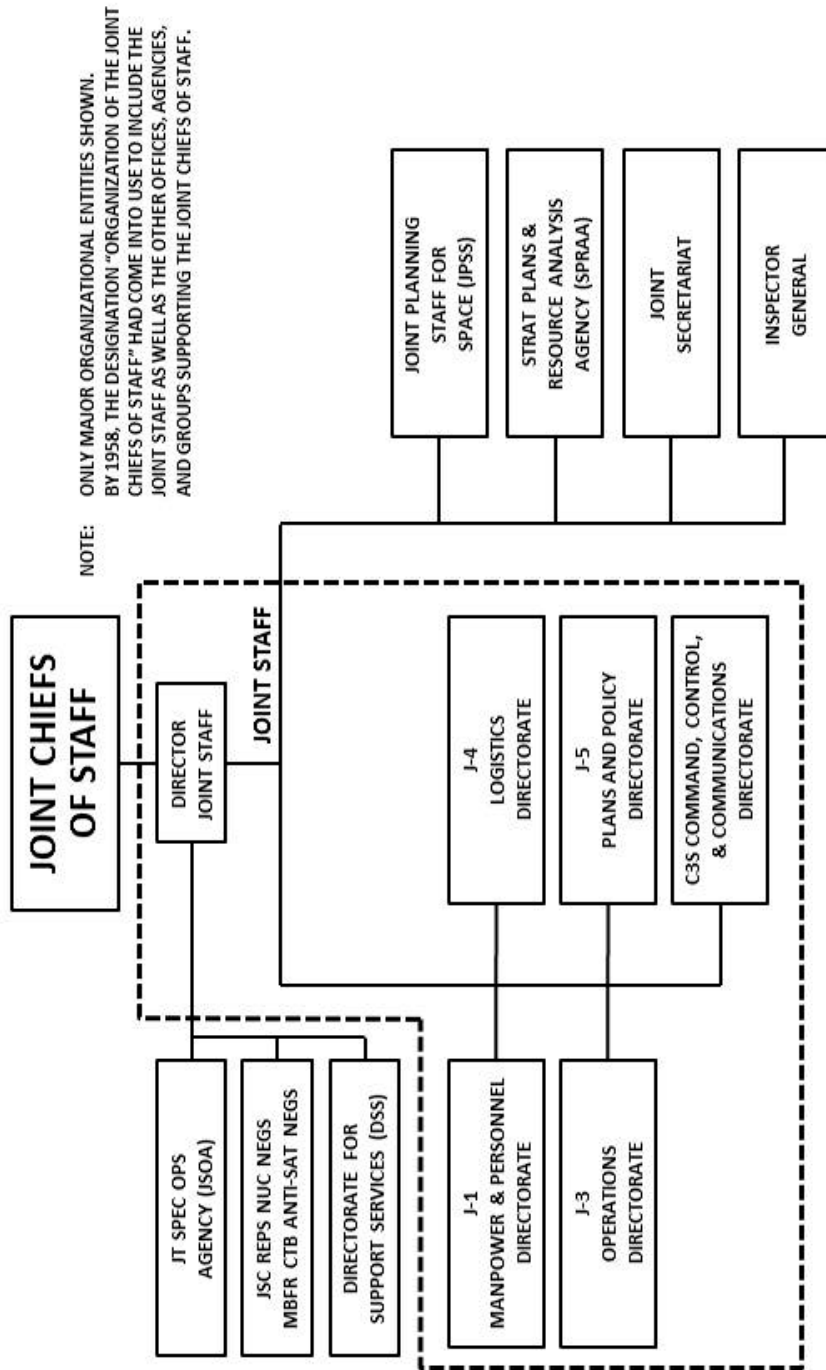
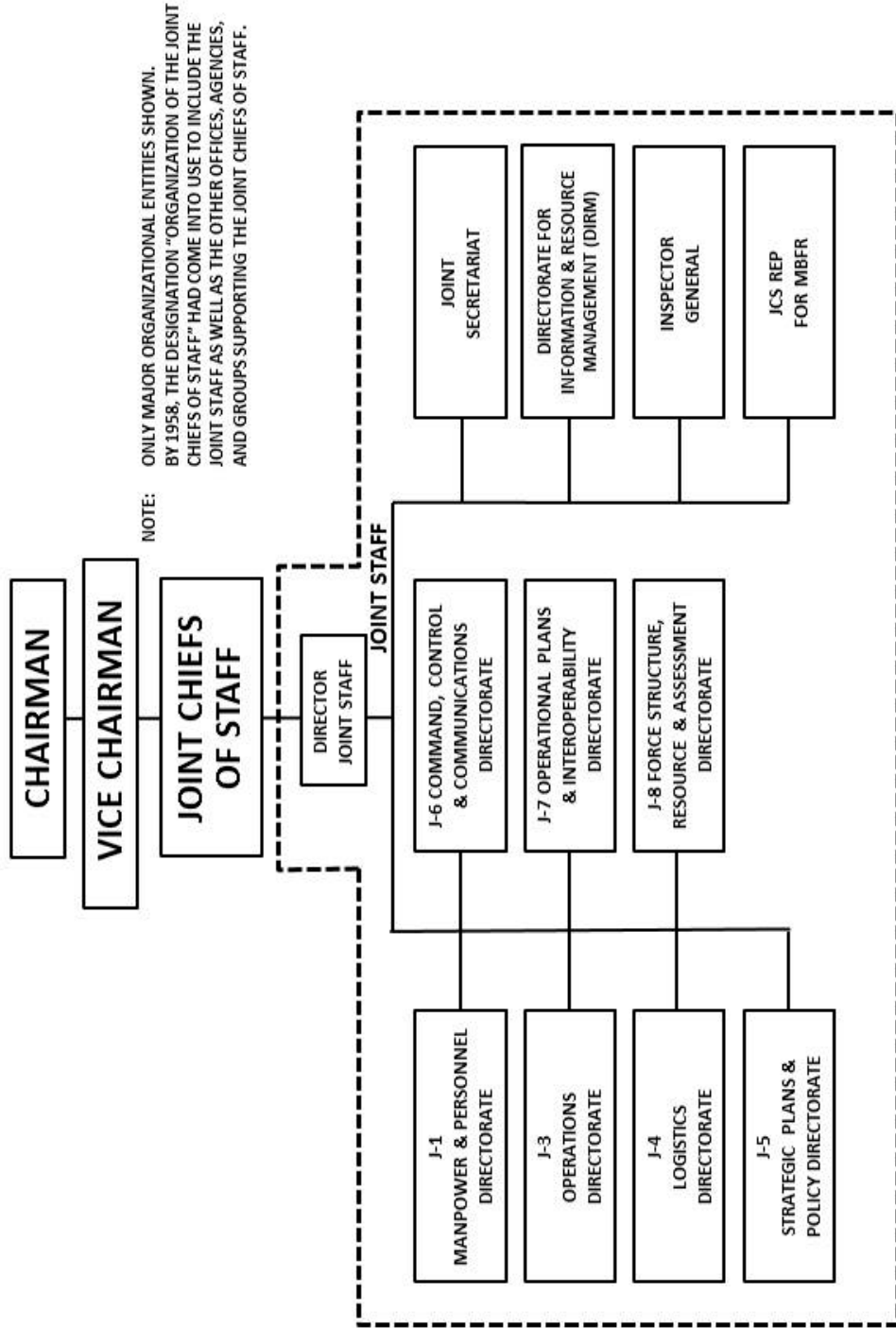

CHART XV

JCS ORGANIZATION

30 JUNE 1987



NOTE: ONLY MAJOR ORGANIZATIONAL ENTITIES SHOWN. BY 1958, THE DESIGNATION "ORGANIZATION OF THE JOINT CHIEFS OF STAFF" HAD COME INTO USE TO INCLUDE THE JOINT STAFF AS WELL AS THE OTHER OFFICES, AGENCIES, AND GROUPS SUPPORTING THE JOINT CHIEFS OF STAFF.

8. JOINT STAFF REORGANIZATION, 1989 – 2001

Following passage of the Goldwater–Nichols Department of Defense Reorganization Act of 1986, successive Chairmen of the Joint Chiefs of Staff worked to reshape and refocus the Joint Staff. After the collapse of the Soviet Union and the dissolution of the Warsaw Pact in 1991, the prospect of a “peace dividend” led the President and Secretary of Defense to cut defense spending by reducing the manpower of the Joint Staff, the headquarters and field forces of the geographic and functional commands, even though the responsibilities of those organizations did not necessarily decrease. In place of the large staffs and force structures of the Cold War era, the Secretaries and the Chairmen relied on advanced technology and smaller, more integrated joint structures to compensate for the apparent mismatch between people and missions.

The Joint Staff attained its maximum strength in September 1990 with 1,607 authorized military and civilian personnel. Four years later, authorizations had dropped to 1,364 which was consistent with the overall force structure and military budget reductions of the 1990s. This gradual decline continued to around 1,250 authorizations by 2007.

After Goldwater-Nichols

Initial implementation of the Goldwater-Nichols reforms proceeded at an evolutionary not revolutionary pace. Admiral William J. Crowe, Jr., USN, made changes slowly to gain the Service chiefs’ confidence in the new system. His adjustments were relatively minor and involved reshuffling existing offices and personnel. The Joint Staff continued to operate as it had in the past, as a long-range planning and strategic body. Admiral Crowe deferred to the Chiefs for their recommendation on issues that clearly lay in his or the Combatant Command’s new authorities.

General Colin L. Powell, USA, was the first to assert the new authorities. He guided the development of doctrine for Joint Warfare and devoted considerable energy to promoting joint culture. This led to an expansion of the Joint Staff J-7 and J-8 despite the overall reduction on the Joint Staff. In January 1991, the J-2 was reconstituted as a full directorate of the Joint Staff. Additionally, in the aftermath of lessons learned during Operation DESERT STORM, General Powell directed a reorganization and expansion of responsibilities for the Joint Staff J-3.

The emergence of the Vice Chairman of the Joint Chiefs of Staff was the most striking organizational development. As authorized by the Goldwater-Nichols Act, the Vice Chairman had no statutory duties other

than to preside in place of the Chairman. The Vice Chairman did, however, serve as the Chairman of the Joint Requirements Oversight Council (JROC) and Vice Chairman of the Defense Acquisition Board—setting requirements for major weapons, logistics, and information systems—that reinvigorated the JROC and put the requirements process back in the hands of the military and the Joint Staff.

In the late summer of 1990 the Vice Chairman, Admiral David E. Jeremiah, directed the Joint Staff to rewrite the JROC charter to reflect the JROC Chairman's increased authority in identifying major systems' requirements, assigning priorities to them, and sending them to the Defense Acquisition Board (DAB) for approval. After DAB review and authorization of the proposed concept, the JROC would validate performance goals and baselines before the final DAB review.

In June 1991, the DoD General Counsel forwarded to the Senate a proposed amendment to Title 10 of the *US Code* to designate the Vice Chairman a full member of the Joint Chiefs of Staff in part due to the responsibilities he had as Chairman of the JROC and Vice Chairman of the DAB. Previously, the Vice Chairman could serve as a full member of the Joint Chiefs of Staff only when he was acting Chairman due to the absence or disability of the Chairman. Agreeing with DoD's rationale, on 26 March 1992 the Senate approved the amendment and declared the Vice Chairman a full member of the Joint Chiefs of Staff.

Peacekeeping & Humanitarian Assistance

Between 1992 and 2009, the Joint Staff conducted minor internal reorganizations within directorates and shuffled authorized personnel within directorates to deal with new or expanded functions like information technology or crisis management. President William J. Clinton entered office in January 1993 and endorsed peacekeeping and humanitarian assistance missions to promote international stability when confronting post-Cold War problems. Internal adjustments in the J-4, J-5, J-6, J-8, and the Directorate for Information and Resource Management (DIRM) reflected these new missions. On 1 July 1994, for example, the Vice Director of the Joint Staff, and *ex officio* director of DIRM, realigned its divisions, placed its Operations Division within the Joint Secretariat, and renamed DIRM the Directorate of Management (DOM).

US military participation in peacekeeping and stability operations in Somalia (1992-1994) and Haiti (1994-1995) as well as the enforcement of no-fly zones over the former Yugoslavia (1992-1995) and Iraq (1992 - 2001) illustrated the complexities of regional operations. To address regional issues, the J-3 created two deputy directorates, each headed by a one-star general officer: J-33 (Current Operations) and J-38 (Current Readiness and

Capabilities). Emphasizing the regional focus, J-33 was organized into four branches: Western Hemisphere, European Command, Central Command, and Pacific Command. J-38 was organized along functional lines to accommodate special operations, counter-narcotics, and information special technical operations.

In 1995, the J-5 established a Russian-Ukraine-Eurasia Division within the Deputy Directorate for International Negotiations and split the over-burdened Deputy Directorate for Politico-Military Affairs into two separate deputy directorates for politico-military affairs, each headed by a general or flag officer, one for Europe and the Western Hemisphere and the other for Asia-Pacific (APAC)/Middle East and Africa (MEAF)/Global Issues (UN). The J-6 Director consolidated internal functions to improve the Global Command and Communications System (GCCS) and placed the new Information Warfare Division in the Deputy Directorate for Defense-Wide C4 Support.

During the 1990s the joint commands established information warfare cells to influence the decision-making of regional opponents. To monitor and support their activities, on 5 September 1996, J-38 expanded its functions to include information warfare. Owing to rapid technological advances, however, in early 1997, J-38 upgraded the division to Assistant Deputy Directorate for Information Operations, J-39.

In response to the June 1996 Hezbollah terrorist attack on an USAF billeting facility in Khobar, Saudi Arabia; the Secretary of Defense directed the Chairman on 15 September 1996 to “organize a portion of the Joint Staff for anti-terrorism and force protection.” That October, the Director, Joint Staff established within J-3 a Deputy Directorate for Combating Terrorism, J-34, to lead counter-terrorism and force protection planning efforts world wide and synchronize plans with State Department, the FBI, and the CIA. The J-34 became a mini-joint staff with branches for current operations, plans and policy, programs and requirements; and training, doctrine, and assessment.

In late 1997 the *National Defense Authorization Act of FY 1998* enjoined Secretary of Defense William Cohen to create two new assistants for the Chairman, one for National Guard Matters and the other for Reserve Matters—each to be a two-star general or flag officer who would serve for two years. In May 1998, after asking the state governors to nominate the National Guard candidate and the Services to propose the Reserve candidate, the Chairman of the Joint Chiefs of Staff, General Hugh Shelton, named two majors generals, one from the Army National Guard and one from the Air Force Reserve, to join the Office of the Chairman. Each officer would act as the Chairman’s personal liaison with his respective Service and related associations. Within Defense forums such as the Joint Review

Board, however, either or both could participate when National Guard and/or Reserve issues were being considered.

A pattern of minor internal readjustments continued within the J-4, J-7, and J-8. Among other changes, in January 1999, the J-4 divided its International Logistics and Engineering Division into two separate divisions to manage the differing functions. That December the J-8 moved the War-fighting Analysis Division from his direct control into the Deputy Directorate of War-gaming, Simulation, and Operations, making it the Deputy Directorate for War-gaming, Simulation, and Analysis.

Military transformation also caused readjustments within directorates. The Joint Staff on 4 February 2000 established a steering group to “shape, accelerate, and focus [the Joint Staff] on joint transformation efforts.” In mid-July 2000, the J-7’s designation changed from the Directorate of Operational Plans and Interoperability to the Directorate for Operational Plans and Joint Force Development. Other J-7 divisions reorganized to support transformation initiatives, culminating in the spring of 2001 with the creation of a Joint Vision Integration Cell (JVIC). The new entity enabled the Chairman to monitor worldwide *Joint Vision 2010* implementation and all other DoD transformation initiatives.

Proposals for Major Headquarters Reductions

For a decade the Joint Staff had reorganized at the margins, but the OSD leadership sought more thoroughgoing reforms. Among the recommendations of the first *Quadrennial Defense Review* (QDR), issued in May 1997, was a charge to the DoD to adopt better business processes in order to reduce forces and facilities while simultaneously dominating the battlefield. The following month the Department of Defense Comptroller, Dr. John Hamre, called for downsizing staffs, reducing infrastructure, and decreasing funding for weapons systems. Included in his targets was a reduction of the Joint Staff. Two years earlier an ad hoc Joint Staff Reorganization Committee (JSRC) had noted that since the Goldwater-Nichols Act the Joint Staff had become the central agency for managing a growing number of major and minor regional contingencies; yet the Staff remained small in size and relied on outdated technology. The study recommended improving Joint Staff technology and reallocating Joint Staff personnel and resources where they were most needed.

On 10 November 1997, Secretary Cohen directed Dr. Hamre, now the Deputy Secretary of Defense, to form the Defense Reform Task Force to find ways to modernize and save money within OSD and the Joint Staff by downsizing and restructuring both organizations. Within eighteen days Dr. Hamre recommended that many post Cold War missions that had accrued to the Joint Staff be redistributed to OSD, the CINCs, and various joint agencies. The Deputy Secretary estimated that such restructuring

would reduce the Joint Staff's 1,441 billets (1,401 billets were authorized) by as much as 22 percent, which in his view was more than enough for the efficient performance of its core mission. Dr. Hamre made no comparable recommendation for downsizing OSD.

The Joint Staff contracted an independent study to evaluate the Deputy Secretary's proposals. The report, submitted one year later, concluded that the Joint Staff suffered from excessive competing demands and was so preoccupied with short term issues and management functions that it lacked the time needed for essential long range planning and restructuring. It prescribed three fixes—creation of a cross directorate management board, simplification and integration of the Joint Staff processes, and improved interoperability of the automated information management system.

During the interval, Congress had enacted the National Defense Authorization Act of FY 2000 on 5 October 1999 (PL 106-65). One provision of the legislation specified a 15 percent reduction to headquarters staffs by 30 September 2002. At the time, the Joint Staff numbered around 1,300 personnel, already a significant drop from the 1,627 authorized in 1986, when the Goldwater-Nichols Act removed the 400 officer limitation on the Joint Staff. The latest personnel reductions, if implemented, would decrease staffing to just over 1,100 authorizations. To deal with the implications of such a reduction, on 28 March 2000 the Chairman established the Joint Staff Organizational Assessment (JSOA) Working Group to analyze and implement certain of the changes recommended in the various reorganization studies.

General Shelton also requested congressional relief from the proposed personnel reductions, but they remained in place. Furthermore, the new Secretary of Defense, Donald Rumsfeld, hoped to consolidate overlapping Office of the Chairman, Joint Chiefs of Staff (OCJCS) functions such as Protocol, Legislative Liaison, and the Legal Counsel into OSD as he restructured the JCS organization. On the personnel front, the Secretary of Defense's August 2001 *Defense Planning Guidance Fiscal Years 2003-2007* restated the 15 percent headquarters reduction effective by 1 October 2002 with the resources saved directed to the Standing Joint Task Forces. No consolidations or reductions had been implemented by the time of General Shelton's retirement on 30 September 2001.

CHART XVI JCS ORGANIZATION

30 MARCH 1992

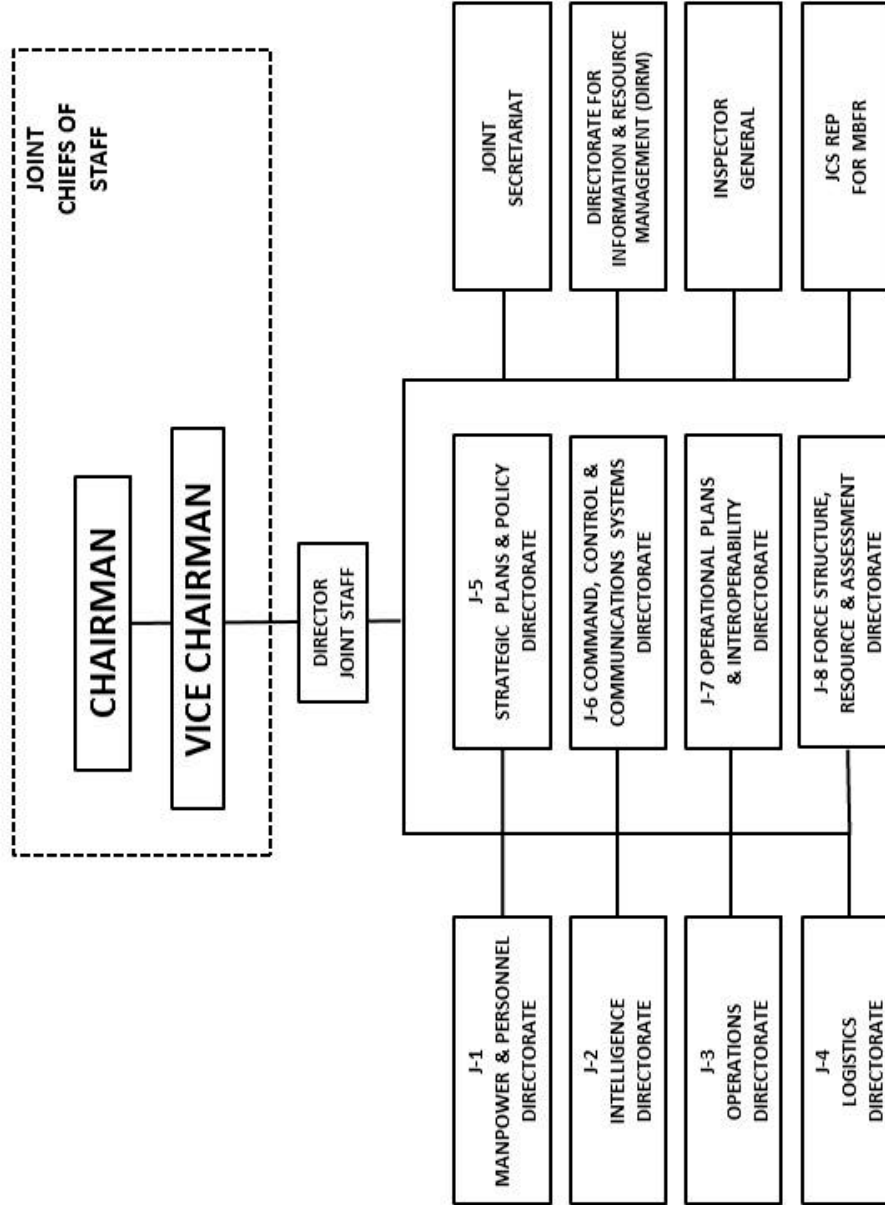

9. JOINT STAFF REORGANIZATION, 2001-2013

The Joint Staff after the 9-11 Attacks

The decade following 11 September 2001 terrorist attacks on the United States witnessed some of the most significant changes to the Joint Staff since its inception. The evolving nature of the threat caused numerous changes to the Joint Staff's Directorates and organization. Efforts to reduce the size of the Joint Staff forced in-house reorganizations. The J-6 would be disestablished only to quickly re-emerge as cyber warfare grew in importance. The disestablishment of Joint Forces Command forced many statutory responsibilities of the Chairman back underneath the Joint Staff. This more than doubled the size of the Joint Staff with a significant number of assigned personnel now working outside of the Pentagon.

In the aftermath of the attack on the Pentagon and World Trade Center, the Joint Staff began reorganizing under the existing directorates adding new titles and responsibilities. The J-31 and four of the deputy directors—J-33, J-34, J-35, and J-39—became the Vice Director of Operations, the Deputy Director for Current Operations, the Deputy Director for Anti-Terrorism/Force Protection, the Deputy Director for National Systems Support, and the Deputy Director for Information Operations, respectively. The J-38 designation for the Deputy Director for Current Readiness and Capabilities was renamed the Deputy Director for Global Operations. This encompassed operational issues that overlapped multiple geographic areas. It gained several billets from the Deputy Directorate for Information Operations while ceding others to the National Military Command Center.

Meanwhile the JSOA, created by General Shelton, sought to eliminate functions, not just reduce personnel, from the Joint Staff. The sweeping reorganization JSOA initially proposed in January 2002 would remove the J-6, J-7, and the Director of Management, transferring their functions elsewhere on the Joint Staff or to OSD, JFCOM, and other commands. While neither was approved, subsequent iterations over the next three months offered various options for eliminating, reorganizing, or streamlining Joint Staff directorates.

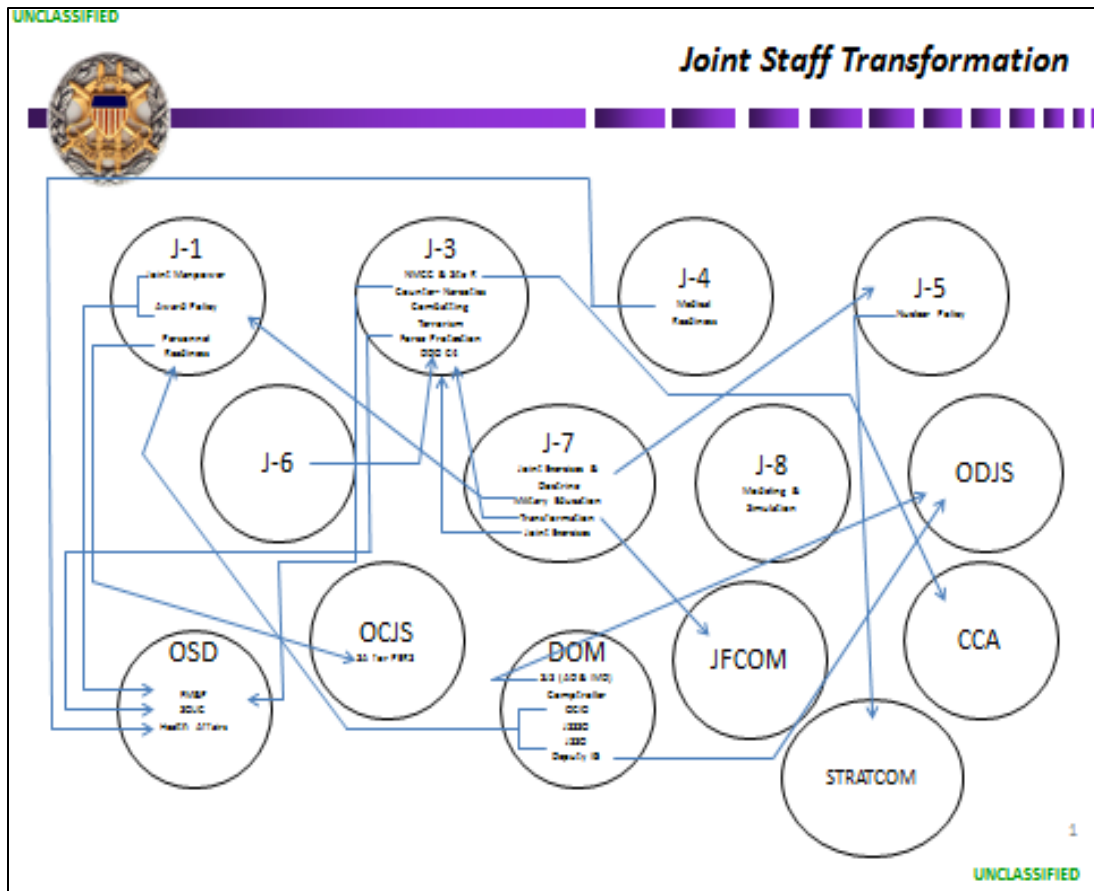

In early 2002, Secretary of Defense Donald Rumsfeld pushed to reduce the sizes of both the Joint Staff and the combatant commands. Despite the expanded missions for homeland defense and counter-terrorism, in August 2002, General Richard Myers, Chairman of the Joint Chiefs of Staff, approved this now congressionally mandated 15 percent reduction that eliminated 129 Joint Staff billets, with most coming out of J-3 (39 slots), J-5 (24 slots), and J-8 (23 slots). The J-3 transferred its nuclear operations functions to USSTRATCOM; the J-5 sent its security assistance and technology transfer functions to the Defense Threat Reduction Agency (DTRA); and the J-6 transferred thirteen information technology related functions to JFCOM, USSPACECOM, the ASD C3I, and DISA. Conversely, the J-5, Directorate for Strategic Plans and Policy received 12 manpower authorizations to establish a Strategic Planning Cell and the J-8's Directorate for Force Structure, Resources, and Assessment received 8 billets to establish a JPC/JOA.

In addition, the Joint Staff had to contribute 39 billets to the newly established US NORTHCOM, whose staff personnel, according to the terms of the 2002 Unified Command Plan (UCP), had to come from existing headquarters' billets. On 16 August, the Director of the Joint Staff notified

the J-Directorates of their respective reductions (129 total) and provided guidance on the external and internal realignment of the Joint Staff.

Joint Staff 15% HQ Reduction (as of 2 Oct 02)

FY 01-03 Cuts	FY 03 Billets	NORTHCOM Tax	Approved Cuts	Total	Billets (Post-cuts)	Add Back	Total
1300-1246	1246	39	129	168	1078	26	1104

In the spring of 2003, internal realignments associated with the war on terror continued, the Deputy Directorate for Anti-Terrorism/Force Protection (AT/FP), created in October 2002, moved from the Deputy Directorate for Global Operations to a new deputy directorate that integrated Homeland Defense with anti-terrorism and force protection. On 13 February 2003 the Joint Staff and the Army agreed to transfer the Army’s Director of Military Support (DOMS) to the Joint Staff for more effective coordination of consequence management in the wake of future terrorist attacks. With the approval of Deputy Secretary of Defense Paul Wolfowitz on 25 March, the Army sent 13 billets to the Joint Staff as the Joint Directorate of Military Support (JDOMS) Division that, together with the AT/FP Division and a Homeland Defense Division, formed the Deputy Directorate for Anti-terrorism/Homeland Defense (DDAT/HD). In April 2004, the Deputy Director for Special Operations designation was changed to J-37, Deputy Director for Special Operations, and the director billet rank elevated from colonel to brigadier general.

By early August 2004, the Joint Staff crept back up to 1,219 authorizations, 1,011 military and 208 civilian billets. That December, Secretary Rumsfeld asked General Myers to review OSD’s draft Pentagon Reorganization Study that consolidated functions to save manpower and accelerate decision-making. As he had with General Shelton, the Secretary again singled out for consolidation specific areas of duplication between the OJCS and OSD staffs such as public affairs, legislative liaison, legal affairs, budget, training, and doctrine; and management of information, personnel, and logistics. General Myers believed that such specific recommendations would steer a study group to predetermined conclusions. He proposed instead that an independent contractor conduct a more generalized in-depth analysis of the DoD’s organizational structure.

Almost a year later, in early June 2005, Secretary Rumsfeld again raised the functions and manpower issues, requesting General Myers to prepare “a list of people in all the J-s and what they think their charter is—what they think they do.” The Vice Chairman, General Peter Pace, USMC,

responded on 1 September by restating the current functions of each directorate and noting that the Joint Staff had 1,326 authorized personnel, although 1,268 were actually assigned.

Internal reorganizations of directorates using current authorizations were acceptable. The Vice Director of the Joint Staff (concurrently the Director of Management) reorganized the offices of Joint Staff Security and the Chief of Information consistent with the “no growth” restrictions. But J-8 efforts to augment the directorate by transferring several Chairman Controlled Activities (CAAs) and 38 new slots to the Joint Staff were rejected because DoD remained in “a no growth mode” and the Joint Staff was implementing the second phase of the 15 percent personnel reduction.

Faced with fighting two wars, General Myers believed that it was important for the Chairman to have the perspective from the enlisted ranks because warfare had become more Joint at the lower levels. Based on an earlier suggestion by Representative Ike Skelton, in July 2005 General Myers convened a senior advisory panel to assist him in selecting a senior enlisted advisor. General Myers wanted the position established by that September to ensure that the enlisted advisor's two-year, renewable term, coincided with that of his successor. General Myers then deferred appointing the new enlisted advisor in order to allow his successor, General Pace, to decide who would fill this new position.

On 1 October 2005, concurrent with General Pace's assumption of the Chairmanship, Command Sergeant Major William Gainey, USA, became the first Senior Enlisted Advisor to the Chairman of the Joint Chiefs of Staff (SEAC). The House Armed Services Committee subsequently inserted language into the 2006 National Defense Authorization Act to provide the SEAC with appropriate pay and allowances. The SEAC was to advise both the Chairman and the Secretary of Defense on all matters involving enlisted personnel.

General Pace made several changes within the office of the Chairman. In 2006, the Chairman established a council of colonels, with an O-6 level officer pulled from each of the Services, which served as an internal think tank for General Pace on diverse issues ranging from Service force structure to military strategy for Iraq. Headed by the Chairman's special assistant, it soon was formally designated as the Chairman's Action Group. Working in conjunction with the Office of the Secretary of Defense, General Pace established an Office of Strategic Communications, a short-lived effort merging public diplomacy, information operations, and public affairs.

The new Chairman, Admiral Michael G. Mullen, USN, made his own changes to the office. After CSM Gainey's retirement in 2008, he consulted with the senior enlisted advisors from each of the four Services, who advised

him that a SEAC was redundant. The Services had their own senior enlisted advisors who fulfilled the role of advising the Defense Department of enlisted issues. The Chairman opted not to appoint a new senior enlisted advisor, believing there were sufficient senior non-commissioned officers already assigned to the Joint Staff and in the offices of each of the four Service Chiefs. The official press release stated that this was not a reflection on General Pace, merely that Admiral Mullen did not feel the office was required. Additionally, Admiral Mullen did retain the Chairman's Action Group, adding additional special advisors on the E-Ring, including a small office to aid him in Strategic Synchronization.

During the Russian invasion of Georgia in August 2008, Admiral Mullen was unable to assemble vital information quickly enough to provide the best possible military advice to the President and the Secretary of Defense. He concluded that the Joint Staff was not organized to anticipate or respond to a fast breaking crisis. The Director of the Joint Staff, Lieutenant General Stanley McChrystal, USA, offered a remedy for this deficiency based upon his recent operational experience in Special Operations Forces. He created a National Joint Operations and Intelligence Center (NJOIC) in January 2009. Approximately 25 field grade officers drawn from the various Joint Staff Directorates initially staffed NJOIC, whose mission expanded traditional (NMCC) functions. The NJOIC became the Joint Staff's focal point for national and strategic information fusion, providing round-the-clock organic resources and Joint Staff expertise to accelerate situational awareness in response to a developing crisis. It serves as a hub around which all Joint Staff activities operate and provides outside elements (Services, Combatant Commands, and the interagency) with clear access to the Joint Staff.

In March 2009, the Chairman directed Lieutenant General McChrystal to review Afghanistan strategy. During meetings and discussions, McChrystal identified the value of a rear-element cell within the Joint Staff that focused exclusively on Afghanistan and Pakistan to support both the Chairman and the forward headquarters. On 22 May 2009, the Joint Staff activated the Pakistan-Afghanistan Coordination Cell (PACC) in the NMCC. The PACC Director reported through the Director, Joint Staff to the Chairman. Field grade officers drawn from the Joint directorates staffed PACC, which as of March 2011 had 39 military and 7 civilian billets.

As the PACC became institutionalized and U.S. military policy following the increased in forces in Afghanistan solidified, on May 1, 2011, Admiral Mullen directed it move from the Director's office to underneath the J-5. While still headed by a brigadier general, the PACC retained its mission as a focus for concentrated, cross-functional regional expertise for Pakistan and Afghanistan. In other areas, the PACC assumed a similar function to the other regional, geographical directorates.

Upon becoming Chairman in October 2011, General Martin Dempsey, USA, added his own stamp on the office of the Chairman. He expanded the size of the Chairman's Action Group, and was more favorably disposed towards the senior enlisted advisor. He appointed a new SEAC as well as codified the SEAC's responsibilities to serve as an advisor to the Chairman and the Secretary of Defense on all matters involving joint and combined total force integration, utilization, health of the force, and joint development for enlisted personnel.

Chief of the Guard Bureau Elevated to JCS Membership

The ongoing wars in Afghanistan and Iraq caused a major statutory change in the composition of the Joint Chiefs of Staff. The post 9-11 conflicts relied heavily on the National Guard and Reserve. The continuous deployments and the operational use of the Guard led Congress to commission a bipartisan blue ribbon panel in 2005. Titled the Commission on the National Guard and Reserves, its purpose was to recommend changes to Guard and Reserves forces based upon the ongoing needs of the war on terrorism. The commission's 2008 report made numerous wide-ranging recommendations, including elevating the Chief of the National Guard Bureau (CNGB) from three to four stars based on the changing and expanding responsibilities of the position. The commission, however, recommended against the CNGB being a statutory member of the Joint Chiefs. The following year, Congress agreed with both recommendations and elevated the CNGB to four stars, but not as a formal voting member of the JCS. Nevertheless, the Chairman issued a standing invitation for the CNGB, General Craig R. McKinley, USAF, to attend meetings of the Joint Chiefs of Staff on issues that affected the National Guard.

Congressional pressure grew to make the CNGB an official member of the JCS. The National Guard State Adjutant Generals strongly supported the idea, arguing that since the September 2001 terrorist attacks the National Guard had assumed substantial homeland security and homeland defense responsibilities. These new missions, in turn, required the CNGB to be a full member of the JCS to assure federal officials were fully informed about Guard matters. In May 2011, 68 members of the U.S. Senate cosponsored a bill titled "The National Guard Empowerment and State-National Defense Integration Act of 2011." Section 3 of the proposed legislation would make the CNGB a full member of the Joint Chiefs of Staff.

The Joint Chiefs again unanimously opposed the legislation. In October 2011, they stated their objections in writing to the Senate Committee on Armed Forces. The Joint Chiefs again voiced their unanimous opposition to such a reorganization during their testimony on

the legislation in early November 2011, contending that the CNGB represented only Army and Air National Guards, leaving the other 46 percent of reserves unrepresented. The Guard could act either as a federal or state entity according to the situation, and in its state capacity the state governors were in command of Guard units. While each Service Chief was subject to civilian oversight of the Secretary of Defense, the CNGB was not, thus making him equal to the Chiefs but without commensurate accountability. The presence of the CNGB would also interfere with unity of command because the CNGB did not represent a branch or Service and was not responsible for organizing, manning, training, and equipping the National Guard. In sum, the CNGB as a member of the JCS would create unnecessary leadership duplication and could lead to divided or redundant force management, training, and funding.

The CNGB, General McKinley, disagreed with the Joint Chiefs. He testified that only full JCS membership would ensure that the responsibilities and capabilities of the non-federalized National Guard were considered in a manner that took into account the domestic mission of the Guard when making military contingency plans. Only statutory membership in the JCS guaranteed the CNGB a voice in JCS deliberations.

More than 70 senators agreed with the Guard's position and, overriding the Joint Chiefs' objections, Congress specifically expressed concern that the Title 32 non-federalized missions related to homeland lacked adequate representation. That November Senate and House conferees attached the National Guard Empowerment Act to the 2012 defense authorization bill. The final authorization bill, agreed to by conferees in mid-December, became the National Defense Authorization Act of Fiscal Year 2012 that made the CNGB a full, voting member of the Joint Chiefs of Staff to address matters involving non-federalized National Guard forces in support of homeland defense and civil support missions.

Disestablishment of Joint Forces Command

In June 2010 the Chairman approved the reorganization of the Operations Directorate (J-3) by establishing the Deputy Directorate for C2 and Nuclear Operations (J-36) to provide focused oversight and standardized operational responsibilities for global/joint command and control and nuclear operations. It also improved Joint Staff guidance and support for global C2, the National Military Command System, and nuclear operations. This minor change preceded a sweeping reorganization of the Joint Staff and Joint Chiefs of Staff.

One month earlier, Secretary of Defense Robert M. Gates, concerned about the DoD's ability to sustain the current force structure and continue military modernization in an era of reduced Defense budgets, directed the Defense Business Board to review personnel, organization, and operations to identify efficiencies and savings. In mid-July the board recommended a downsizing of the COCOMs, beginning with the elimination of JFCOM. On 9 August, Secretary Gates announced that he would recommend to the President JFCOM's closure and the assignment of its force management and sourcing functions to the Joint Staff. He also directed the elimination of the Assistant Secretary of Defense for Networks and Information Integration (NII) and the Joint Staff, J-6. Their functions would be transferred to the Under Secretary of Defense, Acquisition, Technology, & Logistics (USD, AT&L). One week later, the Secretary officially notified the Chairman of the Joint Chiefs of Staff, among others, of a series of initiatives to reduce excess and duplication department-wide that would eliminate the J-6 and JFCOM.

Following the President Barak Obama's approval of the recommendations on 6 January 2011, the Secretary of Defense decided to disestablish JFCOM effective 31 August 2011. Until that time, JFCOM would be responsible for executing its assigned missions and tasks.

On 9 February 2011, Secretary Gates announced his initial guidance and direction for JFCOM's disestablishment. The command's functions would be reassigned to other Combatant Commands (abbreviated now as CCDM per Joint Publication 1-02, 8 November 2010), the Air Force, OSD, and the Joint Staff. A subsequent Secretary of Defense memorandum, based on recommendations from a Chairman-led DoD working group (that included OSD, the CCMDs, and Services), specified the redistribution of USJFCOM organizations and functions to other CCDMs, Services, OSD, and the Joint Staff to be accomplished not later than 31 August 2011.

While the Vice Chairman headed the DoD process, he delegated the responsibility of managing the Chairman's equities to the Vice Director and the Director, Joint Staff J-8, the latter heading the Joint Staff Efficiency Cell that worked the details of the disestablishment effort with JFCOM and OSD. JFCOM identified some 1,200 tasks and 77 functions that had to be executed based upon UCP, JROC or legislative decisions. Many of these directly related to the responsibilities of the Joint Staff, especially under the J-7. Secretary Gates added his input by specifically tasking that the JFCOM's global force management function should be realigned under the J-3. From the outset, the planners understood that cost alone would necessitate maintaining a significant organizational presence in Suffolk, Virginia. At the heart of the plan would be the establishment of smaller more efficient organization within the Joint Staff J-7 designed to synchronize joint training, doctrine, concept development, education, lessons learned, and experimentation.

The process of absorbing specific JFCOM functions produced substantial organizational and functional change on the Joint Staff. The J-7 became a three-star directorate in 2011 charged with implementing the Chairman's Joint Force Development program, which included overall responsibility for joint training, education, joint concepts, and doctrine. One of the J-7's two Deputy Directors, Joint and Coalition Warfighting (JCW), was composed largely of elements of the former USJFCOM's J-7, J-9, and Joint Center for Operational Analysis (JCOA) and was located in Suffolk. The other deputy directorate, Strategy and Policy, was in the Pentagon.

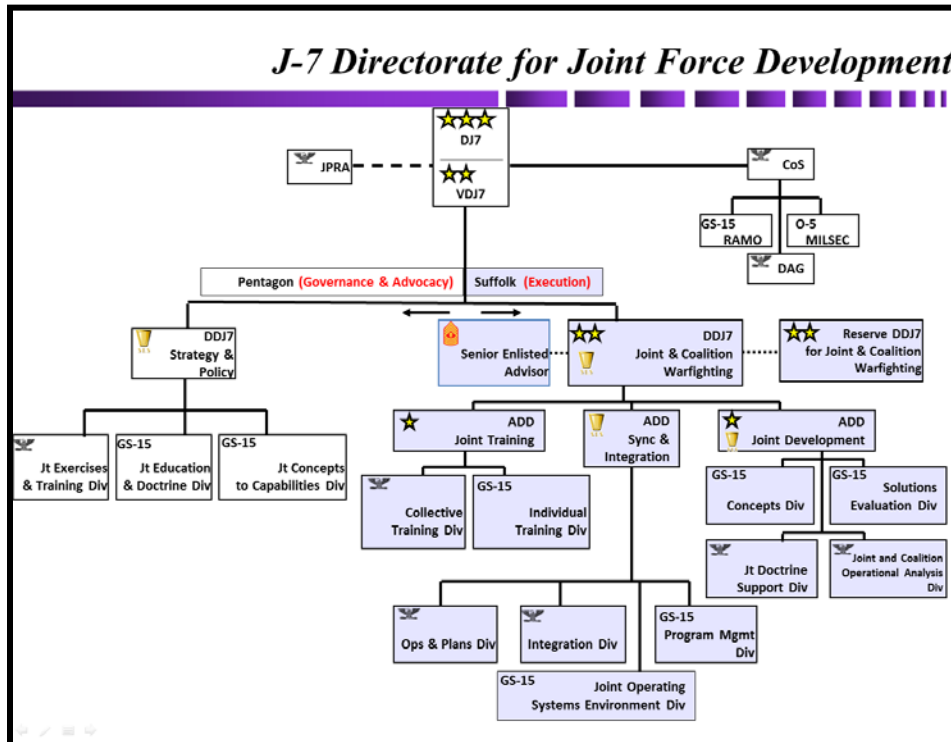

On 25 January 2011, the Director, Joint Staff recommended the Deputy Secretary of Defense approve the transfer of functions and manpower from the J-6 to the Office of the DoD Chief Information Officer (DoD CIO) and to USSTRATCOM /USCYBERCOM beginning in FY 2012. Of the J-6's 144 personnel, 22 positions were transferred to OSD, USCC, and the Joint Staff, J-3. Another fifty were transferred to J-8. The 72 remaining slots were eliminated by attrition (31 military billets), personnel reductions (33 contractors), and position reviews (8 civilian positions). The Joint Staff J-6 Directorate was formally disestablished on 2 November 2011.

Due to the increased importance and dependence on information technology and networks, the Joint Staff reestablished the J-6 Directorate on 29 March 2012 to better align and advance C4 and cyber capabilities within the Joint Force. All functions previously under the Deputy Director for Command, Control, Communications, and Computers (DDC4) were

transferred to the Director, J-6 to include the Chair of the Military Communications Electronics Board. The Chief Information Officer (CIO), J-6 became responsible for better aligning, integrating, and advancing C4 and Cyber capabilities within the Joint Force. J-6 entities were located in the Pentagon; Norfolk and Suffolk, Virginia; and Eglin Air Force Base, Florida.

Transfer of JFCOM J-3 Functions to the Joint Staff

Function	Short Title	New Alignment	Location	MIL	CIV	CTR	RC
J3_4-1	Joint Force Provider	JS J3	Norfolk, VA	51	51	10	50
J3_4-2	GFM Continuous Improvement	JS J3	Norfolk, VA	7	13	6	1
J3_4-3	Adaptive Planning and Execution (APEX) system Transition	JS J3	Norfolk, VA	2	9	5	3
J3_4-4	Logistics Assessment/ Planning	Eliminated	0	0	0	0	0
J3_4-4a	Acquisition and Cross-Service Agreements	JS J4	NCR	1	1	0	1
J3_4-5	Logistics Concept Development	Eliminated	0	0	0	0	0
J3_4-6	Integrated Joint Special Technical Ops	JS J3	Norfolk, VA	2	1	0	0
J3_4-7	Command Support Enablers	JSSE	Norfolk, VA	0	0	0	0
Total				63	75	21	58

The JFCOM disestablishment plan also eliminated two of the current eight JFCOM J3/J4 functions and aligned the remainder under the Joint Staff J-3. To accommodate the increased responsibilities, in 2012 the J-3 added a Deputy Directorate for Joint Force Coordination (J-31), whose main element was located in Norfolk, Virginia. Its mission was to develop conventional force sourcing recommendations for the CJCS and to supervise the implementation of allocation decisions to support the CCMDs. J-31 also synchronized USSOCOM and USTRANSCOM sourcing recommendations with Global Force Management Allocation Plan processes. Joint Force Provider functions were located at Naval Support Activity, Norfolk, VA.

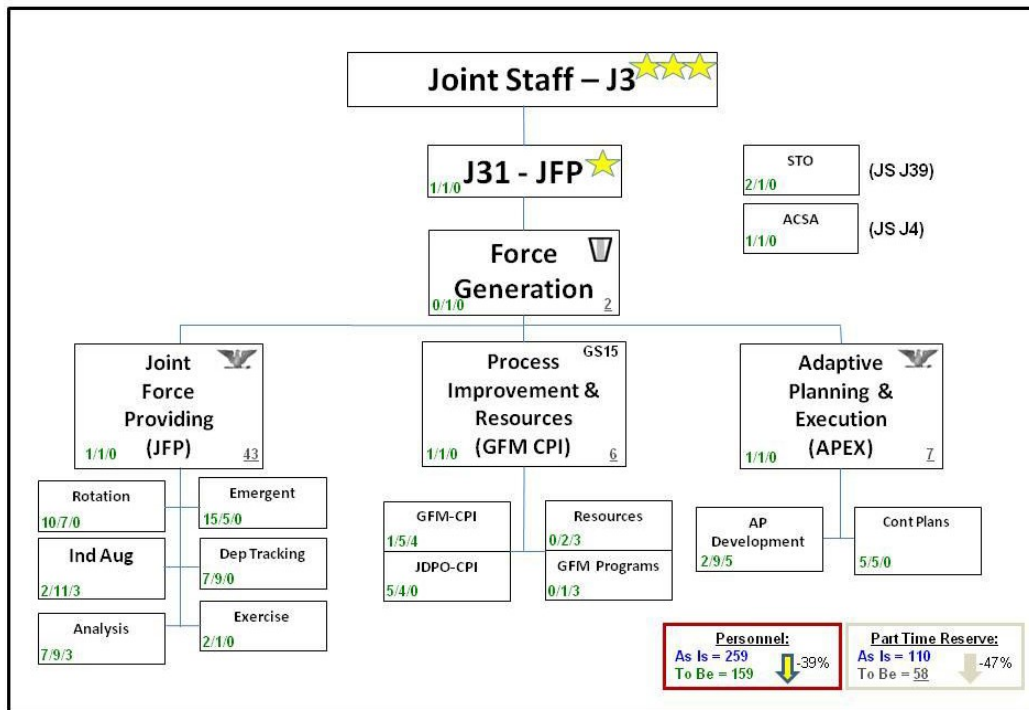

The absorption of JFCOM personnel significantly increased the size of the Joint Staff. Initially, these numbers were combined with several other Secretary of Defense efficiencies, all of which landed temporarily under the Joint Staff's organization for budgeting. This caused the Joint Staff to appear larger than it was in actuality, with an authorized manning level on paper of 2,750 military and civilians. These artificial overages were programmed back out of the Joint Staff in PBR-13. But the inclusion of the JFCOM missions expanded the authorized size to the Joint Staff to an all-time high of more than 2,500 military and civilians, although the actual assigned numbers remained considerably lower, between 2,000 and 2,200. SEE APPENDIX 2.

For almost ten years following the 9-11 attacks, the Joint Staff had resisted OSD pressure to consolidate functions and reduce personnel. Until

2011, reorganizations were minor, leaving the Joint Staff directorates intact, although internally altered by numerous small realignments. That changed radically in 2011 with the disestablishment of JFCOM and the temporary elimination of the J-6. JFCOM's disestablishment forced the Joint Staff to assume many of the former CCMDs responsibilities and that resulted in a much enlarged Joint Staff that had a major component distant from the Pentagon. The importance of cyber space caused a reexamination of the J-6 disestablishment that resulted in the directorate's re-establishment as the focal point of the Joint Staff's cyber space efforts.

CHART XVII

JCS ORGANIZATION

30 JUNE 2010

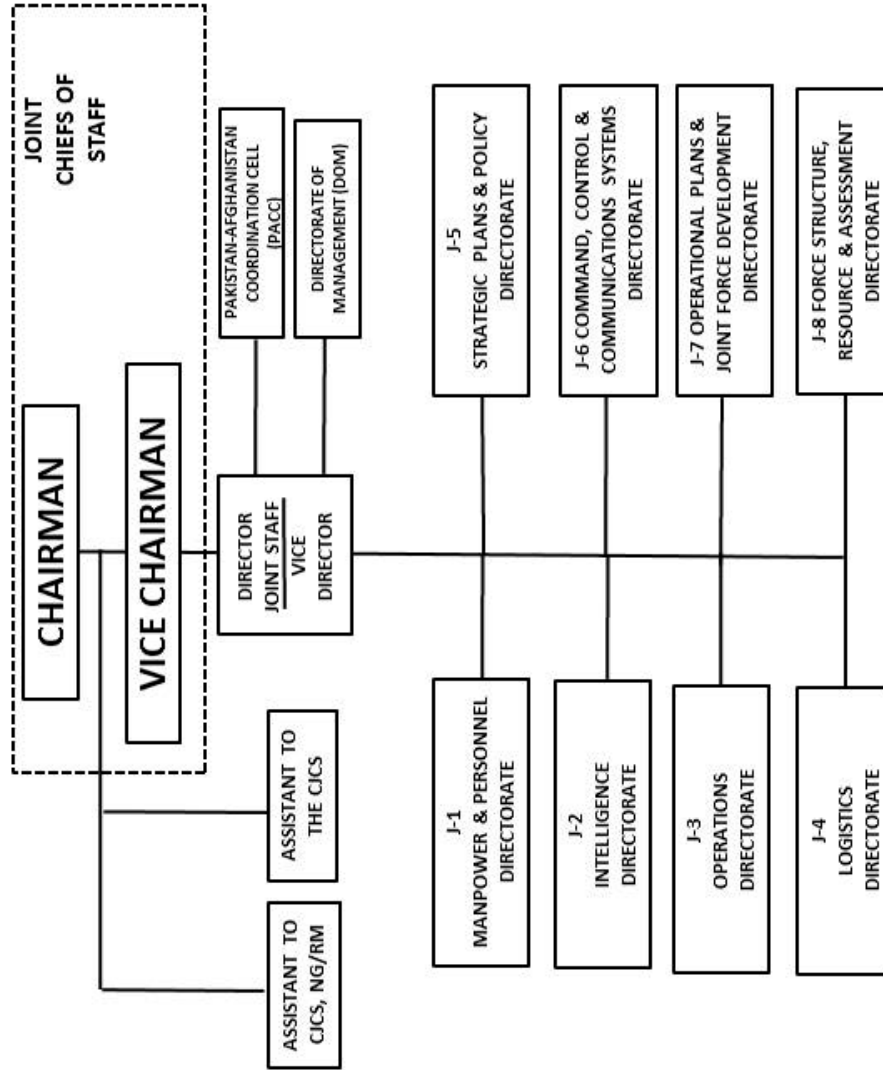

CHART XVIII JCS ORGANIZATION 1 JUNE 2012

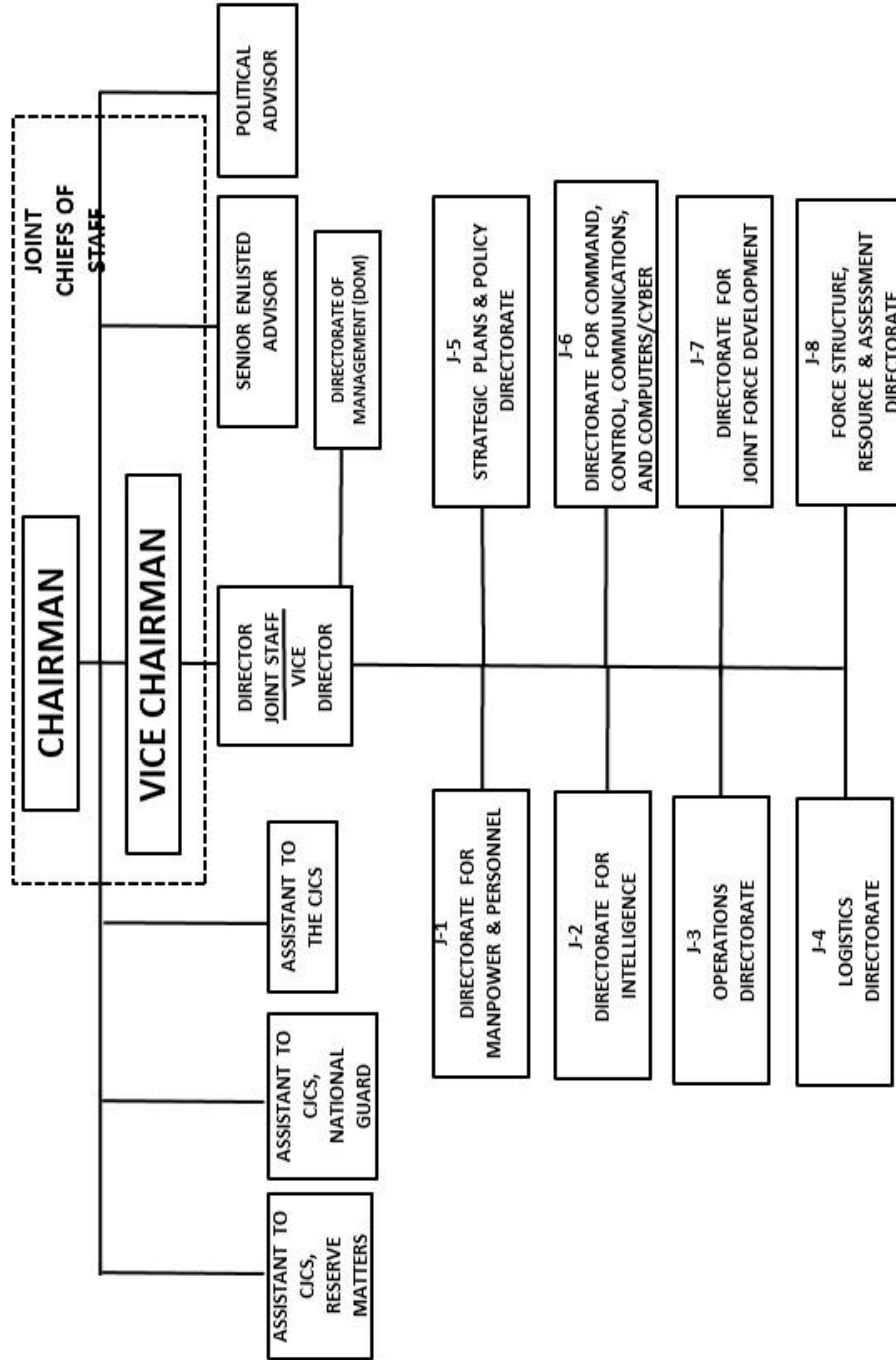
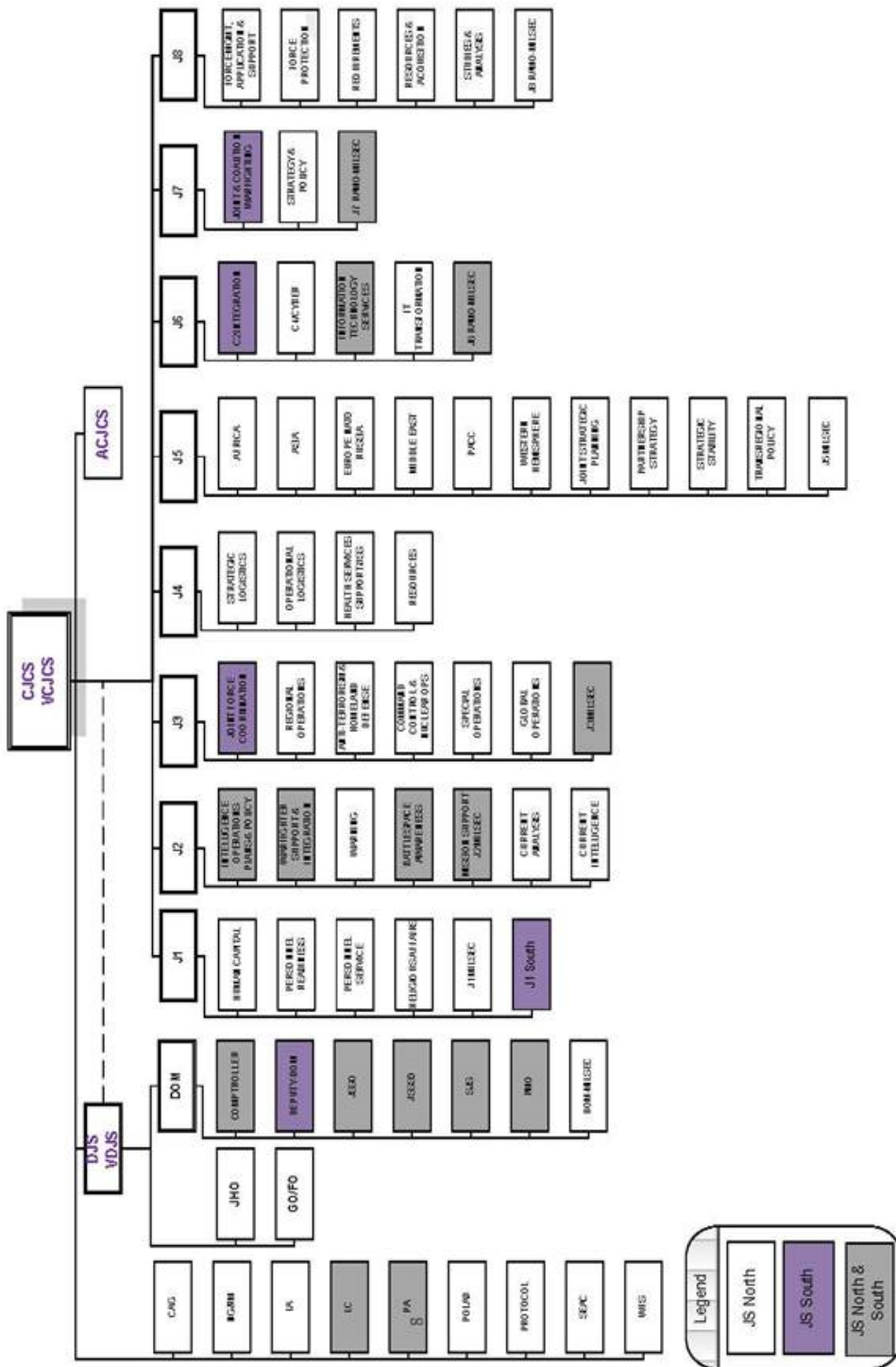

CHART XIX JCS ORGANIZATION 7 August 2012



APPENDIX 1

MEMBERSHIP OF THE JOINT CHIEFS OF STAFF

Chief of Staff to the Commander in Chief
of the Army and Navy^a

	<u>From</u>	<u>To</u>
*Fleet Adm. William D. Leahy	20 Jul 42	21 Mar 49 ^b

Chairman, Joint Chiefs of Staff^c

*GA of the Army Omar N. Bradley, USA	16 Aug 49	15 Aug 53
*ADM Arthur W. Radford, USN	15 Aug 53	15 Aug 57 ^d
*Gen Nathan F. Twining, USAF	15 Aug 57 ^e	30 Sep 60 ^d
*GEN Lyman L. Lemnitzer, USA	01 Oct 60	30 Sep 62
*GEN Maxwell D. Taylor, USA	01 Oct 62	01 Jul 64 ^f
*GEN Earle G. Wheeler, USA	03 Jul 64	02 Jul 70 ^g
*ADM Thomas H. Moorer, USN	02 Jul 70	01 Jul 74 ^d
*Gen George S. Brown, USAF	01 Jul 74	20 Jun 78 ^d
Gen David C. Jones, USAF	21 Jun 78 ^h	18 Jun 82 ^h
GEN John W. Vessey, Jr., USA	18 Jun 82 ⁱ	30 Sep 85 ^d
*ADM William J. Crowe, Jr., USN	01 Oct 85	30 Sep 89 ^d
GEN Colin L. Powell, USA	01 Oct 89	30 Sep 93 ^d
Acting ADM David E. Jeremiah, USN	01 Oct 93	24 Oct 93
*GEN John M. Shalikashvili, USA	25 Oct 93	30 Sep 97
GEN Henry H. Shelton, USA	01 Oct 97	30 Sep 01
Gen Richard B. Myers, USAF	01 Oct 01	30 Sep 05 ^d
Gen Peter Pace, USMC	01 Oct 05	30 Sep 07
ADM Michael G. Mullen, USN	01 Oct 07	30 Sep 11
GEN Martin E. Dempsey, USA	01 Oct 11	-

* Deceased.

^a President Roosevelt established this position on 20 July 1942 to provide an officer to preside over JCS meetings and maintain liaison with the White House. The position lapsed in March 1949 when Admiral Leahy was detached.

^b Date detached. General of the Army Dwight D. Eisenhower, while president of Columbia University, at the request of President Truman, served as the principal military adviser to the President and the Secretary of Defense, and presiding officer of the Joint Chiefs of Staff, from February to August 1949.

^c The position of chairman was created by the 1949 Amendments to the National Security Act of 1947 approved 10 August 1949. The chairman is appointed by the President with the advice and consent of the Senate. Originally, the chairman served a two-year term with eligibility for a second two-year term, except in time of war when there would have been no limit on the number of reappointments. Since 1 October 1986, the chairman is appointed for a two-year term beginning on 1 October of odd-numbered years. He may be reappointed for two additional terms, except in time of war when there is no limit on the number of reappointments. An officer may not serve as chairman or vice chairman if his combined service in such positions exceeds six years.

^d Date of retirement.

^e Served as special assistant to Secretary of Defense Charles E. Wilson 1 July to 15 August 1957. He was formally sworn in as Chairman, Joint Chiefs of Staff at the White House on 15 August 1957.

^f Retired 1 July 1959; recalled to active duty 1 July 1961; relieved from active duty 1 July 1964; reverted to retired status 2 July 1964.

^g Reappointed for a two-year term in 1966, for a one-year term in 1968, and an additional one-year term in 1969; retired 3 July 1970.

^h His Presidential commission was dated 20 June 1978. General Jones became Acting Chairman on 21 February 1978, when General Brown entered the hospital; he was sworn in publicly as Chairman at a ceremony attended by President Jimmy Carter at the Pentagon on 30 June 1978. He retired 1 July 1982.

ⁱ Took oath of office privately on 18 June 1982; he was sworn in publicly at the White House on 21 June 1982.

<u>Vice Chairman, Joint Chiefs of Staff^a</u>	<u>From</u>	<u>To</u>
*Gen Robert T. Herres, USAF	06 Feb 87	28 Feb 90
ADM David E. Jeremiah, USN	01 Mar 90	28 Feb 94
ADM William "Bill" Owens, USN	01 Mar 94	27 Feb 96
Gen Joseph W. Ralston, USAF	01 Mar 96	29 Feb 00
Gen Richard B. Myers, USAF	29 Feb 00	01 Oct 01
Gen Peter Pace, USMC	01 Oct 01	12 Aug 05
ADM Edmund P. Giambastiani, Jr. USN	12 Aug 05	27 Jul 07
Gen James E. Cartwright, USMC	02 Sep 07	03 Aug 11
ADM James A. Winnefeld, Jr. USN	04 Aug 11	-

* Deceased.

^a The position of vice chairman was created by the Goldwater-Nichols Department of Defense Reorganization Act (PL 99-433) of 1 October 1986. The vice chairman acts as chairman when there is a vacancy in that office or in the absence or disability of the chairman. The vice chairman is a member of the Joint Chiefs of Staff only when he is acting for the chairman. The chairman and the vice chairman may not be members of the same military Service although the President may briefly waive that restriction in order to facilitate the orderly filling of the positions.

The vice chairman is appointed by the President, with the advice and consent of the Senate, for a term of two years. He may be reappointed for two additional terms, except in time of war when there is no limit on the number of reappointments.

<u>Chief of Staff, U.S. Army^a</u>	<u>From</u>	<u>To</u>
*GEN of the Army George C. Marshall	09 Feb 42 ^b	18 Nov 45
*GEN of the Army Dwight D. Eisenhower	19 Nov 45	07 Feb 48
*GEN Omar N. Bradley	07 Feb 48	16 Aug 49
*GEN J. Lawton Collins	16 Aug 49	15 Aug 53
*GEN Matthew B. Ridgway	15 Aug 53	30 Jun 55
*GEN Maxwell D. Taylor	30 Jun 55	01 Jul 59
*GEN Lyman L. Lemnitzer	01 Jul 59	30 Sep 60
*GEN George H. Decker	01 Oct 60	30 Sep 62
*GEN Earle G. Wheeler	01 Oct 62	02 Jul 64
*GEN Harold K. Johnson	03 Jul 64	02 Jul 68
*GEN William C. Westmoreland	03 Jul 68	30 Jun 72
*GEN Bruce Palmer, Jr. (acting)	01 Jul 72	11 Oct 72
*GEN Creighton W. Abrams	12 Oct 72	04 Sep 74 ^c
*GEN Fred C. Weyand ^d	03 Oct 74	01 Oct 76
*GEN Bernard W. Rogers	01 Oct 76	21 Jun 79
GEN Edward C. Meyer	22 Jun 79	22 Jun 83
GEN John A. Wickham, Jr.	23 Jun 83	22 Jun 87
GEN Carl E. Vuono	23 Jun 87	21 Jun 91
GEN Gordon R. Sullivan	21 Jun 91	20 Jun 95
GEN Dennis J. Reimer	20 Jun 95	21 Jun 99
GEN Eric K. Shinseki	21 Jun 99	11 Jun 03
GEN Peter J. Schoomaker	01 Aug 03	10 Apr 07
GEN George W. Casey, Jr.	10 Apr 07	10 Apr 11
GEN Martin E. Dempsey	11 Apr 11	07 Sep 11
GEN Raymond T. Odierno	07 Sep 11	-

* Deceased.

^a Since 1 January 1969 (under Public Law 90-22 approved 5 June 1967 which amended Section 3034(a) of Title 10, U.S. Code) the Chief of Staff, U.S. Army, is appointed by the President with the advice and consent of the Senate for a four-year term and, in time of war, is eligible for reappointment for a term of not more than four years.

^b Date of first formal JCS meeting.

^c Date of death.

^d Acting Chief of Staff, 4 September to 2 October 1974.

<u>Chief of Naval Operations, U.S. Navy^a</u>	<u>From</u>	<u>To</u>
*ADM Harold R. Stark	09 Feb 42 ^b	12 Mar 42
*Fleet Adm. Ernest J. King ^c	09 Feb 42 ^b	15 Dec 45
*Fleet Adm. Chester W. Nimitz	15 Dec 45	15 Dec 47
*ADM Louis E. Denfeld	15 Dec 47	02 Nov 49
*ADM Forrest P. Sherman	02 Nov 49	22 Jul 51 ^d
*ADM William M. Fechteler	16 Aug 51	16 Aug 53
*ADM Robert B. Carney	17 Aug 53	17 Aug 55
*ADM Arleigh A. Burke	17 Aug 55	01 Aug 61
*ADM George W. Anderson, Jr.	01 Aug 61	01 Aug 63
*ADM David L. McDonald	01 Aug 63	01 Aug 67
*ADM Thomas H. Moorer	01 Aug 67	01 Jul 70
*ADM Elmo R. Zumwalt, Jr.	01 Jul 70	01 Jul 74
ADM James L. Holloway III	01 Jul 74	01 Jul 78
ADM Thomas B. Hayward	01 Jul 78	01 Jul 82
*ADM James D. Watkins	01 Jul 82	01 Jul 86
ADM Carlisle A.H. Trost	01 Jul 86	29 Jun 90
ADM Frank B. Kelso II	29 Jun 90	23 Apr 94
*ADM Jeremy M. Boorda	23 Apr 94	16 May 96
ADM Jay L. Johnson	16 May 96	21 Jul 00
ADM Vern E. Clark	21 Jul 00	22 Jul 05
ADM Michael G. Mullen	22 Jul 05	29 Sep 07
ADM Gary Roughead	29 Sep 07	23 Sep 11
ADM Jonathan W. Greenert	23 Sep 11	-

* Deceased.

^a Since 1 January 1969 (under Public Law 9-22 approved 5 June 1967 which amended Section 5081(a) of Title 10, U.S. Code) the Chief of Naval Operations is appointed by the President with the advice and consent of the Senate for a four-year term and, in time of war, may be reappointed for a term of not more than four years.

^b Date of first formal JCS meeting.

^c At the initial JCS meetings both the Chief of Naval Operations, Admiral Stark, and the Commander in Chief, U.S. Fleet, Admiral King, represented the Navy. By Executive Order 9096, 12 March 1942, the two positions were combined in one individual, Admiral King, who served as Commander in Chief, U.S. Fleet and Chief of Naval Operations. In accordance with Executive Order 9635, on 10 October 1945, Admiral King's title became simply Chief of Naval Operations, and the title of Commander in Chief, U.S. Fleet, ceased to exist.

<u>Chief of Staff, U.S. Air Force^a</u>	<u>From</u>	<u>To</u>
*Gen of the Army Henry H. Arnold ^b	09 Feb 42 ^c	28 Feb 46
*Gen Carl Spaatz ^d	01 Mar 46	30 Apr 48
*Gen Hoyt S. Vandenberg	30 Apr 48	30 Jun 53
*Gen Nathan F. Twining	30 Jun 53	30 Jun 57
*Gen Thomas D. White	01 Jul 57	30 Jun 61
*Gen Curtis E. LeMay	30 Jun 61	31 Jan 65
*Gen John P. McConnell	01 Feb 65	01 Aug 69
*Gen John D. Ryan	01 Aug 69	31 Jul 73
*Gen George S. Brown	01 Aug 73	30 Jun 74
Gen David C. Jones	01 Jul 74	20 Jun 78
*Gen Lew Allen, Jr. ^e	01 Jul 78	30 Jun 82
*Gen Charles A. Gabriel	01 Jul 82	30 Jun 86
Gen Larry D. Welch	01 Jul 86	30 Jun 90
Gen Michael J. Dugan	01 Jul 90	17 Sep 90
Acting Gen John M. Loh	18 Sep 90	29 Oct 90
Gen Merrill A. McPeak	30 Oct 90	25 Oct 94
Gen Ronald R. Fogleman	26 Oct 94	01 Sep 97
Gen Michael E. Ryan	06 Nov 97	05 Sep 01
Gen John P. Jumper	06 Sep 01	02 Sep 05
Gen T. Michael Moseley	02 Sep 05	01 Aug 08
Gen Norton A. Schwartz	12 Aug 08	10 Aug 12
Gen Mark A. Welsh III	10 Aug 12	-

* Deceased.

^a Position created by the National Security Act of 1947. Since 1 January 1969 (under Public Law 90-22 approved 5 June 1967 which amended Section 8034(A) of Title 10, U.S. Code) the Chief of Staff, U.S. Air Force, is appointed by the President with the advice and consent of the Senate for a four-year term and, in time of war, may be reappointed for a term of not more than four years.

^b Served as member of the Joint Chiefs of Staff as Commanding General, Army Air Forces.

^c Date of first formal JCS meeting.

^d Commanding General, Army Air Forces, until sworn in as the first Chief of Staff, U.S. Air Force, on 26 September 1947.

^e Acting Chief of Staff, U.S. Air Force, from 21 to 30 June 1978.

<u>Commandant, U.S. Marine Corps^a</u>	<u>From</u>	<u>To</u>
*Gen Lemuel C. Shepherd, Jr.	28 Jun 52	31 Dec 55
*Gen Randolph McC. Pate	01 Jan 56	31 Dec 59
*Gen David M. Shoup	01 Jan 60	31 Dec 63
*Gen Wallace M. Greene, Jr.	01 Jan 64	31 Dec 67
*Gen Leonard F. Chapman, Jr.	01 Jan 68	31 Dec 71
*Gen Robert E. Cushman, Jr.	01 Jan 72	30 Jun 75
*Gen Louis H. Wilson	01 Jul 75	30 Jun 79
*Gen Robert H. Barrow	01 Jul 79	30 Jun 83
Gen Paul X. Kelley	01 Jul 83	30 Jun 87
Gen Alfred M. Gray, Jr.	01 Jul 87	30 Jun 91
Gen Carl E. Mundy, Jr.	01 Jul 91	30 Jun 95
Gen Charles C. Krulak	01 Jul 95	30 Jun 99
Gen James L. Jones	01 Jul 99	12 Jan 03
Gen Michael W. Hagee	13 Jan 03	13 Nov 06
Gen James T. Conway	14 Nov 06	22 Oct 10
Gen James F. Amos	22 Oct 10	-

* Deceased.

^a By Public Law 416, 82d Congress, approved 28 June 1952, the Commandant of the U.S. Marine Corps was placed in co-equal status with the members of the Joint Chiefs of Staff when matters of direct concern to the Marine Corps were considered. In 1978, Section 141 of Title 10, U.S. Code, was amended by Public Law 485, 95th Congress, approved 20 October 1978, to provide full membership for the Commandant of the Marine Corps in the Joint Chiefs of Staff.

Effective 1 January 1969 (under Public Law 90-22 approved 5 June 1967 which amended Section 5201(a) of Title 10, U.S. Code) the Commandant of the U.S. Marine Corps is appointed by the President with the advice and consent of the Senate for a four-year term and, in time of war, may be reappointed for a term of not more than four years.

<u>Chief of the National Guard Bureau^a</u>	<u>From</u>	<u>To</u>
Gen Craig R. McKinley, USAF	31 Dec 11	-

^a The Chief of the National Guard Bureau became a statutory member of the Joint Chief of Staff when President Barack Obama signed the 2012 National Defense Authorization Act.

APPENDIX 2

AUTHORIZED AND ASSIGNED STRENGTH OF THE ORGANIZATION OF THE JOINT CHIEFS OF STAFF and THE JOINT STAFF (1947-2012)*

<u>Date</u>	<u>Military</u>		<u>Civilian</u>		<u>Total</u>	
	<u>Auth</u>	<u>/Asgd</u>	<u>Auth</u>	<u>/Asgd</u>	<u>Auth</u>	<u>/Asgd</u>
30 Jun 48	238	257	170	151	408	408
30 Jun 49	282	257	218	184	500	441
30 Jun 50	310	272	200	177	510	449
30 Jun 51	333	308	222	192	555	500
30 Jun 52	334	325	200	190	534	515
30 Jun 53	339	323	197	188	536	511
30 Jun 54	345	338	192	183	537	521
30 Jun 55	300	310	185	187	485	497
30 Jun 56	314	312	180	173	494	485
30 Jun 57	315	322	180	173	495	497
30 Jun 58	308	328	175	199	483	527
30 Jun 59	588	594	326	303	868	946
30 Jun 60	559	635	309	311	868	946
30 Jun 61	884	654	329	317	1213	971
30 Jun 62	1068	645	398	385	1466	1030
30 Jun 63	1061	773	423	403	1484	1176
30 Jun 64	1154	1173	426	417	1580	1590
30 Jun 65	1192	1201	438	426	1630	1627
30 Jun 66	1288	1238	490	453	1778	1691
30 Jun 67	1349	1338	493	470	1842	1808
30 Jun 68	1480	1438	531	486	2011	1924
30 Jun 69	1485	1571	455	441	1940	2012
30 Jun 70	1293	1325	417	383	1710	1708
30 Jun 71	1299	1272	400	370	1699	1642
30 Jun 72	1314	1305	403	379	1717	1684
30 Jun 73	1321	1308	391	356	1712	1664
30 Jun 74	1251	1234	369	342	1620	1576
30 Jun 75	1130	1141	352	344	1482	1485
30 Jun 76	1131	1049	352	303	1483	1352
30 Sep 77	976	999	285	278	1261	1277
30 Sep 78	986	976	277	270	1263	1246
30 Sep 79	1023	996	286	257	1309	1253
30 Sep 80	1023	1017	281	261	1304	1278
30 Sep 81	1040	1039	281	271	1321	1310
30 Sep 82	1073	1077	286	274	1359	1351
30 Sep 83	1111	1132	301	272	1412	1405

30 Sep 84	1157	1197	327	297	1484	1494
30 Sep 85	1223	1272	346	313	1569	1585
30 Sep 86	1282	1294	345	321	1627	1615
30 Sep 87	1295	1280	332	292	1627	1572
30 Sep 88	1315	1295	312	283	1627	1578
30 Sep 89	1319	1325	308	288	1627	1613
30 Sep 90	1323	1333	304	269	1607	1602
30 Sep 91	1260	1255	275	255	1535	1510
30 Sep 92	1203	1165	263	242	1466	1407
30 Sep 93	1153	1149	250	230	1403	1379
30 Sep 94	1131	1128	233	207	1364	1335
30 Jun 95	1132	1157	235	205	1367	1362
30 Sep 96	1157	1187	227	205	1384	1392
30 Sep 97	1182	1216	219	205	1401	1421
30 Sep 98	1139	1163	217	199	1356	1362
30 Sep 99	1095	1110	214	194	1309	1304
30 Sep 00	1073	1088	209	178	1282	1266
30 Sep 01	1059	1084	210	191	1269	1275
31 Oct 02	1003	1036	200	198	1203	1234
30 Sep 03	1013	1038	208	190	1221	1228
05 Oct 04	1040	1046	209	187	1249	1233
01 Oct 05	1004	996	212	191	1216	1187
01 Oct 06	1004	997	209	192	1213	1199
01 Oct 07	1007	1004	209	195	1216	1199
01 Oct 08	966	1002	247	208	1213	1210
01 Oct 09	965	977	247	212	1218	1192
01 Oct 10	991	913	424	364	1415	1277
01 Oct 11	2089	1307	1334	1031	3423	2338
01 Oct 12	1369	1261	1175	1026	2544	2287

* Figures supplied by Staff Management Br., J-1. Data prior to 1948 is not available. These numbers do not include contractors.

INDEX

- Abrams, General Creighton W.: 86
Acheson, Dean: 24, 25
Allen, General Lew, Jr.: 89
Amos, General James F.: 90
Anderson, Admiral George W., Jr.: 87
Anti-terrorism and force protection: 73
ARCADIA conference: 1–2
Armed Forces Policy Council: 38, 45
Army-Navy Petroleum Board, charts: 10, 19, 21
Arnold, General Henry H.: 2, 3, 12, 89
Assistant Deputy Directorate for Information Operations: 73
Assistant for Automation, charts: 56, 57, 58, 59
- Barrow, General Robert H.: 90
Bennett, Charles E.: 35
Blue Ribbon Commission on Defense Management: 65
Blue Ribbon Defense Panel: 51–52
Boorda, Admiral Jeremy M.: 87
Bradley, General Omar N.: 23, 27, 31, 32, 33, 38, 83, 86
British Chiefs of Staff Committee: 1–2, 5
Brown, General George S., USAF: 83, 84, 89
Brown, Harold: 55
Burke, Admiral Arleigh: 42, 87
Bush, Vannevar: 4, 31, 32
- Carney, Admiral Robert B.: 87
Carter, Jimmy: 53, 84
Cartwright, General James E., USMC: 85
Casablanca Conference: 5
Casey, General George W., Jr.: 86
Center for Strategic and International Studies, Georgetown University: 64
Central Intelligence Agency: 4, 14, 15
Chain of command
 need for civilian control of: 37–38, 41
 role of the Chairman, Joint Chiefs of Staff, in: 53
 role of the Joint Chiefs of Staff in: 31, 32, 33, 35, 39–40, 45–46, 51
 role of the Secretary of Defense in: 31, 32, 33, 35, 39–40, 45–46
 for unified commands: 39–40, 44, 45–46, 53
Chairman, Joint Chiefs of Staff: 23, 24–25
 and development of doctrine for joint operations: 66, 71
 and intelligence operations: 79
 and management of the work of the Joint Staff: 34, 40, 42
 and officers for the Joint Staff: 25–26, 27, 34, 40, 42, 64, 66
 as principal military adviser to the President and the Secretary of Defense: 25, 26, 53, 61, 65, 66
 relationship to other Joint Chiefs: 25, 26, 27, 64
 relationship with the Secretary of Defense: 35, 40, 66
 relationship with the Services: 25, 27
 responsibilities: 23, 24, 26, 27, 28, 31, 32, 34, 35, 40, 41, 53, 61–62, 63, 64, 65–66
 and the specified commands: 64
 and strategic planning: 66
 term of office: 26–27, 50
 and the unified commands: 64
 voting by: 23, 26, 32, 40, 41
Chairman's Action Group: 79
Chairman's Special Studies Group: 50, 52
 chart: 56
Chapman, General Leonard F., Jr.: 90
Chief of Naval Operations: 2, 3, 39, 87
Chief of Staff, US Air Force: 39, 89
Chief of Staff, US Army: 2, 86
Chief of Staff to the Commander in Chief of the Army and Navy: 3, 14, 23

Chief of the Army Air Forces: 2
 Churchill, Winston: 1
 Clark, Admiral Vern: 87
 Clinton, William J.: 72
 Cohen, William: 73, 75
 Collins, Lieutenant General J. Lawton: 14, 15, 86
 Collins Plan: 14–15
 Combined Chiefs of Staff: 1, 2–3, 4
 Combined Intelligence Committee: 4
 Combined Staff Planners: 3–4
 Command, Control, and Communications (C3) Systems Directorate: 55, 67, 72, 73, 76
 charts: 59, 68, 69, 70, 81, 82
 Commandant, US Marine Corps: 33, 42, 54, 90
 Commander in Chief, US Fleet: 2, 3
 Committee on War Planning Agencies: 6
 Communications-Electronics Directorate: 44, 52
 chart: 48, 56, 57
 Conway, General James T.: 90
 Coolidge, Charles A.: 38
 Council of national military advisers, proposed: 62
 Crowe, Admiral William J., Jr., USN: 66–67, 71, 83
 Current Operations Division: 52
 Cushman, General Robert E., Jr.: 90

Decker, General George H.: 86
 Defense Acquisition Board: 72
 Defense Atomic Support Agency: 49, 51
 Defense Communications Agency: 49, 51, 52, 54, 55
 Defense Intelligence Agency: 49, 51, 52, 54
 Defense Mapping Agency: 52, 54
 Defense Nuclear Agency: 49, 52, 54
Defense Organization: The Need for Change: 64–65
Defense Planning Guidance Fiscal Years 2003–2007: 75
 Defense Reform Task Force: 75
 Defense Science Board: 55

Dempsey, General Martin: 86
 Denfeld, Admiral Louis E.: 27, 87
 Department of Defense Reorganization Act of 1958: 42–43, 45
 Deputy Director for Anti-Terrorism/Force Protection: 76, 78
 Deputy Director for Current Operations: 75
 Deputy Director for Global Operations: 76, 78
 Deputy Director for Information Operations: 76
 Deputy Director for National Systems Support: 76
 Deputy Director for Operations (Counterinsurgency and Special Activities): 52
 Deputy Director for Special Operations: 78
 Deputy Directorate for Anti-terrorism/Homeland Defense: 78
 Deputy Directorate for Combating Terrorism: 73
 Deputy Directorate for Current Operations: 73
 Deputy Directorate for Current Readiness and Capabilities: 73
 Deputy Directorate for War-gaming, Simulation, and Analysis: 74
 Directorate for Information and Resource Management: 62, 72
 charts: 70, 81
 Directorate for Operational Plans and Joint Force Development: 74, 76
 Directorate of Administrative Services: 49–50, 52, 62
 charts: 56, 57, 58, 59, 68
 Directorate of Management: 72, 76, 79
 chart: 82
 Directorate of Support Services: 62
 chart: 69
 DOD Appropriations Bill, Conference Report, FY 1984: 63
 DOD Directive 5100.1: 45–46
 Dodge, Joseph M.: 35
 Dugan, General Michael J.: 89

Eberstadt, Ferdinand: 13, 24, 26, 27–28, 35
 Eberstadt committees: 13–14, 15–16, 17, 24
 Eisenhower, Dwight D.: 23, 26, 31, 33, 34,
 35, 37–40, 41, 42, 43, 84, 86
 Eisenhower, Milton S.: 31

Fechteler, Admiral William M.: 87
 Finletter, Thomas K.: 35, 38
 Finucane, Charles: 38
 Fitzhugh, Gilbert W.: 51
 Flemming, Arthur S.: 31
 Fogleman, General Ronald R.: 89
 Force Structure, Resource, and Assessment
 Directorate: 67, 71, 72, 74, 77, 79
 charts: 70, 81, 82
 Foreign military aid programs: 46
 Forrestal, James V.: 13, 14, 16, 17, 19–20,
 23–24, 25, 26, 27–28
 Foster, William C.: 38
 “Functions of the Armed Forces and the
 Joint Chiefs of Staff”: 20

Gabriel, General Charles A.: 89
 Gainey, Command Sergeant Major William,
 USA: 79
 Gates, Thomas: 38
 Giambastiani, Admiral Edmund, USN: 85
 Global Command and Communications
 System: 73
 Global war on terror: 76, 78
 Goldwater, Barry: 65
 Goldwater-Nichols Department of Defense
 Reorganization Act (1986): 65–67,
 71, 72, 75, 85
 Gray, General Alfred M., Jr.: 90
 Greene, General Wallace M., Jr.: 90
 Gruenther, Major General Alfred M., USA:
 18, 23, 27

Hagee, General Michael W.: 90
 Haiti: 73
 Hamre, John: 74, 75
 Hayward, Admiral Thomas B.: 87

Heritage Foundation: 64
 Herres, General Robert T., USAF: 67, 85
 Hoffman, Clare E.: 35
 Holloway, Admiral James L., III: 87
 Homeland Defense Division: 78
 Hoover, Herbert C.: 24, 26, 27–28, 35
 Hoover Commission: 24–25, 38

Information Warfare Division: 73
 Intelligence Directorate: 44, 49, 52, 54, 71
 charts: 48, 81, 82
 Intelligence Negotiations Division: 52
 Intelligence operations: 79
 Iraq: 73

J-1, Manpower and Personnel Directorate:
 62, 67
 charts: 68, 69, 70, 81, 82
 J-1, Personnel Directorate: 44, 52
 charts: 48, 56, 57
 J-2, Intelligence Directorate: 44, 49, 52, 54,
 71
 charts: 48, 81, 82
 J-3, Operations Directorate: 44, 49, 50, 51–
 52, 55, 62–63, 67, 72, 73, 76, 77
 charts: 48, 56, 57, 58, 59, 68, 69, 70, 81,
 82
 J-4, Logistics Directorate: 44, 52, 72, 74
 charts: 48, 56, 57, 58, 59, 68, 69, 70, 81,
 82
 J-5, Plans and Policy Directorate: 44, 49,
 50, 52, 62, 67, 72, 73, 77
 charts: 48, 56, 57, 58, 59, 68, 69, 73
 J-5, Strategic Plans and Policy Directorate:
 77
 charts: 81, 82
 J-6, Command, Control, and
 Communications Systems Directorate:
 67, 72, 73, 76
 charts: 70, 81, 82
 J-6, Communications-Electronics
 Directorate: 44, 52
 charts: 48, 56, 57

J-7, Directorate for Operational Plans and Joint Force Development: 74, 76

J-7, Operational Plans and Interoperability Directorate: 67, 71, 74
charts: 70, 81, 82

J-8, Force Structure, Resource, and Assessment Directorate: 67, 71, 72, 74, 77, 79
charts: 70, 81, 82

J-31, Vice Director of Operations: 76

J-33, Deputy Director for Current Operations: 75

J-33, Deputy Directorate for Current Operations: 73

J-34, Deputy Director for Anti-Terrorism/Force Protection: 76, 78

J-34, Deputy Directorate for Combating Terrorism: 73

J-35, Deputy Director for National Systems Support: 76

J-37, Deputy Director for Special Operations: 78

J-38, Deputy Director for Global Operations: 76, 78

J-38, Deputy Directorate for Current Readiness and Capabilities: 73

J-39, Assistant Deputy Directorate for Information Operations: 73

J-39, Deputy Director for Information Operations: 76

Jeremiah, Admiral David E., USN: 72, 83, 85

Johnson, General Harold K.: 86

Johnson, Admiral Jay L.: 87

Johnson, Louis: 26

Johnson, Lyndon B.: 50

Johnson administration: 49

Joint Administrative Committee: 6
chart: 9

Joint Advance Study Committee: 43
chart: 36

Joint Advance Study Group: 43, 44, 49
charts: 47, 48

Joint Analysis Directorate: 63, 67

Joint Board of the Army and Navy: 1, 3, 4

Joint Chiefs of Staff

abolition of the committee system: 43

and allocation of resources: 17

channel to the President: 3

composition of: 2–3, 14–15, 17, 32, 50, 54, 72

and force structure: 53, 63

and foreign military aid programs: 46

Historical Section: 19

and intelligence operations: 45, 49, 54, 79

liaison with the Secretary of Defense: 23–25, 27

and logistic planning: 17, 32, 45

and long-range planning: 5

and materiel and personnel needs of the Services: 17

members responsibilities to individual Services: 32, 35, 40, 51, 53–54, 61–62, 65

and the military budget: 12, 14–15, 16, 17, 46

as military staff of the Secretary of Defense: 45–46

and the National Security Act of 1947: 16–17

operational command responsibility: 45–46

and organization of the military: 12–13

as principal military advisers to the National Security Council: 23, 45

as principal military advisers to the President: 3, 14, 17, 26, 27, 45–46

as principal military advisers to the Secretary of Defense: 17, 26, 27, 45–46

relationship with the military departments: 14, 45–46

relationship with the Secretary of Defense: 24, 25, 27, 32, 39–40, 45–46, 51

representatives to international negotiations: 52

and resource allocation: 53, 54, 61, 63

responsibilities of: 1, 3, 13, 14–15, 16–17, 19–20, 25, 33, 39–40, 41, 44, 45–47, 51, 63, 71

role in the chain of command: 31, 32, 33, 35, 39–40, 41, 45–46, 51
 role in the National Security Council: 14
 and specified commands: 44, 45, 51
 staff with dual responsibilities: 5, 6, 32, 51
 and strategic decisions on current situations: 5–6, 12, 16, 17
 and strategic planning: 17, 20, 32, 33, 45–46, 63
 strength: 44, 63, 91–92
 supervision of Defense agencies: 49, 51, 52, 54
 supporting organization for: 3–4, 5–6, 18
 term of office of members: 50
 and training: 17, 20, 46
 and unified commands: 17, 20, 32, 33, 41, 44, 45–46, 51
 US Delegation to the UN Military Staff Committee: 17, 19, 46, 65
 workload of members: 51
 Joint Chiefs of Staff Special Assistant for NSC Affairs, chart: 36
 Joint Civil Affairs Committee: 7, 19
 charts: 10, 21
 Joint Command and Control Requirements Group: 49, 50, 52
 chart: 56
 Joint Communications Board: 4, 19
 charts: 8, 9, 10, 21
 Joint Communications-Electronics Committee: 43
 charts: 29, 36
 Joint Communications-Electronics Group: 44
 chart: 47
 Joint Deputy Chiefs of Staff: 5–6
 charts: 9, 10
 Joint Directorate of Military Support Division: 78
 Joint Intelligence Committee: 4, 6, 19, 43
 charts: 8, 9, 10, 21, 29, 36
 Joint Intelligence Group: 19, 44
 charts: 21, 29, 36, 47
 Joint Intelligence Objectives Agency, chart: 29, 36
 Joint Intelligence Staff: 4, 6, 19
 chart: 10
 Joint Intelligence Subcommittee: 4
 charts: 8, 9
 Joint Logistics Committee: 6, 19
 chart: 10
 Joint Logistics Plans Committee: 6, 19, 43
 charts: 10, 21, 29, 36
 Joint Logistics Plans Group: 19, 44
 charts: 21, 29, 36, 47
 Joint Meteorological Committee: 4, 19, 43
 charts: 8, 9, 10, 21, 29, 36
 Joint Meteorological Group: 43
 charts: 47, 48
 Joint Middle East Planning Committee: 43
 Joint Middle East Planning Group: 43
 Joint Military Assistance Affairs Committee: 43
 Joint Military Assistance Affairs Directorate: 44
 chart: 48
 Joint Military Assistance Affairs Group, chart: 47
 Joint Military Transportation Committee: 4, 19, 43
 charts: 8, 9, 10, 21, 29, 36
 Joint Munitions Allocation Committee: 19, 43
 charts: 10, 21, 29, 36
 Joint New Weapons Committee: 4
 charts: 8, 9, 10
 Joint Operations Division: 52
 Joint Planning Staff for Space: 63
 chart: 69
 Joint Post-War Committee: 7
 chart: 10
 Joint Production Survey Committee: 7
 chart: 10
 Joint Programs Office: 44, 49
 chart: 48
 Joint Psychological Warfare Committee: 4
 chart: 8
 Joint Requirements and Management Board: 63–64
 Joint Requirements Oversight Council: 64, 72

Joint Secretariat: 4, 19, 49–50, 52, 72
 charts: 21, 29, 36, 47, 48, 56, 57, 58, 59, 68, 69, 70, 81
 Joint Security Control, chart: 8, 9
 Joint Special Operations Agency: 62–63, 67
 chart: 69
 Joint Staff
 authority of the Secretary of Defense
 over: 26
 composition of: 18, 66
 dual responsibilities of members to Joint Staff and Service staffs: 5, 6, 32, 42, 53–54
 military promotion of officers assigned to: 64, 65–66
 organization of: 18–19, 42–44, 73–74, 75, 76, 77, 78, 79, 80
 procedures: 18–19, 40, 41–42, 43–44, 53, 54, 75
 relationship with the Office of the Secretary of Defense: 34
 reorganized into J-directorates: 44
 and resource allocation: 72
 responsibilities: 18, 26, 32, 41, 44, 53, 55, 71, 72, 76, 78
 staffing of: 34, 51, 53, 64, 66, 72
 strength: 18, 23, 24, 25, 27, 40, 41, 42–43, 44, 50, 51, 65, 66, 71, 74, 75, 76, 77, 78, 79, 80, 91–92
 workload: 32, 42
 Joint Staff, Director of the: 18, 64
 charts: 21, 29, 36, 47, 48, 56, 57, 58, 59, 68, 69, 70, 81, 82
 limitations on authority of: 18
 responsibilities: 18, 19, 24, 50, 52, 62–63, 64
 selection of: 18, 25–26, 27, 34, 40, 42, 66
 and staff reorganizations: 62, 63, 77
 Joint Staff Organizational Assessment (JSOA) Working Group: 75, 76
 Joint Staff Planners: 3–4, 5, 6, 19
 charts: 8, 9, 10
 Joint Staff Reorganization Committee: 74
 Joint Strategic Plans Committee: 19, 43
 charts: 21, 29, 36
 Joint Strategic Plans Group: 19, 44
 charts: 21, 29, 36, 47
 Joint Strategic Survey Committee: 5–6, 19, 43
 charts: 9, 10, 21, 29, 36
 Joint Strategic Survey Council: 43, 49
 charts: 47, 48
 Joint Subsidiary Activities Committee: 43
 Joint Subsidiary Activities Group, chart: 47
 Joint US Chiefs of Staff: 2–3
 Joint US Strategic Committee: 4, 5, 6
 charts: 8
 Joint Vision Integration Cell: 74
 Joint War Games Agency: 49, 50, 52
 chart: 56
 Joint War Plans Committee: 6, 14, 19
 chart: 10
 Joint warfare doctrine: 66, 67, 71
 Jones, General David C., USAF: 61–62, 65, 83, 89
 Jones, General James L.: 90
 Jumper, General John P.: 89

 Kelley, General Paul X.: 90
 Kelso, Admiral Frank B., II: 87
 Kennedy administration: 49
 Key West Agreement of 1948: 19–20
 Kimball, Dan A.: 26–27
 King, Admiral Ernest J.: 2, 3, 12, 87
 Krulak, General Charles C.: 90
 Kyes, Roger M.: 34, 35

 Laird, Melvin R.: 51, 52
 Law of the Sea, Joint Chiefs of Staff
 representative to negotiations
 regarding: 52
 chart: 58
 Leahy, Admiral William D.: 3, 12, 23, 83
 LeMay, General Curtis E.: 89
 Lemnitzer, General Lyman L., USA: 83, 86
 Lodge-Brown Act: 24
 Logistics Directorate: 44, 52, 72, 74
 charts: 48, 56, 57, 58, 59, 68, 69, 70, 81, 82

Loh, General John M.: 89
 Lovett, Robert A.: 31–32

Mandate for Leadership II, Continuing the Conservative Revolution: 64

Manpower and Personnel Directorate: 62, 67
 charts: 68, 69, 70, 81, 82

Marshall, General George C.: 2, 3, 11, 12, 31, 86

McChrystal, Lieutenant General Stanley, USA: 80

McCloy, John J.: 24, 25

McConnell, General John P.: 89

McDonald, Admiral David L.: 87

McElroy, Neil H.: 38, 40, 42, 43, 44, 45

McNarney, General Joseph T.: 11

McPeak, General Merrill A.: 89

Meyer, General Edward C.: 61–62, 86

Military budgets, authority over: 11–12, 14–15, 17, 46

Moorer, Admiral Thomas H., USN: 83, 87

Moseley, General T. Michael: 89

Mullen, Admiral Michael, USN: 79, 83, 87

Mundy, General Carl E., Jr., 90

Munitions Assignments Board, chart: 8, 9

Mutual and Balanced Force Reductions, Joint Chiefs of Staff representative to negotiations for: 52
 charts: 58, 59, 68, 69, 70, 81

Myers, General Richard B., USAF: 77, 78, 83, 85

National Defense Authorization Act of FY 1998: 73

National Defense Authorization Act of FY 2000: 75

National Guard affairs: 73–74

National Joint Operations and Intelligence Center: 79

National Military Command Center: 49, 76, 79, 80

National Security Act Amendments of 1949: 23, 28

National Security Act of 1947: 16–18, 23, 25, 27, 32, 33

National Security Council
 Chairman, Joint Chiefs of Staff, as principal military adviser to: 61, 65, 66
 Joint Chiefs of Staff as principal military advisers to: 23, 45
 Joint Chiefs of Staff role in: 13–14
 proposals for the creation of: 13–14, 15

National Security Resources Board: 15

Nichols, Bill: 65

Nimitz, Fleet Admiral Chester W.: 18, 31, 87

Nixon, Richard M.: 51

No-fly zones, enforcement of: 73

Norstad, Major General Lauris: 15, 16, 17

Office of Strategic Communications: 79

Office of Strategic Services: 4–5
 charts: 8, 9, 10

Office of the Chairman Joint Chiefs of Staff: 75, 78

Office of the Coordinator of Information: 4–5

Office of the Secretary of Defense
 duplication of Office of the Chairman, Joint Chiefs of Staff, functions: 75, 78
 military staff for: 39–40
 provision of experts to the Joint Staff: 34
 and reorganization of the Joint Staff: 74

Office of War Information: 4–5

Operation DESERT STORM: 71

Operational Plans and Interoperability
 Directorate: 67, 71, 74
 charts: 70, 81, 82

Operations Directorate: 44, 49, 50, 51–52, 55, 62–63, 67, 72, 73, 76–77
 charts: 48, 56, 57, 58, 59, 68, 69, 70, 81, 82

Operations Plans Division: 62, 67

Organization of the Joint Chiefs of Staff: 50, 65
 organization of: 51–52, 63
 staffing for: 50–51, 52

strength: 66
 Owens, Admiral William "Bill," USN: 85

Pace, General Peter, USMC: 78, 79, 83, 85
 Packard, David: 65
 Packard Commission: 65
 Pakistan-Afghanistan Coordination Cell: 80
 chart: 82
 Palmer, General Bruce, Jr.: 86
 Pate, General Randolph McCall: 42, 90
 Patterson, Robert P.: 16, 17, 24, 26
 Peacekeeping and stability operations: 73
 Pentagon Reorganization Study: 78
 Personnel Directorate: 44, 52
 charts: 48, 56, 57
 Plans and Policy Directorate: 44, 49, 50, 52,
 62, 67, 72, 73, 77
 charts: 48, 56, 57, 58, 59, 68, 69, 73
 Powell, General Colin L., USA: 71, 83
 President of the United States
 Chairman, Joint Chiefs of Staff, as
 principal military adviser to: 25–26,
 53, 61, 65, 66
 Joint Chiefs of Staff as military advisers
 to: 1, 17, 26, 27, 45
 Program Budget Analysis Division: 62
 Psychological warfare: 4

Quadrennial Defense Review, 1997: 74

Radford, Admiral Arthur W.: 15, 38, 83
 Ralston, General Joseph, USAF: 85
 Reagan, Ronald: 65
 Reimer, General Dennis J.: 86
 Reorganization Plan No. 6: 33–35
 Reserve forces affairs: 73–74
 Richardson, Admiral J. O.: 12
 Ridgway, General Matthew B.: 86
 Robertson, Reuben: 38
 Rockefeller, Nelson A.: 31, 35, 38
 Rockefeller commission: 32–33
 Rogers, General Bernard W.: 86
 Rogers, Captain Michael S., USN: 79

Roosevelt, Franklin D.: 1, 3, 4–5, 83
 Roughead, Admiral Gary: 87
 Royall, Kenneth C.: 23, 26–27
 Rumsfeld, Donald H.: 52, 75, 78
 Russian-Ukraine-Eurasia Division: 73
 Ryan, General John D.: 89
 Ryan, General Michael E.: 89

Sarnoff, David: 31
 Schoomaker, General Peter J.: 86
 Schwartz, General Norton A.: 89
 Secretary of Defense
 authority over the Joint Staff: 26, 34
 authority over the military Services: 41,
 42
 Chairman, Joint Chiefs of Staff, as
 principal military adviser to: 25–26,
 53, 61, 65, 66
 Joint Chiefs as the military staff for: 45–
 46, 51
 Joint Chiefs of Staff as principal military
 advisers to: 17, 26, 27, 45–46
 limitations on the powers of: 16, 17
 relationship with the Joint Chiefs of Staff:
 24, 25, 27, 32, 45–46
 responsibilities: 23, 24–25, 31–32, 39–40,
 41
 Secretary of the Navy
 and organization of the military: 12, 13,
 15–16
 responsibilities: 3
 Secretary of War
 and organization of the military: 11–12,
 14–16
 responsibilities: 3
 Shalikashvili, General John, USA: 83
 Shelton, General Hugh, USA: 73–74, 75,
 76, 78, 83
 Shepherd, General Lemuel C., Jr.: 90
 Sherman, Admiral Forrest: 16, 17, 87
 Shinseki, General Eric K.: 86
 Shoup, General David M.: 90
 Somalia: 73
 Soviet Union: 37, 50
 Spaatz, General Carl, USAF: 31, 89

Space systems: 63

Special Assistant for Arms Control: 49, 50, 52
 charts: 56, 57

Special Assistant for Counterinsurgency and Special Activities: 49, 50, 51–52
 chart: 56

Special Assistant for Disarmament Affairs: 49

Special Assistant for Environmental Services: 50, 52
 chart: 56

Special Assistant for Military Assistance Affairs: 50, 52
 chart: 56

Special Assistant for NSC Affairs: 49
 charts: 36, 47, 48

Special Assistant to the Chairman, Joint Chiefs of Staff, for Strategic Arms Negotiations: 50–51, 52

Special Assistant to the Joint Chiefs of Staff for Strategic Mobility: 50
 chart: 56

Special Joint Chief of Staff Committee on Reorganization of National Defense: 12

Special operations: 62–63

Special Operations Division: 52, 62–63, 67

Specified commands
 Joint Chiefs of Staff responsibility for: 20, 44, 45–46, 51, 53, 55, 64
 responsibilities of commanders of: 61–62, 65–66

Stark, Admiral Harold R.: 2, 3, 87

Steadman, Richard C.: 53–54

Stimson, Henry L.: 11

Strategic Arms Limitation Talks (SALT), Joint Chiefs of Staff representatives to: 50–51, 52
 charts: 58, 59

Strategic arms negotiations: 50–51, 52

Strategic Planning Cell: 77

Strategic Plans and Policy Directorate: 77
 charts: 81, 82

Strategic Plans and Resource Analysis Agency: 63, 67
 chart: 69

Studies, Analysis, and Gaming Agency: 52, 63
 charts: 57, 58, 59, 68

Sullivan, General Gordon R.: 86

Taylor, General Maxwell D., USA: 37, 42, 83, 86

Thomas, Elbert: 15, 16
Toward a More Effective Defense: 64

Trost, Admiral Carlisle A. H.: 87

Truman, Harry S.: 15–16, 18, 23, 25, 26, 27, 28, 31, 84

Twining, General Nathan F., USAF: 38, 41, 44, 83, 89

Tydings, Millard: 25, 26, 27, 28

Unified Command Plan, 2002: 77

Unified commands
 Eisenhower's promotion of: 38–39, 41
 Joint Chiefs of Staff responsibility for: 17, 20, 32, 33, 41, 45–46, 51, 53, 55, 64
 responsibilities of commanders of: 61–62, 65–66
 Secretary of Defense responsibility for: 33, 39–40

United Kingdom: 1–2

United Nations, Military Staff Committee: 17, 19, 46, 66

US-British military cooperation: 1–3

US Army, and military organization: 11–12, 14–16

US Congress
 hearings regarding military organization: 11–12, 13–15, 26–27, 35, 40–42, 64–65
 and organization of the Joint Chiefs of Staff: 64

US House of Representatives: 35
 Armed Services Committee: 38, 40–41, 42

Committee on Government Operations:
35
US Marine Corps: 15, 16, 41, 42, 54
US Navy, and military organization: 12, 13,
15–16
US Northern Command: 77
US Senate
Armed Services Committee: 25, 26–27,
42, 64–65
Committee on Naval Affairs: 13, 15
Military Affairs Committee: 13, 14–15
US Space Command: 63, 77
US Special Operations Command: 67
US Strategic Command: 77

Vandenberg, General Hoyt S.: 89
Vessey, General John W., Jr., USA: 63, 83
Vice Chairman, Joint Chiefs of Staff: 65,
66, 67, 72, 85
Vice Director of Operations: 76
Vice Director of the Joint Staff: 79
Vietnam War: 50
Vinson, Carl: 38, 40
Vuono, General Carl E.: 86

Walsh, David I.: 13
Watkins, Admiral James D.: 87
Welch, General Larry D.: 89
Westmoreland, General William C.: 86
Weyand, General Fred C.: 86
Wheeler, Major General Earle G., USA: 37,
51–52, 83, 86
White, General Thomas D., USAF: 42, 89
Wickham, General John A., Jr.: 86
Wilson, Charles E.: 31, 35, 38, 84
Wilson, General Louis H.: 90
Wolfowitz, Paul: 78
Woodrum, Clifton A.: 11, 12
World War II: 1–7, 11

Yugoslavia: 73

Zumwalt, Admiral Elmo R., Jr.: 87