



# DEFENSE ACQUISITION STRUCTURES AND CAPABILITIES REVIEW ADDENDUM



National Defense  
Authorization Act  
Fiscal Year 2006  
Section 814 Report



# **DEFENSE ACQUISITION STRUCTURES AND CAPABILITIES REVIEW**

**ADDENDUM  
JUNE 2007**

**PURSUANT TO SECTION 814, NATIONAL DEFENSE AUTHORIZATION ACT,  
FISCAL YEAR 2006**



# Addendum

---

This Addendum contains supplemental information to the Defense Acquisition Structures and Capabilities Review.

## COMPONENT ANNEXES

The annexes fulfill the Section 814 requirement to report on the acquisition structure and capabilities of each organization. These are presented as follows:

- ◆ Annex A: Army
- ◆ Annex B: Navy
- ◆ Annex C: Air Force
- ◆ Annex D: Combatant Commands
- ◆ Annex E: Missile Defense Agency
- ◆ Annex F: Defense Logistics Agency
- ◆ Annex G: Defense Information Systems Agency
- ◆ Annex H: National Geospatial-Intelligence Agency
- ◆ Annex I: Defense Contract Management Agency
- ◆ Annex J: Defense Agencies and Field Activities
- ◆ Annex K: Office of the Under Secretary of Defense for Acquisition, Technology, and Logistics.

## ADDITIONAL APPENDIXES

The Report contained Appendixes A through E. This Addendum contains further supplemental information that is presented as additional appendixes. These appendixes begin their numbering with F and are as follows:

- ◆ Appendix F summarizes trends that appeared in the survey responses.
- ◆ Appendix G shows the survey that was used.
- ◆ Appendix H relates the survey questions to the 814 required study areas.



# Annex A

## Army

---

This annex represents the inputs received from the Army to the survey directive sent out from Mr. Kenneth Krieg, USD(AT&L). The annex discusses acquisition within the Army. Specifically,

- ◆ Current organization and its evolution,
- ◆ Mission and capabilities,
- ◆ Joint acquisition, and
- ◆ Recommendations.





## I. Current Organization

Figure A-1 illustrates the Department of the Army's acquisition structure at its most senior level, beginning with the Assistant Secretary of the Army for Acquisition Logistics and Technology ASA(ALT). The ASA(ALT) organization is responsible for the development and acquisition of Army platforms and weapon systems. The organization consists of the Assistant Secretary's immediate staff, Program Executive Officers (PEOs), a Direct Reporting Program Manager (DRPM) and Army Contracting Organizations. The PEOs and DRPM are responsible for the life cycle management of Army systems including development and acquisition. The Army Materiel Command (AMC) and its Major Subordinate Commands (MSC) partner with the PEOs in the life cycle management by providing technology, acquisition support and sustainment for the weapons systems and equipment once fielded.

Figure A-2 illustrates the Army acquisition reporting structure. For "stand alone" PEOs and PMs the reporting runs directly from the PEO/PM to the ASA(ALT). For the PEOs that are dual-hatted within the Life Cycle Management Command (LCMC) structure, program reporting responsibilities run from the Program Managers (PMs) to the PEO and then directly to ASA(ALT). However, these PEOs also report for operational matters through a command chain to the LCMC commander, then to the Commander, Army Materiel Command, and then to the Army Chief of Staff.

Figure A-1. Army PM Reporting Chain

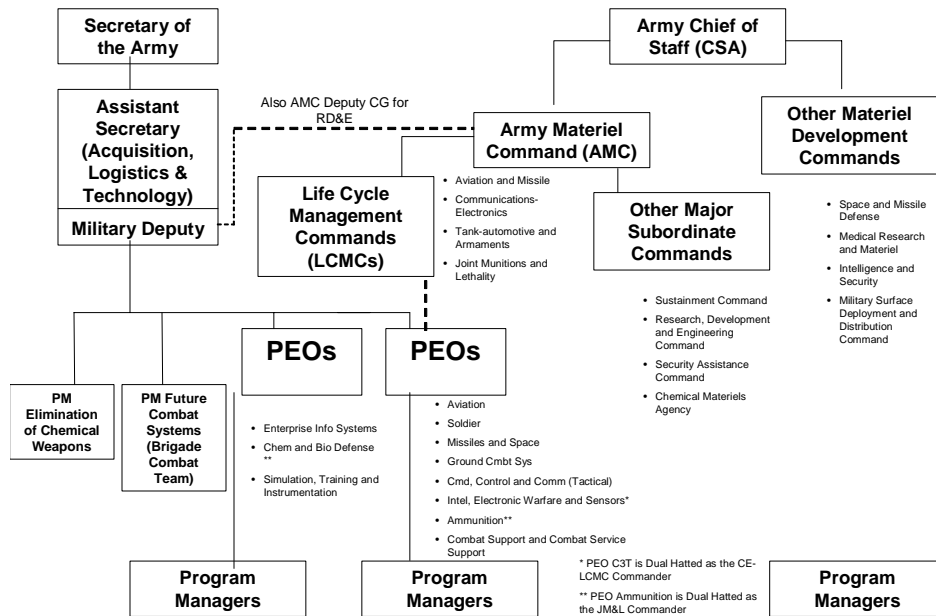

## II. Evolution to the Current Structure Since 2000

### 1. Army Acquisition Executive (AAE) HQ/Staff

The Packard Commission recommended the establishment of an Under Secretary of Defense for Acquisition, the appointment of Program Executive Officers (PEO) who would be responsible for a specific number of programs and would report only to the Service Executive, and having the PMs report only to PEOs on program matters.

The Packard Commission recommendations, which included grouping Project Managers of like end items under the supervision of PEOs, took effect in May 1987. The transition to having the PEOs report to an Army Acquisition Executive Support Agency (AAESA), occurred by the end of 1990. The personnel for these offices came primarily from the commodity commands. For the most part, the transition did not require any geographical moves on the part of personnel, as the PEO locations were chosen to be at the same locations as the support commands. The restructure meant that the PEOs and their PMs would receive support technology, acquisition support and sustainment support from AMC commodity commands, but would not be in the AMC reporting chains. AMC no longer would have programmatic authority over the projects.

AAESA was established in February 1990, to comply with Defense Management Report direction to eliminate duplicate layers of management within the Army acquisition management structure and to separately administer funding and

personnel authorizations for PEOs and their assigned PMs. Its mission was to provide support to the PEOs in a number of areas, such as resource management support, personnel management and personnel management support, automation and information management support, acquisition career management support and manpower management and manpower management support.

The Acquisition Career Management Office (ACMO) evolved in 1996 from the Army Acquisition Corps (AAC) Re-engineering Team. It was established out of a charter completed by that team. The basis of the charter centered on recommending actions to the Director, Acquisition Career Management that would prepare the civilian members of the AAC to participate fully with their military counterparts in the AAC of the 21st century by ensuring the execution of the intent of the DAWIA statute to professionalize the acquisition workforce.

The ACMO was formally changed to the Acquisition Support Center (ASC) in October 2002. The ASC became the U.S. Army Acquisition Support Center (USAASC) in October 2006 to make it distinguishable from other organizations that share the “ASC” acronym.

Figure A-2 below depicts the evolution of the Army Acquisition Executive HQ and staff from 2000 to 2006.

Figure A-2. Evolution of the Office of the AAE HQ and Staff from 2000 to 2006

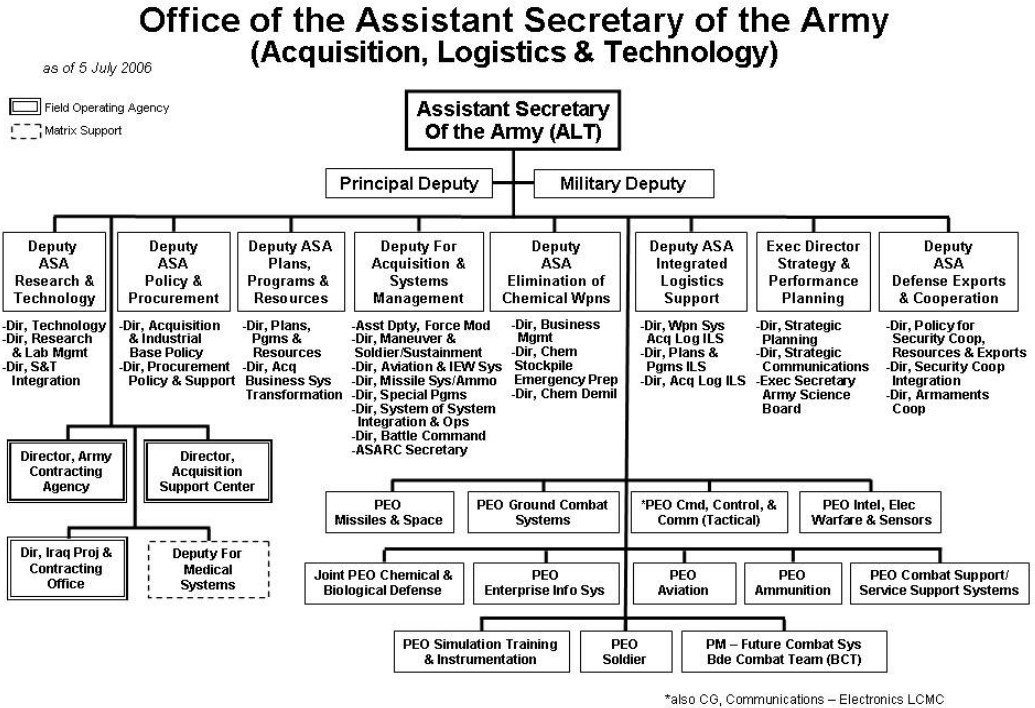
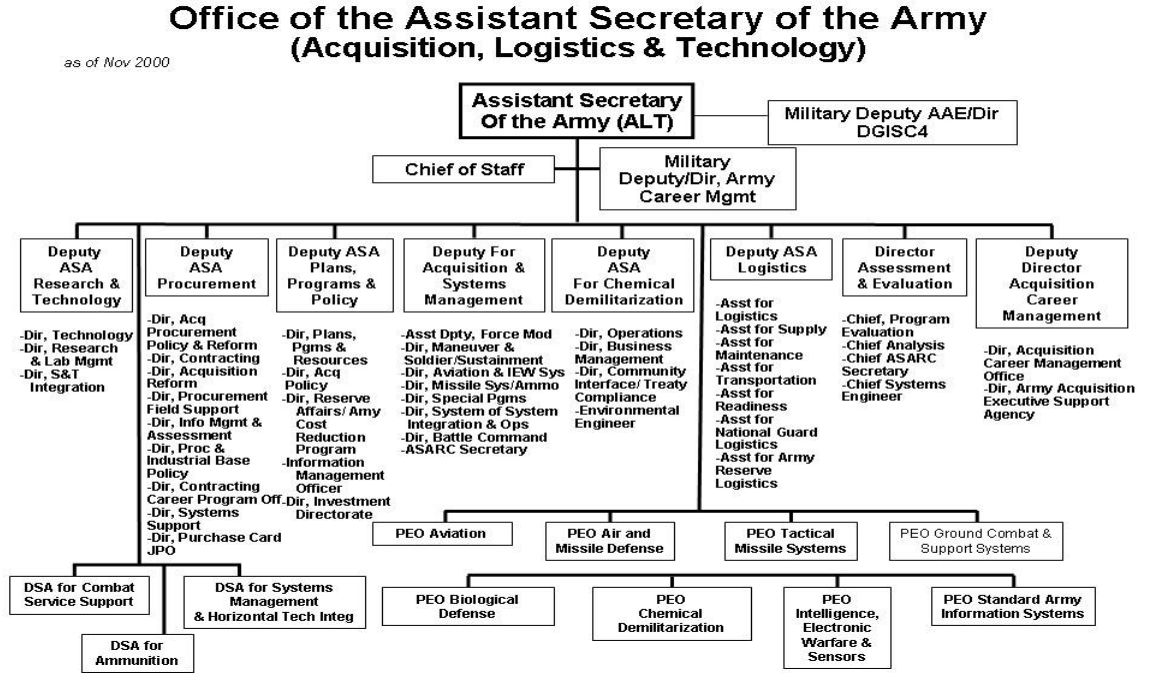

## 2. AMC Contracting and MSC Acquisition Centers

The overall mission today, as it relates to standard contracting concepts, is similar to that in 1990. At that time, the missions were primarily compliance-driven, with more direction and oversight provided by headquarters to the field. Today the headquarters has pushed down and empowered the field at the lowest possible level as authorized by regulations, to perform the mission. Today the headquarters is more discretionary in its mission and has become more of an advisor assisting the subordinate commands to accomplish their mission. Because of the disappearance of the organic base, military and civilians, the workload of contracting offices within AMC has evolved to now include services, chemical demilitarization, maintenance, contingency contracting and the Logistics Civil Augmentation Program (LOGCAP) in addition to research & development, systems, spares and ammunition contract purchases.

## 3. PEO Structure

As a result of the 1986 Packard Commission report, the Army implemented a PEO structure. This structure designated key managers who would devote full-time attention to the business and administrative management of assigned programs. These managers have a clear line of accountability and responsibility dedicated to the success of their assigned programs. Currently there are eleven PEOs. Figure A-3, below, tracks the evolution of the Army's PEO Structure from 1987 to the present.

Figure A-3. Army PEO Structure Implementation to 2006

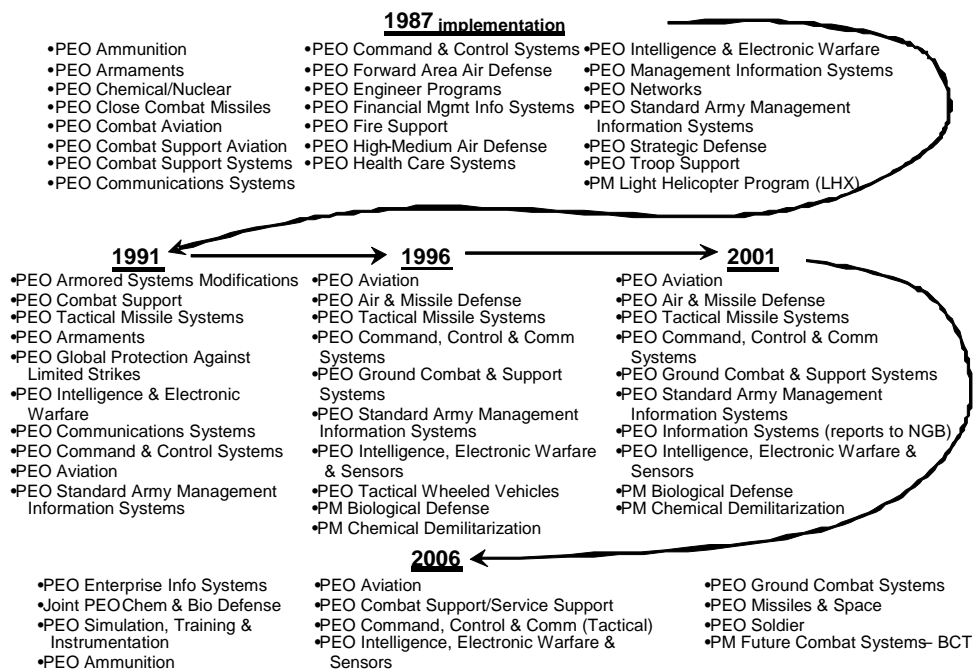

---

In addition, other changes include establishment and disestablishment of Project and Product Management Offices. These changes occurred as a result of Congressional, OSD and Army decisions. Some recent examples include the establishment of Program Manager, Future Combat System; disestablishments include program terminations such as Comanche, Crusader, Joint Common Missile, and other systems which no longer met leadership priorities. Individuals affected through these decisions were realigned to support new and/or existing program requirements or offered the opportunity for voluntary early retirement.

An internal Army study provided the impetus for the 2001/2002 Program Executive Officer (PEO)/Program Manager (PM) Reorganization. The Army Acquisition Corps determined that acquisition management must incorporate a strategic long-term vision to enhance program stability. The PEO/PM Reorganization required that all acquisition programs, regardless of acquisition category, report to either a PEO or directly to the Army Acquisition Executive (AAE). On October 3, 2001, the Army approved for immediate implementation, the Army's acquisition reorganization guidance. The goal was a streamlined acquisition process that was achieved through the reorganization of Project and Product Managers and the establishment of new Program Executive Offices to better support the transformational Army and the warfighter. Efficiencies were gained through this process in that all acquisition programs report directly to the AAE and are under his direct purview. Prior to the reorganization, there were Deputies for Systems Acquisition who reported to the Commanding General for the Army Materiel Command, and there were Program Executive Officers who reported to the AAE. The reorganization brought these functions in line to report to one single acquisition authority and thereby gained efficiencies for the Army.

#### **Program Executive Office, Ammunition (PEO AMMO)**

- The processes of PEO AMMO have matured since 2002 with minimal changes to the organizational structure. The four Project Managers have not changed, and they are: Close Combat Systems (CCS), Maneuver Ammunition Systems (MAS), Combat Ammunition Systems (CAS), and Joint Services (JS). To meet the increased procurement of ammunition in support of the war, the mission for medium caliber cannon ammunition was separated from the small and medium caliber ammunition (part of PM MAS). This new office created the opportunity for appropriate management oversight over the growing missions. The second area the PEO experienced growth is with the addition of Product Manager Intelligent Munitions Systems (PM-IMS), which is part of PM CCS. This program meets requirements for the national landmine policy as well as requirements for Future Combat Systems, Spin Out 1. The program is an ACAT II effort and a dedicated office has been established for this mission. The Industrial Base (IB) mission previously was managed at the PEO level with an associate PEO for oversight. The mission has been realigned with PM JS. The execution of the industrial base modernization is being exercised like a typical acquisition program with appropriate management

oversight applied. The IB effort is closely coordinated with the acquisitions of each PM and with the Joint Munitions Command execution of Base Realignment and Closure (BRAC) provisions.

### **Program Executive Office, Aviation (PEO AVN)**

- PEO AVN primary missions in 1990 have not changed from what they are today. Managing the life cycle of all air and ground platforms associated with supporting the Aviation War Fighter during peacetime and wartime has been and continues to be the primary mission.
- PEO AVN no longer has the mission for the Comanche Platform. This program was terminated by Congress in the spring of 2004.

### **Joint PEO Chemical and Biological Defense (JPEO-CBD)**

- In 1993, Congress passed Public Law 103-160, Section 1703, creating the Joint Service Chemical and Biological Defense Program (CBDP) and designated the Army (Assistant Secretary of the Army for Acquisition, Logistics and Technology (ASA(ALT))) as the Executive Agent. Title 50 USC 1522, the 19 Sept 2002 USD (AT&L) Acquisition Decision Memorandum titled Management of the Chemical/Biological Defense Programs, and the 9 Sept 2002 JROC Memorandum titled Establishment of the Chemical, Biological, Radiological and Nuclear Defense, established the JPEO-CBD on 1 Oct 2002. The JPEO-CBD is responsible for research, development, acquisition, fielding and life-cycle support of Chemical, Biological, Radiological, and Nuclear (CBRN) defense equipment, medical countermeasures, and installation and force protection supporting the National Military Strategy. In support of this mission the JPEO CBD serves as the Material Developer, the Total Life-Cycle Manager and the delegated Milestone Decision Authority for all CBD programs. The JPEO-CBD vision is to transform CBRN defense equipment, medical countermeasures and installation force protection capabilities they provide from stand-alone capabilities to net-centric, modular, tailorable and multi-purpose capabilities. The JPEO-CBD is jointly manned and its JPMs meet all Joint service criteria of the Goldwater-Nichols Act. The JPEO-CBD is also joint-funded to acquire these CBD capabilities for all the services. This is a significantly expanded mission from the PEO Biological Defense mission of 2000.
- After 9/11 the JPEO-CBD provided chemical and biological protection to the Pentagon and other key facilities in the National Capitol Region. Over the next 24 months, JPEO-CBD transitioned that mission to the Pentagon Force Protection Agency, the Office of Homeland Security and other Government agencies.

---

## **Program Executive Office Combat Support & Combat Service Support (PEO CS&CSS)**

- Since the establishment of the PEO CS&CSS in October 2001, the PEO has undergone several significant changes to accommodate Army Transformation initiatives. This has resulted in the gain, loss and reorganization of both Project and Product Management Offices. In 2001, PEO CS&CSS was comprised of three Project Offices: Project Manager, Tactical Vehicles, with subordinate Product Managers for Light Tactical Vehicles, Medium Tactical Vehicles, Heavy Tactical Vehicles and Trailers. Project Manager, Force Projection with subordinate Product Managers for Army Watercraft Systems, Petroleum and Water Systems, Sets, Kits and Outfits and Tools (PM SKOT), Force Sustainment Systems, Construction Equipment/Materiel Handling Equipment, Recovery and Bridging. Project Manager, Mobile Electric Power (PM MEP) with subordinate Product Managers for Test, Measurement and Diagnostic Equipment (PM TMDE), and Force Protection Systems (PM FPS).
- In 2003, the missions for Construction Equipment, Materiel Handling Equipment and Bridging equipment were aligned under one Product Manager (PM CE/MHE) due to downsizing of the programs and lack of budgets. Additionally, PM SKOT was realigned under PM MEP. In 2004, PM FPS was realigned to JOINT PEO Chemical and Biological Defense. In 2005, PM MEP was transferred to PEO C3T leaving PM SKOT and PM TMDE as direct-reporting Product Managers to the PEO. In July 2005, PM Trailers was disestablished and trailer systems were re-aligned to the prime mover PMs in PM Tactical Vehicles. Using the PM Trailer billet, PM Bridging was reestablished due to PB 753 funding to reestablished critical bridging programs.
- In November 2005, Project Manager, Future Tactical Systems (Provisional) was created to manage the FTTS ACTD, JLTV program and Maneuver Sustainment Programs and to align PM TMDE and PM SKOTS under the management of an 06 Project Manager organization versus direct reporting Product Managers to the PEO.
- In Feb 06, Route Clearing Vehicle mission was realigned from PEO AMMO to PM Bridging doubling/tripling the workload in the Product Office overnight. PM Bridging's name changed to PM Assured Mobility Systems on March 27, 2006. In Jun 06, Product Office Recovery was realigned to PEO GCS.



---

**Program Executive Office, Command, Control, Communications Tactical (PEO C3T)**

- PEO C3T's mission is to be the premier provider of integrated Command, Control and Communications Tactical (C3T) solutions to the joint warfighter while supporting transformation of the future force. The PEO is organized to rapidly develop, field, and support cutting edge survivable, secure, and interoperable command and control and communications (C3) solutions and power equipment through an iterative, spiral development process that results in the right systems, at the right time and at the best value to the warfighter.

**Program Executive Office, Enterprise Information Systems (PEO EIS)**

- In 1990 PEO Enterprise Information System's (PEO EIS), Standard Automated Management Information System (STAMIS) mission was to plan, design, develop, acquire, install, and maintain highly complex management information systems as directed by the AAE. In 2006 the PEO EIS mission is to provide Joint Service and Army warfighters with information dominance by developing, acquiring, integrating, deploying, and sustaining network centric knowledge based information technology and business management systems, communications and infrastructure solutions through leveraged Commercial and Enterprise capabilities that support the total Army, every day and anywhere.
- Multiple IT programs have transitioned out of PEO EIS (STAMIS) for operations and sustainment. Numerous other programs and new missions have been assigned to PEO EIS. The PEO mission scope has expanded over time to include all enterprise communication and infrastructure, information technology and business management systems. The mission of PEO EIS has grown over three fold since 1990.

**Program Manager, Future Combat Systems–Brigade Combat Team (PM FCS (BCT))**

- For 2005, the overarching mission of the PM FCS (BCT) is to develop, produce, field and sustain safe, reliable, suitable and effective Future Combat Systems–Brigade Combat Teams. Other missions enabling the successful execution of the overarching mission are to enable Future Force Joint network capabilities (C4ISR & System of Systems Common Operating Environment (SOSCOE)), and to enhance Brigade Combat Teams by Spinning Out emerging FCS capabilities.

- 
- The PM FCS (BCT) leads four Project management Offices; Manned Systems Integration, Network Systems Integration, Spin Out, and Unmanned Ground Vehicles. In addition, PM FCS (BCT) is supported by Project/Product Managers from PEOs Missiles Space, Ammo, IEW&S, C3T, Soldier, Aviation, and STRI among other complementary programs.
  - Since its inception, the FCS program has successfully operated under a revolutionary “One Team” concept consisting of Government, Lead Systems Integrator (LSI), and “Best of Industry” partners.

#### **Program Executive Office, Ground Combat Systems (PEO GCS)**

- The Program Executive Office, Ground Combat Support Systems (PEO GCSS) as it was called in 2000, was focused on meeting the challenge from the Chief of Staff of the Army to transform the Army while updating the systems found in the motor pools. Developing a sound approach to horizontal technology integration (HTI) was the first priority. Heavy land systems like the Abrams and Bradley were the primary instrument of our Nation’s combat power. Recapitalization of those systems was second cost cutting approach. Development of precision munitions used on various platforms was the third cost-cutting approach. The design of the Crusader was being adjusted to meet the Chief’s directive as well.
- By 2005, some of the older systems Program Executive Office, Ground Combat Systems (PEO GCS) managed had been transferred to the sustaining base for support. Today PEO GCS leads four project manager offices. They are Project Manager Stryker Brigade Combat Team (SBCT), Heavy Brigade Combat Team, Project Manager Joint Lightweight Howitzer and the Robotics Systems Joint Project Office.

#### **Program Executive Office, Intelligence, Electronic Warfare and Sensors (PEO IEW&S)**

- The primary macro-level missions of PEO IEW&S are the same today as they were in 1990 with few expansions, and divestitures. PEO IEW&S gained missions in the area of Future Combat Systems Brigade Combat Team Intelligence, Surveillance, and Reconnaissance, in addition to Counter-Improvised Explosive Devices and established PM CREW in 2003. Through ASA(ALT) direction PEO IEW&S gained Aircraft Survivability Equipment in 1990, from PEO Aviation. Global Positioning Systems (GPS) was a new mission to PEO IEW&S in 2001, which led to PM GPS.
- Since 1990 the following missions have been divested or lost: Directed Energy Weapons, Joint Precision Strike Demo, and Advanced Concept Technology Demonstrations, and Image Intensification which was recommended and moved to PEO Soldier.

## Program Executive Office, Missiles and Space (PEO MS)

- The management of the Army's missile program changed significantly on 1 May 1987 when four PEOs were provisionally established to direct and control the accomplishment of all assigned programs, including the development, production, fielding, product improvement, and follow-on support of assigned programs/systems. The four established PEOs were the Forward Area Air Defense (FAAD); Close Combat Missiles; Fire Support; and High/Medium Air Defense (HIMAD). On 15 September 1988, the FAAD and HIMAD PEOs were merged to form the Air Defense PEO, while the Fire Support and Close Combat Missiles PEOs were combined to form the new Fire Support PEO.
- On 29 July 1992, the Fire Support PEO was officially re-designated the Tactical Missiles PEO. On that same date, the Air Defense PEO and certain projects and programs managed by the U.S. Army Strategic Defense Command were consolidated to form the Global Protection Against Limited Strikes (GPALS) PEO. Effective 24 May 1993, the GPALS PEO was re-designated the Missile Defense PEO and then became the PEO Air and Missile Defense, 18 July 1996.
- On December 17, 1999, DoD issued a decision in PBD 224R, that the Ground-Based Elements of the National Missile Defense report directly to the Ballistic Missile Defense Organization (BMDO). Following this direction transforming the BMDO into an organization that focuses on the strategic missile defense, on 1 October 2001, THAAD and ARROW Project Offices were transferred to the BMDO.
- In July 2003, the PEO Air and Missile Defense's mission was expanded to include Army space programs, and the PEO was renamed the PEO Air, Space and Missile Defense (PEO ASMD). The PEO ASMD had the responsibility to develop, integrate, acquire, field and sustain systems to enable the Army to dominate, control, and exploit aerospace in a joint environment.
- In January 2005, the PEO Missiles and Space (MS) was established with the merger of the PEO Air, Space and Missile Defense and the PEO Tactical Missiles. The PEO is responsible for the full life-cycle management of assigned programs. Today the PEO Missiles and Space provides centralized management for all Army tactical and air defense missile programs.
- During 2005 the Army Space Office (ASPO) was transitioned to PEO Intelligence, Electronic Warfare and Sensors (IEWS). Also occurring in 2005, PEO MS activities associated with the Space Control Office and the Space Division was transitioned to U.S. Army Space and Missile Defense Command/U.S. Army Forces Strategic Command (USASMDC/ARSTRAT).

---

## **Program Executive Office, Simulation, Training and Instrumentation (PEO STRI)**

- In 1990, PEO STRI established and maintained training device technology base; developed concept formulation packages for all training devices; directed activities of Product Managers for armor, aviation, ground forces training devices, and Army communication systems; ensured development and acquisition of non-system training devices, synthetic flight training systems, and system training devices assigned by HQ, AMC.
- Today PEO STRI provides life cycle management of interoperable training, testing and simulation solutions for soldier readiness and the defense community; is the Army's training, testing, modeling and simulation materiel developer; the Army's executive agent for Combat Training Centers' Instrumentation; and provides support to other Materiel Developers (PEOs & PMs), Combat CDRs and Battle labs.

## **Program Executive Office, PEO Soldier**

- PEO Soldier was established in October 2002. Since its establishment, PEO Soldier has been focused on the Soldier and treating the Soldier as a System (SaaS). PEO Soldier is the focal point to develop, produce, field, and sustain everything that the Soldier wears and carries. Throughout 2005, PEO Soldier was fully engaged as the Executive Agent for the Chief of Staff, Army's Rapid Fielding Initiative (RFI). This mission resulted in the expeditious fielding of equipment to remedy shortcomings both in theater and to troops about to deploy. Currently, the RFI mission has been expanded to include providing equipment to the remainder of the active force plus Enhanced Brigades from the Reserve Component as well. PEO Soldier was created by the Army with one primary purpose: to develop the best equipment and field it as quickly as possible so that our Soldiers remain second to none in missions that span the full spectrum of military operations. As recent operations in Iraq and Afghanistan have vividly demonstrated, getting the right equipment to our military men and women is absolutely critical.
- By viewing the Soldier as part of an integrated system, PEO Soldier ensures that the Soldier and everything he or she wears or carries works together as an integrated system. The result is an overall systematic design that benefits Soldiers by enhancing their ability to accomplish individual and collective tasks, improving quality of life, building confidence, and saving lives. In this respect, PEO Soldier is at the vanguard of Army transformation. PEO Soldier designs, develops, procures, fields, and sustains virtually everything the Soldier wears or carries.

#### **4. Other**

##### **Life Cycle Management Command (LCMC)**

In 2004, the Army Acquisition Executive/Assistant Secretary of the Army for Acquisition, Logistics and Technology and the U.S. Army Materiel Command (AMC) Commanding General signed a Memorandum of Agreement formally establishing the Army's Life Cycle Management (LCM) initiative. The initiative's objective was to create a synergy that would enhance the efficiency and effectiveness of the Army's Acquisition, Logistics and Technology (AL&T) communities in delivering better products and capabilities to our Soldiers faster, while also minimizing total life-cycle cost across an entire grouping of systems.

## 5. Impact of Structural Changes on Acquisition Career Field Trends

Table A-1 below illustrates the impact of structural changes from 2000 to 2006 on the Army acquisition workforce.

*Table A-1. Army Acquisition Career Field Trends, 2000–2006*

	Sep 00	Sep 01	Sep 02	Sep 03	Sep 04	Sep 05	Sep 06*	'00 to '06 Delta	%00 to 06 Change
Program Management	2264	3601	5315	4493	4566	3804	4489	2225	98%
Contracting^	5987	5854	5814	5783	8183	5796	6034	47	< 1%
Industrial/Property Management	24	124	190	175	211	155	125	101	421%
Purchase and Procurement Assistant	422	985	467	440	437	348	334	-88	-21%
Facilities Engineering**	n/a	n/a	n/a	5522	5584	4922	441	-5081	-92%
Production Quality and Manufacturing	1027	2039	2333	2215	2226	2295	2193	1166	114%
Business, Cost Estimating & Financial Management	803	1495	4145	4452	4461	4384	4310	3507	437%
Life Cycle Logistics	926	2428	4098	5820	4936	6143	6320	5394	583%
Information Technology	371	839	3008	3227	2998	3023	2745	2374	640%
SPRDE - SE	6404	8031	11250	10571	11271	11259	11950	5546	87%
SPRDE - S&T Manager**	n/a	n/a	n/a	14	60	132	126	112	800%
Test & Evaluation Engineering	1472	1664	2299	2341	2452	2500	2148	676	46%
Other/Unknown	6272	12280	112	338	803	2089	203	-6069	-97%
Total AT&L Workforce	24806	39689	41783	47697	48188	49146	45443	20637	83%

\* As of 30 September 2006. \*\*No data exists prior to September 2003.

^ Totals from WASS database for series 1102, 1103, 1105, 1106, and 1150.

The Army has taken significant steps in recent years to improve and institutionalize the process of acquisition. Efforts are focused on delivering better products and capabilities to our customers faster. The innovation of the LCMC has created the opportunity for much greater cooperation and synergy between the Army Acquisition Corps and its customers.

For years there was considerable controversy regarding the composition and size of the Army Acquisition Workforce. Over time, the Army continued to modify and mature the workforce definitions first developed by the 1986 President's Blue Ribbon Commission on Defense Management (the Packard Commission). Part of the process was the methodology developed by DOD and the Jefferson Solutions approach. In addition, the Defense Acquisition Workforce Improvement Act (DAWIA) was amended significantly during Fiscal Year 2004 and 2005. These amendments (generally referred to as DAWIA II) also changed the landscape for Acquisition Corps accessions.

These changes account for the bulk of increase in the numbers over the years. The Army Acquisition Corps did not hire more than 20,000 new acquisition workforce employees between 2000 and 2005, but rather reclassified existing positions as part of the Army Acquisition Corps.

What can be inferred from this chart is how the density of the various Acquisition Career Fields has changed over time relative to the overall population of the Army Acquisition Corps. The real impact of these increases in numbers is the impact to the Defense Acquisition University (DAU) training base and the need for initial and sustaining training courses.

### **III. Mission, Capabilities and Service Issues**

#### **1. Missions**

##### **Army Acquisition Executive (AAE) HQ/Staff**

**USAASC:** The mission of the U.S. Army Acquisition Support Center (USAASC) is to provide support to the PEOs in a number of areas, such as resource management support, personnel management and personnel management support, automation and information management support, acquisition career management support and manpower management and manpower management support.

##### **Life Cycle Management Command**

The Life Cycle Management (LCM) initiative's intent was to integrate significant elements of AL&T leadership responsibilities and authority to enable a closer working relationship between AMC and the PEOs. Since its inception, the LCM initiative has provided an integrated, holistic approach to product development and system support across the Army.

Four Life Cycle Management Commands (LCMC) have been established to align AMC's systems oriented major subordinate commands with the PEOs to create the synergy that meets the overall LCM goals. The LCMC concept of operations was created to better manage the life cycle of equipment—by commodity—to create greater effectiveness for our Soldiers, while also

---

achieving greater efficiencies within major enterprise and organizational level processes. Through continued collaboration, each LCMC aligns its resources to support the value produced for combatant commanders and their Soldiers.

As part of the LCM initiative, each LCMC has implemented Lean/Six Sigma processes to increase efficiencies and to conserve fiscal and personnel resources.

## **PEOs**

The PEOs continue to perform life cycle management responsibilities for the successful execution of weapon and information system priorities as directed by Congress, OSD and the Army. A new concept is the Joint PEO (JPEO). The first JPEO is the JPEO-Chemical and Biological Defense (JPEO CBD).

### **Program Executive Office, Ammunition (PEO AMMO)**

PEO Ammunition is the Single Manager for Conventional Ammunition (SMCA) Executor with responsibility for buying conventional ammunition for all DOD customers. PEO AMMO develops and procures both conventional and leap-ahead munitions that increase combat power to warfighters. These include Precision Guided Munitions and Smart Weapons, as well as improving and sustaining the conventional ammunition stockpile.

PEO Ammunition manages over 200 Army programs that are in various stages of development, and/or procurement (to include several OPA and WTCV funded non-ammunition items). The PEO also manages the procurement of over 120 other service munitions items that are procured under the authority of the SMCA.

### **Program Executive Office, Aviation (PEO AVN)**

PEO AVN is the Army manager for the Apache®, Cargo Helicopter, Utility Helicopter, Unmanned Aircraft Systems, Armed Reconnaissance Helicopter, and Aviation Systems programs. The PEO reports directly to AAE.

PEO Aviation is the responsible management official who provides overall direction and guidance for the development, acquisition, testing systems integration, product improvement and fielding of assigned programs.



**Joint PEO Chemical and Biological Defense (JPEO-CBD)**

The JPEO-CBD is responsible for research, development, acquisition, fielding, and life-cycle support of chemical, biological radiological and nuclear defense equipment, medical countermeasures, and installation and force protection supporting the national military strategy.

**Program Executive Office Combat Support & Combat Service Support (PEOCS&CSS)**

The Program Executive Office for Combat Support and Combat Service Support (PEO CS&CSS) provides acquisition expertise, sustainment support, and superior systems in support of Army Transformation and the Global War on Terror (GWOT). The PEO's responsibility encompasses approximately 270 different weapon systems representing the tactical wheeled vehicle fleet which includes the M915, PLS, HET, HEMTT, FMTV, and HMMWV family of vehicles and associated trailers, and the areas of watercraft, bridging, combat engineer and material handling equipment, force sustainment, petroleum and water, recovery systems.

In addition, PEO CS&CSS oversees the development, acquisition, and fielding of the Army's Sets, Kits, and Outfits including hand carried, containerized, and mobile tool sets, diving equipment, and shop support equipment, along with all general purpose test, measurement and diagnostic equipment, automatic test equipment, and calibration standards. The PEO CS & CSS focus is on equipping and supporting the joint warfighter through development and fielding of systems with increased capability which support DOD jointness objectives, using a system of systems approach, maximizing modularity, and enabling a more expeditionary force. Efforts are currently being implemented across all product lines to connect our logisticians, modernize theater distribution efforts, improve force reception, and integrate the supply chain.

**Program Executive Office, Command, Control, Communications Tactical (PEOC3T)**

In 2005 PEO C3T reorganized disestablishing two Colonel/NH-IV-level Project Management Offices realigning their subordinate Lieutenant Colonel level Product Management Offices within the four remaining Command, Control and Communication Project Management Offices. Currently the PEO consists of the following Project Management Offices: Battle Command, Force XXI Battle Command Brigade and below, Warfighter Information Network Tactical, Tactical Radio Communication Systems, and Mobile Electric Power.

---

**Program Executive Office, Enterprise Information Systems  
(PEO EIS)**

Program Executive Office, Enterprise Information Systems (PEO EIS) provides joint service and Army warfighters with information dominance by developing, acquiring, integrating, deploying and sustaining network-centric knowledge-based information technology and business management systems, communications and infrastructure solutions through leveraged commercial and enterprise capabilities that support the total Army.

**Program Manager, Future Combat Systems–Brigade Combat Teams  
(PM FCS (BCT))**

The overarching mission of the PM FCS (BCT) is to develop, produce, field and sustain safe, reliable, suitable and effective Future Combat Systems–Brigade Combat Teams. Other missions enabling the successful execution of the overarching mission are to enable Future Force Joint network capabilities (C4ISR & System of Systems Common Operating Environment (SOSCOE)), and to enhance Brigade Combat Teams by Spinning Out emerging FCS capabilities.

**Program Executive Office, Ground Combat Systems (PEO GCS)**

The mission of PEO GCS is to maintain a total Army perspective in managing the development, acquisition, testing, systems integration, product improvement and fielding that places the best ground combat and support systems in the hands of our soldiers. Systems managed include the Stryker Brigade Combat Team, Heavy Brigade Combat Team, Joint Lightweight Howitzer and Robotics Systems Joint Program Office.

**Program Executive Office, Intelligence, Electronic Warfare and  
Sensors (PEO IEW&S)**

The PEO IEW&S mission is to provide a persistent and integrated surveillance and reconnaissance capability which enables actionable intelligence at the point of decision, empowering all to understand and act.

**Program Executive Office, Missiles and Space (PEO MS)**

The PEO MS provides centralized management for all Army tactical and air defense missile programs and selected Army Space programs. The PEO was established in January 2005 with the merger of the PEO Air, Space and Missile Defense and the PEO Tactical Missiles.

The portfolio of programs assigned to the PEO Missiles and Space spans the full spectrum of the acquisition process from system development to production, fielding, sustainment, and eventual retirement from the force. A number of programs are Joint and are being developed with the other

services. Two programs within the PEO are international programs, with other countries sharing in the development as full partners. In addition to specific acquisition programs, the PEO also manages the Single Integrated Air Picture Initiative.

### **Program Executive Office, Simulation, Training and Instrumentation (PEO STRI)**

The mission of PEO STRI is to provide life cycle management of interoperable training, testing and simulation solutions for soldier readiness and the defense community. PEO STRI is also the Army's Training, Testing, Modeling and Simulation Materiel Developer, as well as the Army Executive Agent for Combat Training Centers' Instrumentation. PEO STRI provides training aids, devices, simulators and simulations, in addition to instrumentation, targets and threat simulators for training & testing. PEO STRI supports other Materiel Developers, Combatant Commanders and Battle Labs. PEO STRI provides Life Cycle Support from development through disposal.

### **Program Executive Office, PEO Soldier**

PEO Soldier designs, develops, procures, fields, and sustains virtually everything the Soldier wears or carries. By employing innovative concepts and technologies, PEO Soldier has made great strides in quickly getting improved equipment into the hands of Soldiers when and where they need it.

## **2. Capabilities Needed to Accomplish Mission(s)**

Having the right number of people that are trained and certified in the requisite acquisition career field is the most important capability needed to perform the AAC mission.

Key skills needed include Systems Engineering, System Test and Evaluation, Program Management, Business and Financial Management, and Contracting.

## **3. Shortfalls/Gaps**

Every year since the passage of DAWIA the AAC gets better at what it does. It has gone through TQM, Re-engineering, Acquisition Reform, Lean Six Sigma and other process improvements intending to improve efficiency. All the low hanging fruit has been harvested and today the AAC does a much greater mission than ever before with fewer and fewer people. While all resources will remain an issue and funding constrains all AAC operations, people remain the most important shortfall to the AAC.

The AAC overall is experiencing an acute shortage of experienced contracting personnel with between 5 and 15 years of experience. The shortage will

---

become more pronounced in the near term because roughly half of the current workforce is eligible to retire in the next 4 years. The Federal Government as a whole is critically short of contracting professionals.

The AAC particularly needs personnel in the specific areas of: 1) Cost/Price Analysts that understand the intricacies involved with analyzing complex industry cost proposals and accounting systems; 2) Business Managers that have the acumen and current knowledge of the industrial base and the problems that they face; and, 3) Systems Engineers that understand the technologies and approaches needed to develop and field future systems.

#### **4. Personnel Issues: Recruiting, Retention, Professional Development Requirements**

On the military side, there were some issues with the types of jobs assigned to the military. The AAC reviewed every job and every military position within the Army acquisition community. As a result many positions were either eliminated or moved elsewhere in the organization. The resulting spaces were used to fulfill other requirements that were both higher priority and better for the military in terms of personal growth and providing jobs that were really challenging. Priority was given to move the maximum number of military restructured positions and slots to the PEO and PM shops.

In July 2004, the AAC implemented the Regionalization Program. Designed to provide AAC professional development standardization, the program affords captains and majors the opportunity to grow into positions of increasing responsibility. Regional senior acquisition officials are responsible for providing officers with professional development opportunities through multiple assignments within a region to support diversification and professional development while broadening their overall acquisition experience. The program's goal is to stabilize each officer for 48 months. However, some officers may move after 36 months to pursue other professional development opportunities or to meet the greater needs of the Army and AAC in different assignments. The Regionalization Program is being implemented in Warren, MI; Picatinny Arsenal and Fort Monmouth, NJ; the National Capital Region; Aberdeen, MD; Redstone and Huntsville, AL; and Orlando, FL.

Another issue pertained to the Army's contingency contracting mission and the training of contingency contracting officers. The Army was not prepared to provide the contracting support for the contingency missions in Iraq and Afghanistan. A record number of military and civilians with contracting expertise have been deployed in the past three years to support a wide range of contingency efforts. Recognizing that contracting will provide important services in future military operations, the Army approved a new contingency contracting modular structure in FY06. This

modular structure will include Contract Support Brigades (CSBs), Contingency Contracting Officer (CCO) Battalions, senior contingency contracting teams, and 4-person contingency contracting teams. This entire structure has been assigned to AMC's Army Sustainment Command. AMC, teamed with the Army Contracting Agency, will train the soldiers to support contingency contracting missions.

#### **IV. Joint Acquisition**

##### **1. Summary of Current Joint Acquisition Programs Led by this Service**

- Program Executive Office, Aviation (PEO AVN) manages Joint Cargo Aircraft (JCA) and Joint Heavy Lift (JHL).
- Program Executive Office, Enterprise Information Systems (PEO EIS) manages the Automated Identification Technology Program (AIT), the Transportation Coordinator–Automated Information for movement System (TC-AIMS), and the Joint Computer Aided Acquisition Logistics Support System (JCALS).
- The JPEO-CBD is the Milestone Decision Authority for 58 Joint Developmental Programs and 149 Joint/Army Sustainment Programs. Joint Development Programs include:
  - Joint Chemical Biological Radiological Agent Water Monitor (JCBRAWM)
  - Joint Expeditionary Collective Protection (JECP)
  - Venezuelan Equine Encephalitis (VEE)
  - Bioscavenger
  - Bioscavenger II
  - Improved Nerve Agent Treatment System (INATS)
  - Family of Tactical Obscuration Devices (FOTOD)
  - Botulinum Multivalent Recombinant Vaccine
  - Advanced Anticonvulsant System (AAS)
  - Recombinant Botulinum A/B Vaccine (rBot)
  - Joint Effects Model (JEM)
  - Joint Operational Effects Federation (JOEF)
  - Joint Warning and Reporting Network (JWARN)
  - Joint Service Aircrew Mask (JSAM)
  - JSLIST - Block II Glove
  - JSLIST - Alternative/Integrated Footwear
  - Plague Vaccine (Plague)
  - Joint Services Personnel Decontamination System (JSPDS)
  - Joint Material Decontamination System (JMDS)
  - Joint Chemical Agent Detector (JCAD)
  - Joint Biological Point Detection System (JBPDS)
  - Joint Biological Standoff Detection System (JBSDS)
  - Joint Service Light NBC Reconnaissance System (JSLNBCRS)
  - Stryker NBC Recon Vehicle (NBCRV)

- 
- Joint Service Lightweight Standoff Chemical Agent Detector (JSLSCAD)
  - Joint Service Chemical Environment Survivability Mask (JSCESM)
  - Joint Service General Purpose Mask (JSGPM)
  - Analytical Laboratory System (ALS) Block 0
  - Unified Command Suite (UCS) Increment I
  - Joint Service Transportable Decontamination System (JSTDS-SS) Small Scale
  - Joint Biological Agent Identification and Diagnostic System (JBAIDS)
  - M93/M93A1 NBC Reconnaissance Vehicle (FOX)
  - Chemical Biological Protective Shelter (CBPS)
  - Joint Collective Protection Equipment (JCPE)
  - Shipboard Collective Protection System Backfit Program (CPS BKFT)
  - Collectively Protected Field Hospitals (CPFH)
  - Anthrax Vaccine Adsorbed
  - Smallpox Vaccine System
  - Skin Exposure Reduction Paste Against Chemical Warfare Agents (SERPACWA)
  - Chemical Biological Installation Protection Program (CB-IPP)
  - Joint Protective Air Crew Ensemble (JPACE)
  - Joint Service Mask Leakage Tester System (JSMLTS)
  - JSLIST Overgarment
  - JBAIDS (Ground Systems)
  - ACADA Simulator (ACADASIM)
  - Access Control Point (ACP)
  - Analytical Laboratory Suite (ALS)
  - Battlefield Anti-Intrusion Detection System AN/PRS-9 (BAIS)
  - Chemical Biological Support Equipment
  - High Value Asset Security Cage (HVASC)
  - Installation Protection Program (IPP)
  - Integrated Commercial Intrusion Detection System (ICIDS)
  - Lighting Kit, Motion Detector AN/GAR-2 (LKMD)
  - Mobile Detection Assessment Response System (MDARS)
  - Mobile Vehicle Inspection System (MVIS)
  - Non-Intrusive Inspection System (NII)
  - Tactical Video Surveillance System (TVSS)
  - Some of the 149 Sustainment Programs include
    - M272 Kit
    - M8 Paper
    - M9 Paper
    - M256A1
    - M274
    - M40 Series Mask
    - ICAM
    - JSMLT
    - JCPE P3I

- Karcher Decontamination System
  - JPS
  - AN/VDR-2
  - DT 236
  - Fox Chip Upgrade
  - TIC PDE Sets
  - M41 PATS
  - CPS-Backfit
  - M31A1 BIDS
  - JWARN 1E/Signal Fire/Cobra Field Scout (UNS)
- PEO Command, Control, Communications Tactical (PEO C3T) manages the Joint Network Management System (JNMS).
  - Program Executive Office, Intelligence, Electronic Warfare and Sensors (PEO IEW&S) manages the Joint Tactical Terminal/Common Integrated Broadcast Service Module (JTT/CIBS-M), and the Joint Tactical Terminal-Integrated Broadcast Service (JTT-IBS).
  - Program Executive Office, Missiles and Space (PEO MS) manages the Joint Land Attack Cruise Missile Defense Elevated Netted Sensor System (JLENS).
  - PEO CS&CSS manages a multi-service initiative for a family of future light tactical vehicles. The Joint Light Tactical Vehicle (JLTV) is not currently a program of record (may become an approved program on successful completion of Milestone B).
  - PM FCS (BCT), in conjunction with the Army and the U.S. Marine Corps (USMC), prepared a plan to form an FCS JPO. This plan included recommendations on JPO structure, objectives and resources. The JROC approved an FCS/USMC MEFFV JPO on March 1, 2004, which leverages the Army's investment in FCS and maximizes the commonality of interoperability and target follow-on increments to FCS to meet USMC requirements.

## 2. Issues/Gaps in Capability

- Processes used for Joint programs are a disaster.
- Requirements are driven by people who have no responsibility to make the system happen. JCIDS is a requirements based system. Instead, designs for future systems should be driven by outcomes or effects based requirements and not specifications. Mean time between anything is meaningless to the soldier. We must design to battlefield effects.

- 
- Science and Technology programs are not adequately coordinated between Services.
  - The decision flow for making decisions within a program is often non-existent or ignored.
  - Funding does not come from a Joint source, but is expected to come from each of the Services. Ultimately the funding burden usually falls only on the lead service.
  - The authorization for additional manpower to execute programs must be supplied by the lead Service and not from a Joint manpower pool.
  - There is often a lack of understanding of program dependency when selecting a contractor who is leveraging another program's development.
  - All of these results in having expectations grow beyond our capability to deliver systems to the field.

## **V. Department of the Army Recommendations**

### **1. Organizational Issues**

- It is clear that the Army has the world's best Acquisition, Logistics and Technology Workforce to keep our Army as the most capable land force on Earth. Our challenge in the future is to continue to manage programs effectively and efficiently so we have the right product, in the right place, at the right time. But this challenge is not solely the purview of the AAC.
- Some people try to focus problems on bringing new systems to the war-fighters as strictly an acquisition problem, when this is usually not the case. Program terminations have resulted because of issues with requirements, resources and testing. Using unrealistic or evolving requirements is not an acquisition problem. When the Cost Analysis Improvement Group (CAIG) uses a 50% confidence level to analyze a cost estimate is not an acquisition problem. Not having DA or DOD policy in regards to testing Commercial of the Shelf (COTS) products is not an acquisition problem.
- While there have been initiatives like TQM, Re-engineering, Acquisition Reform and other process improvements intending to improve efficiency, our acquisition systems must be designed so that they can accurately measure actual results for a system to make progress. In order to improve we must first understand the process, develop achievable expectations, measure actual parameters and react to make adjustments to our systems and processes.



## 2. Resource Issues (Personnel/Funding)

- Unpredictable funding for long-term obligations and lack of reprogramming flexibility.
- The Army cannot do Net Centric, System of Systems, Joint and Coalition and foreign partner technology sharing and remain in a stove pipe. All the processes needed to develop and field a system including requirements, resourcing, acquisition, test and evaluation, and logistics must have people that are trained and certified to do these functions. Progress has occurred, but much more is needed. The LCMC concept will help. New and improved DAU courses are a must.
- New and improved DAU courses are essential, as well as an increase in overall course offerings. For example, there are contracting personnel in the CP-14 program who are not certified at their appropriate level because they have been delayed by the lack of availability of required courses.
- More experienced contracting personnel are needed. The knowledge and skill base necessary to successfully operate the acquisition system and to secure good value for the Government and taxpayers has outstripped the resources available to operate the system. Validated workload models support that the Army contracting workforce is under-resourced to support current and future contracting military operations.
- Increase opportunities and positions supporting developmental assignments.

## 3. Policies and Procedures Needed to Improve Outcomes

Joint processes and procedures are still a challenge. JPEO CBD has worked with its partners in the Chemical and Biological Defense Program to establish Joint CBDP processes and procedures for Joint Experimentation, Joint MDAP Support, Interagency Co-Development, Joint Science & Technology and Advanced Development Integration, Joint Logistics, Joint Business Processes, Joint Program Processes (ADM's, etc.) and Joint Test and Evaluation investment and management processes. Significant accomplishments include integrating all Service finance systems into a single Defense Finance and Accounting Service center (which significantly contributed to JPEO CBD becoming one of only six Department of Defense agencies with an unqualified audit opinion), creating a Joint Total Asset Visibility system for CBRN equipment, significant progress in developing Joint processes under the Joint Logistic Board process (and receiving U.S. Army authority to be the material release authority for ten pilot programs) and creating the structure and process to manage the

---

development of Joint Test and Evaluation capabilities. There are still significant Joint process challenges to be overcome. Those challenges include

- A better linkage between the Joint Capabilities Integration Development System (JCIDS) and DODI 5000 so that trades between requirements, system complexity and cost can be more efficiently performed between milestones A, B and C.
- Joint information assurance and certification requirements to facilitate more rapid fielding of joint systems.
- Joint logistic processes, systems and procedures.
- Joint human resources management support through organizations such as the U.S. Army Acquisition Support Center.
- Service balanced score card and other automated “tools” that facilitate automated input from systems designed to support Joint programs.
- A single Joint Operational Test and Evaluation test plan and report format and process.
- DODI 5000.2 and Army Regulation 70-1 have moved away from the flexibility and streamlining that was intended to be embodied as the cornerstone of acquisition reform. These regulations have fostered increased layers of review, and increased workload and documentation. It is a struggle to tailor acquisition approaches and documentation requirements and implement effective management controls to deliver reliable, effective, and affordable capabilities that meet user requirements.
- Recent conflicts in Iraq and Afghanistan have shown that the traditional method of developing, acquiring and fielding of equipment for the Warfighter are unacceptable during times of war. The Warfighter cannot wait for a program such as the Joint Network Node to go through a life cycle prescribed by the DoD 5000 series with multiple milestones. There needs to be a methodology developed to quickly meet the requirements of the soldier in the field. If the AAC cannot meet the needs of the Warfighter, the commander in the field will circumvent the process and procure with discretionary funds, what they need and when they need it; the rest of the Army will have to figure out how to logistically support it later.

# Annex B

## Navy

---

This annex describes the Navy's acquisition program as required by Section 814 legislation. It specifically addresses the following:

- ◆ Current organization and its evolution
- ◆ Mission and capabilities
- ◆ Joint acquisition
- ◆ Recommendations.

The information presented in this annex was compiled from the 814 Review Survey responses and supplemented with information from Navy documents and Websites. This annex was formally released by the Navy.



## **Department of Navy Annex**

### **Executive Summary**

Over the last several years, there have been numerous acquisition streamlining efforts. To further the goal of creating a more agile and responsive acquisition organization the Defense Acquisition Structures and Capabilities Review (DASCR) was undertaken and revealed additional improvement opportunities for the Navy. Specific areas identified were: to be more process oriented; to establish a culture comfortable with conducting risk assessments and working in a collaborative government/industry partnership; to promote the Human Capital strategy for replacing the Acquisition workforce and make the current force more educated; to open acquisition training to a broader audience; to stabilize budget allocations; and to provide the framework to execute joint program acquisitions.

Keeping up with the volatility and the complexity of technological change will require the acquisition community to rely on industry by building more collaborative partnerships, while still maintaining oversight. The change from the traditional acquisition approach to a performance-based approach requires the oversight organization to be more process focused - it needs to be able to apply risk management principles to perform the contract oversight functions. This change requires modification to the organizational behavior model to accommodate effective risk management.

A clearly defined requirement is the basis for successful weapon systems delivery. Exposing the Fleet and USMC operators, those that generate requirements, to the acquisition process/training appears to be an area that could streamline the coordination and communication flow. Allowing the requirements generators the opportunity to attend DAWIA courses would yield smoother communication lines during the acquisition process.

Stabilizing the allocation of funds throughout the procurement cycle, especially during the Research Development Test & Evaluation period, could result in significant process improvements and leverage economy of scale opportunities. Unexpected budget shortfalls or short-fused budget reallocations often result in sub-optimizing life-cycle cost decisions, and is a major source of program volatility and frustration.

The Naval Enterprise is aligning under five distinct Warfare Enterprises, supported by five Providers/Enablers. The Naval Acquisition Enterprise (ACE) is one of those Providers. The ACE Organizational Model was developed to enable this future alignment and focus the entire acquisition community on delivering the right product to the War Fighter on time and at the right price. The ACE will be guided by the five Fleet-driven metrics assigned to the Warfare Enterprises.

1/30/07  
Date

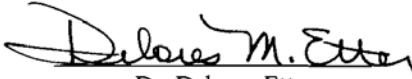
  
Dr. Delores Etter  
Navy Acquisition Executive  
ASN (RDA)



## I. Current Organization

Figure B-1 illustrates the Department of Navy's current acquisition structure in its entirety, beginning with the Assistant Secretary of the Navy for Research Development and Acquisition (ASN/RDA). The ASN (RDA) organization is responsible for the development and acquisition of Navy and Marine Corps platforms and weapon systems. The acquisition structure consists of the Assistant Secretary's immediate staff, Program Executive Officers (PEOs), Direct Reporting Program Managers (DRPMs), and the Naval Systems Commands and their field activities. The PEOs are responsible for the development and acquisition of naval systems. The Naval Systems Commands and their field activities are also responsible for systems acquisition and supporting those systems in the operating Fleet. DRPMs are designed to give high-level attention to acquisition programs that were considered to be especially challenging. DRPMs are established by the ASN (RDA) for a fixed, temporary period to resolve specific acquisition issues.

Figure B-1. Department of Navy's Acquisition Structure—2006

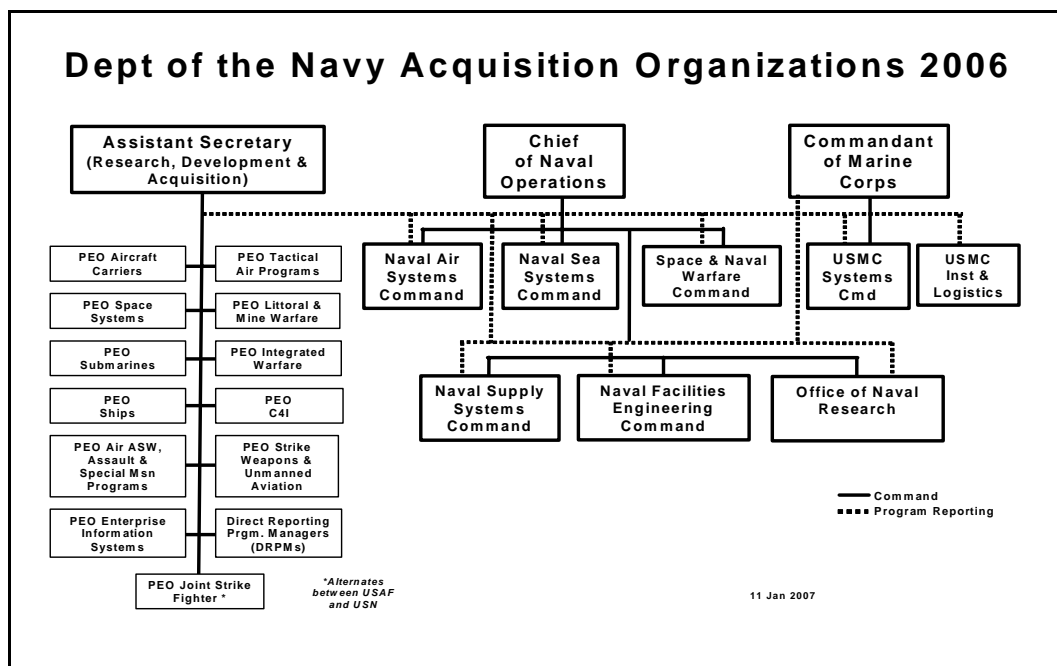

Figure B-2 illustrates the structure of the staff of the ASN (RDA). There are 11 Deputy Assistant Secretaries on the Assistant Secretary's immediate staff. As their titles suggest they are generally aligned with major naval systems. The ASN (RDA) also has a General Counsel to provide advice on legal matters and the Chief Systems Engineer.

Figure B-2. Assistant Secretary of Navy (RDA) Staff

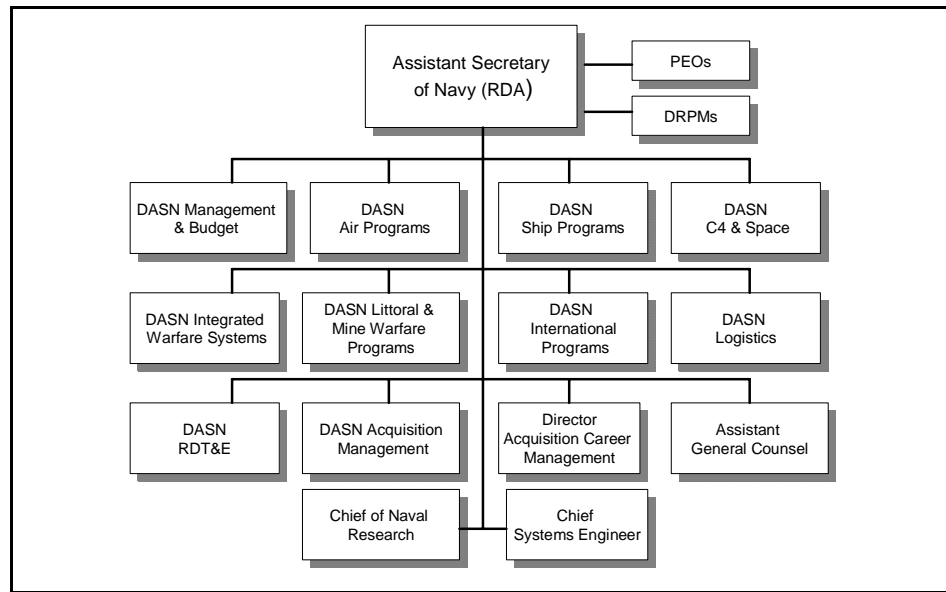

Figure B-3 contains a list of all current Navy Program Executive Officers (PEOs) and DRPMs. As the titles suggest, the PEOs and DRPMs are responsible for the development and acquisition of specific systems.

Figure B-3. Navy PEOs and Direct Reporting Program Managers (DRPMs)

- PEO Joint Strike Fighter
- PEO Ships
- PEO Submarines
- PEO Aircraft Carriers
- PEO Tactical Air Programs
- PEO Air ASW, Assault and Special Mission Programs
- PEO Strike Weapons and Unmanned Aviation
- PEO Space Systems
- PEO Littoral and Mine Warfare
- PEO Integrated Warfare Systems
- PEO for Enterprise Information Systems
- PEO for Command, Control, Communications, Computers and Intelligence (C4I)
- PEO Marine Land Systems
- DRPM Strategic Systems Programs

Figure B-4 illustrates the Navy's acquisition reporting structure from the PM to the PEO. For "stand alone" PEOs of major systems the reporting runs directly from the PM to the PEO and from there to the ASN (RDA). Other PMs report to the appropriate Systems Command and through them to the ASN (RDA) and Chief of Naval Operations (CNO) for fleet and in-service support. All DRPMs report directly to the ASN (RDA).



Figure B-4. Reporting Chain for Navy Program Managers

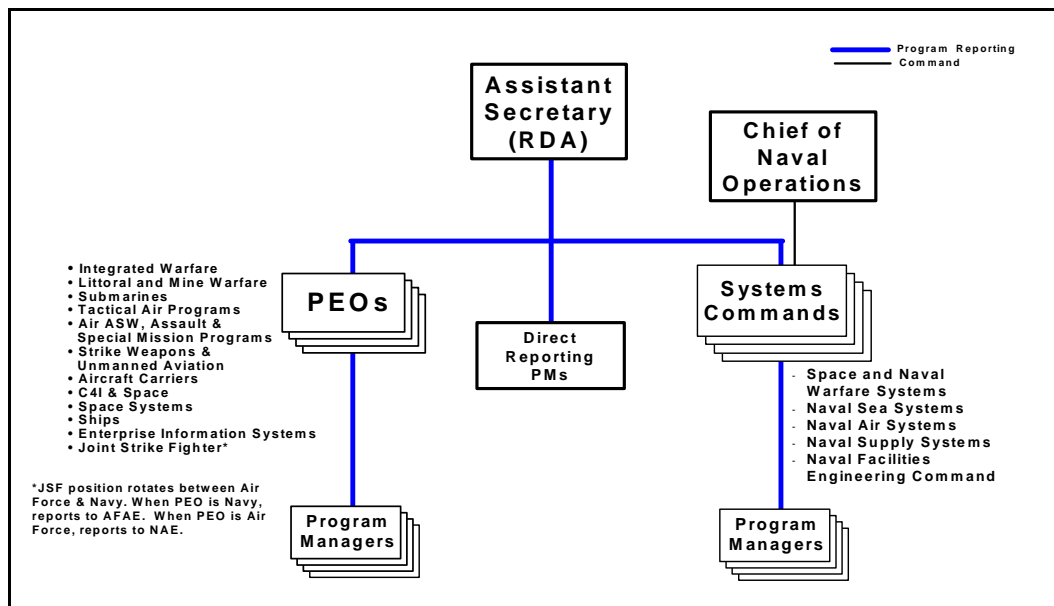

Staffing statistics and numbers of designated Key Leadership Positions (KLPs) for the Navy’s SYSCOMS and PEOs are provided in Table B-1. KLPs, as defined by DoD policy, are Program Executive Officers, ACAT I & II Program Managers, and their officially designated Deputies.

Table B-1. Current Naval Acquisition Organization Staffing

Organization	KLPs	Acquisition Personnel	Non-Acquisition Personnel
ASN (RDA)	0	68	50
NAVSEA	0	14026	35369
NAVAIR*	41	10494	13454
NAVSUP	0	2071	7840
SPAWAR	0	2092	3185
NAVFAC	0	4956	6328
Office of Naval Research	0	239	169
USMC	5	1306	322
PEO Ships	13	227	3
PEO Subs	7	130	4
PEO Carriers	5	66	3
PEO LMW	12	92	2
PEO IWS	8	234	3
PEO Space Systems	1	31	2
PEO C4I	10	320	13
PEO EIS	9	303	24

\* Note: Navair’s KLPs and associated statistics have been consolidated under NAVAIR.

## II. Evolution to the Current Structure Since 2000

### 1. Navy Acquisition Executive (AAE) HQ/Staff

Figure B-5 depicts the evolution of Navy Acquisition Executive HQ/staff from 2000 to 2006.

Figure B-5. Evolution of Navy Acquisition Executive HQ and Staff

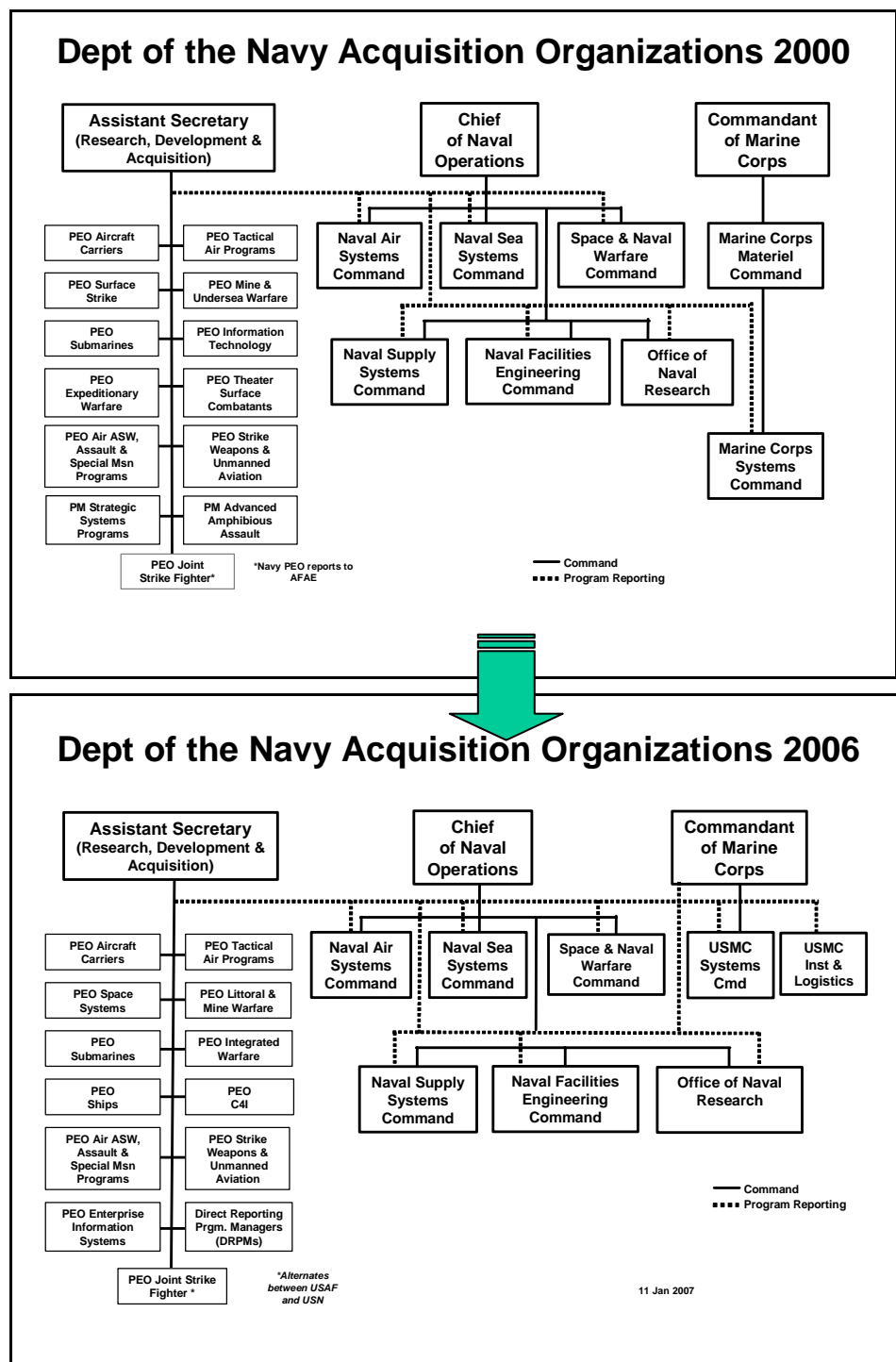

Major changes aimed at enhancing business practices included

- The Navy is moving to the Enterprise method of developing and supporting capabilities
- Most Navy DRPMs realigned under PEOs
- Marine Corps Material Command merged into new Logistics Command
- Marine Corps Systems Command becomes direct report to Commandant
- PEO (JSF) is now an AF General reporting to the Navy SAE

## 2. Acquisition Commands

While all seven of the Navy's acquisition commands have undergone varying degrees of reorganization in the recent years, the most sweeping of these occurred in Space and Naval Warfare Systems Command (SPAWAR) and USMC Systems Command (MARCORSYSCOM). The changes in these two commands are described in the following paragraphs:

### a. SPAWAR

From 1990 to 1997, SPAWAR was significantly downsized, realigned, and relocated as a result of BRAC actions in 1991, 1993, and 1995 plus the 1991 consolidation of RDT&E activities. In 1990, SPAWAR was the third largest civilian manpower claimant and largest land owner in the Department of the Navy with over 30,000 military and civilian personnel assigned and supported by at least a similar number of contractor work-years. In 2005, SPAWAR's staffing had decreased to 5,200 civilian and military.

Between 1992 and 1997 activities on both coasts and the headquarters lost significant numbers of experienced people and their corporate knowledge when as many as 80% of encumbered positions failed to accompany jobs to new duty locations.

The following changes also occurred in SPAWAR's Field Activities:

- In 1992: The SPAWAR Warfare Center (Naval Command, Control and Ocean Surveillance Center) was established in San Diego and included the consolidation with the SPAWAR laboratory, eight NAVELEX Centers and two Central Design Activity (CDA) activities.

- 
- 1993 to 1996: Eight Naval Electronic Systems Command (NAVELEX) Centers and the West Coast CDA were realigned and consolidated through directed BRAC actions to the East Coast (Charleston) and West Coast (San Diego) In-Service Engineering Centers and the R& D Center (San Diego). The West Coast In-Service Engineering Center was later consolidated into the R&D Center.

**b. MARCORSYSCOM**

This Marine command was chartered in 1992. However, its predecessor organization, the Marine Corps RD&A Command, had the same mission in 1990 as MARCORSYSCOM has today.

During 1999-2000, MARCORSYSCOM redesigned itself making major changes to work systems, human systems, and overall organizational structure. Using a “Whole Systems Architecture” methodology, they developed a business case that moved toward a more high-performing, team based, learning organization. After 18 months of redesign effort, numerous, significant changes had been made in internal acquisition management and decision making processes. They also realigned their workforce into a structure that emphasized integrated management and teamwork. They continue to refine those work processes and grow the professional competency of their acquisition workforce. The Global War on Terrorism (GWOT) along with other external forces have resulted in some changes to the organizational design adopted in 2000, but for the most part, the fundamental design of MARCORSYSCOM’s organization and direction is well suited to meet its current and known future requirements.

**3. PEO Structure**

As a result of the 1986 Packard Commission report, all military departments implemented a PEO structure. The PEO structure designates key managers who devote full-time attention to the business, administrative, and technical management of assigned programs. These managers have a clear line of accountability and responsibility dedicated to the success of the programs. This has provided additional continuity for programs and has also created a cross-functional matrix structure for grouping related aircraft and systems under broad functional areas. In the case of PEO(JSF), the PEO structure provides a way to interface more effectively with our Joint Service partners.

The first PEOs in the Department of Navy were established in 1987. Figure B-6 tracks the evolution of the Navy’s PEO Structure from that year. The paragraphs that follow provide amplifying information on the Navy PEOs.

Figure B-6. Evolution of the Department of Navy's PEO Structure

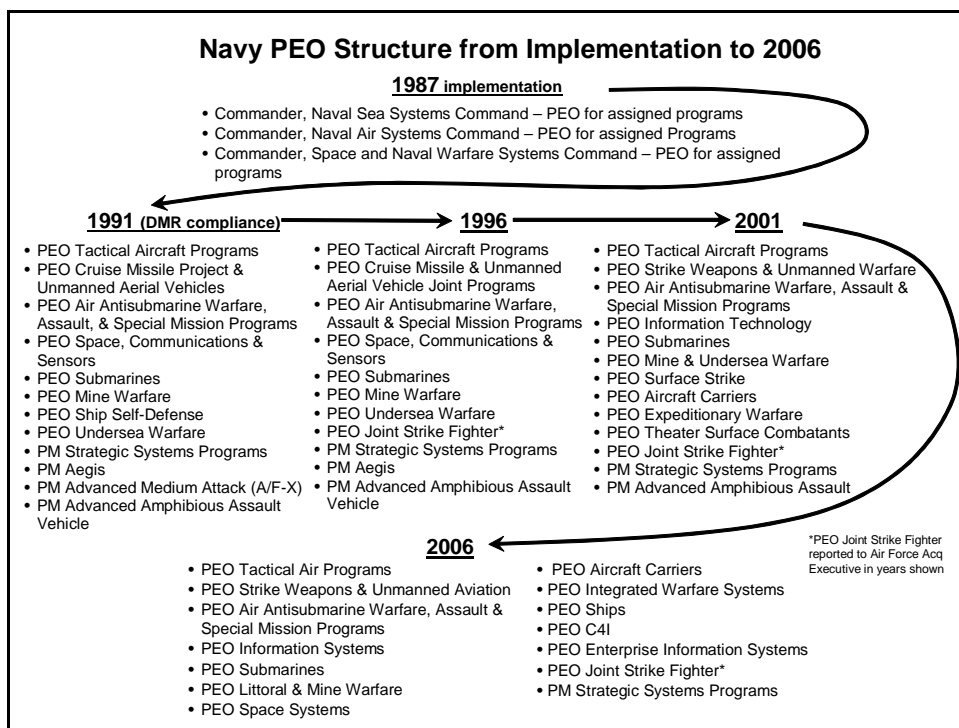

The Naval Aviation Program Executive Office (PEO) structure was formalized by the PEO Operating Agreement, signed 16 August 1990 by the heads of the three Naval Aviation PEOs and the Commander, Naval Air Systems Command. The original three PEOs were:

- **PEO(T)**: The Program Executive Office for Tactical Aircraft was established in August, 1990. PEO(T) exists to facilitate the work of program teams and provide assessments on program cost, schedule, and performance to the appropriate Milestone Decision Authority (MDA) and Resource Sponsor by providing enabling tools (expertise, assistance, resources) to program teams and representing executable programs to higher levels of management; providing evaluations, options, and recommendations on program planning and execution to the appropriate MDA and Resource Sponsor; and to enable program teams to deliver the best, affordable products to the fleet with manageable risk in cost, schedule and performance. Currently, PEO(T) consists of PMA 265 (Super Hornet, Hornet and Growler), PMA 234 (EA-6B), PMA 231 (E-2 and C-2), PMA 213 (Air Traffic Control and Combat Identification systems), and PMA 272 (Tactical aircraft protection systems). PMA 241 (Tomcat) was disestablished in April, 2006.
- **PEO(A)**: The Program Executive Office for Air Anti-Submarine Warfare, Assault, and Special Mission Program, PEO(A), stood up in April 1990 to oversee acquisition and lifecycle management, as well as

---

provide appropriate resources, to assigned acquisition programs. The PEO(A) staff aids the program teams and provide assessments on program cost, schedule and performance to the appropriate Milestone Decision Authority and Resource Sponsor. PEO(A)'s assigned programs include the AV-8B *Harrier*, H-53 Heavy Lift Helicopter, Air Anti-Submarine Warfare Weapons Systems, E-6B *Mercury*, Undergraduate Jet Flight Training, Presidential Helicopters, V-22 *Osprey*, H-1 Attack and Utility Helicopters, Maritime Patrol Aircraft, and Multi-Mission Helicopters.

- **PEO(CU)**: Originally established in Aug 1990, as the PEO for Cruise Missiles and Joint Unmanned Aerial Vehicles-PEO (CU), it was re-named in June 2000 as the PEO (W), Strike Weapons and Unmanned Aviation. At that time, while retaining all previous programs, PEO(W) was given additional responsibility for PMA 201 (Conventional Strike Weapons), 242 (Defense Suppression Systems), 280 (Tomahawk Weapons Systems) and 281 (Strike Planning & Execution Systems). Additionally, in October 2005, PEO(W) was given responsibility for PMA 259 (Air-to-Air Missiles). The PEO(W) mission is to expeditiously develop, acquire, and support quality cruise missiles, air-to-air & air-to-surface missiles, unmanned aerial systems, and target systems with which the operating forces, in support of our Unified Commanders and allies, can train, fight, and win. PEO(W) reports to ASN RDA and receives matrix support from Naval Air Systems Command.

The following paragraphs describe the origin of the current Navy PEOs:

- **PEO(JSF)**: PEO Joint Strike Fighter was established to manage the Joint Strike Fighter program. Responsibility for this PEO is shared, and rotated between the Air Force and the Navy. The most recent rotation occurred in June 2006 when the Navy assumed responsibility for PEO(JSF).
- **PEO(T)**: As noted above, PEO Tactical Air Programs is one of the three original Navy PEOs.
- **PEO(A)**: PEO Air Antisubmarine Warfare, Assault, & Special Mission Programs was one of the three original Navy PEOs.
- **PEO(W)**: PEO Strike Weapons and Unmanned Aviation was originally established as the PEO for Cruise Missiles Project and Unmanned Aerial Vehicles Project. It was later renamed PEO(W), Strike Weapons and Unmanned Aviation.
- **PEO(SS)**: PEO Space Systems was established in May 2004. It was preceded by the PEO for Space, Communications, and Sensors, PEO (SCS); which was disestablished in 1999 to establish PEO Information

Technology. For a staffing comparison, PEO SCS and the Communications Satellite Program Office (PMW-146) can be combined.

- **PEO(LMW):** PEO Littoral and Mine Warfare was established in 2003. Its missions evolved over an extended period of time from predecessor PEOs and Program Offices that were primarily mine warfare focused to the current PEO LMW which supports the Navy/Marine Corps Team's requirement to dominate the littoral battle space. Within PEO LMW, the re-designing of internal structures continues as programs evolve. Although PEO LMW will continue to re-design its internal structure, this is part of the evolutionary process.
- **PEO Ships:** PEO Ships was established in 2002 and the primary missions remain the same today. PEO Ships acquires and supports the current and future Surface Fleet. They translate warfighter requirements into combat capability, producing and supporting ships, boats, and craft, from cradle to grave, enabling our nation and its allies to project presence in peace, power in war, and assure access anytime.
- **PEO Submarines:** PEO Submarines was established in late 1992 when ACAT programs from the Submarine Directorate (SEA92) in NAVSEA were combined with ACAT programs from the abolished PEO SCWS (Submarine Combat and Weapons Systems). The PEO exercises full authority, and is accountable for all matters pertaining to the cost, schedule, and performance of assigned ship construction and associated combat and weapon system acquisition programs. In 2000, undersea defensive warfare systems and undersea weapons programs were added to the purview of PEO(SUB).
- **PEO Aircraft Carriers:** PEO Aircraft Carriers was established in April 1998. The Program Executive Officer (PEO) for Aircraft Carriers is responsible for designing, delivering, and maintaining the nation's aircraft carrier force to include cost, schedule, and performance aspects of New Construction, Refueling Complex Overhauls, Life Cycle Management, and Modernization programs.
- **PEO (IWS):** The Program Executive Office for Integrated Warfare Systems was established in November 2002 to improve the development and management of integrated warfighting capabilities across the naval enterprise.
- **PEO (EIS):** The PEO Enterprise Information Systems replaced the PEO Information Technology (PEO-IT) in March 2006. Under an ASN (RDA) memorandum the Navy-Marine Corps Intranet (NMCI) no longer falls under the Direct Reporting Program Manager (DRPM) structure. However, the formerly direct-reporting NCMI office was a respondent to the DASCRC questionnaire and its input has been

---

incorporated here. NCMI was organized in 2005 as an initiative that launched the Department of the Navy's first step toward reaching both Joint Vision 2010 and Joint Vision 2020's goal of information superiority for the Department of Defense. NMCI delivers comprehensive, end-to-end information services to the DoN through a common computing and communications environment, enhancing system and software interoperability and, in turn, enhancing information exchange capability for garrison and deployed forces. NMCI encompasses everything necessary to ensure the transmission of voice, video, and data information. The mission of the PM NMCI is to deliver and sustain a single, secure Navy Marine Corps Intranet with world-class standards for all users. Its vision is to achieve a single, integrated network by attaining 100% transition to NMCI; subsuming legacy networks and systems into the NMCI environment and consolidating legacy servers where appropriate; enhancing lifecycle management to reduce total cost of ownership; and achieving and maintaining the highest level of customer satisfaction.

- **PEO C4I:** ASN RDA directed the stand-up of the PEO C4I and Space in October 2002. In August 2006, the leadership for the Joint Program Executive Office Joint Tactical Radio System (JPEO JTRS) and the Navy's Program Executive Office (PEO) for C4I and Space were realigned into separate positions. During this realignment, PEO C4I and Space was renamed "PEO C4I" to more accurately reflect the organization's focus. The Distributed Common Ground System-Navy (DCGS-N) program office (PWM 120) formerly headed by a DRPM, is now aligned under PEO C4I. PEO C4I's mission is to "acquire, integrate, deliver, and support interoperable C4I capabilities enabling seamless operations for fleet, joint, and coalition warfighters." To support this mission, PEO C4I is organized in a combination of product and platform program offices (PMWs). Product PMWs focus on acquisition of C4I products while platform PMWs focus on integration of C4I capabilities into platforms acquired and supported by other PEOs.

The changes in the PEO structure during the last nineteen years have been minor compared to the other military services. The biggest change occurred when the PEO structure was established and the programs were moved from under the SYSCOMs to their new PEO organizations. A noticeable trend is the increase in number of PEOs over time and the reduction of DRPMs. The changes made after 1991 were evolutionary, additional PEOs representing new focus areas for the Navy, name changes, or removal of DRPMs reflecting the maturity of a system. Although not large in scope when viewed in 5-year segments, the changes made over the last 15 years were able to further strengthen the acquisition process.



#### 4. Impact of Structural Changes on Acquisition Career Field Trends

Table B-2 displays the numerical changes to the career workforce due to structure changes from 2000 to 2005.

*Table B-2. Navy Acquisition Career Field Trends, 2000-2005*

AT&L Workforce Functional Career Field	2001	2002	2003	2004	2005	Change 2001 to 2005 (#)	Change 2001 to 2005 (%)
Program Management	3354	3625	3522	3491	3550	196	5.8%
Contracting	5654	5438	5406	5296	5070	-584	-10.3%
Industrial/Contract Property Management	82	80	72	73	61	-21	-25.6%
Purchasing	764	702	781	631	583	-181	-23.7%
Facilities Engineering	0	2111	3435	3559	3505	3505	NEW
Production Quality & Man	1997	2297	2259	2232	2032	35	1.8%
BCE&FM	2163	1939	1815	1838	1840	-323	-14.9%
Life Cycle Logistics	4191	4207	4234	4156	4206	15	0.4%
Information Technology	806	715	695	771	760	-46	-5.7%
SPRDE - Systems Engineering	16174	16005	16707	16853	16886	712	4.4%
SPRDE - S&T Manager	0	165	151	123	127	127	New
Test & Evaluation	1791	2340	2498	2479	2453	662	37.0%
Auditing	0	0	0	0	0	0	n.a.
Unknown/Other	182	37	47	50	33	-149	-81.9%
Total	37158	39661	41622	41552	41106	3948	10.6%

Growth in the 'Facilities Engineering' career field occurred because of the Navy's aggressive identification and assimilation of that career field into the acquisition workforce.

The change in 'Purchasing' is a direct result of increased use of the Government Purchase Card, obviating the need for Purchase Clerks.

In the late 90's, the services were directed to better define the acquisition workforce, therefore people that were doing work in the Test & Evaluation arena that were not previously properly categorized were finally recognized as such and were labeled T&E.

---

### III. Mission, Capabilities, and Service Issues

#### 1. Missions

The current mission statements of the seven systems commands are summarized in the following paragraphs:

- a. **NAVAIR:** “As a part of the Naval Aviation Enterprise, NAVAIR is a provider of sustainment (current readiness), systems acquisition (future readiness), and decision support to make the Navy and Marine Corps more capable, ready, and affordable in a joint environment.”
- b. **NAVSEA:** Naval Sea Systems Command’s mission is stated “Put the right capability in the hands of the warfighter at the right time at the right cost.”
- c. **NAVSUP:** Naval Supply System Command’s mission is “To provide Navy, Marine Corps, Joint and Allied Forces quality supplies and services on a timely basis.”
- d. **ONR:** The Office of Naval Research mission is stated “To Foster, plan, facilitate, and transition scientific research in recognition of its paramount importance to enable future naval power and the preservation of national security.” The Office of Naval Research (ONR) coordinates, executes, and promotes the science and technology programs of the United States Navy and Marine Corps through schools, universities, government laboratories, and nonprofit and for-profit organizations. It provides technical advice to the Chief of Naval Operations, Commandant of the Marine Corps, and the Secretary of the Navy and works with industry to improve technology manufacturing processes. While ONR’s core mission remains to foster scientific research for the use and benefit of the current Navy/Marine Corps and the Navy/Marine Corps of the future, the emphasis and workforce evolved to stress the partnership of ONR with the Fleet. Today, there is heavy emphasis on rapid development and insertion of naval capabilities to solve real time technology needs for the Sailor and Marine. The central mission of the Office of Naval Research expanded to include applied research, advanced technology development, and technology transition in the 1990s. Science and Technology focus areas are detailed in a biannual Naval S&T Strategy and endorsed by the Naval S&T Corporate Board consisting of the ASN(RDA), Vice Chief of Naval Operations and the Assistant Commandant of the Marine Corps. More emphasis was placed on near-term relevance of sponsored research. The DAWIA category of S&T Managers was created to recognize the importance of early involvement of research managers in the Acquisition cycle.

- e. **MCSC:** The Marine Corps Systems Command mission/vision is stated: “To serve as the Commandant’s principal agent for acquisition and sustainment of systems and equipment used by the Operating Forces to accomplish their warfighting mission.” MARCORSYSCOM serves as the Commandant’s principle agent for equipping the operating forces of the USMC with the ground weapons systems and equipment they require to accomplish their warfighting mission. MARCORSYSCOM has management authority and accountability for all Marine Corps expeditionary force programs with the exception of naval aviation programs.
- f. **NAVFAC:** Naval Facilities Engineering Command states “We are the war fighter’s engineering professionals. Fleet focused, innovative, surge enabled, ever faster, and committed to continuous cost reduction. The Naval Facilities Engineering Command furnishes technical and material support regarding shore facilities to the Chief of Naval Operations; the Commander, Navy Installations Command; the Marine Corps; and other DOD entities as assigned.
- g. **SPAWAR:** Space and Naval Warfare Systems Command states “Team SPAWAR “delivers” FORCEnet - transforming information into decisive effects.” The SPAWAR organizational construct allows focus on the core equities necessary to effectively carry out our assigned mission. SPAWAR’s major functions include:
- Partner with PEO C4I, PEO Space Systems, and PEO Enterprise Information Systems, to deliver C4ISR and FORCEnet capability to the joint warfighter.
  - Develop Navy, joint, and coalition interoperability.
  - Serve as the Navy C4ISR Chief Engineer.
  - Serve as the Navy FORCEnet Chief, PEO Space Systems and PEO Enterprise Information Systems, to deliver C4ISR and FORCEnet capability to the joint warfighter.

## 2. Capabilities Needed to Accomplish Mission(s)

The Naval Enterprise, as depicted in Figure B-7, is aligning under five distinct Warfare Enterprises, supported by five Providers/Enablers. The Naval Acquisition Enterprise (ACE), as depicted in Figure B-8, was developed to enable this future alignment and focus the acquisition community on delivering the right product to the War Fighter on time and at the right price. The ACE will be guided by the five Fleet-driven metrics assigned to each of the Warfare enterprises.

Figure B-7. The Naval Enterprise

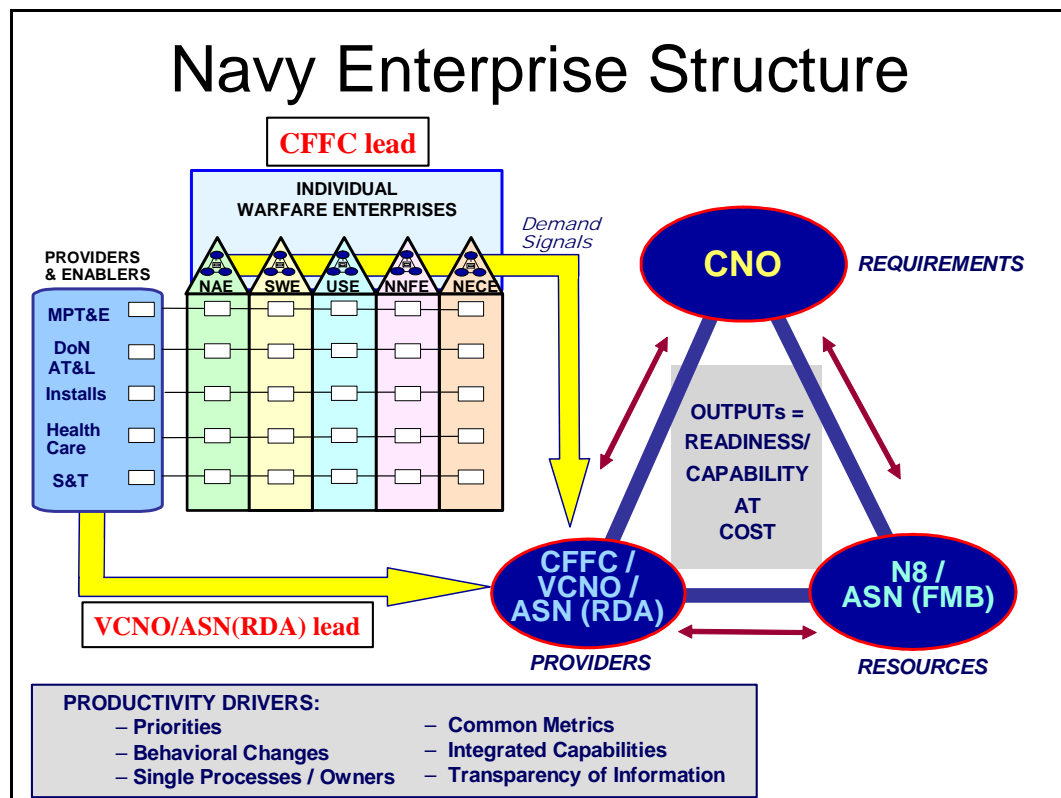
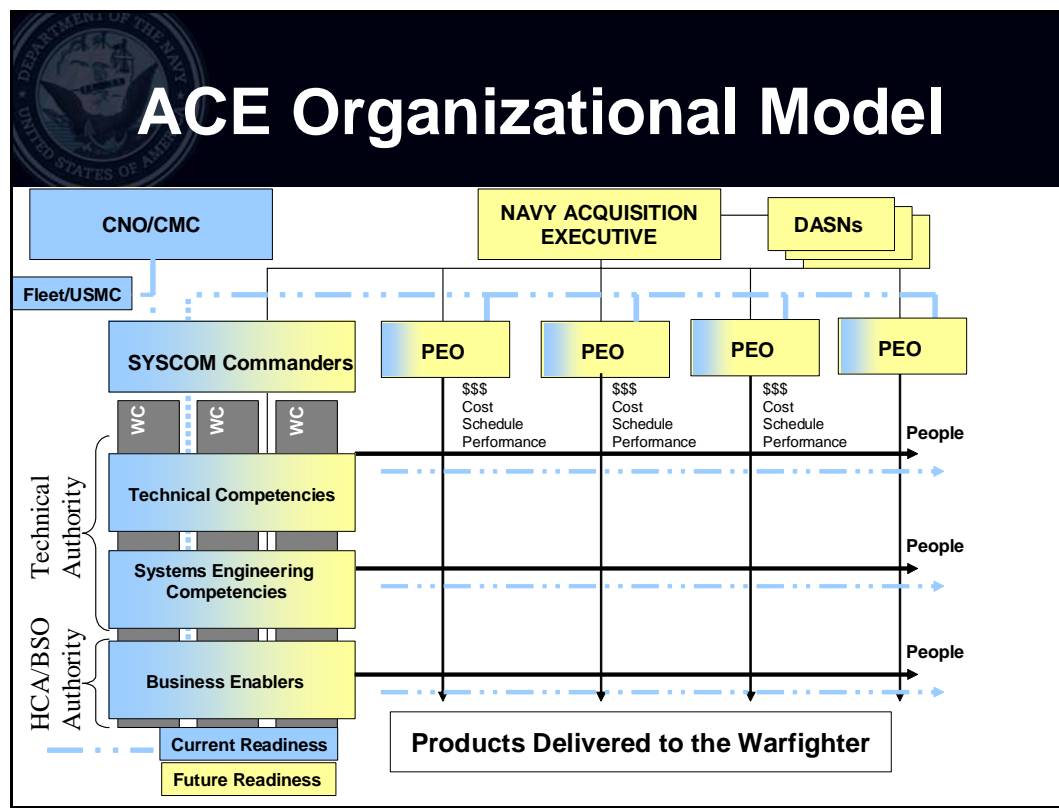

Figure B-8. The Naval Acquisition Enterprise (ACE)



### 3. Shortfalls/Gaps

- a. Several organizations reported concern over a decreasing workforce size while workload has not decreased. One organization had a 54% reduction in workforce from FY1989 to FY2005, and did not see a proportionate reduction in the number of acquisition programs assigned and affiliated PEOs. This organization noted that the reduction of the acquisition workforce and increased reliance on industry and support contractors is a contributing factor to increased collaboration (with industry).
- b. One PEO noted that separate technical and contractual chains of authority exist outside the Acquisition chain of authority. While the Technical and Contracting chains generally support the PEO/PMs in executing Acquisition program, friction and conflict occasionally develop. It is expected this command's transition to a Competency Aligned organization in FY2007 will improve alignment of the technical and contracting chains in support of the Acquisition chains of authority.

- 
- c. Several organizations commented that while the Navy PEOs and Program Offices have the ability to aggressively and innovatively streamline milestone documentation and still show compliance, OSD staffs at the middle to lower levels have not yet embraced such streamlined innovation.
  - d. Inflexibility in the use of funding (Color of Money issues): Funding usage limitations during the design, develop, integrate, test, and field stages often result in sub-optimization of these elements due to trade-off to meet policy limits on funding flexibility. Increasing the flexibility on the use of funds will avoid the opportunity costs associated with the inability to realign appropriations to support changes in acquisition program requirements.
  - e. The impact of “acquisition reform” and other major initiatives intended to improve DoD business practices and change DoD business structures has been basically the same for each initiative, an improved insight to the program for management with an increased workload and increased responsibility upon the lower levels of the organization. The negative impacts occur when additional responsibilities and reporting are required while reducing the resources (personnel, support, etc.) to meet the requirements.
  - f. Stability in requirements, funding and acquisition workforce: Numerous organizations stated this as a major concern, but one summarized it very well:

“The keys to improving the Defense Acquisition System are well understood and have been highlighted in recommendations of various panels and commissions over the past 20 years. They remain:

- Well understood and stable requirements
- Adequate, properly structured and stable budgets, and
- A highly skilled and experienced acquisition workforce. Everything else is secondary to these three foundational elements of a sound acquisition system.”

#### **4. Personnel Issues: Recruiting, Retention, and Professional Development Requirements**

As noted in the section above, several organizations reported concern over the increase in contracted efforts due to the decrease in in-house capacity and personnel billets. These concerns and impacts are summarized below:

- a. **Ethics:** As a result of this increase in contracting, the lines between government and contractor efforts become less defined. This

change has placed added emphasis on ethics training, monitoring, and the efforts in investigating and resolving attendant ethics issues.

- b. **Acquisition Workforce Replenishment:** This concern exists in several organizations and was succinctly stated as the need for “Developing and executing a human capital strategy for replacing and sustaining the Acquisition Workforce is a critical priority.”
- c. **Requirement Development Training:** Two organizations expressed specific concern that the individuals that develop systems requirements are not adequately trained in the entire acquisition process. One recommended development of “training and possibly skills and knowledge requirements for people responsible for generating requirements packages. This may be directed towards Systems Acquisition, but it also needs to be applicable to the Facilities Engineering and Field Contracting communities.”

#### **IV. Joint Acquisition**

##### **1. Joint Programs Led by Department of Navy**

The Navy and Marine Corp reported owning approximately 121 joint acquisition programs. The majority of joint programs were in the Marine Corp at 42 percent and NAVAIR and its affiliated PEOs at 39 percent of their total programs.

##### **2. Issues/Gaps in Joint Program Capability**

- a. Joint programs can present management challenges due to differences in the various services decision making structures, systems requirements, financial management processes, and the differing services cultures in general; however, the advantages that accrue in terms of cost savings far outweigh any minor inconveniences that may exist as a result thereof. The most difficult problems are generally associated with trying to align the budgets and detailed requirements of two or more services so as to meet the requirements of the war fighting communities. Failures in that regard can lead to one service being out of phase with the other, making it difficult to initiate or maintain a program that is truly joint from inception.
- b. Joint programs bring unique organizational constructs and business methodologies that add additional complexity to acquisition management. Chains of command, fiscal authority, requirements, and stakeholder equities will typically vary among the participating Service and Agencies; this can pose challenges in reaching consensus regarding a program management structure that satisfies requirements and preserves equities. Variations in software development and systems engineering processes have the potential to negatively impact compatibility

---

and interoperability, while divergent component program schedules can affect the transition of legacy to future capability.

- c. One PEO believes joint acquisition programs are best managed through a construct similar to the Joint Tactical Radio System (JTRS) Joint Program Executive Office (JPEO). The JTRS JPEO provides an enduring Joint organization that balances Service equities with DOD enterprise needs through its governance structure, single point of responsibility and direct reporting relationship to the USD (AT&L) vice a Service Senior Acquisition Executive.
- By adopting an enterprise approach to capabilities development and acquisition, the JTRS JPEO has harmonized systems engineering efforts, driven collaboration across the JTRS communities of interest, and achieved accurate and integrated POM submissions and execution year budgets.
  - Through close partnership with the Joint Staff, the JTRS JPEO has developed stable baseline requirements that satisfy user expectations with available funds. Incremental development and delivery, coupled with broadened industry involvement and greater leveraging of commercial technologies, lessens program risk without compromising capability.
  - Another structure with significant advantages in pursuit of program objectives while preserving service equities is the Joint Strike Fighter. Strong sponsorship within USD(AT&L) and rotating Service Acquisition Executives (depending on which service acts as Program Director) while maintaining a dual service Director/Deputy at the Flag level encourages unity of effort and discourages service parochialism.
- d. When working joint interest MDAPs for Space across DoD components and the National Security Agency (NSA), one significant shortfall in coordinating requirements occurs with respect to NSA and the Information Assurance and cryptographic requirements they manage and promulgate. This is particularly true for emerging or new requirements that are identified outside any formal JROC review and vetting process. The result is new requirements that are not planned or funded under the program baseline which leads to funding issues and potential performance and schedule problems. A formal review process for all NSA requirements should therefore be implemented to improve this situation. In working closely across organizational boundaries to execute programs, it is necessary to establish formal Memorandums of Agreement (MOAs). In establishing the necessary formal MOAs with stakeholder organizations, the process to approve them is sometimes difficult and slow and should be considered for standardized



approaches that shorten the length of time required to generate the agreements.

- e. It is frequently difficult to find and gain release of qualified military personnel from the participating service. Staffing of joint Service personnel requirements is challenging given other (parent) Service commitments and requirements, Goldwater-Nichols joint officer criteria, and the paucity of skilled acquisition personnel.
- f. One of the major problems is dealing with money especially for Joint programs. Consolidate and convert multi-service appropriations and/or a single appropriation (i.e. RDT&E) to the prescribed appropriation (i.e., O&M) for funding our program business, in-service and base operating supports functions. Since systems acquisition programs are not institutionally funded, the timely receipt of reimbursable funding affects continuity of operations and contracting actions throughout the execution year and especially starting or crossing fiscal years. Allocation, funding, and filling multi-service military and civilian billets have a similar adverse impact. There needs to be an up-front recognition by Joint Program Resource Managers of the host level business processes required to sustain and support the day-to-day management and operation of Joint Programs. Defining common Joint Program resource management issues across the DoD with the objective of working toward a common fix would be a good start.
- g. Some attempts to enter into joint acquisition strategies have failed due to differing interpretations of contracting, inventory management, and financial policies. Greater emphasis needs to be placed on standardizing the interpretation of policy among the Services. Although the responding organization is involved in the support of these joint acquisition programs, they do not have management responsibility. NAVSUP serves in a support role to the program managers on these programs.
- h. For the Joint Aviation Technical Data Initiative and JEDMICS, the responding organization provides contracting support to the program offices and any participating service that chooses to implement their part of the initiative through its contract vehicles. They have had minimal problems in the execution and management of these joint support contracts due to the consolidated program management in one location, and generating one set of requirements with uniform goals and objectives. The only contention experienced is when funding is decentralized and the member service components decide to reduce, delay or forgo the investment to maintain functional consistency with the other Joint partners.

- 
- i. Joint programs frequently fail to clearly delineate expectations, delivery dates, or funding requirements, hindering smooth progression of joint programs. There is often extended discussion and significant compromise required in joint programs that causes fielding delay for urgently needed warfighting capability. Addressing these concerns would lead to improvements in efficiency and productivity.
  - j. A very prominent difficulty with the management of joint acquisition programs is encountered during testing, certifying, and deploying joint applications. Many program offices are less than forthcoming with application material and technical assistance in support of DoD-mandated testing of joint applications for deployment on NMCI. Several program offices claimed that they did not have test scripts for their applications and were not funded to provide them, that if the organization wanted one it would have to fund the program office to create them. One joint application program office said they knew that their application did not meet DoD security standards for group policy object settings but that since NMCI was the only network that they had encountered that was enforcing the policy, they saw no reason for any action on their part to rectify the situation. This situation will only improve when the priorities that managers perceive for their programs are changed. Currently, the priorities are the same as they are for COTS products—time to market and features. Security, interoperability, and regulatory compliance are not accorded the same level of importance. DoD IT acquisition managers must realize that in a shared-risk environment of enterprise networks the old model of stand-alone, stove-piped applications and systems can no longer work. The existing laws, regulations and policies (such as DITSCAP) that have been in existence for years must be enforced.
  - k. Potentially competing/conflicting priorities for cost, schedule, technical, and programmatic trades. Adhering to service-unique policies, interpretations, and practices while trying to maintain cost and schedule goals and meet Joint Program directives is difficult.
  - l. Budget timelines for each service/organization are not in synch, despite the budgets being dependent on each other.
  - m. There is perception of sub-optimization of the unique service requirements in an effort to create joint performance requirements as well as sub-optimization of capability at IOC compared to what may be required or achievable in a unique service item. Services pulling out of programs after initial program participation commitments are established impacts production unit costs for other services.
  - n. Budget decisions made by one service without regard to impacts to other services is not a good way to run a business.

- o. Communication and administrative challenges for programs with teams not co-located. Additional layer and/or remote management for information, access, and decision making process.
- p. Per Title X, O&M funding is the responsibility of the service. This leads to issues in training systems, logistics/maintenance concepts and implementation, technical/maintenance documentation, configuration management, etc.

## **V. Department of Navy Recommendations**

### **1. Organizational Issues**

There are no major recommendations for reorganization at this time.

### **2. Resource Issues (Personnel/Funding)**

- a. The summary statement in Paragraph III (3) (f) on page 17 of this Annex captures the key elements for a successful acquisition program as; stable requirements, stable funding, and adequate workforce. DoN endorses the adoption of these three foundational elements of a sound acquisition system.
- b. Stabilize the budget process. Budgetary stability is absolutely essential in accurately planning and executing MDAPs from Milestone A through Initial Operational Capability (IOC). The all too frequent annual budget shortfalls and reallocations in both RDT&E and Procurement funds cause significant program instability. As a result, programs are often forced to execute to a minimum budget profile with little or no capacity to achieve economies of scale or improve products/processes. One PEO specifically emphasized the need to reform POM process to fence funding to ensure program stability over the development and production cycle.
- c. Reduce the restrictions on usage of funds within a specific appropriation to allow PMs to use available funds to design, develop, integrate, test, and field systems, or make trade-offs when necessary. In turn, this will reduce the opportunity costs associated with realigning appropriations to support changes in acquisition program requirements.
- d. Another recommendation concerns the use of Shipbuilding and Conversion, Navy (SCN) funding. Current laws preclude the planned use of SCN during Post Delivery Availability (PDA). Significant savings and cost avoidance can be achieved by having the shipbuilder build the “hull” while allowing a C4ISR integrator to install C4ISR equipment during the PDA. Cost avoidance will be realized as shipbuilders will no longer need to prematurely stage and install C4ISR equipment—equipment that is often antiquated by the time the ship is launched and

---

must be upgraded or replaced. Allowing C4ISR upgrades to take place during PDA will eliminate costly and time consuming Engineering Change Proposals.

- e. Improve coordination of budget preparation between PM/MDA, resource sponsor, and controller.
- f. Train Requirements Officers to better understand their roles and responsibilities within the Defense Acquisition System. Requirements Officers represent the operational end-users in the DAS but they are not always sufficiently trained. Consequently, requirements are often not defined in a timely manner or in sufficient detail to refine a concept or develop technology that adequately meets the users' needs.
- g. Ensure that like efforts receive the requisite visibility and support (funding) to achieve the desired product capabilities for all services.
- h. Joint programs should have one funding line managed by the lead Service. The "alimony costs" to withdraw from a joint program should also consider sunk development costs versus just future cost impacts. Withdrawals from joint programs should be reviewed at a JROC level meeting.
- i. Establish service-specific network workstations at participating Service staff organizations and the program office (e.g. NMCI workstation at non-Navy program office, or USAF workstation at USN program offices) and address firewall/incompatibility issues between Service networks to permit true "joint access.
- j. Establish a formal review process for all NSA, or any other non-DoD requirements.

### **3. Policies and Procedures Issues (Needed to Improve Outcomes)**

- a. Tailor and establish program documentation and, after this baseline, obtain documented MDA concurrence, hold closely to the agreed plan and treat additional documentation requirements as scope growth. This information has been previously provided to OSD.
- b. Ensure Regional Contracting Officer (RCO) Directors throughout the Field Contracting System report at a level no lower than the Chief of Staff/Executive Director/Technical Director/Executive Officer, as the situation dictates. This reporting structure will help to ensure proper Command oversight and encourage the establishment of a program management type office for each major command to oversee the development and planning of complex performance based service acquisitions. This office would not be part of the contracting community.

- c. Acquisition Documentation Streamlining - DoD 5000.2 has 64 references and many of those have their own references. SECNAVINST 5000.2C has over 100 references with similar replication of “other” references. This unneeded complexity makes it difficult to effectively interpret, apply, and comply with acquisition guidance and policy. Additionally, recommend that Joint Staff Instructions governing JCIDS (CJCSI 3170.01, CJCSM 3170.01) and Interoperability (CJCSI 6212.01) be combined into a single instruction that provides consolidated, unambiguous guidance concerning Capabilities Documents and Information Support Plans.
- d. The Navy Enterprise behavior model will go a long way towards providing a process/method for discussing/integrating/approving changes in conjunction with the requirer (the Fleet) as part of trade-offs between cost, schedule, and technical requirements, which to date has been a process deficiency. Currently, such changes require re-approval up several process chains (T&E, requirements, acquisition strategy, etc).
- e. Another area where added flexibility would be beneficial is spiral acquisitions. Part of the current difficulty is that the Spirals, which often are at the funding level of an ACAT III or IV program, are still managed at the ACAT I program level (i.e. no MDA delegation down to the PEOs for decisions pertaining to the relatively low cost/lower risk spirals), and additionally, it is unclear what requirements must be met (entrance/exit criteria, documentation, etc.) in order to obtain favorable spiral development/production decisions.
- f. Further modernize acquisition policies for implementation of spiral development, especially as they relate to JCIDS and test and evaluation.
- g. During the DoD 5000.2 rewrite, many of the requirements that were removed to streamline the approval/oversight processes were placed in the Defense Acquisition Guidebook. Unfortunately, they are still viewed as “required” by some approval authorities. Often, waivers of such requirements are still necessary, where oversight is apparently preferred to accountability. Many (48%) of the statutory, regulatory, and contracting reporting information and milestone requirements (depicted in enclosure (3) to DoD 5000.2) are internally DoD/CJCSI created/generated. Authority, accountability, and responsibility should be aligned and implemented at the proper (i.e., most effective and efficient) level.
- h. Improve the timing of major program decisions. Recommend decisions should be made at earliest opportunity in the life of a program regarding funding levels.

- 
- i. Permit increased Government-Industry collaboration by permitting development of long term partnerships.
  - j. Recommend vesting milestone decision authority for each acquisition category level, with the exception of ACAT I, with the PEO. Recommend leaving the decision authority for ACAT I level programs with the Secretary of the associated branch of the military.
  - k. Establish common Operations & Support documentation.
  - l. Institute a process by which all Services (program office and fleet reps) meet periodically to review/agree items that need worked on, and the priority with which each project needs to be worked, with the output of that meeting being a Joint Priority List.
  - m. Sustainment standardization: Require life cycle management be considered up front. Establish joint working groups to manage joint service system modifications. In order to maintain the benefits of a joint system it may require a service that desires to upgrade the system to fund upgrades to all systems.
  - n. Require concurrent Fitness Reports from both Services for personnel serving in a 'joint' capacity (i.e. stationed at an office not run by their service).
  - o. Ensure right of refusal for lead Service of Joint programs prior to generating orders for participating service representatives.

# Annex C

## Air Force

---

This annex represents the inputs received from the Air Force to the survey directive sent out from Mr. Kenneth Krieg, USD(AT&L). The annex discusses acquisition within the Air Force. Specifically,

- ◆ Current organization and its evolution,
- ◆ Mission and capabilities,
- ◆ Joint acquisition, and
- ◆ Recommendations.





## I. Current Organization

Figure C-1 illustrates the Department of the Air Force’s acquisition structure at its most senior level, beginning with the Assistant Secretary of the Air Force for Acquisition (SAF/AQ).

Figure C-1. Office of the Assistant Secretary of the Air Force (Acquisition)

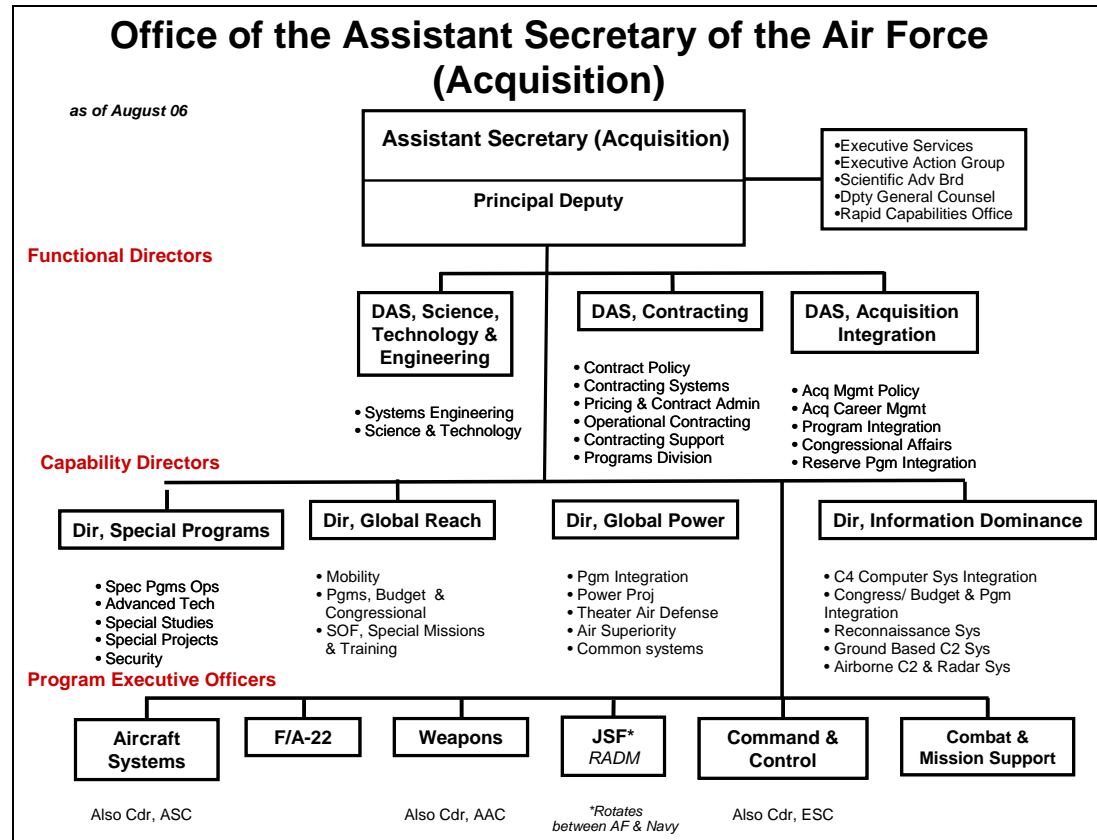
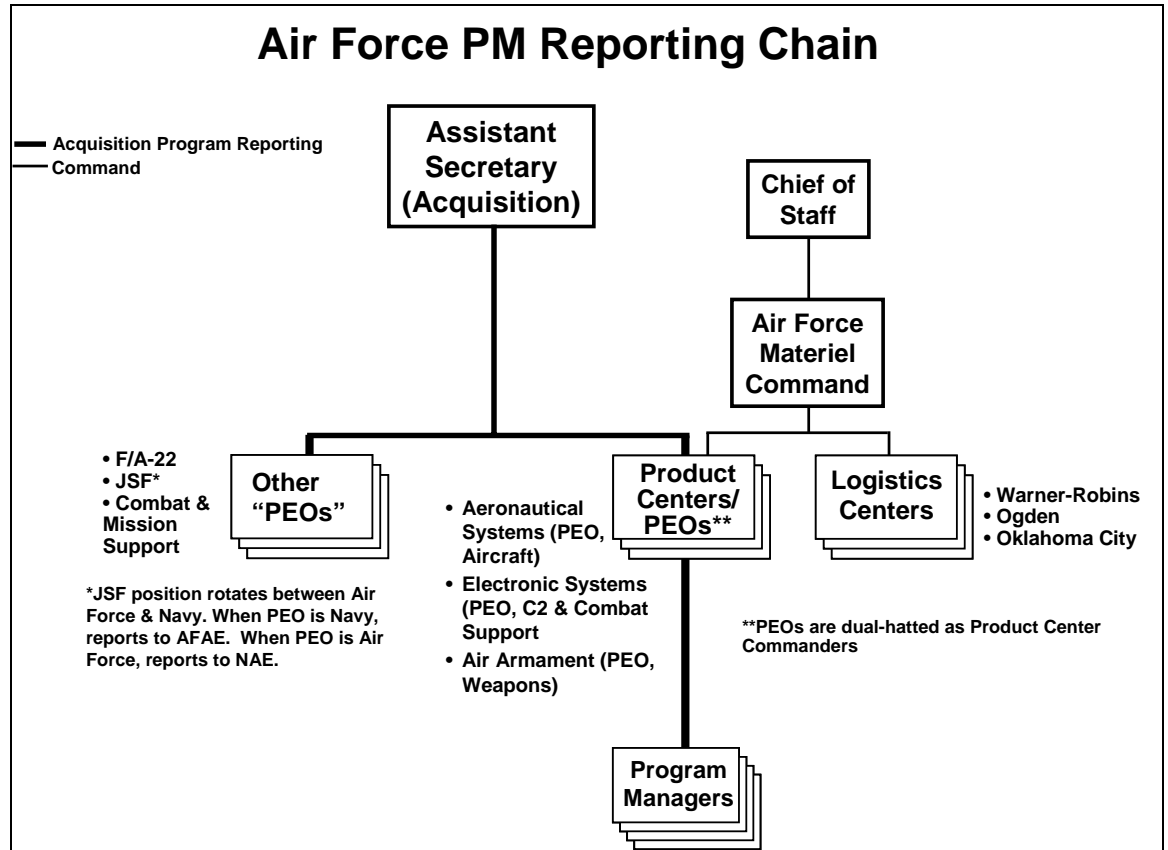

Figure C-2 illustrates the Air Force acquisition reporting structure. For “stand alone” PEOs of major systems the reporting runs directly from the PEO to the SAF/AQ. For the PEOs that are dual-hatted with AF Product Centers, program reporting responsibilities run from the Program Managers to the PEO and then directly to SAF/AQ. However, since these PEOs also serve as Commanders of their respective Product Center, there is also a command chain that runs from these commanders to the Commander, AF Materiel Command (AFMC) and then to the AF Chief of Staff.

Figure C-2. Air Force PM Reporting Chain



Primary acquisition oversight responsibility resides within SAF/AQ, the PEOs, and the three Product Centers: Aeronautical Systems Center (ASC), Electronic Systems Center (ESC), and Air Armament Center (AAC). AFMC oversees the Air Force Flight Test Center, the Arnold Engineering Development Center, the Air Force Security Assistance Center, Air Force Research Laboratory, and three Air Logistics Centers (ALCs) at Warner Robbins, GA, Oklahoma City, OK, and Ogden, UT.

This dual-hatted arrangement was authorized in a Memorandum for Record, July 23, 2003 signed by the Secretary of the Air Force (James G. Roche) and the AF Chief of Staff (General John P. Jumper). The following describes this authorized arrangement—for the non-Space Air Force Acquisition—directly from the memo:

Service Acquisition Executive:

The non-space Service Acquisition Executive (SAE) will continue to be the Assistant Secretary of the Air Force for Acquisition (SAF/AQ). The SAE will be the single civilian official with full-time responsibility for all non-space Service acquisition functions.

The SAE will be responsible to the Secretary of the Air Force and CSAF for oversight and direction of Headquarters USAF and field command acquisition activities.

For purposes of defining SAE responsibilities, acquisition of systems is the process from Milestone A to delivery of new systems, or significant modifications to existing systems, to the using operational command.

#### Program Management:

The authority, responsibility and accountability for program execution for non-space acquisition programs reside with the SAE. Management responsibility flows directly, without intervention, from the SAE to the Program Executive Officers (PEOs) to Program Managers (PMs). All Designated Acquisition Commander (DAC) responsibilities will be realigned under the PEOs. The PEOs are responsible for the execution of a program throughout the entire lifecycle. The SAE will be consulted prior to, and will have approval authority, for PEO personnel assignments. Some PEOs may be dual-hatted as the PEO and the product center commander; however, program reporting requirements will be strictly within the SAE/PEO chain. For those PEOs that are dual-hatted, their primary responsibility will be program execution. To assist the dual-hatted PEOs in carrying out his/her duties, a general officer or Senior Executive Service member will be assigned as the deputy PEO. Additionally, the PEO's staff will include individuals located in Washington D.C. to facilitate coordination with Headquarters Air Force, Office of the Secretary of Defense (OSD) and Congress.

#### Program Planning and Support:

The Commander of AFMC is responsible for front-end planning prior to Milestone A as the users' requirements are being defined and to provide the required support to the SAE/PEO/PM from Milestone A to delivery and sustainment of fielded systems after delivery. AFMC/CC will recommend, for SAE approval, program assignment to a PEO for the Milestone A decision.

The Commander of AFMC will be responsible directly to the SAE for support to PEOs and PMs. Support will include technical assistance, infrastructure, test capabilities, laboratory support, professional education and development, personnel management and all other aspects of support for

SAE/PEO/PM functions. For the product center commanders that are dual-hatted as PEOs, they will be assigned a general officer or Senior Executive Service member as the deputy for support who will manage the day-to-day operations of the center. This individual will provide the support necessary to allow the PEOs and PMs to execute acquisition programs, but will not have any program execution responsibilities. The Commander of AFMC will also provide advice and assistance, as required, to the SAE on other aspects of acquisition.

The Commander of AFMC will continue to report to CSAF on all matters.

There is a second acquisition structure within the Air Force. Space acquisition follows a separate chain of command through the Under Secretary of the Air Force who also serves as the Air Force Executive for Space as shown in Figure C-3.

Figure C-3. Space Acquisition Reporting Structure

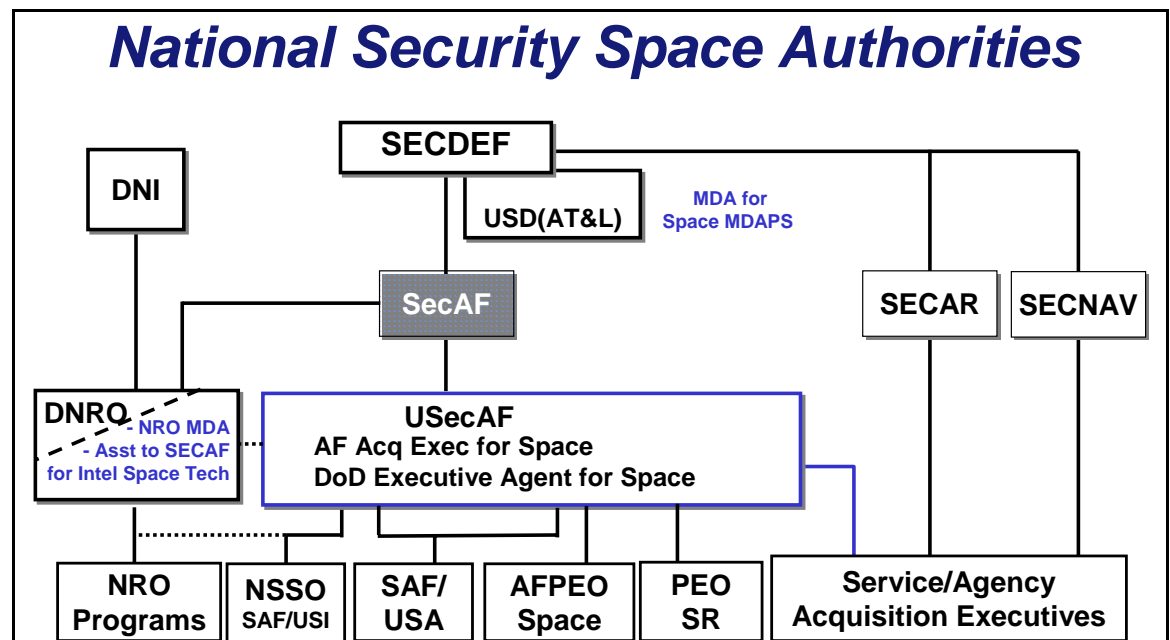

## II. Evolution to the Current Structure since 2000

### 1. Air Force Acquisition Executive (SAE) HQ/Staff

Figure C-4 depicts the evolution of the Air Force Acquisition Executive HQ and staff from 2000 to 2006.

Figure C-4. Evolution of Air Force Acquisition Executive HQ and Staff

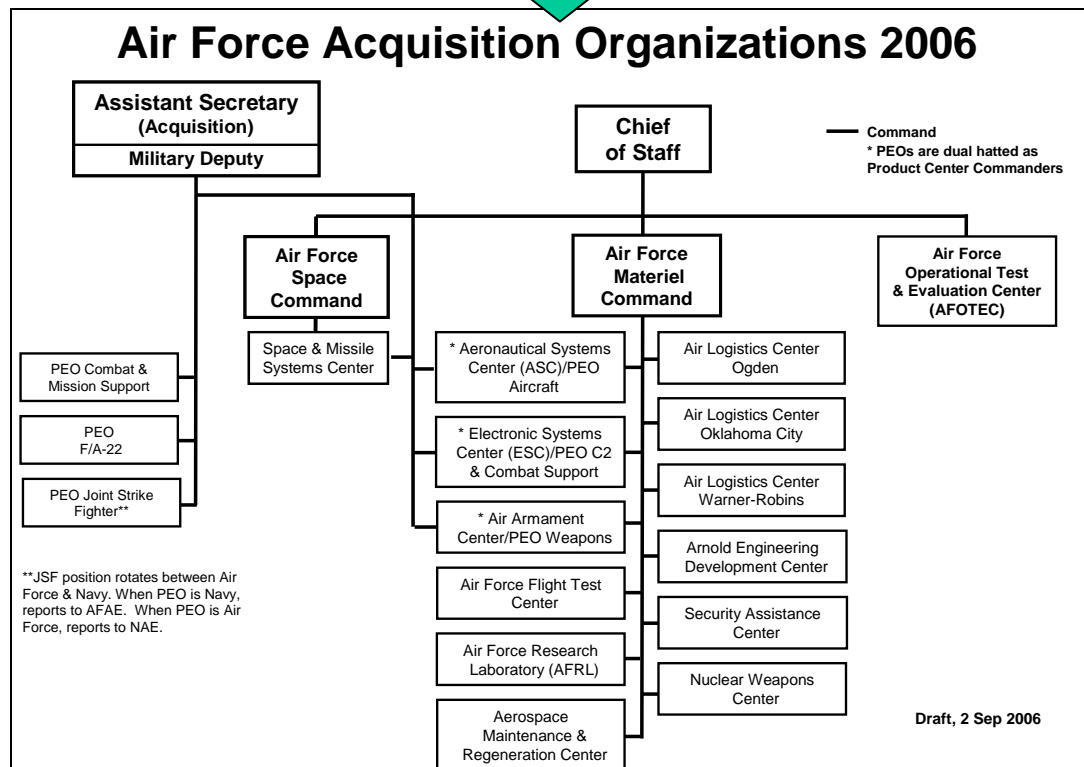
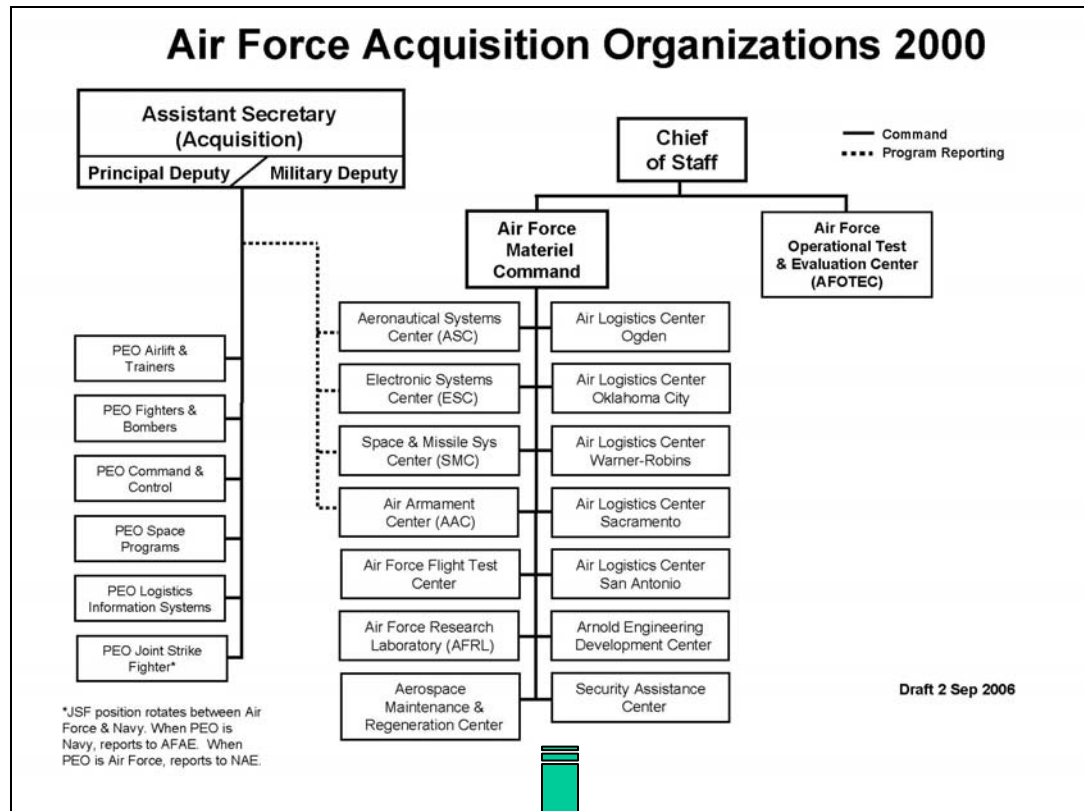

---

Key features of the Air Force Acquisition in 2000 included

- ◆ Six Air Force PEOs report direct to Assistant Secretary (Acquisition). All Air Force PEOs are located in the Pentagon.
- ◆ Product Centers report direct to Asst. Secretary (Acquisition) on acquisition program matters.
- ◆ Air Force Materiel Command (AFMC) has four product centers and five logistics centers. Product and Logistics centers are “Designated Acquisition Commands” or DACs. They provide matrix support to PEO programs and manage all non-PEO programs. HQ AFMC has no program management role; it provides policy support to Asst. Secretary (Acquisition).
- ◆ Development test and evaluation is conducted by Air Force Flight Test Center.
- ◆ AFOTEC conducts independent operational test and evaluation.
- ◆ Arnold Engineering Development Center performs simulation flight testing and evaluation for all military departments and other government agencies.
- ◆ Air Force Research Laboratory supports Science and Technology (S&T) efforts
- ◆ Aerospace Maintenance and Regeneration Center provides storage, preservation, restoration, parts reclamation and limited depot-level maintenance for aircraft and aerospace vehicles.

Major changes aimed at enhancing business practices included

- ◆ 2001: Sacramento and San Antonio Air Logistics Centers (ALCs) close because of BRAC 1995.
- ◆ 2002: Space & Missile Systems Center (SMC) transferred from AFMC to Air Force Space Command. Under Secretary of Air Force was designated the DoD executive agent for Space/MDA for ACAT I space programs.
- ◆ 2003: Major PEO realignment dual-hatted product center commanders. The Commander of AAC assumes role of PEO, Weapons. The ESC Commander assumes role of PEO, Command & Control and Combat Support. The Commander of ASC assumes role of PEO, Aircraft (combining program oversight from PEO Fighters & Bombers and PEO Airlift and Tankers). Product centers report operationally to Commander, AFMC, and reports to Assistant Secretary (Acquisition) for acquisition matters. PEO F/A-22 was activated.

- ◆ 2004: AFMC initiates major reorganization to “wing, group and squadron” structure—moving away from an acquisition unique structure to one closely resembling other MAJCOMS. Product commanders lose installation commander responsibility to Air Base Wing (ABW) commanders, allowing them to devote more time to their acquisition-related duties.
- ◆ 2005: Civilian deputy position eliminated from office of Asst. Secretary (Acquisition).
- ◆ 2006: Nuclear Weapons Center activated under AFMC.

## 2. Acquisition Commands

AFMC acquisition workforce declined 54 percent from FY90 to FY99, containing 56,726 personnel in FY99<sup>1</sup> (DoD/IG). Total assigned personnel declined 37 percent from FY90 (combined AFLC and AFSC) to FY99, containing 89,157 in FY99. Assigned personnel declined an additional 12 percent from FY99 to FY05, to 78,549.

## 3. PEO Structure

As a result of the 1986 Packard Commission report, all military departments implemented a PEO structure. The PEO structure designates key managers who devote full-time attention to the business and administrative management of assigned programs. These managers have a clear line of accountability and responsibility dedicated to the success of the programs. This has provided additional continuity for programs and has also created a cross-functional matrix structure for grouping related aircraft and systems under broad functional areas. In the case of PEO(JSF), the PEO structure provides a way to interface more effectively with our Joint Service partners.

The first PEOs in the Department of Air Force were established in 1987. Figure C-5 tracks the evolution of the Air Force’s PEO Structure from that year.<sup>1</sup>

---

<sup>1</sup> AFPEO grew 120 percent from FY90 to FY99, containing 44 personnel in FY99.

Figure C-5. Evolution of the Department of Air Force's PEO Structure

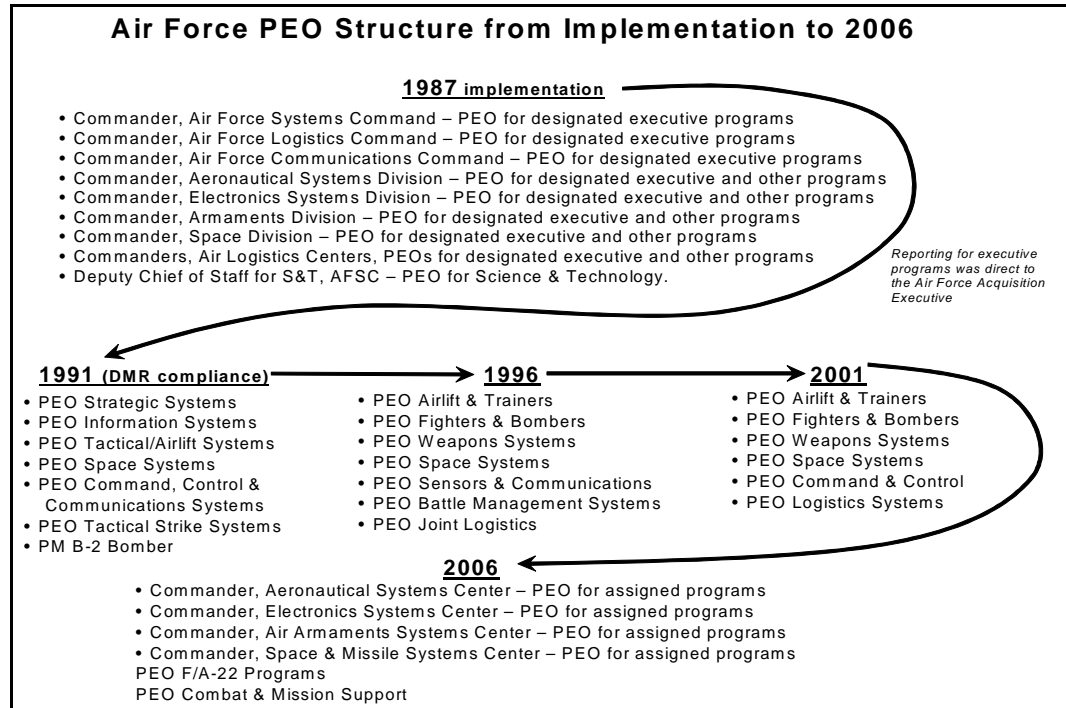

#### 4. Impact of Structural Changes on Acquisition Career Field Trends

Table C-1 demonstrates the impact of structural changes from 2000 to 2006 on the Air Force acquisition workforce.

Table C-1. Air Force AT&L Workforce Count (Civilian + Military)  
(as of September 30, 2005)

AT&L Workforce Functional Career Field	2001	2002	2003	2004	2005	2001 to 2005 Change (#)	2001 to 2005 Change (%)
Program Management	3,867	3,472	3,410	4,689	4,442	↑ 575	14.9%
Contracting	5,791	7,559	7,684	7,487	7,429	↑ 1638	28.3%
Industrial/Contract Property Management	43	38	35	38	36	↓ -7	-16.3%
Purchasing	751	716	678	731	627	↓ -124	-16.5%
Facilities Engineering	0	0	0	0	0	0	New
Production Quality and Manufacturing	518	499	409	408	407	↓ -111	-21.4%
Business, Cost Estimating & Financial Management	2,916	2,945	1,878	1,779	1,826	↓ -1,090	-37.4%
Life Cycle Logistics	1,627	1,646	1,568	1,953	2,081	↑ 454	27.9%



Table C-1. Air Force AT&L Workforce Count (Civilian + Military)  
(as of September 30, 2005)

AT&L Workforce Functional Career Field	2001	2002	2003	2004	2005	2001 to 2005 Change (#)	2001 to 2005 Change (%)
Information Technology	1,303	1,390	1,117	1,476	1,551	↑ 248	19.0%
SPRDE–Systems Engi- neering	6,310	6,207	5,864	6,473	6,505	↑ 195	3.1%
SPRDE–S&T Manager	0	0	0	74	57	↑ 57	New
Test & Evaluation	1,610	1,506	1,709	2,181	2,417	↑ 807	50.1%
Auditing	0	0	0	0	4	↑ 4	
Unknown/Other	3,084	2,466	3,536	486	564	↓ -2,520	-81.7%
TOTAL	27,820	28,444	27,888	27,775	27,946	↑ 126	0.5%

### III. Mission, Capabilities, and Service Issues

#### 1. Missions

The current mission statements (or missions) are

- a. Within the Office of the Under Secretary of the Air Force (Acquisition):
  - i. **Deputy Assistant Secretary of the Air Force (Contracting) (SAF/AQC).** The senior contracting and business advisor to SAF/AQ. Ensures policy, processes, training, and information technology for Air Force military and civilian contracting personnel worldwide to include the readiness of Air Force contingency contracting officers. Is the functional manager for the development of all contracting personnel. Serves as the Competition Advocate General for the Air Force. Develops, integrates, and promulgates all Air Force contracting policy and provides tools and training to support its implementation. Assesses Air Force field operations to ensure policy is adequate. Represents the Air Force to the DAR Council. Interfaces daily with senior leaders in Air Force, DoD, General Accountability Office (GAO), Air Force Audit Agency (AFAA) and other Federal agencies, and the defense industry to develop, present, and defend Air Force positions on acquisition matters. Provides information, assistance and business advice for programs at product centers, logistic centers and operational contracting squadrons. This includes support of active source selections; acquisition strategy panels; portfolio reviews; acquisitions teams for major systems, logistics and operational acquisitions; acquisition plans; Life Cycle Management Plans (LCMP); justification and analysis; and the approval of other contract related documentation. Provides govern-

---

ment purchase card program management and assistance with Central Contractor Registration (CCR). Responsible for contract reporting, Congressional inquiries, Inspector General (IG) hot-line inquiries, protests, Freedom of Information Act requests, and the Contract Research Program. Implements facilitating technology initiatives to transform Air Force procurement. Serves as the focal point for all legacy and future Information Technology procurement systems. Assists in the deployment and provides support for DoD and Air Force business systems, the acquisition domain and the Functional Requirements Board. Directs electronic commerce, improved customer-focused service delivery and enterprise architecture for procurement. Supports implementation of Air Force commodity councils.

- ii. **Deputy Assistant Secretary of the Air Force (Acquisition Integration) (SAF/AQX).** Oversees current and future year acquisition requirements into a balanced program that reflects guidance on operational needs, force structure, and funding constraints. Responsible for the integration of all SAF/AQ programs to achieve the best Air Force acquisition program mix. Prepares position on unfunded requirements and identifies funding sources. Participates in the PPBE process and represents SAF/AQ on the Air Force Board and Group. Chairs the RDT&E Panel that is responsible for programming S&T, Test and Evaluation (T&E) infrastructure and defense wide support activities. Develops and implements plans, policies, and procedures related to Air Force RDT&E, procurement, acquisition management, budget formulation, program planning, resource allocation, and financial program execution. Exercises below threshold investment appropriation reprogramming authority for designated major and selected acquisition programs within the portfolio. Is the functional manager for the RDT&E and procurement appropriations. Ensures compliance with statute, Congressional direction, OSD and Air Force policy. Issues Program Authorizations (PA). Develops and communicates plans and policies for OSD, Air Force transformation and streamlined acquisition initiatives. Develops and implements acquisition program reporting policy covering Selected Acquisition Reports, Congressional (Nunn/McCurdy) reporting, Defense Acquisition Executive Summary, and the Air Force Monthly Acquisition Reports. Reviews and tracks GAO, DoD IG, AFAA, and Air Force IG audits and inspections. Co-chairs the Rapid Response Process Council. Develops, reviews, and coordinates policy regarding the Air Force acquisition workforce, including both organic (Air Force civilians and military) and contracted resources. Responsible for Air Force acquisition professional development, including the direction, coordination, and review of actions mandated by the Defense Acquisition Workforce Improvement Act (DAWIA) and DoD Directives. Air Force Liaison to OSD and the President, Defense Acquisition University (DAU), on behalf of the AFAEs and all Air Force acquisition, technology and logistics career

field managers, and for career fields covered by DAWIA. Career Field Functional Manager for the training, development, and awards program of all Air Force acquisition management personnel, including acquisition program managers (PM). Establishes policy and reporting procedures for the planning, programming, and execution of the Air Force use of Advisory and Assistance Service (A&AS) and the Air Force-sponsored Federally Funded Research and Development Centers (FFRDC). Manages acquisition-training resources, including DAU course quotas. Oversees acquisition training selection boards including the PM Course and Industrial College of the Armed Forces Senior Acquisition Course, for the acquisition community. Manages all SAF/AQ Management Level Review (MLR) officer promotion processes, including Brigadier General Promotion Board actions. Responsible for promotion board results and test scheduling. Represents the Air Force in the Weapon System Life Cycle Management Business Mission Area portion of the Acquisition Technology and Logistics (AT&L) Investment Review Board (IRB), a component of the Defense Business Systems Management Committee (DBSMC). Develops and maintains a transition plan for business information technology initiatives in support of Air Force acquisition transformation efforts. Develops and maintains a data strategy and associated taxonomy that supports the acquisition process within the Air Force. Co-Lead representative for the Air Force on the Total Life Cycle System Management (TLCSM) Council with AF/A4/7. Lead representative of the Joint Cross Service Group. Oversees Expectations Management Agreements (EMA) and Acquisition Program Baselines (APB). Responsible for the development and implementation of Earned Value Management (EVM) policy and coordination with OSD on EVM issues. Develops and maintains acquisition portions of the Air Force's Operational Support Enterprise Architecture (OSEA).

- iii. **Directorate of Global Power Programs (SAF/AQP).** Directs, plans and programs research, development and acquisition of fighter, bomber, air-to-ground weapons, air-to-air weapons, electronic attack, theater air defense, battle management and chemical/biological defense programs. Advises on all conventional issues from production through sustainment. Manages, monitors, and provides direction to field commands. Monitors force composition and quality. Participates in the PPBE process. Acts as principal mission area point of contact to SAF/LL and SAF/FML. Prepares position on unfunded requirements and identifies funding sources as required. Maintains liaison for advanced technologies with technology development agencies, including the Joint Service Review Committee (JSRC), National Aeronautics and Space Administration (NASA), DARPA, the Department of Energy, Sandia National Laboratory, U.S. Navy, U.S. Army, aerospace industry contractors and subordinate Air Force organizations. Monitors Office of the Secretary of Defense (OSD) Conventional, NATO Coop-

---

erative and Emerging Technologies Initiatives for potential application to Air Force missions and development. Represents SAF/AQ on the Air Force Requirements for Operational Capabilities Council (AFROCC).

- iv. **Directorate of Information Dominance Programs (SAF/AQI).** Directs, plans and programs research, development and acquisition of programs in the Information Dominance capability area. This includes airborne and ground based Command and Control (C2) and combat support systems, airborne reconnaissance systems, unmanned aerial systems, Information Warfare/Cyberspace systems, and future Command, Control, Communications, and Computer, Intelligence, Surveillance, Reconnaissance (C4ISR) capability programs from concept and technology development through production, deployment and sustainment. Provide key support to steering committees and boards of directors for several NATO programs to include: Airborne Warning, and Control Systems (AWACS), Advanced Command and Control System (ACCS), and Alliance Ground Surveillance. Participates in the Defense Planning, Programming, Budgeting and Execution (PPBE) process. Prepares position on unfunded requirements and identifies funding sources. Focal point for information requests from members of Congress, personal and professional staff members in both Congress and the White House and other sources such as SAF/PA. Manages preparation of responses including suspense tracking and format guidance.
- v. **Air Force Program Executive Officers (AFPEO).** Responsible for the execution of a program throughout the entire lifecycle. The PEOs have been established in the command line between the AFAE and the PM for all acquisition programs. The PEOs are: PEO for Aircraft, PEO for Weapons, PEO for Combat and Mission Support, PEO for Command & Control and Combat Support Systems, and PEO for Joint Strike Fighter. In reference to joint service programs, the PEOs will establish memoranda of agreement to describe program oversight, management and organization responsibilities. Ensure cost, schedule and performance aspects of acquisition programs are executed within the acquisition program baseline and in accordance with approved acquisition strategy and applicable DoD 5000 Series directives and instructions. Directs the PMs in all aspects of program execution with emphasis on planning, reporting and preparation for milestones and other program reviews. Ensures program offices remain focused on satisfying the operational requirements. Participates with program offices in establishing and maintaining a continuous dialogue with the users to ensure program execution provides the required system and product. Maintains currency with emerging technologies and assesses their impact on current and future Air Force weapon systems. Ensures program offices exercise contracting authorities and responsibilities as prescribed by the contracting rule structure established by the AFAE.

Advises program offices on and approves acquisition strategies. Reviews and approves program documentation (Acquisition Program Baseline, Selected Acquisition Reports, Defense Acquisition Executive System Reports, selected Test and Evaluation Master Plans, Request for Proposals, etc.), and presentations for higher authorities and budget execution exercises. Advises the AFAE on resource decisions affecting Acquisition Program Baseline parameters and alternatives that may mitigate the impact of such actions and consults with the AFAE on resource issues during the execution of assigned programs. Approves acquisition strategies consistent with established guidance, direction and policies, and resolves or refers to the AFAE programmatic issues requiring the attention of Air Force corporate management. Ensures the AFAE and acquisition staffs are informed of all significant or sensitive problems or issues in sufficient time to influence the outcome. Assists the Air Force Capability Director staff in identifying reprogramming sources from within their programs for “top down” directed requirements, and otherwise advises on programming and budgeting matters. Develops and oversees EMA for the programs within their respective portfolio.

- b. Within the Office of the Under Secretary of the Air Force:
  - i. **The Office of the Under Secretary of the Secretary of the Air Force (Military Space):** Subject to the direction and control of the Under Secretary of the Air Force, the Deputy Under Secretary of the Air Force (Military Space), also known as SAF/US(D), is responsible for the supervision of military space and space-related matters to include supporting the Under Secretary in the discharge of responsibilities for DoD space activities, to include acting on behalf of the Under Secretary as required; ensuring military space activities are properly integrated within the Air Force and DoD, the National Reconnaissance Office, the National Aeronautics and Space Administration, other agencies, and other nations; advising the Under Secretary on Air Force Space Acquisition Executive matters and on space Milestone Decision Authority matters for all national security space acquisitions; and performing space portfolio and/or individual program reviews to periodically assess programmatic health, execution, and status.
  - ii. **SAF/USA:** Acquisition support and program management direction to field organizations for the development and procurement of Air Force surveillance, communications, navigation, and weather satellites; space launch systems; information warfare capabilities; ground-based strategic radars; communications and command centers; acting as chairman of the DoD Space Experiments Review Board (SERB) and providing access to space for DoD science and technology payloads; and sustaining the nation’s land-based strategic nuclear missile

---

systems. SAF/USA reports directly to the Under Secretary of the Air Force.

iii. **PEO/SP:** As the AFPEO/SP, the Space and Missile Systems Center (SMC) Commander is responsible for managing the research, design, development, acquisition, and sustainment of space launch, command and control, missile systems, and satellite systems. The AFPEO/SP reports directly to the Under Secretary of the Air Force to provide program execution oversight and staff support for Air Force space acquisition programs. As the SMC Commander, reports directly to the Commander, Air Force Space Command.

iv. **PEO/SR:** The Space Radar (SR) Program Executive Officer and System Program Director serves the Under Secretary of the Air Force by managing the research, design, development, acquisition, and sustainment of space radar launch support, command and control, ground processing, and satellite systems. The SR PEO provides program execution oversight and staff support for the SR space acquisition program.

c. Within the Acquisition Commands and Centers:

i. **AFMC:** Delivers war-winning expeditionary capabilities to the warfighter through development and transition of technology, professional acquisition management, exacting test and evaluation, and world-class sustainment of all Air Force weapon systems. From cradle-to-grave, AFMC provides the work force and infrastructure necessary to ensure the United States remains the world's most respected Air and Space Force.

ii. **AAC:** "Deliver war winning ... technology, acquisition, test, sustainment ... expeditionary capabilities to the warfighter." Responsible for development, acquisition, testing, deployment, and sustainment of all air-delivered weapons. Applies advanced technology, engineering, and programming efficiencies across the entire product life cycle to provide superior combat capability. Plans, directs, and conducts test and evaluation of US and allied air armament, navigation/guidance systems, and Command and Control (C2) systems. Supports the largest single base mobility commitment in the Air Force.

iii. **ASC:** Responsible for operating Wright Patterson Air Force Base (WPAFB). ASC is composed of 6 Materiel Systems Wings, 2 Materiel Systems Direct Report Groups, and 12 functional home offices which manage over 400 programs and projects worth \$27B in FY2007 (includes Foreign Military Sales) as well as the 88th Air Base Wing (ABW) which includes the 74th Medical Group (MDG).

- iv. **ESC:** “Delivering Information Dominance for Air & Space Operations.” To serve as the Center of Excellence for command and control and information systems to support the warfighter in war and peace. ESC will provide full spectrum architectures, weapon systems management and technical cognizance throughout the life cycle of communications, intelligence, surveillance, reconnaissance, and information systems for the Air Force and Department of Defense components.
- v. **SMC:** Develop, acquire, field and sustain unrivaled space and missile capabilities for the joint warfighter and the nation SMC reports to AFSPC and not AFMC.

## 2. Capabilities Needed to Accomplish Mission(s)

### a. Other

Both acquisition processes and automation have changed during the last decade. Some changes have brought about efficiencies which have allowed for downsizing; others have had the opposite effect and require that some of the staffing be restored. Here are some of the changes and their impacts.

### b. Acquisition Reforms Implemented in AF Organizations

- i. Several programs have implemented Cost as an Independent Variable (CAIV) principles integrated with an evolutionary acquisition strategy. Examples include the current Electronic Technical Information Management System (ETIMS), Purchase Request Process System (PRPS), Deployment Readiness System (DRS), and the Contract Business Intelligence Service (CBIS) programs. Implementing CAIV required each program team to stratify and cost-out customer identified requirements. This was a significant effort requiring the Program Management office (PMO) to staff with subject matter experts who could help translate customer requirements into functional requirements, and cost analysts who could then develop high quality cost estimates for each stratified requirement. During this phase of the acquisition program, the PMO team requires approximately 25-50% more resources than what is required to execute and administer the contract once awarded. Those additional resources must also cross a variety of functional knowledge including Systems Engineering, DoD Architecture Framework (DODAF) Architecture, Information Technology (IT) systems, and understanding of legacy systems that will interface with the end product.
- ii. Single Process Initiative (SPI). Defense Secretary Perry’s memorandum of December 6, 1995, on SPI requested the acquisition commu-

---

nity to circulate guidance for making block changes to existing contracts in an attempt to unify the management and manufacturing requirements of those contracts on a facility-wide basis, wherever such changes are technically acceptable to the government. The goal was replacement of multiple government-unique management and manufacturing systems with common, facility-wide systems that should, in the long run, reduce the costs to both contractors and DOD. SAF managed SPI for the Air Force during the mid-1990s until it was codified in Defense Federal Acquisition Regulations Supplement (DFARS) 211.273, Substitutions for military or Federal specifications and standards and the contract clause at 252.211-7005, Substitutions for Military or Federal Specifications and Standards. We believe there were SPI cost savings/avoidances; however, there was not sufficient effort done on most SPIs to quantify actual savings or future cost avoidances.

- iii. Software Applications using nongovernmental Enterprise Resource Planning (ERP) specifications in conjunction with System Integration (SI) Contractors. The 554th Electronic Systems Group (ELSG) initiative relates the DFARS to implement the policy set forth in Office of the Undersecretary of Defense (Acquisition and Technology) memorandum dated April 30, 1997, as it relates to the SPI and new contracts. This interim rule encourages offerors to propose the use of nongovernmental specifications and industry wide practices that meet the intent of military or Federal specifications and standards, and establish procurements of previously developed items. Defense Enterprise Accounting and Management System (DEAMS) savings to the Defense Finance Accounting Service (DFAS) are substantial. As the Analysis of Alternatives (AoA) states “In addition to operating costs savings, there are also DFAS personnel savings due to the deployment of the DEAMS system. The DFAS total labor savings estimate is a total 357 work years.”
- iv. As the Air Force lead for Acquisition Quality Assurance (QA), SAF/AQR collaborated with industry associations in the development and replacement of military QA standards. Military QA standards Mil-Q-9858A and Mil-I-45208A were canceled in 1996. In its place, DoD contractors were encouraged to use commercial QA standards such as the ISO 9000 quality management standards. Emphasis was also placed on building quality into a product and holding the contractor responsible for quality instead of having Government QA specialist inspect for quality. This office also coordinated DoD adoption of AS 9100, Quality Management Systems - Aerospace - Requirements, in 2001 for use in DoD acquisitions. Visible savings are seen in the number of 1910 quality assurance specialists currently assigned to Air Force Materiel Command (AFMC). The number of GS-1910 QA specialists dropped from well over 1,000 in both Air Force Systems



Command and Air Force Logistics Command in 1990 to a little over 500 in AFMC today working system acquisition and sustainment programs.

- v. Workload increased, in the form of surveys, questionnaires, and reviews. Office of Secretary of Defense (OSD) oversight has become a much greater burden (Integrating Integrated Product Team (IIPT), Overarching Integrated Product Team (OIPT), and the Defense Acquisition Board (DAB) structure). The Program Objective Memorandum (POM) process has become more complex
- vi. With respect to organizational changes, the 18 Oct 2001 Secretary of Defense memorandum on National Security Space management and operations established the Under Secretary of the Air Force as the DoD Executive Agent (EA) for Space to streamline space acquisition. The DoD EA for Space was also dual-hatted as the Director of the National Reconnaissance Office (NRO) and the Milestone Decision Authority (MDA) for space acquisition. However, the Director of the NRO was separated from the EA for Space in 2005. The Under Secretary of Defense for Acquisition, Technology and Logistics (USD, AT&L) currently possesses MDA for all space Major Defense Acquisition Program (MDAPs). based on a 25 March 2005 USD (AT&L) memorandum and reaffirmed in a 4 January 2006 USD (AT&L) memorandum.
- vii. AF Contracting recently completed an effort to consolidate Major Command (MAJCOM) Supplements to the Federal Acquisition Regulation (FAR) under one Operational Supplement. This effort has streamlined and standardized processes and policies to help increase efficiency and productivity.
- viii. Review, Discuss and Concur (RDC) process had the following effects:
  - (1) Streamlined sole source contract award procedures.
  - (2) Reduced documentation required while cutting time to award by 30%.
  - (3) Enhanced source selection team's ability to ensure offerors really understood AF requirements.
  - (4) Streamlined AF evaluation of proposals by reducing documentation review to an absolute minimum.
  - (5) Cut time to award by 25%.

- 
- ix. Long-Term Pricing Agreements (LTPA) had the following effects:
    - (1) Joint Direct Attack Munition LTPAs enabled immediate 1998 production ramp-up during Operation ALLIED FORCE in Kosovo.
    - (2) Reduced time to contract award from months to days, while maintaining current pricing.
    - (3) Streamlined program office manning. Reduced typical System Program office (SPO) size by 50% from 1990-2005.
  
  - x. Acquisition initiatives are continually added to the program management oversight requirements levied on programs through the DoD 5000 series and various policy memoranda. In many cases, the need to respond to these requirements is independent of the “standard” programmatic process. When coupled to requirements to respond to GAO, Congress, DoD Inspector General (IG), Service IGs and other programmatic requests for information, this burdens both the program office and the prime contractor in time and resources to respond to “new” protocols and personnel with little or no level of familiarity with the program. In keeping with the DoD Directive (DoDD) 5000.1 to streamline the management process, an effort must be made to harmonize these initiatives within the standard oversight process maximizing reuse of data provided, etc. The amount of data provided to DoD and the Services for Acquisition Category (ACAT) I C/D programs is formidable and is the basis from which these requests for information for “new” initiatives are satisfied. Hence, if the DoD and Service initiative owners were to use materials routinely provided a great deal of rework could be avoided.

**c. Impacts of Collaborating with Industry**

- i. As a Center, we collaborate with industry on a wide variety of acquisition processes and issues via various forums. Examples of recurring industry collaboration at ASC are:
  - (1) Regular recurring Partnership With Industry Days (PWID) involving a number of contractors with large business base or major contracts allows for a better exchange of information and a better understanding of business processes and expectations that results in a better understanding of each other’s needs and objectives.
  - (2) Industry Days in connection with competitive Requests for Proposals (RFPs) for significant acquisition program contracts allow prospective offerors for major source selections to hear oral presentations clarifying RFP requirements and how the source selection will be made and to meet individually with the government

program team to discuss the RFP and planned contract provisions in a more confidential environment.

- (3) When the acquisition environment permits, notably on high-dollar sole-source programs where competition is not feasible, there is additional collaboration with industry in areas such as acquisition planning, risk management, and achieving important program milestones. These meetings allow the notion of government and industry cooperation to efficiently achieve common goals for a program.
- ii. In our view, collaboration with our industry partners is an inherent part of how we do business and is essential to improving agility and delivering the best possible products to the Using Commands. Working closely with Industry helps them better understand what the warfighter's requirements are and helps the Air Force better understand what industry is able to accomplish to meet warfighter needs. This synergy enables both government and Industry to avoid false starts and the associated manhours of wasted effort. It also paves the way for us to meet the demands for rapid delivery of capabilities to the warfighter. Because collaboration is part of our normal business processes, it is not possible to discretely identify resource savings due to avoidance of wasted effort. It should also be noted that, in our opinion, the more we collaborate with industry, the more additional resources (people and travel dollars) are required.
  - iii. Price Based Acquisition establishes the price based on competition or other price analysis. The contractors did not have to expend resources on sweeps internally and with their vendors to comply with TINA. (JDAM, JASSM, WCMD had competition, AMRAAM had a TINA waiver, but is now having to get certified cost and pricing data.)
  - iv. Use of Long Term Price Commitment Curves supported by competition and/or long term J&As enabled contractors to establish long term relationships with their vendors. (JDAM, SFW, JASSM, WCMD, AMRAAM):
    - (1) For example, the Production Price Commitment Curve (PPCC) agreement for JDAM (versus Certified Cost/Pricing) provides the Government with stable pricing as long as production quantities remain above a threshold. This PPCC agreement has also allowed Boeing the freedom to make continuous hardware and software changes to address obsolescence and to take advantage of technological advances to control costs as well as increase the weapon system's capability.

- 
- (2) While lean manufacturing has been a Boeing corporate initiative, the PPCC agreement with JDAM has greatly kindled Boeing's pursuit of lean manufacturing not only at their JDAM facility but also at their supplier's. This ongoing pursuit of lean has helped Boeing not only maintain their PPCC agreement but has ensured JDAM's continued high quality and reliability.
  - (3) As a result the Boeing JDAM team has won the Missouri Quality Award and the Shingo Award and has gained numerous accolades from the warfighter. Similar programs at Boeing such as the Small Diameter Bomb also benefit from the cost cutting and performance enhancing updates.
  - (4) Also, SFW used LTPA to save \$33.6M over 5 years with 6 Sigma, Lean, & partnering of the prime and supplier saving another \$129.9M.
- v. Planning for long-term warranties upfront in the design and development of the weapon system and providing the contractor(s) with configuration control—encouraged contractor(s) to design extended shelf life for systems, prepare for parts obsolescence. (JDAM, WCMD)
  - vi. Putting an Average Unit Price Requirement (AUPR) in the system specification so the contractor(s) can design the weapon system to a price—comparable to how the automotive industry designs to a price category for cars (luxury, economy, mid-size, etc.).
  - vii. Focus on key objective resolves conflict between goals, helps field programs on time. For JDAM it was affordability—emphasized in source selection, throughout program. For SDB, focus spelled out in commander's intent.
  - viii. IPT pricing is the recognized term in the AFFARS for negotiating as teams vs. using the traditional negotiation method of throwing numbers back and forth over the fence. (JDAM, JASSM, WCMD, AMRAAM):
    - (1) Streamlined time consuming process.
    - (2) Reduced contractor preparations costs.
  - ix. Industry Days and use of Draft RFPs:
    - (1) Useful in making sure industry understands requirements, directions, etc.
    - (2) Government understands/recognizes industry concerns prior to starting source selection.

- x. Annual National Defense Industrial Association symposia (and similar events) review opportunities to match emerging technologies with warfighter needs:
  - (1) Focus industry on important issues such as à fuzes, directed energy, interfaces (UAI), etc.
  - (2) Helps to align industry IRAD and other investments.
- xi. Surge in JDAM production following Sept 11th:
  - (1) The JDAM program was challenged to ramp up production capacity to 3000 units per month. The program office awarded an undefinitized contract action (UCA) to Boeing to achieve those rates.
  - (2) Boeing and the Government formulated JIPTs (Joint Integrated Pricing Teams) to conduct on-site reviews of the major subcontract costs reflected on Boeing's Priced Bill of Material (PBOM). During these subcontract JIPT sessions, conducted at each of the designated suppliers, the JIPTs reviewed, evaluated, and formed an objective agreement for the subcontract effort proposed.
  - (3) As a result of the close and timely collaboration between the program office and Boeing and their key suppliers, the cost of the high rate tooling and equipment was reduced from the initial estimate of \$125.6M to \$104.7M.
- xii. Universal Armament Interface (UAI):
  - (1) Industry members teamed up with each other and Government to develop a collaborative standard for aircraft to air-to-ground weapons.
  - (2) Implementation of UAI will avoid the \$15-100M costs associated with each weapon/aircraft interface required for each weapon variant or new aircraft.

---

#### **d. Impacts of Automation**

- i. During this period, implementation of automated software systems has generally improved our organizational effectiveness and efficiency. Specifically, automated web-based systems have enhanced our internal/external communications and concurrently increased our ability to produce consistent quality contractual documentation. Consequently, we have seen an overall reduction in operational acquisition lead times during this period.
- ii. With respect to resource impacts, automated software systems have allowed us to continue meeting our mission requirements during this period while our manning has significantly decreased.
- iii. Email systems have probably provided the greatest amount of increased efficiency, especially with the use of the Weekly Activity Reports (WARs) which allow a myriad of people to remain informed on our programs. Also, Video Teleconferences (VTCs) have allowed for more face-to-face meetings without wasted time traveling. Automated Business Services System (ABSS) business document system has improved processing accuracy, documentation retention and processing time. Integrated Budget Documentation and Execution System (IDEC) investment document system has improved accuracy, documentation retention and processing time. Wide Area Workflow (WAWF) receiving report system has improved accuracy, documentation retention and processing time and most importantly vendor interest penalties.
- iv. Not all impacts were positive. Some unintended consequences were:
  - (1) Major automated systems require significant resources (funds, people & time) to maintain and evolve - some evolutions are not helpful.
  - (2) DTS system requires approximately 1.5 manhours MORE to process a single TDY order than previous semi-automated system in ABSS and previous manual paper system.
  - (3) Converting to new databases has left historic information unavailable (i.e., reports on personnel from 1990).
  - (4) Attempts to consolidate seem to both help and hurt resulting in no real improvement. "One size fits all" results in mediocrity everywhere.
- v. Overall, the impact of major automated software systems has been positive. Systems such as the Knowledge Management Decision Support (KMDS) system used by the Joint Staff for requirements management, the CPAR Automated Information System (CPAR AIS) used

by DoD for collection of past performance information and the Consolidated Acquisition Report System (CARS) used for program baselines and the Selected Acquisition Report (SAR) are all well integrated into DoD and Service workflows in which the Joint Strike Fighter (JSF) Program participates. Many other systems are involved such as those for physical and personnel Security, Budget/Financial and Contracting. Most impacts have been short term technical integration issues given the nature of the JSF Programs' complicated network environment with connections to geographically dispersed Government, International Partner and Contractor operating sites and various networks (e.g. Navy/Marine Corps Intranet (NMCI)). The Net Centric Enterprise Services paradigm seems to be supporting and reducing integration issues and facilitating use of these systems. JSF Program Office organizational manning (roles and responsibilities) and resources have been planned for the incorporation use of these systems.

- vi. Introduction of the various IT systems has significantly improved action officer (AO) productivity. Access to internet information portals has increased AO productivity through easy access to current acquisition policy, best practices, and lessons learned (e.g., Air Force e-Publishing, Hill AFB FAR Site Contracting Laboratory, and the DAU Acquisition Community Connection). Improved "global" e-mail address lists have also contributed to increased AO productivity by allowing timely interchange of information and decisions. The recent introduction of the System Metric and Reporting Tool (SMART) has improved access to program status for the Chief Engineer assessments for Acquisition Strategy Panels and program reviews.

### 3. Shortfalls/Gaps

- a. Air Force organizations identified the following shortfalls/gaps regarding organizational structure:
  - i. Duplicate chains of authority do exist - specifically the division of duties between XP, FM, and AQ. This slows our responsiveness and duplicates efforts.
  - ii. An Air Force initiative to move the Program Executive Officers (PEOs) to the field has increased workload on the Capability Director (CD) staffs (AQI, AQP, AQQ). Much of the work done by the PEO staff (coordination of program documentation with Air Staff offices, monitoring of program execution, interfacing with AQXR, etc.) has been moved to the CD's offices (and onto the Program Element Monitor's shoulders) with no increase in CD manpower. Some of this work is now being done at both locations (CDs in the Pentagon and PEO offices in the field), resulting in duplication of effort and overlap of responsibilities. Confusion also remains regarding who is responsible for

---

certain execution responsibilities, with some organizations looking to the CD as the lead office and other offices looking to the PEO (who is officially charged with program execution).

- iii. Initiative: Establishment of the Joint Logistics Systems Center and subsequent cancellation caused major delays and abandonment of AF, Army, and Navy information systems developments. Estimate of resource impact of initiative: The cost is un-calculable but the fact is the Military Services were not able to field new information programs to support many operational elements, such as Depot Maintenance, Digital Technical Orders, and Supply Chain Management. Impact of any unintended consequences: The Military Services lost over 5 years of possible resource savings and reduced organization's effectiveness and efficiency.
- b. Air Force organizations identified the following shortfalls/gaps regarding oversight and reporting requirements:
- i. There is too much involvement at the OSD level. OSD should designate a lead service and let them work the program. Instead, OSD is giving programs to OSD Agencies so they can do daily management.
  - ii. OSD is taking a much more active role in program review and oversight. This increased role resulted in the Working Integrated Product Team (WIPT), Integrating Integrated Product Team (IIPT), Overarching Integrated Product Team (OIPT) and Defense Acquisition Board (DAB) structure. Supporting all these reviews is a significant activity and significantly drives additional cost and manpower requirement to ACAT I programs (either Major Defense Acquisition Programs or Major Automated Information Systems). In addition, the emergence of the OSD Networks and Information Infrastructure (NII) office as a key player in the program oversight role for some C4ISR programs has created separate reporting and review requirements.
  - iii. While policy states there are only two layers between the Program Manager (PM) and the MDA, in reality there are several other "check-points", depending on the level of the MDA. The new alignment of AFMC into the Wing/Group/Squadron structure has clouded this arrangement. Example: Suppose a Squadron Commander is an ACAT IC PM. This person would have to go through approval levels at the Group, Wing, PEO, and CD before briefing the SAE for a decision. Even if the "reporting" structure on paper is PM-PEO-SAE, the other levels constitute a parallel chain that must be kept abreast of the program decision-making process. Further, there is a significant amount of outside influence that should be considered. At times, the user is too involved in the program (significantly beyond setting the requirements). As an example, some users are involved in defining



requirements and working with battle labs to develop/select specific solutions concurrently. Other negative outside influences are funding decision impacts through the POM build process at the MAJCOMS/HAF level.

- iv. Finally, the impact of the creation of the Chief Information Officer (CIO) for each service is still not fully known. The specific role of the CIO is still evolving, and the CIO's specific role in the acquisition process is not clear. This might eventually drive another reporting chain—it's already resulted in additional reporting requirements.
- c. Air Force organizations identified the following shortfalls/gaps regarding automation impacts:
  - i. In considering unintended consequences, the widespread implementation of automated software systems has created a number of situations where non-compatible cross-functional automated systems have been mandated to interface in the contracting/acquisition process. While automation is typically implemented with the intention of improving efficiency/capability, actions must be taken to ensure that interface "compatibility" is carefully considered when mandated use of an automated system is contemplated.

#### 4. **Personnel Issues: Recruiting, Retention, Professional Development Requirements**

- a. One PEO noted that their organization is not an organically manned so personnel located at many geographically-separated sites are assigned to the PEO from several "resourcing" organizations. Personnel and manpower is not managed centrally, but a unified view of current, not historical, PEO personnel and manpower information is maintained. This arrangement generates management inefficiencies and a coordination burden to man and track the over 1000 full and part-time positions.
- b. The Defense Acquisition Performance Assessment (DAPA) report published in Jan 2006 made recommendations to improve the outcomes of the Defense Acquisition System in four major elements; Organization, Workforce, Budget, and Requirements. In the Workforce element the DAPA report recommended the need to "Rebuild and value the acquisition workforce, and incentivized leadership". DAPA further recommended "Immediately increase the number of federal employees focused on the critical skill areas, such as program management, system engineering, and contracting."
- c. Acquisition Reform put our workforces in a passive observer role and nearly destroyed our tools/processes for oversight. Several career fields were identified as "not inherent government functions" and personnel

---

assigned to them had to be eliminated and the responsibility transferred over to contractors building the hardware. SMC alone has suffered >2,000 personnel cuts in such areas as Industrial Specialist, Configuration Management, etc. We are now in the process of re-building these career fields.

- d. **Systems Engineering Revitalization.** Under acquisition reform and the Total System Program Responsibility (TSPR) concept, where the military gave responsibility for system development to industry and retained only a reduced level of oversight, the technical community and acquisition programs have suffered. Less government oversight led to less detailed insight, and many advertised initial cost savings due to manpower savings became cost and schedule overruns as many systems failed to meet requirements. We have eliminated TSPR as a process and are again strongly emphasizing the need for rigorous application of key systems engineering (SE) processes and sub-processes throughout the life cycle of all Air Force systems. These critical elements include, but are not limited to, such things as technical planning; technical reviews; decision analysis; management of requirements, risks, configurations, baselines, interfaces, and data; and measures/metrics.
- e. Under Air Force Smart Operations for the 21st Century (AFSO21) we have the vehicle and leadership support for the following actions.
  - i. Improve the Civilian Hiring Process for Acquisition related positions by reducing the cycle time to no more than 30 days to fill a vacant civilian position.
  - ii. Improve Air Force Contract Closeout by reducing the backlog from 48 months to 24 months thereby reducing workload on Acquisition related positions.
  - iii. Delegate Acquisition documents/Milestone reviews to lower leadership levels.
- f. **Force Development (FD):** Air Force Contracting has a number of FD initiatives to improve our FD processes to ensure we develop our civilian and officer workforce to produce the kind of leaders we need for tomorrow's Air Force-developing breadth and depth of experience, providing leadership opportunities, promoting education and training. AF Contracting stood-up a combined military and civilian Development Team to review and access the records of our officers and civilians and provide vectors (advice) to them on their future development (education and assignment) needs. To-date, we have vectored our GS-15's and 14's and all of our Field Grade officers. This year, we will also vector our GS-13's. Additionally, SAF stood-up a new development program for our officers called PACE. PACE is a competitive opportunity for Program Managers and Contracting officers to complete a tour in the other career field, earn a

Master's degree and return to their original career field with a broader Acquisition perspective.

- g. Required very selective manning; no room for the “average” employee or DoD priority-placement candidates. Employees reluctant to attend more lengthy (> 2 weeks) training; impacts high-performers’ professional development. Increased reliance on contractors as a result of the mid-90’s desire to retain in service only those functions that are inherently governmental. Organization became very highly leveraged. As a result, most recent effort to reduce contractors and push back to government operations, without increasing civilian workforce is highly impactful. Reliance on contractors (TSPR) greatly complicated the T&E business due to access limitations. Six Degrees of Freedom (6DOF) models of the weapons, flutter and loads data for aircraft, etc were no longer available. Additional funding had to be used to acquire and, in some cases, to redevelop this data.

#### **IV. Joint Acquisition**

##### **1. Joint Programs Led by Department of Air Force**

- a. The Air Force reported approximately thirty-three joint projects. The projects were evenly distributed across all reporting organizations.
- b. Joint Strike Fighter (JSF)—lead rotates between AF and Navy; joint, multi-national program to develop and field a three variant family of highly common and affordable strike fighters.

##### **2. Issues/Gaps in Capability**

- a. The major difficulty in managing a joint acquisition program is to develop a system that responds to multiple requirements without driving unnecessary risk and elevating costs. It requires more collaboration and multiple levels of approval chains due to the joint nature of the programs.
- b. Defense Integrated Military Human Resources System (DIMHRS): The Human Resources (HR) SPO is not the managing agency for this joint program, nor is it the Air Force program management office.
- c. DEAMS: Establishing proper governance at outset is most important key to success. Second priority is alignment of execution roles across participating team members to ensure participating agencies are properly engaged in roles that leverage their expertise and agency.
- d. The JSF Program structure and charter has been to use the “best of breed” approach in adopting processes, procedures and practices from the Services and International Partners. This is aided by the fact that there is no lead service. The Component Acquisition Executive (CAE) alternates in

---

opposition to the alternation of the PEO(JSF) between USN and USAF. This obviates, in many respects, the clash of cultures between services. The down side is the need to coordinate, develop and implement joint processes. Although a certain amount of “borrowing” from previous/ongoing joint programs is possible and practical, there remains the need for the coordination and socialization of these joint methodologies. Additionally, managing the differing manning priorities and practices between the services is a challenge in order to avoid gaps in talent and expertise.

### 3. Challenges/Difficulties in Joint Programs

Air Force makes the following comments and recommendations regarding joint acquisition issues:

- a. Tie requirements to funding provided for true joint programs.
- b. Cost sharing—with varying priorities and requirements between services the ability to equitably share development and sustainment costs is a major challenge. Memoranda of Agreement (MOAs) supported by independent cost estimates can provide clear visibility into critical cost elements and distribution of costs among service.
- c. Implementation of facilitated requirements review followed by an independent technical review provides a disciplined process to identify and validate program requirements.
- d. The co-location of 46Test Group, Det 1 (USAF) and a US Navy T&E Det at White Sands Missile Range (US Army) offers a tremendous potential for joint T&E/acquisition activities. This potential has been largely unrealized to date. However, talks have begun between the principals in the local area (Det commanders, Test Group/CC, Army Test Center CC, and WSMR Director) to develop a Joint Test Office as a first step towards an enduring, robust joint test organization. Assistance will be needed with manning/funding as this process goes forward.
- e. Program coordination and planning effort is required for any joint program that requires sufficient manpower funding for that specific project/task. The environment is constantly changing and we must be agile enough to meet multiple threats. This poses an extra degree of difficulty in joint programs.
- f. Integrated funding strategy is required in order to balance against different service program priorities and planning. Each of the services must balance all of their programs (joint and service unique) on projected FY budget expectations and joint programs make this effort more challenging. There needs to be one color of money and one set of rules for how the money is used.

- g. Integrated requirements are essential. Conflicting requirements can be a problem when one service makes a performance trade impact due to a limitation of a sister service. Requirements changes by one service can adversely impact another service's schedule and cost.
- h. Integrated personnel considerations are important. It is difficult to get people to relocate to high cost areas (such as Wright-Patterson to DC). It may be harder to recruit USAF employees or prior-service USAF personnel to relocate to a Navy base, than it would be to recruit them at a USAF base where they may have more ties and cultural affiliation and vice-versa. Previous training, certifications, and experiences are going to be different.
- i. Different services use different types of jet fuel/oils/lubrications; aircrew personal gear is different from one service to another; tech orders are harder to write and maintain for more than one service. The sustainment structure becomes quite complex.
- j. All joint acquisition programs must have the following to be successful:
  - i. Constant communication.
  - ii. Clearly document joint decisions.
  - iii. Document a clear process for issue resolution.
  - iv. Stabilize funding and requirements. One color of money is imperative.
  - v. Properly compensate employees when moving to a high-cost area so there is no decrease in the standard of living for the family.
  - vi. Direct a single service to be responsible for all sustainment on weapon systems.

## **V. Department of Air Force Recommendations**

### **1. Organizational Issues**

- a. Air Force makes the following recommendations regarding review levels:
  - i. ACAT I—OSD NII or AT&L DOD per 5000.2. ACAT II—SAE. ACAT III— PEO (Recommend significant delegation below PEO level. Rationale: Too many small programs are ACAT III. Keeping delegation at PEO level creates a bottleneck. Alternately, revive ACAT IV.
  - ii. ACAT ID: Defense Acquisition Executive (DAE) (no change). ACAT 1C: CAE (but can be delegated to PEO if appropriate). ACAT II: PEO. ACAT III: PEO.

- 
- iii. The MDA for ACAT I space programs should reside with the Under Secretary of the Air Force. MDA for ACAT II and III are appropriately delegated to the Program Executive Officer (PEO) for Space.
  - iv. The DAE for ACAT I programs, and the PEOs for ACATs II and III programs. This would provide sufficient oversight and consistent procedures for all Milestone Decisions.
  - v. ACAT 1D programs should remain at with USD(AT&L) since by nature these programs involve multiple services and/or high interest/high dollar value acquisitions that are best evaluated above the service level. ACAT IC programs should be at the SAE level since they are large enough and tend to be politically sensitive enough to warrant top level oversight/decision making. SAE could delegate to the PEO who serves as the senior acquisition official for weapons, authority has been vested in this individual to carry out these responsibilities. ACAT II programs should reside with the PEO. ACAT III should be delegated to the Wing Commanders/Directors in accordance with DoD guidance that calls for decisions to be retained at the lowest possible levels.
- b. Air Force makes the following recommendations regarding restructuring:
- i. Eliminate SAF/XC, and AFC2ISRC.
  - ii. Centers of Excellence should be formed for the other AF Acquisition Enterprises to mirror the Air Armament Enterprise at Eglin. Having all components of the Acquisition process from lab, SEEK EAGLE, development and sustainment in one location along with the complete complement of T&E (DT&E, LFT&E, IOT&E, OT&E) helps to guarantee success through synergy. Collocation of the Air Armament Enterprise (lab, SEEK EAGLE, weapons program offices and T&E) are essential for efficient and effective operation.

## 2. Resource Issues (Personnel/Funding)

- a. Air Force makes the following recommendations regarding funding and acquisition processes:
  - i. Simplify the POM process.
  - ii. One major change initiative, the transition to the Planning, Programming, Budgeting, and Execution (PPBE) System, has caused significant concerns. As currently structured, the PPBE process is addressing shortfalls in Operations and Maintenance (O&M) accounts by using Investment funds (RDT&E and Procurement) as sources. This is leading to program funding shortfalls and instabilities. In addition, the

current fiscal constraints have made the creation of the POM significantly more complex.

- iii. The single most effective change that would increase overall Defense acquisition stability would be to “fence” investment funds (RDT&E and Procurement). This would curb the ability to reprogram money from investment accounts to O&M and Military Personnel accounts, eliminating the significant program impacts seen in 2005 and expected in 2006 as Services cut investment to pay for ongoing operations and Military Personnel (MILPERS) shortfalls. This change will lead to increased program stability, overall.
- iv. First, there should be a greater emphasis on finalizing user requirements before acquisition programs advance too far down the process. Changes in requirements during the acquisition process are historically a major driver of cost growth and schedule slips. Second, we must decrease our reliance on breakthrough technologies to meet deployment schedules but rather field programs in blocks that take advantage of lower-risk, mature technologies. Finally, funding for acquisition needs to be stable. Frequent changes to a program’s funding make it difficult for a Program Manager to effectively execute his or her program and contribute to higher prices at the sub-contractor/supplier level. This approach is consistent with the Under Secretary of the Air Force’s “Back to Basics” vision for space acquisition.
- v. Implement the recommendations of the Defense Acquisition Performance Assessment Report. For example:
  - (1) The budget process should be reviewed to ensure a long range view where short term cuts for savings today don’t create long-term cost increases
  - (2) Streamline oversight to make clear the lines of authority, responsibility, and accountability to ensure multiple staff functions don’t “take over” an acquisition. The acquisition system should be process focused, not program focused.
  - (3) The resource allocation process often starts more weapons programs than it can afford, leading to competition for funding that often results in the shifting of funds from well-performing programs to pay for poorly performing ones. Program resource stability is consistently a number one factor in program success.
  - (4) Acquisition programs are often started too early, prior to the required technology maturation, resulting in cost growth and schedule delays while technologies are proven. Technology development

---

should occur and be funded in the laboratory, with maturing capabilities fielded through a spiral development process.

(5) Key requirements must be identified and locked into the program baseline. Program managers should not feel compelled to continue to accept new requirements throughout program development, which increases technical cost and risk, and delays the program schedule. No major changes should be made in program specifications after the start of development. There needs to be a tolerance for risk and uncertainty that occurs in weapons systems development. Programs should be funded with sufficient management reserve to cover unknown issues that must be solved for program success.

b. Air Force makes the following recommendations regarding personnel issues:

- i. Have certified acquisition professionals more involved in pre-acquisition activities such as requirements development, concept refinement, analysis of alternatives (AoA), etc. In particular, better documentation of systems engineering and trade studies would better support later acquisitions activities, typically worked by a completely different set of people and organizations.
- ii. There needs to be a program management university. The current programs teach process but not the detailed courses and techniques needed to be a Program Manager of ACAT I programs.

3. **Policies and Procedures Issues (needed to improve outcomes):** None.



# Annex D

## Combatant Commands

---

Two of the nine combatant commands (COCOMs) have significant acquisition capabilities: Special Operations Command (SOCOM) and Transportation Command (TRANSCOM).

This annex describes SOCOM's and TRANSCOM's acquisition programs as required by Section 814 legislation. It specifically addresses the following for each command, beginning with SOCOM's Special Operations Acquisition and Logistics (SOAL) Center:

- ◆ Current organization and its evolution
- ◆ Mission and capabilities
- ◆ Joint acquisition
- ◆ Recommendations.

The information presented in this annex was compiled from the 814 Review Survey responses and supplemented with information from SOCOM and TRANSCOM documents and Web sites. Both SOCOM and TRANSCOM have formally released their sections of this annex.





**UNITED STATES SPECIAL OPERATIONS COMMAND**  
OFFICE OF THE ACQUISITION EXECUTIVE  
7701 TAMPA POINT BLVD.  
MACDILL AIR FORCE BASE, FLORIDA 33621-5323

Special Operations Acquisition and Logistics Center

Executive Summary

The Special Operations Acquisition and Logistics (SOAL) Center directly enables the missions of the United States Special Operations Command (USSOCOM) by providing acquisition, technology, and logistics support to Special Operations warfighters. Because Special Operations Forces (SOF) are joint forces, USSOCOM acquisition programs are inherently joint programs from inception. USSOCOM uses three oversight and management strategies: milestone decision authority (MDA) and program management responsibility retained within USSOCOM; MDA retained within USSOCOM but day-to-day program management responsibility assigned to one of the military departments (MILDEPs); both MDA and program management delegated to one of the MILDEPs.

USSOCOM benefited from the Department of Defense (DoD) and Congressional acquisition reform and other related initiatives of the 1990s and early 2000s. These reforms and initiatives had a significant influence on the development of USSOCOM's acquisition capabilities, organizational structure, policies, processes, and procedures. Because USSOCOM's acquisition organization and processes were in the early stages of formulation during this same timeframe, the DoD and Congressional reform policies and streamlining initiatives were readily adopted and today are well established in SOAL's day-to-day operations. This fortunate confluence of events also created a cultural environment within SOAL that stresses innovation and process efficiencies, both of which have enabled SOAL to produce an agile, effective acquisition response to the rapidly evolving demands of the Global War on Terrorism.

The cornerstone of the USSOCOM acquisition philosophy is to knowingly accept risk and then thoroughly understand and manage it. Each program manager (PM) and procuring contracting officer (PCO) is encouraged to create innovative system development and contracting strategies, and to make maximum use of spiral development, the tailoring and streamlining of documents and processes, and the various waiver authorities that exist under statute, regulation, and/or policy. Process efficiency, innovation, and agility are further enhanced by virtue of a small, but knowledgeable oversight and management staff, and the fact that only two individuals in the decision chain have the authority to say no--the USSOCOM Commander and the Special Operations Acquisition Executive (SOAE). This in turn creates an extraordinarily high level of responsiveness to the warfighters' needs.

While not part of the formal acquisition process itself, there are two other noteworthy aspects of the Command's management philosophy and associated processes which

---

greatly enhance the effectiveness of the acquisition process. The SOAE is an integral part of the two major USSOCOM planning processes--the Strategic Planning Process (SPP) and the Long Range Planning Process (LRP). The SOAE is also a voting member of the Special Operations Command Requirements Evaluation Board (SOCREB) which is the USSOCOM operational requirement approval body that is equivalent to the AROC, NROC, MROC, and AFROC in the respective Services. Thus the SPP, LRP, and operational requirement generation and approval processes all benefit from having strong acquisition, technology, and logistics input throughout their respective planning, deliberation and approval cycles.

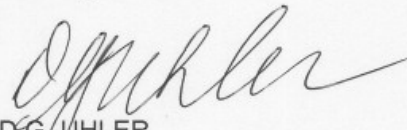

D.G. UHLER  
Acquisition Executive

## I. Current Organization

The Special Operations Acquisition and Logistics Center (SOAL) has benefited from the Department of Defense (DoD) acquisition reform and other major initiatives of the 1990s and early 2000s. The reforms and initiatives had a significant influence on the development of United States Special Operations Command's (USSOCOM) acquisition capabilities, processes, and procedures. Since USSOCOM's acquisition organization and processes were in the early stages of development, the DoD reform policies and streamlining initiatives were readily adopted and today are well established in SOAL's day-to-day operations. Figure D-1 shows the present SOAL organization.

Figure D-1. Special Operations Acquisition and Logistics Center

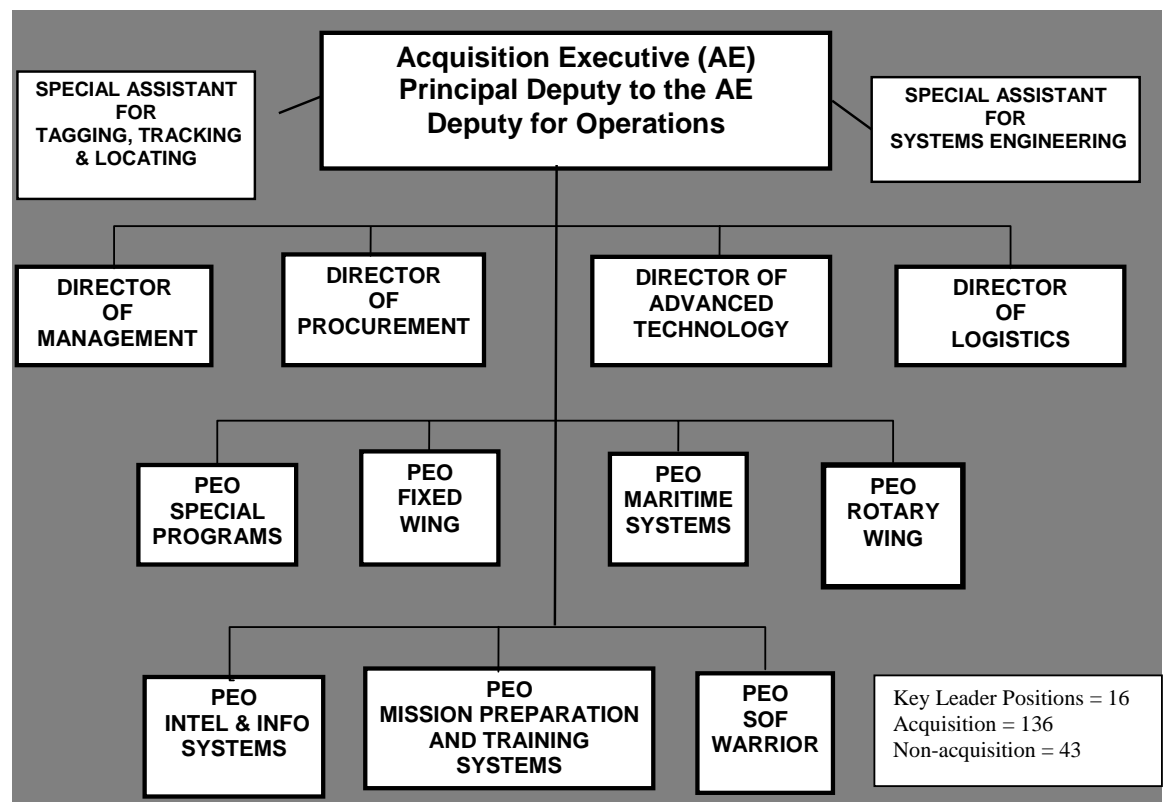

Of the 136 acquisition personnel, all are located at MacDill Air Force Base, Tampa, FL except for one individual who is located in Lexington, KY.

## II. Evolution to the Current Structure Since 1990

### 1. Service Acquisition Executive Headquarters Staff (SAE HQ/Staff)

Two SECDEF decisions influenced the current structure. First, the decision to add a Marine Corps component to SOCOM. Second, assigning SOCOM the responsibility for the new mission for the Global War on Terrorism (GWOT) leading, planning, synchronizing, and, as directed, executing global operations

---

against terrorist networks. This later responsibility was codified in the 2004 Unified Command Plan (UCP). As a result of the expanded GWOT mission, the Quadrennial Defense Review (QDR) program decision memorandum directed additional resources for the accelerated growth of USSOCOM, including its acquisition organization, SOAL. The most significant growth will occur through 2008. The growth in the Acquisition workforce positions allows SOAL to equip an ever expanding and increasingly diversified Special Operations Force (SOF), as well as to better comply with new Departmental acquisition and accounting policies and initiatives (e.g. System Engineering revitalization, Military Equipment Valuation, and Unique Identification).

## **2. Program Executive Office (PEO) Structure**

From 1990 to 1999, SOAL established itself as an Acquisition Center. After appointment of an Acquisition Executive, Four PEOs were established: Fixed Wing, Maritime and Rotary Wing (M&R), Special Programs, and Intelligence and Information Systems. Since the GWOT started, SOAL has split M&R into two separate PEOs, PEO Rotary Wing (RW) and PEO Maritime (NS). SOAL has also created PEO SOF Warrior and PEO Mission Preparation and Training Systems. This new structure was needed to support SOAL's increased acquisition responsibilities with an annual budget that has grown from approximately \$700M per year in the 1990s to over \$2B per year presently.

### **III. Mission, Capabilities, and Service Issues**

#### **1. Current Mission Statement**

Provide rapid and focused acquisition, technology, and logistics support to Special Operations Warfighters. Manage and/or oversee all Special Operations-peculiar acquisition, logistics, and technology programs.

#### **2. Capabilities Needed to Accomplish Mission(s)**

SOAL requires a well trained acquisition workforce that thoroughly understands the DoD 5000 process and the various ways to get equipment fielded.

#### **3. Shortfalls/Gaps**

Two unintended consequences of DoD acquisition reform initiatives are loss of organic Government systems engineering capability and, in some cases, Government over reliance on contractors to perform Government program management functions such as development of acquisition and program management strategies, cost estimating, and contract management support:

- a. SOAL is currently seeking to hire qualified Government system engineers, improve internal cost estimating capabilities, and increase management and executive level oversight of acquisitions assigned

to integrating contractors. SOAL is also working with the respective MILDEP acquisition organizations to obtain such support.

- b. USSOCOM continues to be challenged in its ability to monitor funds obligation and expenditure status. Recent USSOCOM, DoD Comptroller, and Defense Finance and Accounting System initiatives are improving capabilities.
- c. From an overarching DoD architectural perspective, the acquisition, logistics, procurement and financial management systems should be interoperable and utilize common data sets.

#### **4. Personnel Issues**

Recruiting, retention, and professional development steps needed:

- a. SOAL's workload has substantially increased since being assigned the GWOT mission. The resultant corresponding increase in buying and developing new equipment to support the war fighter has severely stressed our workforce. We are just now seeing some personnel growth.
- b. Tampa has a limited population of acquisition personnel and this population has limited experience thus we're unable to find fully qualified people to fill our positions, nor are we being able to attract large numbers of well qualified applicants from other DoD components. USSOCOM is a microcosm of DoD in terms of platforms and systems, so we need access to broad categories of experience, running the gamut of DAWIA career fields and the full lifecycle acquisition process.
- c. System Engineers are needed in each of the Program Executive Offices, but very few universities teach this field. Also some acquisition career fields have become very specialized with little training outside of DAU. Both situations hinder SOAL's ability to recruit personnel from this small DoD career pool.

#### **IV. Joint Acquisition**

Almost all USSOCOM programs are joint because SOF is a joint force. Thus SOCOM routinely performs joint acquisition. In addition to managing their joint acquisition programs using the SOAL organization, SOCOM also participates with the MILDEPs in their programs and vice versa. Examples include:

- a. At the ACAT I level, participating with the Navy, Marine Corps, and Air Force in the CV-22 SOF Osprey Tilt Rotor Aircraft program, the Army in the MH-47 and MH-60 programs, and the Army, Navy and Marine Corps in the Joint Heavy Lift program.

- 
- b. At the ACAT II level, participating with the Army and Air Force in programs that apply SOF modifications to Service provided aircraft and with the Army in the Small Unmanned Aerial Systems (SUAS) program.

Also, USSOCOM frequently uses program managers and associated technical expertise from the MILDEPs to manage USSOCOM programs and to provide acquisition and logistics support in management of Special Operations-peculiar, MFP-11 funded programs. An example is the SOF Combat Assault Rifle (SCAR). USSOCOM is the MDA. Navy provides the program manager. For the Advanced SEAL Delivery System, the Navy Department performs the MDA and PM function.

#### **1. Issues/Gaps in Capability**

- a. USSOCOM has experienced challenges influencing joint programs managed by the MILDEPs. Problem areas included trading away SOCOM requirements, timely MILDEP execution of USSOCOM program funds, cost estimating and control, information flow among USSOCOM acquisition staff and the MILDEP organization, and disparity in levels of executive review between the USSOCOM and MILDEP organizations. These issues were mitigated by rescinding previously delegated MDA from the MILDEPs for ACAT III programs and by negotiating USSOCOM Acquisition Executive participation with MILDEP Milestone Decision Authority (MDAs) for joint programs.
- b. The Command established a PEO for Rotary Wing aviation programs co-located with the Command Headquarters and SOAL. This organization provides increased focus and acquisition oversight of joint (MFP-11 funded) programs that apply SOF modifications to Service provided rotary wing aircraft as well as oversight of the Army programs that are producing the basic aircraft.

### **V. Recommendations**

#### **1. Organizational Issues**

- a. The DOT&E community has not kept up with Acquisition Reform and advanced technology for testing. The OT&E community:
  - Should test and report only on performance characteristics articulated in the requirements document; frequently, operational test personnel make gratuitous comments or expand the focus of the report beyond the formal testing parameters and boundaries.



- Accept modeling and simulation results in lieu of live fire testing, large scale testing, or complex system testing.
  - b. Invite USSOCOM AE to DAE, MILDEP AE, and component AE program reviews and decision meetings when the platforms or systems being discussed are those which affect SOCOM and its forces (USSOCOM is a microcosm of DoD and as such is extremely dependent on various efforts of the MILDEPs and the DoD components).
  - c. Find ways to attract employees having more breadth of acquisition PM experience (too few of our existing PMs and SAMs, and applicants for these positions, have experienced all phases of program life cycle (i.e. pre-M/S A through post-M/S C).
2. **Resource Issues (Personnel/Funding)**
- a. There needs to be stability of program funding. Lock in funding for longer periods of time so PMs can better plan.
  - b. Create and/or enhance programs to develop a pool of future experienced acquisition personnel. For example, internships for recent college graduates.
3. **DoD Policies and Procedures Needed to Improve Outcomes**
- a. Service Related proposals to improve outcomes:
    - Reduce size and limit the power of the layers of the OSD oversight staff (not the leaders but the staff).
    - If can't say "yes," shouldn't be able to say "no" in terms of approval of strategies and documents; nor should these review layers be allowed to continually delay sending a decision or document forward.
    - Don't require consensus before bringing an issue or request for decision to the leadership.
    - Eliminate inconsistent guidance from different individuals on the same staff.

---

b. Proposals to improve MILDEP lead on joint acquisition programs:

- Require signed agreements between lead MILDEP and non-lead MILDEP or component agencies to ensure non-lead agencies' concerns are addressed.
- Require non-lead agencies to attend milestone decisions and other major program events.

4. **Joint Issues**

- a. Create a safety review and certification organization and/or process with a built in adjudication mechanism. Currently certifications must be obtained from multiple services for similar items. Recommend enhancing and empowering the Joint Weapons Safety Working Group to find ways of consolidating testing requirements and/or organizations.
- b. Reform the Programming, Planning, Budgeting and Execution System to be more responsive to rapidly changing operational requirements and to provide necessary flexibility to the Acquisition Management System to respond to those requirements changes.

## United States Transportation Command

### Executive Summary

The United States Transportation Command (USTRANSCOM) acquisition workforce provides the resources to meet the USTRANSCOM mission by employing contract vehicles and program management to obtain the commercial transportation services required by the Department of Defense (DOD) and the information technology (IT) tools that enable the USTRANSCOM workforce and its customers.

On 6 August 2004, Secretary of Defense, the Under Secretary of Defense (Acquisition, Technology, and Logistics), the Assistant Secretary of Defense (Networks and Information Integration) and the Director of Defense Procurement and Acquisition Policy approved establishment of a USTRANSCOM contracting activity and delegated to the Commander of USTRANSCOM the authority to act as “head of agency” or “agency head” for the purposes of the Federal Acquisition Regulation (FAR) and the Defense FAR Supplement. USTRANSCOM became the third unified command, in addition to Special Operations Command and Joint Forces Command, granted acquisition authority.

The Commander, USTRANSCOM, has delegated authority to act as the Senior Procurement Executive, to the Chief of Staff, who delegated the head of contracting activity (HCA) to the Director, Command Acquisition.

To support this new mission, the command grew its contracting staff from a team of five to 25 world-class acquisition professionals in 2005. The Base Realignment and Closure (BRAC) legislation of 2005 significantly impacted acquisition within the command. As a result, the Command Acquisition Directorate will grow to an end-strength of approximately 150 personnel by fiscal year 2010. As the organization grows in scope and complexity, a Senior Executive Service (SES) leader is critical to focusing the command contracting and management functions in support of transportation and distribution for the Department of Defense.

USTRANSCOM also recognized the need for program managers to lead the acquisition of service and information technology development. The command possesses two O-6 program manager billets to lead the command’s two flagship programs, and has added O-5 and GS-14 program managers to establish policy for program management and provide assistance to the command’s smaller IT projects.

I am proud of the work each of these individuals has accomplished in standing up a world class organization and accomplishing the day to day mission. I am confident that USTRANSCOM is prepared to accomplish our acquisition mission today and in the future.

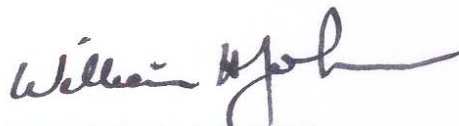

WILLIAM H. JOHNSON,  
Major General, U.S. Army  
Senior Procurement Executive



## I. Current Organization

### 1. General

The United States Transportation Command (USTRANSCOM) acquisition workforce provides the resources to meet the USTRANSCOM mission by employing contract vehicles and program management to obtain the commercial transportation services required by the Department of Defense (DOD) and the information technology (IT) tools that enable the USTRANSCOM workforce and its customers.

Currently, USTRANSCOM has four key acquisition leadership positions; one O-8 military position (Senior Procurement Executive), one GS-15 (Contracting career field), and two O-6 military positions (Program Management career field). A total of 31 acquisition personnel and 542 non-acquisition support personnel were assigned in 2005.

The USTRANSCOM organizational structure is presented in Figure D-2. The USTRANSCOM Commander has authority to act as head of the agency, subject to the direction of the Secretary of Defense, the Under Secretary of Defense (Acquisition, Technology, and Logistics), the Assistant Secretary of Defense (Networks and Information Integration) and the Director of Defense Procurement and Acquisition Policy. By memorandum dated 3 March 2006, the Commander, USTRANSCOM, delegated authority to act as the Senior Procurement Executive, to the Chief of Staff. By memorandum dated 3 March 2006, the Senior Procurement Executive delegated head of contracting activity (HCA) to the Chief, Command Acquisition.

Figure D-2. USTRANSCOM Flow of Contracting and Oversight Authority

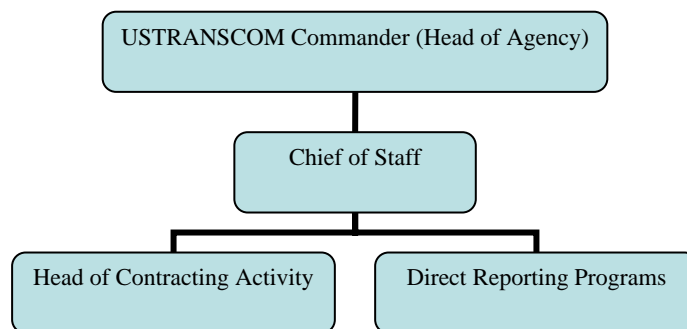

\* SPE–Senior Procurement Executive.

---

## II. Command Evolution (1990–2005)

USTRANSCOM did not have acquisition authority in 1990 but the command staff included one contracting professional (1102) to keep abreast of contracting policy. The command also employed several computer program management professionals (2210 and military equivalents) for management of the information technology (IT) infrastructure.

From the initial charter in 1987, USTRANSCOM sought acquisition authority to provide streamlined contract and program management, increased accountability for meeting program milestones and make supervision of transportation process initiatives more efficient. During the late 1990s, in the absence of an acquisition organization within the command, the Chief Information Officer (CIO) formed a team of program managers to oversee development of the command's IT efforts. The result was the CIO Program Review Process (CPRP) for prioritizing IT requirements and approving the associated funding. Today, Command Acquisition (TCAQ) is an advisor to the CPRP and provides acquisition advice to new and existing programs.

On 6 August 2004, Secretary of Defense, the Under Secretary of Defense (Acquisition, Technology, and Logistics), the Assistant Secretary of Defense (Networks and Information Integration) and the Director of Defense Procurement and Acquisition Policy approved establishment of a USTRANSCOM contracting activity and delegated to the Commander of USTRANSCOM the authority to act as “head of agency” or “agency head” for the purposes of the Federal Acquisition Regulation (FAR) and the Defense FAR Supplement. USTRANSCOM became the third unified command, in addition to Special Operations Command and Joint Forces Command, granted acquisition authority.

To execute this authority the USTRANSCOM Commander designated the Chief of Staff as the Senior Procurement Executive. The Chief of Staff then delegated head of contracting activity authority to the Chief of Command Acquisition. During 2005, the command grew its contracting staff from a team of five to 25 world-class acquisition professionals to comply with the laws, regulations and policies outlined in the memorandum. The command is also pursuing a Senior Executive Service (SES) billet to lead the acquisition organization.

A major event that impacted acquisition within the command was the Base Realignment and Closure (BRAC) legislation of 2005, which directed the consolidation of USTRANSCOM's Air Force and Army Service Component Commands at Scott Air Force Base, Illinois. The legislation further directed that the three organizations consolidate business operations to achieve greater efficiency. As a result, the Command Acquisition Directorate will grow to an end-strength of approximately 150 personnel by fiscal year 2010. The BRAC realignment has compelled Command Acquisition to mature at a pace much faster than is the norm for other DOD organizations. As the organization grows in scope and complexity, a Senior Executive Service (SES) leader is critical to focusing the command

contracting and management functions in support of transportation and distribution for the Department of Defense.

### **III. Mission, Capabilities, and Service Issues**

Command Acquisition is responsible for all matters relating to the execution and performance of contracts; the command's small business programs; competition in contracting issues within USTRANSCOM. Command Acquisition is also the business advisor to, and external liaison with, other DOD agencies.

A significant issue facing the command is that the local labor pool lacks a sufficient number of high-caliber candidates to support the addition of 43 contracting billets transferred from USTRANSCOM's Army component, the Surface Deployment and Distribution Center. Command Acquisition is working with our Personnel Office to identify alternative sources to reach "the best of the best" candidates.

In addition to the build up of contracting capabilities, the USTRANSCOM recognized the need for program managers to lead the acquisition of service and information technology development. The command already possessed two O-6 program manager billets; one to manage the command's data warehouse modernization effort and the other to lead an initiative to consolidate a substantial portion of DOD's CONUS trucking requirements into a single contract. In 2005, the command hired an O-5 and a GS-14 program manager to establish policy for program management and to provide assistance to the smaller IT projects. During an initial review of ongoing command activities, the team identified shortfalls in the following disciplines:

- Acquisition Management
- Business, Cost Estimating, and Financial Management
- Risk Management
- Scheduling and Earned Value Management
- Systems Engineering
- System Test & Evaluation

The command is developing new billet justification packages and funding for contractor support to meet these new mission requirements.

While the command does not currently manage any ACAT I programs, USTRANSCOM understands the value of qualified executive oversight for ACAT III programs. Command leadership recognized that the command's Deputy CIO possessed the qualifications and experience to perform executive oversight for IT programs. The USTRANSCOM Commander designated the Deputy CIO as

an advisor on program execution. The command has developed a charter that specifies the Deputy CIO's responsibilities and directs the Deputy CIO to report to the Senior Procurement Executive for all program execution-related duties. Once the command receives an SES, all acquisition executive responsibilities will transfer to that individual.

USTRANSCOM'S vision for the future acquisition organization is pictured in Figure D-3.

Figure D-3. USTRANSCOM Acquisition Structure

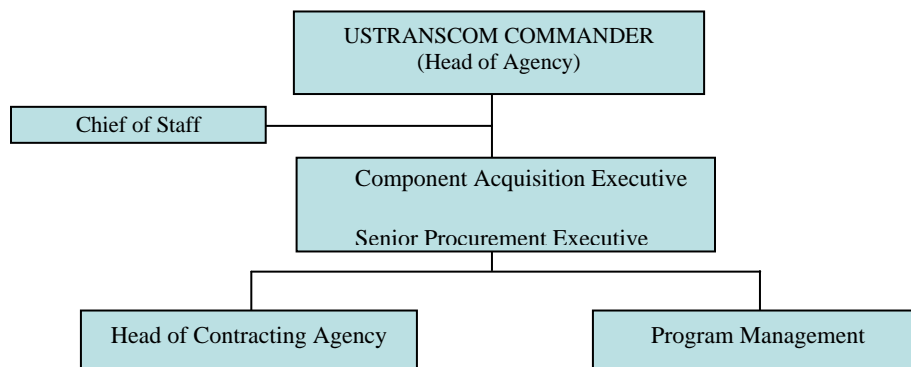

#### IV. Joint Acquisition

Prior to receiving acquisition authority, all of USTRANSCOM's significant acquisitions were performed by the Air Force. Our recent dealing with Defense Logistic Agency (DLA) on the Integrated Data Environment/Global Transportation Network Convergence (IDE/GTN) convergence is the command's first official joint acquisition experience. This effort will consolidate the existing data warehouses within DLA and USTRANSCOM and result in a common data environment that spans the majority of the DOD supply chain.

#### V. Recommendations for DOD Acquisition

USTRANSCOM submits the two following recommendations to improve the DOD acquisition process.

**Shortfall:** The Services and Components are routinely driven to manage acquisition programs without sufficient personnel/expertise on the government team.

**Recommendation:** The USD(AT&L) and the Defense Acquisition University (DAU) should publish guidelines that recommend the government acquisition management team composition (quantity and capabilities), dependent on the type of acquisition (weapon system, IT, service) and program size for ACAT I-III programs.



**Shortfall:** The Government historically has not done a good job of fully defining capability requirements prior to beginning development. The current initial capabilities documents, capabilities development document and capabilities production document (ICD/CDD/CPD) process does not define requirements to a level of detail necessary to completely develop the intended materiel solution.

**Recommendation:** Add a detailed requirements definition or refinement phase to the acquisition cycle just prior to or just after Milestone B. This could be a government led task or a separate contract. The end product would be a fully documented and testable Requirements Specification, Requirements Traceability Matrix, or similar documentation that is signed by the functional user and confirmed by the MDA prior to the award of a development contract.



# Annex E

## Missile Defense Agency

---

This annex describes the Missile Defense Agency's (MDA's) acquisition program as required by Section 814 legislation. It specifically addresses the following:

- ◆ Current organization and its evolution
- ◆ Mission and capabilities
- ◆ Joint acquisition
- ◆ Recommendations.

The information presented in this annex was compiled from the 814 Review Survey responses and supplemented with information from MDA documents and Web sites. This annex has been formally released by MDA.





DA

DEPARTMENT OF DEFENSE  
MISSILE DEFENSE AGENCY  
7100 DEFENSE PENTAGON  
WASHINGTON, DC 20301-7100

MAR 8 2007

MEMORANDUM FOR THE PRESIDENT, DEFENSE ACQUISITION UNIVERSITY

SUBJECT: Missile Defense Agency Annex to Section 814 Report to Congress

As required by Section 814 of the FY06 National Defense Authorization Act, the Missile Defense Agency is pleased to submit the Agency's Annex to the Defense Acquisition University's report to Congress "Review of Defense Acquisition Structure and Capabilities".

Should you have any questions, or require additional information, please contact Mr. Barry Richardson at (703) 882-6431, or by e-mail at [barry.richardson@mda.mil](mailto:barry.richardson@mda.mil).

A handwritten signature in black ink, appearing to read "Patricia Sanders".

PATRICIA SANDERS  
Executive Director

Attachment:  
MDA Section 814 Annex



## I. Current Organization

Figure E-1 depicts the current organizational structure of the Missile Defense Agency (MDA) and lists the number of Key Leadership Personnel (KLP), the number of acquisition and non-acquisition personnel, and the number of contracting actions performed.

Figure E-1. Missile Defense Agency

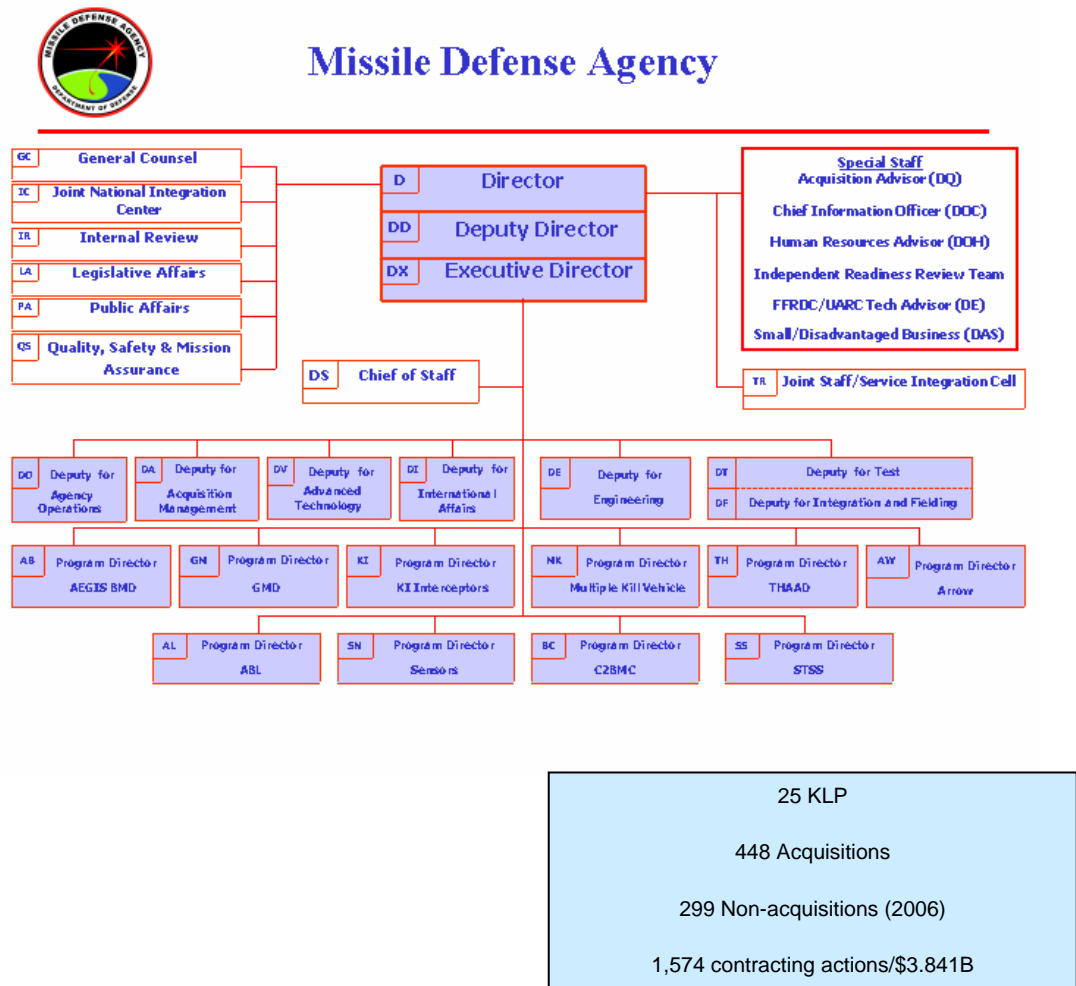

Figure E-2 represents the current Missile Defense Management structure. The roles of the Senior Executive Council were defined by DoD Directive 5105.66, July 10, 2001, and the Missile Defense Support Group was defined by the Under Secretary of Defense for Acquisition Technology and Logistics Memorandum, “Missile Defense Support Group,” February 13, 2002. DoD Directive 5134.9 “Missile Defense Agency”, October 9, 2004, the MDA organizational charter, prescribes the mission, responsibilities, functions, relationships, and authorities of

the Missile Defense Agency, while also adding additional functions to the Senior Executive Council.

Figure E-2. Program Management Structure



The Army, Navy, and the Air Force Boards of Directors were established in January 2002 to serve as discussion for a resolution of issues between MDA and the individual Military Departments. A Joint MDA Board of Directors was formed later to address issues cross-cutting the Military Departments, Defense Agencies, and MDA.



## II. Evolution to the Current Structure Since 1990

Figure E-3. SDIO Organization Structure 1990



### 1. CAE HQ/Staff

Figure E-3 depicts the organizational structure of the Strategic Defense Initiative (SDI) program and the Strategic Defense Initiative Organization (SDIO) in 1990, reflecting its mission at that time, i.e. the development of non-nuclear missile defenses.

Upon the establishment of SDIO in 1984, missile defense programs that had been scattered among the Services, several Defense Agencies and other government organizations, were consolidated under the direction of SDIO and molded into a coherent program guided by a clear strategic vision- “*develop non-nuclear missile defenses.*” The SDI program defined the system architecture, identified potential and emerging technologies and conducted experiments to demonstrate promising technologies for potential application in an integrated missile defense system aimed at protecting the United States against a massive Soviet first strike.

The SDIO Charter, DoD Directive 5141.5 dated June 4, 1987, established SDIO as a separate agency of the Department of Defense under the direction, authority, and control of the Secretary of Defense, and under the overall supervision of the

---

Deputy Secretary of Defense. The Charter identified the responsibilities, functions, relationships, and authorities of the Agency, the Director, the Secretaries of the Military Departments and Directors of Defense Agencies with respect to the execution of the SDI program. Furthermore, in accordance with the Charter, the Director SDIO served as:

- The Executive Secretary of the SDI Executive Committee,
- The SDI Acquisition Executive for the SDIO,
- A member of the Defense Resources Board when SDI matters were under consideration, and
- The head of an Agency and Contracting Activity within the meaning of FAR 2.1

Although the Charter mandated that the Director establish a streamlined management structure and procedures, it did not exempt the SDI Program from the Defense Acquisition System, requiring the Director to take direction from the Under Secretary of Defense for Acquisition on matters of acquisition policy, procedure and execution. The SDI Program was subject to milestone review and approval by the Defense Acquisition Board (DAB). In June and July, 1987 the DAB conducted its first review of the SDI program (Milestone 1). A second review was held that September. As a result of these reviews, the SDI Program Phase I baseline architecture was approved and six specific components of the program were authorized to enter the demonstration and validation stage of the acquisition process.

In 1990, the SDI Program was largely centrally managed but de-centrally executed, with SDIO executing \$638M in contracts or less than 20% of the program budget. The remainder of the contracts were awarded by the Military Departments, other Defense Agencies and other government agencies outside the Department of Defense.

After Operation Desert Storm, the Agency's mission expanded to include the development of defenses against theater class missiles. In December, 1991 President George Bush signed into law H.R. 2100, the "National Defense Authorization Act for Fiscal Years 1992 and 1993." That portion of H.R. 2100 dealing with missile defenses was known as the Missile Defense Act of 1991. This act required the Defense Department to "aggressively pursue the development of advanced theater missile defense systems, with the objective of down selecting and deploying such systems by the mid-1990s." Additionally, DOD was to "develop for deployment by the earliest date allowed by the availability of appropriate technology or by fiscal year 1996 a cost-effective, operationally effective, and ABM Treaty compliant antiballistic missile system at a single site as the initial step toward deployment of an antiballistic missile system." This system was to be "designed to

protect the United States against limited ballistic missile threats, including accidental or unauthorized launches or Third World attacks.”

In May 1993, SDIO was re-designated as the Ballistic Missile Defense Organization (BMDO) to reflect the new focus in DOD’s missile defense program and the new way in which the program would be managed. The major change in management was that the organization would no longer report directly to the Secretary of Defense, but rather to the Under Secretary of Defense for Acquisition.

Congress enacted the National Missile Defense Act of 1999 which established a policy of deploying as soon as technologically possible an effective national missile defense system capable of defending the territory of the United States against limited ballistic attack.

This enactment was followed by Secretarial and Presidential directives.

On January 2, 2002, Secretary Rumsfeld established the Missile Defense Agency (MDA) and assigned it sole responsibility for the development of a single integrated system, the Ballistic Missile Defense System (BMDS). Reporting directly to the Under Secretary of Defense (Acquisition, Technology, and Logistics), the Director assumed responsibility for BMDS development to include all elements and MDAPs under development by the military services; the service Operational Requirements Documents were cancelled. To streamline OSD executive oversight and reporting, the Senior Executive Council, chaired by DepSecDef, was assigned responsibility for policy guidance. Acquisition management of the BMDS was not subject to the DoD 5000 services and consisted of three phases: development, transition, and procurement and operations. The Director was assigned responsibility for managing the BMDS through the development and transition phases and for the baselining capability and configuration of all BMDS elements. BMDS elements would enter the formal DoD acquisition cycle at Milestone C concurrent with the transfer of procurement responsibility to the services. The BMDS was also exempted from the traditional JCS requirements generation process. To encourage flexible acquisition practices, the Director was delegated authority to use transactions other than contracts, grants, and cooperative agreements. To further consolidate his authority, the Director was given budgetary authority over all ballistic missile defense programs.

In National Security Presidential Directive/NSPD-23, December, 16, 2002, President Bush made the deterrence of emerging threats and missile defense deployment one of the nation’s highest priorities. Determining that the nation was facing growing threats from weapons of mass destruction in the hands of hostile states and non-state actors, he directed the Secretary to begin deployment of missile defense capabilities in 2004, and to use an evolutionary approach for fielding improved and expanded missile defense capabilities. The President also made promotion of international missile defense cooperation a key feature of missile defense.

---

MDA's Charter (DOD Dir 5134.9, October 9, 2004) clarified these authorities and formally assigned the Director authority for the acquisition management of the BMDS consistent with the principles in the DoD 5000 series. The Director was assigned responsibility as the BMDS acquisition executive for all programs funded by the MDA and assigned milestone decision authority up to Milestone C.

In recognition of the Agency's evolving acquisition structure, a new position, the Deputy for Acquisition Management, was created in 2006. The mission for this position is to develop acquisition policy and processes for Agency procurements, develop direction and guidance for Ballistic Missile Defense System contracts, and to assess contract performance. The Deputy for Acquisition Management reports to the Director, MDA through the Executive Director. The MDA Deputy for Acquisition Management is assisted by a Director for Acquisition Policy, Planning, and Assessment; a Director of Contracts; and a Director of the Office for Small Business Programs.

The Director for Acquisition Policy and Planning:

- Develops Agency acquisition policies and processes.
- Assists performing elements of the organization with guidance and implementation.
- Provides support to Agency Management on acquisition strategy reviews.
- Generates planning documents and reports.
- Collects and reports contract performance status information.

The MDA Director of Contracts reports directly to the Deputy for Acquisition and serves as the Assistant Deputy for Acquisition. The MDA Director of Contracts and staff:

- Provides the people, training, tools, and oversight to ensure that missile defense contracts are awarded in a prudent and timely manner.
- Advises on all contracting matters involving the planning, management, execution, and reporting of programs and activities under the cognizance of MDA.
- Develops and implements policies and processes promoting efficient and effective procurement of missile defense research, development, test and evaluation; science and technology; systems integration and engineering; and contracted services.

- Trains and equips a contracting work force that meets or exceeds Defense Acquisition Workforce Improvement Act (DAWIA) requirements in the planning and execution of domestic and international BMDS business agreements.
- Serves as MDA Competition Advocate.
- Facilitates multi-functional government and early industry involvement in acquisition strategy formulation and solicits, negotiates, awards and administers contracts within the BMDS portfolio.
- Ensures statutory and regulatory compliance in the execution and closeout of contractual and other transaction business agreements.

The MDA Director of the Office for Small Business Programs:

- Plans, directs, coordinates, and administers MDA Small Business and other Socio-Economic Programs
- Advises the Director, MDA on actions regarding the goals, objectives, and performance of MDA OSBP programs
- Provides guidance and assistance to the MDA contracting officers and other MDA staff components to ensure compliance with program directives, goals, and objectives
- Participates in interagency and Office of the Secretary of Defense programs related to OSBP matters

The 2006 geographic locations for acquisition personnel are as follows:

- Albuquerque/Kirtland AFB, NM
- Anchorage, AK
- Arlington County, VA
- Colorado Springs/Schriever AFB, CO
- Columbus, OH
- Ft. Greeley, AK
- Hanscom AFB, MA
- Los Angeles AFB, CA
- Huntsville, AL

- 
- Vandenberg AFB, CA
  - Farnborough, United Kingdom
  - The Hague Netherlands.

## 2. Acquisition Commands

MDA has no subordinate acquisition commands.

## 3. PEO Structure

In accordance with the Agency Charter (DoDD 5134.9) the Director serves as Acquisition Executive for all programs funded by the MDA. The Agency program managers report directly to the Director, who acts as Milestone Decision Authority for development of the entire BMDS.

## 4. Other

The MDA has very recently undergone an extensive reengineering effort. The resultant organization reflects management's optimal organization for the mission and challenges that face the MDA for the immediate future. In addition to relocating program offices and functions, the reengineering plan created the following Knowledge Centers for programs with similar attributes or missions:

- Interceptors
- Sensors
- C<sup>2</sup>BMC
- Directed Energy Systems
- Space Systems.

The objectives of establishing the Knowledge Centers are to:

- effectively develop responsive unique core competencies and infrastructure,
- institutionalize organizational learning of best practices,
- establish and enforce highest state-of-the-art practices across disciplines,
- effectively manage MDA assets, and
- enhance corporate Missile Defense acquisition strategies.

### **III. Mission, Capabilities, and Service Issues**

#### **1. Current Mission Statement**

As defined in the MDA Charter, DoD Directive 5134.9, the MDA shall manage, direct, and execute the development of the BMDS in accordance with National Security Presidential Directive-23, “National Policy on Ballistic Missile Defense” and to achieve the following DoD priorities:

- 4.1. To defend the United States, deployed forces, allies, and friends from ballistic missile attacks of all ranges in all phases of flight.
- 4.2. To develop and deploy, as directed, a layered BMDS.
- 4.3. To enable the fielding of elements of the BMDS as soon as practicable.
- 4.4. To provide capability in Blocks, improving the effectiveness of fielded capability by inserting new technologies as they become available.

#### **2. Capabilities Needed to Accomplish Mission**

The complexity and technical challenges associated with achieving a missile defense capability, coupled with the joint nature of the program, requires the collaboration of Industry, the Military Departments and other Government activities to accomplish the MDA mission. This was true in 1990 and it is equally true today. The true result of the Agency’s collaboration with industry, in identifying and developing enabling technologies, defining the architecture and developing the systems, is that today we have a missile defense capability that did not exist and could not have existed in 1990. Cooperation and collaboration with industry was key to achieving initial defensive capability of the system in 2004. Furthermore, we now have a clear path for periodic block upgrades to our missile defense capability as emerging technologies, mature to the point where they can be integrated into the system architecture. Cooperation and collaboration with the Military Departments has improved through Joint and Military Department Boards of Directors, and General Officer/Flag Officer Level conferences. These conferences have driven vertical and horizontal communication across BMDS stakeholders addressing technical or support issues that could otherwise slow the fielding of capability or the arranging for sustained operation and support. Collaboration with the warfighter community has resulted in the identification of an annual prioritized list of desired capabilities.

#### **3. Shortfalls/Gaps**

With the Secretary of Defense decision to establish the Missile Defense Agency in January 2002, the Director was granted the necessary authority to execute the Missile Defense mission in the most efficient and effective manner. With input from the user, STRATCOM, and guidance and advice from the Senior Executive Council, the USD(AT&L) and the Missile Defense Support Group, the Director

---

has the requisite infrastructure in place to ensure that the program is executed in accordance with the four Department of Defense priorities stated in the Agency's charter. As such the Director has a clear statement of priorities, adequate authority and the necessary resources, barring unforeseen budget cuts, to accomplish the Agency's mission in an efficient and effective manner.

#### **4. Personnel Issues**

Our primary personnel concerns in the coming years stem from the pending BRAC relocation of MDA personnel and functions from the National Capital Region (NCR) to Huntsville, Alabama. Our surveys indicate that a very small percentage of the MDA workforce intends to make the move to Huntsville. Since the announcement of the BRAC move, our rate of attrition has increased dramatically, even though the final move will not occur for four years. In some cases, such as the contracting career field, the demand for qualified personnel in the NCR has only exacerbated the situation. Fortunately, we have the authority and the tools to provide incentives for people to remain with the Agency during this period of transition and we are actively recruiting new personnel who are willing to relocate when the Agency does move to Huntsville in 2010/11.

### **IV. Joint Acquisition**

#### **1. Summary of Current MDA Joint Acquisition Programs**

MDA as an Agency is composed of representatives from each of the Services. Because ballistic missile defense covers a very broad mission area and requires the integration of interceptors, sensors, and command and control capability across all Military Departments, MDA has been a joint acquisition program since its inception as SDIO. BMDS elements programs, which are executed by MDA and each of the Military Departments, must be integrated throughout development and complimentary upon deployment and in operation.

All three Military Departments and Other Defense Agencies (such as DISA) participate in Board of Director meetings on a regular basis to address issues that affect two or more participants. USSTRATCOM represents all COCOMs.

#### **2. Issues/Gaps in Capability**

No insurmountable difficulties have been encountered. Joint acquisition programs require intensive effort on a continuing basis and MDA's relationships are challenging in the sheer numbers and variety of them. MDA has established appropriate mechanisms through such forums as the Boards of Directors, the Missile Defense Support Group and the Senior Executive Council to resolve any difficulties.



## V. Agency Recommendations

At this time, MDA has adequate resources (current budget and the POM) and authority to fulfill its assigned mission.

### 1. Organizational Issues

- As discussed earlier, the establishment of MDA in 2002 and the subsequent approval of the MDA charter established clear, streamlined lines of authority that greatly enhanced the Agency's ability to accomplish its assigned mission. More recently, MDA has undergone an extensive reengineering effort that resulted in the establishment of the Knowledge Centers discussed earlier.
- The resultant organization reflects management's optimal organization for the mission and challenges that face the MDA for the immediate future. Therefore, MDA does not recommend any organizational changes at this time.

### 2. Resource Issues (Personnel/Funding)

- **Personnel**—Since its inception as the Strategic Defense Initiative Organization, the Agency has relied on a blended government/contractor workforce to accomplish its mission. The mix of government personnel to perform those functions that are inherently governmental, complemented by a contractor workforce, gives us a depth of resources and breadth of talent not otherwise available in a Government-only organization. Our primary personnel challenges in the coming years will be retaining and replacing our government workforce as we transfer functions to locations outside the National Capital Region as a result of BRAC and our recent re-engineering efforts. We feel that we have the authority and flexibility necessary to recruit, hire, train and pay the personnel with the unique skills and talents necessary to accomplish the missile defense mission. Therefore, MDA does not recommend any changes at this time.
- **Funding**—Based on the most recent conference report, we feel that we have adequate funding to meet our FY07 personnel requirements. No MDA recommended changes at this time.

### 3. Policies and Procedures Needed to Improve Outcomes

As discussed earlier, the Director, MDA currently has the requisite policies, procedures and authorities to effectively and efficiently execute the Agency's mission.

---

a. Agency Related proposals to improve outcomes

- In 2002, MDA introduced a capability-based evolutionary acquisition approach to be in a position to deliver useful capability to the warfighter rapidly. The intent was two-pronged:
  1. to improve flexibility by breaking away from the traditional model of responding to a specific set of ORD requirements and instead designing a defensive capability based on physics-based limits that anticipates unexpected changes in the threat, and
  2. to evolve deliverable increments of capability that would be available for fielding in two-year blocks.

This approach will deliver militarily useful capability in increments rather than resorting to a “grand design” for an improved system that may take decades to be ready for fielding.

- Other DoD components also have moved to the evolutionary model. The recent Defense Acquisition Performance Assessment Report (Jan 06) recommends adding the value of time while conducting cost/performance tradeoffs. MDA endorses the Panel’s recommendations for early fielding and time-certain development.
- While Milestone C decisions, proposed by the appropriate Service, are contemplated for Ballistic Missile Defense System elements, none have occurred yet. MDA reports quarterly to the USD(AT&L) on its development program execution. Similarly, the program elements and components are on a review cycle that is more frequent than the traditional development milestone reviews. Transition planning for developed systems is key for any program element approaching a Milestone C. Coordination with the Services is in progress.

b. Proposals to improve Agency lead on joint acquisition programs:

- No insurmountable difficulties have been encountered. Joint acquisition programs require intensive effort on a continuing basis and MDA’s relationships are challenging (as noted) in their sheer numbers and variety. Through the Boards of Director, MDA has established appropriate mechanisms to resolve any difficulties. Therefore, MDA does not recommend any changes at this time.

# Annex F

## Defense Logistics Agency

---

This annex describes the Defense Logistics Agency's (DLA's) acquisition program as required by Section 814 legislation. It specifically addresses the following:

- ◆ Current organization and its evolution
- ◆ Mission and capabilities
- ◆ Joint acquisition
- ◆ Recommendations.

The information presented in this annex was compiled from the 814 Review Survey responses and supplemented with information from DLA documents and Web sites. This annex has been formally released by DLA.



## Defense Logistics Agency

### Executive Summary

As the Defense Department's only Combat Logistics Support Agency, the Defense Logistics Agency (DLA) has a broad-based, joint service mission. As the Department of Defense (DoD) is transforming to meet current and future threats, so is DLA. Transforming logistics is a continuous process. The Agency is engaged in a more focused, collaborative approach to customer and supplier relations, satisfying their dynamic requirements with state-of-the-art integrated logistics solutions. We are leaving behind our legacy business model and organizational structures and transforming to become a single, fully integrated enterprise utilizing a COTS Enterprise Resource Planning System. Instead of managing supplies, DLA has become a manager and integrator of supply chains essential to military readiness with world class commercial supplier partnering capabilities. But DLA, like DoD, needs to continue to establish sound business arrangements if we are to maintain a strong, best value edge necessary for us to continue to provide the warfighter with critical requirements – around the clock, around the world.

The acquisition workforce has remained relatively stable in size even though procurement workload has increased significantly over the past few years. Growing long range fiscal challenges mandate that DoD maximize its return on investment while providing warfighters with the required capabilities at the best value to the taxpayer. Today's challenging environment provides an excellent opportunity for creative solutions and a higher level of commitment and responsiveness to managing our acquisition processes. The Section 814 forum provides an excellent opportunity for DLA to identify further enhancements needed to improve acquisition outcomes.

The issue of buying defense components from foreign suppliers is a particularly challenging issue for DLA on whom the restrictions of the Berry Amendment have the biggest impact of any of the DoD components because of the quantities and types of items we buy. This affects our clothing and textile, subsistence, and hardware supply chains, and requires commercial and DoD products to be segregated during manufacture to insure compliance. The Office of the Secretary of Defense (OSD) should continue to pursue reasonable "deminimus" legislation to reduce the financial and administrative burden on our vendors while still preserving the necessary defense industrial base.

DoD is using different acquisition approaches to support its missions by entering into more complex, integrated system support contracts. While we should be finding ways to partner with our contractors, using their expertise to determine the statements of work and parameters of contract performance whenever it makes sense to do so, use of performance-based acquisition support strategies in some of our long term, complex contracts is more difficult and less practical than in more traditional supply and service contracts, and requires that more consistent and comprehensive guidance be provided to the acquisition workforce in terms of defining requirements, establishing expected outcomes, and assessing contractor performance. Improved

---

performance work statements coupled with solid business objectives create positive performance outcomes, and OSD needs to resource and train both of these functions in order to achieve success.

DoD is transitioning from the traditional way of supporting the warfighter by buying products and services to buying pre-determined levels of availability. Such fundamental transformation requires an end-to-end integration of logistics systems and supply chains within and across the public and private sectors in order to achieve improved warfighter support and sustainability. DLA has been working closely with DoD on implementing some proposed changes to the DoDI 5000 series that address our specific concerns with a need for alignment of and adherence to acquisition and logistics policies for weapons systems support strategies designed to maximize use of DLA as a product support integrator without jeopardizing warfighter readiness or increasing costs. We encourage DoD to continue its efforts to re-emphasize existing policy in areas such as technical data access and configuration control. We welcome DoD's continued support as together we work through observed issues and proposed approaches to sustainment with associated policy and standards for key support areas designed to ensure achievement of successful acquisition strategies and sustainment planning.

Managing our acquisitions in today's environment requires teaming, communicating, information sharing, and improved planning to meet shorter timelines and schedules. The pending implementation of Base Realignment and Closure (BRAC) brings new opportunities and challenges to DLA. We need to recognize the value of and support the use of innovative contracting solutions to help reduce operational costs and incorporate better business practices to provide increasingly responsive and high quality services to our customers. Senior leaders in DLA are committed to ensuring that each contract is conducted in the most efficient and fair manner possible. DLA is committed to assuring both the private and public sectors of the fairness of the process and of a level playing field. Effective implementation of DLA's transformation initiatives will ease the BRAC transition and enable the new missions DLA will inherit. Support from senior leaders in DoD will help ensure that DLA can continue to perform its mission of providing best value logistics support for America's warfighter, in peace and war.

SEP 29 2006

Date

  
\_\_\_\_\_  
CLAUDIA S. KNOTT  
Component Acquisition Executive

## I. Current Organization

### 1. General

The Defense Logistics Agency (DLA) acquisition workforce provides the resources to meet the DLA logistics support mission by employing various contractual instruments to obtain the consumable items required by the Military Services. The workforce includes staff elements that provide agency level policy, program direction, and oversight for contracting organizations at our field activities, and the operational organizations at the field activities that execute contracts.

Figure F-1 depicts the current organizational structure of DLA. There are nine key leadership positions in DLA. Six are GS-15s (all in the Contracting career field); two are members of the Senior Executive Service (one in the Contracting career field and one in the Program Management career field) and one O-6 military position. A total of 3,178 acquisition personnel were assigned in 2005. A total of 17,870 non-acquisition support personnel were assigned in 2005.

Figure F-1 also depicts the flow of contracting and oversight authority within the organization. Pursuant to DFARS 202.101, "Head of the agency" means, for the Department of Defense (DoD), the Secretary of Defense, and the Secretaries of the Military Departments. The directors of the defense agencies have been delegated authority to act as head of the agency for their respective agencies, except for such actions that by terms of statute, or any delegation, must be exercised within the Office of the Secretary of Defense (OSD), subject to the direction of the Secretary of Defense, the Under Secretary of Defense (Acquisition, Technology, and Logistics), and the Director of Defense Procurement and Acquisition Policy. The directors of the defense agencies have also been delegated authority to act as Senior Procurement Executive for their respective agencies, except for such actions that by terms of statute, or any delegation, must be exercised by the Under Secretary of Defense (Acquisition, Technology, and Logistics).

By memorandum dated June 17, 2003, the Director, DLA, delegated authority to act as the Component Acquisition Executive/Senior Procurement Executive, where required by the FAR or DFARS, to the Deputy Director, Logistics Operations, (J-3), except for certain specific authorities which are reserved to others. Delegation of head of agency (HOA) authority was also made to J-3 in this memorandum. Further delegation of these authorities is not permitted.

FAR 1.601 provides that the agency head may establish contracting activities and delegate broad authority to manage the agency's contracting functions to heads of such contracting activities (HCAs). DLA's contracting activities are designated in DFARS 202.101 and include the Office of the Deputy Director, Logistics Operations; the Defense Supply Centers (DSCs); and the Defense Energy Support Center (DESC). These contracting activities are shown in Figure 1. The Defense Logistics Acquisition Directive (DLAD) 2.101 designates the Deputy Director, Logistics Operations, J-3, as the HCA for the six contracting offices listed that are not designated as contracting activities in DFARS. They are also shown in Figure F-1.

Figure F-1 also depicts the further flow of contracting authority from the HCAs to the Chiefs of the Contracting Offices (CCOs) at the DSCs within DLA. These positions are also identified in DLAD 2.101.

FAR 1.601(a) states that “Contracts may be entered into and signed on behalf of the Government only by contracting officers.” The authority in FAR 1.603-1 for selection, appointment, and termination of appointment of contracting officers has been delegated by the Director, DLA, to the DLA HCAs in DLAD 1.603-1. DLAD provides that this authority is delegable without power of redelegation to the chief of the contracting office. Contracting officers are delegated contracting authority to act as agents of the government within the limits specified by the appointing authority in the written delegation of authority or warrant issued to them by their respective CCOs.

Figure F-1. Current DLA Organization/Acquisition Structure

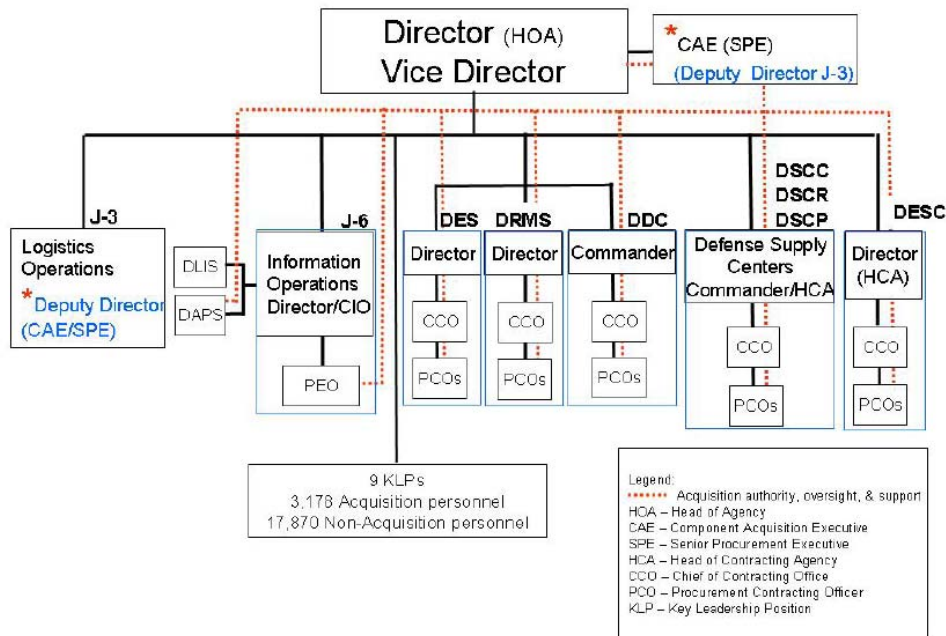

## 2. PEO Structure: Systems Acquisition Organization Specific

Program Executive Office (J-62) serves as Program Executive Officer (PEO) for the Information Operations, with oversight responsibilities to the DLA Acquisition Executive. The PEO was established in September 2000 under a DLA General Order. The DLA PEO performs as the single agency official who provides overall direction and guidance for the development; acquisition, testing, systems integration, product improvement, and fielding of assigned DLA programs while maximizing Return on Investment (ROI) and contribution to DLA’s mission outcome through portfolio management and oversight. The PEO sits as a member of the DLA ACAT IA Review Board and Chairs the ACAT III Review Board. DLA’s PEO ensures that the Agency uses a robust portfolio management approach to all automated information systems; develops and maintains a portfolio of automated information



systems that mitigates risk while moving the Agency's systems forward; and structures the portfolio so continuous technology refreshment and business practice reengineering are enabled and addressed. The PEO acts as steward of DLA's IT investments, ensuring cost/schedule/performance are achieved in each program and project; integrates developmental activities to ensure synergy and interoperability; and champions efforts to embrace commercial software and best business practices. The PEO has the management and oversight responsibility for automated information systems (AIS) programs and projects to ensure compliance with acquisition directives, instructions, regulations, and IT policy, and to ensure best business practices are applied to the development and/or acquisition of AIS emerging systems.

The PEO is responsible to

- ◆ Ensure DLA's AIS programs and projects are baselined, tracked, and implemented within acceptable cost, schedule, and performance variances. Major products are documented repeatable processes, program baselines, status reports, and In-Progress-Reviews (IPRs). Measure of success is the completion of programs on time and within cost while meeting customers' requirements. The PEO must ensure DLA's major programs and projects of special interest meet designated program milestone decisions. Major products are IPRs and documentation reviews. Measure of success is the ability of major programs to meet milestone decision criteria on schedule.
- ◆ Establish and maintain a cadre of trained program managers certified in the acquisition management discipline. Major products are a documented certification process and identification of all certified program managers in DLA. Measure of success is the certification of all program managers and the establishment of a cadre of potential program managers who are certified.
- ◆ Maintain an acquisition and management process that involves the participation of all stakeholders as a DLA collaborative effort. Major products are review boards, Integrated Product Teams (IPTs), and documented processes. Measure of success is the participation of stakeholders and customer satisfaction.
- ◆ Lead DLA's effort to establish the culture, processes, organization, and technology needed to institutionalize knowledge management. The PEO establishes a knowledge-centric culture that facilitates information sharing and organizational learning.

In 2004, DLA was audited on its enterprisewide process. Provided below is an excerpt from the report:

“As identified by the review team, DLA has established and is executing a number of noteworthy best practices that enable it to effectively implement its IT Systems. The best practices that were identified include:

Excellent PEO IT Systems acquisition expertise matrixed to Program Management Offices (PMOs) providing program management flexibility;

Extensive use of knowledge management that makes best practices and processes available to Program Managers (PMs); and,

Proactive PEO Stewardship resulting in well managed programs.”

Figure F-2 illustrates the DLA PM/PEO organization/reporting structure. There are not more than two levels of review for ACAT IA and ACAT III programs. None of the program managers at DLA report to more than one chain of authority for acquisition oversight.

Figure F-2. PM/PEO Organization/Structure

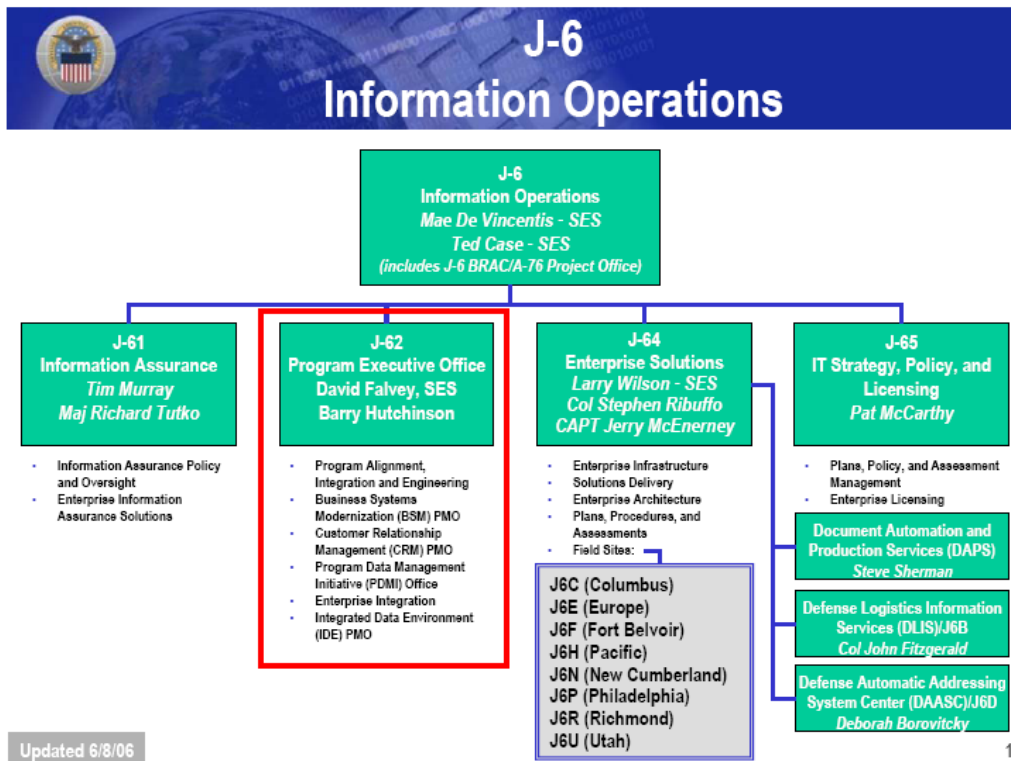

## II. Agency Evolution

### 1. Acquisition Structure and Organization 1990–2000

In 1990, we did not maintain the career fields on acquisition employees. The total for all employees in the 1102, 1103, 1105, 1106, 1150 and 1910 series in 1990 was 18,058. This number included the employees of the Defense Contract Management Command, an acquisition command which was a part of DLA at that time. In 1990, 41,595 non-acquisition support personnel were assigned to DLA (including DCMA). The decrease in acquisition and non-acquisition personnel in DLA between 1990 and 2005 is largely attributable to the separation in 2000 of DCMC into a separate agency, the Defense Contract Management Agency.

## **2. Acquisition Commands**

The Defense Contract Management Command (DCMC) was established as a command within the DLA in February 1990 to satisfy the findings of Defense Management Review Decision (DMRD) 916 to ensure that consistent policies and standards were applied to the contract administration process. On March 27, 2000, DCMC was renamed as the Defense Contract Management Agency and established independently from DLA. The change was made to allow the Defense Department to be more responsive to its customers. As a result of this change, Agency Senior Procurement Executive authority previously vested in the DCMC side of the Agency was redelegated by the Director, DLA, to the Executive Director, Procurement Management, with whom authority already resided to act as both “agency head” and “head of the contracting activity.” As the Agency’s mission continued to evolve and DLA reorganized accordingly, these procurement authorities were reassigned to the Deputy Director, Logistics Operations, (J-3), formerly the Executive Director, Acquisition, Technical, and Supply Directorate, Logistics Operations, with the additional designation by the Director, DLA, in June 2003, of Component Acquisition Executive (See Figure F-1 for the current acquisition management structure).

A dominant theme for the 1990s was the Agency’s efforts to reorganize so that it could support the warfighter more effectively and efficiently. DLA Headquarters underwent a major reorganization. In 1995, the DLA Headquarters and the Defense Fuel Supply Center (renamed Defense Energy Support Center in January 1998) moved from Cameron Station to Fort Belvoir, Virginia. In October 1996, Defense Printing Services, renamed the Defense Automated Printing Service, transferred to DLA.

The Defense Reutilization and Marketing Service (DRMS) had as its primary mission in 1990 the provision of disposal contract support for DOD hazardous waste generators within the continental United States, Hawaii, Alaska, and the territories of Guam and Puerto Rico. Between 1990 and 2006, DRMS assumed responsibility for this support in Europe and Asia.

In 1990 the Defense National Stockpile Center (DNSC), another field organization of DLA, performed a dual mission which included acquiring and selling commodities. In 1993 Congress changed the organization’s mission by requiring a greater emphasis to be placed on the selling of commodities. As a result of this change, the DNSC acquisition mission is limited to writing sales contracts.

In 1993, Brand Name and Market Ready (milk, bread, dairy) procurement and logistics services were transferred to the Defense Commissary Agency (DeCA). DeCA assumed sole responsibility for all aspects of order planning, acquisition, and pipeline management of grocery items for the commissaries. DLA continued to supply all fresh fruits and vegetables to support DeCA.

At our field activities during the mid-1990s, personnel performing supply management, technical, and quality assurance functions were co-located with acquisition personnel in newly formed directorates. Co-locating the various functional regimens in teams fostered a cohesive approach to management and acquisition of assigned items that benefited the customer by helping to streamline the overall acquisition process. During this period,

---

workload assignments transitioned from an Federal Supply Class breakout method to weapons systems platforms and major Original Equipment Manufacturer alignments. As the Agency has fundamentally changed its business practices supported by a new information technology environment, the organization has become more customer focused integrating and aligning its processes and business units by supply chains.

Supply chains are replacing DLA commodities to improve alignment of expertise and items with industry and customers under an As-Is/Where-Is organizational philosophy, i.e., existing items and people remain at existing locations so as not to engage in the disruptive movement of people and materiel between geographic locations. This principle is supported by having supply chain detachments at geographic locations. Detachments will have matrixed reporting relationships to both geographic sites and supply chains. The customer operations focus will remain separate from the supplier operations focus.

## **2. 2000–Present**

Oversight for the procurement process within Business Systems Modernization (BSM) was added in 2001, and in 2005 a Performance Based Logistics Strategy Branch was added as part of the Headquarters organization.

In the 2004-/2005 timeframe, DLA was designated the DoD Executive Agent (EA) for subsistence, bulk fuels, medical materiel and construction/barrier materiel. Under this designation, DLA is now responsible for developing and implementing joint disciplined processes that provide improved, uninterrupted end-to-end support to the warfighter through increased supply chain integration, efficiency, and effectiveness. Assigning DLA/DoD EA responsibilities has resulted in joint material management and requirements determination; increased interoperability and material standardization; better integration of commercial capabilities into military processes; and increased operational effectiveness.

In 2005, the Commissary Operating Board determined that DeCA would assume the fresh fruit and vegetable (FF&V) buying and distribution operations from DLA.

DLA has transformed itself from a “small purchase” materiel warehouse to an agile logistics combat support agency working closely with the military services to provide exceptional, worldwide, logistics combat support. As DLA has taken on more weapons systems support responsibilities in the past several years, the complexity and scope of our contracting mission have increased significantly. In many ways, our acquisition mission and process differ from that of the military departments and provide unique challenges.

## **3. Other**

Overall, DLA’s acquisition reform, automated software systems, and collaboration with industry have positively changed during the last decade.

Here are some impacts from acquisition reform:

- ◆ As an Agency, DLA has been a pioneer in acquisition reform, adopting commercial buying practices and embracing Electronic Commerce/Electronic Data Interchange

(EC/EDI) technology well before the passage of the Federal Acquisition Streamlining Act (FASA) of 1994 and other reform measures which followed. We adapted from industry the concept of Prime Vendor, using a commercial distribution network and a closed loop EDI system to speed the delivery of items directly to the customer. DLA was among the first government agencies to provide customers with the power to choose which commercial items represent the best value for their money in terms of price, delivery, and performance features; to use industrial capacity to satisfy customers, reduce inventory, and maintain readiness on the most cost effective basis possible by applying the concept of buy response vice inventory at our various inventory control points (ICPs); and to stress the use of past performance information in making best value buying decisions.

- ◆ In the area of information technology, DLA has been in the forefront of acquisition reform from the very beginning by making electronic commerce the method of choice for transacting business with our industry partners. By providing some of our military customers with electronic search, ordering, receipt, and payment capabilities for purchases of select items from electronic commercial catalogs, DLA improved customer service, decreased costs, and supported small business goals all at the same time, while laying the foundation for the future EMall. Our automated solicitation, evaluation, and award systems used at our hardware ICPs accelerated and streamlined the simplified acquisition process throughout the Agency and resulted in better overall support to the customer, including lower total costs. (The automated information systems referenced are being replaced under BSM.) These initiatives made good business sense and saved us money or time. They provided maximum flexibility to support our customers while leveraging our resources and facilitating achievement of our strategic goals of buying better, faster, and cheaper.
- ◆ Many of the acquisition reforms DLA embraced helped us to do our jobs better, support our customers better, and facilitated our logistics support mission, uniquely positioning us to move towards these fundamental business changes.

Here are some impacts through automated software systems:

- ◆ BSM is the major automated software system that has had the greatest impact on the efficiency and effectiveness of the DLA acquisition workforce between 1990 and 2005. We are still in the process of implementing the system; therefore any characterization of the impact of BSM is preliminary.
- ◆ One specific facet of BSM implementation that can be described at this point is its effect on contract data reported to the DLA Contract Action Reporting System (DCARS). Since BSM includes automatic loading of contract action information to DCARS, we have experienced a decreased error rate in reporting. Prior to BSM deployment, DLA had an error rate of 5% using manual input. With BSM implementation, the error rate has declined to 3.2%. The automation also decreases the workload for our workforce.

- 
- ◆ DLA has implemented several other automated systems to enhance efficiency and effectiveness. One of the primary systems is the DLA Internet Bid Board System (DIBBS), which became available for use in August 1999. DIBBS is a web-based application that provides the capability to search for, view, and submit secure quotes on Requests For Quotations (RFQs). The DIBBS system also allows Requests For Proposals (RFPs) and Invitations For Bid (IFBs) to be searched and viewed online. The Procurement Automated Contracting Evaluation (PACE) tool was also installed in 1999. The PACE system solicits, evaluates, and makes awards automatically via the DLA Pre-Award Contracting System (“DPACS”, which is the standard PC workstation used by the contracting workforce at DLA to process solicitations, receive and evaluate offers, and process contract awards.) Both these systems make significant contributions to more effective and efficient use of our workforce.

Here are impacts through DLA’s collaboration with industry:

- ◆ The primary collaborative efforts between DLA and commercial industry have been realized through the use of two primary tools, Strategic Supplier Alliances (SSA) and Tailored Vendor Relationships (TVR), both of which are under the overarching Supplier Relationship Management (SRM) umbrella and were born from the Strategic Material Sourcing (SMS) program. SRM is one of the 13 transformation initiatives currently underway at DLA, and while there are many other tools that make the program a success, SMS is the primary driver and SSAs and TVRs are the primary collaborative efforts that drive resource savings.
- ◆ SSAs are collaborative partnerships between DLA and alliance partners, including participation among senior leadership, to reduce lead-times, prices, and to improve overall business processes. Performance is charted at the supplier level using pre and post SSA performance, and is displayed in a vendor report card at semi-annual reviews. This report card provides both the government and the vendor oversight into performance, and allows leverage of the relationship to define obstacles and improve performance. As of the end of FY05, SSAs are estimated to account for over \$68 million in cumulative inventory savings.
- ◆ The other primary tool that drives collaborative efforts, TVRs, are arrangements that strive to provide quality products and/or services when and where they are needed. TVRs focus on serving the warfighter, and improvements realized by these arrangements have led to benefits including:
  - Reduced lead-times
  - Surge capability
  - Services and warranties
  - 24 hour customer support
  - Direct Vendor/Customer interface

- One-stop shopping
- Technical expertise
- Name-brand products
- Ease of ordering
- Improved resource management.

Though TVRs focus on the warfighter, they also save the government time and money by having the relationship tap into distribution networks, take advantage of volume discounts, store materials until needed, and deliver directly to the customer. TVRs eliminate the layering of supplies at multiple levels and shift inventory, inventory management, transportation, and personnel costs from the government to commercial firms. TVR programs take advantage of the experience of commercial vendors, whose profit-based business practices demand lean inventories and rapid deliveries. TVRs allow DOD to achieve significant annual savings and revolutionize the logistics support of the retail customer.

### **III. Mission, Capabilities, and Service Issues**

#### **1. Current Mission Statements**

**DLA Mission:** *To provide best value logistics support to America's Armed Forces, in peace and war... around the clock, around the world.*

DLA provides worldwide logistics support for the missions of the Military Departments and the Unified Combatant Commands under conditions of peace and war. It also provides logistics support to other DoD Components and certain federal agencies, foreign governments, international organizations, and others as authorized. While the basic acquisition mission for DLA has not changed, over the years there have been changes to the commodities we support.

DLA has embarked on an overarching transformation initiative unlike any other in its history. This transformation will fundamentally alter DLA's core business model, supporting processes, and systems architecture. At the core business model level, customer focus, supply chain management, and seamless partnering constitute the transformation. A key contribution is organizational alignment. In the past, DLA operated as a traditional holding company, where a number of semi-autonomous activities such as its Inventory Control Points (or Supply Centers) and Distribution Centers reported to a centralized headquarters staff. The agency has taken the strategic steps required to establish a single, tightly integrated organizational structure where DLA is, and is perceived to be, one enterprise.

---

Logistics Operations (J-3) is responsible for the worldwide logistics support throughout DoD. The primary focus of J-3 is to support the warfighter in time of war and peace. J-3 supports the procurement, management, storage, and distribution of 5.2 million items for U. S. military customers, other federal agencies, and allied forces.

Information Operations (J-6) is the DLA's knowledge broker, providing comprehensive, best practice technological support to the DOD/DLA Logistics Business Community.

**Mission:** *DLA knowledge broker, providing comprehensive, best practice technological support to the DOD/DLA Logistics Business Community resulting in highest quality information systems, efficient, and economical computing, data management, electronic business, and telecommunication services.*

## **2. Capabilities Needed to Accomplish Missions**

Below is an excerpt of the DLA Information Technology (IT) Portfolio Management Process One Book policy by which DLA addresses capability gaps in DLA's mission.

DLA IT investments shall be considered as corporate assets and will be managed by the Enterprise Portfolio Manager under the direction of the Chief Information Officer (CIO). Groups of investments will be reviewed and managed by individual Portfolio Managers relative to Return on Investment (ROI), contributions to mission outcomes, and achievement of DLA's strategic goals and objectives. Although managed as corporate investments, the analysis, selection, control, and evaluation of IT investments may be conducted at the various levels of the organization. The management of the portfolio is a collaborative effort between the Portfolio Management/Capabilities Analysis Team, program managers, functional proponents, and IT community. Investment decisions are supported by boards and teams of representatives throughout DLA. The Corporate Board and DLA Director have the final approval for major IT investment decisions and establish the priority for DLA IT investments.

Tracking of IT investments is conducted through an IT portfolio and the DLA Profile System (DPS) investment database. The DLA CIO owns the DPS as the database of record for IT investments. The Enterprise Portfolio Manager, in coordination with the Portfolio Managers, manages the database. Information Operations (J-6), Enterprise Solutions (J-64) provides oversight and administrative support to the database. In order to provide enterprise visibility of all potential IT solutions/capabilities, such initiatives will be captured in the DPS at the earliest possible stage. New items must be input into DPS regardless of whether they have received functional proponent or Headquarters staff approval. At the point that a program, project, emerging capability, or developing requirement has a proposed name or definition, and/or point of contact (POC), it must be entered into DPS by the POC. In addition, the POC should collaborate with his or her Customer Fulfillment Representative in the Solutions Delivery Office (J-642) to ensure that the proper information is entered into DPS. The Customer Fulfillment Representative will ensure that the Portfolio Management Team is aware of the new DPS entry.

Decisions made related to IT investments must be made based on quantifiable data and sound opinions related to the importance of one investment over another. The Investment Scoring Criteria Process (ISCP) is a repeatable process that employs an automated tool, which is used in the development of IT business values in support of executive funding decisions for IT



investments in DLA. The process ensures that IT investments are closely aligned to DLA's mission and strategic goals and objectives, and ensures that the portfolio will consist of those projects with a meaningful relationship to the DLA mission. The Enterprise Portfolio Manager oversees the annual scoring.

Program justification documentation consists of the Initial Capabilities Document (ICD), validated initial Rough Order of Magnitude Business Case Analysis (ROM BCA), or Economic Analysis (EA). Effective January 1, 2004, the ICD replaces the Mission Needs Statement, per the Chairman of the Joint Chiefs of Staff Instruction (CJCSI) 3170.01C, dated June 24, 2003. The DLA Capabilities Analysis team reviews all documentation for proposed new emerging requirements, including the ICD, validated initial ROM BCA, or EA, and prepares requirements packages for submission into the Portfolio Management process.

The Program Business Review Group (PBRG) uses investment business values, and recommends IT investment priorities and IT or non-IT trade-offs to the Corporate Board. The Corporate Board is the final DLA review that makes recommendations to the Director for the submission of the IT portion of the Program Budget Review (PBR). The DLA Resource Board is the forum for communicating the recommendations and decisions of the Program Business Review Group and Corporate Board in preparation of DLA's PBR submission.

The Program Executive Officer Review Board (PEO-RB) is the milestone decision authority for designated DLA Acquisition Category (ACAT) IIIA and IIIB Automated Information System (AIS) projects and projects of special interest. The PEO-RB conducts In-process Reviews (IPRs) quarterly and on an as-needed basis. The PEO-RB is chaired by the PEO with members representing each of the DLA J-codes and J-6 staff. The board provides guidance and direction to the appropriate program managers.

DLA IT Portfolio Management Investment Area Teams may be employed as working-level standing teams that support the Portfolio Managers and Enterprise Portfolio Manager in reviewing the functional, strategic, technical, and financial justifications of proposed IT investments to assess impact on the enterprise IT portfolios. Membership of the team will include an appropriate mix of technical and functional experts from the

### **3. Shortfalls/Gaps**

There are challenges in implementing fast paced, innovative reforms in acquisition such as Prime Vendor, EMall, and other collaborative efforts with industry, i.e., knowing when they fit and when they do not. Although the tendency is to inculcate the same innovations using the broadest brush into everything an agency does, the most successful tactic generally is a tailored approach using carefully chosen assessment criteria to avoid implementing particular types of reforms, such as some commercial business practices like warehousing, where it is not needed or is needed only infrequently and adds to the cost of the contract instead of saving the customer money.

### **4. Personnel/Funding Issues**

One of the challenges of reengineering and restructuring is continuing to provide the same high level of contracting quality and management oversight, particularly in the face of

---

reductions in workforce numbers. Insuring a regulatory and statutorily compliant acquisition, while also insuring achievement of agency business goals, can sometimes be conflicting objectives. Agencies need to refocus on training and recruiting efforts and on strategic placement of valuable and experienced resources with the necessary skills needed to evaluate and document appropriate trade-offs.

DLA is currently working with industry to create a Competency Assessment Management Tool (CAMT) as part of the DLA Learning Management System (LMS). This tool will provide a profile on each individual DLA employee that enables employees to view the competencies required for their positions, to assess their skills in relation to those competencies, and to identify skill gaps. The CAMT will then permit employees to establish training goals to close those gaps and include the goals in their Individual Development Plans. The skill gap analysis will identify opportunities for improvements on individual and enterprise bases to create a more qualified workforce. The CAMT and the LMS will include succession planning for employees to plan their career development and to keep abreast of advancement opportunities. The estimated completion date for the DLA CAMT is FY 2009.

#### **IV. Joint Acquisition**

Currently, DLA is involved with US Transportation Command in the Integrated Data Environment (IDE)/Global Transportation Network GTN Convergence effort, and the Common Food Management System (CFMS).

#### **V. Agency Recommendations**

##### **1. Organizational Issues**

The impact of the continuing transformation to BSM represents a fundamental business change that will enable DLA to share information and data as a single corporate enterprise better positioned to support its customers. In a related move, DLA has reorganized its former stovepipes into customer focused supply chains for aviation, land, and maritime, supported by common business rules with common jobs, roles, and responsibilities across the enterprise. DLA is still transitioning to this new organizational alignment and faces unique challenges in management and execution, but is committed to resolving remaining issues quickly.

The efficiency of the DLA acquisition system would be greatly enhanced by the return of Domestic Non-Availability Determination (DNAD) approval authority to the head of the agency. This change would put alignment with other Service Secretary approval levels and eliminate confusion among industry, DCMA, and other government agencies when these levels differ. It also would be in concert with DLA waiver approval authorities, such as the one for ball and roller bearings. It would allow organizations to provide more timely support to military customers. Copies of all DNADs granted by the organizations would be forwarded to OSD to provide transparency of the organization's process as well as valuable information to the Department about industrial capability.

## 2. Policies and Procedures Needed to Improve Outcomes

### a. Agency-Related Proposals to Improve Outcomes

- ◆ Recent legislative changes (such as the changes to the Berry Amendment in the FY 06 National Defense Authorization Act) have had a significant impact on our processes and require extensive efforts to bring those processes into compliance without lead time for implementation. OSD assistance would be beneficial to mitigate the impact of such legislative changes. Uniform implementation using the FAR/DFARS system would be in DoD's and the other executive agencies' best interest.
- ◆ The policies of the Defense Acquisition System, embodied in DOD Directive 5000.1 and DOD Instruction 5000.2 are not applicable to the majority of supply and services contracts executed at DLA. Where it does apply, primarily for significant IT acquisitions, the designated Program Managers at DLA provide the following input:
  - A Streamlined approach for acquisition of Major Automated Information Systems including Commercial-off-the Shelf (COTS) IT Systems
  - As initially conceived, the original MAIS guidance was oriented on issues of systems development and creation of IT programs based upon extensive software development and the significant system integration efforts required to field a completed system. Over time, however, DOD has increasingly moved toward the purchase and implementation of commercial off-the-shelf (COTS) applications for its major business and even some infrastructure systems. Needless to say, COTS products do not have the same developmental challenges as do the programs that are based upon development of software from raw code.
  - The original MAIS rules visualized a process by which appropriate oversight activities proceeded in pace with the basic software development process—accepting the time delay and consequent cost of oversight management as a risk mitigation strategy. The reality of COTS implementations is that the basic capability exists “out of the box” and now, rather than serving as a developmental risk mitigation strategy, the traditional MAIS oversight process becomes time consuming and costly to the acquisition process. The challenge is to establish a regime of oversight that is: (1) appropriate to the task at hand; (2) is rational and sufficiently flexible to conform to the statutory guidance. The oversight process must also retain the necessary discipline, accountability, and stewardship to mitigate risks of unnecessary IT system proliferation, non interoperable system acquisition or systems acquisitions that subvert the goals and objectives of DOD's business transformation imperative.

### b. Proposals to Improve Service Lead on Joint Acquisition Programs

- ◆ The ideal approach focuses senior DoD leadership on joint, enterprise-wide or otherwise very important capabilities, the front end of the acquisition process where the most important investment decisions are made. This approach reduces senior DoD

---

management involvement in routine acquisition milestone decision making but instills strengthened stewardship through delegated, tiered and earned autonomy.

- ◆ The recommended approach delegates oversight and approval authority at program initiation and ties this delegation to assessed component acquisition management discipline, essentially implementing a process of earned autonomy. Key elements of this approach are:
  - Definition of major IT acquisitions based on factors other than cost. These other factors include (a) Joint/DOD/enterprise-wide scope, (b) High technical or integration risk, (c) Importance to component or mission owner, (d) High external visibility (e.g. Congress, GAO, OMB), and (e) qualifications of the acquisition entity.
  - Demonstrated and earned autonomy as determined by OSD/NII or the Defense Business Systems Acquisition Executive (DBSAE) based on program assessment associated with the Defense Business Systems Management Committee (DBSMC) Investment Review Board (IRB) process.
  - Component Acquisition Executives (CAE) and Program Managers would be required to successfully demonstrate minimal risks for a given program within the DBSMC IRB process that will support the DBSAE determination of acquisition approval authority and support rapid delivery of the given business capability to the user community/war-fighter in conjunction with the business transformation initiative. DLA in conjunction with US TRANSCOM has been selected as an Enterprise Risk Assessment Model (ERAM) pilot project, which conforms to the above recommend improvements to the DOD Acquisition Process. The ERAM pilot projects that DLA is participating in gives DOD the opportunity to validate that DOD is moving in the right direction in delivering capabilities to the user community/warfighter.

# Annex G

## Defense Information Systems Agency

---

This annex describes the Defense Information Systems Agency's (DISA's) acquisition program as required by Section 814 legislation. It specifically addresses the following:

- ◆ Current organization and its evolution
- ◆ Mission and capabilities
- ◆ Joint acquisition
- ◆ Recommendations.

The information presented in this annex was compiled from the 814 Review Survey responses and supplemented with information from DISA documents and Web sites. This annex has been formally released by DISA.





DEFENSE INFORMATION SYSTEMS AGENCY

P. O. BOX 4502  
ARLINGTON, VIRGINIA 22204-4502

IN REPLY  
REFER TO:

Component Acquisition Executive (CAE)

21 February 2007

MEMORANDUM FOR UNDER SECRETARY OF DEFENSE FOR ACQUISITION,  
TECHNOLOGY & LOGISTICS (AT&L)

SUBJECT: FY06 Review of Defense Acquisition Structures and Capabilities

Reference: USD(AT&L) Memo, FY06 Review of Defense Acquisition Structures and  
and Capabilities, 3 April 2006

1. Section 814 of the national Defense Authorization Act for Fiscal Year 2006 directed the Department to undertake a review of its acquisition structures and capabilities and provide a report to Congress. This review has been referred to as the Defense Acquisition Structures and Capabilities Review (DASCR). The reference solicited Agency support and input for accomplishing the DASCR and indicated that methodology would consist of data collection through face-to-face interviews and questionnaires. Additionally, as the review progressed, the report to Congress requirement came to include separate annexes for participating Defense organizations. The enclosure provides the document to fulfill Agency annex requirement.

2. Our primary acquisition concern is speed of delivery of capability to the Department of Defense (DoD) community namely the Warfighter. We want to be able to deliver capability to the Warfighter in similar timeframes as industry delivers capability to their customers and consumers.

1 Enclosure:  
DISA Annex

  
DIANN L. MCCOY  
Acquisition Executive





## **I. Current Organization**

The Defense Information Systems Agency (DISA) is a Department of Defense (DoD) combat support agency under the direction of the Assistant Secretary of Defense for Networks and Information Integration [ASD(NII)]. DISA is responsible for planning, engineering, acquiring, fielding and supporting global net-centric solutions and operating the Defense Information System Network to serve the needs of the President, Vice President, Secretary of Defense, Joint Chiefs of Staff, Combatant Commanders and other DoD components under all conditions of peace and war.

DISA provides a seamless, secure and reliable web of communications networks, computers, software, databases, applications and other capabilities that meet the information processing and transport needs of DoD. DISA also ensures the integration and interoperability of command and control, communications, computers and intelligence (C4I) systems.

DISA's acquisition structure consists of the Office of the Component Acquisition Executive (CAE) and four major portfolios with Program Executive Office (PEO) like responsibilities. This portfolio-based structure is patterned after the PEO structures of the MILDEPs of today - a normalizing step DISA has taken along the maturity path of acquisition management within DISA. A criteria-based approach was used to determine portfolio content for each DISA acquisition, which included all programs, projects and the acquisition of services for which DISA is responsible. The four PEOs or major portfolios are Command and Control Capabilities, Information Assurance/NETOPS, GIG Enterprise Services, and SATCOM, Teleport, and Services. Specific contents of these portfolios will be addressed in other paragraphs.

Figure G-1 depicts the high-level 2006 organizational structure DISA and lists the number of Key Leadership Personnel, the number of acquisition and non-acquisition personnel, dollar's funded, and total number of contracting actions performed.

Figure G-1. DISA Org Chart

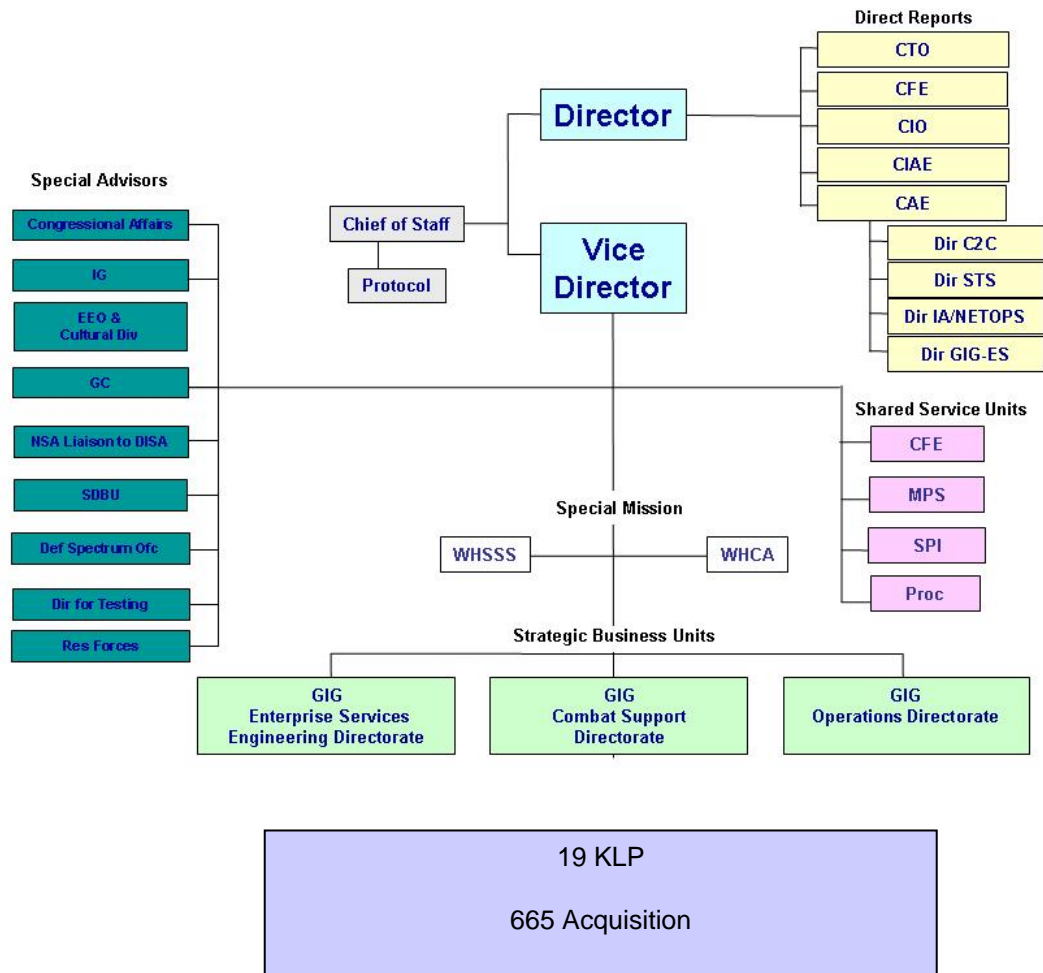
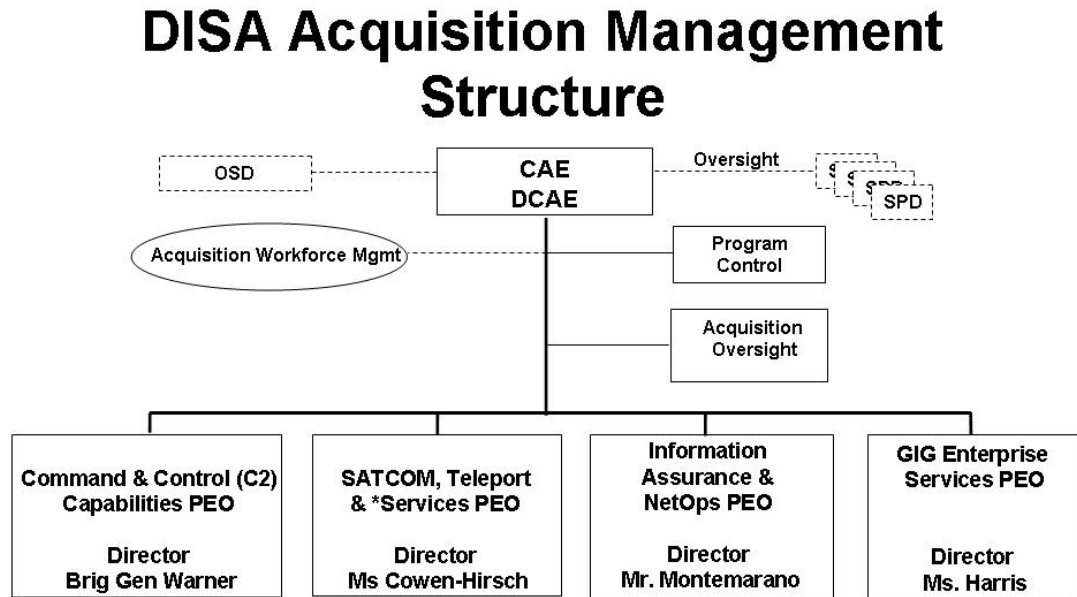

Figure G-2 depicts the portfolio-based acquisition structure in place today within DISA.

Figure G-2. DISA Acquisition Organization



\*Services means the 'acquisition of services contracts' oversight

## II. Evolution to the Current Structure Since 1990

### 1. Agency Evolution

#### 1960 through 1990

The Defense Information Systems Agency (DISA) was established on May 12, 1960 in Washington, D.C. as the Defense Communications Agency (DCA) with 450 employees, by Secretary of Defense Thomas B. Gates. Its mission was to manage the Defense Communications System (DCS), a consolidation of the independent long-haul communications functions of the Army, Navy, and Air Force.

In the 1960s, DCA moved to Arlington, Va., and took on several major organizations. The Air Force Office of Commercial Communications Management (now the Defense Information Technology Contracting Organization), White House Signal Agency (now the White House Communications Agency), and the Department of Defense (DoD) Damage Assessment Center (now the Joint Staff

---

Support Center) all became a part of DCA. DCA also established six regional communications control centers and two area centers for operational control of the DCS.

In the 1970s, DCA picked up the Minimum Essential Emergency Communications Network and the Military Satellite Communications Systems Office. It also became responsible for engineering and operating the Worldwide Military Command and Control System.

In the 1980s, DCA absorbed the Joint Tactical Command, Control, and Communications Agency, improving its ability to manage and enhance the interoperability of command, control, and communications systems. The Joint Interoperability Test Command was formed within DCA to provide interoperability compliance testing and certification.

### **1990 through 2000**

On June 25, 1991, DCA was renamed DISA to reflect its role in providing total information systems management for DoD. DCA implemented several Defense Management Review Decisions (DMRDs), most notably DMRD 918, which created the Defense Information Infrastructure, now known as the Global Information Grid. DISA became an information system focuses agency vice just communications focused. The Joint Spectrum Center and the Defense Technical Information Center also became part of DISA. Other missions such as the DISA Information Assurance and Defense Message System (DMS) have also been added.

### **2000 through 2006**

DISA participated in the DoD CIO, USD (AT&L), USD (C), and VCJCS co-sponsored Rapid Improvement Team (RIT) Pilots during 2001-2003. The Global Combat Support System (GCSS (CC/JTF)), formerly GCSS (CINC/JTF), was the DISA pilot under this effort and proved itself to be one of the most successful programs under the RIT Pilot effort. The program shortened acquisition cycle time by restructuring documentation to avoid redundancy and using concurrent reviews with stakeholders during document development. This led to the GCSS (CC/JTF) Program's first Milestone B decision in only 6 months, allowing the program to develop and field three capability increments in twelve months, while managing to stay within cost and schedule.

In late 2002, DISA recognized the need to add rigor to the DISA acquisition process. Soon thereafter in 2003, an ASD(NII) assessment served to confirm many adjustments that were needed. This ASD(NII) assessment reviewed the acquisition environments of several Defense Agencies. DISA was the first of these to be completed. The review identified twenty recommendations. DISA developed a roadmap and plan of action to incorporate these recommendations through implementation of a multi-phased approach identified below. Also, DISA

designated a full time SES as the DISA CAE. Today, DISA is in Phase III of the approach and has stood up a portfolio approach to acquisition. These four major portfolios are Command and Control Capabilities, Information Assurance/NETOPS, GIG Enterprise Services, and SATCOM, Teleport, and Services. The leadership of these portfolios is provided through either a General Officer or member of the Senior Executive Service (SES). Several minor portfolios, under SES leadership, are also stood up and contain ACAT III and below programs, projects, and service acquisitions.

## **2. DISA Acquisition Transformation**

The DISA Acquisition Transformation began in late 2002. The ASD(NII) assessment served to confirm many deficiencies that had recently realized. A phased approach to Acquisition Transformation was identified to the ASD(NII) who agreed with the approach. The phases of the transformation are delineated below:

Phase I - During the initial phase of DISA's Acquisition Transformation the focus was on standing up a dedicated Office of the Component Acquisition Executive, establishing a regulatory environment, and focus on provided oversight and direction for primarily the ACAT I programs assigned to DISA.

Phase II (FY2005)- Phase II's focus was on practicing key aspects that had been established during Phase I and developing an acquisition rhythm of recurring events. Movement was also directed toward becoming an acquisition organization supporting joint customers. Expansion of the acquisition oversight focus was extended beyond ACATI level acquisitions to include all programs, projects, and acquisition of services in DISA.

Phase III (FY2006) - During Phase III the goal is to move toward being a joint IT and IA acquisition organization. One significant goal was to professionalize the acquisition workforce through acquisition position identification, appropriate training and experience, and assigning the right people to the right job. Lines of acquisition authority were adjusted to accommodate the newly designated PEO or portfolio organizations.

As part of Phase III, DISA has grouped all acquisitions into a set of portfolios. Major acquisitions, generally at the ACAT I level, are assigned to one of four portfolios of Command and Control Capabilities, Information Assurance/NETOPS, GIG Enterprise Services, and SATCOM, Teleport, and Services. The leadership of these portfolios is provided through either a General Officer or member of the Senior Executive Service (SES). DISA realized that creating a portfolio structure has the potential for enormous gains; however, it requires an incredible commitment for excellence and must be embraced throughout the organization since it requires both a functional, operational, and a cultural change to ensure success. Additionally, several minor portfolios, under the leadership of an SES have also been stood up and contain generally ACAT III and below programs and service acquisitions. The DISA acquisition process is fully compliant

---

with the DoD 5000 series which defined the DoD Acquisition System, and includes working under appropriate OSD oversight while delivering joint capabilities to the warfighter.

### **3. Acquisition Commands**

The Defense Systems Information Agency (DISA) has an acquisition structure but has no acquisition command. The DoD chartered Joint Interoperability and Test Command (JITC) is a DISA organization. JITC's mission is to support the Warfighter by serving as independent operational test and evaluation/assessor of DISA, and other DoD Command, Control, Communications, Computers and Intelligence (C4I) acquisitions; identifying and solving C4I and Combat Support Systems interoperability deficiencies; providing C4I joint and combined interoperability testing, evaluation and certification; bringing C4I interoperability support, operational field assessments, and technical assistance to the Combatant Commands, Services, and Agencies; and providing training on C4I systems, as appropriate.

## **III. Mission, Capabilities, and Service**

### **1. Current Mission Statement**

The Defense Information Systems Agency is a combat support agency responsible for planning, engineering, acquiring, fielding, and supporting global net-centric solutions to serve the needs of the President, Vice President, the Secretary of Defense, and other DoD Components, under all conditions of peace and war.

Today's Core Mission Areas: DISA performs a number of very important missions in support of the President, the Secretary of Defense, the Joint Chiefs of Staff, the Combatant Commanders, and the other Department of Defense (DoD) components under all conditions of peace and war. All of these missions are acquisition based - meaning that they include the acquisition of capabilities or services that are delivered to the customer base indicated above. The designated core missions of DISA that have an acquisition base are communications, joint command and control, defensive information operations, combat support computing, and joint interoperability support. The acquisition of capabilities in each of these core business areas is an overarching and inherent DISA mission.

### **2. Capabilities Needed to Accomplish Missions**

As new missions are assigned to DISA, accompanying resources must also be allocated by the Department. There are insufficient Agency-level funds to absorb new missions. Often new missions are attempted to be added without appropriate resources.

### 3. Human Capital

The DISA workforce consists of over 6,500 (military and civilian) personnel, located around the world. The recruitment, retention and development of that force is critical to DISA successfully continuing to meet assigned mission.

As a vital part of its succession plan, DISA has several entry-level hiring programs. The Career Development Intern Program offers full-time permanent employment and aims at hiring high-caliber recent college graduates. This is a three-year program that provides on-the-job training, leadership and core training, rotational assignments, and an educational allowance. All interns are assigned a mentor and must complete a comprehensive individual development plan tailored to specific goals. Interns are hired at GS-5, 7 or 9, with promotion potential to the GS-13 for Engineers and Computer Scientists, and hired at GS-7 with promotion potential to GS-12 for all other positions.

DISA also has programs offering opportunities for high school and college students. The Student Career Experience Program (SCEP), also known as Co-Op, offers students the option of full or part-time employment that provides work experience directly related to the student's educational program. Successful completion of the SCEP may offer students the opportunity for non-competitive conversion to a permanent intern position. The Student Temporary Employment Program (STEP) has two components, STEP Summer and STEP Year Round. The program provides flexible temporary employment to enable students to earn a salary while continuing their education, working full or part time, summer or year round.

The DOD Information Assurance Scholarship Program (IASP) is another means of recruiting for Interns and SCEPs. This program is designed to increase the number of qualified personnel entering the Information Assurance (IA) and Information Technology (IT) fields within the Department of Defense. Utilizing all the above programs; DISA hired over 250 interns the past two years and expects to continue at a similar rate for the future.

DISA is very active in collaborating with schools and educational institutions, encouraging students to develop a passion for math and science. DISA provides role models who by their contributions as mentors or school volunteers encourage the students to consider a career in public service, particularly in the engineering and information technology career fields. Through a partnership with the National Science Center in Augusta, Georgia, DISA provided assistance in several technical areas, including web technology and robotics. DISA also established Adopt-a-School partnerships with three schools in the National Capitol Region (NCR) and several others throughout the country.

DISA's recruitment strategy involves a "blended approach," providing promotional opportunities for the current workforce while also filling many mid and

---

senior level positions from other federal agencies, former military personnel and the private sector. The goal is to select the best of the best.

With a corporate strategy to “recruit and retain the right mix of people,” DISA constantly seeks the highest quality workforce. Because DISA is a Joint Organization, the respective services nominate military personnel based upon their experience and expertise. Once selected, military members get an initial three-year tour with many receiving “joint duty” credit for the assignment. Military personnel assigned at DISA get the opportunity to participate in many of the developmental opportunities specifically designed for the DISA workforce.

In order to compete in the highly competitive civilian marketplace, DISA offers its managers flexibility to recruit a quality workforce. Managers have the option of hiring individuals above the minimum rate of Step 1 for new hires into federal service or rehires with a break in service of 90 days or more because of a candidate’s superior qualifications or agency special need. Another flexibility is to offer a recruitment incentive of up to 25 percent of the annual rate of basic pay for new employees. DISA implemented the Student Loan Repayment Program in January 2003 as a recruitment tool for hard-to-fill positions in the DISA Career Development Intern Program. A maximum per calendar year of \$10,000 may be paid, not to exceed a maximum overall amount of \$60,000 for each participant.

Once on board, DISA offers employees several Quality of Worklife programs to include Telework, Compressed Work Schedules (CWS), the Employee Assistance Program (EAP) and the Wellness Program. Employees may be eligible to telework at an alternative worksite (i.e., GSA Telework Center, Work-at-home, or Satellite Office) on a regular and recurring schedule for a maximum of two days per week. CWS consist of an approved work schedule composed of eight, nine-hour workdays and one, eight-hour workday. CWS allows for an additional non-workday within each biweekly pay period. The Employee Assistance Program (EAP) brings together a variety of personal services. The primary focus of the EAP is to assist employees who want help dealing with a multitude of problems—emotional, relationship, family, alcohol, drug, financial or job concerns. All EAP services are free. The Wellness Program is an added benefit to all DISA employees that allows eligible employees to participate in an exercise program during the workday without charge to leave for a maximum of one hour per day, three times per week. The DISA Wellness Program encourages and motivates employees to develop a healthy lifestyle and enhance the quality of worklife.

Workforce development is essential in attracting and retaining a knowledgeable and skilled workforce. The intent is to obtain the optimal balance of the right number of employees with the right skills at the right place in support of the war fighter using the Career Management Program (CMP). In FY04, DISA implemented the CMP as the major avenue to develop additional high performers.

DISA provides the opportunity for its employees to apply for advanced development activities through its Competitive Development Program (CDP). The CDP



gives employees an opportunity to compete for such programs as the Senior Services Schools, Federal Executive Institute, and other Executive Development and Leadership Programs. The CDP provides employees an opportunity to receive an education stipend to pursue focused academic study and improve technical and business knowledge both in undergraduate and graduate study.

The Executive Leadership and Development Program (ELDP) and the Emerging Leaders Program (ELP) are critical components of the DISA Succession Planning methodology. The ELDP provides those promising, ambitious, and talented mid to senior-grade employees with a systematic and coherent framework in which to clarify their career goals, develop their managerial and leadership potential, and continue to enhance their technical and functional expertise. The ELP provides a similar program for DISA's promising junior to mid-grade employees.

DISA also offers an agency-wide mentoring program that pairs employees with more experienced individuals for coaching, counseling, and teaching. The program is part of the Agency's commitment to continuous personal and professional improvement of the civilian and military workforce.

Systems used by the DISA workforce for development include the DISA Talent Management System (DTMS). Employees complete a survey, identify gaps between current skill levels and desired skill levels, and then complete an automated Individual Development Plan. DTMS captures the information and provides the basis for mapping an employee's professional development needs to ensure DISA's workforce is fully enabled to deliver its mission. With "eLearning," DISA is able to bring in excess of 2,000 computer-based training (CBT) titles and over 8,000 digitized books and technical documents to its employees.

To ensure a quality work environment, DISA is currently working initiatives to develop and operate a Computer Aided Facility Management (CAFM) system to manage space and facility assets across the Agency.

Whether it is recruitment, development or quality of worklife, DISA is constantly looking for ways to improve supporting its workforce. Additionally, the DISA workforce is committed to guaranteeing America's forces global information dominance by providing jointly interoperable systems, assured security, survivability, availability, and superior quality. DISA is truly an "Employer of Choice."

DISA acquisition professionals such as Program Managers, Deputy Program Managers, and other senior leaders in key positions such as Program Management Offices (PMOs) require knowledge, experience and skills that are a scarce commodity. Major acquisitions need acquisition leadership that is able to hit the ground running, requiring no ramp up or training time. We have found that these experienced acquisition professional commodities are in high demand across the Federal Government and are therefore in scarce supply. It takes time to grow assets like these by any organization so frequently organizations need to bring in these experienced resources from outside their immediate community.

---

Beginning in FY2004, DISA initiated an annual review process that reviewed each and every civilian and military acquisition position in the Agency with the goal of appropriately identifying those that should be designated acquisition positions. A criteria-based approach focusing on the work to be done by the position was used. The process consisted of defining appropriate criteria, applying the same criteria across the Agency to consistently identify which positions should be acquisition positions, determining the educational and experience gaps of the incumbents in the positions, and identifying a way-a-head to close these gaps. DISA found that some positions previously identified as acquisition positions were incorrect while others that should be acquisition positions had not been identified as such. The resulting gaps were significantly larger than annual quotas DISA receives for DAU training. Sufficient training seats must be made available to DISA so the gap can be rapidly closed in a progressive fashion.

#### **IV. Joint Acquisition**

##### **1. Summary of Current DISA Joint Acquisition Programs**

Joint acquisitions are DoD sponsored acquisitions that deliver a DoD-level enterprise solutions/capabilities in support of the Warfighter. All DISA acquisitions are joint in this sense. Although DISA is the lead for many of these enterprise solutions, MILDEPS and other Defense Agencies play an important role as either a direct participant in developing part of the capability or as a user of the delivered solution/capability. Joint acquisitions at DISA are unlike other acquisitions such as the Joint Strike Fighter where two Services share the lead for a two Service solution. The Joint Acquisitions that DISA is responsible for are broken out by portfolio as follows:

##### **Command and Control Portfolio**

- Net-Enabled Command Capability (NECC): NECC will be the DoD's principal command and control information technology. NECC will enable decision superiority via advanced collaborative information sharing achieved through vertical and horizontal interoperability. As the net-centric migration path for the Global Command and Control System (GCCS) Family of Systems (FoS), NECC will support force-level planning, execution, monitoring, and assessment of joint and multinational operations. NECC will use Net-Centric Enterprise Services (NCES) core enterprise services and will be able to exchange information across multiple security domains.

On 2 September 2005, the Assistant Secretary of Defense for Networks and Information Integration (ASD (NII)) designated the Defense Information Systems Agency (DISA) as the lead component for NECC. DISA has established the Program Executive Office Command and Control Capabilities (PEO C2C) to manage the NECC Program.

The NECC Program Management Office is the single office responsible for management of the NECC and is responsible for development activities for

common, joint capabilities within NECC. In addition to development activities, this includes the planning and conducting of test and evaluation of development products for common and joint capability and coordinating operational testing with the lead Operational Test Activity (OTA).

The NECC program was formerly known as the Joint Command and Control (JC2) program.

- **Global Command and Control Joint (GCCS-J):** GCCS-J is a Command, Control, Communications, Computer, and Intelligence (C4I) system, consisting of hardware, software, procedures, standards, and interfaces that provide a robust, seamless C2 capability. The system uses the Defense Information Systems Network (DISN) and must work over tactical communication systems to ensure connectivity with deployed forces in the tactical environment.

GCCS-J is the DOD joint C2 system of record for achieving full spectrum dominance. It enhances information superiority and supports the operational concepts of full-dimensional protection and precision engagement. GCCS-J is the principal foundation for dominant battlespace awareness, providing an integrated, near real-time picture of the battlespace necessary to conduct joint and multinational operations. It fuses select C2 capabilities into a comprehensive, interoperable system by exchanging imagery, intelligence, status of forces, and planning information. GCCS-J offers vital connectivity to the systems the joint warfighter uses to plan, execute, and manage military operations.

GCCS-J is primarily an integration program where the GCCS-J Program Management Office (PMO) develops limited mission capabilities in-house. GCCS-J integrates Service and Agency developed mission applications/functional capabilities that are delivered to the joint community. It is the mission applications/functional capabilities, integrated together with the core infrastructure that provides a joint C2 capability supporting the following mission areas: Force Employment, Force Readiness, Force Sustainment, Force Projection (Planning and Deployment/Redeployment), Force Protection, Situational Awareness, Intelligence, and Cross-Functional/Infrastructure.

- **Global Combat Support System (CC/JTF):** The Global Combat Support System (GCSS) Combatant Commanders/Joint Task Force (CC/JTF) was developed by the Defense Information Systems Agency (DISA) to respond to the operational concept of Focused Logistics articulated in Joint Vision 2010, and reinforced in Joint Vision 2020. Focused logistics is the fusion of logistics information and transportation technologies for rapid crisis response; deployment and sustainment; the ability to track and shift units, equipment and supplies and the delivery of tailored logistical packages directly to the warfighter.

GCSS (CC/JTF) supports the Combatant Command/Joint Task Force level by supplying read-only access to comprehensive combat support (CS) information from authoritative CS data sources. This access provides the warfighter

---

with a single, end-to-end capability to manage and monitor units, personnel and equipment through all stages of the mobilization process. By providing access to high-level integrated information and decision support tools, GCSS (CC/JTF) enhances the ability of Combatant Commands and JTF commanders to make timely, informed decisions.

GCSS (CC/JTF) complements the Global Command and Control System (GCCS) by being fielded as a GCCS mission application. As such, it adds capability to the common Operational Picture, and provides a web-based query tool. Together, GCCS and GCSS present a comprehensive command and control (C2) and CS battlespace picture to its user community.

- **Multinational Information Sharing (MNIS):** MNIS is a multinational information sharing effort intended to provide standard multinational information sharing services and applications for the future Global Information Grid enterprise information environment. Additionally, MNIS will facilitate information sharing among DoD components and eligible foreign nations in support of planning and execution of military operations.

The components of MNIS today are:

- Combined Enterprise Regional Information Exchange System (CENTRIXS) - A collection of services to sustain, maintain, and operate a seamless, interoperable, trans-regional coalition information sharing and exchange system among Combatant Commands, Services, Agencies, and Partner nations supporting collaborative planning for combined operations.
- Griffin - A collection of services to provide a permanent classified electronic information-sharing environment supporting collaborative planning activities between national SECRET C2 systems of participating nations for planning, implementing, and executing multinational operations.
- Combined Federated Battle Lab Network (CFBLNet) - A collection of services to provide a permanent infrastructure for multinational C4ISR research, development, trials and assessments that enables participating nations to explore, promote and confirm Coalition capabilities.

### **SATCOM, Teleport, and Acquisition of Services Portfolio**

- Commercial Satellite Communications Satellite Communications supports the warfighter with global Fixed (FSS) and Mobile Satellite Services (MSS). PMO, SATCOM provides a contractual vehicle for the DoD, Federal Agencies, and other users authorized by DoD, to obtain global fixed satellite service (FSS) bandwidth and related business and enterprise satellite-based services and applications, including but not limited to satellite bandwidth, bandwidth and service management, leased earth terminal services, leased

earth terminal operation and maintenance services, commercial teleport services, all necessary U.S. and foreign bandwidth and terminal licenses and approvals, optional terrestrial interconnection services, optional host nation agreement negotiating support and optional systems engineering support.

Mobile Satellite Services provided by PMO SATCOM includes International Maritime Satellite (INMARSAT) I3 and I4 (Broadband Global Area Network) airtime, terminals and services for services. Services provided include on land or ship-to-ship, ship-to-shore, shore to ship, and air/ground/air on a global basis, including calls made to a foreign earth station. Service will be available to all DOD and Non-DOD agencies.

- Teleport: The Defense Information Systems Agency (DISA) is implementing the Department of Defense (DoD) Teleport System. The system will integrate, manage, and control a variety of communications interfaces between the Defense Information System Network (DISN) terrestrial and tactical satellite communications (SATCOM) assets at a single point of presence.

The system is a telecommunications collection and distribution point, providing deployed warfighters with multi-band, multimedia, and worldwide reach-back capabilities to DISN that far exceed current capabilities. This new system provides additional connectivity via multiple military and commercial SATCOM systems, and it provides a seamless interface into DISN. The system provides inter- and intra-theater communications through a variety of SATCOM choices and increased DISN access capabilities.

- Acquisition of Services: Within DoD the Acquisition of Services is the execution of one or more contracts or other instruments committing or obligating funds for a special requirement. Under this concept, acquisition begins the point where the organization needs are established and includes all functions directly related to the process of fulfilling those needs by contract, agreements, or funds transfer. Additionally, IT Services is the performance of any work related to IT and the operation of IT, including National Security Systems. IT Services also includes outsourced IT-based business processes, outsourced information technology and outsourced information functions. DISA acquisitions of services include acquisitions such as Commercial Satellite Communications (COMSATCOM) and Encore Information Technology (IT) Solutions (ENCORE).

### **Global Information Grid - Enterprise Services (GIG-ES) Portfolio**

- Net Centric Enterprise Services (NCES): NCES will enable the secure, agile, robust, dependable, interoperable data-sharing environment for DOD where warfighter, business, and intelligence users share knowledge on a global network. This, in turn, facilitates information superiority, accelerates decision-making, effective operations and net-centric transformation across the DoD enterprise. Collaboration, mediation, information assurance/security, discovery, service management, storage, and messaging are among the core

---

enterprise services that NCES will deliver through the four product lines of Enterprise Collaboration, Enterprise Portal, Content Discovery & Delivery, and Service Oriented Architecture Foundation.

NCES represents a different approach to building and fielding DOD Information Systems. It is a market-based approach, recognizing that a user's information technology (IT) needs are dynamic and are rarely satisfied by systems that were built with a set of pre-determined user needs. NCES recognizes that it is the users themselves who are best able to define their requirements. The NCES approach is DOD-wide. It offers unprecedented access to information from global sources, thereby extending the reach of people and resources while leveraging existing IT investments.

### **Information Assurance/NETOPS Portfolio**

- Information Assurance: The DISA information assurance program is broadly focused on designing and deploying proactive protections, deploying attack detection, and on performing information assurance (IA) operations. It secures DoD enterprise systems and provides support to the Combatant Commanders and deployed forces. It also provides capstone capabilities for the entire department such as the DoD Computer Emergency Response Team, the DoD-wide anti-virus license, the DoD Public Key Infrastructure (PKI), and accreditation and certification process, policy, and implementation.
- Global Electromagnetic Spectrum Information System (GEMSIS): The GEMSIS initiative is intended to provide capabilities for integrated spectrum operations across the entire Department of Defense (DoD) in addition to interoperability with Federal, State and local government spectrum agencies, and coalition forces. GEMSIS is envisioned as a net-centric emerging capability providing commanders with an increased common picture of spectrum situational awareness of friendly and hostile forces while transparently deconflicting competing mission requirements for spectrum use. This capability will enable the transformation from the current preplanned and static assignment strategy into autonomous and adaptive spectrum operations.
- DoD Public Key Infrastructure (PKI): The DoD PKI program provides a mechanism to issue public key cryptology credentials to the entire DoD population. The use of these credentials will raise the level of assurance afforded DoD mission critical information, and provide a foundation for DoD e-business initiatives. The executive agent for the program is the National Security Agency (NSA) while DISA's partnership role is to provide the Deputy Program Manager. On 6 May 1999, the Deputy Secretary of Defense issued a memorandum that encouraged widespread use of public key-enabled applications and provided specific guidelines for applying PKI services throughout the Department. On 10 November 1999, the Deputy Secretary of Defense directed that the CAC be used as the DoD's primary platform for the PKI authentication token.

## **Sustainment Portfolio**

DISA has numerous programs that are considered to be in sustainment. Only the major programs with recent visibility are addressed below.

- **GIG-Bandwidth Expansion (GIG-BE):** The Global Information Grid Bandwidth Expansion (GIG-BE) Program was a major Department of Defense (DOD) net-centric transformational initiative executed by DISA. GIG-BE created a ubiquitous “bandwidth-available” environment to improve national security intelligence, surveillance and reconnaissance, information assurance, as well as command and control. Through GIG-BE, DISA leveraged DOD’s existing end-to-end information transport capabilities, significantly expanding capacity and reliability to select Joint Staff-approved locations worldwide.

This program provided increased bandwidth and diverse physical access to approximately 87 critical sites in the continental United States (CONUS), Pacific Theater, and European Theater. These locations are interconnected via an expanded GIG core.

GIG-BE provides a secure, robust, optical terrestrial network that delivers very high-speed classified and unclassified Internet Protocol (IP) services to key operating locations worldwide. The Assistant Secretary of Defense for Networks and Information Integration’s (ASD/NII) vision is a “color to every base,” physically diverse network access, optical mesh upgrades for the backbone network, and regional/MAN upgrades, where needed. “A color to every base” implies that every site has an OC-192 (10 gigabits per second) of useable IP dedicated to that site.

After extensive component integration and operational testing, implementation began in the middle of the 2004 fiscal year and extended through calendar year 2005. The initial implementation concentrated on six sites used during the proof of initial operational capability (IOC), achieved on Sept. 30, 2004. Final operational test and evaluation at 54 operational sites was completed on Oct. 7, 2005. Full Operational Capability (FOC) was achieved as of Dec. 20, 2005.

GIG-BE is now in sustainment.

- **Defense Message System (DMS):** The Defense Message System (DMS) is the system of record for organizational messaging used by the Department of Defense (DOD), it is a modified commercial-off-the-shelf (COTS) application that provides multimedia messaging services, directory services, and security services. It uses the underlying Defense Information Infrastructure (DII) network and security services in conjunction with the National Security Agency (NSA) security products.

DMS provides message service to all DOD users (including deployed tactical users), interfaces to other U.S. government agencies, allied forces, and

---

defense contractors. DMS makes available secure organizational messaging and/or record traffic supporting confidentiality, integrity, non-repudiation, and guaranteed delivery of information. The National Gateway System, which is a DMS transition Hub (DTH) with centers at Fort Detrick, Md., and the Pentagon (the Pentagon Telecommunications System Center), provides DOD with a continuing capability to satisfy legacy messaging requirements, allied and tactical interoperability, and emergency-action-message (EAM) dissemination.

DMS is now in sustainment.

## **2. Issues/Gaps in Capability**

The difficulties encountered have indicated that DoD needs to change the way we acquire IT capability through acquisitions. Specifically, we need to accelerate speed of delivery, embrace risk-based testing, right-size the information assurance (IA) certification, and streamline the requirements process. All these are required to reduce cycle time so that capability can be delivered to the warfighter inside the proverbial 18 month IT change window. Capability must be deliverable before technology changes.

Ultimately, what matters is getting information to the decision-maker. Information saves lives. However, there are currently barriers between getting that information to the warfighter—be it a barrier between services or between coalition partners or a barrier in acquiring the technology required. The warfighter is not going to get perfect information. The warfighter is fine with this approach as long as he is provided new capability. You've got to get information fast and you've got to be able to act. Perfect information that is after the fact is of no value.

## **V. Agency Recommendations**

### **1. Speed**

The changing business model has one major goal in mind: speed. Technological capabilities need to be given to the consumer and to the warfighter faster if they're going to keep pace with the fast changes the industry is seeing. We're used to talking about what we're going to do five years from now. We need to think and act in shorter timeframes. We need to get decisions made sooner. We need to pay attention to doing things right. We need to get the requirements to meet the threat and we need those requirements to address capabilities needed rather than to specify a particular solution. We have to change. We need to move faster. We are capable of better acquisitions. We need to achieve flexibility. Part of DISA's plan for speedier acquisitions is to allow more flexibility in fulfilling requirements.

Industry partnerships are becoming an important part of the acquisitions process and therefore influence speed of delivery. We need to encourage industry to make research and development investments such that they facilitate our adoption or



buying of needed capabilities rather than always having to develop them. We need to tap appropriate industry subject matter experts when needed, and facilitate the transfer of that knowledge and expertise to government assets. We need to work with contracting officers to understand the way to “negotiate” with industry in this dynamic technology driven business base. We need to build close partnerships with industry.

DISA will increase the speed and flexibility of the requirements and acquisition processes used in delivering capabilities and services by following the precepts of adopt-before-we-buy and buy-before-we-create. If another organization has developed or acquired a capability that either fits or is close to fitting a need we have, we will adopt that capability. Where adoption opportunities are not available, we will acquire a capability that either fits or is close to fitting the need. The final choice is to create or build a solution. We intend to avoid development when we can. Our goal is to close the gap between the availability of technologies and fielding them for warfighting advantage.

DISA will follow the precepts of adopt-before-we-buy and buy-before-we-create based on a business analysis. If another organization has developed or acquired a solution that either fits or is close to fitting a need we have, we will adopt it. Where adoption opportunities are not available, we will turn to the private sector and acquire a service that either fits or is close to fitting the need. The final choice is to create or build a solution. We intend to avoid development and turn to others for solutions when we can.

Speed of deployment is often more important than a perfect solution. We will pursue the adopt-before-we-buy and buy-before-we-create approach partly as a way of getting the 80 percent solution in the hands of the warfighter quickly and tailor oversight and governance to be commensurate with risk.

## **2. The Adopt, Buy, Create Concept**

When DISA begins the process of creating an information technology solution, its first step will be to take an existing capability or service developed or acquired by the government that can meet the needs of the warfighter and adopt it for DoD use. An example is DISA’s adoption of the Army Knowledge Online Portal for use across DoD. DISA takes advantage of a product or process that is already available and can also use the expertise of Army engineers who developed the software. As a result, the agency saves millions of dollars that would have been spent in developing a tool from scratch.

If adopting an existing capability or service isn’t possible, DISA will turn to industry to acquire existing commercial capabilities and managed services. Additionally, DISA is requests for proposals that are broader requests for proposals than it has in the past. Previously, DISA used specific descriptions when putting out request for proposal. A request would contain specific requirements—a checklist—that the prospective bidders would have to meet. Now, requests for

---

proposals will be far more generic. Proposals will state a problem, and it will be up to DISA's industry partners to suggest solutions to the problem.

DISA will create (build) a solution only if a technology cannot be adopted from within the government or acquired from the private sector. DISA will not seek to develop a complete solution right away. Although this ABC Concept is a different approach to providing capability, it is consistent with existing DoD policy and delivers capability without compromising security.

### 3. Testing

We need to move to risk-based testing where we determine how much testing needs to be done to mitigate potential problems. Depending on the approach, either A, B, or C in the ABC acquisition concept, testing should be based on overall risk for capabilities identified as critical consistent with risk-based testing approaches endorsed by DoD.

We need to ensure go/no go decisions for fielding/deployment are risk-based decisions balanced with the delivery of new capability. Frequently having even 50% of a new capability now is better than 80% or 100% of the capability in many months or years. The decision to field/deploy the capability should rest in the hands of the functional proponent/end user who should ask, "Am I willing to accept the risks?"

**Adopt**—For the **A**dopt approach, the product or service has been developed or acquired by another government organization and has a wide community of acceptance, a proven track record, and a strong history of vendor support/sustainment. Testing and acceptance risk for this type of acquisition is minimal to low because the testing process can rely on previous data collected by the developing organization as well as a certain level of confidence that the product or service meets DoD/government acceptance standards. Thus testing is tailored for speed of delivery.

**Buy**—For the **B**uy approach, the product or service has been developed within the commercial environment for non-government/military use but the product or service meets a critical or essential warfighter need. Additionally, many commercial products or services have a proven track record and available test data. Testing and acceptance risk is low to moderate and the testing process is tailored for speed of delivery by only testing for conformance to government/military standards and mitigating the potential risks, not toward requirements acceptance.

**Create**—In the **C**reate approach the product or service has not been developed either commercially or by another government organization. In fact, the capability doesn't exist. Maturity of the technology is usually an issue requiring lengthy development cycles. Testing and acceptance risk is moderate to high and the testing process is very time consuming and costly to ensure the product or service meets DoD acceptance and conformance standards.

DISA is piloting a Federated Development and Certification Environment (FDCE) construct. FDCE is a set of governance, processes, and infrastructure that will enable faster development, test, evaluation, certification, and delivery of Net-Centric capabilities. FDCE is ideally suited for risk management strategies like the previously mentioned DISA Adopt Buy Create (ABC) concept where the process will allow for tailoring of evaluation criteria based on technical maturity and performance among other factors. FDCE fosters innovation, by setting a low barrier of entry into the environment. It allows Material Providers the ability to compose services with other Material Providers, while gaining exposure and feedback from business, intelligence, and warfighting domains. FDCE's value proposition is that it fosters innovation and collaboration, while allowing for re-use—the true benefit of Service Oriented Architectures (SOAs). The infrastructure of the FDCE will leverage assets of the Joint Mission Environment Test Capability (JMETC) and Major Range & Test Facility Base (MRTFB) to provide a persistent, operationally realistic transport layer and Live-Virtual-Construct models and simulations. This operationally realistic environment will help minimize the failure rate when fielded, typical with some software development efforts presently.

A fundamental element of our strategy is teamwork—teamwork with stakeholders, customers, and vendor partners. We will use the FDCE concept, which we also refer to as the “sandbox”, in which all can participate to foster innovation and collaboration and to introduce new capabilities and services into the GIG. We will ask developers, testers, and users to play in this “sandbox” by exposing candidate capabilities and services to warfighting, intelligence, and business users via the FDCE. We will provide incentives for vendors to do the same. Some candidates will take off; some will not. Success of the FDCE is dependent in part on the ability to do an early kill of those that do not. In any case, this richly collaborative approach will bring the best and brightest to the forefront and help us to speed the delivery of capabilities and services to the warfighter.



# Annex H

## National Geospatial-Intelligence Agency

---

This annex describes the National Geospatial-Intelligence Agency's (NGA's) acquisition program as required by Section 814 legislation. It specifically addresses the following:

- ◆ Current organization and its evolution
- ◆ Mission and capabilities
- ◆ Joint acquisition
- ◆ Recommendations.

The information presented in this annex was compiled from the 814 Review Survey responses and supplemented with information from NGA documents and Web sites. This annex has been formally released by NGA.



**National Geospatial-Intelligence Agency**

**Executive Summary**

National Geospatial-Intelligence Agency (NGA) is both a national intelligence agency and a combat support agency. Just as the Department of Defense (DoD) is transforming to meet current and future threats, so is NGA. Our acquisition challenge is providing and maintaining new solutions while NGA continues to perform its operational mission. NGA is working a Service Oriented Architecture to provide mature Network-enabled capabilities over time. NGA utilizes Industry forums to communicate both future technology challenges and acquisition opportunities. NGA has used the Section 814 review forum as an opportunity to identify further efforts needed to improve acquisition outcomes in support of NGA's national intelligence and combat support mission.

NGA has always tried to reach out to our Industry partners to foster collaboration and communications. NGA InnoVision's Basic and Applied Research and Information Integration Offices have existing contracts for adopting visualization, information management, and other commercial technologies for the advancement of geospatial intelligence. NGA is the community executive agent for the National Technology Alliance (NTA). NGA recently sponsored an Industry Outreach Forum in October 2006. NGA acquisition executives and program managers presented a roadmap of potential business opportunities to support the development of the National System for Geospatial-Intelligence (NSG) Service Oriented Architecture (SOA). More than 200 senior-level representatives from firms that support the defense and intelligence communities attend the meeting.

Just as NGA continues to evolve the GEOINT tradecraft, Defense should also work toward improving competencies of the acquisition workforce from a tradecraft (Program Manager, System Engineer, Contracting, etc) and leadership skills perspective. NGA recommends an increase in training capacity and ability to respond to short term training needs for Defense Acquisition Workforce Improvement Act (DAWIA) certification.

NGA is transitioning to a Net-Centric Services Oriented Architecture (SOA). NGA recommends continued DoD support for that transition and that DoD encourage early transition to SOA for all DoD IT programs. Included in the establishment of this architecture is evaluation and modification of current NSG legacy and heritage systems to enterprise services. NGA's professional dedicated acquisition workforce will continue to be key in accomplishing the agency's mission for the Department of Defense, the Intelligence Community, and the Nation.



KEITH E. LITTLEFIELD, Ph.D  
Director, Acquisition Directorate

UNCLASSIFIED





## I. Current Organization

NGA is both a national intelligence agency and a combat support agency. NGA's Director reports to both the Secretary of Defense and the Director of National Intelligence. NGA receives funding from both the Department of Defense and the Intelligence Community.

NGA's predecessor was the National Imagery and Mapping Agency, created on October 1, 1996, by uniting several organizations, including the CIA's National Photographic Interpretation Center (NPIC) and the Defense Department's Defense Mapping Agency. Because both organizations wished to maintain their tradecraft legacy ties, a compromise was reached to retain both imagery and mapping within the new organization's name. Since 1996, the Agency quickly developed its own tradecraft, geospatial intelligence.

On November 24, 2004, the President signed the 2004 Defense Authorization Bill, which authorized NIMA to formally change its name to the National Geospatial-Intelligence Agency (NGA). NGA's new name was the latest step in a transformation process underway since its inception to introduce the new intelligence discipline within the Intelligence Community (IC).

Figure H-1 depicts the high-level 2005 organizational structure of the Office of the Secretary of Defense (OSD), Acquisition, Technology and Logistics (AT&L). Figure H-1 also lists the number of Key Leadership Personnel, number of acquisition and non-acquisition personnel, dollars funded, and total number of contracting actions performed.

Figure H-2 illustrates the Defense Agencies' acquisition reporting structure. NGA does not have more than two levels of review between Program Managers (PM) and Milestone Decision Authorities (MDA) and there are no duplicate chains of authority. Primary MDA for Systems is the Director of NGA. That authority is delegated to the Director of Acquisition (D/A) for systems-acquisition activities. The D/A is also the designated Agency Component Acquisition Executive (CAE) and Milestone Decision Authority (MDA) for all Milestone A, B, C, etc. events. The D/A further delegates MDA authorities for individual milestones of legacy-heritage and functionality segments to appropriate levels. In each case, the designated work manager is no more than two levels removed from the (delegated) MDA.

Figure H-1. Office of Acquisition, Technology and Logistics

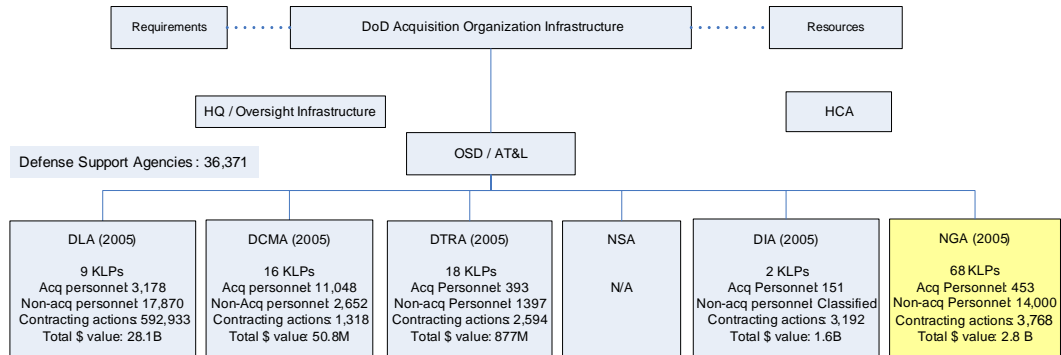

Figure H-2. PM Structures

## Program Management Structure

### Defense Agencies/OSD (automated information systems - typical)

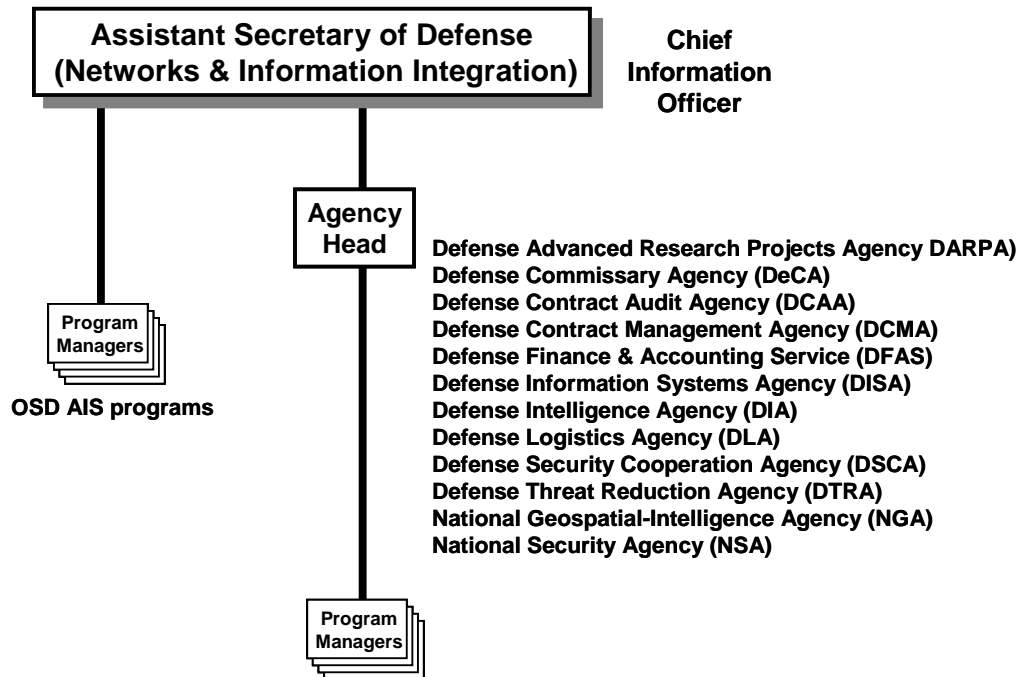
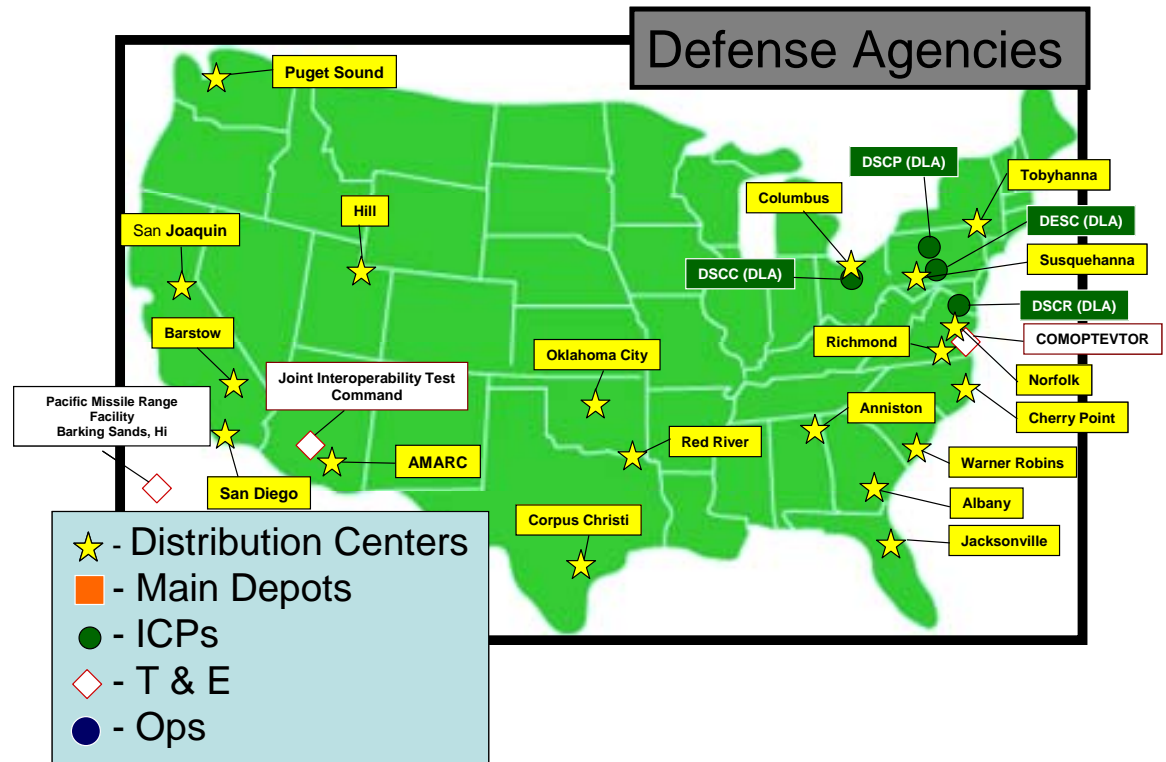

Figure H-3 illustrates the Defense Agency's distribution locations.

Figure H-3. Defense Agency Locations



## II. Evolution to the Current Structure Since 1990

### 1. Component Acquisition Executive Headquarters (CAE HQ)/Staff

- There was an increased requirement to provide more acquisition functions and people from the 1998 workforce numbers such as Program Management (+75), Contracting (+35), Systems Planning, Research, Development, and Engineering (SPRDE)- Science & Technology (S&T) (+20), Business, Cost Estimating and Financial Management (+14), and SPRDE-Systems Engineering (+20).
- NGA's acquisition workforce has increased from 280 in 1998 to 453 in 2005.
- NGA has moved from a working environment that is heavily dependent on government employees to one in which there are many contractors working throughout the agency. NGA is rapidly integrating contractors as part of the NGA team. NGA must work with industry to create an ongoing dialogue on new GEOINT technologies, techniques, and practices.

- The Office of Corporate Relations states that NGA’s workforce is approximately 14,000 with an even split between Government/Military and contractors.
- In the fall of 2004, NGA rebase lined its Acquisition Position List to reflect all acquisition positions associated with NGA major acquisition programs (\$30 million or greater) to include all acquisition career fields not included since the 1998 data, such as Facilities Engineering and SPRDE for Science and Technology Management. NGA started a transition period with outsourcing some government information technology and facility installation positions, increasing the Agency’s operational tempo for the war on terror, and adapting to meet the Agency’s evolving geospatial intelligence tradecraft. The NGA workforce shifted to a greater reliance on contractors.

Figure H-4. National Imagery & Mapping Agency Organization (NIMA) Chart 1998

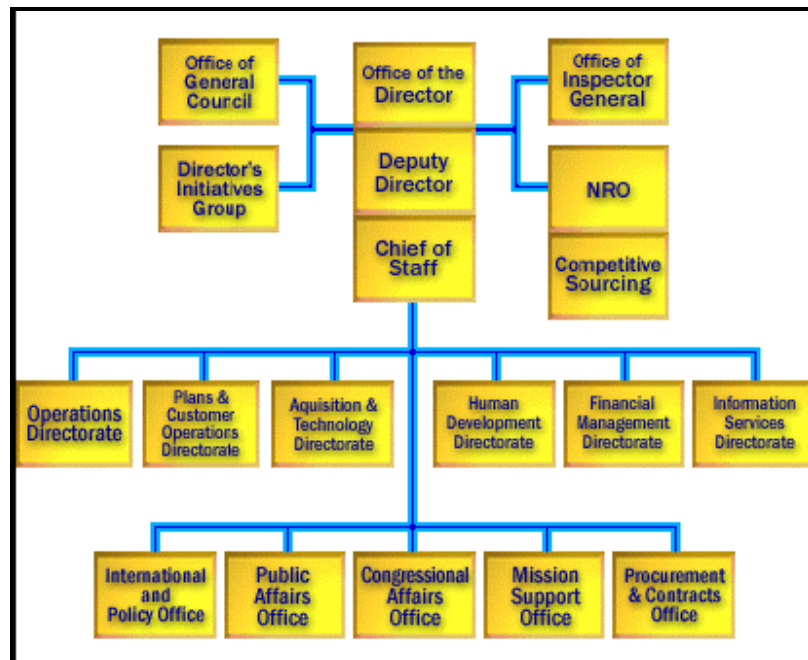
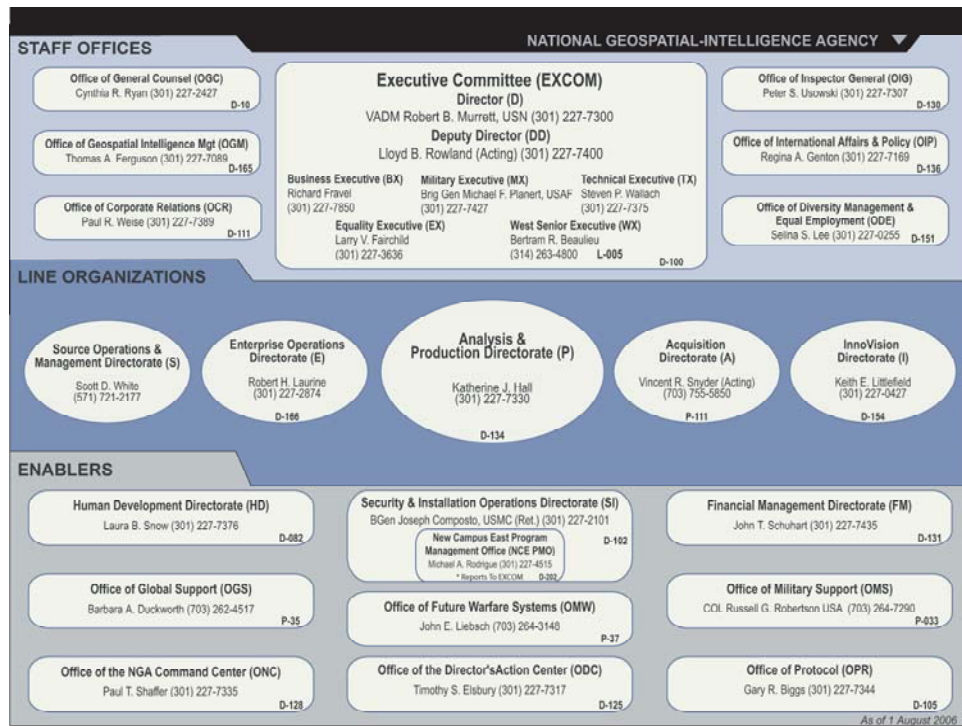

Figure H-5. NGA Organization (September 2006)



[Same as on NGA Organization Splash Page with EXCOM, Staff, Line Organizations, Enablers]

## 2. Acquisition Commands: N/A

## 3. Program Execution Officer (PEO) Structure

- The PEO structure (as tailored to NGA) offers a corporate approach to milestone decision-making in which operations groups are engaged and broad interests are represented in the readiness review. The NGA Program Executives are allocated from the Director of Acquisition directorate (as the CAE) to develop and advance acquisition programs based on the National System for Geospatial Intelligence (NSG). The program elements are determined from a functional capabilities architecture model towards a complete enterprise architecture. The main advantage of this approach is that the vision, architecture, and end-state are clearer and serve agency objectives. Divisions and branches of the Acquisition Systems Office (AS), whose functions are organized along architecture lines, advise the National System for Geospatial-Intelligence (NSG) Program Manager, dual-hatted as Director of AS, Direction of the NSG, on system issues relative to their position in the architecture. At the same time, they are directly in the D/S chain-of-control.
- There is potential disadvantage that the separation of PEO's will result in the creation of stove-piped approaches. From an end-to-end system

---

engineering model the balancing of long-term research and development (R&D), as well as near-term operational and sustainment (O&S) efforts, becomes more difficult. NGA addresses these issues with an overarching NSG Program Manager and a Chief Architect for the enterprise (supported by an Enterprise-Engineering contract cadre with a broad view of the enterprise).

#### 4. Other

NGA's acquisition reform, automated software systems, and collaboration with industry have changed during the last decade. To date NGA has not collected metrics that provide a basis of estimate of resource impacts or a good estimate of resource savings for the listed collaboration efforts.

Below is an example of acquisition reform impact:

- NGA created an Acquisition Business Office (AB) with one of its primary functions to provide a broad range of business management planning and operational support to the CAE, including stewardship for the implementation of statutory acquisition requirements and best practices. AB developed and implemented an Agency-wide earned value and integrated contract performance management system to facilitate program evaluation. Functions included are:
  - Serve as the Earned Value Management (EVM) focal point.
  - Develop Agency wide language for the implementation of EVM.
  - Provide consultation and compliance oversight for all acquisition programs using Integrated Contractor Performance Management (ICPM).
  - Facilitate and support Contract Implementation Reviews and Integrated Baseline Reviews (IBR).
  - Conduct EVM gap analysis.
  - Lead EVM Joint Surveillance Reviews (JSR).
  - Facilitate ICPM use, stewardship, mentorship, and training.
  - Support integration of ICPM data with risk management processes.

Below are some impacts through automated software systems:

- Procurement Information System (PRISM) Web has been the system for automated procurement for NGA since 2002. The PRISM solution has integrated paper and non-integrated systems into one streamlined

vehicle for conducting the agency's procurement from requisitioning through contracts. PRISM allows for streamlined routing of documents, through the various required approvers and reviewers, providing the necessary auditing of procurement actions. The initial start up cost of PRISM Web was \$4.2M including initial product, maintenance, and support. Since 2005, the agency has spent a grand total of \$8.1M on PRISM Web.

- The Enterprise uses a variety of automated systems for human resource and personnel requirements. NGA provides employees with a variety of ways to manage their personal benefits and employee records using our internal human resource system called PeopleSoft. Financial Management uses the Defense Finance Accounting System (DFAS). DFAS processes NGA's payroll. For travel NGA employees must use the Defense Travel System.

Below are impacts through NGA's collaboration with industry:

- Within the InnoVision Directorate (R&D) collaboration occurs through Cooperative Research and Development Agreements (CRADAs), technology transfers, dual-use technologies, and partnerships with industry/colleges. An example is when, in 1999, the Open GIS Consortium (OGC), Inc., a NGA partner in defining, developing, and solving open geospatial needs and products for the community, came together to devise a World Wide Web-based mapping test bed. The proliferation of commercial imagery analysis, geographic information system technologies, and standardized data formats, creates opportunities for collaborative R&D between the private sector and NGA laboratories. Particular emphasis is placed on R&D initiatives that are consistent with the NSG technical reference model and associated standards in the NSG technical architecture.

In addition, NGA InnoVision's Basic and Applied Research and Information Integration Offices have existing contracts for adopting visualization, information management, and other commercial technologies for the advancement of geospatial intelligence. NGA is the community executive agent for the National Technology Alliance (NTA). Finally, NGA is partnering with the Central Intelligence Agency (CIA), Defense Intelligence Agency (DIA), and the Federal Bureau of Investigation (FBI) by way of the In-Q-Tel venture firm, which connects the Intelligence Community (IC) to cutting-edge commercial technologies early in the development stage to solve our nation's most critical security challenges.

- Acquisition Contracts' (AC) collaboration with industry has been focused on increasing communications with industry and providing a single point of entry for industry to bring new ideas into the Agency.

---

NGA has established an Industry Interaction Panel with its Business Executive Office that provides a single office to receive unsolicited proposals and white papers from industry and tracks responses to the correct office and back to industry. This has resulted in eliminating multiple reviews by different NGA offices and more industry ideas being shared across the NGA enterprise. Industry is then afforded faster and more meaningful feedback.

- NGA's Office of Corporate Relations participates in several out reach programs and conferences such as the GEOINT Conference. NGA members attend Armed Forces Communications-Electronics Associate Intelligence Symposiums.
- AC sponsors two to four industry forums per year to discuss improving Government-Industry processes (e.g. Award Fee process) and explore with ways to increase and improve communications and streamline processes.

### **III. Mission, Capabilities and Service Issues**

#### **1. Current Mission Statements**

- "NGA provides timely, relevant, and accurate geospatial intelligence in support of national security." The definition of GEOINT is, "The exploitation and analysis of imagery, imagery intelligence, and geospatial information to describe, assess, and visually depict physical features and geographically referenced activities on the earth."
- NGA is also responsible for developing the NSG, the integration of technology, policies, capabilities, and doctrine necessary to conduct geospatial intelligence in a multi-intelligence environment. Inherent in that NSG development and in support of our combat mission, NGA must also acquire and manage O&S and other services.
- NGA has retained its mission for providing geospatial intelligence but is transforming its capabilities to meet the GEOINT tradecraft needs and relevant products to support changes in national security objectives.



Figure H-6. Capabilities Needed to Accomplish Missions

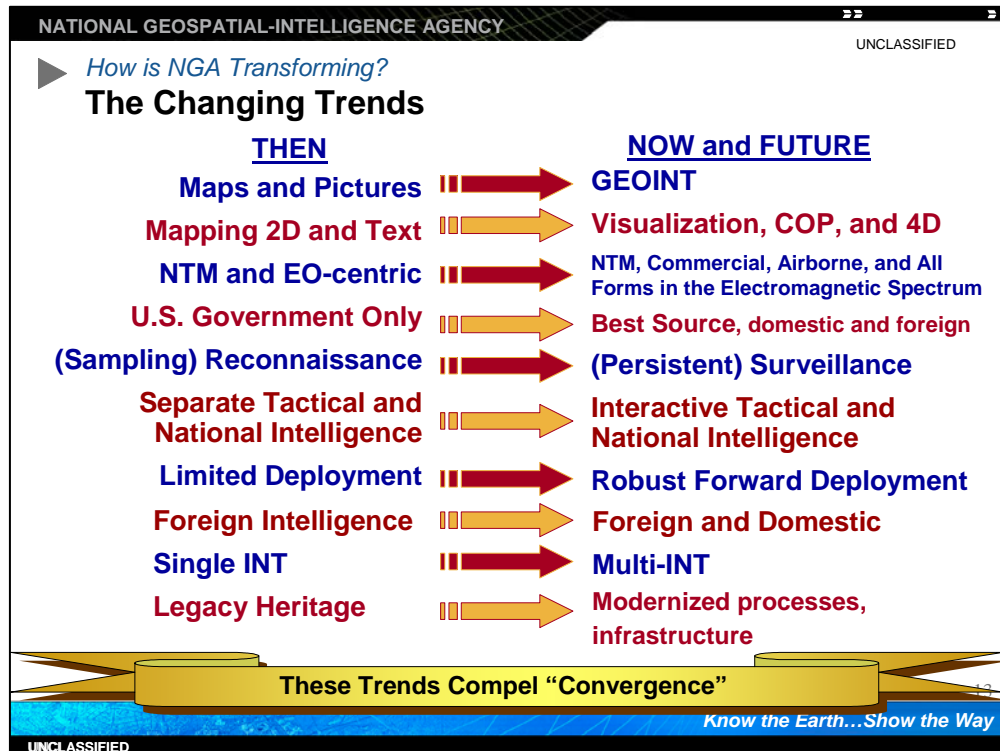

NGA has moved from traditional mapping and imagery to GEOINT. NGA is transforming and combining the mapping and imagery disciplines to produce rich geospatial intelligence. Where maps are 2 dimensional, GEOINT can be used to create fly-through visualizations to help warfighters understand where they are going before the mission starts.

NGA has moved from a reliance on National Technical Means (NTM) and Electro-Optical (EO) imagery to commercial imagery reduces the load on NTM. NGA increasingly uses airborne surveillance and imagery, and all forms of the electromagnetic spectrum, from multi- to hyper-spectral imagery products.

NGA has moved from a working environment that is heavily dependent on government employees, to one in which there are many contractors working throughout our agency. NGA is rapidly integrating contractors as part of the NGA team. NGA must also work with industry to create an ongoing dialogue on new GEOINT technologies, techniques, and practices.

NGA continues to pursue a robust Task, Process, Exploit and Disseminate (TPED) architecture. To achieve this NGA will converge systems to provide a more inclusive, persistent, responsive, accessible, and tailored architecture to maximize GEOINT capabilities.

---

Another capability needed to accomplish NGA's mission is to keep informed of new and emerging technologies related to GEOINT. NGA has started many initiatives to keep abreast of emerging technologies.

NGA has a robust technology cycle which includes current day advancements and longer-term research and development. The Acquisition Directorate works directly with vendors and contractors during the near-term acquisition cycle to acquire and field the best of technology. Similarly, personnel on the Transformation Team (GeoScout Program Office) monitor and evaluate a multitude of new products, continually searching for elements that will support the transformation effort. NGA's Systems Integrator performs an objective role to ensure that interoperable and open systems capabilities are part of the new technology and that it serves the enterprise. The Enterprise Operations Directorate (O&S mission) also stays abreast of new and emerging technologies through changes to versions, updates for hardware and software, and general optimization efficiencies. This immediate set of new and emerging technologies is usually event driven by vendors; whereby, NGA is informed by consultants (e.g., Gartner, Mitre) and/or vendors/sub-contractors.

The NGA research and development function is focused in its InnoVision Directorate, which is comprised of three offices with discrete responsibilities in the conduct of R & D within NGA. These three offices are: The Basic & Applied Research office (IB) responsible for basic & Applied Research for NGA; the Information Integration Office (II) responsible for prototyping, testing & evaluation, and technology insertion; and the Full Spectrum Office (IJ) responsible for advanced research into sensor phenomenology across the entire spectrum.

The InnoVision directorate of NGA engages regularly in emerging technologies of interest, how those technologies might be directed toward our most pressing user needs, and how advances in them can be tailored and transitioned into our acquisition and operations baselines for the benefit of the NSG. NGA InnoVision is connected with the larger geospatial R&D community, having an "open-door" philosophy with respect to vendor briefings and visits, receiving unsolicited proposals from across the industry, and attending community forums.

A primary means of becoming aware of new and emerging technologies is to read the trade journals of IEEE, Neuroscience, and popular magazines like Discovery and Popular Science. Finally interactions with the National Science Foundation (NSF), Information Technology Information Center (ITIC), Defense Advanced Research Projects Agency (DARPA), and other R&D organizations may reveal new technologies that may not yet be in the open market place.

InnoVision also has a number of mechanisms for tracking unclassified developments. Some of the most important mechanisms include IB's University programs, the NGA University Research Initiatives (NURI's), and Historically Black Colleges and Universities (HBCU's). NGA gets proposals from the best people in the relevant field; these proposals and the ensuing work provide greatly enhance visibility.

In addition, NGA keeps track of unclassified research and programs by organizations like the National Aeronautics and Space Administration (NASA).

NGA participates in a number of classified symposia and seminars, many held in the Washington Metropolitan area.

In the area of full spectrum R&D, IJ stays abreast and informed on new and emerging technologies by:

- developing and discovering new technology.
- conducting state-of-the-art research, development, testing and evaluation within government, DoD, and private sector in new and emerging technology.
- working with both private and government research organizations.
- attending research conferences and symposiums.
- employing highly educated scientist and specialists in their respective fields.
- funding numerous colleges and universities in appropriate areas of technology.
- reviewing and supporting unsolicited proposals from academic, private or other governmental organizations.
- participating in technical conferences and symposiums such as the GEOINT Conference.
- working with Federally Funded Research and Development Center (FFRDC) organizations involved with new and emerging technologies.
- providing and supporting employees in continuing education in fields of technologies.
- reviewing technical and scientific publications, journals, papers, etc.

---

NGA utilizes Financial Management and Acquisition control systems to align and enforce responsibility, authority, and accountability to accomplish its assigned acquisition mission. The NGA Financial Management Directorate (FM) executes fiscal management process for the Agency. NGA has management controls with annual audits for its internal control program.

NGA follows the DoD 5000 Acquisition series for authority and accountability, adapting where necessary, to allow for Intelligence Community (IC) missions. The Acquisition authority and accountability process is documented in an internal NGA Policy Directive for Acquisition, PD 5000 and NGA Instruction for Acquisition Program Review and Approval, NI 5000.1.

The NGA Acquisition Review Board (NARB) is the NGA oversight and approval board of senior leadership for all major programs greater than or equal to \$30 million. The NARB approves the acquisition strategy, provides a program office acquisition baseline, and assigns a Milestone Decision Authority for the program. The NARB also holds quarterly meetings and reviews ongoing program acquisition status. Under the auspices of NGA's Senior Procurement Executive, the NGA Procurement Board (NPB) reviews all programs greater than \$5 million. The NPB provides for a contracts review and in those cases where the program may not be covered by a NARB level approval process, a program office acquisition baseline.

NGA's IC mission receives reporting procedures and periodic reviews from the Director of National Intelligence (DNI).

## **2. Shortfalls/Gaps**

Refer to section V Service Recommendations.

## **3. Personnel Issues**

Refer to section V.2. Resource Issues.

# **IV. Joint Acquisition**

## **1. Summary of Current Defense Agency Joint Acquisition Programs**

- NGA is involved in many joint acquisition programs across the Intelligence and DoD community. NGA has been part of the Future Imagery Architecture (FIA) joint program with the National Reconnaissance Office (NRO). The two organizations created a FIA Joint Management Office with representatives from both agencies. NGA also participates in special access programs (SAPs) with various mission partners. NGA serves as the Functional Manager for GEOINT across the Geospatial

Intelligence community. This is defined as any program that serves maps, intelligence products, or related capabilities. Specific examples include:

- Defense Information Systems Agency (DISA)–Global Information Grid–Bandwidth Expansion (GIG-BE).
- DCGS - Distributed Common Ground System (DCGS) - Army, Navy, Air Force, Marines.
- Advanced Geospatial Intelligence (AGI) - Air Force, NRO.
- FIA - Future Imagery Architecture (FIA)–NRO.
- Commercial Imagery - DoD and Civil Agencies and the Intelligence Community.
- Intelligence Community Multi-Intelligence Acquisition Program (ICMAP) - Intelligence Community Agencies.
- Commercial Joint Mapping Tool Kit (CJMTK) - DISA via the Network Centric Enterprise Services (NCES) mapping services for geospatial visualization.

## 2. Issues/Gaps in Capability

- Joint acquisition programs generally serve more than one enterprise with varying differences in requirements, priority, funding, and management authority. Other challenges are configuration control, traceability, and tracking of requirements. There are issues in clean, clear, and orderly transition of developmental efforts into operations, especially when phased or only partial transfers occur. Efforts to treat joint acquisition programs as special projects and integrated process teams (IPT) mitigate a portion of the issues, but the dynamics of execution at the Agency level continue to present the largest problems, especially where roles and responsibilities of partners are not clearly defined. While the process of boarding decisions and advancements show promise, the bureaucracy of multiple organizations (with multiple processes) makes movement very slow.
- Prior to forming the FIA-Joint Management Office (JMO), NGA and mission partners had differing priorities, program baselines, and processes. In the post-FIA-JMO state, NGA and NRO have an agreed set of priorities, fully aligned funding and schedules, and joint processes. NGA and NRO developed and followed the Joint Systems Engineering Management Plan and Joint Systems Engineering Processes which provide documented repeatable processes to work through the broad range of system and technical activities.
- To the extent possible, lessons learned from the FIA-JMO effort are being applied to other programs. Not all of the mission partners have

had the positive, FIA-JMO experience. They are, therefore, not yet fully engaged in a joint management process.

**V. Service Recommendations**

**1. Organizational Issues**

- CAE believes that NGA should combine InnoVision (Research and Development), Acquisition, and Enterprise Operations (O&S) to ensure system performance of the entire enterprise. This also provides a Systems Engineering complete life cycle view for better performance, cost, and schedule tradeoff recommendations to management.

This combined organization allows greater accountability for the End to End (E2E) System and the long term investment strategy to balance future research, delivery of near term mission capabilities, and support the infrastructure of new mission capabilities.

- NGA perspective from the OSD acquisition category definition level is outlined in the table below:

Level	Definition	Authority	NGA Recommendation
ACAT I	Major Defense Acquisition Program (MDAP); RDT&E > \$365M, Procurement > \$2.19B, or USD(AT&L) designation	Current MDA Designation	NGA Recommendation
ACAT ID	Sub-category of ACAT I; Defense Acquisition Board advises USD(AT&L)	USD(AT&L)	no change
ACAT IC	Sub-category of ACAT I; C refers to Component.	DoD Component Head (or delegation to CAE)	no change
ACAT IA	Major Automated Information Systems (MAISs); single year costs > \$32M, total program > \$126M, lifecycle costs > \$378M, or ASD(NII) designation.	Current MDA Designation	NGA Recommendation
ACAT IAM	Sub-category of ACAT IA; M refers to MAIS	ASD(NII), as DoD CIO	Delegate Component programs to CAE
ACAT IAC	Sub-category of ACAT IA; C refers to Component	ASD(NII) delegates to CAE or Component CIO	Delegate Component programs to CAE
ACAT II	Major system not meeting ACAT I criteria; RDT&E > \$140M, procurement > \$660M, or Component Head designation.	CAE	no change

Level	Definition	Authority	NGA Recommendation
ACAT III	Program not meeting ACAT I, IA, or II criteria (i.e. MAIS RDT&E < \$32M, total program < \$126M, lifecycle costs < \$378M, and not designated as I, IA, or II)	Designated by the CAE; lowest possible level	no change

The NGA recommendations are based on decisions and criteria to be made at lower levels within the organization and relative to several factors. 1) Does the acquisition impact the enterprise or other higher-level systems? 2) Does the acquisition dollar threshold meet a lower criterion? 3) Is this a special interest project and/or decision? As these questions are addressed, decisions of acquisition authority can, and should, be passed to lower levels within the organization as long as visibility of those decisions are parts of higher level reviews.

NGA perspective from an Agency level and below is that the Enterprise Readiness process clearly defines the assignment process for MDAs. Director of Acquisition Directorate (D/A) is the CAE and serves as the MDA for all major Milestones A, B, C, etc. MDAs for lower level reviews are SESs or Senior Band 5 personnel depending on the type and complexity of the review. Acquisition issues are addressed at lower level milestone reviews such as requirements reviews, design reviews, test readiness reviews, operational readiness reviews, operational acceptance reviews, etc.

## 2. Resource Issues (Funding/Personnel)

- NGA recommends a Defense Budget structure that supports enterprise services (Network Centric Enterprise Services-like capabilities), corporate applications/services (e.g. financial, personnel, training systems), and mission services (e.g. mission planning, exploitation ...). The funding process needs to incentivize technology's rapid discovery, service reuse, rapid test, Certification and Accreditation (C&A), and transition into mission services. NGA recommends a Budget and Financial Management system that would provide for multi-year single color money to provide more flexibility and stability in funding of acquisition programs over a five year planning cycle.
- NGA recommends an increase in training capacity and ability to respond to short term training needs for Defense Acquisition Workforce Improvement Act (DAWIA) certification. Defense should also work toward improving competencies of the acquisition workforce from a tradecraft (program management (PM), system engineering (SE), Business/Cost Management) and leadership skills perspective;

---

continual dialog across OSD to improve acquisition management processes and systems. Improved cooperation between PMs, SEs, and Business and Cost Managers/functions.

### **3. Policies and Procedures Needed to Improve Outcomes**

- Service Related proposals to improve outcomes.
  - NGA is transitioning to a Net-Centric Services Oriented Architecture (SOA). NGA recommends continued DoD support and encouragement for early SOA transition for all DoD IT programs. DoD should support establishment of a SOA across the NSG for GEOINT. Part of the establishment of this architecture includes evaluation and modification of current NSG legacy/heritage systems to enterprise services. Support also entails negotiation of appropriate Service Level Agreements with DoD GEOINT suppliers and consumers.
  - Defense Acquisition Systems are moving to COTS tools, applications, and services that enable a Net Centric SOA. DoD and IC need to support a strong governance process, if enterprise services, as a new architecture layer, are to be successfully defined, built, and procured. DoD/IC needs strong governance as standards are being developed such as XML and other web services. DoD/IC governance needs to be harmonized and streamlined across multiple communities, review authorities, and approval boards. The roles between the CIO and CAE in the Governance process need to be clear to preclude overlapping, competing, and conflicting guidance.
  - Information Assurance needs clear processes, a standard qualified parts list, and adequate accreditation resources. NGA recommends that DoD clarify ability to use one agency security C&A for any given product, tailored only by implementation changes. NGA also suggests that DoD identify an approved set of cross domain solutions to streamline security approvals and foster information sharing across IT systems.
- Proposals to improve Service lead on joint acquisition programs
  - Refer to IV Joint Acquisition.



# Annex I

## Defense Contract Management Agency

---

This annex describes the Defense Contract Management Agency's (DCMA's) acquisition program as required by Section 814 legislation. It specifically addresses the following:

- ◆ Current organization and its evolution
- ◆ Mission and capabilities
- ◆ Joint acquisition
- ◆ Recommendations.

The information presented in this annex was compiled from the 814 Review Survey responses and supplemented with information from DCMA documents and Web sites. This annex has been formally released by DCMA.



## Defense Contract Management Agency (DCMA)

### Executive Summary

The Defense Contract Management Agency (DCMA) is the Department of Defense (DoD) contract manager, responsible for ensuring federal acquisition programs, supplies, and services are delivered on time, within cost, and meet performance requirements. Since 2001, DCMA has been a standard bearer in DoD's accelerated march to transformation. DCMA has shaped its transformation efforts to dovetail with those of its primary customers - the Military Services.

DCMA is a designated combat-support agency with a mission that has grown in scope and criticality in the last 6 years, particularly in the area of contingency contract administration. DCMA personnel are currently deployed around the world in all theaters of operation and continue to be a strong and familiar pillar of support to the warfighter. The Agency has taken the initiative to organize itself into six divisions (Aeronautical Systems, Naval Sea Systems, Ground Systems and Munitions, Space and Missile Systems, International, and DCMA Special Programs), which oversee 47 Contract Management Offices (CMOs) responsible for the work performed at over 800+ operating locations worldwide.

DCMA's transformation goes well beyond the application of new technologies and is a manifestation of innovative performance management and predictive analysis to ensure that contractors and suppliers deliver the right product, at the right time, at the right cost. DCMA has established meaningful performance measures at all layers of the organization and we are focusing on those indicators that will best light the way to improved service, increased customer satisfaction, and high-quality products in the hands of our operational forces. Through this coordinated transformation, DCMA continues to evolve as an indispensable and responsive partner to its customers, providing flexible and effective acquisition life-cycle solutions for 305,488 active contracts with a face value of \$1,773 billion.

Today, DCMA is a team of empowered individuals that focus on mission accomplishment and strive to find innovative ways to serve its customers and trusted partners in the acquisition community. DCMA is a leader among Federal agencies in adopting best business practices, improving financial management, developing performance-based metrics for organizational and personnel evaluation, and continually reshaping its services and procedures to meet changing customer needs that directly contribute to military readiness and the preservation of the nation's freedom.

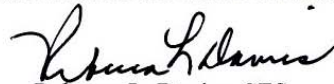

Rebecca L. Davies, SES  
Executive Director  
Contract Operations and Customer Relations



**I. Current Organization**

Figure I-1. Defense Contract Management Agency

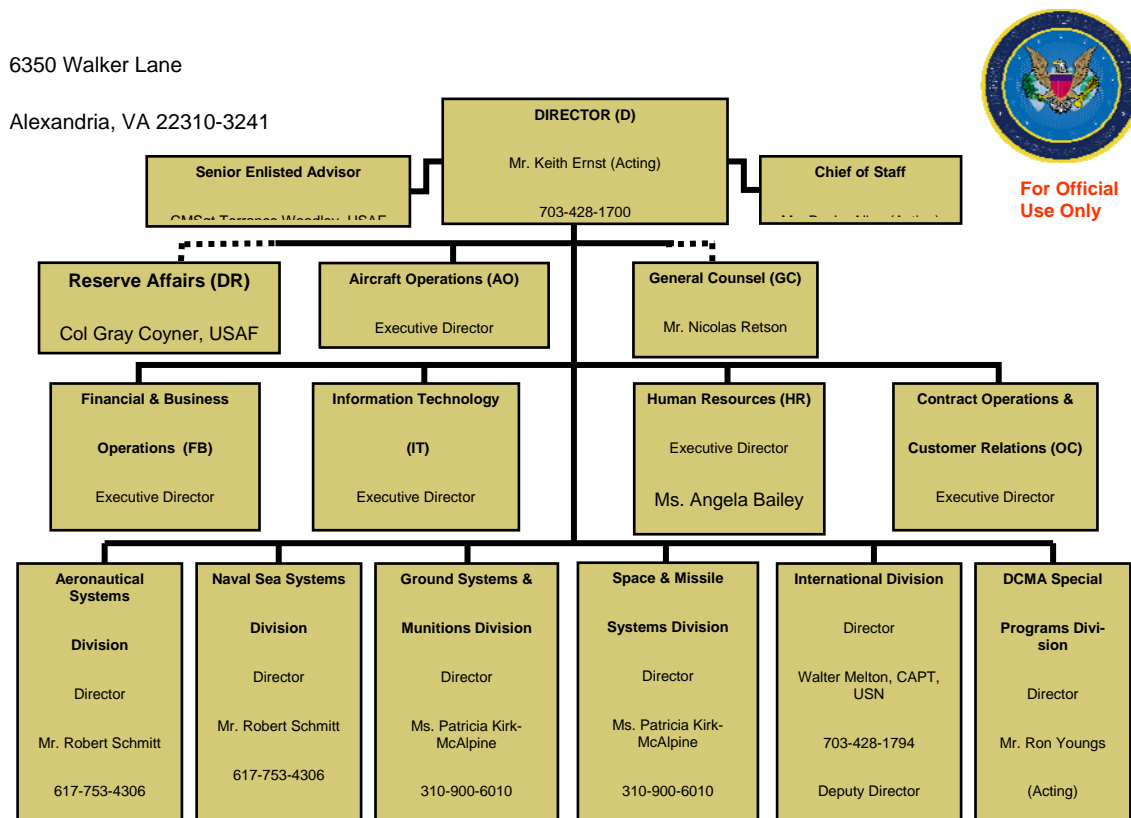

Figure I-1 shows the Defense Contract Management Agency is an independent combat support agency within the Department of Defense (DOD). The agency is responsible for 305,488 active contracts at a face value of \$1,773 billion. DCMA is DoD’s contract manager, responsible for ensuring Federal acquisition programs (systems, supplies, and services) are delivered on time, within projected cost or price, and meet performance requirements. DCMA directly contributes to the military readiness of the United States and its allies, and helps preserve the nation’s freedom. DCMA is organized into six divisions (Aeronautical Systems, Naval Sea Systems, Ground Systems and Munitions, Space and Missile Systems, International, and DCMA Special Programs), which oversee 47 Contract Management Offices (CMO’s) responsible for the work performed at over 800+ operating locations worldwide. DCMA has a workforce of approximately 10,000 (as of 30 Sept 06) civilian and in excess of 500 military professionals to carry out a broad array of missions assigned by DoD. Our DCMA professionals serve as “information brokers” and in-plant representatives for military, federal, and allied government buying agencies—both during the initial stages of the acquisition cycle and throughout the life of the associated contracts.

DCMA is one team. It leverages its workforce capabilities as a force multiplier. DCMA’s activities reach out across the geographic boundaries to find and

---

implement innovative solutions by maximizing the Agency's joint environment to develop creative business strategies that benefit all military Services. It is a team of empowered individuals that focus on mission accomplishment and strive to find innovative ways to serve its customer. DCMA is a team of trusted partners in the acquisition community that bring to the table unquestioned personal and professional integrity and excellence - keeping the promise by providing extraordinary customer-focused support that demonstrates a strong commitment and loyalty to our war fighters.

In 1990, the organization was a command within the Defense Logistics Agency, managing contracts within DLA's overall structure, primarily on behalf of the Military Services. In 2000 DCMA was separated from DLA and was established as an independent Agency. DCMA continues to manage contracts on behalf of the military services and several Federal agencies; however, it has evolved its own uniquely customer-focused approach to managing the acquisition cycle and providing combat support to ensure readiness worldwide.

Today, DCMA is a leader among Federal agencies in adopting best business practices, improving financial management, developing performance-based metrics for organizational and personnel evaluation, and continually reshaping its services and procedures to meet changing customer needs. This enables the Agency to:

- More efficiently manage contracts for product lines ranging from aircraft, space launch vehicles, and spacecraft to military vehicles and munitions, from electrical and electronic commodities to medical and subsistence items
- Perform more timely and accurate price/cost analyses, contractor reviews, and financial analyses
- Better administer contract financing and payments, terminations, contract closeouts, and contract property and plant clearances
- Refine quality assurance through more stringent verification of contractor processes and final inspections of critical items
- Improve program and technical support through more sophisticated analyses of contractor costs, schedules and technical performance
- Strengthen fraud protection through the DCMA Fraud Program, which includes training, investigative assistance, and coordination of administrative remedies
- Support DoD and the military services' major weapon systems acquisition, logistics and readiness programs with integrated industrial capability analyses, and

- Provide contingency contract administration services (CCAS) to U.S. forces deployed anywhere in the world.

To accomplish these functions in today’s environment of ever decreasing re-sources, DCMA uses Performance Based Management (PBM) techniques to make risk based tradeoffs. Working closely with our customers, these tradeoffs result in DCMA meeting customer expectations while disengaging from low priority workload. An example of an area where DCMA is disengaging is Contracts with a criticality designator of C.

Figure I-2. Office of Acquisition, Technology and Logistics

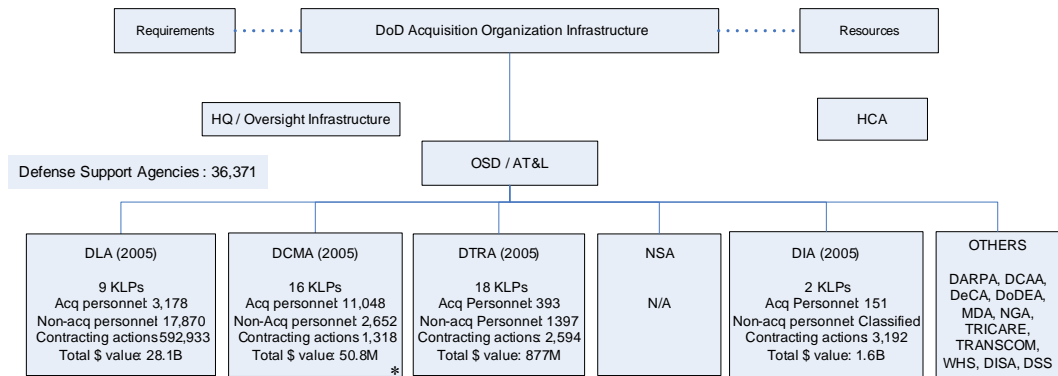

\* DCMA is not a major buying activity but oversees effective acquisition life-cycle solutions for 305,488 active contracts with a face value of \$1,773 billion. The relatively small \$ value indicated in the chart represents only those contracting actions required to support DCMA's internal operations.

Figure I-3. Program Management Structure

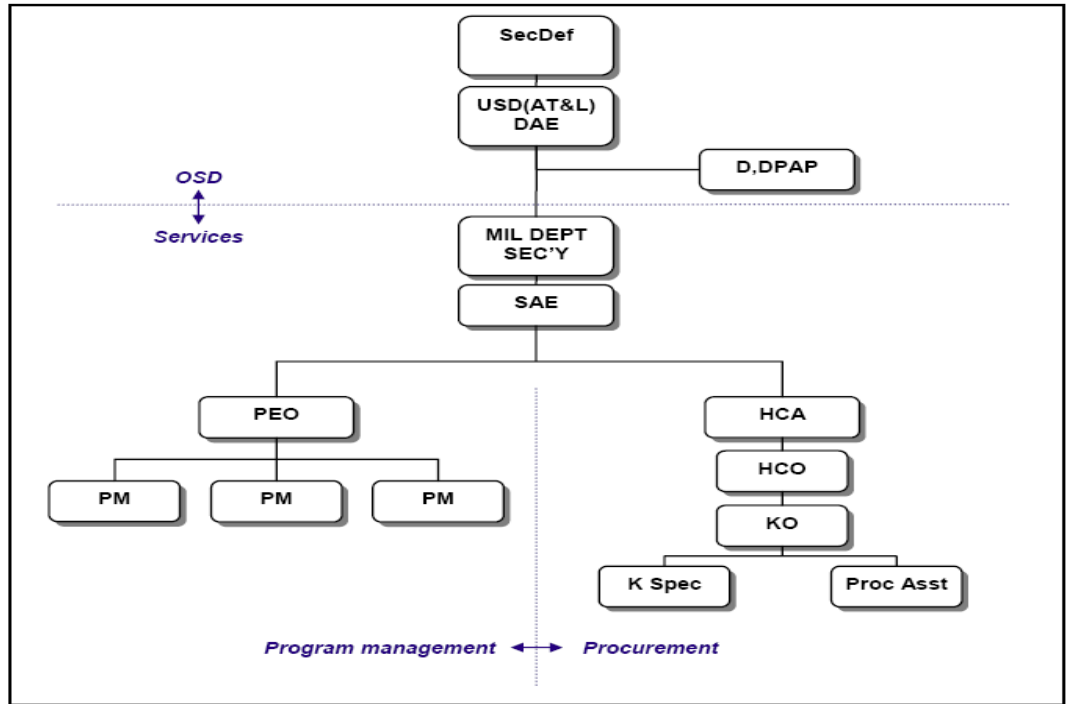

Figure I-4. DCMA Locations





## II. Evolution to the Current Structure Since 1990

### 1. Component Acquisition Executive Headquarters (CAE HQ)/Staff

- In 2005 the Deputy Secretary of Defense designated DCMA a Combat Support Agency. This expanded DCMA’s mission from strictly acquisition duties to duties that include assisting warfighters with long-range and strategic logistical planning, transitioning logistical practices and procedures to meet new military needs, strengthening and streamlining supply chains, and advising commanders and coordinating logistical operations on the ground in-theater.
- Acquisition Commands.
- As of December 31, 2005, 10,454 civilian and 594 military personnel were assigned to DCMA. This reflects a 56 percent reduction in civilian personnel since 1990. Of the 11,048 personnel, 8396 (76 percent) are in five key DAWIA-coded acquisition positions:

27%	GS-1910 (Quality Assurance)	2,983
20%	GS-1102 (Contracts & Pricing)	2,210
13%	GS-1101 (General Business)	1,436
9%	GS-0800 (Engineering)	994
7%	GS-1150 (Industrial Specialist)	773
24%	Other	2,652
100%	Total	11,048

- DCMA was the Program Manager for an ACAT 1A program named the Standard Procurement System (SPS). SPS was transferred to the Army in 2003.

### 2. PEO Structure

DCMA support to Program Executive Offices includes DCMA use of its seamless network of offices, CONUS and OCONUS, to best support PEO outcomes, goals, objectives and strategies to achieve customer vision and mission. Major programs can involve thirty major subcontractors and DCMA can provide the PEO and PM visibility into unique subcontractor risks as well as prime contractor EVMS performance to the program baseline.

DCMA supports the PEO structure by aligning its resources with PEO program outcomes. This enables DCMA to focus on critical issues and concerns. Division Directors are the Agency’s single entry point for PEOs and are responsible for effective communication with PEOs, Life Cycle Management Commanders, Air Logistics Commanders, Inventory Control Point Commanders, Defense Supply Center Commanders, NASA Program Managers, other senior military officials,

---

and industry executives. In addition, we have a network of DCMA Customer Liasons to enhance PEO and Program Manager communication and teaming with our Divisions and field offices. Division Directors are charged with leveraging enterprise resources and expertise to deliver the highest level of support to acquisition, life cycle sustainment, and readiness activities. The relationships between DCMA's Division Directors and its customers are the foundation for its cohesive product-oriented information network.

In addition, members of the Senior Leadership Team (SLT) engage all levels of the Office of the Secretary of Defense (OSD) and the Service Acquisition Executives (SAEs). HQ personnel support all Stakeholder, Overarching Integrated Product Team (OIPT), and Defense Acquisition Board (DAB) meetings. Strategic expectations are gathered from these engagements and flowed into the Agency's strategic planning process.

3. **Other:** N/A

### **III. Mission, Capabilities, and Service Issues**

#### **1. Current Mission Statements**

DCMA Provides Customer Focused Acquisition Life Cycle and Combat Support to Ensure Readiness, Worldwide 24/7.

#### **2. Capabilities Needed to Accomplish Missions**

Accomplishing the DCMA mission requires DCMA to focus on several "Key Capabilities." These include:

- Fraud Deterrence, Mitigation and Remediation
- Contract Safety
- Industrial Analysis
- Special Access Program Management
- Management of Maintenance and Overhaul for Aviation Assets
- Management of Government Property in Contractor possession (including Plant Clearance)
- Global Supplier Management
- Earned Value Management
- Safe and Effective Flight Operations at Contractor Facilities

- Business and Financial Analysis Functions to include DCEs, CIPR, Forward Price Rate Agreements and Corporate Systems Approvals (ERP, EVMS, Purchasing, etc.)
- Product Assurance
- Management of Navy Special Emphasis Programs \*

\* DCMA performs oversight of contractor's processes to assess and assure supplier compliance with contract quality and technical requirements. NSEPs require maximum confidence in the materials, components, documents and systems used on board submarines and nuclear powered surface vessels. These materials, components, documents and systems are identified as essential to the safe operation of the nuclear fleet and are considered to have the highest level of criticality. This level of criticality warrants additional oversight by DCMA NSEP personnel.

To accomplish these Key Capabilities a wide variety of job skills and competencies are needed. Regarding its workforce needs; the core skills required will continue to include; Engineers (8XXs), Quality Assurance (1910s), Industrial Specialists (1150), General Business and Industry (1101), Contracting (1102), Industrial Property Management (1103), Information Technology Management (2210). These series comprise approximately 70% of the DCMA workforce. The remaining 30% of the workforce is comprised of support job series that also enable DCMA to achieve its mission in a support role, but no less important. All workforce manpower requirements are valid and exist because each position is linked to the Agency's mission goals and objectives. The support series include: General Administrative, Clerical and Office Services (03XXs), Human Resources Management (0200), Accounting and Budget (0500), Legal and Kindred (0900), and Miscellaneous Occupations (0000). DCMA is working various human capital initiatives to better align its workforce skill requirements to customer needs. This is to create the agility and flexibility required for future mission requirements as articulated in the 2006 QDR and the 2006 AT&L Human Capital Strategic Plan. We continue to look at different ways to better analyze available data and develop different ways to recruit, retain and or shape our workforce. Some of our efforts include:

- **DETERMINING DCMA's FUTURE WORKFORCE REQUIREMENTS.** The analysis required to determine DCMA's future workforce requirements are driven by a number of variables. DCMA must assess; the evolving acquisition strategies of the Military Services, the current acquisition lifecycle stage and future plans for ACAT programs, and the changes in the technologies used in DoD weapon systems. This analysis is needed to develop human capital (HC) strategies that serve to meet short, mid and long term workforce needs.
- **ANALYSIS AND UTILIZATION OF RETIRED OR RETIRING EMPLOYEES.** A significant portion of retired or retiring DCMA employees have expressed an interest in serving in a less than fulltime

---

capacity. We have identified a number of possible ways that we can utilize the expertise or intellectual capital of this workforce source and must develop the most efficient yet effective strategies that we can map against our current, mid and long term requirements.

- **WORLD CLASS ENTERPRISE LEADERS.** DCMA will continue to ask its leaders to motivate and drive employees for continuous improvement in a healthy learning environment. Leaders will also ensure workforce efforts focus on or meet diversity; readiness; and effective joint operation requirements. They must be more inclusive in assessing their missions and resulting requirements. They must communicate, inform, challenge and encourage innovation and risk taking. DCMA must develop qualified leaders in its own culture. DCMA will align with DOD's strategies to effectively manage its leaders through recruitment, selection, education, training, and development strategies.
- **Workload Drivers–Workforce requirements are derived from the Agency's mission analysis.** Important to that end is having consistent policies, processes and procedures that consider all important variables and allow for consistent analysis and determinations of manpower requirements (by skill, by location, by type). Some of those variables include:
  - Shifting workload requirements resulting from the fluid global situation (Political, Military, Economic, and Social) and the paradigm shifts as articulated in the QDR, DOD HCSP and AT&L HCSP.
  - Customer based mission requirements and the processes that better define mission based workload, skills/competencies required and efficiencies and workforce agility resulting from HC process, procedure and applied innovations.
  - Innovative methodologies that will drive the Agency to accurate workload prioritization assessments allowing the leadership to target the "most important" customer outcomes to maximize the application of our limited resources.
  - Other mandated events: BRAC, NSPS, world events, service shifts in military manpower utilization, etc.
  - Industry impacts resulting from changing military program emphasis as military hardware, software, firmware moves through the acquisition life-cycle.
  - Workforce dynamics based on evolving cultural views regarding professional careers coupled with technology innovations.

### 3. Shortfalls/Gaps

- **DCMA–HOW WE MUST EVOLVE TO MEET THE CHALLENGES OF TOMORROW (2006 - 2026).** With the increasing speed that political, economic and cultural landscapes are changing, it is essential that we develop systems and processes that provide the analysis necessary to plan alternative futures driven by a thorough assessment of available facts and reasoned, well developed assumptions. This “Future Think” approach must posture the Agency’s workforce in a manner that gives it the alacrity and flexibility to have the right workforce in the right place at the right time. To this end, new approaches must be taken - approaches that are beyond the norm or standard approaches of the past. We must use every available source of information however atypical. We must leverage every “good idea” and any and all expertise in the area of strategic planning
- **FUNDAMENTAL WORKFORCE SKILL REQUIREMENTS–** Currently, DCMA is developing the processes and identifying the expertise to assess the mission based skill/competency requirements ICW CPMS and DAU efforts targeting specific fields. But all employees must have a set of competencies/core skills that should provide the synapse between technical skills and competencies. They must have the ability to effectively apply that knowledge in the performance of one’s duties and responsibilities
- Leverage DCMA’s Industrial Analysis Center (IAC) to model alternate futures based on socio/political/economic analysis of known facts and reasoned, rational assumptions.
- Leverage Quadrennial Defense Review findings and recommendations that provide the DOD community with a clear vision with regard to human capital planning; identifies the new, innovative concepts that will drive future workforce development and seeks to create workforce synergies to meet current and future mission needs.
- Leverage technology in conjunction with policy, process, and program requirements–ensure IT systems and the customer needs they serve meet the operational needs and are integrated as well as compatible with other systems. Finally, these capabilities must be developed in a manner that takes into account potential future needs–that they have the capacity to be expanded commensurate with the evolution of the mission requirements.
- **DCMA STRATEGIES/INITIATIVES TO CLOSE THE GAP.** DCMA is in the process of conducting an inventory of its HC work that is complete, work that is ongoing and work that has yet to be initiated in

---

an effort to develop a comprehensive, integrated approach to HC strategy development (Recruiting, Retention, Shaping),

- Completed (Skill and Competency/Gap Assessment and Career Guide Development)—DCMA is nearing the end of a 2 year effort that analyzed most of its core and support series careers.
  - 200 Series—In the final stages—final draft to print
  - 300 Series—In the final stages—final draft to print
  - 500 Series—In the final stages—final draft to print
  - 900 Series—In the final stages—final draft to print
  - 1101 Series—Complete
  - 1102 Series—Complete
  - 1103 Series—Complete
  - 1150 Series—Complete
  - 2210 Series—Complete
  - 2210 (IT) Series—Complete
  - 800 Series—DCMA-OC is working (Completion TBD)
  - 1910 Series—DCMA-OC is working (Completion TBD)
- WORKING INITIATIVES. DCMA has several efforts underway that have direct or indirect HC implications.
- 1101 (Engineer, Manufacturing and Technology Specialist)—This effort combines competencies and skills in the 1150, 1101, 1910 and 800 series. There are several colleges and universities across the country that has degree programs in the EMTS discipline

Quality assurance specialists need greater expertise in technology-specific skills such as non-destructive testing methods and techniques as new technologies have emerged to inspect new materials such as composites and ceramics. Quality Assurance specialists will also need analytical skills that facilitate more complex decision making on surveillance strategies, risk management and decomposition of performance based management outcomes.

- 1102/1102 (EVMS) - The intent of this initiative is to sustain and enhance the knowledge and skills of 1102 personnel to meet customers' expanded pricing needs. It includes but is not limited to developing new expertise in EVM to aid customers make better cost projections and avoid or reduce unexpected cost growth. The initiative will increase employee participation in reviews of contractor EACs and Basis of Estimates (BOEs) and in the development of independent EACs. As the Executive Agent and IAW the customer's input, DCMA is establishing new baselines for its data in an effort to identify shortcomings in the capability and to improve the utility for all stakeholders.

Cost analysis engineers are needed to effectively utilize management tools such as Earned Value Management. The knowledge required to provide predictive analysis of cost and schedule data is neither business nor technical alone, but a combination of the two that is best satisfied with engineering talent. In addition, technical support to negotiations must be revitalized to address the trend towards cutting-edge, proprietary (and therefore sole-source) solutions that are the greatest challenge in obtaining fair value for government funding.

- 1103 (Property)–There is a DAU effort that DCMA is participating in by providing process and subject matter expertise as required.
- Systems Engineering–DCMA-OC is leading an effort to study this area. It is anticipated that this effort will have direct or indirect impacts on HC strategies–TBD.

Systems Engineering expertise is needed to support System Development and Demonstration contracts for complex defense systems. Once simple, mechanical products of all sizes are now highly complex systems that must integrate software, hardware and electronics to function effectively. Sustainment efforts require Systems Engineering knowledge to effectively design and execute logistics support strategies for procurement of spares and repairs. Information technology projects for internal use require extensive requirements engineering to ensure applications satisfy user needs.

Software acquisition management resources are thinly spread throughout the agency. Specialists need engineering knowledge to understand complex, mission critical IT programs that defense systems need to function.

Professional engineering credentials and specialty certifications are needed to establish authority as technical experts in fields such as aeronautical systems, munitions, vehicles, and electronics. The quality engineering function requires revitalization to ensure that technicians

---

receive adequate support when possible non-conformances are identified.

Industrial engineering capability is needed to effectively manage supplier transitions from development to production. Traditionally, industrial engineers were used for pricing functions rather than production surveillance. When the pricing effort was downsized, our industrial engineering expertise dwindled. Engineering knowledge and expertise is necessary to understand supplier systems and processes, and conduct face-to-face discussions with supplier and customer engineering managers.

- 0018 Contract Safety/2130 Traffic Management Specialist–Contract Safety expertise and the safety certification program are essential for continued mission support for ammunition and explosive, aircraft ground safety and industrial safety operations. Specific training identified for Contract Safety certification is above and beyond the regular training identified for the Occupational Safety and Health series and focuses on aspects of contract safety applications that are unique and not necessarily covered by services safety organizations or State and Federal OSHA. Contract Safety training can take from one to three years to accomplish depending upon the level and type of training an individual has received prior to coming into the DCMA Contract Safety Division.

Traffic Management Specialists are a vital link in the acquisition process to ensure that the end item is moved from the dock to the War Fighter quickly and at the most economical cost. The specialist must have knowledge of Federal traffic management policies, transportation industry operation, practices and capabilities and special handling or movement requirement associated with freight operations. They must also have knowledge of DCMA’s other functional activities such as contract administration and production.

- Capability gaps exist in the Quality Assurance area and are related to analytical decision making for complex surveillance strategies. Gaps also exist as a result of difficulties finding/hiring qualified Quality Assurance engineers. The number of DCMA’s manufacturing and production specialists have declined over the past 10 years leaving a significant gap in the Agency’s ability to do effective auditing and surveillance planning in this area.
- For Software Acquisition Management within DCMA, skill gaps exist in program analysis in that DCMA needs to be in a position to provide “big picture” impact and functional insights in regard to the supplier’s ability to accomplish cost/schedule/performance objectives. DCMA personnel also need a better understanding of Software Cost



Estimation principles in order to validate the Suppliers methodology, inputs, parameters, assumptions, and predictions of actual costs as the program evolves.

- Logistics Competency Analysis–The is a DAU effort that DCMA-HR supports with process and subject matter experts.
- Keystone (Intern) Program - A review is underway of DCMA’s Keystone Program. The review will analyze the cost-benefit of centralizing the training of interns (Centers of Excellence). Currently, interns are trained at the lowest operational level. The centralized concept will consider the benefits of grouping interns for training and professional development purposes so as to leverage the “20-something view of the world” with regard to being a part of the workforce. Also, consider expanding KS Program to International Division–heretofore not considered.
- Modifications to DCMA Cyclical Processes–The HCSP is a complex set of policies, processes, procedures that require complex analysis using current and ever changing data as well as mission guidance. In order to “get it right,” all HC strategy efforts must be carefully and thoroughly synchronized, integrated and implemented in concert with all other Agency’s moving parts - and they are numerous. Given the nature of all HC related strategic actions, efforts and initiatives, it is critical to better align its cyclical processes and procedures within the Agency’s overarching requirements development and resourcing framework so that timely, accurate and defensible decisions can be made that align the right resources the most important outcome at the right time. To this end, efforts are ongoing to identify areas requiring better alignment and integration.
- Workforce Training Initiatives–DMCA continues to develop its Learning Management System (LMS) as well as it training systems and processes that will have trained and certified personnel in the right place at the right time.
- Training Funding–DCMA continues to refine its policies, processes and procedures to validate, prioritize and manage the Agency’s training requirements as developed by the operational organizations.
- Study–Effective Utilization of Senior Service School Graduates. DCMA-HR is conducting a study to determine how best to utilize leadership education and skills of personnel who graduate from senior service schools within the regulatory guidance currently in place. Feedback from the Agency’s operational elements indicate ineffective placement of SSC graduates upon completion. This issue is being reviewed to assess shortcomings and to modify the policy/process in a

---

manner that it provides a comprehensive approach to this program from candidate selection to placement upon graduation.

#### **4. Personnel Issues**

Staff reductions in today's environment of ever decreasing resources has required DCMA, in close coordination with our customers, to use Performance Based Management (PBM) techniques in making risk based tradeoffs. These tradeoffs have enabled DCMA to shift resources to key contract management areas, including:

- contract safety
- special access program management
- industrial analysis
- fraud deterrence, mitigation and remediation
- management of the maintenance and overhaul of aviation assets
- management of Government property
- global supplier management
- earned value management
- business systems and financial analysis
- product assurance and
- management of Navy special emphasis programs.

### **IV. Joint Acquisition**

#### **1. Summary of Current Defense Agency Joint Acquisition Programs**

DCMA provides contract management for the majority of DoD Joint Acquisition Programs.

#### **2. Issues/Gaps in Capability**

The issues and gaps associated with performing contract management services for joint programs are no different than providing contract management services for other than joint programs. As discussed in Section III.3 above DCMA's primary issues are associated with retaining/maintaining an acquisition workforce with technical skills needed to support DCMA's Key Capabilities.

## **V. Service Recommendations**

### **1. Organizational Issues**

Recently the Agency realigned its structure to better meet the needs of its customers. The realignment organizes DCMA's CMOs and other operating units along commodity lines rather than by geographical regions and converts the DCMA East and West Districts into four Product Divisions: Aerospace Systems, Naval Sea Systems, Space and Missile Systems, and Ground Systems and Munitions.

Now, instead of each DCMA office having to be all things to all customers in its region, it can focus on providing and supporting specific types of products. This enables DCMA to concentrate its expertise, better anticipate customer needs, and custom-tailor support to meet those needs.

For customers this means having one point of contact within DCMA—no matter where they or their suppliers are located—and dealing with an Agency that has a coordinated customer strategy. For DCMA, teaming personnel with product-specific skills and proficiencies will make sharing information easier and eliminate redundant efforts and unnecessary reporting.

The realignment is making it easier for customers to do business with the Agency and for Agency personnel to work closely with customers. It is creating opportunities to apply new tools to old tasks to emphasize results over activities, and to steadily measure and improve performance. Most important, it aligns DCMA with DoD's long-term Acquisition, Technology and Logistics strategy.

Essentially, the realignment DCMA has undertaken is exactly what the Agency would look like if we undertook to redesign it.

### **2. Resource Issues (Personnel/Funding)**

Personnel issues: Rebuilding a stable and well-trained acquisition workforce.

### **3. Policies and Procedures Needed to Improve Outcomes**

a. Service Related proposals to improve outcomes: Establishing public-private exchange programs for mid-level managers in both DoD and industry. This would provide opportunities for DoD managers to better understand private-sector business practices. Conversely, mid-level industry managers would be able to better understand Government policymaking.

b. Proposals to improve Service lead on joint acquisition programs: Alternating the Service Acquisition Executive (SAE) and Program Executive Officer (PEO) responsibilities where the SAE changes every few years and the PEO is a member of a Service other than that of the SAE helps balance parochial interests and creates a need for continued cooperation throughout the program. It also helps to maintain the interest of all

---

Services involved and reduces the likelihood of attempts to seek a Service unique solution.

The use of stakeholder interface forums allows the PEO and program leadership to keep the Services and DoD leadership informed on the program progress and issues. Additionally, the PEO stays up-to-date on the priorities and needs of the leadership with respect to the program's objectives. Forums can be structured at various levels. A key forum for joint programs should be a Joint Requirements Coordination Council or Forum. The primary purpose of this forum should be to address any requirements issues. Requirements trades to control cost and schedule, adding new requirements, and status on meeting Key Performance Parameters (KPPs) are the primary areas this forum should focus on.

Program leadership needs to determine what business and management practices will be used as early and quickly as possible in the program. The decision to use a single Service's process or procedure, blend the processes and procedures of several Service's, or develop new processes and/or procedures should be made as soon as possible to provide adequate guidance to the product teams as they develop their management approaches for executing the program.

Program leadership should strive to maintain a balance of expertise and personnel from across the Services involved. This balance can bring knowledge and experience to the program that will be invaluable during development decision and issue resolution processes.

# Annex J

## Defense Agencies and Field Activities

---

This annex describes the Defense Agencies and Field Activities acquisition program as required by Section 814 legislation. It specifically addresses the following:

- ◆ Current organization and its evolution
- ◆ Mission and capabilities
- ◆ Joint acquisition
- ◆ Recommendations.

The information presented in this annex was compiled from the 814 Review Survey responses and supplemented with information from Defense Agencies and Field Activities documents and Web sites.



## **I. Current Organization**

This chapter is a compilation of the information submitted by the Department of Defense (DoD) Components that participated in the review, but were not separately described in an individual annex to the report.

### **1. Defense Agencies**

**Defense Advanced Research Projects Agency (DARPA)** was established in 1958 as the first U.S. response to the Soviet launching of Sputnik. Since that time, DARPA's mission has been to assure that the U.S. maintains a lead in applying state-of-the-art technology for military capabilities and to prevent technological surprise from her adversaries. The DARPA organization was as unique as its role, reporting directly to the Secretary of Defense and operating in coordination with, but completely independent of, the military research and development (R&D) establishment. Strong support from the senior DoD management has always been essential since DARPA was designed to be an anathema to the conventional military and R&D structure and, in fact, to be a deliberate counterpoint to traditional thinking and approaches.

**Defense Commissary Agency (DeCA)** with headquarters at Fort Lee, Virginia, operates a worldwide chain of commissaries providing groceries to military personnel, retirees, and their families in a safe and secure shopping environment. DeCA was created on October 1, 1991, by DoD Directive 5105.55. The directive consolidated the four separate military service commissary systems into one new DoD agency charged with the responsibility of providing the commissary benefit worldwide.

**Defense Contract Audit Agency (DCAA)** was formed on January 8, 1965. Today, the DCAA consists of approximately 4,000 people located at more than 300 field audit offices throughout the United States, Europe, and in the Pacific. The Agency provides standardized contract audit services for the DoD, as well as accounting and financial advisory services regarding contracts and subcontracts to all DoD components responsible for procurement and contract administration. These services are provided in connection with negotiation, administration, and settlement of contracts and subcontracts. DCAA also provides contract audit services to some other government agencies.

**Defense Intelligence Agency (DIA)** became operational on October 1, 1961 as the nation's primary producer of foreign military intelligence. It filled a critically important need for a central intelligence manager for DoD to support the requirements of the Secretary of Defense, the Joint Chiefs of Staff, and the warfighter. Today, DIA continues to build on its proud traditions as this country's preeminent military intelligence organization and remains "Committed to Excellence in Defense of the Nation."

---

**Defense Security Cooperation Agency (DSCA)** fosters security cooperation programs vital to U.S. national security to build trust and influence in peacetime, to have access to regions of the world during times of crisis, and to ensure interoperability with coalition partners during times of conflict. Security cooperation programs provide financial and technical assistance; transfer of defense materiel, training, and services to friends and allies; and promote military-to-military contacts.

**Defense Security Service (DSS)**, formerly known as Defense Investigative Service (DIS), was established on January 1, 1972, to consolidate DoD personnel security investigations in one organization. On October 2, 1980, the Defense Industrial Security Program was transferred to DIS from Defense Logistics Agency (DLA) and DIS began to train personnel through the Defense Industrial Security Institute. The Personnel Security Investigations program was transferred to Office of Personnel Management on February 20, 2005. DSS is authorized 582 civilian personnel and has a fiscal year 2007 budget of \$372 million.

**Defense Threat Reduction Agency (DTRA)** was established on October 1, 1998. DTRA was made up of three existing defense agencies that fit into the broader weapons of mass destruction (WMD) nonproliferation/counter proliferation mission area. Under DTRA, DoD resources, expertise, and capabilities are combined to ensure the United States remains ready and able to address the present and future WMD threat. It performs four essential functions to accomplish the mission: combat support, technology development, threat control, and threat reduction.

**National Security Agency (NSA)** is America's cryptologic organization. It coordinates, directs, and performs highly specialized activities to protect U.S. government information systems and produce foreign signals intelligence information. A high technology organization, NSA is on the frontiers of communications and data processing. It is also one of the most important centers of foreign language analysis and research within the government. NSA was created in November 1952 and has provided timely information to U.S. decision makers and military leaders for more than 50 years.

## 2. **Field Activities**

**American Forces Information Service (AFIS):** AFIS is the primary tool for the Secretary of Defense and senior Joint Staff and DoD leaders to communicate important messages, news, and information about DoD programs and activities to U.S. Service members, their families, and DoD civilians stationed around the world. AFIS accomplishes this centralized mission by using its news production, television, radio, newspaper, print news service, and World Wide Web distribution services and facilities. In addition, AFIS provides visual and public communications support and



products that support a wide range of internal and external DoD missions. The Department transferred to AFIS several former Military Department and U.S. Combatant Command-owned and operated internal communications training, photography collection, storage, and distribution activities; broadcasting and visual information engineering and procurement activities; and newspaper production activities. These consolidations, coupled with existing capabilities, make AFIS the preeminent DoD provider of high quality, economical and cost-effective products, services, and support.

**Department of Defense Education Activity (DoDEA)** provides education to eligible DoD military and civilian dependents from preschool through grade 12 with two distinct programs, DoD Domestic Dependent Elementary and Secondary Schools (DDESS) for dependents at locations within the continental United States where DoD operates schools, and DoD Dependents Schools (DoDDS) for dependents outside the continental United States.

The DDESS system serves an estimated 25,500 students in 63 schools located in seven states, Guam, and the Commonwealth of Puerto Rico. The DoDDS system serves approximately 65,500 students in 154 schools in 13 countries. Courses of study in DoDEA schools parallel those found in public schools in the United States.

**TRICARE Management Activity (TMA)** was established as a DoD field operating activity as part of the Defense Reform Initiative to oversee the TRICARE managed health care program. The TMA and its executive director report to the Office of the Assistant Secretary of Defense for Health Affairs. The TRICARE Management Activity began operations February 10, 1998. The purpose of TMA is to enhance the performance of TRICARE worldwide. TRICARE was developed to provide quality health care for members of the uniformed services and their families, as well as for military retirees, their families, and other TRICARE-eligible persons.

**Washington Headquarters Services (WHS)** was established as a DoD Field Activity on October 1, 1977 as part of a DoD headquarters streamlining initiative. Approximately 1,200 civilian and military employees and thousands of contract staff are organized into 11 directorates and offices. WHS personnel contribute to the mission of our Defense customers by managing DoD-wide programs and operations for the Pentagon Reservation and DoD leased facilities in the National Capital Region. WHS is organizationally aligned under the Director of Administration and Management for the Office of the Secretary of Defense (OSD).

Figure J-1 illustrates the Defense Agencies and Field Activity acquisition reporting structure.

Figure J-1. PM Structures

## Program Management Structure

### Defense Agencies/OSD (automated information systems - typical)

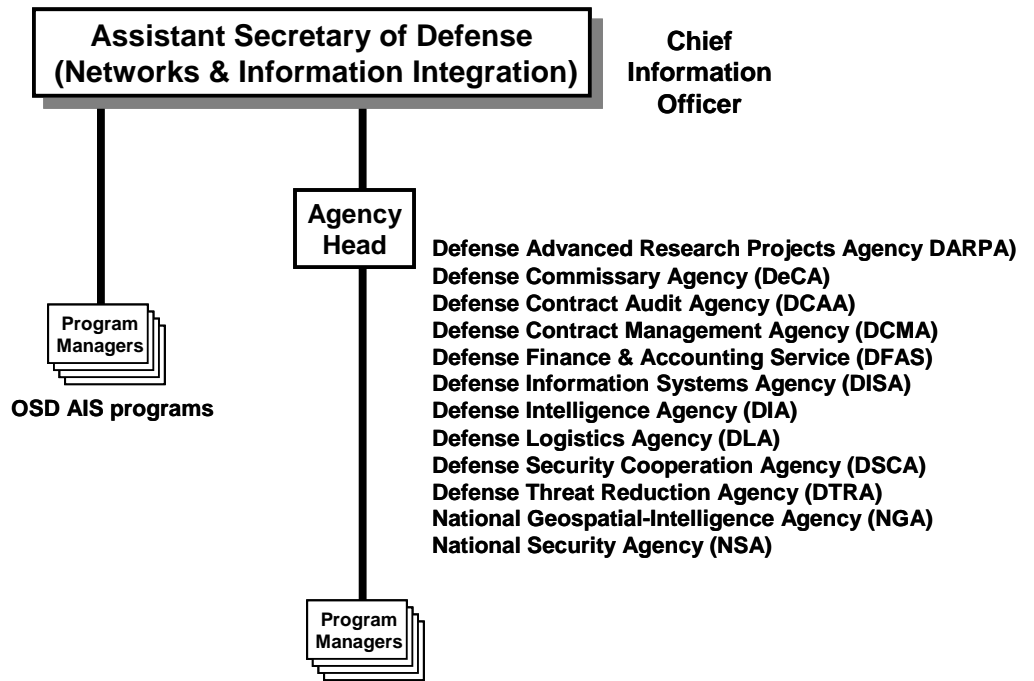

## II. Evolution to the Current Structure Since 1990

### 1. Component Acquisition Executive Headquarters/Staff

A majority of organizations' missions have evolved and expanded over time. While the basic acquisition missions have not changed, over the years there have been changes to the commodities organization's support.

Many of these organizations continuously assessed their operations and activities and have taken appropriate actions over the years to streamline the organization and realign resources as necessary to meet mission and customer requirements. Many organizations have recently undergone realignment and restructuring as a result of continued reengineering, balanced scorecard, or Lean Six Sigma efforts.

Many organizations have fundamentally changed their business practices supported by a new information technology environment, the organization

has become more customer focused integrating and aligning its processes and business units by supply chains. For example, one agency trimmed some internal programs and functions only tangentially related to its core mission that has enabled them to shift resources to key contract management areas.

## 2. Acquisition Commands

DCAA has closed 88 field audit offices, increased the supervisory span of control, and eliminated over 400 middle management positions. DCAA has not encountered any barriers to making the organizational changes considered necessary.

Workforce has shifted to a greater reliance on contractors. One organization identified that there was an increased requirement to provide more acquisition functions and people from their 1998 workforce numbers such as Program Management (+75), Contracting (+35), Systems Planning, Research, Development and Engineering- Science & technology (SPRDE-S&T) (+20), Business, Cost Estimating and Financial Management (+14), and SPRDE–Systems Engineering (+20).

## 3. Program Executive Officer Structure

Half of the organizations that responded incorporate a Program Executive Officer (PEO) structure into their organization. Some organizations stated neither an advantage nor a disadvantage to the PEO structure. It was suggested by one organization that PEOs should always be oriented toward supporting the warfighting capabilities and needs of customers rather than the needs of those responsible for the acquisition process.

DTRA interfaces with one PEO, the Joint Program Executive Office (JPEO) for Chemical Biological Defense Program (CBDP).

## 4. Other: N/A

### III. Mission, Capabilities, and Service Issues

#### 1. Current Mission Statements

##### a. Defense Agencies

**DARPA:** DARPA's mission is to maintain the technological superiority of the U.S. military and prevent technological surprise from harming our national security by sponsoring revolutionary, high-payoff research that bridges the gap between fundamental discoveries and their military use.

---

**DeCA:** Delivers a Premier Commissary Benefit to the Armed Services Community that

- ◆ encourages an exciting shopping experience,
- ◆ satisfies patron demand for quality grocery and household products, and
- ◆ delivers exceptional savings while
  - enhancing quality of life;
  - fostering recruitment, retention, and readiness; and
  - supporting warfighters' peace of mind, knowing their families have secure and affordable access to American products.

**DCAA:** DCAA's primary mission is to perform all necessary contract audits for the DoD and to provide accounting and financial advisory services regarding contracts and subcontracts to all DoD Components responsible for procurement and contract administration. DCAA's services are provided in connection with the negotiation, administration, and settlement of contracts and subcontracts.

**DIA:** The mission of DIA is to provide timely, objective, and cogent military intelligence to warfighters, defense planners, and defense and national security policy makers. The mission of the DIA Acquisition Executive is to enable and enhance DIA and intelligence community capabilities to provide effective and relevant all-source intelligence to DoD warfighters, decision makers, and policy makers through its contracting, acquisition, and program management oversight.

**DSCA:** The primary mission of DSCA is to lead, direct, and manage security cooperation programs to support United States national security objectives that strengthen America's alliances and partnerships through, transfer of defense capabilities, international military education, and humanitarian assistance and mine action.

**DSS:** DSS supports national security and the warfighter, secures the nation's technological base, and oversees the protection of the United States and foreign classified information in the hands of industry. DSS accomplishes this mission by clearing industrial facilities, accrediting information systems, facilitating the personnel security clearance process, delivering security education and training, and providing information technology services that support the industrial and personnel security missions of DoD and its partner agencies.

**DTRA:** DTRA's mission is to safeguard the United States and its allies from WMD (chemical, biological, radiological, nuclear, and high-yield explosives) by providing capabilities to reduce, eliminate, and counter the threat and mitigate its effects.

**NSA:** Executive Order 12333, dated 4 December 1981, describes the responsibility of NSA and the Central Security Service (CSS) in more detail. The resources of NSA/CSS are organized for the accomplishment of two national missions:

- ◆ The Information Assurance mission provides the solutions, products and services, and conducts defensive information operations, to achieve information assurance for information infrastructures critical to U.S. national security interests.
- ◆ The foreign signals intelligence or SIGINT mission allows for an effective, unified organization and control of all the foreign signals collection and processing activities of the United States. NSA is authorized to produce SIGINT in accordance with objectives, requirements, and priorities established by the Director of Central Intelligence with the advice of the National Foreign Intelligence Board.

b. Field Activities

**AFIS:** The mission of the AFIS is to provide high-quality news, information, and entertainment to U.S. forces worldwide to promote and sustain unit and individual readiness, situational awareness, quality of life, and morale. AFIS is the principal resource within the DoD for joint-service education and training in the career fields of public affairs and visual information. AFIS trains military and civilian public affairs, broadcast, and visual information professionals of all the Military Departments, the Coast Guard, and other DoD.

**DoDEA:** The DoDEA mission is to provide an exemplary education that inspires and prepares all DoDEA students for success in a dynamic, global environment.

**TMA:** The mission of the TMA is to

- ◆ manage TRICARE,
- ◆ manage and execute the Defense Health Program Appropriation and the DoD Unified Medical Program, and
- ◆ support the Uniformed Services in implementation of the TRICARE Program and the Civilian Health and Medical Program of the Uniformed Services (CHAMPUS).

---

**WHS:** WHS mission to provide administrative and operational support to specified activities in the National Capital Region (NCR). WHS has primary responsibilities for

- ◆ providing administrative support to OSD, ODAs, and DoD Field Activities that do not have an internal administrative support capability to include:
  - Budget and accounting
  - Personnel management
  - Security
  - Travel
  - Data management and reporting
- ◆ Managing DoD-occupied, GSA-controlled administrative space in the NCR to include
  - Space management
  - Physical security and law enforcement
  - Maintenance, repair, and alteration
  - Property management.

**2. Capabilities Needed to Accomplish Missions: N/A**

**3. Shortfalls/Gaps**

- ◆ Overall, organizations have downsized over the past 15 years, non-acquisition support personnel were reduced consistent with reductions to the auditing career workforce.
- ◆ While the acquisition reform initiatives and competitive pricing processes were expected to achieve savings to the department that were previously achieved through obtaining and evaluating cost and pricing data, there is no data to show that this has actually occurred. In general, there has been minor or a negative acquisition reform impact on organizations. Below are some of the issues expressed by organizations:
  - The oversight requirements do not come with money to support additional personnel, making it nearly impossible to accomplish all oversight requirements that continue to increase.

- There are some problematic issues with administration of the Government Purchase Card program.
- There is no standardized series or grade identified.
- The change from Mil-SPECs and Mil-STDs to the use of “best commercial practice” and ISO standards has had some unintended consequences. This resulted in an overall loss of capability to inspect final manufactured items, due to loss of inspection workforce fulltime equivalent (FTEs) and loss of knowledge and experience.
- There have been some quality issues in diverse products and processes and it is now working with all its contractors to correct problems. This is requiring a greater resource investment by organizations to produce the desired results.
- The inability to have visibility into baseline costs in a very heavy and complex change order environment; offerors do not totally understand the government’s requirements; the government does not totally understand proposed services; and a misperception that “collaboration” removes an obligation of the government to enforce contractual remedies for contractual non-compliance.
- ◆ Majority of organizations have stated positive impacts that automated software systems have had on their organizations; however, those positive impacts have come with unintended consequences. There generally has been no resource impact or resources have either not been calculated. Below are examples of some of these impacts:
  - Cooperation and collaboration with industry was key to obtaining initial defensive capability of the system in 2004. Furthermore, we now have a clear path for periodic block upgrades to our missile defense capability as emerging technologies, developed by industry, mature to the point where they can be integrated into the system architecture. The impact of our collaborative efforts with industry cannot be measured or defined in terms of efficiency, effectiveness, or resource savings.
  - Acquisition Contracts collaboration with industry has been mainly focused on increasing communications with industry and providing a single point of entry for industry to bring new ideas into the agency.
  - Collaboration of industry prior to contract award has generally resulted in shorter procurement lead times, and in some cases, a better understanding and identification of government needs and requirements. After contract award, collaboration with industry

---

has slowed the contract management process. We do not have an estimate of resource savings; massive changes in benefits and cost sharing levels have occurred along with the acquisition innovations.

- Our collaboration with industry through honest partnering arrangements to increase communication during both pre-award and post-award contracting phases as well as to increase the quantity and quality of performance-based contracts, especially for contracted services and construction. Pre-proposal conferences have proven to be highly effective in communicating and refining government requirements while design-build construction contracts have improved the schedule and performance-based aspects of major construction efforts.

#### 4. Personnel Issues

- ◆ A majority of organizations expressed a strong need to refocus on training and recruiting efforts and on strategic placement of valuable and experienced resources with the necessary skills needed to evaluate and document appropriate trade-offs. Below are some of the agency comments:
  - When these acquisition reform initiatives were introduced, there was little to no DoD training for contracting personnel nor the technical personnel who were responsible for development of a performance based document.
  - The lack of personnel and the transfer of the workload in 2002 severely impacted headquarters with the lack of knowledge transfer, lack of purchase card holders, increased administration oversight, the transfer of large dollar awards of Indefinite Quantity/Indefinite Delivery (requirements) type contracts, and an increase in contract actions/orders without the personnel to support the requirements.
  - Defense Acquisition should address 1102 retention and recruitment timeline constraints created by not receiving funds until January and demanding obligation rates (from the Comptroller) by June/July, and improved training for 1102s in operational contracting.
  - Many organizations recommend an increase in training capacity and ability to respond to short term training needs for Defense Acquisition Workforce Improvement Act certification. Defense should also work toward improving competencies of the acquisi-



tion workforce from a tradecraft (Program Manager, Business/Cost Management) and leadership skills perspective.

- Lacking professional acquisition credentials and training, the leadership does not fully exercise the full scope of Head of Contracting Agency authority, but rather continues to see it primarily as a provider of discrete services. Thus, organizations have not fully instituted program managed systems control or oversight for major construction and information technology programs. Consequently, organization programs depend on the Federal Acquisition Regulation and Defense Federal Acquisition Regulation (DFAR) acquisition and contract protocols for control and oversight.
- Professionals within the acquisition community must receive the appropriate training, attain the proper credentials/certifications, and gain practical/documented experience through challenging assignments working within their field of endeavor.
- One of the challenges of reengineering and restructuring is continuing to provide the same high level of contracting quality and management oversight, particularly in the face of reductions in workforce numbers.

#### **IV. Joint Acquisition**

##### **1. Summary of Current Defense Agency Joint Acquisition Programs**

The Defense Agencies reported approximately eleven (11) joint projects.

##### **2. Issues/Gaps in Capability**

- ◆ Problem: Network security standards mandated by the Military Departments differ and are more stringent than those established by DoD. These network security standards are applied based on different interpretation across posts, camps, and installations within a given Service. DoD Information Technology Security Certification Accreditation Process is cumbersome and takes many months for approval. This lack of standardization has a significant impact on cost and schedule when implementing Tri-Service enterprise health IT solutions.

Recommendation: ASD(NII) establish and enforce common network security processes and standards, applicable to medical treatment facilities at all posts, camps and installations.

- ◆ Problem: Lack of a DoD Joint Medical Information Management and Technology Organization presents complex issues when dealing with multiple personnel systems, chain of command, timely recruitment, availability of Director of Acquisition Career Management (DACM)

---

slots for acquisition training, and recognition as a Joint assignment for promotion purposes. Military and Government positions assigned to the Tri-Service Information Management/Information Technology Organization are currently “owned” by the Services.

Recommendation: The Under Secretary of Defense for Personnel and Readiness and the Assistant Secretary of Defense for Networks and Information Integration [ASD (NII)] support the establishment of a DoD Joint Medical Information Management and Information Technology Organization.

- ◆ Problem: Backlog of available openings for attendance at Defense Acquisition University (DAU) courses.

Recommendation: DAU increase the number of acquisition courses to reduce backlog.

- ◆ Problem: Commercial Off-the-Shelf (COTS) products require, in some cases substantial, integration work efforts for application in the Department’s health IT environment. The reason is that COTS products are developed for commercial sector health care providers who do not require fully integrated suites of products. As such, modules of COTS products are not always integrated to the degree to which is required by the Military Health System. Integration is an important factor in estimating design, development, and testing costs.

Recommendation: That the ASD(NII) provide guidance that when developing Life Cycle Cost Estimates, PMs should consider more realistic costs associated with COTS integration.

- ◆ Problem: The issue with joint programs is the competing nature of the requirements/objectives from the respective Services. In many instances, these requirements/objectives are diametrically opposed. The difficulties encountered have indicated that DoD needs to change the way we do testing. We need to do certification to support net-centric capabilities.
- ◆ Problem: Joint acquisition programs usually serve more than one enterprise with varying differences in requirements, priority, funding, and management authority. Other difficulties are configuration control, traceability and tracking of requirements. There are problems in clean, clear and orderly transition of developmental efforts into operations, especially when phased or only partial transfers occur. Efforts to treat joint acquisition programs as special projects and integrated process teams (IPT)s mitigate a portion of the issues, but the dynamics of execution at the Agency level continue to present the largest problems; especially where there are not clear definition of roles and responsibilities.

ties of partners. While the process of boarding decisions and advancements show promise, the bureaucracy of multiple organizations (with multiple processes) makes the movement very slow.

- ◆ Problem: Service partners/sponsors for one agency's Advanced Concept Technology Demonstration have withdrawn from technology transition agreements/plans, leaving no avenue to transfer demonstrated, enhanced capabilities into acquisition, production, and delivery into the hands of warfighters. Technology transition to the Services is a major concern. Transition agreements are changed for many reasons but a major cause is budget adjustments to higher priority efforts. Joint transition agreements need to be strengthened so that well-performing technology programs stay on track and are transitioned. Under normal circumstances, these are programs in which the established standards for cost, schedule, or performance metrics are met.

Recommendation: Enhancing communication between Joint Science and Technology Office (JSTO) and JPEO CDBP will ensure that when a need for a specific biological or chemical countermeasure is identified, an effective product can be delivered to the warfighter as quickly as possible. This product may have to be developed from an early stage; other times the product may already be developed or nearing completion.

- ◆ Problem: Many researchers (especially those affiliated with industry) consider their work proprietary, and oftentimes do not publish their findings for the scientific community. This issue may continue to be a stumbling block for JSTO in efforts to identify and promote the most mature products to advanced development. It would be helpful if there were some way to conduct a market research survey that would accurately identify current research with potential to benefit the warfighter while overcoming proprietary concerns.
- ◆ Problem: Currently one agency has no central acquisition oversight authority, from program initiation to disposal, of its acquisition programs. Individual program acquisition decisions are not coordinated across the enterprise, making it difficult to achieve efficiency and overall accountability of appropriated funds. These difficulties could be greatly alleviated by establishing oversight and statute authorities typically associated with Acquisition Executive (AE) functions within the agency Office of the AE. Such a strategy is under review in the Office of the Director of National Intelligence (ODNI), and is articulated in a draft directive.

---

## V. Agency Recommendations

### 1. Organizational Issues

- ◆ Many organizations recommended organizational changes.
  - There needs to be guidance and assistance with developing an acquisition roadmap through collaborative engagement with senior mission managers, facilitated by onsite expertise within the individual directorates of the agency. The AE would exercise directly, or delegate appropriately, assessments of cost, schedule, technical feasibility, and program risk and provide to the director primary advice on resource allocations for appropriate funds. The AE would work closely with the Chief Financial Executive to ensure funds would be obligated and expended with the appropriate priorities.
  - Establishing public-private exchange programs for mid-level managers in both DoD and industry. This would provide opportunities for DoD managers to better understand private-sector business practices. Conversely, mid-level industry managers would be able to better understand and participate in government policymaking.

### 2. Resource Issues (Personnel/Funding)

- ◆ Funding issues: Several organizations feel the budget process and funding should be simplified and more stable.
  - DoD can greatly lower the cost, schedule, and technical risk of its programs by doing the following:
    - Ensure stability in the technical, schedule, and budget baselines of its acquisition program. Development risks are particularly sensitive to changes in any of these dimensions, particularly if they are sudden or of relatively great magnitude; and
    - Manage the acquisitions in a comprehensive, holistic, fashion across the DoD enterprise such that interdependencies are known and understood.
  - As acquisition and modernization funds have decreased over the last twenty years, acquisition professionals within industry and DoD are increasingly leveraging developments from other DoD acquisition programs. Knocking down these ‘stovepipes’ make for cheaper and faster development, but the increasing

interdependencies make programming and budgeting more complex.

- All too often the budgets are narrowly focused and the assumptions are poorly documented.
  - Eliminate the use of three types of funds (Operations and Maintenance, Procurement, and Research, Development, Test and Evaluation) as oftentimes it is difficult to anticipate the type of funds when negotiating with industry adding an unnecessary level of complexity and time to the program schedule.
  - One organization recommends a Defense Budget structure that supports - enterprise services (Network Centric Enterprise Services like capabilities), corporate applications/services (e.g. financial, personnel, training systems), and mission services (e.g. mission planning, exploitation ...). The funding process needs to incentivize technology's rapid discovery, service reuse, rapid test, Certification and Accreditation (C&A), and transition into mission services. The organization recommends a Budget and Financial Management system that would provide for multi-year single color money to provide more flexibility and stability in funding of acquisition programs over a five year planning cycle.
- ◆ Personnel issues
- Human capital must be increased. Excessive manpower reductions in the acquisition career field have impacted performance. Workload has increased over the years and while at the same time the workforce has been reduced. DoD cannot continue this inverse relationship and expect to develop/execute good acquisition strategies and perform adequate contract administration.
  - The volume and dollar value of purchasing transactions have increased in recent years, which has resulted in greater reliance on support contractors within the AE organization.

### **3. Policies and Procedures Needed to Improve Outcomes**

- a. Agency related proposals to improve outcomes
  - ◆ Many organizations stated that the regulation/information process must be simplified. Below are some of the comments and recommendations made.

- 
- The “downsizing” of regulations has increased the number of places acquisition personnel must research. With the downsizing of the DFARS, one now has to research the DFARS and then the Procedures, Guidance, and Information, the “companion resource” to the DFARS. Then the agency supplement and any “mandatory procedures” must be researched.
  - Multiple, competing structures and processes (e.g., Joint Capabilities Integration and Development; Defense Business Transformation; DoD Acquisition, and Office of Management and Budget [e.g., IT 300 Exhibits]) require extensive documentation; much of which is the same information, just presented in different formats. Preparation of these documents are time intensive, costly, and of limited value to the PM. As the shift in procurement dollars moves from systems and hardware acquisition to services acquisition, need more structured approach to services acquisition.
  - In many instances, the senior leadership within the Department has committed to streamlining the Integrated Defense Acquisition, Technology, & Logistics Life Cycle Management Framework and yet at the action officer level it is business as usual. The acquisition process has a great deal of flexibility (streamlining) available.
  - One organization recommended a streamlined Approach for Acquisition of Major Automated Information Systems including COTS IT Systems.

b. Proposals to improve Service lead on joint acquisition programs

- ◆ Many organizations identified issues with authority and oversight. Below are examples of recommended changes:
  - The challenge is to establish a regime of oversight that is
    - appropriate to the task at hand;
    - rational and sufficiently flexible to conform to the statutory guidance. The oversight process must also retain the necessary discipline, accountability, and stewardship to mitigate risks of unnecessary IT system proliferation, non interoperable system acquisition, or systems acquisitions that subvert the goals and objectives of DoD’s business transformation imperative.

- Need to delegate oversight and approval authority at program initiation and tie this delegation to assessed component acquisition management discipline, essentially implementing a process of earned autonomy.
- Joint transition agreements need to be strengthened so that well performing technology programs stay on track and are transitioned. Under normal circumstances, these are programs in which the established standards for cost, schedule, or performance metrics are met.
- Many researchers (especially those affiliated with industry) consider their work proprietary, and oftentimes do not publish their findings for the scientific community. This issue may continue to be a stumbling block for JSTO in efforts to identify and promote the most mature products to advanced development. It would be helpful if there were some way to conduct a market research survey that would accurately identify current research with potential to benefit the warfighter while overcoming proprietary concerns.





# Annex K

## Office of the Under Secretary of Defense for Acquisition, Technology and Logistics

---

The following pages contain the Office of the Under Secretary of Defense for Acquisition, Technology and Logistics, USD(AT&L) annex as required by Section 814 legislation. The annex discusses acquisition within the USD(AT&L). Specifically, this annex discusses the current organization and its evolution and mission.



## I. Current Organization

Figure K-1 shows the organization of OUSD(AT&L) as of December 2006. The recent changes and major features are delineated in the Evolution of the Organization section.

Figure K-1. Office of the Under Secretary of Defense (Acquisition, Technology and Logistics), 2006

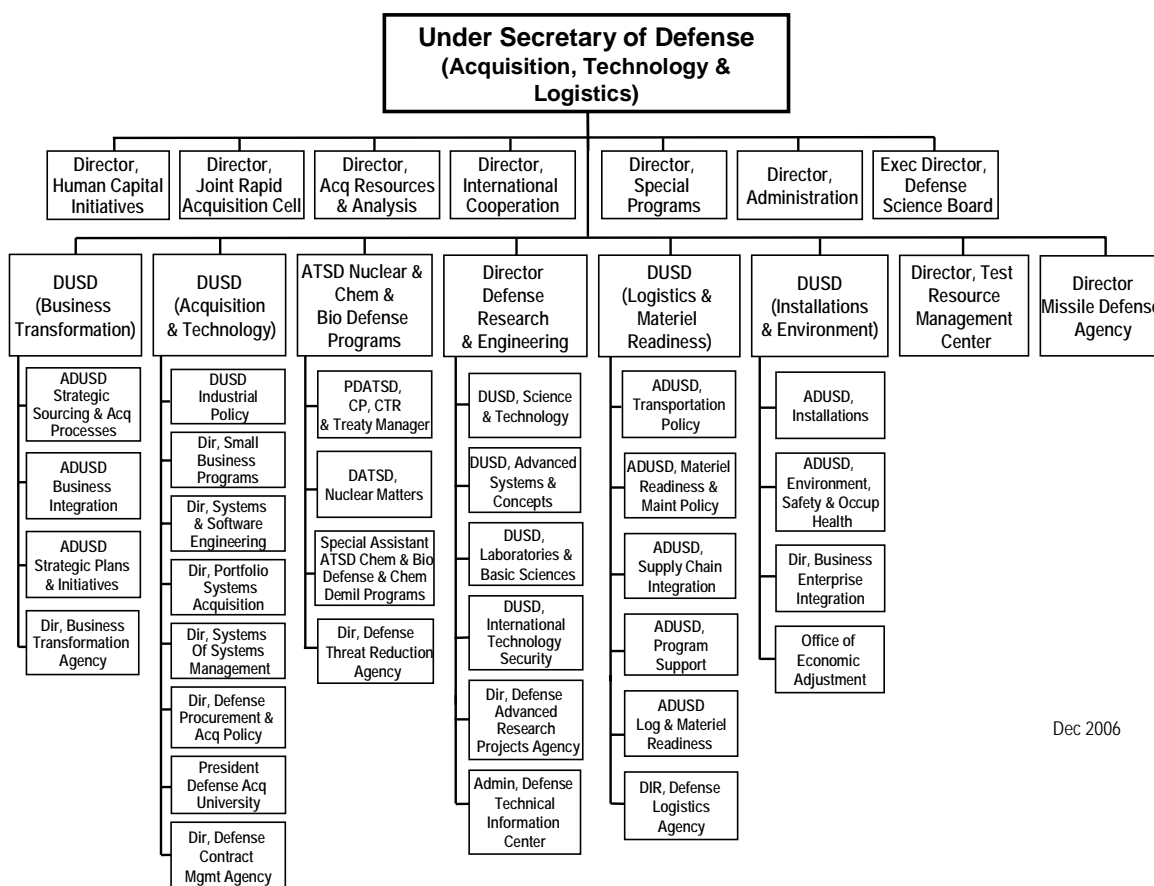

Dec 2006

## II. Evolution of the Organization of the Office of the Under Secretary of Defense for Acquisition, Technology and Logistics (1987–2006)

### 1. The Godwin Year (September 1986 to September 1987)

The first USD(A), Richard P. Godwin, an executive with Bechtel, Inc., was sworn in on September 30, 1986 and served until September 30, 1987.<sup>1</sup> Mr. Godwin formed an office by merging a number of existing offices and agencies into a new organization. He exercised “direction, authority and control” over three assistant

<sup>1</sup> Department of Defense Key Officials, 1947–1992, Historical Office of the Secretary of Defense, 1992, page 24.

---

secretaries of defense, the Director of Defense Research and Engineering (DDR&E),<sup>2</sup> five defense agencies, and the Defense Systems Management College (DSMC). The following were major features of the new office:<sup>3</sup>

- ◆ The Assistant Secretary (Production & Logistics), ASD(P&L) provided support to the USD(A) for development and oversight of contracting policy (FAR/DFARS), major systems acquisition policy (DoD 5000 series), and policy oversight for logistics, production support, the environment, and installations. The Defense Logistics Agency (DLA) reported to ASD(P&L).
- ◆ The Assistant Secretary (Research & Technology), first established by the SECDEF in 1984, was moved to the office of the USD(A), along with the Assistant to the Secretary of Defense (Atomic Energy), ATSD(AE), and the Defense Nuclear Agency (DNA).
- ◆ USD(A) had authority over the Defense Mapping Agency (DMA) and the Defense Communications Agency (DCA), and over the “acquisition related activities” of the Assistant Secretary of Defense (Command, Control, Communications & Intelligence), (ASD)(C3I). DMA and DCA were aligned under ASD(C3I).
- ◆ The DDR&E supported USD(A) in the areas of science and technology, developmental test and evaluation, international programs, and provided the oversight and review function for major systems acquisition.
- ◆ One new office was created in 1987, that of Program Operations (later renamed Program Integration). This office was formed to help the USD(A) develop more coherent positions on acquisition issues and provide an interface with the planning, programming, and budgeting system (PPBS).

Figure K-2 shows the composition of the office of the USD(A) in mid-1987.

---

<sup>2</sup> When Congress created the USD(Acquisition) in the Military Retirement Reform Act of 1986, the position of USD(Research & Engineering) was redesignated Director of Defense Research and Engineering—returning to the title the position had prior to 1958.

<sup>3</sup> *Defense Acquisition: Observations Two Years After the Packard Commission*, Volume I, Institute for Defense Analysis (IDA Report R-347), pgs. III-2-III-6, November, 1988. Also, see DoDD 5134.1, February 10, 1987, and the U.S. Government Manual, 1987–1988, Office of the Federal Register, National Archives and Records Administration, pgs. 163–166.

Figure K-2. Office of the Under Secretary of Defense (Acquisition), 1987

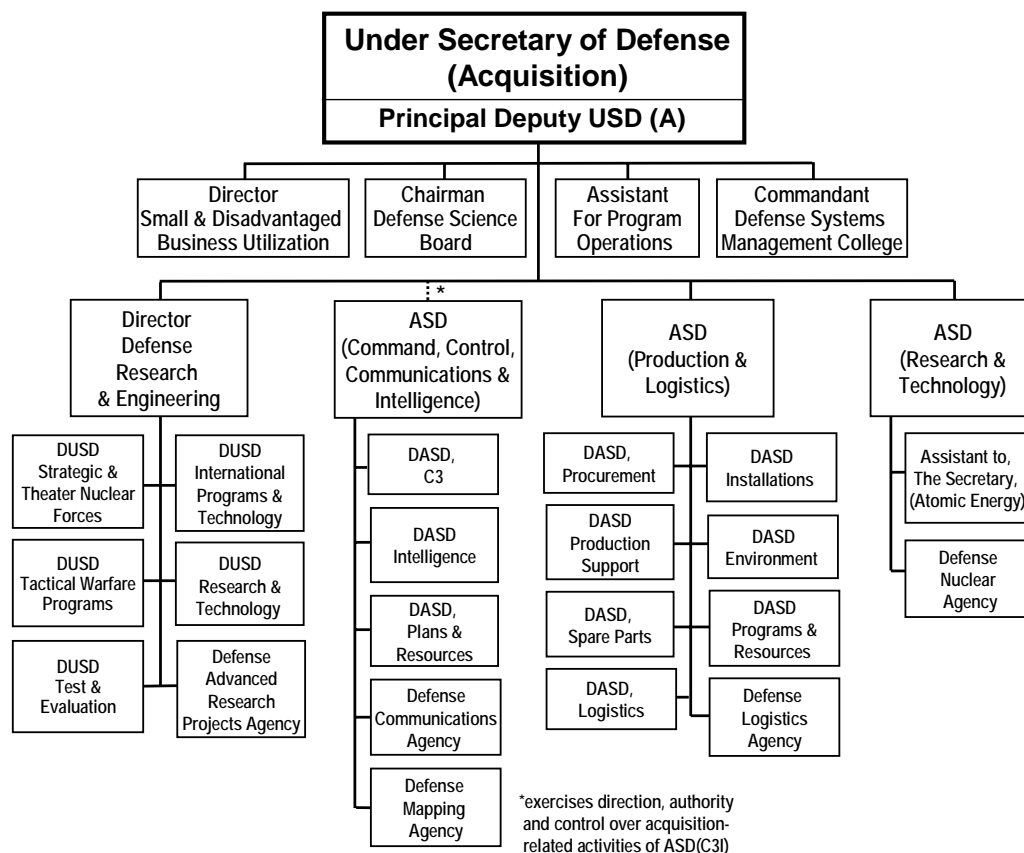

Mr. Godwin made a number of changes to the oversight and review process for major defense acquisition programs. In late 1986, the Defense Acquisition Board (DAB) replaced the Defense Systems Acquisition Review Council (DSARC).<sup>4</sup> To provide a more structured and formal staffing process for acquisition programs subject to DAB review, 10 acquisition committees were formed. These ten committees replaced over 100 committees and working groups established under the DSARC. Three of the committees prepared programs for milestone reviews: strategic systems, conventional systems, and command, control, communications and intelligence (C3I). The other seven rarely met: Science & Technology, Nuclear Weapons, Test & Evaluation, Production and Logistics, Installation Support and Military Construction, International Programs, and Policy Initiatives.<sup>5</sup>

The DAB's Conventional Systems Committee was chaired by the Deputy Under Secretary for Tactical Warfare Programs and the Strategic Systems Committee

<sup>4</sup> The DSARC was initially renamed the Joint Requirements and Management Board (JRMB) for a very short period of time. *Joint Requirements and Management Board*, memorandum for Secretaries of the Military Departments, DEPSECDEF Taft, June 3, 1986.

<sup>5</sup> *Defense Acquisition: Observations Two Years After the Packard Commission*, pgs. III-8 and III-9. The Defense Acquisition Board (DAB) process and its supporting committees were institutionalized in a revised DoD Instruction 5000.2, *Defense Acquisition Program Procedures*, and DoD Directive 5000.49, *Defense Acquisition Board*, both dated September 1, 1987.

---

was chaired by the Deputy Under Secretary for Strategic and Theater Nuclear Forces, both reporting to the DDR&E. The C3I Committee was chaired by the ASD(C3I).

The roles and responsibilities of the USD(A) were included in a new DoD Directive 5134.1,<sup>6</sup> first issued on February 10, 1987. This directive also provided for additional authorities, responsibilities, delegations of authority from the Secretary of Defense, and specified what offices and agencies would report directly to the USD(A). Although DoDD 5134.1 designated the USD(A) as the Defense Acquisition Executive and Chair of the DAB, Milestone Decision Authority (MDA) for programs reviewed by the DAB was retained by the Secretary of Defense until 1989.

Godwin resigned his position in September 1987, indicating that he did not believe the Department had made the necessary commitments necessary to bring about needed changes. In particular, he was frustrated to find that the new DoD Directive 5000.1, Major and Non-Major Defense Acquisition Programs, issued in September 1987, did not reflect the draft directive he had development and submitted for approval. He resigned days after the directive was issued.<sup>7</sup>

## 2. The Costello Years, 1987–1989

Robert B. Costello, a former executive with General Motors, and former ASD(P&L), became the USD(A) on December 18, 1987 and served until May 12, 1989. Some of the changes that took place in the Office of the USD(A), 1988–1989, included:<sup>8</sup>

- ◆ The position of Assistant Secretary of Defense (Research and Technology) was eliminated and the functions of that office were transferred to the DDR&E.<sup>9</sup>
- ◆ A Director for Special Projects was created to assist in the oversight of highly sensitive classified programs.
- ◆ The Assistant for Program Operations became the Director, Program Integration with responsibility for the DAB secretariat.
- ◆ The On-Site Inspection Agency was established as a defense agency reporting to the USD(A), with the responsibility to carry out the on-site

---

<sup>6</sup> DoD Directive 5134.1, *Under Secretary of Defense for Acquisition*, February 10, 1987.

<sup>7</sup> *Defense Acquisition: Observations Two Years After the Packard Commission*, pgs II-10 and II-11.

<sup>8</sup> The U.S. Government Manual, 1988–1989, pgs. 161–164, and U.S. Government Manual, 1989–1990, pgs. 167–171. DoD Directive 5134.1, *Under Secretary of Defense (Acquisition)*, August 8, 1989, pgs. 5–6.

<sup>9</sup> Department of Defense Key Officials, 1947–1992, p. 46.

inspection and escorting responsibilities of the U.S. government under the Intermediate-Range Nuclear Forces (INF) Treaty.<sup>10</sup>

- ◆ The Secretary of Defense delegated signature authority for acquisition decision memoranda (ADM) documenting milestone reviews by the DAB to the USD(A).
- ◆ The Strategic Defense Initiative Organization (SDIO), created in 1984 to consolidate all Service and *Defense Agency other government missile defense programs*, was chartered by DoDD 5145.1, June 4, 1987 as a separate agency reporting to the DEPSECDEF, but subject to USD(A) DAB review and milestone decision authority.
- ◆ Oversight of international programs was moved from DDR&E and placed under the Deputy Under Secretary (Industrial and International Programs) reporting direct to the USD(A).
- ◆ A Deputy Assistant Secretary of Defense (DASD) for Total Quality Management (TQM) was created under the ASD(P&L).

### 3. The Betti Years, 1989–1990

John A. Betti, an automobile company executive with both Chrysler and Ford, became USD(A) on August 11, 1989 and served until December 31, 1990. Mr. Betti made a few changes to OUSD(A) during his short tenure.<sup>11</sup>

- ◆ In 1990, the position of DASD(TQM) was renamed Deputy Under Secretary for TQM, DUSD(TQM), and became a direct report to the USD(A).
- ◆ In addition to the DUSD(TQM), a number of other new positions were created in 1990: the Director, Contract Advisory Assistance Services, the Director, Ethics Training and Communications Policy, the DUSD (Acquisition Planning), and the Director, Acquisition Education Training and Career Development (AET&CD).<sup>12</sup> Also, the Director, Program Integration became the Director, Acquisition Policy and Program Integration.

<sup>10</sup> In December 1997, President Reagan and Soviet Secretary General Gorbachev signed the Intermediate-Range Nuclear Forces (INF) Treaty. In January 1998, President Reagan issued Presidential Directive 286 calling for an agency to monitor compliance under the INF treaty. The On-Site Inspection Agency was created to do this monitoring. See Defense Threat Reduction Agency TRA Link, On-Site Inspection History, <http://www.dtra.mil/oe/osi/history.cfm>.

<sup>11</sup> U.S. Government Manual, 1989–1990, pgs. 167–171, and U.S. Government Manual 1990–1991, pgs. 170–171.

<sup>12</sup> The Defense Acquisition Workforce Improvement Act (DAWIA), Title XII of the NDAA, FY1991, October 1990, directed the establishment of the Director, Acquisition Education Training and Career Development, and Directors of Acquisition Career Management (DACMs) in the military departments. The Act also provided for extensive measures to professionalize the acquisition workforce, and directed the establishment of the Defense Acquisition University (DAU).

- 
- ◆ Mr. Betti drove a major change to the 5000 series of acquisition directives and instructions, issued in February 1991, shortly after his departure. The number of DAB committees were reduced from 10 to 3. Over 60 other directives, instructions, and policy memoranda were eliminated or merged into three new 5000 documents.<sup>13</sup>

#### 4. The Yockey Years, 1991–1993

Mr. Donald J. Yockey served with the U.S. Army and the U.S. Air Force, 1944–1966, and was an executive with Rockwell International. He served as Mr. Betti’s principal deputy and assumed the role of acting USD(A) when Betti departed in December 1990, and until he was sworn in as USD(A) on June 20, 1991. He served until January 20, 1993. Changes during his term in office included:<sup>14</sup>

- ◆ In 1991, the ASD(P&L)’s Deputy Assistant Secretary (Procurement) was redesignated the Director, Defense Procurement and moved to a direct report position to the Principal Deputy USD(A). The DUSD(TQM) position became the Assistant for Quality Management, and by the end of 1992 had been eliminated.
- ◆ DDR&E’s Deputy for Test and Evaluation was moved to a direct report position to USD(A) as the Director, Test and Evaluation.
- ◆ In 1992 there was a major restructuring of the oversight and review process for major defense acquisition programs: The DDR&E’s Deputy Directors for Strategic and Theater Nuclear Forces, Tactical Warfare Programs were moved from DDR&E and renamed Directors reporting direct to the Principal Deputy USD(A).
- ◆ The Defense Acquisition University (DAU), a consortium of 16 existing Army, Navy, Air Force, and DoD schools, was officially in place August 1, 1992.
- ◆ With the issuance of a revised DoDD 5134.1 in 1992, the USD(A) lost directive authority over the “acquisition related” activities of the ASD(C3I). The USD(A) also lost directive authority over DCA (in 1991 renamed the Defense Information Systems Agency) and DMA—both remained aligned with ASD(C3I).

---

<sup>13</sup> See DoD Directive 5000.1, *Defense Acquisition*; DoD Instruction 5000.2, *Defense Acquisition Policy and Procedures*; and DoD Manual 5000.2-M, *Defense Acquisition Management Documentation and Reports*, all issued on February 23, 1991.

<sup>14</sup> U.S. Government Manual, 1991–1992, pgs. 178–179. DoD Directive 5134.1, *Under Secretary of Defense for Acquisition (USD(A))*, September 30, 1992, p. 6. Some of the details on deputy under secretary and deputy assistant secretary positions were obtained from Defense Acquisition University material for program management training.



## 5. The Deutch Year, 1993–1994

After 12 years in the White House, the Republicans lost to Bill Clinton in 1992. In Clinton's first term, Dr. John M. Deutch, a former Under Secretary, Department of Energy, and Provost, Massachusetts Institute of Technology, assumed the position of USD(A). He was sworn in on April 2, 1993 and served until March 11, 1994. He was the 5<sup>th</sup> USD(A) in 7 years. Some of the changes to OUSD(A) during his year in office included:<sup>15</sup>

- ◆ The title, USD(Acquisition) was changed to USD(Acquisition & Technology), USD(A&T) reflecting increasing emphasis on science and technology efforts.<sup>16</sup>
- ◆ New Deputy Under Secretaries of Defense (DUSD) were created for: Acquisition Operations, Advanced Technology, Environmental Security, Logistics, and Acquisition Reform. All reported direct to the USD(A&T).
- ◆ Oversight for part of the advanced technology development portion of the science and technology budget was transferred from DDR&E to the DUSD(Advanced Technology) for Advanced Concept Technology Demonstrations (ACTD) and other advanced technology development programs.
- ◆ The DUSD(Acquisition Reform) was established to direct “fundamental and far-reaching acquisition and procurement reform measures” with oversight responsibilities for the Acquisition Education Training and Career Development Directorate, the DAU, and the DSMC.<sup>17</sup> The first acquisition reform process action teams (PATs) were chartered: Electronic Commerce/Electronic Data Interchange, and Military Specifications and Standards. Both teams submitted final reports during before Deutch left.
- ◆ In 1993, DARPA was redesignated the Advanced Research Projects Agency (ARPA)—as the agency was known before 1972.<sup>18</sup>
- ◆ The Defense Airborne Reconnaissance Office (DARO) was established in November 1993. DARO was a result of Congressional direction to unify

<sup>15</sup> U.S. Government Manual editions for 1992–1993, p. 176, and 1993–1994, p. 179. Also, see Department of Defense Key Officials, 1947–2000, Historical Office, Office of the Secretary of Defense, pgs. 21–53. Some of the details on deputy under secretary and deputy assistant secretary positions were obtained from Defense Acquisition University material for program management training.

<sup>16</sup> National Defense Authorization Act for FY 1994 (Public Law 103-160), Section 904.

<sup>17</sup> USD(A) Memorandum for Director, Administration and Management, subject: Establish Deputy Under Secretary of Defense for Acquisition Reform, May 14, 1993.

<sup>18</sup> ARPA-DARPA: The History of the Name, [http://www.darpa.mil/body/arpa\\_darpa.html](http://www.darpa.mil/body/arpa_darpa.html). April 14, 2006.

---

existing manned and unmanned tactical airborne reconnaissance efforts.<sup>19</sup> DARO was assigned to the DUSD(Advanced Development).

- ◆ An Assistant Secretary of Defense (Economic Security), ASD(ES) was established in 1993, replacing the ASD(P&L). The ASD(P&L) supply and logistics functions were transferred to the new DUSD(Logistics), environmental matters transferred to the DUSD(Environmental Security), and production and installation functions transferred to the ASD(ES).
- ◆ The DUSD (Industrial and International Programs), a direct report to the PDUSD(AT&T), was disestablished and two new Deputy Assistant Secretaries of Defense (DASD), one for Dual-Use Technology and International Programs, and one for Industrial Affairs were established under the ASD(ES).
- ◆ In May 1993, the SDIO was designated the Ballistic Missile Defense Organization (BMDO) reporting to the USD(A).

## 6. The Kaminski Years, 1994–1997

In May 1994, Dr. Deutch left DoD to become the Director of Central Intelligence. He was replaced by Dr. Paul G. Kaminski, a former career Air Force officer and special assistant to the USD(Research & Engineering). Dr. Kaminski was sworn in as the USD(A&T) on October 3, 1994, and served until May 16, 1997. During his tenure a number of changes were made to OUSD(A&T), and a great deal of emphasis was placed on acquisition reform.<sup>20</sup>

By the end of 1994, the oversight of major defense acquisition programs had been consolidated into one office, the Director for Strategic and Tactical Systems. In

---

<sup>19</sup> House Report 103-357, Conference Report, NDAA for Fiscal Year 1994, p. 144, Management of tactical reconnaissance programs. The conferees were “alarmed by the military department’s failed attempts to develop a tactical level reconnaissance capability,” and directed the USD(A&T) “to create a new acquisition executive position to oversee a single, integrated tactical reconnaissance office (TRO). The conferees envision that the TRO would complement the existing National Reconnaissance Office (NRO), but would focus on aerial reconnaissance missions at the theater-level and below to support the combatant commanders.” From 1983 to 1998 DARO would oversee the development of tactical unmanned aerial vehicles (UAV), such as the Predator, Hunter, Pioneer, and Global Hawk. DARO would also oversee improvements to selected manned systems, such as the U2, and development/upgrades to the information infrastructure for both manned and unmanned systems.

<sup>20</sup> U.S. Government Manual, 1993–1994, p. 179. For a discussion of Acquisition Reform initiatives, see Annual Report to the President and the Congress, William J. Perry, Secretary of Defense, February 1995, pgs. 101–110. DoD Directive 5134.1, Under Secretary of Defense for Acquisition, Technology, USD(A&T), June 8, 1994, part 2.F. lists the subordinate organizations of USD(A&T).

1995, Overarching Integrated Product Teams (OIPTs), chaired by the Director for Strategic and Tactical Systems, replaced the DAB Committee Structure.<sup>21</sup>

The Federal Acquisition Streamlining Act (FASA) of 1994 assigned the responsibility for live fire test and evaluation (LFT&E) to the Director, Operational Test and Evaluation (DOT&E).<sup>22</sup> The Live Fire test office was moved from USD(A&T)'s Director, Test and Evaluation (DT&E) to DOT&E. The DT&E office was redesignated Director, Test, Systems Engineering and Evaluation reporting to the Principal DUST(A&T), responsible for developmental test policy and the foreign comparative test (FCT) program policy and oversight.

The position of Deputy Under Secretary (Space) was created in December, 1994—responsible for developing, coordinating, and overseeing the implementation of DoD space policy. This was a shared responsibility with ASD(C3I) and DDR&E.<sup>23</sup>

In September 1995, Dr. Kaminski moved responsibility for dual-use technology and the Dual-Use Technology Policy Office from ASD(ES) to DDR&E, to consolidate technology policy under one office. DARO was moved from DUSD(Advanced Technology) to a direct report under the Principal Deputy due to the maturing nature of the airborne reconnaissance programs—reflecting an acquisition oriented, rather than a technology oriented portfolio.<sup>24</sup>

The ASD(ES) picked up responsibilities for Base Realignment and Closure activities (BRAC), and for SECDEF Perry's initiative to reduce specifications and standards. However, by mid-1996, the ASD(ES) position was no longer required and disestablished.<sup>25</sup>

With the disestablishment of the ASD(ES), a DUSD for International and Commercial Programs, and a DUSD for Industrial Affairs and Installations were established as direct reports to the USD(A&T).

As a result of congressionally mandated reviews in 1992 and 1993, the Defense Nuclear Agency (DNA) was re-chartered in 1995. Traditional roles involving nuclear matters were retained, along with the cooperative threat reduction (CTR)

---

<sup>21</sup> *Rules of the Road—A Guide for Leading Successful Integrated Product Teams*, Under Secretary of Defense for Acquisition and Technology, Assistant Secretary of Defense for Command, Control, Communications & Intelligence (C3I), November 1995.

<sup>22</sup> Federal Acquisition Streamlining Act of 1994 (Public Law 103-355), Section 3012.

<sup>23</sup> Deputy Secretary of Defense Memorandum, subject: *Responsibilities and Functions of the Deputy Under Secretary of Defense for Space*, 8 March 1995.

<sup>24</sup> DoD News Release no. 499-95, September 14, 1995.

<sup>25</sup> *Department of Defense Key Officials, 1947–2000*, Historical Office, Office of the Secretary of Defense, 2000, p. 33.

---

mission, and the agency gained responsibility for some non-nuclear development activities that took advantage of the agency's nuclear heritage.<sup>26</sup>

In 1996, ARPA was redesignated DARPA, and the ATSD(AE) position was renamed ATSD for Nuclear, Chemical and Biological Defense Programs.<sup>27</sup>

A major characteristic of the Kaminski years were numerous acquisition reform process action teams (PATs).<sup>28</sup> To help implement the results of acquisition reform, the nearly 900 pages of DoD Directive 5000.1, DoD Instruction 5000.2, and DoD Manual 5000.2M were replaced by two new documents: DoD Directive 5000.1 and a regulation, DoD 5000.2-R, about 160 pages with mandatory policy and procedure. Discretionary practice and optional document formats were issued in a CD-based Defense Acquisition Deskbook.<sup>29</sup> By the end of Dr. Kaminski's tenure the office of the USD(A&T) was organized as shown in Figure K-3.

---

<sup>26</sup> *Defense's Nuclear Agency, 1947-1997*, Defense Threat Reduction Agency, September 24, 2002, p. 314.

<sup>27</sup> National Defense Authorization Act (NDAA) for FY1996 (Public Law 104-106), Sections 904 and 908.

<sup>28</sup> These PATs included teams to streamline regulations, developing a DoD-wide electronic commerce strategy, reducing military specifications and standards, improving contract administration, streamlining the procurement process, reducing acquisition systems oversight and review, communications reform, reducing regulatory cost, using commercial practices for pilot programs, revising protest reform, establishing process improvement metrics, and improving automation of acquisition information. See DoD News Release 542-96, September 20, 1996 for a complete list of teams and team leaders.

<sup>29</sup> The 1996 versions of DoDD 5000.1 and DoD 5000.2R integrated automated information systems into the "5000 process," and implemented acquisition reform initiatives such as integrated product and process development (IPPD) and cost as an independent variable (CAIV). The Deskbook provided access to a complete library of acquisition information, to include FAR, DFARS, public law, all documents referenced in the 5000 series, and numerous military department and defense agency documents. An Air Force led Deskbook joint program office reported to the DUSD(Acquisition Reform).

Figure K-3. Office of the Under Secretary of Defense (Acquisition and Technology), 1997

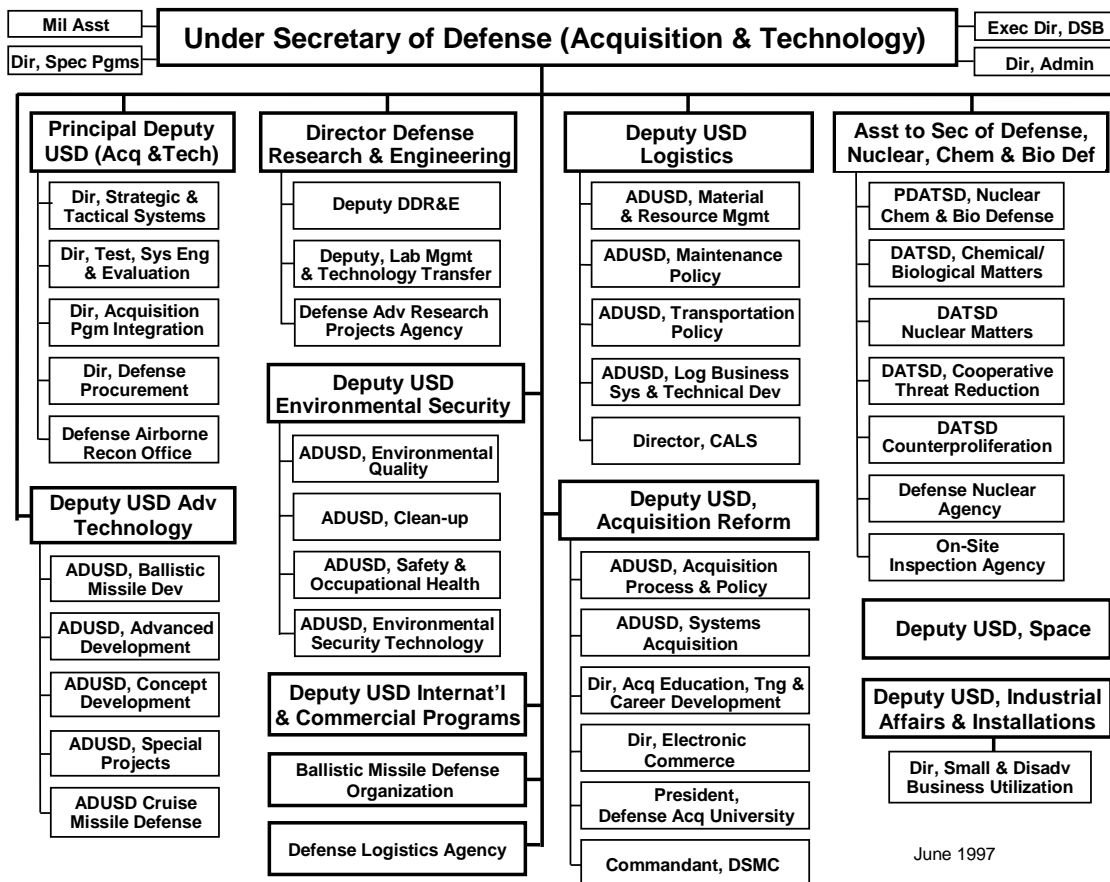

## 7. The Gansler Years, 1997 to 2001

Dr. Jacques S. Gansler served as USD (Acquisition, Technology and Logistics)<sup>30</sup> from November 1997 to January 2001. Noel Longuemare, Jr., the principal deputy, served as acting under secretary when Dr. Kaminski departed in May 1997 until Dr. Gansler arrived in November 1997. Dr. Gansler was Executive Vice President and Corporate Director for TASC, Inc., and had also served as Deputy Under Secretary of Defense (Material Acquisition). During Dr. Gansler's time in office the following organizational changes took place.<sup>31</sup>

- ◆ In 1997 Congress changed their minds on management of airborne reconnaissance programs. DARO had been created as a result of direction by the NDAA FY1992 conference report; in 1997 the NDAA for 1998 directed that functions assigned to the DARO (then under the

<sup>30</sup> The title change from Acquisition and Technology to Acquisition, Technology and Logistics was enacted in the NDAA for FY 2000, section 911.

<sup>31</sup> See U.S. Government Manual editions for 1995–1996, p. 172, and 1996–1997, p. 172. Some of the details on deputy under secretary and deputy assistant secretary positions were obtained from Defense Acquisition University material for program management training.

---

DUSD(Advanced Technology), and of the joint unmanned aerial vehicle program office, be transferred to the Secretaries of the Military Departments.<sup>32</sup> The Conference Report indicated that OSD should retain oversight responsibilities for airborne reconnaissance architecture determination and systems interface requirements. “The conferees note the Hicks & Associates Report, which recommends that the OSD should focus ‘exclusively on top leadership and management tasks, assigning program management and execution tasks and lower priority tasks elsewhere in DoD.’ This report goes on to say that, ‘OSD is a staff and advisory component...’ that should divest itself of hands-on management. The conferees agree.”<sup>33</sup>

- ◆ As a result of SECDEF Cohen’s 1997 Defense Reform Initiative, the functions of the DUSD (Advanced Technology) were transferred to the DDR&E, and a DUSD (Advanced Systems and Concepts) was established in DDR&E to assume oversight of the ACTD program, consolidating all OUSD(A&T) S&T efforts under the DDR&E. The functions of the DUSD (Space) were transferred back to USD (Policy).<sup>34</sup>
- ◆ In October 1998, the Defense Special Weapons Agency, the On-Site Inspection Agency, and the Defense Technology Security Administration, along with selection elements of the OSD staff were merged to form the Defense Threat Reduction Agency (DTRA).<sup>35</sup>
- ◆ In late 1998, DUSD(Industrial Affairs & Installations), DUSD(Acquisition Reform), DUSD(Logistics), and DUSD (Environmental) were transferred from direct reports to the USD(A&T) to the PDUSD(A&T). The DUSD (International & Commercial Programs) became the DUSD (International Programs) reporting to the PDUSD(A&T).
- ◆ The Director, Strategic and Tactical Systems, and the Director, Test, Systems Engineering and Evaluation were transferred back to DDR&E. This once again moved oversight of ACAT I acquisition programs back under DDR&E. By the end of 1998, the office of the DDR&E included:
  - Director, Strategic and Tactical Systems, with the major warfare directors for the ACAT I programs, and the Arms Control Implementation and Compliance office.

<sup>32</sup> PL 105-85, November 18, 1997, Section 905 (NDAA for FY 1998).

<sup>33</sup> House Report 105-340, NDAA for FY1998, Conference Report, October 23, 1997, p. 783.

<sup>34</sup> Defense Reform Initiative (DRI) Report, William S. Cohen, Secretary of Defense, November 1997, appendix C-3, Acquisition & Technology Secretariat.

<sup>35</sup> The DEPSECDEF, John Hamre, believed that current nonproliferation programs needed to be refocused to concentrate on the threat from terrorism. Dr. Gansler believed there were two sides to controlling weapons of mass destruction—first to cut back on proliferation, then to emphasize the defensive techniques that could be used. This two sided concept was the core organizing principle for DTRA. See, *Creating the Defense Threat Reduction Agency*, Joseph P. Harahan, Ph.D., and Captain Robert J. Bennett, DTRA History Series, January 2002.

- DUSD (Advanced Systems and Concepts) responsible for the ACTD program, begun in 1995.
- DUSD (Science and Technology) responsible for oversight of basic research, advanced research and advanced technology development efforts for DoD.
- Director, Test, Systems Engineering and Evaluation responsible for oversight of developmental test and systems engineering policy and procedures. This office also had responsibility for the Foreign Comparative Test Program (FCT).
- Assistant to the Secretary of Defense for Nuclear, Chemical and Biological Defense (ATSD(NCB)). The DRI indicated that the corporate level policy functions assigned to ATSD(NCB) would transfer to the DDR&E, and the position would be eliminated. This was intended to take place and the position was held vacant; however, events of September 11, 2001 changed that plan.
- ◆ DUSD (Acquisition Reform), DUSD (Environmental Security), and DUSD International Cooperation (now a director) who had been direct reports to USD(AT&L), were moved under the principal deputy in 1998.
- ◆ In 1999, DUSD (Industrial Affairs and Installations) was separated into two new offices: DUSD (Industrial Affairs) and DUSD (Installations). The Director for Small and Disadvantage Business Utilization (SADBU), became a direct report to the PDUSD(A&T).
- ◆ In late 1999, Director, Test, Systems Engineering and Evaluation moved into the Office of Director, Strategic and Tactical Systems and renamed Deputy Director, Test and Evaluation.
- ◆ The Defense Acquisition Policy Steering Group (DAPSG) and Defense Acquisition Policy Working Group (DAPWG) were chartered in 1996 to manage and review DoD-wide acquisition policies and procedures recommended to the USD(A&T), Director OT&E, and ASD (C3I). In 1999, the charter was revised to provide for the Director, Systems Acquisition as the Chair and the DUSD(Acquisition Reform) as co-chair of the DAPSG. Those two offices also provided the Chair and co-chair of the DAPWG.<sup>36</sup>
- ◆ Director, Acquisition Resources and Analysis (ARA), was created in 1999 absorbing the Systems Acquisition/Acquisition Systems Management offices. ARA assumed duties as the DAB executive secretariat, the Defense Acquisition Executive Summary (DAES) reports, Selected Acquisition

---

<sup>36</sup> Memorandum for Members and Advisors of the Defense Acquisition Policy Steering Group, signed by the USD(A&T), the Director, Operational Test and Evaluation, and the Senior Civilian Official, Office of the ASD(C3I), 5 August 1999.

---

Reports (SAR), and Unit Cost Reports (UCR). ARA also assumed responsibility for OUSD(AT&L) participation in the Planning, Programming, and Budgeting System (PPBS).

- ◆ In March 2000, the Defense Contract Management Command was separated from DLA and became a new Defense agency reporting direct to the USD(AT&L).<sup>37</sup>
- ◆ A new Deputy Under Secretary (Logistics and Materiel Readiness) DUSD(LM&R) was created by the FY 2000 National Defense Authorization Act.<sup>38</sup> DUSD(LM&R) absorbed the functions of the DUSD (Logistics), an organization that had existed since 1993. The 2000 Act resulted in two deputy under secretaries requiring Senate confirmation, one for A&T and one for LM&R. However, the DUSD(A&T) continued to be dual-hatted as the PDUSD(AT&L) until 2005.<sup>39</sup>

Figure K-4 shows the organization of the OUSD(AT&L) as of October 2000.

---

<sup>37</sup> DoD News Release No. 159-00, April 3, 2000. Also, see DoDD 5105.64, *Defense Contract Management Agency (DCMA)*, September 21, 2000.

<sup>38</sup> PL 106-65, October 5, 1999, Section 911 (NDAA for FY2000) established 10 USC 133b., authorizing the new DUSD(LM&R).

<sup>39</sup> DoDD 5134.13, May 25, 2000, Deputy Under Secretary of Defense for Acquisition and Technology, part 3.2, assigned DUSD(A&T) the role of “principal deputy” AT&L. The revised DoDD 5134.13, October 5, 2005 no longer provided for this role.



Figure K-4. Office of the Under Secretary of Defense (Acquisition, Technology and Logistics), 2000

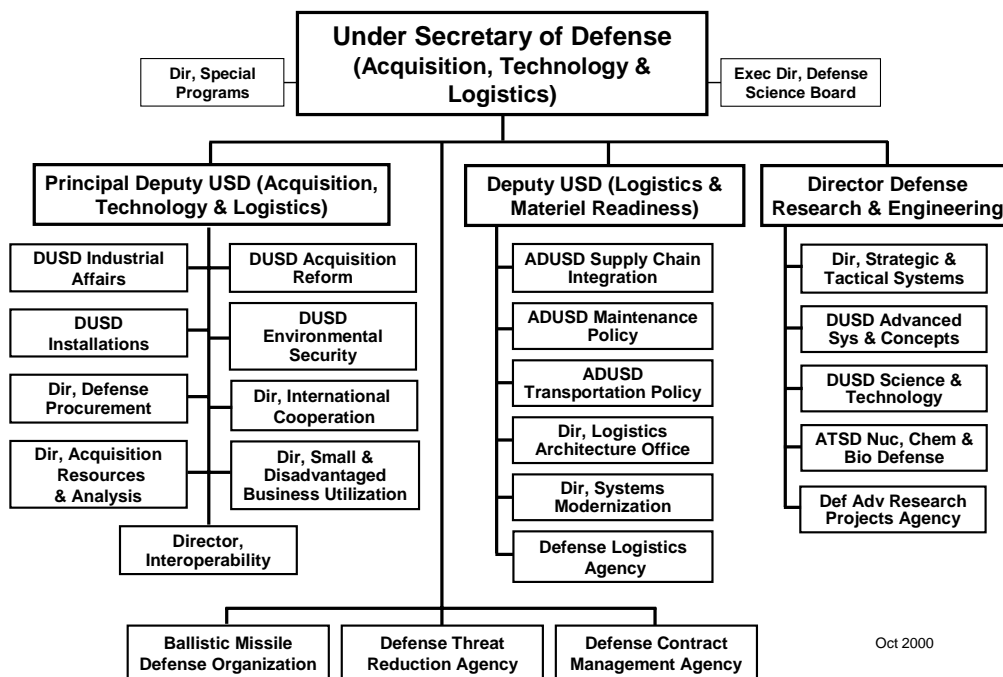

## 8. The Aldridge Years, 2001–2003

This was the first year of President George W. Bush’s administration. Edward C. “Pete” Aldridge was the Chief Executive Officer of The Aerospace Corporation and had also served as President of McDonnell Douglas Electronic Systems Company, and as both Under Secretary and Secretary of the Air Force. He sworn in as USD(AT&L) in May 2001 and served until May 2003. OUSD(AT&L) was changed as follows during Mr. Aldridge’s tenure.<sup>40</sup>

- ◆ The DUSD (Acquisition Reform) was moved under the DUSD(A&T) and redesignated DUSD (Acquisition Initiatives). Mr. Aldridge indicated the department was moving from a philosophy of acquisition reform to a focus on acquisition excellence. DAU and DSMC continued to report to this office.<sup>41</sup> In 2002, the offices of Director, Acquisition Initiatives and

<sup>40</sup> Editions of the U.S. Government Manual, 2000–2001, p. 154; 2001–2002, p. 155; and, 2002–2003, p. 151. Some of the details on deputy under secretary and deputy assistant secretary, and director positions were obtained from Defense Acquisition University material for program management training.

<sup>41</sup> Town Hall Meeting with the Under Secretaries of Defense, December 18, 2002, News Transcript, DoD, OUSD(PA). Aldridge said that when he first came on board in May 2001, he wanted a change in philosophy from something called acquisition form to a focus on acquisition excellence. “And so the theme of my office has been acquisition excellence—doing things right, doing them quickly, doing them with skill and precision.”

---

Director, Defense Procurement were merged into a new office, Director of Procurement and Acquisition Policy (DPAP).

- ◆ Director, Strategic and Tactical Systems: Moved from DDR&E to DUSD(A&T), leaving DDR&E with oversight of science and technology activities only, and the name was changed to Defense Systems. The foreign comparative test program was broken out of the Office of the Deputy Director for Test and Evaluation and made a separate office. In early 2003, the Director, Interoperability was merged into Defense Systems as a Deputy Director.
- ◆ Director, International Cooperation and Director, Acquisition Resources and Analysis were moved from the DUSD(A&T) to direct reports to the USD(AT&L).

On January 2, 2002, BMDO became the Missile Defense Agency (MDA) and continued to report direct to the USD(A&T). MDA was exempted from the DoD 5000 documents acquisition policies and procedures.

The DUSD for Installations and the DUSD for Environmental Security were combined into one office, DUSD for Installations and Environment, and moved from the DUSD(A&T) to the DUSD (LM&R).

The position of ATSD(NCB) was filled and that office was moved from DDR&E to direct report to the USD(AT&L). The Defense Threat Reduction Agency was placed under the ATSD(NCB).

DUSD International Technology Security Policy was established as an office under the DUSD(A&T).

In 2002, Mr. Aldridge delegated milestone decision authority for DoD Acquisition Category I (ACAT I) space systems to the Secretary of the Air Force. This authority was redelegated to the Under Secretary of the Air Force.<sup>42</sup>

During Mr. Aldridge's tenure the DAU consortium of schools transitioned to a consolidated DAU structure, with five full-service campuses aligned with major AT&L workforce locations. Curriculum development was centralized at Fort Belvoir and DAU dedicated additional resources to expand training and knowledge management assets to reach a larger percentage of the acquisition workforce on a

---

<sup>42</sup> USD(AT&L) memorandum, *Delegation of Milestone Decision Authority for DoD Space Systems*, February 14, 2002. Also, see SECDEF memorandum, *National Security Space Management and Organization*, October 18, 2001, implementing the recommendations of the Commission to Assess United States National Security Space Management. This memo directed realignment of acquisition and organizational functions to create a cradle-to-grave approach for space, to include the transfer of the Air Force Space and Missile Systems Center (SMC) to the Air Force Space Command and the designation of the SMC commander as PEO for Space. DoDD 5101.2, DoD Executive Agent for Space, June 3, 2003 establishes policy and assigns responsibilities within DoD for acquisition of space systems.

24 hour basis. Combined with large-scale re-engineering of career field training, starting with the program management career field, this was the most comprehensive re-engineering of acquisition training since DSMC was established in 1971.<sup>43</sup>

## 9. The Wynne Years, 2003–2005

Michael W. Wynne became the Acting USD(AT&L) in May 2003 when Mr. Aldridge left. He had spent 23 years with General Dynamics, and 3 years with Lockheed Martin. Prior to joining Defense in 2001, he was involved in venture capital nurturing small technology companies. Mr. Wynne had been Mr. Aldridge's principal deputy since July 2001. He served as Acting USD(AT&L) from May 2003 to April 2005 when he was confirmed as USD(AT&L). He then served as USD(AT&L) until June 2005. Changes in OUSD(AT&L) during his time as both acting and as USD(AT&L) included:<sup>44</sup>

- ◆ A Director for Systems Engineering, a Deputy Director for Enterprise Development, and an office for software intensive systems were established under Director, Defense Systems. The Defense Systems Director for Interoperability was changed to Director for Integration, then to Director for Systems and Mission Integration. Mr. Wynne also implemented a number of initiatives requiring OUSD(AT&L) oversight, to include revitalization of systems engineering skills within the AT&L workforce, corrosion control, unique item identification (UID), and radio frequency identification (RFID).

The Defense Acquisition Workforce Improvement Act (DAWIA) was amended in late 2003 and the Director, AET&CD position was repealed.<sup>45</sup> The position had already been vacated in late 2002, and the position of Deputy Director, Acquisition Workforce and Career Management created under the Director, DPAP. In late 2003, policy oversight responsibility for the acquisition workforce was transferred to the President, DAU, and the position of Deputy Director for Acquisition Workforce and Career Management was eliminated.

The Test Resource Management Center (TRMC) was established in 2003 as a field activity of the DoD as directed by Congress.<sup>46</sup> TRMC has the mission to

<sup>43</sup> DAU consolidation was first directed by USD(A&T) memo, December 23, 1997, *Decisions Regarding the Report of the Acquisition, Education and Training Process Action Team*, and subsequently approved by DoD Reform Initiative Directive No. 52, *Defense Acquisition University Consolidation*, DEPSECDEF, October 21, 1999. For additional information on the transformation of DAU from a consortium to a unified university structure, see The Defense Acquisition University Annual Report, 2001, available from the Acker Library, <http://www.dau.mil/library>.

<sup>44</sup> U.S. Government Manual, 2002–003, p. 152. Some of the details on changes at the director level were obtained from Defense Acquisition University material for program management training.

<sup>45</sup> National Defense Authorization Act for 1994 (Public Law 108-136), Section 831. This Act contained extensive changes to DAWIA that resulted in complete revisions to the DoD directives and instructions governing the Defense acquisition workforce.

<sup>46</sup> National Defense Authorization Act for FY2003 (Public Law 107-314), Section 231.

---

“plan for and assess the adequacy of the Major Range and Test Facility Base (MRTBF)...., to provide adequate testing in support of development, acquisition, fielding and sustainment of defense systems; and, maintain awareness of other T&E facilities and resources, within and outside the Department, and their impacts on DoD requirements.”<sup>47</sup>

A Joint Rapid Acquisition Cell (JRAC)<sup>48</sup> was jointly established in 2004 by the USD(AT&L) and the USD(Comptroller), by direction of the DEPSECDEF, to “facilitate meeting the urgent material and logistics requirements which the Combatant Commanders (CoCom) certify as operationally critical.”<sup>49</sup>

## 10. The Krieg Years, 2005 to present

Kenneth J. Krieg was the Director of Program Analysis and Evaluation prior to assuming the role of USD(AT&L). He had also been Special Assistant to the Secretary of Defense and Executive Secretary of the Senior Executive Council (SEC). Prior to joining DoD in 2001, Mr. Krieg was Vice President and General Manager at International Paper. He was confirmed as USD(AT&L) in June 2005. Mr. Krieg has made significant changes to ensure the OUSD(AT&L) organizational structure facilitates improved processes for defense acquisition in accordance with the 2006 Quadrennial Defense Review (QDR) results, and other initiatives driven by the urgencies of the global war on terror (GWOT).<sup>50</sup> The changes include:

- ◆ In October 2005, the Defense Business Transformation Agency (BTA) was established to advance defense-wide business transformation and to ensure consistency and continuity across the core business missions of DoD.<sup>51</sup>

---

<sup>47</sup> DoD Directive 5105.71, March 8, 2004.

<sup>48</sup> Section 806, Rapid Acquisition and Deployment Procedures, of the National Defense Authorization Act for FY 2003, required the Secretary of Defense to prescribe procedures for the rapid acquisition and deployment of items “currently under development by the Department of Defense or available from the commercial sector; and urgently needed to react to an enemy threat or to respond to significant and urgent safety situations.” Section 811, of the National Defense Authorization Act for FY 2005 provided additional authority for the acquisition of equipment to respond to combat emergencies, and authorized waivers for many of the requirements that apply to traditional acquisition programs.

<sup>49</sup>Memorandum, DEPSECDEF, Meeting the Immediate Warfighter Needs, September 3, 2004. Also, Section 806, Rapid Acquisition and Deployment Procedures, of the National Defense Authorization Act for FY 2003, required the Secretary of Defense to prescribe procedures for the rapid acquisition and deployment of items “currently under development by the Department of Defense or available from the commercial sector; and urgently needed to react to an enemy threat or to respond to significant and urgent safety situations.” Section 811, of the National Defense Authorization Act for FY 2005 provided additional authority for the acquisition of equipment to respond to combat emergencies, and authorized waivers for many of the requirements that apply to traditional acquisition programs.

<sup>50</sup> The Report of the Quadrennial Defense Review, the Secretary of Defense, 6 February 2006, pages vii, 66, 67, 69, 80.

<sup>51</sup> DEPSECDEF memorandum, *Establishment of the Defense Business Transformation Agency (BTA)*, October 7, 2005.

- ◆ DoD Directive 5134.13, eliminated the provision for dual-hatting the DUSD(A&T) as the Principal Deputy USD(AT&L).<sup>52</sup>
- ◆ The Director, Human Capital was created as a result of congressional interest in human capital planning and the QDR 2006 emphasis on human capital. The President, Defense Acquisition University is dual-hatted as the Director, Human Capital for the Acquisition, Technology and Logistics (AT&L) workforce.
- ◆ Deputy Under Secretary of Defense (DUSD) for Business Transformation was created in early 2006 to lead business modernization for the DoD across the military services and defense agencies to provide for rapid transformation of business processes and systems to ensure support to the warfighter and improved financial accountability.
- ◆ Director, Defense Systems. This office was disestablished and the following organizational changes were made to reflect strategic direction in support of the 2006 QDR, to emphasize core competencies, and to improve communication, teamwork, and integration within the office of the DUSD(A&T).<sup>53</sup>
  - Director, Systems Acquisition was renamed to Director, Portfolio Management, reporting to the DUSD(A&T). The office continues to manage the OIPT process for oversight of major defense acquisition programs.
  - Director, Systems and Mission Integration was renamed to Director, Systems of Systems Management, reporting to the DUSD(A&T). In late 2006, this office was again renamed to Director, Joint Advanced Concepts.
  - The position of Director, Systems Engineering was renamed to Director, Systems Engineering and Software Management, reporting to the DUSD(A&T), to reflect the unique oversight and review requirements for the development of software intensive weapons systems.
  - DUSD (International Technology Security) was moved to the DDR&E.

---

<sup>52</sup> See DoD Directive 5134.13, *Deputy Under Secretary of Defense for Acquisition and Technology*, October 5, 2005.

<sup>53</sup> *Organizational Restructuring in the Office of the Deputy Under Secretary of Defense (Acquisition and Technology)*, DoD memorandum, May 18, 2006.

---

### III. Origin and Authority

#### 1. Mission

The Under Secretary of Defense (Acquisition)(USD(A)), (now the USD (Acquisition, Technology & Logistics)(AT&L)) position was recommended by the President's Blue Ribbon Commission on Defense Management (the Packard Commission) in 1986 to provide a single senior official to provide overall supervision of the Defense acquisition system.

“We strongly recommend creation by statute of the new position of Under Secretary of Defense (Acquisition) and authorization of an additional Level II appointment in the Office of the Secretary of Defense (OSD). This new Under Secretary should have full-time responsibility for managing the defense acquisition system. He should be a Level II Presidential appointee and should have a solid industrial background in the management of complex technical programs. The new Under Secretary should be the Defense Acquisition Executive. As such, he should supervise the performance of the entire acquisition system and set overall policy for R&D, procurement, logistics, and testing. He should have the responsibility to determine that new programs are thoroughly researched, that military requirements are verified, and that realistic cost estimates are made before the start of full-scale development. (In general, we believe, cost estimates should include the cost of operating and maintaining a system through its life.) He should assure that an appropriate type of procurement is employed, and that adequate operational testing is done before the start of high-rate production. He also should be responsible for determining the continuing adequacy of the defense industrial base.”<sup>54</sup>

To implement the Packard Commission's recommendation, the USD (A) position was created by the Military Retirement Reform Act of 1986.<sup>55</sup> Congress specified the unique roles and responsibilities of the USD(A) in the National Defense Authorization Act for 1987.<sup>56</sup> These have been slightly amended since, and are currently reflected in 10 U.S.C. 133 as:<sup>57</sup>

- 1) supervising Department of Defense acquisition;
- 2) establishing policies for acquisition (including procurement of goods and services, research and development, developmental testing, and contract administration) for all elements of the Department of Defense;

---

<sup>54</sup> *A Quest for Excellence*, Final Report to the President by the President's Blue Ribbon Commission on Defense Management, page 53.

<sup>55</sup> Military Retirement Reform Act of 1986, Public Law 99-348, July 1, 1986.

<sup>56</sup> Section 901, National Defense Authorization Act for FY1987 (Public Law 99-661, November 14, 1986). This Act also created the Deputy Under Secretary of Defense for Acquisition (Section 902), and directed that the Director, Small and Disadvantaged Business Utilization report to the USD(Acquisition) (Section 903).

<sup>57</sup> Office of the Law Revision Counsel, U.S. House of Representatives, 10 USC 133, update 01/03/05.

- 3) establishing policies for logistics, maintenance, and sustainment support for all elements of the Department of Defense;
- 4) establishing policies of the Department of Defense for maintenance of the defense industrial base of the United States; and
- 5) the authority to direct the Secretaries of the military departments and the heads of all other elements of the Department of Defense with regard to matters for which the Under Secretary has responsibility.

The Under Secretary—

- (1) is the senior procurement executive for the Department of Defense for the purposes of section 16(3) of the Office of Federal Procurement Policy Act (41 U.S.C. 414(3));
- (2) is the Defense Acquisition Executive for purposes of regulations and procedures of the Department providing for a Defense Acquisition Executive; and
- (3) to the extent directed by the Secretary, exercises overall supervision of all personnel (civilian and military) in the Office of the Secretary of Defense with regard to matters for which the Under Secretary has responsibility, unless otherwise provided by law.





# Appendix F

## Survey Trends

---

### INTRODUCTION

The review team analyzed the survey results from the Section 814 questionnaire for common trends and themes in the responses. This appendix outlines the issues identified by most respondents. It is organized by the following themes: budget, process, workforce, and joint programs.

### Budget

Virtually all respondents from the military departments, defense agencies, defense field activities, and COCOMs identified the budget process to be a critical impediment to acquisition projects. Approximately one-third of those surveyed cited changes to acquisition funding in their recommendations to improve the outcomes of the Defense Acquisition System. Recurring issues identified in the budget process included the following:

- ◆ Budget instability—A need for increases in steady, long-term funding.
- ◆ A need to “fence” acquisition funds so they cannot be reallocated to make up for shortfalls in Operations and Military Personnel accounts.
- ◆ Frequent budget shortfalls and reallocations in Research, Development, Testing and Evaluation (RDT&E) and Procurement (OPA) accounts.
- ◆ Need for a single “color” of money instead of three categories—RDT&E, OPA, and Operation and Maintenance (OMA) to allow greater flexibility in the acquisition process.
- ◆ Fixing the Planning, Programming, Budgeting and Execution (PPBE) and Program Objective Memorandum (POM) processes.
- ◆ An expressed need for multi-year procurement authority and funds to provide predictability over a 5-year planning cycle.
- ◆ A perceived lack of alignment between the budget and acquisition cycles (funding is calendar driven, while acquisition is event driven).
- ◆ Too many programs for available funding.
- ◆ Non-performing programs are seldom cancelled.

---

## Process

Several survey responses indicated that reform initiatives are hampered by high-level acquisition staff personnel who slow review, coordination, and approval processes. Although acquisition reform has been embraced at the most senior levels and by the PMs and PEOs, several respondents stated that changes directed through acquisition reforms are not being universally adopted, especially by individuals in the mid and lower levels of reviewing or oversight offices. This has resulted in

- ◆ unproductive, and in some cases, increased layers of review and oversight;
- ◆ burdensome reporting requirements; and
- ◆ unclear lines of authority and responsibility.

Survey respondents recommended the following corrective actions to improve the acquisition process:

- ◆ Streamline the acquisition process
- ◆ Reduce the layers of oversight and review
- ◆ Reduce the reporting requirements and documentation necessary for milestone review
- ◆ Improve the requirements development process.

## Workforce

Section 814 survey respondents reported the following issues with regard to workforce size and quality:

- ◆ A need to rebuild the acquisition workforce; a perception that the AT&L workforce is too small and is increasingly relying on support contractors
- ◆ Shortages in certain critical career fields, especially contracting officers
- ◆ Requests for better training programs for selected functions, most notably program management and requirements development
- ◆ Recommendations to institute recruiting and retention incentive programs for acquisition professionals.

## Joint Programs

Responses to the Section 814 survey indicated that the military departments and defense agencies are involved in 284 traditional joint acquisition programs. This environment presents some unique challenges as follows:

- ◆ Difficulty in getting the participating Services or agencies to agree on requirements
- ◆ Difficulty obtaining priority on funding and staffing for the joint program office
- ◆ Poorly documented roles and responsibilities because of the lack of a charter or one that is poorly written
- ◆ Parochialism and competition among lead and participating Services or agencies.

Based on the survey responses and previous studies, it is clear that stable and predictable funding is critical to all acquisition processes. These budget challenges are magnified in the joint acquisition process, and many respondents reported experiencing difficulties with funding joint programs, including the following:

- ◆ Difficulties with aligning the budgets and detailed requirements of two or more Services
- ◆ Funding burden falling only on the lead Service and other cost sharing inequities
- ◆ Need for integrated POM submissions and execution year budgets
- ◆ Participating Services changing priorities and not fulfilling funding commitments
- ◆ Requirements for an integrated funding strategy to balance Service priorities
- ◆ Consolidating and converting multi-service appropriations to the prescribed appropriation for funding programs
- ◆ Additional “color of money” issues that prevent flexibility in the joint acquisition process.



# Appendix G

## Survey Instrument

---

This appendix presents the survey instrument that was completed by 63 respondents who participated in the Defense Acquisition Structures and Capabilities Review.

### Defense Acquisition Structures & Capabilities Review (DASCR)

#### Questionnaire

*In Accordance With Section 814 of the FY06 Defense Authorizations Act*

#### **Section I: Administrative Data**

Date:

Questionnaire Control #:

Name of Organization:

Contact Information for Person Responsible for this Questionnaire:

Name:

Position:

Grade:

Series:

Phone No.

E-mail:

Contact Information for Defense Acquisition University (DAU) DASCR POCs:

Army: Mr. Brad Brown, 703.805-4979

Navy: Dr. Paul Alfieri, 703.805-5282

Air Force: Mr. Bill Erie, 703.805-3742

Defense Agencies: Mr. Gerry Emke, 937.781-1083

---

## **Section II: Administrative Instructions**

- 1.) Congress has asked the Undersecretary of Defense, Acquisition Technology and Logistics (USD, AT&L), with the Defense Acquisition University (DAU) acting as the executive agent, to “conduct a review of the acquisition structures and capabilities of the Department of Defense...” and to report back findings and recommendations. To that end, we are soliciting your full cooperation in providing thoughtful, reasoned and complete responses to this questionnaire.
- 2.) Questionnaire responses will be held in confidence and will not be attributed back to the answering organization.
- 3.) Not all questions apply to all organizations. If a question does not apply to your organization simply respond “Not Applicable.”
- 4.) A glossary of key terms used in this questionnaire is included at the enclosure.
- 5.) Each Military Department and separate reporting Defense Agency has a designated Defense Acquisition University POC from the DASCRC team. The DAU DASCRC POC will meet with the designated Service or Agency POC to ensure a thorough understanding of section 814 information requirements and terminology and to facilitate the completion of this questionnaire.
- 6.) Please submit the completed questionnaire to the above named DASCRC POC no later than 16 June 2006.

## **Section III: Personnel**

(NOTE: Although similar data may have been reported by your organization in other formats, we require your response in this format to establish a historical timeline.)

- 1.) As of March 2006, how many Key Leadership Positions, by career field and grade level, were in your organization?
- 2.) By career field and grade, how many acquisition personnel were assigned to your organization in 1990? By career field and grade, how many acquisition personnel were assigned to DAWIA-coded acquisition positions in your organization in 2005?
- 3.) By labor category, how many non-acquisition support personnel were assigned to your organization in 1990? In 2005?
- 4.) List all geographic locations, including number of assigned personnel at each location, at which acquisition personnel were assigned in your organization in 1990 and 2005.

**Section IV: Mission**

- 1.) What were the primary missions of your organization in 1990? What are they today?
- 2.) For any missions that no longer exist, explain what happened to them, e.g., eliminated, transferred to another organization, outsourced to contractors.
- 3.) How many contracting actions did your organization have in 1990? What was their total value?
- 4.) How many contracting actions did your organization have in 2005? What was their total value?
- 5.) How many contingency contracting actions did your organization have in 1990? What was their total value?
- 6.) How many contingency contracting actions did your organization have in 2005? What was their total value?

**Section V: Organizational**

- 1.) Discuss the impact, on your organization, of “acquisition reform” and any other major initiatives (e.g., SPI and CAIV) intended to improve DoD business practices and change DoD business structures. Provide an estimate of the resource impact of each. Discuss the impact of any unintended consequences.
- 2.) Discuss the impact that major automated software systems have had on your organization’s effectiveness and efficiency from 1990 through 2005. Provide an estimate of the resource impact. Discuss the impact of any unintended consequences.
- 3.) What impacts on your organization’s effectiveness and efficiency have there been through collaboration with industry from 1990 to 2005? Provide an estimate of resource savings achieved through this collaboration.
- 4.) How do your organization’s control systems align and enforce responsibility, authority and accountability to allow it to accomplish its assigned mission(s)?
- 5.) What would your organization look like if you could completely re-design it?
- 6.) What recommendations do you have to improve the outcomes of the Defense Acquisition System?

---

## **Section VI: Systems Acquisition Organizations Specific**

- 1.) Current policy stipulates that there should be no more than two levels of review between the Program Manager and the Milestone Decision Authority. Is this the case in your organization? Do parallel/duplicate chains of authority such as those for performance reporting or funding exist in your organization? If so, what is their impact?
- 2.) What is the process in your organization for oversight and review of acquisition programs (all categories) prior to milestone decisions?
- 3.) At which level would you recommend vesting milestone decision authority for each acquisition category level? Please explain.
- 4.) What are the advantages and disadvantages of the PEO structure to your organization?
- 5.) How does your organization keep informed on new and emerging technologies?
- 6.) In which Joint Acquisition Programs (defined as those in which more than one Service or agency is involved in management and execution) is your organization involved?
- 7.) Comment on any difficulties your organization may have encountered in the management of joint acquisition programs and provide any recommendations for improvement.

### **ENCLOSURE: Glossary of Key Terms:**

Acquisition Category Level: Categories established to facilitate decentralized decision making and execution and compliance with statutorily imposed requirements. The categories determine the level of review, decision authority, and applicable procedures. The ACATs are listed below:

- ◆ **ACAT I** programs are Major Defense Acquisition Programs (MDAPs). An MDAP is defined as a program estimated by the Under Secretary of Defense (Acquisition, Technology, and Logistics) (USD(AT&L)) to require eventual expenditure for Research, Development, Test and Evaluation (RDT&E) of more than \$365 million (Fiscal Year (FY) 2000 constant dollars) or procurement of more than \$2.19 billion (FY 2000 constant dollars), or those designated by the USD(AT&L) to be ACAT I. ACAT I programs have two sub-categories:
  - **ACAT ID** for which the Milestone Decision Authority (MDA) is USD(AT&L). The *D* refers to the *Defense Acquisition Board (DAB)*, which advises the USD(AT & L) at major decision points.



- **ACAT IC** for which the MDA is the DoD Component Head or, if delegated, the DoD Component Acquisition Executive (CAE). The *C* refers to *Component*.
- **ACAT IA** programs are Major Automated Information Systems (MAISs) or programs designated by the Assistant Secretary of Defense for Networks and Information Integration (ASD(NII)) to be ACAT IA. An MAIS is an Automated Information System (AIS) program that is: 1) designated by the ASD(NII) as an MAIS; or 2) estimated to require program costs in any single year in excess of \$32 million (FY 2000 constant dollars), total program in excess of \$126 million (FY 2000 constant dollars), or total Life Cycle Costs (LCCs) in excess of \$378 million (FY 2000 constant dollars). MAISs do not include Information Technology (IT) that involves equipment that is an integral part of a weapon system or is an acquisition of services program. ACAT IA programs have two sub-categories:
  - **ACAT IAM** for which the MDA is the Chief Information Officer (CIO) of DoD, the ASD(NII). The *M* in ACAT IAM refers to *MAIS*.
  - **ACAT IAC** for which the DoD CIO has delegated MDA to the CAE or Component CIO. The *C* (in ACAT IAC) refers to *Component*. The ASD(NII) designates programs as ACAT IAM or ACAT IAC.
- ◆ **ACAT II** programs are defined as those acquisition programs that do not meet the criteria for an ACAT I program, but do meet the criteria for a major system. A major system is defined as a program estimated by the DoD Component Head to require eventual expenditure for RDT&E of more than \$140 million in FY 2000 constant dollars, or for procurement of more than \$660 million in FY 2000 constant dollars or those designated by the DoD Component Head to be ACAT II. The MDA is the DoD CAE.
- ◆ **ACAT IIA** programs are AIS programs that do not meet the criteria for ACAT IA, but are designated by the Army Acquisition Executive (AAE) or Army CIO for Program Manager (PM) management and Army Major Automated Information System Review Council (MAISRC) review. (Army only)
- ◆ **ACAT III** programs are defined as those acquisition programs that do not meet the criteria for ACAT I, ACAT IA, or ACAT II programs. The MDA is designated by the CAE and shall be at the lowest appropriate level. This category includes less-than-major AISs.
- ◆ **ACAT IV (Navy and Marine Corps only)** ACAT programs in the Navy and Marine Corps not otherwise designated as ACAT I, II or III are designated ACAT IV. There are two categories of ACAT IV programs: IVT

---

and IVM. ACAT IVT programs require Operational Test and Evaluation (OT&E) while ACAT IVM programs do not.

Acquisition Personnel: DoD Acquisition, Technology, and Logistics (AT&L) workforce personnel performing AT&L functions directly.

AT&L Positions: Those civilian and military positions within the Department of Defense that are designated to be acquisition positions in accordance with Title 10, United States Code, Section 1721, and regulations issued by the Under Secretary of Defense, Acquisition, Technology and Logistics (USD, AT&L).

Acquisition, Technology & Logistics (AT&L) Workforce: Those uniformed Service personnel or civilian Department of Defense employees who occupy designated AT&L positions. Within DoD the term *Acquisition Workforce* has been replaced by *AT&L Workforce* to more accurately reflect the breadth of the types of functions and duties performed by employees currently in positions designated as acquisition (now referred to as AT&L) positions. This terminology change does not change the scope of the workforce as defined in Section 1701, Title 10, United States Code. The term *Acquisition* is still used when it is part of a title, such as *Acquisition Corps*, or when referring to its use in Title 10.

Component Acquisition Executive (CAE): The Service Acquisition Executive of a Military Department or the person designated to be the CAE by the Head of a DoD Component other than a Military Department. The Head of a DoD Component is the CAE for the DoD Components that do not have a designated CAE. The Undersecretary of Defense for Acquisition, Technology and Logistics (USD, AT&L) performs this role for the Office of the Secretary of Defense (OSD).

Contracting Action: An action resulting in the award of a new contract or modification to an existing contract.

Contingency Contracting Action: A contracting action in support of a Joint Chiefs of Staff declared contingency operation or exercise.

Contractor Acquisition Support Personnel: Contract personnel, i.e. “contractors,” providing direct or indirect acquisition support.

Critical Acquisition Positions (CAP): A subset of AT&L positions specifically designated by the Component Acquisition Executive in accordance with the Defense Acquisition Workforce Improvement Act and its implementing directives. The designation of an AT&L position as a CAP is based on the criticality of that position to the acquisition program, effort, or function that it supports.

Defense Acquisition System: The management process by which the Department of Defense provides effective, affordable, and timely systems to the users. (DoDD 5000.1)

Key Leadership Positions (KLPs): A subset of Critical Acquisition Positions with a significant level of responsibility and authority and that are key to the success of an acquisition program or acquisition effort, e.g. Program Executive Officers and ACAT I Program Managers. KLPs warrant special management attention to qualification and tenure requirements.

Milestone Decision Authority: The designated individual with overall responsibility for a program. The MDA shall have the authority to approve entry of an acquisition program into the next phase of the acquisition process and shall be accountable for cost, schedule, and performance reporting to higher authority, including congressional reporting. (DoDD 5000)

Non-Acquisition Support Personnel: Non-DoD Acquisition, Technology & Logistics workforce personnel (government employees) performing support functions such as firefighting, police, human resources, administration, accounting, legal, engineering technicians, supply, transportation and trades such as equipment and facilities operation and maintenance. Also includes contractors performing functions that would otherwise be performed by government employees if the functions had not been outsourced.



# Appendix H

## Comparison of Survey to 814 Questions

---

This appendix links the Section 814 requirements to specific questions in the DASCR survey.

*Table H-1. Linkage between Section 814 Requirements and Survey Questions*

Section 814 requirements	DASCR survey questions
Determine the current structure of the organization	III 1. As of March 2006, how many Key Leadership Positions, by career field and grade level, were in your organization?
	III 4. List all geographic locations, including number of assigned personnel at each location, at which acquisition personnel were assigned in your organization in 1990 and 2005.
	IV 1. What were the primary missions of your organization in 1990? What are they today?
Review the evolution of the current structure of the organization, including the reasons for each reorganization of the structure	IV 2. For all missions which no longer exist, explain what happened to them, e.g., eliminated, transferred to another organization, or outsourced to contractors.
	IV 3. How many contracting actions did your organization have in 1990? What was their total value?
	IV 4. How many contracting actions did your organization have in 2005? What was their total value?
	IV 5. How many contingency contracting actions did your organization have in 1990? What was their total value?
	IV 6. How many contingency contracting actions did your organization have in 2005? What was their total value?
	V 1. Discuss the impact, on your organization, of "acquisition reform" and any other major initiatives (e.g., SPI and CAIV) intended to improve DoD business practices and change DoD business structures. Provide an estimate of the resource impact of each. Discuss the impact of any unintended consequences.
	V 2. Discuss the impact that major automated software systems have had on your organization's effectiveness and efficiency from 1990 through 2005. Provide an estimate of the resource impact. Discuss the impact of any unintended consequences.
	V 3. What impacts on your organization's effectiveness and efficiency have there been through collaboration with industry from 1990 to 2005? Provide an estimate of resource savings achieved through this collaboration.
	V 4. How do your organization's control systems align and enforce responsibility, authority and accountability to allow it to accomplish its assigned mission(s)?

Identify the capabilities needed by the organization to fulfill its function and assess the capacity of the organization, as currently structured, to provide such capabilities	VI 1. Current policy stipulates that there should be no more than two levels of review between the Program Manager and the Milestone Decision Authority. Is this the case in your organization? Do parallel/duplicate chains of authority such as those for performance reporting or funding exist in your organization? If so, what is their impact?
	VI 2. What is the process in your organization for oversight and review of acquisition programs (all categories) prior to milestone decisions?
	VI 4. What are the advantages and disadvantages of the PEO structure to your organization?
	VI 5. How does your organization keep informed on new and emerging technologies?
Identify any gaps, shortfalls, or inadequacies relating to acquisitions in the current structures and capabilities of the organization	
Identify any recruiting, retention, training, or professional development steps that may be needed to address any such gaps, shortfalls, or inadequacies	III 2. By career field and grade, how many acquisition personnel were assigned to your organization in 1990? By career field and grade, how many acquisition personnel were assigned to DAWIA-coded acquisition positions in your organization in 2005?
	III 3. By labor category, how many non-acquisition support personnel were assigned to your organization in 1990? In 2005?
Make such recommendations as the review team determines to be appropriate	V 5. What would your organization look like if you could completely re-design it?
	VI 3. At which level would you recommend vesting milestone decision authority for each acquisition category level? Please explain.
Place special emphasis on structures, capabilities, and processes for joint acquisition, including actions needed to improve such structures, capabilities, and processes	VI 6. In which joint acquisition programs (defined as those in which more than one service or agency is involved) is your organization involved?
	VI 7. Comment on any difficulties your organization may have encountered in the management of joint acquisition programs and provide any recommendations for improvement.
Actions that may be needed to improve acquisition outcomes	V 6. What recommendations do you have to improve the outcomes of the Defense Acquisition System?



